

Directional 4x4MiMo 4G/5G Antenna with GNSS

WMM4GG-6-60

PANORAMA ANTENNAS



- 4x4 MiMo High Gain Directional Antenna for 4G/5G
- Frequency range 617-960/1710-6000MHz
- Integrated High Performance GPS/GNSS Antenna Module
- Suitable for wall or mast mounting

The WMM4GG-6-60 is a high gain directional 4x4 MiMo antenna for 4G and 5G networks. It incorporates four pairs of wideband element assemblies in a single housing and is designed to support fixed site CAT18/20 client devices. It offers 6dBi peak gain for 617- 960MHz and 9dBi peak gain for 1710-6000MHz.

The antenna also includes an active, high performance GPS/GNSS antenna module with advanced filtering to give satellite acquisition resilience when used in LTE B13/14 and enables the user to have real time location of their asset.

The weather resistant housing is designed for wall or mast mounting with the supplied hardware. WMM4GG-6-60-5FKJ version is fitted with FAKRA D jacks.

The standard WMM4G-6-60-5SP version has 5m length ultra-low loss CS32 type coaxial cables which eliminates exposed connector joints and simplifies the installation process. The WMM4GG-6-60-05NJ version has 50cm length cables, fitted with N type jack, which is ideal for installations that require a longer cable run, where Panorama's CS240 or CS400 type coaxial cable can be used to minimise the cable insertion loss.

The WMM4GG-6-60 is a value added product for network operators and service providers by improving the link resilience to the router, achieving increased data rates for the subscriber, resulting in customer satisfaction and retention.

Technical Drawing

WMM4GG-6-60-5SP Shown

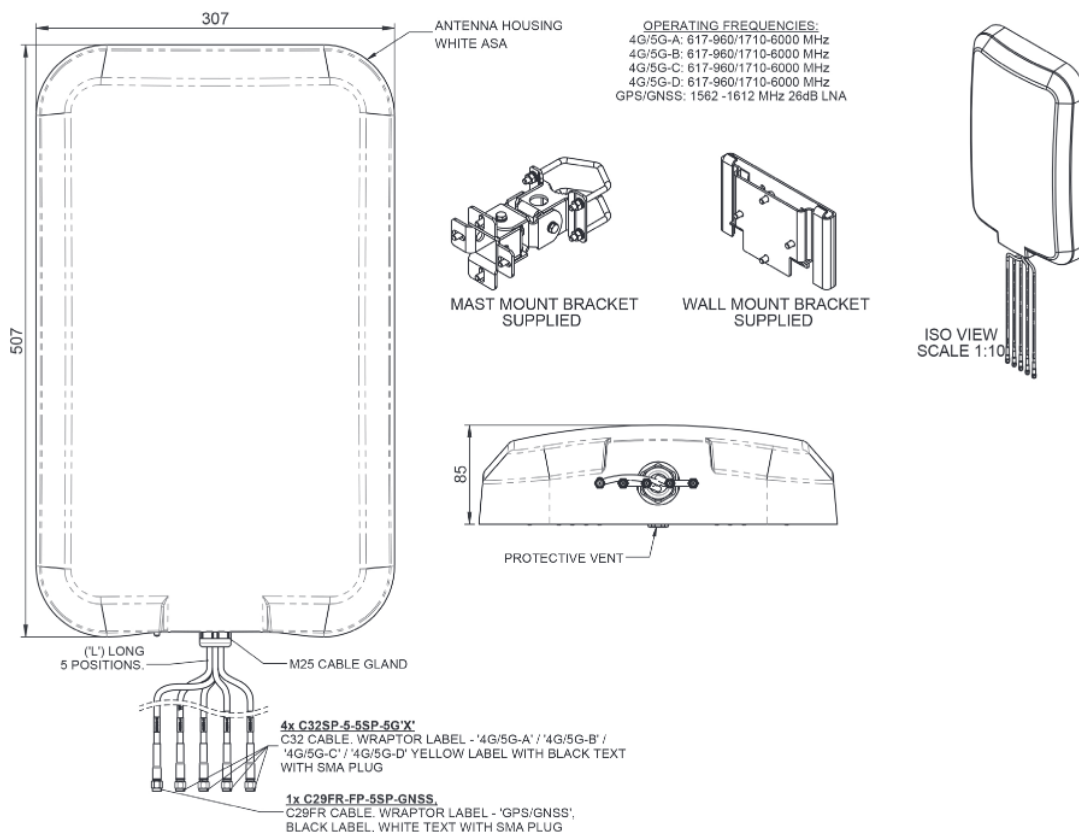

Directional 4x4MiMo 4G/5G Antenna with GNSS

WMM4GG-6-60

PANORAMA  ANTENNAS

Product Data

Part No.	WMM4GG-6-60-5SP	WMM4GG-6-60-5FKJ	WMM4GG-6-60-05NJ
Electrical Data			
Frequency range (MHz)	617-960/1710-6000		
Operational bands	4G/5G		
Radiation pattern	Directional		
Nominal polarisation	+/- 45deg / Vertical		
Peak gain	617-960MHz	6dBi	
(excl cable loss)+	1710-6000MHz	9dBi	
Efficiency - excluding cable loss (all bands)	> 60%		
Correlation co-efficient (all bands)	< 0.2		
Max input power (W)	20 Watts		
GPS/GNSS Data			
Frequency range (MHz)	1562-1612		
Typical LNA gain (dB)	26 +/- 3		
Out of band rejection	>40dB (@ > +/- 100MHz f)		
Noise figure (dB)	<2.7		
Notch Filter rejection @787MHz (dB)	24dB		
Typical Current (mA)	15		
Nominal Operating Voltage	3-5 V DC		
Mechanical Data			
Dimensions (mm)	Height	507 (19.96")	
	Width	307 (12.01")	
	Depth	85 (3.34")	
Operating temp (°C)	-40° / +80°C (-40° / 176°F)		
Material	ASA		
Colour	White		
IP Rating	IP66		
Radome material certifications	UL94-HB, UL746C-f2		
Weight (g)	5400		
Survival wind speed (m/s)	55		
Typical wind load @ 45 m/s (N)	200		
Mounting Data			
Fixing	wall mount / flush wall mount /mast mount		
Mounting bracket material	Coated steel / Aluminium / Stainless Steel		
Pole diameter (mm)	20-50 / (0.78 - 1.96")		
Cable & Connector Data			
Cable Type	Cell Cables: CS32 FRZH GNSS Cable: CS29 FRZH (Both meet EN6722 / EN45545-2)		
Diameter (mm)	5 (0.2")		
Length (m)	5 (16.4')	0.5 (19")	
Connector	SMA(m) x 5	FAKRA D x 4	N Socket (f) x 5

+ Peak gain derived from CST Microwave Studio and excludes cable loss.

Directional 4x4MiMo 4G/5G Antenna with GNSS

WMM4GG-6-60

PANORAMA ANTENNAS

Electrical Data

Typical VSWR*

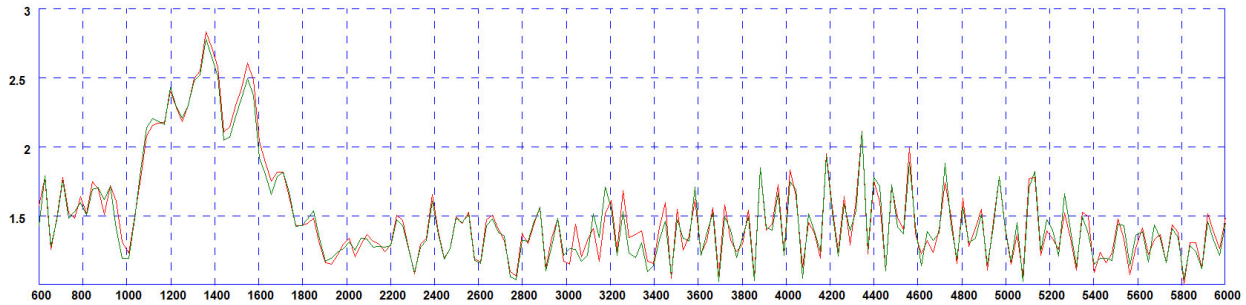

*VSWR for elements assemblies 1 and 2 measured with 5m (16') of CS32 cable.

Typical Efficiency 617-2700MHz*

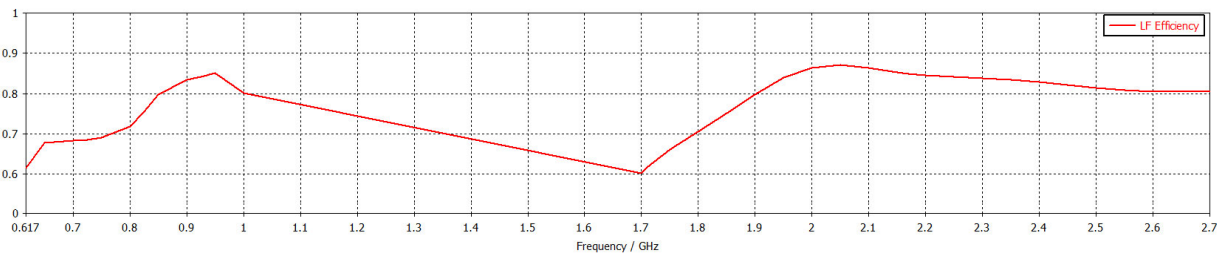

*Efficiency simulated in CST Microwave Studio excluding cable loss.

Typical Efficiency 3400-6000MHz*

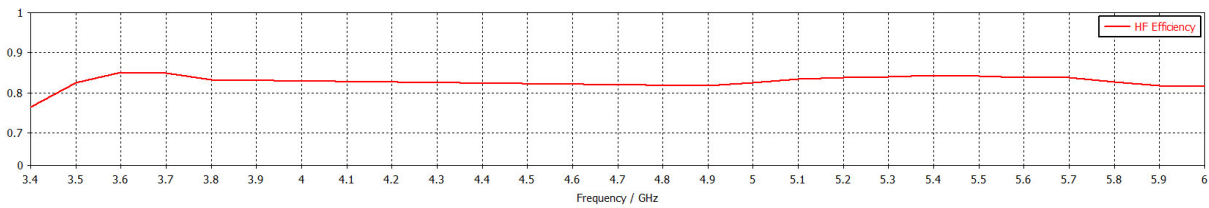

*Efficiency simulated in CST Microwave Studio excluding cable loss.

Typical Swept Gain 617-2700MHz*

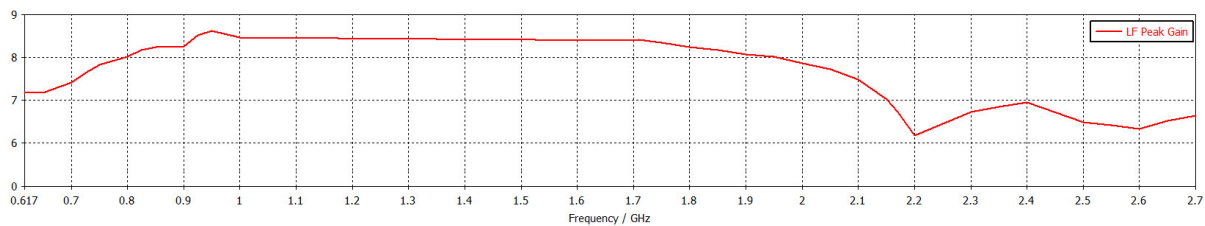

*Swept gain simulated in CST Microwave Studio excluding cable loss.

Typical Swept Gain 3400-6000MHz*

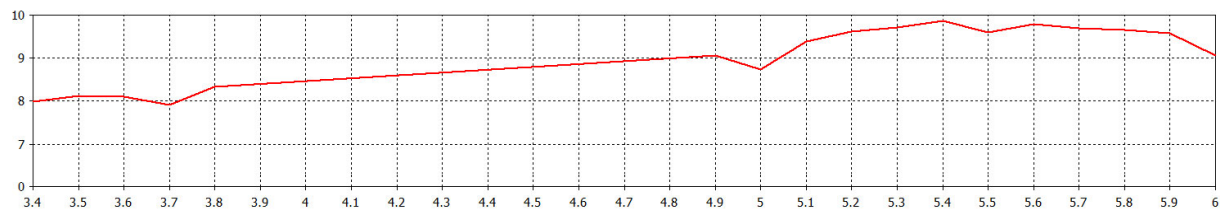

*Swept gain simulated in CST Microwave Studio excluding cable loss.

Directional 4x4MiMo 4G/5G Antenna with GNSS

WMM4GG-6-60

3D Patterns

Typical 3D Pattern 617MHz*

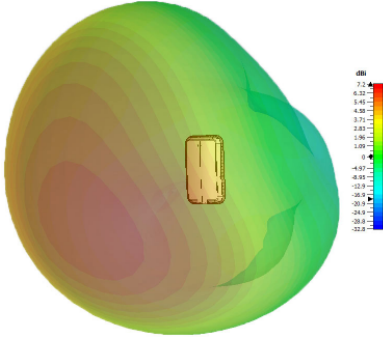

Typical 3D Pattern 700MHz*

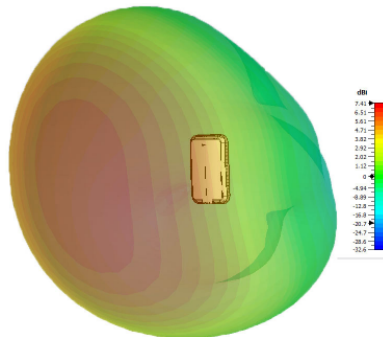

Typical 3D Pattern 800MHz*

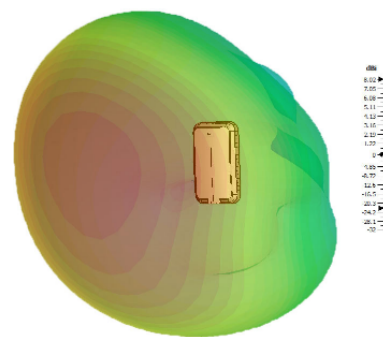

Typical 3D Pattern 900MHz*

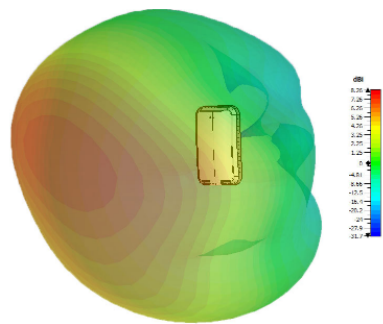

Typical 3D Pattern 1800MHz*

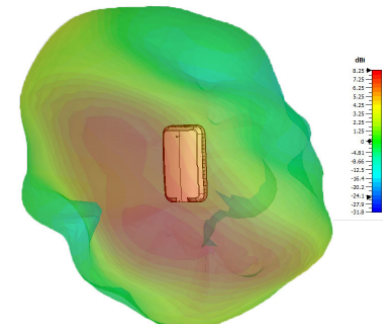

Typical 3D Pattern 2100MHz*

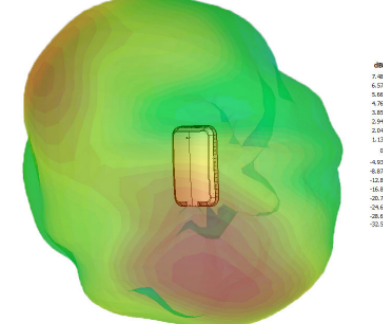

Typical 3D Pattern 2600MHz*

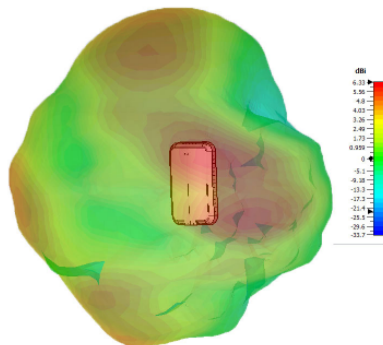

Typical 3D Pattern 3600MHz*

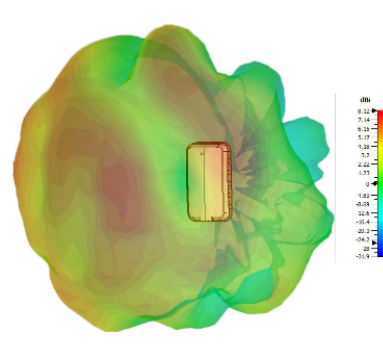

Typical 3D Pattern 5600MHz*

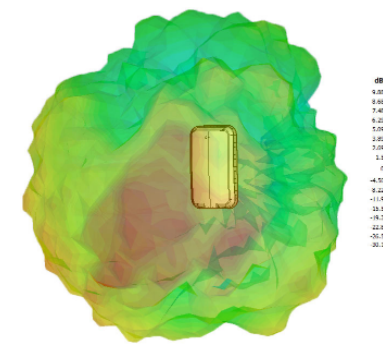

Typical E Plane Pattern GPS 1575MHz*

