

***Vess A6600/A7600 (VES0603)***  
***Vess A6800/A7800 (VES0604)***

***Storage Appliance for  
Video Surveillance  
Quick Start Guide***

***Version 1.0***



---

## Warning

---

This is a Class A product. In a domestic environment this product may cause radio interference in which case the user may be required to take adequate measures.

---



---

## Warning

---

The electronic components within the enclosure are sensitive to damage from Electro-Static Discharge (ESD). Observe appropriate precautions at all times when handling the Vess A7000 or its subassemblies.

---



---

## Warning

---

Turn off the power and disconnect the power cord before servicing this device.

---

## BSMI

Please go to <https://www.promise.com/tw/Promotion/BSMI>

## Additional Safety Information

Please go to <https://www.promise.com/Promotion/Safety-precautions>

<b>ABOUT THIS GUIDE</b> .....	<b>1</b>
<b>INTRODUCTION</b> .....	<b>1</b>
MODELS INCLUDED IN THIS GUIDE .....	1
<b>FRONT PANEL</b> .....	<b>2</b>
<b>REAR PANEL</b> .....	<b>4</b>
Vess A7600 / Vess A7800 REAR PANEL OVERVIEW .....	4
Vess A6600 / Vess A6800 REAR PANEL OVERVIEW .....	6
<b>SECURE COVER</b> .....	<b>8</b>
INSTALLING THE COVER .....	9
<b>SETUP TASKS</b> .....	<b>10</b>
<b>TASK 1: UNPACKING</b> .....	<b>10</b>
PACKING LIST .....	10
<b>TASK 2: MOUNTING IN A RACK</b> .....	<b>11</b>
<b>TASK 3: INSTALLING DISK DRIVES</b> .....	<b>15</b>
<b>DRIVE SLOT NUMBERING</b> .....	<b>15</b>
<b>REMOVING THE DRIVE CARRIER</b> .....	<b>17</b>
<b>INSTALLING 3.5" DISK DRIVE IN THE CARRIER</b> .....	<b>19</b>
<b>INSTALLING 2.5" DISK DRIVE IN THE CARRIER</b> .....	<b>20</b>
<b>TASK 4: MANAGEMENT I/O CONNECTIONS</b> .....	<b>21</b>
FIRST TIME SETUP - USE KEYBOARD AND MONITOR TO ACCESS OS .....	22
MANAGEMENT PATH - NETWORK CONNECTION.....	22
<b>TASK 5: CONNECT POWER AND POWER ON</b> .....	<b>23</b>
POWER ON.....	24
FRONT PANEL LED BEHAVIOR.....	26
DISK DRIVE LEDs .....	26
PSU LEDs.....	27
REAR PANEL LED BEHAVIOR .....	27

TASK 6: LOGIN TO WINDOWS .....	28
TASK 7: CREATE LOGICAL DRIVES .....	29
LOGGING INTO PROMISE MANAGEMENT GUI .....	29
CHOOSE A LANGUAGE - PROMISE MANAGEMENT GUI .....	30
<b>CREATING YOUR LOGICAL DRIVES .....</b>	<b>31</b>
SYSTEM SHUTDOWN .....	37
<b>TECHNICAL SUPPORT .....</b>	<b>38</b>

## About this guide

This Quick Start Guide provides a brief overview of the Vess A6000 and Vess A7000 Series Storage Appliance for Video Surveillance, and then provides instructions to install the system hardware in an equipment rack, make the necessary network and I/O device connections.

## Introduction

The Vess A Series Storage Appliance for Video Surveillance is specially engineered for medium to large scale IP video surveillance deployment. The Vess A Series is ideally suited for continuous surveillance in banks, malls, casinos, factories, warehouses, and similarly sized commercial, residential, governmental or private enterprises. The sub-systems are capable of continuous recording and playback operation without dropping frames for networked installations of 32 to 100 High-Definition IP cameras.

### *Models included in this guide*

<b>Model</b>	<b>Interface</b>	<b>Number of Drives</b>	<b>Power Supplies</b>	<b>Cooling Units</b>
Vess A6600	2 x 1000 BASE-T	16	2	2
Vess A6800	2 x 1000 BASE-T	24	3	2
Vess A7600	2 x 1000 BASE-T	16	2	2
Vess A7800	2 x 1000 BASE-T	24	3	2

## Front Panel

The front panel hardware components on the Vess A6600, Vess A6800 are similar to the Vess A7600 and Vess A7800. The differences are cosmetic, for the purpose of easy identification. The Vess A6600 and Vess A6800 use a different style of disk carrier and feature black colored front panel, where the Vess A7600 and Vess A7800 have a silver front panel.

A defective drive may be replaced without interruption of data availability to the host computer. If so configured, a hot spare drive will automatically replace a failed drive, securing the fault-tolerant integrity of the logical drive. The self-contained hardware-based RAID logical drive provides maximum performance in a compact external enclosure.

**Vess A7600 front view**

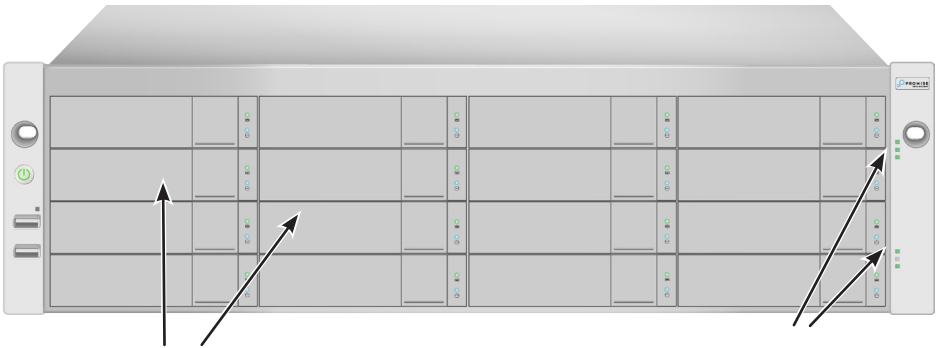

Drive carriers  
See "Task 3: Installing Disk Drives" on page 15

Power and Status LEDs  
See "Front panel LED behavior" on page 26

**Vess A7800 front view**

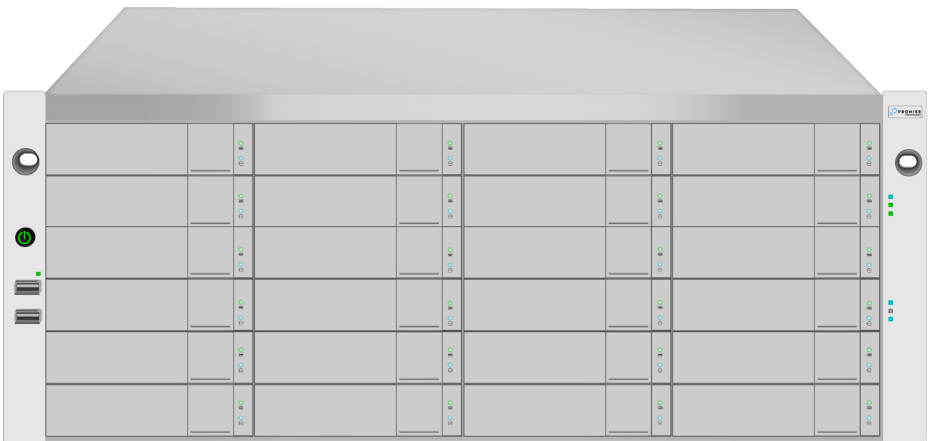

**Vess A6600 front view**



Drive carriers  
See "Task 3: Installing Disk Drives" on page 15

Power and Status LEDs  
See "Front panel LED behavior"  
on page 26

**Vess A6800 front view**

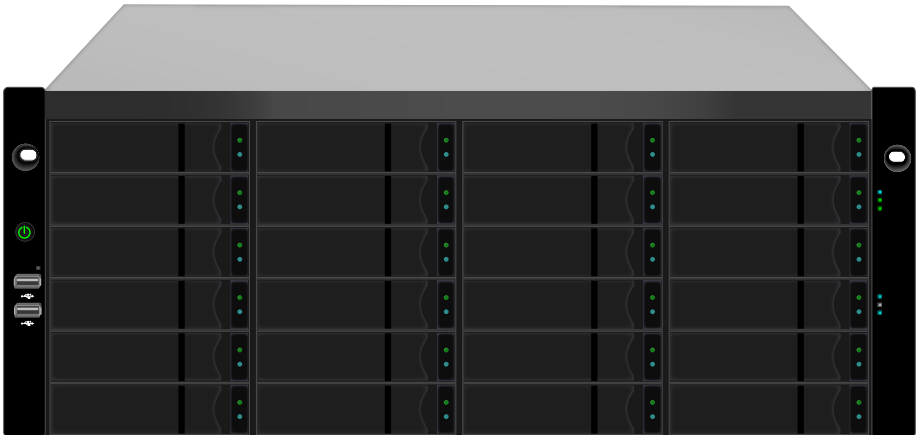



# Rear Panel

## Vess A7600 / Vess A7800 Rear Panel Overview

The rear panel hardware components on the Vess A7800 are nearly the same as the Vess A7600. This is where you connect power cables, I/O connections, IPMI port, audio out/in, video (VGA), USB serial ports, COM1 (serial port) and SAS port Backend Controller card. Both enclosures include PCIe slots for added system versatility. See the *Product Manual* for details about what PCIe components are supported.

Please see more detailed close-up view of power supplies and controller components in the illustration on the next page.

**Vess A7600 rear view**

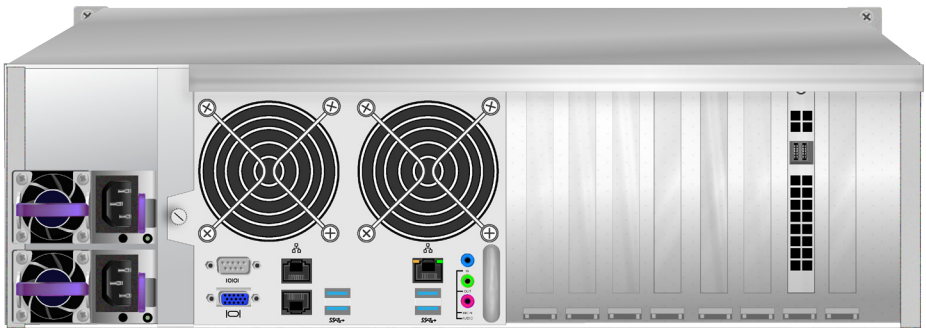

**Vess A7800 rear view**

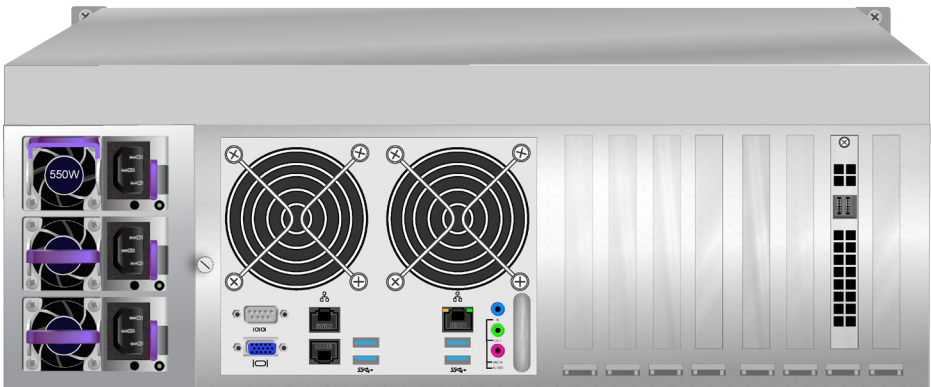

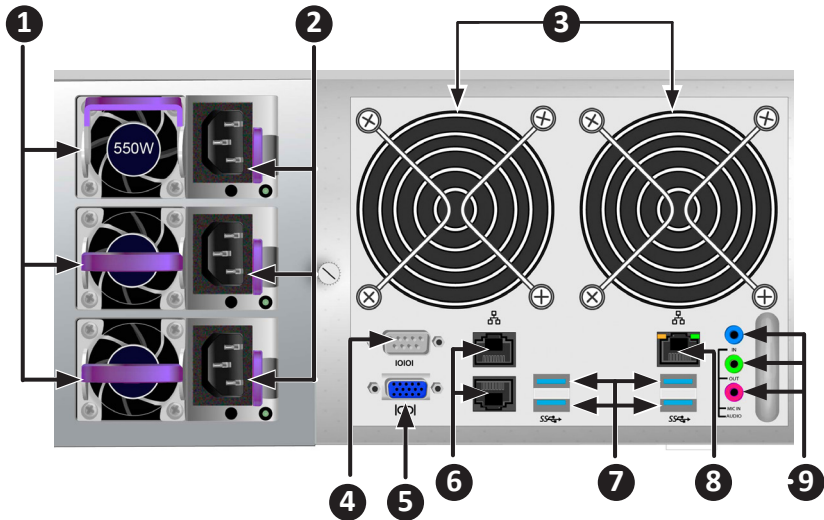
**Vess A7800 rear panel components**

1	PSU fan vents
2	Power inserts
3	System fan vents
4	Serial port (COM1)
5	VGA port
6	1000BASE-T RJ-45 (2 ports)
7	USB 3.0 (4 ports)
8	RJ-45 IPMI LAN port
9	Audio In/Out ports

## Vess A6600 / Vess A6800 Rear Panel Overview

The rear panel hardware components on the Vess A6800 are nearly the same as the Vess A6600. This is where you connect power cables, I/O connections, audio out/in, video (VGA), USB ports, and SAS port Backend Controller card. Both enclosures include PCIe slots for adding additional hardware such as an RS-232 console port (available for purchase from Promise). See the *Product Manual* for details about what PCIe components are supported.

Please see more detailed close-up view of power supplies and controller components in the illustration on the next page.

**Vess A6600 rear view**

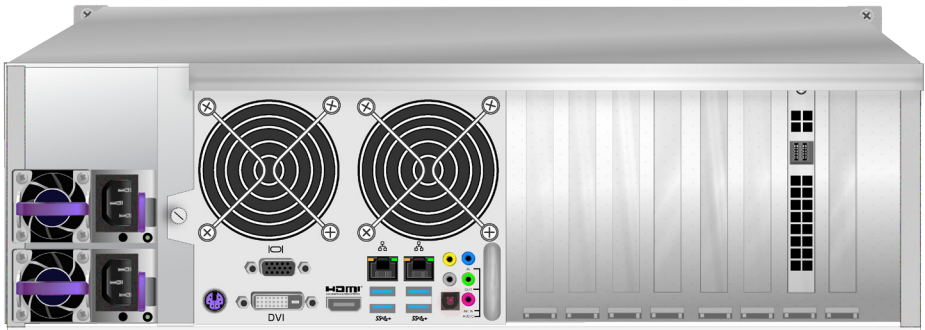

**Vess A6800 rear view**

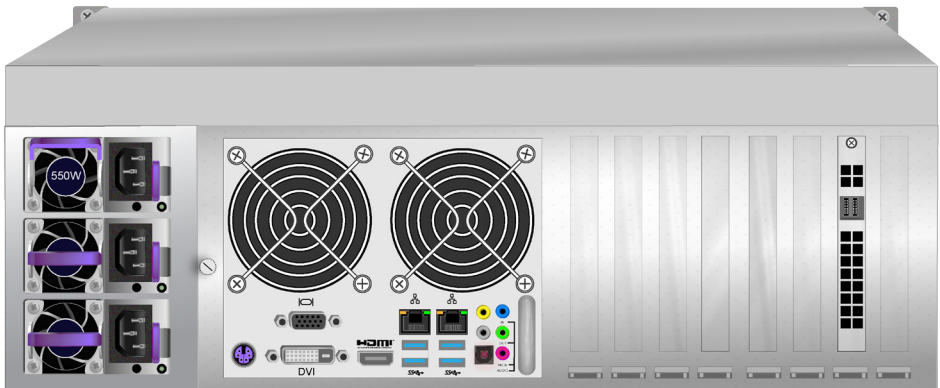

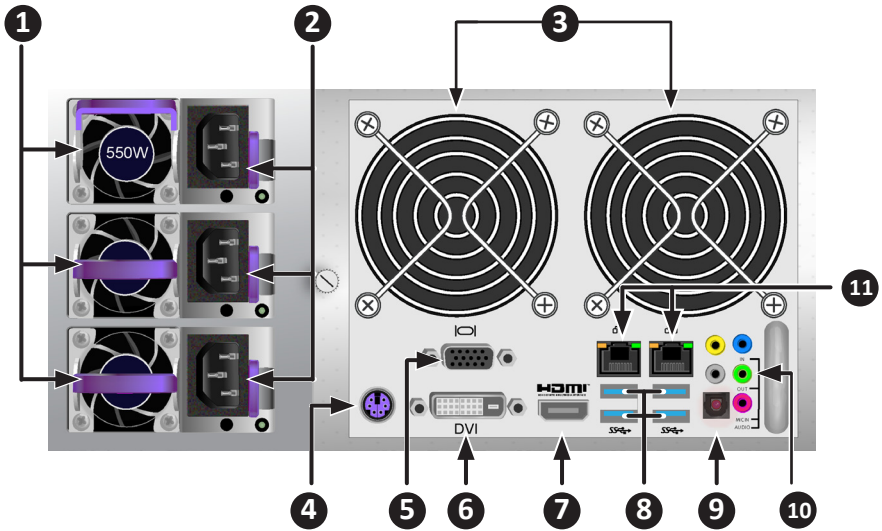
**Vess A6800 rear panel components**

1	PSU fan vents
2	Power inserts
3	System fan vents
4	PS/2 mouse/keyboard port
5	VGA port
6	DVI port
7	HDMI port
8	USB 3.0 (4 ports)
9	Optical SPDIF Out port
10	Audio In/Out ports
11	1000BASE-T RJ-45 (2 ports)

## Secure cover

The Vess A6600/A6800/A7600/A7800 include secure covers to for better physical security and to help prevent unintended or accidental removal of hard drives. The cover are secured with a single tubular cam lock located near the left side of the cover. Turn the key clockwise to lock, counter clockwise to unlock.

***Vess A6600/A7600 with secure cover (unlocked)***



Tubular cam lock

***Vess A6800/A7800 with secure cover (locked)***

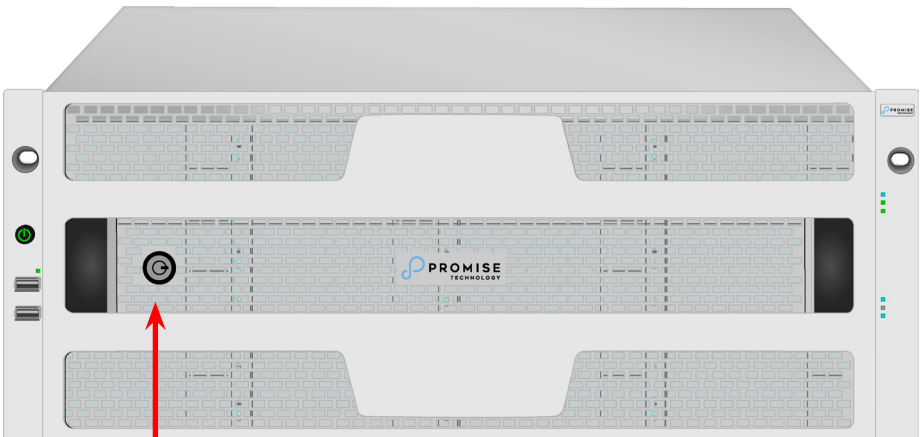

Tubular cam lock

## ***Installing the cover***

The secure cover hardware is operated in the same fashion on the Vess A7600 and Vess A6600 models.

To attach the secure cover:

1. Make sure the lock is in the unlocked position. *To unlock, insert the key into the lock and turn counter clockwise.*
2. Insert the tab on the right side of the cover into the slot receptacle on the right handle.
3. Place the cover in position and push in the latch release (to the left of the keyhole).
4. Push the cover into position so that the tab on the right side inserts into the receptacle on the right handle when releasing the latch.
5. Insert the key and turn clockwise to lock.

To remove the cover, unlock it, press the latch release on the left side and pull the left end out first, holding it with both hands.

### ***Vess A7800 / Vess A6800 installing and removing secure cover***

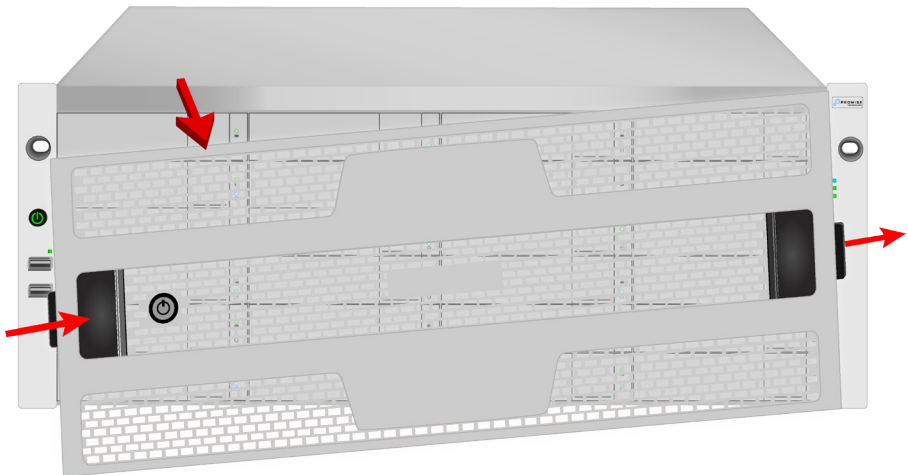

# SETUP TASKS

The basic setup tasks described in the guide are the following:

- “Task 1: Unpacking”
- “Task 2: Mounting in a Rack”
- “Task 3: Installing Disk Drives”
- “Task 4: Management I/O Connections”
- “Task 5: Connect power and power on”
- “Task 6: Login to Windows”
- “Task 7: Create Logical Drives”

## ***TASK 1: UNPACKING***

Note that the two models are nearly identical, except for the number of disk drive bays.

### ***Packing List***

The box contains the following items:

- One of the following Vess storage appliances:
  - Vess A6600
  - Vess A6800
  - Vess A7600
  - Vess A7800
- Screws for disk drives
- Three 1.5m (4.9 ft) power cords
- Front panel bezel cover
- (Optional) Sliding rail assembly for rack mounting  
*This item is optional. Please ask your reseller for purchasing details.*

## TASK 2: MOUNTING IN A RACK

The instructions here apply to 3U 16-bay models, Vess A7600 and Vess A6600 , as well as the 4U 24-bay models, Vess A7800 and Vess A6800.



### Cautions

---

- \* Do not populate any enclosure hardware with hard drives until it has been securely installed in the rack.
  - \* At least two persons are required to safely lift, place, and attach the enclosure hardware into a rack system.
  - \* Do not lift or move the enclosure hardware by the handles, or power supplies. Hold the system itself.
  - \* Do not install the enclosure hardware into a rack without rails to support the system.
  - \* Only a qualified technician who is familiar with the installation procedure should mount and install the enclosure hardware.
  - \* Mount the rails to the rack using the appropriate screws and flange nuts, fully tightened, at each end of the rail.
  - \* Do not load the rails unless they are installed with screws as instructed.
  - \* The rails available for the Promise enclosure hardware are designed to safely support that Promise enclosure hardware when properly installed. Additional loading on the rails is at the customer's risk.
  - \* Promise, Inc. cannot guarantee that the mounting rails will support your Promise enclosure hardware unless you install them as instructed.
- 

The enclosure installs to the rack using the optional mounting rails available for purchase from Promise.



### Note

---

To lighten the enclosure, you can remove the power supplies. Replace the power supplies after the unit is mounted in your rack.

---



To install the enclosure hardware into a rack with the supplied mounting rails:

1. Check the fit of the mounting rails in your rack system.
2. Adjust the length of the mounting rails as needed.
  - The rear half of the rail slides inside the front half. The rail halves are riveted together, so no adjustment screws are needed.
  - The front-left and front-right mounting rail ends are labeled.
  - Be sure the front rail support is on the bottom facing inward.

**Installing the rails onto the rack**

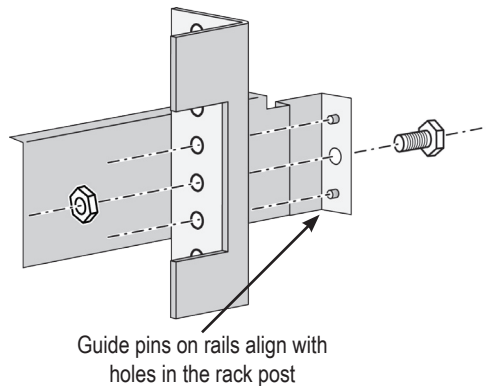
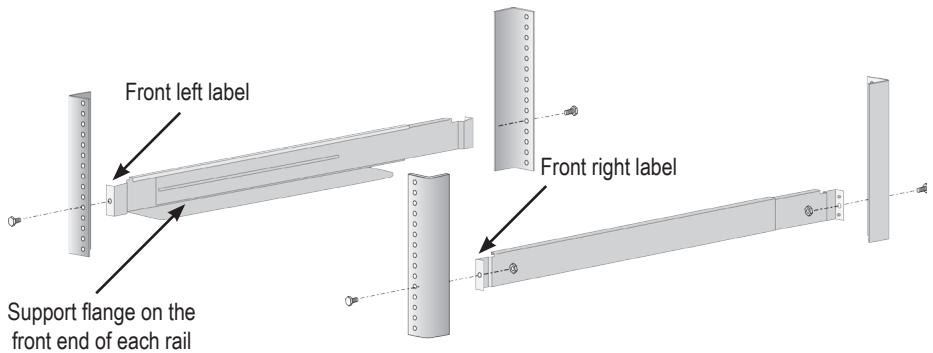

- All rail ends, front and rear, attach at the outside of the rack posts.
- The guide pins at the rail ends align with the holes in the rack posts.
- Use the attaching screws and flange nuts from your rack system. Tighten the screws and nuts according to instructions for your rack system.

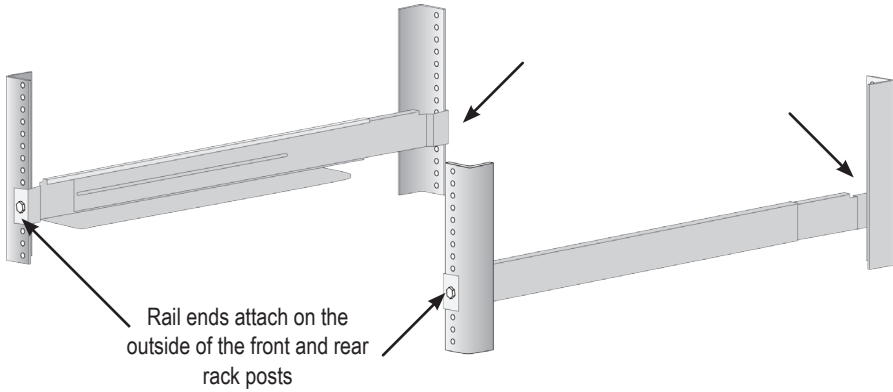
**Rail ends attach to the outside of each post**

3. Place the enclosure hardware onto the rails.
  - At least two persons are required to safely lift the system.
  - Lift the enclosure hardware itself. Do not lift the system by its brackets.

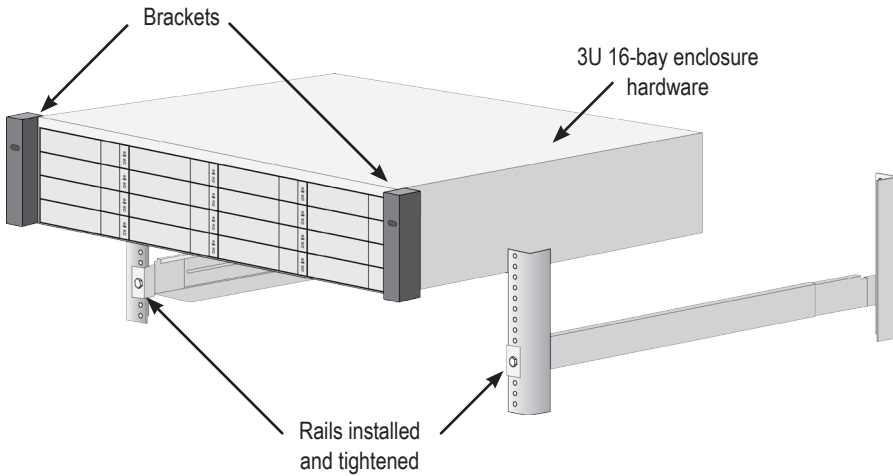
**Placing the enclosure hardware onto the rack rails**

4. Secure the enclosure hardware or to the rack.
  - The unit attaches to the rack posts using the included screws and flange nuts. One screw each side, in the upper hole only.
  - Use the attaching screws and flange nuts that came with the enclosure hardware.

**Secure to rack**

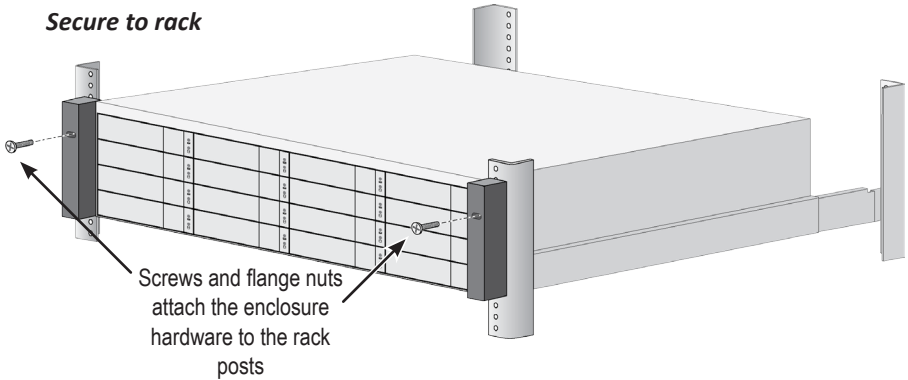

**System installed in rack**

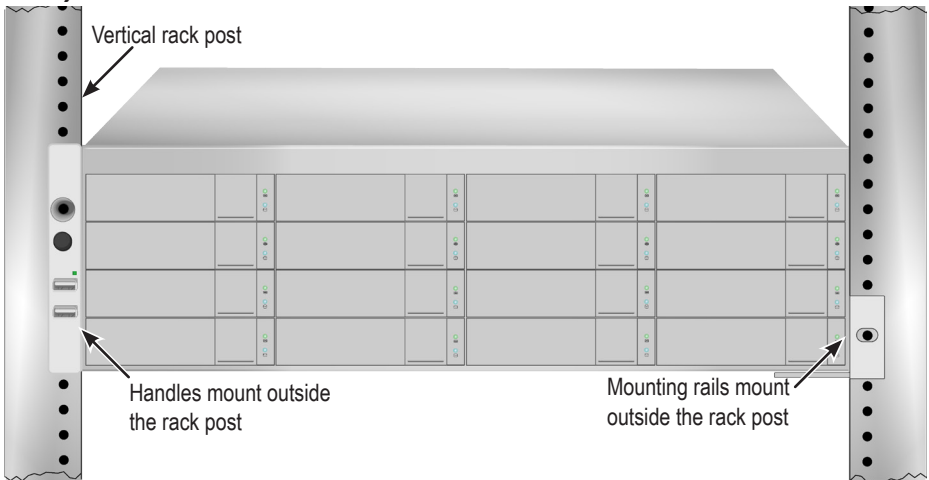

## TASK 3: INSTALLING DISK DRIVES

The Vess A6600, Vess A7600, Vess A6800 and Vess A7800 subsystems support:

- SATA/SAS 3.5-inch hard disks
- SAS 2.5-inch hard disk drives (Optional)

For a list of supported physical drives, download the latest compatibility list from the Promise support website.

### Drive Slot Numbering

You can install any suitable disk drive into any slot in the enclosure. See the illustrations below for slot numbering on the 3U Vess A6600 /A7600, as well as the 4U Vess A6800/A7800.

Slot numbering is reflected in the GUI of the web-based system management user interface.

#### *Drive slot numbering for 3U models*

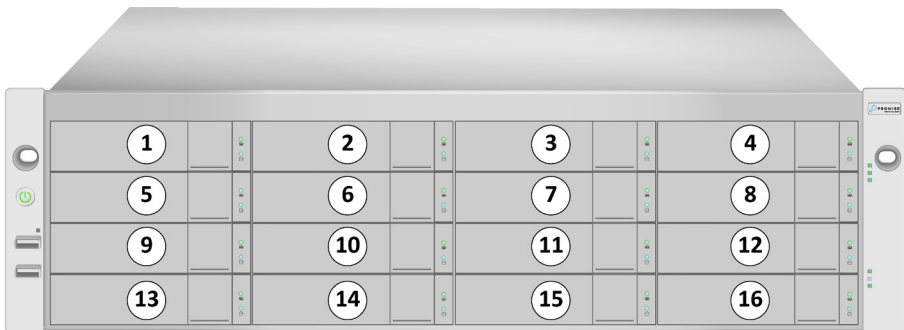

Insert all of the drive carriers into the enclosure to ensure proper airflow, even if you do not populate all the carriers with disk drives.



#### Caution

The Vess models included in this guide support disk drive hot-swapping. To avoid hand contact with an electrical hazard, do not remove more than one drive carrier a time.

### Drive slot numbering for 4U models



Insert all of the drive carriers into the enclosure to ensure proper airflow, even if you do not populate all the carriers with disk drives.

## Removing the Drive Carrier

The drive carrier accommodates 2.5-inch and 3.5-inch drives.



### Cautions

---

**Swing open the drive carrier handle before you insert the drive carrier into the enclosure.**

**To avoid hand contact with an electrical hazard, remove only one drive carrier a time.**

---

The instructions below apply to all types of drive carriers intended for use with the Vess models A6600, A6800, A7600 and A7800.

1. Remove a disk drive carrier.
2. Carefully lay the disk drive into the drive carrier at the front, so that the screw holes on the sides line up.
3. Insert the screws through the holes in the drive carrier and into the sides of the disk drive.

Install only the counter-sink screws supplied with the drive.

- Install four screws per drive.
  - Snug each screw. Be careful not to over-tighten.
4. Reinstall the drive carrier into the enclosure.

Repeat steps 1 through 3 until all of your disk drives are installed.

**Vess A7600/A7800 rive carrier front view**

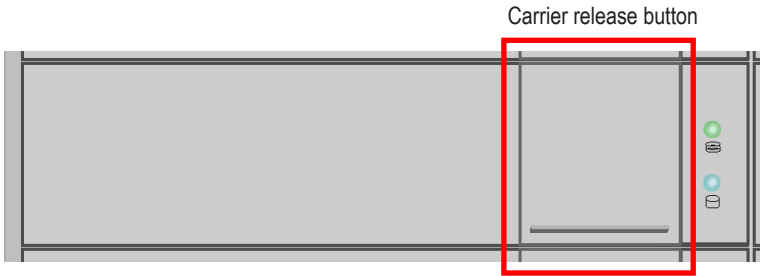

**Vess A6600/A6800 Disk carrier with HDD installed - front view**

Push here when returning or replacing the carrier into an empty drive bay.

Pull here to release the carrier handle latch. Then pull the carrier straight out by the handle. Place your free hand under the carrier. Do not drop the disk carrier, even if it is empty.

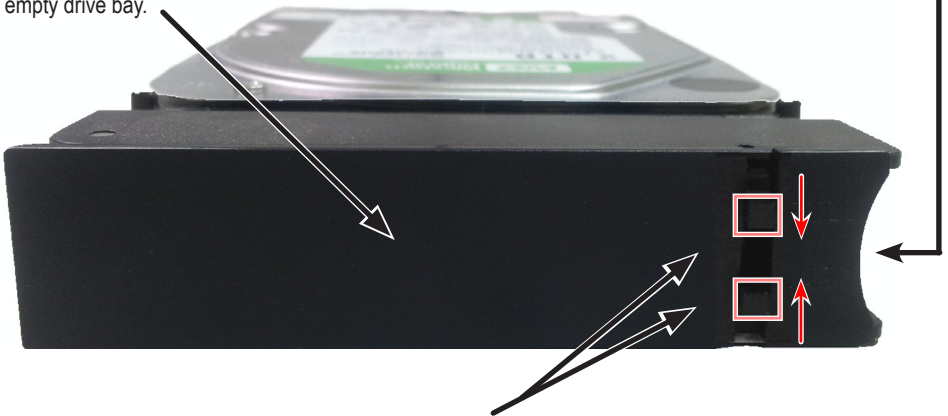

Tabs for locking mechanism insert. This piece must be removed to unlatch the carrier. To remove, squeeze the tabs together and pull out. To reinsert, squeeze the tabs together and replace in position. Do not discard the locking mechanisms.

## Installing 3.5" Disk Drive in the Carrier

The instructions below apply 3.5" hard disk drives installed in drive carriers intended for use with models Vess A6600, Vess A7600, Vess A6800 and Vess A7800.

1. Remove a disk drive carrier.
2. Carefully lay the disk drive into the drive carrier at the front, so that the screw holes on the sides line up correctly with the power and data connectors facing away from the carrier handle.
3. Insert the screws through the holes in the drive carrier and into the sides of the disk drive.

Install only the counter-sink screws supplied with the drive.

- Install four screws per drive.
  - Snug each screw. Be careful not to over-tighten.
4. Reinstall the drive carrier into the enclosure.

Repeat steps 1 through 3 until all of your disk drives are installed.

### *SATA disk drive mounted in a drive carrier*





## Installing 2.5" Disk Drive in the Carrier

The instructions below apply to 2.5" hard disk drives installed in drive carriers intended for use with models Vess A6600, Vess A7600, Vess A6800 and Vess A7800.

1. Remove a disk drive carrier.
2. Carefully lay the disk drive into the drive carrier at the front, so that the screw holes on the bottom of the carrier line up correctly with the power and data connectors facing away from the carrier handle.
3. Insert the screws through the holes on the bottom of the drive carrier and into the bottom of the disk drive.

Install only the counter-sink screws supplied with the drive.

- Install four screws per drive.
  - Snug each screw. Be careful not to over-tighten.
4. Reinstall the drive carrier into the enclosure.

Repeat steps 1 through 3 until all of your disk drives are installed.

### ***Bottom view of empty disk carrier***

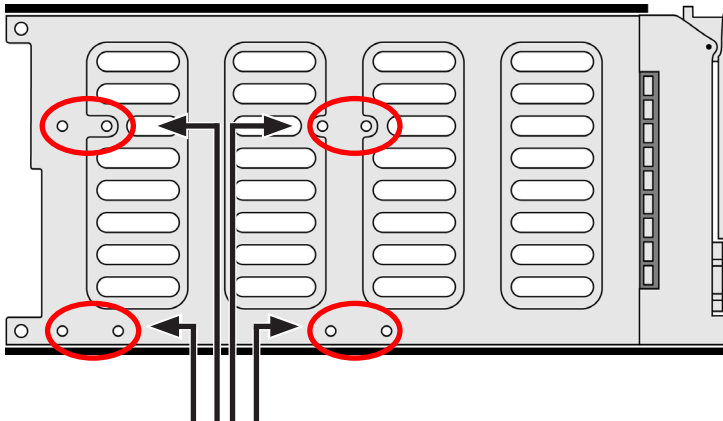

Use these holes on the bottom for mounting 2.5" hard disk drives. Four screw holes on the bottom of the drive will line up with four of the holes on the carrier.

## TASK 4: MANAGEMENT I/O CONNECTIONS

This section describes how to establish a connection and login as the administrator to the operating system. There are two methods to establish the physical connection used for management of the device. Management can be done remotely through the network using text-based command line or web-based GUI. Or connect directly to the server with a keyboard, mouse and monitor.

For the initial system configuration, follow the instructions below to connect and keyboard and monitor so you can login to the operating system, then change the network settings for the Ethernet ports to suit your network.

### *I/O ports on the rear panel*

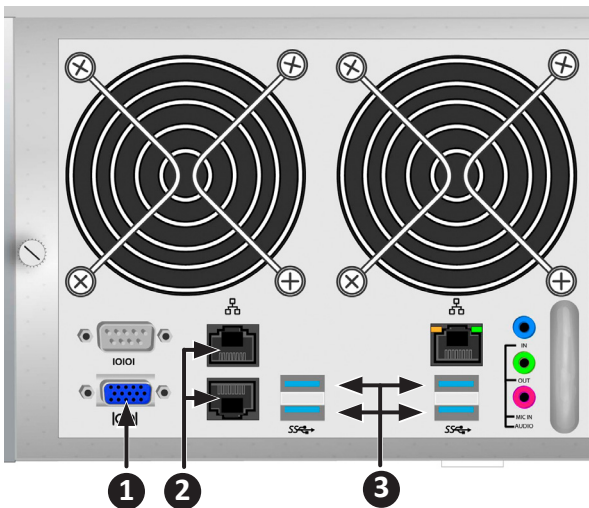

Connections for system management on rear panel:

1. VGA port
2. 1000BASE-T RJ-45 ports
3. USB 3.0 ports

## ***First time setup - use keyboard and monitor to access OS***

Use a USB or PS/2 keyboard and a VGA monitor to establish a direct connection to the Windows operating system. All the I/O ports needed to do this are located on the rear panel. Connect a monitor, keyboard and mouse to the appropriate port and you will be ready to login after the server has booted up.

See “Task 6: Login to Windows” for instructions on how to login as administrator to the Windows OS user interface.

## ***Management Path - network connection***

There are two 1 Gb/s Ethernet RJ-45 ports on the rear panel for connection to an Ethernet network. After logging in to the operating system as administrator, you can change the network settings.

To connect the server to a local Ethernet for management, follow these steps:

1. Attach one end of an Ethernet cable to the network connector or standard NIC in the Host PC.

Attach the other end of the Ethernet cable to one of the ports on the standard network switch.

2. Attach one end of an Ethernet cable to one of the ports on the standard network switch.

Attach the other end of the Ethernet cable to an Ethernet port (1000 BASE-T) on the back of the server (See “I/O ports on the rear panel” on page 21).

## TASK 5: CONNECT POWER AND POWER ON

Insert one power cable into the power receptacle for each power supply and connect the each PSU to a suitable power source. The subsystem is equipped with two or three power supplies in an N+1 arrangement.



### Important

For information about installing or hot swapping power supplies, please see the product manual.

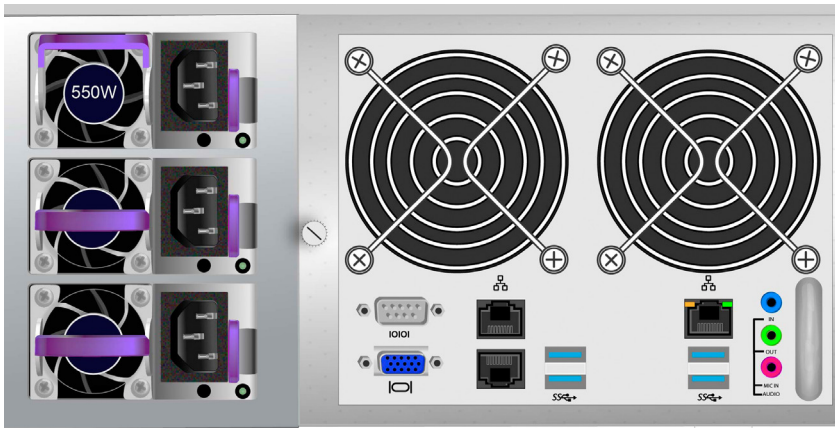

### Important

The enclosure is equipped with LED indicators on the power supplies. Check these after powering the devices on to make sure the cooling and power status for the power module is normal.

## **Power On**

With the power supplies connected, the system can now be powered on.

To power on the subsystem, press the power button on the front left bracket facing (see “Vess A7600 front panel components, left side”).

Then observe the LEDs on the right front bracket facing (see “Vess A7600 front panel LED display on right side bracket”).

### ***Vess A7600 front panel components, left side***

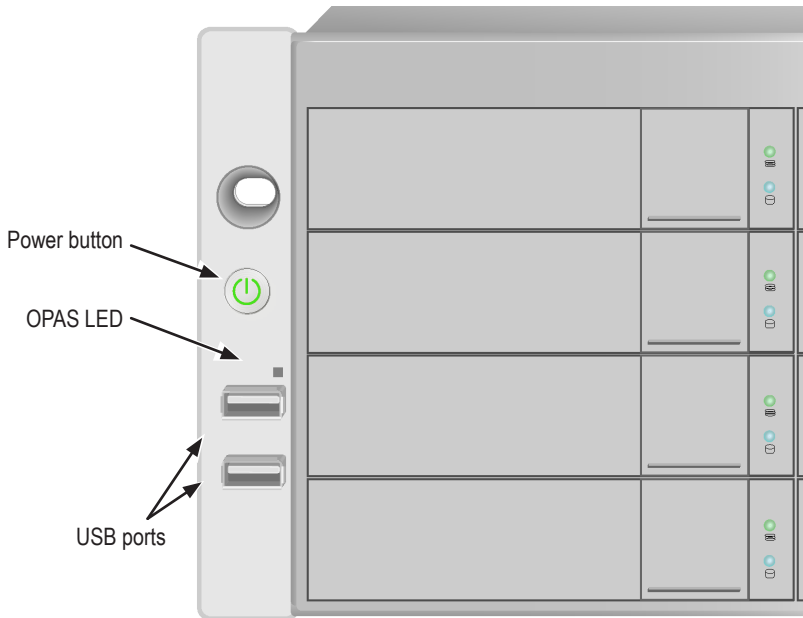

**Vess A7600 front panel LED display on right side bracket**

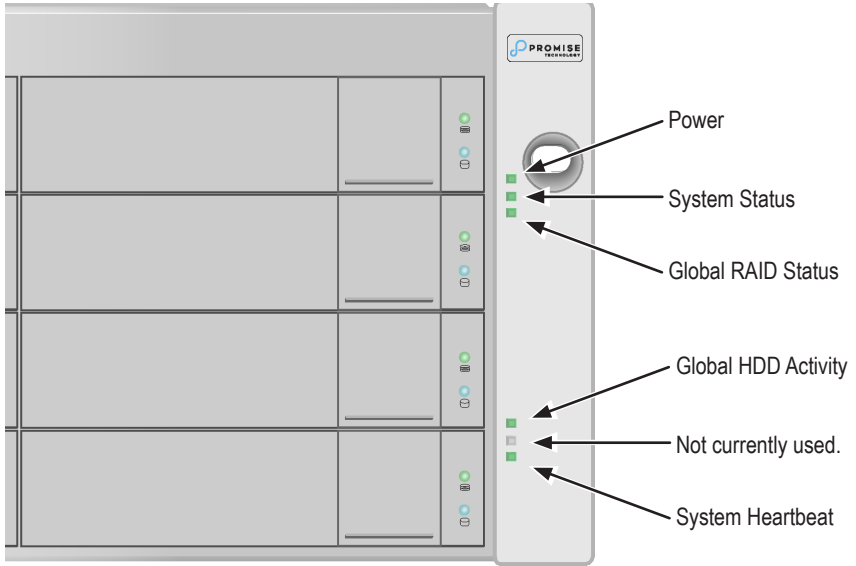

See “Front panel LED behavior” on page 26 for a description of LED behavior.

## Front panel LED behavior

The table below describes LED behavior when boot-up is finished and the system is functioning normally:

LED	Description
<b>Power</b>	Lights BLUE to indicate the system is powered on.
<b>System Status</b>	Lights GREEN when healthy, RED if there is a critical problem (LD offline, fan malfunction, voltage out of range, system temperature alert), blinks RED for HDD high temperature alert remains dark when not ready.
<b>Global RAID Status</b>	Lights GREEN when healthy or RED if any RAID volume is offline, ORANGE for critical state of any logical drive, or when the system is rebuilding.
<b>Global HDD Activity</b>	Blinks BLUE to indicate one or more drives are being accessed, lights steady BLUE when no drives are being accessed.
<b>System Heartbeat</b>	Blinks BLUE slowly at regular intervals to indicate the firmware and software are operating normally.
<b>OPAS USB</b>	Lights GREEN if an OPAS device (USB disk) is detected, remains RED if the OPAS operation has failed, blinks GREEN when an OPAS operation is in progress.

## Disk Drive LEDs

There are two LEDs on each Drive Carrier. They report activity of the drive, and the drive's current condition.

### Hard disk drive carrier LEDs

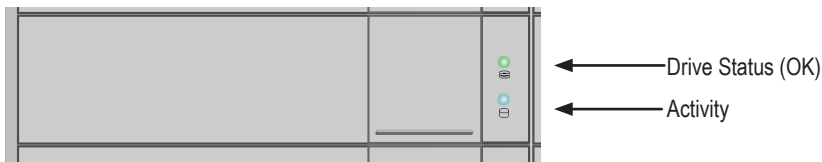

The **Activity** LED flashes BLUE during drive activity.

The **Disk Status** LED displays GREEN when a drive is configured and working properly. When the lights are RED the HDD requires manual replacement. When ORANGE is observed it indicates background RAID activity on this particular HDD. It is just a status notification and no user action is required.

## PSU LEDs

After powering on the subsystem, check the LEDs on each power supply on the back of the device. These LEDs will light GREEN to indicate normal operation. A RED or ORANGE LED indicates a problem or unit failure. See the Product Manual for a complete description of PSU and other LED indicators.

### Status LEDs on Power Supplies

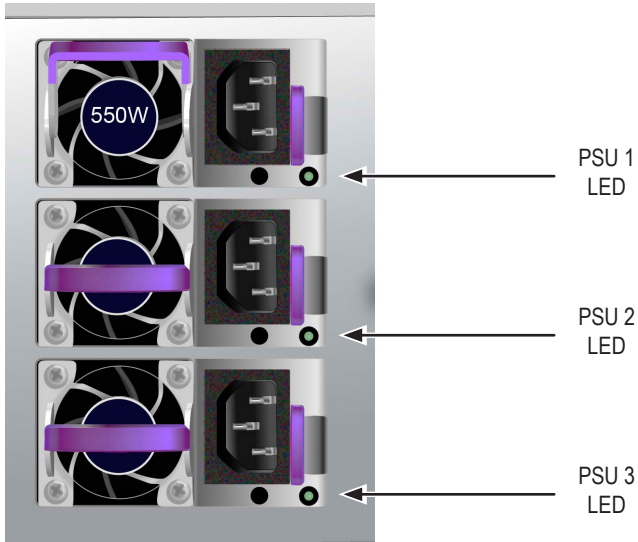

## Rear panel LED behavior

When system boot-up is finished, use the LEDs on the controller on the rear of the device to monitor various functions (described below).

LED	Description (refer to product manual for more details)
<b>Ethernet</b> <i>Link/Act and Speed</i>	The LED located on below each port, on the left side, lights ORANGE when connected, flashes ORANGE when there is activity on the port and remains dark no connection has been established. The LED on the upper right of each port indicates connection speed, ORANGE is 100 Mbps, GREEN is 1000 Mbps.



## ***TASK 6: LOGIN TO WINDOWS***

For Windows installations, once the system has booted up it will be necessary to choose various options to complete the OS setup. You will be prompted to select a default language and other user interface preferences. Follow the instructions on screen to complete your preferences selection and to establish a user name and password for the administrator. After completing these final tasks, the Windows desktop appears. Notice that there are two quick link icons, one for a web browser connection to Promise Management GUI and one link to a file that contains user documents.

### ***Windows Server OS desktop quick links to web browser and documents***



## ***TASK 7: CREATE LOGICAL DRIVES***

This section describes how to complete the final task for initial setup, to configure logical drives (LD) using the html-based management GUI.

### ***LOGGING INTO PROMISE MANAGEMENT GUI***

Double click the Promise Management GUI link icon on the desktop to launch the default browser and go to the login page.

When the log-in screen appears:

- Type **administrator** in the User Name field.
- Type **password** in the Password field.
- Click the **Login** button.

The User Name and Password are case sensitive

After sign-in, the Promise Management GUI opening screen appears. If there are any unconfigured physical drives in the enclosure, an Array Configuration menu also appears.



#### **Note**

---

Make a Bookmark (Firefox) or set a Favorite (Internet Explorer) of the Login Screen so you can access it easily next time.

---

## CHOOSE A LANGUAGE - PROMISE MANAGEMENT GUI

Promise Management GUI displays in English, French, German, Italian, Spanish, Portuguese, Russian, Japanese, Korean, Traditional Chinese and Simplified Chinese. Language preference can be chosen at the login screen or after logging in from the Promise Management GUI menu header.

1. Select the **Language** to use for the interface from the menu header in the Login screen.
2. Click the language you prefer. The Promise Management GUI user interface displays in the chosen language.

### Choose “Language” used for Promise Management GUI interface

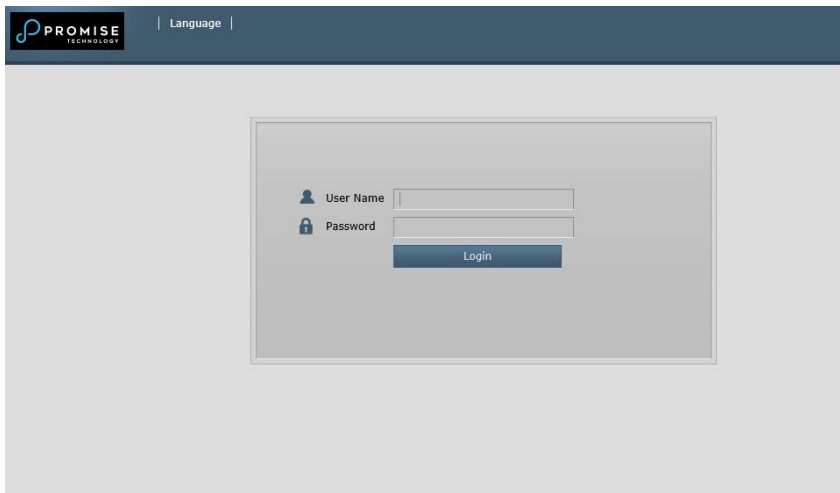

## CREATING YOUR LOGICAL DRIVES

On a newly activated Vess A7000/A6000 Series system, there are no disk arrays or logical drives. To create a logical drive:

1. Log in to Web PAM PROe. If there are no arrays configured, you will be automatically directed to the **Disk Array Configuration** menu.

### *Disk Array menu (when no arrays present)*

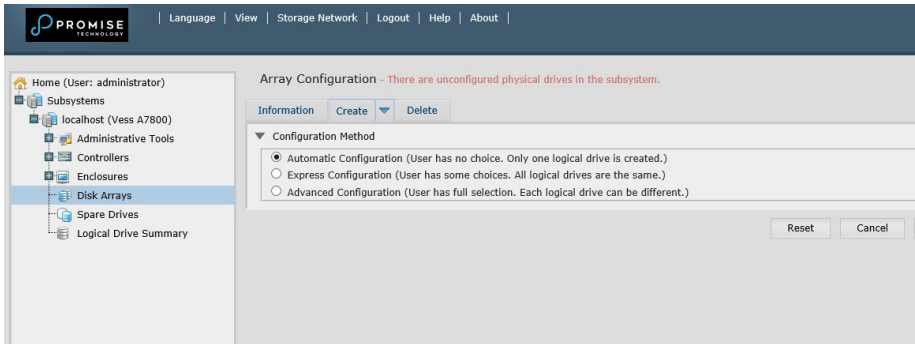

2. The Disk Array Configuration menu offers three options for configuration. Choose one of the options:
  - **Automatic Configuration** – Creates a new disk array following a default set of parameters. Makes one logical drive automatically. Also makes a hot spare drive for all RAID levels except RAID 0, if at least four unconfigured physical drives are available.
  - **Express Configuration** - You choose the parameters for a new disk array by specifying the characteristics you want. You can create multiple logical drives at the same time, however they will all be identical. You can choose to make a hot spare drive for all RAID levels except RAID 0, if at least four unconfigured physical drives are available
  - **Advanced Configuration**– You directly specify all parameters for a new disk array. Makes one logical drive automatically. You can create additional logical drives at a later time, if additional configurable capacity is available. Does not make a hot spare drive.
3. Click the **Next** button.

## Automatic

When you choose the Automatic option, the following parameters appear on the screen:

- **Disk Arrays** – The number of physical drives in the disk array, their ID numbers, configurable capacity, and the number of logical drives to be created
- **Logical Drives** – The ID number of the logical drive(s), their RAID level, capacity, and stripe size
- **Spare Drives** – The physical drive slot number of the dedicated hot spare assigned to this disk array. A hot spare drive is created for all RAID levels except RAID 0, when five or more unconfigured physical drives are available

### Automatic Disk Array Configuration menu

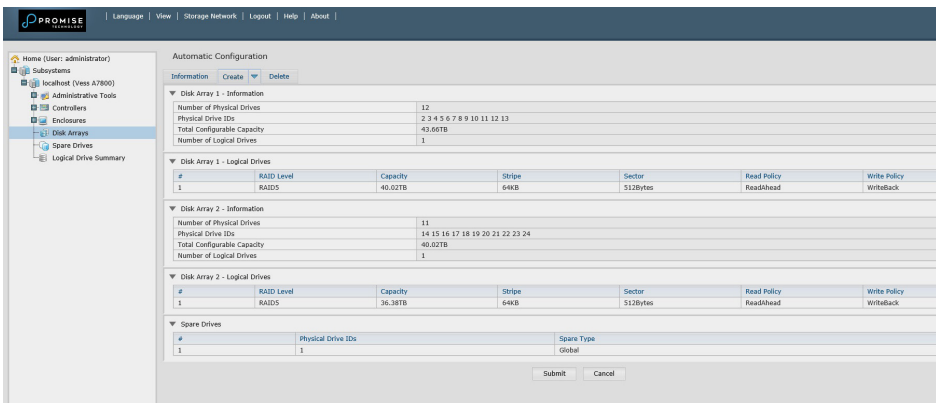

If you accept these parameters, click the **Submit** button.

The new disk array appears in the Disk Array List on the Information tab.

If you do NOT accept these parameters, use the Express or Advanced option to create your logical drive.

## Express Configuration

When you choose the Express option, a set of characteristics and options appears on the screen.

### Express Configuration options menu

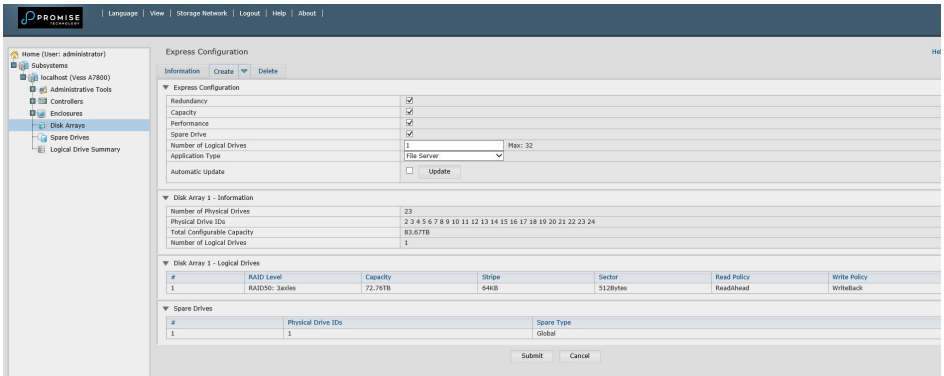

- Check the boxes to choose any one or a combination of:
  - Redundancy – The array will remain available if a physical drive fails
  - Capacity – The greatest possible amount of data capacity
  - Performance – The highest possible read/write speed
  - Spare Drive – A hot spare drive is created when you choose Redundancy, Spare Drive, and five or more unconfigured physical drives are available.
- In the Number of Logical Drives field, enter the number of logical drives you want to make from this disk array.
 

The maximum possible number of logical drives appears to the right of this field.
- From the **Application** Type menu, choose an application that best describes your intended use for this disk array:

- File Server
  - Video Stream
  - Transaction Data
  - Transaction Log
  - Other
4. Click the **Update** button.

Or check the Automatic Update box and updates will occur automatically.

The following parameters display:

- **Disk Arrays** – The number of physical drives in the disk array, their slot numbers, configurable capacity, and the number of logical drives to be created
- **Logical Drives** – The slot number of the logical drive(s), their RAID level, capacity, and stripe size
- **Spare Drives** – The physical drive slot number of the dedicated hot spare assigned to this disk array (all RAID levels except RAID 0)

If you accept these parameters, proceed to the next step.

If you do NOT accept these parameters, review and modify your selections in the previous steps.

5. When you are done, click the **Submit** button.

The new disk array appears in the Disk Array List on the Information tab.

## Advanced

When you choose the Advanced option, the *Step 1 – Disk Array Creation* screen displays.



### Note

For an explanation of the parameters under the Advanced option, see the Product Manual (download from [promise.com](http://promise.com)).

### Advanced Configuration (Step 1 Disk Array Creation)

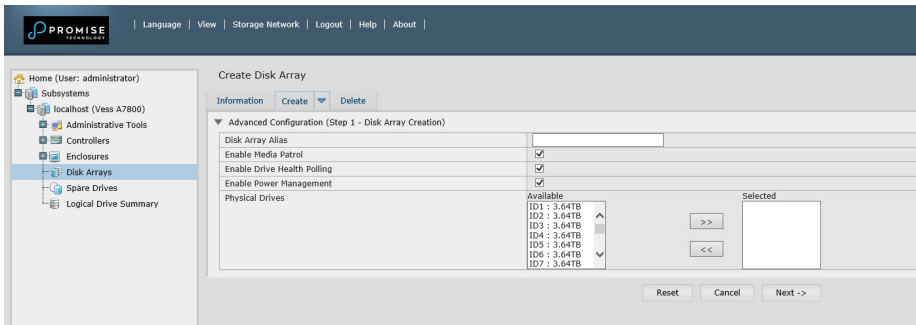

## Step 1 – Disk Array Creation

- Optional. Enter a name for the disk array in the field provided.

Maximum of 32 characters; letters, numbers, space between characters, and underline.

Uncheck the boxes if you want to disable Media Patrol.

Promise recommends leaving these features enabled.

Highlight physical drives you want in the disk array from the Available list and press the >> button to move them to the Selected list.

You can also double-click them to move them.

- When you are done, click the **Next** button.



## Step 2 – Logical Drive Creation

### Advanced Configuration (Step 1 Logical Drive Creation)

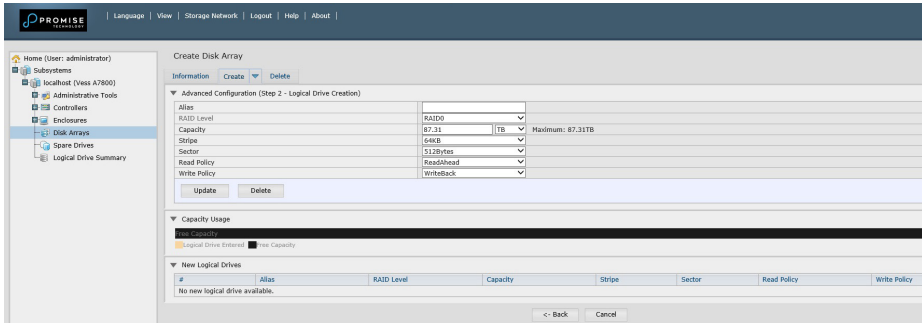

Optional. Enter an alias for the logical drive in the field provided. Maximum of 32 characters; letters, numbers, space between characters, and underline.

Choose a RAID level for the logical drive from the dropdown menu.

The choice of RAID levels depends the number of physical drives you selected.

RAID 30, 50 and 60 only – Specify the number of axles for your array.

Specify a Capacity and the unit of measure (B, KB, MB, GB, TB).

This value will be the data capacity of the first logical drive in your new disk array. If you specify less than disk array’s maximum capacity, the remaining capacity is available for additional logical drives that you can create now or later.

3. For the following items, accept the default or choose a new value from the dropdown menu:
  - Stripe size. 64 KB is the default.
  - 64 KB, 128 KB, 256 KB, 512 KB, and 1 MB are available.
  - Sector size. 512 B is the default.
  - 512 B, 1 KB, 2 KB, and 4 KB are available.
  - Read (cache) Policy. Read Ahead is the default.
  - Read Cache, Read Ahead, and No Cache are available.
  - Write (cache) Policy. Write Back is the default.
  - Write Back and Write Through (Thru) are available.
4. Click the **Update** button.

A new logical drive is displayed under New Logical Drives. If there is free capacity remaining, you can specify another logical drive now or wait until later.

5. When you are done specifying logical drives, click the **Next** button.

## Step 3 – Summary

The Summary lists the disk array and logical drive information you specified.

To proceed with disk array and logical drive creation, click the **Submit** button.

## Logging out of Promise Management GUI

There are two ways to log out of Promise Management GUI :

- Close your browser window



### Note

---

This function does not automatically create a hot spare drive. After the disk array is created, you can create a hot spare drive for it. See the Product Manual (download from [promise.com](http://promise.com)).

---

- Click **Logout** on the Promise Management GUI banner

Clicking **Logout** brings you back to the Login Screen. After logging out, you must enter your user name and password in order to log in again.

## ***SYSTEM SHUTDOWN***

To shutdown the system, perform the normal shutdown procedure according to the Windows operating system.

# TECHNICAL SUPPORT

PROMISE Technical Support provides several support options for PROMISE users to access information and updates. We encourage you to use one of our electronic services, which provide product information updates for the most efficient service and support.

PROMISE E-Support: <https://support.promise.com>

PROMISE web site: <http://www.promise.com/>