

TRENDnet[®]

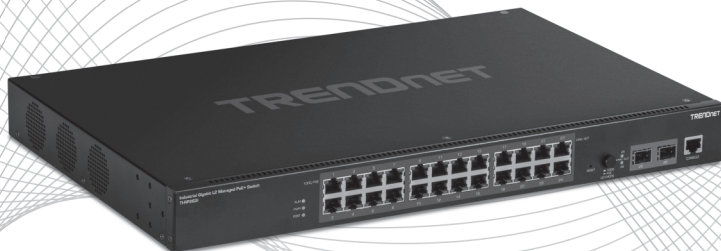

Quick Installation Guide

TI-RP262i (V1)

Table of Contents

1 English

1. Before You Start
2. Quick Reference
3. Hardware Installation
4. Rack Mount Hardware Installation
5. Hardware Configuration
6. Additional Information

1. Before You Start

Package Contents

- TI-RP262i
- Quick Installation Guide
- Console cable

Minimum Requirements

- Power supply (ex. model TI-RSP100048)
- Networked computer
- RJ-45 Network Cable
- Phillips Screwdriver

Optional Equipment

- Rack mount kit
- SFP modules (e.g. TI-MGBSX, TI-MGBS10, TI-MGBS40)

2. Quick Reference

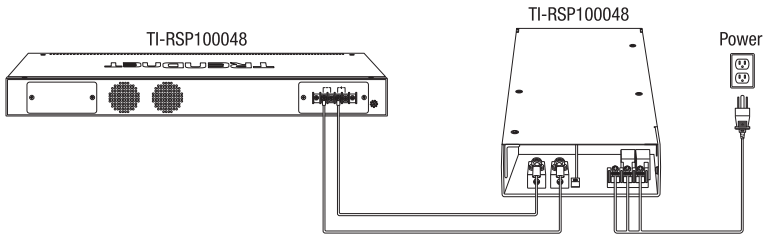

3. Hardware Installation

Note:

The maximum amount of power available is 30W per port and 685W total. If a power overload has occurred, the switch will prioritize the distribution of power by port (from lowest to highest). That is, port 1 will receive the highest priority and port 24 will receive the lowest priority. The ports with lower priority will have its PoE function disabled until more than 7.5W of power becomes available.

Applying Power

1. Connect the power supply (sold separately) to the screw terminal block (as shown below) and secure with the screws.

Note: Polarities must match.

Optional: The switch chassis can also be connected to a known grounding point for additional safety and protection (grounding wire is not included).

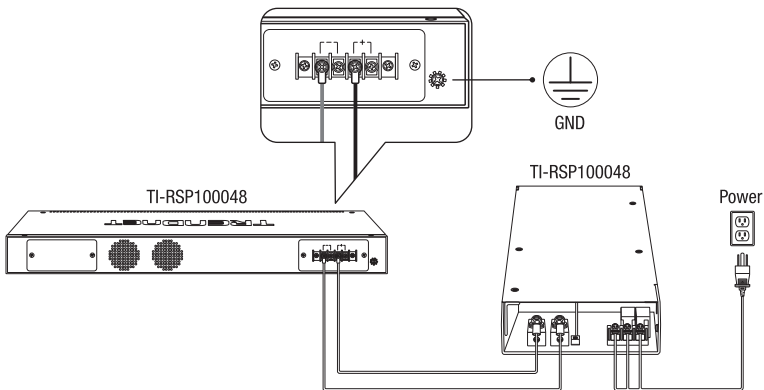

4. Rack Mount Hardware Installation

The switch can be mounted in an EIA standard-size, 19-inch rack, which can be placed in a wiring closet with other equipment. Attach the mounting brackets at the switch's front panel (one on each side), and secure them with the provided screws.

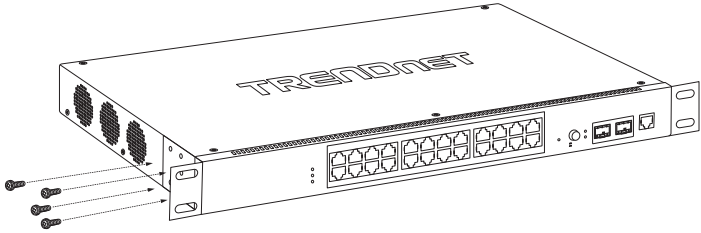

Use screws of the equipment rack to mount each switch in the rack.

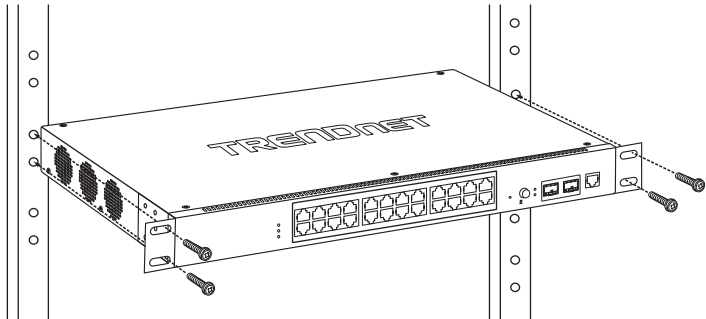

Safety Note



- Turn off the power before connecting any module or wire. The correct power supply voltage (48 – 57 V DC) is listed on the product label. Check the voltage of your power source to make sure that you are using the correct part. Do NOT use voltage greater than 48 – 57 V DC, as specified on the product label.
- Calculate the maximum possible current in each power wire and common wire. Observe all electrical codes dictating the maximum current allowable for each wire size. If the current surpasses the maximum ratings, the wiring could overheat, causing serious damage to your equipment.

5. Hardware Configuration

1

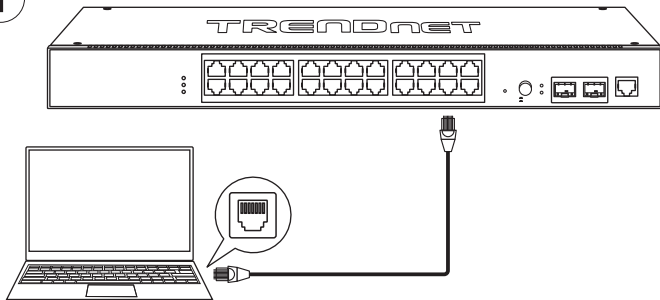

2. Assign a Static IP address to your computer's network adapter in the subnet of 192.168.10.x (e.g. 192.168.10.25) and a subnet mask of 255.255.255.0.
3. Open your web browser, type the IP address of the switch in the address bar, and then press **Enter**. The default IP address is 192.168.10.200
4. Enter the **User name** and **Password**, and then click **Login**. By default:
User Name: **admin**
Password: **admin**

Note: User Name and Password are case sensitive.



5. Click **Basic Settings** and then click **General Settings**.

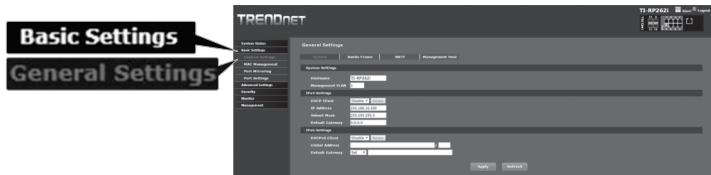

6. Configure the switch to match the requirements of your network. Then click **Apply**.

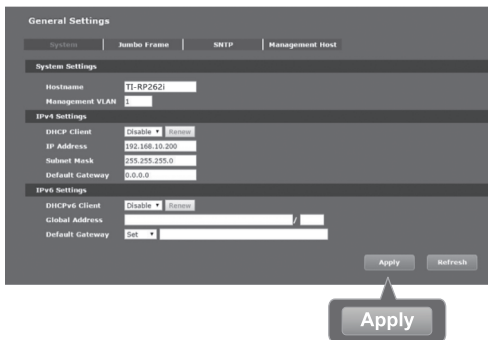

7. Click **Save**.

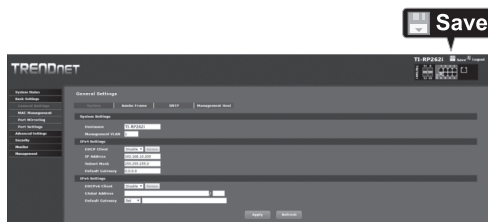

8. Connect a network source and devices to the switch. Check the LEDs to confirm the connections are established. Your installation is complete.

6. Additional Information

LED Push Button MODE

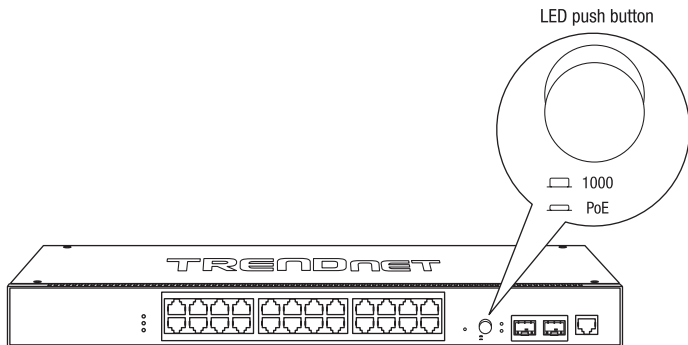

Note: To download the latest version of the user's guide, please go to <http://www.trendnet.com/support> and select the **TI-RP262i** within the Products Download dropdown list.

Declaration of conformity

TRENDnet[®]

Manufacturer's Name and Address

TRENDnet, Inc.
20675 Manhattan Place
Torrance, CA 90501 USA

Zwolsestraat 156 2587 WB
The Hague The Netherlands



Product Information:

Model Number: TI-RP262i
Product Name: 26-Port Industrial Gigabit L2 Managed PoE+ Rackmount Switch
Trade Name: TRENDnet

TRENDnet hereby declare that the product is in compliance with the essential requirements and other relevant provisions under our sole responsibility.

EMC EN 55032: 2015 + AC: 2016 (Class A)
EN 55024: 2010 + A1: 2015
EN 61000-4-2
EN 61000-4-3
EN 61000-4-4
EN 61000-4-5
EN 61000-4-6
EN 61000-4-8
EN 61000-3-2: 2014 Class A
EN 61000-303: 2013

This product is herewith confirmed to comply with the Directives.

Directives: EMC Directive 2014/30/EU
RoHS Directive 2011/65/EU
REACH Regulation (EC) No. 1907/2006

Person responsible for this declaration.

Place of Issue: Torrance, California, USA

Date: March 25, 2020

Name: Sonny Su

Title: Director of Technology

Signature: _____

A handwritten signature in black ink, appearing to read 'Sonny Su', is written over a horizontal line.



Certifications

This device complies with Part 15 of the FCC Rules.

Operation is subject to the following two conditions:

- (1) This device may not cause harmful interference.
- (2) This device must accept any interference received.

Including interference that may cause undesired operation.



Waste electrical and electronic products must not be disposed of with household waste. Please recycle where facilities exist. Check with your Local Authority or Retailer for recycling advice.

Applies to PoE Products Only: This product is to be connected only to PoE networks without routing to the outside plant.

Note

The Manufacturer is not responsible for any radio or TV interference caused by unauthorized modifications to this equipment. Such modifications could void the user's authority to operate the equipment.

Advertencia

En todos nuestros equipos se mencionan claramente las características del adaptador de alimentación necesario para su funcionamiento. El uso de un adaptador distinto al mencionado puede producir daños físicos y/o daños al equipo conectado. El adaptador de alimentación debe operar con voltaje y frecuencia de la energía eléctrica domiciliar existente en el país o zona de instalación.

Technical Support

If you have any questions regarding the product installation, please contact our Technical Support.

Toll free US/Canada: **1-855-373-4741**

Regional phone numbers available at www.trendnet.com/support

TRENDnet

20675 Manhattan Place
Torrance, CA 90501
USA

Product Warranty Registration

Please take a moment to register your product online. Go to TRENDnet's website at: www.trendnet.com/register