



## Healthcare Supplies Catalog

Zebra has the right labels for hospital applications. Genuine Zebra labels are available in a range of sizes, materials and adhesives that can withstand all types of and storage requirements. Our labels are suitable for labeling all shapes and sizes of specimen containers, including test tubes, vials, microscope slides, petri dishes, and cassettes—plus pharmacy unit dose containers, including syringes and IV bags. Zebra even offers special blood bag labels that meet ISBT 128 compliance requirements.

Prices Effective June 14, 2021

## Table of Contents

### Lab

|                       |      |
|-----------------------|------|
| Cerner.....           | 3    |
| MISYS/Sunquest.....   | 8    |
| Meditech.....         | 8    |
| Microscope Slide..... | 9-10 |
| General.....          | 11   |

|                      |           |
|----------------------|-----------|
| <b>ISBT 128.....</b> | <b>13</b> |
|----------------------|-----------|

### Mobile Specimen Collection

|                                |    |
|--------------------------------|----|
| Cerner, McKesson, Siemens..... | 14 |
| Meditech.....                  | 16 |
| IQ Color.....                  | 18 |

### Pharmacy

|              |    |
|--------------|----|
| Cerner.....  | 19 |
| General..... | 20 |

### Breast Milk Tracking

|                                |    |
|--------------------------------|----|
| Cerner, McKesson, Siemens..... | 21 |
| CareFusion.....                | 22 |

|                          |           |
|--------------------------|-----------|
| <b>Multipurpose.....</b> | <b>23</b> |
|--------------------------|-----------|

|                       |           |
|-----------------------|-----------|
| <b>Specialty.....</b> | <b>26</b> |
|-----------------------|-----------|

### Wristbands

|   |    |
|---|----|
| Wristband Cartridges.....                           | 29 |
| Wristbands for Desktop and Industrial Printers..... | 37 |
| RFID Wristbands.....                                | 44 |

### Wristbands - Non Printable

|                                       |    |
|---------------------------------------|----|
| Alert Solutions.....                  | 46 |
| OmniBand.....                         | 49 |
| Vinyl Infant Wristband Solutions..... | 50 |
| ComfyCuff Solutions.....              | 51 |

|                     |           |
|---------------------|-----------|
| <b>Ribbons.....</b> | <b>53</b> |
|---------------------|-----------|

# Lab

## Cerner

### 8000D Lab

A direct thermal paper label with a high-tack permanent acrylic adhesive specifically designed to adhere to small, curved, surfaces.

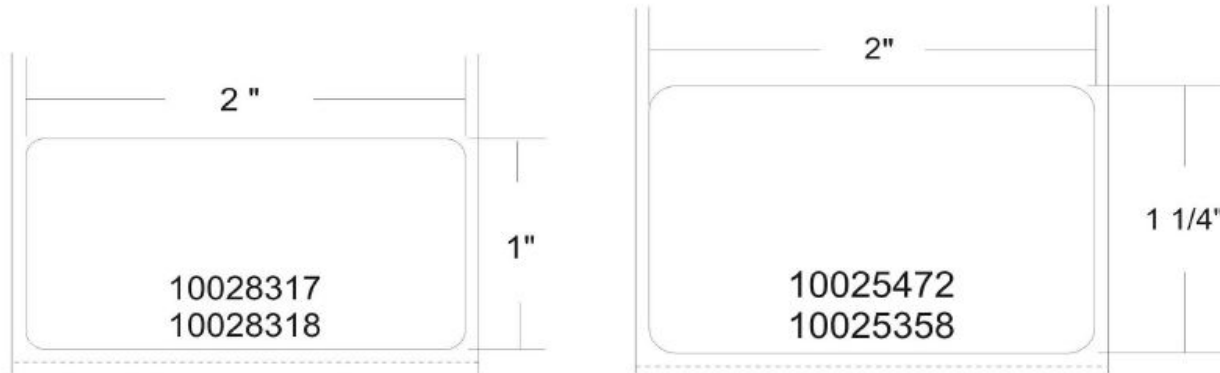

| Size |   |      | Part #   | ID, OD       | Amount/<br>roll | Rolls/<br>carton | Stock/<br>MTO |
|------|---|------|----------|--------------|-----------------|------------------|---------------|
| W    | x | L    |          |              |                 |                  |               |
| 2    | x | 1    | 10028317 | 3" ID, 8" OD | 5,200           | 6                | MTO           |
| 2    | x | 1    | 10028318 | 1" ID, 5" OD | 2,330           | 6                | MTO           |
| 2    | x | 1.25 | 10025472 | 3" ID, 8" OD | 3,000           | 6                | MTO           |
| 2    | x | 1.25 | 10025358 | 1" ID, 5" OD | 1,000           | 6                | Stock         |

### PolyPro 4000D

A direct thermal polypropylene label with an all-temp permanent acrylic adhesive. Offers good resistance to scratching, smearing, and moisture. Provides some flexibility for labeling curved surfaces.

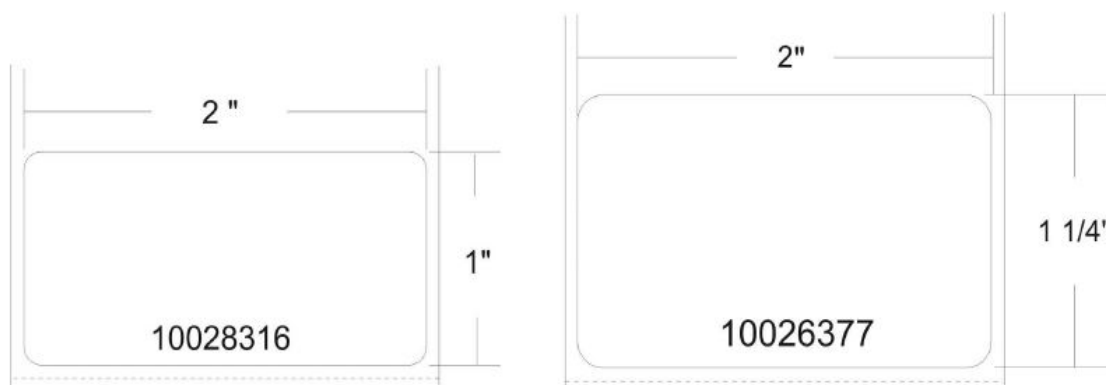

| Size |   |      | Part #   | ID, OD       | Amount/<br>roll | Rolls/<br>carton | Stock/<br>MTO |
|------|---|------|----------|--------------|-----------------|------------------|---------------|
| W    | x | L    |          |              |                 |                  |               |
| 2    | x | 1    | 10028316 | 3" ID, 8" OD | 6,000           | 6                | MTO           |
| 2    | x | 1.25 | 10026377 | 3" ID, 8" OD | 5,000           | 6                | MTO           |

Stock - ships within one business day. Made to order (MTO) - see product category for specific lead time information. Products purchased in less than full inner carton quantities are subject to a \$75 broken carton charge, per destination. Prices effective June 14, 2021. Prices/stocking locations subject to change w/o notice. Refer to [www.zebra.com](http://www.zebra.com).

# Lab

## Cerner

### 8000D Lab

A direct thermal paper label with a high-tack permanent acrylic adhesive specifically designed to adhere to small, curved, surfaces.

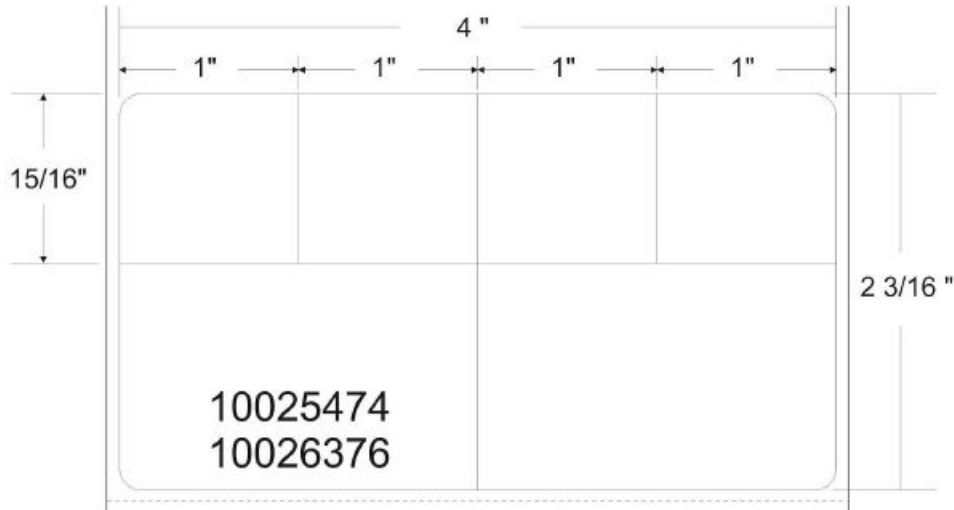

| Size |   |        | Part #   | ID, OD       | Amount/<br>roll | Rolls/<br>carton | Stock/<br>MTO |
|------|---|--------|----------|--------------|-----------------|------------------|---------------|
| W    | x | L      |          |              |                 |                  |               |
| 4    | x | 2.1875 | 10025474 | 3" ID, 8" OD | 2,600           | 2                | MTO           |
| 4    | x | 2.1875 | 10026376 | 1" ID, 5" OD | 1,000           | 2                | MTO           |

### PolyPro 4000D

A direct thermal polypropylene label with an all-temp permanent acrylic adhesive. Offers good resistance to scratching, smearing, and moisture. Provides some flexibility for labeling curved surfaces.

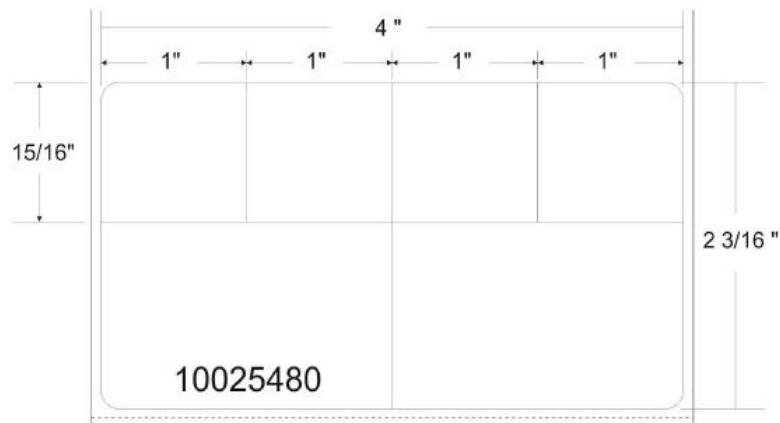

| Size |   |        | Part #   | ID, OD       | Amount/<br>roll | Rolls/<br>carton | Stock/<br>MTO |
|------|---|--------|----------|--------------|-----------------|------------------|---------------|
| W    | x | L      |          |              |                 |                  |               |
| 4    | x | 2.1875 | 10025480 | 3" ID, 8" OD | 2,600           | 2                | MTO           |

Stock - ships within one business day. Made to order (MTO) - see product category for specific lead time information. Products purchased in less than full inner carton quantities are subject to a \$75 broken carton charge, per destination. Prices effective June 14, 2021. Prices/stocking locations subject to change w/o notice. Refer to [www.zebra.com](http://www.zebra.com).

# Lab

## Cerner

### 8000D Lab

A direct thermal paper label with a high-tack permanent acrylic adhesive specifically designed to adhere to small, curved, surfaces.

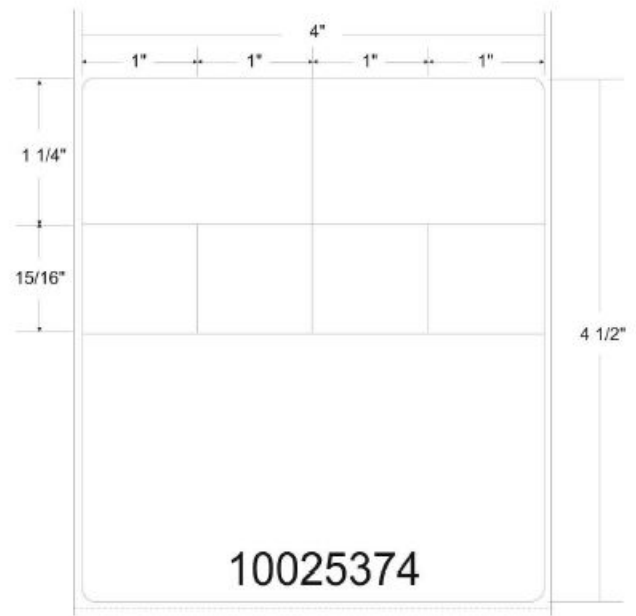
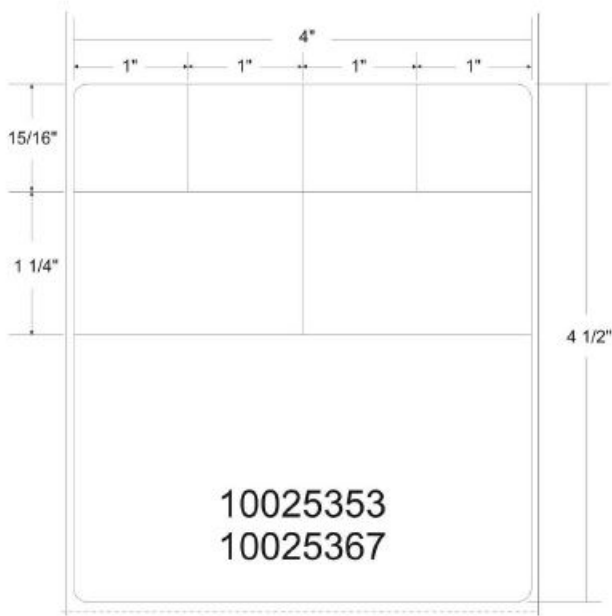

| Size |   |     | Part #   | ID, OD       | Amount/<br>roll | Rolls/<br>carton | Stock/<br>MTO |
|------|---|-----|----------|--------------|-----------------|------------------|---------------|
| W    | x | L   |          |              |                 |                  |               |
| 4    | x | 4.5 | 10025353 | 3" ID, 8" OD | 1,000           | 2                | MTO           |
| 4    | x | 4.5 | 10025367 | 1" ID, 5" OD | 500             | 4                | MTO           |
| 4    | x | 4.5 | 10025374 | 3" ID, 8" OD | 1,000           | 2                | MTO           |

Stock - ships within one business day. Made to order (MTO) - see product category for specific lead time information. Products purchased in less than full inner carton quantities are subject to a \$75 broken carton charge, per destination. Prices effective June 14, 2021. Prices/stocking locations subject to change w/o notice. Refer to [www.zebra.com](http://www.zebra.com).

# Lab

## Cerner

### 8000D Lab

A direct thermal paper label with a high-tack permanent acrylic adhesive specifically designed to adhere to small, curved, surfaces.

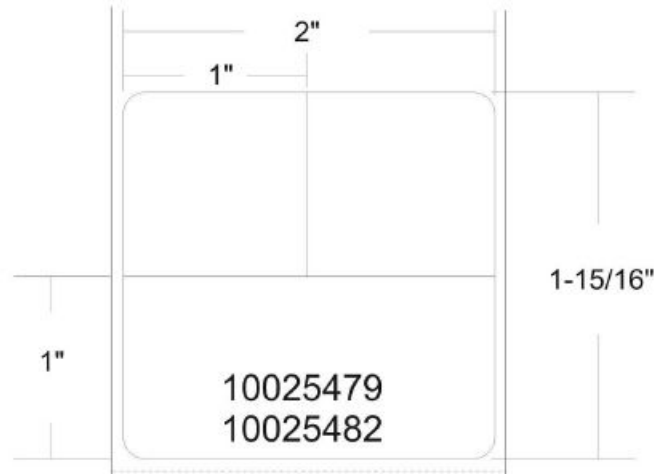

| Size |   |        | Part #   | ID, OD       | Amount/<br>roll | Rolls/<br>carton | Stock/<br>MTO |
|------|---|--------|----------|--------------|-----------------|------------------|---------------|
| W    | x | L      |          |              |                 |                  |               |
| 2    | x | 1.9375 | 10025479 | 3" ID, 8" OD | 2,700           | 6                | MTO           |
| 2    | x | 1.9375 | 10025482 | 1" ID, 5" OD | 1,000           | 6                | MTO           |

### 8000D Lab

A direct thermal paper label with a high-tack permanent acrylic adhesive specifically designed to adhere to small, curved, surfaces.

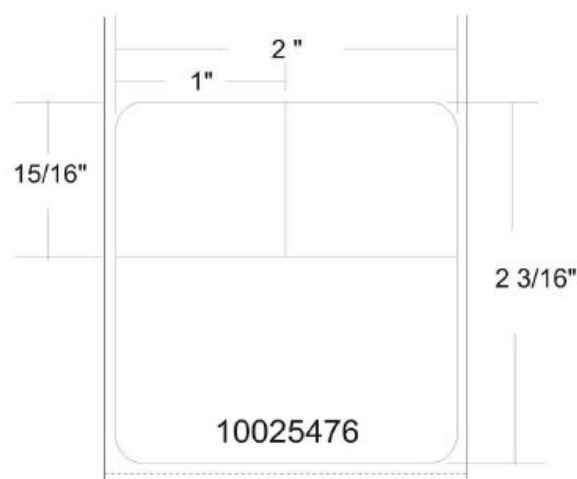

| Size |   |        | Part #   | ID, OD       | Amount/<br>roll | Rolls/<br>carton | Stock/<br>MTO |
|------|---|--------|----------|--------------|-----------------|------------------|---------------|
| W    | x | L      |          |              |                 |                  |               |
| 2    | x | 2.1875 | 10025476 | 3" ID, 8" OD | 1,000           | 4                | MTO           |

Stock - ships within one business day. Made to order (MTO) - see product category for specific lead time information.  
 Products purchased in less than full inner carton quantities are subject to a \$75 broken carton charge, per destination.  
 Prices effective June 14, 2021. Prices/stocking locations subject to change w/o notice. Refer to [www.zebra.com](http://www.zebra.com).

# Lab

## Cerner

### PolyPro 4000D

A direct thermal polypropylene label with an all-temp permanent acrylic adhesive. Offers good resistance to scratching, smearing, and moisture. Provides some flexibility for labeling curved surfaces.

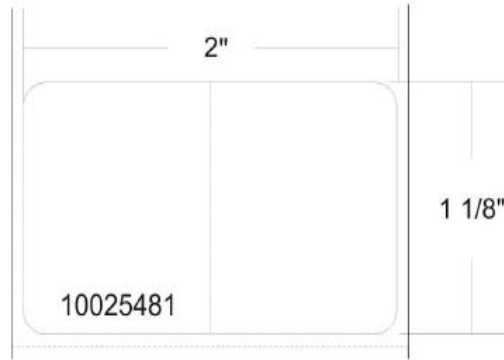

| Size |   |       | Part #   | ID, OD       | Amount/<br>roll | Rolls/<br>carton | Stock/<br>MTO |
|------|---|-------|----------|--------------|-----------------|------------------|---------------|
| W    | x | L     |          |              |                 |                  |               |
| 2    | x | 1.125 | 10025481 | 3" ID, 8" OD | 5,000           | 6                | MTO           |

Stock - ships within one business day. Made to order (MTO) - see product category for specific lead time information. Products purchased in less than full inner carton quantities are subject to a \$75 broken carton charge, per destination. Prices effective June 14, 2021. Prices/stocking locations subject to change w/o notice. Refer to [www.zebra.com](http://www.zebra.com).

# Lab

## MISYS/Sunquest

### 8000D Lab

A direct thermal paper label with a high-tack permanent acrylic adhesive specifically designed to adhere to small, curved, surfaces.

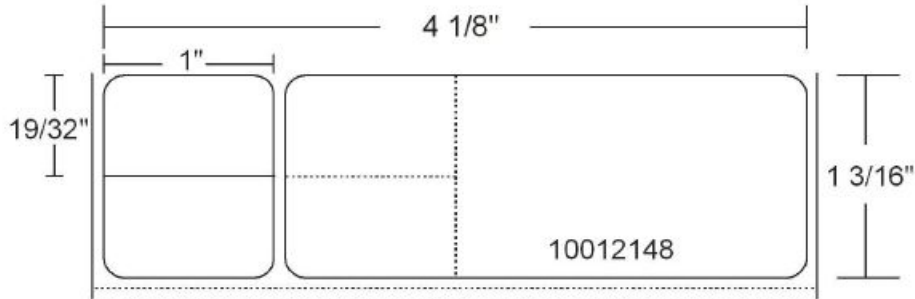

| Size  |   |        | Part #   | ID, OD       | Color | Amount/<br>roll | Rolls/<br>carton | Carton<br>Weight | Stock/<br>MTO |
|-------|---|--------|----------|--------------|-------|-----------------|------------------|------------------|---------------|
| W     | x | L      |          |              |       |                 |                  |                  |               |
| 4.125 | x | 1.1875 | 10012148 | 1" ID, 5" OD | White | 2,000           | 4                | 20 lbs.          | Stock         |

## Meditech

### 8000D Lab

A direct thermal paper label with a high-tack permanent acrylic adhesive specifically designed to adhere to small, curved, surfaces.

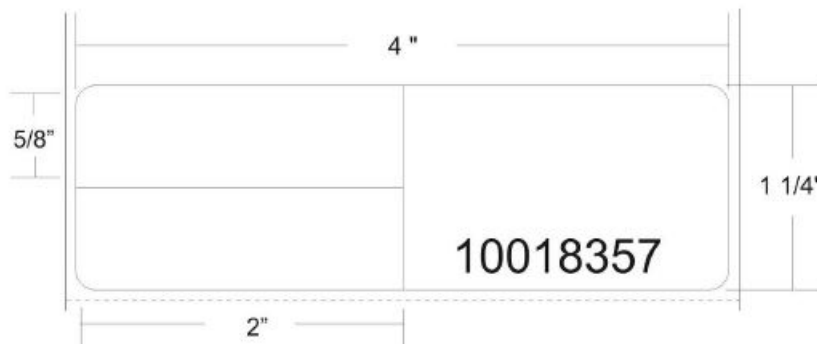

| Size |   |      | Part #   | ID, OD       | Color | Amount/<br>roll | Rolls/<br>carton | Carton<br>Weight | Stock/<br>MTO |
|------|---|------|----------|--------------|-------|-----------------|------------------|------------------|---------------|
| W    | x | L    |          |              |       |                 |                  |                  |               |
| 4    | x | 1.25 | 10018357 | 1" ID, 5" OD | White | 1,911           | 6                | 26 lbs.          | MTO           |

Stock - ships within one business day. Made to order (MTO) - see product category for specific lead time information.  
 Products purchased in less than full inner carton quantities are subject to a \$75 broken carton charge, per destination.  
 Prices effective June 14, 2021. Prices/stocking locations subject to change w/o notice. Refer to [www.zebra.com](http://www.zebra.com).



# Lab

## Microscope Slide

### Z-Xtreme 5000T

A thermal transfer, coated label with a high performance acrylic adhesive that provides extreme chemical resistance.

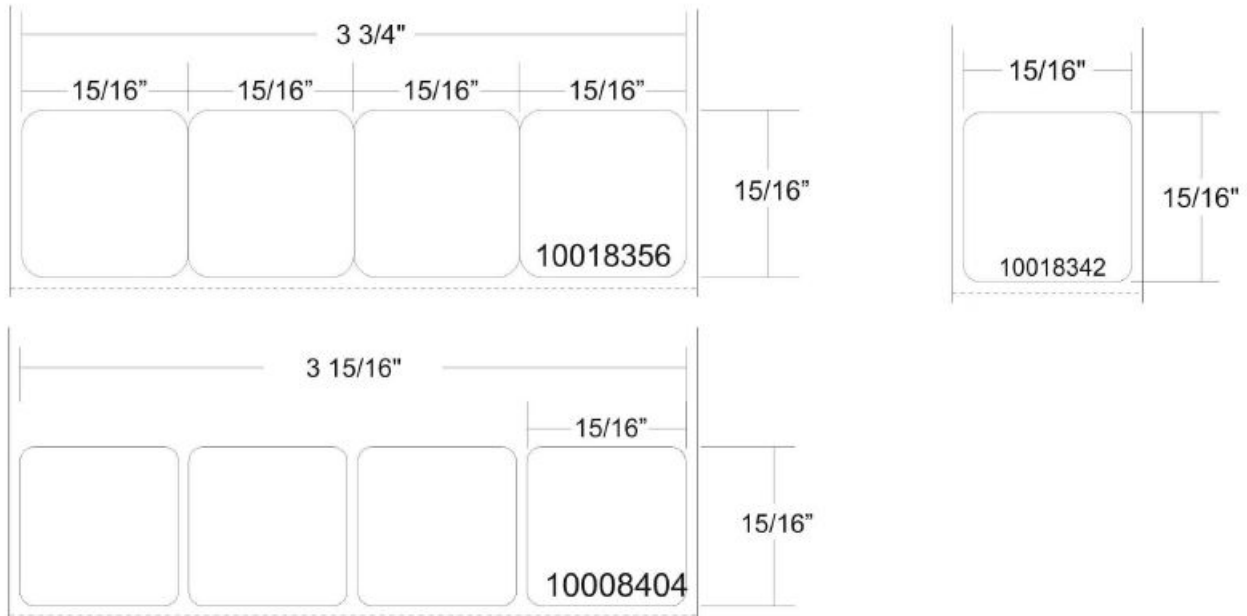

| Size   |   |        | Part #   | ID, OD       | Amount/<br>roll | Rolls/<br>carton | Carton<br>Weight | Stock/<br>MTO | Ribbon Part<br>Number*    |
|--------|---|--------|----------|--------------|-----------------|------------------|------------------|---------------|---------------------------|
| W      | x | L      |          |              |                 |                  |                  |               |                           |
| 0.9375 | x | 0.9375 | 10018356 | 1" ID, 5" OD | 8,780           | 4                | 6 lbs.           | MTO           | 74943, 74783 <sup>^</sup> |
| 0.9375 | x | 0.9375 | 10008404 | 1" ID, 5" OD | 8,760           | 4                | 6 lbs.           | Stock         | 74943, 74783 <sup>^</sup> |
| 0.9375 | x | 0.9375 | 10018342 | 1" ID, 5" OD | 2,195           | 4                | 4 lbs.           | Stock         | 74941                     |

\*Ribbon pricing located on the last page of the price list  
<sup>^</sup>74783 for the ZD420 printer only

# Lab

## Microscope Slide

### 8000T Slide

Thermal transfer, premium, white gloss polyester label with a permanent acrylic adhesive. Withstands immersion in harsh chemicals when paired with Image Lock ribbon.

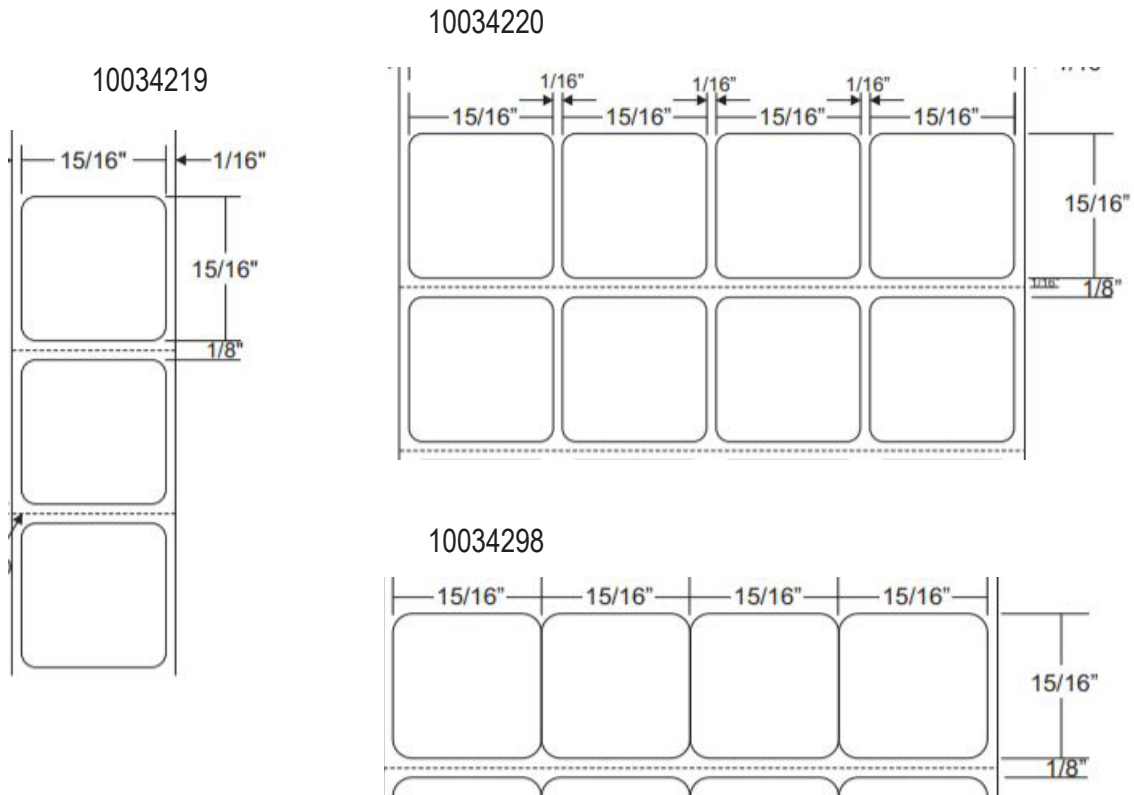

| Size   |   |        | Part #   | ID, OD       | Lables/<br>across | Amount/<br>roll | Rolls/<br>carton | Carton<br>Weight | Stock/<br>MTO |
|--------|---|--------|----------|--------------|-------------------|-----------------|------------------|------------------|---------------|
| W      | x | L      |          |              |                   |                 |                  |                  |               |
| 0.9375 | x | 0.9375 | 10034219 | 1" ID, 5" OD | 1                 | 2,512           | 4                | 4 lbs.           | Stock         |
| 0.9375 | x | 0.9375 | 10034220 | 1" ID, 5" OD | 4                 | 10,048          | 4                | 8 lbs.           | Stock         |

| Size   |   |        | Part #   | ID, OD       | Lables/<br>across | Amount/<br>roll | Rolls/<br>carton | Carton<br>Weight | Stock/<br>MTO |
|--------|---|--------|----------|--------------|-------------------|-----------------|------------------|------------------|---------------|
| W      | x | L      |          |              |                   |                 |                  |                  |               |
| 0.9375 | x | 0.9375 | 10034298 | 1" ID, 5" OD | 4                 | 8,760           | 4                | 8 lbs.           | Stock         |

No gap between labels across.

Stock - ships within one business day. Made to order (MTO) - see product category for specific lead time information.  
 Products purchased in less than full inner carton quantities are subject to a \$75 broken carton charge, per destination.  
 Prices effective June 14, 2021. Prices/stocking locations subject to change w/o notice. Refer to [www.zebra.com](http://www.zebra.com).

# Lab

## General

### 8000D Lab

A direct thermal paper label with a high-tack permanent acrylic adhesive specifically designed to adhere to small, curved, surfaces.

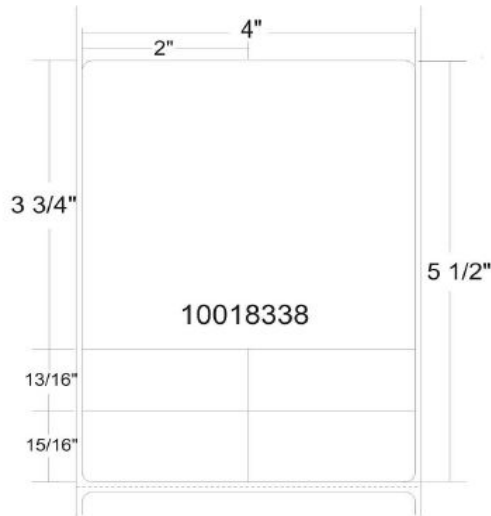

| Size |   |     | Part #   | ID, OD       | Amount/<br>roll | Rolls/<br>carton | Carton<br>Weight | Stock/<br>MTO |
|------|---|-----|----------|--------------|-----------------|------------------|------------------|---------------|
| W    | x | L   |          |              |                 |                  |                  |               |
| 4    | x | 5.5 | 10018338 | 3" ID, 8" OD | 1,050           | 4                | 26 lbs.          | Stock         |

### PolyPro 4000D

A direct thermal polypropylene label with an all-temp permanent acrylic adhesive. Offers good resistance to scratching, smearing, and moisture. Provides some flexibility for labeling curved surfaces.

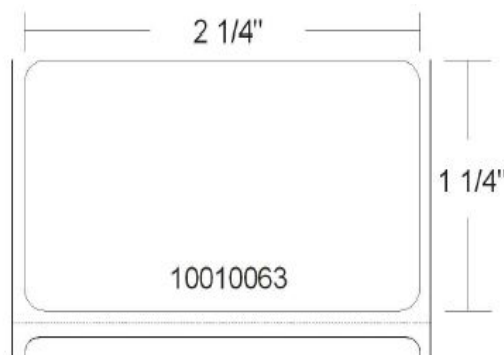

| Size |   |      | Part #   | ID, OD       | Amount/<br>roll | Rolls/<br>carton | Carton<br>Weight | Stock/<br>MTO |
|------|---|------|----------|--------------|-----------------|------------------|------------------|---------------|
| W    | x | L    |          |              |                 |                  |                  |               |
| 2.25 | x | 1.25 | 10010063 | 1" ID, 5" OD | 2,000           | 6                | 12 lbs.          | Stock         |

Stock - ships within one business day. Made to order (MTO) - see product category for specific lead time information. Products purchased in less than full inner carton quantities are subject to a \$75 broken carton charge, per destination. Prices effective June 14, 2021. Prices/stocking locations subject to change w/o notice. Refer to [www.zebra.com](http://www.zebra.com).

# Lab

## General

### PolyPro 4000T

A thermal transfer Kimdura® polypropylene label with a permanent acrylic adhesive.

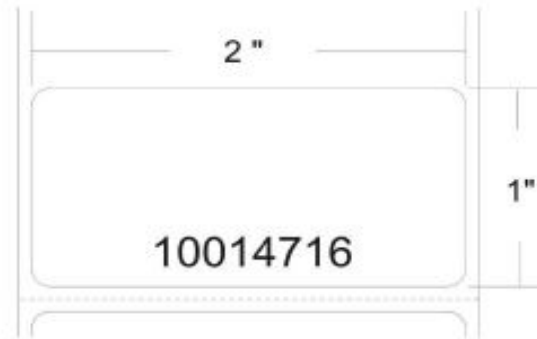

| Size |   |   | Part #   | ID, OD       | Amount/<br>roll | Rolls/<br>carton | Carton<br>Weight | Stock/<br>MTO | Ribbon Part<br>Number* |
|------|---|---|----------|--------------|-----------------|------------------|------------------|---------------|------------------------|
| W    | x | L |          |              |                 |                  |                  |               |                        |
| 2    | x | 1 | 10014716 | 3" ID, 8" OD | 3,940           | 4                | 10 lbs.          | Stock         | 06100BK06045           |

\*Ribbon pricing located on the last page of the price list.

# ISBT 128

## General

### 8000T Primary Blood Bag Label

A thermal transfer polypropylene label with a permanent acrylic adhesive for direct application to a blood bag.

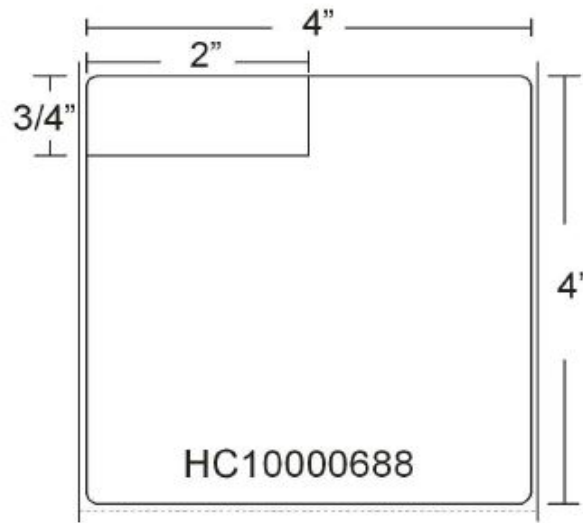

| Size |   |   | Part #     | ID, OD       | Amount/<br>roll | Rolls/<br>carton | Carton<br>Weight | Stock/<br>MTO | Ribbon Part<br>Number* |
|------|---|---|------------|--------------|-----------------|------------------|------------------|---------------|------------------------|
| W    | x | L |            |              |                 |                  |                  |               |                        |
| 4    | x | 4 | HC10000688 | 3" ID, 8" OD | 1,110           | 4                | 24 lbs.          | Stock         | 06100BK11045           |

\*Ribbon pricing located on the last page of the price list.

# Mobile Specimen Collection

Cerner, McKesson, Siemens

## 8000D Lab

A direct thermal paper label with a permanent acrylic adhesive specifically designed to adhere to small, curved surfaces.

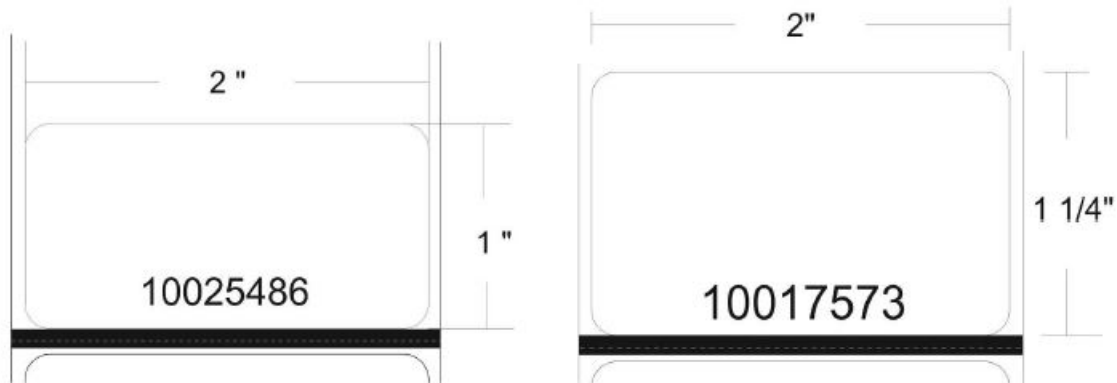

| Size |   |      | Part #   | ID, OD            | Amount/<br>roll | Rolls/<br>carton | Carton<br>Weight | Stock/<br>MTO |
|------|---|------|----------|-------------------|-----------------|------------------|------------------|---------------|
| W    | x | L    |          |                   |                 |                  |                  |               |
| 2    | x | 1    | 10025486 | 0.75" ID, 2.2" OD | 428             | 12               | 3 lbs.           | MTO           |
| 2    | x | 1.25 | 10017573 | 0.75" ID, 2.2" OD | 330             | 12               | 3 lbs.           | Stock         |

## PolyPro 4000D

A direct thermal polypropylene label with an all-temp permanent acrylic adhesive. Offers good resistance to scratching, smearing and moisture. Provides some flexibility for labeling curved surfaces.

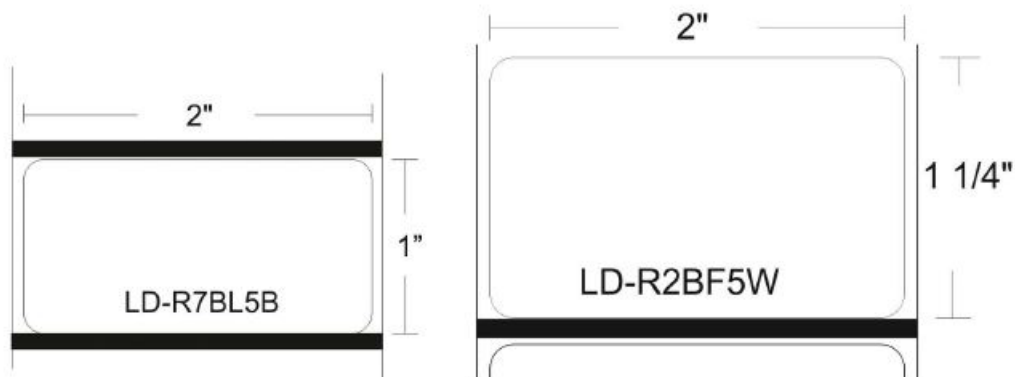

| Size |   |      | Part #    | ID, OD          | Amount/<br>roll | Rolls/<br>carton | Carton<br>Weight | Stock/<br>MTO |
|------|---|------|-----------|-----------------|-----------------|------------------|------------------|---------------|
| W    | x | L    |           |                 |                 |                  |                  |               |
| 2    | x | 1    | LD-R7BL5B | 0.75" ID, 2" OD | 350             | 36               | 7 lbs.           | Stock         |
| 2    | x | 1.25 | LD-R2BF5W | 0.75" ID, 2" OD | 280             | 36               | 8 lbs.           | Stock         |

Stock - ships within one business day. Made to order (MTO) - see product category for specific lead time information. Products purchased in less than full inner carton quantities are subject to a \$75 broken carton charge, per destination. Prices effective June 14, 2021. Prices/stocking locations subject to change w/o notice. Refer to [www.zebra.com](http://www.zebra.com).

# Mobile Specimen Collection

## Cerner

### 8000D Lab

A direct thermal paper label with a permanent acrylic adhesive specifically designed to adhere to small, curved surfaces.

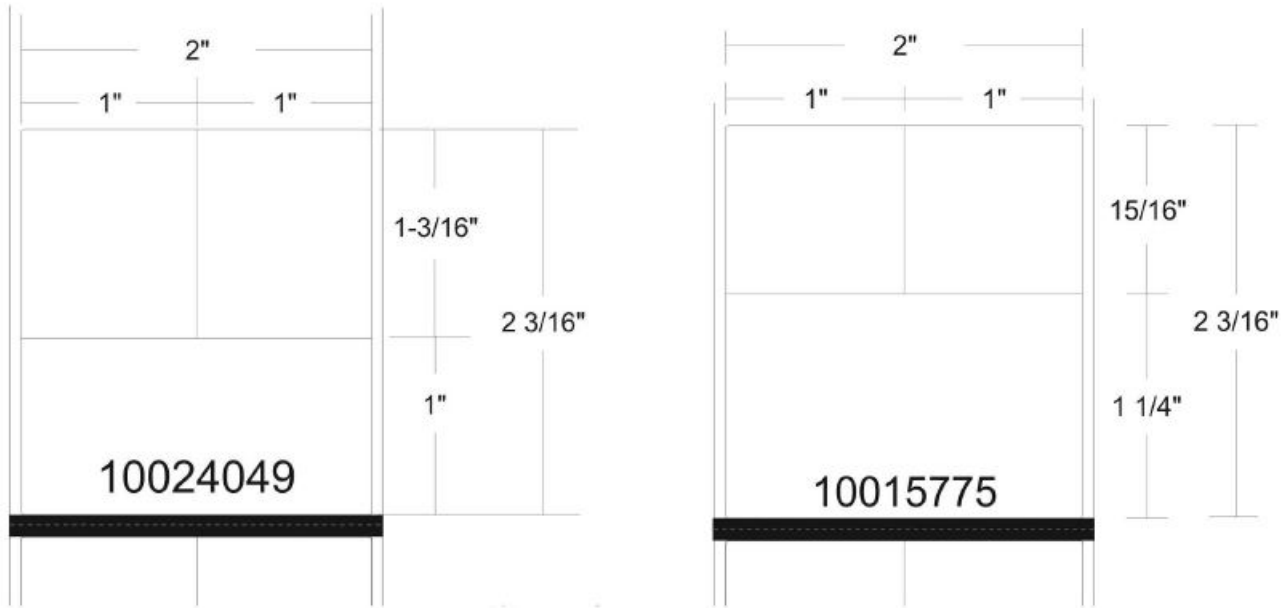

| Size |   |        | Part #   | ID, OD            | Amount/<br>roll | Rolls/<br>carton | Carton<br>Weight | Stock/<br>MTO |
|------|---|--------|----------|-------------------|-----------------|------------------|------------------|---------------|
| W    | x | L      |          |                   |                 |                  |                  |               |
| 2    | x | 2.1875 | 10015775 | 0.75" ID, 2.2" OD | 200             | 12               | 5 lbs.           | Stock         |
| 2    | x | 2.1875 | 10024049 | 0.75" ID, 2.2" OD | 200             | 36               | 15 lbs.          | Stock         |

Stock - ships within one business day. Made to order (MTO) - see product category for specific lead time information.  
 Products purchased in less than full inner carton quantities are subject to a \$75 broken carton charge, per destination.  
 Prices effective June 14, 2021. Prices/stocking locations subject to change w/o notice. Refer to [www.zebra.com](http://www.zebra.com).

# Mobile Specimen Collection

## Meditech

### 8000D Lab

A direct thermal paper label with a permanent acrylic adhesive specifically designed to adhere to small, curved surfaces.

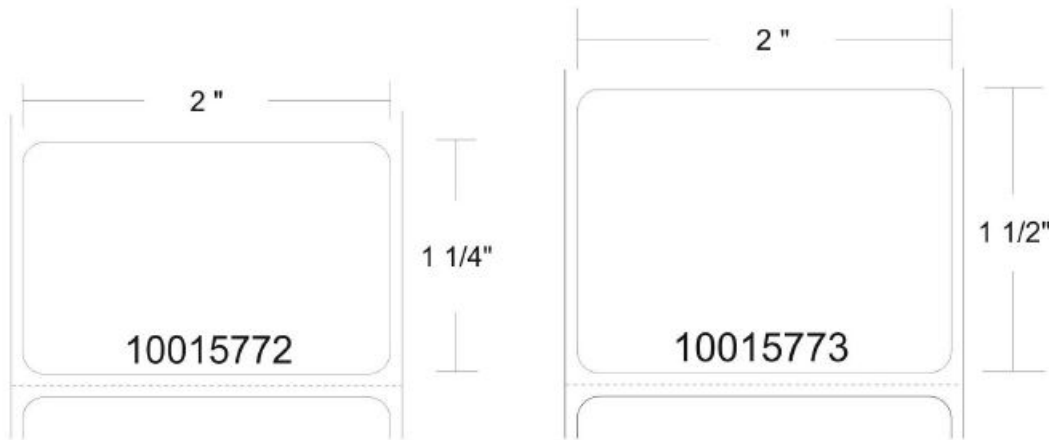

| Size |   |      | Part #   | ID, OD            | Amount/<br>roll | Rolls/<br>carton | Carton<br>Weight | Stock/<br>MTO |
|------|---|------|----------|-------------------|-----------------|------------------|------------------|---------------|
| W    | x | L    |          |                   |                 |                  |                  |               |
| 2    | x | 1.25 | 10015772 | 0.75" ID, 2.2" OD | 330             | 12               | 3 lbs.           | Stock         |
| 2    | x | 1.5  | 10015773 | 0.75" ID, 2.2" OD | 280             | 12               | 3 lbs.           | Stock         |

### PolyPro 4000D

A direct thermal polypropylene label with an all-temp permanent acrylic adhesive. Offers good resistance to scratching, smearing and moisture. Provides some flexibility for labeling curved surfaces.

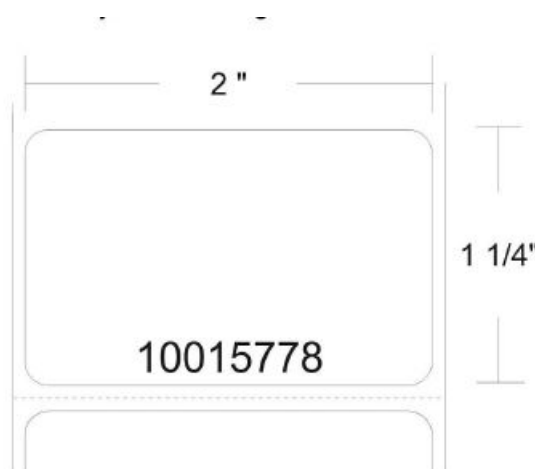

| Size |   |      | Part #   | ID, OD            | Amount/<br>roll | Rolls/<br>carton | Carton<br>Weight | Stock/<br>MTO |
|------|---|------|----------|-------------------|-----------------|------------------|------------------|---------------|
| W    | x | L    |          |                   |                 |                  |                  |               |
| 2    | x | 1.25 | 10015778 | 0.75" ID, 2.2" OD | 380             | 12               | 3 lbs.           | Stock         |

Stock - ships within one business day. Made to order (MTO) - see product category for specific lead time information. Products purchased in less than full inner carton quantities are subject to a \$75 broken carton charge, per destination. Prices effective June 14, 2021. Prices/stocking locations subject to change w/o notice. Refer to [www.zebra.com](http://www.zebra.com).



# Mobile Specimen Collection

## Meditech

### 8000D Lab

A direct thermal paper label with a permanent acrylic adhesive specifically designed to adhere to small, curved surfaces.

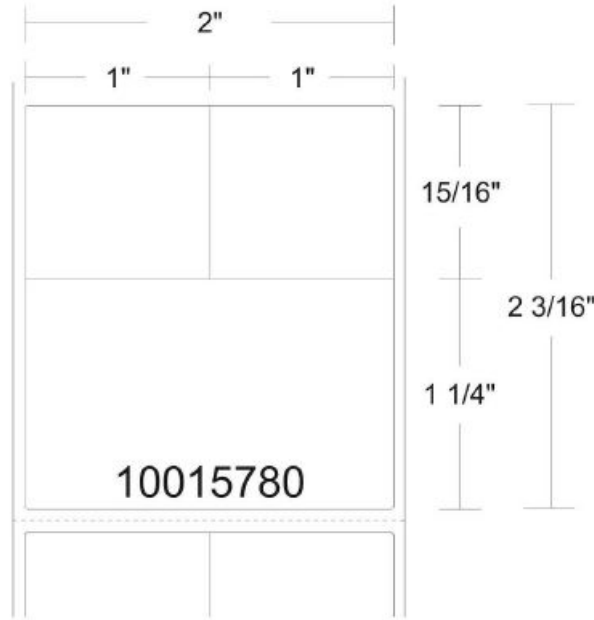

| Size |   |        | Part #   | ID, OD            | Amount/<br>roll | Rolls/<br>carton | Carton<br>Weight | Stock/<br>MTO |
|------|---|--------|----------|-------------------|-----------------|------------------|------------------|---------------|
| W    | x | L      |          |                   |                 |                  |                  |               |
| 2    | x | 2.1875 | 10015780 | 0.75" ID, 2.2" OD | 200             | 12               | 3 lbs.           | Stock         |

# Mobile Specimen Collection

## IQ Color Specimen Collection Labels

### IQ Color 2000D

A white, coated direct thermal paper label with a permanent acrylic adhesive which allows the ability to print vibrant color on-demand in pre-defined zones to be used as a visual cue.



| Size |   |   | Part #   | ID, OD            | Amount/<br>roll | Rolls/<br>carton | Carton<br>Weight | Stock/<br>MTO |
|------|---|---|----------|-------------------|-----------------|------------------|------------------|---------------|
| W    | x | L |          |                   |                 |                  |                  |               |
| 2    | x | 1 | 10020397 | 0.75" ID, 2.2" OD | 450             | 36               | 18 lbs.          | Stock         |

Red color zone runs along left edge of the label and measures 0.25" wide x 1" long.  
Black mark sensing and perforation between labels.

# Pharmacy

## Cerner

### Z-Perform 2000D

A direct thermal paper label with a permanent acrylic adhesive.

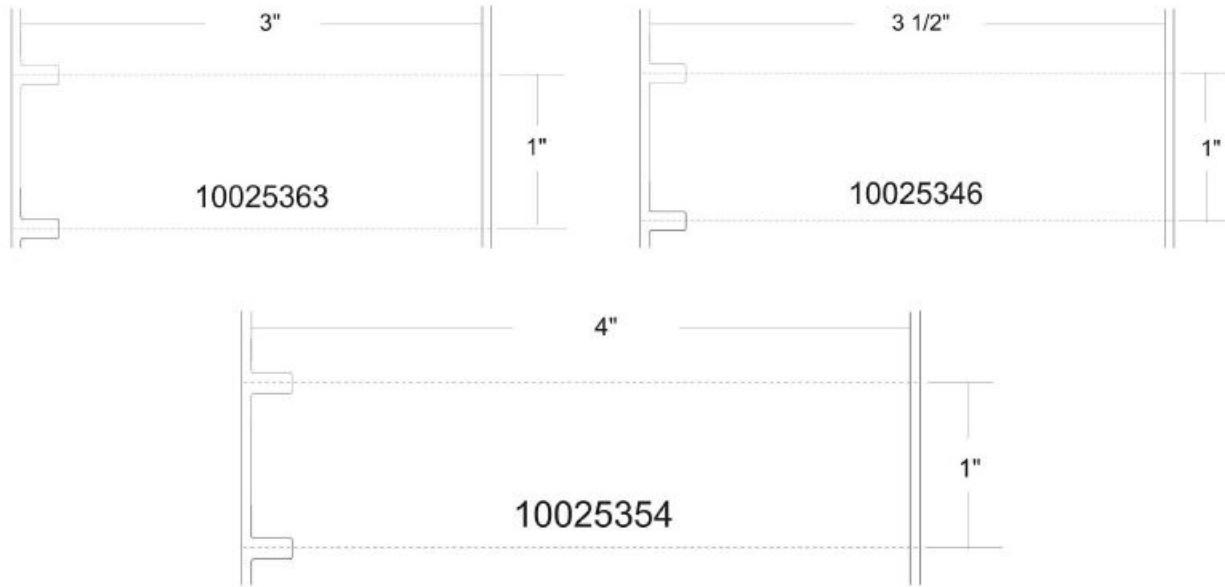

| Size |   |   | Part #   | ID, OD       | Amount/<br>roll | Rolls/<br>carton | Stock/<br>MTO |
|------|---|---|----------|--------------|-----------------|------------------|---------------|
| W    | x | L |          |              |                 |                  |               |
| 3    | x | 1 | 10025363 | 3" ID, 8" OD | 5,000           | 2                | MTO           |
| 3.5  | x | 1 | 10025346 | 3" ID, 8" OD | 5,800           | 2                | MTO           |
| 4    | x | 1 | 10025354 | 3" ID, 8" OD | 6,000           | 2                | MTO           |

Stock - ships within one business day. Made to order (MTO) - see product category for specific lead time information.  
 Products purchased in less than full inner carton quantities are subject to a \$75 broken carton charge, per destination.  
 Prices effective June 14, 2021. Prices/stocking locations subject to change w/o notice. Refer to [www.zebra.com](http://www.zebra.com).

# Pharmacy

## General

### Z-Select 4000D

A direct thermal, bright white coated paper label with an all-temp permanent acrylic adhesive.

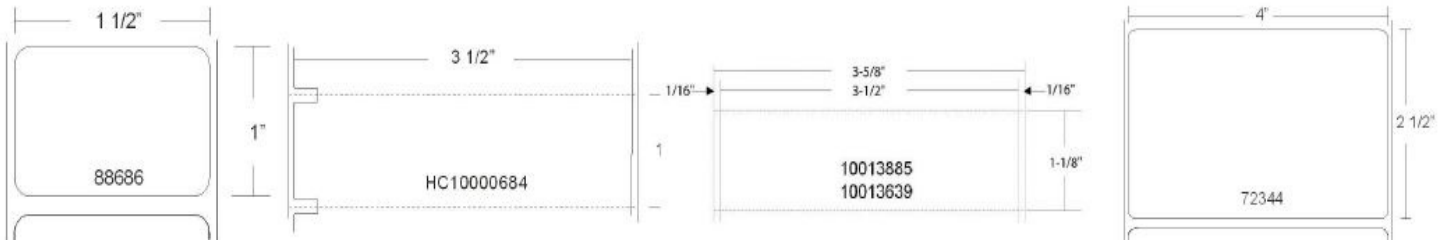

| Size |   |       | Part #     | ID, OD       | Amount/<br>roll | Rolls/<br>carton | Carton<br>Weight | Stock/<br>MTO |
|------|---|-------|------------|--------------|-----------------|------------------|------------------|---------------|
| W    | x | L     |            |              |                 |                  |                  |               |
| 1.5  | x | 1     | 88686      | 3" ID, 8" OD | 5,120           | 14               | 29 lbs.          | Stock         |
| 3.5  | x | 1     | HC10000684 | 3" ID, 8" OD | 5,760           | 6                | 30 lbs.          | Stock         |
| 3.5  | x | 1.125 | 10013885   | 1" ID, 5" OD | 2,374           | 4                | 10 lbs.          | MTO           |
| 4    | x | 2.5   | 72344      | 3" ID, 8" OD | 2,220           | 4                | 25 lbs.          | Stock         |

### Z-Select 4000T

A premium, thermal transfer, bright white, coated, ultra-smooth paper label with a permanent acrylic adhesive.

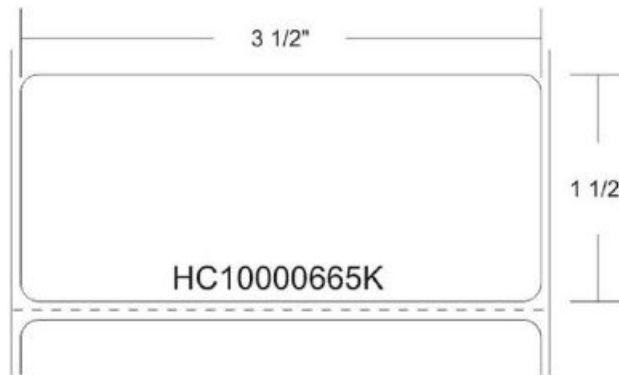

| Size |   |     | Part #      | ID, OD       | Amount/<br>roll | Rolls/<br>carton | Carton<br>Weight | Stock/MTO |
|------|---|-----|-------------|--------------|-----------------|------------------|------------------|-----------|
| W    | x | L   |             |              |                 |                  |                  |           |
| 3.5  | x | 1.5 | HC10000665K | 1" ID, 5" OD | 1,570           | 3                | 15 lbs.          | Stock     |

\*Kit includes 3 rolls of labels and 3 rolls of ribbon part number 05319GS11007. Perforation between labels.

# Breast Milk Tracking

Cerner, McKesson, Siemens

## PolyPro 4000D

A direct thermal polypropylene label with an all-temp permanent acrylic adhesive. For use in water temperatures up to 160°F.

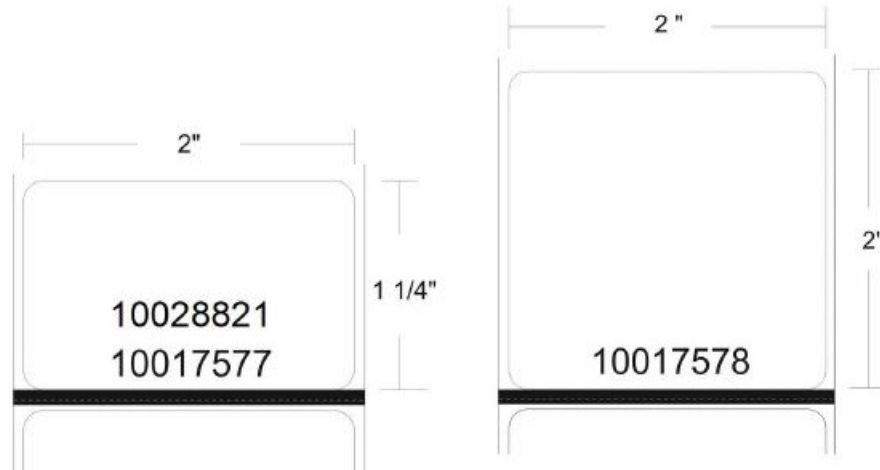

| Size |   |      | Part #   | ID, OD            | Amount/<br>roll | Rolls/<br>carton | Carton<br>Weight | Stock/<br>MTO |
|------|---|------|----------|-------------------|-----------------|------------------|------------------|---------------|
| W    | x | L    |          |                   |                 |                  |                  |               |
| 2    | x | 1.25 | 10028821 | 1" ID, 5" OD      | 2,189           | 8                | 14 lbs.          | MTO           |
| 2    | x | 1.25 | 10017577 | 0.75" ID, 2.2" OD | 380             | 12               | 3 lbs.           | Stock         |
| 2    | x | 2    | 10017578 | 0.75" ID, 2.2" OD | 245             | 12               | 3 lbs.           | Stock         |

Labels equipped with overprotective varnish.

# Breast Milk Tracking

## CareFusion

### Z-Ultimate 4000T

A thermal transfer, pearl white, gloss polyester label with a high performance acrylic adhesive. Provides unparalleled smear and scratch resistance to moderate chemicals.

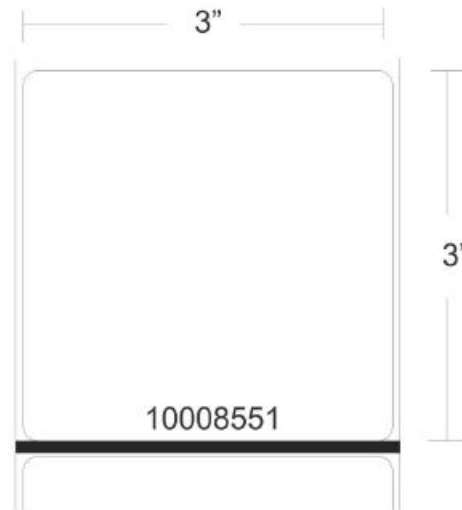

| Size |   |   | Part #   | ID, OD            | Amount/<br>roll | Rolls/<br>carton | Carton<br>Weight | Stock/<br>MTO | Ribbon Part<br>Number* |
|------|---|---|----------|-------------------|-----------------|------------------|------------------|---------------|------------------------|
| W    | x | L |          |                   |                 |                  |                  |               |                        |
| 3    | x | 3 | 10008551 | 0.75" ID, 2.6" OD | 230             | 12               | 16 lbs.          | Stock         | 05095BK110D            |

\*Ribbon pricing located on the last page of the price list.

# Multipurpose

## General

### Z-Perform 2000D

A white, coated direct thermal paper label with an all-temp permanent acrylic adhesive.

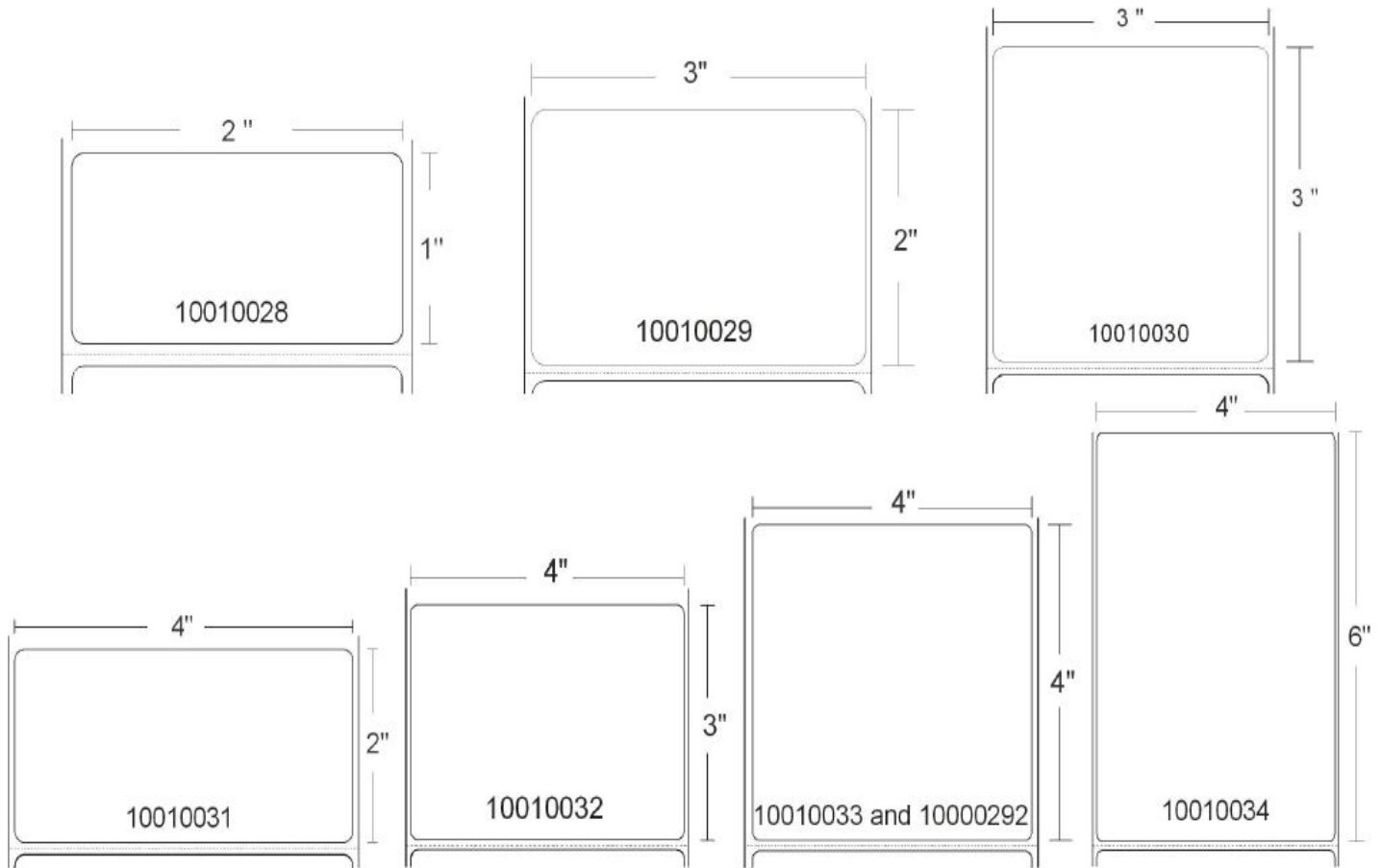

| Size |   |   | Part #   | ID, OD       | Amount/<br>roll | Rolls/<br>carton | Carton<br>Weight | Stock/<br>MTO |
|------|---|---|----------|--------------|-----------------|------------------|------------------|---------------|
| W    | x | L |          |              |                 |                  |                  |               |
| 2    | x | 1 | 10010028 | 1" ID, 5" OD | 2,340           | 6                | 10 lbs.          | Stock         |
| 3    | x | 2 | 10010029 | 1" ID, 5" OD | 1,240           | 6                | 11 lbs.          | Stock         |
| 4    | x | 2 | 10010031 | 1" ID, 5" OD | 1,240           | 6                | 14 lbs.          | Stock         |
| 4    | x | 3 | 10010032 | 1" ID, 5" OD | 840             | 6                | 15 lbs.          | Stock         |
| 4    | x | 4 | 10000292 | 3" ID, 8" OD | 1,500           | 4                | 26 lbs.          | Stock         |
| 4    | x | 4 | 10010033 | 1" ID, 5" OD | 640             | 6                | 15 lbs.          | Stock         |
| 4    | x | 6 | 10010034 | 1" ID, 5" OD | 430             | 6                | 16 lbs.          | Stock         |

Stock - ships within one business day. Made to order (MTO) - see product category for specific lead time information.  
 Products purchased in less than full inner carton quantities are subject to a \$75 broken carton charge, per destination.  
 Prices effective June 14, 2021. Prices/stocking locations subject to change w/o notice. Refer to [www.zebra.com](http://www.zebra.com).

# Multipurpose

## General

### Z-Perform 2000D Floodcoated

A coated direct thermal paper label with an all-temp permanent acrylic adhesive.

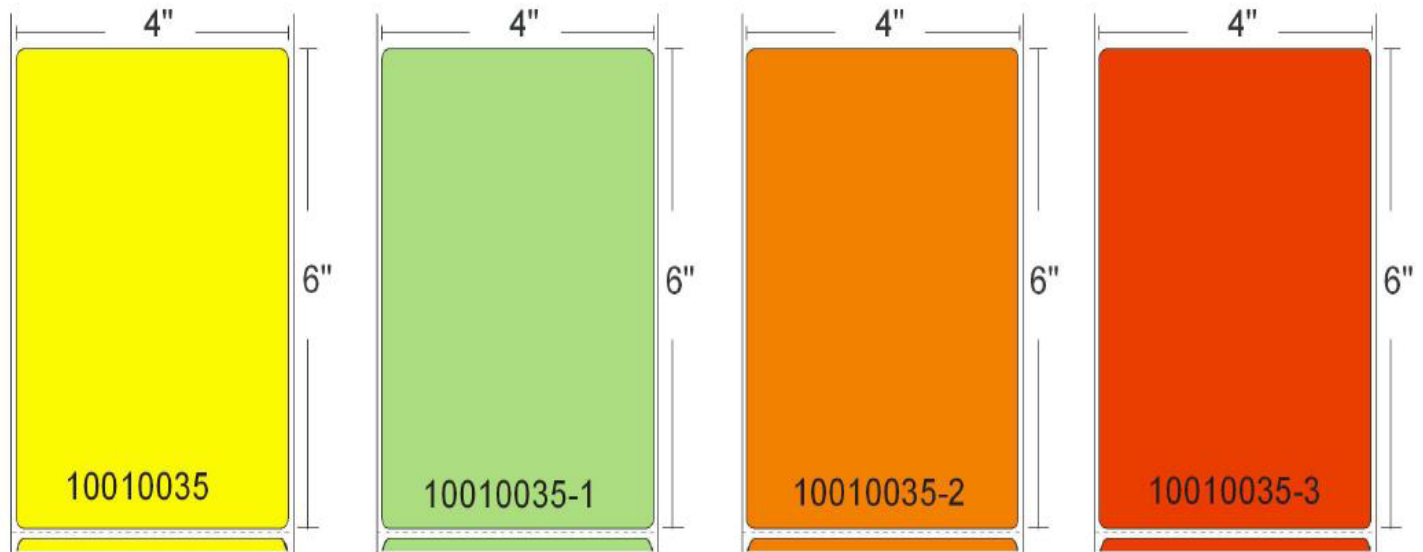

| Size |   |   | Part #     | ID, OD       | Color | Amount/<br>roll | Rolls/<br>carton | Carton<br>Weight | Stock/<br>MTO |
|------|---|---|------------|--------------|-------|-----------------|------------------|------------------|---------------|
| W    | x | L |            |              |       |                 |                  |                  |               |
| 4    | x | 6 | 10010035   | 1" ID, 5" OD | Yel.  | 430             | 6                | 16 lbs.          | Stock         |
| 4    | x | 6 | 10010035-1 | 1" ID, 5" OD | Grn.  | 430             | 6                | 12 lbs.          | Stock         |
| 4    | x | 6 | 10010035-2 | 1" ID, 5" OD | Org.  | 430             | 6                | 12 lbs.          | Stock         |
| 4    | x | 6 | 10010035-3 | 1" ID, 5" OD | Red   | 430             | 6                | 12 lbs.          | Stock         |

Stock - ships within one business day. Made to order (MTO) - see product category for specific lead time information.  
 Products purchased in less than full inner carton quantities are subject to a \$75 broken carton charge, per destination.  
 Prices effective June 14, 2021. Prices/stocking locations subject to change w/o notice. Refer to [www.zebra.com](http://www.zebra.com).



# Multipurpose

## General

### Z-Select 4000D

A direct thermal, bright white coated paper label with an all-temp permanent acrylic adhesive.

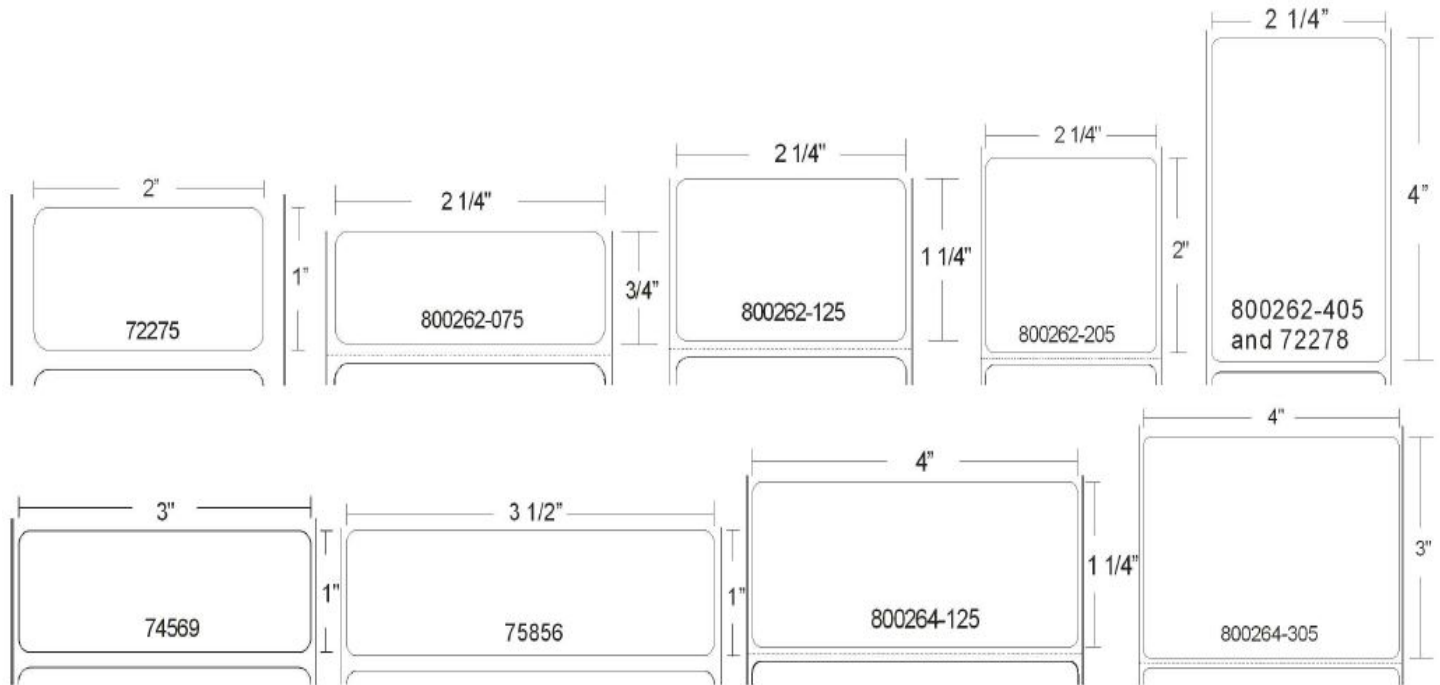

| Size |   |      | Part #   | ID, OD       | Amount/<br>roll | Rolls/<br>carton | Carton<br>Weight | Stock/<br>MTO |
|------|---|------|----------|--------------|-----------------|------------------|------------------|---------------|
| W    | x | L    |          |              |                 |                  |                  |               |
| 2    | x | 1    | 72275    | 3" ID, 8" OD | 4,620           | 8                | 22 lbs.          | Stock         |
| 2.25 | x | 0.75 | 10015340 | 1" ID, 5" OD | 3,315           | 12               | 20 lbs.          | Stock         |
| 2.25 | x | 1.25 | 10015341 | 1" ID, 5" OD | 2,100           | 12               | 20 lbs.          | Stock         |
| 2.25 | x | 2    | 10015342 | 1" ID, 5" OD | 1,370           | 12               | 20 lbs.          | Stock         |
| 2.25 | x | 4    | 10015343 | 1" ID, 5" OD | 700             | 12               | 20 lbs.          | Stock         |
| 2.25 | x | 4    | 72278    | 3" ID, 8" OD | 1,260           | 8                | 25 lbs.          | Stock         |
| 3    | x | 1    | 74569    | 3" ID, 8" OD | 5,120           | 6                | 24 lbs.          | Stock         |
| 3.5  | x | 1    | 75856    | 3" ID, 8" OD | 5,120           | 6                | 29 lbs.          | Stock         |
| 4    | x | 1.25 | 10015349 | 1" ID, 5" OD | 2,100           | 12               | 28 lbs.          | Stock         |
| 4    | x | 3    | 10015344 | 1" ID, 5" OD | 930             | 12               | 30 lbs.          | Stock         |

Stock - ships within one business day. Made to order (MTO) - see product category for specific lead time information.  
 Products purchased in less than full inner carton quantities are subject to a \$75 broken carton charge, per destination.  
 Prices effective June 14, 2021. Prices/stocking locations subject to change w/o notice. Refer to [www.zebra.com](http://www.zebra.com).

# Specialty

## Radiology

### Z-Select 4000D Specialty

A direct thermal, bright white coated paper label with an all-temp permanent acrylic adhesive.

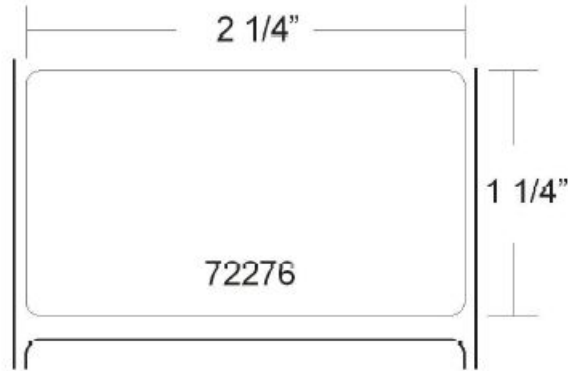

| Size |   |      | Part # | ID, OD       | Amount/<br>roll | Rolls/<br>carton | Carton<br>Weight | Stock/<br>MTO |
|------|---|------|--------|--------------|-----------------|------------------|------------------|---------------|
| W    | x | L    |        |              |                 |                  |                  |               |
| 2.25 | x | 1.25 | 72276  | 3" ID, 8" OD | 3,770           | 8                | 24 lbs.          | Stock         |

Stock - ships within one business day. Made to order (MTO) - see product category for specific lead time information.  
 Products purchased in less than full inner carton quantities are subject to a \$75 broken carton charge, per destination.  
 Prices effective June 14, 2021. Prices/stocking locations subject to change w/o notice. Refer to [www.zebra.com](http://www.zebra.com).

# Specialty

## Sterilization

### Z-Ultimate 2000T White

A pearl white, gloss polyester thermal transfer label with a high performance permanent acrylic adhesive.

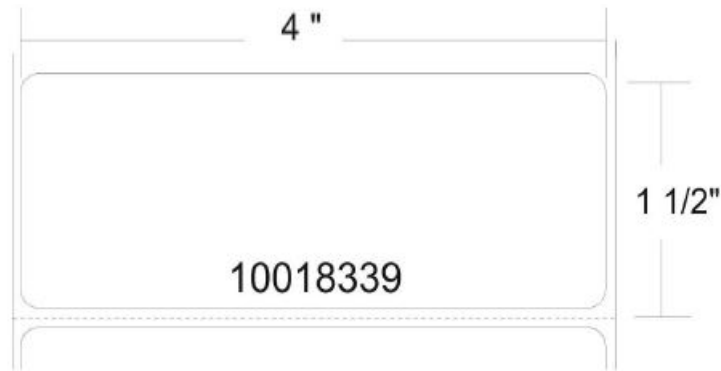

| Size |   |     | Part #   | ID, OD       | Amount/<br>roll | Rolls/<br>carton | Carton<br>Weight | Stock/<br>MTO | Ribbon Part<br>Number* |
|------|---|-----|----------|--------------|-----------------|------------------|------------------|---------------|------------------------|
| W    | x | L   |          |              |                 |                  |                  |               |                        |
| 4    | x | 1.5 | 10018339 | 3" ID, 8" OD | 3,800           | 4                | 32 lbs           | Stock         | 06200BK11045           |

\*Ribbon pricing located on the last page of the price list.

### Z-Ultimate 3000T White

A pearl white, gloss polyester thermal transfer label with a high performance permanent acrylic adhesive

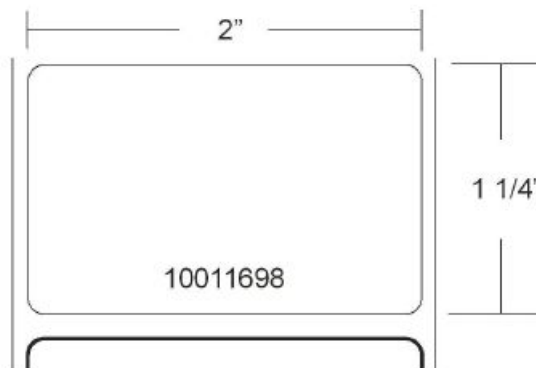

| Size |   |      | Part #   | ID, OD       | Amount/<br>roll | Rolls/<br>carton | Carton<br>Weight | Stock/<br>MTO | Ribbon Part<br>Number* |
|------|---|------|----------|--------------|-----------------|------------------|------------------|---------------|------------------------|
| W    | x | L    |          |              |                 |                  |                  |               |                        |
| 2    | x | 1.25 | 10011698 | 3" ID, 8" OD | 4,270           | 4                | 10 lbs.          | Stock         | 06200BK06045           |

\*Ribbon pricing located on the last page of the price list

# Specialty

## Asset Tracking

### PolyPro 4000T

A thermal transfer Kimdura® polypropylene label with a permanent acrylic adhesive.

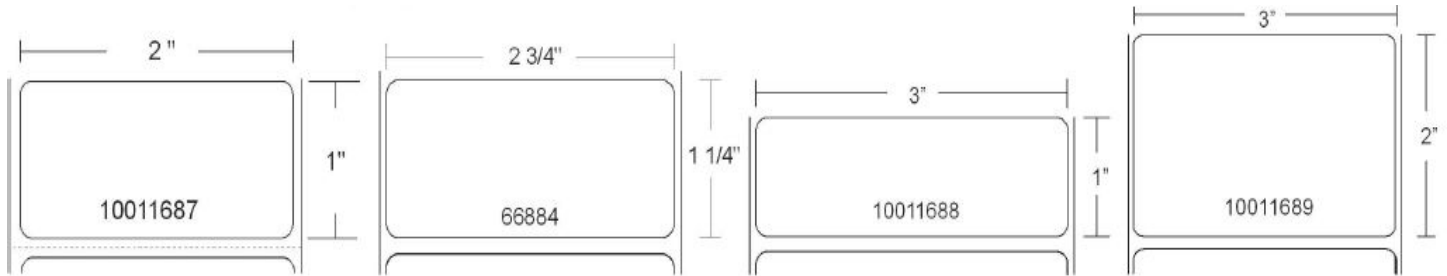

| Size |   |      | Part #   | ID, OD       | Amount/<br>roll | Rolls/<br>carton | Carton<br>Weight | Stock/<br>MTO | Ribbon Part<br>Number* |
|------|---|------|----------|--------------|-----------------|------------------|------------------|---------------|------------------------|
| W    | x | L    |          |              |                 |                  |                  |               |                        |
| 2    | x | 1    | 10014716 | 3" ID, 8" OD | 3,940           | 4                | 10 lbs.          | Stock         | 06100BK06045           |
| 2.75 | x | 1.25 | 10014717 | 3" ID, 8" OD | 3,210           | 4                | 28 lbs.          | Stock         | 06100BK08045           |
| 3    | x | 1    | 10011688 | 3" ID, 8" OD | 4,350           | 4                | 20 lbs.          | Stock         | 06100BK08045           |
| 3    | x | 2    | 10011689 | 3" ID, 8" OD | 2,230           | 4                | 20 lbs.          | Stock         | 06100BK08045           |

\*Ribbon pricing located on the last page of the price list

# Wristbands

## Wristband Cartridges

### Z-Band UltraSoft Kit

Ultra-soft and flexible direct thermal polypropylene and vinyl wristband with an adhesive tamper-evident tab for securement. Scannable up to 14 days. Wristbands contained in an easy-to-load cartridge for the HC100/ZD510 Printer.

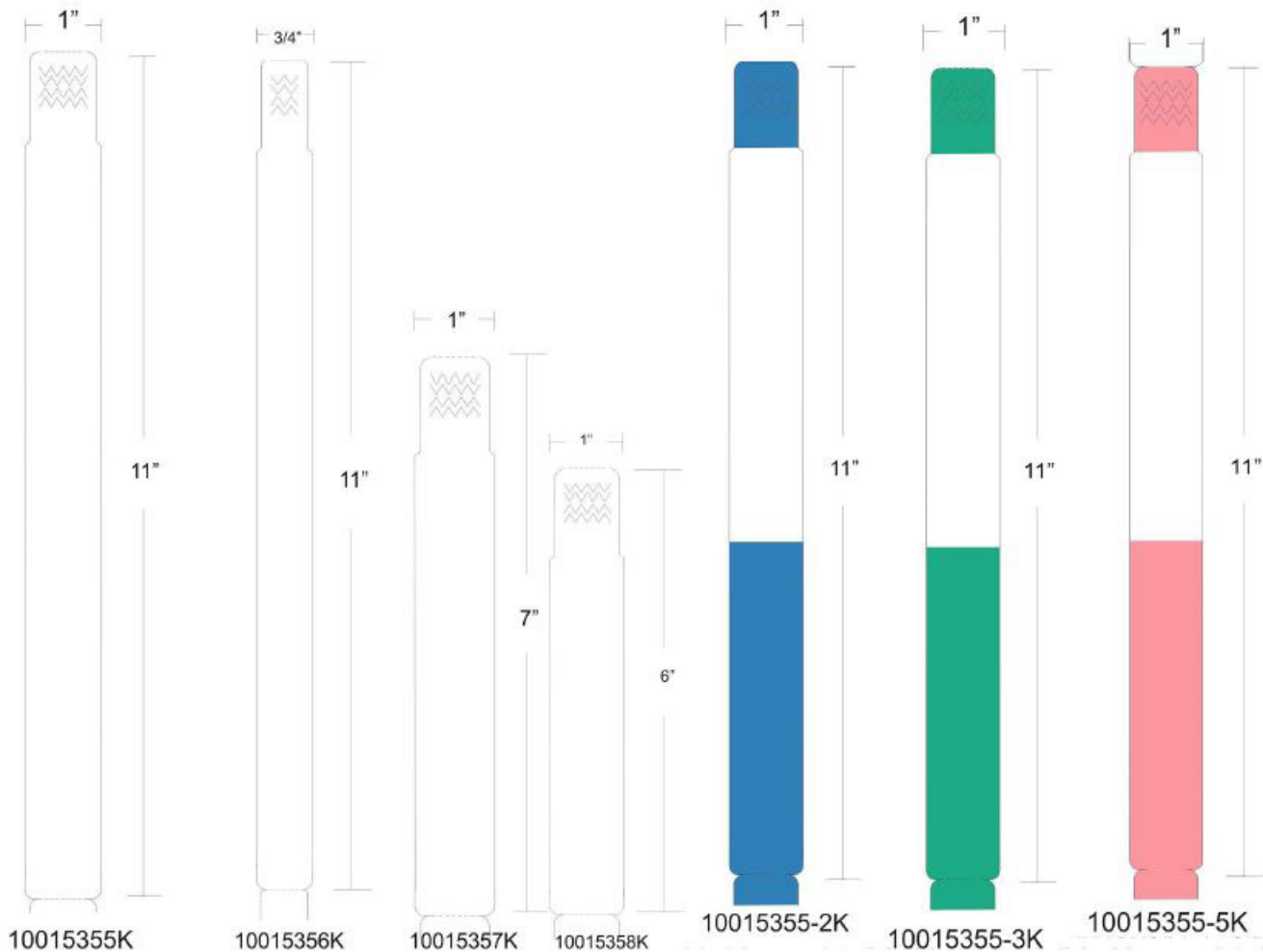

| Size |   |    | Part #      | Color | Amount/roll | Rolls/carton | Carton Weight | Stock/MTO |
|------|---|----|-------------|-------|-------------|--------------|---------------|-----------|
| W    | x | L  |             |       |             |              |               |           |
| 1    | x | 11 | 10015355-2K | Blue  | 175         | 6            | 6 lbs.        | Stock     |
| 1    | x | 11 | 10015355-3K | Green | 175         | 6            | 6 lbs.        | Stock     |
| 1    | x | 11 | 10015355-5K | Pink  | 175         | 6            | 6 lbs.        | Stock     |
| 1    | x | 11 | 10015355K   | White | 175         | 6            | 6 lbs.        | Stock     |
| 0.75 | x | 11 | 10015356K   | White | 175         | 6            | 6 lbs.        | Stock     |
| 1    | x | 7  | 10015357K   | White | 250         | 6            | 6 lbs.        | Stock     |
| 1    | x | 6  | 10015358K   | White | 300         | 6            | 6 lbs.        | Stock     |

Must be ordered in carton quantities. Each part number represents 1 carton.

Stock - ships within one business day. Made to order (MTO) - see product category for specific lead time information. Products purchased in less than full inner carton quantities are subject to a \$75 broken carton charge, per destination. Prices effective June 14, 2021. Prices/stocking locations subject to change w/o notice. Refer to [www.zebra.com](http://www.zebra.com).

# Wristbands

## Wristband Cartridges

### Z-Band UltraSoft - Bracelet Design

Ultra-soft and flexible direct thermal polypropylene and vinyl wristband with an adhesive tamper-evident tab for securement. The bracelet design provides superior patient comfort by reducing the size of the wristband on the back of the wrist. Scannable up to 14 days. Wristbands contained in an easy-to-load cartridge for the HC100/ZD510 Printer.

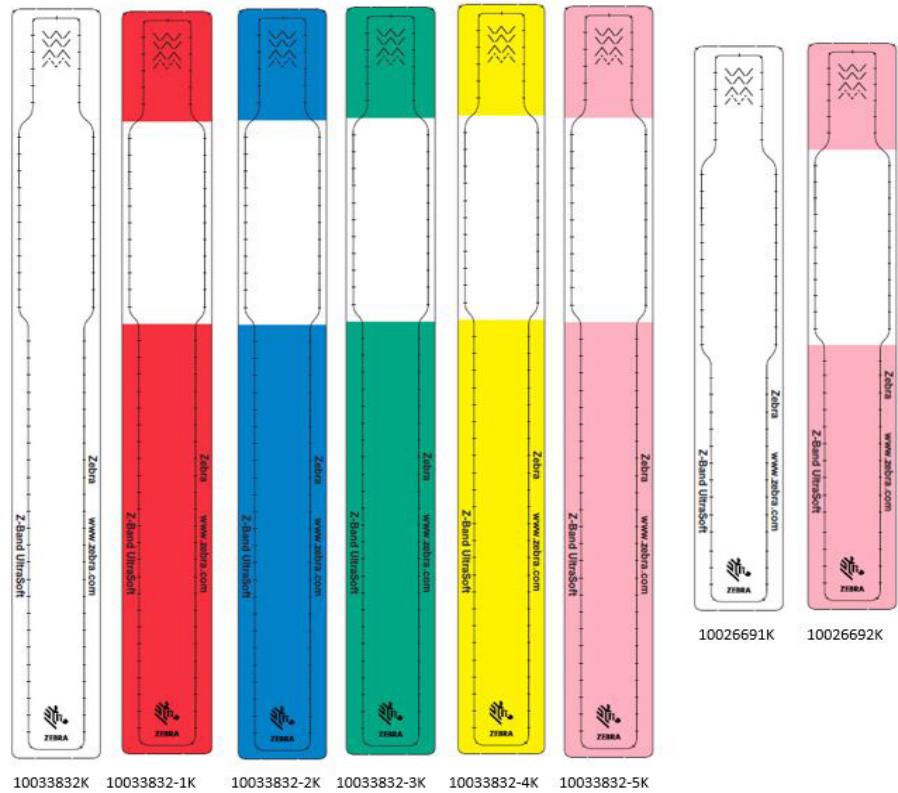

| Size |   |       | Part #      | Color  | Amount/roll | Rolls/carton | Carton Weight | Stock/MTO |
|------|---|-------|-------------|--------|-------------|--------------|---------------|-----------|
| W    | x | L     |             |        |             |              |               |           |
| 1    | x | 7     | 10026691K   | White  | 275         | 6            | 6 lbs.        | Stock     |
| 1    | x | 7     | 10026692K   | Pink   | 275         | 6            | 6 lbs.        | Stock     |
| 1    | x | 10.75 | 10033832K   | White  | 175         | 6            | 6 lbs.        | Stock     |
| 1    | x | 10.75 | 10033832-1K | Red    | 175         | 6            | 6 lbs.        | Stock     |
| 1    | x | 10.75 | 10033832-2K | Blue   | 175         | 6            | 6 lbs.        | Stock     |
| 1    | x | 10.75 | 10033832-3K | Green  | 175         | 6            | 6 lbs.        | Stock     |
| 1    | x | 10.75 | 10033832-4K | Yellow | 175         | 6            | 6 lbs.        | Stock     |
| 1    | x | 10.75 | 10033832-5K | Pink   | 175         | 6            | 6 lbs.        | Stock     |

All wristband part numbers are perforated  
 With the gutter, wristband sizes are 1.1875"x7.25" and 1.1875"x11"

Stock - ships within one business day. Made to order (MTO) - see product category for specific lead time information. Products purchased in less than full inner carton quantities are subject to a \$75 broken carton charge, per destination. Prices effective June 14, 2021. Prices/stocking locations subject to change w/o notice. Refer to [www.zebra.com](http://www.zebra.com).

# Wristbands

## Wristband Cartridges

### Z-Band Direct Kit

Direct thermal polypropylene wristband with an adhesive tamper-evident tab for securement. Scannable up to 14 days. Wristbands contained in an easy-to-load cartridge for the HC100/ZD510 printer.

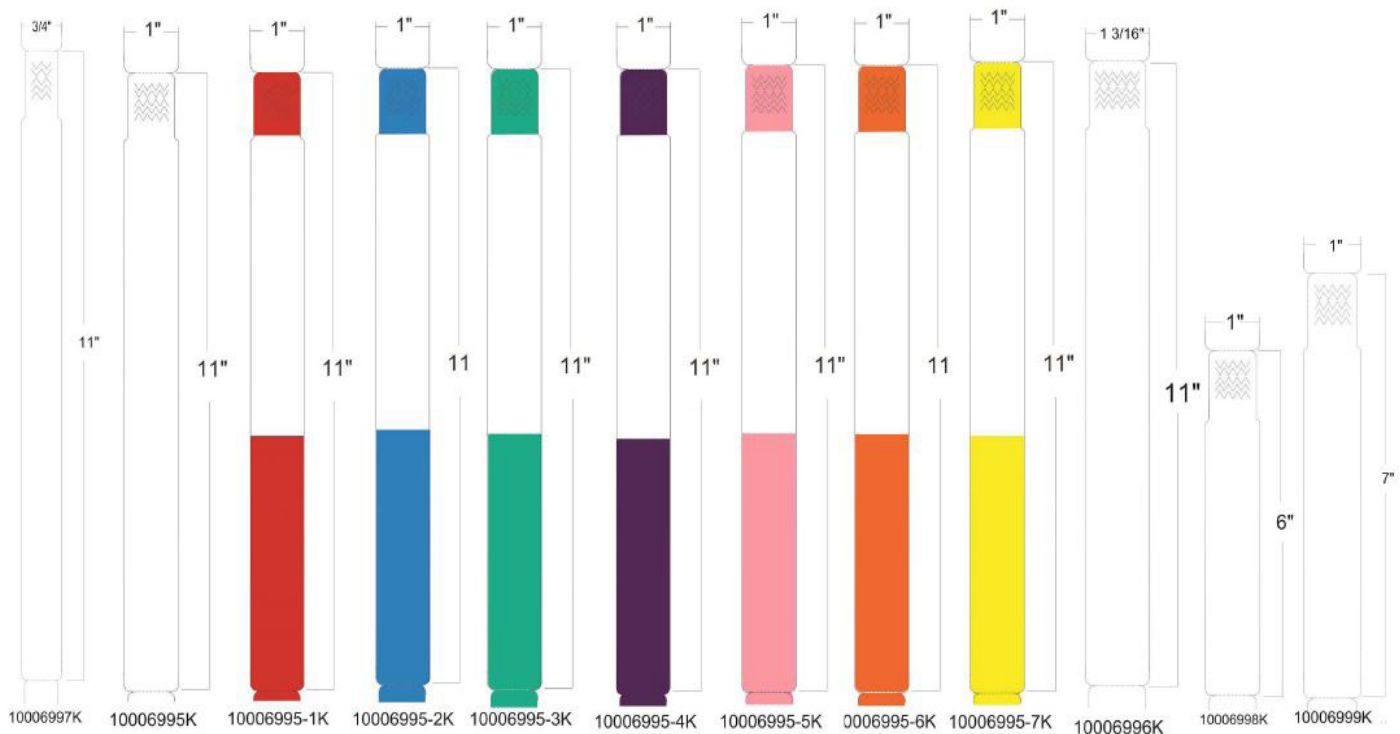

| Size   |   |    | Part #      | Color  | Amount/roll | Rolls/carton | Carton Weight | Stock/ MTO |
|--------|---|----|-------------|--------|-------------|--------------|---------------|------------|
| W      | x | L  |             |        |             |              |               |            |
| 0.75   | x | 11 | 10006997K   | White  | 200         | 6            | 6 lbs.        | Stock      |
| 1      | x | 11 | 10006995K   | White  | 200         | 6            | 6 lbs.        | Stock      |
| 1      | x | 11 | 10006995-1K | Red    | 200         | 6            | 6 lbs.        | Stock      |
| 1      | x | 11 | 10006995-2K | Blue   | 200         | 6            | 6 lbs.        | Stock      |
| 1      | x | 11 | 10006995-3K | Green  | 200         | 6            | 6 lbs.        | Stock      |
| 1      | x | 11 | 10006995-4K | Purple | 200         | 6            | 6 lbs.        | Stock      |
| 1      | x | 11 | 10006995-5K | Pink   | 200         | 6            | 6 lbs.        | Stock      |
| 1      | x | 11 | 10006995-6K | Orange | 200         | 6            | 6 lbs.        | Stock      |
| 1      | x | 11 | 10006995-7K | Yellow | 200         | 6            | 6 lbs.        | Stock      |
| 1.1875 | x | 11 | 10006996K   | White  | 200         | 6            | 6 lbs.        | Stock      |
| 1      | x | 6  | 10006998K   | White  | 350         | 6            | 6 lbs.        | Stock      |
| 1      | x | 7  | 10006999K   | White  | 300         | 6            | 6 lbs.        | Stock      |

Must be ordered in carton quantities. Each part number represents 1 carton.

Stock - ships within one business day. Made to order (MTO) - see product category for specific lead time information. Products purchased in less than full inner carton quantities are subject to a \$75 broken carton charge, per destination. Prices effective June 14, 2021. Prices/stocking locations subject to change w/o notice. Refer to [www.zebra.com](http://www.zebra.com).

# Wristbands

## Wristband Cartridges

### Z-Band Comfort Kit

Light-weight and flexible direct thermal polypropylene wristband with an adhesive tamper-evident tab for securement. Scannable up to 7 days. Wristbands contained in an easy-to-load cartridge for the HC100/ZD510 printer.

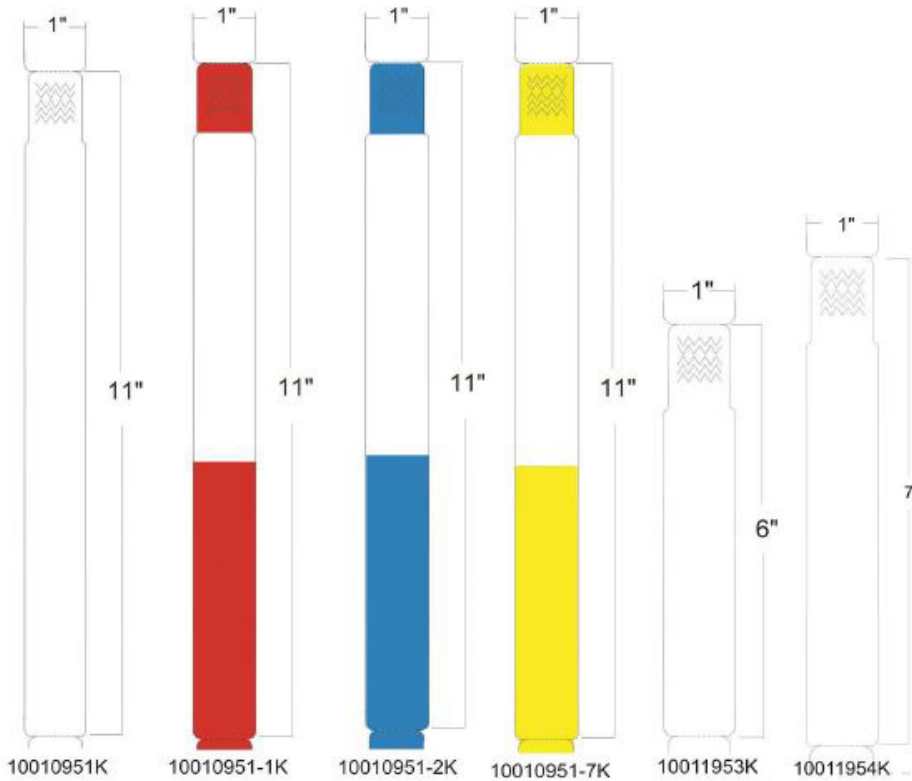

| Size |   |    | Part #      | Color  | Amount/roll | Rolls/carton | Carton Weight | Stock/ MTO |
|------|---|----|-------------|--------|-------------|--------------|---------------|------------|
| W    | x | L  |             |        |             |              |               |            |
| 1    | x | 11 | 10010951K   | White  | 300         | 6            | 6 lbs.        | Stock      |
| 1    | x | 11 | 10010951-1K | Red    | 300         | 6            | 6 lbs.        | Stock      |
| 1    | x | 11 | 10010951-2K | Blue   | 300         | 6            | 6 lbs.        | Stock      |
| 1    | x | 11 | 10010951-7K | Yellow | 300         | 6            | 6 lbs.        | Stock      |
| 1    | x | 6  | 10011953K   | White  | 600         | 6            | 6 lbs.        | Stock      |
| 1    | x | 7  | 10011954K   | White  | 500         | 6            | 6 lbs.        | Stock      |

Must be ordered in carton quantities. Each part number represents 1 carton.



# Wristbands

## Wristband Cartridges

### Z-Band Newborn Soft Kit

A direct thermal white polypropylene wristband with soft nylon lining and an adhesive tab for securement. Wristbands contained in an easy-to-load cartridge for the HC100/ZD510 printer.

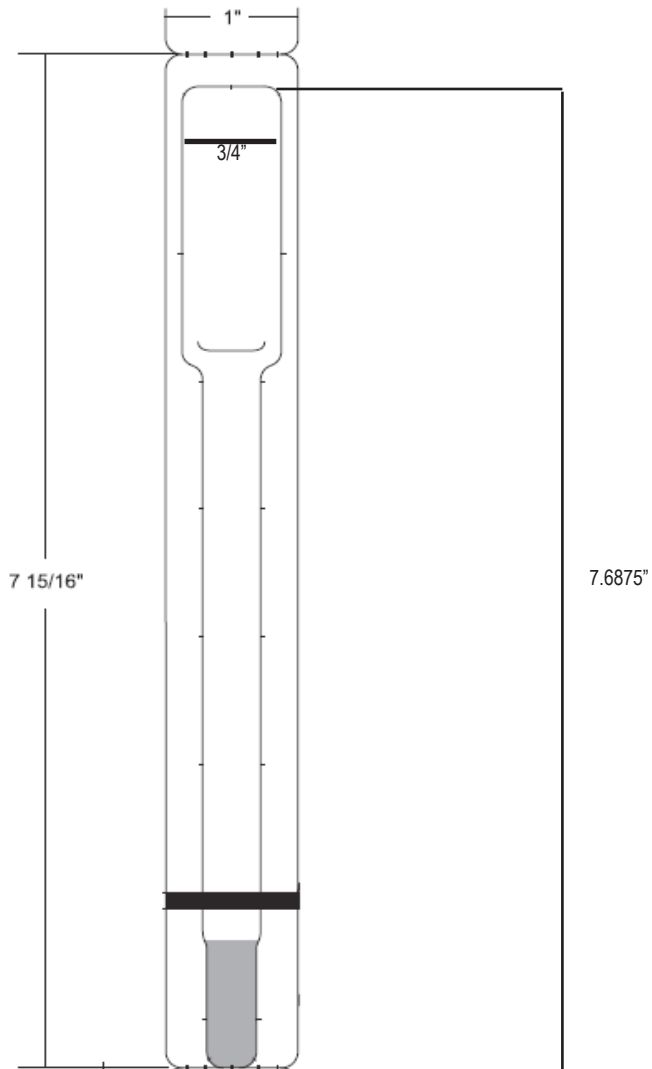

| Size |   |        | Part #    | Color | Amount/roll | Rolls/carton | Carton Weight | Stock/MTO |
|------|---|--------|-----------|-------|-------------|--------------|---------------|-----------|
| W    | x | L      |           |       |             |              |               |           |
| 0.75 | x | 7.6875 | 10031289K | White | 260         | 6            | 5 lbs.        | Stock     |

Wristband size is 1x7.9375 before tearing from gutter.  
Must be ordered in carton quantities. Each part number represents 1 carton.

# Wristbands

## Wristband Cartridges

### Z-Band Newborn Kit

A direct thermal white polypropylene wristband with an adhesive tab for securement. Wristbands contained in an easy-to-load cartridge for the HC100/ZD510 printer.

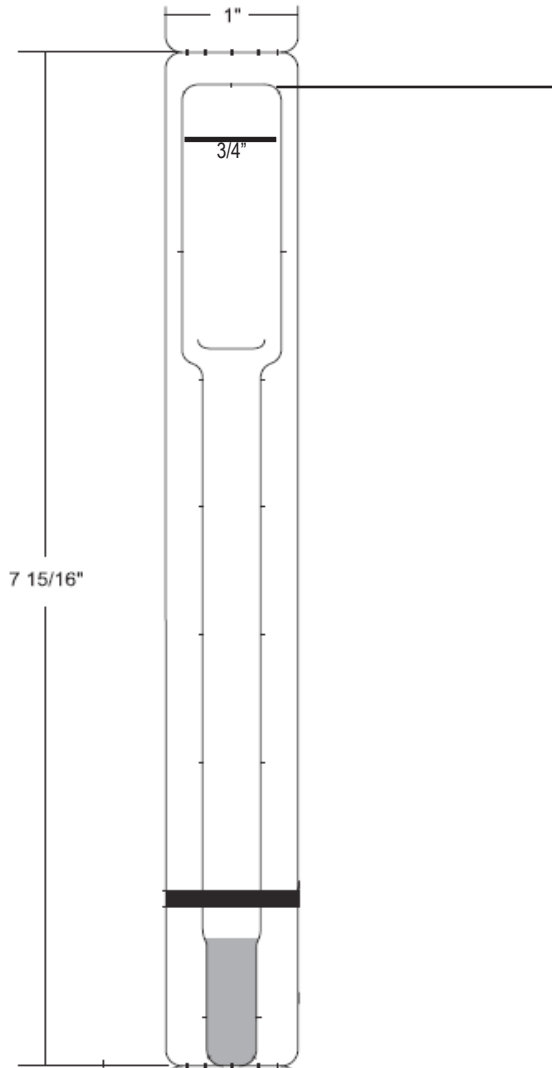

| Size |   |        | Part #    | Color | Amount/roll | Rolls/carton | Carton Weight | Stock/MTO |
|------|---|--------|-----------|-------|-------------|--------------|---------------|-----------|
| W    | x | L      |           |       |             |              |               |           |
| 0.75 | x | 7.6875 | 10035439K | White | 260         | 6            | 5 lbs.        | Stock     |

Stock - ships within one business day. Made to order (MTO) - see product category for specific lead time information. Products purchased in less than full inner carton quantities are subject to a \$75 broken carton charge, per destination. Prices effective June 14, 2021. Prices/stocking locations subject to change w/o notice. Refer to [www.zebra.com](http://www.zebra.com).

# Wristbands

## Wristband Cartridges

### Z-Band Maternity ID Solution

**Maternity ID Solution (1 Adult and 1 Infant Wristbands in 1 Set)**

|              |  |
|--------------|--|
| 10035358-M1K | Total set: 1" x 17" / 25mm x 432mm<br>Adult Size: 1" x 11" / 25mm x 279mm<br>Infant Size: 1" x 6" / 25mm x 152mm |
|--------------|--|



## Wristband Cartridges

### Z-Band UltraSoft Maternity ID Solution

Ultra-soft and flexible direct thermal polypropylene and vinyl wristband with a tamper-evident adhesive closure and bracelet design. Latex-free.

| Size |   |    | Color | Part Number  | Bands/<br>roll | Rolls/kit | Carton<br>Weight | Stocking Locations |    |    |    |  |
|------|---|----|-------|--------------|----------------|-----------|------------------|--------------------|----|----|----|--|
| W    | x | L  |       |              |                |           |                  | WI                 | GA | TX | CA |  |
| 1    | x | 17 | White | 10035358-M1K | 115            | 6         | 6 lbs.           | X                  |    |    |    |  |

\*115 sets of wristbands per cartridge: 1 adult wristband (1x11") + 1 infant wristband (1x6") per set. 230 Total wristbands per cartridge.

This wristband helps ensure that every newborn is properly identified and matched to their mother. This solution features one adult wristband and one infant wristband per set. Two sets can easily be used to match the infant to the birth partner.

# Wristbands

## Wristband Cartridges

### Z-Band Quick Clip Kit

Direct thermal polypropylene wristband with secure clip closures. Scannable up to 14 days. Wristband contained in an easy-to-load cartridge for the HC100/ZD510 printer.

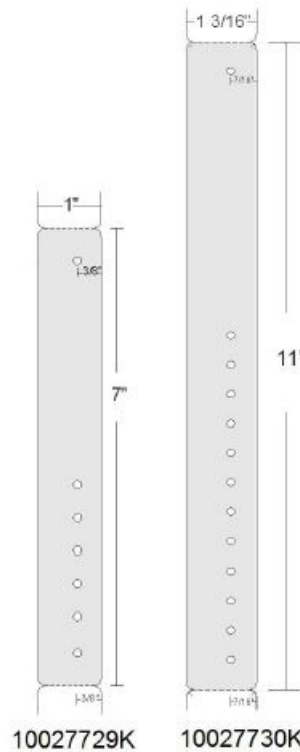

| Size   |   |    | Part #    | Color | Amount/roll | Rolls/carton | Carton Weight |
|--------|---|----|-----------|-------|-------------|--------------|---------------|
| W      | x | L  |           |       |             |              |               |
| 1.1875 | x | 11 | 10027730K | White | 240         | 4            | 6 lbs.        |
| 1      | x | 7  | 10027729K | White | 380         | 3            | 6 lbs.        |

(1x7) Quickclip: Includes 3 wristband cartridges and 1,450 white clips. Color clips sold separately.  
 (1.1875x11) Quickclip: Includes 4 wristband cartridges and 1,160 white clips. Color clips sold separately.

### Color Clips for use with QuickClip Wristbands

| Part #       | Color  | Clips Per Pack | Stock/MTO |
|--------------|--------|----------------|-----------|
| 97032-Blue   | Blue   | 275            | Stock     |
| 97032-Green  | Green  | 275            | Stock     |
| 97032-Pink   | Pink   | 275            | Stock     |
| 97032-Purple | Purple | 275            | Stock     |
| 97032-Red    | Red    | 275            | Stock     |
| 97032-Yellow | Yellow | 275            | Stock     |

Stock - ships within one business day. Made to order (MTO) - see product category for specific lead time information.  
 Products purchased in less than full inner carton quantities are subject to a \$75 broken carton charge, per destination.  
 Prices effective June 14, 2021. Prices/stocking locations subject to change w/o notice. Refer to [www.zebra.com](http://www.zebra.com).

# Wristbands

## Z-Band UltraSoft

### Z-Band UltraSoft Wristbands

Ultra-soft and flexible direct thermal polypropylene and vinyl wristband with an adhesive tamper-evident tab for securement. Scannable up to 14 days.

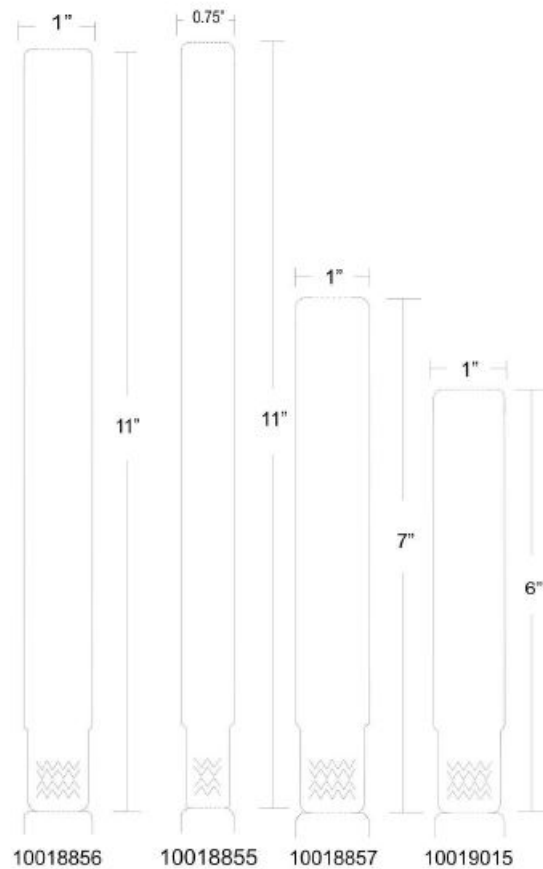

| Size |   |    | Part #   | ID, OD       | Color | Amount/<br>roll | Rolls/<br>carton | Carton<br>Weight | Stock/<br>MTO |
|------|---|----|----------|--------------|-------|-----------------|------------------|------------------|---------------|
| W    | x | L  |          |              |       |                 |                  |                  |               |
| 0.75 | x | 11 | 10018855 | 1" ID, 5" OD | White | 175             | 6                | 6 lbs.           | Stock         |
| 1    | x | 11 | 10018856 | 1" ID, 5" OD | White | 175             | 6                | 6 lbs.           | Stock         |
| 1    | x | 7  | 10018857 | 1" ID, 5" OD | White | 250             | 6                | 6 lbs.           | Stock         |
| 1    | x | 6  | 10019015 | 1" ID, 5" OD | White | 300             | 6                | 6 lbs.           | Stock         |

Stock - ships within one business day. Made to order (MTO) - see product category for specific lead time information. Products purchased in less than full inner carton quantities are subject to a \$75 broken carton charge, per destination. Prices effective June 14, 2021. Prices/stocking locations subject to change w/o notice. Refer to [www.zebra.com](http://www.zebra.com).

# Wristbands

## Z-Band Direct

### Z-Band Direct Wristbands

Direct thermal polypropylene wristbands with an adhesive tamper-evident for securement. Scannable up to 14 days.

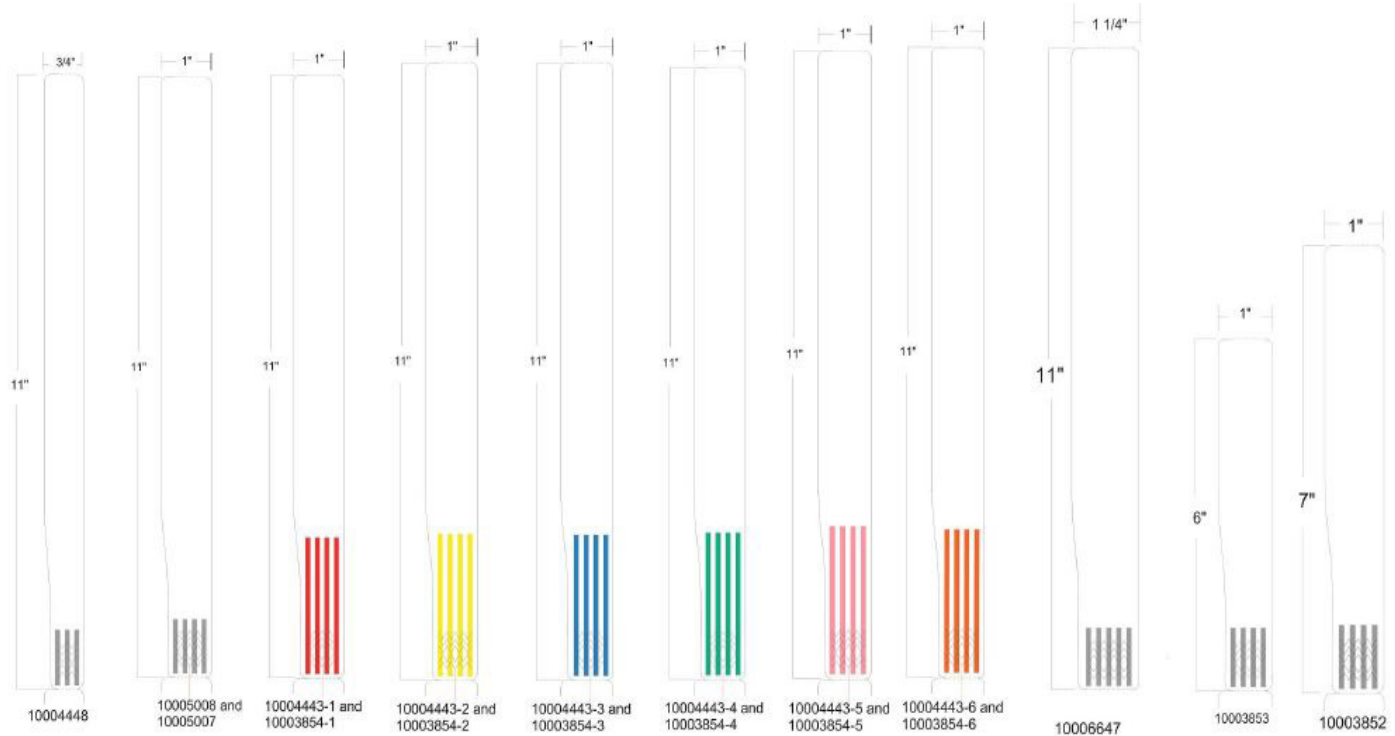

| Size |   |    | Part #     | ID, OD       | Color  | Amount/<br>roll | Rolls/<br>carton | Carton<br>Weight | Stock/<br>MTO |
|------|---|----|------------|--------------|--------|-----------------|------------------|------------------|---------------|
| W    | x | L  |            |              |        |                 |                  |                  |               |
| 0.75 | x | 11 | 10004448   | 1" ID, 5" OD | White  | 200             | 6                | 4.8 lbs.         | Stock         |
| 1    | x | 11 | 10005008   | 1" ID, 5" OD | White  | 200             | 6                | 4.8 lbs.         | Stock         |
| 1    | x | 11 | 10005007   | 3" ID, 8" OD | White  | 450             | 6                | 9 lbs.           | Stock         |
| 1    | x | 11 | 10004443-1 | 1" ID, 5" OD | Red    | 200             | 6                | 4.8 lbs.         | Stock         |
| 1    | x | 11 | 10003854-1 | 3" ID, 8" OD | Red    | 450             | 6                | 9 lbs.           | MTO           |
| 1    | x | 11 | 10004443-2 | 1" ID, 5" OD | Yellow | 200             | 6                | 4.8 lbs.         | Stock         |
| 1    | x | 11 | 10003854-2 | 3" ID, 8" OD | Yellow | 450             | 6                | 9 lbs.           | MTO           |
| 1    | x | 11 | 10004443-3 | 1" ID, 5" OD | Blue   | 200             | 6                | 4.8 lbs.         | Stock         |
| 1    | x | 11 | 10003854-3 | 3" ID, 8" OD | Blue   | 450             | 6                | 9 lbs.           | MTO           |
| 1    | x | 11 | 10004443-4 | 1" ID, 5" OD | Green  | 200             | 6                | 4.8 lbs.         | Stock         |
| 1    | x | 11 | 10003854-4 | 3" ID, 8" OD | Green  | 450             | 6                | 9 lbs.           | MTO           |
| 1    | x | 11 | 10004443-5 | 1" ID, 5" OD | Pink   | 200             | 6                | 4.8 lbs.         | Stock         |
| 1    | x | 11 | 10003854-5 | 3" ID, 8" OD | Pink   | 450             | 6                | 9 lbs.           | MTO           |
| 1    | x | 11 | 10004443-6 | 1" ID, 5" OD | Orange | 200             | 6                | 4.8 lbs.         | Stock         |
| 1    | x | 11 | 10003854-6 | 3" ID, 8" OD | Orange | 450             | 6                | 9 lbs.           | MTO           |
| 1.25 | x | 11 | 10006647   | 1" ID, 5" OD | White  | 200             | 6                | 4.8 lbs.         | Stock         |
| 1    | x | 6  | 10003853   | 1" ID, 5" OD | White  | 350             | 6                | 4.8 lbs.         | Stock         |
| 1    | x | 7  | 10003852   | 1" ID, 5" OD | White  | 300             | 6                | 4.8 lbs.         | Stock         |

Stock - ships within one business day. Made to order (MTO) - see product category for specific lead time information. Products purchased in less than full inner carton quantities are subject to a \$75 broken carton charge, per destination. Prices effective June 14, 2021. Prices/stocking locations subject to change w/o notice. Refer to [www.zebra.com](http://www.zebra.com).

# Wristbands

## Z-Band Fusion

### Z-Band Fusion Wristbands: 3" ID, 8" OD

Self-laminating direct thermal polypropylene wristband with an adhesive closure and a wristband extender to fit a wide range of wrist sizes. Scannable up to 60 days.



FID-ADULT-L3-3-500T

| Size |   |       | Part #              | ID, OD       | Color | Amount/<br>roll | Rolls/<br>carton | Carton<br>Weight | Stock/<br>MTO |
|------|---|-------|---------------------|--------------|-------|-----------------|------------------|------------------|---------------|
| W    | x | L     |                     |              |       |                 |                  |                  |               |
| 2.75 | x | 0.875 | FID-ADULT-L3-3-500T | 3" ID, 8" OD | White | 500             | 2                | 7 lbs.           | Stock         |

All Z-Band fusion part numbers are perforated.

# Wristbands

## Z-Band Fusion

### Z-Band Fusion Wristbands: 1" ID, 5" OD

Self-laminating direct thermal polypropylene wristband with an adhesive closure and a wristband extender to fit a wide range of wrist sizes. Scannable up to 60 days.

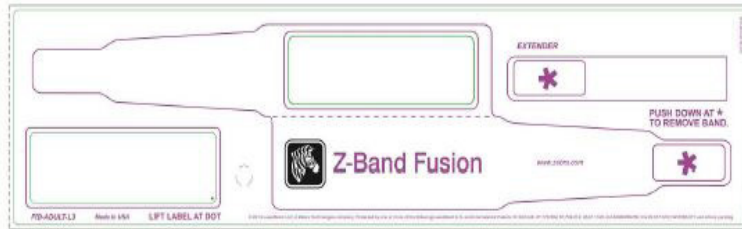

FID-ADULT-L3-1-200T  
FID-ADULT-L3-3-500T

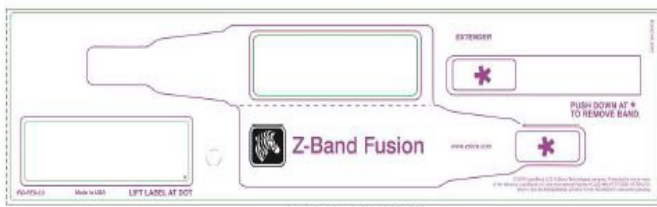

FID-PED-L3-1-200T

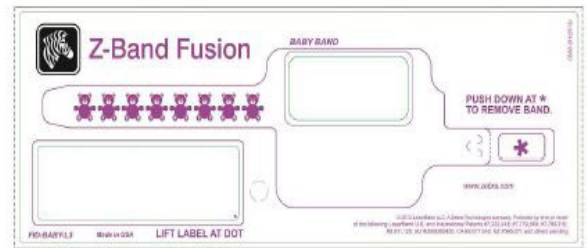

FID-BABY-L3-1-200T

| Image Size |   |       | Part #              | ID, OD       | Color | Amount/<br>roll | Rolls/<br>carton | Carton<br>Weight | Stock/<br>MTO |
|------------|---|-------|---------------------|--------------|-------|-----------------|------------------|------------------|---------------|
| W          | x | L     |                     |              |       |                 |                  |                  |               |
| 2.75       | x | 0.875 | FID-ADULT-L3-1-200T | 1" ID, 5" OD | White | 200             | 5                | 7 lbs.           | Stock         |
| 2.75       | x | 0.875 | FID-PED-L3-1-200T   | 1" ID, 5" OD | White | 200             | 5                | 8 lbs.           | Stock         |
| 1.63       | x | 0.750 | FID-BABY-L3-1-200T  | 1" ID, 5" OD | White | 200             | 5                | 8 lbs.           | Stock         |

All Z-Band fusion part numbers are perforated.



# Wristbands

## Z-Band Fusion

### Z-Band Fusion Infant ID Tags

Self-laminating direct thermal polypropylene infant tags, perfect for use in the NICU where the average infant stay exceeds 14 days. Can be used in conjunction with the ComfyCuff foam wristband, SwaddleBand, and Vinyl Infant Wristband Solution. Latex-free.



FID-BABY-T-1-500  
FID-BABY-T-3-1M

| Size |   |       | Part #           | ID, OD       | Color | Amount/<br>roll | Rolls/<br>carton | Carton<br>Weight | Stock/<br>MTO |
|------|---|-------|------------------|--------------|-------|-----------------|------------------|------------------|---------------|
| W    | x | L     |                  |              |       |                 |                  |                  |               |
| 1.75 | x | 0.875 | FID-BABY-T-1-500 | 1" ID, 5" OD | White | 500             | 2                | 7 lbs.           | Stock         |
| 1.75 | x | 0.875 | FID-BABY-T-3-1M  | 3" ID, 8" OD | White | 1,000           | 1                | 7 lbs.           | Stock         |

All Z-Band fusion part numbers are perforated.

# Wristbands

## Quick Clip

### Z-Band Quick Clip Kit

Direct thermal polypropylene wristband with secure clip closures. Scannable up to 14 days.

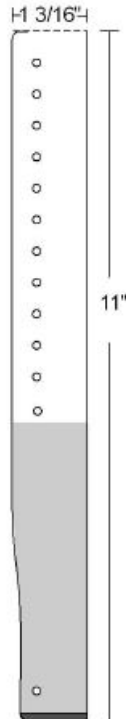

97890K and  
10027728K

| Size   |   |    | Part #    | ID, OD       | Color | Amount/<br>roll | Rolls/<br>carton | Carton<br>Weight | Stock/<br>MTO |
|--------|---|----|-----------|--------------|-------|-----------------|------------------|------------------|---------------|
| W      | x | L  |           |              |       |                 |                  |                  |               |
| 1.1875 | x | 11 | 10027728K | 1" ID, 5" OD | White | 240             | 6                | 11 lbs.          | Stock         |
| 1.1875 | x | 11 | 97890K    | 3" ID, 8" OD | White | 550             | 6                | 11 lbs.          | Stock         |

PN 10027728K (1.1875x11) Includes 6 rolls of perforated wristbands and 1,740 white clips. Color clips sold separately.  
 PN 97890 (1.1875x11) Includes 6 rolls of perforated wristbands and 3,480 white clips. Color clips sold separately.

### Color Clips for use with QuickClip Wristbands

| Part #       | Color  | Clips Per Pack | Stock/MTO |
|--------------|--------|----------------|-----------|
| 97032-Blue   | Blue   | 275            | Stock     |
| 97032-Green  | Green  | 275            | Stock     |
| 97032-Pink   | Pink   | 275            | Stock     |
| 97032-Purple | Purple | 275            | Stock     |
| 97032-Red    | Red    | 275            | Stock     |
| 97032-Yellow | Yellow | 275            | Stock     |

Stock - ships within one business day. Made to order (MTO) - see product category for specific lead time information.  
 Products purchased in less than full inner carton quantities are subject to a \$75 broken carton charge, per destination.  
 Prices effective June 14, 2021. Prices/stocking locations subject to change w/o notice. Refer to [www.zebra.com](http://www.zebra.com).

# Wristbands

## Infant

### Soft Infant Wristband

A direct thermal white polypropylene wristband with soft nylon lining with a t-shaped adjustable design, flat surface print area and an adhesive tab for securement.

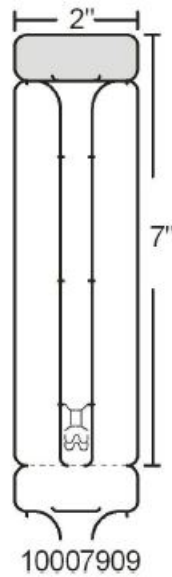

| Size |   |   | Part #   | ID, OD       | Color | Amount/<br>roll | Rolls/<br>carton | Carton<br>Weight | Stock/<br>MTO |
|------|---|---|----------|--------------|-------|-----------------|------------------|------------------|---------------|
| W    | x | L |          |              |       |                 |                  |                  |               |
| 2    | x | 7 | 10007909 | 1" ID, 5" OD | White | 275             | 6                | 6 lbs.           | Stock         |

# Wristbands

## RFID Wristbands

### Z-Band Direct SR (Short Range)

Zebra's RFID wristband is ideal for use cases where the wristband is in close proximity to the reader, such as at the bedside through blankets or during a patient's surgery through the drape to quickly associate supplies and equipment used

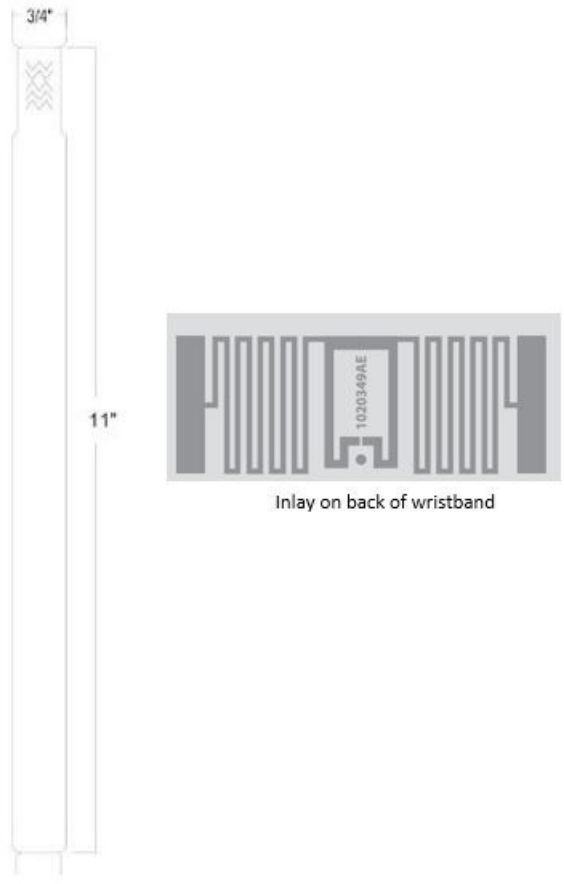

**1" ID, 5" OD**  
 Direct Thermal RFID Wristbands  
 For use with Zebra's ZD500R printer.

| Size |   |    | Part #  | Perf. | Inlay  | Antenna/Chip | Material      | Labels/<br>roll | Rolls/<br>case | Case<br>Weight | Stock<br>Locations |    |
|------|---|----|---------|-------|--------|--------------|---------------|-----------------|----------------|----------------|--------------------|----|
| W    | x | L  |         |       |        |              |               |                 |                |                | WI                 | GA |
| 1    | x | 11 | 3014578 | X     | BT0600 | UCODE 8      | Z-Band Direct | 175             | 3              | 3 lbs.         | X                  |    |

Stock - ships within one business day. Made to order (MTO) - see product category for specific lead time information.  
 Products purchased in less than full inner carton quantities are subject to a \$75 broken carton charge, per destination.  
 Prices effective June 14, 2021. Prices/stocking locations subject to change w/o notice. Refer to [www.zebra.com](http://www.zebra.com).

# Wristbands

## RFID Wristbands

### Z-Band UltraSoft LR (Long Range)

Zebra's Z-Band UltraSoft LR Wristband is uniquely designed with a specialty inlay designed for use against the human body. The design allows the wristband to flag away from the body, enabling longer read ranges. Ideal for use when over-head readers or portals are being used to provide best last known location tracking abilities.



### 1" ID, 5" OD

#### Direct Thermal RFID Wristbands

For use with Zebra's ZD500R printer.

| Size |   |    | Part #       | Perf. | Inlay         | Antenna/Chip | Material         | Labels/<br>roll | Rolls/<br>case | Case<br>Weight | Stock<br>Locations |    |
|------|---|----|--------------|-------|---------------|--------------|------------------|-----------------|----------------|----------------|--------------------|----|
| W    | x | L  |              |       |               |              |                  |                 |                |                | WI                 | GA |
| 1    | x | 14 | ZIPRD3015155 | X     | Zebra ZBR2002 | UCODE 8      | Z-Band UltraSoft | 175             | 3              | 3 lbs.         | X                  |    |

\*Wristband measures 1.1875" x 14.25" before gutter is removed.

# Wristbands - Non-printable

## Alert Solutions

### Spot Alert Labels

Spot-alert color-coded labels can be adhered to any Zebra wristband and feature a strong tamper-evident adhesive that causes the label to tear if tampered with. Available in standard color and designation combinations to support the most critical patient conditions.

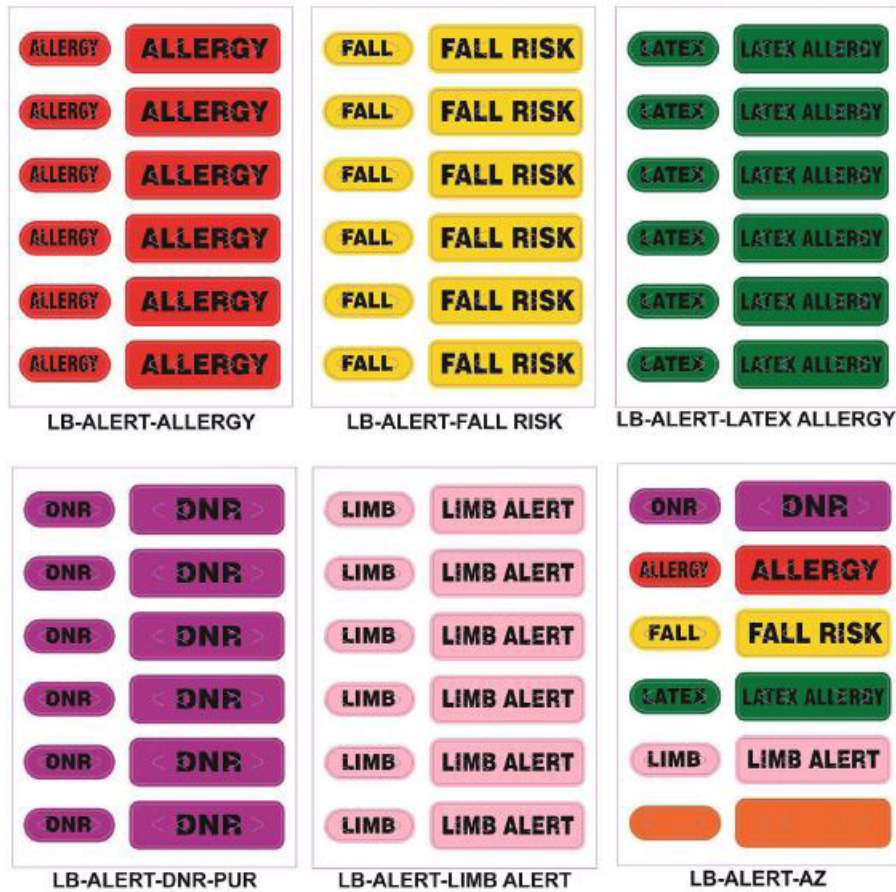

| Size |   |     | Part #                | Alert Designation | Color  | Labels/<br>form | Forms/<br>case | Case<br>Weight | Stock/<br>MTO |
|------|---|-----|-----------------------|-------------------|--------|-----------------|----------------|----------------|---------------|
| W    | x | L   |                       |                   |        |                 |                |                |               |
| 2.5  | x | 3.5 | LB-ALERT-ALLERGY      | ALLERGY           | Red    | 12              | 1,000          | 3 lbs.         | Stock         |
| 2.5  | x | 3.5 | LB-ALERT-FALLRISK     | FALL RISK         | Yellow | 12              | 1,000          | 3 lbs.         | Stock         |
| 2.5  | x | 3.5 | LB-ALERT-DNR-PUR      | DNR               | Purple | 12              | 1,000          | 3 lbs.         | Stock         |
| 2.5  | x | 3.5 | LB-ALERT-LATEXALLERGY | LATEX ALLERGY     | Green  | 12              | 1,000          | 3 lbs.         | Stock         |
| 2.5  | x | 3.5 | LB-ALERT-LIMBALERT    | LIMB ALERT        | Pink   | 12              | 1,000          | 3 lbs.         | Stock         |
| 2.5  | x | 3.5 | LB-ALERT-AZ           | ALL               | All    | 12              | 1,000          | 3 lbs.         | Stock         |

Each sheet contains (6) labels sized 1.3125" x 0.375" and (6) labels sized 0.75" x 0.25".

Stock - ships within one business day. Made to order (MTO) - see product category for specific lead time information. Products purchased in less than full inner carton quantities are subject to a \$75 broken carton charge, per destination. Prices effective June 14, 2021. Prices/stocking locations subject to change w/o notice. Refer to [www.zebra.com](http://www.zebra.com).

# Wristbands - Non-printable

## Alert Solutions

### Slim Alert Wristbands

Pre-printed vinyl wristbands with an integrated clip closure. Available in standard color and designation combinations to support the most critical patient conditions.

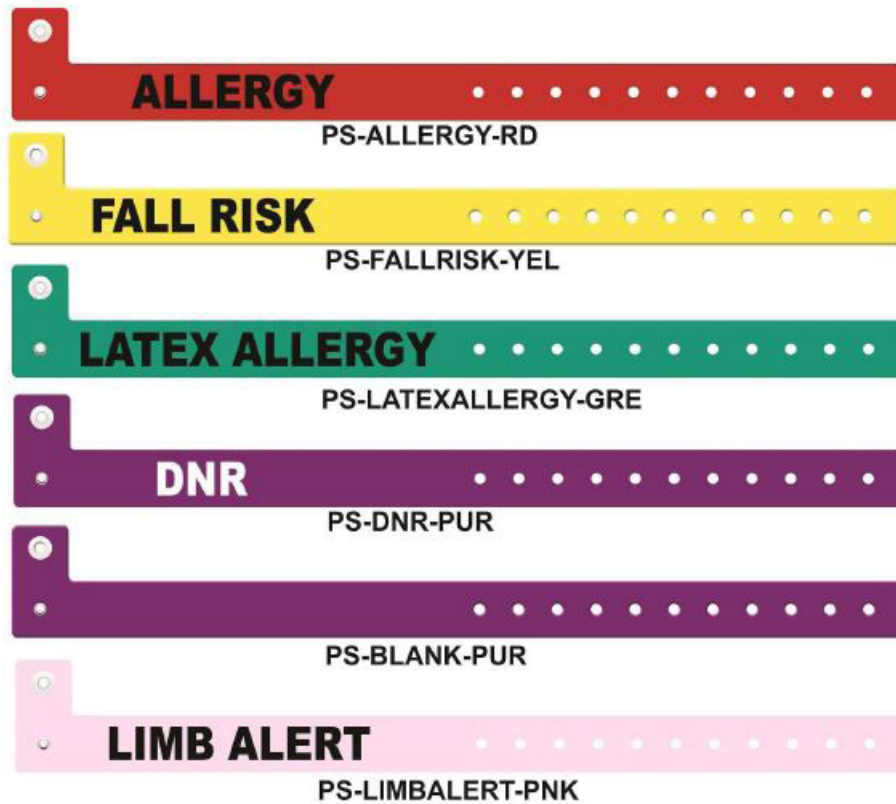

| Size  |   |    | Part #              | Alert Designation | Color  | Bands/<br>case | Case<br>Weight | Stock/<br>MTO |
|-------|---|----|---------------------|-------------------|--------|----------------|----------------|---------------|
| W     | x | L  |                     |                   |        |                |                |               |
| 0.625 | x | 10 | PS-ALLERGY-RED      | ALLERGY           | Red    | 500            | 3 lbs.         | Stock         |
| 0.625 | x | 10 | PS-FALLRISK-YEL     | FALL RISK         | Yellow | 500            | 3 lbs.         | Stock         |
| 0.625 | x | 10 | PS-DNR-PUR          | DNR               | Purple | 500            | 3 lbs.         | Stock         |
| 0.625 | x | 10 | PS-LATEXALLERGY-GRE | LATEX ALLERGY     | Green  | 500            | 3 lbs.         | Stock         |
| 0.625 | x | 10 | PS-LIMBALERT-PNK    | LIMB ALERT        | Pink   | 500            | 3 lbs.         | Stock         |
| 0.625 | x | 10 | PS-BLANK-PUR        | BLANK             | Purple | 500            | 3 lbs.         | Stock         |

Stock - ships within one business day. Made to order (MTO) - see product category for specific lead time information.  
 Products purchased in less than full inner carton quantities are subject to a \$75 broken carton charge, per destination.  
 Prices effective June 14, 2021. Prices/stocking locations subject to change w/o notice. Refer to [www.zebra.com](http://www.zebra.com).

# Wristbands - Non-printable

## Alert Solutions

### Tyvek Alert Wristbands

Color-coded Tyvek® alert wristbands with a tamper-evident adhesive closure. Available in standard color and designation combinations to support the most critical patient conditions.

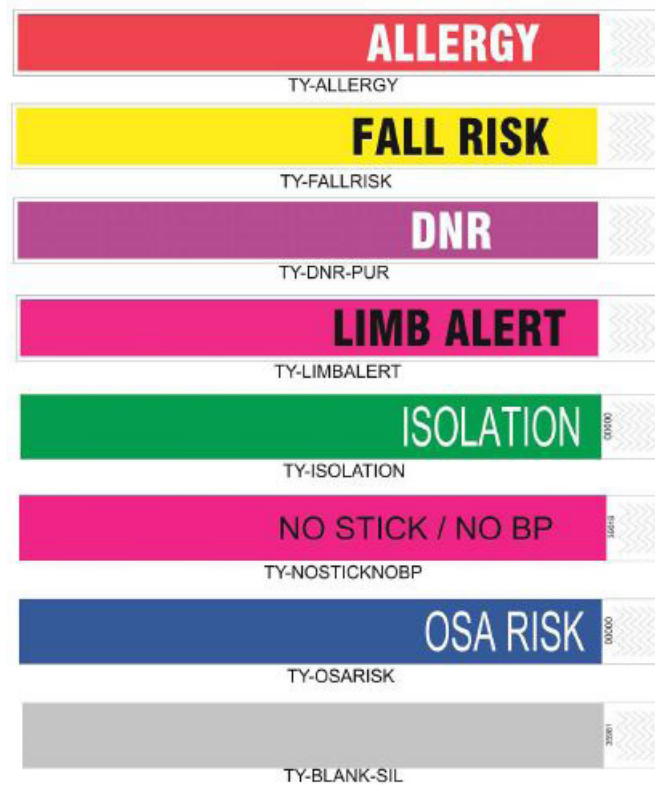

| Size |   |    | Part #         | Alert Designation | Color  | Bands/<br>case | Case<br>Weight | Stock/<br>MTO |
|------|---|----|----------------|-------------------|--------|----------------|----------------|---------------|
| W    | x | L  |                |                   |        |                |                |               |
| 1    | x | 10 | TY-ALLERGY     | ALLERGY           | Red    | 1000           | 2 lbs.         | Stock         |
| 1    | x | 10 | TY-FALLRISK    | FALL RISK         | Yellow | 1000           | 2 lbs.         | Stock         |
| 1    | x | 10 | TY-DNR-PUR     | DNR               | Purple | 1000           | 2 lbs.         | Stock         |
| 1    | x | 10 | TY-LIMBALERT   | LIMB ALERT        | Pink   | 1000           | 2 lbs.         | Stock         |
| 1    | x | 10 | TY-ISOLATION   | ISOLATION         | Green  | 1000           | 2 lbs.         | Stock         |
| 1    | x | 10 | TY-NOSTICKNOBP | NO NEEDLES/NO BP  | Pink   | 1000           | 2 lbs.         | Stock         |
| 1    | x | 10 | TY-OSARISK     | OSA RISK          | Blue   | 1000           | 2 lbs.         | Stock         |
| 1    | x | 10 | TY-BLANK-SIL   | BLANK             | Silver | 1000           | 2 lbs.         | Stock         |

Stock - ships within one business day. Made to order (MTO) - see product category for specific lead time information.  
 Products purchased in less than full inner carton quantities are subject to a \$75 broken carton charge, per destination.  
 Prices effective June 14, 2021. Prices/stocking locations subject to change w/o notice. Refer to [www.zebra.com](http://www.zebra.com).



# Wristbands - Non-printable

## OmniBand

### OmniBand

Self-laminating wristband with a tamper evident adhesive closure that can be used in conjunction with virtually any printing label. Includes wristband extender to fit a wide variety of wrist sizes.

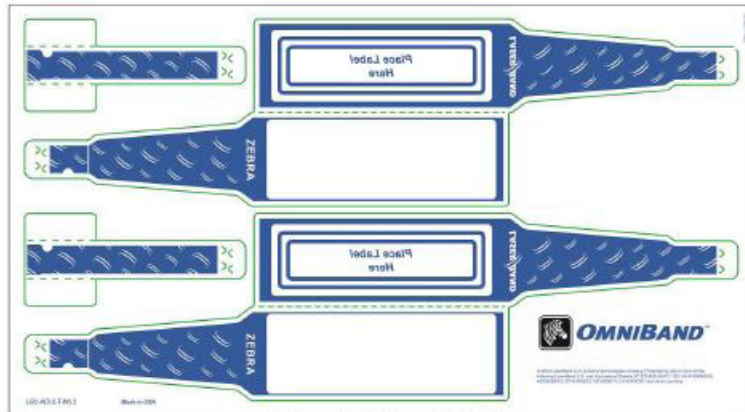

**LB2-ADULT-WL3**  
Available in white, red, blue and orange

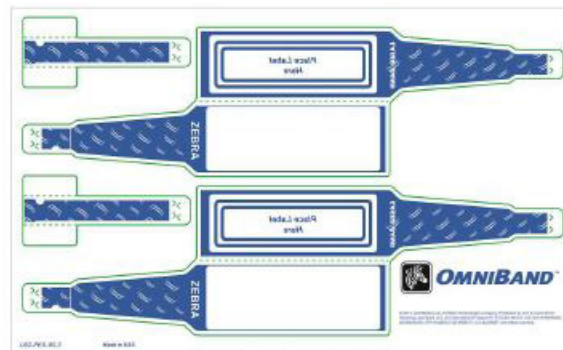

**LB2-PED-WL3**  
Available in white

| Max Label Size |   |      | Part #            | Wristband Length | Extender Length | Color  | Bands/ case | Case Weight | Stock/ MTO |
|----------------|---|------|-------------------|------------------|-----------------|--------|-------------|-------------|------------|
| W              | x | L    |                   |                  |                 |        |             |             |            |
| 3.25           | x | 1    | LB2-ADULT-WL3     | 10               | 3.25            | White  | 1000        | 10 lbs.     | Stock      |
| 3.25           | x | 1    | LB2-ADULT-WL3-RED | 10               | 3.25            | Red    | 1000        | 10 lbs.     | MTO        |
| 3.25           | x | 1    | LB2-ADULT-WL3-BLU | 10               | 3.25            | Blue   | 1000        | 10 lbs.     | Stock      |
| 3.25           | x | 1    | LB2-ADULT-WL3-ORA | 10               | 3.25            | Orange | 1000        | 10 lbs.     | Stock      |
| 2.25           | x | 0.75 | LB2-PED-WL3       | 8                | 2.625           | White  | 1000        | 7 lbs.      | Stock      |

Sheet measures 4.25" x 11".  
500 sheets/case containing (2) wristbands and (2) extenders each.

Stock - ships within one business day. Made to order (MTO) - see product category for specific lead time information. Products purchased in less than full inner carton quantities are subject to a \$75 broken carton charge, per destination. Prices effective June 14, 2021. Prices/stocking locations subject to change w/o notice. Refer to [www.zebra.com](http://www.zebra.com).

# Wristbands - Non-printable

## Vinyl Infant Wristband Solutions

### Vinyl Infant Wristband Solutions

Soft, flexible vinyl wristbands for use with the Z-Band Fusion Infant ID Tags. The narrow width allows some models of “Abduction Prevention Systems” to be attached. Available in clip or self-locking closure. Self-locking closure can be adjusted with a gentle tug as the infant loses mass around the wrists and ankles within the first 24 hours of birth. Latex-free.



PS-BABY



PS-INFANT-ADJ

\* PS-BABY and PS-INFANT-ADJ are pictured with Z-Band Fusion Infant ID Tags.

| Max Label Size |   |      | Part #        | Closure Style | Color | Bands/case | Case Weight | Stock/<br>MTO |
|----------------|---|------|---------------|---------------|-------|------------|-------------|---------------|
| W              | x | L    |               |               |       |            |             |               |
| 0.39           | x | 6.25 | PS-BABY       | Clip          | White | 250        | 1 lb.       | Stock         |
| 0.39           | x | 8.5  | PS-INFANT-ADJ | Self-Locking  | White | 250        | 1 lb.       | Stock         |

## Wristbands - Non-printable

### ComfyCuff Solution

#### ComfyCuff

Soft foam cuff featuring an adjustable Velcro® closure ensuring infant comfort. Can be used in conjunction with Z-Band Fusion Infant ID tags, ComfyCuff Infant SwaddleBand and ComfyCuff Security Seal.



LB2-BABY-P

\*Pictured with Z-Band Fusion Infant ID Tag

| Size  |   |     | Part #     | Color | Bands/case | Case Weight | Stock/MTO |
|-------|---|-----|------------|-------|------------|-------------|-----------|
| W     | x | L   |            |       |            |             |           |
| 1.375 | x | 5.5 | LB2-BABY-P | White | 100        | 1 lb.       | Stock     |

#### ComfyCuff Security Seal

Label designed to securely stick to the ComfyCuff material and self-destruct to indicate wristband tampering. Latex-free.



LB2-BABY-CCS

\*Pictured with LB2-BABY-P (ComfyCuff) and Z-Band Fusion Infant ID Tag

| Size  |   |        | Part #       | Color | Bands/case | Case Weight | Stock/MTO |
|-------|---|--------|--------------|-------|------------|-------------|-----------|
| W     | x | L      |              |       |            |             |           |
| 2.875 | x | 0.4375 | LB2-BABY-CCS | White | 1000       | 1 lb.       | Stock     |

# Wristbands - Non-printable

## ComfyCuff Solution

### ComfyCuff Infant Swaddle Band

ComfyCuff Infant Swaddleband makes identifying a swaddles infant quick and easy. The Swaddleband creates an extension between the ComfyCuff and Z-Band Fusion Infant ID Tags or wristband, allowing the tag to be easily accessible. Available in Tyvek® (LB2-Baby-SWB). Latex-free.



LB2-BABY-SWB9

\*Pictured with ComfyCuff and Z-Band Fusion Infant ID Tags

| Size |   |   | Part #        | Color | Bands/case | Case Weight | Stock/MTO |
|------|---|---|---------------|-------|------------|-------------|-----------|
| W    | x | L |               |       |            |             |           |
| 0.25 | x | 6 | LB2-BABY-SWB  | White | 250        | 1 lb.       | Stock     |
| 0.41 | x | 9 | LB2-BABY-SWB9 | White | 500        | 1 lb.       | Stock     |

Stock - ships within one business day. Made to order (MTO) - see product category for specific lead time information. Products purchased in less than full inner carton quantities are subject to a \$75 broken carton charge, per destination. Prices effective June 14, 2021. Prices/stocking locations subject to change w/o notice. Refer to [www.zebra.com](http://www.zebra.com).

## Ribbons

### 6100 Wax/Resin

| Part Number  | Formulation | Width  |       | Length |      | Quantity Per |           | Outer Box Weight | Stock/ MTO | Printer Type |
|--------------|-------------|--------|-------|--------|------|--------------|-----------|------------------|------------|--------------|
|              |             | inches | mm    | feet   | m    | Carton       | Outer Box |                  |            |              |
| 06100GS06407 | Wax/Resin   | 2.52"  | 64mm  | 243'   | 74m  | 48           | 48        | 9 lbs.           | Stock      | Desktop      |
| 06100BK06045 | Wax/Resin   | 2.36"  | 60mm  | 1476'  | 450m | 6            | 6         | 6 lbs.           | Stock      | Industrial   |
| 06100BK08045 | Wax/Resin   | 3.15"  | 80mm  | 1476'  | 450m | 6            | 6         | 7 lbs.           | Stock      | Industrial   |
| 06100BK11045 | Wax/Resin   | 4.33"  | 110mm | 1476'  | 450m | 6            | 6         | 7 lbs.           | Stock      | Industrial   |

### 6200 Resin

| Part Number  | Formulation | Width  |       | Length |      | Quantity Per |           | Outer Box Weight | Stock/ MTO | Printer Type |
|--------------|-------------|--------|-------|--------|------|--------------|-----------|------------------|------------|--------------|
|              |             | inches | mm    | feet   | m    | Carton       | Outer Box |                  |            |              |
| 06200BK06045 | Resin       | 2.36"  | 60mm  | 1476'  | 450m | 6            | 6         | 6 lbs.           | Stock      | Industrial   |
| 06200BK08345 | Resin       | 3.27"  | 83mm  | 1476'  | 450m | 6            | 6         | 7 lbs.           | Stock      | Industrial   |
| 06200BK11045 | Resin       | 4.33"  | 110mm | 1476'  | 450m | 6            | 6         | 7 lbs.           | Stock      | Industrial   |

### 5095 Resin

| Part Number | Formulation | Width  |       | Length |     | Quantity Per |           | Outer Box Weight | Stock/ MTO | Printer Type |
|-------------|-------------|--------|-------|--------|-----|--------------|-----------|------------------|------------|--------------|
|             |             | inches | mm    | feet   | m   | Carton       | Outer Box |                  |            |              |
| 05095BK110D | Resin       | 4.33"  | 110mm | 98'    | 30m | 10           | 10        | 2 lbs.           | Stock      | Mobile       |

### Image Lock Resin

| Part Number | Formulation | Width  |       | Length |     | Quantity Per |           | Outer Box Weight | Stock/ MTO | Printer Type |
|-------------|-------------|--------|-------|--------|-----|--------------|-----------|------------------|------------|--------------|
|             |             | inches | mm    | feet   | m   | Carton       | Outer Box |                  |            |              |
| 74941       | Resin       | 2.52"  | 64mm  | 243'   | 74m | 12           | 48        | 8 lbs.           | MTO        | Desktop      |
| 74943       | Resin       | 4.33"  | 110mm | 243'   | 74m | 12           | 48        | 12 lbs.          | MTO        | Desktop      |

### ZD420 Ribbon Cartridges

| Part Number  | Formulation | Width  |       | Length |     | Quantity Per |           | Outer Box Weight | Stock/ MTO | Printer Type |
|--------------|-------------|--------|-------|--------|-----|--------------|-----------|------------------|------------|--------------|
|              |             | inches | mm    | feet   | m   | Carton       | Outer Box |                  |            |              |
| 02000CT11007 | Wax         | 4.33"  | 110mm | 243'   | 74m | 6            | 6         | 3 lbs.           | Stock      | ZD420 Only   |
| 05095CT11007 | Resin       | 4.33"  | 110mm | 243'   | 74m | 6            | 6         | 2 lbs.           | Stock      | ZD420 Only   |
| 05555CT11007 | Wax/Resin   | 4.33"  | 110mm | 243'   | 74m | 6            | 6         | 3 lbs.           | Stock      | ZD420 Only   |
| 74783        | Resin       | 4.33"  | 110mm | 243'   | 74m | 6            | 6         | 2 lbs.           | Stock      | ZD420 Only   |

Stock - ships within one business day. Made to order (MTO) - see product category for specific lead time information.  
 Products purchased in less than full inner carton quantities are subject to a \$75 broken carton charge, per destination.  
 Prices effective June 14, 2021. Prices/stocking locations subject to change w/o notice. Refer to [www.zebra.com](http://www.zebra.com).