

Multifunction MiMo Antenna

SHK[G]-7-27[-X24-58]

Available Colours:

- Black
- White

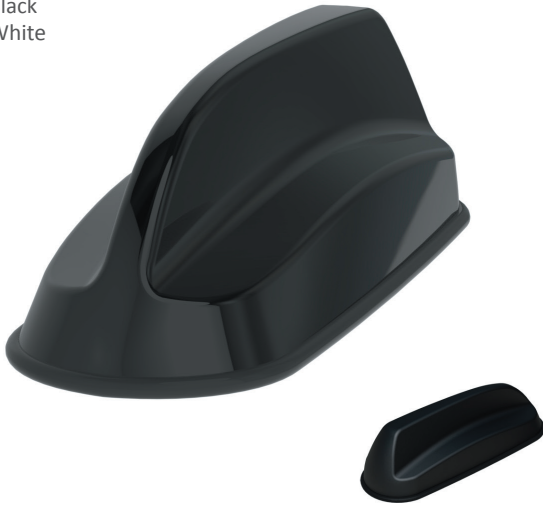

SHK[G]-7-27[-X24-58]

- OEM Shark Fin Styling
- 2G/3G/4G 3.8GHz 5G cellular (bands n77, n78)
- GPS/GNSS (SHKG version)
- Optional 2x2 or 3x3 MiMo dual band WiFi

The SHK[G]-7-27 has a compact OEM style shark fin housing that contains 2x2 MiMo antenna function for 5G/4G/3G/2G. The SHKG version has an active antenna for GPS/GLONASS/Galileo/BeiDou with 30dB gain LNA. Versions of the SHK[G] are available that include either 2x2 MiMo or 3x3 MiMo 2.4/5.8GHz WiFi function.

The shark fin style design provides multiple antenna functions whilst remaining discreet and is suitable for public safety (overt/covert), industrial and transport applications where a cost effective, efficient, and robust antenna is essential.

Requiring only a single hole mounting, the SHK[G] reduces vehicle damage, installation time & cost along with visual impact and protecting a vehicle's resale value.

Technical Drawing

SHKG-7-27-T24-58 Shown

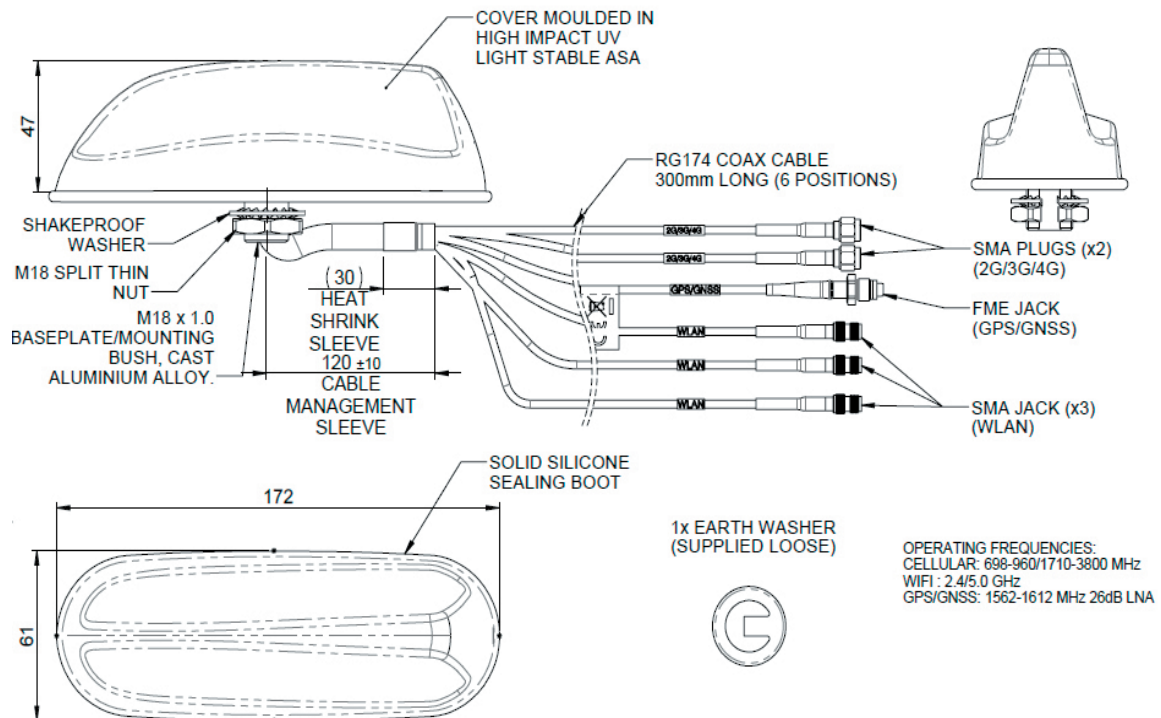

Multifunction MiMo Antenna

SHK[G]-7-27[-X24-58]

PANORAMA ANTENNAS

Product Data

Part No.				
Black Version	SHKG-7-27-T24-58	SHKG-7-27-24-58	SHKG-7-27	SHK-7-27
White Version	SHKGW-7-27-T24-58	SHKGW-7-27-24-58	SHKGW-7-27	SHKW-7-27
Electrical Data				
Frequency Range (MHz)	Element 1	1562-1612		-
	Elements 2 & 3	698-960, 1710-2170, 2500-3800		
	Elements 4 & 5	2300-2500 & 4900-6000	-	-
	Element 6	2300-2500 & 4900-6000	-	-
Operational Bands	Element 1	GPS / GNSS / Galileo / BeiDou		-
	Elements 2 & 3	5G / 4G / 3G / 2G		
	Elements 4 & 5	2.4GHz WLAN / 5.8GHz WiFi		-
	Element 6	2.4GHz WLAN / 5.8GHz WiFi	-	-
Peak gain: Isotropic*	Elements 2 & 3	2dBi (698-960MHz) 5dBi (1710-3800MHz)		-
	Elements 4, 5 (&6)	4dBi (2.4GHz), 6dBi (5.8GHz)		-
Isolation with 5m (16') CS29	Cellular			>12dB
	WiFi	> 20dB		-
Typical Efficiency* w/o Cable Loss	Elements 2 & 3			> 50%
Correlation Co-efficient	Elements 2 & 3			<0.2
Polarisation	Vertical (element 6 is horizontal)			
Pattern	Omni-directional			
Impedance	50Ω			
Max Input Power (W)	25			
GPS/GNSS Data				
Frequency Range (MHz)	1562-1612		-	
VSWR	<2:1 ± 4MHz		-	
Gain: LNA	30dB		-	
Polarisation	Right Hand Circular		-	
Operating Voltage	3-5V DC (fed via coax)		-	
Current	<20mA		-	
Mechanical Data				
Dimensions (mm)	Total Height	50 (2.2")		
	Length	170 (6.77")		
	Width	60 (2.4")		
Operating Temp (°C)	-40° / +80°C (-40° / 176°F)			
Material	ASA, EPDM, Aluminium Alloy			
Approx Weight (g)	260			
Ingress Protection	IP 66			
Mounting Info				
Fixing	Panel Mount			
Hole Size (mm)	19 (3/4")			
Cable Data				
Cable Type - All Feeds	RG174 (UN ECE 118 Compliant)			
Dimensions (mm)	Diameter	2.8 (0.11")		
	Length	300 mm (12")		
Termination	GPS/GNSS	FME socket		-
	5G/4G/3G/2G	2 x SMA plug		
	WiFi	2 or 3 x SMA Socket		

Multifunction MiMo Antenna

SHK[G]-7-27[-X24-58]

Electrical Data - Cell

VSWR
Typical VSWR - 2G/3G/4G Elements 2&3*

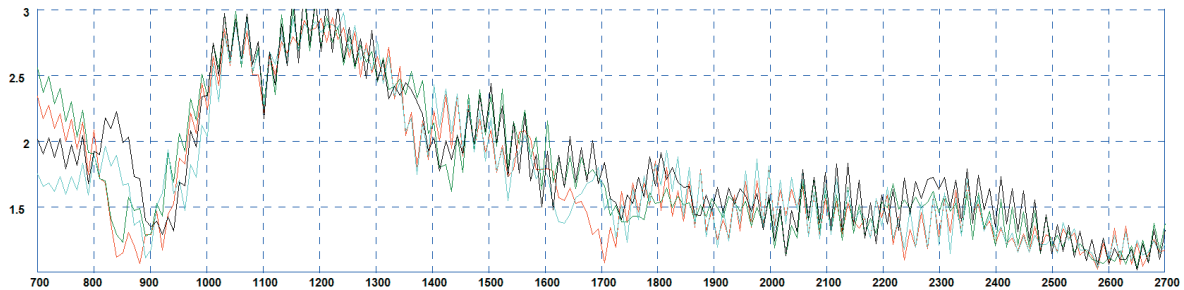

*VSWR measured with no whip and 5m (16') of CS29 cable Black & Blue = no ground plane Green and Red = 600x 600mm (2'x2') ground plane

Typical VSWR - WiFi Elements 4&5*

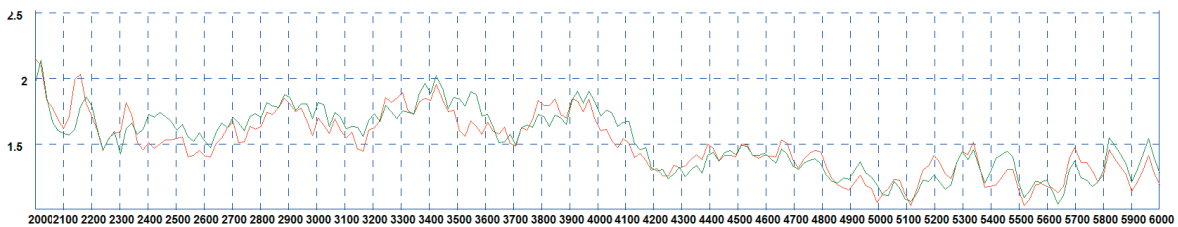

*VSWR measured with no whip and 5m (16') of CS32 cable

Isolation
Typical Isolation - Cellular Elements 2&3*

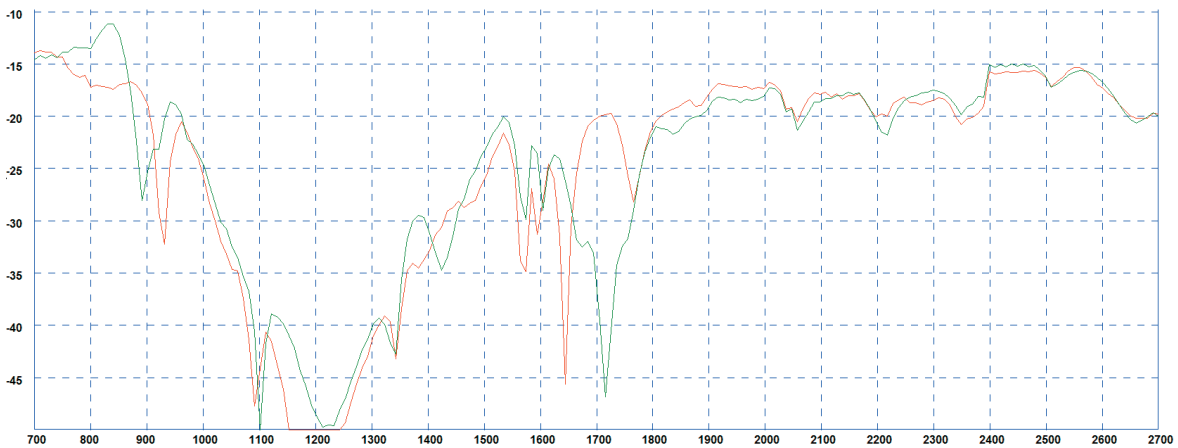

*Isolation measured with no whip and 5m (16') of CS29 cable Green Plot = 600x600mm (2' X2') ground plane Red Plot = no ground plane

Typical Isolation - WiFi Elements 4&5*

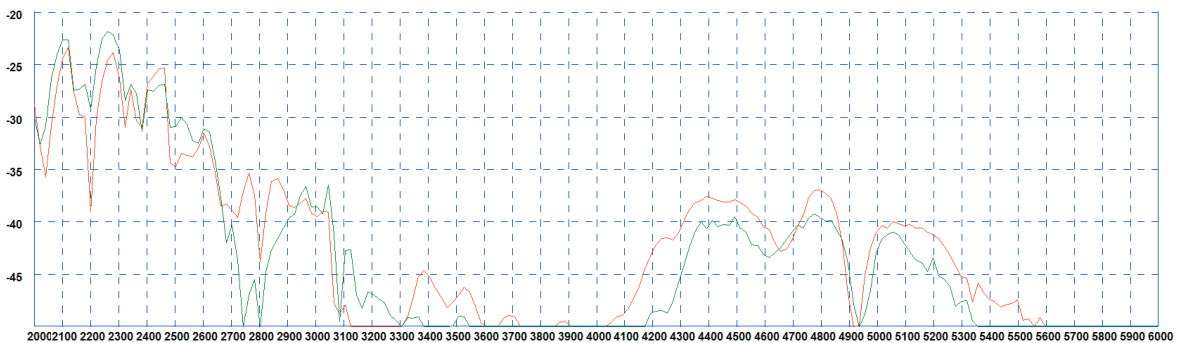

*Isolation measured with no whip and 5m (16') of CS29 cable Red Plot = 600x600mm (2' X2') ground plane Green Plot = no ground plane

Electrical Data - Cell

Typical Total Efficiency
Typical Total Efficiency - Cellular Elements 2&3*

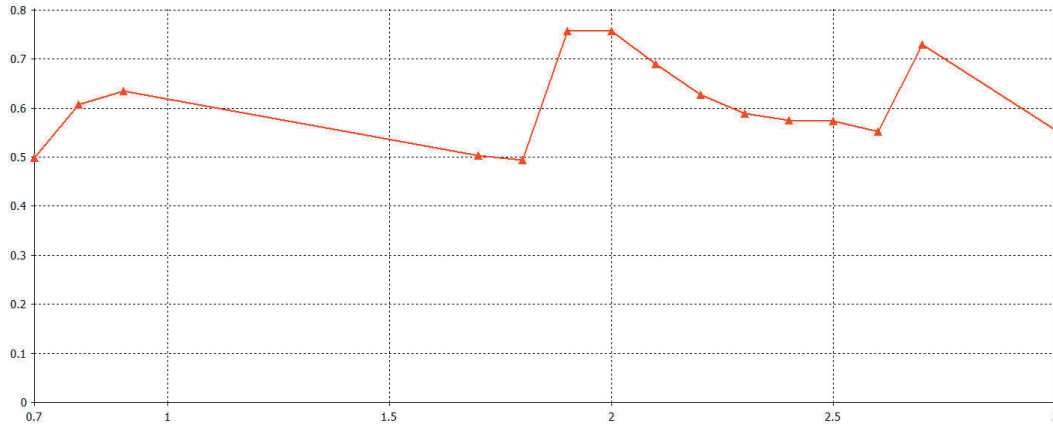

* Efficient simulated in free space with no whip and no ground plane and no cable.

Typical Correlation Co-efficient
Typical Correlation Co-efficient- Cellular Elements 2&3*

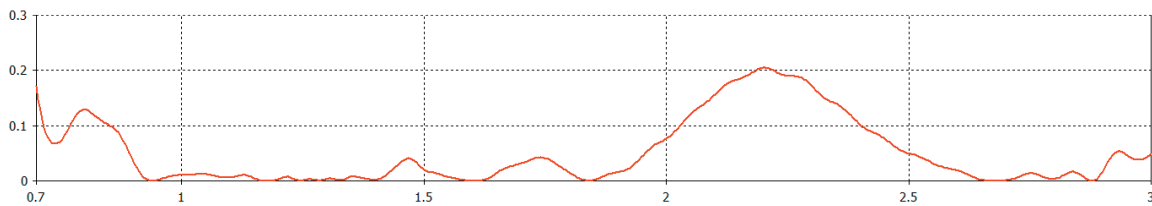

*Correlation co-efficient simulated in free space with no whip, no additional cable and no ground plane

3D Patterns - Cell

3D Radiation Patterns - Cell / LTE Elements 2&3

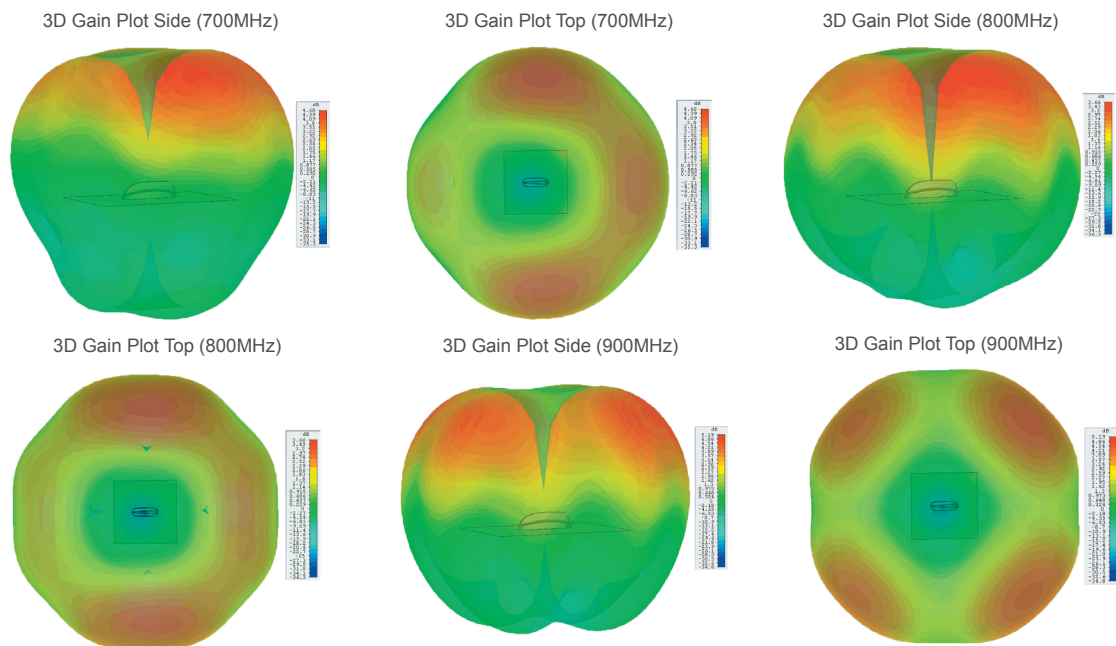

3D Patterns - Cell

3D Gain Plot Side (1800MHz)

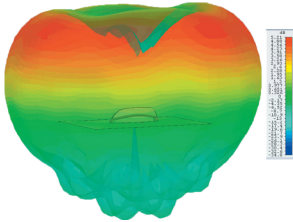

3D Gain Plot Top (1800MHz)

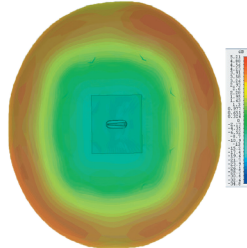

3D Gain Plot Side (2100MHz)

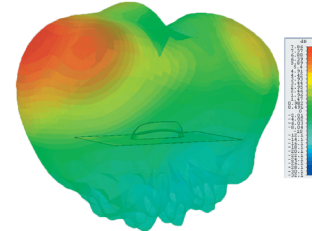

3D Gain Plot Top (2100MHz)

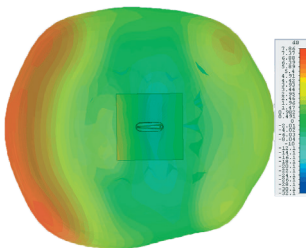

3D Gain Plot Side (2600MHz)

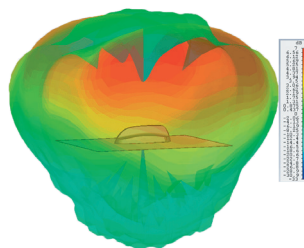

3D Gain Plot Top (2600MHz)

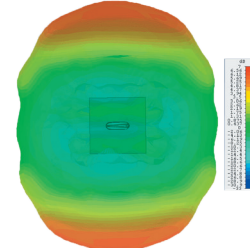

3D Gain Plot Side (3600MHz)

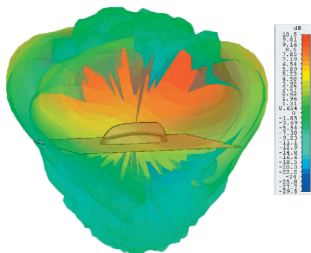

3D Gain Plot Top (3600MHz)

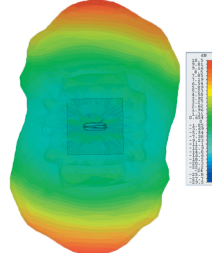

*3D radiation patterns simulated in CST Microwave Studio on a 600x600mm (2' X2') ground plane with both elements fed together.

Typical 3D Radiation Patterns - Wifi Elements 4&5

3D Gain Plot Side (2.4GHz)

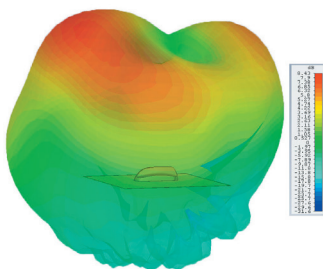

3D Gain Plot Top (2.4GHz)

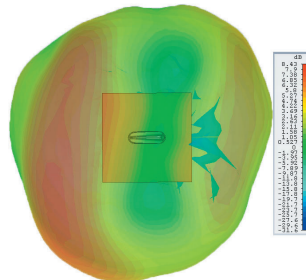

3D Gain Plot Side (5.4GHz)

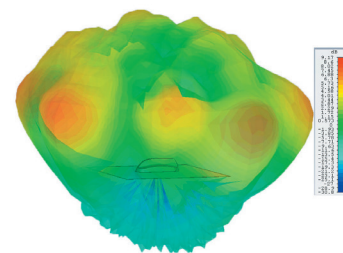

3D Gain Plot Top (5.4GHz)

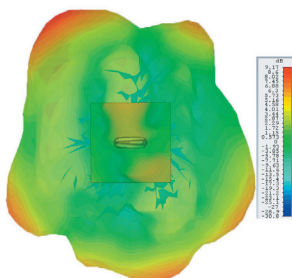

Typical Radiation Patterns - GPS/GNSS Element 1

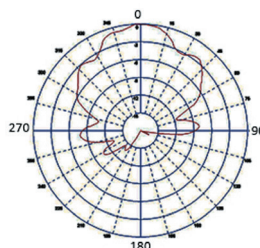

*3D radiation patterns simulated in CST Microwave Studio on a 600x600mm (2' X2') ground plane with both elements fed together.