

TRENDnet[®]



Quick Installation Guide

TEW-841APBO (V1)

Table of Contents

1 English

1. Before You Start
2. Quick Reference
3. Basic Hardware Installation and Configuration (Basic Access Point Setup)
4. Hardware Setup and Configuration (WDS Access Point with Point to Point Bridge Setup)
5. Waterproof Kit Installation

1. Before You Start

Package Contents

- TEW-841APBO
- Quick Installation Guide
- 2 x Detachable 2.4GHz 5dBi antennas
- 2 x Detachable 5GHz 5dBi antennas
- IP67 weather rated cable gland
- Mounting Hardware

Minimum Requirements

- Computer with a network LAN port and web browser
- A network switch or router with an available network LAN PoE+ port or PoE+ injector
- Flat head screwdriver for pole mounting clamp
- RJ-45 network cables
- Additional TEW-841APBO 5 dBi Wireless AC1300 Outdoor PoE+ Omni-Directional Access Point (Optional for point to point bridging only)

Note:

The access point complies with the IEEE 802.3at Power over Ethernet (PoE+) standard and can be used with other 802.3at PoE+ switches or PoE+ injectors to deliver both power and data to the access point through the network LAN (PoE) port.

IMPORTANT NOTE: The device does not have a hardware reset button. When changing the administrator password to the access point configuration page, please make sure to write down your new password.

COMPATIBILITY NOTE: If you are establishing WDS bridge connections to TRENDnet TEW-740APBO H/W: v2.0R outdoor access points, please make sure to upgrade the TEW-740APBO H/W: v2.0R access points to firmware 2.10 or above for WDS compatibility with the TEW-841APBO.

2. Quick Reference

Note: By default, the wireless network name/SSID and wireless encryption settings have been pre-configured for your convenience and can be located on the included preset wireless sticker. By default the access point web management configuration page can be accessed using the URL <http://tew-841apbo> or using the default LAN IP address <http://192.168.10.100>. At default settings and initial setup, if the access point is connected to a network with a DHCP server providing IP address settings automatically, the access point will obtain IP address settings from the network DHCP server and if no DHCP server is available, the access point will use the default IP address settings 192.168.10.100 / 255.255.255.0.

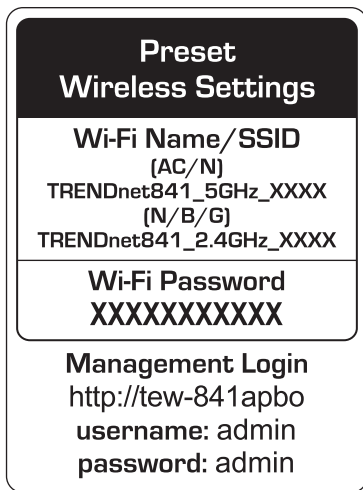

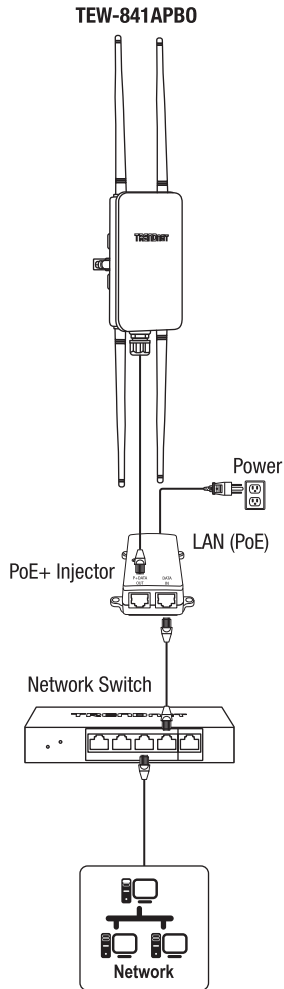

OR

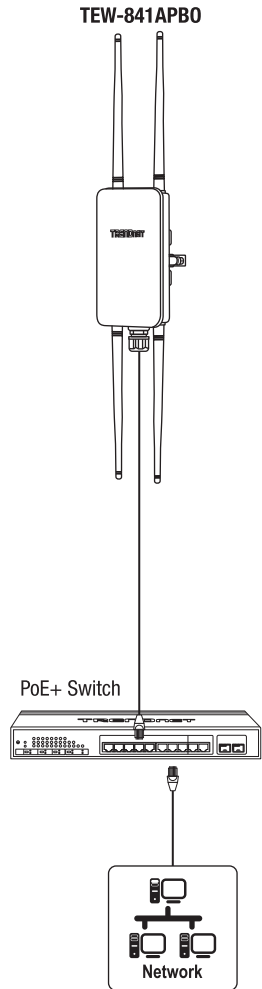

3. Basic Hardware Installation and Configuration (Basic Access Point Setup)

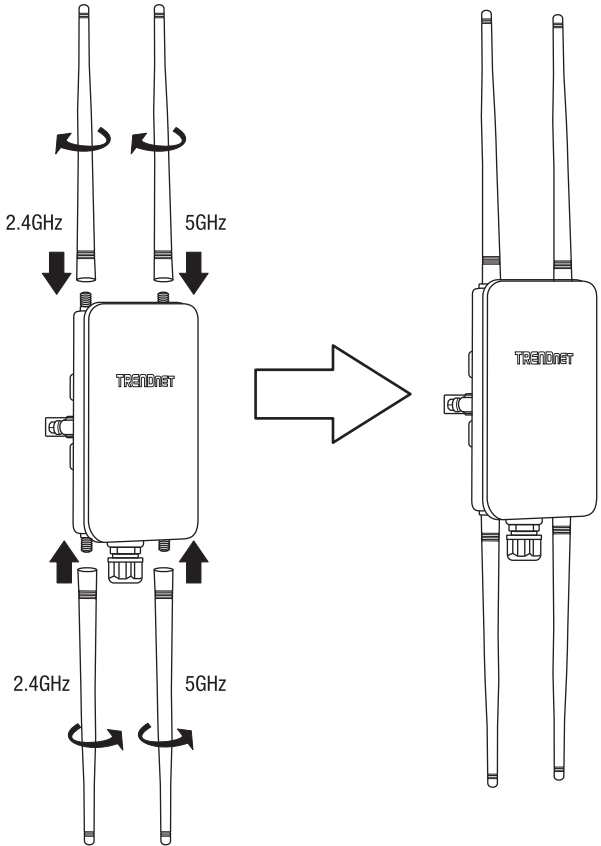

Note: It is strongly recommended to configure the access point first before mounting.

1. Connect a network cable from the LAN (PoE) port of your access point to the available LAN PoE+ port of your network PoE+ switch or PoE+ injector.
2. Using another network cable, connect one end to the network PoE+ switch or PoE+ injector and the other end of the network cable to the computer's Ethernet port.

TEW-841APB0

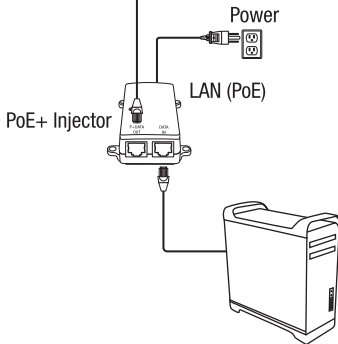

TEW-841APB0

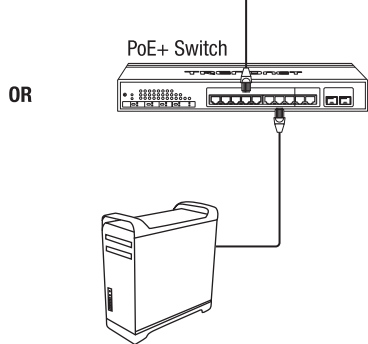

3. Confirm the device is powered on through the LED indicators.

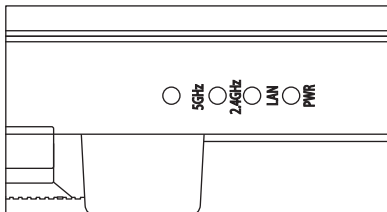

4. Assign a static IP address to your computer's network adapter in the subnet of 192.168.10.x (e.g. 192.168.10.25) and subnet mask of 255.255.255.0.

Note: For more information on assigning a static IP address to your computer's network adapter, please refer to item Q1 in the last section of the installation guide, Installation Tips and Troubleshooting.

5. Open your web browser, type the default URL `http://tew-841apbo` or default IP address `http://192.168.10.100` of the wireless access point in the address bar, and then press Enter. The default IP address is 192.168.10.100.

`http://tew-841apbo`

`http://192.168.10.100`

6. When prompted, login to the browser configuration page using the default user name and password settings.

User Name: **admin**

Password: **admin**

Note: User Name and Password are case sensitive.

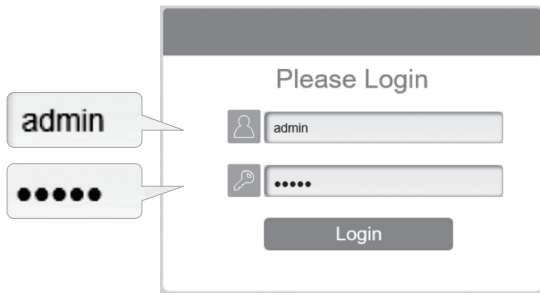

7. To change the administrator password used to access the wireless access point configuration page, in the left hand menu under **System Manager**, click on **Account**.

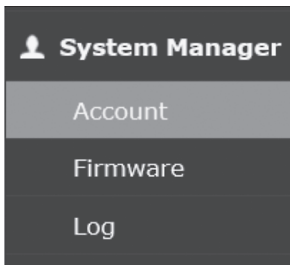

IMPORTANT NOTE: The device does not have a hardware reset button. When changing the administrator password to the access point configuration page, please make sure to write down your new password.

8. Under **Account Settings**, change the default administrator password by typing in the current password admin and your new password in the fields provided and then click the **Apply** button at the bottom of the page. You will be prompted to log back in with the new password settings.

Account Settings

Administrator Username	admin	
Current Password	*****	#
New Password	*****	#
Verify Password	*****	#

Apply

Apply

9. To configure your wireless network name/SSID and wireless encryption settings, under **Network**, click **Wireless**.

Note: By default, the wireless network name/SSID and wireless encryption has been preconfigured for your convenience and can be located on the included wireless sticker. If you are modifying the wireless settings, you will need to connect to the access point with your WiFi clients using the new settings.

10. To change the wireless network name/SSID, under the Wireless Settings – Access Point section, select which band you would like to configure (2.4GHz or 5GHz), and enter the new name in the **SSID** field. Click **Save** at the bottom of the page to temporarily save the settings.

Note: To permanently apply the configuration changes, you can click **Apply** at the prompt that appears at the bottom right corner of the page and wait for the device to commit the changes. If you are applying additional configuration changes, you can apply the temporary changes later on by clicking the **Changes** tab at the top right of the page and click **Apply** in the Configuration / Changes page.

Wireless Settings - Access Point				
Enabled	SSID	2.4GHz	5GHz	Edit
<input checked="" type="checkbox"/>	TRENDnet841_2.4GHz_85	<input checked="" type="checkbox"/>	<input type="checkbox"/>	<input type="button" value="Edit"/>
<input checked="" type="checkbox"/>	TRENDnet841_5GHz_855	<input type="checkbox"/>	<input checked="" type="checkbox"/>	<input type="button" value="Edit"/>

11. To change the wireless encryption key for the selected wireless band, click **Edit**.

Wireless Settings - Access Point				
Enabled	SSID	2.4GHz	5GHz	Edit
<input checked="" type="checkbox"/>	TRENDnet841_2.4GHz_85	<input checked="" type="checkbox"/>	<input type="checkbox"/>	<input type="button" value="Edit"/>
<input checked="" type="checkbox"/>	TRENDnet841_5GHz_855	<input type="checkbox"/>	<input checked="" type="checkbox"/>	<input type="button" value="Edit"/>

12. Under the Wireless Security section, enter the encryption key in the **Passphrase** field. Click **Save** at the bottom of the page to temporarily save the settings.

Note: To permanently apply the configuration changes, you can click **Apply** at the prompt that appears at the bottom right corner of the page and wait for the device to commit the changes. If you are apply additional configuration changes, you can apply the temporary changes later on by clicking the **Changes** tab at the top right of the page and click **Apply** in the Configuration / Changes page.

Wireless Security	
Security Mode	WPA2-PSK
Encryption	AES
Passphrase	841XXXXXXXX
Group Key Update Interval	3600 (30-3600; 0:Disable)

IMPORTANT NOTE: Configuration changes in the access point web management configuration are not applied until you permanently click **Apply** when the prompt appears or under the **Changes** tab at the top right of the page and click **Apply** in the Configuration / Changes page. The Changes tab will indicate the number of temporary configuration changes that are pending to be permanently applied. You can also click **Revert** to discard all of the temporary configuration changes.

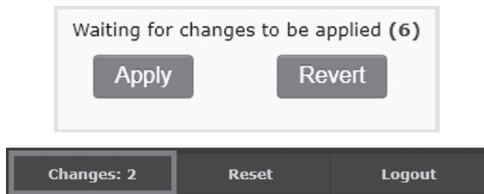

13. To configure your access point LAN IP address settings, under **Network**, click **Basic**.

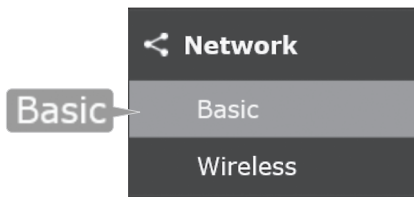

14. Under IPv4 Settings, select either **DHCP** (default setting) or **Static IP**. Selecting **DHCP** will set your access point to obtain IP address settings automatically from a DHCP server on your network and selecting **Static IP** will allow you to manually assign your access point IP address settings to meet the IP requirements of your network. If you select **Static IP**, enter the new IP address settings in the **IP Address**, **Subnet Mask**, **Gateway**, and **Primary/Secondary DNS Server** fields. After you have completed configuring the access point IP address settings, click **Save** at the bottom of the page to temporarily save the settings.

NOTE: To permanently apply the configuration changes, you can click **Apply** at the prompt that appears at the bottom right corner of the page and wait for the device to commit the changes. If you are applying additional configuration changes, you can apply the temporary changes later on by clicking the **Changes** tab at the top right of the page and click **Apply** in the Configuration/Changes page.

IPv4 Settings

IP Network Setting	<input checked="" type="radio"/> DHCP <input type="radio"/> Static IP
--------------------	---

IPv4 Settings

IP Network Setting	<input type="radio"/> DHCP <input checked="" type="radio"/> Static IP
IP Address	<input type="text" value="192.168.10.100"/>
Subnet Mask	<input type="text" value="255.255.255.0"/>
Gateway	<input type="text" value="192.168.10.100"/>
Primary DNS	<input type="text" value="0.0.0.0"/>
Secondary DNS	<input type="text" value="0.0.0.0"/>

15. After you have completed the access point configuration, reconfigure your computer's network adapter back to the original settings to obtain IP address settings automatically using DHCP.

NOTE: For more information on reconfiguring your computer's adapter to obtain IP address settings automatically using DHCP, please refer to item Q2 in the last section of the installation guide, Installation Tips and Troubleshooting.

4. Hardware Setup and Configuration

(WDS Access Point with Point to Point Bridge Setup)

Note:

1. The initial configuration should be completed a testing environment with two TEW-841APBO access points approximately 15 ft. (5 m) apart from one another with the front of the access points directly facing each other.
2. It is strongly recommended to configure and connect the access points before mounting.
3. In this example, we will configure the two access points to establish a WDS bridge using the 5GHz band.

Phase 1: Overview

In this installation guide, we will assume the following:

Router Settings

Default Gateway IP address: 192.168.10.1

Subnet Mask: 255.255.255.0

The TEW-841APBO access points will be configured with the following settings:

TEW-841APBO #1

IP Address: 192.168.10.50

Netmask (Subnet Mask): 255.255.255.0

Gateway (Default Gateway): 192.168.10.1

Primary DNS: 192.168.10.1

TEW-841APBO #2

IP Address: 192.168.10.51

Netmask (Subnet Mask): 255.255.255.0

Gateway (Default Gateway): 192.168.10.1

Primary DNS: 192.168.10.1

In this example, we will assume the access points use the following MAC addresses:

TEW-841APBO #1 5GHz WiFi MAC Address: 00:11:22:33:44:00

TEW-841APBO #2 5GHz WiFi MAC Address: 00:11:22:33:44:11

Phase 2: TEW-841APBO #1 Hardware Setup and Configuration

1. Write down the WiFi MAC address (5GHz MAC) of both the TEW-841APBO #1 and TEW-841APBO #2 access points located on the device label as shown below.

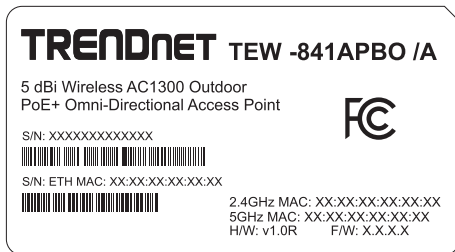

2. Connect a network cable from the LAN (PoE) port of your access point to the available LAN PoE+ port of your network PoE+ switch or PoE+ injector.
3. Using another network cable, connect one end to the network PoE+ switch or PoE+ injector and the other end of the network cable to the your computer's Ethernet port.

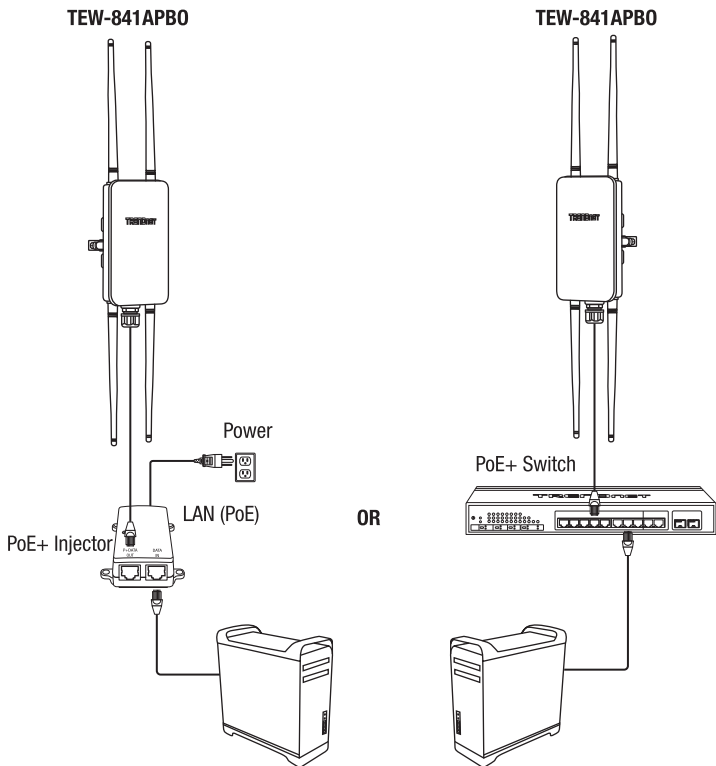

- Assign a static IP address to your computer's network adapter in the subnet of 192.168.10.x (e.g. 192.168.10.10) and subnet mask of 255.255.255.0.
- Open your web browser and type the IP address of the access point in the address bar, then press Enter. The default IP address is 192.168.10.100.

Note: If you changed the IP address of the access point in the previous section, Section 3: Basic Hardware Installation and Configuration (Basic Access Point Setup), you will need use the new IP address you assigned.

6. Open your web browser and type the IP address of the access point in the address bar, then press **Enter**. The default IP address is 192.168.10.100.

Note: If you changed the IP address of the access point in the previous section, Section 3: Basic Hardware Installation and Configuration (Basic Access Point Setup), you will need use the new IP address you assigned.

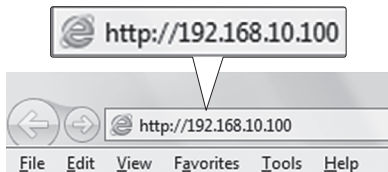

7. When prompted, login to the browser configuration page. The default user name and password **admin**.

Note: User Name and Password are case sensitive. If you changed the admin password of the access point in the previous section, Section 3: Basic Hardware Installation and Configuration (Basic Access Point Setup), you will need use the new password you assigned.

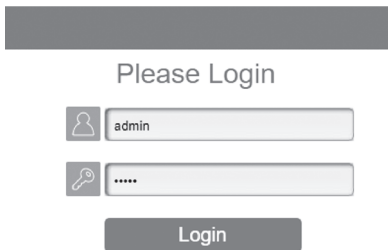

8. To configure your access point LAN IP address settings, under **Network**, click **Basic**.

9. Under IPv4 Settings, select **Static IP** and enter the IP address **192.168.10.50**, Subnet Mask **255.255.255.0**, Gateway **192.168.10.1**, and Primary DNS 192.168.10.1. After you have completed configuring the access point IP address settings, click **Save** at the bottom of the page to temporarily save the settings.

Note: To permanently apply the configuration changes, you can click **Apply** at the prompt that appears at the bottom right corner of the page and wait for the device to commit the changes. If you are applying additional configuration changes, you can apply the temporary changes later on by clicking the **Changes** tab at the top right of the page and click **Apply** in the Configuration / Changes page.

Note: When configuring TEW-841APB0 #2 IP address settings, enter the IP Address 192.168.10.51 and the same Subnet Mask, Gateway, and Primary DNS settings.

IPv4 Settings

IP Network Setting	<input checked="" type="radio"/> DHCP <input type="radio"/> Static IP
IP Network Setting	<input type="radio"/> DHCP <input checked="" type="radio"/> Static IP
IP Address	<input type="text" value="192.168.10.50"/>
Subnet Mask	<input type="text" value="255.255.255.0"/>
Gateway	<input type="text" value="192.168.10.1"/>
Primary DNS	<input type="text" value="192.168.10.1"/>
Secondary DNS	<input type="text" value="0.0.0.0"/>

IMPORTANT NOTE: Configuration changes in the access point web management configuration are not applied until you permanently click **Apply** when the prompt appears or under the **Changes** tab at the top right of the page and click **Apply** in the Configuration / Changes page. The Changes tab will indicate the number of temporary configuration changes that are pending to be permanently applied. You can also click **Revert** to discard all of the temporary configuration changes.

Waiting for changes to be applied (6)

Apply
Revert

Changes: 2
Reset
Logout

10. To configure the wireless WDS bridge settings, under **Network**, click **Wireless**.

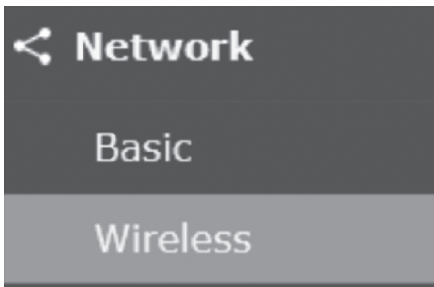

11. Under **5GHz**, click the **Operation Mode** drop-down list and select **WDS Access Point**.

	2.4GHz	5GHz
Operation Mode	Access Point ▾	WDS Access Point ▾
Wireless Mode	802.11 B/G/N ▾	802.11 AC/N ▾
Channel HT Mode	20MHz ▾	80MHz(AC Only) ▾

12. Next to **Channel**, click **Configuration** and under the **5GHz** section, make sure channel **48** is selected and click **Save** at the bottom of the page.

Note: When configuring TEW-841APB0 #2, the 5GHz wireless channel must be the same as TEW-841APB0 #1.

Channel Configuration

5GHz

All None

U-NII-1 U-NII-3

Ch 36 : 5.180 GHz Ch 40 : 5.200 GHz

Ch 44 : 5.220 GHz Ch 48 : 5.240 GHz

Ch149 : 5.745 GHz Ch153 : 5.765 GHz

Ch157 : 5.785 GHz Ch161 : 5.805 GHz

13. Under **WDS Link Settings – 5GHz**, click the **Security** drop-down list and select **AES**. Enter al WDS encryption key in the **AES Passphrase** field (8-63 alphanumeric characters).

Note: When configuring TEW-841APB0 #2, the WDS AES Passphrase must be the same TEW-841APB0 #1.

WDS Link Settings - 5GHz

Security	AES
AES Passphrase	XXXXXXXX (8-63 ASCII characters or 64 hexadecimal digits)

14. Under the **MAC Address** section, click the **Mode** drop-down list and select **Enable**. In the fields provided, enter the 5GHz WiFi MAC address of TEW-841APB0 #2 and click **Save** at the bottom of the page.

Note: To permanently apply the configuration changes, you can click **Apply** at the prompt that appears at the bottom right corner of the page and wait for the device to commit the changes. If you are applying additional configuration changes, you can apply the temporary changes later on by clicking the **Changes** tab at the top right of the page and click **Apply** in the Configuration / Changes page.

MAC Address Mode

00 11 22 33 44 11 Enable

Waiting for changes to be applied (6)

Apply Revert

Changes: 2 Reset Logout

Phase 3: TEW-841APB0 Unit #2 Hardware Setup and Configuration

When configuring TEW-841APB0 #2, repeat all of the steps in Phase 2 setup and configuration.

1. In Step 9, under IPv4 Settings, select **Static IP** and enter the IP address **192.168.10.51**, Subnet Mask **255.255.255.0**, Gateway **192.168.10.1**, and Primary DNS **192.168.10.1**. After you have completed configuring the access point IP address settings, click **Save** at the bottom of the page to temporarily save the settings.

Note: To permanently apply the configuration changes, you can click **Apply** at the prompt that appears at the bottom right corner of the page and wait for the device to commit the changes. If you are applying additional configuration changes, you can apply the temporary changes later on by clicking the **Changes** tab at the top right of the page and click **Apply** in the Configuration / Changes page.

IPv4 Settings

IP Network Setting	<input type="radio"/> DHCP <input checked="" type="radio"/> Static IP
IP Address	<input type="text" value="192.168.10.51"/>
Subnet Mask	<input type="text" value="255.255.255.0"/>
Gateway	<input type="text" value="192.168.10.1"/>
Primary DNS	<input type="text" value="192.168.10.1"/>
Secondary DNS	<input type="text" value="0.0.0.0"/>

2. In Step 14, under the **MAC Address** section, click the **Mode** drop-down list and select **Enable**. In the fields provided, enter the 5GHz WiFi MAC address of TEW-841APB0 #1 and click **Save** at the bottom of the page.

Note: To permanently apply the configuration changes, you can click **Apply** at the prompt that appears at the bottom right corner of the page and wait for the device to commit the changes. If you are applying additional configuration changes, you can apply the temporary changes later on by clicking the **Changes** tab at the top right of the page and click **Apply** in the Configuration / Changes page.

MAC Address	Mode
<input type="text" value="00"/> <input type="text" value="11"/> <input type="text" value="22"/> <input type="text" value="33"/> <input type="text" value="44"/> <input type="text" value="00"/>	<input type="text" value="Enable"/>

IMPORTANT NOTE: Configuration changes in the access point web management configuration are not applied until you permanently click **Apply** when the prompt appears or under the **Changes** tab at the top right of the page and click **Apply** in the Configuration / Changes page. The Changes tab will indicate the number of temporary configuration changes that are pending to be permanently applied. You can also click **Revert** to discard all of the temporary configuration changes.

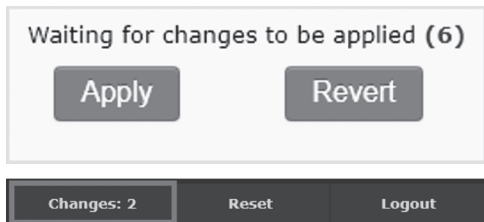

Phase 4: Confirm Connectivity

1. Leave your computer connected to TEW-841APB0 #2 and keep the access point configuration page open.
2. Make sure both TEW-841APB0 #1 and TEW-841APB0 #2 access point are powered on approximately 15 ft. (5 m) apart from one another.

TEW-841APB0 #1

TEW-841APB0 #2

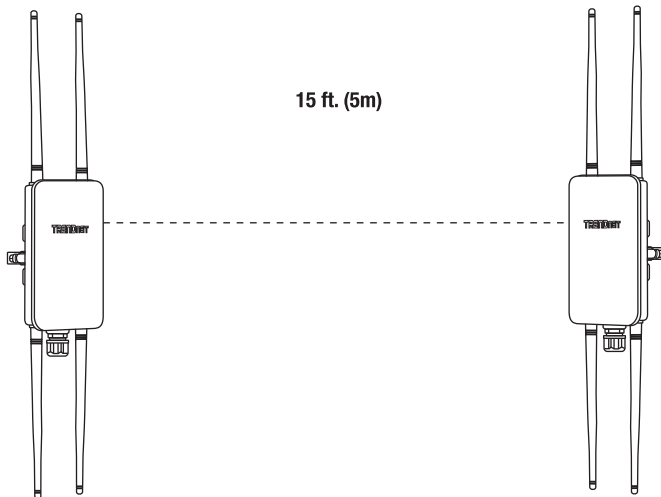

3. To verify connectivity, in the TEW-841APBO #2 access point configuration page, under **Management**, click on Tools and click on **Ping**.

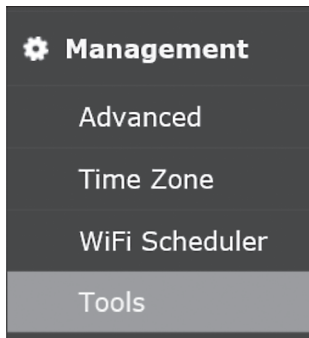

4. In the **Target IP / Domain Name** field, enter the IP address of the TEW-841APBO #1 access point, 192.168.10.50, then click **Start**.

Ping Test Parameters

Target IP / Domain Name	<input type="text" value="192.168.10.50"/>	
Ping Packet Size	<input type="text" value="64"/>	Bytes
Number of Pings	<input type="text" value="4"/>	
<input type="button" value="Start"/>		

5. Ping replies and 0% packet loss will indicate a successful point to point bridge connection between the TEW-841APBO #1 and #2 access points.

Note: If the connectivity test fails, wait for about a minute and try again. Make sure there are no obstacles between the two access point when running the connectivity test and make sure the two access point are not too close together.

5. Waterproof Kit Installation

1. Unscrew the sealing nut from the main body.
2. Separate the rubber seal from the claw.
3. Verify that you have the following parts:



4. Insert one end of an Ethernet cable into the sealing nut.

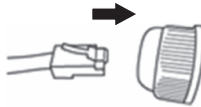

5. Insert the Ethernet cable into the seal.

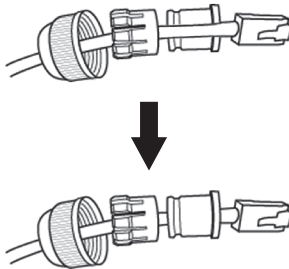

6. Insert the seal into the claw.

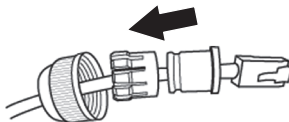

7. Insert the seal/rubber claw into the Cable Gland.

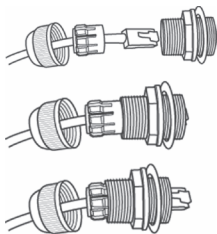

8. Connect the Ethernet cable to the LAN (PoE) port on the bottom of the access point.

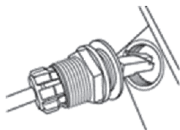

9. By hand, screw the main body counter clockwise to secure it to the access point.

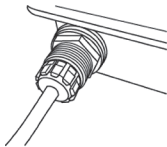

10. By hand, screw the seal nut clockwise to secure it to the main body.



6. Pole Mount Installation

Note: The pole mounting clamp supports poles with a maximum diameter of 66 mm (2.63 in.)

1. Insert the included pole mounting clamp through the hole located in the back of the access point.
2. Wrap the clamp around the pole where the access point will be installed and secure by turning the pole clamp screw clockwise at the desired height and position.

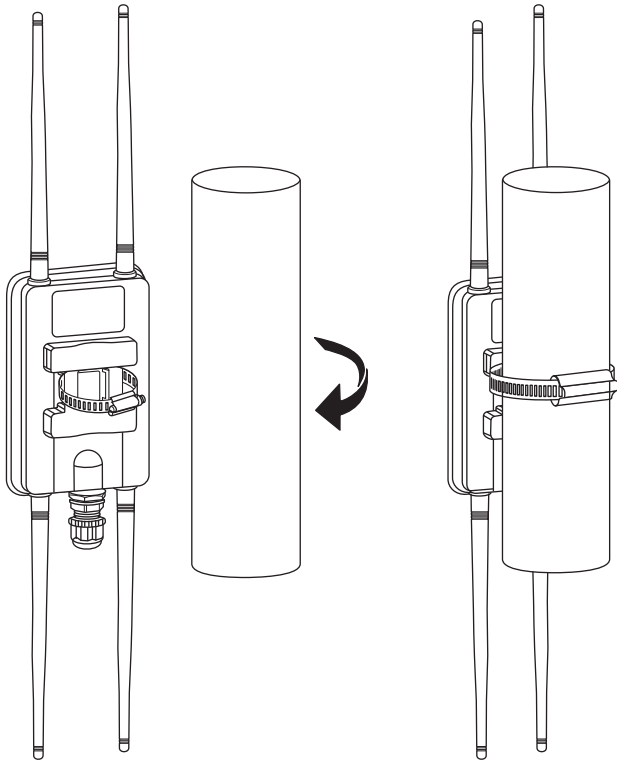

Completed Installation Reference

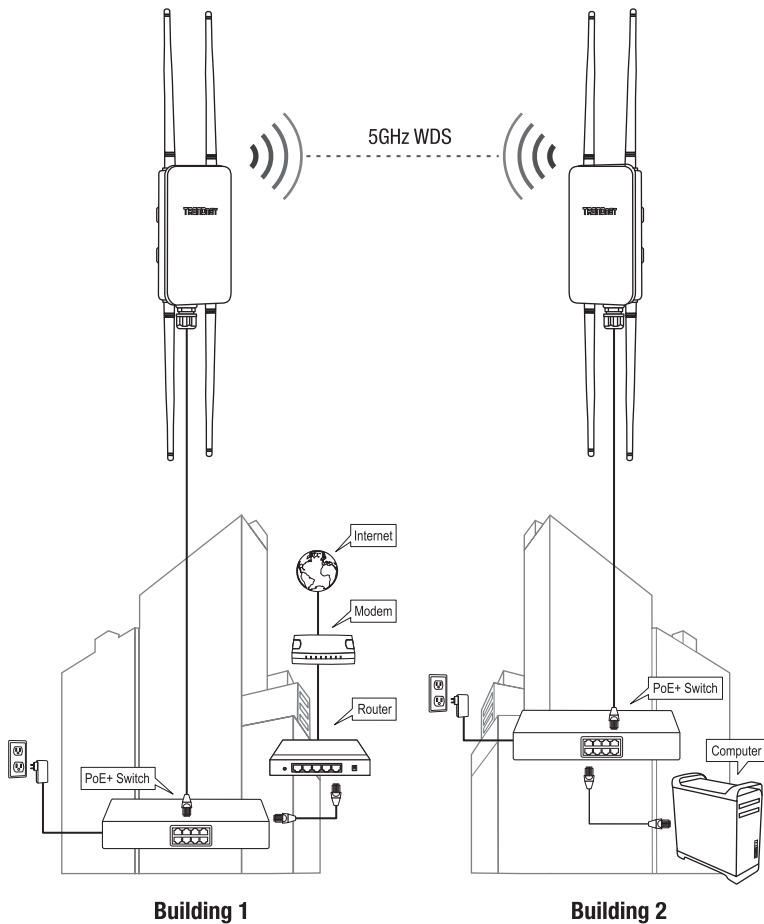

Installation Tips and Troubleshooting

Q1: How do I configure my computer's network adapter with a static IP address?

Note: Please note that although the following procedures are provided to follow for your operating system network adapter settings to be used as general guidelines, however, it is strongly recommended that you consult your computer or operating system manufacturer directly for assistance on the proper procedure for configuring network settings. If you are experiencing difficulties, please contact your computer or operating system manufacturer for assistance.

Windows 2000/XP/Vista/7/8/8.1/10

1. On your keyboard, press **Windows Logo + R** keys simultaneously to bring up the Run dialog box.
2. In the dialog box, type **ncpa.cpl** to bring up the Network Connections window.
3. Right-click the **Local Area Connection** or **Ethernet** icon, click **Properties**, and double-click **Internet Protocol Version 4 (TCP/IPv4)**.
4. Then click **Use the following IP address** and assign your network adapter a static IP address. See example static IP address settings below.
 - IP address: 192.168.10.25
 - Subnet mask: 255.255.255.0
5. Click **OK** on both TCP/IPv4 Properties and Local Area Connection Properties windows.

MAC OS X

1. From the **Apple** drop-down list, select **System Preferences**.
2. Click the **Network** icon.
3. From the **Location** drop-down list, select **Automatic**.
4. Select and view your Ethernet connection.
 - For MAC OS 10.4, from the **Show** drop-down list, select **Built-in Ethernet** and select the **TCP/IP** tab.
 - For MAC OS 10.5 and above, in the left column, select **Ethernet**.
5. Configure TCP/IP to use a static IP.
 - From the **Configure IPv4** or **Configure** drop-down list, select **Manually** and assign your network adapter a static IP address. Then click the **Apply** or **Apply Now** button. See example static IP address settings below.
 - IP address: 192.168.10.25
 - Subnet mask: 255.255.255.0
6. You may be prompted to restart your computer to apply the new IP address settings.

Q2: I configured my computer's network adapter with a static IP address, how do I reconfigure my computer's network adapter to default settings and obtain an IP address automatically using DHCP?

Note: Please note that although the following procedures are provided to follow for your operating system network adapter settings to be used as general guidelines, however, it is strongly recommended that you consult your computer or operating system manufacturer directly for assistance on the proper procedure for configuring network settings. If you are experiencing difficulties, please contact your computer or operating system manufacturer for assistance.

Windows 2000/XP/Vista/7/8/8.1/10

1. On your keyboard, press **Windows Logo + R** keys simultaneously to bring up the Run dialog box.
2. In the dialog box, type **ncpa.cpl** to bring up the Network Connections window.
3. Right-click the **Local Area Connection** or **Ethernet** icon, click **Properties**, and double-click **Internet Protocol Version 4 (TCP/IPv4)**.
4. Then click **Obtain an IP address automatically** and **Obtain DNS server address automatically**.
5. Click **OK** on both TCP/IPv4 Properties and Local Area Connection Properties windows.

MAC OS X

1. From the **Apple** drop-down list, select **System Preferences**.
2. Click the **Network** icon.
3. From the **Location** drop-down list, select **Automatic**.
4. Select and view your Ethernet connection.
 - In MAC OS 10.4, from the **Show** drop-down list, select **Built-in Ethernet** and select the **TCP/IP** tab.
 - In MAC OS 10.5 and above, in the left column, select **Ethernet**.
5. Configure TCP/IP to use a static IP.
 - From the **Configure IPv4** or **Configure** drop-down list, select **Using DHCP** and click the **Apply** or **Apply Now** button.
6. You may be prompted to restart your computer to apply the new IP address settings.

Q3: I typed `http://192.168.10.100` in my Internet Browser Address Bar, but an error message says “The page cannot be displayed.” How can I access the wireless access point management page?

1. Double check all physical cable and port connections.
2. Make sure the PWR/LAN/2.4GHz/5GHz LEDs on the wireless access point front panel are on.
3. Make sure your computer's network adapter is configured with a static IP address. (Refer to Q1 for instructions on assigning a static IP address).
4. Make sure your computer is connected to the access point network LAN port and LAN LED is on.
5. Since the access point default IP address is 192.168.10.100, make sure there are no other network devices assigned an IP address of 192.168.10.100

Note: After checking all of the recommended items above, please attempt to access the wireless access point management page again.

Q4: How do I find the current IP address of my computer's network adapter?

Note: Please note that although the following procedures are provided to follow for your operating system network adapter settings to be used as general guidelines, however, it is strongly recommended that you consult your computer or operating system manufacturer directly for assistance on the proper procedure for configuring network settings. If you are experiencing difficulties, please contact your computer or operating system manufacturer for assistance.

Command Prompt Method

Windows 2000/XP/Vista/7/8/8.1/10

1. On your keyboard, press **Windows Logo + R** keys simultaneously to bring up the Run dialog box.
2. In the dialog box, type **cmd** to bring up the command prompt.
3. In the command prompt, type **ipconfig /all** to display your IP address settings.

MAC OS X

1. Navigate to your **Applications** folder and open Utilities.
2. Double-click on **Terminal** to launch the command prompt.
3. In the command prompt, type **ipconfig getifaddr <en0 or en1>** to display the wired or wireless IP address settings.

Note: **en0** is typically the wired Ethernet and **en1** is typically the wireless Airport interface.

Graphical Method

Windows XP/Vista/7/8/8.1/10

1. On your keyboard, press **Windows Logo + R** keys simultaneously to bring up the Run dialog box.
2. In the dialog box, type **ncpa.cpl** to bring up the Network Connections window.
3. Double-click the Local Area Connection icon and click the Details button to view the current IP address settings.

Note: The computer's network adapter must be enabled and connected to view the current IP address settings.

MAC OS X

1. From the **Apple** menu, select **System Preferences**.
2. In System Preferences, from the **View** menu, select **Network**.
3. In the Network preference window, click a network port (e.g., Ethernet, AirPort, modem). If you are connected, you'll see your IP address settings under "Status:"

Federal Communication Commission Interference Statement

This equipment has been tested and found to comply with the limits for a Class B digital device, pursuant to Part 15 of the FCC Rules. These limits are designed to provide reasonable protection against harmful interference in a residential installation. This equipment generates, uses and can radiate radio frequency energy and, if not installed and used in accordance with the instructions, may cause harmful interference to radio communications. However, there is no guarantee that interference will not occur in a particular installation. If this equipment does cause harmful interference to radio or television reception, which can be determined by turning the equipment off and on, the user is encouraged to try to correct the interference by one of the following measures:

- Reorient or relocate the receiving antenna.
- Increase the separation between the equipment and receiver.
- Connect the equipment into an outlet on a circuit different from that to which the receiver is connected.
- Consult the dealer or an experienced radio/TV technician for help.

FCC Caution: Any changes or modifications not expressly approved by the party responsible for compliance could void the user's authority to operate this equipment.

This device complies with Part 15 of the FCC Rules. Operation is subject to the following two conditions: (1) This device may not cause harmful interference, and (2) this device must accept any interference received, including interference that may cause undesired operation.

IMPORTANT NOTE:

Radiation Exposure Statement:

This equipment complies with FCC radiation exposure limits set forth for an uncontrolled environment. This equipment should be installed and operated with minimum distance 25cm between the radiator & your body.

This transmitter must not be co-located or operating in conjunction with any other antenna or transmitter.

Country Code selection feature to be disabled for products marketed to the US/CANADA

TRENDnet hereby declare that the product is in compliance with the essential requirements and other relevant provisions under our sole responsibility.

Industry Canada Statement

This device complies with Industry Canada license-exempt RSS standard(s). Operation is subject to the following two conditions: (1) this device may not cause interference, and (2) this device must accept any interference, including interference that may cause undesired operation of the device.

Le présent appareil est conforme aux CNR d'Industrie Canada applicables aux appareils radio exempts de licence. L'exploitation est autorisée aux deux conditions suivantes : (1) l'appareil ne doit pas produire de brouillage, et (2) l'utilisateur de l'appareil doit accepter tout brouillage radioélectrique subi, même si le brouillage est susceptible d'en compromettre le fonctionnement.

Radiation Exposure Statement:

This equipment complies with IC radiation exposure limits set forth for an uncontrolled environment. This equipment should be installed and operated with minimum distance 25cm between the radiator & your body.

Déclaration d'exposition aux radiations:

Cet équipement est conforme aux limites d'exposition aux rayonnements IC établies pour un environnement non contrôlé. Cet équipement doit être installé et utilisé avec un minimum de 25 cm de distance entre la source de rayonnement et votre corps.

Certifications

This device complies with Part 15 of the FCC Rules.

Operation is subject to the following two conditions:

- (1) This device may not cause harmful interference.
- (2) This device must accept any interference received.

Including interference that may cause undesired operation.



Waste electrical and electronic products must not be disposed of with household waste. Please recycle where facilities exist. Check with your Local Authority or Retailer for recycling advice.

Applies to PoE Products Only: This product is to be connected only to PoE networks without routing to the outside plant.

Note

The Manufacturer is not responsible for any radio or TV interference caused by unauthorized modifications to this equipment. Such modifications could void the user's authority to operate the equipment.

Advertencia

En todos nuestros equipos se mencionan claramente las características del adaptador de alimentación necesario para su funcionamiento. El uso de un adaptador distinto al mencionado puede producir daños físicos y/o daños al equipo conectado. El adaptador de alimentación debe operar con voltaje y frecuencia de la energía eléctrica domiciliar existente en el país o zona de instalación.

Technical Support

If you have any questions regarding the product installation, please contact our Technical Support.

Toll free US/Canada: **1-855-373-4741**

Regional phone numbers available at www.trendnet.com/support

TRENDnet

20675 Manhattan Place
Torrance, CA 90501
USA

Product Warranty Registration

Please take a moment to register your product online. Go to TRENDnet's website at: www.trendnet.com/register