

TRENDnet®



Quick Installation Guide

PoE Web Smart Switch Series

Table of Contents

1 English

1. Before You Start
2. Quick Reference
3. Hardware Installation and Configuration

1. Before You Start

Package Contents

- Quick Installation Guide
- Power cord (1.8m / 6 ft.)
- Rack mount kit

Minimum Requirements

- Computer with an Ethernet port and web browser
- Network cable

Optional Equipment

- EIA standard 19" rack
- SFP modules (e.g. TE100-MGBFX, TEG-MGBSX, TEG-MGBS10, TEG-MGBS40, TEG-MGBS80, TEG-MGBS10D3, TEG-MGBS10D5, TEG-MGBS40D3, TEG-MGBS40D5)

2. Quick Reference

PoE Camera

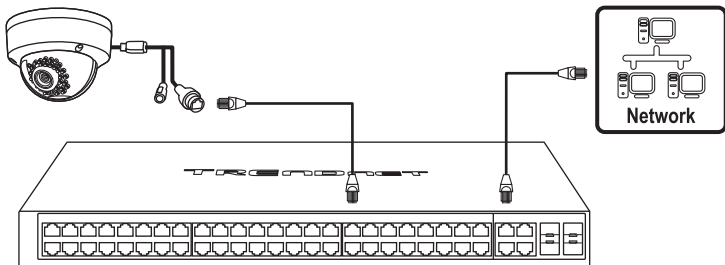

PoE Camera

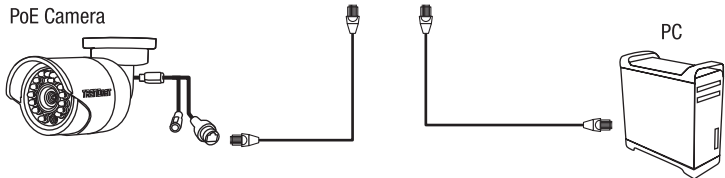

Note: The switch may be different than the one shown in the examples.

3. Hardware Installation and Configuration

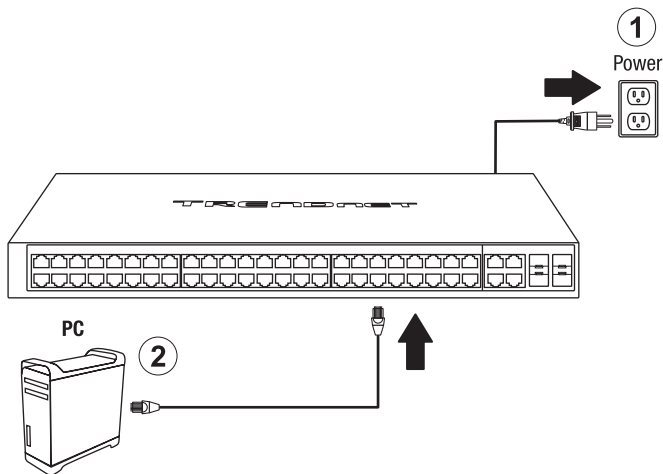

3. Assign a Static IP address to your computer's network adapter in the subnet of 192.168.10.x (e.g. 192.168.10.25) and a subnet mask of 255.255.255.0.
4. Open your web browser, type the IP address of the switch in the address bar, and then press **Enter**. The default IP address is 192.168.10.200.

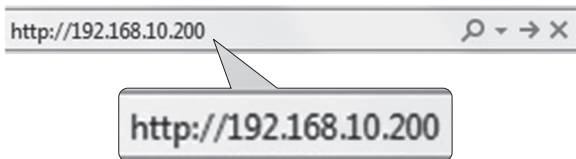

5. Enter the **User name** and **Password**, and then click **LOGIN**. By default:

User Name: **admin**

Password: **admin**

Note: User Name and Password are case sensitive.

The image shows a login form with two input fields. The first field is labeled 'User Name:' and contains the text 'admin'. The second field is labeled 'Password:' and contains six dots. Below the fields are two 'LOGIN' buttons. Callout boxes point to the 'admin' text in both the User Name and Password fields, and another callout box points to the right 'LOGIN' button.

6. Click **System** and then click **IPv4 Setup**.

7. Configure the switch to match the requirements of your network. Then click **Apply**.

The image shows a configuration interface. On the left is a 'System info' sidebar with a 'System' menu. The main area is titled 'IPv4 Setup'. The 'System' menu has callouts pointing to 'System' and 'IPv4 Setup'. The 'IPv4 Setup' page has the following fields:

- System MAC Address: 00:01:02:03:04:05
- System IP Address: 192 . 168 . 10 . 200
- System Subnet Mask: 255 . 255 . 255 . 0
- System Default Gateway: 0 . 0 . 0 . 0
- System IP Mode: Static

Below these fields is an 'Apply' button with a callout pointing to it.

8. Click **OK**.

A warning dialog box with a title bar 'WARNING' and a warning icon. The text inside reads: 'The management session will be disconnected. Use new IP address to connect to device.' Below the text are two buttons: 'OK' and 'Cancel'. A callout box points to the 'OK' button.

9. In the left hand panel, click **Tools**, click on **Configuration**, and click **Save**.

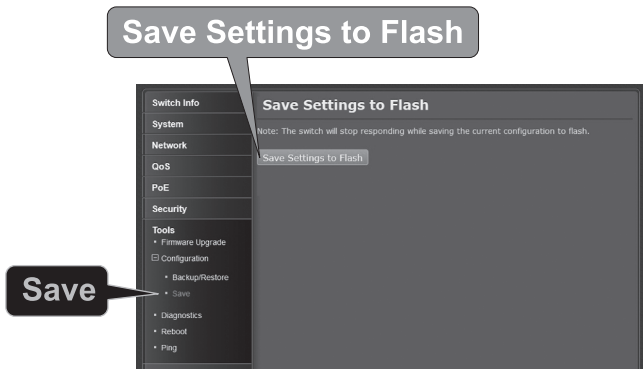

10. Click **OK**.

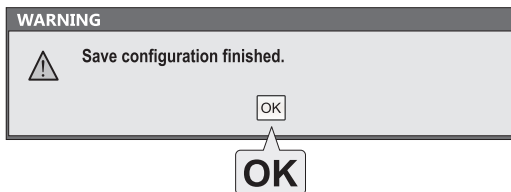

Note:

1. If you would like to easily discover all the Web Management Switches on the network, assign IP address, change password, then install the Web Smart Switch Management Utility. Follow the steps provided on the user's guide.
2. To download the latest version of the user's guide and the utility, please go to <http://www.trendnet.com/support> and select the **Switch Model** from the products drop down list.

Declaration of Conformity

TRENDnet[®]

Manufacturer's Name and Address

TRENDnet, Inc.
20675 Manhattan Place
Torrance, CA 90501 USA

Zwolsestraat 156 2587 WB
The Hague The Netherlands



Product Information:

Model Number: TPE-1021WS / TPE-1620WS / TPE-1620WSF / TPE-2840WS / TPE-5028WS /
TPE-5240WS / TPE-5048WS / TPE-30284 / TPE-30524WS / TPE-204US / TPE-284US

Product Name: 10-Port Gigabit Web Smart 123W PoE+ Switch /
20-Port Gigabit Web Smart PoE+ Switch /
20-Port Gigabit Web Smart 370W PoE+ Switch /
28-Port Gigabit Web Smart PoE+ Switch /
28-Port Gigabit Web Smart PoE+ Switch /
52-Port Gigabit Web Smart PoE+ Switch /
52-Port Gigabit Web Smart PoE+ Switch /
28-Port Gigabit Web Smart PoE+ Switch with 10G SFP+ slots
52-Port Gigabit Web Smart PoE+ Switch with 10G SFP+ slots /
20-Port Gigabit Web Smart 4PPoE Switch /
28-Port Gigabit Web Smart 4PPoE Switch

Trade Name: TRENDnet

TRENDnet hereby declare that the product is in compliance with the essential requirements and other relevant provisions under our sole responsibility.

Safety EN EN 62368-1:2014+A11:2017

EMC EN 55032:2015+AC:2016 (CISPR32:2015/COR:2016) (Class A)
EN 61000-3-2:2014
EN 61000-3-3:2013
EN 55024:2010+A1:2015

This product is herewith confirmed to comply with the Directives

Directives EMC Directive 2014/30/EU
RoHS Directive 2011/65/EU
WEEE Directive 2012/19/EU
REACH Regulation (EC) No. 1907/2006
Low Voltage Directive 2014/35/EU

Person responsible for this declaration.

Place of Issue: Torrance, California, USA

Date: June 10, 2020

Name: Sonny Su

Title: Director of Technology

Signature: _____



UL Warning

- 1) Elevated Operating Ambient Temperature - If installed in a closed or multi-unit rack assembly, the operating ambient temperature of the rack environment may be greater than room ambient. Therefore, consideration should be given to installing the equipment in an environment compatible with the manufacturer's maximum rated ambient temperature (T_{ma}).
- 2) Reduced Air Flow - Installation of the equipment in a rack should be such that the amount of air flow required for safe operation of the equipment is not compromised.
- 3) Mechanical Loading - Mounting of the equipment in the rack should be such that a hazardous condition is not achieved due to uneven mechanical loading.
- 4) Circuit Overloading - Consideration should be given to the connection of the equipment to the supply circuit and the effect that overloading of circuits might have on over current protection and supply wiring. Appropriate consideration of equipment nameplate ratings should be used when addressing this concern.
- 5) Reliable Earthing - Reliable earthing of rack-mounted equipment should be maintained. Particular attention should be given to supply connections other than direct connections to the branch circuit (e.g., use of power strips).

Rack Installation

The Switch can be mounted in an EIA standard, 19-inch rack, which can be placed in a wiring closet with other equipment. To install, attach the mounting brackets to the switch's front panel (one on each side) and secure them with the screws provided.

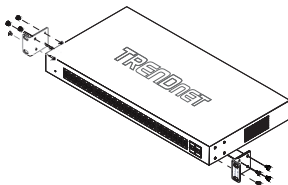

Attaching the mounting brackets to the Switch

Use the screws provided with the equipment rack to mount the Switch on the rack.

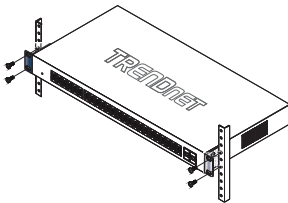

Installing the Switch in an equipment rack

TRENDNET[®]

Certifications

This device complies with Part 15 of the FCC Rules.

Operation is subject to the following two conditions:

- (1) This device may not cause harmful interference.
- (2) This device must accept any interference received.

Including interference that may cause undesired operation.



Waste electrical and electronic products must not be disposed of with household waste. Please recycle where facilities exist. Check with your Local Authority or Retailer for recycling advice.

FCC warning:

This equipment has been tested and found to comply with the limits for a Class A digital device, pursuant to part 15 of the FCC Rules. These limits are designed to provide reasonable protection against harmful interference when the equipment is operated in a commercial environment. This equipment generates, uses, and can radiate radio frequency energy and, if not installed and used in accordance with the instruction manual, may cause harmful interference to radio communications. Operation of this equipment in a residential area is likely to cause harmful interference in which case the user will be required to correct the interference at his own expense.

FCC Caution:

Any changes or modification not expressly approved by the party responsible for compliance could void the user's authority to operate this equipment.

Technical Support

If you have any questions regarding the product installation, please contact our Technical Support.

Toll free US/Canada: **1-855-373-4741**

Regional phone numbers available at www.trendnet.com/support

TRENDnet

20675 Manhattan Place
Torrance, CA 90501
USA

Applies to PoE Products Only: This product is to be connected only to PoE networks without routing to the outside plant.

Note

The Manufacturer is not responsible for any radio or TV interference caused by unauthorized modifications to this equipment. Such modifications could void the user's authority to operate the equipment.

Avertissement

S'applique uniquement aux produits PoE: Ce produit doit être raccordé qu'aux réseaux PoE sans routage vers l'installation extérieure.

Advertencia

En todos nuestros equipos se mencionan claramente las características del adaptador de alimentación necesario para su funcionamiento. El uso de un adaptador distinto al mencionado puede producir daños físicos y/o daños al equipo conectado. El adaptador de alimentación debe operar con voltaje y frecuencia de la energía eléctrica domiciliaria existente en el país o zona de instalación.

UL warning:

The equipment power supply cord shall be connected to a socket-outlet with earthing connection.

Le cordon d'alimentation de l'appareil doit être raccordé à une prise de courant avec mise à la terre.

Fiber product warning note:

If the Optical Transceiver doesn't ship with the unit, the user manual shall have the description as below or equivalent:

"This product is intended to be used with a UL Listed Optical Transceiver product, Rated DC3.3V, Laser Class I."

Laser warning note:

This product is intended to be used with a UL Listed Optical Transceiver product, Rated DC3.3V, Laser Class I.

Product Warranty Registration

Please take a moment to register your product online. Go to TRENDnet's website at:

www.trendnet.com/register