



How to Use This Manual
Printing This Manual

MP280 series

On-screen Manual

MC-4700-V1.00



Basic Guide

Describes the summary of this product.

Advanced Guide

Describes the detailed function of this product.

Troubleshooting



Contents

❖ Overview of the Machine

Main Components
LED Display and Basic Operations

❖ Copying

Copying Documents
Copying Photos
Fit-to-Page Copying

❖ Scanning

Saving Scanned Data on the Computer

❖ Printing from Your Computer

Printing Photos (Easy-PhotoPrint EX)
Printing Documents
Printing Web Pages (Easy-WebPrint EX)
Starting Various Software Applications

❖ Loading Paper / Originals

Loading Paper
Loading Originals

❖ Routine Maintenance

When Printing Becomes Faint or Colors Are Incorrect
Replacing a FINE Cartridge
Cleaning the Machine

❖ Appendix

Legal Limitations on Use of Your Product and Use of Images
Tips on How to Use Your Machine

Overview of the Machine

This section shows the component names of the machine and describes the basic operations you need to know before using it.

Main Components

[Front View](#)

[Rear View](#)

[Inside View](#)

[Operation Panel](#)

LED Display and Basic Operations



 [Page top](#)

C001

Main Components

- ➔ [Front View](#)
- ➔ [Rear View](#)
- ➔ [Inside View](#)
- ➔ [Operation Panel](#)

■ Front View

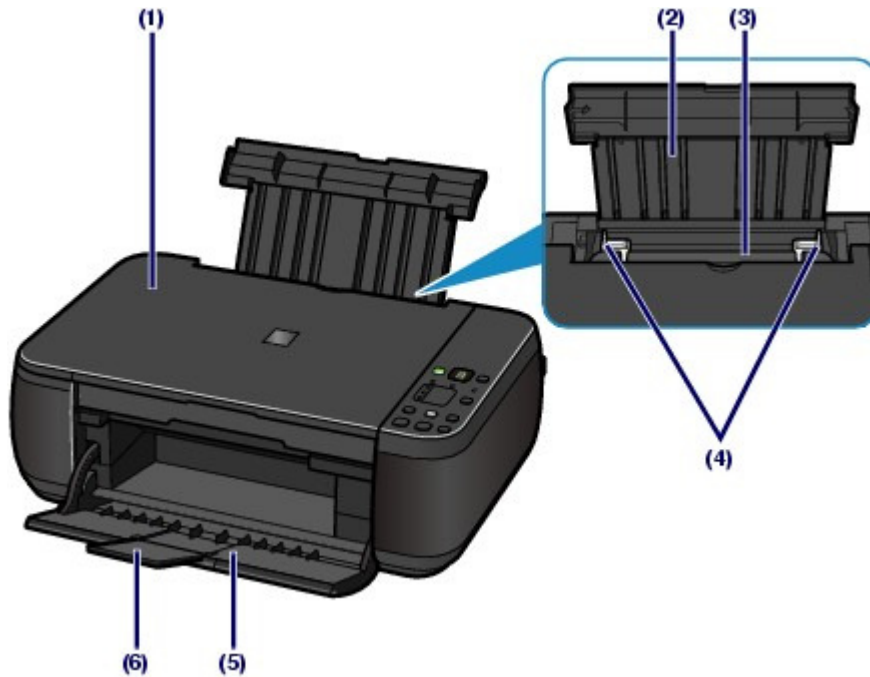

(1) Document Cover

Open to load an original on the Platen Glass.

(2) Paper Support

Raise and tip back to load paper in the Rear Tray.

(3) Rear Tray

Load various sizes or types of paper which you can use on the machine. Two or more sheets of the same size and type of paper can be loaded at the same time, and fed automatically one sheet at a time.

See [Loading Paper](#).

(4) Paper Guides

Slide to align with both sides of the paper stack.

(5) Paper Output Tray

Opens automatically when printing or copying starts and printed paper is ejected.

(6) Output Tray Extension

Open to support the printouts. Open it when printing or copying.

**(7) Platen Glass**

Load an original to copy or scan.

(8) Operation Panel

Use to change the settings of the machine or to operate it.

See [Operation Panel](#).

 **Note**

- The LED and lamps on the Operation Panel other than the **POWER** lamp will go out if the machine is not operated for about 5 minutes. To restore them, press any button except the **ON** button or perform the print operation.

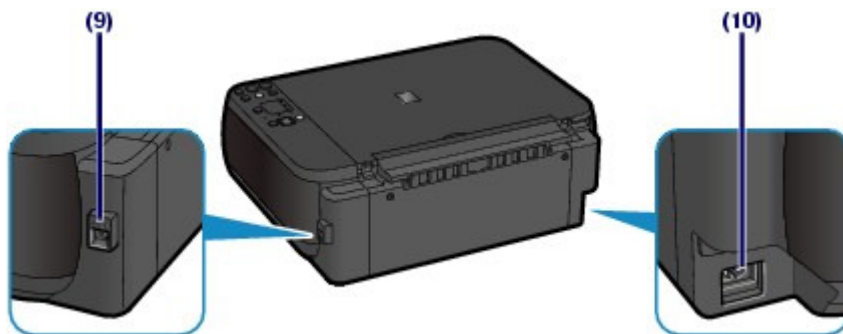
■ Rear View**(9) USB Port**

Plug in the USB cable to connect the machine with a computer.

 **Important**

- Do not touch the metal casing.
- Do not plug in or unplug the USB cable while the machine is printing or scanning originals with the computer.

(10) Power Cord Connector

Plug in the supplied power cord.

■ Inside View

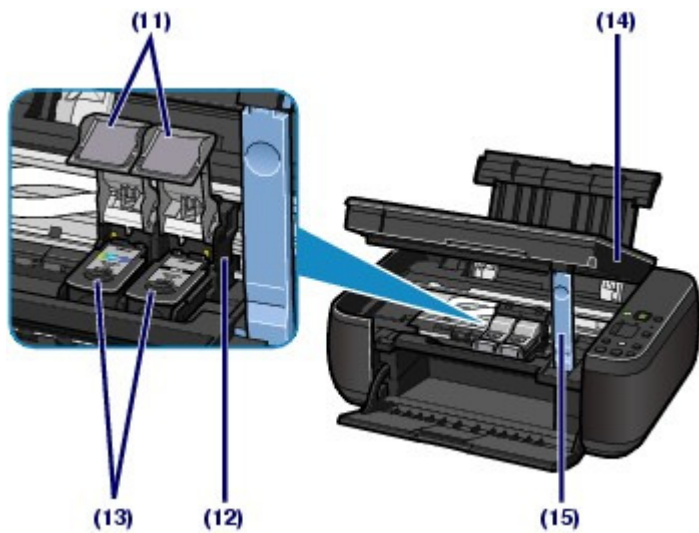

(11) Ink Cartridge Locking Covers

Lock the FINE Cartridges into place.

(12) FINE Cartridge Holder

Install the FINE Cartridges.

The Color FINE Cartridge should be installed into the left slot (C) and the Black FINE Cartridge should be installed into the right slot (B).

(13) FINE Cartridges (Ink Cartridges)

A replaceable cartridge that is integrated with Print Head and ink tank.

Note

- For details on installing the FINE Cartridges, refer to the printed manual: *Getting Started*.

(14) Scanning Unit (Cover)

Scans originals. Open it to replace the FINE Cartridges or remove jammed paper inside the machine. When opening the Scanning Unit (Cover), lift it with the Document Cover closed.

(15) Scanning Unit Support

Holds the Scanning Unit (Cover) while it is open.

Important

- The area (A) indicated in the figure below may be splattered with ink. It does not affect the performance of the machine.
- Do not touch the area (A). The machine may not print properly if you touch it.

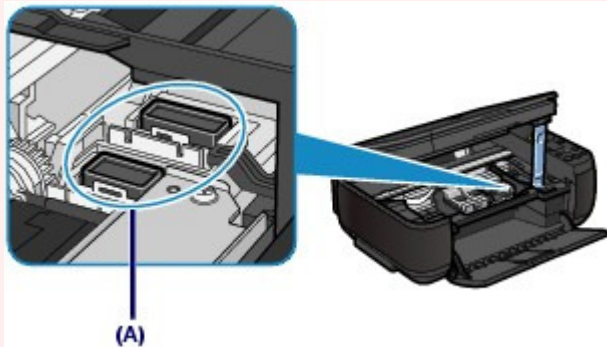

■ Operation Panel

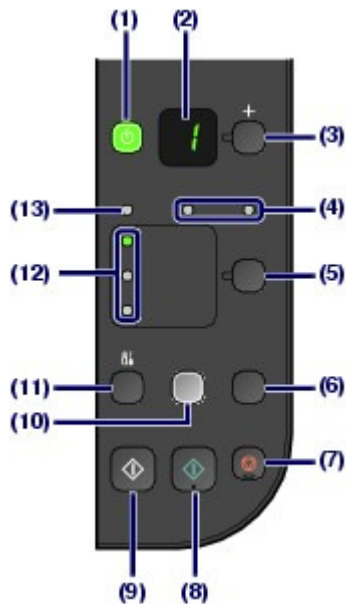

(1) ON button / POWER lamp

Turns the power on or off. Before turning on the power, make sure that the Document Cover is closed.

Important

Disconnecting the power plug

- When disconnecting the power plug after turning off the power, be sure to confirm that the **POWER** lamp is not lit. If the power plug is disconnected from the wall outlet while the **POWER** lamp is lit or flashing, the machine may become unable to print properly since the Print Head is not protected.

Note

POWER and Alarm lamps

- You can check the status of the machine with the **POWER** lamp and **Alarm** lamp.
 - **POWER** lamp is off: The power is off.
 - **POWER** lamp lights green: The machine is ready to print.
 - **POWER** lamp flashes green: The machine is initializing or shutting down.
 - **Alarm** lamp lights or flashes orange: An error has occurred and the machine is not ready to print. For details, refer to "[Troubleshooting](#)" in the on-screen manual: *Advanced Guide*.
 - **POWER** lamp flashes green and **Alarm** lamp flashes orange alternately: An error that requires contacting the service center may have occurred. For details, refer to "[Troubleshooting](#)" in the on-screen manual: *Advanced Guide*.

(2) LED (Light Emitting Diode)

Displays the number of copies, Maintenance code, or operational status such as an error code.

(3) [+] button

Specifies the number of copies.

(4) Ink lamps

Light or flash orange when ink runs out, etc. The lamp on the left indicates the Color FINE Cartridge status and the lamp on the right indicates the Black FINE Cartridge status.

(5) Paper button

Selects the page size and media type.

(6) SCAN button

Starts scanning the original to save it on the computer.

(7) Stop/Reset button

Cancels operations. You can also press this button to cancel a print, copy, or scan job in progress.

(8) Color button *

Starts color copying. You can also press this button to finalize your selection for the setting item.

(9) Black button*

Starts black & white copying. You can also press this button to finalize your selection for the setting item.

(10) Fit to Page button / Fit to Page lamp

Enables the Fit-to-Page copy function. When the Fit-to-Page copy function is enabled, the **Fit to Page** lamp lights up and you can copy the original automatically enlarged or reduced to fit the selected page size. When the Fit-to-Page copy function is disabled, you can make copies in the same size as the original.

(11)  (Maintenance) button

Specifies the Maintenance code.

(12) Paper lamp

Lights to indicate the page size and media type selected with the **Paper** button.

(13) Alarm lamp

Lights or flashes orange when an error occurs, such as paper-out or ink-out.

* In the software applications or manuals, the **Black** and **Color** buttons are collectively called the "Start" or "OK" button.



 [Page top](#)

C002

LED Display and Basic Operations

You can use the machine to make copies or perform maintenance operations without a computer. This section describes the LED display and basic operations on the Operation Panel.

The number **1** appears on the LED normally when turning on the power.



The LED display indicates the machine status as follows.

Machine Status	LED Display
While copying	Number of copies (flashing)
While printing, scanning, or performing maintenance operations	 (flashing in order)
When an error occurs	<ul style="list-style-type: none"> ● E and number appear alternately. For details on the error codes, refer to "Troubleshooting" in the on-screen manual: <i>Advanced Guide</i>. ● P and number appear alternately. An error that requires contacting the service center may have occurred. For details, refer to "Troubleshooting" in the on-screen manual: <i>Advanced Guide</i>.
While the Scanning Unit (Cover) is open	 (flashing)

● Number of Copies

When copying starts, the specified number of copies appears on the LED. While copying is in progress, the number on the LED flashes and decreases by one to indicate the remaining number of copies to be made.













Each time you press the [+] button, the number on the LED increases by one. When **F** appears, the number of copies is set to "20". Press the [+] button again to return to "1".



● Maintenance Codes

To perform maintenance of the machine, press the (Maintenance) button repeatedly until the desired

code appears on the LED, and then press the **Black** or **Color** button.

Maintenance Code	Operation	See
	Prints the nozzle check pattern.	Printing the Nozzle Check Pattern
	Cleans the Print Head.	Cleaning the Print Head
	Cleans the Print Head deeply.	Cleaning the Print Head Deeply
	Prints the print head alignment sheet.	Aligning the Print Head
	Scans the print head alignment sheet to align the Print Head automatically.	Aligning the Print Head
	Prints the current head position adjustment values.	Aligning the Print Head
	Cleans the Paper Feed Roller.	Cleaning the Paper Feed Roller
	Cleans the inside of the machine.	Cleaning the Inside of the Machine (Bottom Plate Cleaning)
	Switches the size of paper loaded in the Rear Tray between A4 and 8.5" x 11" (Letter). (This setting is used for making copies.)	Switching the Page Size between A4 and 8.5" x 11" (Letter)
	Sets the machine to prevent paper abrasion.	Refer to "Paper Is Smudged/Printed Surface Is Scratched" in " Troubleshooting " of the on-screen manual: <i>Advanced Guide</i> .

● Error Codes

When an error occurs, **E** and number appear alternately on the LED to indicate the error code.

e.g. "E, 1, 6"



(flashing in order)

Note

- For details on the error codes, refer to "[Troubleshooting](#)" in the on-screen manual: *Advanced Guide*.
- If an error code with **P** appears, an error that requires contacting the service center may have occurred.
For details, refer to "[Troubleshooting](#)" in the on-screen manual: *Advanced Guide*.



Copying

You can make enlarged or reduced copies of the original to fit the page size, and borderless copies of a printed photo, besides standard copies.

Copying Documents

[Switching the Page Size between A4 and 8.5" x 11" \(Letter\)](#)

Copying Photos

Fit-to-Page Copying



[↑ Page top](#)

[Contents](#) > [Copying](#) > Copying Documents

C021

Copying Documents

This section describes the procedure to copy a document of A4 or Letter size on plain paper. For the operation, see the notes and operation procedure described in the reference page.

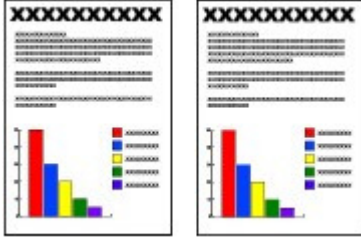

You need to prepare:

Originals to copy. See [Originals You Can Load](#).

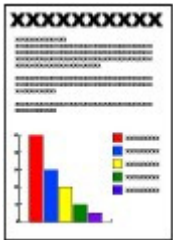

Paper for printing. See [Media Types You Can Use](#).

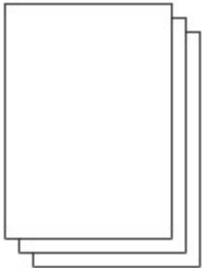

1. Prepare for copying.

(1) Turn on the power.

See [Operation Panel](#).

(2) Load paper.

See [Loading Plain Paper / Photo Paper](#).

Here we load A4 or Letter-sized plain paper in the Rear Tray.

(3) Open the Paper Output Tray gently, and open the Output Tray Extension.

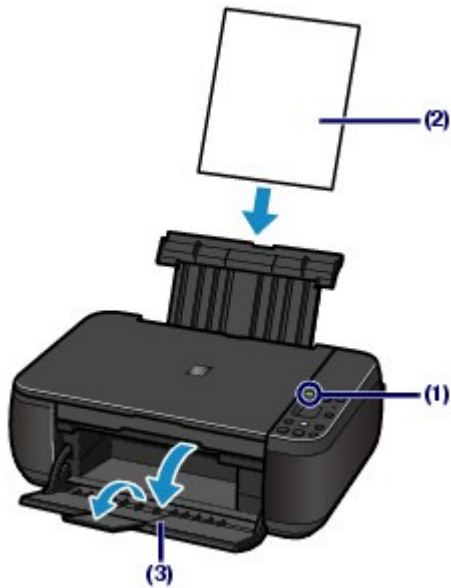

(4) Load an original on the Platen Glass.

See [Loading Originals](#).

Load the original WITH THE SIDE TO COPY FACING DOWN and align it with the alignment mark  as shown below.

Then close the Document Cover gently.

Note

- For details on the types and conditions of the original which can be copied, and how to load the original, see [Loading Originals](#).
- Characters and lines written with a light colored pen or highlight pen may not be copied properly.

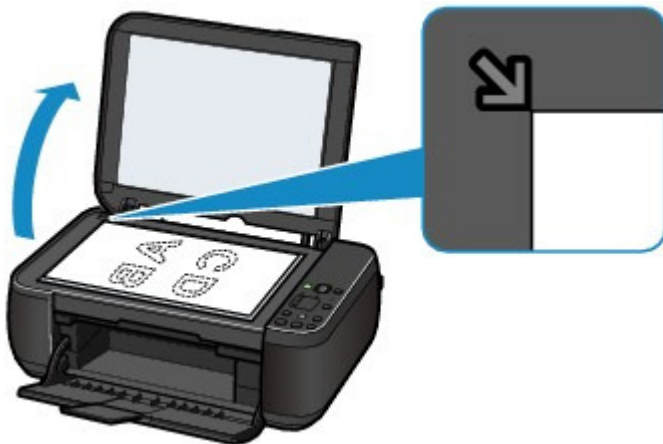

2. Start copying.

- (1) Press the [+] button repeatedly to specify the number of copies (max. 20 copies).



To make 1 to 9 copies or 20 copies

Display the desired number of copies on the LED.

Each time you press the [+] button, the number on the LED increases by one. When **F** appears, the number of copies is set to "20". Press the [+] button again to return to "1".

To make 10 to 19 copies

- (1) Display **F** on the LED.
- (2) Load only the desired number of sheets to copy.

(2) Press the **Paper** button repeatedly to select the page size and media type.

The **Paper** lamp indicates the selected page size and media type.

Here we select A4 or 8.5" x 11" Plain Paper.

Note

- You can select the following page sizes and media types.
 - A4 or 8.5" x 11" Plain Paper
 - A4 or 8.5" x 11" Photo Paper
 - 10 x 15 cm or 4" x 6" Photo Paper
- You can switch the size of paper loaded in the Rear Tray between A4 and 8.5" x 11" (Letter) regardless of the size indicated on the Operation Panel.
See [Switching the Page Size between A4 and 8.5" x 11" \(Letter\)](#) .
- When the Fit-to-Page copy function is enabled, you can copy the original in the size automatically enlarged or reduced to fit the selected page size. In this case, the original is copied with borders on the plain paper and without borders on the photo paper.
Cancel the Fit-to-Page copy function to copy the original in the same size.
See [Fit-to-Page Copying](#).

(3) Press the **Color** button for color copying, or the **Black** button for black & white copying.

The machine starts copying.

While copying is in progress, the number on the LED flashes and decreases by one to indicate the remaining number of copies to be made.

Remove the original on the Platen Glass after copying is completed.

To make 10 to 19 copies

The paper-out error will occur ("E, 0, 2" will appear on the LED) when all of the loaded paper runs out. Press the **Stop/Reset** button to release the error.

Note

- You can set the print quality to "Fast" (speed priority) only when A4 or Letter-sized plain paper is selected for the page size and media type.

To set the print quality to "Fast" (speed priority)

1. Press and hold down the **Color** or **Black** button for 2 or more seconds in (3) of step 2.
The LED flashes once.
* When you press the **Color** or **Black** button for less than 2 seconds, the machine starts copying in the print quality "Standard".
2. Release the button.
The machine starts copying.
- When the print quality is set to "Fast", print speed is given priority over quality. To give priority to quality, press the **Color** or **Black** button for less than 2 seconds to copy in the print quality "Standard".

Important

- Do not open the Document Cover or move the loaded original until copying is completed.

Note

- To cancel copying, press the **Stop/Reset** button.

■ Switching the Page Size between A4 and 8.5" x 11" (Letter)

You can switch the size of paper loaded in the Rear Tray between A4 and 8.5" x 11" (Letter). This setting is useful if you usually load Letter-sized paper in the Rear Tray regardless of the page size indication "A4" on the Operation Panel, or vice versa.

1. Press the  (Maintenance) button repeatedly until **d** appears.



2. Press the **Black** button to select A4, or the **Color** button to select 8.5" x 11" (Letter).

Note

- When you switch the page size to A4 or 8.5" x 11" (Letter), load paper of the selected size regardless of the size indicated on the Operation Panel.
 - When the page size is set to A4, load A4 plain paper or photo paper.
 - When the page size is set to 8.5" x 11" (Letter), load Letter-sized plain paper or photo paper.



 [Page top](#)

C023

Copying Photos

This section describes the procedure to copy a printed photo on 4" x 6" / 10 x 15 cm photo paper.



You need to prepare:

Printed photos.



Photo paper for printing. See [Media Types You Can Use](#).



1. Prepare for copying a photo.

(1) Turn on the power.

See [Operation Panel](#).

(2) Load paper.

See [Loading Plain Paper / Photo Paper](#).

Here we load 4" x 6" / 10 x 15 cm photo paper in the Rear Tray.

(3) Open the Paper Output Tray gently, and open the Output Tray Extension.

(4) Load a photo on the Platen Glass.

See [Loading Originals](#).

2. Start copying.

(1) Press the **[+]** button repeatedly to specify the number of copies.

See step 2 in [Copying Documents](#).

(2) Press the **Paper** button repeatedly to select the page size and media type.

The **Paper** lamp indicates the selected page size and media type.

Here we select 10 x 15 cm or 4" x 6" Photo Paper.

Note

- You can select the following page sizes and media types.
 - A4 or 8.5" x 11" Plain Paper
 - A4 or 8.5" x 11" Photo Paper
 - 10 x 15 cm or 4" x 6" Photo Paper
- You can switch the size of paper loaded in the Rear Tray between A4 and 8.5" x 11" (Letter) regardless of the size indicated on the Operation Panel.
See [Switching the Page Size between A4 and 8.5" x 11" \(Letter\)](#).

- When the Fit-to-Page copy function is enabled, you can copy the original in the size automatically enlarged or reduced to fit the selected page size. In this case, the original is copied with borders on the plain paper and without borders on the photo paper. Cancel the Fit-to-Page copy function to copy the original in the same size. See [Fit-to-Page Copying](#).
-

(3) Press the **Color** button for color copying, or the **Black** button for black & white copying.

The machine starts copying.

Remove the photo on the Platen Glass after copying is completed.

 **Important**

- Do not open the Document Cover or move the loaded photo until copying is completed.

 **Note**

- To cancel copying, press the **Stop/Reset** button.
-



 [Page top](#)

C024

Fit-to-Page Copying

The Fit-to-Page copy function enables you to copy the original automatically enlarged or reduced to fit the selected page size.



1. Prepare for copying.

See step 1 in [Copying Documents](#).

2. Press the **[+]** button repeatedly to specify the number of copies.

See step 2 in [Copying Documents](#).

3. Press the **Paper** button repeatedly to select the page size and media type.

Note

- When the plain paper is selected for the media type, the original is copied with borders. When the photo paper is selected for the media type, the original is copied without borders and fills the entire page.
- In borderless copying, slight cropping may occur at the edges since the copied image is enlarged to fill the whole page.

4. Press the **Fit to Page** button.

The **Fit to Page** lamp lights up and the Fit-to-Page copy function is enabled. The original is copied in the size automatically enlarged or reduced to fit the selected page size.

Note

- Press the **Fit to Page** button again to cancel the Fit-to-Page copy function and copy the original in the same size.

5. Press the **Color** button for color copying, or the **Black** button for black & white copying.

The machine starts Fit-to-Page copying.

Remove the original on the Platen Glass after copying is completed.

Important

- Do not open the Document Cover or move the loaded original until copying is completed.

Note

- You can set the print quality to "Fast" (speed priority) only when A4 or Letter-sized plain paper is selected for the page size and media type. To set the print quality to "Fast", press and hold down the **Color** or **Black** button for 2 or more seconds in step 5. See [To set the print quality to "Fast" \(speed priority\)](#).
- To cancel copying, press the **Stop/Reset** button.



 [Page top](#)

Scanning

You can save scanned data on your computer, and edit or process them with the supplied software application.

Saving Scanned Data on the Computer

[Preparing for Scanning with the Operation Panel](#)
[Saving Scanned Data on the Computer](#)



 [Page top](#)

C041

Saving Scanned Data on the Computer

This section describes the procedure to scan originals using the Operation Panel on the machine and save them on the computer, according to the settings specified with MP Navigator EX.

For operations to scan originals from the computer, refer to the on-screen manual: [Advanced Guide](#).

Important

- Please note that Canon shall not be liable for any damage or loss of the data for any reason whatsoever, even within the warranty period of the machine.

■ Preparing for Scanning with the Operation Panel

Before scanning originals, check the following.

- Are the necessary software applications (MP Drivers and MP Navigator EX) installed?
Install MP Drivers and MP Navigator EX from the *Setup CD-ROM* when they have not been installed or have been uninstalled. To install MP Drivers and MP Navigator EX, select MP Drivers and MP Navigator EX in Custom Install.
- Are the settings for saving scanned data specified with MP Navigator EX?
When you save scanned data on the computer using the Operation Panel, you can specify the settings for saving scanned data in Preferences of MP Navigator EX.
For details on the settings, refer to the on-screen manual: [Advanced Guide](#).
- Does the original to be scanned meet the requirements for the original to be loaded on the Platen Glass?
For details, see [Originals You Can Load](#).
- Is the machine connected to a computer correctly?
Confirm that the connection between the machine and the computer is physically secure.

■ Saving Scanned Data on the Computer

1. Prepare for scanning.

- (1) Turn on the power.
See [Operation Panel](#).

- (2) Load an original on the Platen Glass.
See [Loading Originals](#).

Note

- Characters and lines written with a light colored pen or highlight pen may not be scanned properly.

2. Press the **SCAN** button to start scanning.

MP Navigator EX will be started, and the scanned data will be saved on the computer according to the settings specified with MP Navigator EX.

Remove the original on the Platen Glass after scanning is completed.

Important

- Do not turn off the power while the machine is operating.
- Do not plug in or unplug the USB cable while the machine is scanning originals.
- Do not open the Document Cover or move the loaded original until scanning is completed.

Note

- The position or size of the original may not be scanned correctly depending on the type of

original.

In this case, refer to the on-screen manual: [Advanced Guide](#) to change the settings in Document Type and Document Size of MP Navigator EX to match the original and scan it.

When the program selection screen appears:

- The program selection screen may appear after performing step 2.
If the program selection screen appears, select MP Navigator EX Ver4.0 and click OK.
To start MP Navigator EX automatically without displaying the program selection screen, follow the procedure below.
 - For Windows 7 or Windows Vista users, refer to "For Windows Users" in "[Troubleshooting](#)" of the on-screen manual: *Advanced Guide*.
 - For Windows XP users, select MP Navigator EX Ver4.0 as the software application to be used in the program selection screen, select Always use this program for this action, then click OK.
-



Printing from Your Computer

This section describes the procedure to print documents or photos with a computer. You can easily print photos taken with your digital camera by using Easy-PhotoPrint EX supplied with the machine.

Printing Photos (Easy-PhotoPrint EX)

[Using Various Functions of Easy-PhotoPrint EX](#)

Printing Documents

Printing Web Pages (Easy-WebPrint EX)

Starting Various Software Applications

[Solution Menu EX](#)
[Easy-WebPrint EX](#)



[↑ Page top](#)

C051

Printing Photos (Easy-PhotoPrint EX)

Print image data saved on your computer by using Easy-PhotoPrint EX supplied with the machine. This section describes the procedure to print borderless photos on 4" x 6" / 10 x 15 cm photo paper. For details on Easy-PhotoPrint EX, refer to the on-screen manual: [Advanced Guide](#).

Note

- Install Easy-PhotoPrint EX from the *Setup CD-ROM* when it has not been installed or has been uninstalled. To install Easy-PhotoPrint EX, select Easy-PhotoPrint EX in Custom Install.

1. Prepare for printing.

(1) Make sure that the machine is turned on.

See [Operation Panel](#).

(2) Load paper.

See [Loading Plain Paper / Photo Paper](#).

Here we load 4" x 6" / 10 x 15 cm photo paper in the Rear Tray.

(3) Open the Paper Output Tray gently, and open the Output Tray Extension.

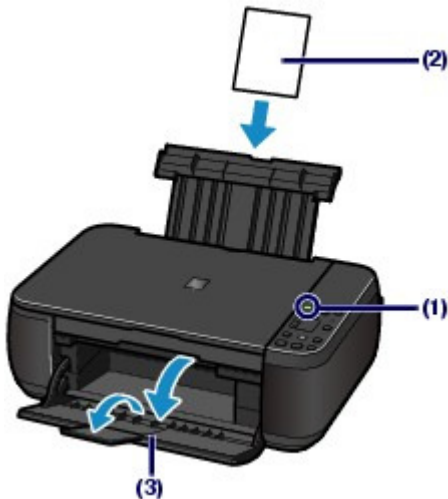

2. Start Easy-PhotoPrint EX from Solution Menu EX.

(1) Start Solution Menu EX.

See [Solution Menu EX](#).



Click Here: [Solution Menu EX](#)

(2) Click (Photo Print) in the Photo Print menu.

Easy-PhotoPrint EX will be started, and the operation screen of Photo Print will appear.



Note

- In addition to photo printing, functions for creating albums, calendars, and other photo items are available.
See [Using Various Functions of Easy-PhotoPrint EX](#).





3. Select a photo to print.

(1) Select the folder in which images are saved.

(2) Click the image to print.

The number of copies appears as "1", and the image you selected appears in the selected image area (A). You can select two or more images at the same time.

Note

- To print two or more copies, click  (Up arrow) to change the number of copies.
- To cancel the selection, click the image to cancel in the selected image area (A) and click  (Delete Imported Image) (B). You can also use  (Down arrow) to change the number of copies to zero.
- You can also correct or enhance the selected image.
For details, refer to the on-screen manual: [Advanced Guide](#).
- You can capture and print an image from a video.
See [Using Various Functions of Easy-PhotoPrint EX](#).

(3) Click Select Paper.



4. Select the loaded paper.

(1) Make sure that your machine's name is selected in Printer.

(2) Select the size and type of the loaded paper in Paper Size and Media Type.

Here we select 4"x6" 10x15cm in Paper Size and the type of the loaded photo paper in Media Type.

Note

- If you select the wrong media type, the machine may not print with the proper print quality.

(3) Click Layout/Print.

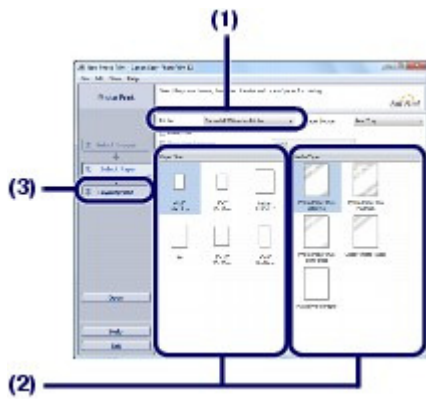

5. Select a layout and start printing.

(1) Select the layout of the photo.

Here we select Borderless (full).

The preview will appear in the selected layout for confirmation of the required print result.

Note

- You can change the direction of photo or crop photos to print.
For details on the operation, refer to the on-screen manual: [Advanced Guide](#).

(2) Click Print.



Note

- To cancel a print job in progress, press the **Stop/Reset** button on the machine or click Cancel Printing on the printer status monitor.
To display the printer status monitor, click the printer icon on the taskbar. In Windows Vista or Windows XP, click Canon XXX Printer (where "XXX" is your machine's name) on the taskbar.



Basic Guide

■ [Advanced Guide](#) ■ [Troubleshooting](#)

[Contents](#) > [Printing from Your Computer](#) > [Printing Photos \(Easy-PhotoPrint EX\)](#) > Using Various Functions of Easy-PhotoPrint EX

C052

■ Using Various Functions of Easy-PhotoPrint EX

This section introduces a few of the useful functions of Easy-PhotoPrint EX.

For details, refer to the on-screen manual: [Advanced Guide](#).

● Creating Your Own Prints

You can create an album or calendar using your photos.



Album



Calendar



Stickers



Layout Print

● Creating Still Images from Videos

You can capture video frames and create still images.



[↑ Page top](#)

C053

Printing Documents

This section describes the procedure to print a document of A4 size on plain paper.
For details, refer to the on-screen manual: [Advanced Guide](#).

Note

- Operations may vary depending on your software application. For details on the operation, refer to the instruction manual of your application.
- The screens used in this section are for printing with Windows 7 operating system Home Premium (hereafter referred to as "Windows 7").

1. Make sure that the machine is turned on.

See [Operation Panel](#).

2. Load paper.

See [Loading Plain Paper / Photo Paper](#).

Here we load A4 plain paper in the Rear Tray.

3. Open the Paper Output Tray gently, and open the Output Tray Extension.

4. Create (or open) a document to print using an appropriate software application.

5. Open the printer driver setup window.

(1) Select Print on the File menu or the command bar in your software application.

The Print dialog box will appear.

(2) Make sure that your machine's name is selected.

Note

- If another printer's name is selected, click and select your machine's name.

(3) Click Preferences (or Properties).

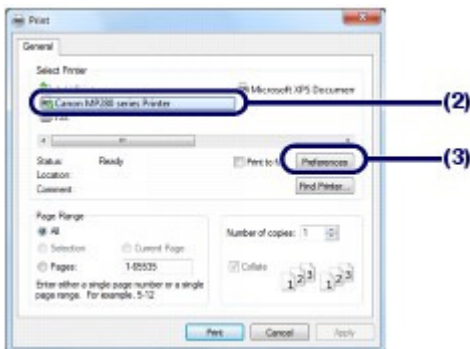

6. Specify the required print settings.

(1) Select Business Document in Commonly Used Settings.

Note

- When the print object such as Business Document or Photo Printing is selected in

Commonly Used Settings, the items in Additional Features will be selected automatically. The settings suitable for the print object such as media type or print quality will also appear.

(2) Make sure of the displayed settings.

Here we make sure that Plain Paper in Media Type, Standard in Print Quality, and A4 in Printer Paper Size are selected.

Note

- When you specify two or more copies in Copies, the printed pages will be collated.
- The settings can be changed. However, after changing Printer Paper Size, confirm that the setting for Page Size on the Page Setup sheet matches the setting set in the software application. For details, refer to the on-screen manual: [Advanced Guide](#).
- If you select the wrong media type, the machine may not print with the proper print quality.

(3) Click OK.

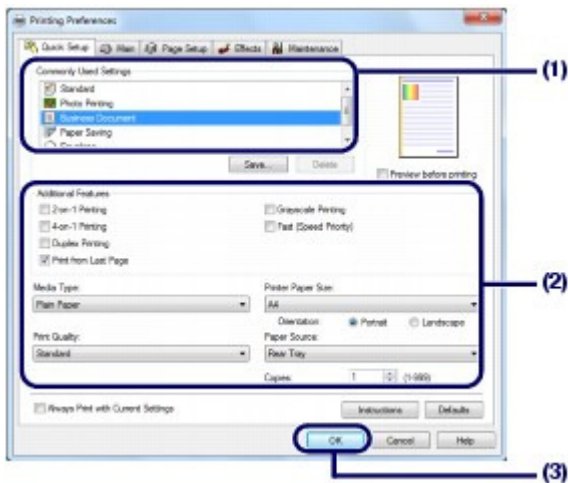

Note

- For details on the printer driver functions, click Help or Instructions to view the online help or the on-screen manual: *Advanced Guide*. The Instructions button appears on the Quick Setup, Main and Maintenance sheets if the on-screen manual is installed on your computer.
- You can name the changed settings and add to Commonly Used Settings. For details, refer to the on-screen manual: [Advanced Guide](#).
- If the Always Print with Current Settings check box is selected, the current settings will be applied from the next print job onward. Some software applications may not have this function.
- To display the preview to confirm the print result, select the Preview before printing check box. Some software applications may not have a preview function.
- You can specify the detailed print settings on the Main sheet or Page Setup sheet. For details, refer to the on-screen manual: [Advanced Guide](#).

7. Start printing.

Click Print (or OK) to start printing.



Note

- The message on how to load envelopes will appear when printing on them. This message will not appear next time if you select the Do not show this message again. check box. For details on the settings to print envelopes, see [Loading Envelopes](#).
- To cancel a print job in progress, press the **Stop/Reset** button on the machine or click Cancel Printing on the printer status monitor.
To display the printer status monitor, click the printer icon on the taskbar. In Windows Vista operating system (hereafter referred to as "Windows Vista") or Windows XP, click Canon XXX Printer (where "XXX" is your machine's name) on the taskbar.
- If printed ruled lines are misaligned or print results are unsatisfactory, adjust the print head position.
See [Aligning the Print Head](#).



C054

Printing Web Pages (Easy-WebPrint EX)

Easy-WebPrint EX provides quick and easy printing of web pages for Internet Explorer. You can print web pages automatically resized to fit the paper width without cutting off the sides of pages, or preview and select the desired web pages to print.

Easy-WebPrint EX requires Internet Explorer 7 or later.

Important

- It is unlawful to reproduce or edit the copyrighted work of another person without permission from the copyright holder, except for personal use, use within the home, or other use within the limited scope as defined by the copyright. Additionally, reproducing or editing photographs of people may infringe on portrait rights.

Note

- For information on installing or starting Easy-WebPrint EX, see [Easy-WebPrint EX](#).

The clip function, for example, allows you to clip desired parts of web pages and edit them to print. For details on operating Easy-WebPrint EX, refer to the online help. Click Easy-WebPrint EX (A) on the toolbar, then select Help from the pull-down menu to view the online help.

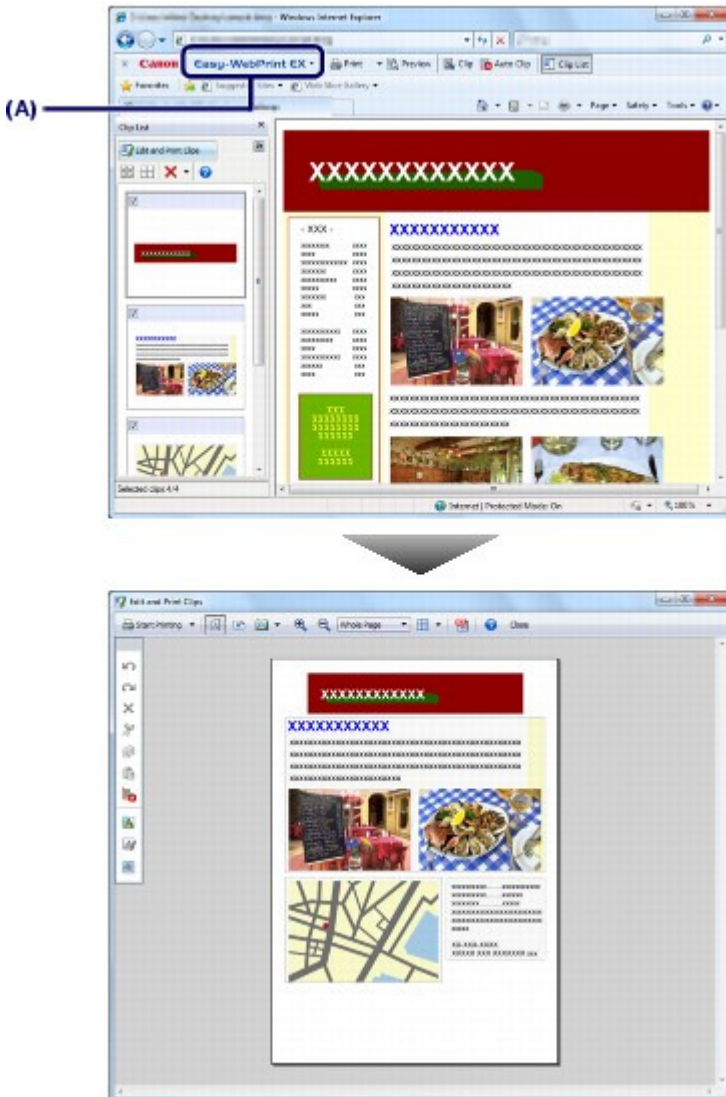



 [Page top](#)

C055

Starting Various Software Applications

This section describes Solution Menu EX, which is used to start the software applications supplied with the machine. The information on Easy-WebPrint EX, a software application for printing web pages, is also included.

■ Solution Menu EX

Solution Menu EX is a software application that provides quick access to other software applications supplied with the machine, manuals, and online product information.

Note

- Install Solution Menu EX, the on-screen manual, or other supplied software applications you want to use from the *Setup CD-ROM* when they have not been installed or have been uninstalled. To install them, select them in Custom Install.

Menus are displayed in Category Menu Area of Solution Menu EX Main Screen. Click a menu in Category Menu Area to display icons for functions available in that menu, in Function Icon Area of Main Screen. The number and types of icons or menus displayed in Main Screen may vary depending on your machine and region.

* The screen below is for Windows 7.



(A) Main Screen

(B) Function Icon Area

(C) Category Menu Area

(D) Desktop Accessory

(E) Shortcut menu to which you can add the icons of frequently used functions

(F) Accessory Icon that lets you display Main Screen, show or hide Shortcut menu, etc.

Photo Print

Print photos taken with a digital camera.

Use Scanner

Scan photos or documents.

Canon Web Service

Download content or materials from the website for printing.

Help & Settings

View the Solution Menu EX online help or the on-screen manual of the machine. Set up Solution Menu EX or the machine.

Start Application

Start the supplied software applications such as Easy-PhotoPrint EX and My Printer.

With My Printer, you can display the printer driver setup window, and get information on what action to take if you have trouble with the operation.

Online Shopping

Purchase consumables such as ink from the website.

Information

Find useful information on the machine.

Note

- The computer must be connected to the Internet to access the website for useful information, etc.
- For details on operating Solution Menu EX, refer to the online help. Select the Help & Settings menu, then click  (Solution Menu EX's Help) to view the online help.

Starting Software Applications from Solution Menu EX

From Solution Menu EX, you can start a software application, and also directly access a function of the software application.

The following procedure is to start Solution Menu EX and, for example, select one of the Easy-PhotoPrint EX functions, Photo Print.

1. Start Solution Menu EX.

Double-click  (Solution Menu EX) on the desktop.

 Click Here: [Solution Menu EX](#)

Note

- Unless the default setting has been changed, Solution Menu EX starts automatically when you start up the computer.
- To start Solution Menu EX from the Start menu, select All Programs, Canon Utilities, Solution Menu EX, then Solution Menu EX.
- If Solution Menu EX Main Screen does not appear after starting Solution Menu EX, right-click  (Accessory Icon) and select Show Main Screen.

2. Select the function of a software application that you want to start.

(1) Click the Photo Print menu.

(2) Click  (Photo Print).

Easy-PhotoPrint EX will be started, and the operation screen of Photo Print will appear.



Note

- In addition to photo printing, functions for creating albums, calendars, and other photo items are available. For details on operations and functions of Easy-PhotoPrint EX, see [Printing Photos \(Easy-PhotoPrint EX\)](#).

■ Easy-WebPrint EX

When Easy-WebPrint EX is installed, it adds a toolbar to your Internet Explorer screen. The toolbar is available whenever Internet Explorer is running.

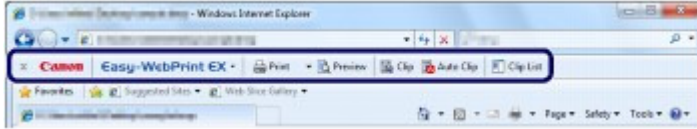

Note

Installing Easy-WebPrint EX

- If Easy-WebPrint EX is not installed, the guidance for installation of Easy-WebPrint EX may appear in the notification area of the taskbar.
To install Easy-WebPrint EX, click the displayed guidance and follow the instructions on the screen.
- You can also install Easy-WebPrint EX from the *Setup CD-ROM*.
To install Easy-WebPrint EX, select Easy-WebPrint EX in Custom Install.
- To install Easy-WebPrint EX on your computer, Internet Explorer 7 or later is required and the computer must be connected to the Internet.



Loading Paper / Originals

This section describes types of paper or originals you can load, how to load printing paper in the Rear Tray, and how to load originals to copy or scan.

Loading Paper

- [Loading Plain Paper / Photo Paper](#)
- [Loading Envelopes](#)
- [Media Types You Can Use](#)
- [Media Types You Cannot Use](#)

Loading Originals

- [Loading Originals](#)
- [Originals You Can Load](#)



 [Page top](#)

C073

Loading Paper

[Loading Plain Paper / Photo Paper](#)[Loading Envelopes](#)[Media Types You Can Use](#)[Media Types You Cannot Use](#)

■ Loading Plain Paper / Photo Paper

▶ Important

- If you cut plain paper into small size such as 4" x 6" / 10 x 15 cm, 4" x 8" / 101.6 x 203.2 mm, 5" x 7" / 13 x 18 cm, or 2.16" x 3.58" / 55.0 x 91.0 mm (Card size) to perform trial print, it can cause paper jams.

📖 Note

- We recommend Canon genuine photo paper for printing photos.
For details on the Canon genuine paper, see [Media Types You Can Use](#).
- You can use general copy paper.
For the page size and paper weight you can use for this machine, see [Media Types You Can Use](#).

1. Prepare paper.

Align the edges of paper. If paper is curled, flatten it.

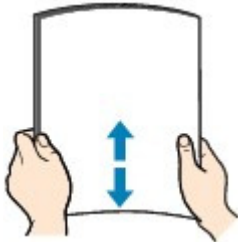

📖 Note

- Align the edges of paper neatly before loading. Loading paper without aligning the edges may cause paper jams.
- If paper is curled, hold the curled corners and gently bend them in the opposite direction until the paper becomes completely flat.
For details on how to flatten curled paper, refer to "[Troubleshooting](#)" in the on-screen manual: *Advanced Guide*.

2. Load paper.

(1) Open the Paper Support, raise it, then tip it back.

(2) Open the Paper Output Tray gently, and open the Output Tray Extension.

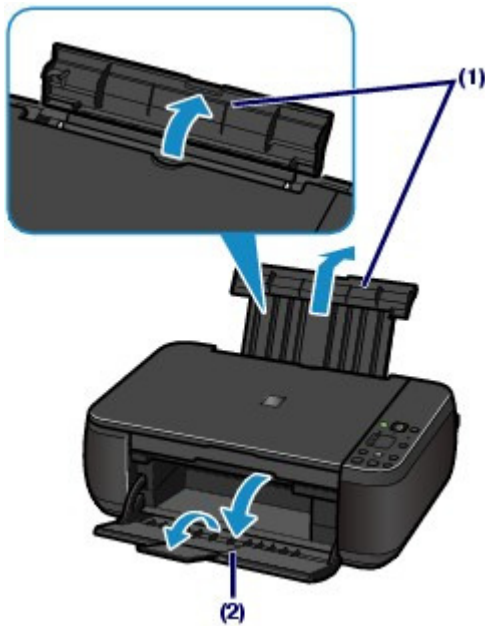

(3) Slide the Paper Guides (A) to open them, and load the paper in the center of the Rear Tray WITH THE PRINT SIDE FACING YOU.

(4) Slide the Paper Guides (A) to align them with both sides of the paper stack. Do not slide the Paper Guides too hard. The paper may not be fed properly.

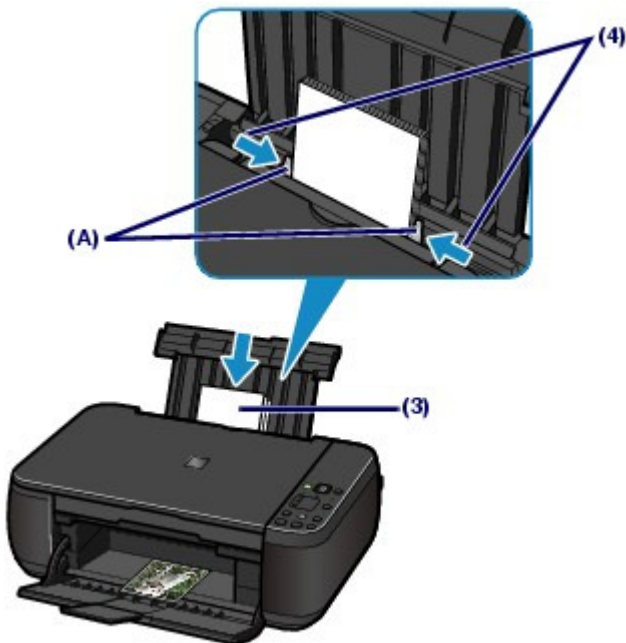

▶ Important

- Always load paper in the portrait orientation (B). Loading paper in the landscape orientation (C) can cause paper jams.

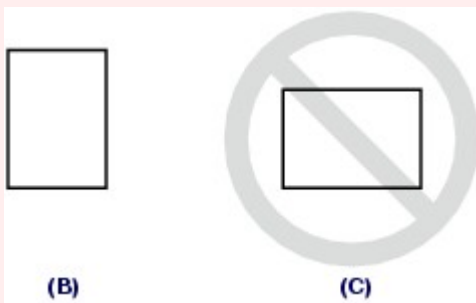

 **Note**

- Do not load sheets of paper higher than the Load Limit Mark (D).

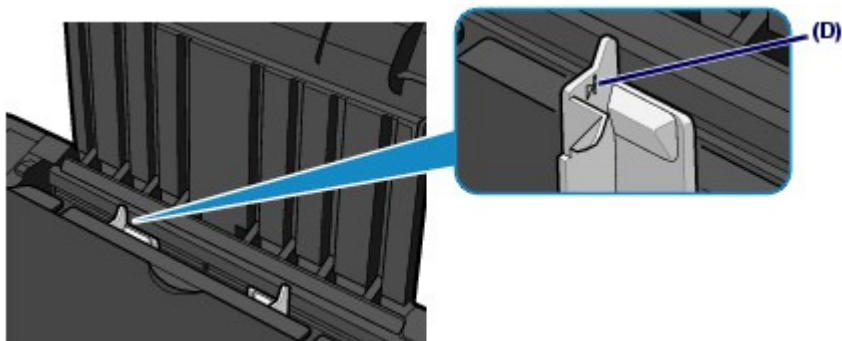
 **Note**

- The machine may make operating noise when feeding paper.

After loading paper

- When copying, select the size and type of the loaded paper using the Operation Panel on the machine.
See [Copying](#).
- When printing with a computer, select the size and type of the loaded paper in Printer Paper Size and Media Type in the printer driver.
See [Printing Documents](#).



Basic Guide

■ [Advanced Guide](#) ■ [Troubleshooting](#)

[Contents](#) > [Loading Paper / Originals](#) > [Loading Paper](#) > Loading Envelopes

C074

■ Loading Envelopes

You can print on European DL and US #10 envelopes.

The address is automatically rotated and printed according to the envelope's direction by specifying with the printer driver properly.

▶ Important

- You can only print on envelopes with the computer.
- Do not use the following envelopes. They could jam in the machine or cause the machine to malfunction.
 - Envelopes with an embossed or treated surface
 - Envelopes with a double flap (or sticker flaps)
 - Envelopes whose gummed flaps are already moistened and adhesive

📖 Note

- The message on how to load envelopes will appear when printing on them. This message will not appear next time if you select the Do not show this message again. check box.

1. Prepare envelopes.

- Press down on all four corners and edges of the envelopes to flatten them.

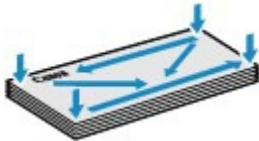

- If the envelopes are curled, hold the opposite corners and gently twist them in the opposite direction.



- If the corner of the envelope flap is folded, flatten it.
- Use a pen to press the leading edge in the inserting direction flat and sharpen the crease.

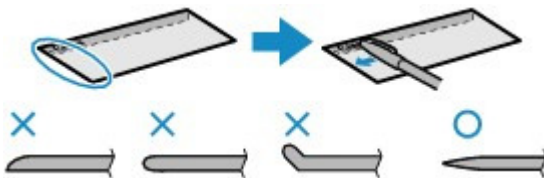

The figures above show a side view of the leading edge of the envelope.

▶ Important

- The envelopes may jam in the machine if they are not flat or the edges are not aligned. Make sure that no curl or puff exceeds 0.1 inches / 3 mm.

2. Load envelopes.

- (1) Open the Paper Support.

Do not raise the Paper Support.

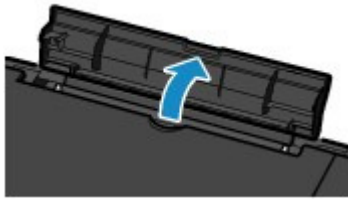

- (2) Open the Paper Output Tray gently, and open the Output Tray Extension.
- (3) Slide the Paper Guides (A) to open them, and load the envelopes in the center of the Rear Tray WITH THE ADDRESS SIDE FACING YOU.
The folded flap of the envelope will be faced down on the left side.

Up to 10 envelopes can be loaded at once.

- (4) Slide the Paper Guides (A) to align them with both sides of the envelopes.
Do not slide the Paper Guides too hard. The envelopes may not be fed properly.

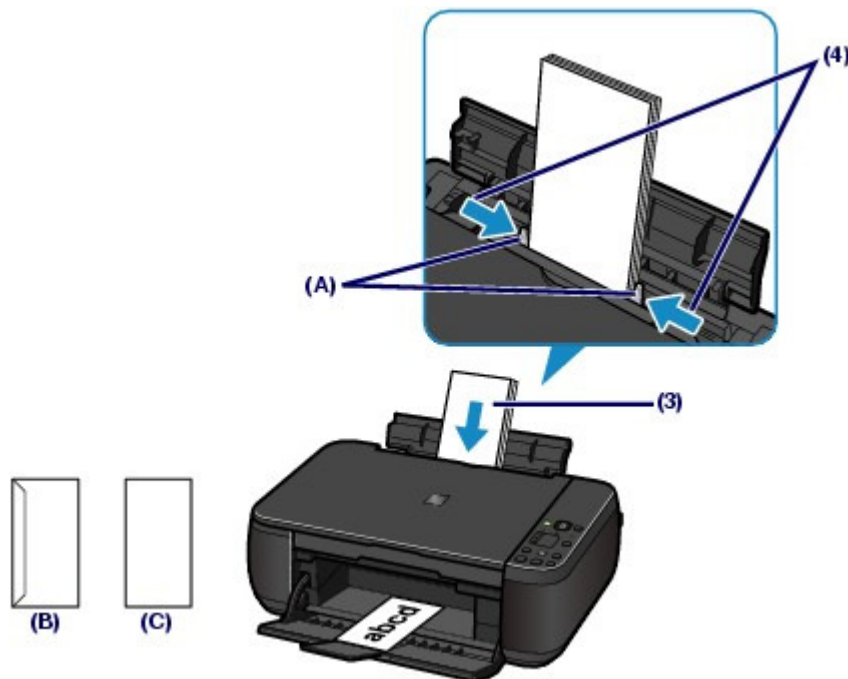

(B) Rear side

(C) Address side

Note

- Do not load envelopes higher than the Load Limit Mark (D).

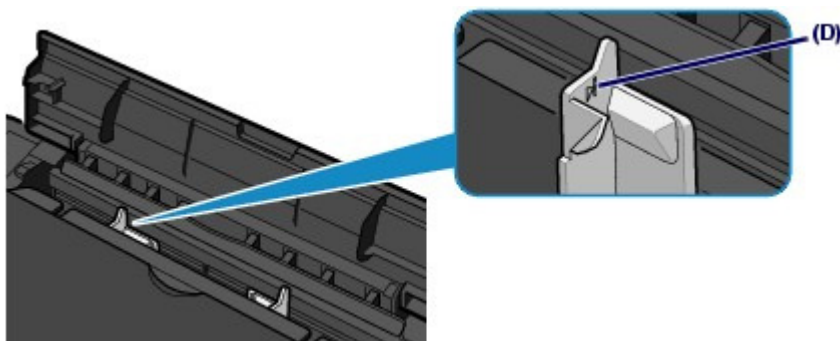

3. Specify the settings with the printer driver.

- (1) Select Envelope in Commonly Used Settings on the Quick Setup sheet.
- (2) Select DL Env. or Comm. Env. #10 in the Envelope Size Setting window.
- (3) Select Landscape in Orientation.

Important

- If you do not specify the envelope size or orientation properly, the address will be printed upside down or will be turned to 90 degrees.

Note

- The machine may make operating noise when feeding envelopes.
- If the print result is upside down, open the printer driver setup window, select Envelope in Commonly Used Settings, then select the Rotate 180 degrees check box in Additional Features.
- For details on the printer driver settings, see [Printing Documents](#).



 [Page top](#)

C075

■ Media Types You Can Use

Choose paper suitable for printing, for the best print results. Canon provides you various types of paper to enhance the fun of printing, such as stickers as well as papers for photo or document. We recommend the use of Canon genuine paper for printing your important photos.

● Media Types

Commercially available papers

● Plain Paper (including recycled paper)

- Media type settings -

Printer driver: Plain Paper

- Paper load limit -

Rear Tray: Approx. 100 sheets

- Paper Output Tray load limit -

Approx. 50 sheets



Note

- Proper feeding of paper may not be possible at the maximum capacity depending on the type of paper or environmental conditions (either very high or low temperature or humidity). In such cases, reduce the number of paper you load at a time to less than half (100% recycled paper can be used).
- This paper can be used for making copies when selecting the media type with the **Paper** button on the Operation Panel. You can only select A4 or Letter-sized plain paper.

● Envelopes

- Media type settings -

Printer driver: Envelope

- Paper load limit -

Rear Tray: 10 envelopes

- Paper Output Tray load limit -

We recommend that you remove the previously printed envelope from the Paper Output Tray before continuously printing to avoid blurs and discoloration.

Canon genuine papers

Refer to the instruction manual supplied with the paper for detailed information on the printable side and notes on handling paper. For information on the page sizes available for each Canon genuine paper, visit our website.



Note

- The Model Number of Canon genuine paper is shown in brackets.
- You may not be able to purchase some Canon genuine papers depending on the country or region of purchase. Paper is not sold in the US by Model Number. Purchase paper by name.

For printing photos:

● Photo Paper Pro Platinum <PT-101>

- Media type settings -

Printer driver: Photo Paper Pro Platinum

● Glossy Photo Paper "Everyday Use" <GP-501> *1

- Media type settings -

Printer driver: Glossy Photo Paper

● **Photo Paper Glossy <GP-502>*1****- Media type settings -**

Printer driver: Glossy Photo Paper

● **Photo Paper Plus Glossy II <PP-201>*1****- Media type settings -**

Printer driver: Photo Paper Plus Glossy II

● **Photo Paper Plus Semi-gloss <SG-201>*1****- Media type settings -**

Printer driver: Photo Paper Plus Semi-gloss

● **Matte Photo Paper <MP-101>****- Media type settings -**

Printer driver: Matte Photo Paper

- Paper load limit -

Rear Tray:

10 sheets for A4, Letter / 8.5" x 11", 5" x 7" / 13 x 18 cm, and 8" x 10" / 20 x 25 cm

20 sheets for 4" x 6" / 10 x 15 cm

- Paper Output Tray load limit -

We recommend that you remove the previously printed sheet from the Paper Output Tray before continuously printing to avoid blurs and discoloration.

*1 This paper can be used for making copies when selecting the media type with the **Paper** button on the Operation Panel. You can only select A4 or Letter-sized photo paper, and 4" x 6" / 10 x 15 cm photo paper.

 **Note**

- When loading paper in stacks, the print side may become marked as it is fed or paper may not feed properly. In this case, load one sheet at a time (except for Matte Photo Paper <MP-101>).

For printing business documents:● **High Resolution Paper <HR-101N>****- Media type settings -**

Printer driver: High Resolution Paper

- Paper load limit -

Rear Tray: 80 sheets

- Paper Output Tray load limit -

50 sheets

For creating your own prints:● **T-Shirt Transfers <TR-301>****- Media type settings -**

Printer driver: T-Shirt Transfers

● **Photo Stickers <PS-101>****- Media type settings -**

Printer driver: Glossy Photo Paper

- Paper load limit -

Rear Tray: 1 sheet

- Paper Output Tray load limit -

We recommend that you remove the previously printed sheet from the Paper Output Tray before continuously printing to avoid blurs and discoloration.



Note

- You can easily specify print settings with Easy-PhotoPrint EX provided on the *Setup CD-ROM*. Install it on your computer.

● Page Sizes

You can use the following page sizes.

Standard sizes:

- Letter (8.50 x 11.00 inches / 215.9 x 279.4 mm)
- Legal (8.50 x 14.00 inches / 215.9 x 355.6 mm)
- A5 (5.83 x 8.27 inches / 148.0 x 210.0 mm)
- A4 (8.27 x 11.69 inches / 210.0 x 297.0 mm)
- B5 (7.17 x 10.12 inches / 182.0 x 257.0 mm)
- 4" x 6" (4.00 x 6.00 inches / 10 x 15 cm)
- 4" x 8" (4.00 x 8.00 inches / 101.6 x 203.2 mm)
- 5" x 7" (5.00 x 7.00 inches / 13 x 18 cm)
- 8" x 10" (8.00 x 10.00 inches / 20 x 25 cm)
- L (3.50 x 5.00 inches / 89.0 x 127.0 mm)
- 2L (5.00 x 7.01 inches / 127.0 x 178.0 mm)
- Hagaki (3.94 x 5.83 inches / 100.0 x 148.0 mm)
- Hagaki 2 (7.87 x 5.83 inches / 200.0 x 148.0 mm)
- Comm. Env. #10 (4.12 x 9.50 inches / 104.6 x 241.3 mm)
- DL Env. (4.33 x 8.66 inches / 110.0 x 220.0 mm)
- Choukei 3 (4.72 x 9.25 inches / 120.0 x 235.0 mm)
- Choukei 4 (3.54 x 8.07 inches / 90.0 x 205.0 mm)
- Youkei 4 (4.13 x 9.25 inches / 105.0 x 235.0 mm)
- Youkei 6 (3.86 x 7.48 inches / 98.0 x 190.0 mm)
- Card (2.16 x 3.58 inches / 55.0 x 91.0 mm)
- Wide (4.00 x 7.10 inches / 101.6 x 180.6 mm)

Non-standard sizes:

You can also specify a custom size within the following range.

- Minimum size: 2.17 x 3.58 inches / 55.0 x 91.0 mm
- Maximum size: 8.50 x 26.61 inches / 215.9 x 676.0 mm

● Paper Weight

17 to 28 lb / 64 to 105 g/m² (except for Canon genuine paper)

Do not use heavier or lighter paper (except for Canon genuine paper), as it could jam in the machine.

● Notes on Storing Paper

- Take out only the necessary number of paper from the package, just before printing.
- To avoid curling, when you do not print, put unused paper back into the package and keep it on a level surface. And also, store it avoiding heat, humidity, and direct sunlight.

● Notes on Paper for Full-page Borderless Printing

- Duplex printing is not available for full-page borderless printing.
- You cannot use A5, B5, and Legal-sized paper, and envelopes for full-page borderless printing.
- You can use plain paper for full-page borderless printing only when printing from a computer. However, this may result in lower print quality. We recommend using plain paper for a trial print.



C076

■ Media Types You Cannot Use

Do not use the following types of paper. Using such paper will cause not only unsatisfactory results, but also the machine to jam or malfunction.

- Folded, curled, or wrinkled paper
- Damp paper
- Paper that is too thin (weighing less than 17 lb / 64 g/m²)
- Paper that is too thick (weighing more than 28 lb / 105 g/m², except for Canon genuine paper)
- Paper thinner than a postcard, including plain paper or notepad paper cut to a small size (when printing on paper smaller than A5)
- Picture postcards
- Postcards affixed with photos or stickers
- Envelopes with a double flap (or sticker flaps)
- Envelopes with an embossed or treated surface
- Envelopes whose gummed flaps are already moistened and adhesive
- Any type of paper with holes
- Paper that is not rectangular
- Paper bound with staples or glue
- Paper with adhesives
- Paper decorated with glitter, etc.

[↑ Page top](#)

C077

Loading Originals

[➔ Loading Originals](#)
[➔ Originals You Can Load](#)

■ Loading Originals

Load originals to copy or scan on the Platen Glass.

▶ Important

- After loading the original, be sure to close the Document Cover before starting to copy or scan.
- When scanning from a computer using a software application, you need to load the original in a different way.

For details, refer to the on-screen manual: [Advanced Guide](#).

1. Load an original on the Platen Glass.

(1) Open the Document Cover.

▶ Important

- Do not place any object on the Document Cover. It will fall into the Rear Tray when the Document Cover is opened and cause the machine to malfunction.

(2) Load the original WITH THE SIDE TO SCAN FACING DOWN on the Platen

Glass.

Align the corner of the original with the alignment mark .

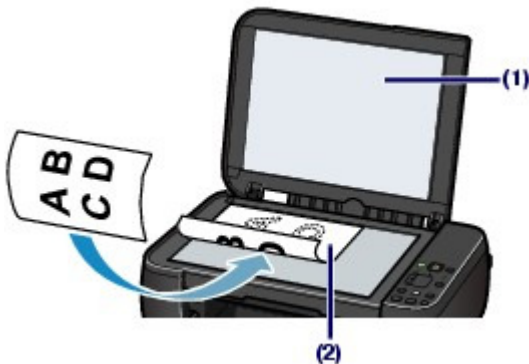

▶ Important

- Be sure to observe the following when loading the original on the Platen Glass.
 - Do not place any objects weighing 4.4 lb / 2.0 kg or more on the Platen Glass.
 - Do not put any pressure of 4.4 lb / 2.0 kg or more on the Platen Glass, such as pressing down the original.
 Failure to observe the above may cause the scanner to malfunction or the Platen Glass to break.
- The machine cannot scan the shaded area (A) (0.04 inches / 1 mm from the edges of the Platen Glass).

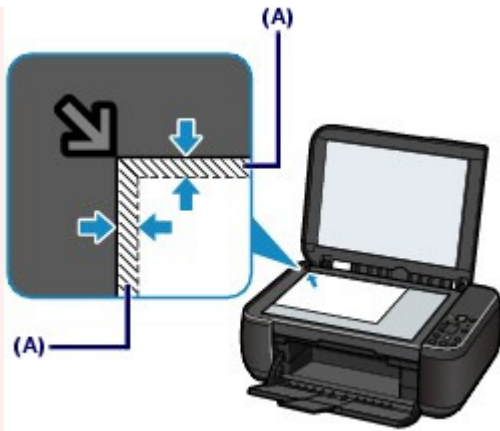

- To ensure the best print quality, the machine allows a margin along each edge of media. The actual printable area will be the area inside these margins.

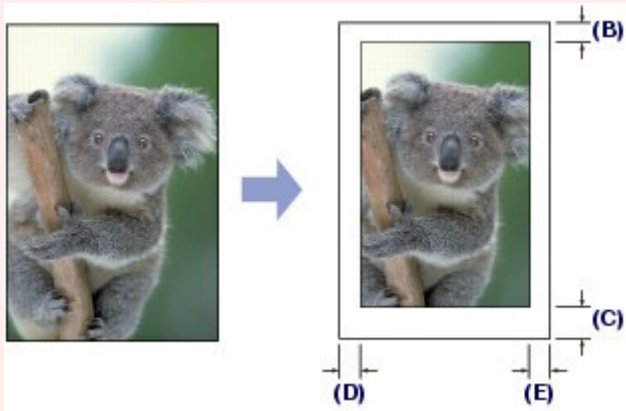

(B) 0.12 inches / 3.0 mm

(C) 0.20 inches / 5.0 mm

(D) 0.13 inches / 3.4 mm (0.25 inches / 6.4 mm for Letter and Legal-sized paper)

(E) 0.13 inches / 3.4 mm (0.25 inches / 6.3 mm for Letter and Legal-sized paper)

2. Close the Document Cover gently.



Basic Guide[Advanced Guide](#) [Troubleshooting](#)[Contents](#) > [Loading Paper / Originals](#) > [Loading Originals](#) > Originals You Can Load

C079

■ Originals You Can Load

You can copy or scan the following originals.

Types of originals: Text document, magazine, or newspaper

Printed photo, picture card, business card, or disc (BD/DVD/CD, etc.)

Size (W x L): Max. 8.5 x 11.7 inches / 216 x 297 mm

Note

- When loading a thick original such as a book on the Platen Glass, you can load it by removing the Document Cover from the machine.
For details on how to remove or attach the Document Cover, refer to the on-screen manual: [Advanced Guide](#).
-

[↑ Page top](#)

Routine Maintenance

This section describes how to clean the machine when the print result is faint, to replace FINE Cartridges when they run out of ink, or to take an action when paper does not feed properly.

When Printing Becomes Faint or Colors Are Incorrect

- [Printing the Nozzle Check Pattern](#)
- [Examining the Nozzle Check Pattern](#)
- [Cleaning the Print Head](#)
- [Cleaning the Print Head Deeply](#)
- [Aligning the Print Head](#)

Replacing a FINE Cartridge

- [Replacing Procedure](#)
- [Checking the Ink Status](#)

Cleaning the Machine

- [Cleaning the Paper Feed Roller](#)
- [Cleaning the Inside of the Machine \(Bottom Plate Cleaning\)](#)
- [Cleaning the Protrusions inside the Machine](#)



C093

When Printing Becomes Faint or Colors Are Incorrect

If print results are blurred or colors are not printed correctly, the print head nozzles (FINE Cartridges) are probably clogged. Follow the procedure below to print the nozzle check pattern, check the print head nozzle condition, then clean the Print Head.

If printed ruled lines are misaligned or print results are otherwise unsatisfactory, aligning the Print Head may improve print quality.

Important

- Do not rinse or wipe the FINE Cartridges. This can cause trouble with the FINE Cartridges.

Note

Before performing maintenance

- Check if ink remains in the FINE Cartridge.
See [Checking the Ink Status](#).
- Check if the FINE Cartridges are installed correctly.
See [Replacing Procedure](#).
- Check if the orange protective tape on the bottom of the FINE Cartridge is removed.
See [Replacing Procedure](#).
- If the **Alarm** lamp lights or flashes orange, refer to " [Troubleshooting](#)" in the on-screen manual: [Advanced Guide](#).
- Increasing the print quality in the printer driver settings may improve the print result.
For details, refer to the on-screen manual: [Advanced Guide](#).

When the Print Results Are Blurred or Uneven:

Step 1

See [Printing the Nozzle Check Pattern](#).
See [Examining the Nozzle Check Pattern](#).

If there are missing lines or horizontal white streaks in the pattern:



Step 2

See [Cleaning the Print Head](#).

If the problem is not resolved after cleaning the Print Head twice:



Step 3

See [Cleaning the Print Head Deeply](#).

If the problem is not resolved, turn off the power and clean the Print Head deeply again after 24 hours.

If the problem is still not resolved:



Step 4

See [Replacing a FINE Cartridge](#).

After cleaning the Print Head, print and examine the nozzle check pattern.

Note

- If the problem is still not resolved after replacing the FINE Cartridge, contact the service center.
-

● When the Print Results Are Not Even such as the Ruled Lines Are Misaligned:

See [Aligning the Print Head](#) .

Note

- You can also perform the maintenance operations from your computer.
For details, refer to the on-screen manual: [Advanced Guide](#) .
-



 [Page top](#)

[Contents](#) > [Routine Maintenance](#) > [When Printing Becomes Faint or Colors Are Incorrect](#) > [Printing the Nozzle Check Pattern](#)

C094

■ Printing the Nozzle Check Pattern

Print the nozzle check pattern to determine whether the ink ejects properly from the print head nozzles.

Note

- If the remaining ink level is low, the nozzle check pattern will not be printed correctly. Replace the FINE Cartridge whose ink is low.
See [Replacing a FINE Cartridge](#).

You need to prepare: a sheet of A4 or Letter-sized plain paper

1. Make sure that the power is turned on.
2. Load a sheet of A4 or Letter-sized plain paper in the Rear Tray.
3. Open the Paper Output Tray gently, and open the Output Tray Extension.
4. Print the nozzle check pattern.
 - (1) Press the  (Maintenance) button to display **A**.



- (2) Press the **Black** or **Color** button.
The nozzle check pattern will be printed.
5. Examine the nozzle check pattern.
See [Examining the Nozzle Check Pattern](#).



C095

■ Examining the Nozzle Check Pattern

Examine the nozzle check pattern, and clean the Print Head if necessary.

1. Check if there are missing lines in the pattern (1) or horizontal white streaks in the pattern (2).

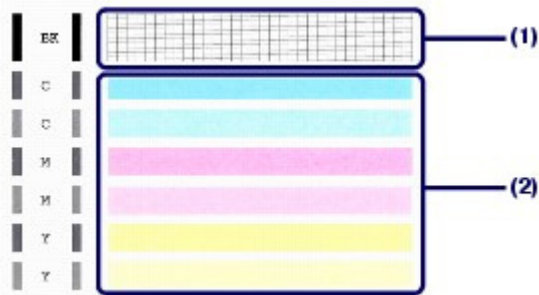

- (1) Check if lines are missing in this pattern.

If yes, the cleaning is required.

See [Cleaning the Print Head](#).

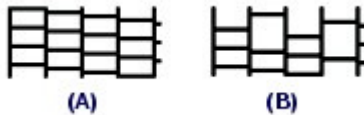

(A) Good

(B) Bad (lines are missing)

- (2) Check if horizontal white streaks are present in this pattern.

If yes, the cleaning is required.

See [Cleaning the Print Head](#).



(A) Good

(B) Bad (horizontal white streaks are present)



C096

■ Cleaning the Print Head

Clean the Print Head if lines are missing or if horizontal white streaks are present in the printed nozzle check pattern. Cleaning unclogs the nozzles and restores the print head condition. Cleaning the Print Head consumes ink, so clean the Print Head only when necessary.

1. Make sure that the power is turned on.

2. Clean the Print Head.

(1) Press the  (Maintenance) button repeatedly until **H** appears.



(2) Press the **Black** or **Color** button.

The machine starts cleaning the Print Head.

Do not perform any other operations until the machine completes the cleaning of the Print Head. This takes about 1 to 2 minutes.

3. Check the print head condition.

When the cleaning is completed, the LED returns to the copy standby mode.

To check the print head condition, print the nozzle check pattern.

See [Printing the Nozzle Check Pattern](#).

Note

- If the problem is not resolved after cleaning the Print Head twice, clean the Print Head deeply. See [Cleaning the Print Head Deeply](#).



[Contents](#) > [Routine Maintenance](#) > [When Printing Becomes Faint or Colors Are Incorrect](#) > [Cleaning the Print Head Deeply](#)

C097

■ Cleaning the Print Head Deeply

If print quality does not improve by the standard cleaning of the Print Head, clean the Print Head deeply. Cleaning the Print Head deeply consumes more ink than the standard cleaning of the Print Head, so clean the Print Head deeply only when necessary.

1. Make sure that the power is turned on.
2. Clean the Print Head deeply.
 - (1) Press the  (Maintenance) button repeatedly until **y** appears.



- (2) Press the **Black** or **Color** button.

The machine starts cleaning the Print Head deeply.

Do not perform any other operations until the machine completes the deep cleaning of the Print Head. This takes about 2 minutes.

3. Check the print head condition.

When the deep cleaning is completed, the LED returns to the copy standby mode.

To check the print head condition, print the nozzle check pattern.

See [Printing the Nozzle Check Pattern](#).

If the problem is not resolved, turn off the power and clean the Print Head deeply again after 24 hours.

If the problem is still not resolved, replace the FINE Cartridge with a new one.

See [Replacing a FINE Cartridge](#).

If the problem is still not resolved after replacing the FINE Cartridge, contact the service center.



C098

■ Aligning the Print Head

If printed ruled lines are misaligned or print results are otherwise unsatisfactory, adjust the print head position.

Note

- If the remaining ink level is low, the print head alignment sheet will not be printed correctly. Replace the FINE Cartridge whose ink is low. See [Replacing a FINE Cartridge](#).

You need to prepare: a sheet of A4 or Letter-sized plain paper (including recycled paper)*

* Be sure to use paper that is white and clean on both sides.

1. Make sure that the power is turned on.
2. Load a sheet of A4 or Letter-sized plain paper in the Rear Tray.
3. Open the Paper Output Tray gently, and open the Output Tray Extension.
4. Print the print head alignment sheet.
 - (1) Press the  (Maintenance) button repeatedly until **u** (lowercase "u") appears.



- (2) Press the **Black** or **Color** button.

The print head alignment sheet will be printed.

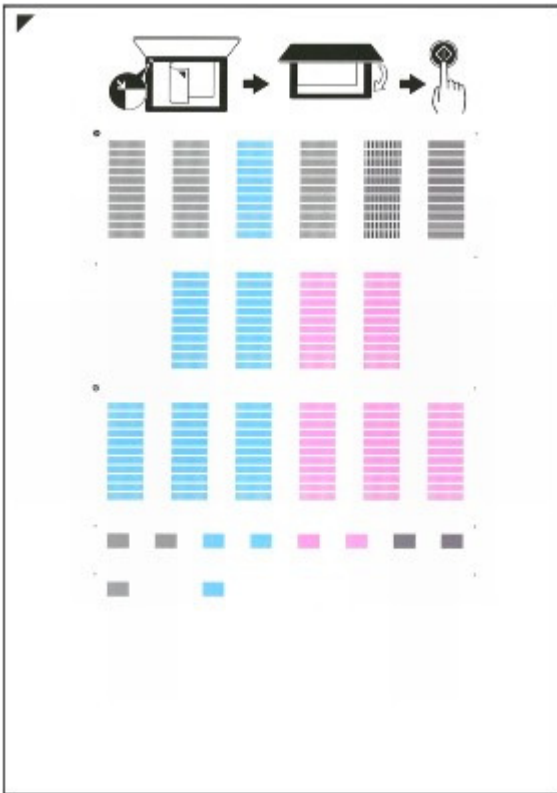



▶ Important

- Do not touch any printed part on the print head alignment sheet.
- Be careful not to get the print head alignment sheet dirty. If the sheet is stained or wrinkled, it may not be scanned properly.

5. Scan the print head alignment sheet to adjust the print head position.

(1) Load the print head alignment sheet on the Platen Glass.

Load the print head alignment sheet WITH THE PRINTED SIDE FACING DOWN and align the mark  on the upper left corner of the sheet with the alignment mark .



(2) Close the Document Cover gently, make sure that **U** (uppercase "U") appears on the LED, then press the **Black** or **Color** button.



The machine starts scanning the print head alignment sheet, and the print head position will be adjusted automatically.

When adjusting the print head position is completed, the LED returns to the copy standby mode. Remove the print head alignment sheet on the Platen Glass.

Important

- Do not open the Document Cover or move the loaded print head alignment sheet until adjusting the print head position is completed.
- If adjusting the print head position has failed, the error code will appear on the LED. Press the **Stop/Reset** button to release the error, then refer to "[Troubleshooting](#)" in the on-screen manual: *Advanced Guide*.

Note

- If the print results are still not satisfactory after adjusting the print head position as described above, adjust the print head position manually from the computer. For details, refer to the on-screen manual: [Advanced Guide](#).
- To print and check the current head position adjustment values, display **L** on the LED, then press the **Black** or **Color** button.



 [Page top](#)

C091

Replacing a FINE Cartridge

When remaining ink cautions or errors occur, the error code will appear on the LED to inform you of the error.

Refer to "An Error Code Is Displayed on the LED" in "[Troubleshooting](#)" of the on-screen manual: *Advanced Guide*, and take an appropriate action.

Note

- For information on the compatible FINE Cartridges, refer to the printed manual: *Getting Started*.

Replacing Procedure

When you need to replace FINE Cartridges, follow the procedure below.

Important

Handling FINE Cartridges

- Do not touch the electrical contacts (A) or print head nozzles (B) on the FINE Cartridge. The machine may not print properly if you touch it.

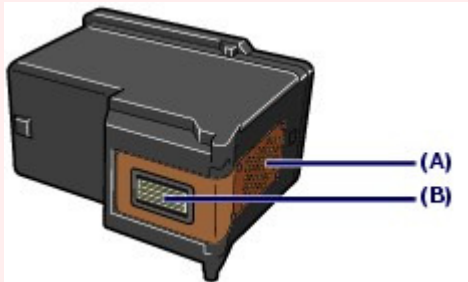

- If you remove a FINE Cartridge, replace it immediately. Do not leave the machine with FINE Cartridges removed.
- Use new FINE Cartridges for replacement. Installing used FINE Cartridges may cause the nozzles to clog. Furthermore, with such cartridges, the machine will not be able to inform you when to replace the cartridges properly.
- Once a FINE Cartridge has been installed, do not remove it from the machine and leave it out in the open. This will cause the FINE Cartridge to dry out, and the machine may not operate properly when it is reinstalled. To maintain optimal printing quality, use a FINE Cartridge within six months of first use.

Note

- If a FINE Cartridge runs out of ink, you can print with either Color or Black FINE Cartridge, in whichever ink remains, only for a while. However the print quality may be reduced compared to when printing with both cartridges. We recommend to use new FINE Cartridges in order to obtain optimum qualities. Even when printing with one ink only, print with leaving the empty FINE Cartridge installed. If either of the Color FINE Cartridge or Black FINE Cartridge is not installed, an error occurs and the machine cannot print. For information on how to configure this setting, refer to the on-screen manual: [Advanced Guide](#).
- Color ink may be consumed even when printing a black-and-white document or when black-and-white printing is specified. Both color ink and black ink are also consumed in the standard cleaning and deep cleaning of the Print Head, which may be necessary to maintain the machine's performance. When ink runs out, replace the FINE Cartridge immediately with a new one. For details, see [Tips on How to Use Your Machine](#).

1. Make sure that the power is turned on, and open the Paper Output Tray.

2. Lift the Scanning Unit (Cover), then hold it open with the Scanning Unit Support (C).

The FINE Cartridge Holder moves to the replacement position.



⚠ Caution

- Do not hold the FINE Cartridge Holder to stop or move it forcibly. Do not touch the FINE Cartridge Holder until it stops completely.

▶ Important

- The inside of the machine may be stained with ink. Be careful not to stain your hands or clothing when replacing FINE Cartridges. You can easily wipe off the ink from the inside of the machine with tissue paper or the like. For details on the cleaning, refer to the printed manual: *Getting Started*.
- Do not place any object on the Document Cover. It will fall into the Rear Tray when the Document Cover is opened and cause the machine to malfunction.
- When opening the Scanning Unit (Cover), lift it with the Document Cover closed.
- Do not touch the metallic parts or other parts inside the machine.
- If the Scanning Unit (Cover) is left open for more than 10 minutes, the FINE Cartridge Holder moves to the right. In this case, close and reopen the Scanning Unit (Cover).

3. Remove the empty FINE Cartridge.

(1) Pinch the tabs and open the Ink Cartridge Locking Cover.

(2) Remove the FINE Cartridge.

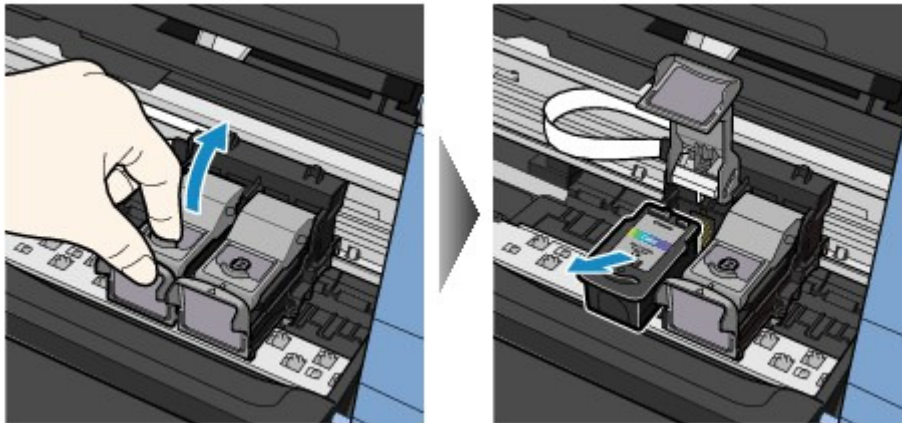

▶ Important

- Handle FINE Cartridges carefully to avoid staining of clothing or the surrounding area.
- Discard empty FINE Cartridges according to the local laws and regulations regarding disposal of consumables.

4. Prepare the new FINE Cartridge.

(1) Take a new FINE Cartridge out of its package and remove the orange protective tape (D) gently.

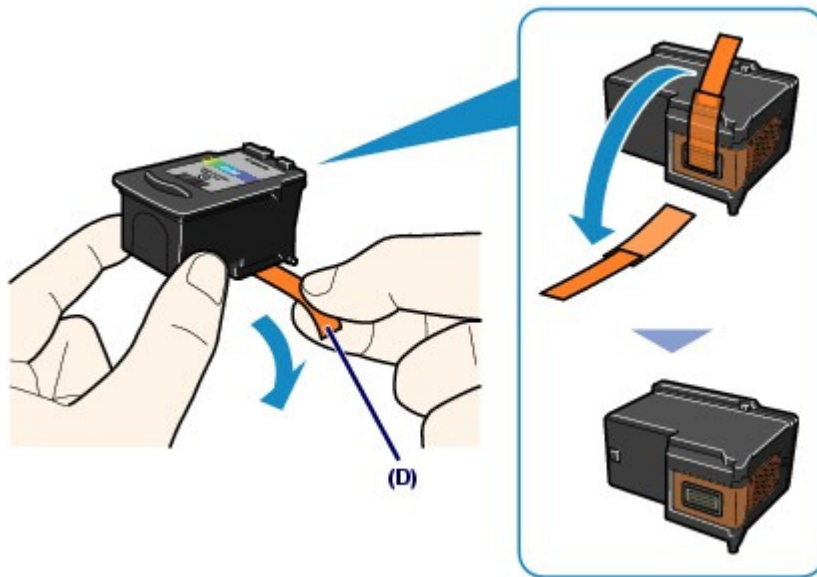

Important

- If you shake a FINE Cartridge, ink may spill out and stain your hands and the surrounding area. Handle a FINE Cartridge carefully.
- Be careful not to stain your hands and the surrounding area with ink on the removed protective tape.
- Do not reattach the protective tape once you have removed it. Discard it according to the local laws and regulations regarding disposal of consumables.
- Do not touch the electrical contacts or print head nozzles on a FINE Cartridge. The machine may not print properly if you touch it.

5. Install the FINE Cartridge.

(1) Put a new FINE Cartridge in the FINE Cartridge Holder.

The Color FINE Cartridge should be installed into the left slot and the Black FINE Cartridge should be installed into the right slot.

(2) Close the Ink Cartridge Locking Cover to lock the FINE Cartridge into place.

Push down the Ink Cartridge Locking Cover until it clicks.

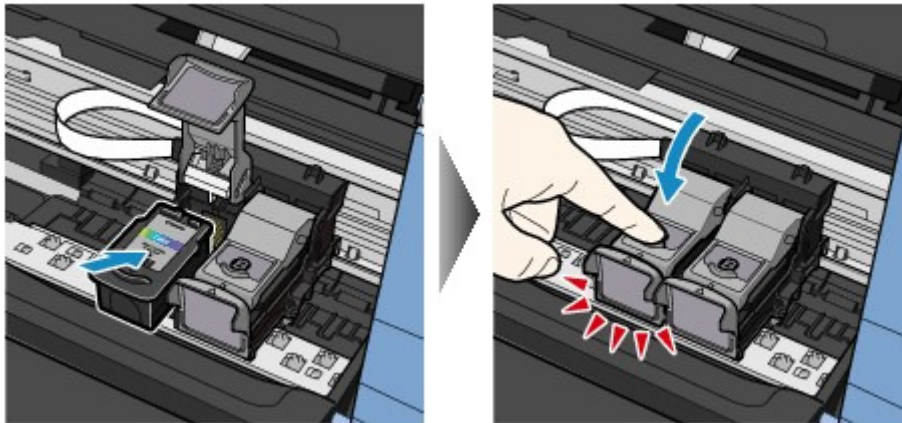

(3) Confirm that the Ink Cartridge Locking Cover is closed correctly.

Note

- If the Ink Cartridge Locking Cover is not closed correctly, push down the Ink Cartridge Locking Cover until it clicks.

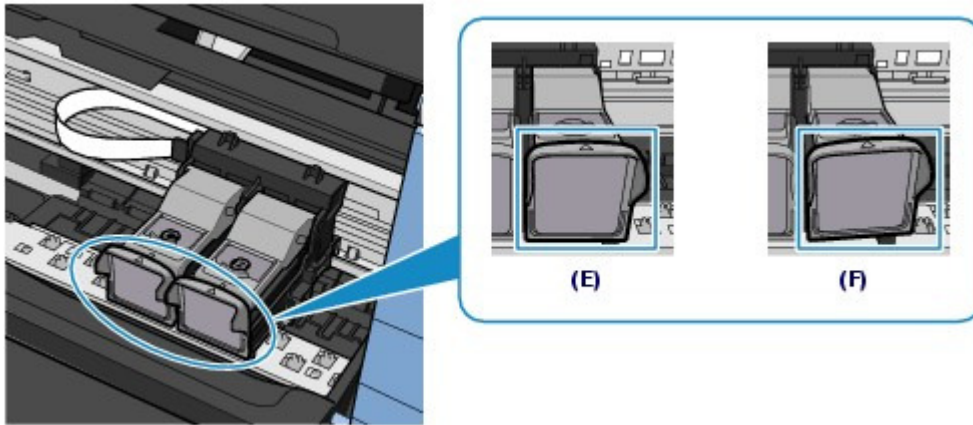

(E) Closed correctly

(F) Not closed correctly (the cover is tilted)

Important

- The machine cannot print unless both the Color and Black FINE Cartridges are installed. Be sure to install both the FINE Cartridges.

6. Lift the Scanning Unit (Cover) slightly to set the Scanning Unit Support back to its original position, and gently close the Scanning Unit (Cover).

Caution

- When setting the Scanning Unit Support back to its original position, be sure to hold the Scanning Unit (Cover) firmly, and be careful not to get your fingers caught.

Note

- If the **Alarm** lamp lights or flashes orange after the Scanning Unit (Cover) is closed, refer to "[Troubleshooting](#)" in the on-screen manual: *Advanced Guide*.
- When you start printing after replacing the FINE Cartridge, the machine starts cleaning the Print Head automatically. Do not perform any other operations until the machine completes the cleaning of the Print Head.
- If printed ruled lines are misaligned or the print head position is misaligned, adjust the print head position. See [Aligning the Print Head](#).



C092

■ Checking the Ink Status

You can check the ink status with the **Ink** lamps on the Operation Panel or with the computer screen.

Note

- The ink level detector is mounted on the machine to detect the remaining ink level. The machine considers as ink is full when a new FINE Cartridge is installed, and then starts to detect a remaining ink level. If you install a used FINE Cartridge, the indicated ink level of it may not be correct. In such case, refer to the ink level information only as a guide.
- When remaining ink cautions or errors occur, the error code will appear on the LED to inform you of the error.

Refer to "An Error Code Is Displayed on the LED" in " [Troubleshooting](#) " of the on-screen manual: *Advanced Guide* , and take an appropriate action.

● With the Ink Lamps on the Operation Panel

Make sure that the LED is in the copy standby mode. You can confirm the ink status with the **Ink** lamps.

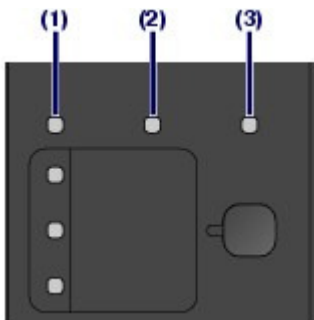

- (1) **Alarm** lamp
- (2) **Color Ink** lamp
- (3) **Black Ink** lamp

Color Ink lamp or Black Ink lamp lights

The ink is running low. Prepare a new ink cartridge.

Color Ink lamp or Black Ink lamp flashes, while Alarm lamp lights

An error has occurred.

For details, refer to " [Troubleshooting](#) " in the on-screen manual: *Advanced Guide* .

* For some types of errors, the **Alarm** lamp may not light.

● With the Computer Screen

You can confirm the ink status with the printer status monitor.

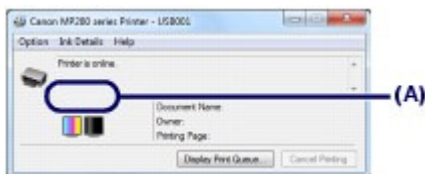

A symbol appears in the area (A) if there is any information about the remaining ink level.

Example: 

The ink is running low. Prepare a new ink cartridge.

Note

- An error message may appear while printing. Confirm the message and take an appropriate

action.

Follow the procedure below to open the confirmation screen.

1. Open the printer driver setup window.

Refer to the on-screen manual: [Advanced Guide](#).

2. Click View Printer Status on the Maintenance sheet.

To confirm the FINE Cartridge information, click the Ink Details menu.

 **Note**

- While printing, you can also display the printer status monitor by clicking the printer icon on the taskbar. In Windows Vista or Windows XP, click Canon XXX Printer (where "XXX" is your machine's name) on the taskbar.
-



 [Page top](#)

[Contents](#) > [Routine Maintenance](#) > [Cleaning the Machine](#)

Cleaning the Machine

This section describes how to clean the inside of the machine.

- [Cleaning the Paper Feed Roller](#)
- [Cleaning the Inside of the Machine \(Bottom Plate Cleaning\)](#)
- [Cleaning the Protrusions inside the Machine](#)



 [Page top](#)

C099

■ Cleaning the Paper Feed Roller

If the Paper Feed Roller is dirty or paper powder is attached to it, paper may not be fed properly. In this case, clean the Paper Feed Roller. Cleaning will wear out the Paper Feed Roller, so perform this only when necessary.

You need to prepare: three sheets of A4 or Letter-sized plain paper

1. Make sure that the power is turned on, and remove any paper from the Rear Tray.
2. Open the Paper Output Tray gently, and open the Output Tray Extension.
3. Clean the Paper Feed Roller without paper.
 - (1) Press the  (Maintenance) button repeatedly until **b** appears.



- (2) Press the **Black** or **Color** button.
The Paper Feed Roller will rotate as it is cleaned.

4. Clean the Paper Feed Roller with paper.
 - (1) Make sure that the Paper Feed Roller has stopped rotating, and load three sheets of A4 or Letter-sized plain paper in the Rear Tray.
 - (2) Make sure that **b** appears on the LED, then press the **Black** or **Color** button.
The machine starts cleaning. The cleaning will be completed after the paper is ejected.

Note

- After the cleaning is completed, press the **Stop/Reset** button to return the LED to the copy standby mode.

If the problem is not resolved after cleaning the Paper Feed Roller, contact the service center.



Basic Guide■ **Advanced Guide** ■ **Troubleshooting**

[Contents](#) > [Routine Maintenance](#) > [Cleaning the Machine](#) > [Cleaning the Inside of the Machine \(Bottom Plate Cleaning\)](#)

C101

■ Cleaning the Inside of the Machine (Bottom Plate Cleaning)

Remove stains from the inside of the machine. If the inside of the machine becomes dirty, printed paper may get dirty, so we recommend performing cleaning regularly.

▶ Important

- Do not perform any other operations while performing the Bottom Plate Cleaning.

You need to prepare: a sheet of A4 or Letter-sized plain paper*

* Be sure to use a new piece of paper.

1. Make sure that the power is turned on, and remove any paper from the Rear Tray.
2. Open the Paper Output Tray gently, and open the Output Tray Extension.
3. Fold a single sheet of A4 or Letter-sized plain paper in half widthwise, and unfold the paper.
4. Load only this sheet of paper in the Rear Tray with the open side facing you.



5. Clean the inside of the machine.

(1) Press the  (Maintenance) button repeatedly until **J** appears.



(2) Press the **Black** or **Color** button.

The paper cleans the inside of the machine as it feeds through the machine.

Check the folded area of the ejected paper. If it is smudged with ink, perform the Bottom Plate Cleaning again.

Note

- When performing the Bottom Plate Cleaning again, make sure to use a new piece of paper.

If the problem is not resolved after performing the Bottom Plate Cleaning twice, the protrusions inside the machine may be stained.

See [Cleaning the Protrusions inside the Machine](#) to clean them.



 [Page top](#)

C102

■ Cleaning the Protrusions inside the Machine

⚠ Caution

- Be sure to turn off the power and disconnect the power plug before cleaning the machine.

If the protrusions inside the machine are stained, wipe off any ink from the protrusions using a cotton swab or the like.

[↑ Page top](#)

Appendix

[Legal Limitations on Use of Your Product and Use of Images](#)

[Tips on How to Use Your Machine](#)



[↑ Page top](#)

Legal Limitations on Use of Your Product and Use of Images

It may be unlawful to make copies of, scan, print, or use reproductions of the following documents. The list provided is non-exhaustive. When in doubt, check with a legal representative in your jurisdiction.

- Paper money
- Money orders
- Certificates of deposit
- Postage stamps (canceled or uncanceled)
- Identifying badges or insignias
- Selective service or draft papers
- Checks or drafts issued by governmental agencies
- Motor vehicle licenses and certificates of title
- Traveler's checks
- Food stamps
- Passports
- Immigration papers
- Internal revenue stamps (canceled or uncanceled)
- Bonds or other certificates of indebtedness
- Stock certificates
- Copyrighted works/works of art without permission of copyright owner



C112

Tips on How to Use Your Machine

This section introduces the tips on how to use your machine and for printing with optimal quality.

■ Ink is used for various purposes.

● How is ink used for various purposes other than printing?

Ink may be used for purposes other than printing. Ink is not only used for printing, but also for cleaning the Print Head to maintain the optimal printing quality.

The machine has the function to automatically clean the ink jet nozzles to prevent clogging. In the cleaning procedure, ink is pumped out from the nozzles. Used ink for nozzle cleaning is limited to a small amount.

● Does black-and-white printing use color ink?

Black-and-white printing may use ink other than black ink depending on the type of printing paper or the settings of the printer driver. So, color ink is consumed even when printing in black-and-white.

■ Printing on special paper: How to print with optimal quality!?

● Tip!: Check the machine status before printing!

● Is the Print Head OK?

If print head nozzles are clogged, print will be faint and papers will be wasted. Print the nozzle check pattern to check the Print Head.

See [When Printing Becomes Faint or Colors Are Incorrect](#) .

● Is the inside of the machine smeared with ink?

After printing large quantities of paper or performing borderless printing, the area where papers go through may get smeared with ink. Clean the inside of your machine with the Bottom Plate Cleaning.

See [Cleaning the Inside of the Machine \(Bottom Plate Cleaning\)](#) .

● Tip!: Check how to load the paper correctly!

● Is the paper loaded in the correct orientation?



Load paper in the Rear Tray with the printing side facing you.

● Is the paper curled?

The curled paper causes paper jam. Flatten the curled paper, then reload it.

Refer to "[Troubleshooting](#)" in the on-screen manual: *Advanced Guide* .

● Tip!: After loading paper, be sure to specify the paper settings!

After loading paper, be sure to select the loaded paper in Media Type of the printer driver or with the **Paper** button on the Operation Panel. If the type of paper is not selected, you may not be able to get the satisfactory print result.

See [Copying, Printing from Your Computer](#), and [Media Types You Can Use](#).

There are various types of paper: paper with special coating on the surface for printing photos with optimal quality and paper suitable for documents. Media Type of the printer driver has different settings for each type of paper in advance (such as using ink, ejecting ink, or distance from nozzles) so that you can print on each paper with the optimal image quality. The **Paper** button on the Operation Panel, which is used for making copies, also has some settings similar to Media Type of the printer driver. You can print with different settings in Media Type of the printer driver or with the **Paper** button on the Operation Panel, suitable for each type of loaded paper.

■ Use the Stop/Reset button to cancel printing!

● Tip!: Never press the ON button!

If you press the **ON** button while printing is in progress, the print data sent from the computer queues in the machine and you may not be able to continue to print. Press the **Stop/Reset** button to cancel printing.

Note

- If you cannot cancel printing by pressing the **Stop/Reset** button while printing from a computer, open the printer driver setup window to delete the unnecessary print jobs from the printer status monitor.

■ Does the machine need to be handled with care when using or transporting?

● Tip!: Do not use or transport the machine vertically or slanted!

If the machine is used or transported vertically or slanted, the machine may become damaged or ink may leak from the machine.

Be sure not to use or transport the machine vertically or slanted.

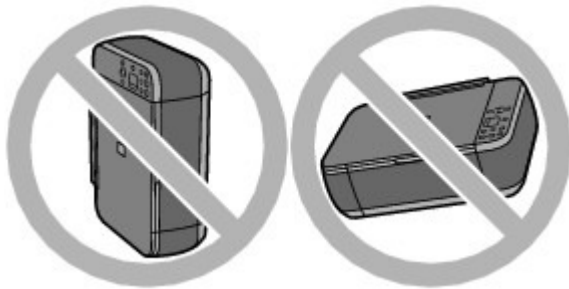

● Tip!: Do not place any object on the Document Cover!

Do not place any object on the Document Cover. It will fall into the Rear Tray when the Document Cover is opened and cause the machine to malfunction.

Also, place the machine where objects will not fall on it.

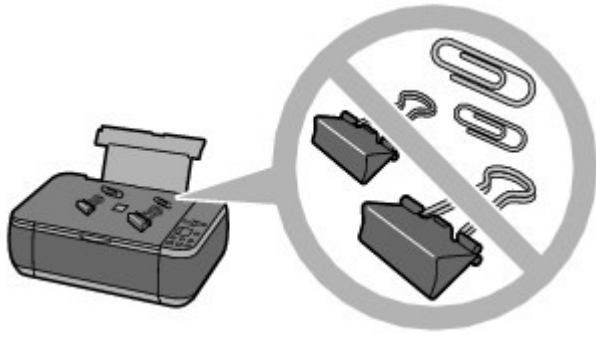

● Tip!: Carefully choose the area to place the machine!

Place the machine at least 5.91 inches / 15 cm away from other electrical appliances such as fluorescent lamps. If the machine is placed closer to those, it may not be able to work properly due to fluorescent noises.

■ How to maintain the optimal printing quality?

The key to printing with the optimal printing quality is to prevent the Print Head from drying or clogging. Always follow the following steps for optimal printing quality.

● Follow the procedure below to disconnect the power plug.

1. Press the **ON** button on the machine to turn it off.
2. Make sure that the **POWER** lamp is not lit.
3. Disconnect the power plug from the wall outlet.

If you press the **ON** button to turn off the power, the machine caps the Print Head (nozzles) automatically to prevent from drying. If you disconnect the power plug from the wall outlet before the **POWER** lamp is turned off, the Print Head will not be capped properly and this will cause drying or clogging.

To disconnect the power plug, be sure to follow this procedure.

● Print periodically!

Just as the tip of a felt pen becomes dry and unusable if it has not been used for a long time, even if it is capped, the Print Head too, may become dried or clogged if the machine has not been used for a long time.

We recommend you to use the machine at least once a month.

Note

- Depending on the type of paper, ink may blur if you trace the printed area with a highlight pen or paint-stick, or bleed if water or sweat comes in contact with the printed area.

■ Colors are uneven, and print results are blurred.

● Tip!: Print the nozzle check pattern to check if the nozzles are clogged.

If the print head nozzles are clogged, colors may become uneven or the print results may be blurred.



In this case



Print the nozzle check pattern

Check the printed check pattern to see if the nozzles are clogged.
See [When Printing Becomes Faint or Colors Are Incorrect](#) .



[↑ Page top](#)



MC-4740-V1.00

Basic Guide 

Printing

Scanning

Copying

Troubleshooting

How to Use This Manual

Printing This Manual

Maintenance

Changing the Machine Settings

Appendix

When you display this on-screen manual in a language environment other than English, some English descriptions may be displayed.

Printing

Printing from a Computer

Printing with the Bundled Application Software

What Is Easy-PhotoPrint EX?

Printing Photos

Starting Easy-PhotoPrint EX

Selecting a Photo

Selecting the Paper

Printing

Creating an Album

Starting Easy-PhotoPrint EX

Selecting the Paper and Layout

Selecting a Photo

Editing

Printing

Printing Calendars

Starting Easy-PhotoPrint EX

Selecting the Paper and Layout

Selecting a Photo

Editing

Printing

Printing Stickers

Starting Easy-PhotoPrint EX

Selecting the Paper and Layout

Selecting a Photo

Editing

Printing

Printing Layout

Starting Easy-PhotoPrint EX

Selecting the Paper and Layout

Selecting a Photo

Editing

Printing

Correcting and Enhancing Photos

Using the Auto Photo Fix Function

Using the Red-Eye Correction Function

Using the Face Brightener Function

- Using the Face Sharpener Function
- Using the Digital Face Smoothing Function
- Using the Blemish Remover Function
- Adjusting Images
- Correct/Enhance Images Window
- Creating Still Images from Videos
 - Video Frame Capture/Movie Print Window
- Downloading Images from Photo Sharing Sites
 - Import Photos from Photo Sharing Sites Window
- Questions and Answers
 - How Can I Move (or Copy) the Saved File?
 - Which Side of the Displayed Image Does the Printing Start from?
 - How Do I Print with Even Margins?
 - What Is "C1" or "C4"?
- Photo Print Settings
 - Printing Vivid Photos
 - Reducing Photo Noise
 - Cropping Photos (Photo Print)
 - Printing Dates on Photos (Photo Print)
 - Printing Multiple Photos on One Page
 - Printing an Index
 - Printing ID Photos (ID Photo Print)
 - Printing Photo Information
 - Saving Photos
 - Opening Saved Files
- Other Settings
 - Changing Layout
 - Changing Background
 - Adding Photos
 - Swapping Positions of Photos
 - Replacing Photos
 - Changing Position, Angle and Size of Photos
 - Cropping Photos
 - Framing Photos
 - Printing Dates on Photos
 - Attaching Comments to Photos
 - Adding Text to Photos
 - Saving
 - Setting Holidays
 - Setting Calendar Display
 - Opening Saved Files
- Printing with Other Application Software
 - Various Printing Methods
 - Printing with Easy Setup
 - Setting a Page Size and Orientation
 - Setting the Number of Copies and Printing Order

- Setting the Stapling Margin
- Execute Borderless Printing
- Fit-to-Page Printing
- Scaled Printing
- Page Layout Printing
- Poster Printing
- Booklet Printing
- Duplex Printing
- Stamp/Background Printing
- Registering a Stamp
- Registering Image Data to be Used as a Background
- Printing an Envelope
- Displaying the Print Results before Printing
- Setting Paper Dimensions (Custom Size)
- Changing the Print Quality and Correcting Image Data
 - Selecting a Combination of the Print Quality Level and a Halftoning Method
 - Printing a Color Document in Monochrome
 - Specifying Color Correction
 - Optimal Photo Printing of Image Data
 - Adjusting Colors with the Printer Driver
 - Printing with ICC Profiles
 - Adjusting Color Balance
 - Adjusting Brightness
 - Adjusting Intensity
 - Adjusting Contrast
 - Simulating an Illustration
 - Representing Image Data with a Single Color
 - Presenting Image Data with Vivid Colors
 - Smoothing Jagged Outlines
 - Changing Color Properties to Improve Coloration
 - Reducing Photo Noise
- Overview of the Printer Driver
 - Printer Driver Operations
 - Canon IJ Printer Driver
 - XPS Printer Driver
 - How to Open the Printer Driver Setup Window
 - Maintenance Tab
 - Canon IJ Status Monitor
 - Canon IJ Preview

Scanning

Scanning

- Scanning Images
 - Scanning Images
 - Before Scanning
 - Placing Documents

Scanning with Using the Operation Panel of the Machine

- Forwarding Scanned Data to the Computer Using the Operation Panel of the Machine

- Appendix: Various Scan Settings

 - Selecting a Response to Commands from the Operation Panel Using MP Navigator EX

Scanning with the Bundled Application Software

- What Is MP Navigator EX (Supplied Scanner Software)?

- Let's Try Scanning

 - Starting MP Navigator EX

 - Easy Scanning with Auto Scan

 - Scanning Photos and Documents

 - Scanning Multiple Documents at One Time

 - Scanning Images Larger than the Platen (Stitch Assist)

 - Easy Scanning with One-click

- Useful MP Navigator EX Functions

 - Correcting/Enhancing Images Automatically

 - Correcting/Enhancing Images Manually

 - Adjusting Images

 - Searching Images

 - Classifying Images into Categories

- Utilizing Images in MP Navigator EX

 - Saving

 - Saving as PDF Files

 - Creating/Editing PDF Files

 - Printing Documents

 - Printing Photos

 - Sending via E-mail

 - Editing Files

 - Setting Passwords for PDF Files

 - Opening/Editing Password-protected PDF Files

- MP Navigator EX Screens

 - Navigation Mode Screen

 - Scan/Import Documents or Images Tab

 - View & Use Images on your Computer Tab

 - Custom Scan with One-click Tab

 - Auto Scan Screen (Scan/Import Window)

 - Scan Settings Dialog Box (Auto Scan)

 - Photos/Documents (Platen) Screen (Scan/Import Window)

 - Scan Settings Dialog Box (Photos/Documents)

 - Save Dialog Box

 - Save as PDF file Dialog Box

 - PDF Settings Dialog Box

 - View & Use Window

 - Create/Edit PDF file Window

 - Print Document Dialog Box

- Print Photo Dialog Box
- Send via E-mail Dialog Box
- Correct/Enhance Images Window
- One-click Mode Screen
- Auto Scan Dialog Box
- Save Dialog Box (One-click Mode Screen)
- Scan Settings Dialog Box (One-click Mode Screen)
- Save Dialog Box
- Exif Settings Dialog Box
- PDF Dialog Box
- Save as PDF file Dialog Box
- Mail Dialog Box
- OCR Dialog Box
- Custom Dialog Box
- Preferences Dialog Box
- General Tab
- Scanner Button Settings Tab (Save to PC)
- Scan Settings Dialog Box (Scanner Button Settings)
- Appendix: Opening Files Other than Scanned Images
 - Opening Images Saved on a Computer
- Scanning with Other Application Software
 - What Is ScanGear (Scanner Driver)?
 - Scanning with Advanced Settings Using ScanGear (Scanner Driver)
 - Starting ScanGear (Scanner Driver)
 - Scanning in Basic Mode
 - Scanning in Advanced Mode
 - Scanning in Auto Scan Mode
 - Scanning Multiple Documents at One Time with ScanGear (Scanner Driver)
 - Correcting Images and Adjusting Colors with ScanGear (Scanner Driver)
 - Correcting Images (Unsharp Mask, Reduce Dust and Scratches, Fading Correction, etc.)
 - Adjusting Colors Using a Color Pattern
 - Adjusting Saturation and Color Balance
 - Adjusting Brightness and Contrast
 - Adjusting Histogram
 - Adjusting Tone Curve
 - Setting Threshold
- ScanGear (Scanner Driver) Screens
 - Basic Mode Tab
 - Advanced Mode Tab
 - Input Settings
 - Output Settings
 - Image Settings
 - Color Adjustment Buttons
 - Auto Scan Mode Tab

- Preferences Dialog Box
- Scanner Tab
- Preview Tab
- Scan Tab
- Color Settings Tab
- Appendix: Useful Information on Scanning
 - Adjusting Cropping Frames
 - Resolution
 - File Formats
 - Color Matching
- Other Scanning Methods
 - Scanning with WIA Driver
 - Scanning Using the Control Panel (Windows XP Only)

Copying

Printing Using the Operation Panel of the Machine

- Copying
 - Making Copies
 - Reducing or Enlarging a Copy
 - Using Useful Copy Functions
 - Switching the Page Size between A4 and Letter
 - Copying without Borders (Borderless Copy)

Troubleshooting

Troubleshooting

- If an Error Occurs
 - The Machine Cannot Be Powered On
 - An Error Code Is Displayed on the LED
 - Alarm Lamp Is Lit Orange
 - POWER Lamp Flashes Green and Alarm Lamp Flashes Orange Alternately
 - LED Cannot Be Seen At All
 - Cannot Install the MP Drivers
 - Cannot Install the Application Program
 - Easy-WebPrint EX Does Not Start up or Easy-WebPrint EX Menu Does Not Appear
 - Cannot Connect to Computer with a USB Cable Properly
 - Printing or Scanning Speed Is Slow/Hi-Speed USB Connection Does Not Work/"This device can perform faster" Message Is Displayed
- Print Results Not Satisfactory
 - Cannot Print to End of Job
 - No Printing Results/Printing Is Blurred/Colors Are Wrong/White Streaks
 - Colors Are Unclear
 - Lines Are Misaligned
 - Printed Paper Curls or Has Ink Blots

Paper Is Smudged/Printed Surface Is Scratched

Back of the Paper Is Smudged

Vertical Lines Are Printed on the Sides of the Printout

Colors Are Uneven or Streaked

Printing Does Not Start

Copying/Printing Stops Before It Is Completed

Machine Moves But Ink Is Not Ejected

Printing Speed Is Not as Fast as Expected

FINE Cartridge Holder Does Not Move to the Position for Replacing

Paper Does Not Feed Properly

Paper Jams

Paper Is Jammed in the Paper Output Slot or the Rear Tray

In Other Cases

Message Appears on the Computer Screen

Error Number: B200 A printer error has occurred. Turn the printer off and unplug the power cord of the printer from the power supply. Then contact the service center. Is Displayed

Error Number: **** A printer error has occurred. Turn the printer off and then on again. If this doesn't clear the error, see the user's guide for more detail. Is Displayed

Error Regarding the Power Cord Being Unplugged Is Displayed

Writing Error/Output Error/Communication Error

Other Error Messages

The Inkjet Printer/Scanner/Fax Extended Survey Program Screen Is Displayed

For Windows Users

Printer Status Monitor Is Not Displayed

Launching MP Navigator EX Whenever Pressing the SCAN Button on the Machine

Problems with Scanning

Scanner Does Not Work

ScanGear (Scanner Driver) Does Not Start

Error Message Appears and the ScanGear (Scanner Driver) Screen Does Not Appear

Scan Quality (Image Displayed on the Monitor) Is Poor

Scanned Image Is Surrounded by Extra White Areas

Cannot Scan Multiple Documents at One Time

Cannot Scan Properly in Auto Scan Mode

Slow Scanning Speed

"There is not enough memory." Message Is Displayed

Computer Stops Operating during Scanning

Scanner Does Not Work After Upgrading Windows

Software Problems

E-mail Software Program You Want to Use Does Not Appear in the Screen for Selecting an E-mail Software Program

Scanned Image Is Printed Enlarged (Reduced)

Scanned Image Is Enlarged (Reduced) on the Computer Monitor

Scanned Image Does Not Open

MP Navigator EX Problems

Cannot Scan at the Correct Size

Position or Size of the Image Cannot be Detected Correctly When Scanning Using the Operation Panel

Document Is Placed Correctly, but the Scanned Image Is Slanted

Document Is Placed Correctly, but the Orientation Changes in the Scanned Image

If You Cannot Resolve the Problem

FAQs

Instructions for Use (Printer Driver)

General Notes (Scanner Driver)

Using Easy-PhotoPrint EX

Using MP Navigator EX

Advanced Guide

[Advanced Guide](#) > [How to Use This Manual](#)

How to Use This Manual

- ➔ [Operating the Contents Pane](#)
- ➔ [Operating the Explanation Window](#)
- ➔ [Printing This Manual](#)
- ➔ [Using Keywords to Find a Document](#)
- ➔ [Registering Documents to My Manual](#)
- ➔ [Symbols Used in This Document](#)
- ➔ [Trademarks and Licenses](#)

[Page top](#) ↑

Advanced Guide

Advanced Guide > How to Use This Manual > Operating the Contents Pane

Operating the Contents Pane

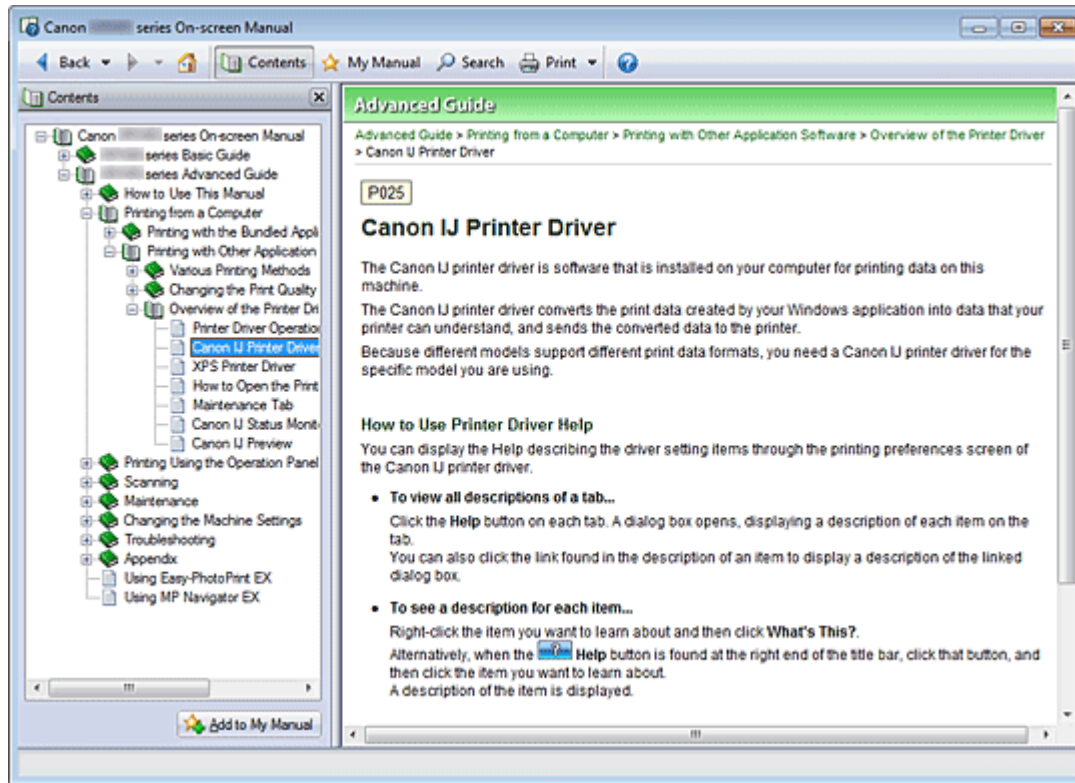

When you click a document title displayed in the contents pane found to the left of the on-screen manual, the documents of that title are displayed in the explanation window on the right side.

When you click  found to the left of , the document titles found in the lower hierarchies are displayed.

Note

- Click  to close or display the contents pane.

Advanced Guide

Advanced Guide > How to Use This Manual > Operating the Explanation Window

Operating the Explanation Window

Explanation Window

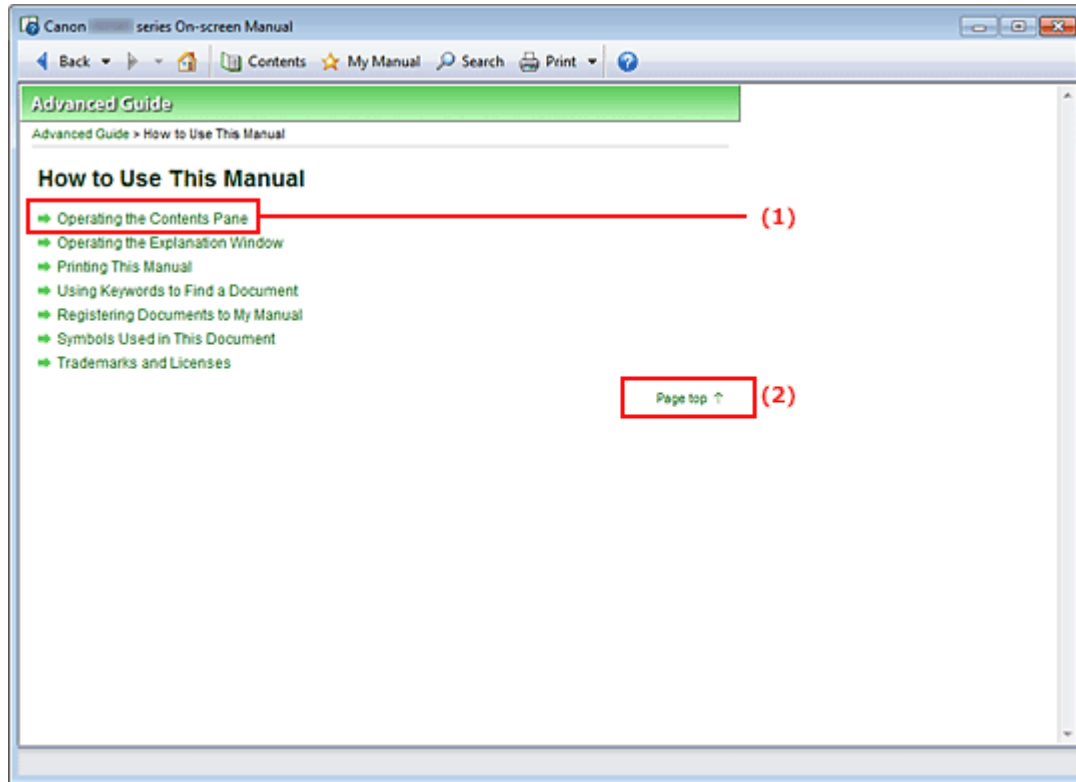

(1) Click the green characters to jump to the corresponding document.

(2) The cursor jumps to the top of this document.

Window Used in Operation Explanation

This on-screen manual describes with a window displayed when the Windows 7 operating system Home Premium (called Windows 7 below) is used.

Page top ↑

Advanced Guide





Advanced Guide > How to Use This Manual > Printing This Manual

Printing This Manual



Click  to display the print pane to the left of the on-screen manual.

Note

- Click  to close or display the print pane.
- When you click  and then click Page Setup, the Page Setup dialog box appears. You can then easily set up the paper to be used for printing.
- Click  and then click Print Settings to display the Print dialog box. When the dialog box is displayed, select the printer to be used for printing. The Print Setup tab also allows you to select the printer to be used.
After selecting the printer to be used, click Properties... to specify the print settings.
- Click  and then click Option Settings to display the Option Settings dialog box. You can then set up the printing operation.
 - Print document title and page number
When this check box is checked, the manual name and the page number are printed in the header (top of the document).
 - Print background color and images
When this check box is checked, the background color and the image are printed. Some images are printed regardless of whether this check box is checked or not.
 - Check number of pages to be printed before printing
When this check box is checked, the Print Page Count Confirmation dialog box is displayed before printing starts. This dialog box allows you to check how many pages will be printed.

On the Document Selection tab, select the method for printing the document. The following four methods of printing are available:

- [Print Current Document](#)
- [Print Selected Documents](#)
- [Print My Manual](#)

- [Print All Documents](#)

Note

- You can select the type to be printed, and then easily specify print settings on the Print Setup tab.
-

Print Current Document

You can print the currently displayed document.

1. From Select Target, select Current Document

The title of the currently displayed document is displayed in the Documents to Be Printed list.

Note

- By selecting Print linked documents, you can also print documents that are linked to the current document. The linked documents are added to the Documents to Be Printed list.
 - Click Print Preview to display and check what the print results will look like before you actually print the document.
-

2. Click Print Setup tab

On the Page Setup tab, select the printer to be used and specify simple print settings, as necessary.

3. Click Start Printing

A message confirming the number of print pages is displayed.

4. Execute print

Confirm the number of pages to be printed, and then click Yes.

The documents that are currently displayed are printed.

Print Selected Documents

You can select and print the documents that you want to print.

1. From Select Target, select Selected Documents

The titles of all documents are displayed in the Documents to Be Printed list.

2. Select the documents to be printed

From the Documents to Be Printed list, select and check the title check boxes of the documents to be printed.

Note

- When you select the Automatically select documents in lower hierarchies check box, the check boxes of all document titles found in the lower hierarchies are selected.
 - Click Select All to select the check boxes of all document titles.
Click Clear All to clear the check boxes of all document titles.
 - Click Print Preview to display and check what the print results will look like before you actually print the document.
-

3. Click Print Setup tab

On the Page Setup tab, select the printer to be used and specify simple print settings, as necessary.

4. Click Start Printing

A message confirming the number of print pages is displayed.

5. Execute print

Confirm the number of pages to be printed, and then click Yes.

All documents with selected check boxes are printed.

Print My Manual

You can select and print documents registered in My Manual.

For details about My Manual, see " [Registering Documents to My Manual](#) ."

1. From Select Target, select My Manual

The titles of the documents that have been registered to My Manual are displayed in the Documents to Be Printed list.

2. Select the documents to be printed

From the Documents to Be Printed list, select and check the title check boxes of the documents to be printed.



Note

- Click Select All to select the check boxes of all document titles.
Click Clear All to clear the check boxes of all document titles.
 - Click Print Preview to display and check what the print results will look like before you actually print the document.
-

3. Click Print Setup tab

On the Page Setup tab, select the printer to be used and specify simple print settings, as necessary.

4. Click Start Printing

A message confirming the number of print pages is displayed.

5. Execute print

Confirm the number of pages to be printed, and then click Yes.

All documents with selected check boxes are printed.

Print All Documents

You can print all documents of the on-screen manual.

1. From Select Target, select All Documents

The titles of all documents are displayed in the Documents to Be Printed list, and the check boxes are automatically selected.



Note

- When you uncheck the check box of a document title, that document is not printed.
 - Click Select All to select the check boxes of all document titles.
Click Clear All to clear the check boxes of all document titles.
 - Click Print Preview to display and check what the print results will look like before you actually print the document.
-

2. Click Print Setup tab

On the Page Setup tab, select the printer to be used and specify simple print settings, as necessary.

3. Click Start Printing

A message confirming the number of print pages is displayed.

4. Execute print

Confirm the number of pages to be printed, and then click Yes.

All documents are printed.

Important

- A large amount of paper is necessary to print all documents. Before printing, be sure to check the number of print pages displayed in the Print Page Count Confirmation dialog box.
- The Print Preview dialog box allows you to scale the printing to the paper width or to set the zoom rate. However, if the print data extends outside the paper because of the new zoom rate, that portion of the document will not be printed on the paper.

[Page top](#) ↑

Advanced Guide

Advanced Guide > How to Use This Manual > Using Keywords to Find a Document

Using Keywords to Find a Document

You can enter a keyword to search for a target document.

All documents in the currently displayed on-screen manual are searched.

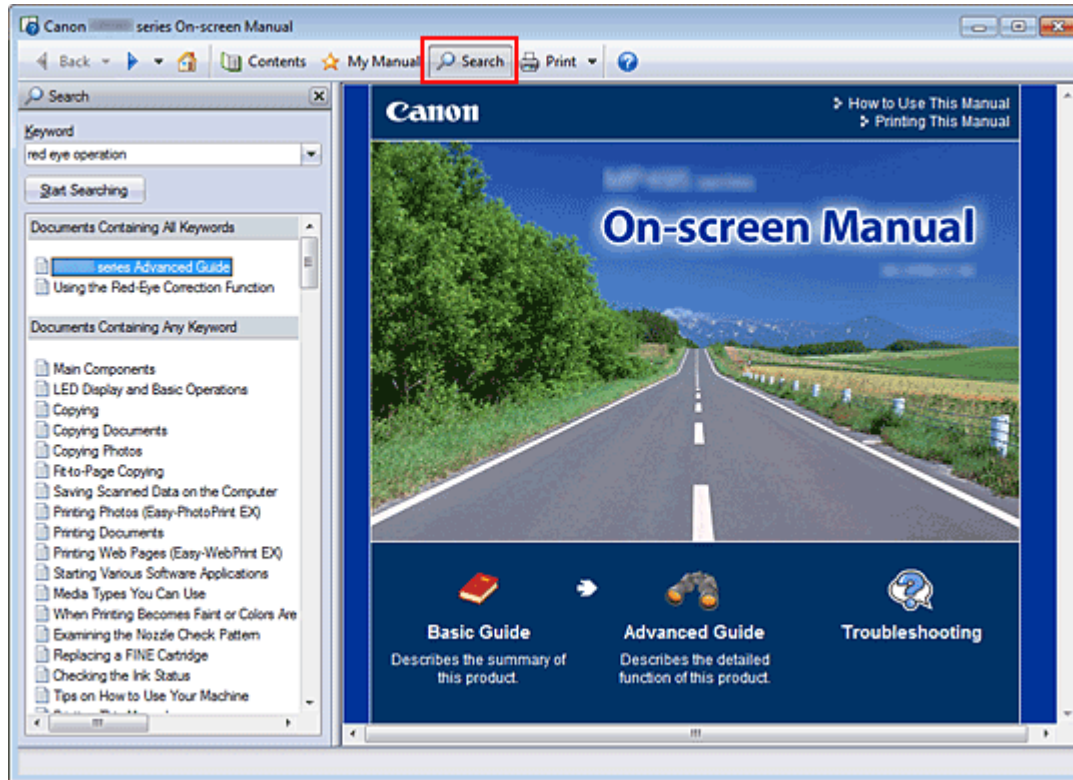

1. Click

The search pane is displayed to the left of the on-screen manual.

Note

- Click  to close or display the search pane.

2. Enter a keyword

In Keyword, enter a keyword for the item to be checked.

When you want to enter multiple keywords, insert a space between the keywords.

Note

- You can enter up to 10 search keywords or up to 255 characters.
- Uppercase and lowercase are not distinguished.
- The program can also search for keywords that contain spaces.
- A convenient way of quickly finding a document to be read is to enter keywords as described below.
 - To learn how to operate a function you are using:
Enter the menu name displayed on the operation panel of this machine or on the computer (for example, frame erase copy).
 - To find an explanation of the operation for a specific purpose:
Enter function + item to be printed (for example, print calendar).

3. Click Start Searching

The search is started, and the titles of documents containing the keyword are displayed in the search results list.

When you execute a search by entering multiple keywords, the search results are displayed as shown below.

[Documents Containing Perfect Match]

Documents containing the entire search character string (including spaces) exactly as entered (perfect match)

[Documents Containing All Keywords]

Documents containing all keywords that were entered

[Documents Containing Any Keyword]

Documents containing at least one of the keywords that were entered

4. Display the document that you want to read

From the search results list, double-click (or select and press Enter key) the title of the document you want to read.

When the documents of that title are displayed, the keywords found on those documents are highlighted.

Note

- The search history remains when you modify the keyword entry and perform search multiple times. To delete the search history, click  located at the right of Keyword, and select Clear History, which is displayed.
-

Advanced Guide

Advanced Guide > How to Use This Manual > Registering Documents to My Manual

Registering Documents to My Manual

Register frequently read documents as My Manual documents so that you can refer to those documents easily at any time.

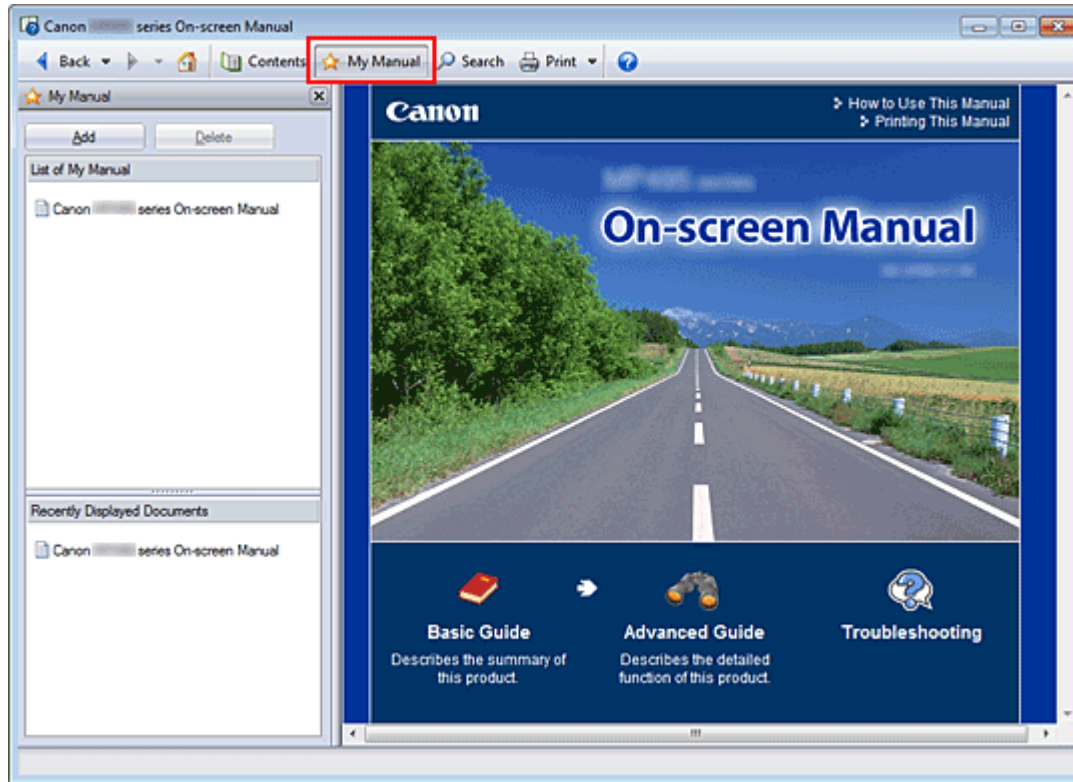

1. Display the document

Display the document to be added to My Manual.

2. Click

The My Manual pane is displayed to the left of the on-screen manual.

Note

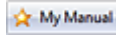
- Click  to close or display the My Manual pane.

3. Register the document to My Manual

Click Add.

The title of the currently displayed document is added to List of My Manual.

Note

- You can also add documents to My Manual by the following methods. If you add a document to My Manual, a  mark is displayed in the document icons in the contents pane.
 - From the Recently Displayed Documents list, double-click the document title that you want to add to My Manual (or select the document and press Enter key) to display the title, and then click Add.
 - Right-click the document title displayed in the contents pane or right-click the explanation window, and then select Add to My Manual from the right-click menu.
 - In the contents pane, select the document title that you want to add to My Manual, and then click Add to My Manual at the bottom right of the pane.

4. Display My Manual

When you double-click (or select and press Enter key) a document title displayed in List of My Manual, that document is displayed in the explanation window.

Note

- To delete a document from List of My Manual, select that document title from the list, and then click Delete (or press Delete key).
-

[Page top ↑](#)

Advanced Guide

[Advanced Guide](#) > [How to Use This Manual](#) > [Symbols Used in This Document](#)

Symbols Used in This Document

Warning

Instructions that, if ignored, could result in death or serious personal injury caused by incorrect operation of the equipment. These must be observed for safe operation.

Caution

Instructions that, if ignored, could result in personal injury or material damage caused by incorrect operation of the equipment. These must be observed for safe operation.

Important

Instructions including important information. Be sure to read these indications.

Note

Instructions include notes for operation and additional explanations.

[Page top](#) 

Advanced Guide

[Advanced Guide](#) > [How to Use This Manual](#) > Trademarks and Licenses

Trademarks and Licenses

- Microsoft is a registered trademark of Microsoft Corporation.
- Windows is a trademark or registered trademark of Microsoft Corporation in the U.S. and/or other countries.
- Windows Vista is a trademark or registered trademark of Microsoft Corporation in the U.S. and/or other countries.
- Internet Explorer is a trademark or registered trademark of Microsoft Corporation in the U.S. and/or other countries.
- Macintosh and Mac are trademarks of Apple Inc., registered in the U.S. and other countries.
- Bonjour is a trademark of Apple Inc., registered in the U.S. and other countries.
- Adobe, Adobe Photoshop, Adobe RGB and Adobe RGB (1998) are either registered trademarks or trademarks of Adobe Systems Incorporated in the United States and/or other countries.

Note

- The formal name of Windows Vista is Microsoft Windows Vista operating system.
-

Exif Print

This machine supports Exif Print.

Exif Print is a standard for enhancing the communication between digital cameras and printers. By connecting to an Exif Print-compliant digital camera, the camera's image data at the time of shooting is used and optimized, yielding extremely high quality prints.

[Page top](#) ↑

Advanced Guide

Advanced Guide > Printing from a Computer

Printing from a Computer

- ➡ Printing with the Bundled Application Software
- ➡ Printing with Other Application Software

[Page top](#) ↕

Advanced Guide

[Advanced Guide](#) > [Printing from a Computer](#) > [Printing with the Bundled Application Software](#)

Printing with the Bundled Application Software

- ➔ [What Is Easy-PhotoPrint EX?](#)
- ➔ [Printing Photos](#)
- ➔ [Creating an Album](#)
- ➔ [Printing Calendars](#)
- ➔ [Printing Stickers](#)
- ➔ [Printing Layout](#)
- ➔ [Correcting and Enhancing Photos](#)
- ➔ [Creating Still Images from Videos](#)
- ➔ [Downloading Images from Photo Sharing Sites](#)
- ➔ [Questions and Answers](#)
- ➔ [Photo Print Settings](#)
- ➔ [Other Settings](#)

[Page top](#) ↕

Advanced Guide

Advanced Guide > Printing from a Computer > Printing with the Bundled Application Software > What Is Easy-PhotoPrint EX?

A000

Easy-PhotoPrint EX

What Is Easy-PhotoPrint EX?

Easy-PhotoPrint EX allows you to create albums, calendars and stickers easily using photos taken with digital cameras.

You can also print borderless photos easily.

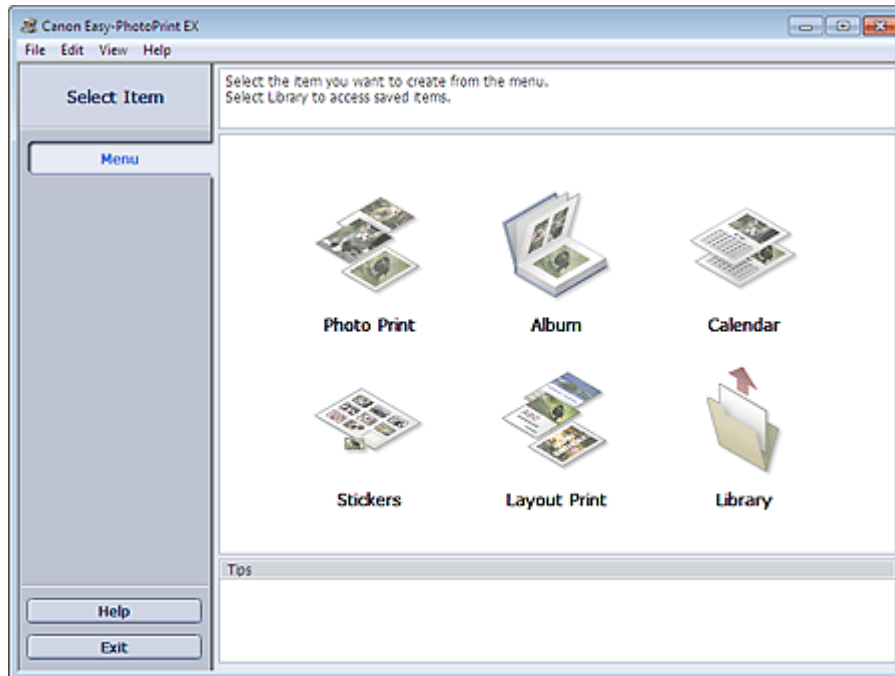

Important

- Easy-PhotoPrint EX can only be used with Canon inkjet printers. It does not support some Canon compact photo printers, including SELPHY CP series.
- If a printer that supports Easy-PhotoPrint EX is not installed, you cannot print items you create.
- If Easy-PhotoPrint EX is installed on a computer that already has Easy-LayoutPrint installed, Easy-LayoutPrint will be replaced by Easy-PhotoPrint EX.

Note

- See Help of Easy-PhotoPrint EX for descriptions of Easy-PhotoPrint EX screens. Click Help in a screen or dialog box, or select Easy-PhotoPrint EX Help... from the Help menu. Help appears.

About Exif Print

Easy-PhotoPrint EX supports "Exif Print." Exif Print is a standard for enhancing the communication between digital cameras and printers.

By connecting to an Exif Print-compliant digital camera, the image data at the time of shooting is used and optimized, yielding extremely high quality prints.

Starting Easy-PhotoPrint EX from Other Applications

Easy-PhotoPrint EX can be started from other applications.

See the application's manual for details on the procedure for starting.

- MP Navigator EX Ver.1.00 or later supports the following functions.
 - Photo Print
 - Album
- ZoomBrowser EX Ver.6.0 or later supports the following functions.
 - Photo Print
 - Album
- ZoomBrowser EX Ver.5.8 or later supports the following function.
 - Album
- Digital Photo Professional Ver.3.2 or later supports the following function.
 - Photo Print

Important

- Easy-PhotoPrint EX is subject to the following restrictions when started from Digital Photo Professional:
 - Menu and Open do not appear in the step button area on the left side of the screen.
 - Images cannot be corrected/enhanced.
 - Image display order cannot be changed.
 - Edited images cannot be saved.
 - Options other than Enable ICC Profile cannot be selected for Color correction for printing on the Advanced tab of the Preferences dialog box. Therefore, you cannot use the Vivid Photo and Photo Noise Reduction functions.

- Solution Menu EX Ver.1.0.0 or later supports the following functions.
 - Photo Print
 - Album
 - Calendar
 - Layout Print

Important

- When Easy-PhotoPrint EX is started by selecting a function from Solution Menu EX, Menu does not appear in the step button area on the left side of the screen.

Supported Image/Video Data Formats (Extensions)

- BMP (.bmp)
- JPEG (.jpg, .jpeg)
- TIFF (.tif, .tiff)
- PICT (.pict, .pct)
- Easy-PhotoPrint image files (.epp)
- MOV (.mov)

Important

- Only MOV format videos recorded with Canon digital cameras are supported.
- When selecting an image, if there is a TIFF file in the selected folder, the image may not be displayed correctly or Easy-PhotoPrint EX may shut down depending on the TIFF format. In such cases, move the TIFF file to another folder or recreate the file in a different data format, and then select the folder again.

Note

- The thumbnails of files in unsupported formats are displayed as  (Question Mark).
- When Easy-PhotoPrint EX is started from Digital Photo Professional, all image files supported by Digital Photo Professional will be displayed.

File Formats (Extensions) Supported by Easy-PhotoPrint EX

- Easy-PhotoPrint EX Photo Print file (.el6)
- Easy-PhotoPrint EX Album file (.el1)
- Easy-PhotoPrint EX Stickers file (.el2)
- Easy-PhotoPrint EX Calendar file (.el4)
- Easy-PhotoPrint EX Layout file (.el5)

[Page top](#)↑

Advanced Guide

Advanced Guide > Printing from a Computer > Printing with the Bundled Application Software > Printing Photos

A010

Easy-PhotoPrint EX

Printing Photos

Easy-PhotoPrint EX allows you to print your favorite photos in a variety of layouts.

You can also create borderless photos easily.

Corrections suitable for photos can be applied automatically when printing.

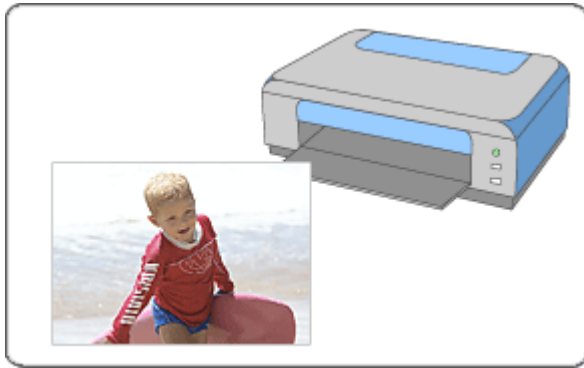

Steps

1. Starting Easy-PhotoPrint EX
2. Selecting a Photo
3. Selecting the Paper
4. Printing

Try This

- ➔ Correcting and Enhancing Photos
- ➔ Creating Still Images from Videos
- ➔ Downloading Images from Photo Sharing Sites
- ➔ Printing Vivid Photos
- ➔ Reducing Photo Noise
- ➔ Cropping Photos (Photo Print)
- ➔ Printing Dates on Photos (Photo Print)
- ➔ Printing Multiple Photos on One Page
- ➔ Printing an Index
- ➔ Printing ID Photos (ID Photo Print)
- ➔ Printing Photo Information
- ➔ Saving Photos
- ➔ Opening Saved Files

Questions and Answers

- ➡ How Can I Move (or Copy) the Saved File?
- ➡ Which Side of the Displayed Image Does the Printing Start from?
- ➡ How Do I Print with Even Margins?

[Page top](#) ↕

Advanced Guide

Advanced Guide > Printing from a Computer > Printing with the Bundled Application Software > Printing Photos > Starting Easy-PhotoPrint EX

A011

Easy-PhotoPrint EX



Starting Easy-PhotoPrint EX

1. From the Start menu, select All Programs > Canon Utilities > Easy-PhotoPrint EX > Easy-PhotoPrint EX.

Easy-PhotoPrint EX starts and Menu appears.

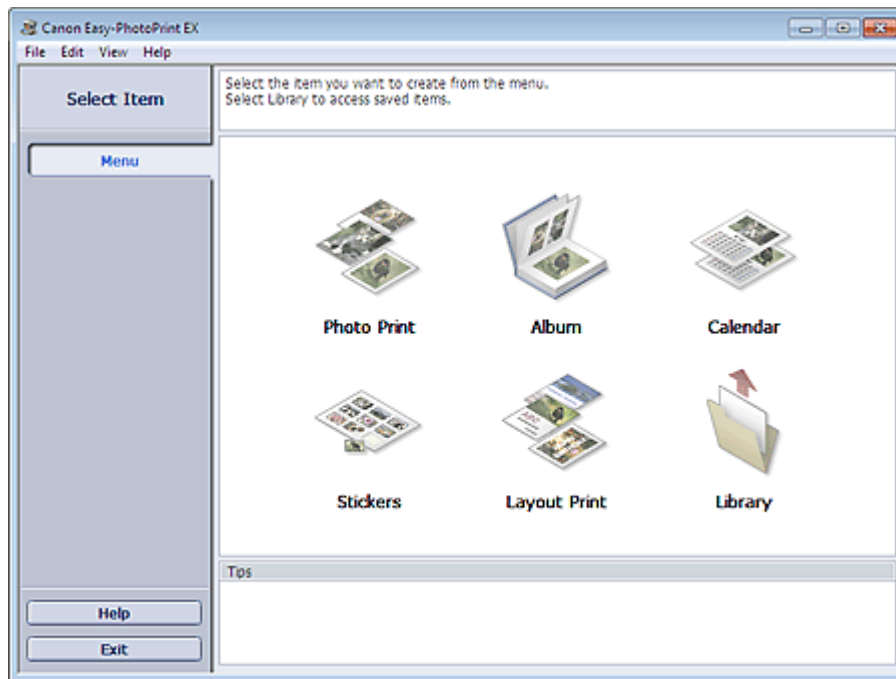

[Page top](#)

Advanced Guide

Advanced Guide > Printing from a Computer > Printing with the Bundled Application Software > Printing Photos > Selecting a Photo

A012

Easy-PhotoPrint EX



Selecting a Photo

1. Click Photo Print from Menu.

The Select Images screen appears.

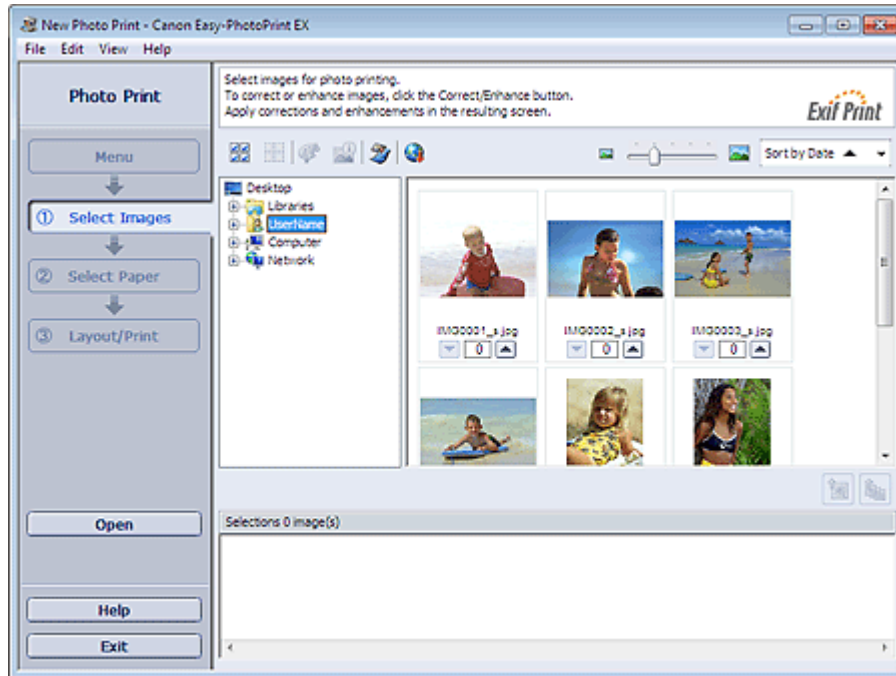

Important

- The thumbnails (reduced images) displayed in the screen may appear as follows:
 - A black line appears along an edge of the image.
 - An edge of the image appears cropped.
 However, such images will be displayed normally when enlarged or previewed, and print results will not be affected.

2. Select the folder that contains the image you want to print from the folder tree area.

The images in the folder will be displayed as thumbnails (miniatures).

Important

- If Easy-PhotoPrint EX is started from another application (MP Navigator EX, ZoomBrowser EX or Digital Photo Professional), the folder tree area will not be displayed. The images selected in the application will be displayed as thumbnails.

Note

- You can also use still images captured from videos.
 - ➔ [Creating Still Images from Videos](#)
- You can also use images downloaded from photo sharing sites on the Internet.
 - ➔ [Downloading Images from Photo Sharing Sites](#)

3. Click the image you want to print.

The number of copies appears as "1" below the clicked image, while the selected image itself will appear in the selected image area.



Note

- To delete an image in the selected image area, select the image you want to delete and click



(Delete Imported Image).

To delete all images from the selected image area, click  (Delete All Imported Images).

- To print two or more copies of an image, click  (Up arrow) until the number of copies you want is reached. To reduce the number of copies shown in the box, click  (Down arrow).
 - You can change the order of photos using the list located at the top right corner of the screen. You can select the printing order from Sort by Date and Sort by Name.
-

Note

- You can correct or enhance the selected image before printing.
 - ➔ [Correcting and Enhancing Photos](#)
 - See Help for details on the Select Images screen.
-



[Page top](#)[↕]

Advanced Guide

Advanced Guide > Printing from a Computer > Printing with the Bundled Application Software > Printing Photos > Selecting the Paper

A013

Easy-PhotoPrint EX



Selecting the Paper

1. Click Select Paper.

The Select Paper screen appears.

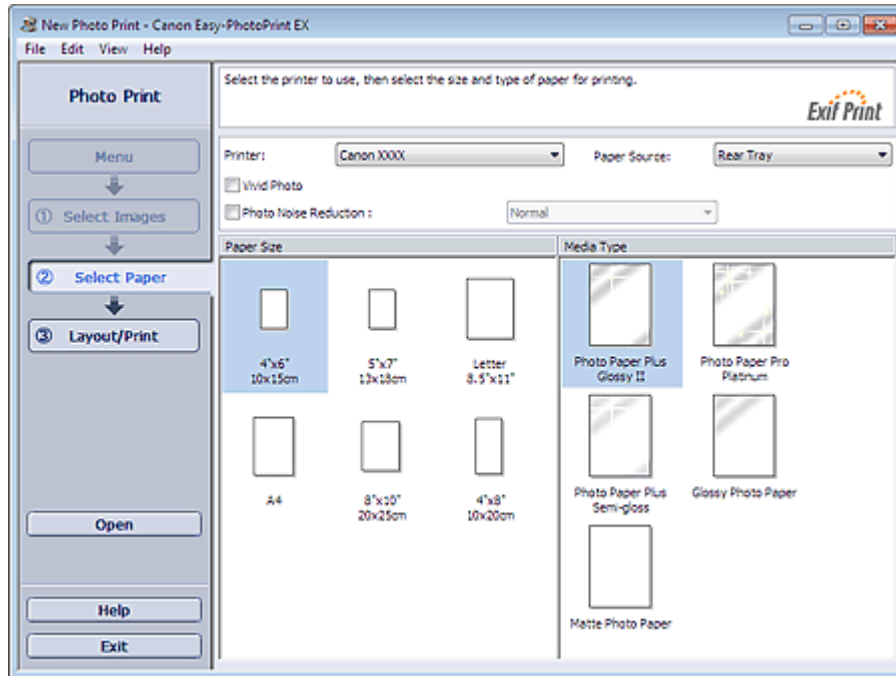

2. Set the following items according to the printer and paper to be used:

Printer

Paper Source

Paper Size

Media Type



Note

- The paper sizes and media types may vary depending on the printer. See Help for details.
- The paper sources may vary depending on the printer and the media type.



Note

- You can print photos with more vivid colors or you can reduce the photo noise.
 - ➔ Printing Vivid Photos
 - ➔ Reducing Photo Noise
- See Help for details on the Select Paper screen.



Advanced Guide

Advanced Guide > Printing from a Computer > Printing with the Bundled Application Software > Printing Photos > Printing

A014

Easy-PhotoPrint EX



Printing

1. Click Layout/Print.

The Layout/Print screen appears.

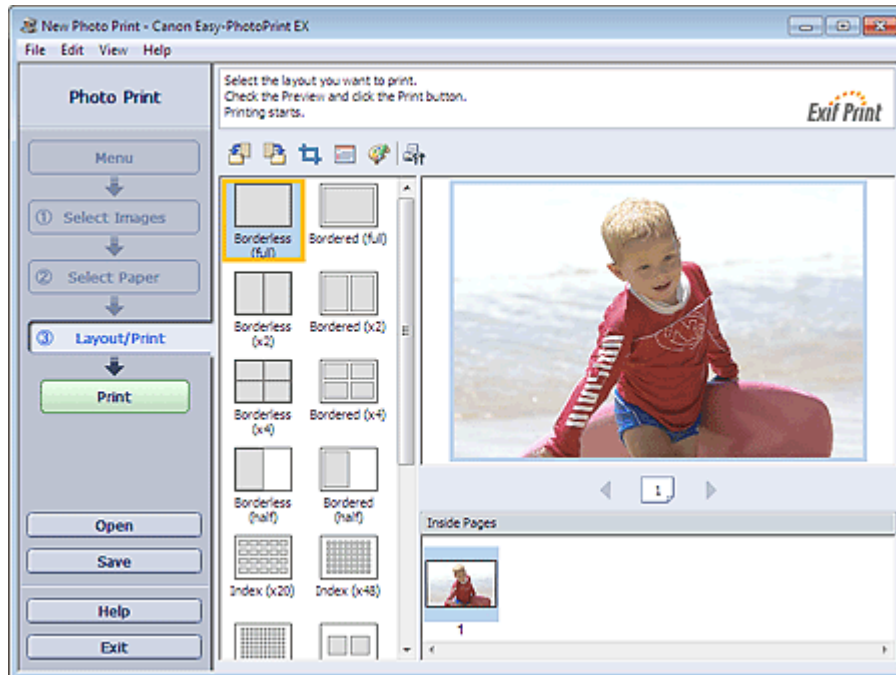

Important

- The thumbnails (reduced images) displayed in the screen may appear as follows:
 - A black line appears along an edge of the image.
 - An edge of the image appears cropped.
 However, such images will be displayed normally when enlarged or previewed, and print results will not be affected.

2. Select a layout you want to use.

Click a borderless layout to print borderless photos.

Note

- The layouts that can be selected may vary depending on the printer, paper size, and media type.

3. Click Print.

Important

- The photo print settings will be discarded if you exit Easy-PhotoPrint EX without saving the settings. It is recommended that you save the printed image if you want to print it again.
 - ➔ **Saving Photos**
- When you print on a bordered layout, the margins on the left and right or the top and bottom may become wider than the other.

➔ [How Do I Print with Even Margins?](#)

Note

- You can crop images or print dates on photos.
 - ➔ [Cropping Photos \(Photo Print\)](#)
 - ➔ [Printing Dates on Photos \(Photo Print\)](#)
 - You can correct or enhance the selected image before printing.
 - ➔ [Correcting and Enhancing Photos](#)
 - You can specify advanced Photo Print settings (number of copies, print quality, etc.) in the Preferences dialog box.

To display the Preferences dialog box, click  (Settings) or select Preferences... from the File menu.
 - See Help for details on the Layout/Print screen.
-



[Page top](#) ↕

Advanced Guide

Advanced Guide > Printing from a Computer > Printing with the Bundled Application Software > Creating an Album

A020

Easy-PhotoPrint EX

Creating an Album

Easy-PhotoPrint EX allows you to create your own personalized photo album.

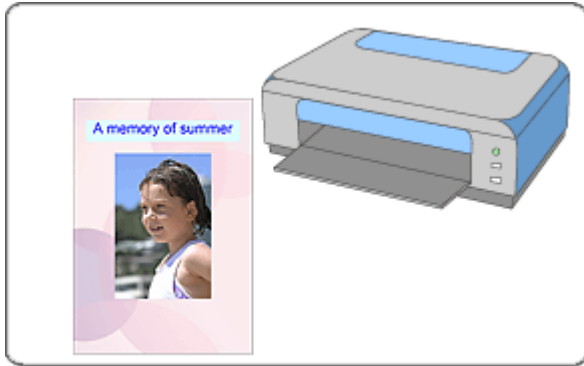

Steps

1. Starting Easy-PhotoPrint EX
2. Selecting the Paper and Layout
3. Selecting a Photo
4. Editing
5. Printing

Try This

- ➔ Correcting and Enhancing Photos
- ➔ Creating Still Images from Videos
- ➔ Downloading Images from Photo Sharing Sites
- ➔ Changing Layout
- ➔ Changing Background
- ➔ Adding Photos
- ➔ Swapping Positions of Photos
- ➔ Replacing Photos
- ➔ Changing Position, Angle and Size of Photos
- ➔ Cropping Photos
- ➔ Framing Photos
- ➔ Printing Dates on Photos
- ➔ Attaching Comments to Photos
- ➔ Adding Text to Photos
- ➔ Saving
- ➔ Opening Saved Files

Questions and Answers

- ➡ How Can I Move (or Copy) the Saved File?
- ➡ What Is "C1" or "C4"?

[Page top](#) ↕

Advanced Guide

Advanced Guide > Printing from a Computer > Printing with the Bundled Application Software > Creating an Album > Starting Easy-PhotoPrint EX

A021

Easy-PhotoPrint EX



Starting Easy-PhotoPrint EX

1. From the Start menu, select All Programs > Canon Utilities > Easy-PhotoPrint EX > Easy-PhotoPrint EX.

Easy-PhotoPrint EX starts and Menu appears.

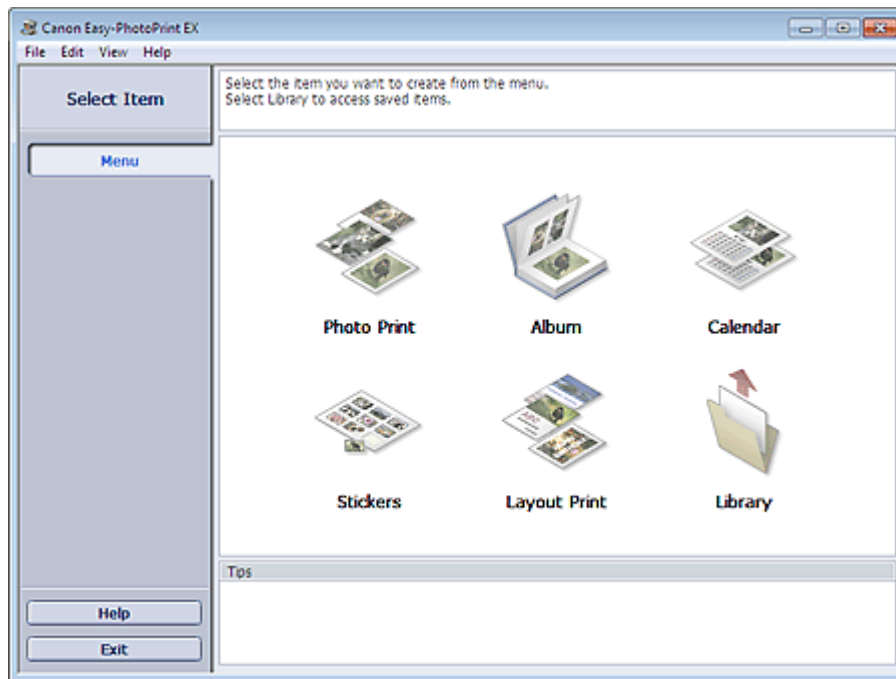

[Page top](#)

Advanced Guide

Advanced Guide > Printing from a Computer > Printing with the Bundled Application Software > Creating an Album > Selecting the Paper and Layout

A022

Easy-PhotoPrint EX



Selecting the Paper and Layout

1. Click Album from Menu.

The Page Setup screen appears.

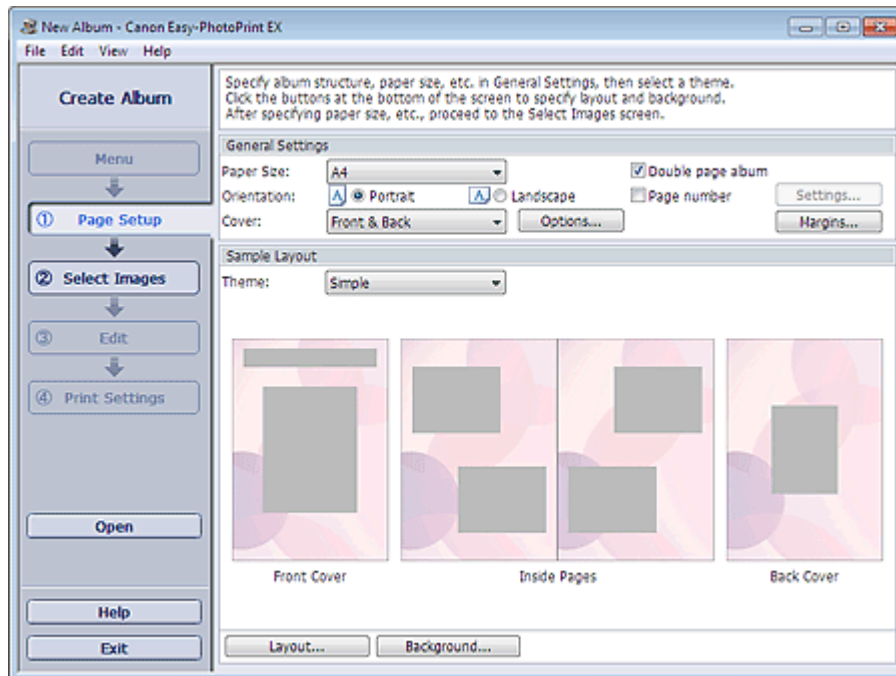

2. Set the following items in the General Settings section:

Paper Size

Orientation

Cover

Double page album

Page number



Note

- See Help on the paper size that can be selected.
- You can select whether to display images on the inside of the front and back covers in the Cover Options dialog box. To display the Cover Options dialog box, select Front or Front & Back for Cover and click Options....
- Select the Double page album checkbox to enable the spread page layout (consisting of two-page master). In a double-page album, you can arrange an image across the left and right pages.
- You can customize the page numbers (position, font size, etc.) in the Page Number Settings dialog box. To display the Page Number Settings dialog box, select the Page number checkbox and click Settings....
- You can customize the margins of the front cover, inside pages and back cover in the Margin Settings dialog box. To display the Margin Settings dialog box, click Margins....

3. Select the theme you want to use from Theme in Sample Layout.

4. If you want to change the layout, click Layout....

The Change Layout dialog box appears.

In the Change Layout dialog box, you can change the layout or select whether to print the date (on which the picture was taken) on the photo.

Note

- The layouts that can be selected may vary depending on the Paper Size, Orientation, Double page album, or the type of page selected (front cover, inside pages or back cover).
 - You can customize the date (position, size, color, etc.) in the Date Settings dialog box. To display the Date Settings dialog box, select the Print date checkbox in the Change Layout dialog box and click Date Settings....
-

5. If you want to change the background, click Background....

The Change Background dialog box appears.

In the Change Background dialog box, you can paint the background in a single color or paste an image file to it.

Note

- See Help for details on the Page Setup screen.
-



[Page top](#)[↕]

Advanced Guide

Advanced Guide > Printing from a Computer > Printing with the Bundled Application Software > Creating an Album > Selecting a Photo

A023

Easy-PhotoPrint EX



Selecting a Photo

1. Click Select Images.

The Select Images screen appears.

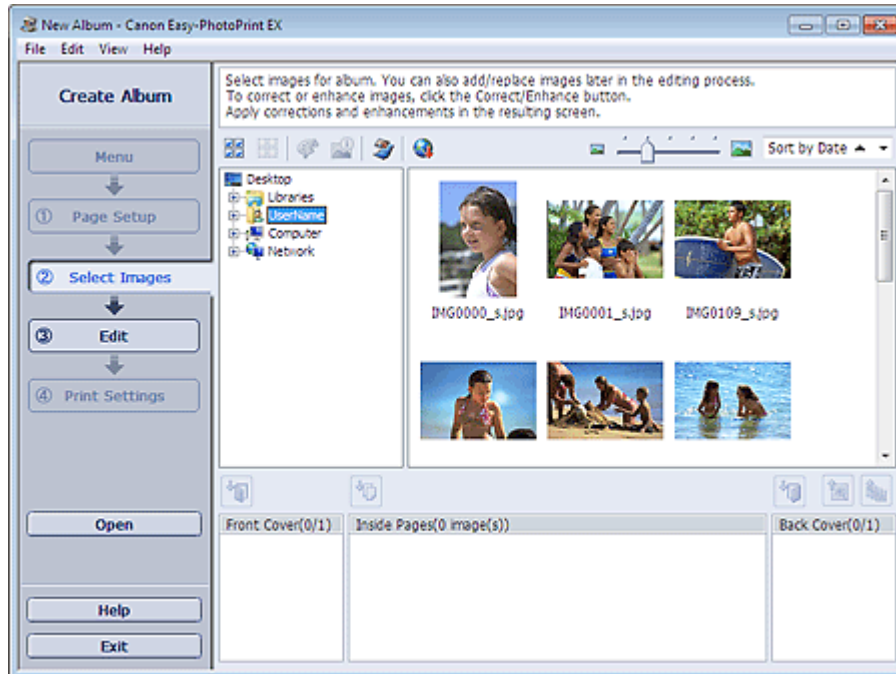

2. Select the folder that contains the image you want to print from the folder tree area.

The images in the folder will be displayed as thumbnails (miniatures).

Important

- If Easy-PhotoPrint EX is started from another application (MP Navigator EX or ZoomBrowser EX), the folder tree area will not be displayed. The images selected in the application will be displayed as thumbnails.

Note

- You can also use still images captured from videos.
 - ➔ [Creating Still Images from Videos](#)
- You can also use images downloaded from photo sharing sites on the Internet.
 - ➔ [Downloading Images from Photo Sharing Sites](#)

3. Select the image(s) you want to print, and click one of the buttons below.

To print on the front cover, click  (Import to Front Cover).

To print on the inside pages, click  (Import to Inside Pages).

To print on the back cover, click  (Import to Back Cover).

The selected image(s) is (are) displayed in the selected image area.

You can also select the image(s) you want to print by dragging it (them) into the selected image area.

Note

- To delete an image in the selected image area, select the image you want to delete and click



(Delete Imported Image).

To delete all images from the selected image area, click



(Delete All Imported Images).

Note

- You can correct or enhance the selected image before printing.
 - ➔ [Correcting and Enhancing Photos](#)
 - See Help for details on the Select Images screen.
-



[Page top](#) 

Advanced Guide

Advanced Guide > Printing from a Computer > Printing with the Bundled Application Software > Creating an Album > Editing

A024

Easy-PhotoPrint EX



Editing

1. Click Edit.

The Edit screen appears.

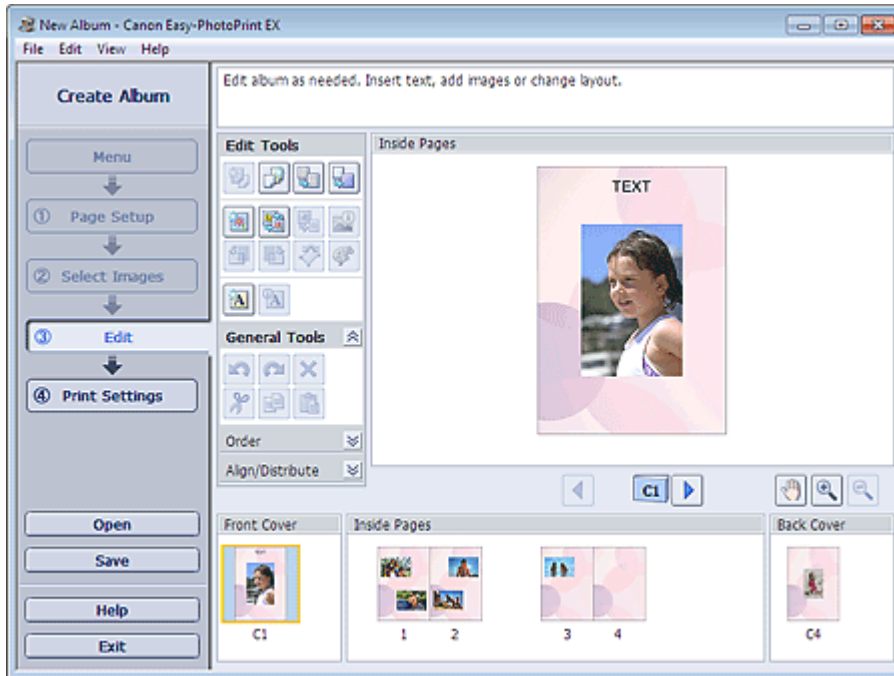

2. Edit your album if necessary.

- ➔ Changing Layout
- ➔ Changing Background
- ➔ Adding Photos
- ➔ Swapping Positions of Photos
- ➔ Replacing Photos
- ➔ Changing Position, Angle and Size of Photos
- ➔ Cropping Photos
- ➔ Framing Photos
- ➔ Printing Dates on Photos
- ➔ Attaching Comments to Photos
- ➔ Adding Text to Photos

Important

- The edit information will be discarded if you exit Easy-PhotoPrint EX without saving the edited album. It is recommended that you save the item if you want to edit it again. The page numbers on the front and back covers of the album are displayed as follows:

C1: Front cover

C2: Inside the front cover

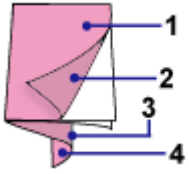

C3: Inside the back cover

C4: Back cover

- "C2"/"C3" appears only when the Leave the inside of front cover blank/Leave the inside of back cover blank checkbox is selected in the Cover Options dialog box.

→ Saving

Note

- See Help for details on the Edit screen.



[Page top](#)↑

Advanced Guide

Advanced Guide > Printing from a Computer > Printing with the Bundled Application Software > Creating an Album > Printing

A025

Easy-PhotoPrint EX



Printing

1. Click Print Settings.

The Print Settings screen appears.

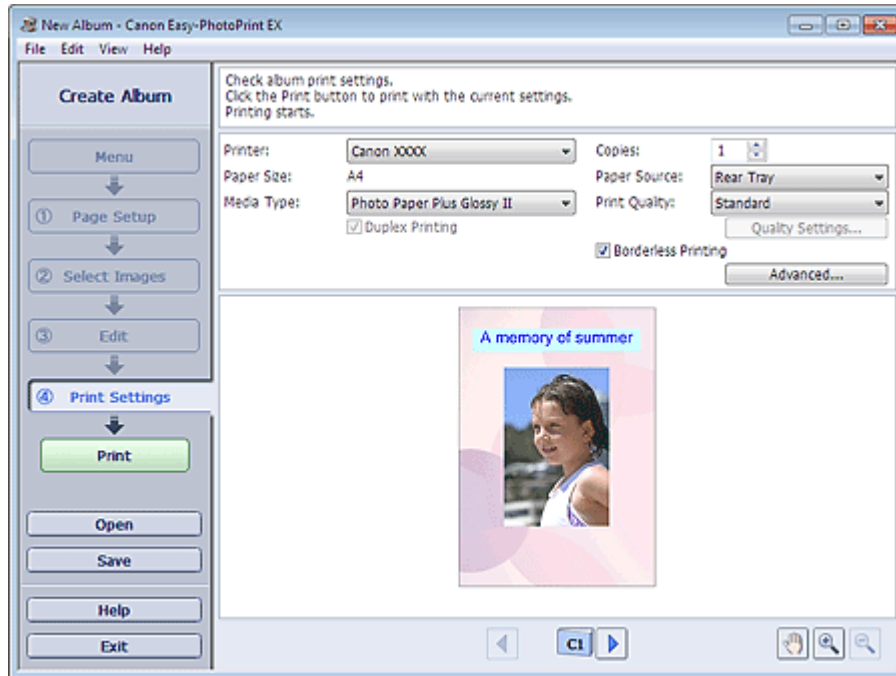

2. Set the following items according to the printer and paper to be used:

Printer

Media Type

Copies

Paper Source

Print Quality

Borderless Printing



Note

- The media types may vary depending on the printer and the paper size.
- Duplex Printing appears if the selected printer and media type support duplex printing. Select this checkbox to print on both sides of the paper.
- Automatic appears if you select the Duplex Printing checkbox after selecting a printer that supports automatic duplex printing and media type that supports duplex printing. Select this checkbox to print on both sides of the paper automatically.
- The paper sources may vary depending on the printer and the media type.
- You can set a custom print quality level in the Print Quality Settings dialog box. To display the Print Quality Settings dialog box, select Custom for Print Quality and click Quality Settings....
- Select the Borderless Printing checkbox to print each page of the album on a full page without borders.
- You can specify the print range and the amount of extension for borderless printing in the Print Settings dialog box. To display the Print Settings dialog box, click Advanced....

3. Click Print.

 **Note**

-
- See Help for details on the Print Settings screen.
-



[Page top](#)[↕]

Advanced Guide

Advanced Guide > Printing from a Computer > Printing with the Bundled Application Software > Printing Calendars

A040

Easy-PhotoPrint EX

Printing Calendars

Easy-PhotoPrint EX allows you to create your own calendar using your favorite photos.

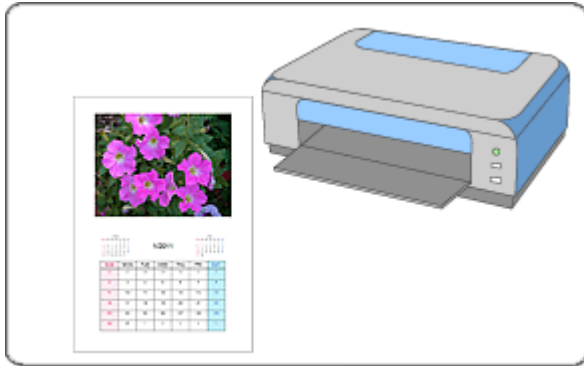

Steps

1. Starting Easy-PhotoPrint EX
2. Selecting the Paper and Layout
3. Selecting a Photo
4. Editing
5. Printing

Try This

- ➔ Correcting and Enhancing Photos
- ➔ Creating Still Images from Videos
- ➔ Downloading Images from Photo Sharing Sites
- ➔ Changing Layout
- ➔ Changing Background
- ➔ Adding Photos
- ➔ Swapping Positions of Photos
- ➔ Replacing Photos
- ➔ Changing Position, Angle and Size of Photos
- ➔ Cropping Photos
- ➔ Framing Photos
- ➔ Printing Dates on Photos
- ➔ Adding Text to Photos
- ➔ Setting Calendar Display
- ➔ Setting Holidays
- ➔ Saving

➡ Opening Saved Files

Questions and Answers

➡ How Can I Move (or Copy) the Saved File?

Page top ↕

Advanced Guide

Advanced Guide > Printing from a Computer > Printing with the Bundled Application Software > Printing Calendars > Starting Easy-PhotoPrint EX

A041

Easy-PhotoPrint EX



Starting Easy-PhotoPrint EX

1. From the Start menu, select All Programs > Canon Utilities > Easy-PhotoPrint EX > Easy-PhotoPrint EX.

Easy-PhotoPrint EX starts and Menu appears.

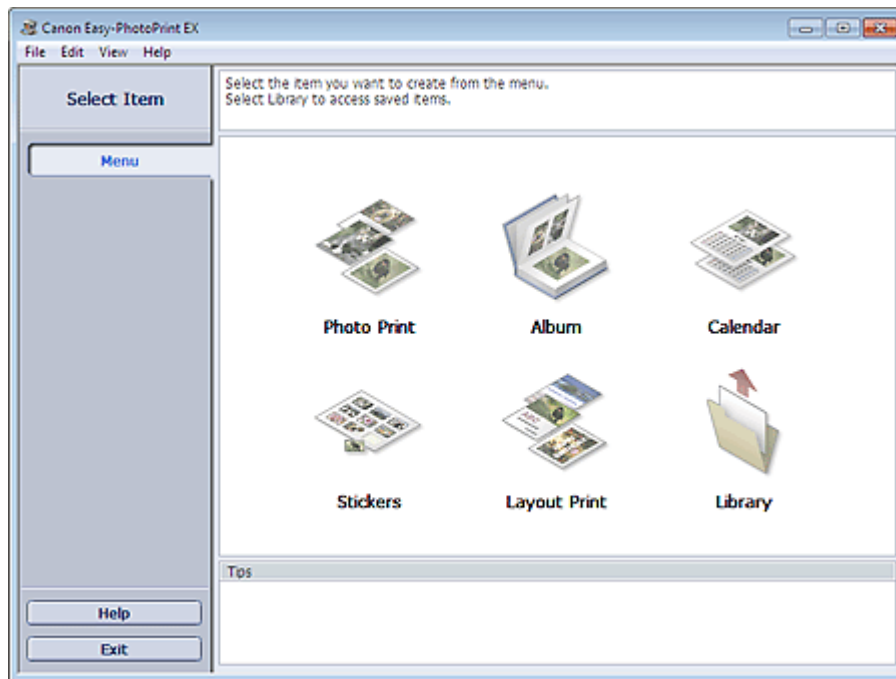

[Page top](#)

Advanced Guide

Advanced Guide > Printing from a Computer > Printing with the Bundled Application Software > Printing Calendars > Selecting the Paper and Layout

A042

Easy-PhotoPrint EX



Selecting the Paper and Layout

1. Click Calendar from Menu.

The Page Setup screen appears.

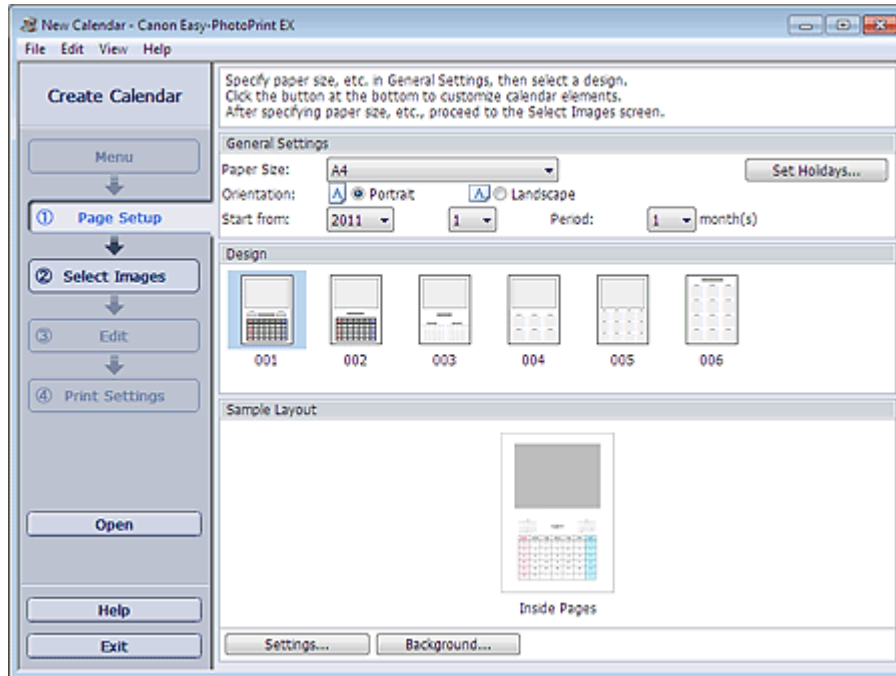

2. Set the following items in the General Settings section:

Paper Size

Orientation

Start from

Period



Note

- See Help on the paper size that can be selected.
- You can add holidays to your calendar.
➔ [Setting Holidays](#)

3. Select a layout for Design.

If necessary, make advanced settings on the calendar and set the background.



Note

- You can customize the calendar display (font colors of the dates and days of the week, position and size of the calendar, etc.).
➔ [Setting Calendar Display](#)
- You can paint the background in a single color or paste an image file to it in the Change Background dialog box. To display the Change Background dialog box, click Background....

 **Note**

-
- See Help for details on the Page Setup screen.
-



[Page top](#)[↕]

Advanced Guide

Advanced Guide > Printing from a Computer > Printing with the Bundled Application Software > Printing Calendars > Selecting a Photo

A043

Easy-PhotoPrint EX



Selecting a Photo

1. Click Select Images.

The Select Images screen appears.



2. Select the folder that contains the image you want to print from the folder tree area.

The images in the folder will be displayed as thumbnails (miniatures).

Note

- You can also use still images captured from videos.
➔ [Creating Still Images from Videos](#)
- You can also use images downloaded from photo sharing sites on the Internet.
➔ [Downloading Images from Photo Sharing Sites](#)

3. Select the image(s) you want to print and click (Import to Inside Pages).

The selected image(s) is (are) displayed in the selected image area.

You can also select the image(s) you want to print by dragging it (them) into the selected image area.

Note

- To delete an image in the selected image area, select the image you want to delete and click



(Delete Imported Image).

To delete all images from the selected image area, click  (Delete All Imported Images).

 **Note**

- You can correct or enhance the selected image before printing.
 - ➔ [Correcting and Enhancing Photos](#)
 - See Help for details on the Select Images screen.
-



[Page top](#) 

Advanced Guide

Advanced Guide > Printing from a Computer > Printing with the Bundled Application Software > Printing Calendars > Editing

A044

Easy-PhotoPrint EX



Editing

1. Click Edit.

The Edit screen appears.

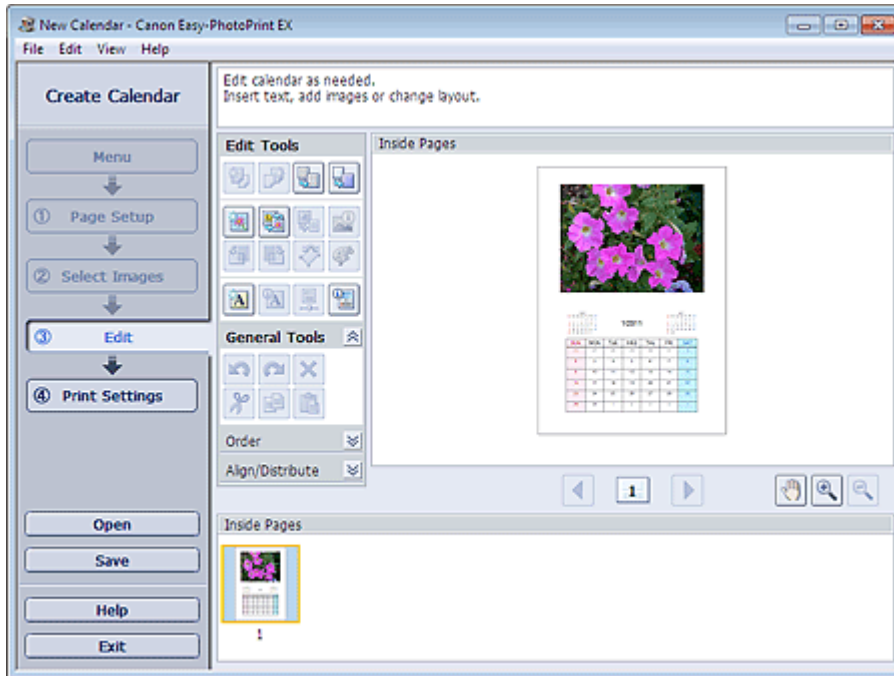

2. Edit the calendar if necessary.

- ➔ Changing Layout
- ➔ Changing Background
- ➔ Adding Photos
- ➔ Swapping Positions of Photos
- ➔ Replacing Photos
- ➔ Changing Position, Angle and Size of Photos
- ➔ Cropping Photos
- ➔ Framing Photos
- ➔ Printing Dates on Photos
- ➔ Adding Text to Photos
- ➔ Setting Calendar Display
- ➔ Setting Holidays

Important

- The edit information will be discarded if you exit Easy-PhotoPrint EX without saving the edited calendar. It is recommended that you save the item if you want to edit it again.

- ➔ Saving

Note

- See Help for details on the Edit screen.
-



[Page top](#) 

Advanced Guide

Advanced Guide > Printing from a Computer > Printing with the Bundled Application Software > Printing Calendars > Printing

A045

Easy-PhotoPrint EX



Printing

1. Click Print Settings.

The Print Settings screen appears.

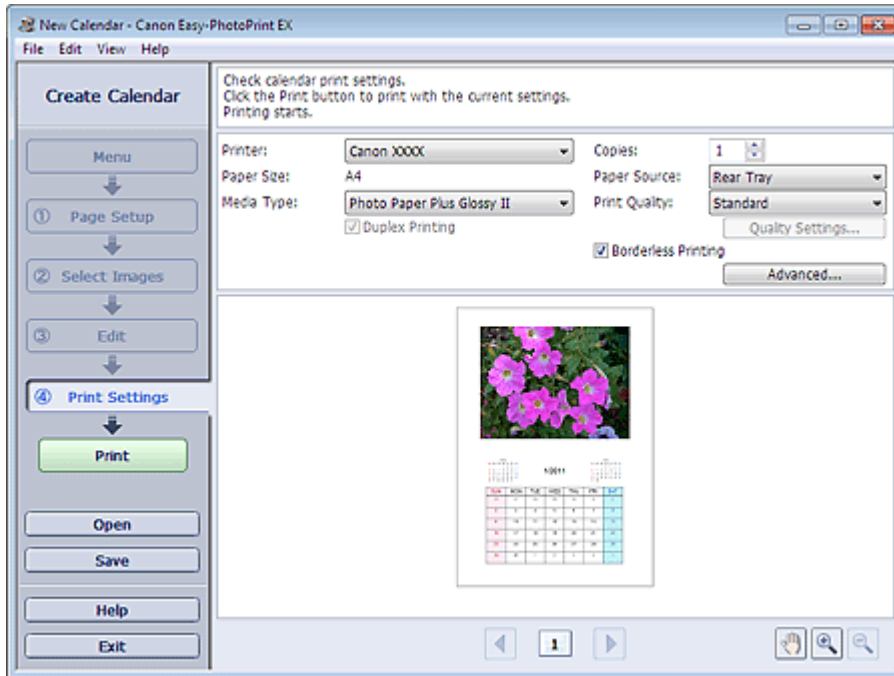

2. Set the following items according to the printer and paper to be used:

Printer

Media Type

Copies

Paper Source

Print Quality

Borderless Printing

Note

- The media types may vary depending on the printer and the paper size.
- Duplex Printing appears if the selected printer and media type support duplex printing. Select this checkbox to print on both sides of the paper.
- Automatic appears if you select the Duplex Printing checkbox after selecting a printer that supports automatic duplex printing and media type that supports duplex printing. Select this checkbox to print on both sides of the paper automatically.
- The paper sources may vary depending on the printer and the media type.
- You can set a custom print quality level in the Print Quality Settings dialog box. To display the Print Quality Settings dialog box, select Custom for Print Quality and click Quality Settings....
- You can specify the print range and the amount of extension for borderless printing in the Print Settings dialog box. To display the Print Settings dialog box, click Advanced....

3. Click Print.

 **Note**

-
- See Help for details on the Print Settings screen.
-



[Page top](#)[↕]

Advanced Guide

Advanced Guide > Printing from a Computer > Printing with the Bundled Application Software > Printing Stickers

A050

Easy-PhotoPrint EX

Printing Stickers

You can print your favorite photos on compatible sticker sheets.



Steps

1. Starting Easy-PhotoPrint EX
2. Selecting the Paper and Layout
3. Selecting a Photo
4. Editing
5. Printing

Try This

- ➔ Correcting and Enhancing Photos
- ➔ Creating Still Images from Videos
- ➔ Downloading Images from Photo Sharing Sites
- ➔ Adding Photos
- ➔ Swapping Positions of Photos
- ➔ Replacing Photos
- ➔ Changing Position, Angle and Size of Photos
- ➔ Cropping Photos
- ➔ Printing Dates on Photos
- ➔ Adding Text to Photos
- ➔ Saving
- ➔ Opening Saved Files

Questions and Answers

- ➔ How Can I Move (or Copy) the Saved File?

Advanced Guide

Advanced Guide > Printing from a Computer > Printing with the Bundled Application Software > Printing Stickers > Starting Easy-PhotoPrint EX

A051

Easy-PhotoPrint EX



Starting Easy-PhotoPrint EX

1. From the Start menu, select All Programs > Canon Utilities > Easy-PhotoPrint EX > Easy-PhotoPrint EX.

Easy-PhotoPrint EX starts and Menu appears.

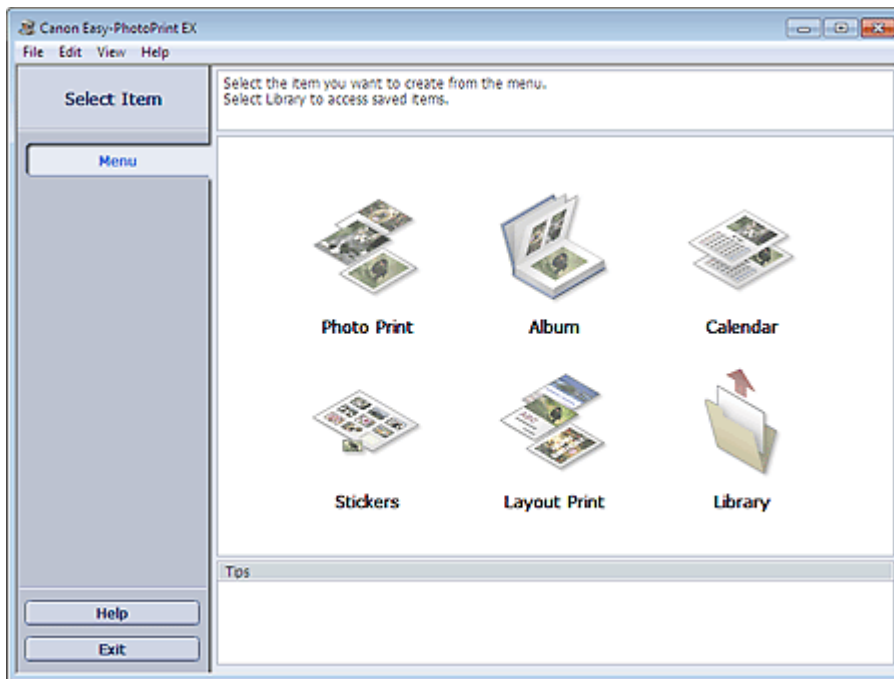

Page top↑

Advanced Guide

Advanced Guide > Printing from a Computer > Printing with the Bundled Application Software > Printing Stickers > Selecting the Paper and Layout

A052

Easy-PhotoPrint EX



Selecting the Paper and Layout

1. Click Stickers from Menu.

The Page Setup screen appears.

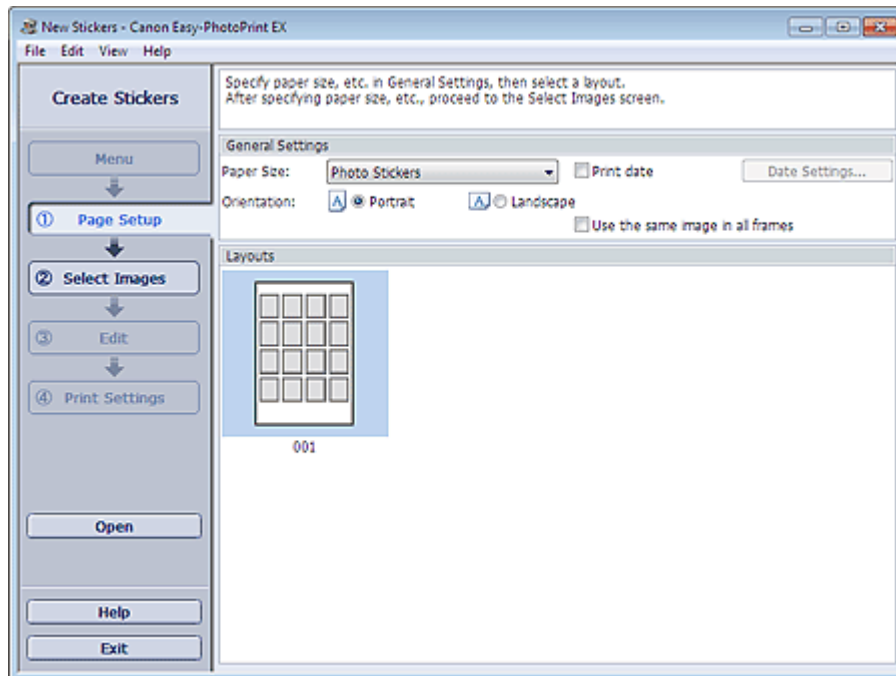

2. Set the following items in the General Settings section:

Paper Size

Orientation

Print date

Use the same image in all frames



Note

- Paper sizes other than Photo Stickers cannot be selected.
- You can customize the date (position, size, color, etc.) in the Date Settings dialog box. To display the Date Settings dialog box, select the Print date checkbox and click Date Settings....
- Select the Use the same image in all frames checkbox to use the same image in all the frames on the page.



Note

- See Help for details on the Page Setup screen.



Advanced Guide

Advanced Guide > Printing from a Computer > Printing with the Bundled Application Software > Printing Stickers > Selecting a Photo

A053

Easy-PhotoPrint EX



Selecting a Photo

1. Click Select Images.

The Select Images screen appears.

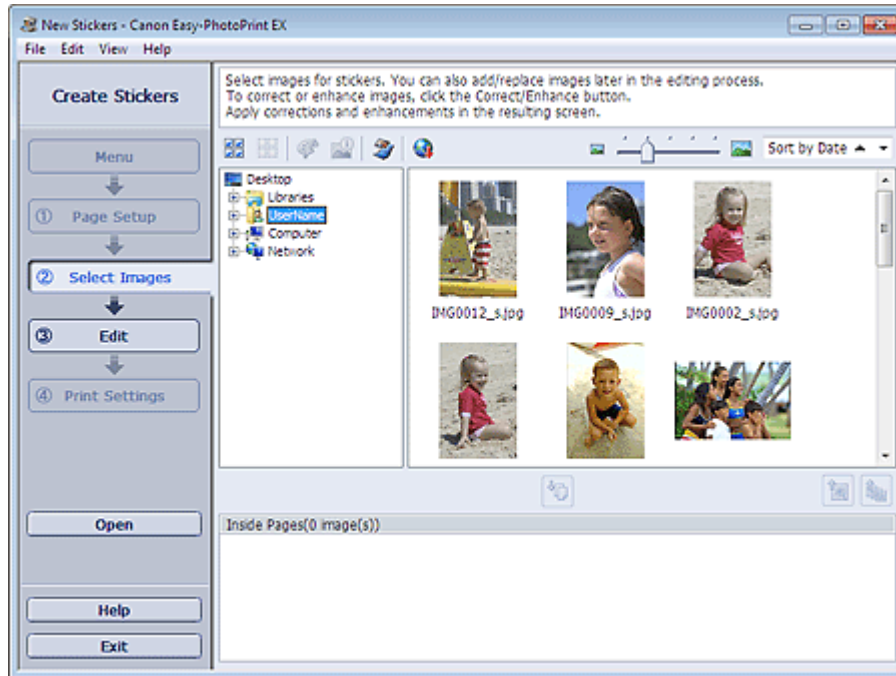

2. Select the folder that contains the image you want to print from the folder tree area.

The images in the folder will be displayed as thumbnails (miniatures).

Note

- You can also use still images captured from videos.
➔ [Creating Still Images from Videos](#)
- You can also use images downloaded from photo sharing sites on the Internet.
➔ [Downloading Images from Photo Sharing Sites](#)

3. Select the image(s) you want to print and click (Import to Inside Pages).

The selected image(s) is (are) displayed in the selected image area.

You can also select the image(s) you want to print by dragging it (them) into the selected image area.

Note

- To delete an image in the selected image area, select the image you want to delete and click



(Delete Imported Image).

To delete all images from the selected image area, click  (Delete All Imported Images).

 **Note**

- You can correct or enhance the selected image before printing.
 - ➔ [Correcting and Enhancing Photos](#)
 - See Help for details on the Select Images screen.
-



[Page top](#) 

Advanced Guide

Advanced Guide > Printing from a Computer > Printing with the Bundled Application Software > Printing Stickers > Editing

A054

Easy-PhotoPrint EX



Editing

1. Click Edit.

The Edit screen appears.

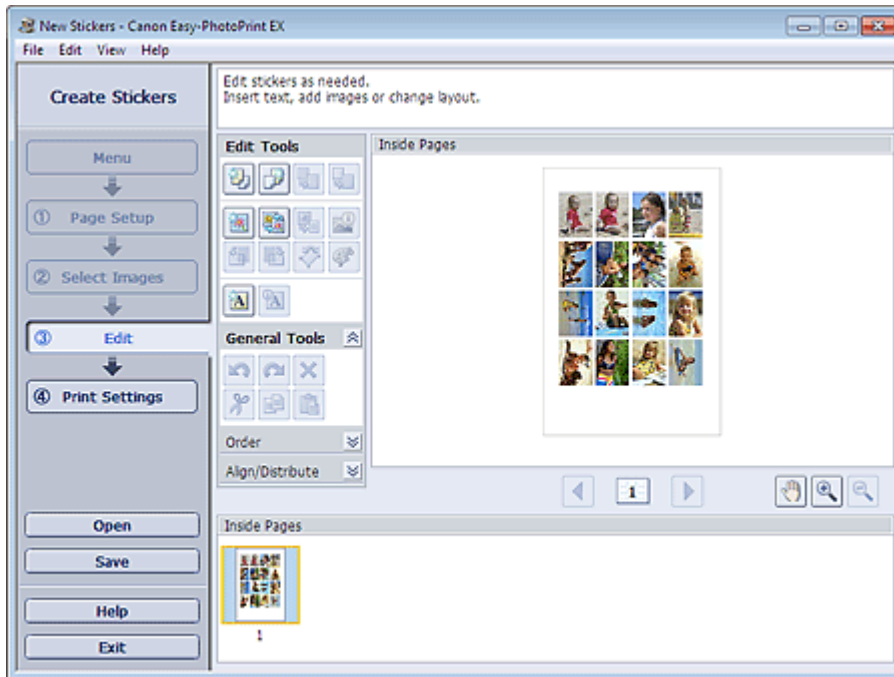

2. Edit the stickers if necessary.

- ➔ Adding Photos
- ➔ Swapping Positions of Photos
- ➔ Replacing Photos
- ➔ Changing Position, Angle and Size of Photos
- ➔ Cropping Photos
- ➔ Printing Dates on Photos
- ➔ Adding Text to Photos

Important

- The edit information will be discarded if you exit Easy-PhotoPrint EX without saving the edited stickers. It is recommended that you save the item if you want to edit it again.
- ➔ Saving

Note

- See Help for details on the Edit screen.



Advanced Guide

Advanced Guide > Printing from a Computer > Printing with the Bundled Application Software > Printing Stickers > Printing

A055

Easy-PhotoPrint EX



Printing

1. Click Print Settings.

The Print Settings screen appears.

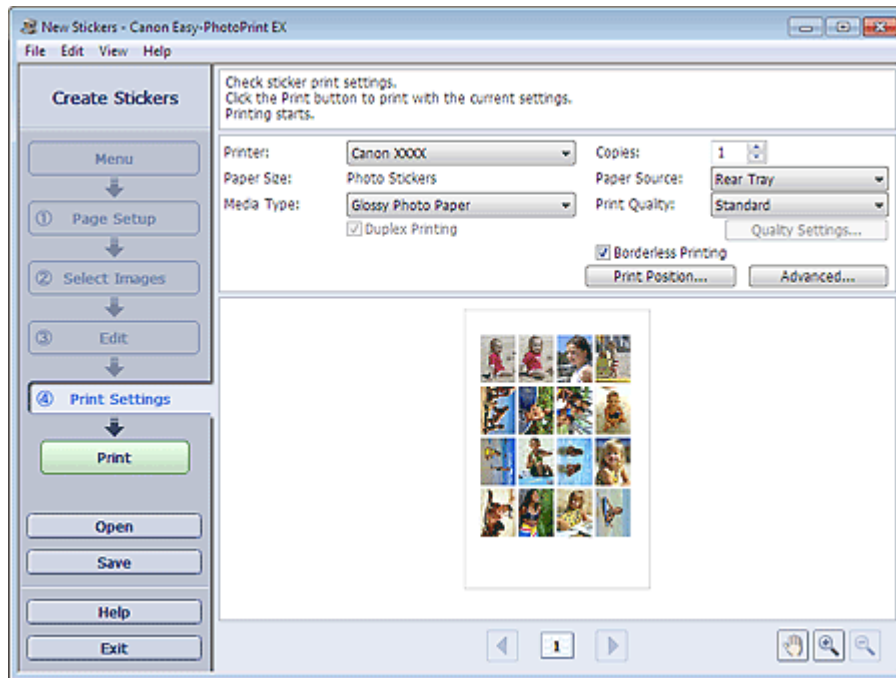

2. Set the following items according to the printer and paper to be used:

- Printer
- Media Type
- Copies
- Paper Source
- Print Quality
- Borderless Printing

Note

- The media types may vary depending on the printer and the paper size.
- The paper sources may vary depending on the printer and the media type.
- You can set a custom print quality level in the Print Quality Settings dialog box. To display the Print Quality Settings dialog box, select Custom for Print Quality and click Quality Settings....
- You can adjust the printing position in the Adjust Print Position dialog box. To display the Adjust Print Position dialog box, click Print Position....
- You can specify the print range and the amount of extension for borderless printing in the Print Settings dialog box. To display the Print Settings dialog box, click Advanced....

3. Click Print.

Note

- See Help for details on the Print Settings screen.
-



[Page top](#) 

Advanced Guide

Advanced Guide > Printing from a Computer > Printing with the Bundled Application Software > Printing Layout

A150

Easy-PhotoPrint EX

Printing Layout

You can add text to your favorite photos and print them in a variety of layouts.



Steps

1. Starting Easy-PhotoPrint EX
2. Selecting the Paper and Layout
3. Selecting a Photo
4. Editing
5. Printing

Try This

- ➔ Correcting and Enhancing Photos
- ➔ Creating Still Images from Videos
- ➔ Downloading Images from Photo Sharing Sites
- ➔ Changing Layout
- ➔ Adding Photos
- ➔ Swapping Positions of Photos
- ➔ Replacing Photos
- ➔ Changing Position, Angle and Size of Photos
- ➔ Cropping Photos
- ➔ Printing Dates on Photos
- ➔ Adding Text to Photos
- ➔ Saving
- ➔ Opening Saved Files

Questions and Answers

➡ How Can I Move (or Copy) the Saved File?

[Page top](#) ↕

Advanced Guide

Advanced Guide > Printing from a Computer > Printing with the Bundled Application Software > Printing Layout > Starting Easy-PhotoPrint EX

A151

Easy-PhotoPrint EX



Starting Easy-PhotoPrint EX

1. From the Start menu, select All Programs > Canon Utilities > Easy-PhotoPrint EX > Easy-PhotoPrint EX.

Easy-PhotoPrint EX starts and Menu appears.

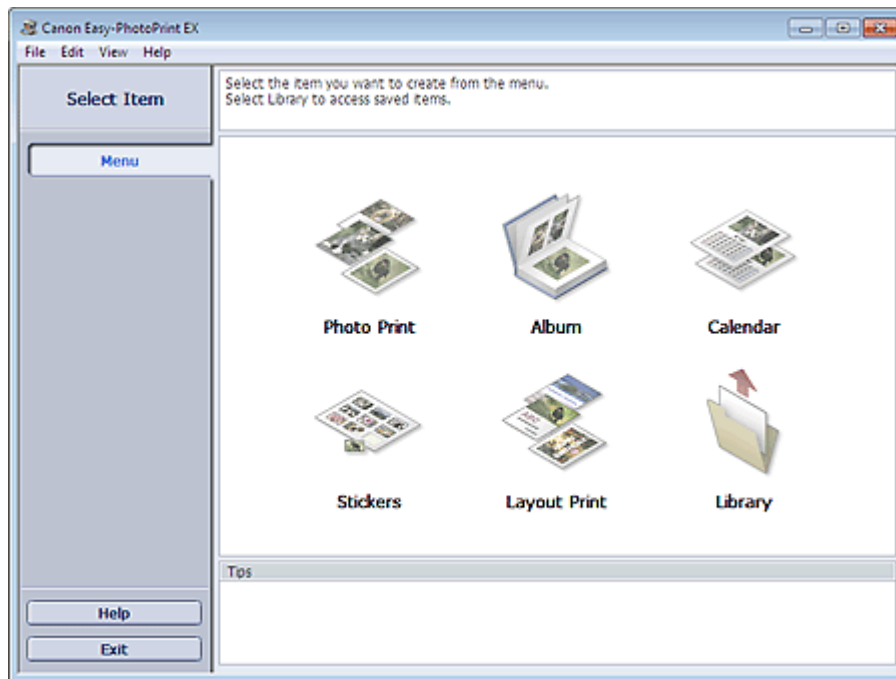

[Page top](#)

Advanced Guide

Advanced Guide > Printing from a Computer > Printing with the Bundled Application Software > Printing Layout > Selecting the Paper and Layout

A152

Easy-PhotoPrint EX



Selecting the Paper and Layout

1. Click Layout Print from Menu.

The Page Setup screen appears.

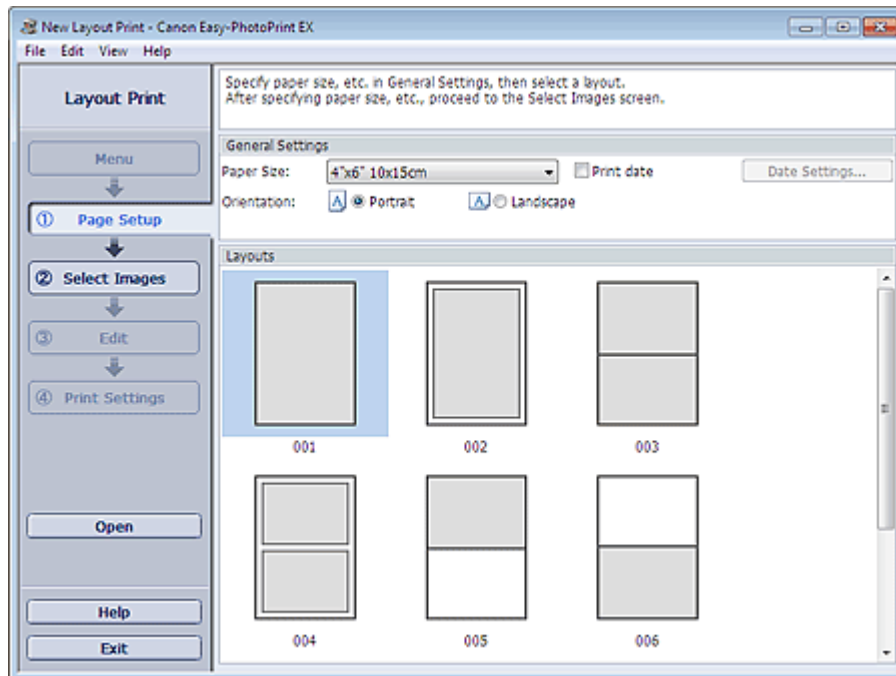

2. Set the following items in the General Settings section:

Paper Size

Orientation

Print date

Note

- See Help on the paper size that can be selected.
- You can customize the date (position, size, color, etc.) in the Date Settings dialog box. To display the Date Settings dialog box, select the Print date checkbox and click Date Settings....

3. Select a layout from Layouts.

Note

- The layouts may vary depending on the Orientation.

Note

- See Help for details on the Page Setup screen.



Advanced Guide

Advanced Guide > Printing from a Computer > Printing with the Bundled Application Software > Printing Layout > Selecting a Photo

A153

Easy-PhotoPrint EX



Selecting a Photo

1. Click Select Images.

The Select Images screen appears.



2. Select the folder that contains the image you want to print from the folder tree area.

The images in the folder will be displayed as thumbnails (miniatures).

Note

- You can also use still images captured from videos.
➔ [Creating Still Images from Videos](#)
- You can also use images downloaded from photo sharing sites on the Internet.
➔ [Downloading Images from Photo Sharing Sites](#)

3. Select the image(s) you want to print and click (Import to Inside Pages).

The selected image(s) is (are) displayed in the selected image area.

You can also select the image(s) you want to print by dragging it (them) into the selected image area.

Note

- To delete an image in the selected image area, select the image you want to delete and click



(Delete Imported Image).

To delete all images from the selected image area, click  (Delete All Imported Images).

 **Note**

- You can correct or enhance the selected image before printing.
 - ➔ [Correcting and Enhancing Photos](#)
 - See Help for details on the Select Images screen.
-



[Page top](#) 

Advanced Guide

Advanced Guide > Printing from a Computer > Printing with the Bundled Application Software > Printing Layout > Editing

A154

Easy-PhotoPrint EX



Editing

1. Click Edit.

The Edit screen appears.

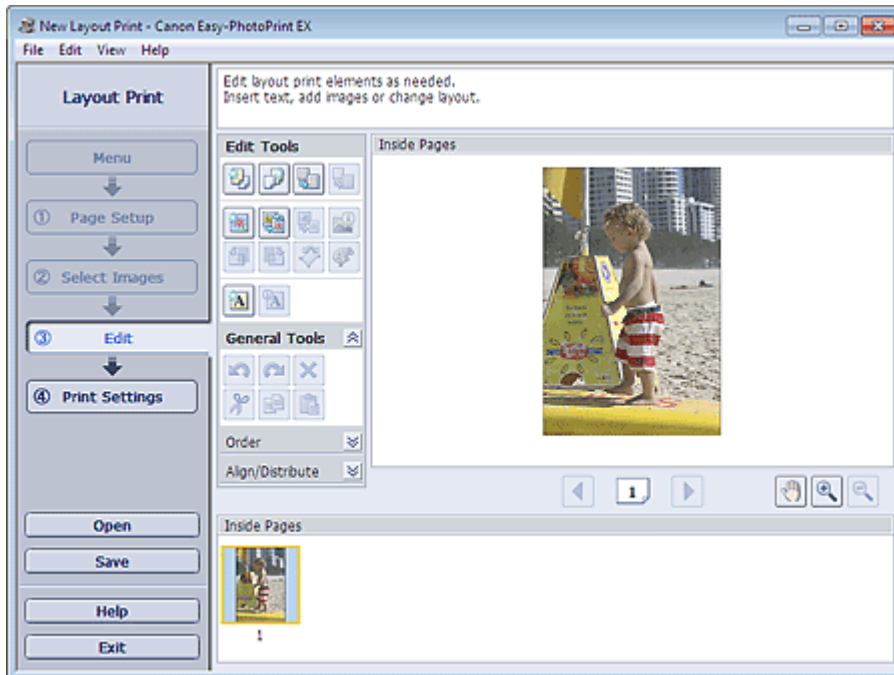

2. Edit the layout if necessary.

- ➔ Changing Layout
- ➔ Adding Photos
- ➔ Swapping Positions of Photos
- ➔ Replacing Photos
- ➔ Changing Position, Angle and Size of Photos
- ➔ Cropping Photos
- ➔ Printing Dates on Photos
- ➔ Adding Text to Photos

Important

- The edit information will be discarded if you exit Easy-PhotoPrint EX without saving the edited layout. It is recommended that you save the item if you want to edit it again.
 - ➔ Saving

Note

- See Help for details on the Edit screen.



Advanced Guide

Advanced Guide > Printing from a Computer > Printing with the Bundled Application Software > Printing Layout > Printing

A155

Easy-PhotoPrint EX



Printing

1. Click Print Settings.

The Print Settings screen appears.

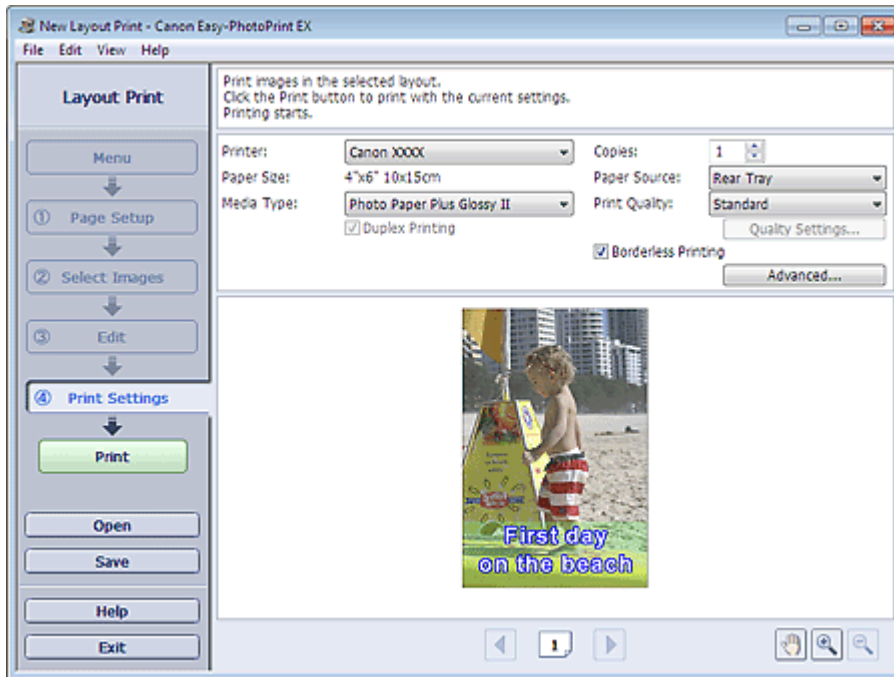

2. Set the following items according to the printer and paper to be used:

Printer

Media Type

Copies

Paper Source

Print Quality

Borderless Printing

Note

- The media types may vary depending on the printer and the paper size.
- Duplex Printing appears if the selected printer and media type support duplex printing. Select this checkbox to print on both sides of the paper.
- Automatic appears if you select the Duplex Printing checkbox after selecting a printer that supports automatic duplex printing and media type that supports duplex printing. Select this checkbox to print on both sides of the paper automatically.
- The paper sources may vary depending on the printer and the media type.
- You can set a custom print quality level in the Print Quality Settings dialog box. To display the Print Quality Settings dialog box, select Custom for Print Quality and click Quality Settings....
- Select the Borderless Printing checkbox to print borderless photos.
- You can specify the print range and the amount of extension for borderless printing in the Print Settings dialog box. To display the Print Settings dialog box, click Advanced....

3. Click Print.

 **Note**

-
- See Help for details on the Print Settings screen.
-



[Page top](#)[↕]

Advanced Guide

Advanced Guide > Printing from a Computer > Printing with the Bundled Application Software > Correcting and Enhancing Photos

A060

Easy-PhotoPrint EX

Correcting and Enhancing Photos

You can correct and enhance images.

Click  (Correct/Enhance Images) in the Select Images or Edit screen, or in the Layout/Print screen of Photo Print. You can make the following corrections and enhancements in the Correct/Enhance Images window.

Important

- For Photo Print, if you select Enable ICC Profile in the Advanced tab of the Preferences dialog box, you cannot correct/enhance images.

Note

- See "[Correct/Enhance Images Window](#)" for details on the Correct/Enhance Images window.

Auto Photo Fix

This function will automatically analyze the captured scene and apply suitable corrections.

➡ [Using the Auto Photo Fix Function](#)

Red-Eye Correction Function

You can correct red eyes caused by a camera flash.

➡ [Using the Red-Eye Correction Function](#)

Face Brightener Function

You can brighten dark faces caused by bright background.

➡ [Using the Face Brightener Function](#)

Face Sharpener Function

You can sharpen out-of-focus faces in a photo.

➡ [Using the Face Sharpener Function](#)

Digital Face Smoothing Function

You can enhance skin beautifully by removing blemishes and wrinkles.

➡ [Using the Digital Face Smoothing Function](#)

Blemish Remover Function

You can remove moles.

➡ [Using the Blemish Remover Function](#)

Image Adjustment

You can adjust brightness and contrast or sharpen the entire image.

You can also blur the outline of the subjects or remove the base color.

[➡ Adjusting Images](#)

[Page top](#) ↕

Advanced Guide

Advanced Guide > Printing from a Computer > Printing with the Bundled Application Software > Correcting and Enhancing Photos > Using the Auto Photo Fix Function

A066

Easy-PhotoPrint EX

Using the Auto Photo Fix Function

This function will automatically analyze the captured scene and apply suitable corrections.

Important

- The Auto Photo Fix function is not available for Photo Print. Photo Print allows you to automatically apply suitable corrections to all photos when printing, by selecting Enable Auto Photo Fix in Color correction for printing on the Advanced tab of the Preferences dialog box.

To display the Preferences dialog box, click  (Settings) in the Layout/Print screen or select Preferences... from the File menu.

- Once image is corrected with Auto Photo Fix and saved, it cannot be corrected again with Auto Photo Fix.

Also, Auto Photo Fix may not be available for images edited using an application, digital camera, etc. manufactured by other companies.

1. Select photos in the Select Images screen, then click  (Correct/Enhance Images).

The Correct/Enhance Images window appears.

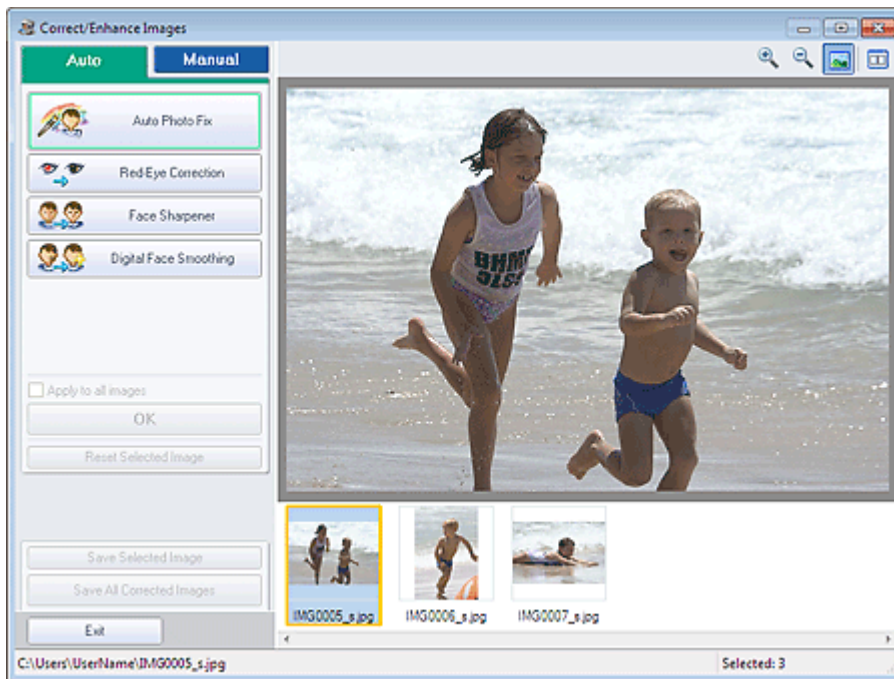

Note

- You can also display the Correct/Enhance Images window by clicking  (Correct/Enhance Images) in the Layout/Print or Edit screen. In that case, only the image displayed in Preview can be corrected/enhanced.
- See "[Correct/Enhance Images Window](#)" for details on the Correct/Enhance Images window.

2. Select the image you want to correct from the thumbnail list in the Correct/Enhance Images window.

The image appears in Preview.

Note

- If only one image is selected, the thumbnail list does not appear below Preview.
-

3. Make sure that Auto is selected.

4. Click Auto Photo Fix, then click OK.

The entire photo is corrected automatically and the  (Correction/Enhancement) mark appears on the upper left of the image.

Note

- Click  (Compare) to display the images before and after the correction side by side so that you can compare and check the result.
 - Click Reset Selected Image to undo the correction operation.
 - If you want to apply the correction to all the selected images at once, select the Apply to all images checkbox.
 - Select the Prioritize Exif Info checkbox to apply corrections primarily based on the settings made at the time of shooting.
Deselect this checkbox to apply corrections based on the image analysis results. It is recommended that you normally select this setting.
-

5. Click Save Selected Image or Save All Corrected Images.

You can save corrected images as new files.

Note

- To save only the image you like, click Save Selected Image. To save all images, click Save All Corrected Images.
 - Only JPEG/Exif data format is available for corrected images.
-

6. Click Exit.

Important

- The corrections will be lost if you exit before saving corrected images.
-

Advanced Guide

Advanced Guide > Printing from a Computer > Printing with the Bundled Application Software > Correcting and Enhancing Photos > Using the Red-Eye Correction Function

A061

Easy-PhotoPrint EX

Using the Red-Eye Correction Function

You can correct red eyes caused by a camera flash.

You can perform the Red-Eye Correction function either automatically or manually.

Note

- Photo Print allows you to automatically correct red eyes when printing. To correct automatically, select Enable Auto Photo Fix in Color correction for printing on the Advanced tab of the Preferences dialog box and select the Enable Red-Eye Correction checkbox.

- Select photos in the Select Images screen, then click  (Correct/Enhance Images).

The Correct/Enhance Images window appears.

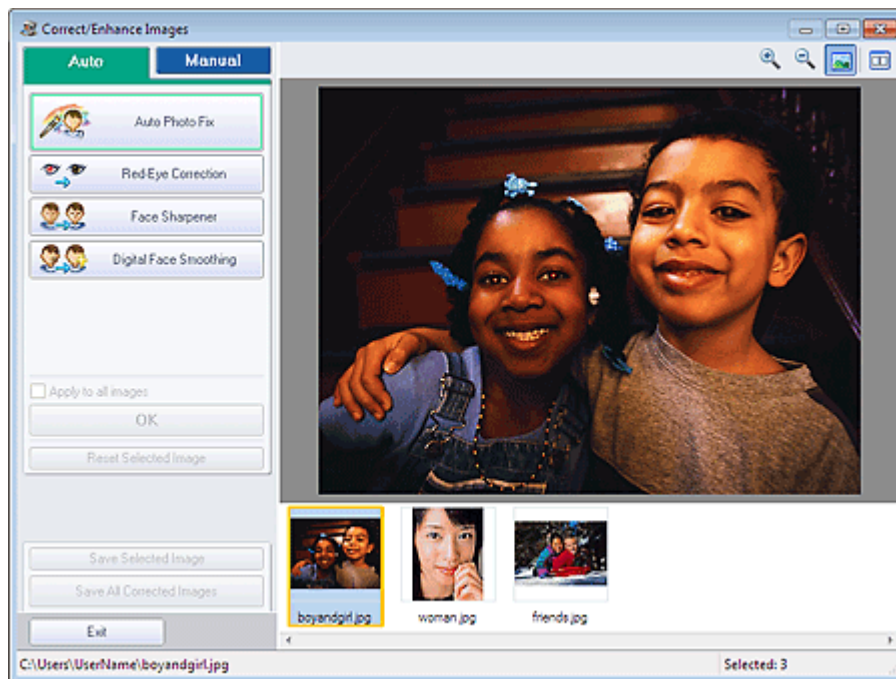

Note

- You can also display the Correct/Enhance Images window by clicking  (Correct/Enhance Images) in the Layout/Print or Edit screen. In that case, only the image displayed in Preview can be corrected/enhanced.
- See "[Correct/Enhance Images Window](#)" for details on the Correct/Enhance Images window.

- Select the image you want to correct from the thumbnail list in the Correct/Enhance Images window.

The image appears in Preview.

Note

- If only one image is selected, the thumbnail list does not appear below Preview.

Auto Correction

3. Make sure that Auto is selected.
4. Click Red-Eye Correction.
5. Click OK.

Red eyes are corrected and the  (Correction/Enhancement) mark appears on the upper left of the image.

Important

- Areas other than the eyes may be corrected depending on the image.

Note

- Click  (Compare) to display the images before and after the correction side by side so that you can compare and check the result.
- Click Reset Selected Image to undo the correction operation.
- If you want to apply the correction to all the selected images at once, select the Apply to all images checkbox.

Manual Correction

3. Click Manual, then click Correct/Enhance.
4. Click Red-Eye Correction.



Note

- Effect levels can be changed using the slider below Red-Eye Correction.
- Move the cursor over the image. The shape of the cursor changes to  (Paintbrush).

5. Drag to select the red area you want to correct, then click OK that appears over the image.

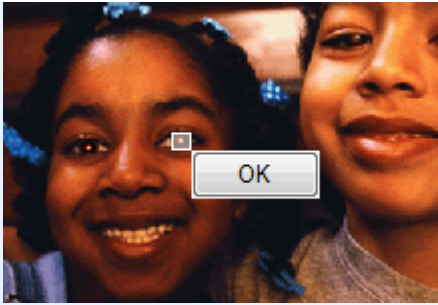

Red eye is corrected and the  (Correction/Enhancement) mark appears on the upper left of the image.

Note

- Click  (Compare) to display the images before and after the correction side by side so that you can compare and check the result.
- Click Undo to undo the preceding correction operation.

6. Click Save Selected Image or Save All Corrected Images.

You can save corrected images as new files.

Note

- To save only the image you like, click Save Selected Image. To save all images, click Save All Corrected Images.
- Only JPEG/Exif data format is available for corrected images.

7. Click Exit.

Important

- The corrections will be lost if you exit before saving corrected images.

Advanced Guide

Advanced Guide > Printing from a Computer > Printing with the Bundled Application Software > Correcting and Enhancing Photos > Using the Face Brightener Function

A062

Easy-PhotoPrint EX

Using the Face Brightener Function

You can brighten dark faces caused by bright background.

Note

- You can brighten dark photos caused by bright background automatically by selecting Auto Photo Fix. If the correction had not been made sufficiently, applying Face Brightener function is recommended.
 - ➔ [Using the Auto Photo Fix Function](#)

- Select photos in the Select Images screen, then click  (Correct/Enhance Images).

The Correct/Enhance Images window appears.

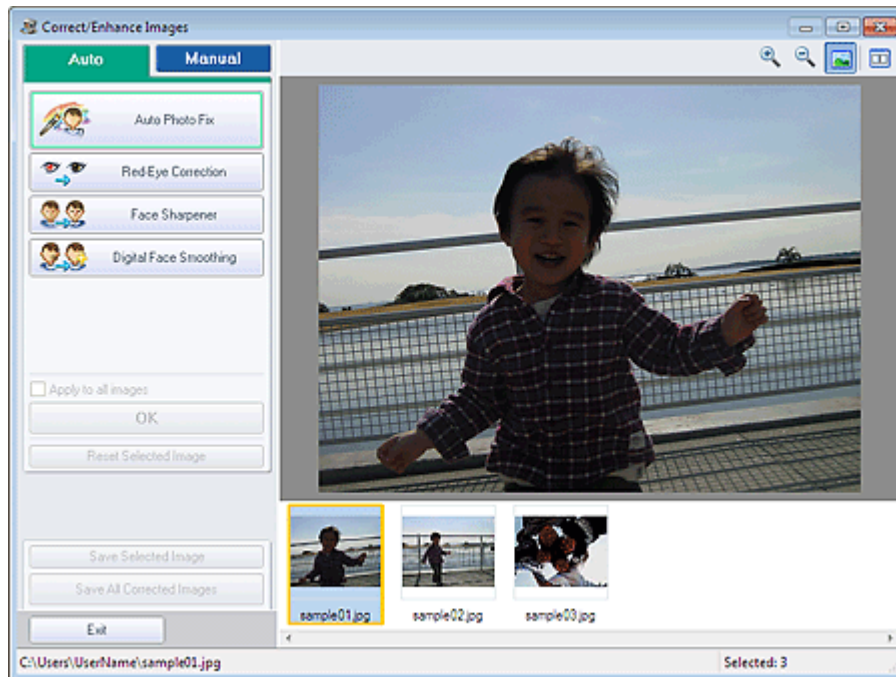

Note

- You can also display the Correct/Enhance Images window by clicking  (Correct/Enhance Images) in the Layout/Print or Edit screen. In that case, only the image displayed in Preview can be corrected/enhanced.
- See "[Correct/Enhance Images Window](#)" for details on the Correct/Enhance Images window.

- Select the image you want to correct from the thumbnail list in the Correct/Enhance Images window.

The image appears in Preview.

Note

- If only one image is selected, the thumbnail list does not appear below Preview.

3. Click Manual, then click Correct/Enhance.

4. Click Face Brightener.



Note

- Effect levels can be changed using the slider below Face Brightener.
- Move the cursor over the image. The shape of the cursor changes to **+** (Cross).

5. Drag to select the area you want to correct, then click OK that appears over the image.

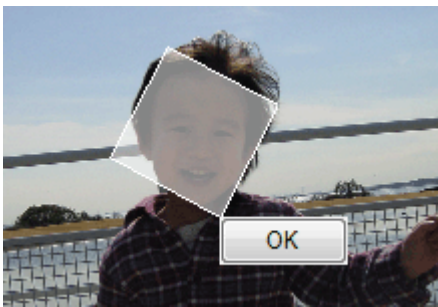

The entire image is corrected so that the selected area containing the face becomes brighter, and the  (Correction/Enhancement) mark appears on the upper left of the image.

Note

- You can also drag to rotate the selected area.
- Click  (Compare) to display the images before and after the correction side by side so that you can compare and check the result.
- Click Undo to undo the preceding correction operation.

6. Click Save Selected Image or Save All Corrected Images.

You can save corrected images as new files.

Note

- To save only the image you like, click Save Selected Image. To save all images, click Save All Corrected Images.
- Only JPEG/Exif data format is available for corrected images.

7. Click Exit.

 **Important**

- The corrections will be lost if you exit before saving corrected images.

[Page top](#) 

Advanced Guide

Advanced Guide > Printing from a Computer > Printing with the Bundled Application Software > Correcting and Enhancing Photos > Using the Face Sharpener Function

A063

Easy-PhotoPrint EX

Using the Face Sharpener Function

You can sharpen out-of-focus faces in a photo.

You can perform the Face Sharpener function either automatically or manually.

1. Select photos in the Select Images screen, then click  (Correct/Enhance Images).

The Correct/Enhance Images window appears.

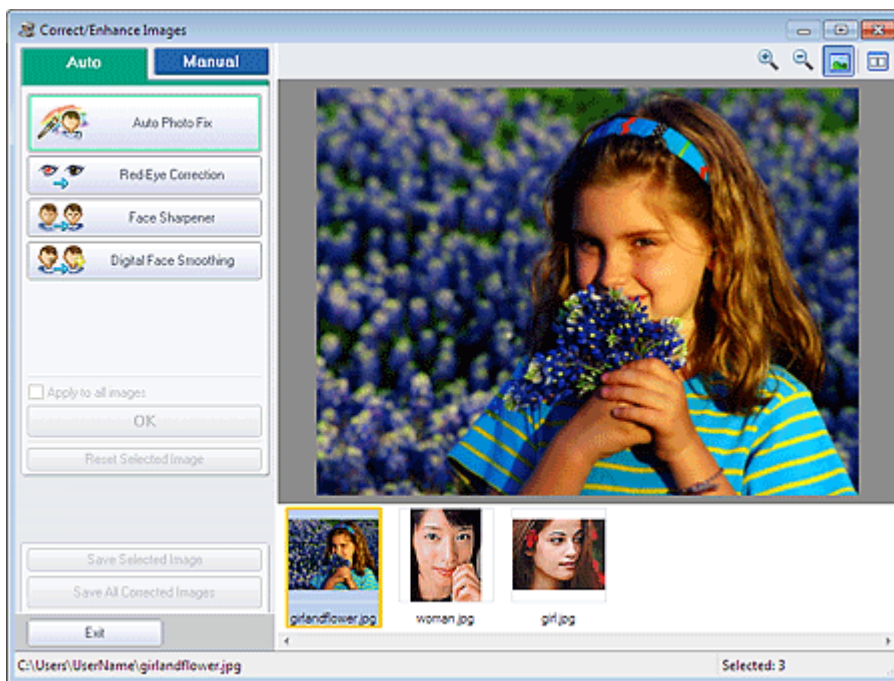

Note

- You can also display the Correct/Enhance Images window by clicking  (Correct/Enhance Images) in the Layout/Print or Edit screen. In that case, only the image displayed in Preview can be corrected/enhanced.
- See "[Correct/Enhance Images Window](#)" for details on the Correct/Enhance Images window.

2. Select the image you want to correct from the thumbnail list in the Correct/Enhance Images window.

The image appears in Preview.

Note

- If only one image is selected, the thumbnail list does not appear below Preview.

Auto Correction

3. Make sure that Auto is selected.

4. Click Face Sharpener. **Note**

- Effect levels can be changed using the slider below Face Sharpener.

5. Click OK.

The face is sharpened and the  (Correction/Enhancement) mark appears on the upper left of the image.

 **Note**

- Click  (Compare) to display the images before and after the correction side by side so that you can compare and check the result.
- Click Reset Selected Image to undo the correction operation.
- If you want to apply the correction to all the selected images at once, select the Apply to all images checkbox.

Manual Correction**3.** Click Manual, then click Correct/Enhance.**4.** Click Face Sharpener. **Note**

- Effect levels can be changed using the slider below Face Sharpener.
- Move the cursor over the image. The shape of the cursor changes to  (Cross).

5. Drag to select the area you want to correct, then click OK that appears over the image.

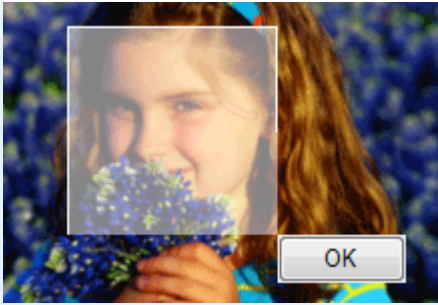

The facial area in and around the selected area is sharpened and the  (Correction/Enhancement) mark appears on the upper left of the image.

Note

- You can also drag to rotate the selected area.
- Click  (Compare) to display the images before and after the correction side by side so that you can compare and check the result.
- Click Undo to undo the preceding correction operation.

6. Click Save Selected Image or Save All Corrected Images.

You can save corrected images as new files.

Note

- To save only the image you like, click Save Selected Image. To save all images, click Save All Corrected Images.
- Only JPEG/Exif data format is available for corrected images.

7. Click Exit.

Important

- The corrections will be lost if you exit before saving corrected images.

Advanced Guide

Advanced Guide > Printing from a Computer > Printing with the Bundled Application Software > Correcting and Enhancing Photos > Using the Digital Face Smoothing Function

A064

Easy-PhotoPrint EX

Using the Digital Face Smoothing Function

You can enhance skin beautifully by removing blemishes and wrinkles.

You can perform the Digital Face Smoothing function either automatically or manually.

1. Select photos in the Select Images screen, then click  (Correct/Enhance Images).

The Correct/Enhance Images window appears.



Note

- You can also display the Correct/Enhance Images window by clicking  (Correct/Enhance Images) in the Layout/Print or Edit screen. In that case, only the image displayed in Preview can be corrected/enhanced.
- See "[Correct/Enhance Images Window](#)" for details on the Correct/Enhance Images window.

2. Select the image you want to enhance from the thumbnail list in the Correct/Enhance Images window.

The image appears in Preview.

Note

- If only one image is selected, the thumbnail list does not appear below Preview.

Auto Enhancement

3. Make sure that Auto is selected.

4. Click Digital Face Smoothing.

Note

- Effect levels can be changed using the slider below Digital Face Smoothing.

5. Click OK.

Skin is enhanced beautifully and the  (Correction/Enhancement) mark appears on the upper left of the image.

Note

- Click  (Compare) to display the images before and after the enhancement side by side so that you can compare and check the result.
- Click Reset Selected Image to undo the enhancement operation.
- If you want to apply the enhancement to all the selected images at once, select the Apply to all images checkbox.

Manual Enhancement

3. Click Manual, then click Correct/Enhance.

4. Click Digital Face Smoothing.

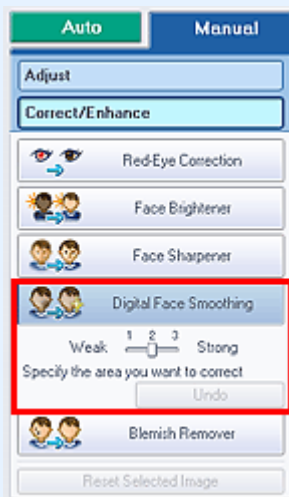

Note

- Effect levels can be changed using the slider below Digital Face Smoothing.
- Move the cursor over the image. The shape of the cursor changes to  (Cross).

5. Drag to select the area you want to enhance, then click OK that appears over the image.



Skin in and around the selected area is enhanced beautifully and the  (Correction/Enhancement) mark appears on the upper left of the image.

Note

- You can also drag to rotate the selected area.
- Click  (Compare) to display the images before and after the enhancement side by side so that you can compare and check the result.
- Click Undo to undo the preceding enhancement operation.

6. Click Save Selected Image or Save All Corrected Images.

You can save enhanced images as new files.

Note

- To save only the image you like, click Save Selected Image. To save all images, click Save All Corrected Images.
- Only JPEG/Exif data format is available for enhanced images.

7. Click Exit.

Important

- The enhancements will be lost if you exit before saving enhanced images.

Advanced Guide

Advanced Guide > Printing from a Computer > Printing with the Bundled Application Software > Correcting and Enhancing Photos > Using the Blemish Remover Function

A065

Easy-PhotoPrint EX

Using the Blemish Remover Function

You can remove moles.

1. Select photos in the Select Images screen, then click  (Correct/Enhance Images).

The Correct/Enhance Images window appears.

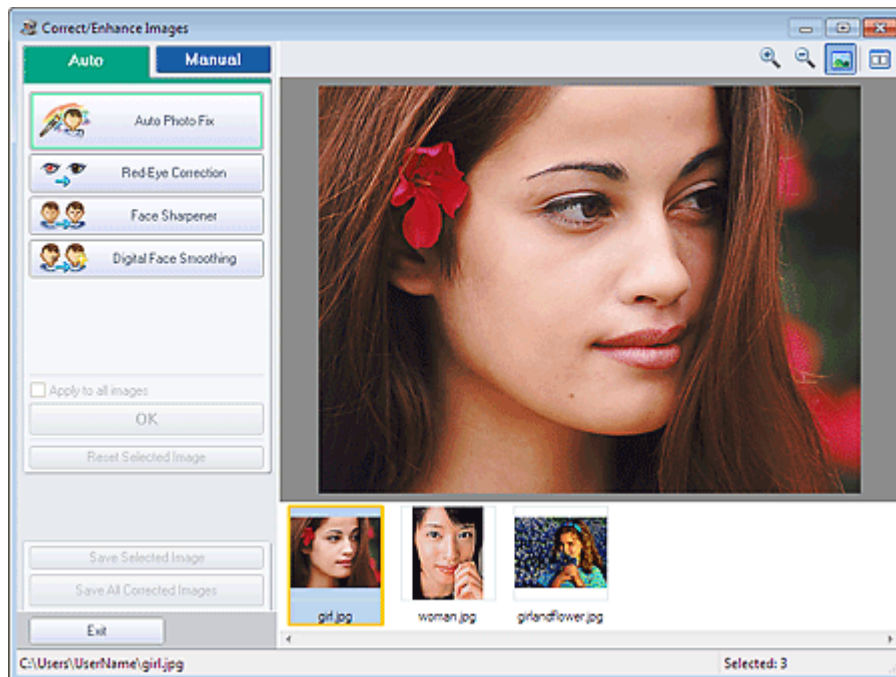

Note

- You can also display the Correct/Enhance Images window by clicking  (Correct/Enhance Images) in the Layout/Print or Edit screen. In that case, only the image displayed in Preview can be corrected/enhanced.
- See "[Correct/Enhance Images Window](#)" for details on the Correct/Enhance Images window.

2. Select the image you want to enhance from the thumbnail list in the Correct/Enhance Images window.

The image appears in Preview.

Note

- If only one image is selected, the thumbnail list does not appear below Preview.

3. Click Manual, then click Correct/Enhance.
4. Click Blemish Remover.



Note

- Move the cursor over the image. The shape of the cursor changes to **+** (Cross).

- Drag to select the area you want to enhance, then click OK that appears over the image.

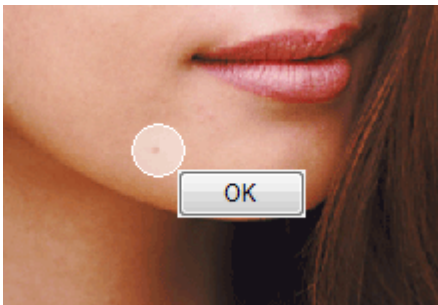

Moles in and around the selected area are removed and the  (Correction/Enhancement) mark appears on the upper left of the image.

Note

- Click  (Compare) to display the images before and after the enhancement side by side so that you can compare and check the result.
- Click Undo to undo the preceding enhancement operation.

- Click Save Selected Image or Save All Corrected Images.

You can save enhanced images as new files.

Note

- To save only the image you like, click Save Selected Image. To save all images, click Save All Corrected Images.
- Only JPEG/Exif data format is available for enhanced images.

- Click Exit.

Important

- The enhancements will be lost if you exit before saving enhanced images.

Advanced Guide

Advanced Guide > Printing from a Computer > Printing with the Bundled Application Software > Correcting and Enhancing Photos > Adjusting Images

A067

Easy-PhotoPrint EX

Adjusting Images

You can make fine adjustments to the overall brightness, contrast, etc. of images.

1. Select photos in the Select Images screen, then click  (Correct/Enhance Images).

The Correct/Enhance Images window appears.

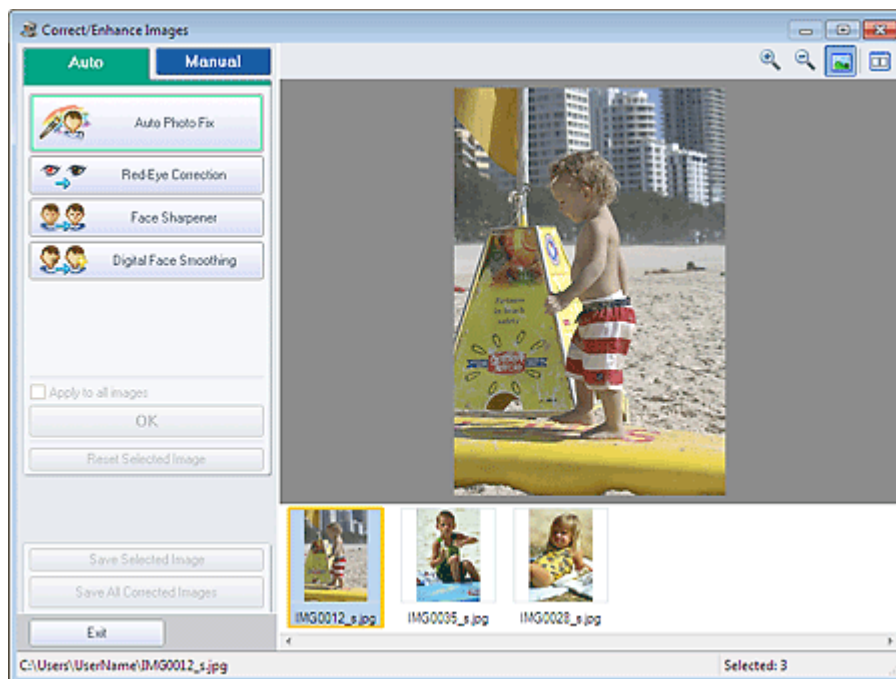

Note

- You can also display the Correct/Enhance Images window by clicking  (Correct/Enhance Images) in the Layout/Print or Edit screen. In that case, only the image displayed in Preview can be adjusted.
- See "[Correct/Enhance Images Window](#)" for details on the Correct/Enhance Images window.

2. Select the image you want to adjust from the thumbnail list in the Correct/Enhance Images window.

The image appears in Preview.

Note

- If only one image is selected, the thumbnail list does not appear below Preview.

3. Click Manual, then click Adjust.
4. Move the slider of the item you want to adjust and set the effect level.

The following adjustments are available:

Brightness

Contrast
Sharpness
Blur
Show-through Removal

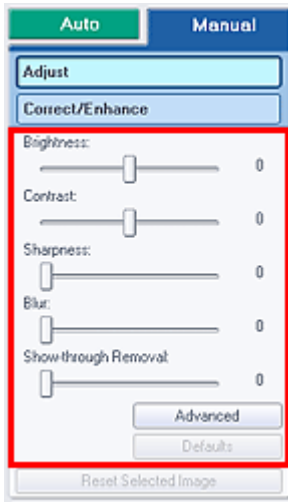

Note

- Click  (Compare) to display the images before and after the adjustment side by side so that you can compare and check the result.
- Click Advanced to make fine adjustments to the image brightness and color tone. See "[Advanced](#)" in the descriptions of the Correct/Enhance Images window for details.
- Click Defaults to reset all adjustments.

5. Click Save Selected Image or Save All Corrected Images.

You can save adjusted images as new files.

Note

- To save only the image you like, click Save Selected Image. To save all images, click Save All Corrected Images.
- Only JPEG/Exif data format is available for adjusted images.

6. Click Exit.

Important

- The adjustments will be lost if you exit before saving adjusted images.

Advanced Guide

Advanced Guide > Printing from a Computer > Printing with the Bundled Application Software > Correcting and Enhancing Photos > Correct/Enhance Images Window

A068

Easy-PhotoPrint EX

Correct/Enhance Images Window

You can correct/enhance images in this window.

To display the Correct/Enhance Images window, click  (Correct/Enhance Images) in the Select Images or Edit screen, or in the Layout/Print screen of Photo Print.

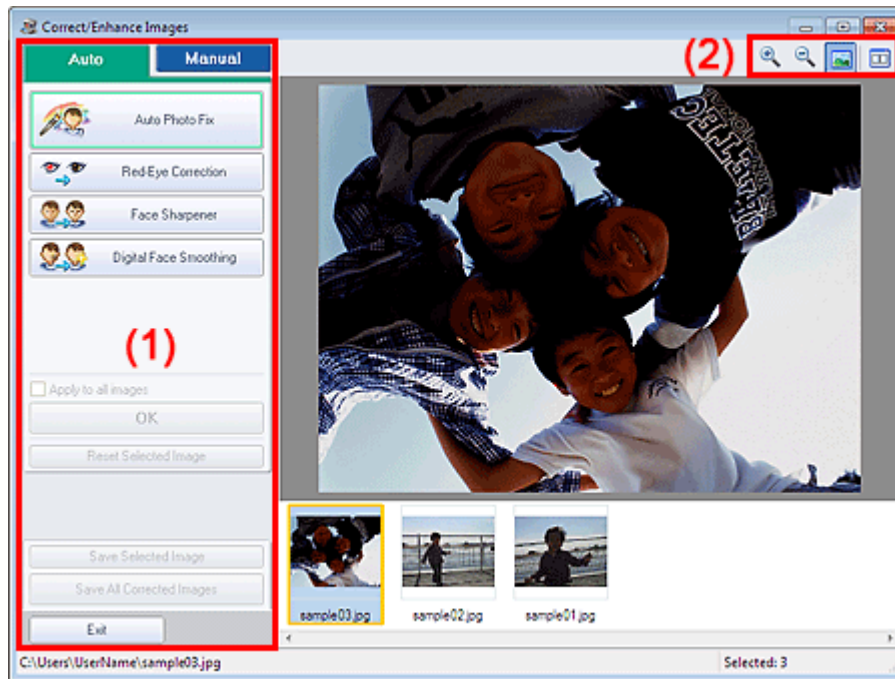

(1) Task Area

(2) Toolbar

(1) Task Area

Available tasks and settings may vary between the Auto and Manual tabs.

Click the Auto or Manual tab to display the corresponding tab.

Auto Tab

Use the functions in the Auto tab to apply corrections and enhancements to the entire image.

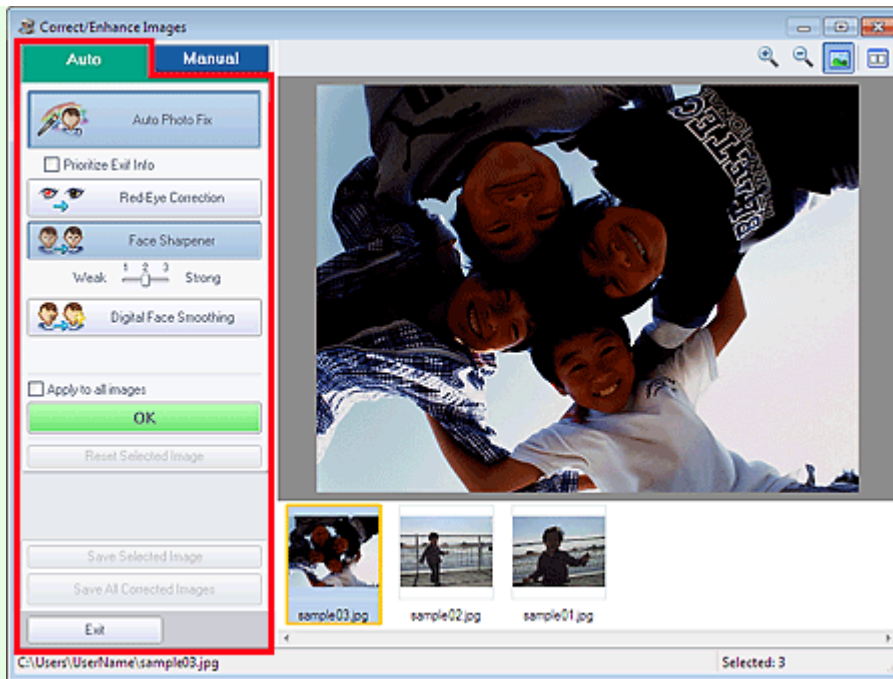

Auto Photo Fix

Applies automatic corrections suitable for photos.

Important

- The Auto Photo Fix function is not available for Photo Print. Photo Print allows you to automatically apply suitable corrections to all photos when printing, by selecting Enable Auto Photo Fix in Color correction for printing on the Advanced tab of the Preferences dialog box.

To display the Preferences dialog box, click  (Settings) in the Layout/Print screen or select Preferences... from the File menu.

Prioritize Exif Info

Select this checkbox to apply corrections primarily based on the settings made at the time of shooting.

Deselect this checkbox to apply corrections based on the image analysis results. It is recommended that you normally select this setting.

Note

- Exif is a standard format for embedding various shooting data in digital camera images (JPEG).
- For Photo Print, you can apply suitable corrections based on Exif information automatically by selecting Enable Auto Photo Fix in Color correction for printing on the Advanced tab of the Preferences dialog box and selecting the Prioritize Exif Info checkbox.

Red-Eye Correction

Corrects red eyes.

Note

- For Photo Print, you can also automatically correct red eyes by selecting Enable Auto Photo Fix in Color correction for printing on the Advanced tab of the Preferences dialog box and selecting the Enable Red-Eye Correction checkbox.

Face Sharpener

Sharpens out-of-focus faces.

You can adjust the effect level using the slider.

Digital Face Smoothing

Enhances skin beautifully by removing blemishes and wrinkles.

You can adjust the effect level using the slider.

Apply to all images

Automatically corrects/enhances all images displayed in the thumbnail list.

OK

Applies the selected effect to the selected image or all images.

Reset Selected Image

Cancels all corrections and enhancements applied to the selected image.

Save Selected Image

Saves the corrected/enhanced image (the selected one).

Save All Corrected Images

Saves all the corrected/enhanced images displayed in the thumbnail list.

Exit

Click to close the Correct/Enhance Images window.

Manual Tab

There are two menus on the Manual tab: Adjust and Correct/Enhance.

Use Adjust to adjust brightness and contrast, or to sharpen the entire image.

Use Correct/Enhance to correct/enhance specific areas.

Adjust

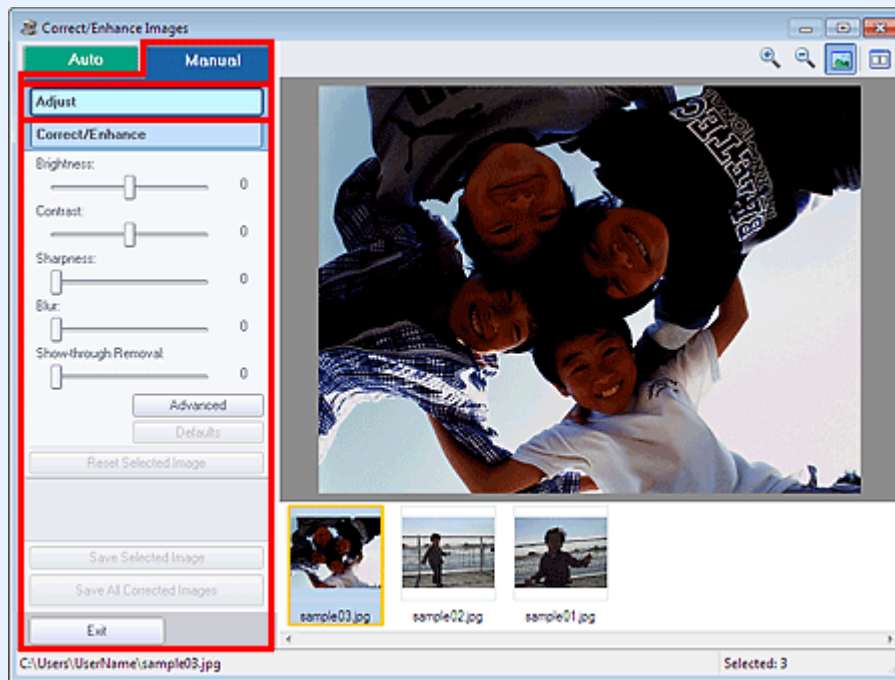

Brightness

Adjusts the overall image brightness.

Move the slider to the left to darken and right to brighten the image.

Contrast

Adjusts the contrast of the image. Adjust the contrast when the image is flat due to lack of contrast.

Move the slider to the left to decrease and right to increase the contrast of the image.

Sharpness

Emphasizes the outline of the subjects to sharpen the image. Adjust the sharpness when the photo is out of focus or text is blurred.

Move the slider to the right to sharpen the image.

Blur

Blurs the outline of the subjects to soften the image.

Move the slider to the right to soften the image.

Show-through Removal

Removes show-through of text from the reverse side or removes the base color. Adjust the show-through level to prevent text on the reverse side of thin document or the base color of the document from appearing on the image.

Move the slider to the right to increase the show-through removal effect.

Advanced

Opens the Advanced Adjustment dialog box in which you can make fine adjustments to the image brightness and color tone.

For Brightness/Contrast and Tone, select a color in Channel to adjust either Red, Green or Blue, or select Master to adjust three colors together.

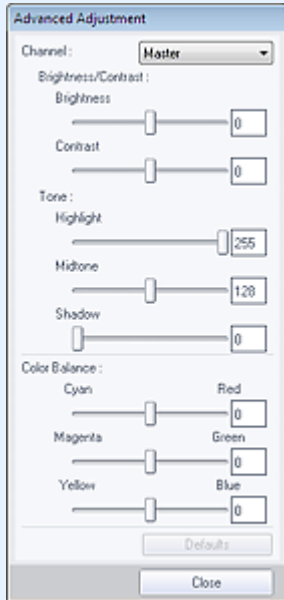

Brightness/Contrast

Adjust the brightness and contrast of the image.

Move the Brightness slider to the left to darken and right to brighten the image.

Move the Contrast slider to the left to decrease and right to increase the contrast of the image.

Tone

Adjust the brightness balance by specifying Highlight (the brightest level), Shadow (the darkest level) and Midtone (the color in the middle of Highlight and Shadow).

Move the Highlight slider to the left to brighten the image.

Move the Midtone slider to the left to brighten and right to darken the image.

Move the Shadow slider to the right to darken the image.

Color Balance

Adjust the vividness and color tone of the image.

Move the Color Balance slider to the left or right to emphasize the corresponding color.



Note

- These are complementary color pairs (each pair produces a shade of gray when mixed). You can reproduce the natural colors of the scene by reducing the cast color and increasing the complementary color. Colorcast is a phenomenon where a specific color affects the entire picture due to the weather or ambient strong colors.
- It is usually difficult to correct the image completely by adjusting only one color pair. It is recommended that you find a portion in the image where it should be white, and adjust all three color pairs so that the portion turns white.

Defaults

Resets all adjustments.

Close

Closes the Advanced Adjustment dialog box.



Note

- The Brightness and Contrast values set in Adjust do not change even if the brightness and

color tone are adjusted in the Advanced Adjustment dialog box.

Defaults

Resets each adjustment (brightness, contrast, sharpness, blur, and show-through removal).

Reset Selected Image

Cancels all corrections, enhancements and adjustments applied to the selected image.

Save Selected Image

Saves the corrected/enhanced/adjusted image (the selected one).

Save All Corrected Images

Saves all the corrected/enhanced/adjusted images displayed in the thumbnail list.

Exit

Click to close the Correct/Enhance Images window.

Correct/Enhance

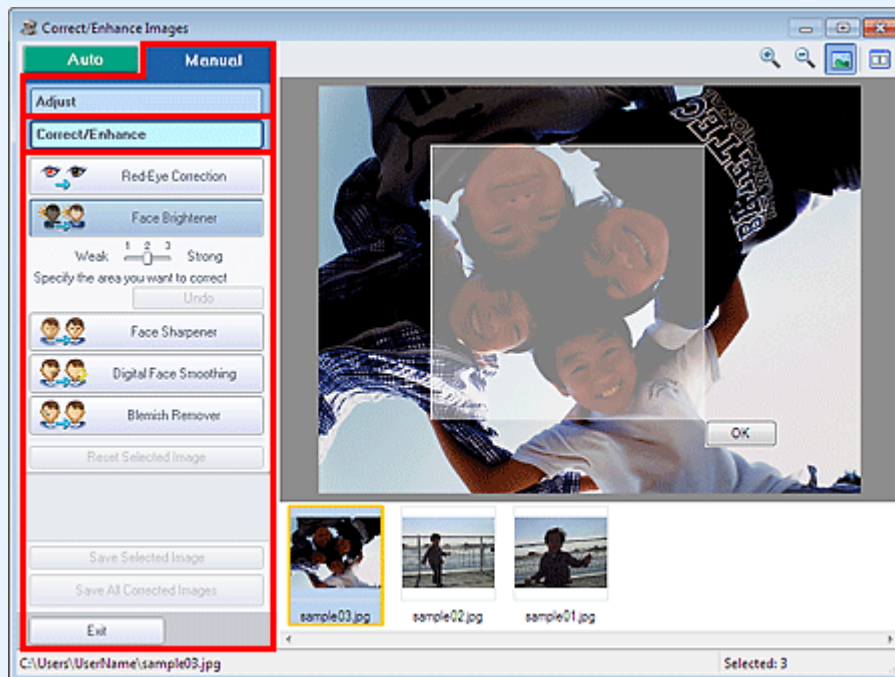

Red-Eye Correction

Corrects red eyes in the selected area.

You can adjust the effect level using the slider.

Note

- For Photo Print, red eyes are automatically corrected when printing by selecting Enable Auto Photo Fix in Color correction for printing on the Advanced tab of the Preferences dialog box and selecting the Enable Red-Eye Correction checkbox. To correct manually, deselect the checkbox.

Face Brightener

Corrects the entire image to brighten the facial area in and around the selected area.

You can adjust the effect level using the slider.

Face Sharpener

Corrects the entire image to sharpen the facial area in and around the selected area.

You can adjust the effect level using the slider.

Digital Face Smoothing

Enhances skin beautifully by removing blemishes and wrinkles in the selected area.

You can adjust the effect level using the slider.

Blemish Remover

Removes moles in the selected area.

OK

Applies the selected effect to the specified area.

Undo

Cancels the latest correction/enhancement.

Reset Selected Image

Cancels all corrections, enhancements and adjustments applied to the selected image.

Save Selected Image

Saves the corrected/enhanced/adjusted image (the selected one).

Save All Corrected Images

Saves all the corrected/enhanced/adjusted images displayed in the thumbnail list.

Exit

Click to close the Correct/Enhance Images window.

(2) Toolbar**Toolbar****(Zoom In/Zoom Out)**

Displays the enlarged or reduced preview of the image.

**(Full Screen)**

Displays the entire image in Preview.

**(Compare)**

Displays the Compare Images window. You can compare the images before and after the correction/enhancement/adjustment side by side.

The image before the correction/enhancement/adjustment is displayed on the left, and the image after the correction/enhancement/adjustment is displayed on the right.

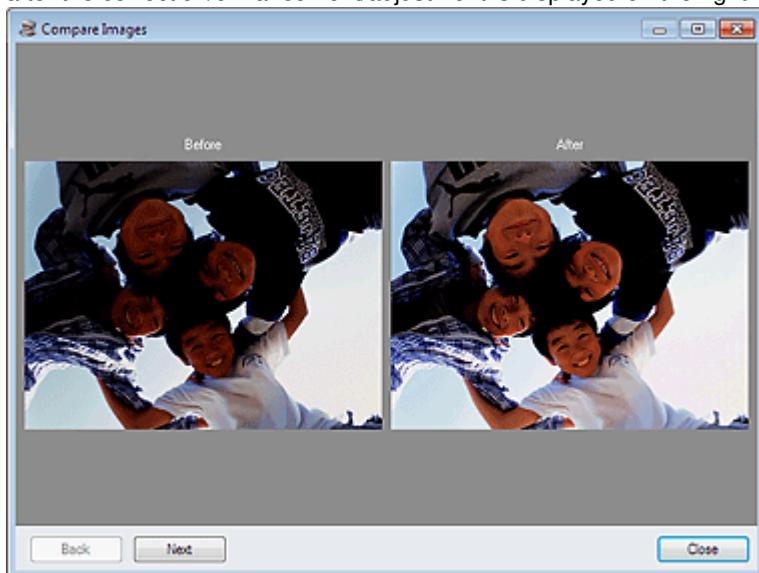

Advanced Guide

Advanced Guide > Printing from a Computer > Printing with the Bundled Application Software > Creating Still Images from Videos

A160

Easy-PhotoPrint EX

Creating Still Images from Videos

You can capture video frames and create still images.

Important



- This function is supported under Windows XP or later. However, it is not supported under the 64-bit editions of Windows XP.
- This function is not available when ZoomBrowser EX Ver.6.5 or later (supplied with Canon digital cameras supporting MOV format video recording) is not installed.
- Videos may not play smoothly depending on your environment.
- When the color tone of a video is changed via the settings of the graphic driver (video card) or its utility, such a change is not reflected in still images captured from the video. Therefore, color tones may differ between videos and captured still images.

1. In the Select Images screen, click  (Capture frames from video).

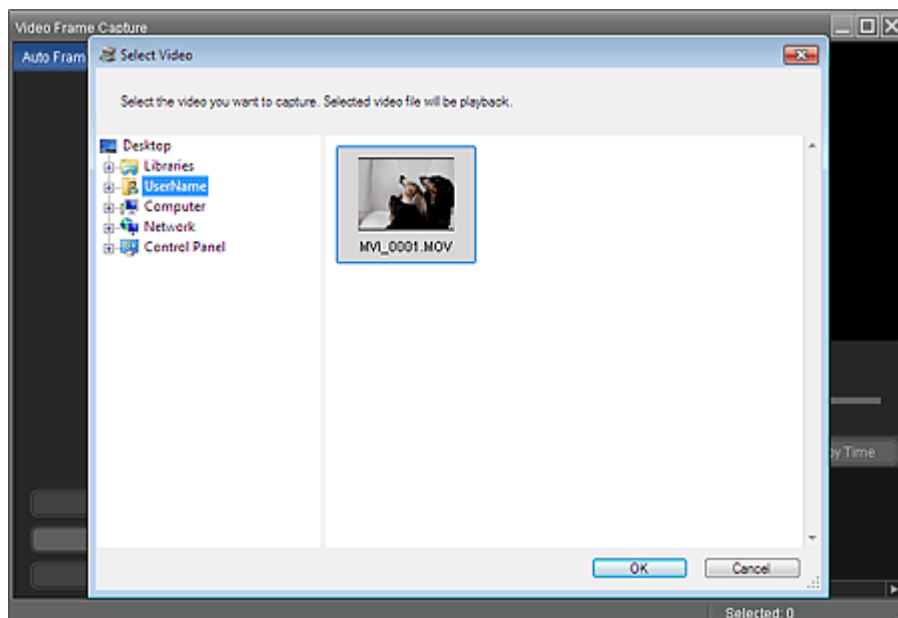
The Video Frame Capture window and Select Video dialog box appear.



Note

- You can also display the Video Frame Capture window by clicking  (Capture frames from video) in the Add Image dialog box. To display the Add Image dialog box, select the page you want to add images to in the Edit screen, then click  (Add Image).
- See "[Video Frame Capture/Movie Print Window](#)" for details on the Video Frame Capture window.

2. In the Select Video dialog box, select the folder containing the video from which you want to capture still images.

The videos in the folder will be displayed as thumbnails (miniatures).

Note

- Only MOV format videos recorded with Canon digital cameras are displayed.
- The selected video plays.

3. Select the video from which you want to capture still images and click OK.

The selected video plays in Preview of the Video Frame Capture window.

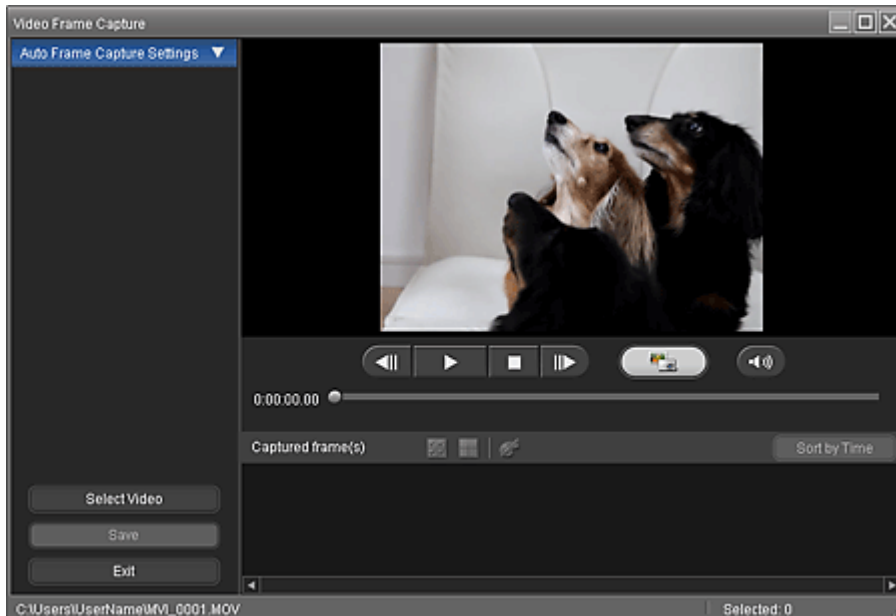

Note

-  (Pause) appears while a video plays, and  (Playback) appears while a video is stopped.
- Use  (Pause) and  (Frame backward/Frame advance) to display the frame you want to capture.

4. Display the frame you want to capture and click (Capture).

The captured still image is displayed in the Captured frame(s) area.

Important

- You can capture up to 150 frames from one video.

5. Select the image(s) you want to save and click Save.

When the Save dialog box appears, specify the save location and file name, then click Save.

Note

- Only JPEG/Exif data format is available for saving created still images.

6. Click Exit.

Important

- The captured still images will be deleted if you exit before saving them.

Note

- You can automatically capture multiple still images from a video.

Display the Auto Frame Capture Settings area, then use  (Set start time/Set end time) in the Preview area to specify the time range. In the Auto Frame Capture Settings area, select a capture method and click Capture.

- You can correct the captured still images in the Correct Captured Frames window. To display the Correct Captured Frames window, select the image(s) you want to correct in the Captured frame(s) area, then click  (Correct image).

- When the Movie Print window is displayed via Solution Menu EX, you can print the captured still images.

To print, specify the printer and media in the Print area, then click Print.

- When you print from the Movie Print window, images are automatically cropped. Therefore, images will be printed with the left and right sides cut off.
- If you want to adjust the cropping area before printing, save the captured still image and print it from a function of Easy-PhotoPrint EX.
- The saved still images can be used along with other images to create albums, calendars, etc. in Easy-PhotoPrint EX.

Advanced Guide

Advanced Guide > Printing from a Computer > Printing with the Bundled Application Software > Creating Still Images from Videos > Video Frame Capture/Movie Print Window

A161

Easy-PhotoPrint EX

Video Frame Capture/Movie Print Window

You can capture video frames and create still images in these windows.

In the Movie Print window, you can print the captured still images.

Important

- This function is supported under Windows XP or later. However, it is not supported under the 64-bit editions of Windows XP.
- This function is not available when ZoomBrowser EX Ver.6.5 or later (supplied with Canon digital cameras supporting MOV format video recording) is not installed.
- When the color tone of a video is changed via the settings of the graphic driver (video card) or its utility, such a change is not reflected in still images captured from the video. Therefore, color tones may differ between videos and captured still images.

To display the Video Frame Capture window, click  (Capture frames from video) in the Select Images screen or Add Image dialog box. To display the Add Image dialog box, select the page you want to add

images to in the Edit screen, then click  (Add Image).

To display the Movie Print window, select Photo Print in Solution Menu EX and click the Movie Print icon.

Note

- The Movie Print window displayed via Solution Menu EX is used as an example in the following descriptions. The window displayed varies depending on how Easy-PhotoPrint EX is started.

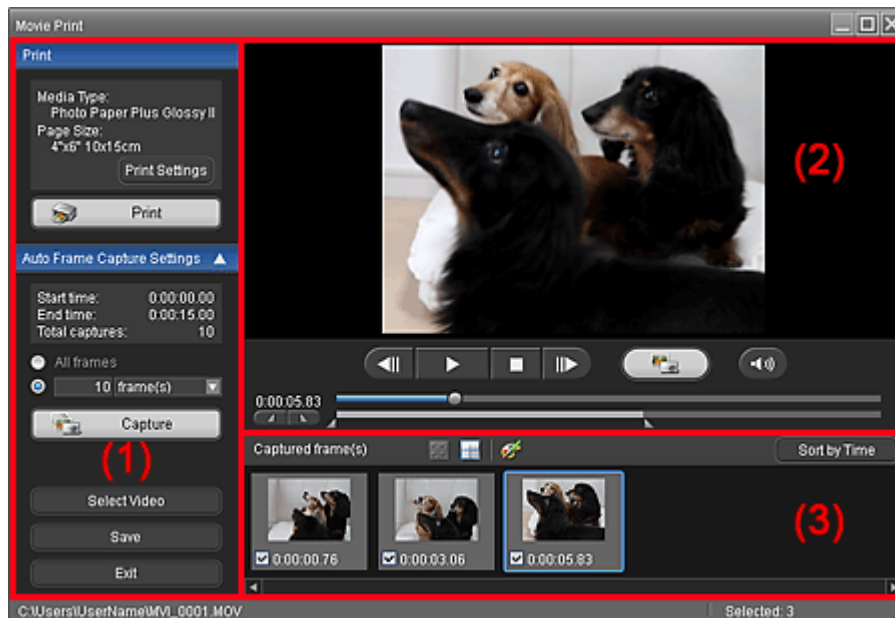

(1) Settings and Operation Buttons Area

(2) Preview Area

(3) Captured Frame(s) Area

(1) Settings and Operation Buttons Area

Print Area

You can print the captured still images.

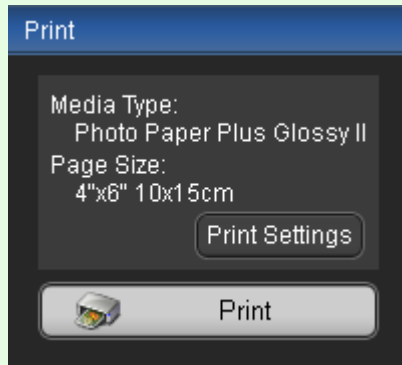

Note

- This function is available only when the Movie Print window is displayed via Solution Menu EX.

Media Type

Displays the media type specified in the Print Settings dialog box.

Page Size

Displays the paper size specified in the Print Settings dialog box.

Print Settings

Displays the Print Settings dialog box in which you can make the basic print settings (select printer/media, etc.).

Print



Starts printing the still images selected in the Captured frame(s) area.

Auto Frame Capture Settings Area

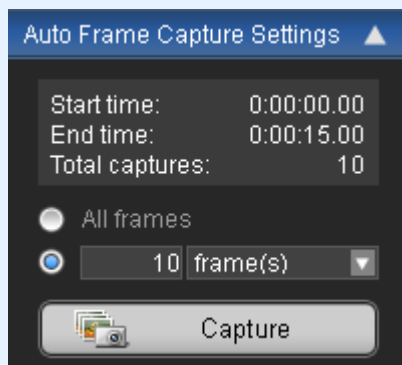
You can capture multiple still images according to the settings.



Note

- Use   (Down arrow/Up arrow) to show/hide the Auto Frame Capture Settings area.

Start time/End time

Displays the start/end time of the time range from which to capture still images.

Total captures

Displays the number of still images to be captured.

Capture Method

Select from All frames, frame(s), sec. int. and frame int..

Capture

Captures still images according to the settings.
You can capture up to 150 frames at a time from one video.

Select Video

Displays the Select Video dialog box.
Select a folder, then select the video from which you want to capture still images.

Save

Saves the still images selected in the Captured frame(s) area.

Exit

Click to close the Video Frame Capture/Movie Print window.

(2) Preview Area

The video selected in the Select Video dialog box appears in Preview.





(Frame backward/Frame advance)

Click to reverse/advance one frame and pause.
You can also click during playback to reverse/advance one frame and pause.



(Playback/Pause)

Plays or pauses the video.

 (Pause) appears while a video plays, and  (Playback) appears while a video is stopped.



(Stop)

Stops the video.



(Capture)

Captures the current frame and displays the still image in the Captured frame(s) area.
You can also capture during playback.



(Mute/Clear mute)

Switches audio OFF/ON.



Playback Slider

Displays the video playback progress.
Current playback time is displayed to the left of the slider.



(Set start time/Set end time)

Set the start/end time of the time range from which to capture still images automatically.

Note

- These buttons are displayed only when the Auto Frame Capture Settings area is displayed.



Time Range Slider

Displays the time range set with  (Set start time/Set end time).
You can also set the start/end time by moving  (Start/End point) located below the slider.

Note

- This slider is displayed only when the Auto Frame Capture Settings area is displayed.

(3) Captured Frame(s) Area

Displays the thumbnails of the captured still images.

Double-click a thumbnail image to display the Zoom In window in which you can check the details of the image.



(Select all frames)

Selects all the images displayed in the Captured frame(s) area.

When you select an image, a checkmark appears in its checkbox.

(Clear all check-marks)

Cancels all image selections in the Captured frame(s) area.

(Correct image)

Displays the Correct Captured Frames window in which you can correct all the images selected in the Captured frame(s) area.

Note

- When a frame in which the subject or camera has moved significantly is captured, the image may not be corrected properly.

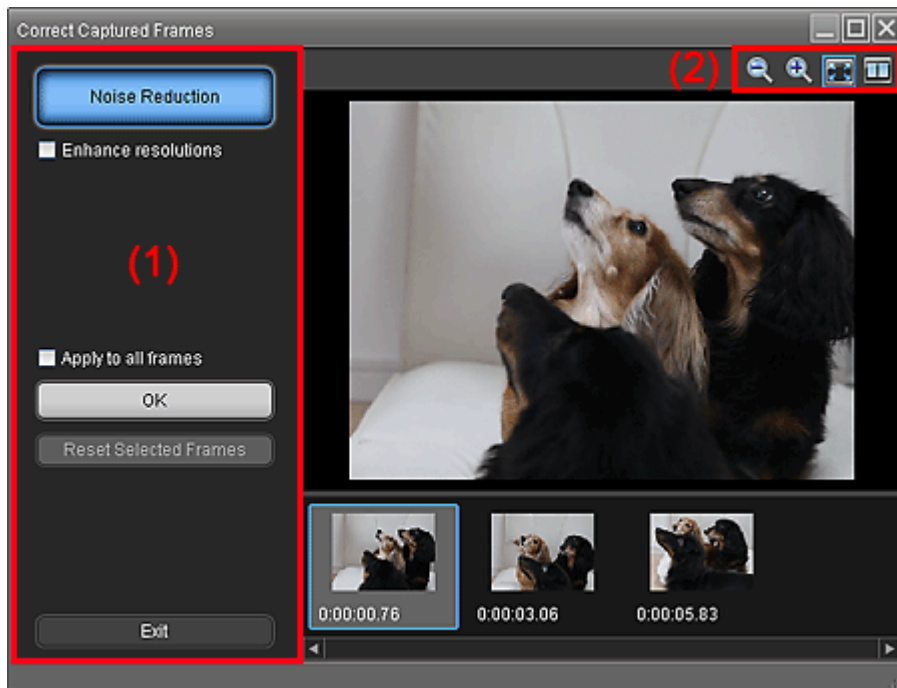

(1) Task Area

Noise Reduction

Reduces noise (tonal variation that may appear in images taken in dark locations such as night scenes using a digital camera).

Enhance resolutions

Select this checkbox to reduce the jaggies (roughness) in images.

Apply to all frames

Select this checkbox to correct all the images displayed in the thumbnail list.

OK

Applies Noise Reduction to the selected images or all images. Noise will be reduced to make the images more vivid.

Note

- Correction may take time depending on your environment.
- When the Enhance resolutions checkbox is selected, Noise Reduction and Enhance resolutions are applied simultaneously.

Reset Selected Frames

Cancels all corrections applied to the selected images.

Exit

Closes the Correct Captured Frames window and returns to the Video Frame Capture or Movie Print window.
Source images will be overwritten by the corrected ones.

(2) Toolbar



(Reduce/Enlarge frame)

Reduces or enlarges the displayed image.



(Whole frame)

Displays the entire image in Preview.



(Compare)

Displays the Compare Captured Frames window. You can compare the images before and after the correction side by side.

The image before the correction is displayed on the left, and the image after the correction is displayed on the right of the window.

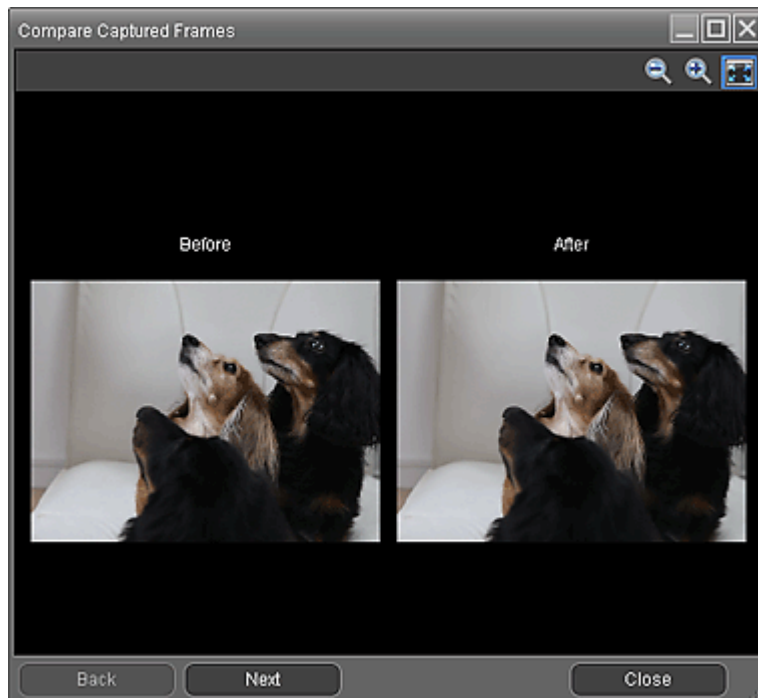

Sort by Time

Displays the captured still images in the order of the time code.



Note

- See "[Creating Still Images from Videos](#)" for details on how to create still images from videos.

Advanced Guide

Advanced Guide > Printing from a Computer > Printing with the Bundled Application Software > Downloading Images from Photo Sharing Sites

A170

Easy-PhotoPrint EX

Downloading Images from Photo Sharing Sites

You can search for images on photo sharing sites on the Internet and download the images you want to print.

Important

- Internet connection is required to use this function. Internet connection fees apply.
- For the purpose of using this function, your product name, OS information, regional information and information that you have clicked  (Import photos from photo sharing sites) will be collected and sent to Canon.
- This function may not be available in some regions.
- It is unlawful to reproduce or edit the copyrighted work of another person without permission from the copyright holder, except for personal use, use within the home, or other use within the limited scope as defined by the copyright. Additionally, reproducing or editing photographs of people may infringe on portrait rights.
- You may be required permission of way to use the work from copyright holder when using the work of others except for personal use, use within the home, or other use within the limited scope as defined by the copyright. Please check the details carefully of the web page of work in the photo sharing site. Please also check terms of service in the photo sharing site before using the work of others. Canon is not responsible for the any copyright problems by using this function.
- This function is supported under Windows XP or later.
- This product uses the Flickr API but is not endorsed or certified by Flickr.

1. In the Select Images screen, click  (Import photos from photo sharing sites).
The Import Photos from Photo Sharing Sites window appears.

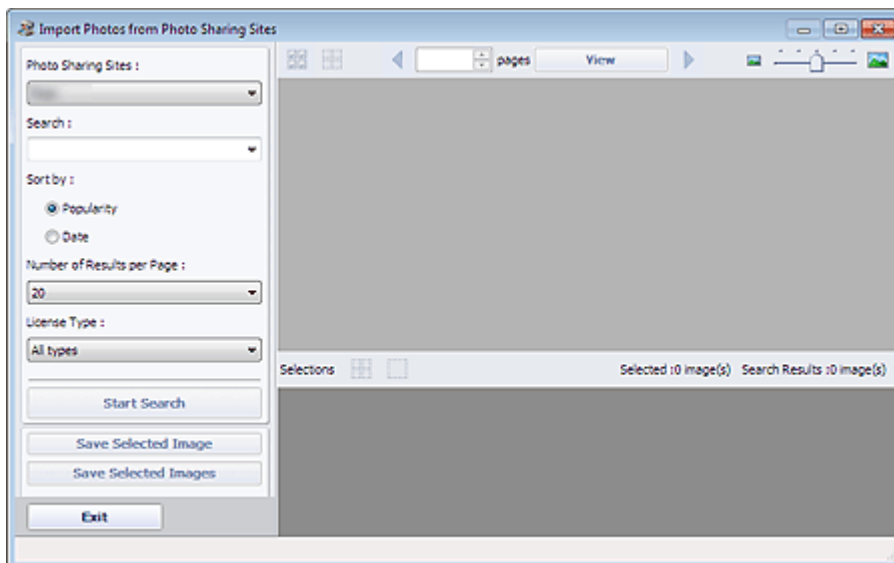

Note

- You can also display the Import Photos from Photo Sharing Sites window by clicking  (Import photos from photo sharing sites) in the Add Image dialog box. To display the Add Image dialog box, select the page you want to add images to in the Edit screen, then click



(Add Image).

- When you click  (Import photos from photo sharing sites), a message about created works and personality rights appear. To hide the message, select the Do not show this message again checkbox.
 - See "[Import Photos from Photo Sharing Sites Window](#)" for details on the Import Photos from Photo Sharing Sites window.
-

2. Enter the search text in Search.

3. Set Sort by, Number of Results per Page and License Type.

4. Click Start Search.

Search starts, then the images that match the search text appear in the Thumbnail window.





Important

- Some images, such as images in formats other than JPEG, do not appear.
-



Note



- Click  (Back to the previous page) to display the previous page. Click  (Go to the next page) to display the next page. Alternatively, enter a page number in the page number entry box and click View to display the page.
 - The number of search results (images) may be small depending on the language of the search text. In that case, entering English search text may increase search results.
-

5. Select the image(s) you want to download.

The selected image(s) is (are) displayed in the Selections area.



Note

- You can select up to 300 images.
 - Click  (Cancel all image selections) to cancel all image selections in the Selections area. Click  (Cancel image selection) to cancel the selection of images selected in the Selections area.
-

6. Click Save Selected Image or Save Selected Images.

When the Save Selected Image/Save Selected Images dialog box appears, specify the save location and file name, then click Save.

The selected images are saved.



Note

- To save only the images you like, select them in the Selections area and click Save Selected Image. To save all images, click Save Selected Images.
 - Only JPEG/Exif data format is available for saving downloaded images.
-

7. Click Exit.



Important

- The search results (images) will be deleted if you exit before saving them.
-

Advanced Guide

Advanced Guide > Printing from a Computer > Printing with the Bundled Application Software > Downloading Images from Photo Sharing Sites > Import Photos from Photo Sharing Sites Window

A171

Easy-PhotoPrint EX

Import Photos from Photo Sharing Sites Window

In this window, you can search for images on photo sharing sites on the Internet and download the images you want to print.

Important

- Internet connection is required to use this function. Internet connection fees apply.
- This function is supported under Windows XP or later.
- This product uses the Flickr API but is not endorsed or certified by Flickr.

To display the Import Photos from Photo Sharing Sites window, click  (Import photos from photo sharing sites) in the Select Images screen or Add Image dialog box. To display the Add Image dialog

box, select the page you want to add images to in the Edit screen, then click  (Add Image).

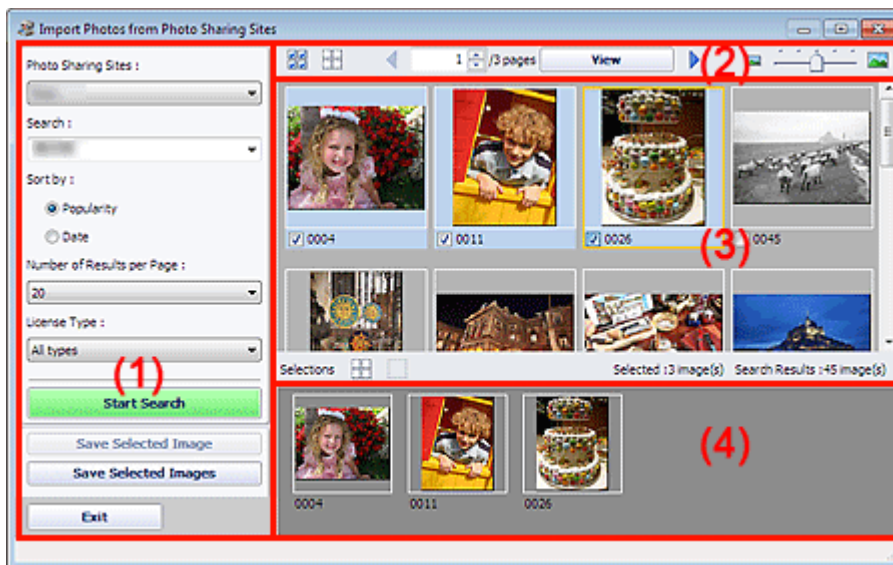

- Settings and Operation Buttons Area
- Toolbar
- Thumbnail Window
- Selections Area

(1) Settings and Operation Buttons Area

Photo Sharing Sites

Displays the name of the photo sharing site.

Search

Enter the search text.

Note

- Alternatively, click  (Down arrow) to display up to 20 search history records and select among them.
- When you want to enter multiple keywords, insert a space between the keywords.

Sort by

Select how to sort the search results in the Thumbnail window. Select Popularity or Date.
You cannot change the setting after a search.

Number of Results per Page

Select the number of images displayed in the Thumbnail window, from 10, 20 and 30.
You cannot change the setting after a search.

License Type

Select the license type of images to search for, from All types, CC license (Non-Commercial) and CC license (Others).

Select All types to display all images regardless of license type.

Select CC license (Non-Commercial) to display CC licensed images that can be used for non-commercial purposes only. Select CC license (Others) to display other CC licensed images.

 **Note**

- License type varies by image. Point to an image to display a tooltip in which you can check the license type.

License Type	License Type	Usage Precautions/Conditions (Comply with the following conditions when using CC licensed images except for personal use or use within the home.)
All types	All Rights Reserved	Unauthorized copying of images is illegal except for personal/home use or for use within such limited scope. Copying portraits (photographs of persons) may infringe personality rights.
	Attribution Non-Commercial (CC license)	- You must show the title and licensor of the original work along with your creation. - You may not use the work for commercial purposes.
	Attribution Non-Commercial No Derivatives (CC license)	- You must show the title and licensor of the original work along with your creation. - You may not use the work for commercial purposes. - You may not modify the work.
	Attribution Non-Commercial Share Alike (CC license)	- You must show the title and licensor of the original work along with your creation. - You may not use the work for commercial purposes. - Even if your creation is built upon the work of others, you must apply the same conditions to it as those set out for the original work by the licensor.
	Attribution (CC license)	- You must show the title and licensor of the original work along with your creation.
	Attribution No Derivatives (CC license)	- You must show the title and licensor of the original work along with your creation. - You may not modify the work.
	Attribution Share Alike (CC license)	- You must show the title and licensor of the original work along with your creation. - Even if your creation is built upon the work of others, you must apply the same conditions to it as those set out for the original work by the licensor.
CC license (Non-Commercial)	Attribution Non-Commercial (CC license)	- You must show the title and licensor of the original work along with your creation. - You may not use the work for commercial purposes.
	Attribution Non-Commercial No Derivatives (CC license)	- You must show the title and licensor of the original work along with your creation. - You may not use the work for commercial purposes. - You may not modify the work.
	Attribution Non-	- You must show the title and licensor of the original

	Commercial Share Alike (CC license)	work along with your creation. - You may not use the work for commercial purposes. - Even if your creation is built upon the work of others, you must apply the same conditions to it as those set out for the original work by the licensor.
CC license (Others)	Attribution (CC license)	- You must show the title and licensor of the original work along with your creation.
	Attribution No Derivatives (CC license)	- You must show the title and licensor of the original work along with your creation. - You may not modify the work.
	Attribution Share Alike (CC license)	- You must show the title and licensor of the original work along with your creation. - Even if your creation is built upon the work of others, you must apply the same conditions to it as those set out for the original work by the licensor.

Start Search

Starts searching for images, and displays the images that match the search text in the Thumbnail window.

 **Important**

- Some images, such as images in formats other than JPEG, do not appear.

Save Selected Image

Saves the image selected in the Selections area.

Save Selected Images

Saves all the images displayed in the Selections area.

Exit

Click to close the Import Photos from Photo Sharing Sites window.

(2) Toolbar

 **(Select all images)**

Selects all the images in the page displayed in the Thumbnail window. When you select an image, a checkmark appears in its checkbox.

 **Note**

- You can select up to 300 images.

 **(Clear all check-marks)**

Cancels all image selections in the page displayed in the Thumbnail window.

 **(Back to the previous page/Go to the next page)**

Displays the previous/next page.

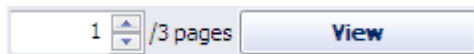

Page number entry box/Total pages/View

Enter a page number and click View to display the page.



Thumbnail Size Slider

Resizes the images in the Thumbnail window. Move the slider to the right to enlarge and left to reduce the images.

(3) Thumbnail Window

Displays the thumbnails (miniatures) of the search results (images). The title is displayed under each

thumbnail.

To select an image, click the thumbnail or checkbox.

Important

- Due to limitations of photo sharing sites, if the search results exceed 4,000 images, the same images as those displayed in the page containing the 4,001st image will be displayed in all the subsequent pages.
For example, when Number of Results per Page is set to 20, the images displayed in page 201 are the same as those displayed in page 202 and subsequent pages.

Note

- Point to a thumbnail to display its title, license type and other information.
- Right-click a thumbnail and select Open web page of work from the displayed menu to start a browser and display the page of a photo sharing site on which the image is posted.

(4) Selections Area

Thumbnails of the images selected in the Thumbnail window are displayed, along with the number of images (number of selected images/number of search results).



(Cancel all image selections)

Cancels all image selections in the Selections area.



(Cancel image selection)

Cancels the selection of images selected in the Selections area.

Note

- See "[Downloading Images from Photo Sharing Sites](#)" for details on how to download images from photo sharing sites.

Advanced Guide

[Advanced Guide](#) > [Printing from a Computer](#) > [Printing with the Bundled Application Software](#) > [Questions and Answers](#)

A200

Easy-PhotoPrint EX

Questions and Answers

- ➡ [How Can I Move \(or Copy\) the Saved File?](#)
- ➡ [Which Side of the Displayed Image Does the Printing Start from?](#)
- ➡ [How Do I Print with Even Margins?](#)
- ➡ [What Is "C1" or "C4"?](#)

[Page top](#)↑

Advanced Guide

Advanced Guide > Printing from a Computer > Printing with the Bundled Application Software > Questions and Answers
> How Can I Move (or Copy) the Saved File?

A095

Easy-PhotoPrint EX



How Can I Move (or Copy) the Saved File?

If you want to move (or copy) a file created and saved with Easy-PhotoPrint EX from one folder to another, you need to move (or copy) the folder that was automatically created when originally saving that file as well.

For example, when you save a file named "MyAlbum.el1," a folder named "MyAlbum.el1.Data" is automatically created in the same folder that contains the "MyAlbum.el1" file. If you want to move (or copy) the "MyAlbum.el1" file to another folder, move (or copy) the "MyAlbum.el1.Data" folder as well. The "MyAlbum.el1.Data" folder contains the photos used in the album.

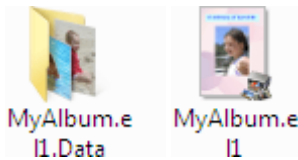

Note

- The icons may vary depending on the items.

Important

- Do not change the Data folder name; otherwise you will not be able to display the photos you edited with Easy-PhotoPrint EX.

[Page top](#)

Advanced Guide

Advanced Guide > Printing from a Computer > Printing with the Bundled Application Software > Questions and Answers
> Which Side of the Displayed Image Does the Printing Start from?

A096

Easy-PhotoPrint EX



Which Side of the Displayed Image Does the Printing Start from?

As shown below, printing starts from the left side of the image displayed in the Layout/Print screen.



Outputs the paper in the direction as the arrow indicates.

See your printer manual for details on how to load paper (to print on the front/back, etc.).

[Page top](#)

Advanced Guide

[Advanced Guide](#) > [Printing from a Computer](#) > [Printing with the Bundled Application Software](#) > [Questions and Answers](#)
> [How Do I Print with Even Margins?](#)

A097

Easy-PhotoPrint EX



How Do I Print with Even Margins?

When you print on a bordered layout, the margins on the left and right or the top and bottom may become wider than the other, depending on the image and printer.

To always print with even margins, select the Always crop images when selecting a layout with margins checkbox on the Advanced tab of the Preferences dialog box.

To display the Preferences dialog box, click  (Settings) in the Layout/Print screen or select Preferences... from the File menu.

Crop the photo to apply even margins individually.

➔ [Cropping Photos \(Photo Print\)](#)

Note

- This setting is available only when Photo Print is selected.
-

[Page top](#) 

Advanced Guide

Advanced Guide > Printing from a Computer > Printing with the Bundled Application Software > Questions and Answers
> What Is "C1" or "C4"?

A098

Easy-PhotoPrint EX



What Is "C1" or "C4"?

When an album is printed, labels such as "C1" and "C4" are printed as page numbers.

The "C1" and "C4" represent the front cover and back cover, respectively.

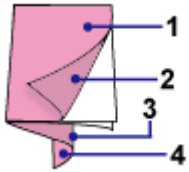

C1: Front cover

C2: Inside the front cover

C3: Inside the back cover

C4: Back cover

Note

- "C2"/"C3" appears only when the Leave the inside of front cover blank/Leave the inside of back cover blank checkbox is selected in the Cover Options dialog box.

[Page top](#)

Advanced Guide

[Advanced Guide](#) > [Printing from a Computer](#) > [Printing with the Bundled Application Software](#) > [Photo Print Settings](#)

A101

Easy-PhotoPrint EX

Photo Print Settings

- ➔ [Printing Vivid Photos](#)
- ➔ [Reducing Photo Noise](#)
- ➔ [Cropping Photos \(Photo Print\)](#)
- ➔ [Printing Dates on Photos \(Photo Print\)](#)
- ➔ [Printing Multiple Photos on One Page](#)
- ➔ [Printing an Index](#)
- ➔ [Printing ID Photos \(ID Photo Print\)](#)
- ➔ [Printing Photo Information](#)
- ➔ [Saving Photos](#)
- ➔ [Opening Saved Files](#)

[Page top](#) ↕

Advanced Guide

Advanced Guide > Printing from a Computer > Printing with the Bundled Application Software > Photo Print Settings > Printing Vivid Photos

A071

Easy-PhotoPrint EX



Printing Vivid Photos

Select the Vivid Photo checkbox in the Select Paper screen to boost the colors in a photo before printing.

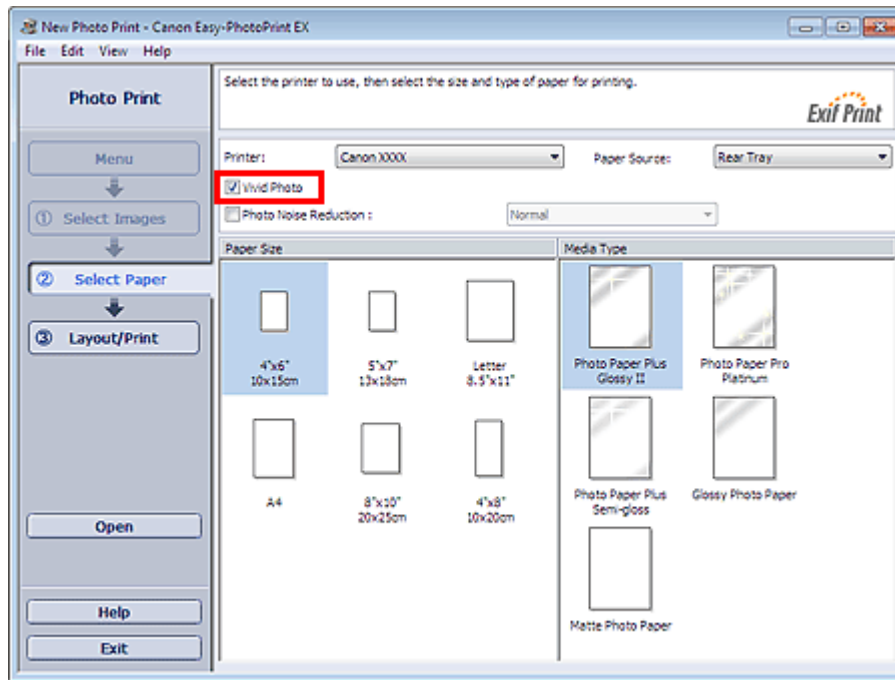

Important

- This function is available only with a printer that supports Vivid Photo.
- This function is not available when Enable ICC Profile is selected on the Advanced tab of the Preferences dialog box.

Note

- Even if you select the Vivid Photo checkbox, this effect applies only to the print result. The original image or preview image will not be affected.

[Page top](#)

Advanced Guide

Advanced Guide > Printing from a Computer > Printing with the Bundled Application Software > Photo Print Settings > Reducing Photo Noise

A072

Easy-PhotoPrint EX



Reducing Photo Noise

When a photo is taken in a dark location such as night scene using digital camera, noise may appear in the image.

Select the Photo Noise Reduction checkbox in the Select Paper screen to reduce noise in the image and make the printed photos more vivid.

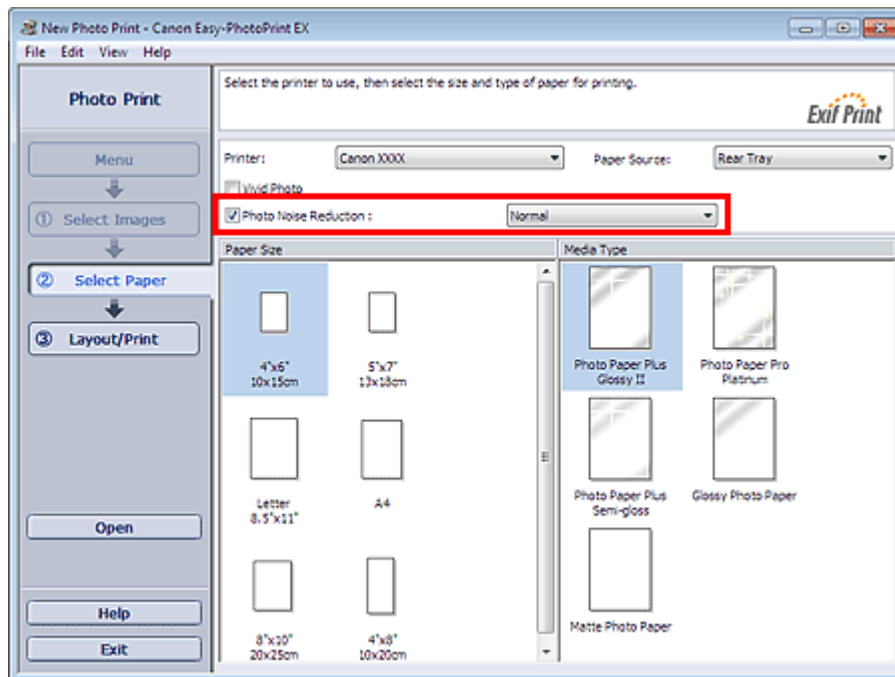

Important

- This function is not available when Enable ICC Profile is selected on the Advanced tab of the Preferences dialog box.

Note

- When the noise is severe, change Normal to Strong.
- The noise reduction effect applies only to the print result. The original image or preview image will not be affected.

[Page top](#)

Advanced Guide

Advanced Guide > Printing from a Computer > Printing with the Bundled Application Software > Photo Print Settings > Cropping Photos (Photo Print)

A073

Easy-PhotoPrint EX



Cropping Photos (Photo Print)

Cropping a photo is the act of removing the unnecessary portions of the photo by selecting the necessary portions.

Click  (Crop Image) in the Layout/Print screen or double-click the preview image.

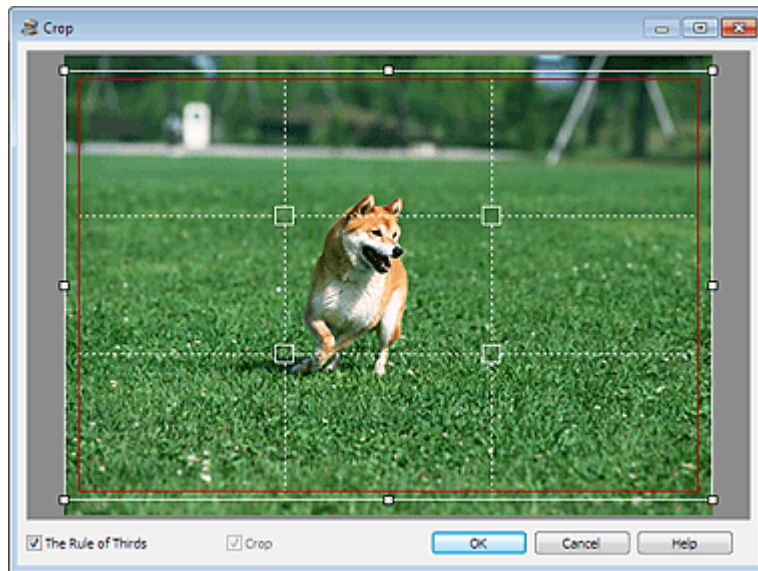

Drag the white squares on the image to adjust the area to be cropped and click OK.

Note

- To move the cropping area, place the cursor within the white frame and drag it. Drag the white lines to enlarge/reduce the cropping area.
- Select the The Rule of Thirds checkbox to display white broken lines. To create a balanced composition, drag any of the intersecting points (white squares) or white broken lines over the main subject of the photo.

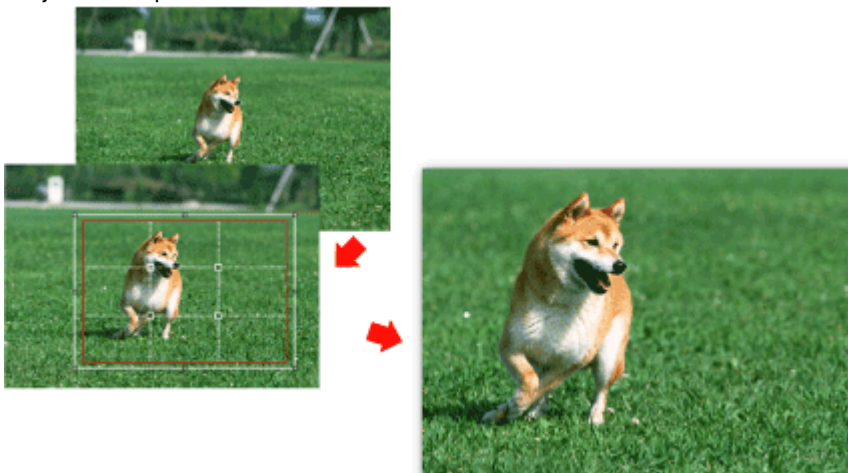

- The cropping effect applies only to the print result. The original image will not be cropped.
- See Help for details on the Crop window.

[Page top](#) 

Advanced Guide

Advanced Guide > Printing from a Computer > Printing with the Bundled Application Software > Photo Print Settings > Printing Dates on Photos (Photo Print)

A074

Easy-PhotoPrint EX



Printing Dates on Photos (Photo Print)

To print the date the photo was taken on the photo, click  (Date Settings) in the Layout/Print screen, then select the Print date checkbox in the Date Settings dialog box.

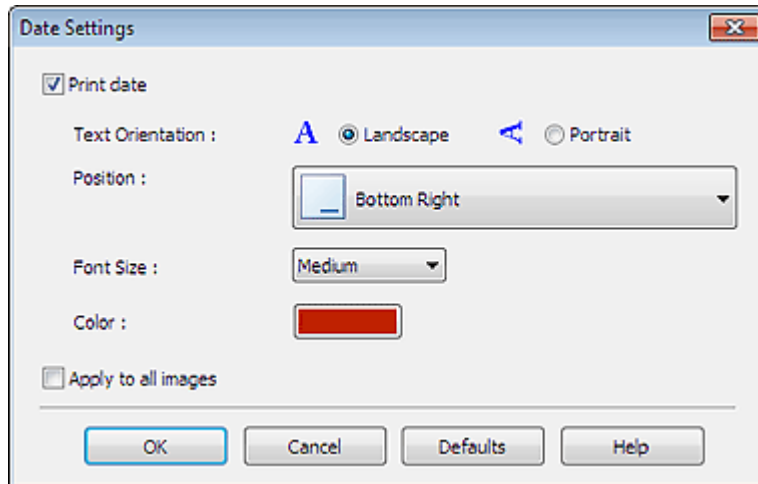

Note

- The date is displayed in the short date format (mm/dd/yyyy, etc.) specified in your operating system.
- See Help for details on setting dates.

[Page top](#)

Advanced Guide

Advanced Guide > Printing from a Computer > Printing with the Bundled Application Software > Photo Print Settings > Printing Multiple Photos on One Page

A076

Easy-PhotoPrint EX



Printing Multiple Photos on One Page

You can print multiple photos on one page by selecting a multiple-photo layout in the Layout/Print screen.



Note

- See the following section for details on how to select photos.
 - ➔ [Selecting a Photo](#)
- The available number of photos and layout may vary depending on the media type.
- Photos are arranged in the following order.
Example: Borderless (x4)

1	3
2	4

- You can change the printing order in Printing Order on the Print tab of the Preferences dialog box. You can select the printing order from By Date, By Name, and By Selection.

To display the Preferences dialog box, click  (Settings) or select Preferences... from the File menu.

Advanced Guide

Advanced Guide > Printing from a Computer > Printing with the Bundled Application Software > Photo Print Settings > Printing an Index

A077



Printing an Index

You can print an index of selected photos. An index print shows the thumbnails of the photos in one page. It is convenient for managing your photos.

To print an index, select Index from the layouts in the Layout/Print screen.

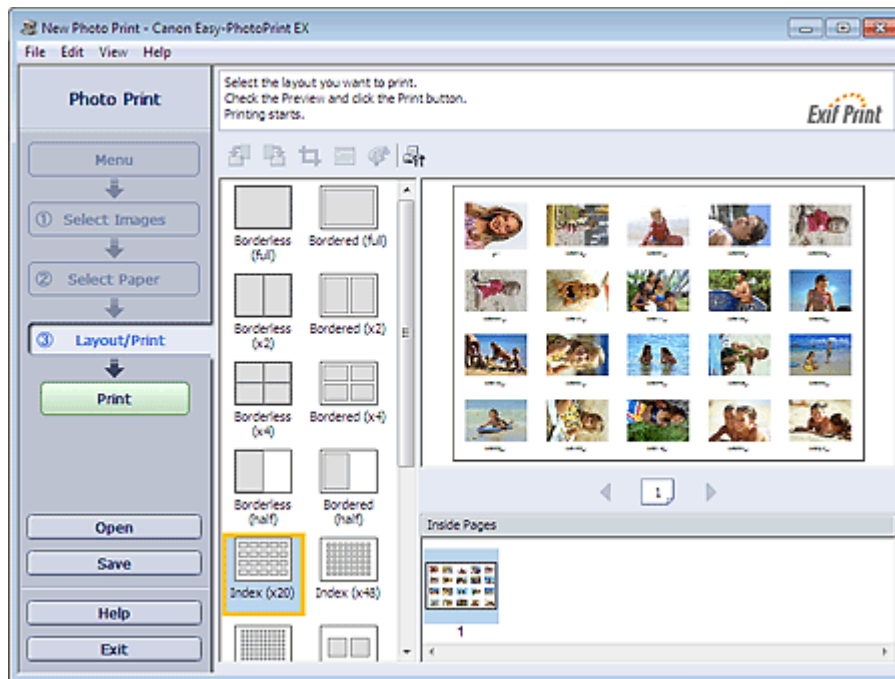

Important

- Index cannot be printed if you select any of the following paper sizes.
 - Credit Card
- You can print up to 80 images on one page.

Note

- See the following section for details on how to select photos.
 - ➔ [Selecting a Photo](#)
- Photos are arranged in the following order. Example: Index (x20)

1	2	3	4	5
6	7	8	9	10
11	12	13	14	15
16	17	18	19	20

- You can change the printing order in Printing Order on the Print tab of the Preferences dialog box. You can select the printing order from By Date, By Name, and By Selection.

To display the Preferences dialog box, click  (Settings) or select Preferences... from the File menu.

[Page top](#) 

Advanced Guide

Advanced Guide > Printing from a Computer > Printing with the Bundled Application Software > Photo Print Settings > Printing ID Photos (ID Photo Print)

A078

Easy-PhotoPrint EX



Printing ID Photos (ID Photo Print)

You can print a variety of ID photos.

Important

- The photo may not qualify as an official ID photo depending on its use. For details, contact the party to whom you will be submitting the photo.

To print ID photos, select 4"x6" 10x15cm for Paper Size in the Select Paper screen, and select a layout of the ID photo from the layouts in the Layout/Print screen.

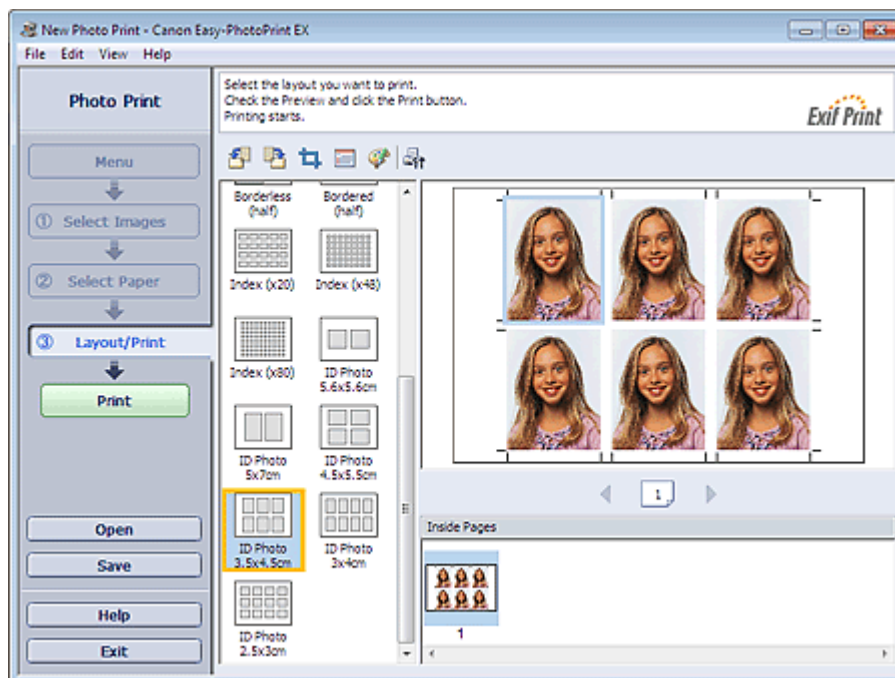

Note

- The number of frames per page varies depending on the size of the ID photo to create. Check the number of frames in the layouts displayed in the Layout/Print screen, then specify the number of copies in the Select Images screen.

You can select two or more images and print different types of ID photos on one page.

- See the following section for details on how to select photos.

➔ [Selecting a Photo](#)

- Photos are arranged in the following order.

Example: ID Photo 3.5x4.5cm



- You can change the printing order in Printing Order on the Print tab of the Preferences dialog box. You can select the printing order from By Date, By Name, and By Selection.

To display the Preferences dialog box, click  (Settings) or select Preferences... from the File menu.

- ID photos can only be printed on 4"x6" 10x15cm paper.
-

[Page top](#) 

Advanced Guide

Advanced Guide > Printing from a Computer > Printing with the Bundled Application Software > Photo Print Settings > Printing Photo Information

A079

Easy-PhotoPrint EX



Printing Photo Information

You can print the photo and the Exif information side by side.

To print them, select Letter 8.5"x11" or A4 for Paper Size in the Select Paper screen, and select Captured Info from the layouts in the Layout/Print screen.

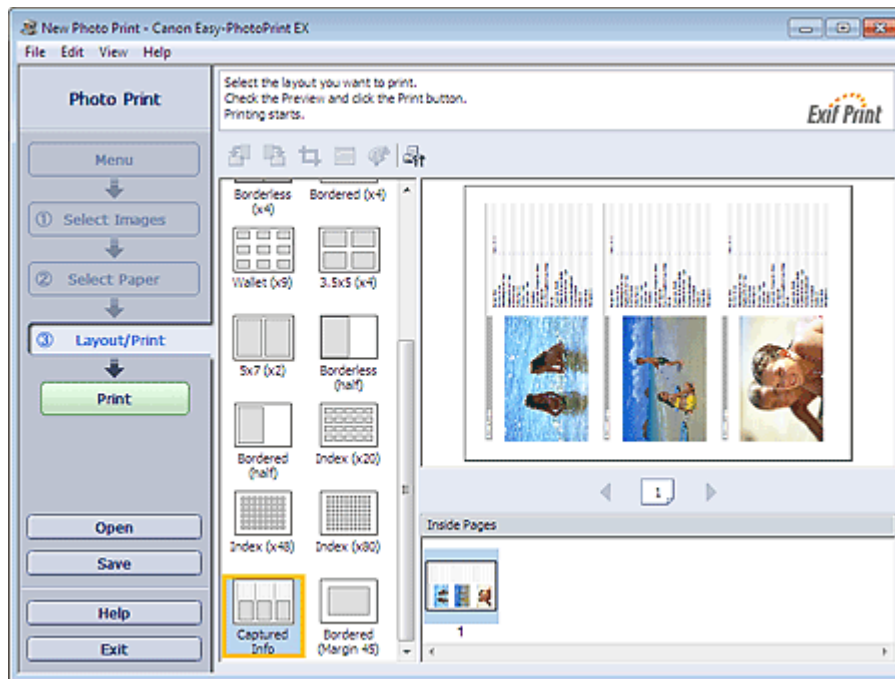

Note

- See the following section for details on how to select photos.
 ➔ [Selecting a Photo](#)
- This function is available only on paper sizes Letter 8.5"x11" and A4.

[Page top](#)↑

Advanced Guide

Advanced Guide > Printing from a Computer > Printing with the Bundled Application Software > Photo Print Settings > Saving Photos

A092

Easy-PhotoPrint EX



Saving Photos

You can save edited photos. The information of cropping and layout can be saved.

Click Save in the Layout/Print screen.

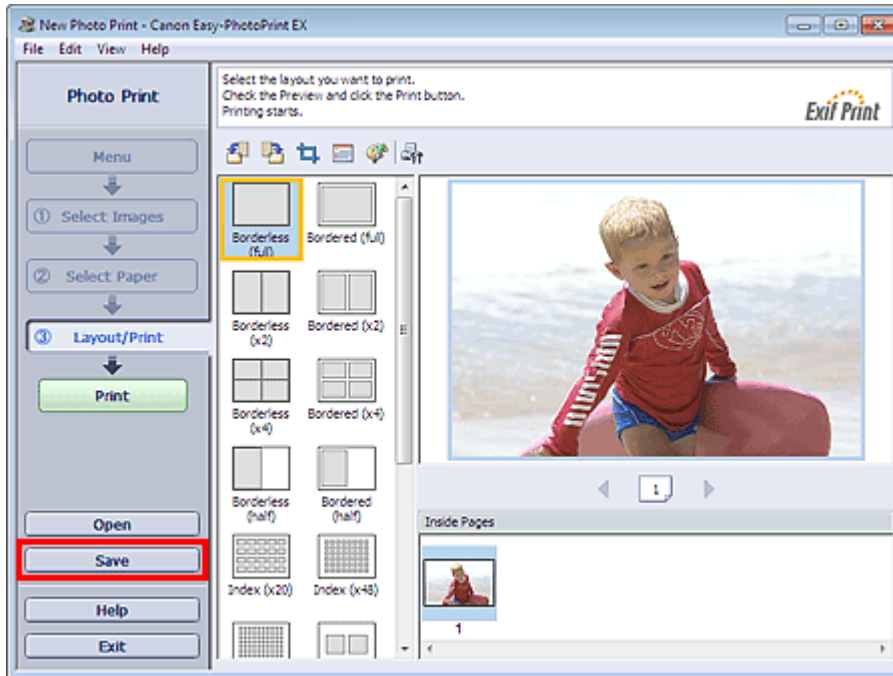

When the Save As dialog box appears, specify the save location and file name, then click Save.

Important

- If you edit a saved file and save it again, the file will be overwritten. To save a file again with a new name or to a different location, select Save As... from the File menu and save.

Note

- Save will not be displayed in the Select Images or Select Paper screen.

[Page top](#)

Advanced Guide

Advanced Guide > Printing from a Computer > Printing with the Bundled Application Software > Photo Print Settings > Opening Saved Files

A093

Easy-PhotoPrint EX



Opening Saved Files

You can open files created with Easy-PhotoPrint EX.

1. Click Library from Menu.

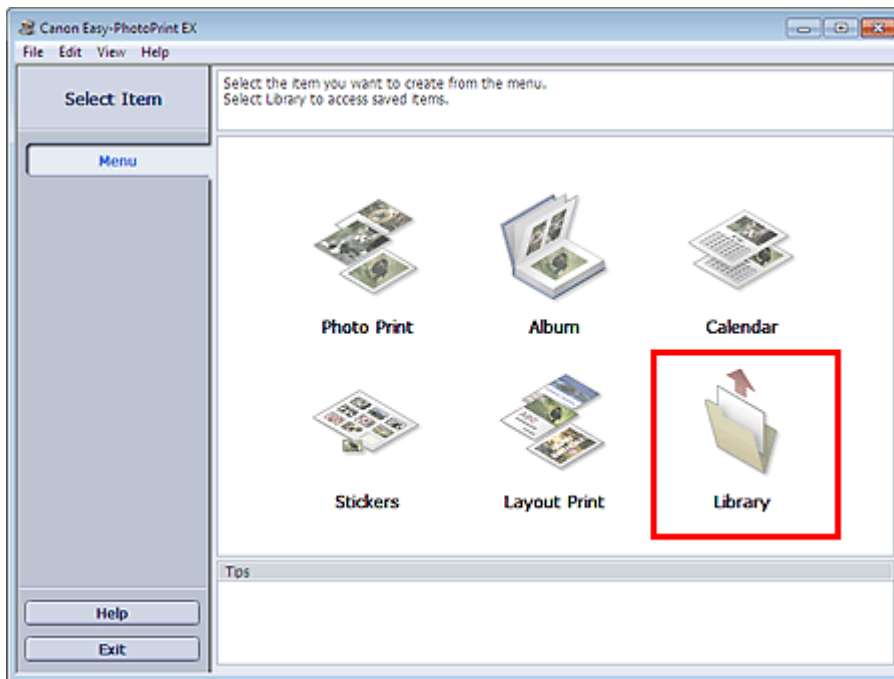

The Open dialog box appears.

You can check files created and saved with Easy-PhotoPrint EX in icon view (only for Windows 7/Windows Vista) or thumbnail view.

Important

- When using 64-bit editions of Windows 7, Windows Vista, or Windows XP, the contents of files cannot be displayed on Explorer.

2. Select the file you want to open and click Open.

The Layout/Print screen appears.

3. Edit the file if necessary.

Note

- Easy-PhotoPrint EX supports the following file format (extension).
 - Easy-PhotoPrint EX Photo Print file (.el6)
- You can open files created with Easy-PhotoPrint EX with the following methods, besides from Library in Menu.
 - Click Open in the step button area of each screen, then select the file you want to edit.
 - Double-click the file.
 - From the File menu, click Open..., then select the file you want to edit.
- You can also open a recently used file by clicking the file name shown in the File menu.

Advanced Guide

[Advanced Guide](#) > [Printing from a Computer](#) > [Printing with the Bundled Application Software](#) > [Other Settings](#)

A102

Easy-PhotoPrint EX

Other Settings

- ➔ [Changing Layout](#)
- ➔ [Changing Background](#)
- ➔ [Adding Photos](#)
- ➔ [Swapping Positions of Photos](#)
- ➔ [Replacing Photos](#)
- ➔ [Changing Position, Angle and Size of Photos](#)
- ➔ [Cropping Photos](#)
- ➔ [Framing Photos](#)
- ➔ [Printing Dates on Photos](#)
- ➔ [Attaching Comments to Photos](#)
- ➔ [Adding Text to Photos](#)
- ➔ [Saving](#)
- ➔ [Setting Holidays](#)
- ➔ [Setting Calendar Display](#)
- ➔ [Opening Saved Files](#)

[Page top](#)↑

Advanced Guide

Advanced Guide > Printing from a Computer > Printing with the Bundled Application Software > Other Settings > Changing Layout

A080

Easy-PhotoPrint EX



Changing Layout

You can change the layout of each page separately.

Select the page you want to change the layout of in the Edit screen, then click  (Change Layout).
Select the layout you want to use in the Change Layout dialog box and click OK.

Album

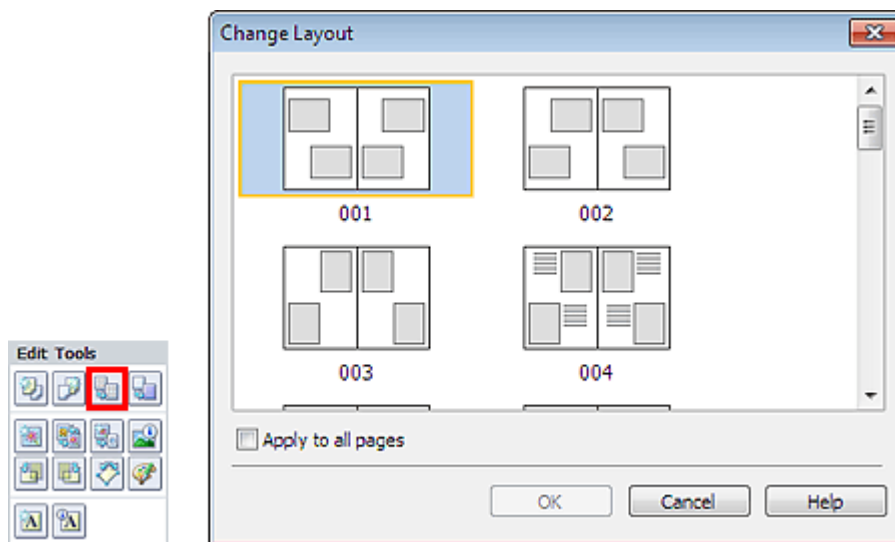

Important

- If the new layout has a different number of frames per page from the current layout, the following will happen:
 - If the number of layout frames is increased : Images will move from the subsequent pages to fill all the frames in the new layout.
 - If the number of layout frames is decreased : Pages with the new layout will be added until all the images on the pages with the current layout can be fitted.
- If you change the current layout for the front or back cover to one that has fewer layout frames, any image that does not fit in the new layout will be deleted, starting with the last image that was added to the former layout page.

Note

- The layouts that can be selected may vary depending on the Paper Size, Orientation, or the type of page selected (front cover, inside pages or back cover).
- Select the Apply to all pages checkbox to change the layouts of all pages to the one you newly selected.

Calendar

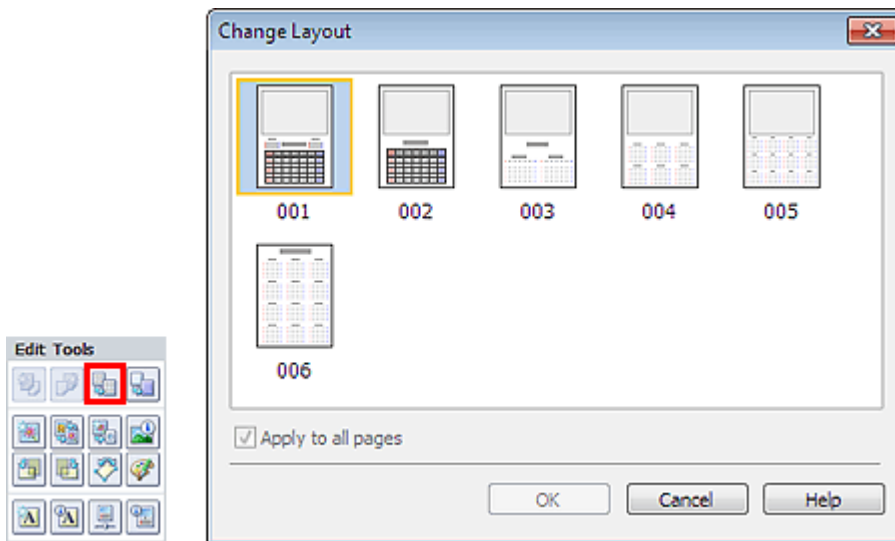

Important

- The layouts of all pages are changed to the selected layout.
- All images that do not fit in the new layout will be collected on the last page.

Note

- The layouts that can be selected may vary depending on the Paper Size and Orientation.

Layout Print

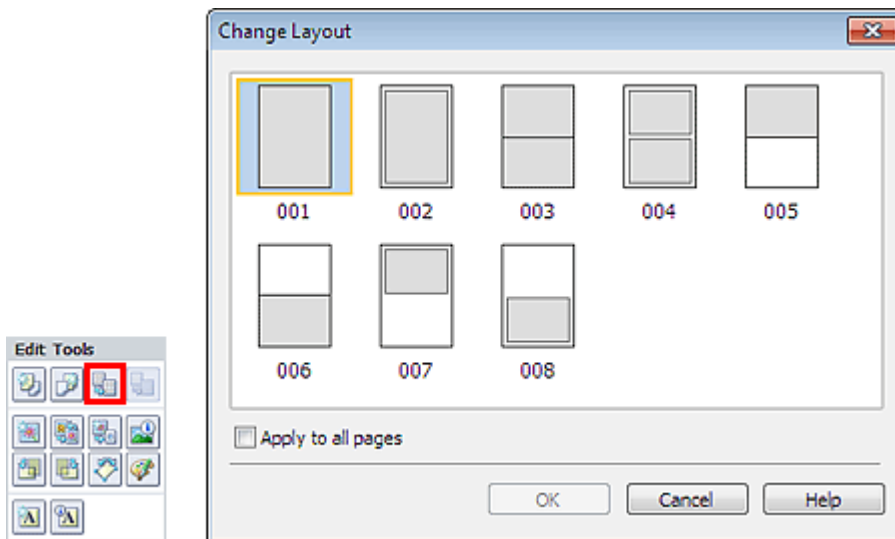

Important

- If the new layout has a different number of frames per page from the current layout, the following will happen:

If the number of layout frames is increased	: Images will move from the subsequent pages to fill all the frames in the new layout.
If the number of layout frames is decreased	: Pages with the new layout will be added until all the images on the pages with the current layout can be fitted.

Note

- The layouts that can be selected may vary depending on the Paper Size and Orientation.
- Select the Apply to all pages checkbox to change the layouts of all pages to the one you newly selected.

Advanced Guide

Advanced Guide > Printing from a Computer > Printing with the Bundled Application Software > Other Settings > Changing Background

A081

Easy-PhotoPrint EX



Changing Background

You can change the background of each page.

Important

- You cannot change the background of the Stickers and Layout Print.

Click Background... in the Page Setup screen or select the page you want to change the background of in the Edit screen, then click  (Change Background).

Note

- The screen(s) for Album printing is (are) used as example(s) in the following descriptions. The screen(s) may vary depending on what you create.

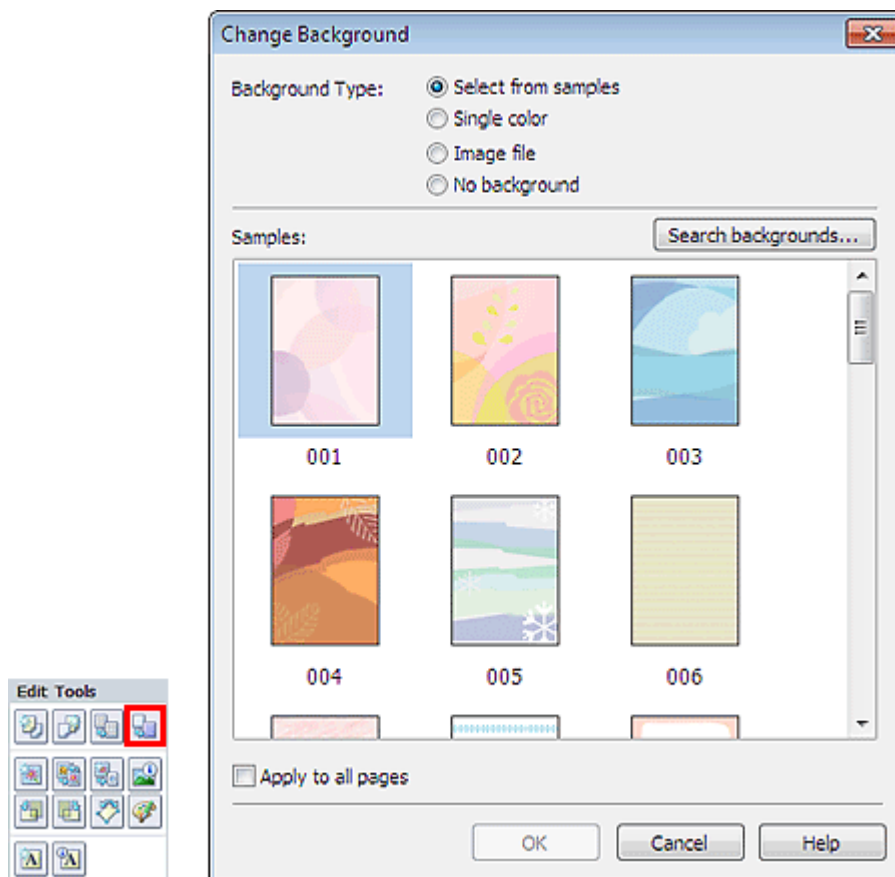

Select the type of background you want to use in the Change Background dialog box.

When Select from samples Is Selected

Select the image you want to use from Samples and click OK.

Note

- Select from samples will be displayed only if Album has been selected.
 - Various backgrounds are available on our website besides those saved in the application. Click Search backgrounds... to access the Canon website from which you can download additional materials for free.
 - Internet connection is required to access the website. Internet connection fees apply.
 - Exit Easy-PhotoPrint EX before installing backgrounds.
-

When Single color Is Selected

Select the color you want to use from Standard color or Custom color and click OK.

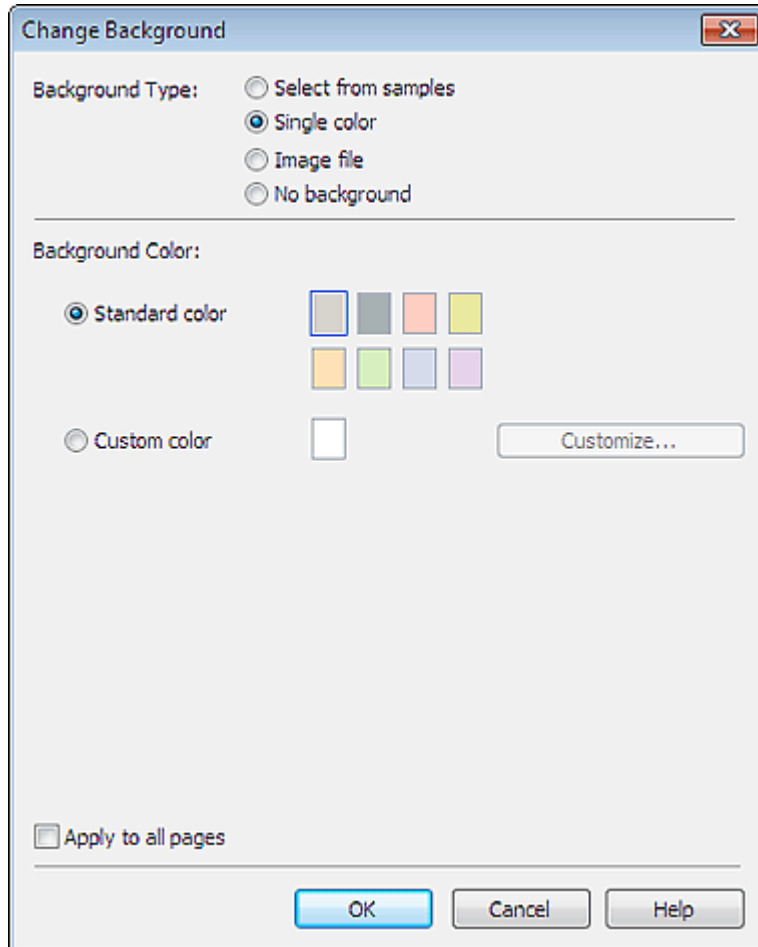

When Image file Is Selected

Set Image File Path and Image Layout, then click OK.

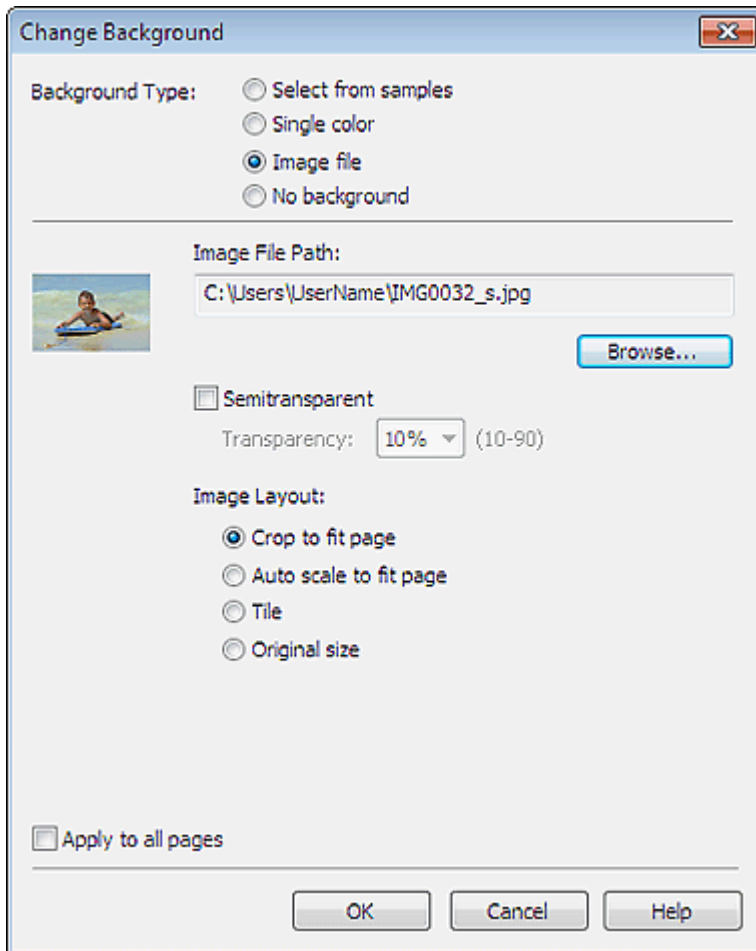

Note

- See Help for details on how to set the background in the Change Background dialog box.

Advanced Guide

Advanced Guide > Printing from a Computer > Printing with the Bundled Application Software > Other Settings > Adding Photos

A082

Easy-PhotoPrint EX



Adding Photos

You can add images to pages.

Select the page you want to add photos to in the Edit screen, then click  (Add Image).

Note

- The screen(s) for Album printing is (are) used as example(s) in the following descriptions. The screen(s) may vary depending on what you create.

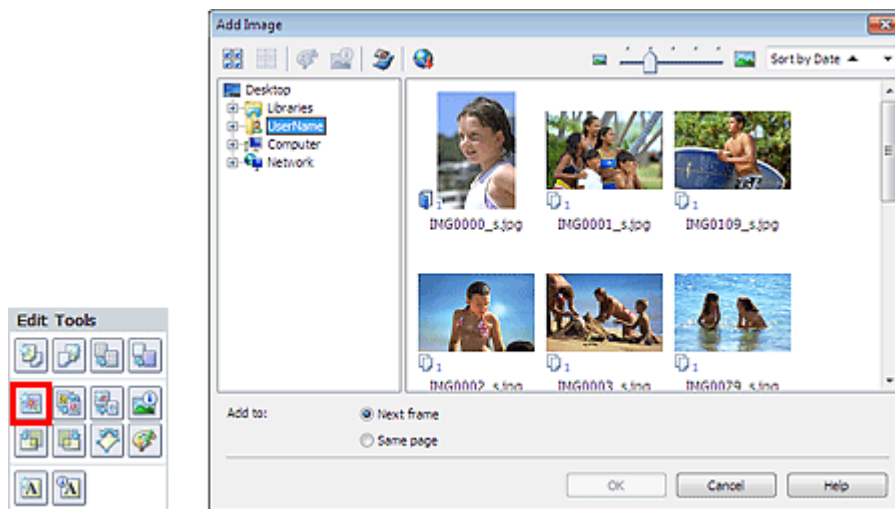

Select the folder containing the image you want to add from the folder tree area on the left of the Add Image dialog box, and select the image you want to add from the thumbnail window on the right.

Note

- Click an image to select it (background turns blue) or deselect it (background turns white). You can also select multiple images.
- You can also use still images captured from videos.
 - ➔ [Creating Still Images from Videos](#)
- You can also use images downloaded from photo sharing sites on the Internet.
 - ➔ [Downloading Images from Photo Sharing Sites](#)

Select an option for Add to and click OK.

Important

- You can add up to 20 images at one time.
- You cannot add two or more of the same image at one time. Add it one at a time.
- Up to 99 of the same images can be added to all pages combined.
- When the number of pages increases due to added images, you cannot add images beyond page 400.

Note

- In the Add Image dialog box, you can select all images at one time or change the display size and order of the thumbnails. See Help for details.

Advanced Guide

Advanced Guide > Printing from a Computer > Printing with the Bundled Application Software > Other Settings > Swapping Positions of Photos

A083

Easy-PhotoPrint EX



Swapping Positions of Photos

You can swap the positions of images.



Click  (Swap Image Positions) in the Edit screen.

Note

- The screen(s) for Album printing is (are) used as example(s) in the following descriptions. The screen(s) may vary depending on what you create.



Select the target and source images you want to swap, then click Swap.

When you finish swapping all images you want to swap, click Back to Edit.

[Page top](#)

Advanced Guide

Advanced Guide > Printing from a Computer > Printing with the Bundled Application Software > Other Settings > Replacing Photos

A084

Easy-PhotoPrint EX



Replacing Photos

You can replace an image with another image.

Select the image you want to replace in the Edit screen, then click  (Replace Selected Image).

Note

- The screen(s) for Album printing is (are) used as example(s) in the following descriptions. The screen(s) may vary depending on what you create.

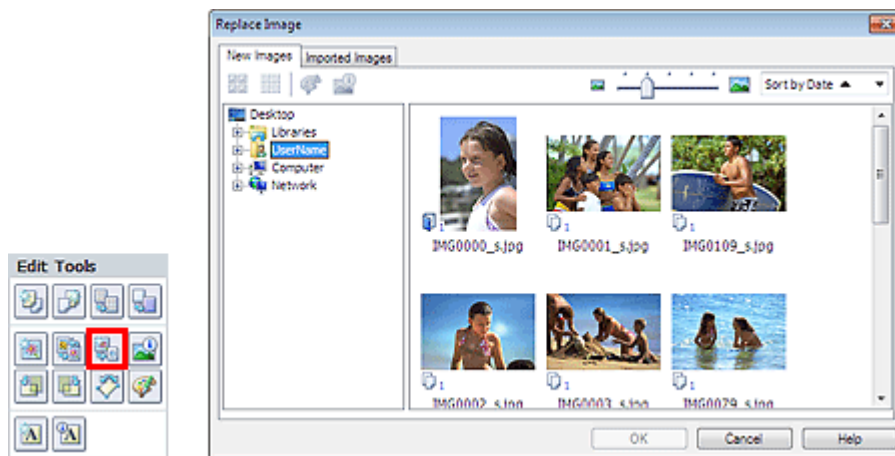

Select the folder containing the image you want to replace with from the folder tree area on the left of the Replace Image dialog box. Select the image you want to replace with from the thumbnail window on the right of the screen and click OK.

If you want to select from the images already imported, click the Imported Images tab and select the image you want to replace with from the thumbnail window and click OK.

Important

- You cannot select multiple images in the Replace Image dialog box.

Note

- If you select multiple images in the Edit screen and use the replacement function, all the images selected in the Edit screen will be replaced with the image selected in the Replace Image dialog box.
- When images are replaced, the following settings of the old image are inherited to the new image.
 - Position
 - Size
 - Frame
 - Position and size of the date
 The cropping information and image orientation are not inherited.
- In the Replace Image dialog box, you can change the display size and order of the thumbnails. See Help for details.

Advanced Guide

Advanced Guide > Printing from a Computer > Printing with the Bundled Application Software > Other Settings > Changing Position, Angle and Size of Photos

A085

Easy-PhotoPrint EX



Changing Position, Angle and Size of Photos

You can adjust the position, angle and size of images.

Select the image of which you want to change the position or size in the Edit screen and click  (Edit Image) or double-click the image.

Note

- The screen(s) for Album printing is (are) used as example(s) in the following descriptions. The screen(s) may vary depending on what you create.

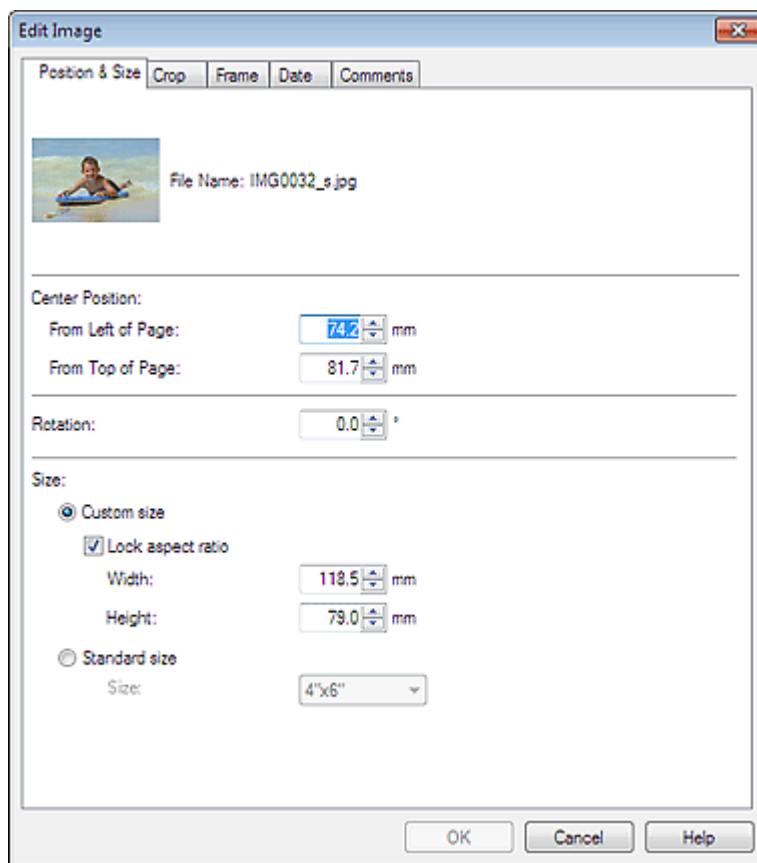

Set the Center Position, Rotation and Size, then click OK.

Note

- You can also change the position and size of an image by dragging it in the Edit screen.
- Select an image in the Edit screen, then click  (Free Rotate) and drag a corner of the image to rotate it.
- See Help for details on the position and size of images.

Advanced Guide

Advanced Guide > Printing from a Computer > Printing with the Bundled Application Software > Other Settings > Cropping Photos

A086

Easy-PhotoPrint EX



Cropping Photos

Cropping an image is the act of removing the unnecessary portions of the image by selecting the necessary portions.

Select the image you want to crop in the Edit screen and click  (Edit Image) or double-click the image.

Click the Crop tab in the Edit Image dialog box.

Note

- The screen(s) for Album printing is (are) used as example(s) in the following descriptions. The screen(s) may vary depending on what you create.

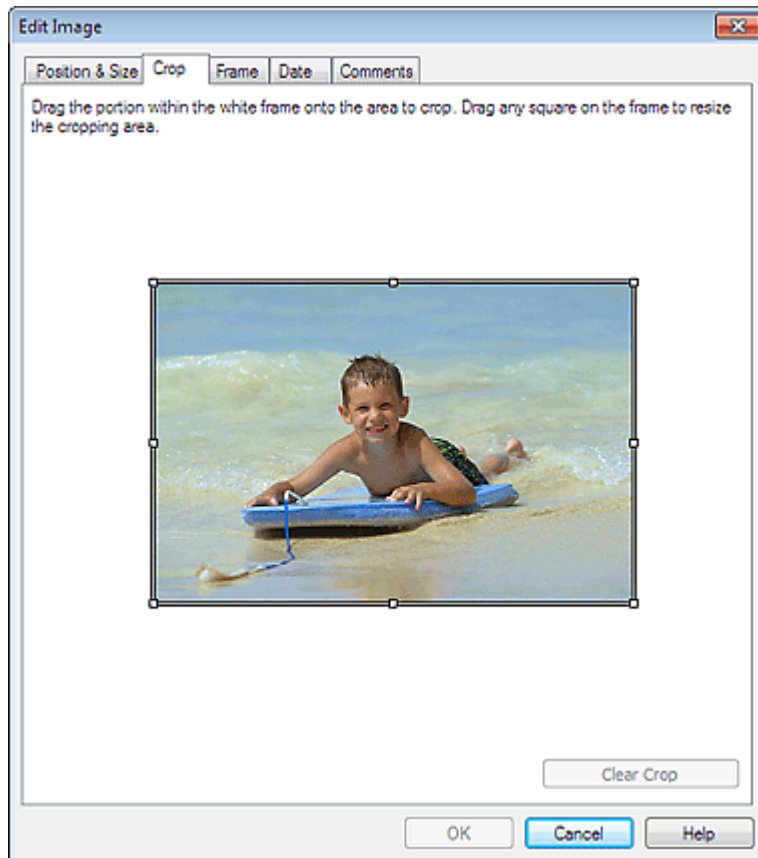

Drag the white squares on the image to adjust the area to be cropped and click OK.

Note

- See Help for details on cropping.

Advanced Guide

Advanced Guide > Printing from a Computer > Printing with the Bundled Application Software > Other Settings > Framing Photos

A087

Easy-PhotoPrint EX



Framing Photos

You can add frames to images.

Important

- You cannot add frames to images in Stickers and Layout Print.

Select the image you want to frame in the Edit screen and click  (Edit Image) or double-click the image.

Click the Frame tab in the Edit Image dialog box.

Note

- The screen(s) for Album printing is (are) used as example(s) in the following descriptions. The screen(s) may vary depending on what you create.

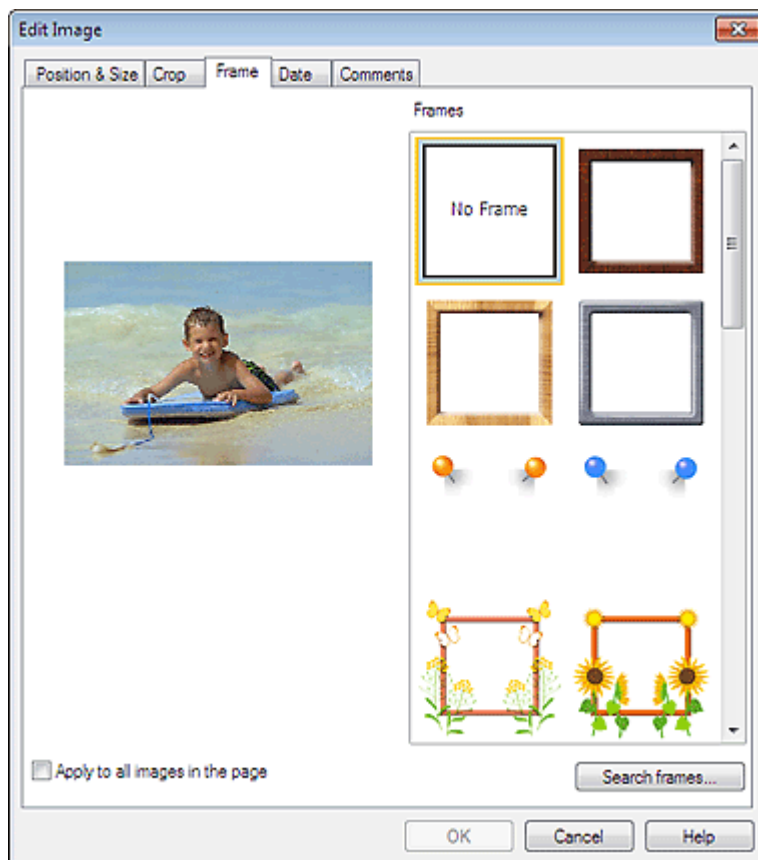

Select the frame you want to use from Frames and click OK.

Important

- You cannot print dates on framed photos.

Note

- Select the Apply to all images in the page checkbox to add the same frame to all the images on a selected page at one time.
 - Various frames are available on our website besides those saved in the application. Click Search frames... to access the Canon website from which you can download additional materials for free.
 - Internet connection is required to access the website. Internet connection fees apply.
 - Exit Easy-PhotoPrint EX before installing frames.
 - Search frames... will be displayed only if Album has been selected.
 - See Help for details on frames.
-

[Page top](#) ↕

Advanced Guide

Advanced Guide > Printing from a Computer > Printing with the Bundled Application Software > Other Settings > Printing Dates on Photos

A088

Easy-PhotoPrint EX



Printing Dates on Photos

You can print dates on images.

Select the image you want to print the date on in the Edit screen and click  (Edit Image) or double-click the image.

Click the Date tab in the Edit Image dialog box.

Note

- The screen(s) for Album printing is (are) used as example(s) in the following descriptions. The screen(s) may vary depending on what you create.

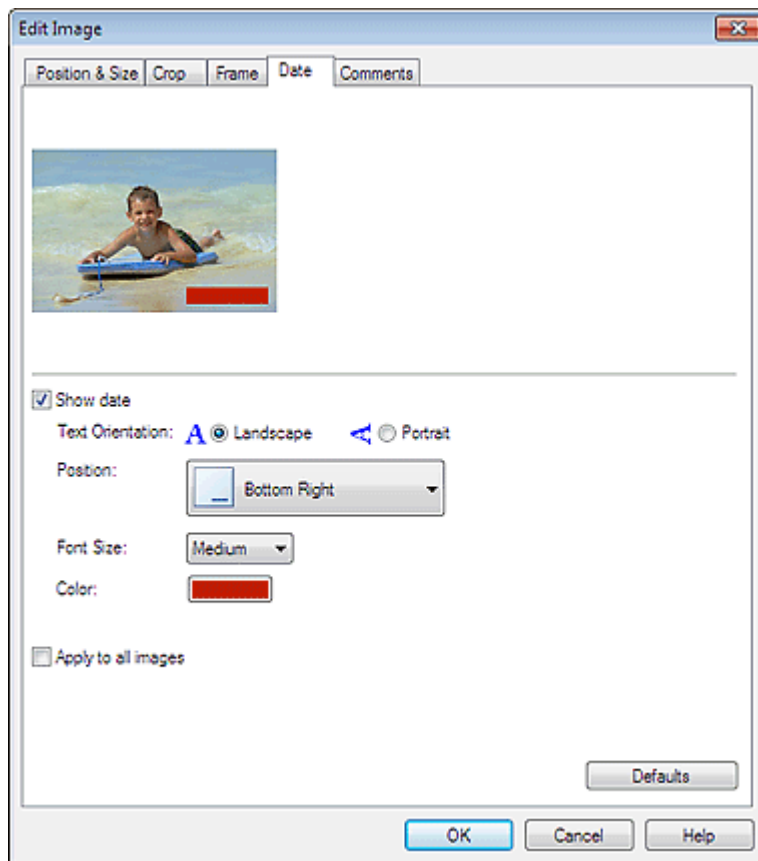

Select the Show date checkbox.

Set the Text Orientation, Position, Font Size and Color, then click OK.

Important

- You cannot print dates on framed images.

Note

- The date is displayed in the short date format (mm/dd/yyyy, etc.) specified in your operating system.
- See Help for details on setting dates.

[Page top](#) 

Advanced Guide

Advanced Guide > Printing from a Computer > Printing with the Bundled Application Software > Other Settings > Attaching Comments to Photos

A089

Easy-PhotoPrint EX



Attaching Comments to Photos

You can attach comments to images and display them in your album. The photo name, shooting date and comments are displayed (from top to bottom) in a comment box.



Important

- You cannot attach comments to Calendar, Stickers, and Layout Print.

Select the image you want to attach comments to in the Edit screen and click  (Edit Image) or double-click the image.

Click the Comments tab in the Edit Image dialog box.

Note

- The screen(s) for Album printing is (are) used as example(s) in the following descriptions. The screen(s) may vary depending on what you create.

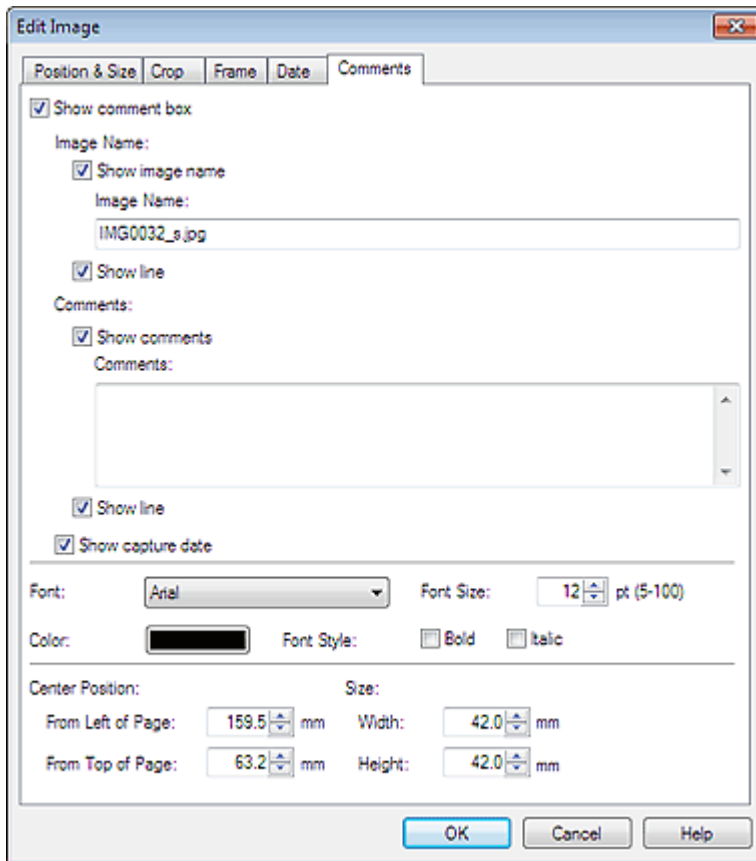

Select the Show comment box checkbox.

Select the checkboxes of the items you want to display, and enter comments.

Set the size and color of font, and position of the comments, etc., then click OK.

Note

- See Help for details on comments.

Advanced Guide

Advanced Guide > Printing from a Computer > Printing with the Bundled Application Software > Other Settings > Adding Text to Photos

A090

Easy-PhotoPrint EX



Adding Text to Photos

You can add text to photos.

Click  (Add Text) in the Edit screen and drag the mouse over the area in which you want to add text.

Note

- The screen(s) for Album printing is (are) used as example(s) in the following descriptions. The screen(s) may vary depending on what you create.

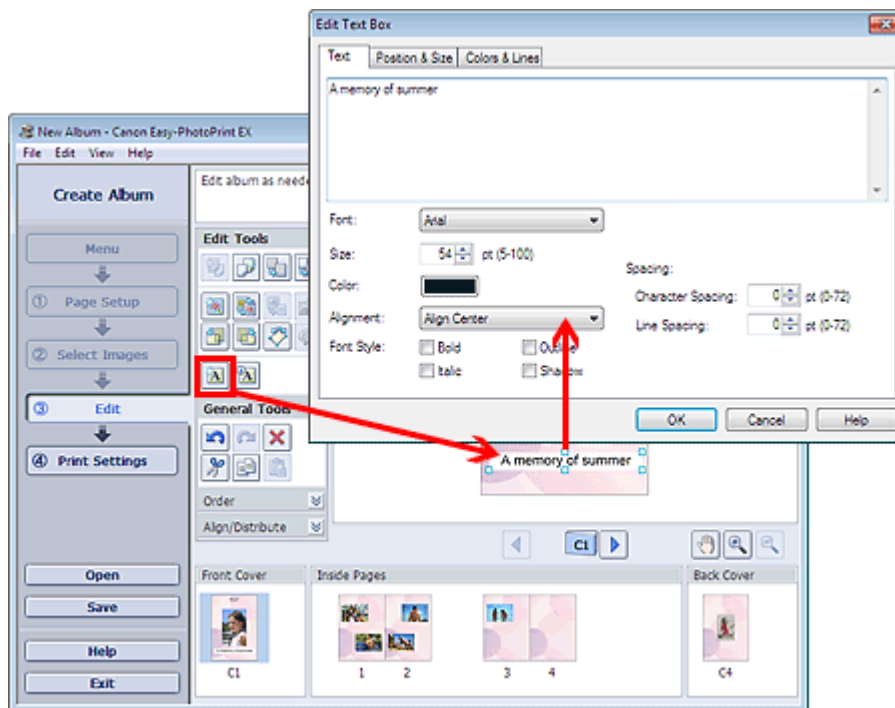

Select the Text tab in the Edit Text Box dialog box and enter text, then click OK.

Note

- In the Edit Text Box dialog box, you can change the position, angle and size of the text. You can also set the color and line of the text box. See Help for details.
- To change the entered text, select the text box and click  (Edit Text Box). The Edit Text Box dialog box appears. You can change the text.

[Page top](#)

Advanced Guide

Advanced Guide > Printing from a Computer > Printing with the Bundled Application Software > Other Settings > Saving

A091

Easy-PhotoPrint EX



Saving

You can save edited items.

Click Save in the Edit or Print Settings screen.

Note

- The screen(s) for Album printing is (are) used as example(s) in the following descriptions. The screen(s) may vary depending on what you create.



When the Save As dialog box appears, specify the save location and file name, then click Save.

Important

- If you edit a saved file and save it again, the file will be overwritten. To save a file again with a new name or to a different location, select Save As... from the File menu and save.

Note

- Save will not be displayed in the Page Setup or Select Images screen.

[Page top](#)

Advanced Guide

Advanced Guide > Printing from a Computer > Printing with the Bundled Application Software > Other Settings > Setting Holidays

A099

Easy-PhotoPrint EX



Setting Holidays

You can add holidays to your calendar.

Click Set Holidays... in the Page Setup screen of Calendar, or click  (Setup Period/Holiday) in the Edit screen and click Set Holidays... in the Calendar General Settings dialog box to display the Holiday Settings dialog box.

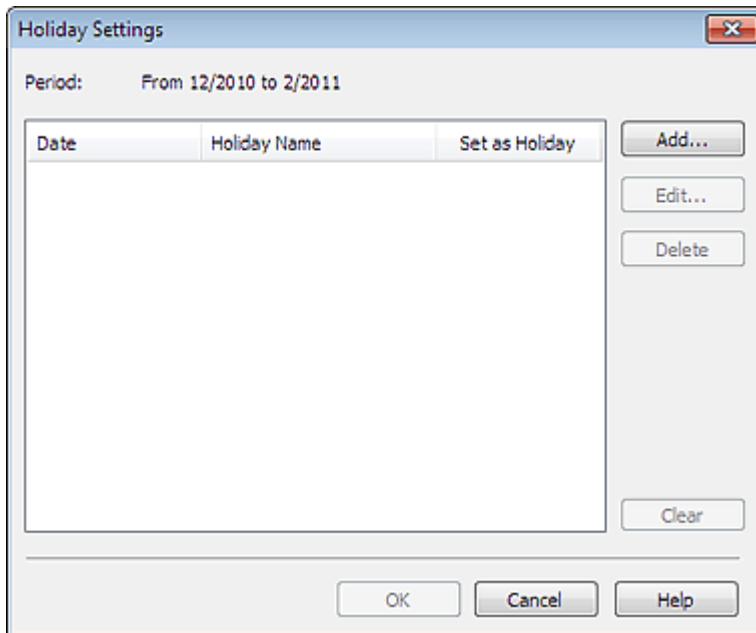

To add a holiday, click Add.... The Add/Edit Holiday dialog box appears. To edit a saved holiday, select it and click Edit....

To delete a holiday, select it and click Delete. To delete all the saved holidays within your calendar period, click Clear.

In the Add/Edit Holiday dialog box that appears by clicking Add... or Edit..., you can specify the name and date of the holiday.

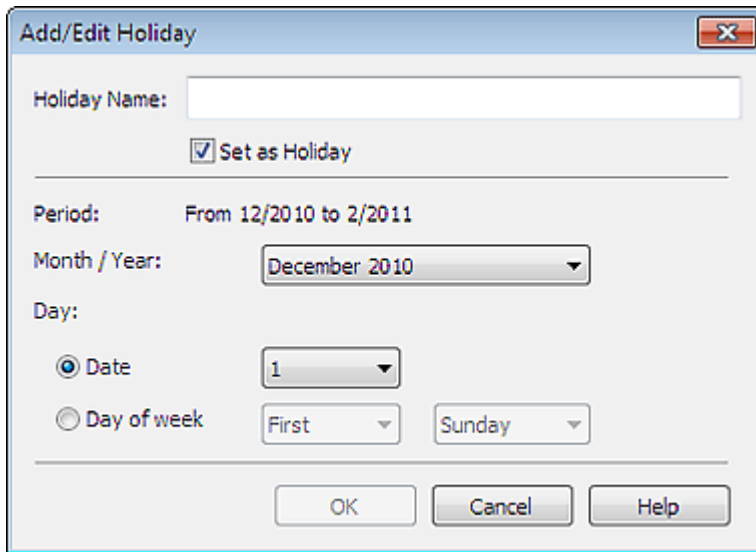

Add/Edit Holiday

Holiday Name:

Set as Holiday

Period: From 12/2010 to 2/2011

Month / Year:

Day:

Date

Day of week

Enter the name in Holiday Name and specify the date.

Select the Set as Holiday checkbox to display that day as a holiday in your calendar.

Note

- See Help for details on each dialog box.

[Page top](#)

Advanced Guide

Advanced Guide > Printing from a Computer > Printing with the Bundled Application Software > Other Settings > Setting Calendar Display

A100

Easy-PhotoPrint EX



Setting Calendar Display

You can customize the calendar display (fonts, lines, colors, position, size, etc.).

Click Settings... in the Page Setup screen of Calendar, or select a calendar in the Edit screen and click



(Setup Calendar) to display the Calendar Settings dialog box.

Important

- The Position & Size tab is displayed only when the Calendar Settings dialog box is displayed from the Edit screen.

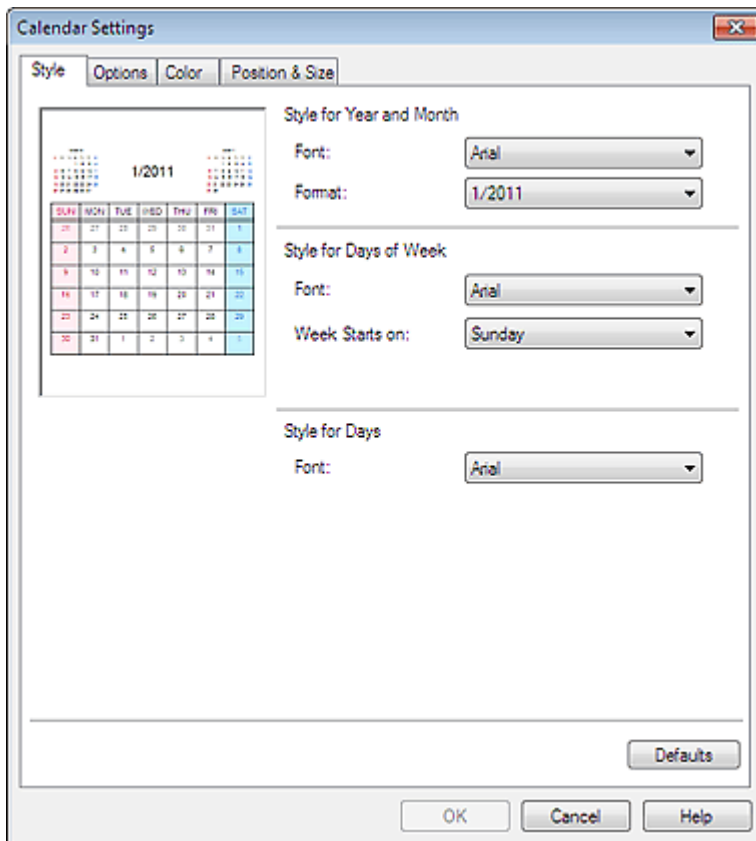

Note

- See Help for details on the Calendar Settings dialog box.

Advanced Guide

Advanced Guide > Printing from a Computer > Printing with the Bundled Application Software > Other Settings > Opening Saved Files

A103

Easy-PhotoPrint EX



Opening Saved Files

You can open files created with Easy-PhotoPrint EX.

1. Click Library from Menu.

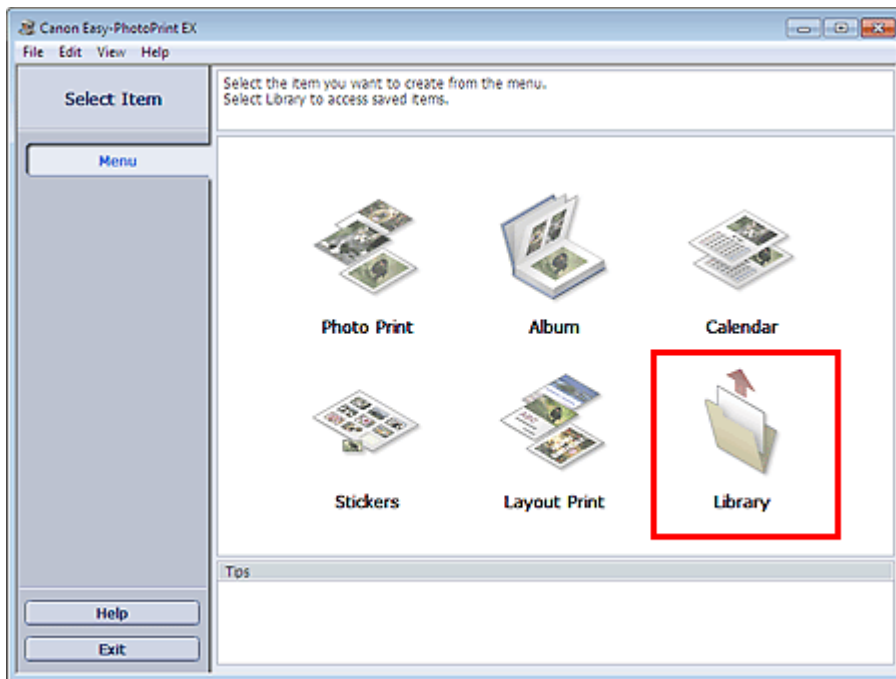

The Open dialog box appears.

You can check files created and saved with Easy-PhotoPrint EX in icon view (only for Windows 7/Windows Vista) or thumbnail view.

Important

- When using 64-bit editions of Windows 7, Windows Vista, or Windows XP, the contents of files cannot be displayed on Explorer.

2. Select the file you want to open and click Open.

The Edit screen appears.

3. Edit the file if necessary.

Note

- See the following sections for details on the editing procedures.
 - ➔ Editing Album
 - ➔ Editing Calendar
 - ➔ Editing Stickers
 - ➔ Editing Layout Print

Note

- Easy-PhotoPrint EX supports the following file formats (extensions).
 - Easy-PhotoPrint EX Album file (.el1)
 - Easy-PhotoPrint EX Stickers file (.el2)
 - Easy-PhotoPrint EX Calendar file (.el4)
 - Easy-PhotoPrint EX Layout file (.el5)
 - You can open files created with Easy-PhotoPrint EX with the following methods, besides from Library in Menu.
 - Click Open in the step button area of each screen, then select the file you want to edit.
 - Double-click the file.
 - From the File menu, click Open..., then select the file you want to edit.
 - You can also open a recently used file by clicking the file name shown in the File menu.
-

[Page top](#) ↕

Advanced Guide

[Advanced Guide](#) > [Printing from a Computer](#) > [Printing with Other Application Software](#)

Printing with Other Application Software

- ➔ [Various Printing Methods](#)
- ➔ [Changing the Print Quality and Correcting Image Data](#)
- ➔ [Overview of the Printer Driver](#)

[Page top](#) ↑

Advanced Guide

Advanced Guide > Printing from a Computer > Printing with Other Application Software > Various Printing Methods

Various Printing Methods

- ➔ [Printing with Easy Setup](#)
- ➔ [Setting a Page Size and Orientation](#)
- ➔ [Setting the Number of Copies and Printing Order](#)
- ➔ [Setting the Stapling Margin](#)
- ➔ [Execute Borderless Printing](#)
- ➔ [Fit-to-Page Printing](#)
- ➔ [Scaled Printing](#)
- ➔ [Page Layout Printing](#)
- ➔ [Poster Printing](#)
- ➔ [Booklet Printing](#)
- ➔ [Duplex Printing](#)
- ➔ [Stamp/Background Printing](#)
- ➔ [Registering a Stamp](#)
- ➔ [Registering Image Data to be Used as a Background](#)
- ➔ [Printing an Envelope](#)
- ➔ [Displaying the Print Results before Printing](#)
- ➔ [Setting Paper Dimensions \(Custom Size\)](#)

[Page top](#) ↑

Advanced Guide

Advanced Guide > Printing from a Computer > Printing with Other Application Software > Various Printing Methods > Printing with Easy Setup

P000

Printing with Easy Setup

The simple setup procedure for carrying out appropriate printing on this machine, is as follows:

1. Open the **printer driver setup window**
2. Select a frequently used profile

In Commonly Used Settings on the Quick Setup tab, select a printing profile suited for the purpose. When you select a printing profile, the Additional Features, Media Type, and Printer Paper Size settings are automatically switched to the values that were preset.

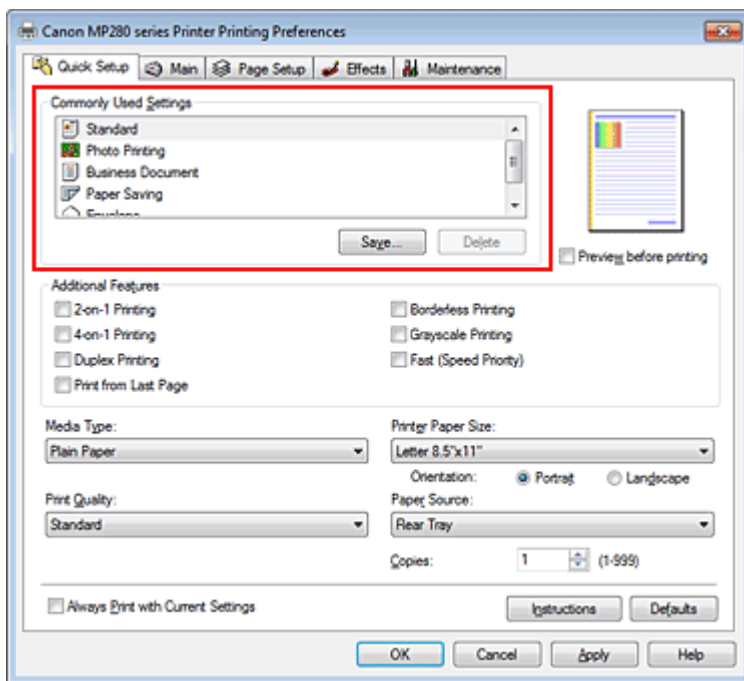

3. Select the print quality

For Print Quality, select High, Standard, or Fast according to your purpose.

4. Complete the setup

Click OK.

When you execute print, the document is printed with settings that matches your purpose.

Important

- When you select the Always Print with Current Settings check box, all settings specified on the Quick Setup, Main, Page Setup, and Effects tabs are saved, and you can print with the same settings from the next time as well. (Effects tab cannot be used when the XPS printer driver is used.)
- Click Save... to register the specified settings. For instructions on registering settings, see "Registering a Frequently Used Printing Profile."

Advanced Guide

Advanced Guide > Printing from a Computer > Printing with Other Application Software > Various Printing Methods > Setting a Page Size and Orientation

P400

Setting a Page Size and Orientation

The paper size and orientation are essentially determined by the application. When the page size and orientation set for Page Size and Orientation on the Page Setup tab are same as those set with the application, you do not need to select them on the Page Setup tab.

When you are not able to specify them with the application, the procedure for selecting a page size and orientation is as follows:

You can also set page size and Orientation on the Quick Setup tab.

1. Open the printer driver setup window

2. Select the paper size

Select a page size from the Page Size list on the Page Setup tab.

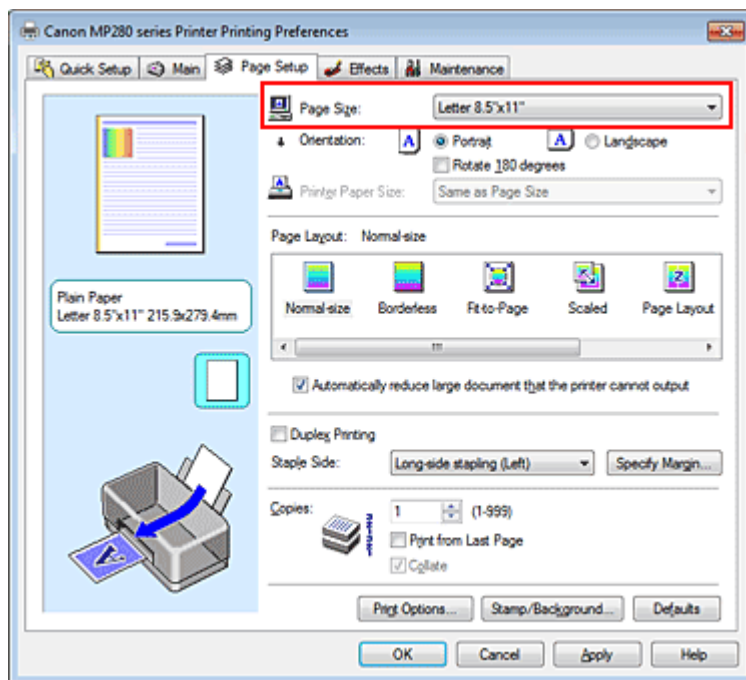

3. Set Orientation

Select Portrait or Landscape for Orientation. Check Rotate 180 degrees check box when you want to perform printing with the original being rotated 180 degrees.

4. Complete the setup

Click OK.

When you execute print, the document will be printed with the selected page size and the orientation.

Note

- If Normal-size is selected for Page Layout, then Automatically reduce large document that the printer cannot output is displayed. Normally, you can leave the Automatically reduce large document that the printer cannot output check box checked. During printing, if you do not want to reduce large documents that cannot be printed on the printer, uncheck the check box.

Advanced Guide

Advanced Guide > Printing from a Computer > Printing with Other Application Software > Various Printing Methods > Setting the Number of Copies and Printing Order

P001

Setting the Number of Copies and Printing Order

The procedure for specifying the number of copies and printing order is as follows:
You can also set the number of copies on the Quick Setup tab.

1. Open the **printer driver setup window**
2. Specify the number of copies to be printed

For Copies on the Page Setup tab, specify the number of copies to be printed.

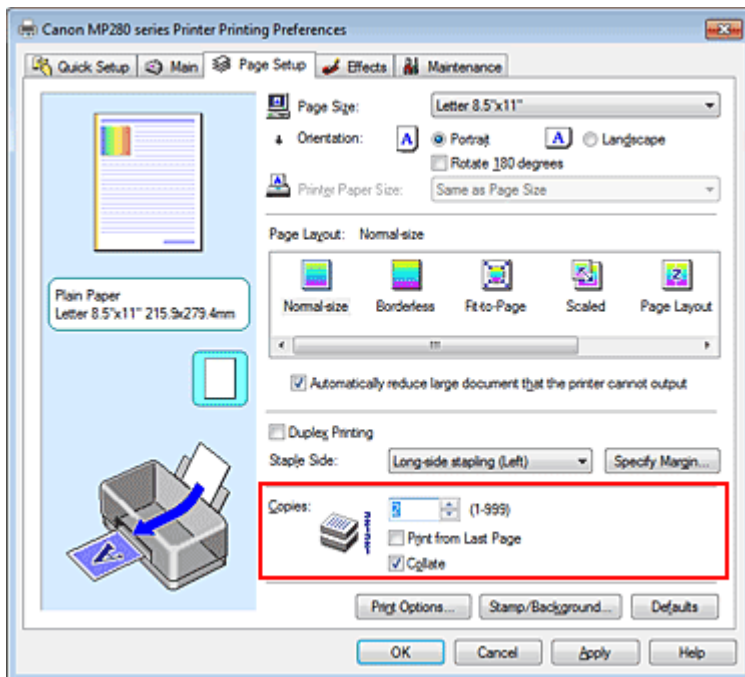

3. Specify the print order

Check the Print from Last Page check box when you want to print from the last page in order, and uncheck the check box when you want to print from the first page.

Check the Collate check box when you are printing multiple copies of a document and want to print out all pages in each copy together. Uncheck this check box when you want to print all pages with the same page number together.

- Print from Last Page: /Collate:

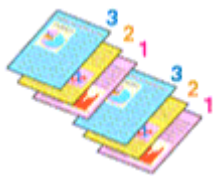

- Print from Last Page: /Collate:

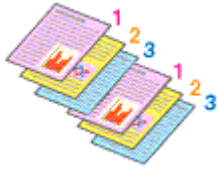

- Print from Last Page: /Collate:

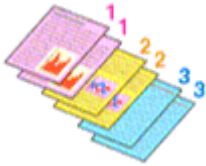

- Print from Last Page: /Collate:



4. Complete the setup

Click OK.

When you execute print, the specified number of copies will be printed with the specified printing order.

Important

- When the application software that you used to create the document has the same function, give priority to the printer driver settings. However, if the print results are not acceptable, specify the function settings on the application software. When you specify the number of copies and the printing order with both the application and this printer driver, the number of copies may be multiplied numbers of the two settings or the specified printing order may not be enabled.
- Print from Last Page and Collate appear grayed out and are unavailable when Booklet is selected for Page Layout.
- Print from Last Page appears grayed out and is unavailable when Poster is selected for Page Layout.

Note

- By setting both Print from Last Page and Collate, you can perform printing so that papers are collated one by one starting from the last page. These settings can be used in combination with Normal-size, Borderless, Fit-to-Page, Scaled, Page Layout, and Duplex Printing.

Advanced Guide

Advanced Guide > Printing from a Computer > Printing with Other Application Software > Various Printing Methods > Setting the Stapling Margin

P002

Setting the Stapling Margin



The procedure for setting the staple side and the margin width is as follows:

1. Open the **printer driver setup window**
2. Specify the side to be stapled

Check the position of the stapling margin from Staple Side on the Page Setup tab.

The printer analyzes the Orientation and Page Layout settings, and automatically selects the best staple position. When you want to change the setting, select from the list.

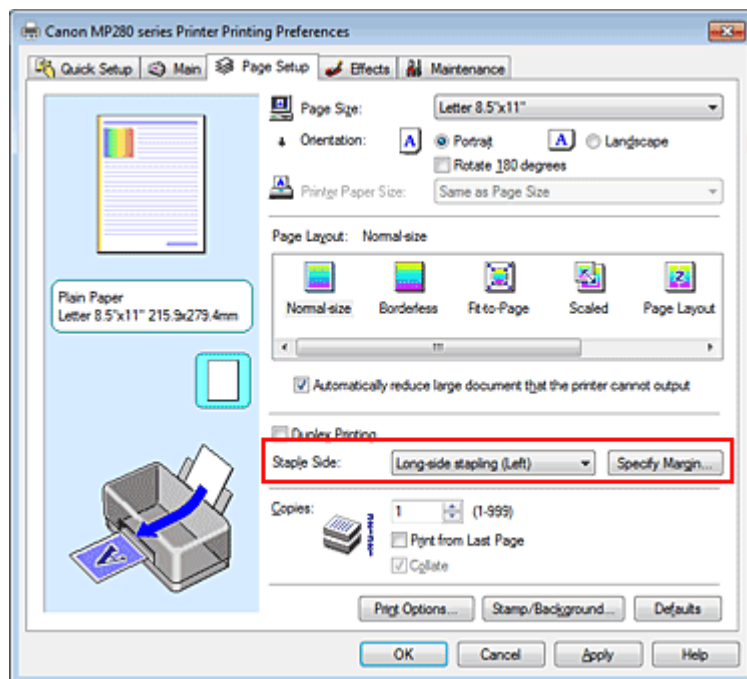

3. Set the margin width

If necessary, click Specify Margin... and set the margin width, and then click OK.

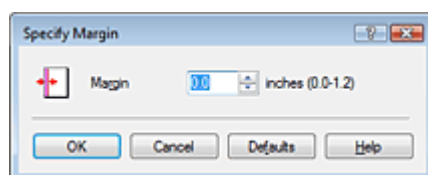

 **Note**

- The printer automatically reduces the print area depending on the staple position margin.

4. Complete the setup

Click OK on the Page Setup tab.

When you execute print, the data is printed with the specified staple side and margin width.

 **Important**

- Staple Side and Specify Margin... appear grayed out and are unavailable when:
 - Borderless, Poster, or Booklet is selected for Page Layout.
 - Scaled is selected for Page Layout (When Duplex Printing is also selected, only Staple Side can be specified).

[Page top](#) ↕

Advanced Guide

Advanced Guide > Printing from a Computer > Printing with Other Application Software > Various Printing Methods > Execute Borderless Printing

P003

Execute Borderless Printing

The borderless printing function allows you to print data without any margin by enlarging the data so that it extends slightly off the paper. Without the borderless printing function, a margin is provided around the printed data. When you want to print data such as a photo without providing any margin around it, set borderless printing.

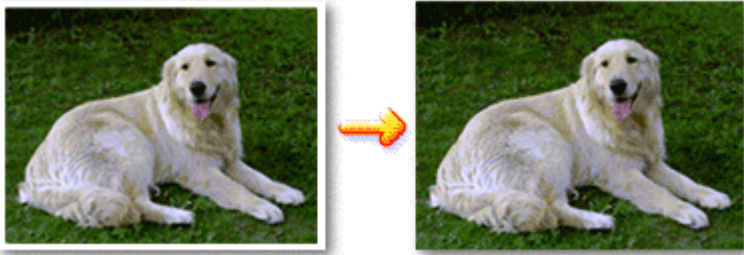

The procedure for performing borderless printing is as follows:

You can also set borderless printing in Additional Features on the Quick Setup tab.

Setting Borderless Printing

1. Open the **printer driver setup window**
2. Set borderless printing

Select Borderless from the Page Layout list on the Page Setup tab.

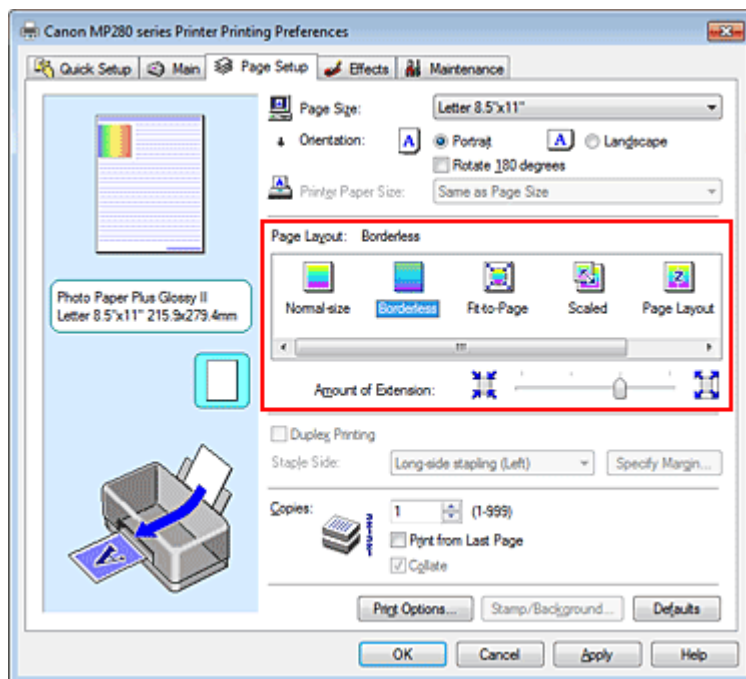

Click OK when the confirmation message appears.

When a message prompting you to change the media type appears, select a media type from the list and click OK.

3. Check the paper size

Check the Page Size list. When you want to change, select another page size from the list. The list displays only sizes that can be used for borderless printing.

4. Adjust the amount of extension from the paper

If necessary, adjust the amount of extension using the Amount of Extension slider.

Moving the slider to the right increases the amount extending off the paper, and moving the slider to the left decreases the amount.

It is recommended to set the slider at the second position from the right for most cases.



Important

- When you set the slider at the rightmost position, the back side of the paper may become smudged.

5. Complete the setup

Click OK.

When you execute print, the data is printed without any margins on the paper.

Important

- When a page size that cannot be used for borderless printing is selected, the size is automatically changed to the valid page sizes for borderless printing.
- When High Resolution Paper, T-Shirt Transfers, or Envelope is selected from the Media Type list on the Main tab, you cannot perform borderless printing.
- When Borderless is selected, the Printer Paper Size, Duplex Printing, Staple Side settings, and the Stamp/Background... (Stamp...) button on the Page Setup tab appear grayed out and are unavailable.
- Depending on the type of the media used during borderless printing, the print quality may deteriorate at the top and bottom of the sheet or stains may form.
- When the ratio of the height to the width differs from the image data, a portion of the image may not be printed depending on the size of the media used.
In this case, crop the image data with an application software according to the paper size.

Note

- When Plain Paper is selected for Media Type on the Main tab, borderless printing is not recommended, and therefore the message for media selection appears.
When you are using plain paper for test printing, select Plain Paper, and click OK.

Expanding the Range of the Document to Print

Setting a large amount of extension allows you to perform borderless printing with no problems. However, the portion of the document extending off the paper range will not be printed. Subjects around the perimeter of a photo may not be printed.

Try borderless printing once. When you are not satisfied with the result of borderless printing, reduce the amount of extension. The extension amount decreases as the Amount of Extension slider is moved to the left.

Important

- When the amount of extension is decreased, an unexpected margin may be produced on the print, depending on the size of the paper.

Note

- When the Amount of Extension slider is set to the leftmost position, image data will be printed in the full size.
- When Preview before printing is checked on the Main tab, you can confirm whether there will be no

border before printing.

[Page top](#) 

Advanced Guide

Advanced Guide > Printing from a Computer > Printing with Other Application Software > Various Printing Methods > Fit-to-Page Printing

P004

Fit-to-Page Printing



The procedure for printing a document that is automatically enlarged or reduced to fit the page size to be used is as follows:

1. Open the printer driver setup window
2. Set fit-to-page printing

Select Fit-to-Page from the Page Layout list on the Page Setup tab.

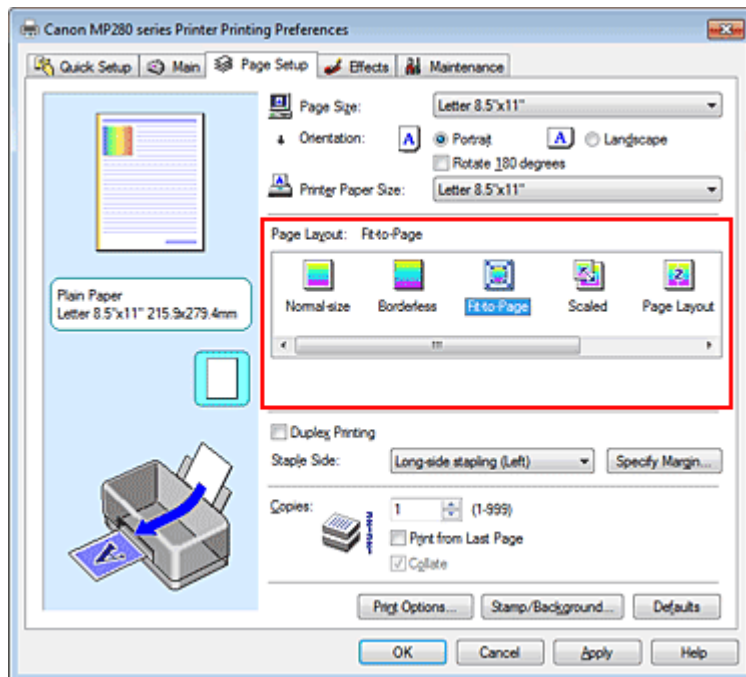

3. Select the paper size for the data

Using Page Size, select the page size that is set with your application.

4. Select the print paper size

Select the size of the paper loaded in the machine from the Printer Paper Size list.

When the Printer Paper Size is smaller than the Page Size, the page image will be reduced. When the Printer Paper Size is larger than the Page Size, the page image will be enlarged.

The current settings are displayed in the settings preview on the left side of the printer driver.

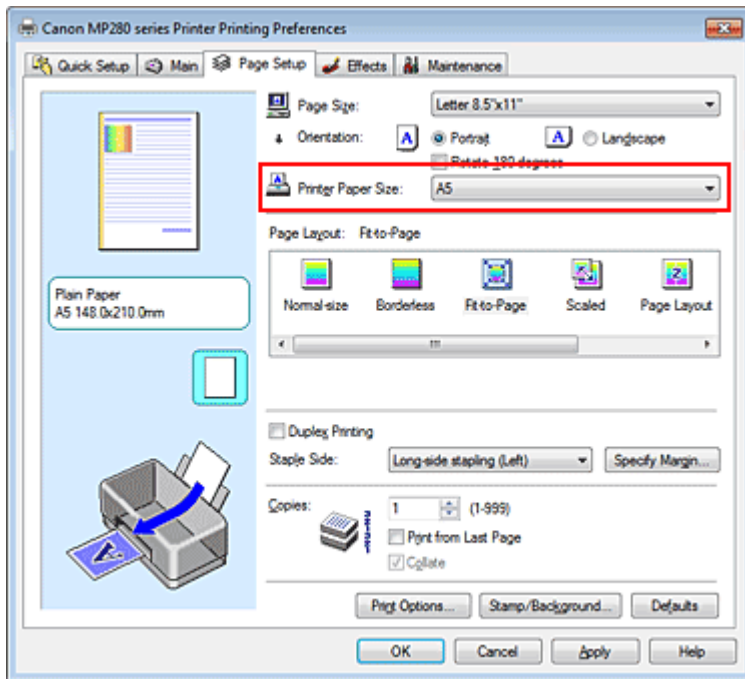

5. Complete the setup

Click OK.

When you execute print, the document will be enlarged or reduced to fit to the page size.

[Page top](#) ↕

Advanced Guide

Advanced Guide > Printing from a Computer > Printing with Other Application Software > Various Printing Methods > Scaled Printing

P005

Scaled Printing

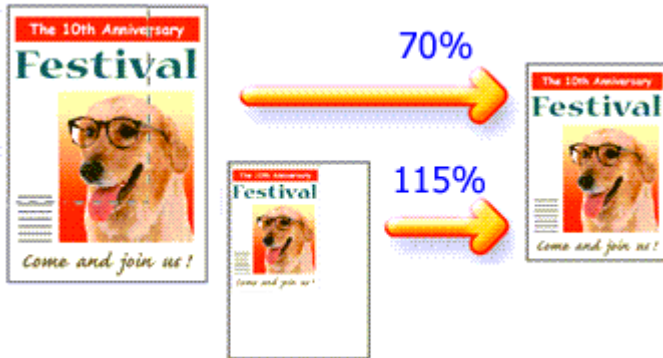

The procedure for printing a document with pages enlarged or reduced is as follows:

1. Open the printer driver setup window

2. Set scaled printing

Select Scaled from the Page Layout list on the Page Setup tab.

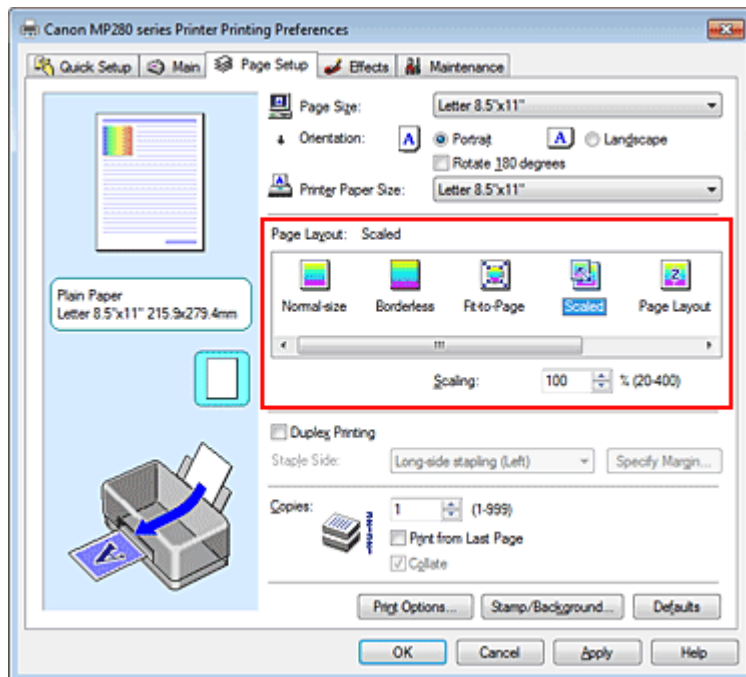

3. Select the paper size for the data

Using Page Size, select the page size that is set with your application.

4. Set the scaling rate by using one of the following methods:

- **Select a Printer Paper Size**

When the printer paper size is smaller than the Page Size, the page image will be reduced.
When the printer paper size is larger than the Page Size, the page image will be enlarged.

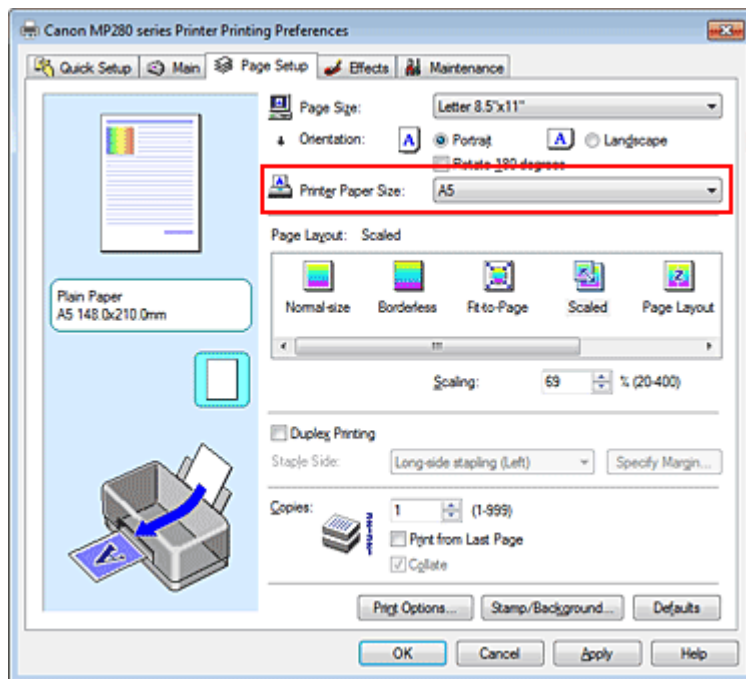

- **Specify a scaling factor**

Directly type in a value into the Scaling box.

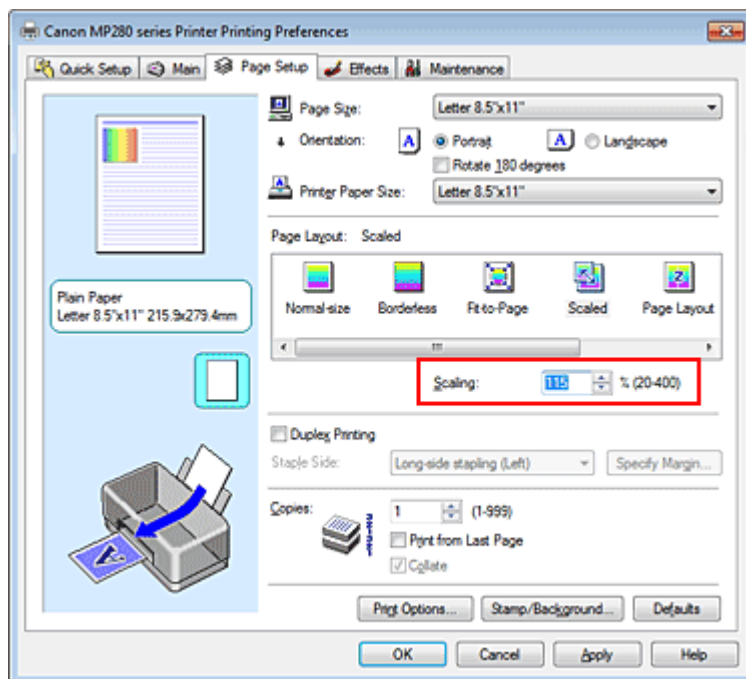

The current settings are displayed in the settings preview on the left side of the printer driver.

5. Complete the setup

Click OK.

When you execute print, the document will be printed with the specified scale.

Important

- When the application software which you created the original has the scaled printing function, configure the settings on your application software. You do not need to configure the same setting in the printer driver.
- When Scaled is selected, the Staple Side list box appears grayed out and is unavailable (when Duplex Printing is not selected).

Note

- Selecting Scaled changes the printable area of the document.
-

[Page top](#) 

Advanced Guide

Advanced Guide > Printing from a Computer > Printing with Other Application Software > Various Printing Methods > Page Layout Printing

P006

Page Layout Printing

The page layout printing function allows you to print more than one page image on a single sheet of paper.

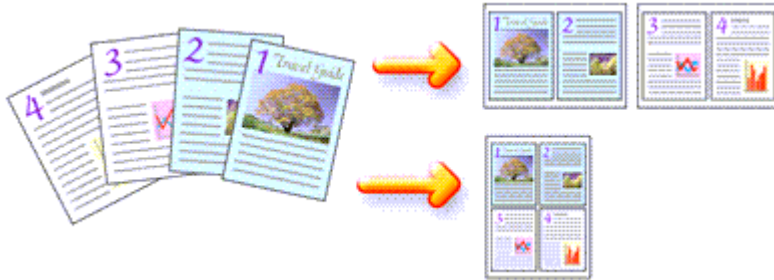

The procedure for performing page layout printing is as follows:

1. Open the **printer driver setup window**
2. Set page layout printing

Select Page Layout from the Page Layout list on the Page Setup tab.

The current settings are displayed in the settings preview on the left side of the printer driver.

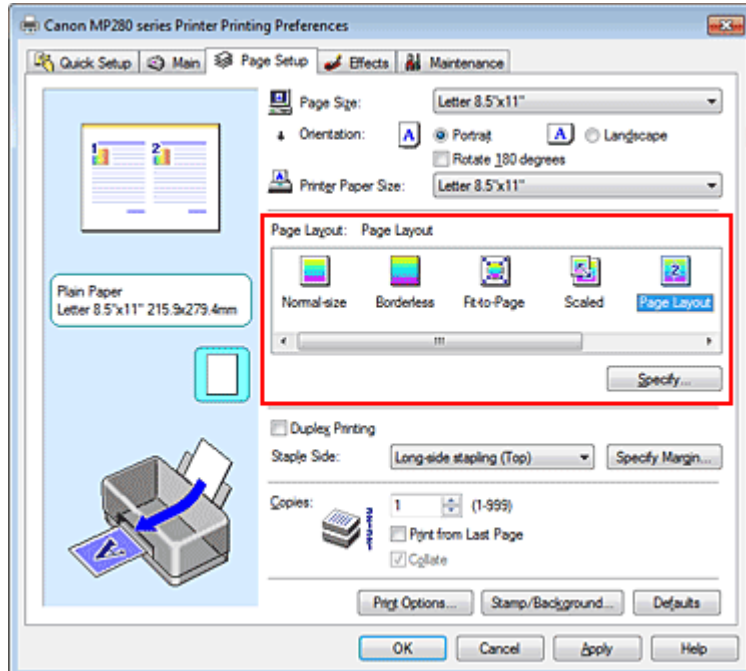

3. Select the print paper size

Select the size of the paper loaded in the machine from the Printer Paper Size list.

Setting the layout of two pages of the document from left to right is complete.

4. Set the number of pages to be printed on one sheet and the page order

If necessary, click Specify..., specify the following settings in the Page Layout Printing dialog box, and click OK.

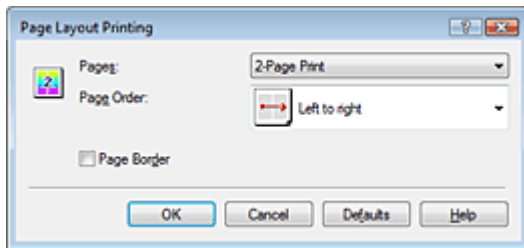
**Pages**

To change the number of pages to be printed on a single sheet of paper, select the number of pages from the list.

You can also set 2-Page Print or 4-Page Print on the Quick Setup tab.

Page Order

To change the page arrangement order, select an icon from the list to change the page placement order.

Page Border

To print a page border around each document page, check this check box.

5. Complete the setup

Click OK on the Page Setup tab.

When you execute print, the specified number of pages will be arranged on each sheet of paper in the specified order.

[Page top](#) ↕

Advanced Guide

Advanced Guide > Printing from a Computer > Printing with Other Application Software > Various Printing Methods > Poster Printing

P401

Poster Printing

The poster printing function allows you to enlarge image data, divide it into several pages, and print these pages on separate sheets of paper. When the pages are pasted together, they form a large print like a poster.

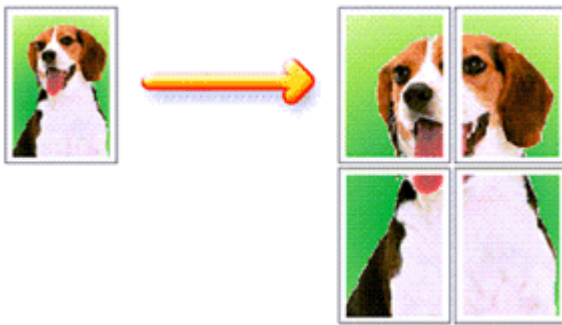

The procedure for performing poster printing is as follows:

Setting Poster Printing

1. Open the printer driver setup window
2. Set poster printing

Select Poster from the Page Layout list on the Page Setup tab.

The current settings are displayed in the settings preview on the left side of the printer driver.

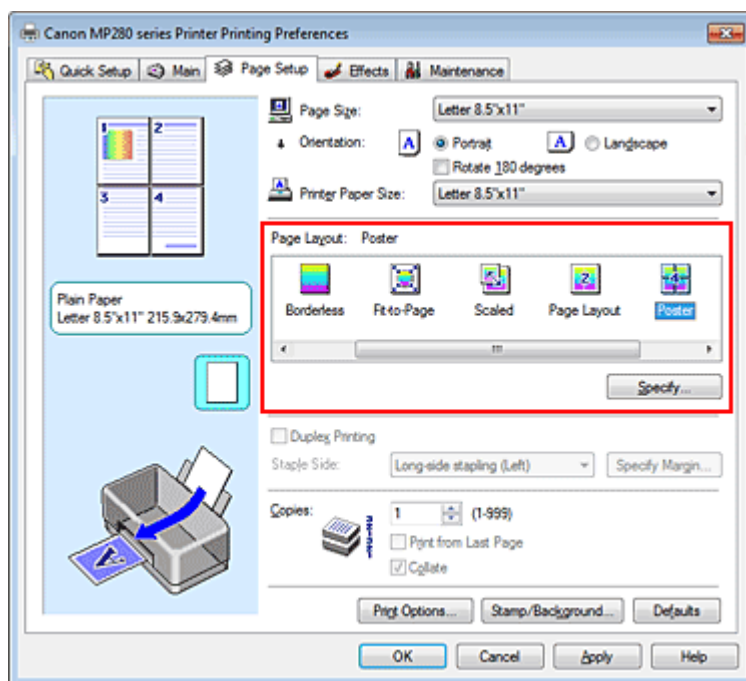

3. Select the print paper size

Select the size of the paper loaded in the machine from the Printer Paper Size list. Setting 2 by 2-page poster printing is complete.

4. Set the number of image divisions and the pages to be printed

If necessary, click Specify..., specify the following settings in the Poster Printing dialog box, and then click OK.

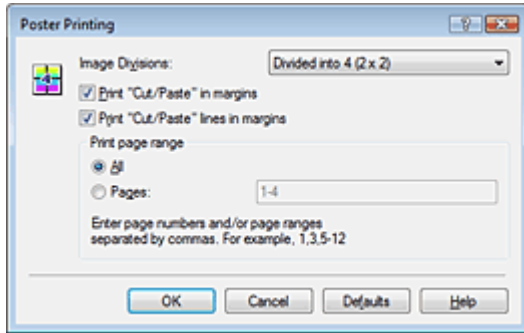

Image Divisions

Select the number of divisions (vertical x horizontal). As the number of divisions increases, the number of sheets used for printing increases, allowing you to create a larger poster.

Print "Cut/Paste" in margins

To leave out words "Cut" and "Paste", uncheck this check box.

Note

- This feature may be unavailable when certain printer drivers are used.

Print "Cut/Paste" lines in margins

To leave out cut lines, uncheck this check box.

Print page range

Specifies the printing range. Select All under normal circumstances.

To reprint only a specific page, select Pages and enter the page number you want to print. To specify multiple pages, enter the page numbers by separating them with commas or by entering a hyphen between the page numbers.

Note

- You can also specify the print range by clicking the pages in the settings preview.

5. Complete the setup

Click OK on the Page Setup tab.

When you execute print, the document will be divided into several pages during printing.

After all poster pages have been printed, paste the pages together to create a poster.

Printing Only Specific Pages

If ink becomes faint or runs out during printing, you can reprint only the specific pages by following the procedure below:

1. Set the print range

In the settings preview on the left of the Page Setup tab, click the pages that do not need to be printed.

The pages that were clicked are deleted, and only the pages to be printed are displayed.

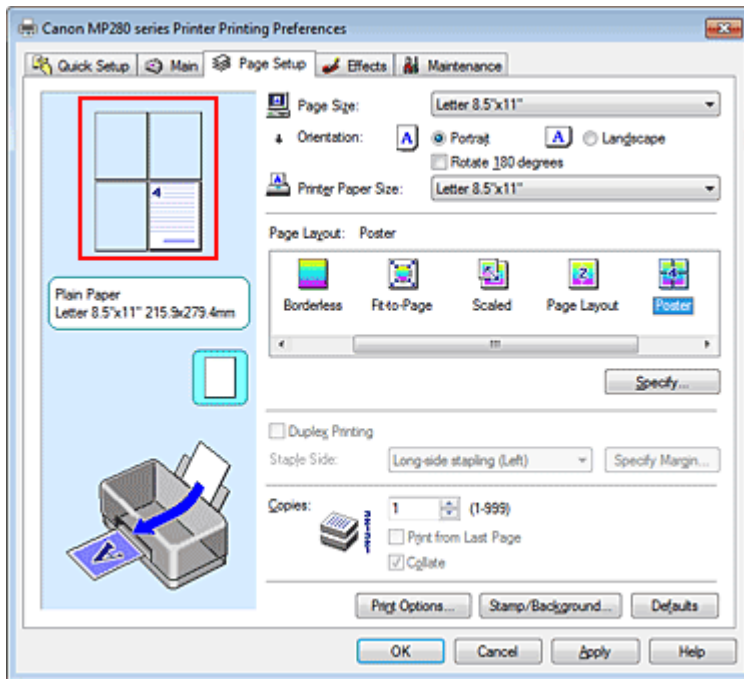

Note

- Click the deleted pages to display them again.
- Right-click the settings preview to select Print all pages or Delete all pages.

2. Complete the setup

After completing the page selection, click OK.
When you execute print, only specified pages will be printed.

Important

- When Poster is selected, the Duplex Printing, Staple Side and Print from Last Page appear grayed out and are unavailable.
- Since poster printing enlarges the document when printing it, the print results may become coarse.

Advanced Guide

Advanced Guide > Printing from a Computer > Printing with Other Application Software > Various Printing Methods > Booklet Printing

P402

Booklet Printing

The booklet printing function allows you to print data for a booklet. Data is printed on both sides of the paper. This type of printing ensures that pages can be collated properly, in page number order, when the printed sheets are folded and stapled at the center.

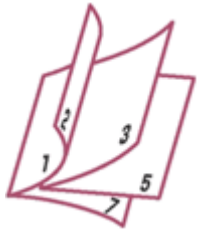

The procedure for performing booklet printing is as follows:

1. Open the **printer driver setup window**
2. Set booklet printing

Select Booklet from the Page Layout list on the Page Setup tab.

The current settings are displayed in the settings preview on the left side of the window.

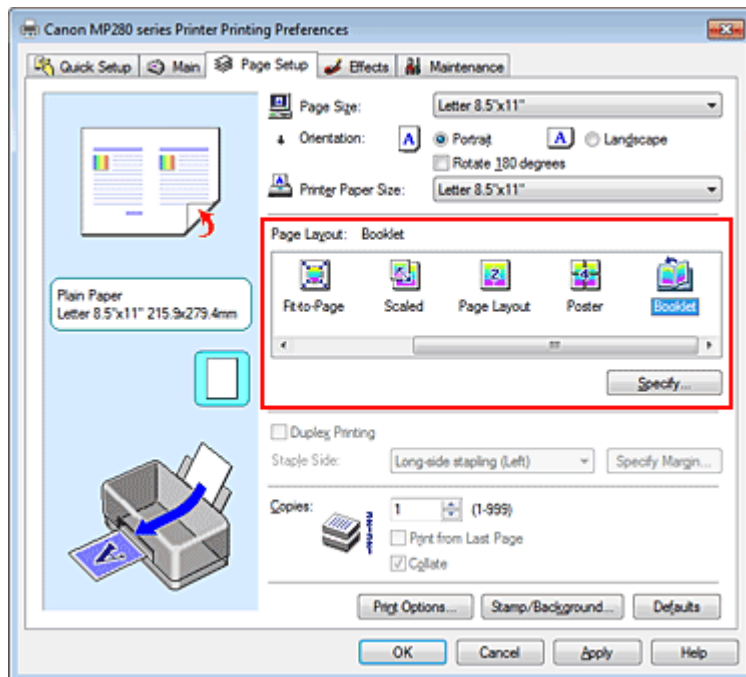

3. Select the print paper size

Select the size of the paper loaded in the machine from the Printer Paper Size list.

4. Set the margin for stapling and the margin width

Click Specify... and specify the following settings in the Booklet Printing dialog box, and then click OK.

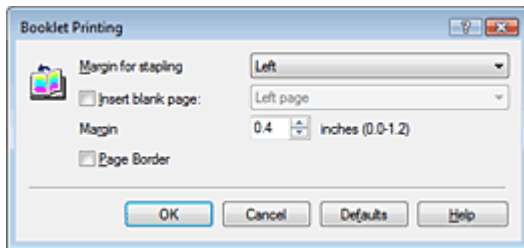
**Margin for stapling**

Select which side should the stapling margin be on when the booklet is completed.

Insert blank page

To leave one side of a sheet blank, check the check box, and select the page to be left blank.

Margin

Enter the margin width. The specified width from the center of the sheet becomes the margin width for one page.

Page Border

To print a page border around each document page, check the check box.

5. Complete the setup

Click OK on the Page Setup tab.

When you execute print, the document will be printed on one side of a sheet of paper. When the printing of one side is complete, set the paper correctly by following the message and click OK. When the printing of the other side is complete, fold the paper at the center of the margin and make a booklet.

Important

- Booklet cannot be selected when a media type other than Plain Paper is selected for Media Type on the Main tab.
- When Booklet is selected, Duplex Printing, Staple Side, Print from Last Page, and Collate appear grayed out and are unavailable.

Note

- The stamp and background are not printed on the inserted blank sheets with the Insert blank page function of booklet printing.

Advanced Guide

Advanced Guide > Printing from a Computer > Printing with Other Application Software > Various Printing Methods > Duplex Printing

P007

Duplex Printing

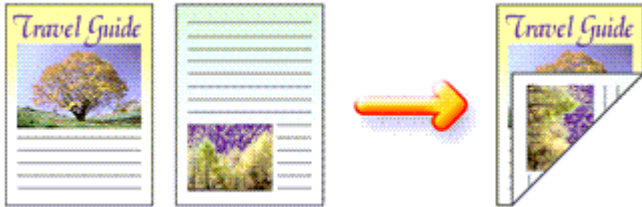

The procedure for printing data on both sides of a sheet of paper is as follows:
You can also set duplex printing in Additional Features on the Quick Setup tab.

1. Open the printer driver setup window
2. Set duplex printing

Check the Duplex Printing check box on the Page Setup tab.

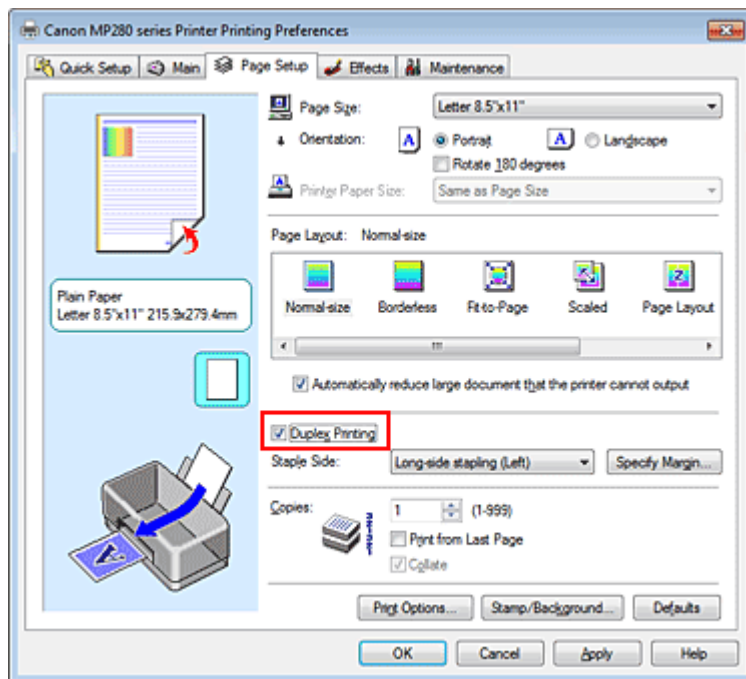

3. Select the layout

Select Normal-size (or Fit-to-Page, Scaled, or Page Layout) from the Page Layout list.

4. Specify the side to be stapled

The machine analyzes the Orientation and Page Layout settings, and automatically selects the best Staple Side. When you want to change the setting, select another value from the list.

5. Set the margin width

If necessary, click Specify Margin... and set the margin width, and then click OK.

6. Complete the setup

Click OK on the Page Setup tab.

When you execute print, the document is first printed on one side of a sheet of paper. After one side is printed, reload the paper correctly according to the message.

Then click OK to print the opposite side.

Important

- When a media type other than Plain Paper is selected from Media Type, Duplex Printing appears grayed out and is unavailable.
- When Borderless, Poster or Booklet is selected from the Page Layout list, Duplex Printing and Staple Side appear grayed out and are unavailable.

Note

- If the back side of the paper becomes smudged during duplex printing, perform Bottom Plate Cleaning in the Maintenance tab.

Related Topic

[➔ Cleaning Inside the Machine](#)

[Page top](#) 

Advanced Guide

Advanced Guide > Printing from a Computer > Printing with Other Application Software > Various Printing Methods > Stamp/Background Printing

P403

Stamp/Background Printing

Stamp or Background may be unavailable when certain printer drivers are used.

The Stamp function allows you to print a stamp text or a bitmap over or behind document data. It also allows you to print date, time and user name. The Background function allows you to print a light illustration behind the document data.

The procedure for performing stamp/background printing is as follows:

Printing a Stamp

"CONFIDENTIAL," "IMPORTANT," and other stamps that are used often in companies are pre-registered.

1. Open the **printer driver setup window**
2. Click Stamp/Background... (Stamp...) on the Page Setup tab

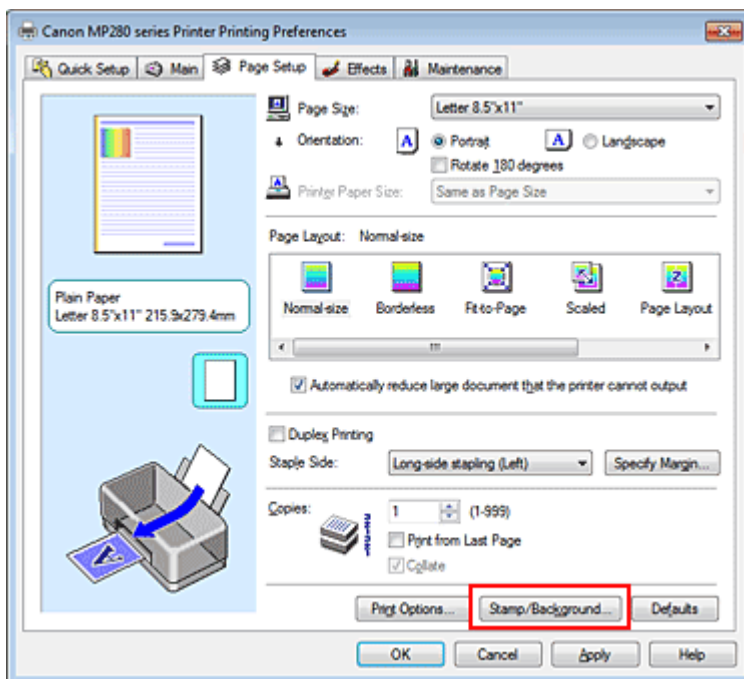

The Stamp/Background (Stamp) dialog box opens.

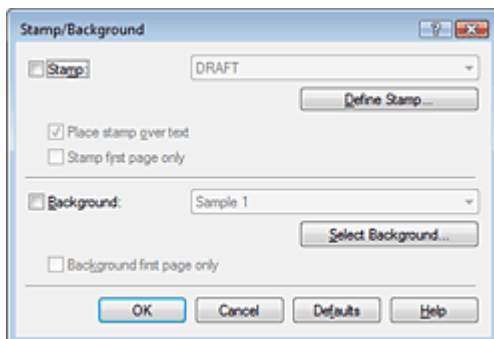

- With the XPS printer driver, the Stamp/Background... button has become the Stamp... button and only the stamp function can be used.
-

3. Select a stamp

Check the Stamp check box, and select the stamp to be used from the list.
The current settings are displayed in the settings preview on the left side of the Page Setup tab.

4. Set the stamp details

If necessary, specify the following settings, and then click OK.

Define Stamp... button

To change the stamp text, bitmap, or position, click this (see "[Registering a Stamp](#)").

Place stamp over text

To print the stamp on the front of the document, check this check box.



Note

- The stamp is given priority because the stamp is printed over the document data in the sections where the stamp and the document data overlap. When this check box is unchecked, the stamp is printed behind the document data and may be hidden in the overlapping sections depending on the application used.
 - Place stamp over text cannot be used when the XPS printer driver is used. When the XPS printer driver is used, the stamp is normally printed in the foreground of the document.
-

Print semitransparent stamp

Check this check box to print a semi-transparent stamp on the document.
This function is available only when the XPS printer driver is used.

Stamp first page only

To print the stamp only on the first page, check this check box.

5. Complete the setup

Click OK on the Page Setup tab.
When you execute print, the data is printed with the specified stamp.

Printing a Background

Two bitmap files are pre-registered as samples.

1. Open the [printer driver setup window](#)

2. Click Stamp/Background... on the Page Setup tab

The Stamp/Background dialog box opens.

3. Select the background

Check the Background check box, and select the background to be used from the list.
The current settings are displayed in the settings preview on the left side of the Page Setup tab.

4. Set the background details

If necessary, complete the following settings, and then click OK.

Select Background... button

To use another background or change the layout or density of a background, click this (see "[Registering Image Data to be Used as a Background](#) ").

Background first page only

To print the background only on the first page, check this check box.

5. Complete the setup

Click OK on the Page Setup tab.

When you execute print, the data is printed with the specified background.

Important

- When Borderless is selected, the Stamp/Background... (Stamp...) button appears grayed out and is unavailable.

Note

- The stamp and background are not printed on blank sheets inserted with the Insert blank page function of booklet printing.

Related Topics

- ➔ [Registering a Stamp](#)
- ➔ [Registering Image Data to be Used as a Background](#)



[Page top](#) 

Advanced Guide

Advanced Guide > Printing from a Computer > Printing with Other Application Software > Various Printing Methods > Stamp/Background Printing > Registering a Stamp

P404

Registering a Stamp

This feature may be unavailable when certain printer drivers are used.

You can create and register a new stamp. You can also change and register some of the settings of an existing stamp. Unnecessary stamps can be deleted at any time.

The procedure for registering a new stamp is as follows:

Registering a New Stamp

1. Open the [printer driver setup window](#)
2. Click Stamp/Background... (Stamp...) on the Page Setup tab

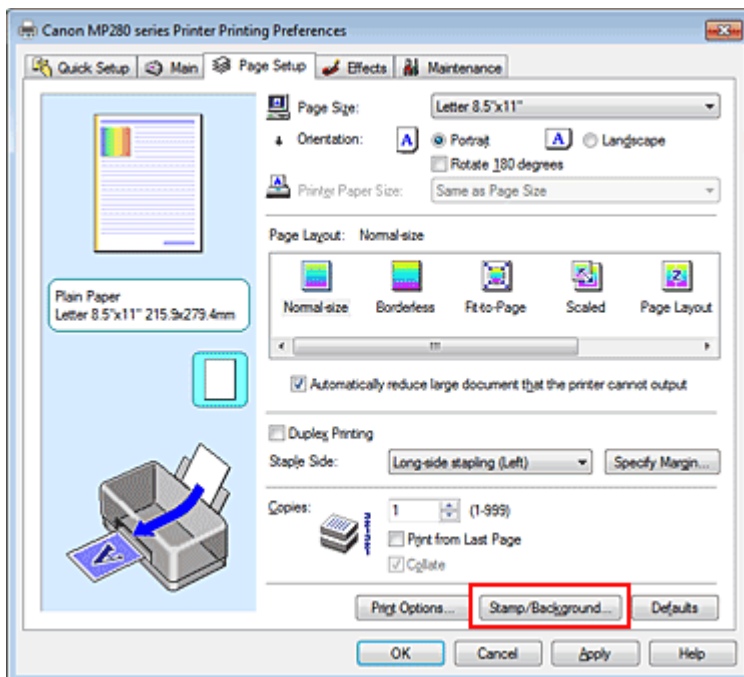

The Stamp/Background (Stamp) dialog box opens.

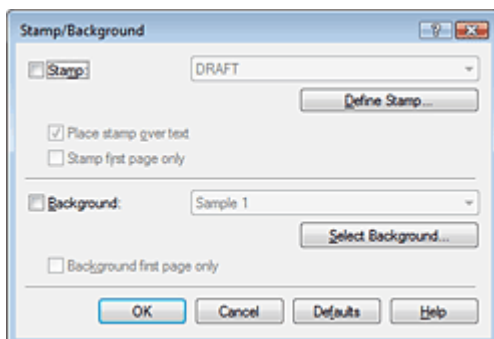

Note

- With the XPS printer driver, the Stamp/Background... button has become the Stamp... button and only the stamp function can be used.

3. Click Define Stamp...

The Stamp Settings dialog box opens.

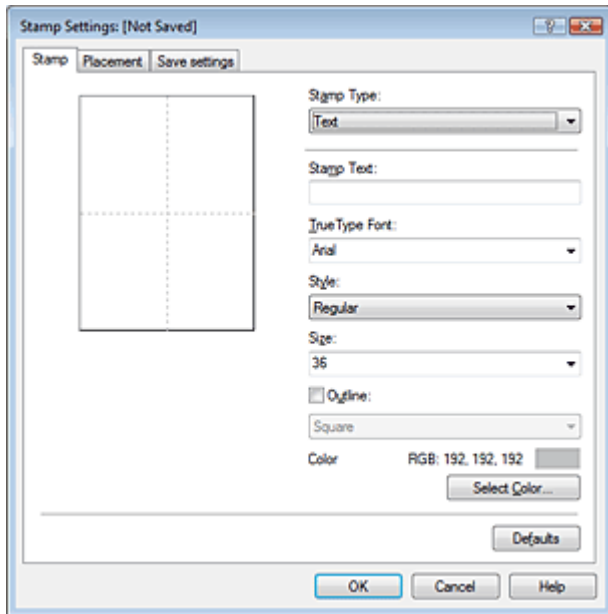

4. Configure the stamp while viewing the preview window

- **Stamp tab**

Select Text, Bitmap, or Date/Time/User Name that matches your purpose for Stamp Type.

- For Text registration, the characters must already be entered in Stamp Text. If necessary, change the TrueType Font, Style, Size, and Outline settings. You can select the color of the stamp by clicking Select Color....
- For Bitmap, click Select File... and select the bitmap file (.bmp) to be used. If necessary, change the settings of the Size and Transparent white area.
- For Date/Time/User Name, the creation date/time and user name of the printed object are displayed in Stamp Text. If necessary, change the settings of TrueType Font, Style, Size, and Outline. You can select the color of the stamp by clicking Select Color....

Important

- Stamp Text appears grayed out and is unavailable when Date/Time/User Name is selected.

- **Placement tab**

Select the stamp position from the Position list. You can also select Custom from the Position list and specify coordinates for X-Position and Y-Position.

You can also change the stamp position by dragging the stamp in the preview window.

To change the stamp position angle, type a value in the Orientation box directly.

5. Save the stamp

Click the Save settings tab and enter a title in the Title box, and then click Save.

Click OK when the confirmation message appears.

6. Complete the setup

Click OK. The Stamp/Background (Stamp) dialog box opens again.

The registered title appears in the Stamp list.

Changing and Registering Some of Stamp Settings

1. Select the stamp for which the settings are to be changed

Check the Stamp check box in the Stamp/Background (Stamp) dialog box, and then select the title of the stamp to be changed from the Stamp list.

2. Click Define Stamp...

The Stamp Settings dialog box opens.

3. Configure the stamp while viewing the preview window

4. Overwrite save the stamp

Click Save overwrite on the Save settings tab.

When you want to save the stamp with a different title, type a new title in the Title box and click Save.

Click OK when the confirmation message appears.

5. Complete the setup

Click OK. The Stamp/Background (Stamp) dialog box opens again.

The registered title appears in the Stamp list.

Deleting an Unnecessary Stamp

1. Click Define Stamp... in the Stamp/Background (Stamp) dialog box

The Stamp Settings dialog box opens.

2. Select the stamp to be deleted

Select the title of the stamp you want to delete from the Stamps list on the Save settings tab. Then click Delete.

Click OK when the confirmation message appears.

3. Complete the setup

Click OK. The Stamp/Background (Stamp) dialog box opens again.



Advanced Guide

Advanced Guide > Printing from a Computer > Printing with Other Application Software > Various Printing Methods > Stamp/Background Printing > Registering Image Data to be Used as a Background

P405

Registering Image Data to be Used as a Background

This feature may be unavailable when certain printer drivers are used.

You can select a bitmap file (.bmp) and register it as a new background. You can also change and register some of the settings of an existing background. An unnecessary background can be deleted at any time.

The procedure for registering image data to be used as a background is as follows:

Registering New Background

1. Open the printer driver setup window
2. Click Stamp/Background... on the Page Setup tab

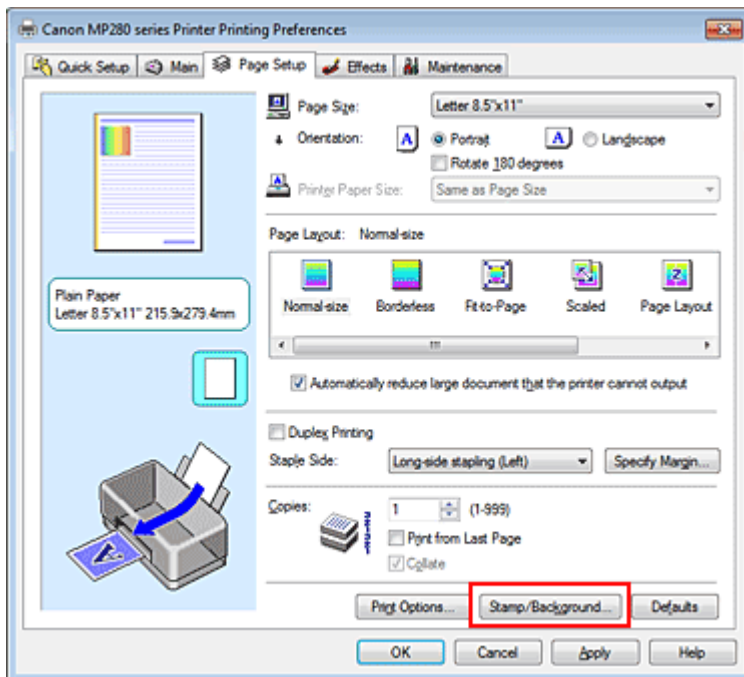

The Stamp/Background dialog box opens.

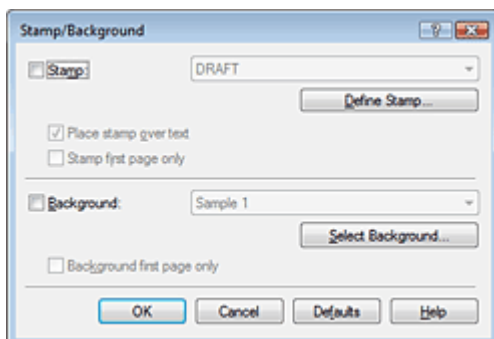

Note

- With the XPS printer driver, the Stamp/Background... button has become the Stamp... button

and Background cannot be used.

3. Click Select Background...

The Background Settings dialog box opens.

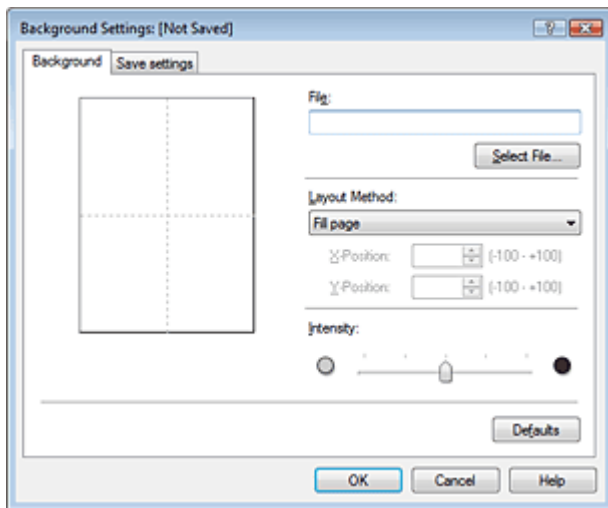

4. Select the image data to be registered to the background

Click Select File.... Select the target bitmap file (.bmp), and then click Open.

5. Specify the following settings while viewing the preview window

Layout Method

Select how the background image data is to be placed.

When Custom is selected, you can set coordinates for X-Position and Y-Position.

You can also change the background position by dragging the image in the preview window.

Intensity

Set the intensity of the background image data with the Intensity slider. To lighten the background, move the slider to the left. To darken the background, move the slider to the right. To print the background at the original bitmap intensity, move the slider to the rightmost position.

6. Save the background

Click the Save settings tab and enter a title in the Title box, and then click Save.

Click OK when the confirmation message appears.

7. Complete the setup

Click OK. The Stamp/Background dialog box opens again.

The registered title appears in the Background list.

Changing and Registering Some Background Settings

1. Select the background for which the settings are to be changed

Check the Background check box in the Stamp/Background dialog box, and then select the title of the background you want to change from the Background list.

2. Click Select Background...

The Background Settings dialog box opens.

3. Specify the items on the Background tab while viewing the preview window

4. Save the background

Click Save overwrite on the Save settings tab. When you want to save the background with a different title, enter a new title in the Title box and click Save.

Click OK when the confirmation message appears.

5. Complete the setup

Click OK. The Stamp/Background dialog box opens again.

The registered title appears in the Background list.

Deleting an Unnecessary Background

1. Click Select Background... in the Stamp/Background dialog box

The Background Settings dialog box opens.

2. Select the background to be deleted

Select the title of the background you want to delete from the Backgrounds list on the Save settings tab, and then click Delete.

Click OK when the confirmation message appears.

3. Complete the setup

Click OK. The Stamp/Background dialog box opens again.



Advanced Guide

Advanced Guide > Printing from a Computer > Printing with Other Application Software > Various Printing Methods > Printing an Envelope

P406

Printing an Envelope

If you are using the XPS printer driver, replace "Canon IJ Status Monitor" with "Canon IJ XPS Status Monitor" when reading this information.

For details on how to load an envelope into the machine, refer to "Loading Paper" in the manual: Basic Guide.

The procedure for performing envelope printing is as follows:

1. Fold down the paper support

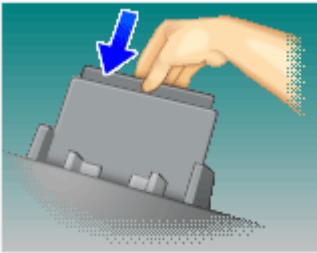

2. Load an envelope into the machine

Fold down the envelope flap.

Orient the envelope so that the address side is on top and the flap is on the left, and then load the envelope vertically in the rear tray.

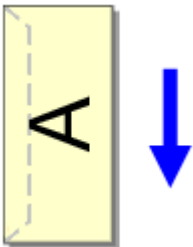

3. Open the printer driver setup window

4. Select the media type

Select Envelope from Commonly Used Settings on the Quick Setup tab.

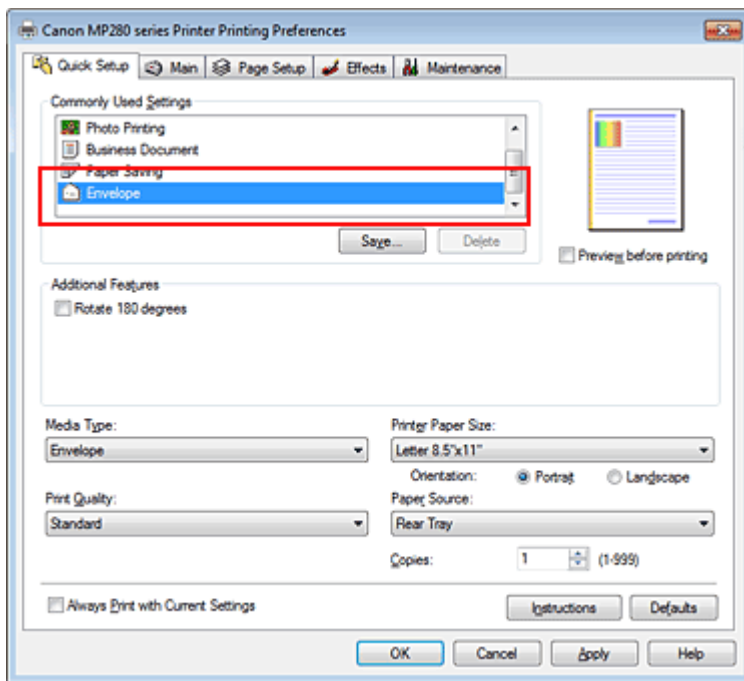

5. Select the paper size

When the Envelope Size Setting dialog box is displayed, select Comm.Env. #10, DL Env., Youkei 4 105x235mm, or Youkei 6 98x190mm, and then click OK.

6. Set the orientation

To print the addressee horizontally, select Landscape for Orientation.

7. Select the print quality

Select High or Standard that matches your purpose for Print Quality.

8. Complete the setup

Click OK.

When you execute print, the information is printed on the envelope.

Important

- When you execute envelope printing, guide messages are displayed. To hide the guide messages, check the Do not show this message again. check box. To show the guide again, click the View Printer Status... button on the Maintenance tab, and start the Canon IJ Status Monitor. Then click Envelope Printing from Display Guide Message of the Option menu, and change the setting to on.

Advanced Guide

Advanced Guide > Printing from a Computer > Printing with Other Application Software > Various Printing Methods > Displaying the Print Results before Printing

P009

Displaying the Print Results before Printing

If you are using the XPS printer driver, replace "Canon IJ Status Monitor" with "Canon IJ XPS Status Monitor" when reading this information.

You can display and check the print result before printing.

The procedure for displaying the print result before printing is as follows:

You can also set the print results display on the Quick Setup tab.

1. Open the [printer driver setup window](#)
2. Set the preview

Check the Preview before printing check box on the Main tab.

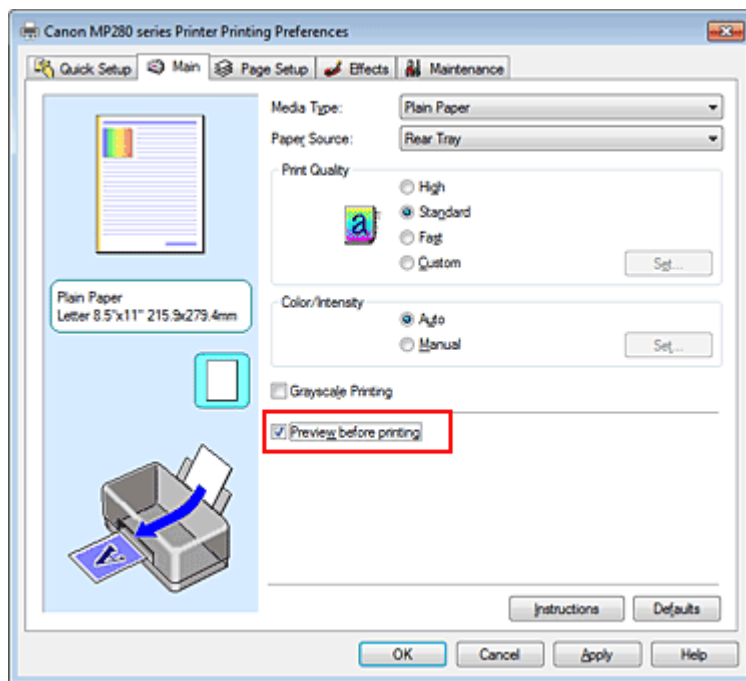

3. Complete the setup

Click OK.

When you execute print, the Canon IJ Preview opens and displays the print results.

Related Topic

➔ [Canon IJ Preview](#)

Advanced Guide

Advanced Guide > Printing from a Computer > Printing with Other Application Software > Various Printing Methods > Setting Paper Dimensions (Custom Size)

P010

Setting Paper Dimensions (Custom Size)

You can specify the height and width of paper when its size cannot be selected from the Page Size. Such a paper size is called "custom size."

The procedure for specifying a custom size is as follows:

You can also set a custom size in Printer Paper Size on the Quick Setup tab.

1. Set the custom size in the application software

On your application's paper size feature, specify the custom size.

Important

- When the application software that created the document has a function for specifying the height and width values, use the application software to set the values. When the application software does not have such a function or if the document does not print correctly, use the printer driver to set the values.

2. Open the printer driver setup window

3. Select the paper size

Select Custom... for Page Size on the Page Setup tab.

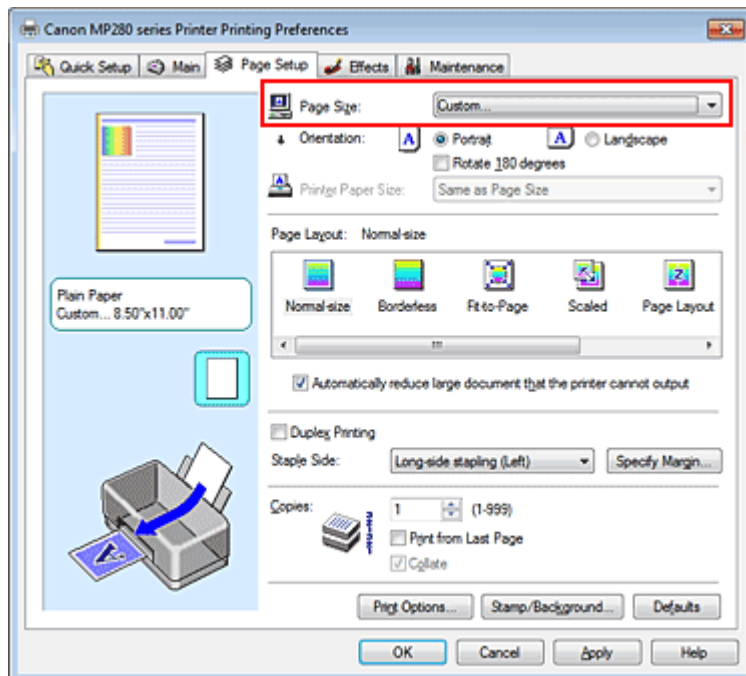

The Custom Paper Size dialog box opens.

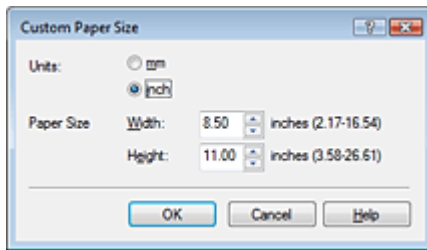

4. Set the custom paper size

Specify Units, and enter the Width and Height of the paper to be used. Then click OK.

5. Complete the setup

Click OK on the Page Setup tab.

When you execute print, the data is printed with the specified paper size.

[Page top](#) ↑

Advanced Guide

[Advanced Guide](#) > [Printing from a Computer](#) > [Printing with Other Application Software](#) > [Changing the Print Quality and Correcting Image Data](#)

Changing the Print Quality and Correcting Image Data

- ➔ [Selecting a Combination of the Print Quality Level and a Halftoning Method](#)
- ➔ [Printing a Color Document in Monochrome](#)
- ➔ [Specifying Color Correction](#)
- ➔ [Optimal Photo Printing of Image Data](#)
- ➔ [Adjusting Colors with the Printer Driver](#)
- ➔ [Printing with ICC Profiles](#)
- ➔ [Adjusting Color Balance](#)
- ➔ [Adjusting Brightness](#)
- ➔ [Adjusting Intensity](#)
- ➔ [Adjusting Contrast](#)
- ➔ [Simulating an Illustration](#)
- ➔ [Representing Image Data with a Single Color](#)
- ➔ [Presenting Image Data with Vivid Colors](#)
- ➔ [Smoothing Jagged Outlines](#)
- ➔ [Changing Color Properties to Improve Coloration](#)
- ➔ [Reducing Photo Noise](#)

[Page top](#) ↑

Advanced Guide

Advanced Guide > Printing from a Computer > Printing with Other Application Software > Changing the Print Quality and Correcting Image Data > Selecting a Combination of the Print Quality Level and a Halftoning Method

P011

Selecting a Combination of the Print Quality Level and a Halftoning Method

You can individually set the combined representation method for the print quality level and the halftoning method.



The procedure for setting the print quality level and the halftoning method is as follows:

1. Open the **printer driver setup window**
2. Select the print quality

Select Custom for Print Quality on the Main tab, and click Set...

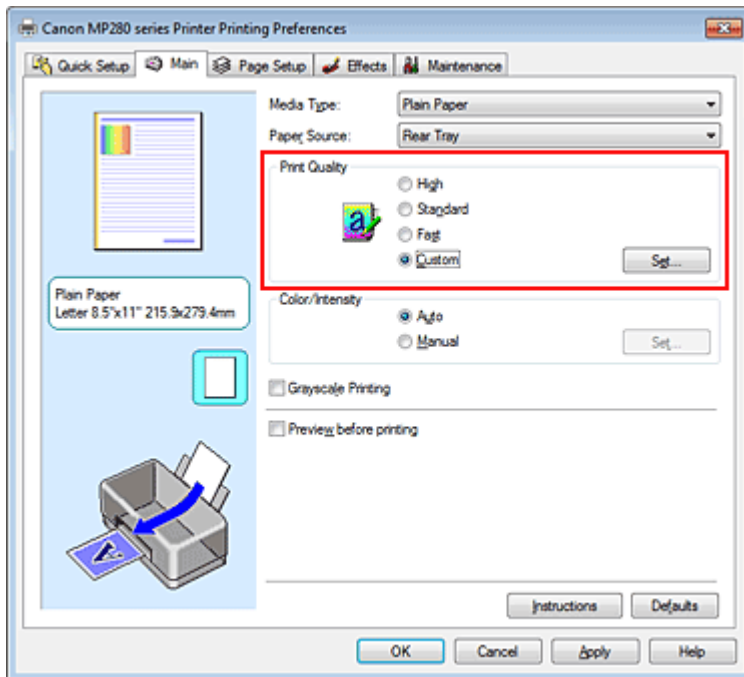

The Custom dialog box opens.

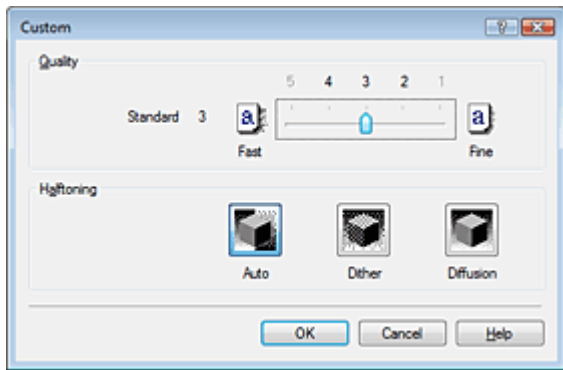

3. Setting the print quality and halftone expression method

Move the Quality slider to select the quality level.

Select the expression method in Halftoning and click OK.

Note

- Halftones refer to color shades between the darkest color and the brightest color. The printer replaces the color shades with a collection of small dots to express the halftones. When you select Auto, the data is printed with the optimal halftoning method for the selected print quality. Dither arranges the dots according to fixed rules to express the halftones. Diffusion places the dots randomly to express the halftones.

4. Complete the setup

Click OK on the Main tab.

When you execute print, the image data is printed with the selected print quality level and halftoning method.

Important

- Certain quality levels and halftoning methods cannot be selected depending on the settings of Media Type.

Note

- If part of an object is not printed, selecting Diffusion for Halftoning may solve the problem.

Related Topics

- ➔ [Specifying Color Correction](#)
- ➔ [Adjusting Color Balance](#)
- ➔ [Adjusting Brightness](#)
- ➔ [Adjusting Intensity](#)
- ➔ [Adjusting Contrast](#)

Advanced Guide

Advanced Guide > Printing from a Computer > Printing with Other Application Software > Changing the Print Quality and Correcting Image Data > Printing a Color Document in Monochrome

P012

Printing a Color Document in Monochrome

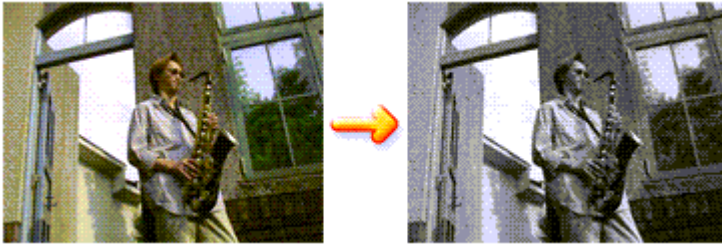

The procedure for printing a color document in monochrome is as follows:

You can also set a grayscale printing in Additional Features on the Quick Setup tab.

1. Open the **printer driver setup window**
2. Set grayscale printing

Check the Grayscale Printing check box on the Main tab.

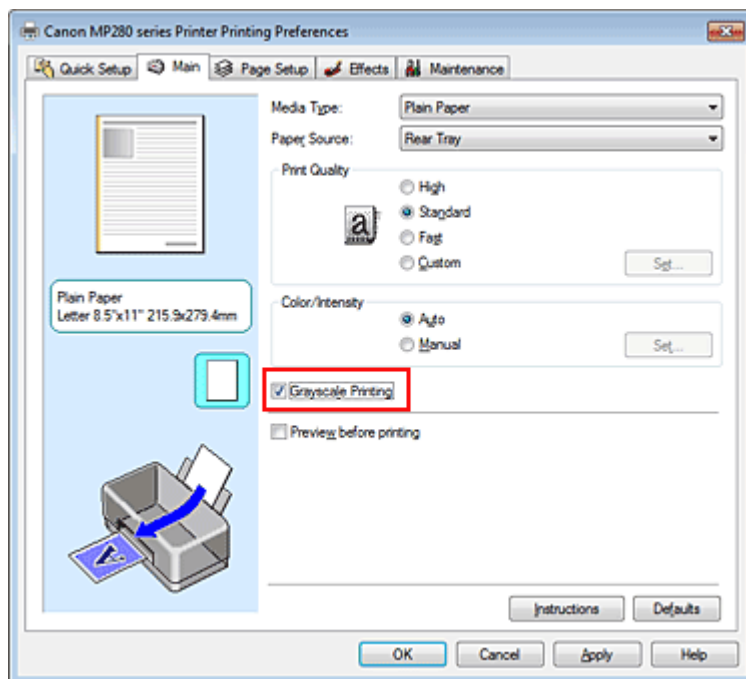

3. Complete the setup

Click OK.

When you execute print, the document is converted to grayscale data. It allows you to print the color document in monochrome.

Important

- When the Grayscale Printing check box is checked, the printer driver processes image data as sRGB data. In this case, actual colors printed may differ from those in the original image data. When using the grayscale printing function to print Adobe RGB data, convert the data to sRGB data using an application software.

 **Note**

-
- During Grayscale Printing, color inks may be used as well as black ink.
-

[Page top](#) 

Advanced Guide

Advanced Guide > Printing from a Computer > Printing with Other Application Software > Changing the Print Quality and Correcting Image Data > Specifying Color Correction

P013

Specifying Color Correction

You can specify the color correction method suited to the type of document to be printed. Normally, the printer driver adjusts the colors by using Canon Digital Photo Color so that data is printed with color tints that most people prefer. This method is suitable for printing sRGB data.

When you want to print by using the color space (Adobe RGB or sRGB) of the image data effectively, select ICM or ICC Profile Matching. When you want to use an application software to specify a printing ICC profile, select None.

The procedure for specifying color correction is as follows:

You can also set color correction on the Quick Setup tab by choosing Photo Printing under Commonly Used Settings, and then choosing Color/Intensity Manual Adjustment under Additional Features.

1. Open the printer driver setup window
2. Select the manual color adjustment

On the Main tab, select Manual for Color/Intensity, and click Set....

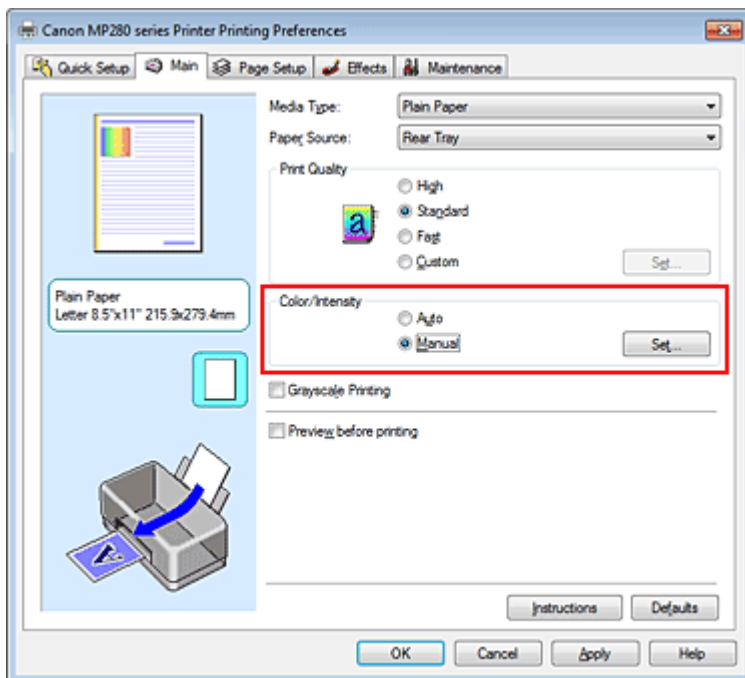

The Manual Color Adjustment dialog box opens.

3. Select color correction

Click Matching tab, select Color Correction setting that matches your purpose from the following, and click OK.

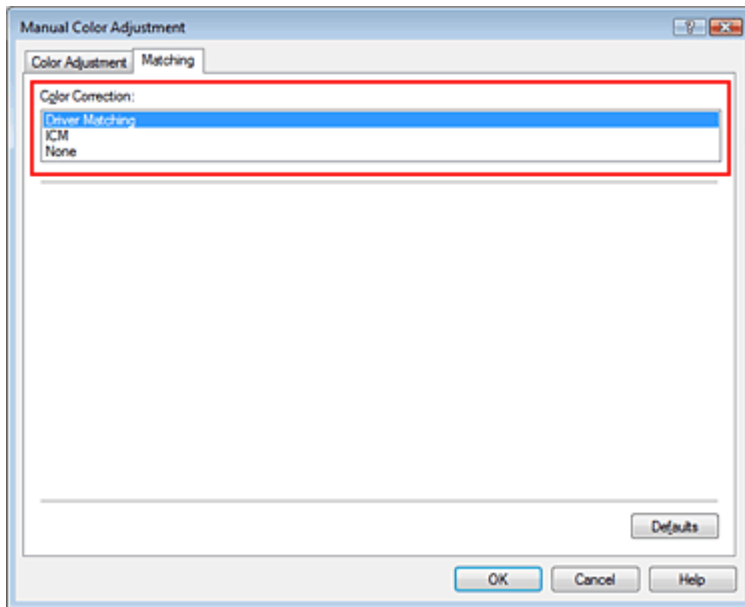

Driver Matching

By using Canon Digital Photo Color, you can print sRGB data with color tints that most people prefer. Driver Matching is the default setting for color correction.

ICM/ICC Profile Matching

Adjusts the colors by using an ICC profile when printing. Specify the input profile to be used.

None

The printer driver does not perform color correction. Select this value when you are specifying an individually created printing ICC profile in an application software to print data.

4. Complete the setup

Click OK on the Main tab.

When you execute print, the data is printed with the specified color correction method.

Important

- When ICM is disabled in the application software, ICM is unavailable for Color Correction and the printer may not be able to print the image data properly.
- When the Grayscale Printing check box on the Main tab is checked, Color Correction appears grayed out and is unavailable.

Related Topics

- ➔ [Optimal Photo Printing of Image Data](#)
- ➔ [Adjusting Colors with the Printer Driver](#)
- ➔ [Printing with ICC Profiles](#)



Advanced Guide

[Advanced Guide](#) > [Printing from a Computer](#) > [Printing with Other Application Software](#) > [Changing the Print Quality and Correcting Image Data](#) > [Specifying Color Correction](#) > [Optimal Photo Printing of Image Data](#)

P014

Optimal Photo Printing of Image Data

When people print images taken with digital cameras, they sometimes feel that the printed color tones differ from those of actual image or those displayed on the monitor.

To get the print results as close as possible to the desired color tones, you must select a printing method that is best suited to the application software used or to your purpose.

Color Management

Devices such as digital cameras, scanners, monitors, and printers handle color differently. Color management (color matching) is a method that manages device-dependent "colors" as a common color space. For Windows, a color management system called "ICM" is built into the operating system. Adobe RGB and sRGB are popularly used as common color spaces. Adobe RGB has a wider color space than sRGB.

ICC profiles convert device-dependent "colors" into a common color space. By using an ICC profile and carrying out color management, you can draw out the color space of the image data within the color reproduction area that the printer can express.

Selecting a Printing Method Suited to the Image Data

The recommended printing method depends on the color space (Adobe RGB or sRGB) of the image data or the application software to be used. There are two typical printing methods. Check the color space (Adobe RGB or sRGB) of the image data and the application software to be used, and then select the printing method suited to your purpose.

Adjusting Colors with the Printer Driver

Describes the procedure for printing sRGB data by using the color correction function of the printer driver.

- **To print using Canon Digital Photo Color**

The printer prints data with color tints that most people prefer, reproducing colors of the original image data and producing three-dimensional effects and high, sharp contrasts.

- **To print by directly applying editing and touch-up results of an application software**

When printing the data, the printer brings out subtle color difference between dark and light areas, while leaving the darkest and lightest areas intact.

When printing the data, the printer applies fine adjustment results, such as brightness adjustments made with an application software.

Printing with ICC Profiles

Describes the procedure for printing by using the color space of Adobe RGB or sRGB effectively. You can print with a common color space by setting up the application software and the printer driver so that the color management matches the input ICC profile of the image data.

The method for setting up the printer driver differs depending on the application software to be used.



Advanced Guide

Advanced Guide > Printing from a Computer > Printing with Other Application Software > Changing the Print Quality and Correcting Image Data > Specifying Color Correction > Adjusting Colors with the Printer Driver

P015

Adjusting Colors with the Printer Driver

You can specify the color correction function of the printer driver to print sRGB data with color tints that most people prefer through the use of Canon Digital Photo Color.

When printing from an application software that can identify ICC profiles and allows you to specify them, use a printing ICC profile in the application software, and select settings for color management.

The procedure for adjusting colors with the printer driver is as follows:

1. Open the **printer driver setup window**
2. Select the media type

Select the type of paper loaded in the machine from the Media Type list on the Main tab.

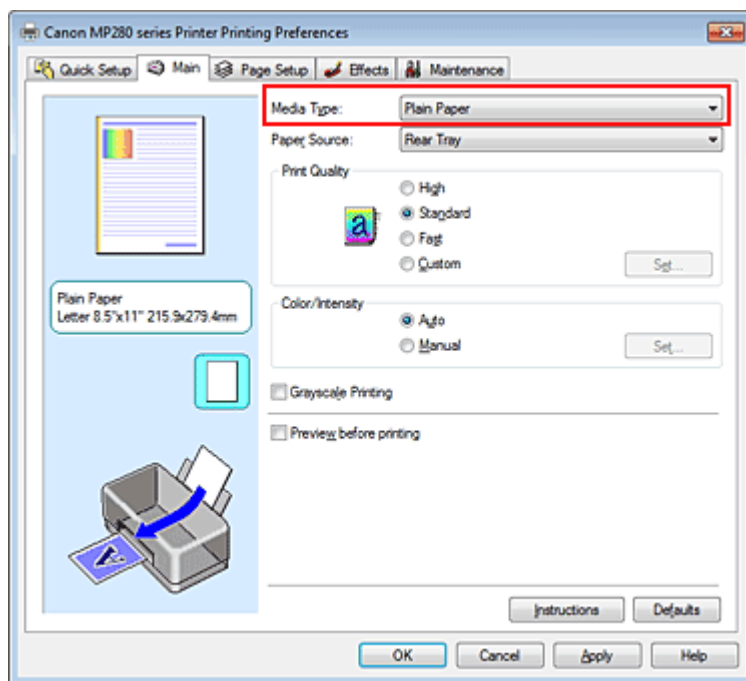

3. Select the print quality
For Print Quality, select High, Standard, or Fast according to your purpose.
4. Select the manual color adjustment
Select Manual for Color/Intensity, and click Set....
The Manual Color Adjustment dialog box opens.
5. Select color correction
Click Matching tab, and select Driver Matching for Color Correction.

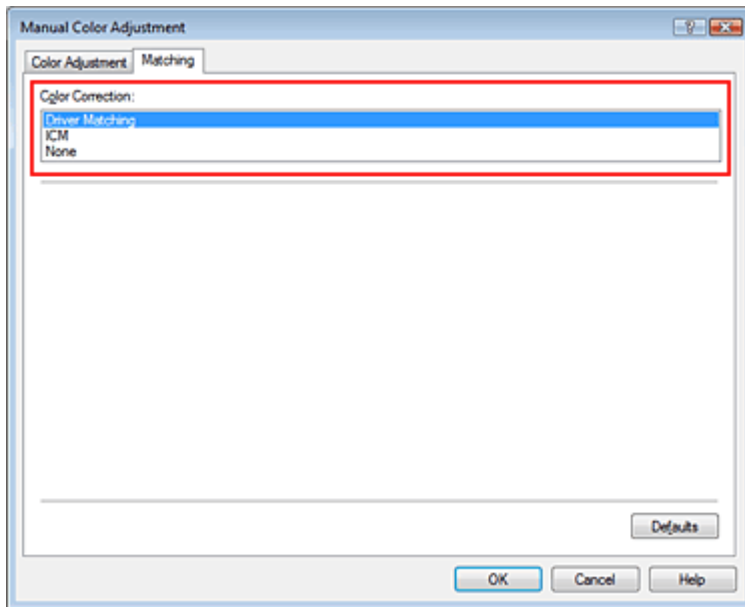

6. Set the other items

If necessary, click Color Adjustment tab, and adjust the color balance (Cyan, Magenta, Yellow) and adjust Brightness, Intensity, and Contrast settings, and then click OK.

7. Complete the setup

Click OK on the Main tab.

When you execute print, the printer driver adjusts the colors when printing the data.

Related Topics

- ➔ [Selecting a Combination of the Print Quality Level and a Halftoning Method](#)
- ➔ [Specifying Color Correction](#)
- ➔ [Adjusting Color Balance](#)
- ➔ [Adjusting Brightness](#)
- ➔ [Adjusting Intensity](#)
- ➔ [Adjusting Contrast](#)



Advanced Guide

Advanced Guide > Printing from a Computer > Printing with Other Application Software > Changing the Print Quality and Correcting Image Data > Specifying Color Correction > Printing with ICC Profiles

P016

Printing with ICC Profiles

When the image data has a specified input ICC profile, you can print by using the color space (Adobe RGB or sRGB) of the data effectively.

The printer driver setting procedure varies depending on the application software used to print.

Specify an ICC Profile from the Application Software and Print the Data

When you print the editing and touch-up results of Adobe Photoshop, Canon Digital Photo Professional, or any application software that allows you to specify input and printing ICC profiles, you print by effectively using the color space of the input ICC profile specified in the image data.

To use this printing method, use your application software to select color management items and specify an input ICC profile and a printing ICC profile in the image data.

Even if you print using a printing ICC profile that you created yourself from your application software, be sure to select color management items from your application software.

For instructions, refer to the manual of the application software you are using.

1. Open the **printer driver setup window**
2. Select the media type

Select the type of paper loaded in the machine from the Media Type list on the Main tab.

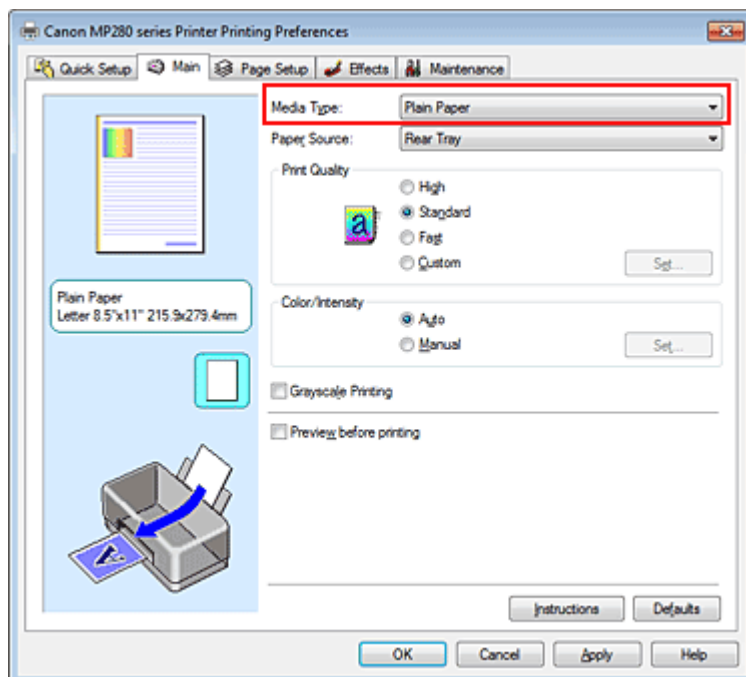

3. Select the print quality

For Print Quality, select High, Standard, or Fast according to your purpose.

4. Select the manual color adjustment

Select Manual for Color/Intensity, and click Set....
The Manual Color Adjustment dialog box opens.

5. Select color correction

Click Matching tab, and select None for Color Correction.

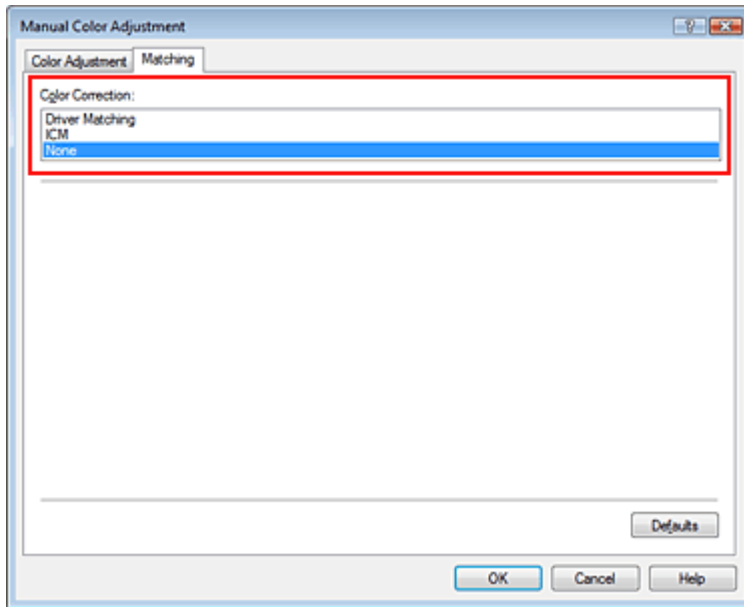

6. Set the other items

If necessary, click Color Adjustment tab, and adjust the color balance (Cyan, Magenta, Yellow) and adjust Brightness, Intensity, and Contrast settings, and then click OK.

7. Complete the setup

Click OK on the Main tab.

When you execute print, the printer uses the color space of the image data.

Specify an ICC Profile with the Printer Driver, and then Print

Print from an application software that cannot identify input ICC profiles or does allow you to specify one by using the color space of the input ICC profile (sRGB) found in the data. When printing Adobe RGB data, you can print the data with the Adobe RGB color space even if the application software does not support Adobe RGB.

1. Open the printer driver setup window

2. Select the media type

Select the type of paper loaded in the machine from the Media Type list on the Main tab.

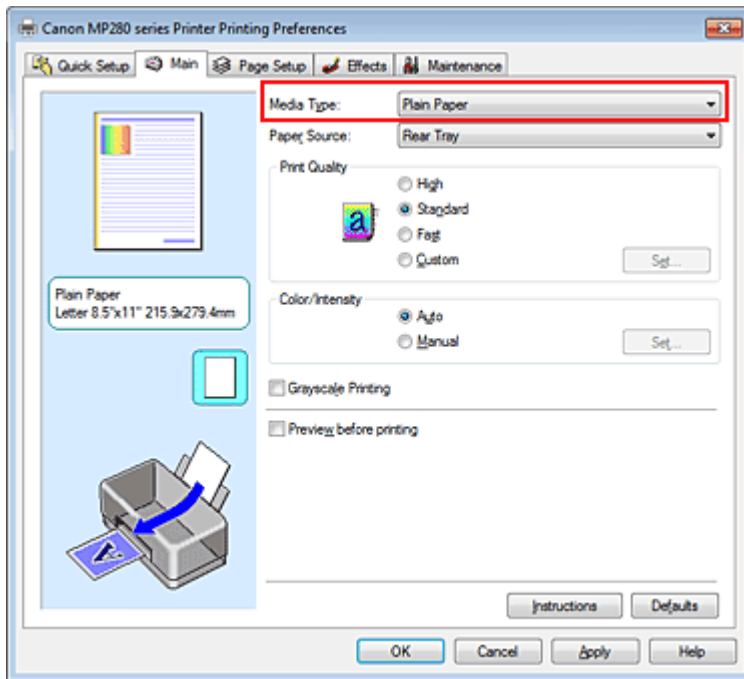

3. Select the print quality

For Print Quality, select High, Standard, or Fast according to your purpose.

4. Select the manual color adjustment

Select Manual for Color/Intensity, and click Set....
Manual Color Adjustment dialog box opens.

5. Select color correction

Click Matching tab, and select ICM or ICC Profile Matching for Color Correction.

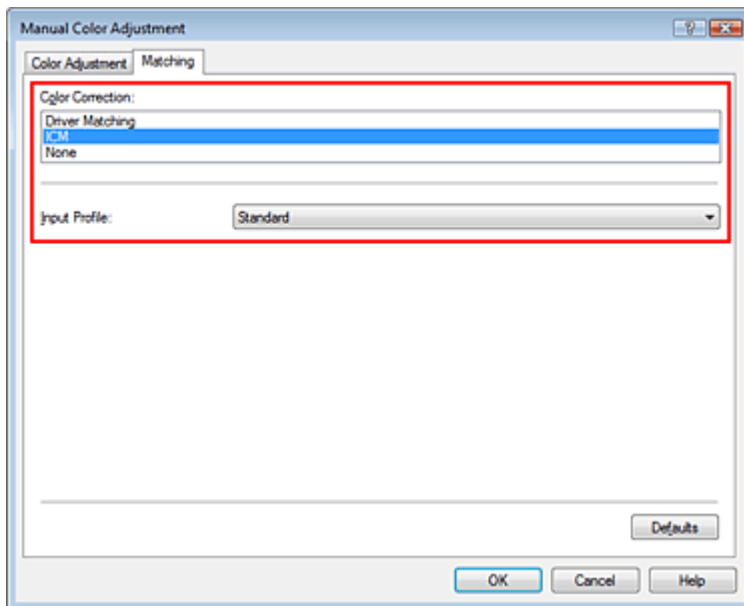

6. Select the input profile

Select an Input Profile that matches the color space of the image data.

- **For sRGB data or data without an input ICC profile:**
Select Standard.
- **For Adobe RGB data:**

Select Adobe RGB (1998).

Important

- When the application software specifies an input profile, the input profile setting of the printer driver becomes invalid.
- When no input ICC profiles are installed on your computer, Adobe RGB (1998) will not be displayed. You can install ICC profiles from the Setup CD-ROM that accompanies the machine.

7. Set the other items

If necessary, click Color Adjustment tab, and adjust the color balance (Cyan, Magenta, Yellow) and adjust Brightness, Intensity, and Contrast settings, and then click OK.

8. Complete the setup

Click OK on the Main tab.

When you execute print, the printer uses the color space of the image data.

Related Topics

- ➡ [Selecting a Combination of the Print Quality Level and a Halftoning Method](#)
- ➡ [Specifying Color Correction](#)
- ➡ [Adjusting Color Balance](#)
- ➡ [Adjusting Brightness](#)
- ➡ [Adjusting Intensity](#)
- ➡ [Adjusting Contrast](#)



[Page top](#) ↑

Advanced Guide

Advanced Guide > Printing from a Computer > Printing with Other Application Software > Changing the Print Quality and Correcting Image Data > Adjusting Color Balance

P017

Adjusting Color Balance

You can adjust the color tints when printing.

Since this function adjusts color balance of the output by changing the ink ratios of each color, it changes the total color balance of the document. Use the application software when you want to change the color balance significantly. Use the printer driver only when you want to adjust the color balance slightly.

The following sample shows the case when color balance is used to intensify cyan and to diminish yellow so that the overall colors are more uniform.



No adjustment Adjust color balance

The procedure for adjusting color balance is as follows:

You can also set color balance on the Quick Setup tab by choosing Photo Printing under Commonly Used Settings, and then choosing Color/Intensity Manual Adjustment under Additional Features.

1. Open the printer driver setup window
2. Select the manual color adjustment

On the Main tab, select Manual for Color/Intensity, and click Set....

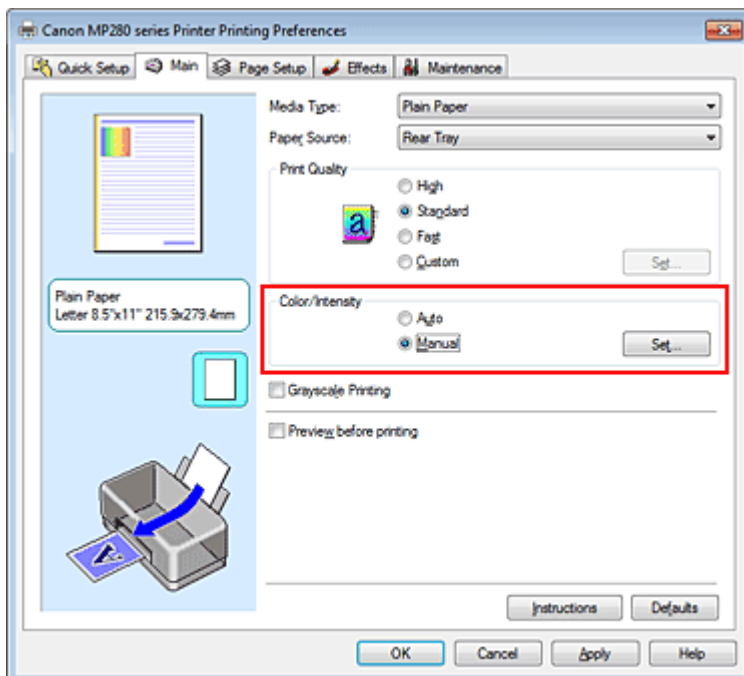

The Manual Color Adjustment dialog box opens.

3. Adjust color balance

There are individual sliders for Cyan, Magenta, and Yellow. Each color becomes stronger when the corresponding slider is moved to the right, and becomes weaker when the corresponding slider is moved to the left. For example, when cyan becomes weaker, the color red becomes stronger. You can also directly enter a value linked to the slider. Enter a value in the range from -50 to 50. The current settings are displayed in the settings preview on the left side of the printer driver.

After adjusting each color, click OK.

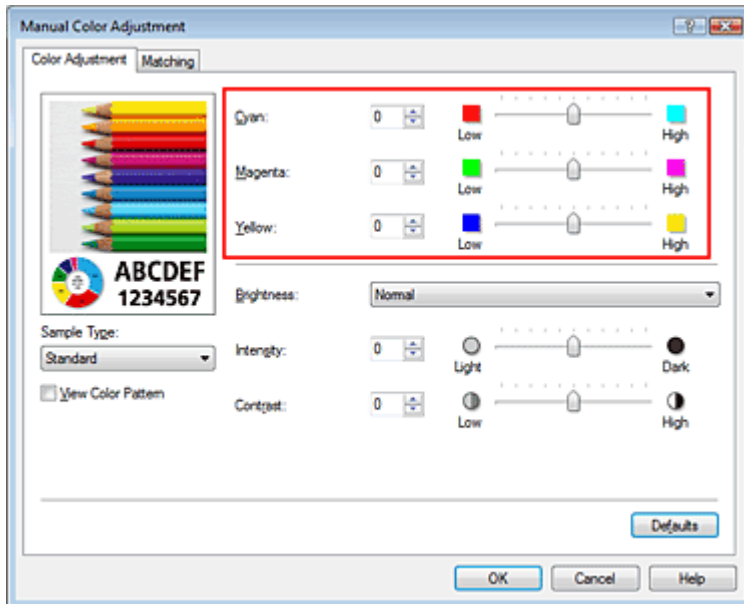

Important

- Adjust the slider gradually.

4. Complete the setup

Click OK on the Main tab.

When you execute print, the document is printed with the adjusted color balance.

Important

- When the Grayscale Printing check box on the Main tab is checked, Cyan, Magenta, and Yellow appear grayed out and are unavailable.

Related Topics

- ➔ [Selecting a Combination of the Print Quality Level and a Halftoning Method](#)
- ➔ [Specifying Color Correction](#)
- ➔ [Adjusting Brightness](#)
- ➔ [Adjusting Intensity](#)
- ➔ [Adjusting Contrast](#)

Advanced Guide

Advanced Guide > Printing from a Computer > Printing with Other Application Software > Changing the Print Quality and Correcting Image Data > Adjusting Brightness

P018

Adjusting Brightness

You can change the brightness of the overall image data during printing.

This function does not change pure white or pure black but it changes the brightness of the intermediate colors.

The following sample shows the print result when the brightness setting is changed.



Light is selected

Normal is selected

Dark is selected

The procedure for adjusting brightness is as follows:

You can also set brightness on the Quick Setup tab by choosing Photo Printing under Commonly Used Settings, and then choosing Color/Intensity Manual Adjustment under Additional Features.

1. Open the printer driver setup window

2. Select the manual color adjustment

On the Main tab, select Manual for Color/Intensity, and click Set....

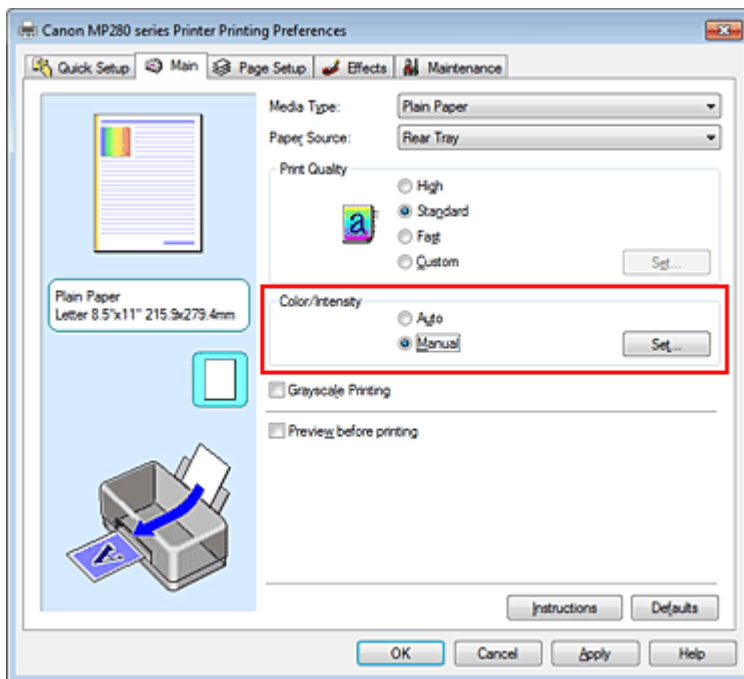

The Manual Color Adjustment dialog box opens.

3. Specify the brightness

Select Light, Normal, or Dark for Brightness, and click OK. The current settings are displayed in the settings preview on the left side of the printer driver.

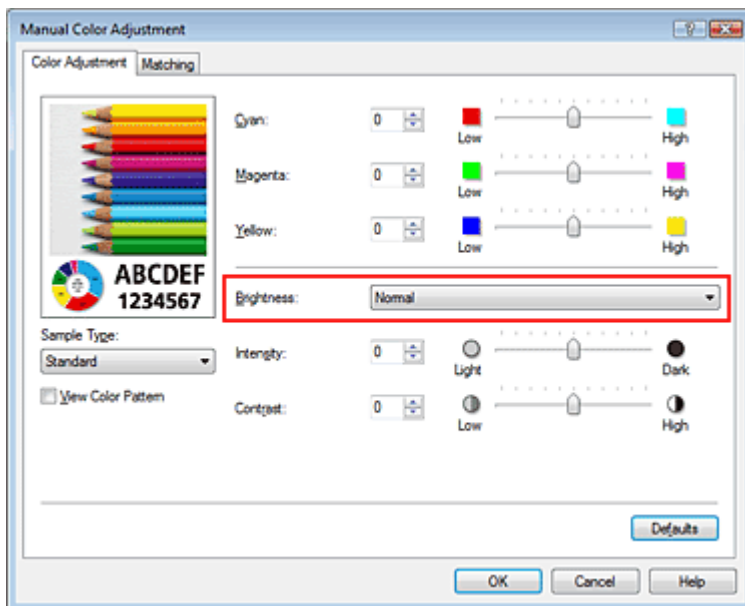

4. Complete the setup

Click OK on the Main tab.

When you execute print, the data is printed at the specified brightness.

Related Topics

- Selecting a Combination of the Print Quality Level and a Halftoning Method
- Specifying Color Correction
- Adjusting Color Balance
- Adjusting Intensity
- Adjusting Contrast

Advanced Guide

Advanced Guide > Printing from a Computer > Printing with Other Application Software > Changing the Print Quality and Correcting Image Data > Adjusting Intensity

P019

Adjusting Intensity

You can dilute (brighten) or intensify (darken) the colors of the overall image data during printing. The following sample shows the case when the intensity is increased so that all colors become more intense when the image data is printed.



No adjustment

Higher intensity

The procedure for adjusting intensity is as follows:

You can also set intensity on the Quick Setup tab by choosing Photo Printing under Commonly Used Settings, and then choosing Color/Intensity Manual Adjustment under Additional Features.

1. Open the **printer driver setup window**
2. Select the manual color adjustment

Select Manual for Color/Intensity on the Main tab, and click Set....

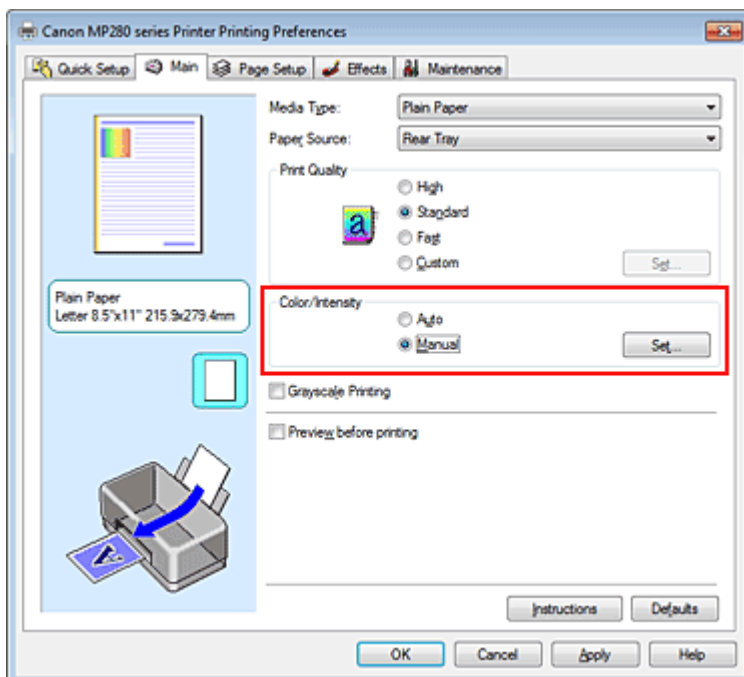

The Manual Color Adjustment dialog box opens.

3. Adjust intensity

Moving the Intensity slider to the right intensifies (darkens) the colors. Moving the slider to the left dilutes (brightens) the colors.

You can also directly enter a value linked to the slider. Enter a value in the range from -50 to 50. The current settings are displayed in the settings preview on the left side of the printer driver.

After adjusting each color, click OK.

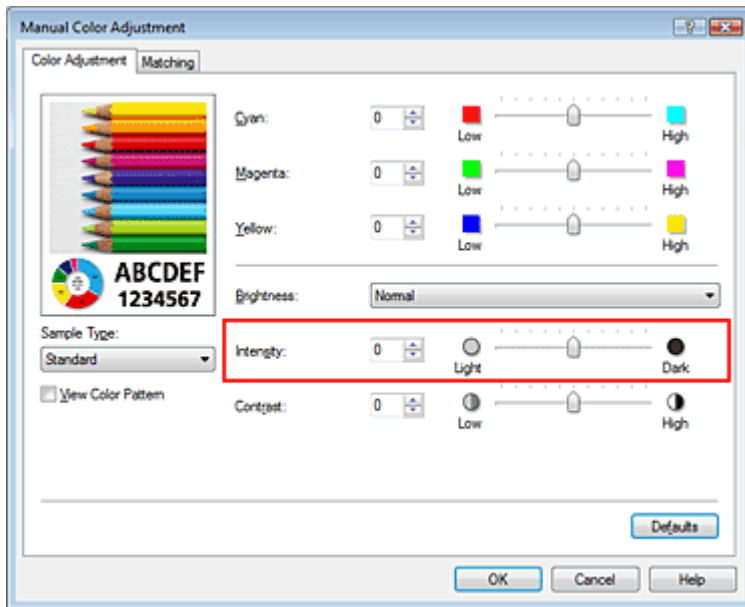

Important

- Adjust the slider gradually.

4. Complete the setup

Click OK on the Main tab.

When you execute print, the image data is printed with the adjusted intensity.

Related Topics

- Selecting a Combination of the Print Quality Level and a Halftoning Method
- Specifying Color Correction
- Adjusting Color Balance
- Adjusting Brightness
- Adjusting Contrast

[Page top](#) ↗

Advanced Guide

Advanced Guide > Printing from a Computer > Printing with Other Application Software > Changing the Print Quality and Correcting Image Data > Adjusting Contrast

P020

Adjusting Contrast

You can adjust the image contrast during printing.

To make the differences between the light and dark portions of images greater and more distinct, increase the contrast. On the other hand, to make the differences between the light and dark portions of images smaller and less distinct, reduce the contrast.



No adjustment

Adjust the contrast

The procedure for adjusting contrast is as follows:

You can also set contrast on the Quick Setup tab by choosing Photo Printing under Commonly Used Settings, and then choosing Color/Intensity Manual Adjustment under Additional Features.

1. Open the **printer driver setup window**
2. Select the manual color adjustment

On the Main tab, select Manual for Color/Intensity, and click Set....

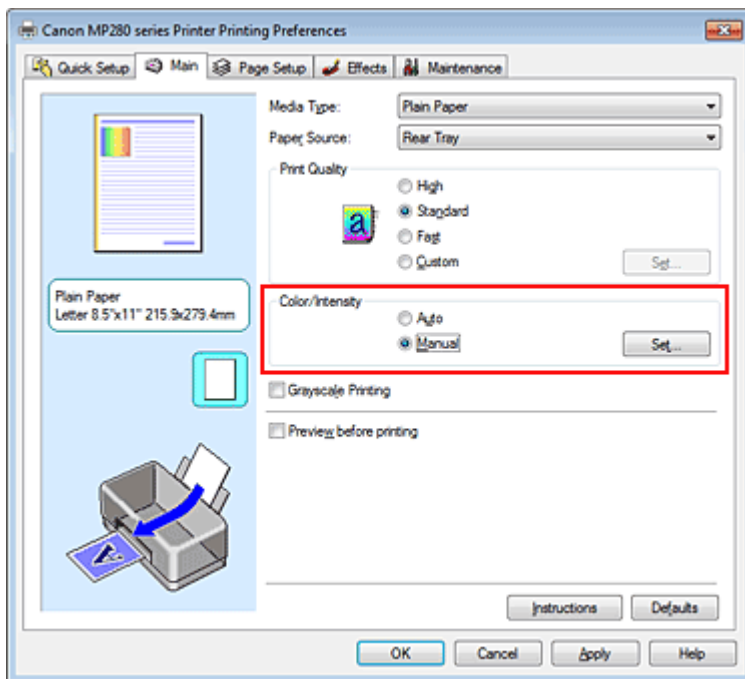

The Manual Color Adjustment dialog box opens.

3. Adjust the contrast

Moving the Contrast slider to the right increases the contrast, and moving it to the left decreases the contrast.

You can also directly enter a value linked to the slider. Enter a value in the range from -50 to 50. The current settings are displayed in the settings preview on the left side of the printer driver.

After adjusting each color, click OK.

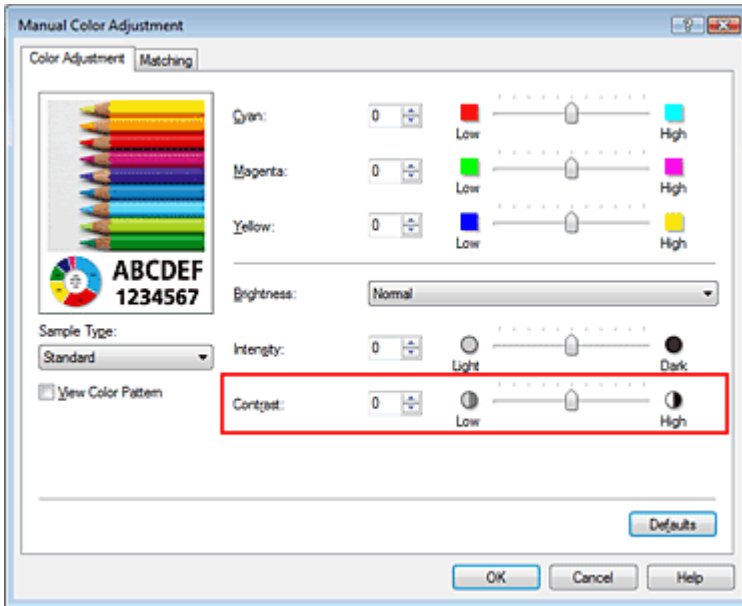

Important

- Adjust the slider gradually.

4. Complete the setup

Click OK on the Main tab.

When you execute print, the image is printed with the adjusted contrast.

Related Topics

- ➔ Selecting a Combination of the Print Quality Level and a Halftoning Method
- ➔ Specifying Color Correction
- ➔ Adjusting Color Balance
- ➔ Adjusting Brightness
- ➔ Adjusting Intensity

Advanced Guide

Advanced Guide > Printing from a Computer > Printing with Other Application Software > Changing the Print Quality and Correcting Image Data > Simulating an Illustration

P021

Simulating an Illustration

This feature is unavailable when the XPS printer driver is used.

With the Simulate Illustration function, you can print full-color or 256-color image data so that it looks like a hand-drawn illustration. This function adds different effects to the original profile and colors.

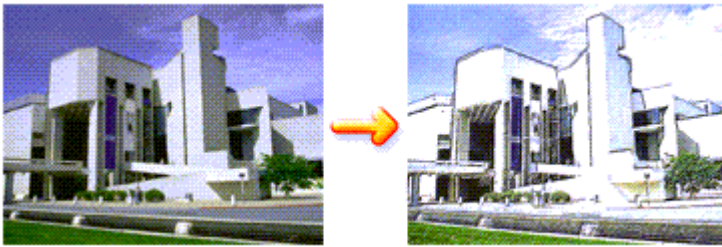

The procedure for performing Simulate Illustration is as follows:

1. Open the **printer driver setup window**
2. Set the Simulate Illustration

If necessary, check the Simulate Illustration check box on the Effects tab, and adjust the Contrast. Moving the slider to the right lightens the image data and moving the slider to the left darkens the image data.

The current settings are displayed in the settings preview on the left side of the printer driver.

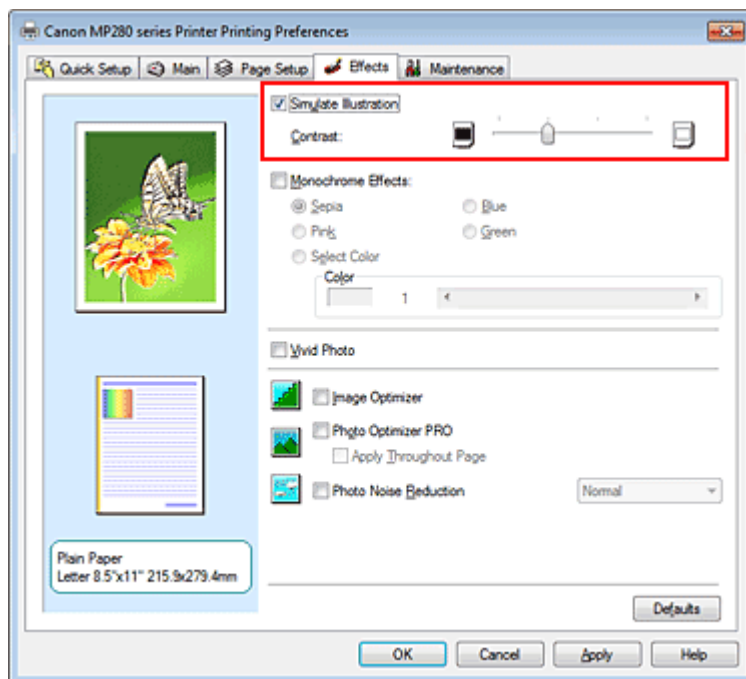

3. Complete the setup

Click OK.

When you execute print, the image will be printed so that it looks hand-drawn.

Advanced Guide

Advanced Guide > Printing from a Computer > Printing with Other Application Software > Changing the Print Quality and Correcting Image Data > Representing Image Data with a Single Color

P022

Representing Image Data with a Single Color

This feature is unavailable when the XPS printer driver is used.

With the Monochrome Effects function, you can benefit from coloring effects such as changing a photograph to a sepia tone image.

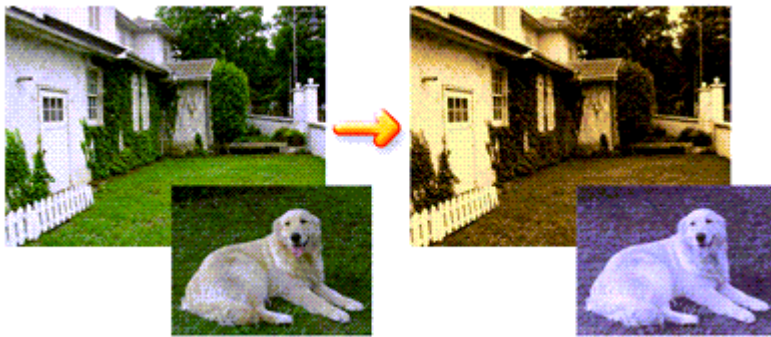

The procedure for performing Monochrome Effects is as follows:

1. Open the **printer driver setup window**
2. Set Monochrome Effects

Check the Monochrome Effects check box on the Effects tab and select your desired color.

When you use Select Color, move the Color slider to specify the color you want.

The current settings are displayed in the settings preview on the left side of the printer driver.

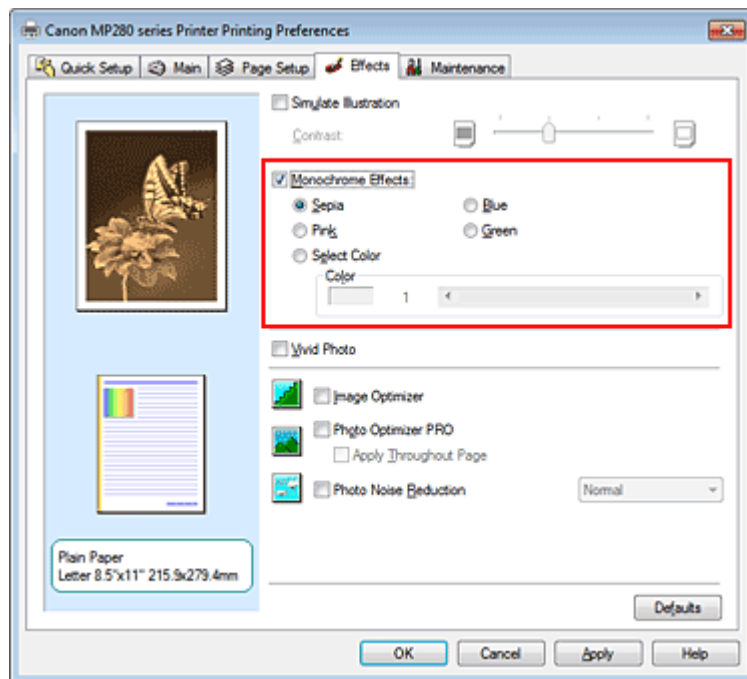

3. Complete the setup

Click OK.

When you execute print, the image will be printed with a single color.

 **Important**

- When the Grayscale Printing check box on the Main tab is checked, Monochrome Effects appears grayed out and is unavailable.

[Page top](#) 

Advanced Guide

Advanced Guide > Printing from a Computer > Printing with Other Application Software > Changing the Print Quality and Correcting Image Data > Presenting Image Data with Vivid Colors

P023

Presenting Image Data with Vivid Colors

This feature is unavailable when the XPS printer driver is used.

The Vivid Photo function allows you to print image data with vivid colors.

The vivid photo function emphasizes the colors in background sceneries while maintaining the human skin color natural. By using this function, you can make vivid hues appear even more vivid.

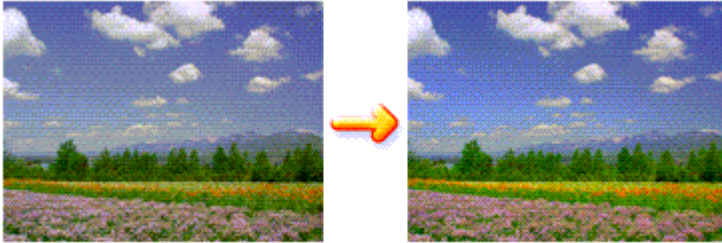

The procedure for performing Vivid Photo is as follows:

You can also set vivid photos on the Quick Setup tab by choosing Photo Printing under Commonly Used Settings, and then choosing Additional Features.

1. Open the printer driver setup window
2. Set Vivid Photo

Check the Vivid Photo check box on the Effects tab.

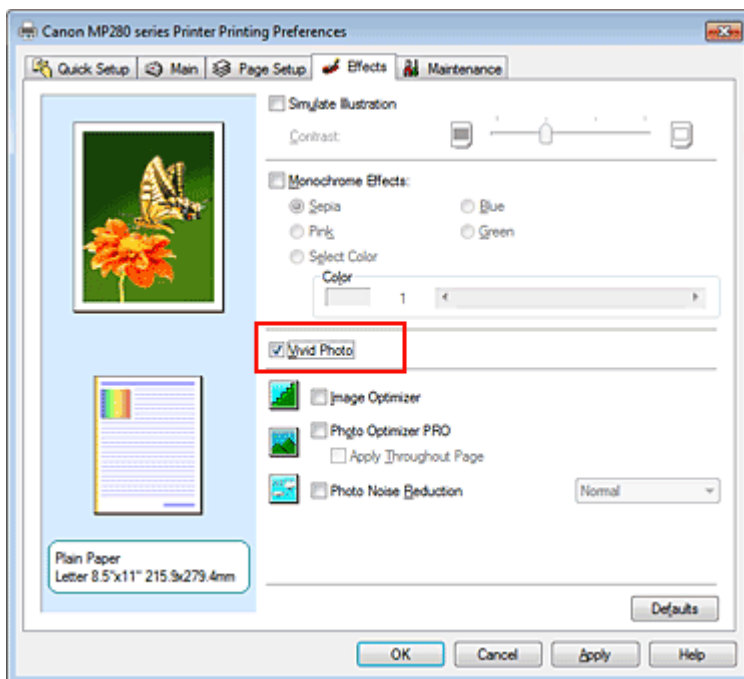

3. Complete the setup

Click OK.

When you execute print, the image will be printed with vivid colors.

Advanced Guide

Advanced Guide > Printing from a Computer > Printing with Other Application Software > Changing the Print Quality and Correcting Image Data > Smoothing Jagged Outlines

P407

Smoothing Jagged Outlines

This feature is unavailable when the XPS printer driver is used.

The Image Optimizer function reduces the jagged outlines that are produced when photos and graphics are enlarged with your application. It allows you to print smooth outlines. This feature is especially useful when printing low-resolution images from Web pages.

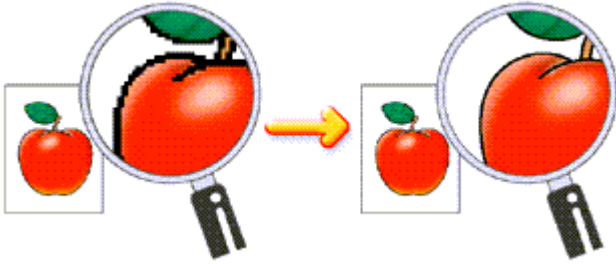

The procedure for performing Image Optimizer is as follows:

1. Open the **printer driver setup window**
2. Set image optimizer

Check the Image Optimizer check box on the Effects tab.

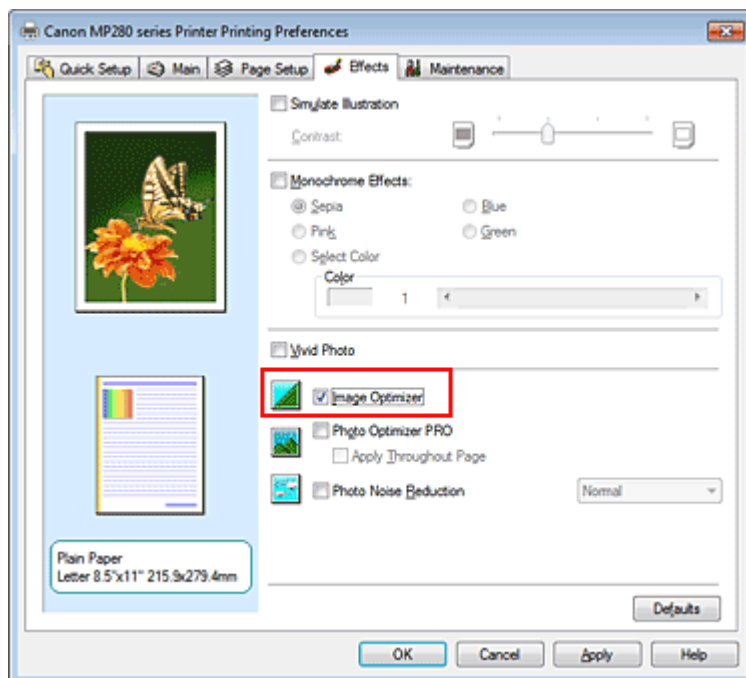

3. Complete the setup

Click OK.

The photos and graphics will be adjusted and printed with smooth outlines.

Note

- Depending on application software or resolution of image data, the image optimizer may have no discernible effects.

- It may take longer to complete printing when the image optimizer is used.
-

[Page top](#) 

Advanced Guide

Advanced Guide > Printing from a Computer > Printing with Other Application Software > Changing the Print Quality and Correcting Image Data > Changing Color Properties to Improve Coloration

P408

Changing Color Properties to Improve Coloration

This feature is unavailable when the XPS printer driver is used.

The Photo Optimizer PRO function corrects colors of digital camera images or scanned images. It is specially designed to compensate for color shift, overexposure, and underexposure.

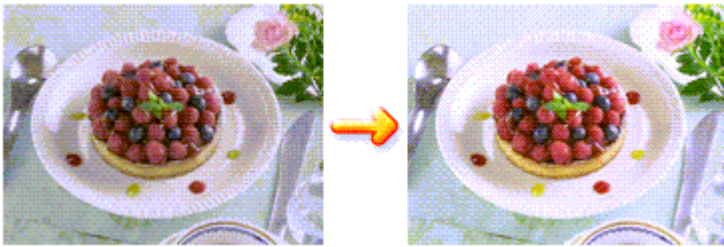

The procedure for performing Photo Optimizer PRO is as follows:

1. Open the **printer driver setup window**
2. Set Photo Optimizer PRO

Check the Photo Optimizer PRO check box on the Effects tab.

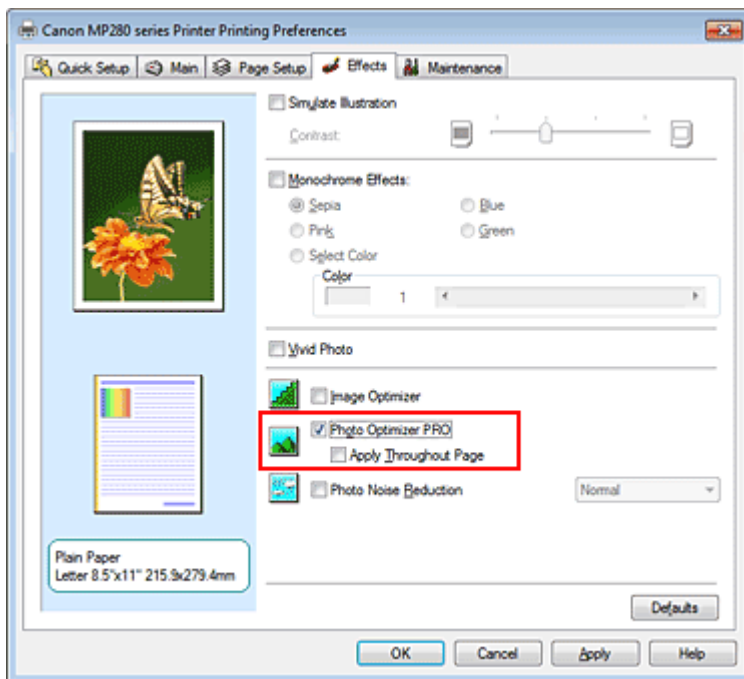

Normally there is no need to check the Apply Throughout Page check box. Images within each page are optimized on an image-by-image basis.

Note

- Check the Apply Throughout Page check box when printing image data that has been processed, such as being cropped or rotated. In this case the entire page will be treated as a single image to be optimized.

3. Complete the setup

Click OK.

When you execute print, the printer corrects the photo coloring and prints out the photos.

Important

- Photo Optimizer PRO does not function when:
 - Background is set in the Stamp/Background dialog box on the Page Setup tab.
 - Define Stamp... is selected in the Stamp/Background dialog box on the Page Setup tab, and the bitmapped stamp is configured.

Note

- Depending on images, the Photo Optimizer PRO may have no discernible effect.

[Page top](#) 

Advanced Guide

Advanced Guide > Printing from a Computer > Printing with Other Application Software > Changing the Print Quality and Correcting Image Data > Reducing Photo Noise

P024

Reducing Photo Noise

This feature is unavailable when the XPS printer driver is used.

With the Photo Noise Reduction function, you can reduce the digital camera noise and improve the image quality of the digital print.

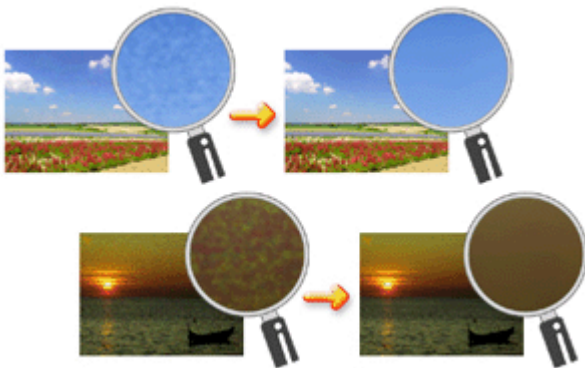

The procedure for performing Photo Noise Reduction is as follows:

1. Open the **printer driver setup window**
2. Set Photo Noise Reduction

Check the Photo Noise Reduction check box on the Effects tab and select Normal or Strong for the level.

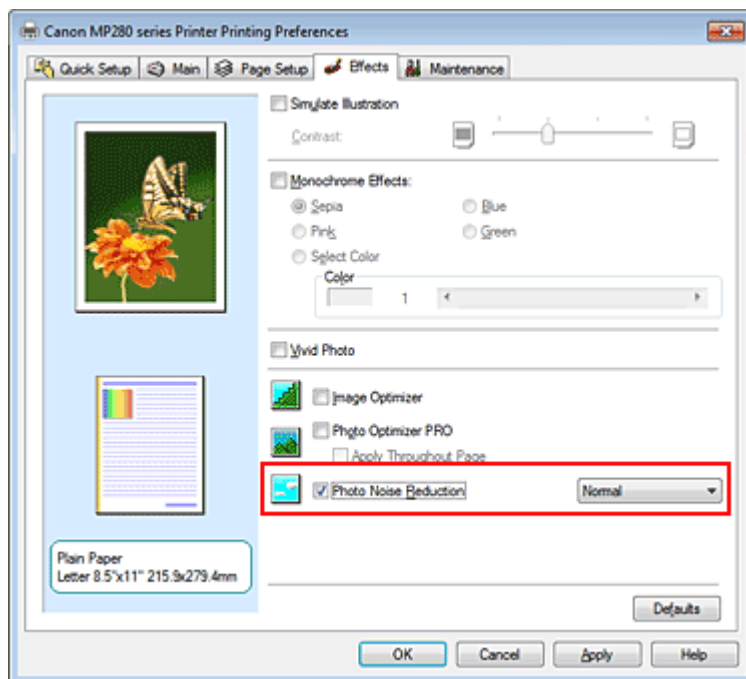

3. Complete the setup

Click OK.

When you execute print, the image will be printed with the digital camera noise being reduced.

 **Note**

-
- It is recommended to select Normal for most cases. Select Strong if you have selected Normal and the noise still bothers you.
 - Depending on application software or resolution of image data, effects of digital camera noise reduction may not be obvious.
 - When this function is used for other than photos taken by digital cameras, image may be distorted.
-

[Page top](#) ↕

Advanced Guide

[Advanced Guide](#) > [Printing from a Computer](#) > [Printing with Other Application Software](#) > [Overview of the Printer Driver](#)

Overview of the Printer Driver

- ➔ [Printer Driver Operations](#)
- ➔ [Canon IJ Printer Driver](#)
- ➔ [XPS Printer Driver](#)
- ➔ [How to Open the Printer Driver Setup Window](#)
- ➔ [Maintenance Tab](#)
- ➔ [Canon IJ Status Monitor](#)
- ➔ [Canon IJ Preview](#)

[Page top](#) ↑



Printer Driver Operations

MA-6355-V1.00

| Instructions for Use (Printer Driver) | How to Use This Manual | Printing This Manual |

Various Printing Methods

- Printing with Easy Setup
- Setting a Page Size and Orientation
- Setting the Number of Copies and Printing Order
- Setting the Stapling Margin
- Execute Borderless Printing
- Fit-to-Page Printing
- Scaled Printing
- Page Layout Printing
- Poster Printing
- Booklet Printing
- Duplex Printing
- Stamp/Background Printing
- Printing an Envelope
- Displaying the Print Results before Printing
- Setting Paper Dimensions (Custom Size)

Changing the Print Quality and Correcting Image Data

- Selecting a Combination of the Print Quality Level and a Halftoning Method
- Printing a Color Document in Monochrome
- Specifying Color Correction
- Adjusting Color Balance
- Adjusting Brightness
- Adjusting Intensity
- Adjusting Contrast
- Simulating an Illustration
- Representing Image Data with a Single Color
- Presenting Image Data with Vivid Colors
- Smoothing Jagged Outlines
- Changing Color Properties to Improve Coloration
- Reducing Photo Noise

Changing Machine Settings from Your Computer

- Changing the Print Options
- Registering a Frequently Used Printing Profile
- Setting the Ink Cartridge to be Used
- Managing the Machine Power
- Reducing the Machine Noise
- Changing the Machine Operation Mode

Performing Maintenance from a Computer

- Cleaning the Print Heads
- Cleaning the Paper Feed Rollers
- Aligning the Print Head Position
- Checking the Print Head Nozzles
- Cleaning Inside the Machine

Overview of the Printer Driver

- Canon IJ Printer Driver
- XPS Printer Driver
- How to Open the Printer Driver Setup Window
- Maintenance Tab
- Canon IJ Status Monitor
- Canon IJ Preview

Updating the MP Drivers

- Obtaining the Latest MP Drivers
- Deleting the Unnecessary MP Drivers
- Before Installing the MP Drivers
- Installing the MP Drivers

Appendix

- Editing the Print Document or Reprinting from the Print History
- Deleting the Undesired Print Job
- Sharing the Printer on a Network

Advanced Guide

[Advanced Guide](#) > [Printing from a Computer](#) > [Printing with Other Application Software](#) > [Overview of the Printer Driver](#)
> [Canon IJ Printer Driver](#)

P025

Canon IJ Printer Driver

The Canon IJ printer driver is software that is installed on your computer for printing data on this machine.

The Canon IJ printer driver converts the print data created by your Windows application into data that your printer can understand, and sends the converted data to the printer.

Because different models support different print data formats, you need a Canon IJ printer driver for the specific model you are using.

How to Use Printer Driver Help

You can display the Help describing the driver setting items through the printing preferences screen of the Canon IJ printer driver.

- **To view all descriptions of a tab...**

Click the Help button on each tab. A dialog box opens, displaying a description of each item on the tab.

You can also click the link found in the description of an item to display a description of the linked dialog box.

- **To see a description for each item...**

Right-click the item you want to learn about and then click What's This?.

Alternatively, when the  Help button is found at the right end of the title bar, click that button, and then click the item you want to learn about.

A description of the item is displayed.

Related Topic

[➔ How to Open the Printer Driver Setup Window](#)



[Page top](#) 

Advanced Guide

[Advanced Guide](#) > [Printing from a Computer](#) > [Printing with Other Application Software](#) > [Overview of the Printer Driver](#)
> [Canon IJ Printer Driver](#) > [XPS Printer Driver](#)

P416

XPS Printer Driver

The following two printer drivers can be installed on Windows Vista SP1 or later:

- IJ printer driver
- XPS printer driver

The XPS printer driver is suited to print from an application that supports XPS printing.

Important

- To use the XPS printer driver, the standard IJ printer driver must already be installed on your computer.
- With the XPS printer driver, application software distributed with printers, such as Easy-PhotoPrint EX and My Printer, cannot be used.

Installing the XPS Printer Driver

Load the Setup CD-ROM that comes with the machine, and then select "XPS Printer Driver" from Custom Install to install the driver.

Using the XPS Printer Driver

To use the XPS printer driver for printing, open the Print dialog box in application you are using, and select "your printer name XPS."



[Page top](#) 

Advanced Guide

Advanced Guide > Printing from a Computer > Printing with Other Application Software > Overview of the Printer Driver > Canon IJ Printer Driver > How to Open the Printer Driver Setup Window

P409

How to Open the Printer Driver Setup Window

The printer driver setup window can be displayed through the application software in use or the Start menu of the Windows.

Open the Printer Driver Setup Window through the Application Software

Follow the procedure below to configure printing profile when printing.

1. Select the command that you perform printing on the application software

In general, select Print on the File menu to open the Print dialog box.

2. Select your model name and click Preferences (or Properties)

The printer driver setup window appears.



Note

- Depending on application software you use, command names or menu names may vary and there may be more steps. For details, refer to the user's manual of your application software.

Open the Printer Driver Setup Window through the Start Menu

Follow the procedure below to perform maintenance operations such as print head cleaning, or to configure printing profile that are common for all application software.

1. Select items from the Start menu as shown below:

- If you are using Windows 7, select the Start menu -> Devices and Printers.
- If you are using Windows Vista, select the Start menu -> Control Panel -> Hardware and Sound -> Printers.
- If you are using Windows XP, select the start menu -> Control Panel -> Printers and Other Hardware -> Printers and Faxes.

2. Right-click your model name icon, and then select Printing Preferences from the displayed menu

The printer driver setup window appears.



Important

- Opening the printer driver setup window through Printer properties (Windows 7) or Properties (Windows Vista, Windows XP) displays such tabs regarding the Windows functions as the Ports (or Advanced) tab. Those tabs do not appear when opening through Printing Preferences or application software. For tabs regarding Windows functions, refer to the user's manual for the Windows.



Advanced Guide

Advanced Guide > Printing from a Computer > Printing with Other Application Software > Overview of the Printer Driver
> Canon IJ Printer Driver > Maintenance Tab

P410

Maintenance Tab

The Maintenance tab allows you to perform machine maintenance or change the settings of the machine.

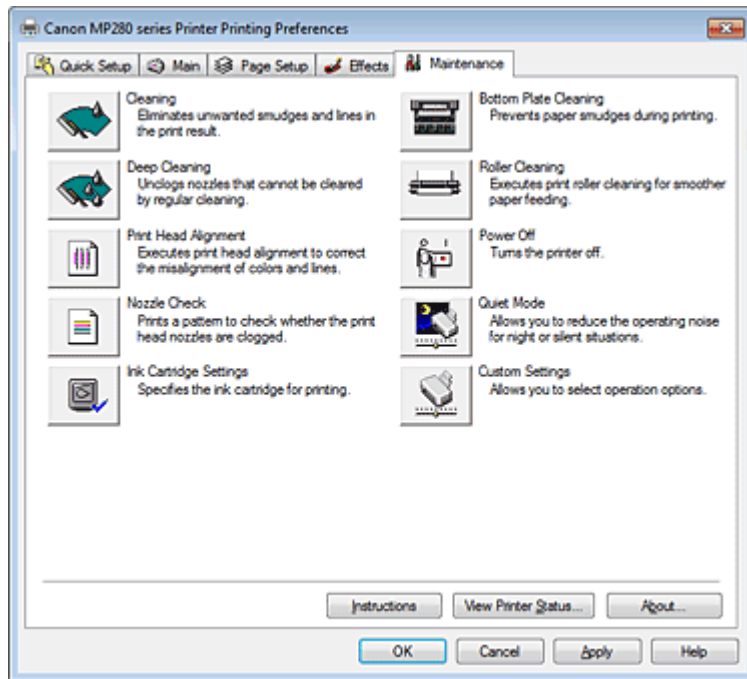

Features

- ➔ Cleaning the Print Heads
- ➔ Cleaning the Paper Feed Rollers
- ➔ Aligning the Print Head Position
- ➔ Checking the Print Head Nozzles
- ➔ Cleaning Inside the Machine
- ➔ Setting the Ink Cartridge to be Used
- ➔ Managing the Machine Power

Related Features

- ➔ Reducing the Machine Noise
- ➔ Changing the Machine Operation Mode



Advanced Guide

Advanced Guide > Printing from a Computer > Printing with Other Application Software > Overview of the Printer Driver > Canon IJ Status Monitor

P411

Canon IJ Status Monitor

If you are using the XPS printer driver, replace "Canon IJ Status Monitor" with "Canon IJ XPS Status Monitor" when reading this information.

The Canon IJ Status Monitor is an application software that shows the status of the printer and the progress of printing on the Windows screen. You will know the status of the printer with graphics, icons, and messages.

Launching the Canon IJ Status Monitor

The Canon IJ Status Monitor launches automatically when data is sent to the printer. When launched, the Canon IJ Status Monitor appears as a button on the task bar.



Click the button of the status monitor displayed on the task bar. The Canon IJ Status Monitor appears.

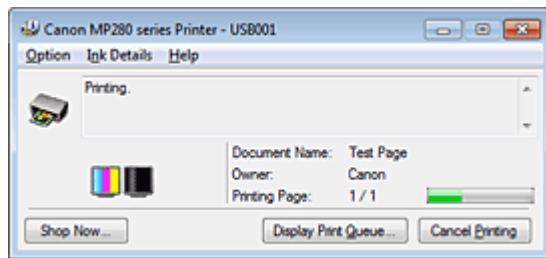

Note

- To open the Canon IJ Status Monitor when the printer is not printing, open the [printer driver setup window](#) and click View Printer Status... on the Maintenance tab.
- The information displayed on the Canon IJ Status Monitor may differ depending on the country or region where you are using your machine.

When Errors Occur

The Canon IJ Status Monitor is automatically displayed if an error occurs (e.g., if the printer runs out of paper or if the ink is low).

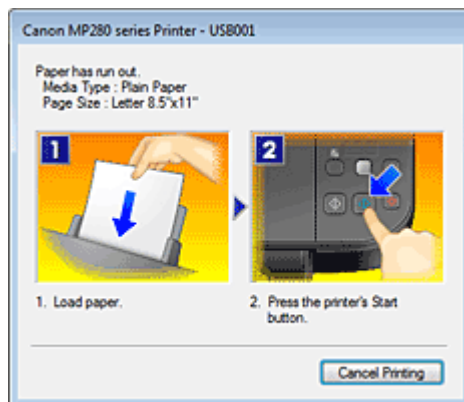

In such cases, take the appropriate action as described.

Advanced Guide

[Advanced Guide](#) > [Printing from a Computer](#) > [Printing with Other Application Software](#) > [Overview of the Printer Driver](#)
> [Canon IJ Preview](#)

P412

Canon IJ Preview

The Canon IJ Preview is an application software that displays what the print result will look like before a document is actually printed.

The preview reflects the information that is set within the printer driver and allows you to check the document layout, print order, and number of pages. You can also change the media type settings.

When you want to display a preview before printing, open the [printer driver setup window](#) , click the Quick Setup tab or the Main tab, and check the Preview before printing check box.

When you do not want to display a preview before printing, uncheck the check box.

Important

- If you are using the XPS printer driver, see "[Editing the Print Document or Reprinting from the Print History.](#)"

Related Topic

[➡ Displaying the Print Results before Printing](#)

[Page top](#) 

Advanced Guide

Advanced Guide > Printing Using the Operation Panel of the Machine

Printing Using the Operation Panel of the Machine

➔ Copying

[Page top](#) ↑

Advanced Guide

Advanced Guide > Printing Using the Operation Panel of the Machine > Copying

Copying

- ➔ Making Copies
- ➔ Reducing or Enlarging a Copy
- ➔ Using Useful Copy Functions

[Page top](#) ↑

Advanced Guide

[Advanced Guide](#) > [Printing Using the Operation Panel of the Machine](#) > [Copying](#) > [Making Copies](#)

U031

Making Copies

For the basic procedure to make copies, refer to [Copying](#).

- ➔ [Reducing or Enlarging a Copy](#)
- ➔ [Using Useful Copy Functions](#)

[Page top](#) ↑

Advanced Guide

Advanced Guide > Printing Using the Operation Panel of the Machine > Copying > Reducing or Enlarging a Copy

U033

Reducing or Enlarging a Copy

The Fit-to-Page copy function enables you to copy the original automatically enlarged or reduced to fit the selected page size.

Note

- You can switch the size of paper loaded in the Rear Tray between A4 and 8.5" x 11" (Letter) regardless of the size indicated on the Operation Panel.
 [Switching the Page Size between A4 and Letter](#)

1. Make sure that the machine is turned on.
2. Load the plain paper on the Rear Tray.
3. Load the original on the Platen Glass.
4. Press the **Paper** button repeatedly to select the page size and media type according to the paper loaded in step 2.

Note

- When the plain paper is selected for the media type, the original is copied with borders. When the photo paper is selected for the media type, the original is copied without borders and fills the entire page.

5. Press the **Fit to Page** button.

The **Fit to Page** lamp lights up.

Note

- To cancel Fit to Page copying, press the **Fit to Page** button again. When pressing the **Fit to Page** button, the **Fit to Page** lamp is off and the Fit to Page copying is canceled.
- You can use the **Fit to Page** button only when you are using the copy function.

6. Specify the number of copies (max. 20 copies).

To make 1 to 9 copies or 20 copies

Display the desired number of copies on the LED. Each time you press the **+** button, the number on the LED increases by one.

When the LED displays as follows, the number of copies is set to "20". Press the **+** button again to return to "1".



To make 10 to 19 copies

1. Press the **+** button repeatedly until the LED displays as follows.



2. Load only the desired number of sheets to copy.

Note

- Pressing the **Stop/Reset** button returns the number of copies to 1.

7. Press the **Color** button for color copying, or the **Black** button for black & white copying.

The machine starts Fit to Page copying.

Remove the original on the Platen Glass after copying is complete.

To make 10 to 19 copies

The paper-out error will occur when all of the loaded paper runs out. Press the **Stop/Reset** button to release the error.

Important

- Do not open the Document Cover or remove the original from the Platen Glass until copying is complete.

Note

- To cancel copying, press the **Stop/Reset** button.
- **To set the print quality to "Fast" (speed priority)**
You can set the print quality to "Fast" (speed priority) only when A4 or Letter-sized plain paper is selected for the page size and media type.

1. Press and hold down the **Color** or **Black** button for 2 or more seconds in step 7.

The LED flashes once.

2. Release the button.

The machine starts copying.

When the print quality is set to "Fast", print speed is given priority over quality. To give priority to quality, press the **Color** or **Black** button for less than 2 seconds to copy in the print quality "Standard".

Advanced Guide

[Advanced Guide](#) > [Printing Using the Operation Panel of the Machine](#) > [Copying](#) > [Using Useful Copy Functions](#)

U036

Using Useful Copy Functions

- **Switching the page size between A4 and Letter**

You can switch the size of paper loaded on the Rear Tray between A4 and Letter.

➔ [Switching the Page Size between A4 and Letter](#)

- **Borderless copy**

You can copy images so that they fill the entire page without borders.

➔ [Copying without Borders \(Borderless Copy\)](#)

[Page top](#) ↑

Advanced Guide

Advanced Guide > Printing Using the Operation Panel of the Machine > Copying > Using Useful Copy Functions > Switching the Page Size between A4 and Letter

U097

Switching the Page Size between A4 and Letter

You can switch the size of paper loaded on the Rear Tray between A4 and Letter.

This setting is useful if you usually load Letter-sized paper in the Rear Tray regardless of the page size indication "A4" on the Operation Panel, or vice versa.

1. Press the **Maintenance** button repeatedly until the LED displays as follows.



2. Press the **Black** button to select A4, or the **Color** button to select Letter.

Note

- When you switch the page size to A4 or Letter, load paper of the selected size regardless of the size indicated on the Operation Panel.
When the page size is set to A4, load A4 plain paper or photo paper.
When the page size is set to Letter, load Letter-sized plain paper or photo paper.
 - This setting is retained even if the machine is turned off.
-

[Page top](#) ↑

Advanced Guide

Advanced Guide > Printing Using the Operation Panel of the Machine > Copying > Using Useful Copy Functions > Copying without Borders (Borderless Copy)

U039

Copying without Borders (Borderless Copy)

You can copy images on photo paper so that they fill the entire page without borders.



1. Make sure that the machine is turned on.
2. Load photo paper on the Rear Tray.
3. Press the **Paper** button to select the page size.

Select the page size according to the paper loaded on the Rear Tray.

Note

- You can switch the size of paper loaded on the Rear Tray between A4 and Letter.
➔ [Switching the Page Size between A4 and Letter](#)
- When the page size for plain paper is selected, borderless copying is not available.

4. Press the **Fit to Page** button.

The **Fit to Page** lamp lights up.

Note

- To cancel borderless copying, press the **Fit to Page** button again. When pressing the **Fit to Page** button, the **Fit to Page** lamp is off and the borderless copying is canceled.
- You can use the **Fit to Page** button only when you are using the copy function.

5. Specify the number of copies (max. 20 copies).

To make 1 to 9 copies or 20 copies

Display the desired number of copies on the LED. Each time you press the **+** button, the number on the LED increases by one.

When the LED displays as follows, the number of copies is set to "20". Press the **+** button again to return to "1".



To make 10 to 19 copies

1. Press the **+** button repeatedly until the LED displays as follows.



2. Load only the desired number of sheets to copy.

Note

- Pressing the **Stop/Reset** button returns the number of copies to 1.

6. Press the **Color** button for color copying, or the **Black** button for black & white copying.

The machine starts borderless copying.

Remove the original on the Platen Glass after copying is complete.

To make 10 to 19 copies

The paper-out error will occur when all of the loaded paper runs out. Press the **Stop/Reset** button to release the error.

Important

- Do not open the Document Cover or remove the original from the Platen Glass until copying is complete.

Note

- Slight cropping may occur at the edges since the copied image is enlarged to fill the whole page.
- To cancel copying, press the **Stop/Reset** button.

[Page top](#) ↑

Advanced Guide

Advanced Guide > Scanning

Scanning

- ➔ Scanning Images
- ➔ Scanning with Using the Operation Panel of the Machine
- ➔ Scanning with the Bundled Application Software
- ➔ Scanning with Other Application Software
- ➔ Other Scanning Methods

[Page top](#) ↕

Advanced Guide

[Advanced Guide](#) > [Scanning](#) > [Scanning Images](#)

Scanning Images

- ➔ [Scanning Images](#)
- ➔ [Before Scanning](#)
- ➔ [Placing Documents](#)

[Page top](#) ↑

Advanced Guide

[Advanced Guide](#) > [Scanning](#) > [Scanning Images](#) > [Scanning Images](#)

U046

Scanning Images

You can scan images from the machine and save them to a computer easily.

In addition, you can scan images with advanced settings from a computer using application software.

Select the scanning method according to your purpose.

- ➡ [Forwarding Scanned Data to the Computer Using the Operation Panel of the Machine](#)
- ➡ [Scanning with the Bundled Application Software](#)
- ➡ [Scanning with Other Application Software](#)

[Page top](#) ↑

Advanced Guide

[Advanced Guide](#) > [Scanning](#) > [Scanning Images](#) > [Before Scanning](#)

U047

Before Scanning

Make sure that the original to be scanned meets the requirements for an original to be set on the Platen Glass.

Refer to [Placing Documents](#) for requirements and how to load the original on the Platen Glass.

[Page top](#) ↑

Advanced Guide

Advanced Guide > Scanning > Scanning Images > Placing Documents

S005

Placing Documents

Learn how to place documents on the machine's Platen. Place documents correctly according to the type of document to be scanned. Otherwise, documents may not be scanned correctly.

Important



- Do not place objects on the Document Cover. The objects may fall into the machine when the Document Cover is opened. This may damage the machine.
- Close the Document Cover when scanning.

Placing Documents

Place documents as described below to allow the machine to detect the document type or size automatically.

Important

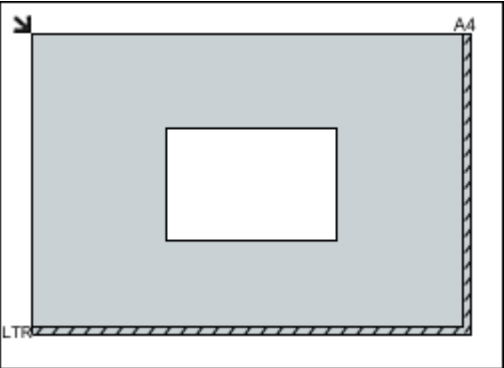
- When scanning by specifying the document size in MP Navigator EX or ScanGear (scanner driver), align an upper corner of the document with the corner at the arrow (alignment mark) of the Platen.
- Photos that have been cut to various shapes and documents smaller than 1.18 inches (3 cm) square cannot be cropped accurately when scanning.
- Reflective disc labels may not be scanned properly.

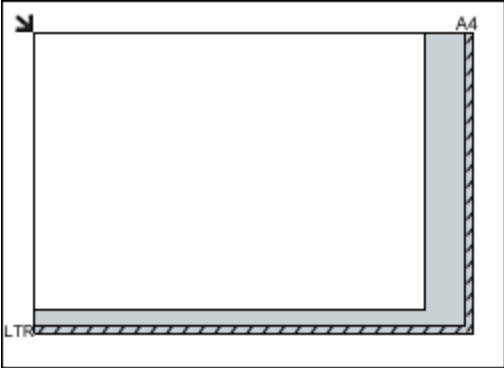
For Photos, Postcards, Business Cards or BD/DVD/CD	For Magazines, Newspapers or Text Documents
 <p style="text-align: center;">↓</p> <p>Placing a Single Document</p> <p>Place the document face-down on the Platen, with 0.39 inches (1 cm) or more space between the edges (diagonally striped area) of the Platen and the document. Portions placed on the diagonally striped area cannot be scanned.</p> 	 <p style="text-align: center;">↓</p> <p>Place the document face-down on the Platen and align an upper corner of the document with the corner at the arrow (alignment mark) of the Platen. Portions placed on the diagonally striped area cannot be scanned.</p> 
<h3>Important</h3> <ul style="list-style-type: none"> Large documents (such as A4 size photos) 	<h3>Important</h3> <ul style="list-style-type: none"> The portion within 0.039 inches (1 mm) inwards from the alignment mark cannot be

that cannot be placed away from the edges/ arrow (alignment mark) of the Platen may be saved as PDF files. To save in a format other than PDF, scan by specifying the file format.

Placing Multiple Documents

Allow 0.39 inches (1 cm) or more space between the edges (diagonally striped area) of the Platen and documents, and between documents. Portions placed on the diagonally striped area cannot be scanned.

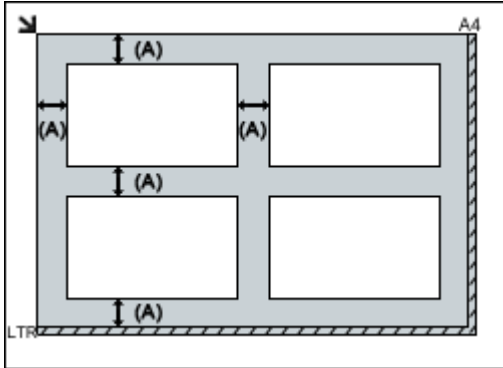

(A) more than 0.39 inches (1 cm)

Note

- You can place up to 12 documents.
- Positions of slanted documents (10 degrees or less) are corrected automatically.

scanned.

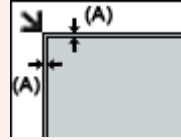

(A) 0.039 inches (1 mm)

Advanced Guide

[Advanced Guide](#) > [Scanning](#) > [Scanning with Using the Operation Panel of the Machine](#)

Scanning with Using the Operation Panel of the Machine

- ➡ [Forwarding Scanned Data to the Computer Using the Operation Panel of the Machine](#)
- ➡ [Appendix: Various Scan Settings](#)

[Page top](#) ↑

Advanced Guide

Advanced Guide > Scanning > Scanning with Using the Operation Panel of the Machine > Forwarding Scanned Data to the Computer Using the Operation Panel of the Machine

U051

Forwarding Scanned Data to the Computer Using the Operation Panel of the Machine

You can forward scanned data to the computer using the Operation Panel of the machine.

The machine detects the type of the originals loaded on the Platen Glass automatically and the image is forwarded to the computer in the optimized size and resolution.

Important

- Load originals properly according to their type; otherwise, some originals may not be scanned properly.
- Refer to [Placing Documents](#) for how to load the original on the Platen Glass.
- The following items can be scanned:
Photos, postcards, visiting cards, magazines, newspapers, documents, BD/DVD/CDs
- The following items cannot be scanned properly.
 - A4 sized photos
 - Documents smaller than 5 inches x 7 inches (127 mm x 178 mm) such as a paperback with its backbone cut off
 - Originals on thin white paper
 - Long and narrow originals such as panoramic photographs

Before forwarding scanned data to the computer, confirm the following:

- **The necessary application software (MP Drivers and MP Navigator EX) is installed.**

If the application software (MP Drivers and MP Navigator EX) is not yet installed, insert the *Setup CD-ROM* into the computer's disc drive, then perform Custom Install and select MP Drivers and MP Navigator EX to install.

- **The machine is connected to a computer correctly.**

Make sure that the machine is connected to the computer correctly.

Do not plug in or unplug the USB cable when scanning images with the machine, or when the computer is in the sleep or standby mode.

- **The destination and the file name are specified in MP Navigator EX.**

You can specify the destination and the file name in MP Navigator EX. For details on how to perform settings or the initial settings, refer to [Scanner Button Settings Tab \(Save to PC\)](#) .

Note

- When scanning with using the Operation Panel of the machine, the document type is automatically detected and the settings in document size and resolution are automatically set.

1. Make sure that the machine is turned on.

2. Load the original on the Platen Glass.

Note

- Refer to [Placing Documents](#) for how to load the original on the Platen Glass.

3. Press the **SCAN** button.

Scanning starts and the images are forwarded to the computer according to the settings specified in MP Navigator EX.

Remove the original on the Platen Glass after scanning is complete.

4. Specify MP Navigator EX 4.0

If you are using Windows 7 or Windows Vista:

The program selection screen may be displayed after pressing the **SCAN** button. In this case, select MP Navigator EX Ver4.0 and click OK.

You can set MP Navigator EX to launch whenever pressing the **SCAN** button. For details, see [For Windows Users](#).

If you are using Windows XP:

The program selection screen may be displayed after pressing the **SCAN** button for the first time. In this case, specify MP Navigator EX Ver4.0 as the application software to use, select Always use this program for this action, then click OK. From the next time, MP Navigator EX is automatically started.

Important

- The position or size of an image is not scanned correctly depending on the type of the original. In this case, refer to [Scanning Photos and Documents](#) to change the settings in Document Type and Document Size of MP Navigator EX to match the original and scan it using MP Navigator EX.

If you want to scan originals with advanced settings, or if you want to edit or print the scanned images:

If you scan originals from a computer using MP Navigator EX, MP Navigator EX enables you to edit the scanned images, such as optimizing or trimming.

In addition, you can edit or print the scanned images using the bundled application software to make better use of them.

[➔ Let's Try Scanning](#)

Note

- You can use a WIA-compliant application software and the Control Panel (Windows XP only) to scan originals with this machine.
- For details, refer to [Other Scanning Methods](#).
- If you want to convert a scanned document to text, refer to [Editing Files](#).

Advanced Guide

[Advanced Guide](#) > [Scanning](#) > [Scanning with Using the Operation Panel of the Machine](#) > [Appendix: Various Scan Settings](#)

S010

Appendix: Various Scan Settings

- **Specifying how to respond when scanning using the Operation Panel of the machine**
 - ➔ [Selecting a Response to Commands from the Operation Panel Using MP Navigator EX](#)

[Page top](#) ↕

Advanced Guide

Advanced Guide > Scanning > Scanning with Using the Operation Panel of the Machine > Appendix: Various Scan Settings > Selecting a Response to Commands from the Operation Panel Using MP Navigator EX

S007

MP Navigator EX

Selecting a Response to Commands from the Operation Panel Using MP Navigator EX

MP Navigator EX enables you to specify how to respond when scanning using the Operation Panel of the machine.

1. Start MP Navigator EX.

➔ Starting MP Navigator EX

2. Click Preferences.

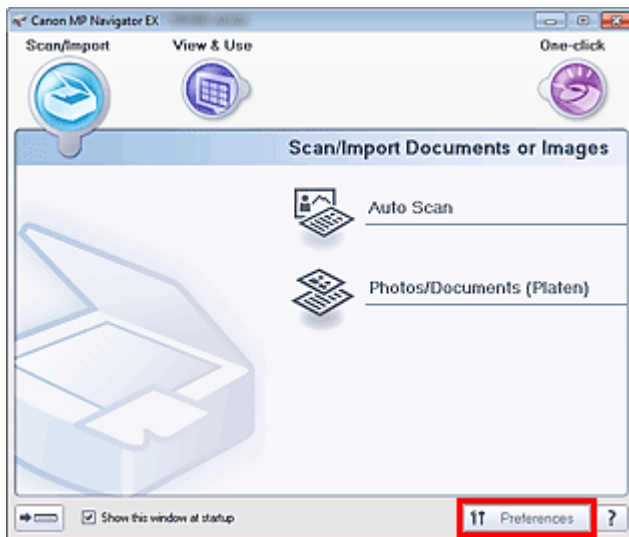

The Preferences dialog box opens.

Note

- The Preferences dialog box can also be opened by clicking Preferences in the One-click Mode screen.

3. On the Scanner Button Settings tab, specify Actions.

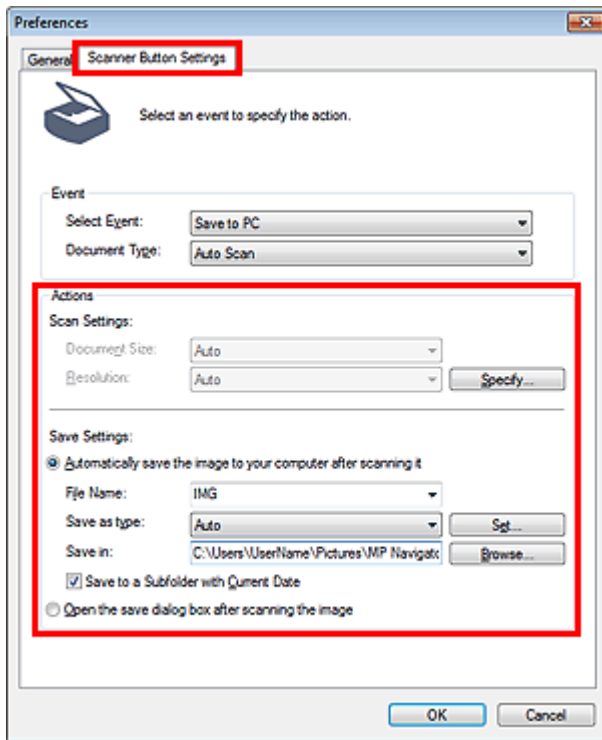

Note

- See the section below for details.
 - ➔ [Scanner Button Settings Tab \(Save to PC\)](#)

4. Click OK.

The operation will be performed according to the settings when you start scanning using the Operation Panel of the machine.

[Page top](#)

Advanced Guide

[Advanced Guide](#) > [Scanning](#) > [Scanning with the Bundled Application Software](#)

Scanning with the Bundled Application Software

- ➡ [What Is MP Navigator EX \(Supplied Scanner Software\)?](#)
- ➡ [Let's Try Scanning](#)
- ➡ [Useful MP Navigator EX Functions](#)
- ➡ [Utilizing Images in MP Navigator EX](#)
- ➡ [MP Navigator EX Screens](#)
- ➡ [Appendix: Opening Files Other than Scanned Images](#)

[Page top](#) ↕

Advanced Guide

Advanced Guide > Scanning > Scanning with the Bundled Application Software > What Is MP Navigator EX (Supplied Scanner Software)?

S101

MP Navigator EX

What Is MP Navigator EX (Supplied Scanner Software)?

MP Navigator EX is an application that enables you to easily scan photos and documents. It is suitable even for beginners.

Important

- MP Navigator EX may not start from the Operation Panel of the machine. In that case, restart the computer.
- Use the default display font size of the OS. Otherwise, software screens may not appear correctly.

What You Can Do with This Software

This software allows you to scan multiple documents at one time, or scan images larger than the Platen. You can also save scanned images, attach them to e-mail or print them using the supplied applications.

Screens

There are two types of MP Navigator EX Main Menu: Navigation Mode screen and One-click Mode screen.

Navigation Mode Screen

You can start various tasks from the Navigation Mode screen, including simple scanning, scanning using ScanGear (scanner driver), and enhancing/correcting images.

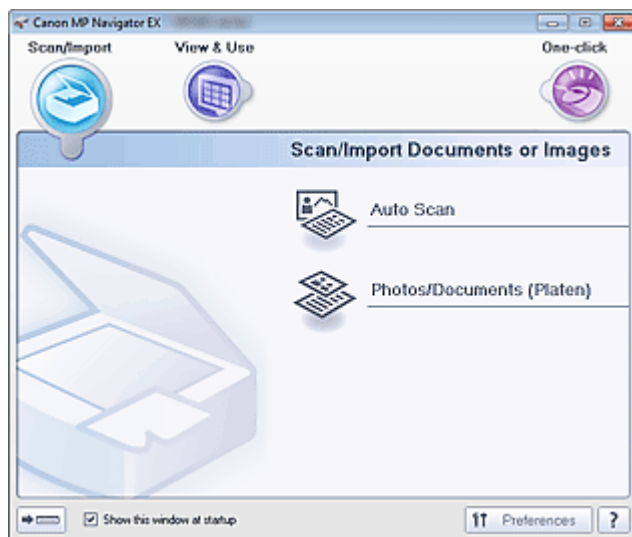

One-click Mode Screen

You can complete "from scanning to saving", etc. at one time by simply clicking the corresponding icon in the One-click Mode screen.

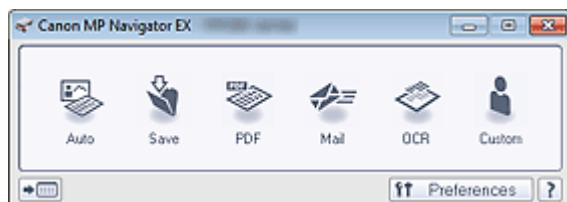

Scan/Import Window

Use the Scan/Import window to scan photos and documents.

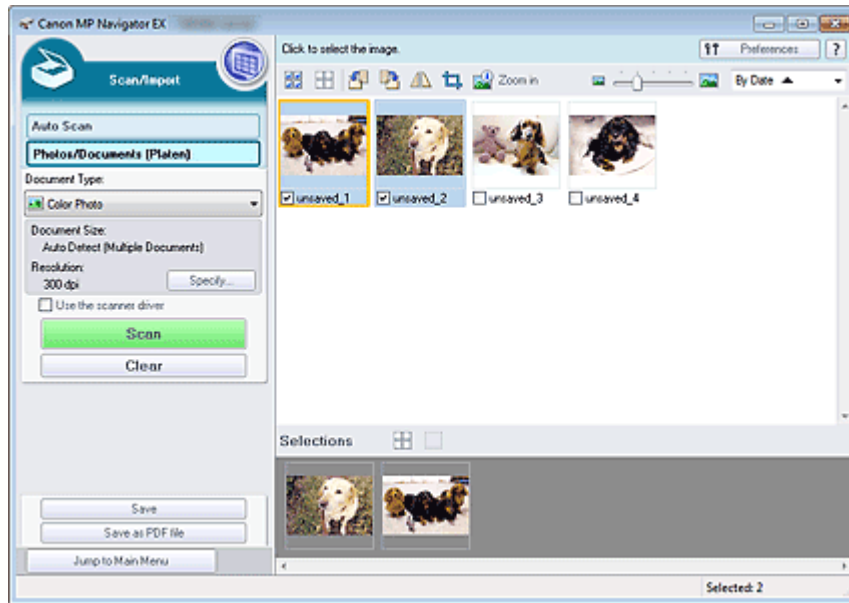

View & Use Window

Use the View & Use window to select what you want to do with the scanned images.

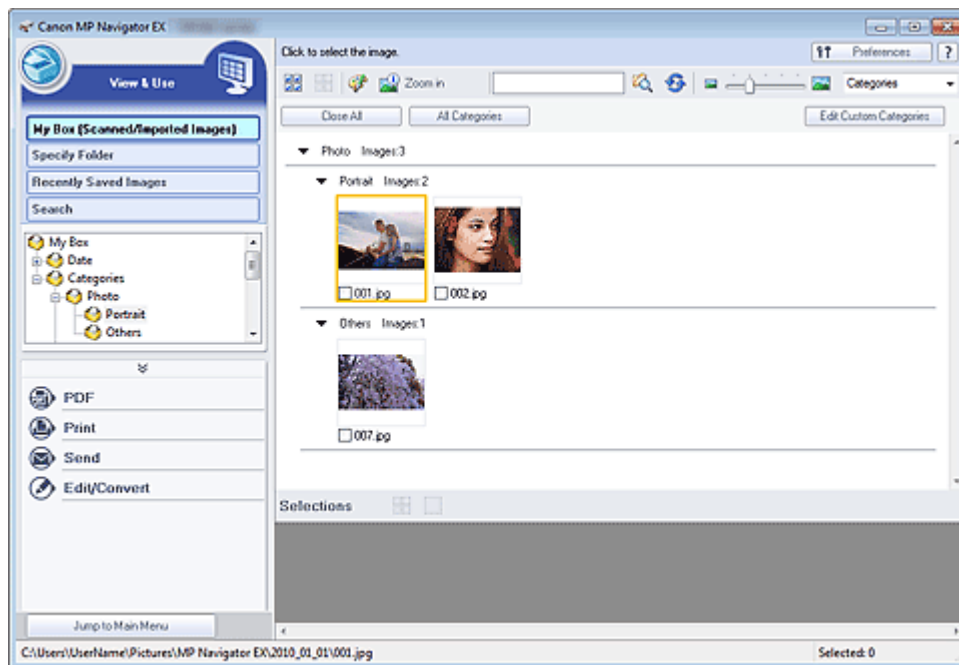

Note

- See "File Formats" for data formats (extensions) supported by MP Navigator EX.

Advanced Guide

[Advanced Guide](#) > [Scanning](#) > [Scanning with the Bundled Application Software](#) > [Let's Try Scanning](#)

S100

MP Navigator EX

Let's Try Scanning

Try scanning using MP Navigator EX.

- **Starting MP Navigator EX**
 - ➔ [Starting MP Navigator EX](#)
- **Scanning with a simple operation**
 - ➔ [Easy Scanning with Auto Scan](#)
- **Scanning documents, photos, magazines, etc. from the Platen**
 - ➔ [Scanning Photos and Documents](#)
- **Scanning two or more photos (small documents) at one time**
 - ➔ [Scanning Multiple Documents at One Time](#)
- **Scanning images larger than the Platen**
 - ➔ [Scanning Images Larger than the Platen \(Stitch Assist\)](#)
- **Scanning easily according to purpose (scan and save, attach to e-mail, etc.)**
 - ➔ [Easy Scanning with One-click](#)

[Page top](#)↑

Advanced Guide

Advanced Guide > Scanning > Scanning with the Bundled Application Software > Let's Try Scanning > Starting MP Navigator EX

S111

MP Navigator EX

Starting MP Navigator EX

Starting MP Navigator EX

1. From the Start menu, select All Programs > Canon Utilities > MP Navigator EX 4.0 > MP Navigator EX 4.0.

MP Navigator EX starts.

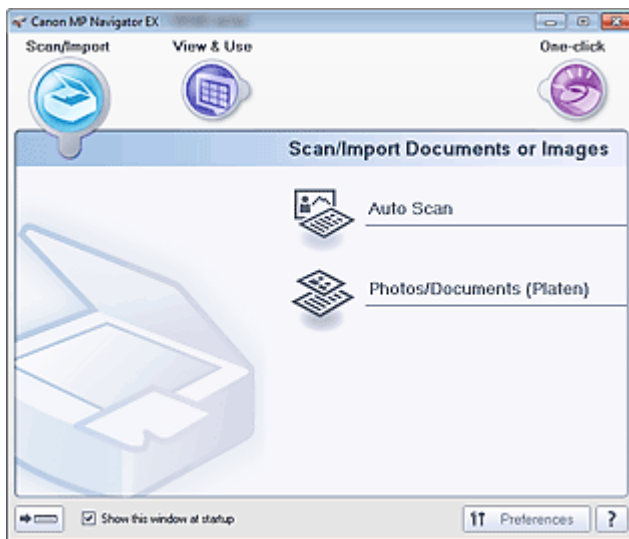

Starting One-click Mode

1. Click  (Switch Mode) at the bottom left of the screen.

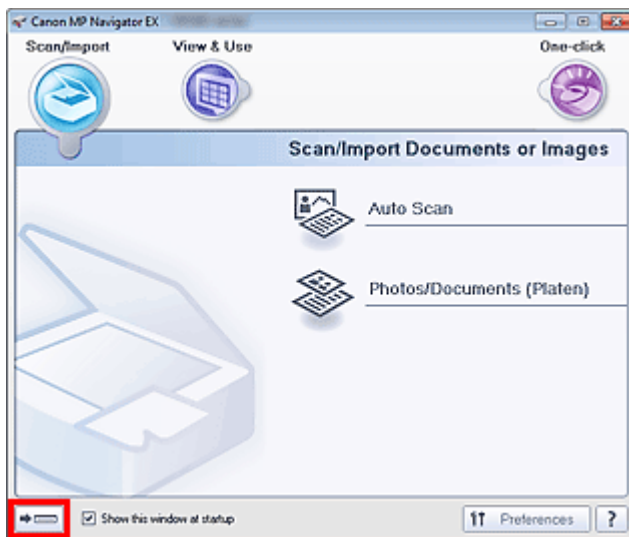

The One-click Mode screen appears.

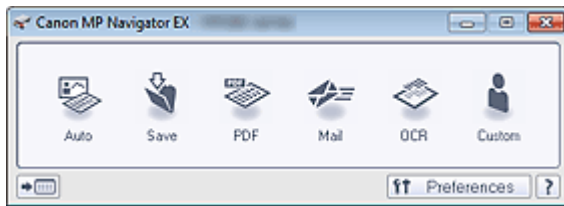

Note

- Select the Show this window at startup checkbox in the Navigation Mode screen to always open the Navigation Mode screen at startup. If this checkbox is not selected, the last used screen appears at startup.

[Page top](#)

Advanced Guide

Advanced Guide > Scanning > Scanning with the Bundled Application Software > Let's Try Scanning > Easy Scanning with Auto Scan

S108

MP Navigator EX

Easy Scanning with Auto Scan

Scan documents easily by automatically detecting the document type.

Important

- Supported document types are photos, postcards, business cards, magazines, newspapers, text documents and BD/DVD/CD. To scan other documents, specify the document type.
➔ [Scanning Photos and Documents](#)

- Place the document on the Platen.
➔ [Placing Documents](#)
- Start MP Navigator EX and open the Navigation Mode screen.
➔ [Starting MP Navigator EX](#)
- In Scan/Import, click Auto Scan.

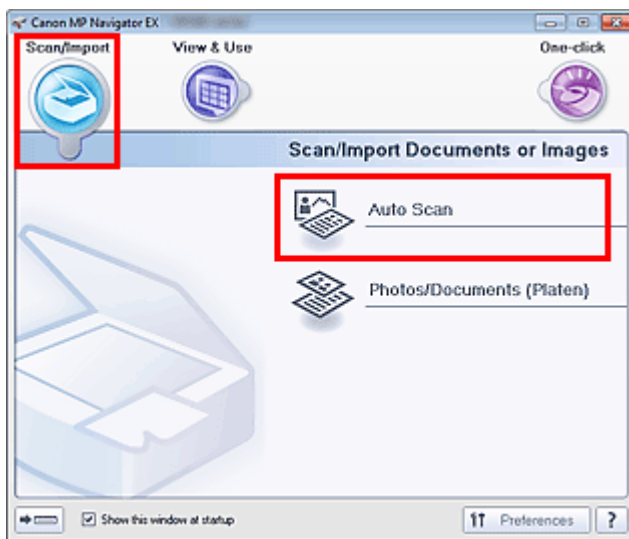

- Click Specify... as required.
Set the preferences if you want to apply suitable corrections based on the document type.
When setting is completed, click OK.
➔ [Scan Settings Dialog Box \(Auto Scan\)](#)
- Click Scan.

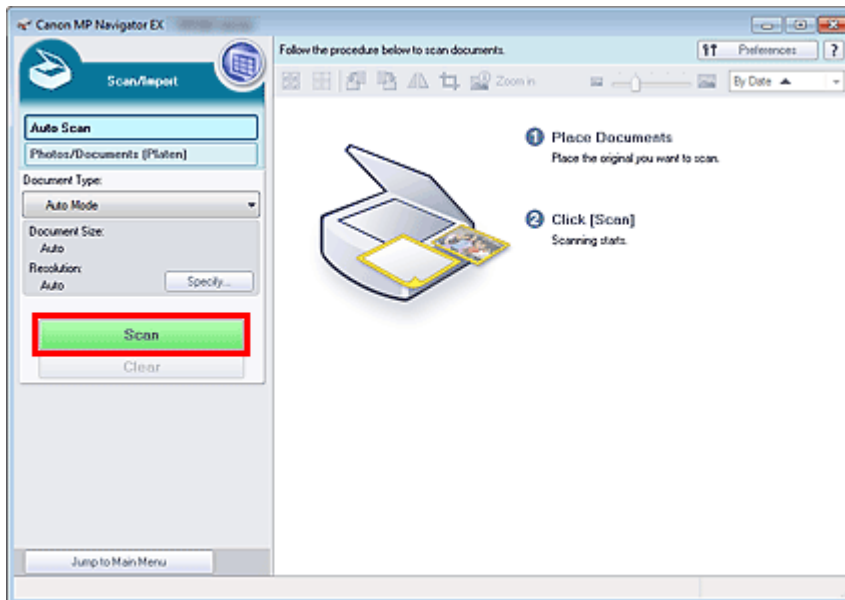

A message about placing documents appears. Click Open Manual to open this guide (if it is installed).

Click OK to start scanning.

Note

- Click Cancel to cancel the scan.

When scanning is completed, the Scan Complete dialog box opens. Select Scan or Exit. Select Scan to scan the next document, or select Exit to end.

The scanned images appear in the Thumbnail window.

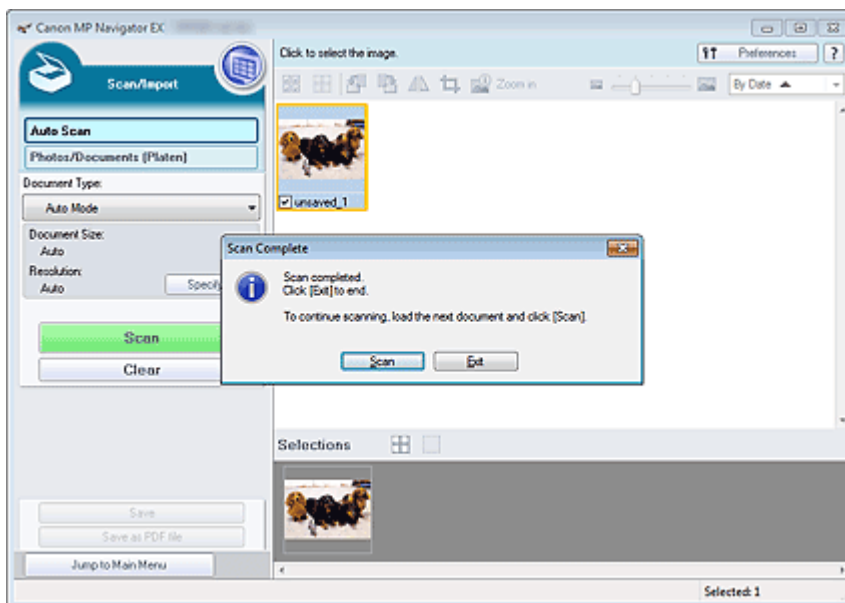

6. Edit the scanned images as required.

Use Edit Tools to rotate images, select a part of an image, etc.

See the Edit Tools in "Auto Scan Screen (Scan/Import Window) " for details.

Note

- First select images to edit. (Selected images are outlined in orange.) Drag the mouse or use Shift + arrow keys to select multiple images. You can also select images by dragging and dropping them into the Selected Images area.

7. Save the scanned images.

➡ Saving

➡ Saving as PDF Files

[Page top](#) ↕

Advanced Guide

Advanced Guide > Scanning > Scanning with the Bundled Application Software > Let's Try Scanning > Scanning Photos and Documents

S102

MP Navigator EX

Scanning Photos and Documents

Scan photos and documents placed on the Platen.

1. Place the document on the Platen.
➔ Placing Documents
2. Start MP Navigator EX and open the Navigation Mode screen.
➔ Starting MP Navigator EX
3. In Scan/Import, click Photos/Documents (Platen).

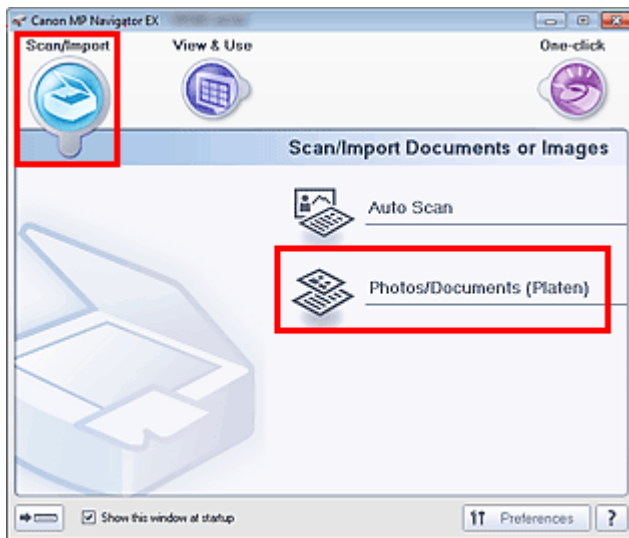

4. Select Document Type according to the document to be scanned.

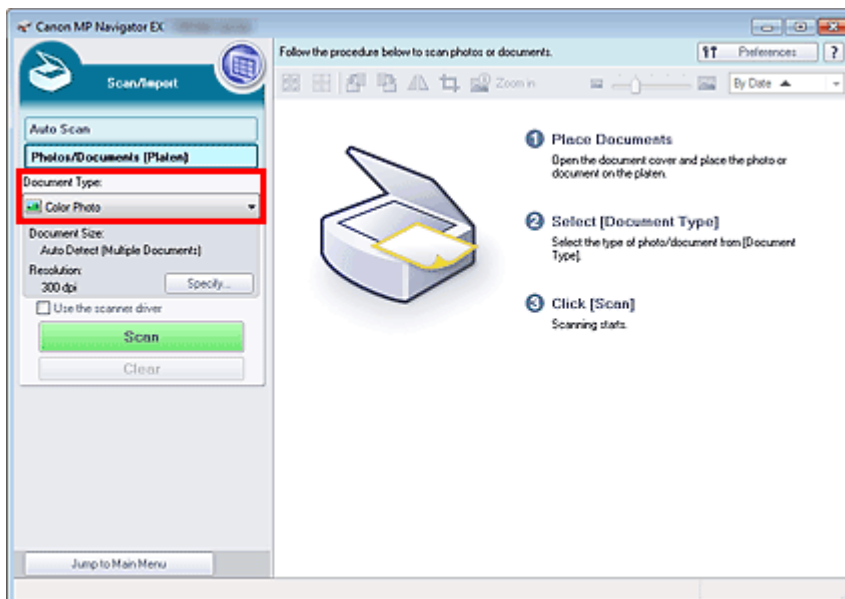

Note

- When you select Magazine(Color), the descreen function will be enabled and scanning takes longer than usual. To disable the descreen function, deselect the Descreen checkbox in the Scan Settings dialog box.
- Select Text(OCR) to extract the text in the image and convert to editable text data using MP Navigator EX.
- Color scanning is not available for Text(OCR). To scan in color, open the OCR dialog box from the One-click Mode screen and scan with Color Mode set to Color.

5. Click Specify... to set the document size and scanning resolution as required.

When setting is completed, click OK.

➔ Scan Settings Dialog Box (Photos/Documents)

Important

- When scanning a large document (such as an A4 size photo), align its corner with the corner at the arrow (alignment mark) of the Platen and specify the document size in the Scan Settings dialog box.

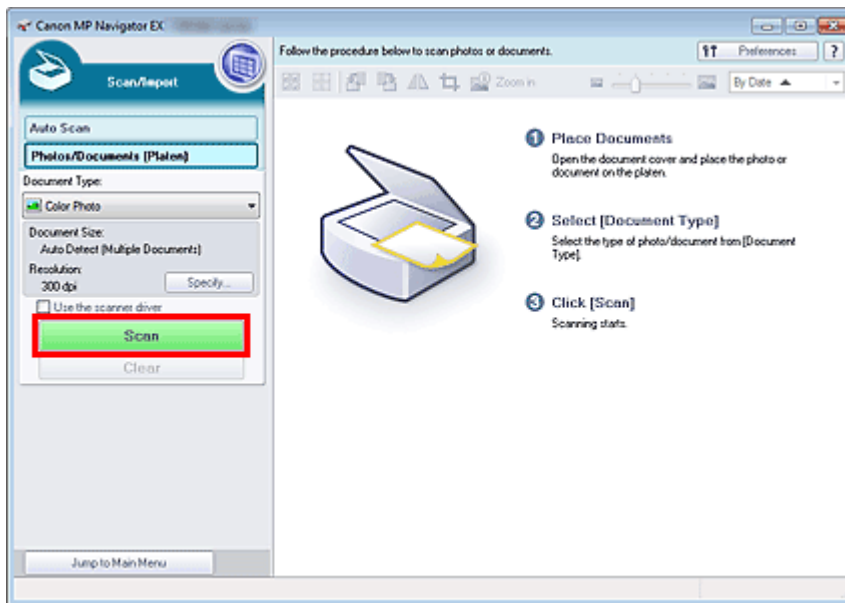
6. Click Scan.

Starts scanning.

Note

- Click Cancel to cancel the scan.

When scanning is completed, the Scan Complete dialog box opens. Select Scan or Exit. Select Scan to scan the next document, or select Exit to end.

The scanned images appear in the Thumbnail window.

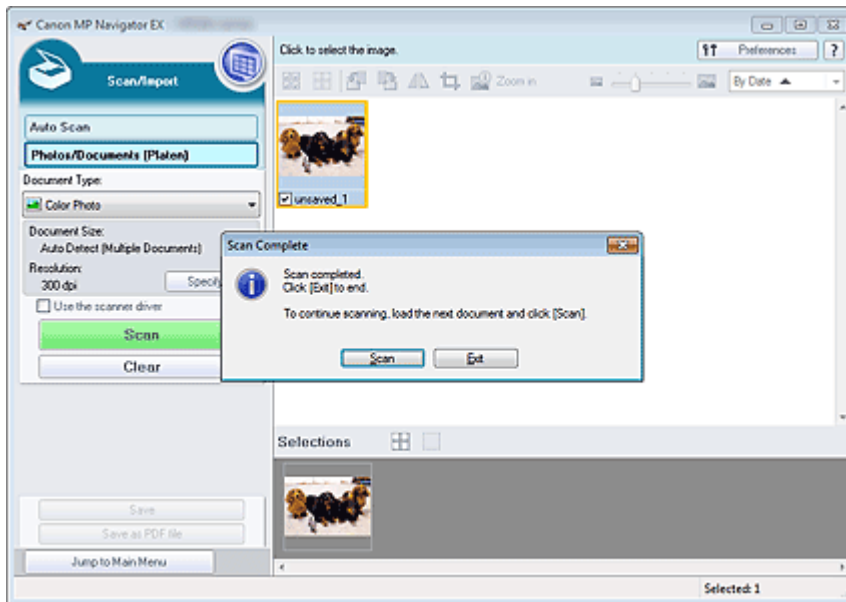

7. Edit the scanned images as required.

Use Edit Tools to rotate images, select a part of an image, etc.

See the Edit Tools in "Photos/Documents (Platen) Screen (Scan/Import Window) " for details.

Note

- First select images to edit. (Selected images are outlined in orange.) Drag the mouse or use Shift + arrow keys to select multiple images. You can also select images by dragging and dropping them into the Selected Images area.

8. Save the scanned images.

➔ Saving

➔ Saving as PDF Files

[Page top](#)

Advanced Guide

Advanced Guide > Scanning > Scanning with the Bundled Application Software > Let's Try Scanning > Scanning Multiple Documents at One Time

S105

MP Navigator EX

Scanning Multiple Documents at One Time

You can scan two or more photos (small documents) at one time by setting Document Size to Auto Detect (Multiple Documents) in the Scan Settings dialog box of MP Navigator EX.

Important

- The following types of documents may not be cropped correctly. In that case, start ScanGear (scanner driver), then adjust the cropping frames (scan areas) in whole image view and scan again.
 - Photos that have a whitish border
 - Documents printed on white paper, hand-written text, business cards, etc.
 - Thin documents
 - Thick documents

➔ [Scanning Multiple Documents in Whole Image View](#)

1. Place the document on the Platen.
➔ [Placing Documents](#)
2. Start MP Navigator EX and open the Navigation Mode screen.
➔ [Starting MP Navigator EX](#)
3. In Scan/Import, click Photos/Documents (Platen).

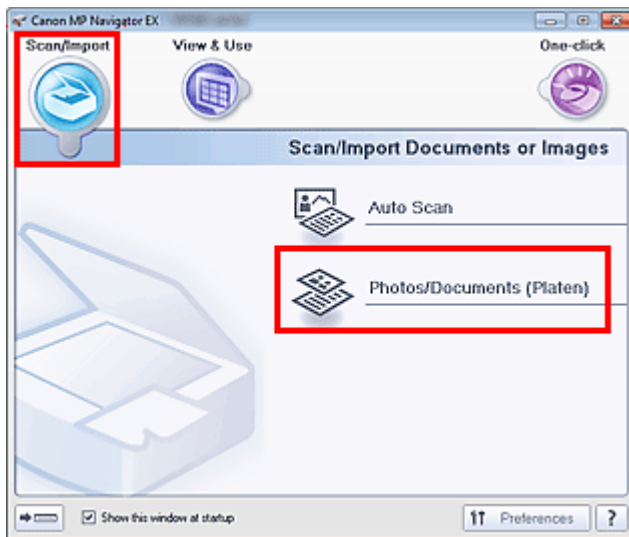

4. Select Document Type according to the document to be scanned.

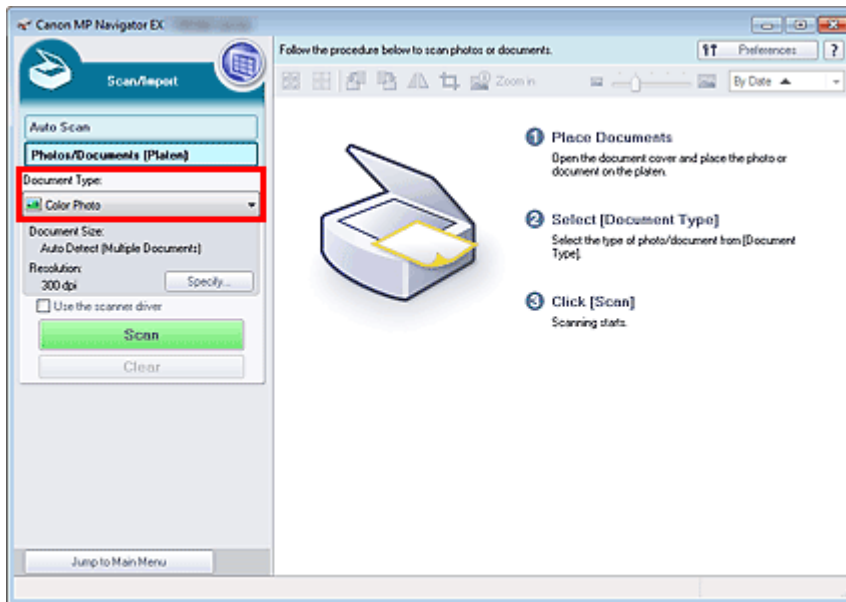

5. Click Specify....

Select Auto Detect (Multiple Documents) for Document Size.

When setting is completed, click OK.

➔ Scan Settings Dialog Box (Photos/Documents)

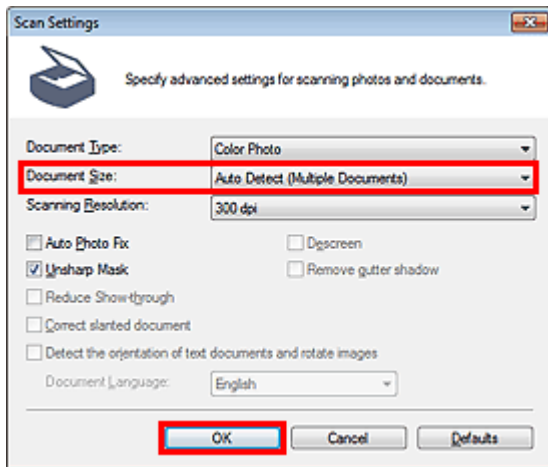

6. Click Scan.

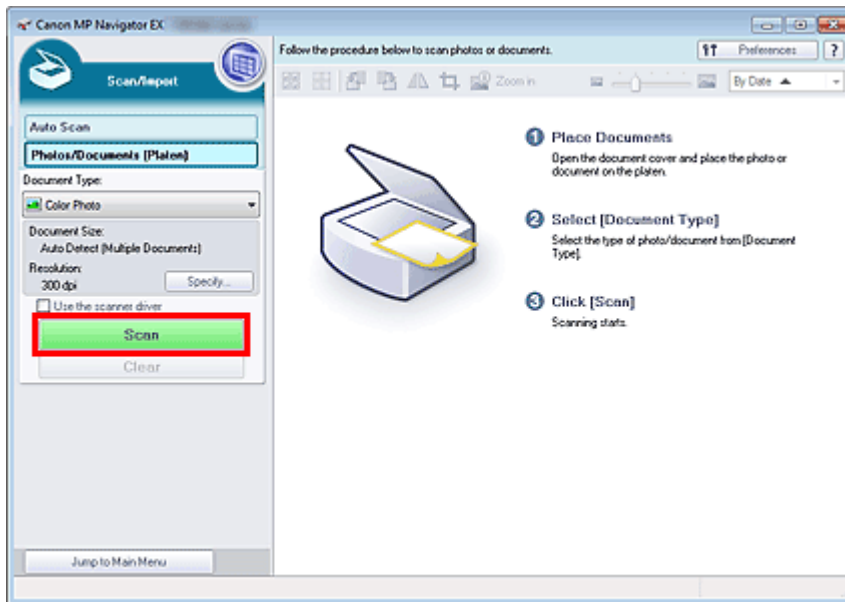

Multiple documents are scanned at one time.

Note

- Click Cancel to cancel the scan.

When scanning is completed, the Scan Complete dialog box opens. Select Scan or Exit. Select Scan to scan the next document, or select Exit to end.

The scanned images appear in the Thumbnail window.

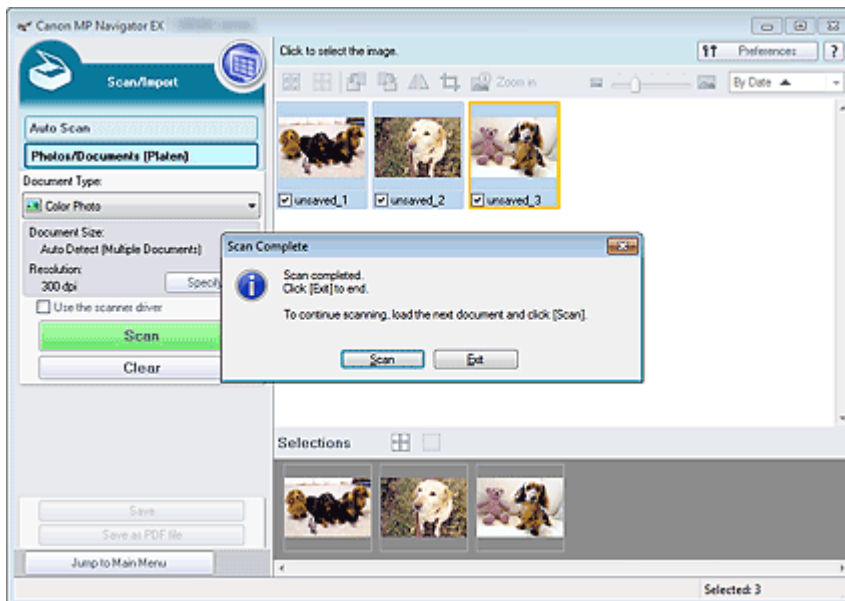

7. Edit the scanned images as required.

Use Edit Tools to rotate images, select a part of an image, etc.

See the Edit Tools in "Photos/Documents (Platen) Screen (Scan/Import Window)" for details.

Note

- First select images to edit. (Selected images are outlined in orange.) Drag the mouse or use Shift + arrow keys to select multiple images. You can also select images by dragging and dropping them into the Selected Images area.

8. Save the scanned images.

➔ Saving

[➔ Saving as PDF Files](#)

 **Note**

- If you want to preview the images before scanning, use ScanGear.
 - [➔ Scanning Multiple Documents at One Time with ScanGear \(Scanner Driver\)](#)
-

[Page top](#) 

Advanced Guide

Advanced Guide > Scanning > Scanning with the Bundled Application Software > Let's Try Scanning > Scanning Images Larger than the Platen (Stitch Assist)

S106

MP Navigator EX

Scanning Images Larger than the Platen (Stitch Assist)

Stitch Assist allows you to scan the left and right halves of a large document separately and combine the scanned images back into one image. You can scan documents that are up to twice as large as the Platen.

1. Start MP Navigator EX and open the Navigation Mode screen.

➔ Starting MP Navigator EX

Note

- You can complete "from scanning to saving", etc. at one time by simply clicking the corresponding icon in the One-click Mode screen. Stitch Assist is available from the One-click Mode screen as well, by changing the document size. Click the corresponding icon and select Stitch Assist for Document Size. Then skip ahead to Step 5.

2. In Scan/Import, click Photos/Documents (Platen).

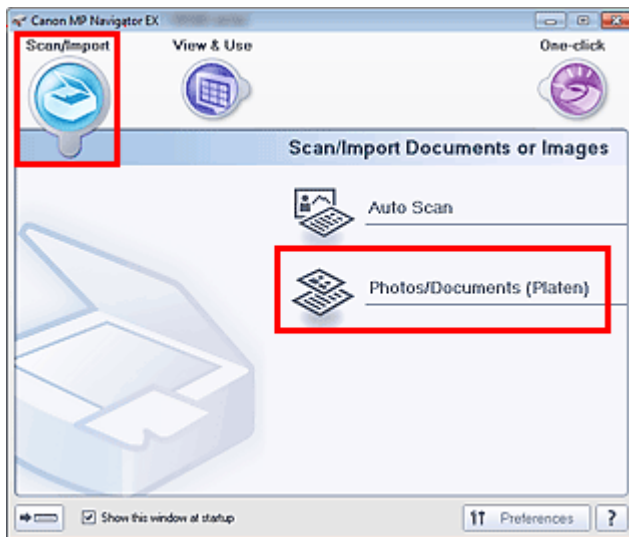

3. Select Document Type according to the document to be scanned.

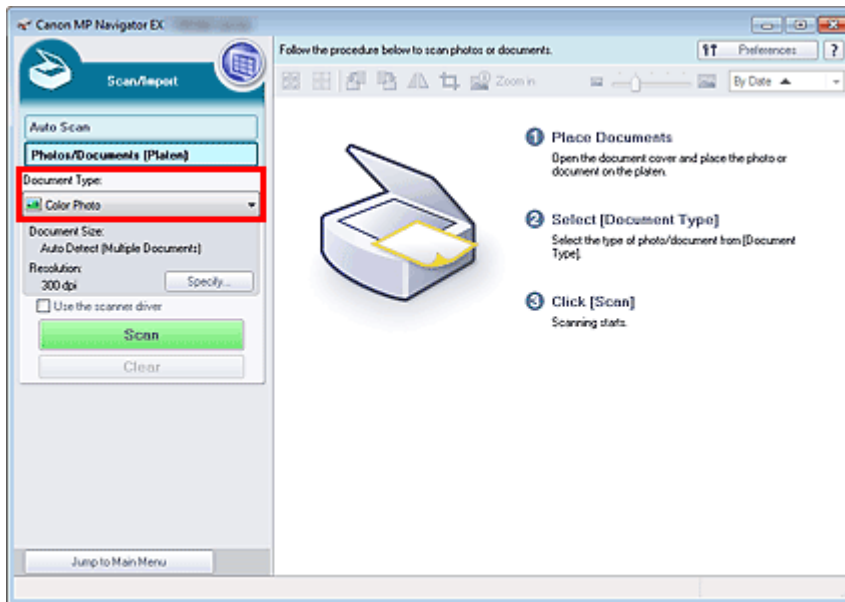

4. Click Specify....

Select Stitch Assist for Document Size, then specify the scanning resolution as required. When setting is completed, click OK.

➔ Scan Settings Dialog Box (Photos/Documents)

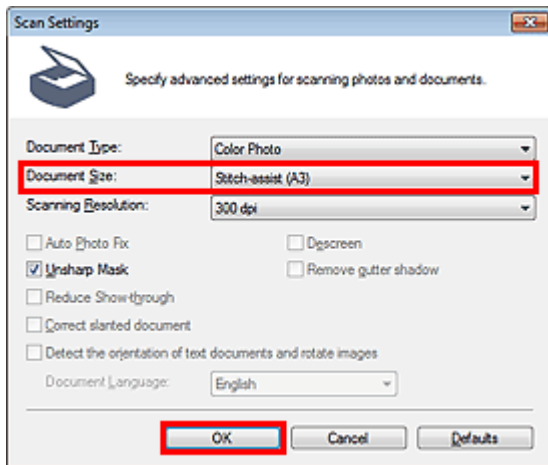

5. Click Scan.

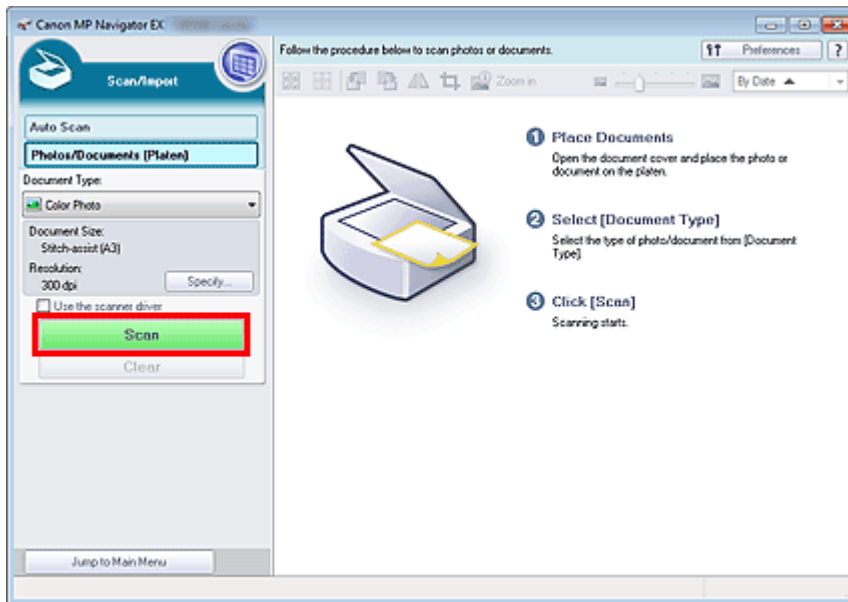

The Stitch-assist window opens.

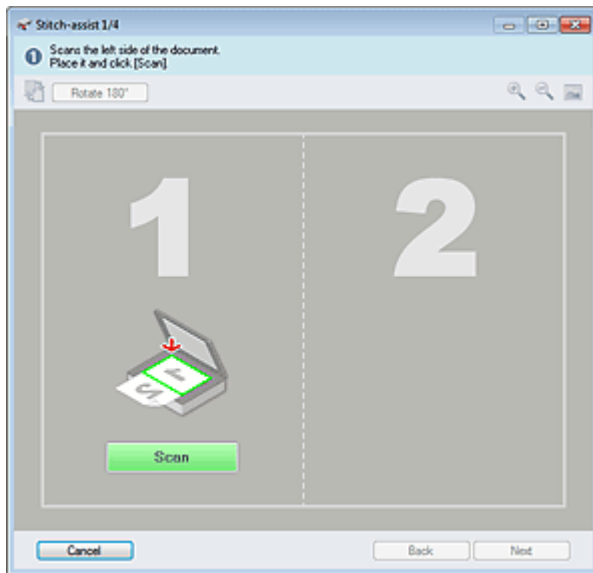

6. Place the left half of the document face-down on the Platen.

7. Click Scan.

The left half of the document is scanned and appears in the Stitch-assist window.

Note

- Click Cancel to cancel the scan.

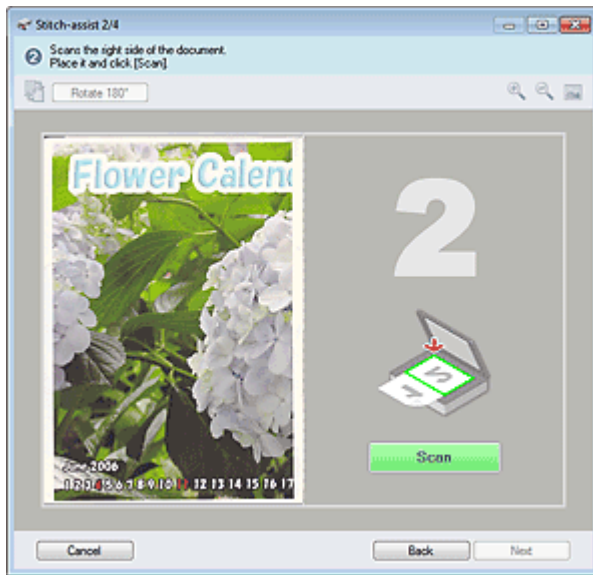

8. Place the right half of the document face-down on the Platen.

9. Click Scan.

The right half of the document is scanned.

Note

- Click Cancel to cancel the scan.

10. Adjust the scanned image as required.

Use the icons to swap the left and right halves, rotate the image 180 degrees or enlarge/reduce the image.

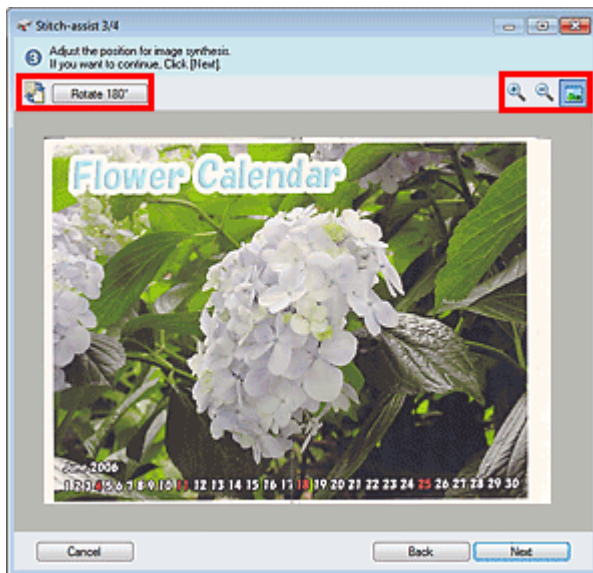

• (Swap Left & Right)

Swaps the left and right halves.

Important



- This function is not available while the image is enlarged/reduced.

• **Rotate 180°**

Rotates right half of the image 180 degrees.

Important

- This function is not available while the image is enlarged/reduced.

-  **(Enlarge)**
Enlarges the displayed image.
-  **(Reduce)**
Reduces the displayed image.
-  **(Full-screen)**
Displays the entire image.

Note

- Enlarge/Reduce does not affect the actual size of the scanned image.
- When the document is scanned upside down, the image displayed in the Stitch-assist window will also be upside down. Click Rotate 180° to rotate the image to the correct orientation.
- You can drag the right half of the image from right to left or up and down to adjust the position.
- If the left and right halves do not match due to a slanted document, place the document correctly and click Back, then scan again.

11. Click Next.

12. Drag the mouse to specify the area to be saved, then click OK.

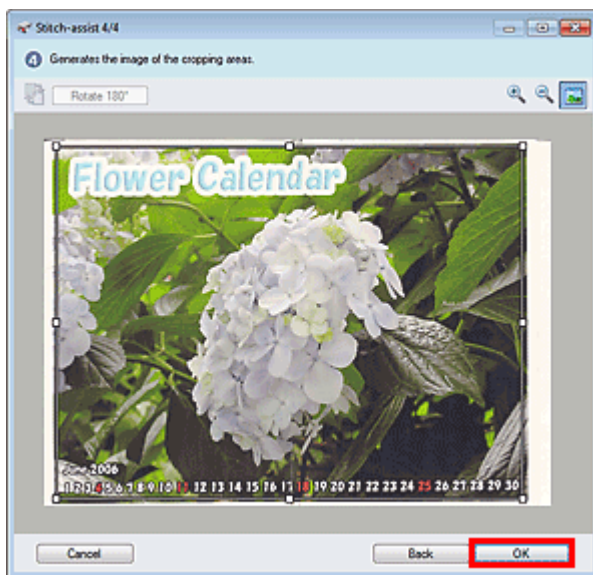

The combined image is created.

When scanning is completed, the Scan Complete dialog box opens. Select Scan or Exit. Select Scan to scan the next document, or select Exit to end.

The scanned images appear in the Thumbnail window.

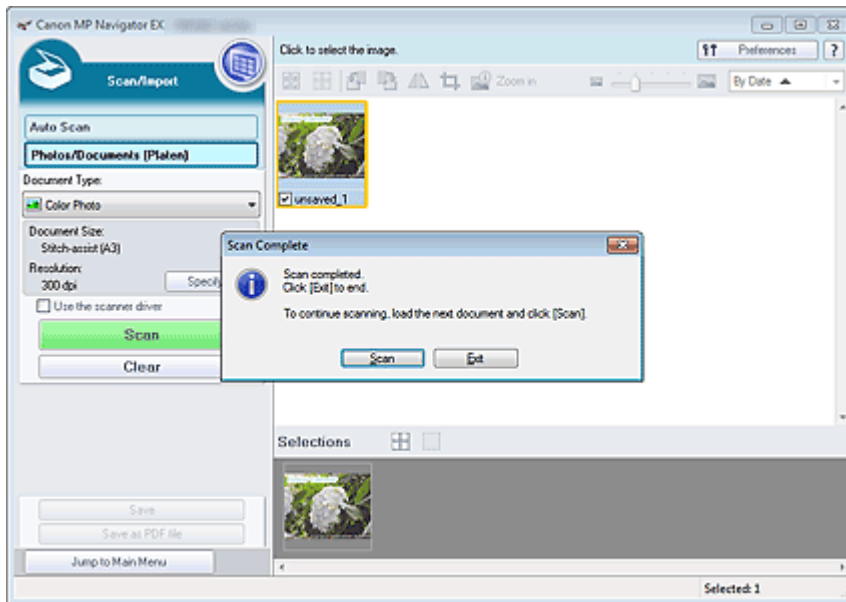

13. Save the scanned images.

- ➡ Saving
- ➡ Saving as PDF Files

[Page top](#) ↕

Advanced Guide

Advanced Guide > Scanning > Scanning with the Bundled Application Software > Let's Try Scanning > Easy Scanning with One-click

S104

MP Navigator EX

Easy Scanning with One-click

You can complete "from scanning to saving", etc. at one time by simply clicking the corresponding icon.

1. Place the document on the Platen.

➔ Placing Documents

2. Start MP Navigator EX.

➔ Starting MP Navigator EX

The MP Navigator EX Navigation Mode screen or One-click Mode screen appears.

Navigation Mode Screen

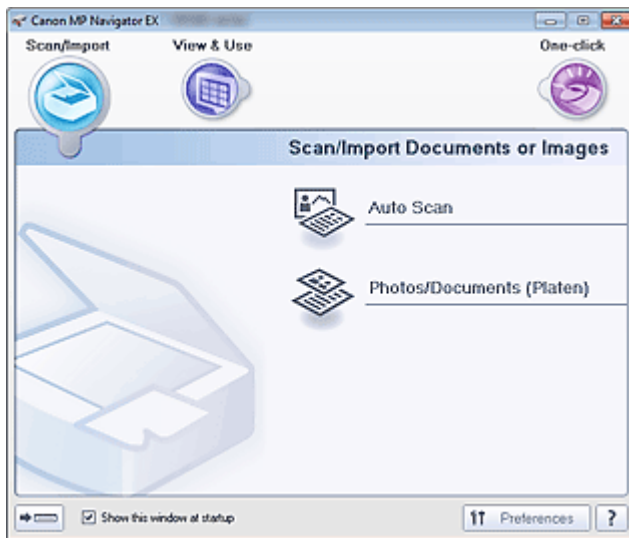

One-click Mode Screen

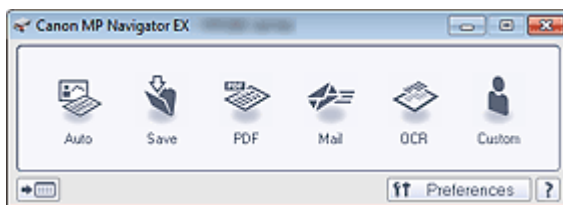

Note

- Skip ahead to Step 4 if One-click Mode screen is open.

3. Click One-click.

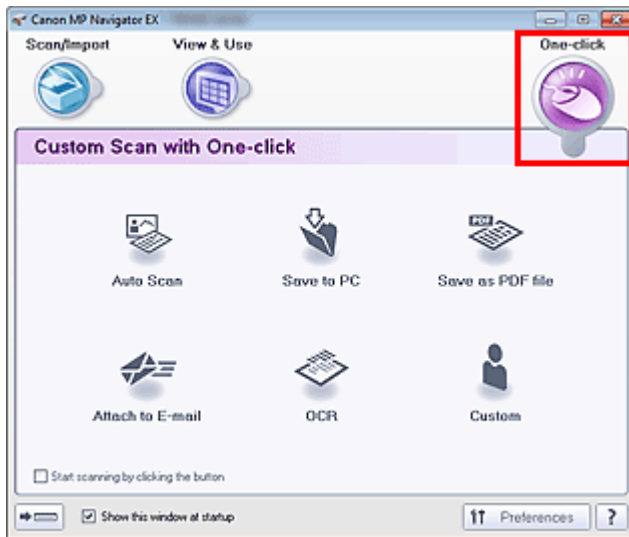

4. Click the corresponding icon.
 - ➔ Custom Scan with One-click Tab
 - ➔ One-click Mode Screen
5. Select Document Type according to the document to be scanned.
6. Set the document size and scanning resolution as required.
7. Start scanning.
Starts scanning.

Note

- Click Cancel to cancel the scan.

Advanced Guide

[Advanced Guide](#) > [Scanning](#) > [Scanning with the Bundled Application Software](#) > [Useful MP Navigator EX Functions](#)

S400

MP Navigator EX

Useful MP Navigator EX Functions

With MP Navigator EX, you can correct/enhance scanned images beautifully, and search saved images quickly.

- **Correcting/enhancing images automatically**
 - ➔ [Correcting/Enhancing Images Automatically](#)
- **Correcting/enhancing images manually**
 - ➔ [Correcting/Enhancing Images Manually](#)
- **Adjusting color characteristics such as brightness and contrast**
 - ➔ [Adjusting Images](#)
- **Searching for lost images**
 - ➔ [Searching Images](#)
- **Classifying and sorting images**
 - ➔ [Classifying Images into Categories](#)

[Page top](#)↑

Advanced Guide

Advanced Guide > Scanning > Scanning with the Bundled Application Software > Useful MP Navigator EX Functions > Correcting/Enhancing Images Automatically

S401

MP Navigator EX

Correcting/Enhancing Images Automatically

MP Navigator EX will analyze and correct/enhance scanned images automatically.

1. Scan documents into MP Navigator EX and save them, then open the View & Use window from the Navigation Mode screen and select the photos you want to correct/enhance.

Note

- See "Let's Try Scanning" to scan images into MP Navigator EX.
- You can also select images saved on a computer.
 - ➔ [Opening Images Saved on a Computer](#)

2. Click Edit/Convert, then click Fix photo images on the list.

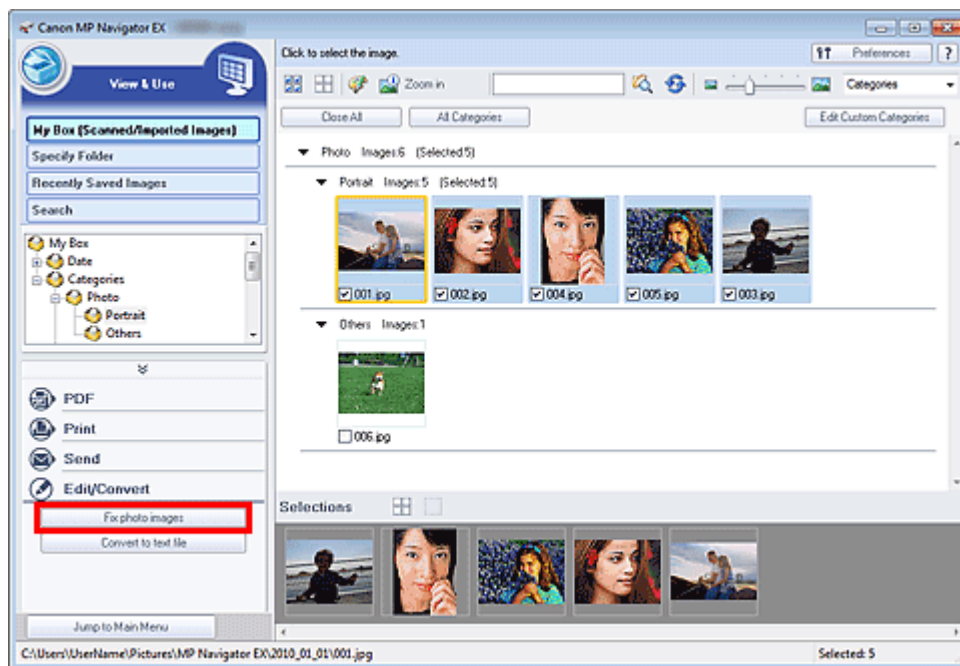

The Correct/Enhance Images window opens.

Note

- The Correct/Enhance Images window can also be opened by clicking  (Image Correction/Enhancement) on the Toolbar or in the Zoom in dialog box. In that case, only the target image (outlined in orange) can be corrected/enhanced.
- See "[Correct/Enhance Images Window](#)" for details on the Correct/Enhance Images window.

3. Select the image you want to correct/enhance from the thumbnail list.

The selected image appears in Preview.



Note

- If you selected only one image in the View & Use window, the thumbnail list does not appear and only the preview image appears.

4. Make sure that Auto is selected.
5. Click Auto Photo Fix, Face Sharpener or Digital Face Smoothing.

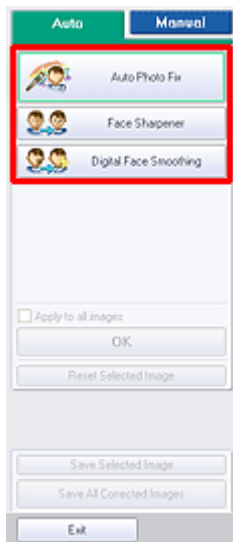

Important

- Once image is corrected with Auto Photo Fix and saved, it cannot be corrected again with Auto Photo Fix. Auto Photo Fix may not be available for images edited using an application, digital camera, etc. manufactured by other companies.

Note

- The Face Sharpener and Digital Face Smoothing effect levels can be changed using the slider that appears by clicking the corresponding buttons.
- When you apply Auto Photo Fix, dark backlit photos will be corrected automatically. If the image is not corrected enough using Auto Photo Fix, it is recommended that you apply Face Brightener on the Manual tab.

➔ [Correcting/Enhancing Images Manually](#)

6. Click OK.

The entire image is corrected/enhanced automatically and  (Correct/Enhance) mark appears on the upper left of the thumbnail and preview image.

Note

- Click Reset Selected Image to undo the correction/enhancement.
 - Select the Apply to all images checkbox to correct/enhance all selected images.
-

7. Click Save Selected Image or Save All Corrected Images.

You can save corrected/enhanced images as new files.

Note

- To save only the images you like, select them and click Save Selected Image. To save all images, click Save All Corrected Images.
 - The file format of corrected/enhanced images is JPEG/Exif.
 - Adobe RGB images are saved as sRGB images.
-

8. Click Exit.

Important

- The corrections/enhancements will be lost if you exit before saving corrected/enhanced images.

Advanced Guide

Advanced Guide > Scanning > Scanning with the Bundled Application Software > Useful MP Navigator EX Functions > Correcting/Enhancing Images Manually

S402

MP Navigator EX

Correcting/Enhancing Images Manually

You can correct/enhance scanned images manually.

1. Scan documents into MP Navigator EX and save them, then open the View & Use window from the Navigation Mode screen and select the photos you want to correct/enhance.

Note

- See "Let's Try Scanning" to scan images into MP Navigator EX.
- You can also select images saved on a computer.
 - ➔ [Opening Images Saved on a Computer](#)

2. Click Edit/Convert, then click Fix photo images on the list.

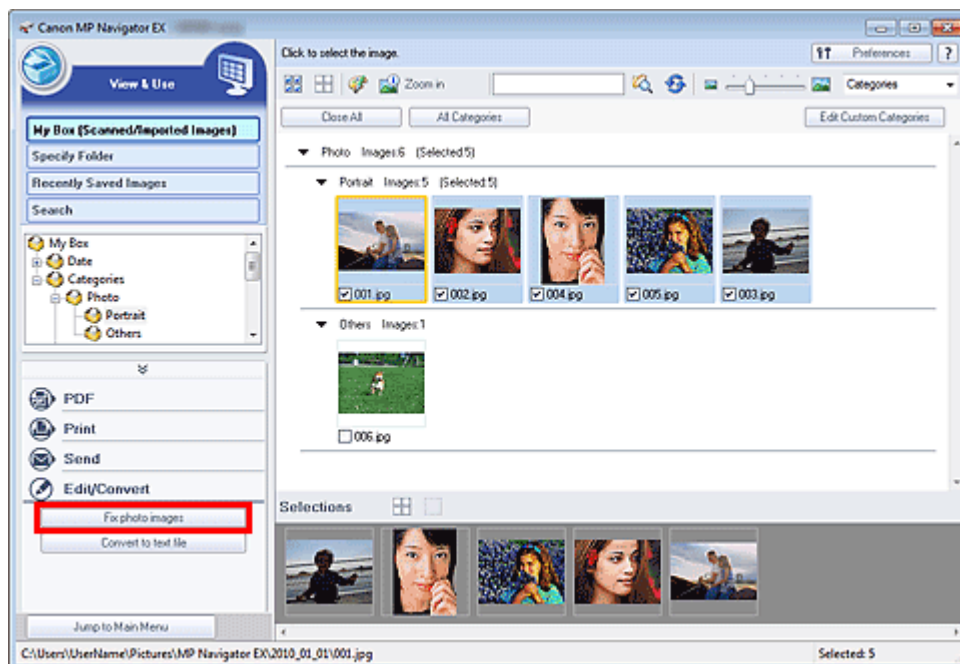

The Correct/Enhance Images window opens.

Note

- The Correct/Enhance Images window can also be opened by clicking  (Image Correction/Enhancement) on the Toolbar or in the Zoom in dialog box. In that case, only the target image (outlined in orange) can be corrected/enhanced.
- See "[Correct/Enhance Images Window](#)" for details on the Correct/Enhance Images window.

3. Select the image you want to correct/enhance from the thumbnail list.

The selected image appears in Preview.



Note

- If you selected only one image in the View & Use window, the thumbnail list does not appear and only the preview image appears.

4. Select Manual, then click Correct/Enhance.
5. Click Face Brightener, Face Sharpener, Digital Face Smoothing or Blemish Remover.

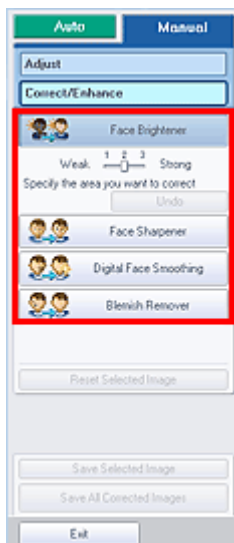

Note

- The Face Brightener, Face Sharpener and Digital Face Smoothing effect levels can be changed using the slider that appears by clicking the corresponding buttons.
- Move the cursor over the image. The shape of the cursor changes to **+** (Cross).

6. Drag to select the area you want to correct/enhance, then click OK that appears over the image.

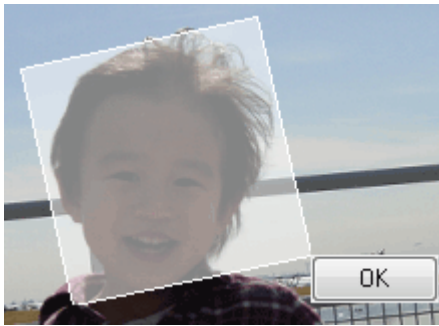

The portion in and around the selected area is corrected/enhanced and  (Correct/Enhance) mark appears on the upper left of the thumbnail and preview image.

Note

- You can also drag to rotate the rectangle.
 - Click Undo to undo the latest correction/enhancement.
 - Click Reset Selected Image to cancel all corrections, enhancements and adjustments applied to the selected image.
-

7. Click Save Selected Image or Save All Corrected Images.

You can save corrected/enhanced images as new files.

Note

- To save only the images you like, select them and click Save Selected Image. To save all images, click Save All Corrected Images.
 - The file format of corrected/enhanced images is JPEG/Exif.
-

8. Click Exit.

Important

- The corrections/enhancements will be lost if you exit before saving corrected/enhanced images.

Advanced Guide

Advanced Guide > Scanning > Scanning with the Bundled Application Software > Useful MP Navigator EX Functions > Adjusting Images

S406

MP Navigator EX

Adjusting Images

You can make fine adjustments to the overall brightness, contrast, etc. of images.

1. Scan documents into MP Navigator EX and save them, then open the View & Use window from the Navigation Mode screen and select the photos you want to adjust.

Note

- See "Let's Try Scanning" to scan images into MP Navigator EX.
- You can also select images saved on a computer.
 - ➔ [Opening Images Saved on a Computer](#)

2. Click Edit/Convert, then click Fix photo images on the list.

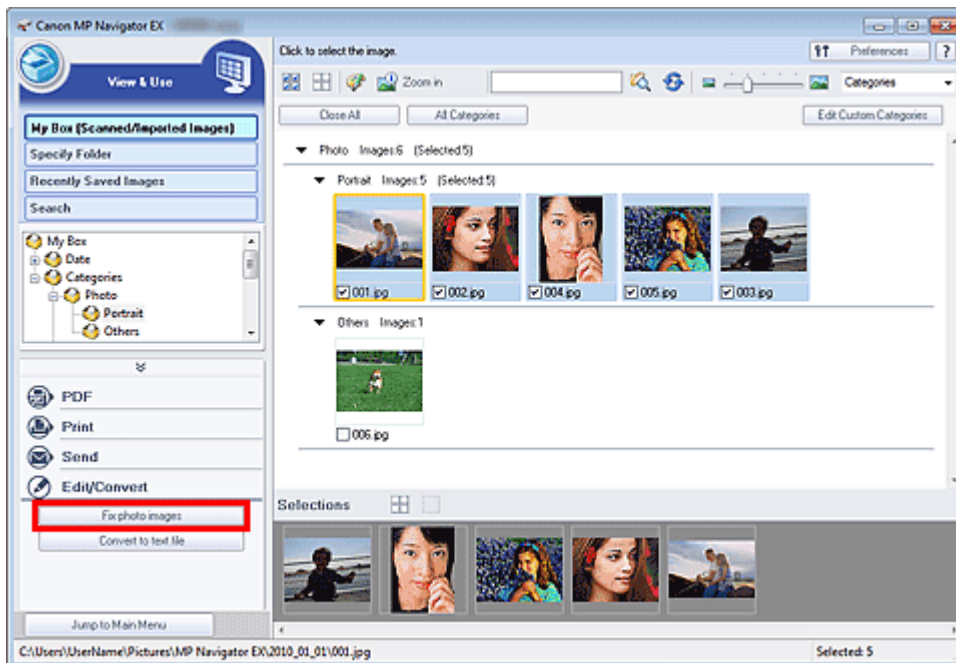

The Correct/Enhance Images window opens.

Note

- The Correct/Enhance Images window can also be opened by clicking  (Image Correction/Enhancement) on the Toolbar or in the Zoom in dialog box. In that case, only the target image (outlined in orange) can be corrected/enhanced.
- See "[Correct/Enhance Images Window](#)" for details on the Correct/Enhance Images window.

3. Select the image you want to adjust from the thumbnail list.

The selected image appears in Preview.



Note

- If you selected only one image in the View & Use window, the thumbnail list does not appear and only the preview image appears.

4. Select Manual, then click Adjust.

5. Move the slider of the item you want to adjust and set the effect level.

When you move a slider,  (Correct/Enhance) mark appears on the upper left of the thumbnail and preview image.

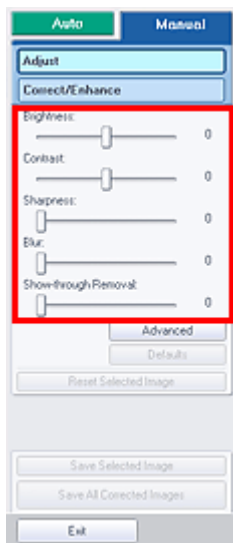

Note

- Click Advanced to make fine adjustments to the image brightness and color tone. See "[Advanced](#)" in the descriptions of the Correct/Enhance Images window for details.
- Click Defaults to reset all adjustments.
- Click Reset Selected Image to cancel all corrections, enhancements and adjustments applied to the selected image.

6. Click Save Selected Image or Save All Corrected Images.

You can save adjusted images as new files.

Note

- To save only the images you like, select them and click Save Selected Image. To save all images, click Save All Corrected Images.
 - The file format of adjusted images is JPEG/Exif.
-

7. Click Exit.

Important

- The adjustments will be lost if you exit before saving adjusted images.

[Page top](#)[↕]

Advanced Guide

Advanced Guide > Scanning > Scanning with the Bundled Application Software > Useful MP Navigator EX Functions > Searching Images

S407

MP Navigator EX

Searching Images

In the View & Use window of the Navigation Mode screen, you can search images saved on your computer and open them in MP Navigator EX. Opened images can be printed, edited, etc.

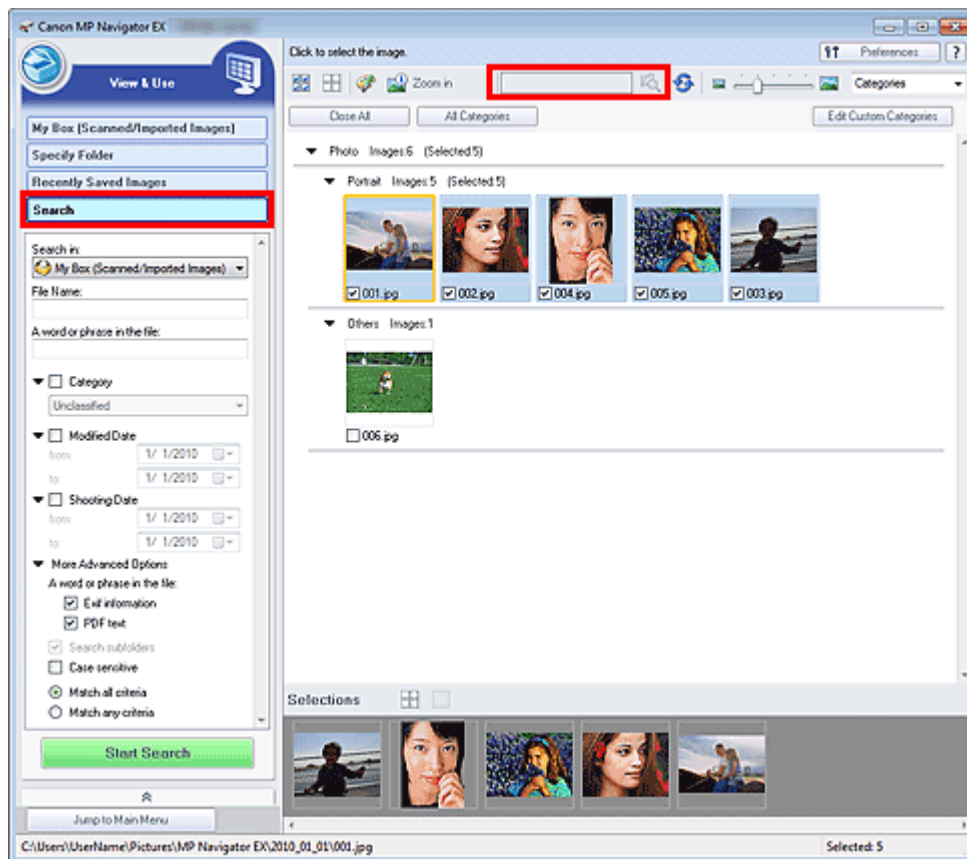

Note

- Search images in My Box (Scanned/Imported Images), Recently Saved Images or a selected folder and its subfolders.
- See "Starting MP Navigator EX" to start MP Navigator EX.

Quick Search

In  (Text box) on the Toolbar, enter a word or phrase included in the file

name, Exif information or PDF text of the image you want to search for, then click  (Search). For Exif information, text in Maker, Model, Description and User Comment is searched.

Advanced Search

Click Search on the left of the screen to open search options. Enter information of the image you want to search for, then click Start Search.

The screenshot shows a search interface with the following elements:

- Search in:** A dropdown menu set to "My Box (Scanned/Imported Images)".
- File Name:** An empty text input field.
- A word or phrase in the file:** An empty text input field.
- Category:** A dropdown menu set to "Unclassified".
- Modified Date:** Two date pickers, both set to "1/ 1/2010".
- Shooting Date:** Two date pickers, both set to "1/ 1/2010".
- More Advanced Options:**
 - A word or phrase in the file:** A sub-section with checkboxes for "Exif information" and "PDF text", both checked.
 - Search subfolders
 - Case sensitive
 - Match all criteria
 - Match any criteria
- Start Search:** A green button at the bottom.

- **Search in**

If you know where to look for, select the drive, folder or network from Specify Folder.

- **File Name**

If you know the file name, enter it.

- **A word or phrase in the file**

Enter a word or phrase included in the items selected in More Advanced Options.

Important

- For PDF files, you can only search for those created with MP Navigator EX. You cannot search PDF files created or edited in other applications. Also, searching PDF files is available only when keyword search is set. For details of creating PDF files that enables keyword search, see " [PDF Settings Dialog Box.](#)"
- Password-protected PDF files cannot be searched.

- **Category**

You can search for images by category.

- **Modified Date**

To search for images that have been updated in a specific time period, enter the first and last dates of the period.

- **Shooting Date**

To search for images captured in a specific time period, enter the first and last dates of the period.

Note

- "Shooting date" is the date and time of data creation, which are included in the image's Exif information.

- **More Advanced Options**

- **A word or phrase in the file**

In A word or phrase in the file, select the items to search. If you select the Exif information

checkbox, text in Maker, Model, Description and User Comment is searched. If you select the PDF text checkbox, text in PDF files is searched.

Important

- Text in password-protected PDF files cannot be searched.

- **Search subfolders**

Select this checkbox to search subfolders.

- **Case sensitive**

Select this checkbox to match case.

- **Match all criteria**

Searches for files that meet all the specified criteria.

- **Match any criteria**

Searches for files that meet any of the specified criteria.

- **Start Search**

Starts search.

Related Topic

▶ [View & Use Window](#)

[Page top](#)↑

Advanced Guide

Advanced Guide > Scanning > Scanning with the Bundled Application Software > Useful MP Navigator EX Functions > Classifying Images into Categories

S403

MP Navigator EX

Classifying Images into Categories

Display images scanned with MP Navigator EX by category. You can classify images displayed in Unclassified automatically, and also create custom categories. You can drag and drop an image to move it from one category to another.

Note

- If you have classified the images in MP Navigator EX 2.0 or later and then upgrade MP Navigator EX to the latest version, the classification information on the second latest version is transferred upon initial startup. After the initial startup, the classification information cannot be transferred.

1. Scan documents into MP Navigator EX and save them, then open the View & Use window from the Navigation Mode screen.

Note

- See "Let's Try Scanning" to scan images into MP Navigator EX.
- You can also select images saved on a computer.
 - ➔ [Opening Images Saved on a Computer](#)

2. In **Categories** (Sort by), select Categories.

Images are automatically sorted by category and appear in the Thumbnail window.

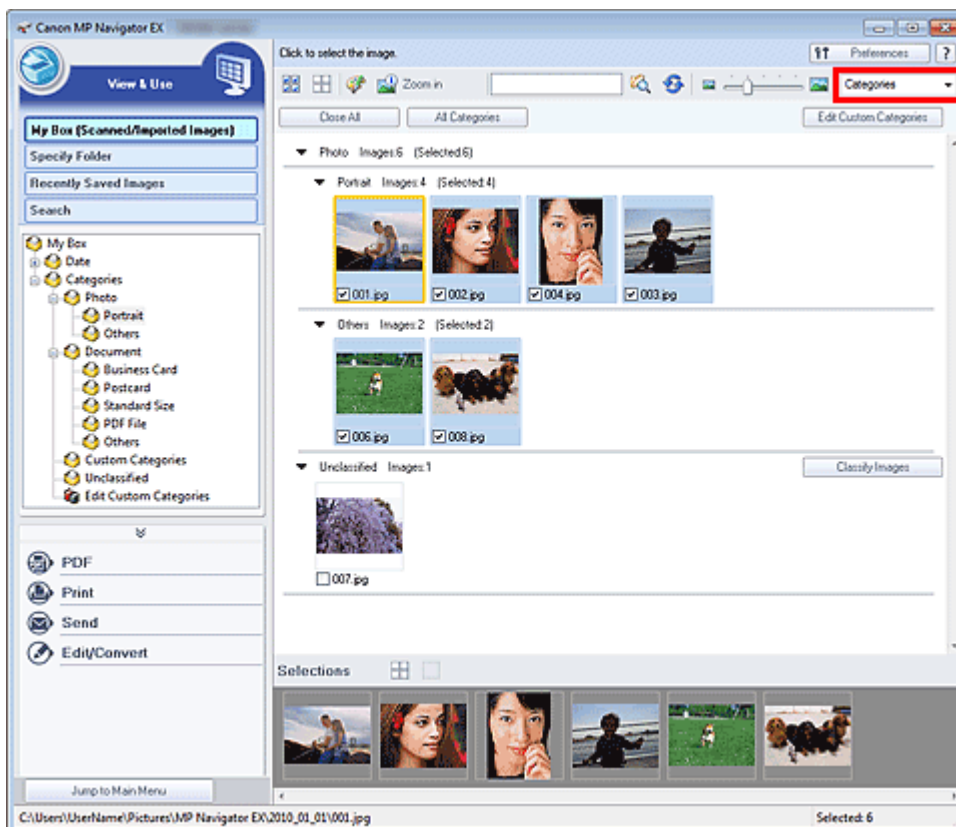

Images are sorted into the following categories.

Photos: Portrait, Others

Documents: Business Card, Postcard, Standard Size, PDF File, Others

Custom categories: Displays your custom categories.

To create custom categories, see "[Creating Custom Categories](#)."

Unclassified: Displays images that are not classified.



Note

- Click Classify Images to classify images displayed in Unclassified automatically. Click Cancel to stop.
- Classification may take time if there are many images to classify.



Important

- Even if you classify images saved in removable media such as USB flash drive and external hard disk, the classification information will be deleted once you remove the media. From the next time, the images are classified to Unclassified.
- Images cannot be classified when Recently Saved Images is selected in the View & Use window.



Note

- Some images may not be detected correctly and thus may be classified into wrong categories. In that case, drag and drop the image to the correct category.
- Images saved in network folders may not be classified.
- You can search for images by category. See "[Searching Images](#)" for details.

Creating Custom Categories

1. In the View & Use window, sort images by category and click Edit Custom Categories.

The Edit Custom Categories dialog box opens.

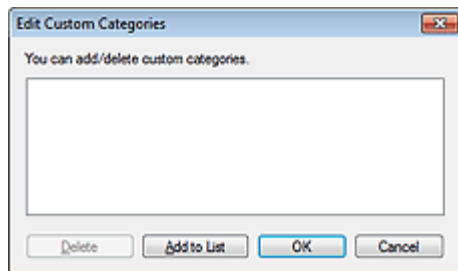

2. Click Add to List.

The Add Category dialog box opens.

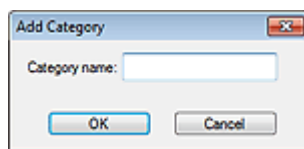

3. Enter Category name and click OK.



Note

- You can create up to 20 custom categories.
- Up to 50 single-byte characters can be used for a category name.
- Double-click a created category to open the Change Category Name dialog box in which you can change the category name.
- Select a custom category and click Delete to delete it.

Related Topic

▶ [View & Use Window](#)

[Page top](#) ↕

Advanced Guide

[Advanced Guide](#) > [Scanning](#) > [Scanning with the Bundled Application Software](#) > [Utilizing Images in MP Navigator EX](#)

S500

MP Navigator EX

Utilizing Images in MP Navigator EX

You can scan images using MP Navigator EX and edit or print the saved images.

See the corresponding sections below for details on saving scanned images.

- **Saving scanned images to computer**

- ➡ [Saving](#)

- **Saving scanned image as PDF Files**

- ➡ [Saving as PDF Files](#)

See the corresponding sections below for details on using images/files.

- **Creating/editing PDF files from scanned images**

- ➡ [Creating/Editing PDF Files](#)

- **Printing multiple scanned images at one time or printing at specific size, quality, etc.**

- ➡ [Printing Documents](#)

- **Printing scanned photos**

- ➡ [Printing Photos](#)

- **Sending scanned images via e-mail**

- ➡ [Sending via E-mail](#)

- **Correcting/enhancing scanned images or converting them to text**

- ➡ [Editing Files](#)

- **Setting passwords for created PDF files**

- ➡ [Setting Passwords for PDF Files](#)

- ➡ [Opening/Editing Password-protected PDF Files](#)

[Page top](#)↑

Advanced Guide

Advanced Guide > Scanning > Scanning with the Bundled Application Software > Utilizing Images in MP Navigator EX > Saving

S112

MP Navigator EX

Saving

Save images scanned with MP Navigator EX to a computer.

1. Select the checkboxes of the images you want to save, then click Save.

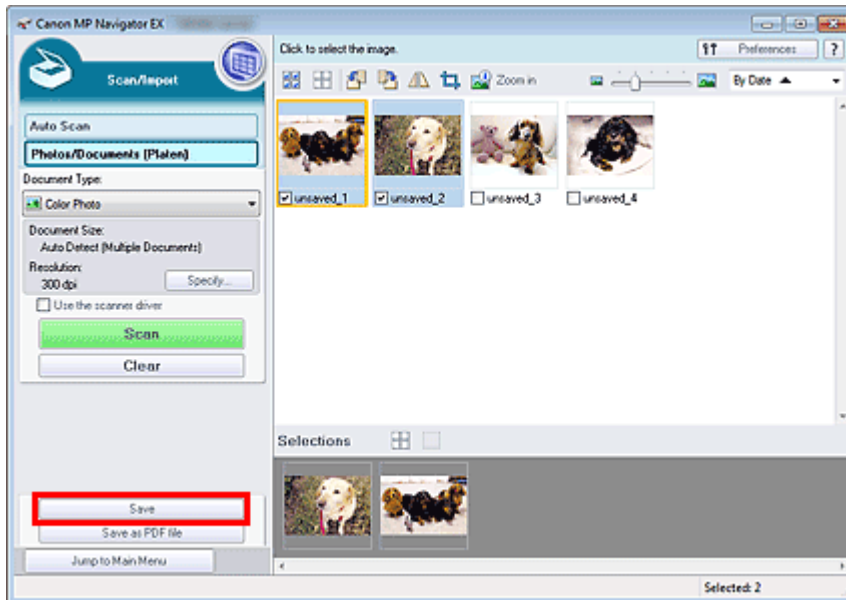

2. In the Save dialog box, specify the save settings.

Specify the destination folder, file name and file type.

➔ Save Dialog Box

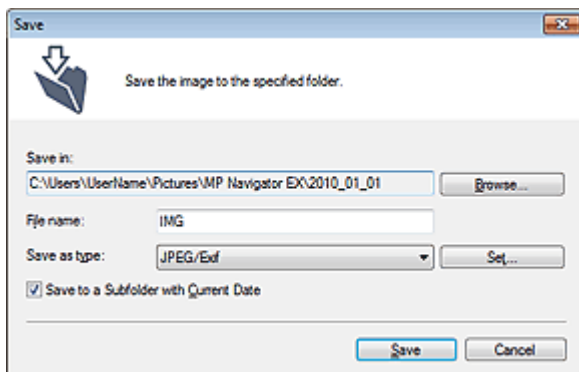

Important

- You cannot select JPEG/Exif when Document Type is Text(OCR).
- You cannot select JPEG/Exif when Black and White is selected for Color Mode on the Advanced Mode tab of ScanGear (scanner driver).

Note

- By default, the scanned images are saved in the following folders.
Windows 7: MP Navigator EX folder in My Pictures folder
Windows Vista: MP Navigator EX folder in Pictures folder

3. Click Save.

Scanned images are saved according to the settings.

To further use/edit the scanned images on MP Navigator EX, click Open saved location in the Save Complete dialog box.

➔ [Creating/Editing PDF Files](#)

➔ [Printing Documents](#)

➔ [Printing Photos](#)

➔ [Sending via E-mail](#)

➔ [Editing Files](#)

[Page top](#) ↕

Advanced Guide

Advanced Guide > Scanning > Scanning with the Bundled Application Software > Utilizing Images in MP Navigator EX > Saving as PDF Files

S113

MP Navigator EX

Saving as PDF Files

Save images scanned with MP Navigator EX as PDF files.

1. Select the checkboxes of the images you want to save, then click Save as PDF file.

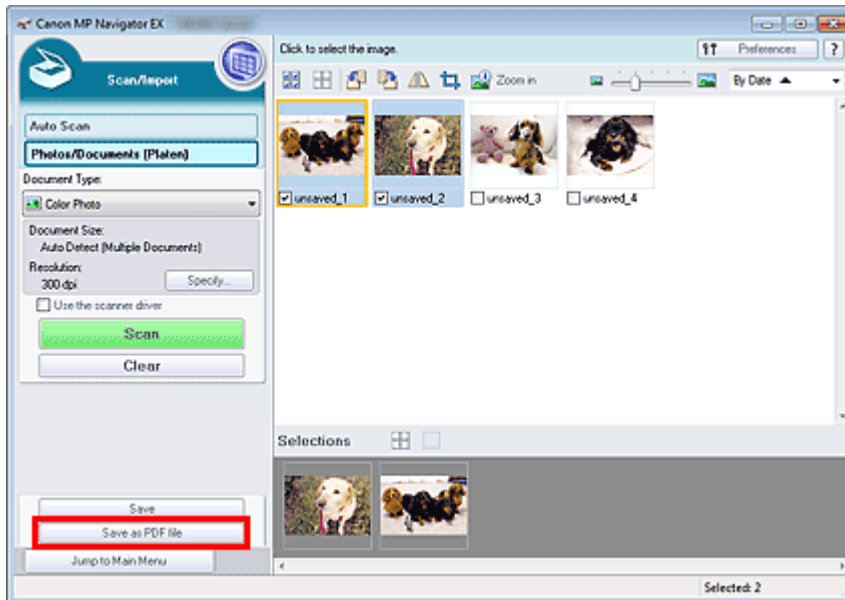

2. In the Save as PDF file dialog box, specify the save settings.
Specify the file type, file name and destination folder.

➔ Save as PDF file Dialog Box

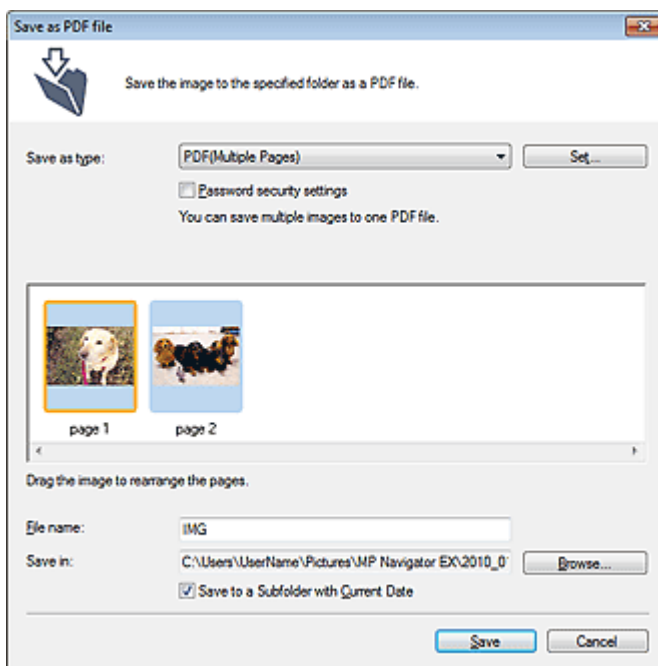

 **Note**

- By default, the scanned images are saved in the following folders.
 - Windows 7: MP Navigator EX folder in My Pictures folder
 - Windows Vista: MP Navigator EX folder in Pictures folder
 - Windows XP: MP Navigator EX folder in My Pictures folder
 - You can set passwords for PDF files.
 - ➔ [Setting Passwords for PDF Files](#)
-

3. Click Save.

Scanned images are saved according to the settings.

To further use/edit the scanned images on MP Navigator EX, click Open saved location in the Save Complete dialog box.

➔ [Creating/Editing PDF Files](#)

➔ [Printing Documents](#)

➔ [Printing Photos](#)

➔ [Sending via E-mail](#)

➔ [Editing Files](#)

[Page top](#) ↕

Advanced Guide

Advanced Guide > Scanning > Scanning with the Bundled Application Software > Utilizing Images in MP Navigator EX > Creating/Editing PDF Files

S501

MP Navigator EX

Creating/Editing PDF Files

Create/edit PDF files using MP Navigator EX. After scanning documents and saving them, open the View & Use window to create PDF files and add/delete pages, rearrange the page order, etc.

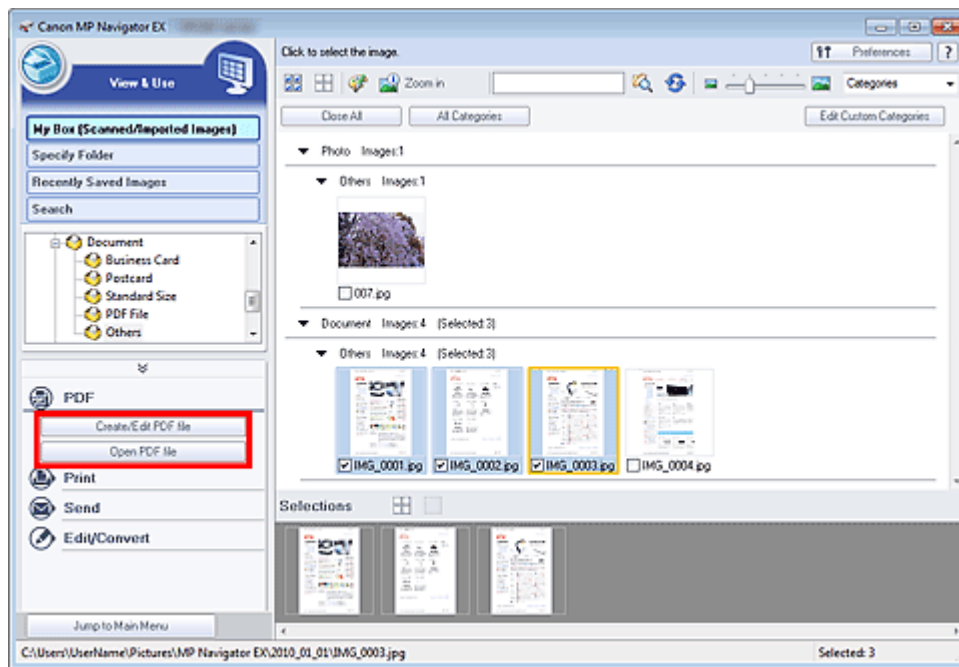

Important

- You can create or edit up to 99 pages at one time using MP Navigator EX.

Note

- See "Let's Try Scanning" to scan images into MP Navigator EX.
- You can also select images saved on a computer.
 - ➔ [Opening Images Saved on a Computer](#)

Creating/Editing PDF Files with MP Navigator EX

- Select images and click PDF.

Note

- You can select PDF, JPEG, TIFF and BMP files.

- Click Create/Edit PDF file on the list.

Important

- For PDF files, you can only edit those created with MP Navigator EX. You cannot edit PDF files created with other applications. PDF files edited in other applications cannot be edited as well.

Note

- If a password-protected PDF file is selected, you will be prompted to enter the password.
➔ [Opening/Editing Password-protected PDF Files](#)

3. Add/delete pages as required.

To add an existing file, click Add Page and select the file. To delete a page, select it and click Delete Selected Pages.

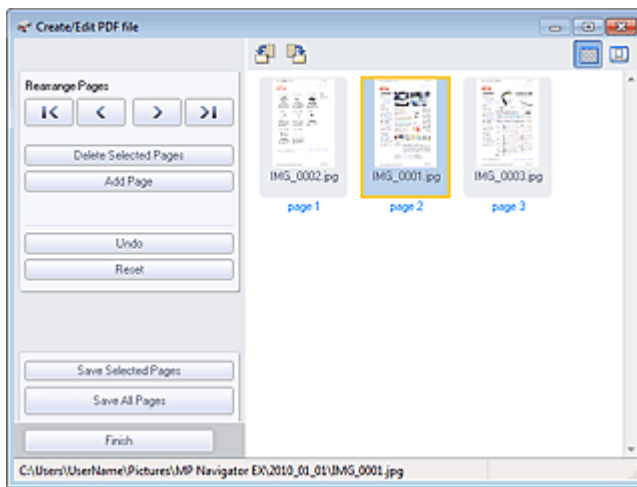

Note

- You can add PDF, JPEG, TIFF and BMP files.
- When adding a password-protected PDF file, you will be prompted to enter the password.

4. Rearrange the page order as required.

Use the icons to rearrange the order. Alternatively, drag the thumbnail to the target location.

Note

- See "[Create/Edit PDF file Window](#)" for details on the Create/Edit PDF file window.

5. Click Save Selected Pages or Save All Pages.

The Save as PDF file dialog box opens.

➔ [Save as PDF file Dialog Box](#)

Important

- You cannot save images scanned at 10501 pixels or more in the vertical and horizontal directions.
- If a password-protected PDF file is edited, the passwords will be deleted. Reset the passwords in the Save as PDF file dialog box.
➔ [Setting Passwords for PDF Files](#)

6. Specify the save settings in the Save as PDF file dialog box, then click Save.

Images are saved according to the settings.

Opening PDF Files in an Application

You can open PDF files created with MP Navigator EX in an associated application and edit or print them.

1. Select PDF files and click PDF.

Important

- For PDF files, you can only select those created with MP Navigator EX. You cannot select PDF files created with other applications. PDF files edited in other applications cannot be selected

as well.

2. Click Open PDF file on the list.

The application associated with the file extension (.pdf) by the operating system starts.

Important

- Password-protected PDF files cannot be opened in applications not supporting PDF security.
- Files may not open if an application that can be associated with PDF files is not installed.

3. Use the application to edit/print the file.

For details, refer to the application's manual.

Important

- In some applications, the commands (print, edit, etc.) restricted by Permissions Password may differ from those in MP Navigator EX.

[Page top](#)[↕]

Advanced Guide

Advanced Guide > Scanning > Scanning with the Bundled Application Software > Utilizing Images in MP Navigator EX > Printing Documents

S502

MP Navigator EX

Printing Documents

You can print multiple scanned images at one time, print at specific quality, etc. using MP Navigator EX.

1. Scan documents into MP Navigator EX and save them, then open the View & Use window from the Navigation Mode screen and select images.

Note

- See "Let's Try Scanning" to scan images into MP Navigator EX.
- You can also select images saved on a computer.
 - ➔ [Opening Images Saved on a Computer](#)

2. Click Print, then click Print Document on the list.

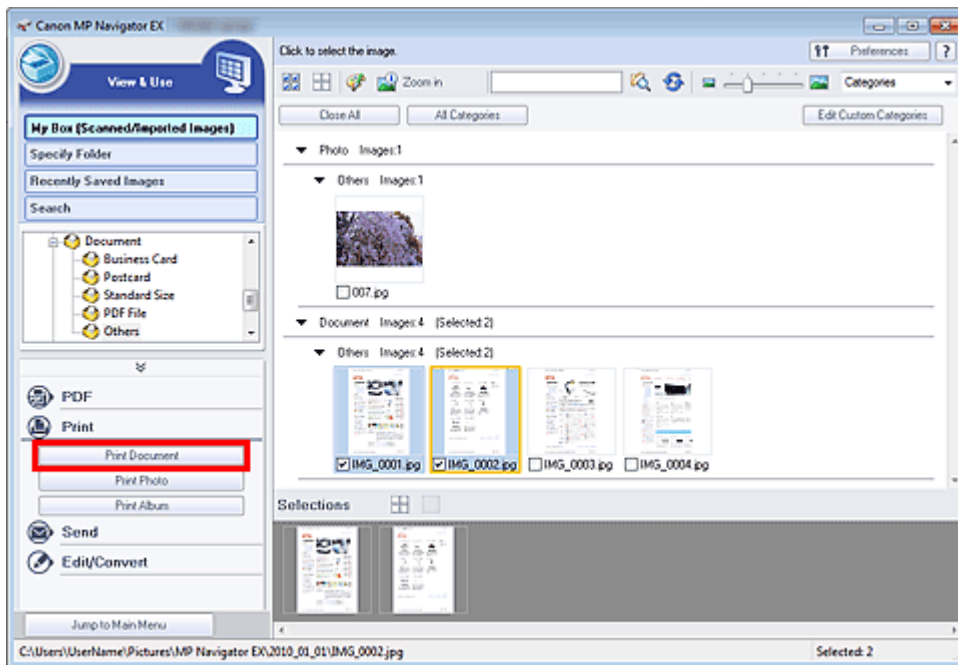

Important

- If a password-protected PDF file is selected, you will be prompted to enter the password.
 - ➔ [Opening/Editing Password-protected PDF Files](#)

3. Specify print settings as required.

In the displayed dialog box, specify print count, quality, scale, etc.

➔ [Print Document Dialog Box](#)

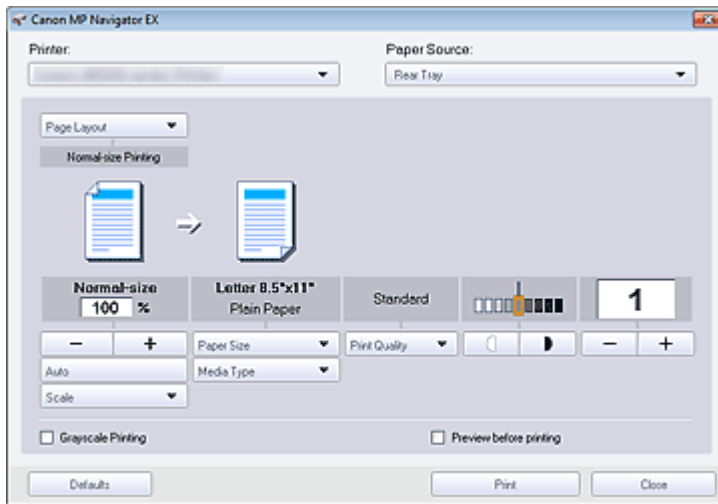

Important

- At normal-size (100%), some images may be printed small or with some portions cropped. In that case, select Auto to resize the print in proportion to the paper size.

4. Click Print.

Starts printing.

Note

- When printing a multiple-page PDF file via Print Document, printing may take time depending on your computer. In that case, follow these steps and change settings.
 - Windows 7:
 1. From the Start menu, select Devices and Printers.
 2. Right-click the icon of your printer and click Printer Properties. The printer properties dialog box opens.
 3. Click the Advanced tab.
 4. Select Spool print documents so program finishes printing faster.
 5. Select Start printing after last page is spooled.
 6. After printing, return the setting on the Advanced tab to Start printing immediately.
 - Windows Vista/Windows XP:
 1. From the Start menu, select Control Panel.
 2. Click Printer (Windows XP: Printers and Faxes).
 3. Right-click the icon of your printer and click Properties. The printer properties dialog box opens.
 4. Click the Advanced tab.
 5. Select Spool print documents so program finishes printing faster.
 6. Select Start printing after last page is spooled.
 7. After printing, return the setting on the Advanced tab to Start printing immediately.
- To cancel while spooling, click Cancel. To cancel while printing, click Cancel Printing in the confirmation window for the printer status. To open a confirmation window for the printer status, click printer icon on the taskbar.

Advanced Guide

Advanced Guide > Scanning > Scanning with the Bundled Application Software > Utilizing Images in MP Navigator EX > Printing Photos

S503

MP Navigator EX

Printing Photos

You can print photos using MP Navigator EX or an application that accompanies the machine. After scanning documents and saving them, open the View & Use window to select how you want to print the photos.

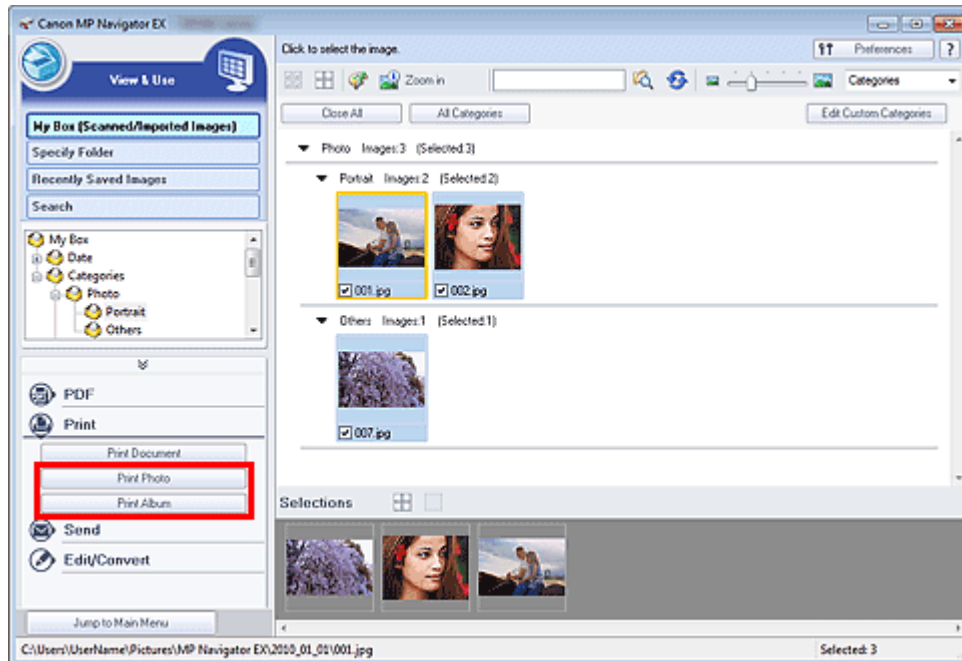

Note

- See "Let's Try Scanning" to scan images into MP Navigator EX.
- You can also select images saved on a computer.
 - ➔ Opening Images Saved on a Computer

When Printing Photos Using Easy-PhotoPrint EX

Easy-PhotoPrint EX enables you to print scanned photos at high quality or to layout and print images.

1. Select images and click Print.
2. Click Print Photo or Print Album on the list.
Easy-PhotoPrint EX starts. See "Printing with the Bundled Application Software" for details.

Note

- If Easy-PhotoPrint EX is not installed, print with MP Navigator EX.

When Printing Photos Using MP Navigator EX

1. Select images and click Print.

2. Click Print Photo on the list.

3. Specify print settings as required.

In the displayed dialog box, specify paper size, print count, etc.

➔ Print Photo Dialog Box

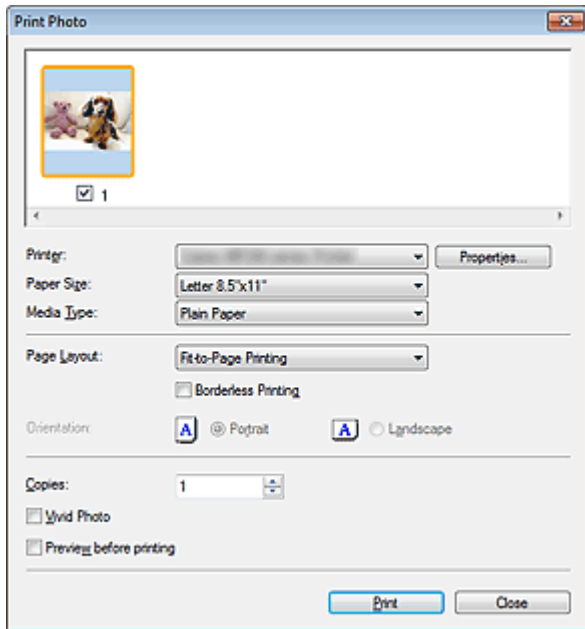

4. Click Print.

Starts printing.

Note

- To cancel while spooling, click Cancel. To cancel while printing, click Cancel Printing in the confirmation window for the printer status. To open a confirmation window for the printer status, click printer icon on the taskbar.

[Page top](#) ↕

Advanced Guide

Advanced Guide > Scanning > Scanning with the Bundled Application Software > Utilizing Images in MP Navigator EX > Sending via E-mail

S504

MP Navigator EX

Sending via E-mail

Send scanned images via e-mail.

Important

- MP Navigator EX is compatible with the following e-mail software programs:
 - Microsoft Outlook
 - Windows Mail (Windows Vista)
 - Outlook Express (Windows XP)
 (If an e-mail software program does not operate properly, check that the program's MAPI is enabled. To enable MAPI, refer to the manual of the e-mail software program.)

Note

- If an e-mail software program is not selected, manually attach the scanned and saved image to e-mail.

1. Scan documents into MP Navigator EX and save them, then open the View & Use window from the Navigation Mode screen and select images.

Note

- Only PDF and JPEG files can be attached to e-mail.
- See "[Let's Try Scanning](#)" to scan images into MP Navigator EX.
- You can also select images saved on a computer.
 - ➔ [Opening Images Saved on a Computer](#)

2. Click Send, then click Attach to E-mail on the list.

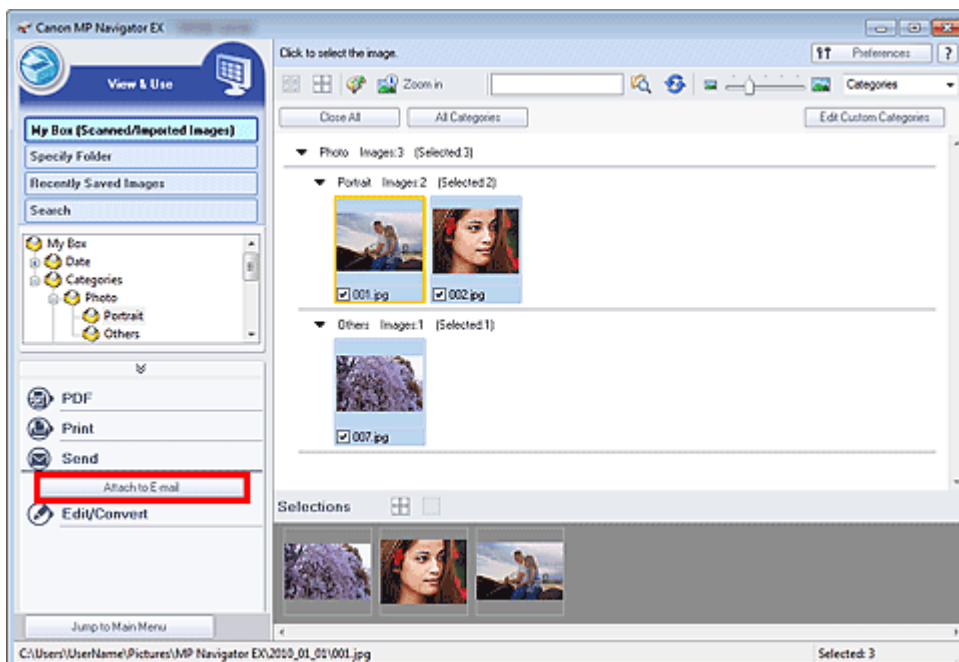

3. Set the e-mail software program and file save options as required.

Specify the e-mail software program, destination folder and file name.

➔ [Send via E-mail Dialog Box](#)

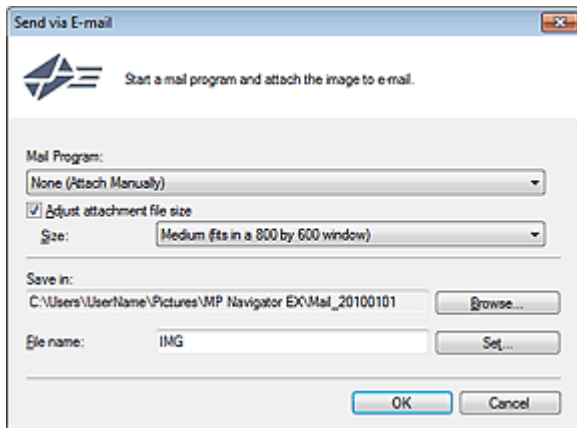

Note

- You can select a compression type when sending JPEG images via e-mail. Click Set... to open a dialog box and select a compression type from High(Low Compression), Standard or Low(High Compression).

4. Click OK.

Files are saved according to the settings, and the e-mail software program starts.

5. Specify the recipient, enter the subject and message, then send e-mail.

For details, refer to the manual of the e-mail software program.

[Page top](#) ↕

Advanced Guide

Advanced Guide > Scanning > Scanning with the Bundled Application Software > Utilizing Images in MP Navigator EX > Editing Files

S505

MP Navigator EX

Editing Files

You can edit images or convert them to text using MP Navigator EX or an application that accompanies the machine. After scanning documents and saving them, open the View & Use window to select what you want to do with the images.

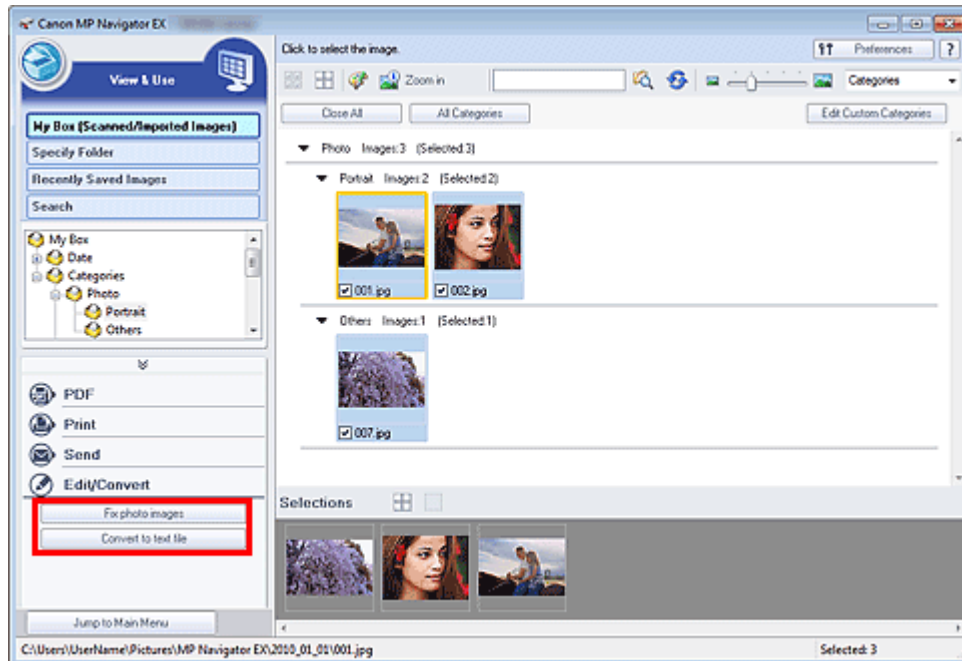

Note

- See "Let's Try Scanning" to scan images into MP Navigator EX.
- You can also select images saved on a computer.
 - ➔ Opening Images Saved on a Computer

Correcting Photo Images

You can correct/enhance images in the Correct/Enhance Images window.

1. Select images and click Edit/Convert.
2. Click Fix photo images on the list.
The Correct/Enhance Images window opens.
3. Correct/enhance images in the Correct/Enhance Images window.

Note

- See "Correct/Enhance Images Window" for details on the Correct/Enhance Images window.
- See the corresponding sections below for correcting/enhancing images.
 - ➔ Correcting/Enhancing Images Automatically
 - ➔ Correcting/Enhancing Images Manually

Converting Documents to Text

Scan text in scanned magazines and newspapers and display it in Notepad (included with Windows).

Important

- PDF files cannot be converted to text.

1. Select images and click Edit/Convert.

2. Click Convert to text file on the list.

Notepad (included with Windows) starts and editable text appears.

Note

- Only text written in languages that can be selected on the General tab can be extracted to Notepad (included with Windows). Click Set... on the General tab and specify the language according to the language of the document to be scanned.
When scanning multiple documents, you can collect the extracted text into one file.
→ [General Tab](#)
- Text displayed in Notepad (included with Windows) is for guidance only. Text in the image of the following types of documents may not be detected correctly.
 - Documents containing text with font size outside the range of 8 points to 40 points (at 300 dpi)
 - Slanted documents
 - Documents placed upside down or documents with text in the wrong orientation (rotated characters)
 - Documents containing special fonts, effects, italics, or hand-written text
 - Documents with narrow line spacing
 - Documents with colors in the background of text
 - Documents containing multiple languages

[Page top](#) 

Advanced Guide

Advanced Guide > Scanning > Scanning with the Bundled Application Software > Utilizing Images in MP Navigator EX > Setting Passwords for PDF Files

S508

MP Navigator EX

Setting Passwords for PDF Files

Set passwords for opening, editing and printing PDF files.

You can set two passwords: one for opening the file and one for editing/printing it.

This section explains how to set passwords for images scanned into the Scan/Import window of MP Navigator EX and how to set passwords for existing files via the View & Use window.

Important

- You will not be able to open/edit the file if you forget the password. Record your passwords in a safe place for future reference.
- Password-protected PDF files cannot be opened in applications not supporting PDF security.
- In some applications, the commands (print, edit, etc.) restricted by Permissions Password may differ from those in MP Navigator EX.
- Password-protected PDF files cannot be searched by text from the "View & Use Window."
- Passwords cannot be set when images are automatically saved after scanning.

1. Open the password setting screen from images scanned into MP Navigator EX or existing files.

Setting Passwords for Scanned Images

1. Scan documents into the Scan/Import window.

➔ [Let's Try Scanning](#)

2. Click Save as PDF file.

The Save as PDF file dialog box opens.

3. Select the Password security settings checkbox.

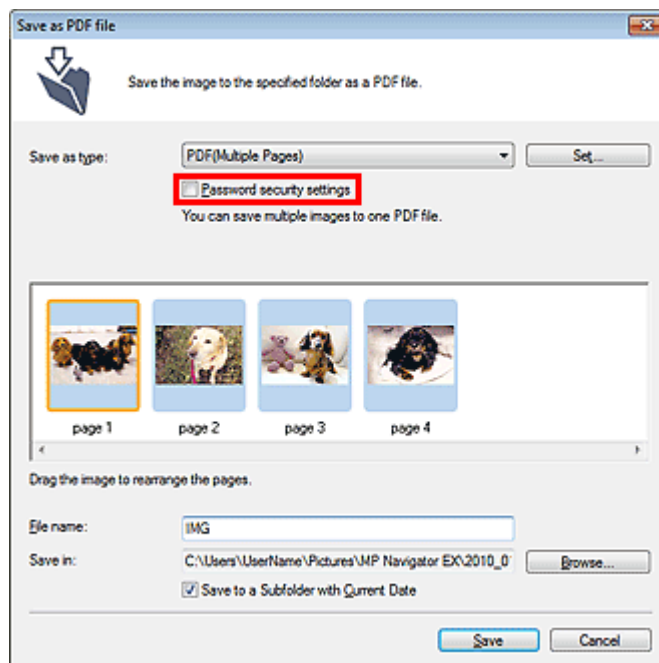

The Password Security -Settings dialog box opens.

Setting Passwords for Existing Files

1. In the View & Use window, select image/PDF files and click PDF.
2. Click Create/Edit PDF file on the list.
→ Creating/Editing PDF Files
3. Edit files in the Create/Edit PDF file window, then click Save Selected Pages or Save All Pages.

The Save as PDF file dialog box opens.

4. Select the Password security settings checkbox.

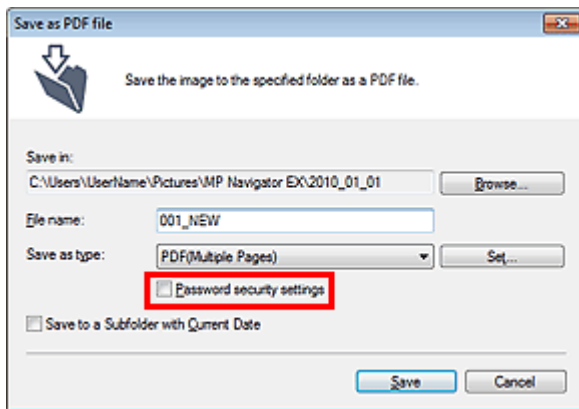

The Password Security -Settings dialog box opens.

Note

- You can also open the Password Security -Settings dialog box by clicking Set..., then selecting Password Security for Security in the PDF Settings dialog box.

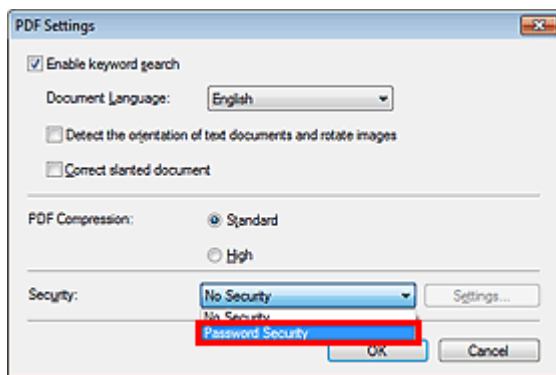

2. Select the Require a password to open the document or Use a password to restrict printing and editing of the document and its security settings checkbox, then enter a password.

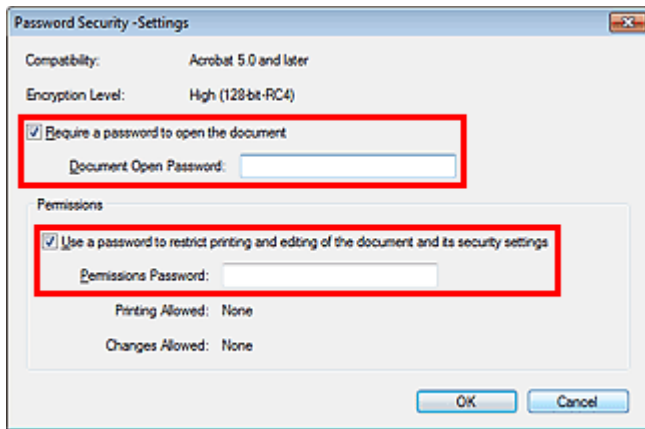

Important

- Up to 32 single-byte alphanumeric characters can be used for the password. Passwords are case sensitive.
- Select both checkboxes to set both Document Open Password and Permissions Password. You cannot use the same password for both.

3. Click OK.

The Confirm Document Open Password or Confirm Permissions Password dialog box opens.

Document Open Password

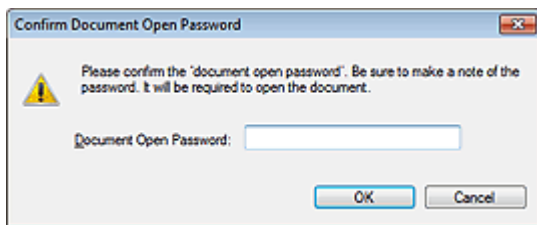

Permissions Password

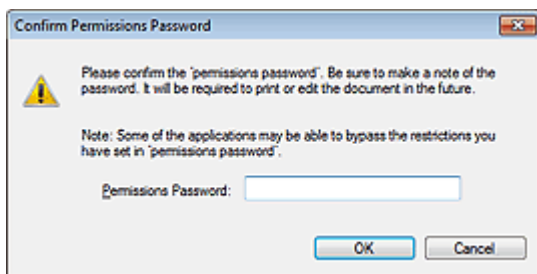

4. Re-enter the password and click OK.

The Save as PDF file dialog box returns.

Important

- If you close the Save as PDF file dialog box without clicking Save, the settings in the Password Security -Settings dialog box will be deleted.
- Passwords are deleted once the file is edited. Reset the passwords when saving edited files.

Note

- If you set the passwords via the PDF Settings dialog box, the PDF Settings dialog box returns. Click OK. The Save as PDF file dialog box returns.

5. Click Save.

Files are saved according to the settings.

Related Topic

▶ [Opening/Editing Password-protected PDF Files](#)

[Page top](#) ↕

Advanced Guide

Advanced Guide > Scanning > Scanning with the Bundled Application Software > Utilizing Images in MP Navigator EX > Opening/Editing Password-protected PDF Files

S509

MP Navigator EX

Opening/Editing Password-protected PDF Files

Enter a password to open or edit/print password-protected PDF files.

Password entry method varies by operation. The following procedures are examples only.

Important

- You can open, edit or print only PDF files whose passwords were set with MP Navigator EX. You cannot edit PDF files edited in other applications or whose passwords were set with other applications. Only MP Navigator EX version 1.1 and 2.0 or later supports opening, editing and printing password-protected PDF files.
- Passwords are case sensitive.
- You can create or edit up to 99 pages at one time using MP Navigator EX.

Entering a Password to Open a File

1. In the View & Use window, select the PDF file you want to open and click  Zoom in.

Alternatively, double-click the PDF file.

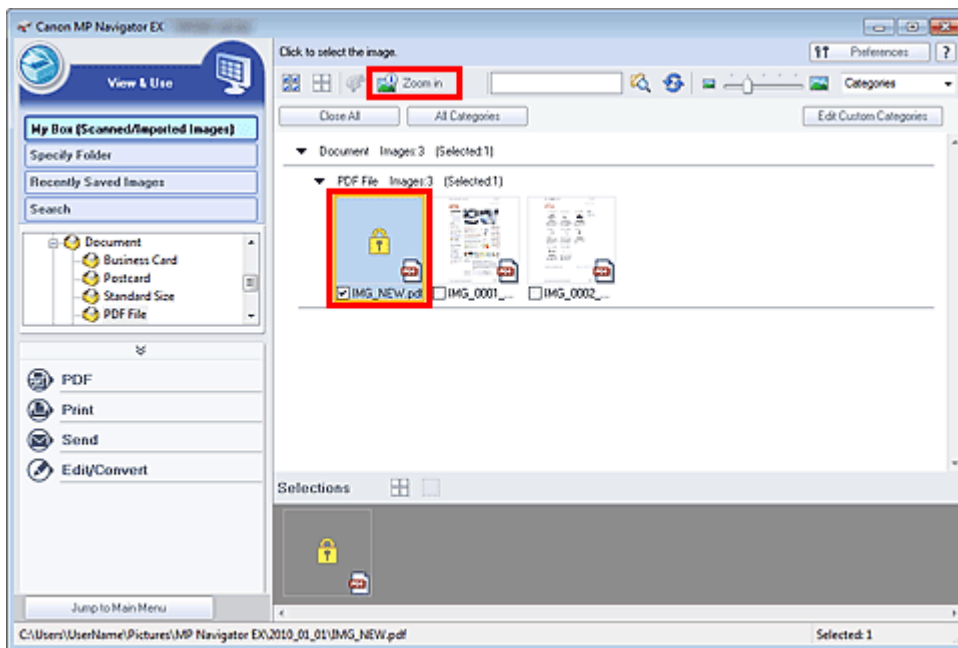

Note

- Only the Document Open Password will be required. The Permissions Password will not be required.
- If the Zoom in dialog box with a lock icon opens, click Enter Password.

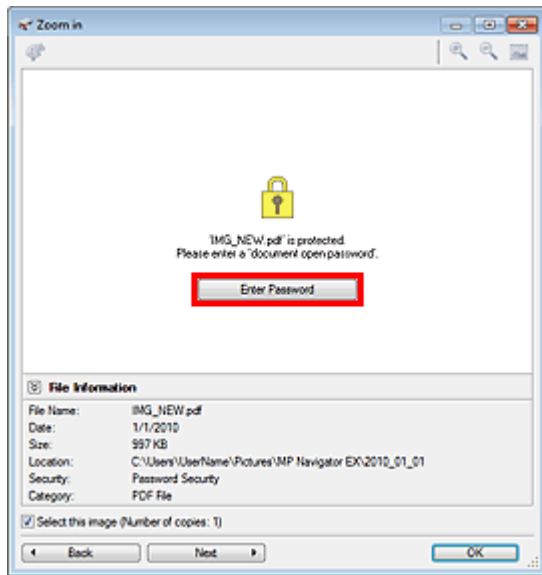

2. The Password dialog box opens. Enter the password and click OK.

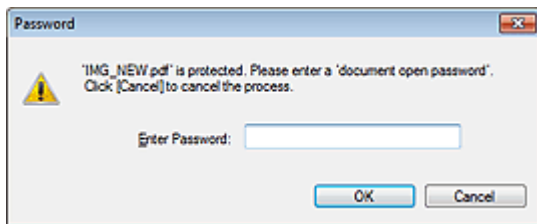

The PDF file opens in the Zoom in dialog box.

Note

- To reopen the file after closing the Zoom in dialog box, re-enter the password.

Entering a Password (Permissions Password) to Edit or Print a File

1. In the View & Use window, select PDF files and click PDF or Print.

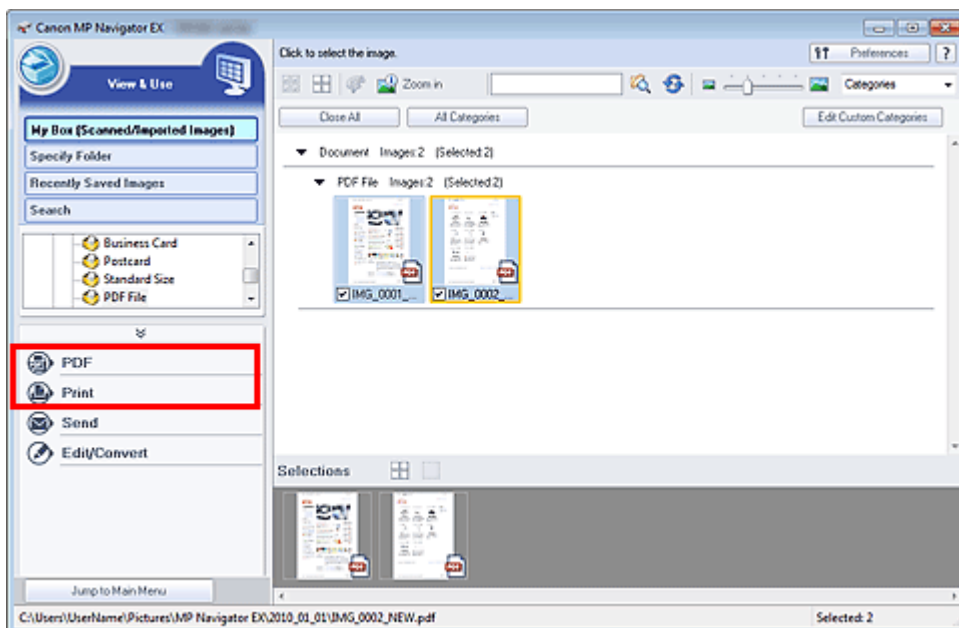

2. To create a PDF file or edit the file, select Create/Edit PDF file on the list. To print the file, click Print Document.

In the Password dialog box, you will be prompted to enter a password.

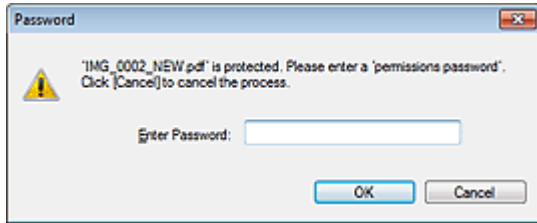

Note

- If the Document Open Password is set as well, the Document Open Password will be required, then the Permissions Password will be required.

3. Enter the password and click OK.

The corresponding dialog box opens.

Important

- If a password-protected PDF file is edited, the passwords will be deleted. Reset the passwords.
➔ [Setting Passwords for PDF Files](#)

Related Topic

- ▶ [Setting Passwords for PDF Files](#)

[Page top](#) ↕

Advanced Guide

Advanced Guide > Scanning > Scanning with the Bundled Application Software > MP Navigator EX Screens

S700

MP Navigator EX

MP Navigator EX Screens

Learn about the screens and functions of MP Navigator EX.

Scan/Import Documents or Images Tab

- ➡ Auto Scan Screen (Scan/Import Window)
 - Scan Settings Dialog Box (Auto Scan)
- ➡ Photos/Documents (Platen) Screen (Scan/Import Window)
 - Scan Settings Dialog Box (Photos/Documents)
 - Save Dialog Box
 - Save as PDF file Dialog Box

View & Use Images on your Computer Tab

- ➡ View & Use Window
 - Create/Edit PDF file Window
 - Print Document Dialog Box
 - Print Photo Dialog Box
 - Send via E-mail Dialog Box
 - Correct/Enhance Images Window

Custom Scan with One-click Tab / One-click Mode Screen

- ➡ Auto Scan Dialog Box
- ➡ Save Dialog Box (One-click Mode Screen)
 - Scan Settings Dialog Box (One-click Mode Screen)
- ➡ PDF Dialog Box
- ➡ Mail Dialog Box
- ➡ OCR Dialog Box
- ➡ Custom Dialog Box

Preferences Dialog Box

- ➡ General Tab
- ➡ Scanner Button Settings Tab (Save to PC)
 - Scan Settings Dialog Box (Scanner Button Settings)

Page top↑

Advanced Guide

Advanced Guide > Scanning > Scanning with the Bundled Application Software > MP Navigator EX Screens > Navigation Mode Screen

S735

MP Navigator EX

Navigation Mode Screen

This is one of the startup screens of MP Navigator EX.

Select an icon at the top of the screen to display the corresponding tab. Use each tab depending on what you want to do.

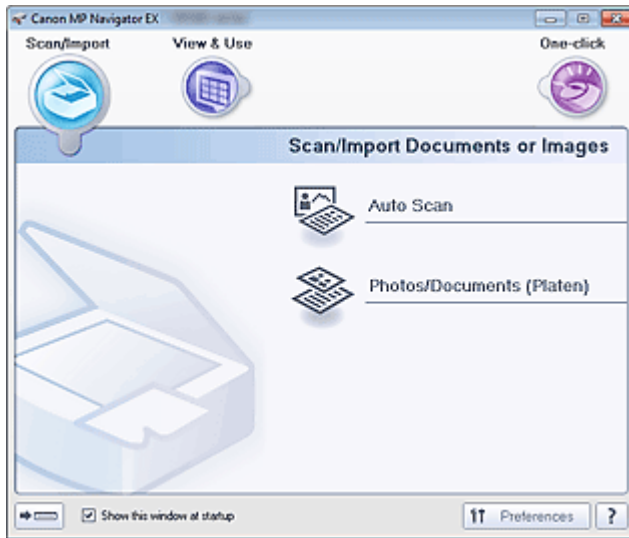

- **Scan/Import**

Scan photos and documents.

➔ [Scan/Import Documents or Images Tab](#)

- **View & Use**

You can open images saved on a computer and print them or attach them to e-mail. You can also edit them using an application that accompanies the machine.

➔ [View & Use Images on your Computer Tab](#)

- **One-click**

You can complete "from scanning to saving", etc. at one time by simply clicking the corresponding icon.

➔ [Custom Scan with One-click Tab](#)



- **(Switch Mode)**

Switches to One-click Mode screen. In the One-click Mode screen, you can complete "from scanning to saving", etc. at one time by simply clicking the corresponding icon.

➔ [One-click Mode Screen](#)

- **Show this window at startup**

Select this checkbox to open the Main Menu at startup. If this checkbox is not selected, the last used screen appears.

- **Preferences**

The Preferences dialog box opens. In the Preferences dialog box, you can make advanced settings to MP Navigator EX functions.

➔ [Preferences Dialog Box](#)



- **(Guide)**

Opens this guide.

[Page top](#) 

Advanced Guide

Advanced Guide > Scanning > Scanning with the Bundled Application Software > MP Navigator EX Screens > Scan/Import Documents or Images Tab

S702

MP Navigator EX

Scan/Import Documents or Images Tab

Select Scan/Import in the Navigation Mode screen to display the Scan/Import Documents or Images tab.

Scan photos and documents.

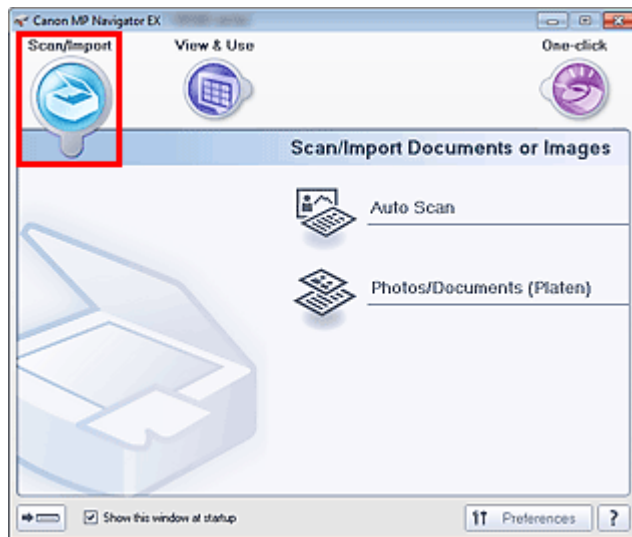

- **Auto Scan**

Opens the Scan/Import window with Auto Scan selected.
Scan documents easily by automatically detecting the document type.

➔ [Auto Scan Screen \(Scan/Import Window\)](#)

- **Photos/Documents (Platen)**

Opens the Scan/Import window with Photos/Documents (Platen) selected.
Scan photos and documents placed on the Platen.

➔ [Photos/Documents \(Platen\) Screen \(Scan/Import Window\)](#)

-  **(Switch Mode)**

Switches to One-click Mode screen. In the One-click Mode screen, you can complete "from scanning to saving", etc. at one time by simply clicking the corresponding icon.

➔ [One-click Mode Screen](#)

- **Show this window at startup**

Select this checkbox to open the Main Menu at startup. If this checkbox is not selected, the last used screen appears.

- **Preferences**

The Preferences dialog box opens. In the Preferences dialog box, you can make advanced settings to MP Navigator EX functions.

➔ [Preferences Dialog Box](#)

-  **(Guide)**

Opens this guide.

Advanced Guide

Advanced Guide > Scanning > Scanning with the Bundled Application Software > MP Navigator EX Screens > View & Use Images on your Computer Tab

S703

MP Navigator EX

View & Use Images on your Computer Tab

Select View & Use in the Navigation Mode screen to display the View & Use Images on your Computer tab.

You can open images saved on a computer and print them or attach them to e-mail. You can also edit them using an application that accompanies the machine.

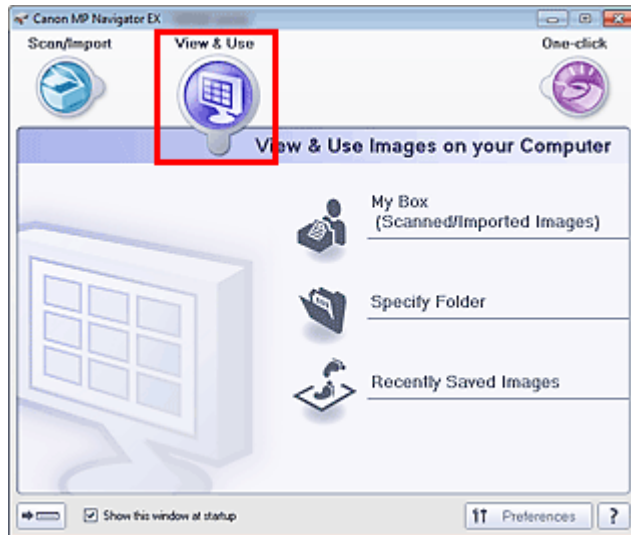

- **My Box (Scanned/Imported Images)**

Opens the View & Use window with My Box (Scanned/Imported Images) selected.

You can open and use images saved in My Box.

"My Box" is a specific folder for saving images scanned with MP Navigator EX.

Note

- By default, the scanned images are saved in the following folders.
Windows 7: MP Navigator EX folder in My Pictures folder
Windows Vista: MP Navigator EX folder in Pictures folder
Windows XP: MP Navigator EX folder in My Pictures folder

- **Specify Folder**

Opens the View & Use window with Specify Folder selected.

You can open and use images saved in specific folders.

- **Recently Saved Images**

Opens the View & Use window with Recently Saved Images selected.

You can open and use "Scanned/Imported Images" and images that have been "Attached to E-mail" or "Sent to Application" recently.

➔ [View & Use Window](#)

-  **(Switch Mode)**

Switches to One-click Mode screen. In the One-click Mode screen, you can complete "from scanning to saving", etc. at one time by simply clicking the corresponding icon.

➔ [One-click Mode Screen](#)

- **Show this window at startup**

Select this checkbox to open the Main Menu at startup. If this checkbox is not selected, the last used screen appears.

- **Preferences**

The Preferences dialog box opens. In the Preferences dialog box, you can make advanced settings to MP Navigator EX functions.

[➔ Preferences Dialog Box](#)

-  **(Guide)**

Opens this guide.

Related Topic

▶ [Opening Images Saved on a Computer](#)

[Page top](#) 

Advanced Guide

Advanced Guide > Scanning > Scanning with the Bundled Application Software > MP Navigator EX Screens > Custom Scan with One-click Tab

S704

MP Navigator EX

Custom Scan with One-click Tab

Select One-click in the Navigation Mode screen to display the Custom Scan with One-click tab.

You can complete "from scanning to saving", etc. at one time by simply clicking the corresponding icon.

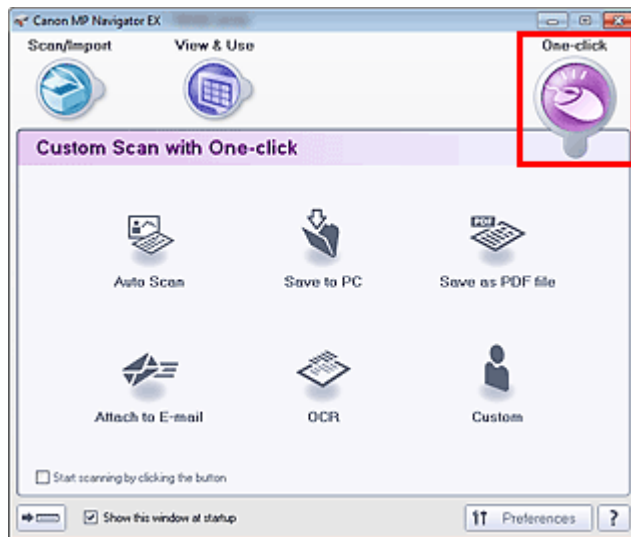

- **Auto Scan**

Scan documents by automatically detecting the document type. File format is automatically set. Files are saved to a computer.

When you click this icon, the Auto Scan dialog box opens and you can specify the save settings.

➔ [Auto Scan Dialog Box](#)

- **Save to PC**

Scan documents or photos and save them to a computer. The document type can be detected automatically.

When you click this icon, the Save dialog box opens and you can specify the scan/save settings.

➔ [Save Dialog Box \(One-click Mode Screen\)](#)

- **Save as PDF file**

Scan documents and save them as PDF files.

When you click this icon, the PDF dialog box opens and you can specify the scan/save and application settings.

➔ [PDF Dialog Box](#)

- **Attach to E-mail**

Scan documents or photos and attach them to e-mail.

When you click this icon, the Mail dialog box opens and you can specify the scan/save and e-mail software program settings.

➔ [Mail Dialog Box](#)

- **OCR**

Scan text documents then extract text in the image and display it in Notepad (included with Windows).

When you click this icon, the OCR dialog box opens and you can specify the scan/save settings.

➔ [OCR Dialog Box](#)

- **Custom**

Scan documents/photos and open them in a specified application. The document type can be automatically detected.

When you click this icon, the Custom dialog box opens and you can specify the scan/save and

application settings.

➔ [Custom Dialog Box](#)

- **Start scanning by clicking the button**

Select this checkbox and click an icon to start scanning immediately.



(Switch Mode)

Switches to One-click Mode. The One-click Mode screen appears.

➔ [One-click Mode Screen](#)

- **Show this window at startup**

Select this checkbox to open the Main Menu at startup. If this checkbox is not selected, the last used screen appears.

- **Preferences**

The Preferences dialog box opens. In the Preferences dialog box, you can make advanced settings to MP Navigator EX functions.

➔ [Preferences Dialog Box](#)



(Guide)

Opens this guide.

Important

- The following restrictions apply when you scan with Document Type set to Auto Mode in the Save dialog box or Custom dialog box.
When you want to convert text in the scanned image to text data, specify Document Type (do not select Auto Mode).

Related Topic

▶ [Easy Scanning with One-click](#)

[Page top](#)[↕]

Advanced Guide

Advanced Guide > Scanning > Scanning with the Bundled Application Software > MP Navigator EX Screens > Auto Scan Screen (Scan/Import Window)

S744

MP Navigator EX

Auto Scan Screen (Scan/Import Window)

Select Scan/Import in the Navigation Mode screen and click Auto Scan or click Auto Scan in the Scan/Import window to open the Auto Scan screen (Scan/Import window).

Open this window when you want to scan documents by automatically detecting the document type.

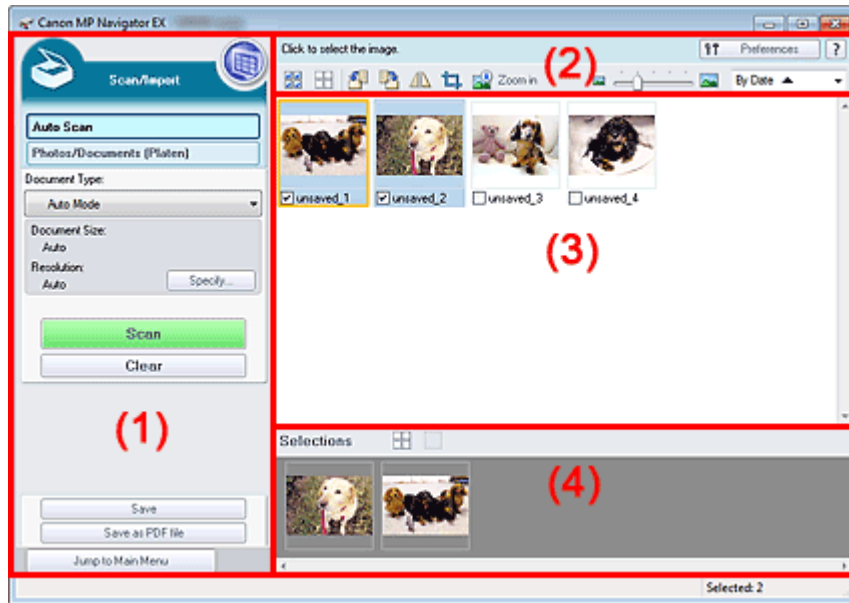

(1) Settings and Operation Buttons

(2) Toolbar

(3) Thumbnail Window

(4) Selected Images Area

- **Supported Documents**

Photos, postcards, business cards, magazines, newspapers, text documents and BD/DVD/CD.

Important

- The following types of documents cannot be scanned correctly. To scan other documents, specify the document type.
 - A4 size photos
 - Text documents smaller than 2L (5 inches x 7 inches) (127 mm x 178 mm), such as paperback pages with the spine cut off
 - Documents printed on thin white paper
 - Long narrow documents such as panoramic photos
- ➔ [Scanning Photos and Documents](#)
- Reflective disc labels may not be scanned properly.
- Place documents correctly according to the type of document to be scanned. Otherwise, documents may not be scanned correctly. See "[Placing Documents](#)" for details on how to place documents.

Note

- To reduce moire, open the "[Photos/Documents \(Platen\) Screen \(Scan/Import Window\)](#)" and set Document Type to Magazine(Color).

Settings and Operation Buttons



-  **(View & Use)**
Click this when you want to open images and PDF files saved on your computer. The View & Use window opens.
➔ [View & Use Window](#)
- **Auto Scan**
Displays the screen for scanning documents by automatically detecting the document type, etc.
- **Photos/Documents (Platen)**
Click this when you want to scan photos, documents, magazines and other printed materials. The screen for scanning photos and documents appears.
➔ [Photos/Documents \(Platen\) Screen \(Scan/Import Window\)](#)
- **Document Type**
Auto Mode is set.
- **Specify...**
Select whether or not to apply suitable corrections based on the document type.
➔ [Scan Settings Dialog Box \(Auto Scan\)](#)
- **Scan**
Scanning starts.
- **Clear**
Delete all images in the Thumbnail window.







Note

-
- Images not saved on a computer will be deleted. To keep important images, use Save or other methods to save them to a computer before clicking Clear.
-

- **Save**
Save the selected images. Click to open the Save dialog box and specify the save settings.
➔ [Save Dialog Box](#)
- **Save as PDF file**
Save the selected images as PDF files. Click to open the Save as PDF file dialog box and specify the save settings.
➔ [Save as PDF file Dialog Box](#)
- **Jump to Main Menu**
Jumps to the Main Menu.

Toolbar

- **Preferences**
The Preferences dialog box opens. In the Preferences dialog box, you can make advanced settings to MP Navigator EX functions.
➔ [Preferences Dialog Box](#)
-  **(Guide)**
Opens this guide.
- **Edit Tools**
 -  **(Select All)**
Selects all images in the Thumbnail window.
 -  **(Cancel All)**
Cancels all image selections in the Thumbnail window.

-  **(Rotate Left)**
Rotates the target image (outlined in orange) 90 degrees counter-clockwise.
-  **(Rotate Right)**
Rotates the target image (outlined in orange) 90 degrees clockwise.
-  **(Invert)**
Inverts the target image (outlined in orange) horizontally.
-  **(Trimming)**
Trims the target image (outlined in orange). "Trimming" is the act of selecting the area you want to keep in a photo and discarding the rest. Click this button to open the Crop window and specify the trimming frame.
-  **Zoom in**
Enlarges the target image (outlined in orange). You can also enlarge the image by double-clicking it.
-  **(Display Size)**
Changes the size of images in the Thumbnail window.
-  **(Sort by)**
Sorts the images in the Thumbnail window by category or by date (ascending or descending).

Thumbnail Window

- **Thumbnail Window**

Scanned images are displayed.

When you select the checkbox of an image, the image appears in the Selected Images area.

Note

- Thumbnails may appear as "?" when there is not enough memory to display the images.

When Images are Sorted by Categories

- **Close All / Open All**



You can hide or show all images in the displayed categories.

- **Close All**
Hides all images.
- **Open All**
Displays all images.

Note

- When you click Close All, the button changes to Open All.

Selected Images Area

-  **(Cancel All)**
Cancels the selection of all images in the Selected Images area.
-  **(Cancel Selection)**
Cancels the selection of the target image (outlined in orange) in the Selected Images area.
- **Selected Images Area**
Images selected in the Thumbnail window are displayed.

Related Topic

▶ [Easy Scanning with Auto Scan](#)

[Page top](#)↑

Advanced Guide

Advanced Guide > Scanning > Scanning with the Bundled Application Software > MP Navigator EX Screens > Scan Settings Dialog Box (Auto Scan)

S745

MP Navigator EX

Scan Settings Dialog Box (Auto Scan)

The Scan Settings dialog box opens when you click Specify... in the Scan/Import window.

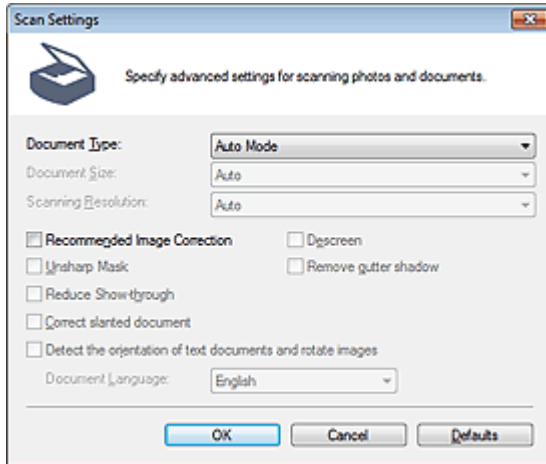

- **Document Type**

Auto Mode is set.

▶ Important

- Place documents correctly according to the type of document to be scanned. Otherwise, documents may not be scanned correctly. See "[Placing Documents](#)" for details on how to place documents.

- **Recommended Image Correction**

Select this checkbox to apply suitable corrections automatically based on the document type.

▶ Important

- When this checkbox is selected, the files can be saved in JPEG/Exif or PDF format only.
- Scanning may take longer than usual when this checkbox is selected.
- The color tone may change from the source image due to corrections. In that case, deselect the checkbox and scan.

- **Defaults**

Restore the default settings.

[Page top](#) ↑

Advanced Guide

Advanced Guide > Scanning > Scanning with the Bundled Application Software > MP Navigator EX Screens > Photos/Documents (Platen) Screen (Scan/Import Window)

S708

MP Navigator EX

Photos/Documents (Platen) Screen (Scan/Import Window)

Select Scan/Import in the Navigation Mode screen and click Photos/Documents (Platen) or click Photos/Documents (Platen) in the Scan/Import window to open the Photos/Documents (Platen) screen (Scan/Import window).

Open this window when you want to scan documents from the Platen.

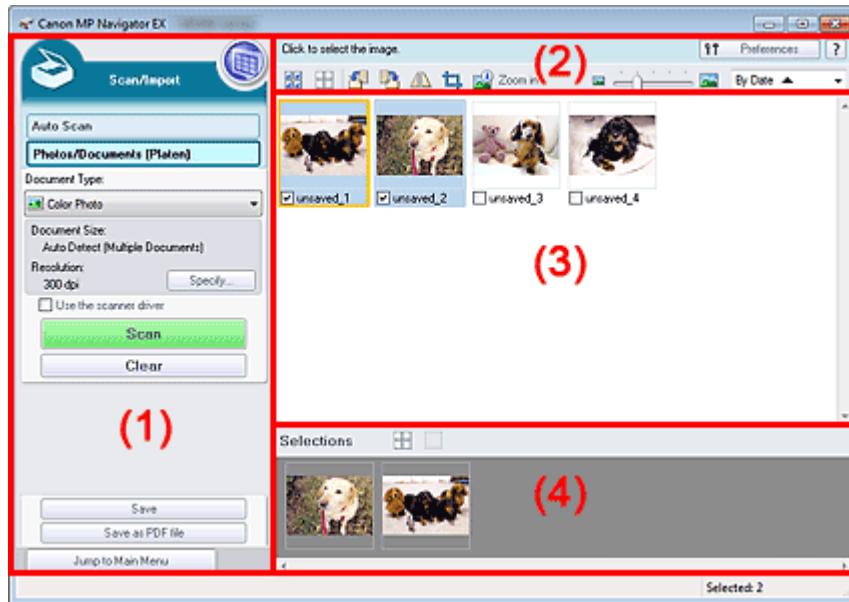

- (1) Settings and Operation Buttons
- (2) Toolbar
- (3) Thumbnail Window
- (4) Selected Images Area

Settings and Operation Buttons

- 
(View & Use)

Click this when you want to open images and PDF files saved on your computer. The View & Use window opens.

➔ [View & Use Window](#)
- Auto Scan**

Click this when you want to scan documents by automatically detecting the document type, etc. The screen for scanning with Auto Scan appears.

➔ [Auto Scan Screen \(Scan/Import Window\)](#)
- Photos/Documents (Platen)**

Displays the screen for scanning photos, documents and other printed materials.
- Document Type**

Select the type of document to be scanned.

Scanning photos: Color Photo or Black and White Photo

Scanning text documents: Color Document, Black and White Document or Text(OCR)

Scanning magazines: Magazine(Color)

Important

- You cannot select Document Type if the Use the scanner driver checkbox is selected.

- **Specify...**

Specify the document size, resolution, and other advanced scan settings.

➔ [Scan Settings Dialog Box \(Photos/Documents\)](#)

Important

- Specify... is not available if the Use the scanner driver checkbox is selected.

- **Use the scanner driver**

Select this checkbox when you want to scan with ScanGear (scanner driver). Use ScanGear to correct images and adjust colors when scanning.

- **Scan**

Scanning starts.

Note

- This button changes to Open Scanner Driver when you select the Use the scanner driver checkbox.

- **Open Scanner Driver**

ScanGear starts.

See "[ScanGear \(Scanner Driver\) Screens](#)" for details on ScanGear screens.

Note

- This button changes to Scan when you deselect the Use the scanner driver checkbox.

- **Clear**

Delete all images in the Thumbnail window.

Note

- Images not saved on a computer will be deleted. To keep important images, use Save or other methods to save them to a computer before clicking Clear.

- **Save**

Save the selected images. Click to open the Save dialog box and specify the save settings.

➔ [Save Dialog Box](#)

- **Save as PDF file**

Save the selected images as PDF files. Click to open the Save as PDF file dialog box and specify the save settings.

➔ [Save as PDF file Dialog Box](#)

- **Jump to Main Menu**

Jumps to the Main Menu.

Toolbar

- **Preferences**









The Preferences dialog box opens. In the Preferences dialog box, you can make advanced settings to MP Navigator EX functions.

➔ [Preferences Dialog Box](#)

-  **(Guide)**

Opens this guide.

- **Edit Tools**

-  **(Select All)**
Selects all images in the Thumbnail window.
-  **(Cancel All)**
Cancels all image selections in the Thumbnail window.
-  **(Rotate Left)**
Rotates the target image (outlined in orange) 90 degrees counter-clockwise.
-  **(Rotate Right)**
Rotates the target image (outlined in orange) 90 degrees clockwise.
-  **(Invert)**
Inverts the target image (outlined in orange) horizontally.
-  **(Trimming)**
Trims the target image (outlined in orange). "Trimming" is the act of selecting the area you want to keep in a photo and discarding the rest. Click this button to open the Crop window and specify the trimming frame.
-  **Zoom in**
Enlarges the target image (outlined in orange). You can also enlarge the image by double-clicking it.
-  **(Display Size)**
Changes the size of images in the Thumbnail window.
-  **(Sort by)**
Sorts the images in the Thumbnail window by category or by date (ascending or descending).

Thumbnail Window

- **Thumbnail Window**

Scanned images are displayed.

When you select the checkbox of an image, the image appears in the Selected Images area.

Note

- Thumbnails may appear as "?" when there is not enough memory to display the images.

When Images are Sorted by Categories

- **Close All / Open All**

You can hide or show all images in the displayed categories.

- **Close All**
Hides all images.
- **Open All**
Displays all images.

Note

- When you click Close All, the button changes to Open All.

Selected Images Area

-  **(Cancel All)**
Cancels the selection of all images in the Selected Images area.

-  **(Cancel Selection)**
Cancels the selection of the target image (outlined in orange) in the Selected Images area.
- **Selected Images Area**
Images selected in the Thumbnail window are displayed.

Related Topic

- ▶ [Scanning Photos and Documents](#)

[Page top](#) 

Advanced Guide

Advanced Guide > Scanning > Scanning with the Bundled Application Software > MP Navigator EX Screens > Scan Settings Dialog Box (Photos/Documents)

S713

MP Navigator EX

Scan Settings Dialog Box (Photos/Documents)

The Scan Settings dialog box opens when you click Specify... in the Scan/Import window.

In the Scan Settings dialog box, you can make advanced scan settings.

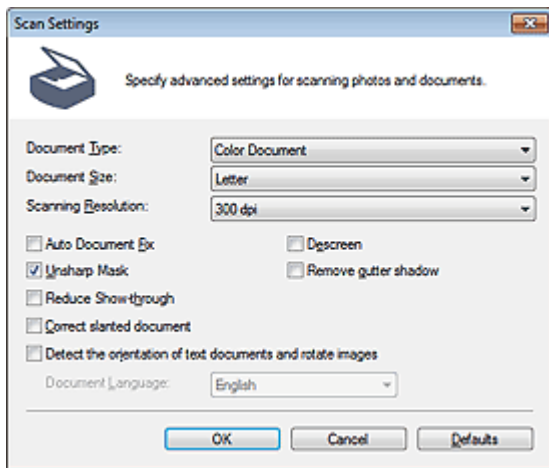

- **Document Type**

Select the type of document to be scanned.

Scanning photos: Color Photo or Black and White Photo

Scanning text documents: Color Document, Black and White Document or Text(OCR)

Scanning magazines: Magazine(Color)

- **Document Size**

Select the size of the document to be scanned.

When you select Custom, a screen in which you can specify the document size appears. Select a Units, then enter the Width and Height and click OK.

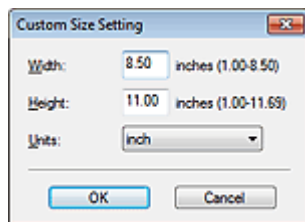

Important

- When you select Auto Detect, the image may not be scanned at the correct position and size. In that case, change the size to the actual document size (A4, Letter, etc.) and align a corner of the document with the corner at the arrow (alignment mark) of the Platen.
- You cannot select Auto Detect (Multiple Documents) or Auto Detect when Document Type is Text(OCR).

- **Scanning Resolution**

Select the resolution at which to scan documents.

➔ Resolution

Note

- The following scanning resolutions can be specified when Document Type is Text(OCR).
300 dpi / 400 dpi

- **Auto Photo Fix / Auto Document Fix**

The displayed item varies by Document Type.

- **Auto Photo Fix**

This is displayed when Document Type is Color Photo. Select this checkbox to automatically analyze the captured scene (landscape, night scene, etc.) and apply suitable corrections.

- **Auto Document Fix**

This is displayed when Document Type is Color Document, Black and White Document or Magazine(Color). Select this checkbox to sharpen text in a document or magazine for better readability.

Important

- When this checkbox is selected, the files can be saved in JPEG/Exif or PDF format only.
- Scanning may take longer than usual when this checkbox is selected.
- You cannot select this checkbox when Document Type is Black and White Photo or Text(OCR).
- The color tone may change from the source image due to corrections. In that case, deselect the checkbox and scan.

- **Descreen**

Select this checkbox to reduce moire patterns.

Printed photos and pictures are displayed as a collection of fine dots. "Moire" is a phenomenon where uneven gradation or a stripe pattern appears when such photos or pictures printed with fine dots are scanned. Descreen is the function for reducing this moire effect.

Important

- You cannot select this checkbox when Document Type is Color Photo, Black and White Photo or Text(OCR).

Note

- Scanning takes longer than usual when you enable Descreen.

- **Unsharp Mask**

Select this checkbox to emphasize the outline of the subjects and sharpen the image.

Important

- You cannot select this checkbox when Document Type is Text(OCR).

- **Remove gutter shadow**

Select this checkbox to correct shadows that appear between pages when scanning open booklets.

Important

- You cannot select this checkbox when Auto Detect, Auto Detect (Multiple Documents) or Stitch Assist is selected for Document Size.
- When scanning, align a corner of the document with the corner at the arrow (alignment mark) of the Platen.

Note

- Use ScanGear (scanner driver)'s Advanced Mode tab to correct gutter shadows when scanning non-standard size documents or when custom cropping frames are set. See "[Gutter Shadow Correction](#)" for details.

- **Reduce Show-through**

Select this checkbox to sharpen text in a document or reduce show-through in newspapers.

Important

- You cannot select this checkbox when Document Type is Color Photo, Black and White Photo or Text(OCR).

 **Note**

- Select this checkbox when Document Type is text document and show-through is apparent in the scanned image.

• Correct slanted document

Select this checkbox to detect the scanned text and correct the angle (within -0.1 to -10 degrees or +0.1 to +10 degrees) of the document.

 **Important**

- You cannot select this checkbox when Document Type is Color Photo or Black and White Photo.
- You cannot select this checkbox when Document Size is Stitch Assist.
- The inclination of the following types of documents may not be corrected, as the text cannot be detected correctly.
 - Documents in which the text lines are inclined more than 10 degrees or the angles vary by line
 - Documents containing both vertical and horizontal text
 - Documents with extremely large or small fonts
 - Documents with small amount of text
 - Documents containing figures/images
 - Hand-written documents
 - Documents containing both vertical and horizontal lines (tables)

 **Note**

- Scanning takes longer than usual when you enable Correct slanted document.

• Detect the orientation of text documents and rotate images

Select this checkbox to detect the orientation of the document from the scanned text and rotate the scanned image to the correct orientation. Select the language of the document to be scanned in Document Language.

 **Important**

- You cannot select this checkbox when Document Type is Color Photo or Black and White Photo.
- You cannot select this checkbox when Document Size is Stitch Assist.
- This function may not work properly depending on the document language. Only text documents written in languages that can be selected from Document Language are supported.
- The orientation of the following types of documents may not be corrected, as the text cannot be detected correctly. In that case, select the scanned image in the Thumbnail window of the " [Photos/Documents \(Platen\) Screen \(Scan/Import Window\)](#) " and rotate it with Edit Tools.
 - Resolution is outside the range of 300 dpi to 600 dpi
 - Font size is outside the range of 8 points to 48 points
 - Documents containing special fonts, effects, italics, or hand-written text
 - Documents with patterned backgrounds

 **Note**

- Scanning takes longer than usual when you enable Detect the orientation of text documents and rotate images.

• Document Language

Select the language of the document to be scanned.

 **Important**

- You cannot select this checkbox when Document Type is Color Photo or Black and White Photo.
- You cannot select this checkbox when Document Size is Stitch Assist.

• Defaults

Restore the default settings.

Advanced Guide

Advanced Guide > Scanning > Scanning with the Bundled Application Software > MP Navigator EX Screens > Save Dialog Box

S716

MP Navigator EX

Save Dialog Box

The Save dialog box opens when you click Save in the Scan/Import window.

In the Save dialog box, you can make settings for saving images to a computer.

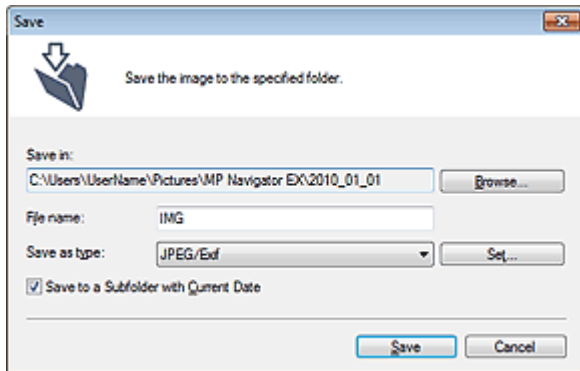

- **Save in**

Displays the folder in which to save the scanned images. To change the folder, click Browse... to specify another one.

By default, the scanned images are saved in the following folders.

Windows 7: MP Navigator EX folder in My Pictures folder

Windows Vista: MP Navigator EX folder in Pictures folder

Windows XP: MP Navigator EX folder in My Pictures folder

- **File name**

Enter the file name of the image to be saved (up to 64 characters). When saving multiple files, 4 digits are appended to each file name.

- **Save as type**

Select a file type to save the scanned images.

Select JPEG/Exif, TIFF or BMP.



Important

- You cannot select JPEG/Exif when Document Type is Text(OCR).
- You cannot select JPEG/Exif when Black and White is selected for Color Mode on the Advanced Mode tab of ScanGear (scanner driver).

- **Set...**

When Save as type is JPEG/Exif

You can specify a compression type for JPEG files. Select High(Low Compression), Standard or Low(High Compression).

- **Save to a Subfolder with Current Date**

Select this checkbox to create a subfolder in the folder specified in Save in with the current date and save scanned files in it. A subfolder with a name such as "2010_01_01" (Year_Month_Date) will be created.

If this checkbox is not selected, files are saved directly in the folder specified in Save in.

Advanced Guide

Advanced Guide > Scanning > Scanning with the Bundled Application Software > MP Navigator EX Screens > Save as PDF file Dialog Box

S717

MP Navigator EX

Save as PDF file Dialog Box

In the Save as PDF file dialog box, you can make advanced settings for saving scanned images as PDF files. You can save multiple documents as one PDF file or add pages to a PDF file created with MP Navigator EX.

Important

- You cannot save images scanned at 10501 pixels or more in the vertical and horizontal directions.

When Opened from the Scan/Import Window

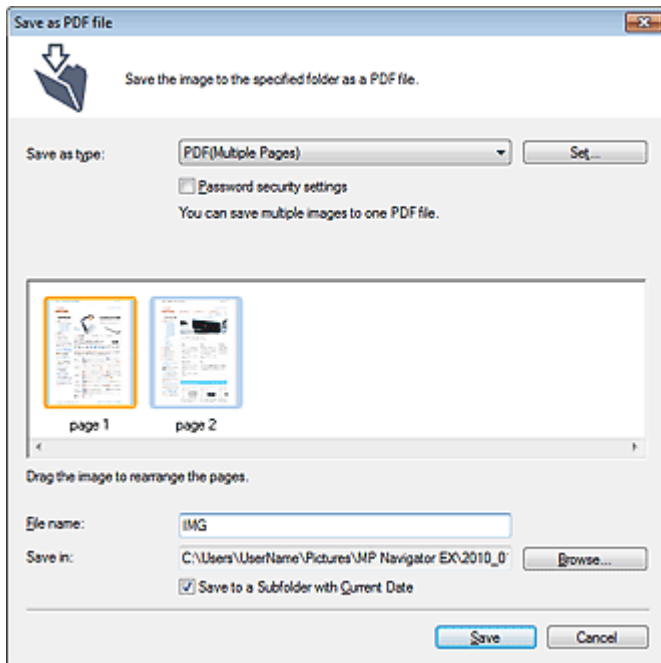

When Opened from the View & Use Window

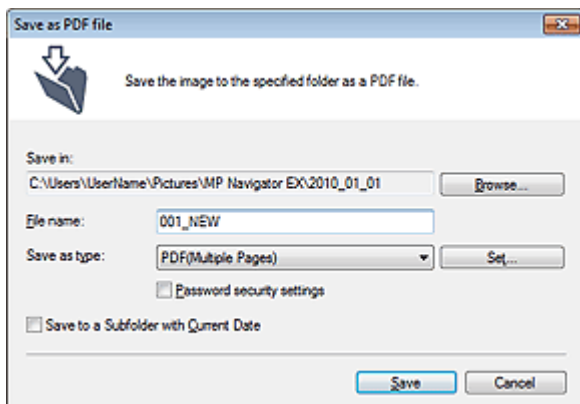

- Save as type**
 Select a PDF file type to save the scanned images.

- **PDF**

Save each of the selected images as a separate PDF file.

- **PDF(Multiple Pages)**

Save multiple images in one PDF file.



Note

- PDF(Multiple Pages) is displayed when multiple images are selected.

- **PDF(Add Page)**

Add the scanned images to a PDF file. The images are added to the end of the PDF file. You cannot rearrange the pages of the PDF file to which the images are added.



Important

- Images can only be added to PDF files created with MP Navigator EX. You cannot specify PDF files created with other applications. PDF files edited in other applications cannot be specified as well.
- When Opened from the View & Use Window, PDF(Add Page) cannot be selected.
- If a password-protected PDF file is edited, the passwords will be deleted. Reset the passwords.
➔ [Setting Passwords for PDF Files](#)

- **Set...**

Make advanced settings for creating PDF files. See "[PDF Settings Dialog Box](#)" for details.

- **Password security settings**

Select this checkbox to open the Password Security -Settings dialog box in which you can set passwords for opening, editing and printing created PDF files.

➔ [Setting Passwords for PDF Files](#)

- **Add to**

This is displayed when you select PDF(Add Page) for Save as type and specify the PDF file to which images are added. To change the file, click Browse... to specify another one.



Important

- Images can only be added to PDF files created with MP Navigator EX. You cannot specify PDF files created with other applications. PDF files edited in other applications cannot be specified as well.

- **File name**

Enter the file name of the image to be saved (up to 64 characters). When saving multiple files as separate PDF files, 4 digits are appended to each file name.

- **Save in**

Displays the folder in which to save the PDF files. To change the folder, click Browse... to specify another one.

By default, the scanned images are saved in the following folders.

Windows 7: MP Navigator EX folder in My Pictures folder

Windows Vista: MP Navigator EX folder in Pictures folder

Windows XP: MP Navigator EX folder in My Pictures folder

- **Save to a Subfolder with Current Date**

Select this checkbox to create a subfolder in the folder specified in Save in with the current date and save scanned files in it. A subfolder with a name such as "2010_01_01" (Year_Month_Date) will be created.

If this checkbox is not selected, files are saved directly in the folder specified in Save in.

Advanced Guide

Advanced Guide > Scanning > Scanning with the Bundled Application Software > MP Navigator EX Screens > PDF Settings Dialog Box

S736

MP Navigator EX

PDF Settings Dialog Box

In the PDF Settings dialog box, you can specify the PDF compression type and other advanced settings for creating PDF files.

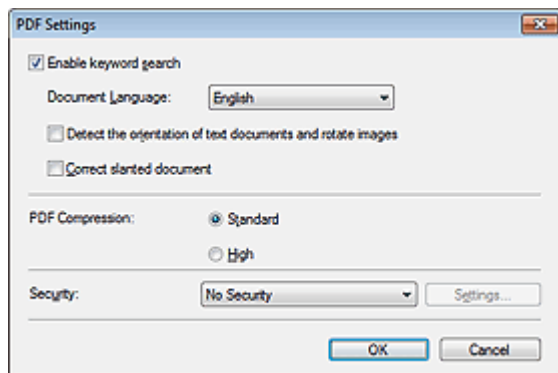

Important

- Only the Security setting is available for images with resolutions outside the range of 75 dpi to 600 dpi.

• Enable keyword search

Select this checkbox to convert characters in a document to text data. This will enable an easy search by keyword.

• Document Language

Select the language of the document to be scanned.

• Detect the orientation of text documents and rotate images

Select this checkbox to detect the orientation of the document from the scanned text and rotate the scanned image to the correct orientation.

Important

- This function may not work properly depending on the document language. Only text documents written in languages that can be selected from Document Language are supported.
- The orientation of the following types of documents may not be corrected, as the text cannot be detected correctly.
 - Resolution is outside the range of 300 dpi to 600 dpi
 - Font size is outside the range of 8 points to 48 points
 - Documents containing special fonts, effects, italics, or hand-written text
 - Documents with patterned backgrounds

• Correct slanted document

Select this checkbox to detect the scanned text and correct the angle (within -0.1 to -10 degrees or +0.1 to +10 degrees) of the document.

Important

- The inclination of the following types of documents may not be corrected, as the text cannot be detected correctly.
 - Documents in which the text lines are inclined more than 10 degrees or the angles vary by line
 - Documents containing both vertical and horizontal text
 - Documents with extremely large or small fonts
 - Documents with small amount of text

- Documents containing figures/images
- Hand-written documents
- Documents containing both vertical and horizontal lines (tables)

- **PDF Compression**

Select a compression type for saving.

- **Standard**

It is recommended that you normally select this setting.

- **High**

Compresses the file size when saving, allowing you to reduce the load on your network/server.

 **Important**

- Highly compressed PDF images may degrade if you repeatedly save them with high compression.

 **Important**

- Compression type cannot be set when Color Mode is Black and White.

- **Security**

Set passwords for opening, editing and printing the created PDF files.

 **Important**

- This function is not available when images are automatically saved after scanning.

 **Note**

- Select Password Security and set passwords in the Password Security -Settings dialog box.
➔ [Setting Passwords for PDF Files](#)

Advanced Guide

Advanced Guide > Scanning > Scanning with the Bundled Application Software > MP Navigator EX Screens > View & Use Window

S711

MP Navigator EX

View & Use Window

Select View & Use in the Navigation Mode screen and click My Box (Scanned/Imported Images), Specify Folder or Recently Saved Images to open the View & Use window.

Open this window to display or use scanned images or images saved on a computer.

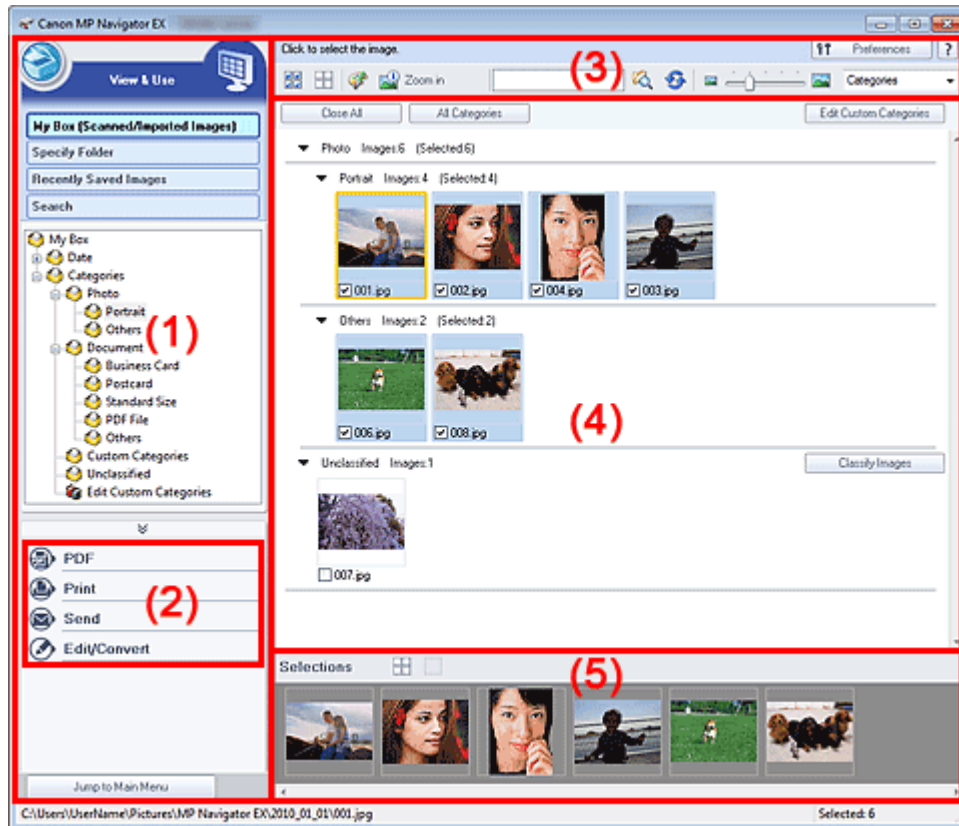

- (1) Display Setting Items
- (2) Image Handling Buttons
- (3) Toolbar
- (4) Thumbnail Window
- (5) Selected Images Area

Important

- For PDF files, only those created with MP Navigator EX are displayed. You cannot display PDF files created with other applications. PDF files edited in other applications cannot be displayed as well.

Display Setting Items

-  (Scan/Import)

Click this when you want to scan photos, documents, magazines and other printed materials. The Scan/Import window opens.

➔ Photos/Documents (Platen) Screen (Scan/Import Window)

- **My Box (Scanned/Imported Images)**

Displays folders of images (grouped by year, year/month and year/month/date) in My Box in tree view. Select a folder to display its contents in the Thumbnail window to the right. Image date is the scanned, captured or updated date.

- **Specify Folder**

Displays all hard disks and folders in tree view. Select a folder to display images in the Thumbnail window to the right.

Selecting a folder and clicking it highlights the folder name, allowing you to rename it.

- **Recently Saved Images**

"Scanned/Imported Images" and images that have been "Attached to E-mail" or "Sent to Application" recently are displayed in tree view by date. Select a Month/Date/Year folder to display images by date in the Thumbnail window to the right.

Image date is the scanned or sent date.

Click Clear History to clear all data (date folders and images) displayed in Recently Saved Images.



Note

- The actual image files are not deleted.
-

- **Search**

The advanced search options opens.

➔ [Searching Images](#)

- **Jump to Main Menu**

Jumps to the Main Menu.



Important

- Jump to Main Menu is not displayed when the window is opened directly from Solution Menu EX.

Image Handling Buttons

- **Image Handling Buttons**

Specify what to do with the selected images. See the corresponding sections below for details on each button.

➔ [Creating/Editing PDF Files](#)

➔ [Printing Documents](#)

➔ [Printing Photos](#)

➔ [Sending via E-mail](#)

➔ [Editing Files](#)



Note

- The buttons in Image Handling Buttons are displayed when the corresponding applications are installed.
-

Toolbar

- **Preferences**

The Preferences dialog box opens. In the Preferences dialog box, you can make advanced settings to MP Navigator EX functions.

➔ [Preferences Dialog Box](#)

-  **(Guide)**

Opens this guide.

- **Edit Tools**

-  **(Select All)**

Selects all images in the Thumbnail window.



-  **(Cancel All)**
Cancels all image selections in the Thumbnail window.

-  **(Image Correction/Enhancement)**
Allows you to correct the target image (outlined in orange). Click this button to open the Correct/Enhance Images window in which you can correct/enhance images and also adjust the brightness, contrast, etc.
➔ [Correct/Enhance Images Window](#)

Important

- Image correction/enhancement cannot be applied to PDF files or black and white binary files.

-  **Zoom in**
Enlarges the target image (outlined in orange). You can also enlarge the image by double-clicking it. You can check all pages when you select a PDF file. You can also check file information such as file name, date, size and security setting. A lock icon appears for PDF files with Document Open Password set.
➔ [Opening/Editing Password-protected PDF Files](#)

-  **(Search)**
Enter a word or phrase included in the file name, Exif information or PDF text of the image you want to search for, then click  (Search). For Exif information, text in Maker, Model, Description and User Comment is searched.

Note

- Search images in My Box (Scanned/Imported Images), Recently Saved Images or a selected folder and its subfolders.

-  **(Refresh)**
Refreshes the Thumbnail window contents.

-  **(Display Size)**
Changes the size of images in the Thumbnail window.

- **(Sort by)**
Sorts the images in the Thumbnail window by category, date (ascending or descending) or name (ascending or descending). Images can be sorted by category only when My Box (Scanned/Imported Images) or Specify Folder is displayed.

Thumbnail Window

• Thumbnail Window

Scanned images are displayed.

When you select the checkbox of an image, the image appears in the Selected Images area.

Selecting an image and clicking the file name highlights the file name, allowing you to rename it.

Drag and drop an image to do the following things.

- Move from one category to another within the Thumbnail window
- Move to a category folder displayed in My Box (Scanned/Imported Images)
- Copy to a folder displayed in Specify Folder

Important

- You cannot change the extension (.jpg, .pdf, etc.) when renaming a file.
- You cannot move or copy images to the date folders displayed in tree view in My Box (Scanned/Imported Images) or Recently Saved Images.

Note

- A lock icon appears for PDF files with Document Open Password set.
- Thumbnails may appear as "?" in the following cases.
 - Opening unsupported images
 - File size is too large and there is not enough memory to display the image
 - The file is corrupted

When Images are Sorted by Categories

Scanned images are displayed by category.

Note

- Some images may not be detected correctly and thus may be classified into wrong categories. In that case, drag and drop an image and move it from one category to another.

● Category name Images: N (Selected: n)

▼ Photo Images:3 (Selected:1)

▼ Portrait Images:2 (Selected:1)



● Category name

The following categories are provided.

Photos: Portrait, Others

Documents: Business Card, Postcard, Standard Size, PDF File, Others

Custom categories: Displays your custom categories.

Unclassified: Displays images that are not classified.

● Images: N

The number of images classified into the category is displayed.

● (Selected: n)

The number of images with the checkbox selected is displayed.

Note

- This portion is displayed only when one or more images are selected.

● Close All / Open All

You can hide or show all images in the displayed categories.

This button is displayed only when My Box (Scanned/Imported Images) or Specify Folder is displayed.

● Close All

Hides all images.

● Open All

Displays all images.

Note

- Immediately after opening the View & Use window or sorting images, all images appear and Close All is displayed.
- When you click Close All, the button changes to Open All.

● All Categories / Specific Categories

You can display all categories or only those containing images.

This button is displayed only when My Box (Scanned/Imported Images) or Specify Folder is displayed.

● All Categories

Displays all categories and images.

- **Specific Categories**

Displays categories containing images, along with the contained images. More images will be displayed in the Thumbnail window, allowing you to find or move images easily.

**Note**

- Immediately after opening the View & Use window, categories containing images appear along with the contained images, and All Categories is displayed.
 - Click All Categories, to changes to Specific Categories.
-

- **Edit Custom Categories**

When My Box (Scanned/Imported Images) or Specify Folder is displayed, the Edit Custom Categories dialog box opens.

In the Edit Custom Categories dialog box, you can add/delete categories displayed in Custom Categories.

See "[Classifying Images into Categories](#)" for details.

- **Classify Images**

Images imported from hard disks appear in Unclassified. Click Classify Images to classify them automatically.

This button is displayed only when My Box (Scanned/Imported Images) or Specify Folder is displayed.

**Note**

- Classification may take time if there are many images to classify.
-

Selected Images Area



- **(Cancel All)**

Cancels the selection of all images in the Selected Images area.



- **(Cancel Selection)**

Cancels the selection of the target image (outlined in orange) in the Selected Images area.

- **Selected Images Area**

Images selected in the Thumbnail window are displayed.

Related Topic

- ▶ [Opening Images Saved on a Computer](#)

Advanced Guide

Advanced Guide > Scanning > Scanning with the Bundled Application Software > MP Navigator EX Screens > Create/Edit PDF file Window

S715

MP Navigator EX

Create/Edit PDF file Window

Click PDF in the View & Use window, then click Create/Edit PDF file on the list to open the Create/Edit PDF file window.

In the Create/Edit PDF file window, you can add/delete pages and rearrange the page order of PDF files created with MP Navigator EX.

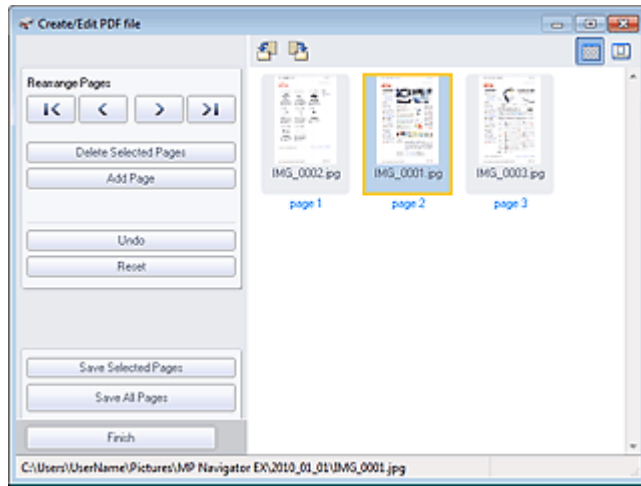

Important

- You cannot save images scanned at 10501 pixels or more in the vertical and horizontal directions.
- If a password-protected PDF file is edited, the passwords will be deleted. Reset the passwords.
 - ➔ [Setting Passwords for PDF Files](#)
- You can create or edit up to 99 pages at one time using MP Navigator EX.

• Rearrange Pages

You can move the selected image (outlined in orange).



- Moves the selected image to the top.



- Moves the selected image up one page.



- Moves the selected image down one page.



- Moves the selected image to the end.

Note

- You can also drag the image to rearrange the order.

• Delete Selected Pages

Deletes the selected image.

- **Add Page**

Allows you to select and add an existing PDF file.

Note

- A password will be required to add a password-protected PDF file.

- **Undo**

Cancels the latest change made.

- **Reset**

Cancels all the changes made.

- **Save Selected Pages**

Opens the Save as PDF file dialog box. Specify the save settings. Only the selected page is saved.

Note

- When multiple pages are selected, a multiple-page PDF file is created.
- See "[Save as PDF file Dialog Box](#) " for details on the Save as PDF file dialog box.

- **Save All Pages**

Opens the Save as PDF file dialog box. Specify the save settings and save all pages in the list as one PDF file or save all pages as separate PDF files.



Note

- See "[Save as PDF file Dialog Box](#) " for details on the Save as PDF file dialog box.

- **Finish**



Closes the Create/Edit PDF file window.

- **Toolbar**

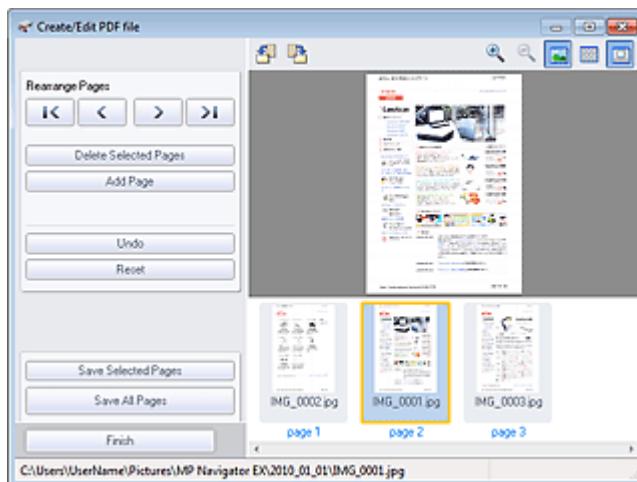
-  **(Rotate Left)**
Rotates the page 90 degrees counter-clockwise.
-  **(Rotate Right)**
Rotates the page 90 degrees clockwise.
-  **(Preview Mode)**
Switches to Preview Mode.
The selected page appears in Preview.



-  **(Enlarge)**
Enlarges the image displayed in Preview.

-  **(Reduce)**
Reduces the image displayed in Preview.
-  **(Full-screen)**
Displays the entire image.
-  **(Thumbnail Mode)**
Switches to Thumbnail Mode. The pages are displayed in thumbnail view.

[Page top](#) 

Advanced Guide

Advanced Guide > Scanning > Scanning with the Bundled Application Software > MP Navigator EX Screens > Print Document Dialog Box

S718



MP Navigator EX

Print Document Dialog Box

Click Print in the View & Use window, then click Print Document on the list to open the Print Document dialog box.

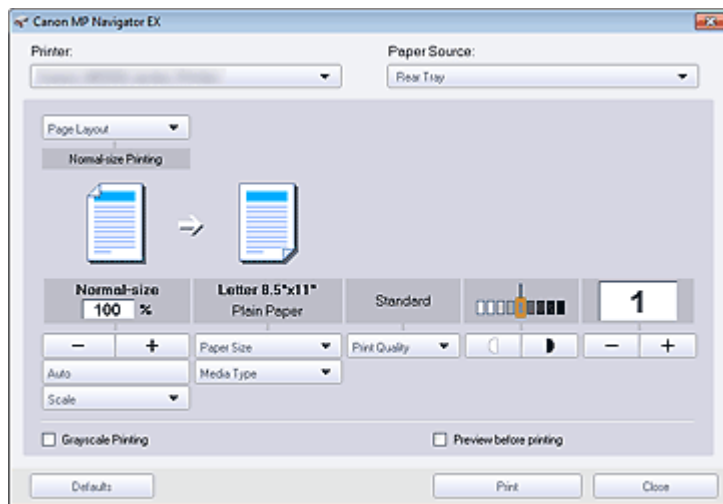
In the Print Document dialog box, you can make advanced settings for printing multiple scanned images at one time.



- **Printer**
Select the printer to use.
- **Paper Source**
Select paper source.
- **Page Layout**
Select a print type.
 - **Normal-size Printing**
Print one image per sheet.
 - **Scaled Printing**
Print images at the selected scale (enlarged or reduced).
 - **Fit-to-Page Printing**
Print an image at the paper size (enlarged or reduced).
 - **Borderless Printing**
Print the image on an entire sheet of paper without borders.
 - **Page Layout Printing (2 on 1)**
Layout and print two images on a sheet of paper.
 - **Page Layout Printing (4 on 1)**
Layout and print four images on a sheet of paper.
- **Enlarge/Reduce**
Enlarge or reduce images to print.
 -   (Enlarge/Reduce)

Print a reduced or enlarged image by specifying a scale in increments of 1%.

- **Auto**

Scale is adjusted automatically according to the detected paper width and the selected paper size. Image may be printed rotated 90 degrees depending on its size.

- **Scale**

Select a scale from the list.

Important

- At normal-size (100%), some images may be printed small or with some portions cropped. In that case, select Auto to resize the print in proportion to the paper size.

- **Paper Size**

Select the size of paper for printing. Match the size to the size of the paper set in the machine.

Note

- Selectable paper sizes depend on the selected printer.

- **Media Type**

Select the type of paper for printing. Print quality may be fixed depending on the paper type.

Note

- Selectable paper types depend on the selected printer.

- **Print Quality**

Select the print quality.

- **Density**

Click  (Density adjustment) to select the print density.

- **Copies**

Click  (Copy setting) to select the number of copies to be printed.

- **Grayscale Printing**

Select this checkbox to print the document in black and white.

- **Preview before printing**

Select this checkbox to display the print result before printing.

- **Defaults**

Restore the default settings.

- **Print**

Start printing with the specified settings.

Note

- To cancel while spooling, click Cancel. To cancel while printing, click Cancel Printing in the confirmation window for the printer status. To open a confirmation window for the printer status, click printer icon on the taskbar.

Advanced Guide

Advanced Guide > Scanning > Scanning with the Bundled Application Software > MP Navigator EX Screens > Print Photo Dialog Box

S729

MP Navigator EX

Print Photo Dialog Box

Click Print in the View & Use window, then click Print Photo on the list to open the Print Photo dialog box.

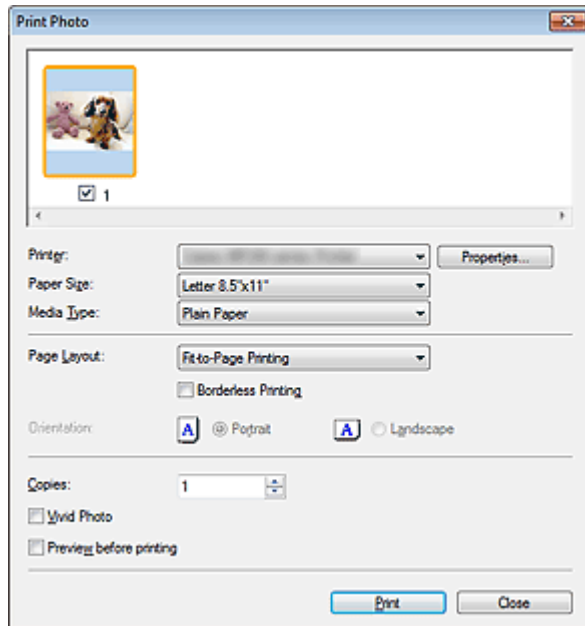

Important

- The Print Photo dialog box will not open if Easy-PhotoPrint EX is installed. Easy-PhotoPrint EX starts instead.
- PDF files cannot be printed.

Note

- Double-click an image to display it in a different window.

• Printer

Select the printer to use.

• Properties...

Displays the selected printer's advanced setting screen.

• Paper Size

Select the size of paper for printing. Match the size to the size of the paper set in the machine.

• Media Type

Select the type of paper for printing. Print quality may be fixed depending on the paper type.

• Page Layout

Select a print type.

• Normal-size Printing

Print one image per sheet.

• Fit-to-Page Printing

Print an image at the paper size (enlarged or reduced).

• Borderless Printing

Select this checkbox to print the image on an entire sheet of paper without borders.

Important

- Page Layout setting will be disabled when you select Borderless Printing.
- This setting is only available with printers that support borderless printing.

● Orientation

Specify the print orientation.

Important

- This setting is available only when Page Layout is Normal-size Printing. For others, the image is automatically rotated according to the aspect ratio of the paper.

● Copies

Specify the number of copies to print.

● Vivid Photo

Select this checkbox to print the image in vivid colors.

● Preview before printing

Select this checkbox to display the print result before printing.

● Print

Starts printing.

Note

- Only the images in the Thumbnail window with the checkbox selected are printed.

● Close

Closes the dialog box without printing the photo.

[Page top](#)[↕]

Advanced Guide

Advanced Guide > Scanning > Scanning with the Bundled Application Software > MP Navigator EX Screens > Send via E-mail Dialog Box

S719

MP Navigator EX

Send via E-mail Dialog Box

Click Send in the View & Use window, then click Attach to E-mail on the list to open the Send via E-mail dialog box.

In the Send via E-mail dialog box, you can make advanced settings for attaching images to e-mail.

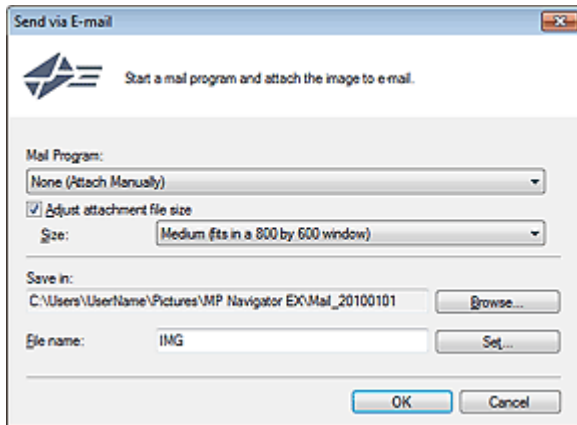

Important

- MP Navigator EX is compatible with the following e-mail software programs:
 - Microsoft Outlook
 - Windows Mail (Windows Vista)
 - Outlook Express (Windows XP)
 (If an e-mail software program does not operate properly, check that the program's MAPI is enabled. To enable MAPI, refer to the manual of the e-mail software program.)

Note

- Only PDF and JPEG files can be attached to e-mail.

● Mail Program

The e-mail software program set up on the General tab of the Preferences dialog box is displayed. Select the e-mail software program you want to use.

● Adjust attachment file size

When the file type is JPEG, selecting this checkbox allows you to resize the images. Select a size from Size.

● Save in

Displays the folder in which to save the images. To change the folder, click Browse... to specify another one. If resized, the resized images are saved.

By default, the scanned images are saved in the following folders.

Windows 7: MP Navigator EX folder in My Pictures folder

Windows Vista: MP Navigator EX folder in Pictures folder

Windows XP: MP Navigator EX folder in My Pictures folder

● File name

Enter the file name of the image to be attached (up to 64 characters). When saving multiple files, 4 digits are appended to each file name.

● Set...

You can specify a compression type for JPEG files.

Select High(Low Compression), Standard or Low(High Compression).

Advanced Guide

Advanced Guide > Scanning > Scanning with the Bundled Application Software > MP Navigator EX Screens > Correct/Enhance Images Window

S712

MP Navigator EX

Correct/Enhance Images Window

Click  (Image Correction/Enhancement) in the View & Use window or click Fix photo images in Image Handling Buttons to open the Correct/Enhance Images window.

In the Correct/Enhance Images window, you can make advanced settings including image correction/enhancement and brightness/contrast adjustment.

You can also display the source image and corrected image side by side for comparison.

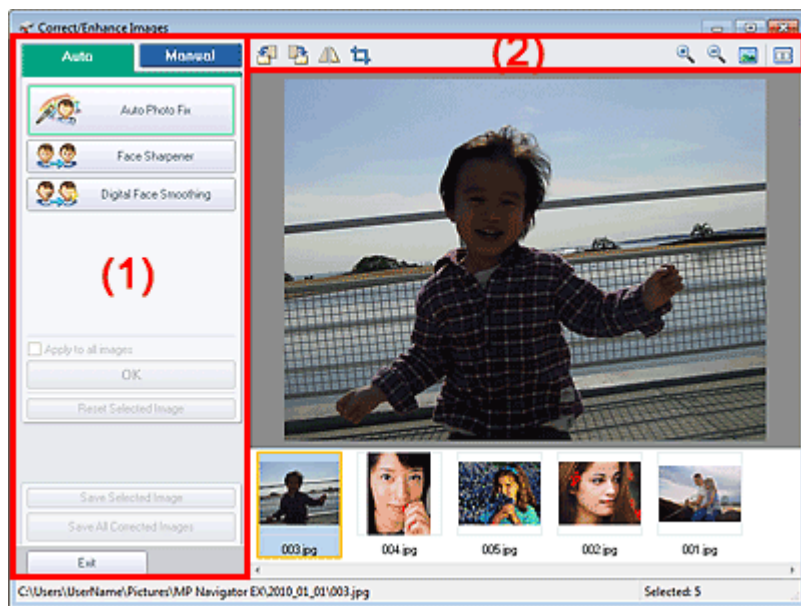

(1) Task Area

(2) Toolbar

Important

- Image correction/enhancement cannot be applied to PDF files or black and white binary files.

Note

- The Correct/Enhance Images window can also be opened by clicking  (Image Correction/Enhancement) in the Zoom in dialog box.
- It may take a while to correct large images.
- See "View & Use Window" for details on the View & Use window.

Task Area

Available tasks and settings vary between the Auto and Manual tabs.

Click the Auto or Manual tab to open the corresponding tab.

Auto Tab

Use the functions in the Auto tab to apply corrections and enhancements to the entire image.

See "Correcting/Enhancing Images Automatically" for details.

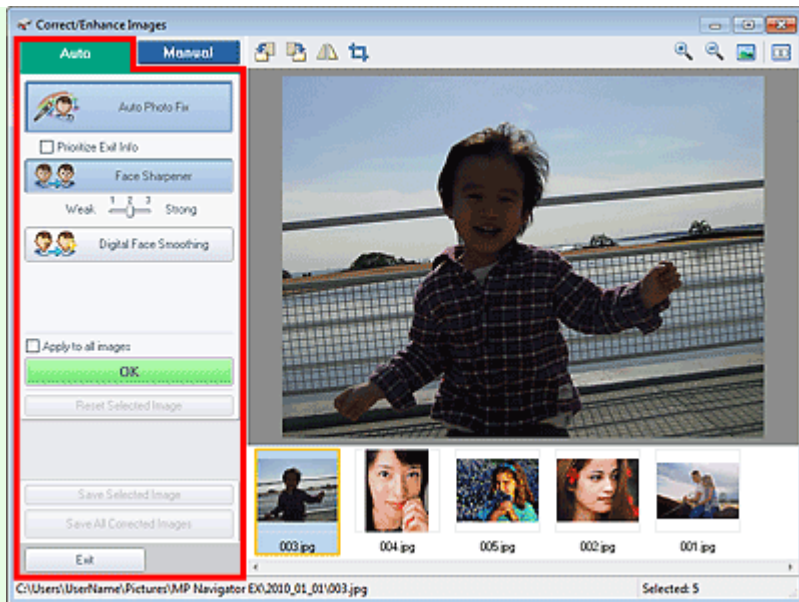

- **Auto Photo Fix**

Applies automatic corrections suitable for photos.

- **Prioritize Exif Info**

Select this checkbox to apply corrections primarily based on the settings made at the time of shooting.

Deselect this checkbox to apply corrections based on the image analysis results. It is recommended that you normally select this setting.



Note

- "Exif" is a standard format for embedding various shooting data in digital camera images (JPEG).

- **Face Sharpener**

Sharpens out-of-focus faces.

You can adjust the effect level using the slider.

- **Digital Face Smoothing**

Enhances skin beautifully by removing blemishes and wrinkles.

You can adjust the effect level using the slider.

- **Apply to all images**

Automatically corrects/enhances all images displayed in the thumbnail list.

- **OK**

Applies the selected effect to the selected image or all images.

- **Reset Selected Image**

Cancels all corrections and enhancements applied to the selected image.

- **Save Selected Image**

Saves the corrected/enhanced image (the selected one).

- **Save All Corrected Images**

Saves all the corrected/enhanced images displayed in the thumbnail list.

- **Exit**

Closes the Correct/Enhance Images window.

Manual Tab

There are two menus on the Manual tab: Adjust and Correct/Enhance.

Use Adjust to adjust brightness and contrast, or to sharpen the entire image.

Use Correct/Enhance to correct/enhance specific areas.

See "Correcting/Enhancing Images Manually " for details.

Adjustment

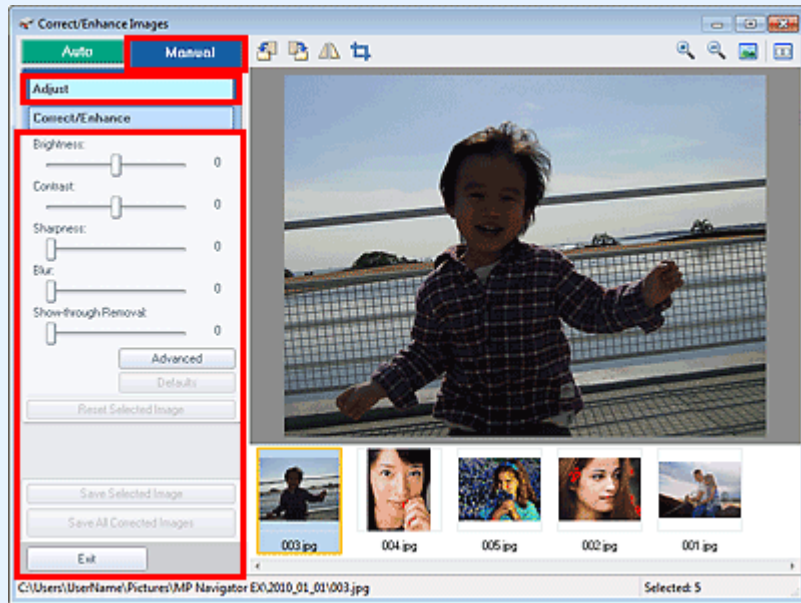

- **Brightness**

Adjusts the overall image brightness.
Move the slider to the left to darken and right to brighten the image.

- **Contrast**

Adjusts the contrast of the image. Adjust the contrast when the image is flat due to lack of contrast.
Move the slider to the left to decrease and right to increase the contrast of the image.

- **Sharpness**

Emphasizes the outline of the subjects to sharpen the image. Adjust the sharpness when the photo is out of focus or text is blurred.
Move the slider to the right to sharpen the image.

- **Blur**

Blurs the outline of the subjects to soften the image.
Move the slider to the right to soften the image.

- **Show-through Removal**

Removes show-through of text from the reverse side or removes the base color. Adjust the show-through level to prevent text on the reverse side of thin document or the base color of the document from appearing on the image.
Move the slider to the right to increase the show-through removal effect.

- **Advanced**

Opens the Advanced Adjustment dialog box in which you can make fine adjustments to the image brightness and color tone.
For Brightness/Contrast and Tone, select a color in Channel to adjust either Red, Green or Blue, or select Master to adjust three colors together.

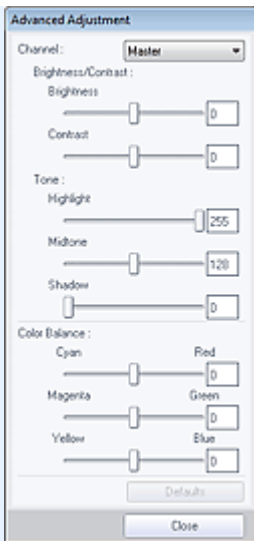

- **Brightness/Contrast**

Adjust the brightness and contrast of the image.

Move the Brightness slider to the left to darken and right to brighten the image.

Move the Contrast slider to the left to decrease and right to increase the contrast of the image.

- **Tone**

Adjust the brightness balance by specifying Highlight (the brightest level), Shadow (the darkest level) and Midtone (the color in the middle of Highlight and Shadow).

Move the Highlight slider to the left to brighten the image.

Move the Midtone slider to the left to brighten and right to darken the image.

Move the Shadow slider to the right to darken the image.

- **Color Balance**

Adjust the vividness and color tone of the image.

Move the Color Balance slider to the left or right to emphasize the corresponding color.



Note

- These are complementary color pairs (each pair produces a shade of gray when mixed). You can reproduce the natural colors of the scene by reducing the cast color and increasing the complementary color. "Colorcast" is a phenomenon where a specific color affects the entire picture due to the weather or ambient strong colors.
- It is usually difficult to correct the image completely by adjusting only one color pair. It is recommended that you find a portion in the image where it should be white, and adjust all three color pairs so that the portion turns white.

- **Defaults**

Resets all adjustments.

- **Close**

Closes the Advanced Adjustment dialog box.



Note

- The Brightness and Contrast values set in Adjust do not change even if the brightness and color tone are adjusted in the Advanced Adjustment dialog box.

- **Defaults**

Resets all settings (brightness, contrast, sharpness, blur, and show-through removal).

- **Reset Selected Image**

Cancels all corrections, enhancements and adjustments applied to the selected image.

- **Save Selected Image**

Saves the corrected/enhanced/adjusted image (the selected one).

- **Save All Corrected Images**

Saves all the corrected/enhanced/adjusted images displayed in the thumbnail list.

- **Exit**

Closes the Correct/Enhance Images window.

Correction/Enhancement

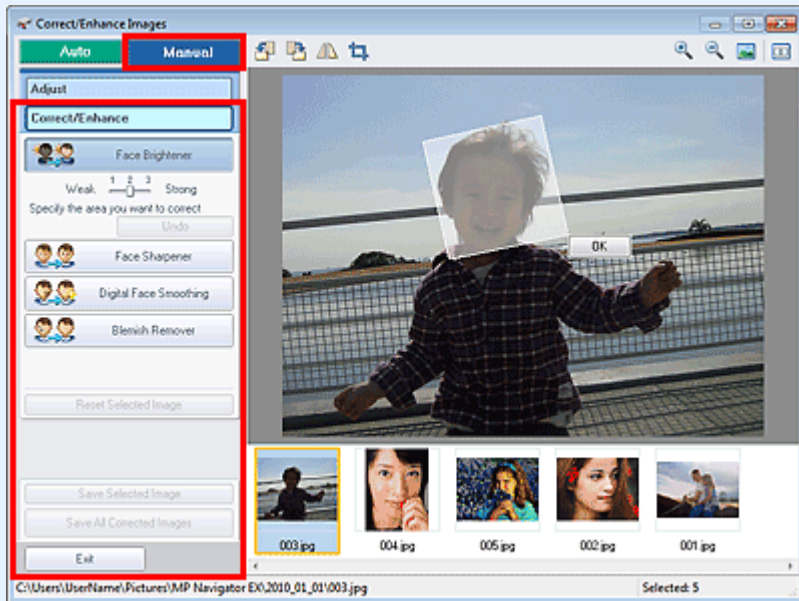

- **Face Brightener**

Corrects the entire image to brighten the facial area in and around the selected area. You can adjust the effect level using the slider.

- **Face Sharpener**

Corrects the entire image to sharpen the facial area in and around the selected area. You can adjust the effect level using the slider.

- **Digital Face Smoothing**

Enhances skin beautifully by removing blemishes and wrinkles in the selected area. You can adjust the effect level using the slider.

- **Blemish Remover**

Removes moles in the selected area.

- **OK**

Applies the selected effect to the specified area.

- **Undo**

Cancels the latest correction/enhancement.

- **Reset Selected Image**

Cancels all corrections and enhancements applied to the selected image.

- **Save Selected Image**

Saves the corrected/enhanced image (the selected one).

- **Save All Corrected Images**

Saves all the corrected/enhanced images displayed in the thumbnail list.

- **Exit**

Closes the Correct/Enhance Images window.

Toolbar

- **Toolbar**

-  **(Rotate Left)**

Rotates the image 90 degrees counter-clockwise.

-  **(Rotate Right)**

Rotates the image 90 degrees clockwise.

-  **(Invert)**

Inverts the image horizontally.

-  **(Trimming)**

Trimming is the act of selecting the area you want to keep in a photo and discarding the rest. In the displayed window, drag the white frame to specify the trimming area. Move the cursor inside the white frame and drag to move the trimming area.

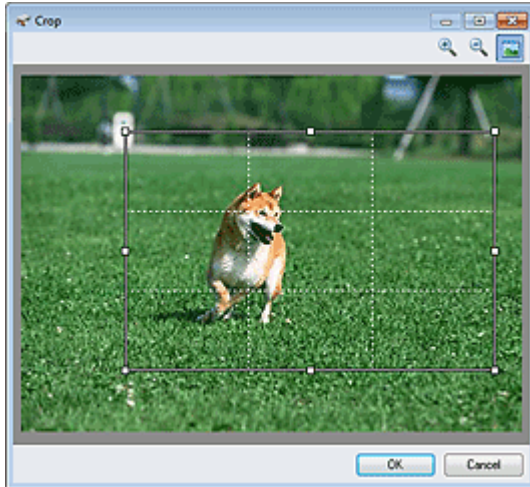

-  **Note**

- Place the main subjects along the broken white lines or at the intersections to create a balanced image.
-

-  **(Enlarge)**

Enlarges the displayed image.

-  **(Reduce)**

Reduces the displayed image.

-  **(Full-screen)**

Displays the entire image in Preview.

-  **(Compare)**

Opens a window in which you can compare the images before and after the correction/enhancement side by side. The source image appears on the left and the corrected image appears on the right.

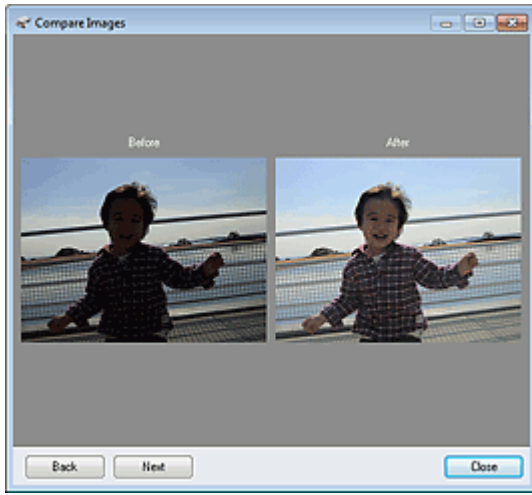

[Page top](#)

Advanced Guide

Advanced Guide > Scanning > Scanning with the Bundled Application Software > MP Navigator EX Screens > One-click Mode Screen

S701

MP Navigator EX

One-click Mode Screen

Click  (Switch Mode) at the bottom left of the Navigation Mode screen to display the One-click Mode screen.

You can complete "from scanning to saving", etc. at one time by simply clicking the corresponding icon.

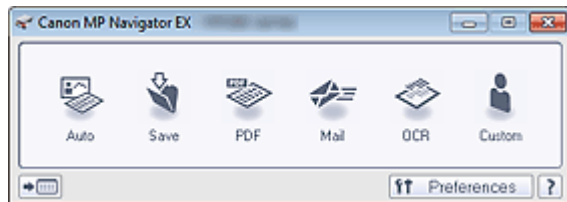

- **Auto**

Scan documents by automatically detecting the document type. File format is automatically set. Files are saved to a computer.

When you click this icon, the Auto Scan dialog box opens and you can specify the save settings.

➔ [Auto Scan Dialog Box](#)

- **Save**

Scan documents or photos and save them to a computer. The document type can be detected automatically.

When you click this icon, the Save dialog box opens and you can specify the scan/save settings.

➔ [Save Dialog Box \(One-click Mode Screen\)](#)

- **PDF**

Scan documents and save them as PDF files.

When you click this icon, the PDF dialog box opens and you can specify the scan/save and application settings.

➔ [PDF Dialog Box](#)

- **Mail**

Scan documents or photos and attach them to e-mail.

When you click this icon, the Mail dialog box opens and you can specify the scan/save and e-mail software program settings.

➔ [Mail Dialog Box](#)

- **OCR**

Scan text documents then extract text in the image and display it in Notepad (included with Windows).

When you click this icon, the OCR dialog box opens and you can specify the scan/save settings.

➔ [OCR Dialog Box](#)

- **Custom**

Scan documents/photos and open them in a specified application. The document type can be automatically detected.

When you click this icon, the Custom dialog box opens and you can specify the scan/save and application settings.

➔ [Custom Dialog Box](#)

-  **(Switch Mode)**

Switches to Navigation Mode. The Navigation Mode screen appears.

➔ [Custom Scan with One-click Tab](#)

- **Preferences**

The Preferences dialog box opens. In the Preferences dialog box, you can make advanced settings to MP Navigator EX functions.

[➔ Preferences Dialog Box](#)

- [?](#) (Guide)

Opens this guide.

Important

- The following restrictions apply when you scan with Document Type set to Auto Mode in the Save dialog box or Custom dialog box.
When you want to convert text in the scanned image to text data, specify Document Type (do not select Auto Mode).

Related Topic

- ▶ [Easy Scanning with One-click](#)

[Page top](#) 

Advanced Guide

Advanced Guide > Scanning > Scanning with the Bundled Application Software > MP Navigator EX Screens > Auto Scan Dialog Box

S742

MP Navigator EX

Auto Scan Dialog Box

Click Auto Scan on the Custom Scan with One-click tab or click Auto in the One-click Mode screen to open the Auto Scan dialog box.

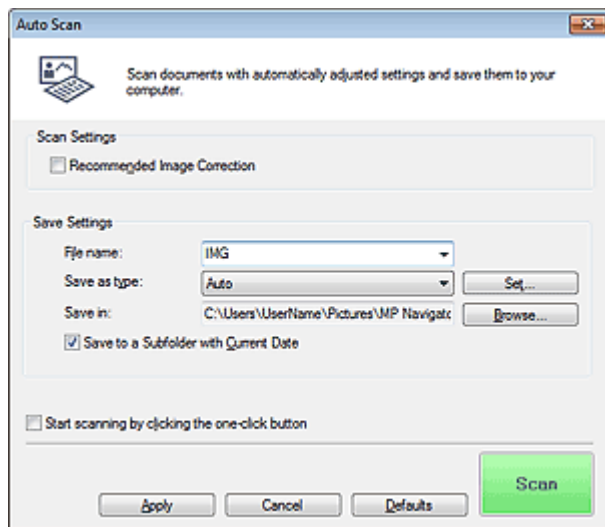

• Supported Documents

Photos, postcards, business cards, magazines, newspapers, text documents and BD/DVD/CD.

► Important

- The following types of documents cannot be scanned correctly. In that case, click another icon in the One-click Mode screen or on the Custom Scan with One-click tab and specify the document type or size.
 - A4 size photos
 - Text documents smaller than 2L (5 inches x 7 inches) (127 mm x 178 mm), such as paperback pages with the spine cut off
 - Documents printed on thin white paper
 - Long narrow documents such as panoramic photos
- Reflective disc labels may not be scanned properly.
- Place documents correctly according to the type of document to be scanned. Otherwise, documents may not be scanned correctly. See "[Placing Documents](#)" for details on how to place documents.

📖 Note

- To reduce moire, click another icon in the One-click Mode screen or on the Custom Scan with One-click tab and set Document Type to Magazine.

Scan Settings

• Recommended Image Correction

Select this checkbox to apply suitable corrections automatically based on the document type.

► Important

- When this checkbox is selected, the files can be saved in JPEG/Exif or PDF format only.
- Scanning may take longer than usual when this checkbox is selected.

- The color tone may change from the source image due to corrections. In that case, deselect the checkbox and scan.

Save Settings

- **File name**

Enter the file name of the image to be saved (up to 64 characters). When saving multiple files, 4 digits are appended to each file name.

- **Save as type**

Select a file type to save the scanned images.
Select Auto, JPEG/Exif, TIFF, BMP or PDF.

Important

- When Save as type is Auto, the file format may differ depending on how you place the document.
See "[Placing Documents](#)" for details on how to place documents.
- You cannot set passwords for PDF files.

Note

- When Auto is selected, files are saved in the following formats according to the document type.
Photos, postcards, BD/DVD/CD and business cards: JPEG
Magazines, newspapers and text documents: PDF
You can change the file format from Set....

- **Set...**

When Save as type is Auto

You can specify the file format in which to save images. Select a file format for items detected as documents, and for items detected as photos.

When Save as type is JPEG/Exif

You can specify a compression type for JPEG files. Select High(Low Compression), Standard or Low(High Compression).

When Save as type is PDF

Make advanced settings for creating PDF files. See "[PDF Settings Dialog Box](#)" for details.

- **Save in**

Displays the folder in which to save the scanned images. To change the folder, click Browse... to specify another one.

By default, the scanned images are saved in the following folders.

Windows 7: MP Navigator EX folder in My Pictures folder

Windows Vista: MP Navigator EX folder in Pictures folder

Windows XP: MP Navigator EX folder in My Pictures folder

- **Save to a Subfolder with Current Date**

Select this checkbox to create a subfolder in the folder specified in Save in with the current date and save scanned files in it. A subfolder with a name such as "2010_01_01" (Year_Month_Date) will be created.

If this checkbox is not selected, files are saved directly in the folder specified in Save in.

- **Start scanning by clicking the one-click button**

Select this checkbox to start scanning when you click an icon in One-click Mode.

Important

- Start scanning by clicking the one-click button is not displayed when the dialog box is opened directly from Solution Menu EX.

- **Apply**

Saves and applies the specified settings.
Click Cancel instead of Apply to cancel the specified settings.

- **Cancel**

Cancels the specified settings. The current screen closes.

- **Defaults**

Returns all settings in the screen to their defaults.

- **Scan**

Scans and saves documents with the specified settings.
When Save as type is Auto, a confirmation appears. Click Open Manual to open this guide (if it is installed).

[Page top](#) ↕

Advanced Guide

Advanced Guide > Scanning > Scanning with the Bundled Application Software > MP Navigator EX Screens > Save Dialog Box (One-click Mode Screen)

S721

MP Navigator EX

Save Dialog Box (One-click Mode Screen)

Click Save to PC on the Custom Scan with One-click tab or click Save in the One-click Mode screen to open the Save dialog box.

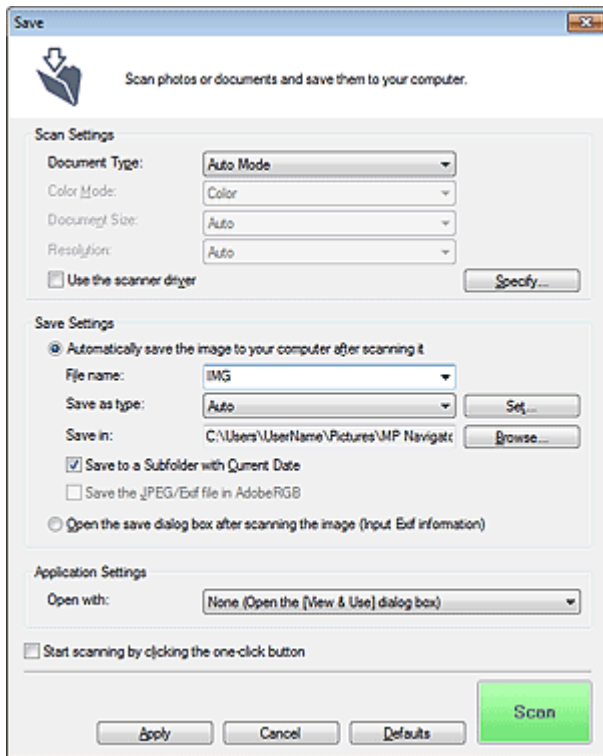

Scan Settings

- **Document Type**

Select the type of document to be scanned. When Auto Mode is selected, the document type is automatically detected. In that case, Color Mode, Document Size and Resolution are automatically set as well.

Important

- Document types supported by Auto Mode are photos, postcards, business cards, magazines, newspapers, text documents and BD/DVD/CD.
- The following types of documents cannot be scanned correctly with Auto Mode. In that case, specify the document type or size.
 - A4 size photos
 - Text documents smaller than 2L (5 inches x 7 inches) (127 mm x 178 mm), such as paperback pages with the spine cut off
 - Documents printed on thin white paper
 - Long narrow documents such as panoramic photos
- Reflective disc labels may not be scanned properly.
- Place documents correctly according to the type of document to be scanned. Otherwise, documents may not be scanned correctly. See "[Placing Documents](#)" for details on how to place documents.

Note

- To reduce moire, set Document Type to Magazine.

- **Color Mode**

Select how to scan the document.

- **Document Size**

Select the size of the document to be scanned.

When you select Custom, a screen in which you can specify the document size appears. Select a Units, then enter the Width and Height and click OK.

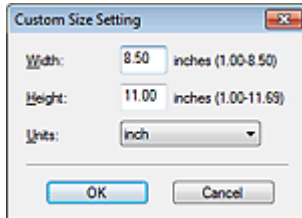

▶ Important

- When you select Auto Detect, the image may not be scanned at the correct position and size. In that case, change the size to the actual document size (A4, Letter, etc.) and align a corner of the document with the corner at the arrow (alignment mark) of the Platen.

- **Resolution**

Select the resolution at which to scan documents.

➔ [Resolution](#)

- **Use the scanner driver**

Select this checkbox to display the ScanGear (scanner driver) screen and make advanced scan settings.

Color Mode, Document Size, Resolution and other settings in the Save dialog box will be disabled. Specify these settings in the ScanGear screen.

- **Specify...**

Opens the Scan Settings dialog box in which you can make advanced scan settings.

➔ [Scan Settings Dialog Box \(One-click Mode Screen\)](#)

Save Settings

- **Automatically save the image to your computer after scanning it**

Select this to save the images to your computer as specified after scanning them. The File name, Save as type and Save in settings will be displayed.

▶ Important

- If you select this function, you will not be able to set passwords for PDF files.

- **File name**

Enter the file name of the image to be saved (up to 64 characters). When saving multiple files, 4 digits are appended to each file name.

- **Save as type**

Select a file type to save the scanned images.

Select Auto, JPEG/Exif, TIFF or BMP. Auto is displayed when Document Type is Auto Mode. When saving as PDF files, select PDF, PDF(Multiple Pages) or PDF(Add Page).

▶ Important

- When Document Type is Auto Mode and Save as type is Auto, the file format may differ depending on how you place the document. See "[Placing Documents](#)" for details on how to place documents.
- Images cannot be added to password-protected PDF files.
- You cannot select JPEG/Exif when Color Mode is Black and White.

 **Note**

- When Auto is selected, files are saved in the following formats according to the document type.
Photos, postcards, BD/DVD/CD and business cards: JPEG
Magazines, newspapers and text documents: PDF
You can change the file format from Set...
Images saved as PDF files may not open depending on the application. In that case, select an option other than Auto in Save as type.
- If you select JPEG/Exif when Document Type is not Auto Mode, the Save the JPEG/Exif file in AdobeRGB checkbox will be selectable.

● **Set...****When Save as type is Auto**

You can specify the file format in which to save images. Select a file format for items detected as documents, and for items detected as photos.

When Save as type is JPEG/Exif

You can specify a compression type for JPEG files. Select High(Low Compression), Standard or Low(High Compression).

When Save as type is PDF, PDF(Multiple Pages) or PDF(Add Page)

Make advanced settings for creating PDF files. See "[PDF Settings Dialog Box](#)" for details.

● **Save in**

Displays the folder in which to save the scanned images. To change the folder, click Browse... to specify another one.

By default, the scanned images are saved in the following folders.

Windows 7: MP Navigator EX folder in My Pictures folder

Windows Vista: MP Navigator EX folder in Pictures folder

Windows XP: MP Navigator EX folder in My Pictures folder

● **Save to a Subfolder with Current Date**

Select this checkbox to create a subfolder in the folder specified in Save in with the current date and save scanned files in it. A subfolder with a name such as "2010_01_01" (Year_Month_Date) will be created.

If this checkbox is not selected, files are saved directly in the folder specified in Save in.

● **Save the JPEG/Exif file in AdobeRGB**

Select this checkbox to save the images in colors that correspond to Adobe RGB.

 **Important**

- This function is available only when Save as type is JPEG/Exif and Document Type is not Auto Mode.
- This function is not available if the Adobe RGB profile is not installed.

 **Note**

- You cannot select this setting if the Use the scanner driver checkbox is selected.
- When you save an image with the Save the JPEG/Exif file in AdobeRGB checkbox selected, an underscore is added to the beginning of the file name. (Example: _Image0001.jpg)

● **Open the save dialog box after scanning the image (Input Exif information)**

Select this to open the Save dialog box after scanning the images and specify the save settings such as destination folder, file name and Exif information.

➔ [Save Dialog Box](#)

 **Note**

- To set passwords for PDF files, select Open the save dialog box after scanning the image (Input Exif information). After scanning, you can set the passwords in the Save dialog box.
➔ [Setting Passwords for PDF Files](#)

Application Settings

- **Open with**

You can select whether to open the View & Use window or Explorer after saving the images.

- **Start scanning by clicking the one-click button**

Select this checkbox to start scanning when you click an icon in One-click Mode.

- **Apply**

Saves and applies the specified settings.

Click Cancel instead of Apply to cancel the specified settings.

- **Cancel**

Cancels the specified settings. The current screen closes.

- **Defaults**

Returns all settings in the screen to their defaults.

- **Scan**

Scans and saves documents with the specified settings.

When Save as type is Auto, a confirmation appears. Click Open Manual to open this guide (if it is installed).

[Page top](#)↑

Advanced Guide

Advanced Guide > Scanning > Scanning with the Bundled Application Software > MP Navigator EX Screens > Scan Settings Dialog Box (One-click Mode Screen)

S734

MP Navigator EX

Scan Settings Dialog Box (One-click Mode Screen)

The Scan Settings dialog box opens when you click Specify... in a dialog box of the One-click Mode screen.

In the Scan Settings dialog box, you can make advanced scan settings.

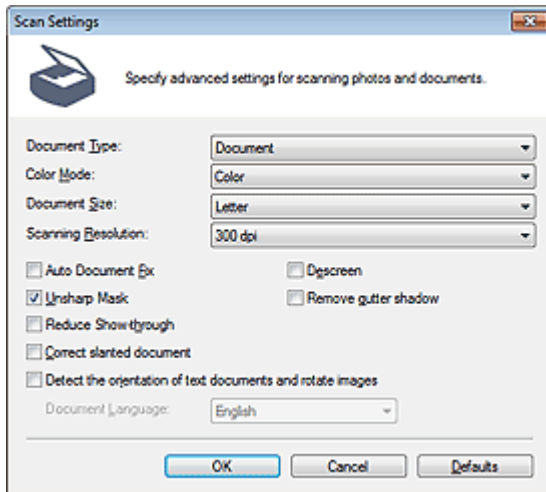

Note

- The displayed items vary by document type and how the screen was opened.

• Document Type

Select the type of document to be scanned. When Auto Mode is selected, the document type is automatically detected.

In that case, Color Mode, Document Size, etc. are automatically set as well.

Important

- Place documents correctly according to the type of document to be scanned. Otherwise, documents may not be scanned correctly.
See "[Placing Documents](#)" for details on how to place documents.

• Color Mode

Select how to scan the document.

• Color

This mode renders the image in 256 levels (8 bit) of R(ed), G(reen), and B(lue).

• Grayscale

This mode renders the image in 256 levels (8 bit) of black and white.

• Black and White

This mode renders the image in black and white. The contrast in the image is divided at certain levels (threshold level) into black and white and is rendered in two colors.

• Document Size

Select the size of the document to be scanned.

When you select Custom, a screen in which you can specify the document size appears. Select a Units, then enter the Width and Height and click OK.

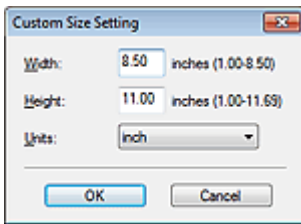

Important

- When you select Auto Detect, the image may not be scanned at the correct position and size. In that case, change the size to the actual document size (A4, Letter, etc.) and align a corner of the document with the corner at the arrow (alignment mark) of the Platen.

● Scanning Resolution

Select the resolution at which to scan documents.

➔ Resolution

● Recommended Image Correction / Auto Photo Fix / Auto Document Fix

The displayed item varies by Document Type.

● Recommended Image Correction

This is displayed when Document Type is Auto Mode. Select this checkbox to apply auto photo fix or auto document fix based on the document type.

● Auto Photo Fix

This is displayed when Document Type is Photo. Select this checkbox to automatically analyze the captured scene (landscape, night scene, etc.) and apply suitable corrections.

● Auto Document Fix

This is displayed when Document Type is Magazine or Document. Select this checkbox to sharpen text in a document or magazine for better readability.

Important

- When this checkbox is selected, the files can be saved in JPEG/Exif or PDF format only.
- Scanning may take longer than usual when this checkbox is selected.
- These functions are not available when the Scan Settings dialog box is opened from the OCR dialog box.
- Auto Photo Fix is not available when Color Mode is Grayscale or Black and White.
- Auto Document Fix is not available when Color Mode is Black and White.
- The color tone may change from the source image due to corrections. In that case, deselect the checkbox and scan.

● Descreen

Select this checkbox to reduce moire patterns.

Printed photos and pictures are displayed as a collection of fine dots. "Moire" is a phenomenon where uneven gradation or a stripe pattern appears when such photos or pictures printed with fine dots are scanned. Descreen is the function for reducing this moire effect.

Note

- Scanning takes longer than usual when you enable Descreen.

● Unsharp Mask

Select this checkbox to emphasize the outline of the subjects and sharpen the image.

● Remove gutter shadow

Select this checkbox to correct shadows that appear between pages when scanning open booklets.

Important

- You cannot select this checkbox when Auto Detect, Auto Detect (Multiple Documents) or Stitch Assist is selected for Document Size.
- When scanning, align a corner of the document with the corner at the arrow (alignment mark) of the Platen.

 **Note**

- Use ScanGear (scanner driver)'s Advanced Mode tab to correct gutter shadows when scanning non-standard size documents or when custom cropping frames are set. See "[Gutter Shadow Correction](#)" for details.

- **Reduce Show-through**

Select this checkbox to sharpen text in a document or reduce show-through in newspapers.

 **Note**

- Select this checkbox when Document Type is text document and show-through is apparent in the scanned image.

- **Correct slanted document**

Select this checkbox to detect the scanned text and correct the angle (within -0.1 to -10 degrees or +0.1 to +10 degrees) of the document.

 **Important**

- You cannot select this checkbox when Document Size is Stitch Assist.
- The inclination of the following types of documents may not be corrected, as the text cannot be detected correctly.
 - Documents in which the text lines are inclined more than 10 degrees or the angles vary by line
 - Documents containing both vertical and horizontal text
 - Documents with extremely large or small fonts
 - Documents with small amount of text
 - Documents containing figures/images
 - Hand-written documents
 - Documents containing both vertical and horizontal lines (tables)

 **Note**

- Scanning takes longer than usual when you enable Correct slanted document.

- **Detect the orientation of text documents and rotate images**

Select this checkbox to detect the orientation of the document from the scanned text and rotate the scanned image to the correct orientation. Select the language of the document to be scanned in Document Language.

 **Important**

- You cannot select this checkbox when Document Size is Stitch Assist.
- This function may not work properly depending on the document language. Only text documents written in languages that can be selected from Document Language are supported.
- The orientation of the following types of documents may not be corrected, as the text cannot be detected correctly.
 - Resolution is outside the range of 300 dpi to 600 dpi
 - Font size is outside the range of 8 points to 48 points
 - Documents containing special fonts, effects, italics, or hand-written text
 - Documents with patterned backgrounds

 **Note**

- Scanning takes longer than usual when you enable Detect the orientation of text documents and rotate images.

- **Document Language**

Select the language of the document to be scanned.

 **Important**

- You cannot select this checkbox when Document Size is Stitch Assist.

- **Defaults**

Restore the default settings.

Advanced Guide

Advanced Guide > Scanning > Scanning with the Bundled Application Software > MP Navigator EX Screens > Save Dialog Box

S731

MP Navigator EX

Save Dialog Box

The Save dialog box opens when you scan from the Save dialog box or Custom dialog box of the One-click Mode screen after selecting Open the save dialog box after scanning the image (Input Exif information).

You can specify the file type and destination while viewing the thumbnails.

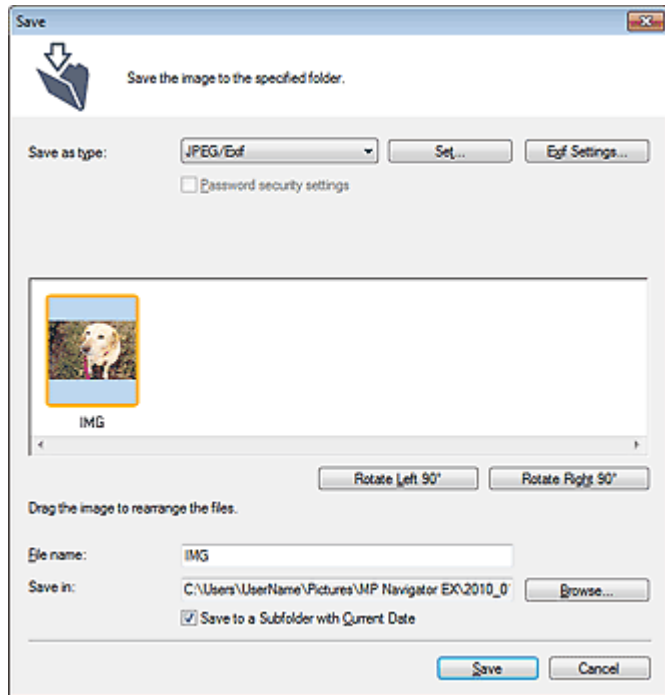

- **Save as type**

Select a file type to save the scanned images.
Select JPEG/Exif, TIFF, BMP, PDF, PDF(Multiple Pages) or PDF(Add Page).

- **PDF**

Save each of the selected images as a separate PDF file.

- **PDF(Multiple Pages)**

Save multiple images in one PDF file.

Note

- PDF(Multiple Pages) is displayed when multiple images are scanned.

- **PDF(Add Page)**

Add the scanned images to a PDF file. The images are added to the end of the PDF file. You cannot rearrange the pages of the PDF file to which the images are added.

Important

- Images can only be added to PDF files created with MP Navigator EX. You cannot specify PDF files created with other applications. PDF files edited in other applications cannot be specified as well.
 - If a password-protected PDF file is edited, the passwords will be deleted. Reset the passwords.

[➔ Setting Passwords for PDF Files](#)

Important

- PDF, PDF(Multiple Pages) and PDF(Add Page) cannot be selected for images scanned from the Custom dialog box.
- You cannot select JPEG/Exif when Color Mode is Black and White.

● Set...

When Save as type is JPEG/Exif

You can specify a compression type for JPEG files. Select High(Low Compression), Standard or Low(High Compression).

When Save as type is PDF, PDF(Multiple Pages) or PDF(Add Page)

Make advanced settings for creating PDF files. See "[PDF Settings Dialog Box](#)" for details.

● Exif Settings...

When Save as type is JPEG/Exif, you can input Exif information into the file to be saved.

[➔ Exif Settings Dialog Box](#)

● Password security settings

Select this checkbox to open the Password Security -Settings dialog box in which you can set passwords for opening, editing and printing created PDF files.

[➔ Setting Passwords for PDF Files](#)

Note

- This function is available only when Save as type is PDF, PDF(Multiple Pages) or PDF(Add Page).

● Add to

This is displayed when you select PDF(Add Page) for Save as type and specify the PDF file to which images are added. To change the file, click Browse... to specify another one.

Important

- Images can only be added to PDF files created with MP Navigator EX. You cannot specify PDF files created with other applications. PDF files edited in other applications cannot be specified as well.

● Rotate Left 90° / Rotate Right 90°

Rotates scanned images 90 degrees counter-clockwise or clockwise.

Select the image you want to rotate and click Rotate Left 90° or Rotate Right 90°.

● File name

Enter the file name of the image to be saved (up to 64 characters). When saving multiple files, 4 digits are appended to each file name.

● Save in

Displays the folder in which to save the scanned images. To change the folder, click Browse... to specify another one.

By default, the scanned images are saved in the following folders.

Windows 7: MP Navigator EX folder in My Pictures folder

Windows Vista: MP Navigator EX folder in Pictures folder

Windows XP: MP Navigator EX folder in My Pictures folder

● Save to a Subfolder with Current Date

Select this checkbox to create a subfolder in the folder specified in Save in with the current date and save scanned files in it. A subfolder with a name such as "2010_01_01" (Year_Month_Date) will be created.

If this checkbox is not selected, files are saved directly in the folder specified in Save in.

[Page top](#)[↕]

Advanced Guide

Advanced Guide > Scanning > Scanning with the Bundled Application Software > MP Navigator EX Screens > Exif Settings Dialog Box

S732

MP Navigator EX

Exif Settings Dialog Box

You can input Exif information into a file to be saved. "Exif" is a standard format for embedding various shooting data in digital camera images (JPEG). Embedding Exif information into scanned images allows you to organize and print them along with digital camera images.

The Exif Settings dialog box can be opened when Save as type is JPEG/Exif.

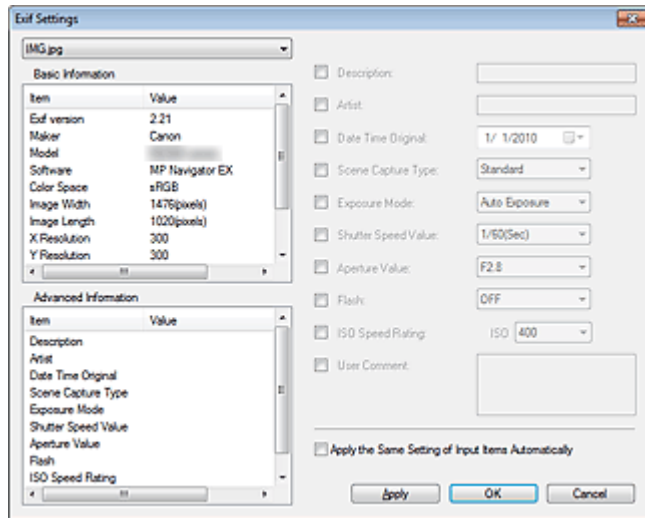

- **Basic Information**

Displays the information obtained automatically from the machine or software.

- **Advanced Information**

Displays the information specified on the right side of the screen.

- **Advanced Information Settings Area**

You can input Exif information such as the title and shooting data. Select the checkbox of the items you want to specify, and select or enter information.

- **Apply the Same Setting of Input Items Automatically**

Select this checkbox to automatically display the information you specified for the previous image.

- **Apply**

After specifying all the information you need, click Apply to embed it into the image. The information appears in Advanced Information.

- **OK**

Embeds the specified information into the image and closes the screen. The specified information is saved.

- **Cancel**

Cancels the settings and closes the screen. Information is embedded when Cancel is clicked after clicking Apply.

Advanced Guide

Advanced Guide > Scanning > Scanning with the Bundled Application Software > MP Navigator EX Screens > PDF Dialog Box

S725

MP Navigator EX

PDF Dialog Box

Click Save as PDF file on the Custom Scan with One-click tab or click PDF in the One-click Mode screen to open the PDF dialog box.

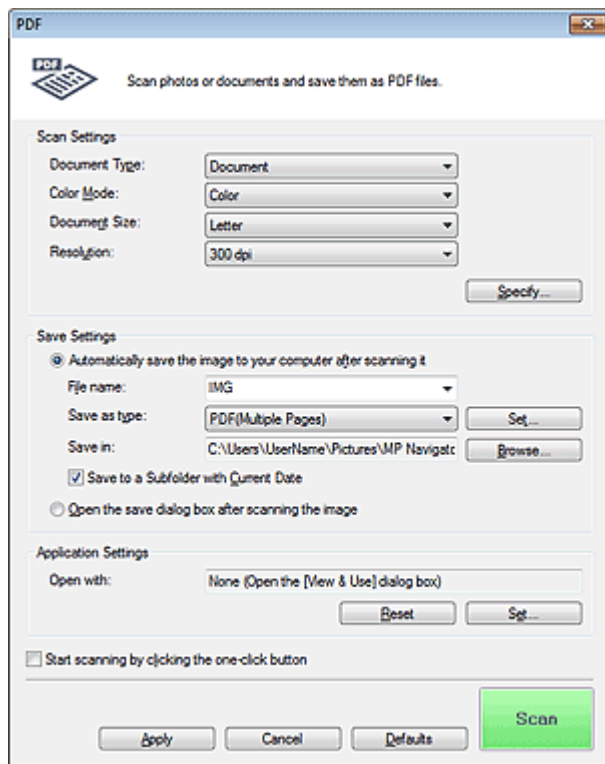

Scan Settings

- Document Type**
 Select the type of document to be scanned.
- Color Mode**
 Select how to scan the document.
- Document Size**
 Select the size of the document to be scanned.
 When you select Custom, a screen in which you can specify the document size appears. Select a Units, then enter the Width and Height and click OK.

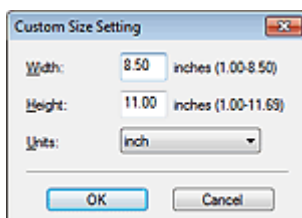

Important

- When you select Auto Detect, the image may not be scanned at the correct position and size. In

that case, change the size to the actual document size (A4, Letter, etc.) and align a corner of the document with the corner at the arrow (alignment mark) of the Platen.

- **Resolution**

Select the resolution at which to scan documents.

➔ [Resolution](#)

- **Specify...**

Opens the Scan Settings dialog box in which you can make advanced scan settings.

➔ [Scan Settings Dialog Box \(One-click Mode Screen\)](#)

Save Settings

- **Automatically save the image to your computer after scanning it**

Select this to save the images to your computer as specified after scanning them.

The File name, Save as type and Save in settings will be displayed.



Important

- If you select this function, you will not be able to set passwords for PDF files.

- **File name**

Enter the file name of the image to be saved (up to 64 characters). When saving multiple files, 4 digits are appended to each file name.

- **Save as type**

Select a file type to save the scanned images.

Select PDF, PDF(Multiple Pages) or PDF(Add Page).

- **PDF**

Save each of the selected images as a separate PDF file.

- **PDF(Multiple Pages)**

Save multiple images in one PDF file.

- **PDF(Add Page)**

Add the scanned images to a PDF file. The images are added to the end of the PDF file. You cannot rearrange the pages of the PDF file to which the images are added.



Important

- Images can only be added to PDF files created with MP Navigator EX. You cannot specify PDF files created with other applications. PDF files edited in other applications cannot be specified as well.
- Images cannot be added to password-protected PDF files.



Note

- See "[Creating/Editing PDF Files](#)" to delete or rearrange the pages of saved PDF files.

- **Set...**

You can specify the PDF compression type and other advanced settings for creating PDF files.

➔ [PDF Settings Dialog Box](#)

- **Save in**

Displays the folder in which to save the scanned images. To change the folder, click Browse... to specify another one.

By default, the scanned images are saved in the following folders.

Windows 7: MP Navigator EX folder in My Pictures folder

Windows Vista: MP Navigator EX folder in Pictures folder

Windows XP: MP Navigator EX folder in My Pictures folder

- **Add to**

This is displayed when you select PDF(Add Page) for Save as type and specify the PDF file to which images are added.

To change the file, click Browse... to specify another one.

Important

- Images can only be added to PDF files created with MP Navigator EX. You cannot specify PDF files created with other applications. PDF files edited in other applications cannot be specified as well.

- **Save to a Subfolder with Current Date**

Select this checkbox to create a subfolder in the folder specified in Save in with the current date and save scanned files in it. A subfolder with a name such as "2010_01_01" (Year_Month_Date) will be created.

If this checkbox is not selected, files are saved directly in the folder specified in Save in.

- **Open the save dialog box after scanning the image**

Select this to open the Save as PDF file dialog box after scanning the images and specify the save settings such as destination folder and file name.

➔ [Save as PDF file Dialog Box](#)

Note

- To set passwords for PDF files, select Open the save dialog box after scanning the image. After scanning, you can set the passwords in the Save as PDF file dialog box.

➔ [Setting Passwords for PDF Files](#)

Application Settings

- **Open with**

Specify an application with which to open scanned images. Drag and drop the icon of an application that supports the file format displayed in Save as type. The specified application starts after images are scanned.

Important

- Depending on the specified application, the images may not appear correctly or the application may not start.

- **Reset**

Cancels the application setting.

- **Set...**

Allows you to select an application to start.

- **Start scanning by clicking the one-click button**

Select this checkbox to start scanning when you click an icon in One-click Mode.

- **Apply**

Saves and applies the specified settings.

Click Cancel instead of Apply to cancel the specified settings.

- **Cancel**

Cancels the specified settings. The current screen closes.

- **Defaults**

Returns all settings in the screen to their defaults.

- **Scan**

Scans and saves documents as PDF files with the specified settings.

Advanced Guide

Advanced Guide > Scanning > Scanning with the Bundled Application Software > MP Navigator EX Screens > Save as PDF file Dialog Box

S730

MP Navigator EX

Save as PDF file Dialog Box

The Save as PDF file dialog box opens when you scan from the PDF dialog box of the One-click Mode screen after selecting Open the save dialog box after scanning the image.

In the Save as PDF file dialog box, you can make settings for saving images to a computer.

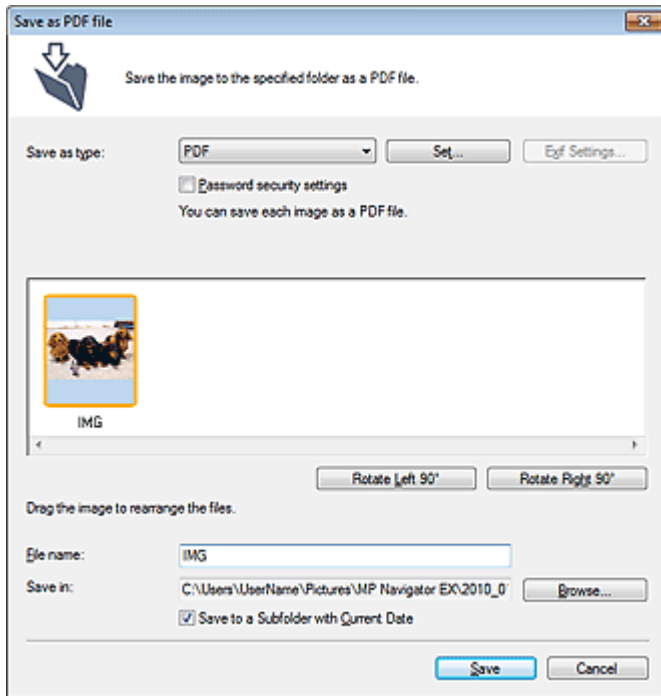

Important

- You cannot save images scanned at 10501 pixels or more in the vertical and horizontal directions.

• Save as type

Select a PDF file type to save the scanned images.

• PDF

Save each of the selected images as a separate PDF file.

• PDF(Multiple Pages)

Save multiple images in one PDF file.



Note

- PDF(Multiple Pages) is displayed when multiple images are scanned.

• PDF(Add Page)

Add the scanned images to a PDF file. The images are added to the end of the PDF file. You cannot rearrange the pages of the PDF file to which the images are added.

Important

- Images can only be added to PDF files created with MP Navigator EX. You cannot specify PDF files created with other applications. PDF files edited in other applications cannot be specified as well.

- PDF(Add Page) cannot be selected for images scanned using the Operation Panel of the machine.
- If a password-protected PDF file is edited, the passwords will be deleted. Reset the passwords.
➔ [Setting Passwords for PDF Files](#)

- **Set...**

Make advanced settings for creating PDF files. See "[PDF Settings Dialog Box](#)" for details.

- **Password security settings**

Select this checkbox to open the Password Security -Settings dialog box in which you can set passwords for opening, editing and printing created PDF files.

➔ [Setting Passwords for PDF Files](#)

- **Add to**

This is displayed when you select PDF(Add Page) for Save as type and specify the PDF file to which images are added. To change the file, click Browse... to specify another one.

Important

- Images can only be added to PDF files created with MP Navigator EX. You cannot specify PDF files created with other applications. PDF files edited in other applications cannot be specified as well.

- **Rotate Left 90° / Rotate Right 90°**

Rotates scanned images 90 degrees counter-clockwise or clockwise.

Select the image you want to rotate and click Rotate Left 90° or Rotate Right 90°.

- **File name**

Enter the file name of the image to be saved (up to 64 characters). When saving multiple files, 4 digits are appended to each file name.

- **Save in**

Displays the folder in which to save the PDF files. To change the folder, click Browse... to specify another one.

By default, the scanned images are saved in the following folders.

Windows 7: MP Navigator EX folder in My Pictures folder

Windows Vista: MP Navigator EX folder in Pictures folder

Windows XP: MP Navigator EX folder in My Pictures folder

- **Save to a Subfolder with Current Date**

Select this checkbox to create a subfolder in the folder specified in Save in with the current date and save scanned files in it. A subfolder with a name such as "2010_01_01" (Year_Month_Date) will be created.

If this checkbox is not selected, files are saved directly in the folder specified in Save in.

[Page top](#)↑

Advanced Guide

Advanced Guide > Scanning > Scanning with the Bundled Application Software > MP Navigator EX Screens > Mail Dialog Box

S722

MP Navigator EX

Mail Dialog Box

Click Attach to E-mail on the Custom Scan with One-click tab or click Mail in the One-click Mode screen to open the Mail dialog box.

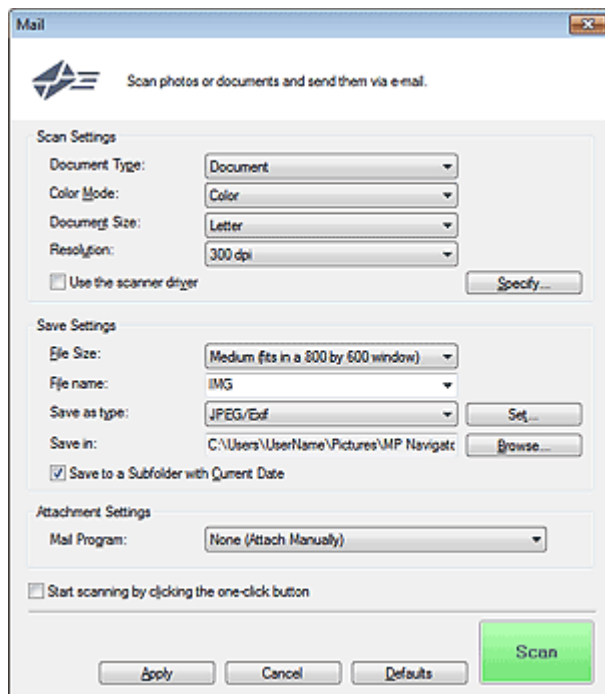

Scan Settings

- Document Type**
 Select the type of document to be scanned.
- Color Mode**
 Select how to scan the document.
- Document Size**
 Select the size of the document to be scanned.
 When you select Custom, a screen in which you can specify the document size appears. Select a Units, then enter the Width and Height and click OK.

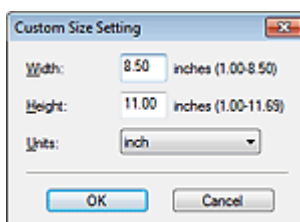

Important

- When you select Auto Detect, the image may not be scanned at the correct position and size. In that case, change the size to the actual document size (A4, Letter, etc.) and align a corner of the document with the corner at the arrow (alignment mark) of the Platen.

- **Resolution**

Select the resolution at which to scan documents.

➔ [Resolution](#)

- **Use the scanner driver**

Select this checkbox to display the ScanGear (scanner driver) screen and make advanced scan settings.

Color Mode, Document Size, Resolution and other settings in the Mail dialog box will be disabled.

Specify these settings in the ScanGear screen.

- **Specify...**

Opens the Scan Settings dialog box in which you can make advanced scan settings.

➔ [Scan Settings Dialog Box \(One-click Mode Screen\)](#)

Save Settings

- **File Size**

Select a size from Small (fits in a 640 by 480 window), Medium (fits in a 800 by 600 window), Large (fits in a 1024 by 768 window) and Original.

- **File name**

Enter the file name of the image to be saved (up to 64 characters). When saving multiple files, 4 digits are appended to each file name.

- **Save as type**

Select a file type to save the scanned images.

Select JPEG/Exif, PDF or PDF(Multiple Pages).



Important

- You cannot set passwords for PDF files.
- You cannot select JPEG/Exif when Color Mode is Black and White.

- **Set...**

When Save as type is JPEG/Exif

You can specify a compression type for JPEG files. Select High(Low Compression), Standard or Low(High Compression).

When Save as type is PDF or PDF(Multiple Pages)

Make advanced settings for creating PDF files. See "[PDF Settings Dialog Box](#)" for details.

- **Save in**

Displays the folder in which to save the scanned images. To change the folder, click Browse... to specify another one.

By default, the scanned images are saved in the following folders.

Windows 7: MP Navigator EX folder in My Pictures folder

Windows Vista: MP Navigator EX folder in Pictures folder

Windows XP: MP Navigator EX folder in My Pictures folder

- **Save to a Subfolder with Current Date**

Select this checkbox to create a subfolder in the folder specified in Save in with the current date and save scanned files in it. A subfolder with a name such as "2010_01_01" (Year_Month_Date) will be created.

If this checkbox is not selected, files are saved directly in the folder specified in Save in.

Attachment Settings

- **Mail Program**

Specify an e-mail software program.



Note

- Select Add... to open the Select Mail Program dialog box in which you can select an e-mail software program. If the e-mail software program you want to use is not listed, click Add to List and select it.

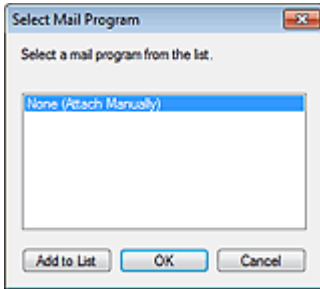

- **Start scanning by clicking the one-click button**

Select this checkbox to start scanning when you click an icon in One-click Mode.

Important

- Start scanning by clicking the one-click button is not displayed when the dialog box is opened directly from Solution Menu EX.

- **Apply**

Saves and applies the specified settings.

Click Cancel instead of Apply to cancel the specified settings.

- **Cancel**

Cancels the specified settings. The current screen closes.

- **Defaults**

Returns all settings in the screen to their defaults.

- **Scan**

Scans documents with the specified settings.

When scanning is completed, attachment files are created and saved. If using an MP Navigator EX compatible e-mail software program, it starts automatically and a new message screen appears with the image attached.

Advanced Guide

Advanced Guide > Scanning > Scanning with the Bundled Application Software > MP Navigator EX Screens > OCR Dialog Box

S724

MP Navigator EX

OCR Dialog Box

Click OCR on the Custom Scan with One-click tab or in the One-click Mode screen to open the OCR dialog box.

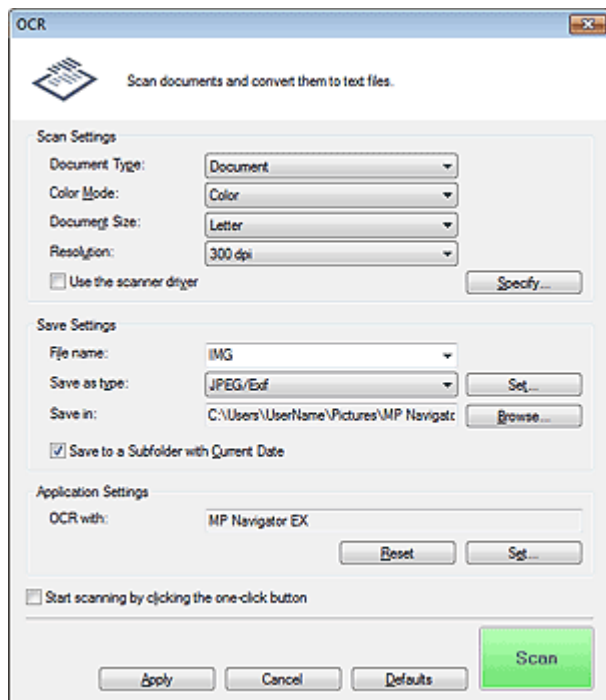

Scan Settings

- **Document Type**
Select the type of document to be scanned.
- **Color Mode**
Select how to scan the document.
- **Document Size**
Select the size of the document to be scanned.
When you select Custom, a screen in which you can specify the document size appears. Select a Units, then enter the Width and Height and click OK.

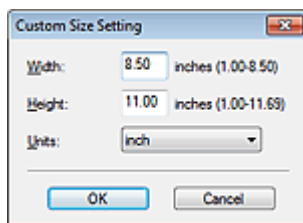

- **Resolution**
Select the resolution at which to scan documents.
➔ Resolution
- **Use the scanner driver**

Select this checkbox to display the ScanGear (scanner driver) screen and make advanced scan settings.
Color Mode, Document Size, Resolution and other settings in the OCR dialog box will be disabled.
Specify these settings in the ScanGear screen.

- **Specify...**

Opens the Scan Settings dialog box in which you can make advanced scan settings.

➔ [Scan Settings Dialog Box \(One-click Mode Screen\)](#)

Note

- When scanning slanted documents, select the Correct slanted document checkbox to improve the text recognition accuracy.
-

Save Settings

- **File name**

Enter the file name of the image to be saved (up to 64 characters). When saving multiple files, 4 digits are appended to each file name.

- **Save as type**

Select a file type to save the scanned images.

Select JPEG/Exif, TIFF or BMP.

Important

- You cannot select JPEG/Exif when Color Mode is Black and White.

- **Set...**

When Save as type is JPEG/Exif

You can specify a compression type for JPEG files. Select High(Low Compression), Standard or Low(High Compression).

- **Save in**

Displays the folder in which to save the scanned images. To change the folder, click Browse... to specify another one.

By default, the scanned images are saved in the following folders.

Windows 7: MP Navigator EX folder in My Pictures folder

Windows Vista: MP Navigator EX folder in Pictures folder

Windows XP: MP Navigator EX folder in My Pictures folder

- **Save to a Subfolder with Current Date**

Select this checkbox to create a subfolder in the folder specified in Save in with the current date and save scanned files in it. A subfolder with a name such as "2010_01_01" (Year_Month_Date) will be created.

If this checkbox is not selected, files are saved directly in the folder specified in Save in.

Application Settings

- **OCR with**

Specify an OCR application.

When MP Navigator EX is specified, after the image is scanned, the text in the image is extracted and appears in Notepad (included with Windows).

Note

- Only text written in languages that can be selected on the General tab can be extracted to Notepad (included with Windows). Click Set... on the General tab and specify the language according to the language of the document to be scanned.
When scanning multiple documents, you can collect the extracted text into one file.
➔ [General Tab](#)
- Text displayed in Notepad (included with Windows) is for guidance only. Text in the image of the following types of documents may not be detected correctly.

- Documents containing text with font size outside the range of 8 points to 40 points (at 300 dpi)
 - Slanted documents
 - Documents placed upside down or documents with text in the wrong orientation (rotated characters)
 - Documents containing special fonts, effects, italics, or hand-written text
 - Documents with narrow line spacing
 - Documents with colors in the background of text
 - Documents containing multiple languages
 - For further procedures, refer to the application's manual.
-

- **Reset**

Cancels the application setting.

- **Set...**

Allows you to select an application.

 **Important**

- Depending on the specified application, the text may not be extracted correctly or the application may not start.

- **Start scanning by clicking the one-click button**

Select this checkbox to start scanning when you click an icon in One-click Mode.

 **Important**

- Start scanning by clicking the one-click button is not displayed when the dialog box is opened directly from Solution Menu EX.

- **Apply**

Saves and applies the specified settings.
Click Cancel instead of Apply to cancel the specified settings.

- **Cancel**

Cancels the specified settings. The current screen closes.

- **Defaults**

Returns all settings in the screen to their defaults.

- **Scan**

Scans documents with the specified settings.

Advanced Guide

Advanced Guide > Scanning > Scanning with the Bundled Application Software > MP Navigator EX Screens > Custom Dialog Box

S726

MP Navigator EX

Custom Dialog Box

Click Custom on the Custom Scan with One-click tab or in the One-click Mode screen to open the Custom dialog box.

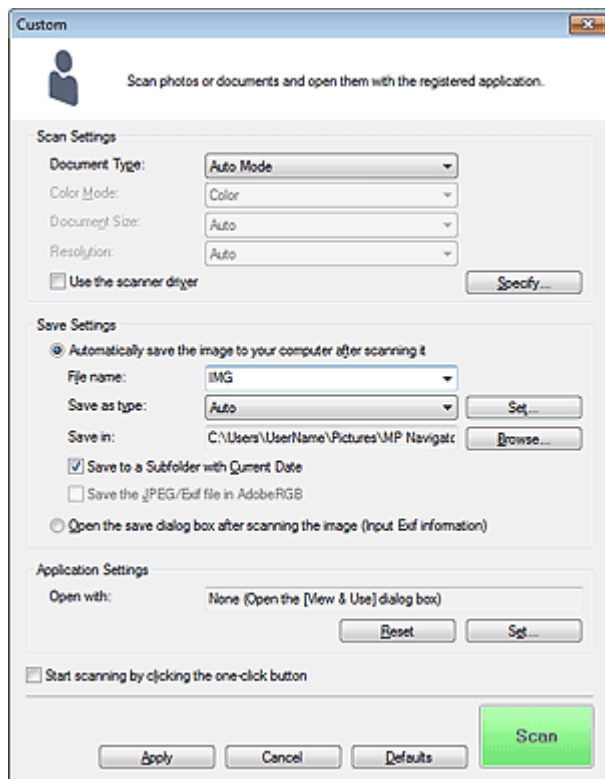

Scan Settings

- **Document Type**

Select the type of document to be scanned. When Auto Mode is selected, the document type is automatically detected. In that case, Color Mode, Document Size and Resolution are automatically set as well.

Important

- Document types supported by Auto Mode are photos, postcards, business cards, magazines, newspapers, text documents and BD/DVD/CD.
- The following types of documents cannot be scanned correctly with Auto Mode. In that case, specify the document type or size.
 - A4 size photos
 - Text documents smaller than 2L (5 inches x 7 inches) (127 mm x 178 mm), such as paperback pages with the spine cut off
 - Documents printed on thin white paper
 - Long narrow documents such as panoramic photos
- Reflective disc labels may not be scanned properly.
- Place documents correctly according to the type of document to be scanned. Otherwise, documents may not be scanned correctly. See "Placing Documents" for details on how to place documents.

Note

- To reduce moire, set Document Type to Magazine.

• Color Mode

Select how to scan the document.

• Document Size

Select the size of the document to be scanned.

When you select Custom, a screen in which you can specify the document size appears. Select a Units, then enter the Width and Height and click OK.

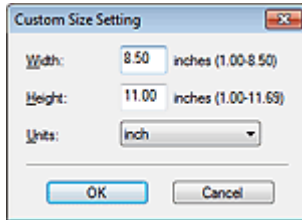

Important

- When you select Auto Detect, the image may not be scanned at the correct position and size. In that case, change the size to the actual document size (A4, Letter, etc.) and align a corner of the document with the corner at the arrow (alignment mark) of the Platen.

• Resolution

Select the resolution at which to scan documents.

➔ [Resolution](#)

• Use the scanner driver

Select this checkbox to display the ScanGear (scanner driver) screen and make advanced scan settings.

Color Mode, Document Size, Resolution and other settings in the Custom dialog box will be disabled. Specify these settings in the ScanGear screen.

• Specify...

Opens the Scan Settings dialog box in which you can make advanced scan settings.

➔ [Scan Settings Dialog Box \(One-click Mode Screen\)](#)

Save Settings

• Automatically save the image to your computer after scanning it

Select this to save the images to your computer as specified after scanning them.

The File name, Save as type and Save in settings will be displayed.

• File name

Enter the file name of the image to be saved (up to 64 characters). When saving multiple files, 4 digits are appended to each file name.

• Save as type

Select a file type to save the scanned images.

Select Auto, JPEG/Exif, TIFF or BMP. Auto is displayed when Document Type is Auto Mode.

Important

- When Document Type is Auto Mode and Save as type is Auto, the file format may differ depending on how you place the document.
See "[Placing Documents](#)" for details on how to place documents.
- You cannot select JPEG/Exif when Color Mode is Black and White.

Note

- When Auto is selected, files are saved in the following formats according to the document type.
Photos, postcards, BD/DVD/CD and business cards: JPEG

Magazines, newspapers and text documents: PDF

You can change the file format from Set....

Images saved as PDF files may not open depending on the application. In that case, select an option other than Auto in Save as type.

- You cannot set passwords for PDF files.
- If you select JPEG/Exif when Document Type is not Auto Mode , the Save the JPEG/Exif file in AdobeRGB checkbox will be selectable.

- **Set...**

When Save as type is Auto

You can specify the file format in which to save images. Select a file format for items detected as documents, and for items detected as photos.

When Save as type is JPEG/Exif

You can specify a compression type for JPEG files. Select High(Low Compression), Standard or Low(High Compression).

- **Save in**

Displays the folder in which to save the scanned images. To change the folder, click Browse... to specify another one.

By default, the scanned images are saved in the following folders.

Windows 7: MP Navigator EX folder in My Pictures folder

Windows Vista: MP Navigator EX folder in Pictures folder

Windows XP: MP Navigator EX folder in My Pictures folder

- **Save to a Subfolder with Current Date**

Select this checkbox to create a subfolder in the folder specified in Save in with the current date and save scanned files in it. A subfolder with a name such as "2010_01_01" (Year_Month_Date) will be created.

If this checkbox is not selected, files are saved directly in the folder specified in Save in.

- **Save the JPEG/Exif file in AdobeRGB**

Select this checkbox to save the images in colors that correspond to Adobe RGB.



Important

- This function is available only when Save as type is JPEG/Exif and Document Type is not Auto Mode.
- This function is not available if the Adobe RGB profile is not installed.



Note

- You cannot select this setting if the Use the scanner driver checkbox is selected.
- When you save an image with the Save the JPEG/Exif file in AdobeRGB checkbox selected, an underscore is added to the beginning of the file name. (Example: _Image0001.jpg)

- **Open the save dialog box after scanning the image (Input Exif information)**

Select this to open the Save dialog box after scanning the images and specify the save settings such as destination folder, file name and Exif information.

➡ [Save Dialog Box](#)

Application Settings

- **Open with**

Specify an application with which to open scanned images. Drag and drop the icon of an application that supports the file format displayed in Save as type. The specified application starts after images are scanned.



Important

- Depending on the specified application, the images may not appear correctly or the application may not start.

 **Note**

-
- For further procedures, refer to the application's manual.
-

- **Reset**

Cancels the application setting.

- **Set...**

Allows you to select an application to start.

- **Start scanning by clicking the one-click button**

Select this checkbox to start scanning when you click an icon in One-click Mode.

- **Apply**

Saves and applies the specified settings.

Click Cancel instead of Apply to cancel the specified settings.

- **Cancel**

Cancels the specified settings. The current screen closes.

- **Defaults**

Returns all settings in the screen to their defaults.

- **Scan**

Scans and saves documents with the specified settings.

When Save as type is Auto, a confirmation appears. Click Open Manual to open this guide (if it is installed).

Advanced Guide

Advanced Guide > Scanning > Scanning with the Bundled Application Software > MP Navigator EX Screens > Preferences Dialog Box

S705

MP Navigator EX

Preferences Dialog Box

Click Preferences to open the Preferences dialog box.

In the Preferences dialog box, you can specify general MP Navigator EX settings and how to respond when scanning using the Operation Panel, via the General and Scanner Button Settings tabs.

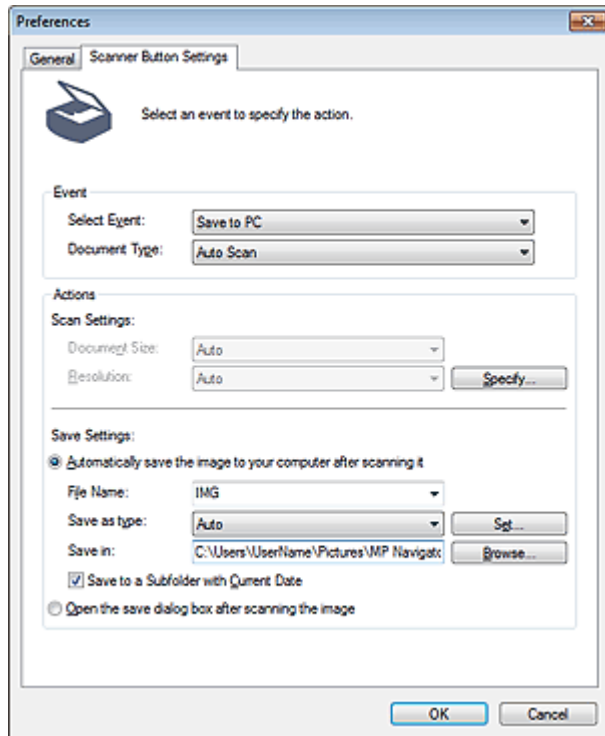

Note

- See the corresponding sections below for details on each tab.
 - ➔ General Tab
 - ➔ Scanner Button Settings Tab (Save to PC)

[Page top](#)

Advanced Guide

Advanced Guide > Scanning > Scanning with the Bundled Application Software > MP Navigator EX Screens > General Tab

S740

MP Navigator EX

General Tab

On the General tab, you can specify general MP Navigator EX settings.

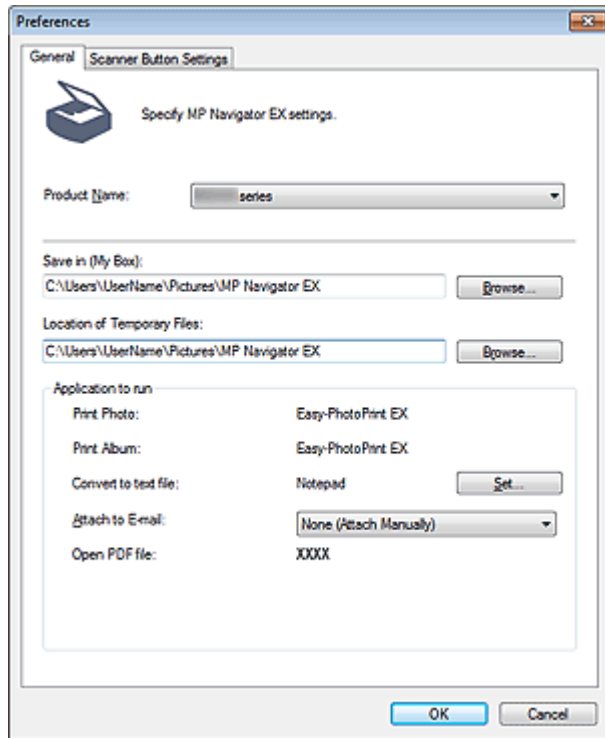

- **Product Name**

Displays the product name of the machine that MP Navigator EX is currently configured to use. If the displayed product is not the one you want to use, select the desired product from the list.

- **Save in (My Box)**

Displays the folder in which to save scanned documents. To change the folder, click Browse... to specify another one.

By default, the scanned images are saved in the following folders.

Windows 7: MP Navigator EX folder in My Pictures folder

Windows Vista: MP Navigator EX folder in Pictures folder

Windows XP: MP Navigator EX folder in My Pictures folder

- **Location of Temporary Files**

Displays the folder in which to save images temporarily. To change the folder, click Browse... to specify another one.

Important

- An error may occur if you set the destination to the root directory of the drive on which the operating system is installed. Be sure to specify a folder.
- An error may occur if you set the destination to a network folder. Be sure to specify a local folder.

- **Application to run**

Displays the applications that can be started via MP Navigator EX. Install the applications from the *Setup CD-ROM* that accompanies the machine.

For Attach to E-mail, you can select an e-mail software program to start.

For Open PDF file, the application associated with the .pdf file extension by the operating system is

displayed.

Important

- You can change which items are installed during installation from the *Setup CD-ROM* by selecting Custom Install. If you choose not to install some applications with Custom Install, the corresponding MP Navigator EX functions will be unavailable. To use those functions, install the corresponding applications.

Note

- For Convert to text file, Notepad (included with Windows) is displayed. Click Set... to open a dialog box, then specify Document Language and how to scan multiple documents.

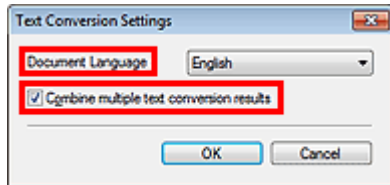

- Document Language
Specify the language according to the language of the document to be scanned. Only text written in languages that can be selected in the Document Language can be extracted to Notepad.
- Combine multiple text conversion results
When scanning multiple documents, select the checkbox to collect the conversion results (text) into one file.
When the checkbox is selected, you can scan up to 99 pages at one time.
Deselect the checkbox to display each conversion result (text) in a separate file.
When the checkbox is not selected, you can scan up to 10 pages at one time.

Advanced Guide

Advanced Guide > Scanning > Scanning with the Bundled Application Software > MP Navigator EX Screens > Scanner Button Settings Tab (Save to PC)

S707

MP Navigator EX

Scanner Button Settings Tab (Save to PC)

On the Scanner Button Settings tab, you can specify how to respond when scanning using the Operation Panel of the machine.

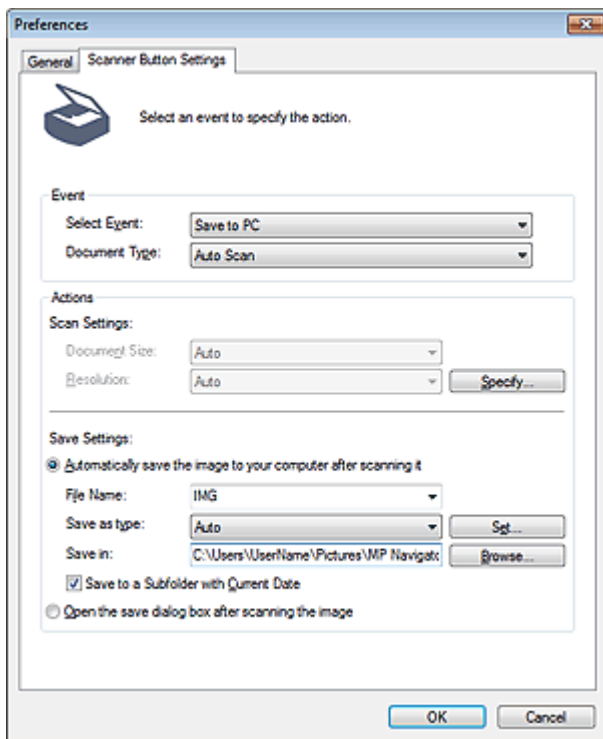

Event

- **Select Event**
Save to PC is set.
- **Document Type**
Auto Scan is set.

Actions

Scan Settings

- **Document Size**
This setting is automatically set.
- **Resolution**
This setting is automatically set.
- **Specify...**
Select whether or not to apply suitable corrections based on the document type.
➔ [Scan Settings Dialog Box \(Scanner Button Settings\)](#)

Save Settings

- **Automatically save the image to your computer after scanning it**

Select this to save the images to your computer as specified after scanning them. The File Name, Save as type and Save in settings will be displayed.

Important

- If you select this function, you will not be able to set passwords for PDF files.

- **File Name**

Enter the file name of the image to be saved (up to 64 characters).

- **Save as type**

Select a file type to save the scanned images. Select Auto, JPEG/Exif or TIFF.

Important

- When Save as type is Auto, the file format may differ depending on how you place the document. See "[Placing Documents](#)" for details on how to place documents.

Note

- When Auto is selected, files are saved in the following formats according to the document type. Photos, postcards, BD/DVD/CD and business cards: JPEG
Magazines, newspapers and text documents: PDF
You can change the file format from Set....

- **Set...**

When Save as type is Auto

Opens the Auto Save Settings dialog box in which you can specify the file format and other advanced save settings. Select a file format for items detected as documents, and for items detected as photos.



- **When JPEG/Exif is Selected**

Click Set... to specify a compression type for JPEG files. Select High(Low Compression), Standard or Low(High Compression).

- **When PDF is Selected**

Click Set... to make advanced settings for creating PDF files. See "[PDF Settings Dialog Box](#)" for details.

When Save as type is JPEG/Exif

You can specify a compression type for JPEG files. Select High(Low Compression), Standard or Low(High Compression).

- **Save in**

Displays the folder in which to save the scanned images. To change the folder, click Browse... to specify another one.

By default, the scanned images are saved in the following folders.

Windows 7: MP Navigator EX folder in My Pictures folder

Windows Vista: MP Navigator EX folder in Pictures folder

Windows XP: MP Navigator EX folder in My Pictures folder

- **Save to a Subfolder with Current Date**

Select this checkbox to create a subfolder in the folder specified in Save in with the current date and save scanned files in it. A subfolder with a name such as "2010_01_01" (Year_Month_Date) will be created.

If this checkbox is not selected, files are saved directly in the folder specified in Save in.

- **Open the save dialog box after scanning the image**

Select this to open the save dialog box after scanning the images and specify the save settings such as destination folder, file name and Exif information.

➔ [Save Dialog Box](#)



Note

- To set passwords for PDF files, select Open the save dialog box after scanning the image. After scanning, you can set the passwords in the Save as PDF file dialog box.

➔ [Setting Passwords for PDF Files](#)

[Page top](#)↑

Advanced Guide

Advanced Guide > Scanning > Scanning with the Bundled Application Software > MP Navigator EX Screens > Scan Settings Dialog Box (Scanner Button Settings)

S743

MP Navigator EX

Scan Settings Dialog Box (Scanner Button Settings)

The Scan Settings dialog box opens when you click Specify... on the Scanner Button Settings tab of the Preferences dialog box.

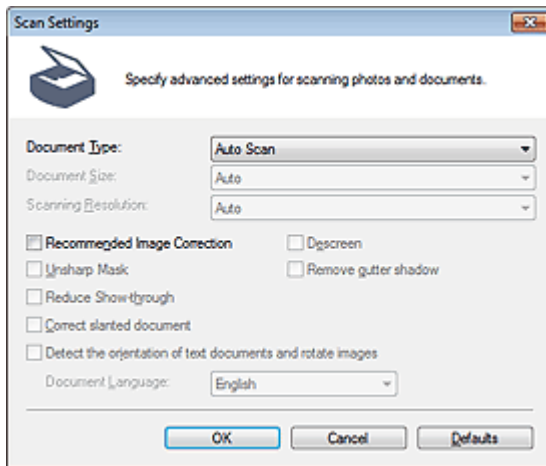

- **Document Type**

Auto Scan is set.

▶ Important

- Place documents correctly according to the type of document to be scanned. Otherwise, documents may not be scanned correctly.
See "[Placing Documents](#)" for details on how to place documents.

- **Recommended Image Correction**

Select this checkbox to apply suitable corrections automatically based on the document type.

▶ Important

- When this checkbox is selected, the files can be saved in JPEG/Exif or PDF format only.
- Scanning may take longer than usual when this checkbox is selected.
- The color tone may change from the source image due to corrections. In that case, deselect the checkbox and scan.

- **Defaults**

Restore the default settings.

[Page top](#) ↑

Advanced Guide

[Advanced Guide](#) > [Scanning](#) > [Scanning with the Bundled Application Software](#) > [Appendix: Opening Files Other than Scanned Images](#)

S011

MP Navigator EX

Appendix: Opening Files Other than Scanned Images

You can save or print data other than scanned images using MP Navigator EX.

- **Using images saved on a computer**
 - ➔ [Opening Images Saved on a Computer](#)

[Page top](#)↑

Advanced Guide

Advanced Guide > Scanning > Scanning with the Bundled Application Software > Appendix: Opening Files Other than Scanned Images > Opening Images Saved on a Computer

S507

MP Navigator EX

Opening Images Saved on a Computer

You can open images saved on a computer and print them or attach them to e-mail using MP Navigator EX. You can also edit them using an application that accompanies the machine.

1. Start MP Navigator EX and open the Navigation Mode screen.

➔ Starting MP Navigator EX

2. In the Navigation Mode screen, select View & Use and click My Box (Scanned/Imported Images), Specify Folder or Recently Saved Images.

Click My Box (Scanned/Imported Images) to open images saved in My Box (Scanned/Imported Images), click Specify Folder to open images saved in a specific folder, or click Recently Saved Images to open recently saved images.

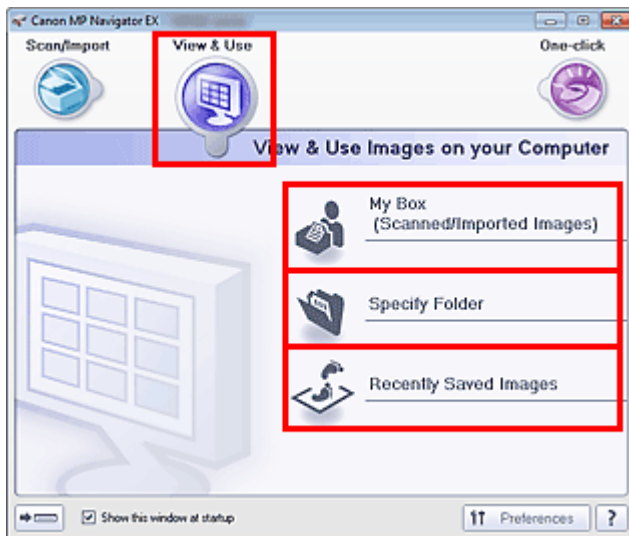

Note

- If the Show this window at startup checkbox is not selected, the last used screen appears. If the Scan/Import window is displayed, click  (View & Use) on the upper left of the screen. The View & Use window opens.
- See "[View & Use Images on your Computer Tab](#)" for details on the View & Use Images on your Computer tab.

3. Click the folder containing the images you want to open.

Images saved in the folder appear in the Thumbnail window.

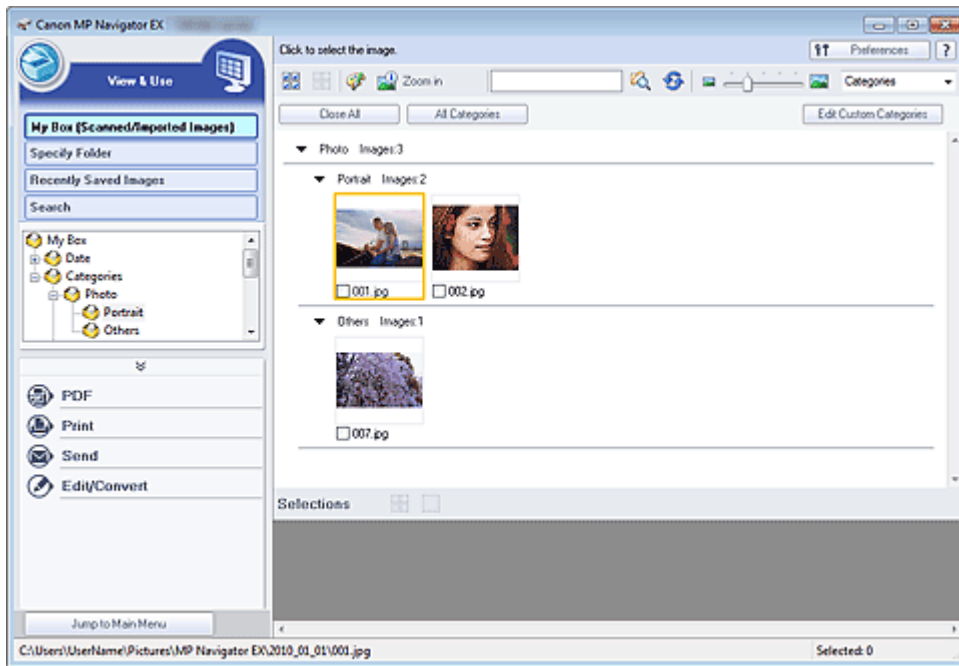

4. Select the images you want to use, then select what you want to do with them.

See the corresponding sections below for details on using images.

➔ [Creating/Editing PDF Files](#)

➔ [Printing Documents](#)

➔ [Printing Photos](#)

➔ [Sending via E-mail](#)

➔ [Editing Files](#)

[Page top](#) ↕

Advanced Guide

[Advanced Guide](#) > [Scanning](#) > [Scanning with Other Application Software](#)

Scanning with Other Application Software

- ➔ [What Is ScanGear \(Scanner Driver\)?](#)
- ➔ [Scanning with Advanced Settings Using ScanGear \(Scanner Driver\)](#)
- ➔ [Correcting Images and Adjusting Colors with ScanGear \(Scanner Driver\)](#)
- ➔ [ScanGear \(Scanner Driver\) Screens](#)
- ➔ [Appendix: Useful Information on Scanning](#)

[Page top](#) ↕

Advanced Guide

Advanced Guide > Scanning > Scanning with Other Application Software > What Is ScanGear (Scanner Driver)?

S201

ScanGear

What Is ScanGear (Scanner Driver)?

ScanGear (scanner driver) is software required for scanning documents. It enables you to specify the output size and make image corrections when scanning.

ScanGear can be started from MP Navigator EX or from other applications that are compatible with a standard interface called TWAIN. (ScanGear is a TWAIN-compatible driver.)

What You Can Do with This Software

This software enables you to preview scan results or set document type and output size, etc. when scanning documents. It is useful when you want to scan in a specific color tone, as it allows you to make various corrections and adjust brightness, contrast, etc.

Screens

There are three modes: Basic Mode, Advanced Mode and Auto Scan Mode.

Switch modes by clicking a tab on the upper right of the screen.

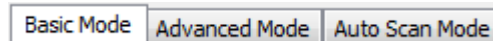

Note

- ScanGear starts in the last used mode.
- Settings are not retained when you switch modes.

Basic Mode

Use the Basic Mode tab to scan easily by following three simple on-screen steps (1 , 2 and 3).

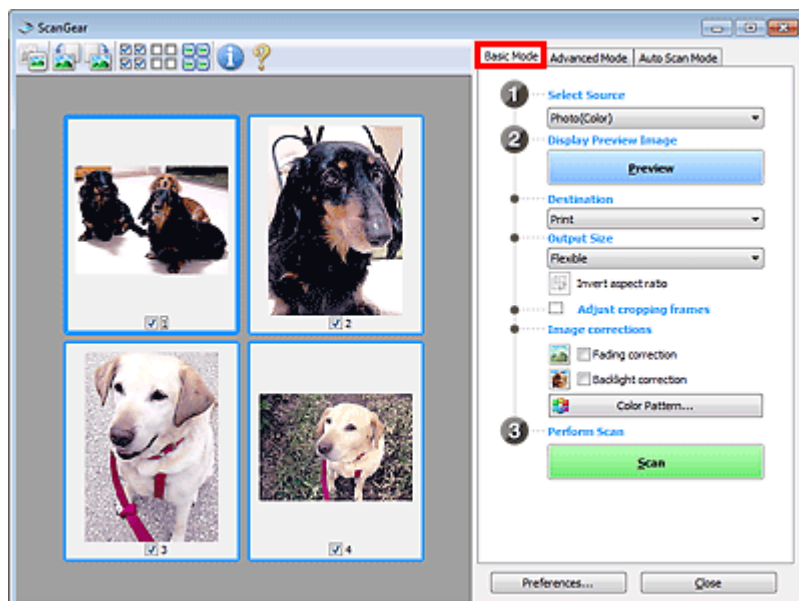

Advanced Mode

Use the Advanced Mode tab to specify color mode, output resolution, image brightness, color tone, etc. when scanning.

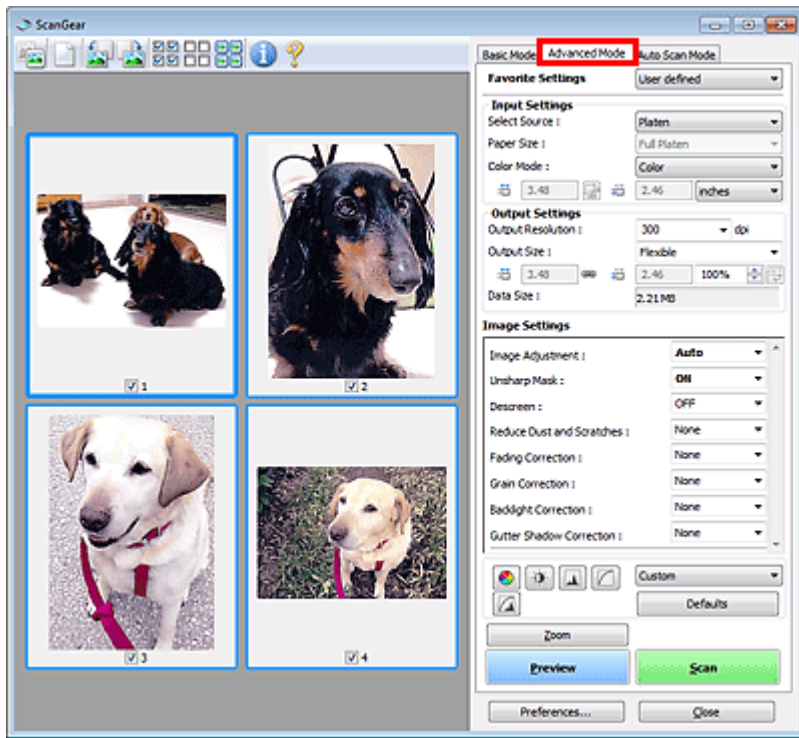

Auto Scan Mode

Use the Auto Scan Mode tab to scan easily by simply placing the document on the Platen and clicking Scan.

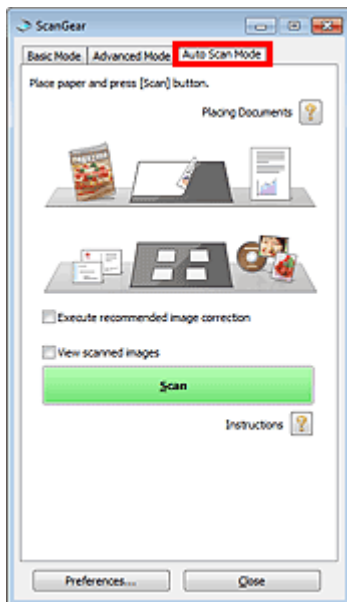

Advanced Guide

[Advanced Guide](#) > [Scanning](#) > [Scanning with Other Application Software](#) > [Scanning with Advanced Settings Using ScanGear \(Scanner Driver\)](#)

S200

ScanGear

Scanning with Advanced Settings Using ScanGear (Scanner Driver)

- **Starting ScanGear (scanner driver)**
 - ➔ [Starting ScanGear \(Scanner Driver\)](#)
- **Scanning documents after making simple image corrections**
 - ➔ [Scanning in Basic Mode](#)
- **Scanning documents after making advanced image corrections and brightness/color adjustments**
 - ➔ [Scanning in Advanced Mode](#)
- **Scanning with a simple operation**
 - ➔ [Scanning in Auto Scan Mode](#)
- **Scanning multiple documents at one time after making image corrections and color adjustments**
 - ➔ [Scanning Multiple Documents at One Time with ScanGear \(Scanner Driver\)](#)

[Page top](#)↑

Advanced Guide

Advanced Guide > Scanning > Scanning with Other Application Software > Scanning with Advanced Settings Using ScanGear (Scanner Driver) > Starting ScanGear (Scanner Driver)

S202

ScanGear

Starting ScanGear (Scanner Driver)

Use ScanGear (scanner driver) to make image corrections and color adjustments when scanning. ScanGear can be started from MP Navigator EX or an application.

Starting from MP Navigator EX

Navigation Mode Screen

Follow these steps to start ScanGear from the Navigation Mode screen of MP Navigator EX.

1. Start MP Navigator EX and open the Navigation Mode screen.
➡ Starting MP Navigator EX
2. In Scan/Import, click Photos/Documents (Platen).
The Scan/Import window opens.
3. Select the Use the scanner driver checkbox, then click Open Scanner Driver.

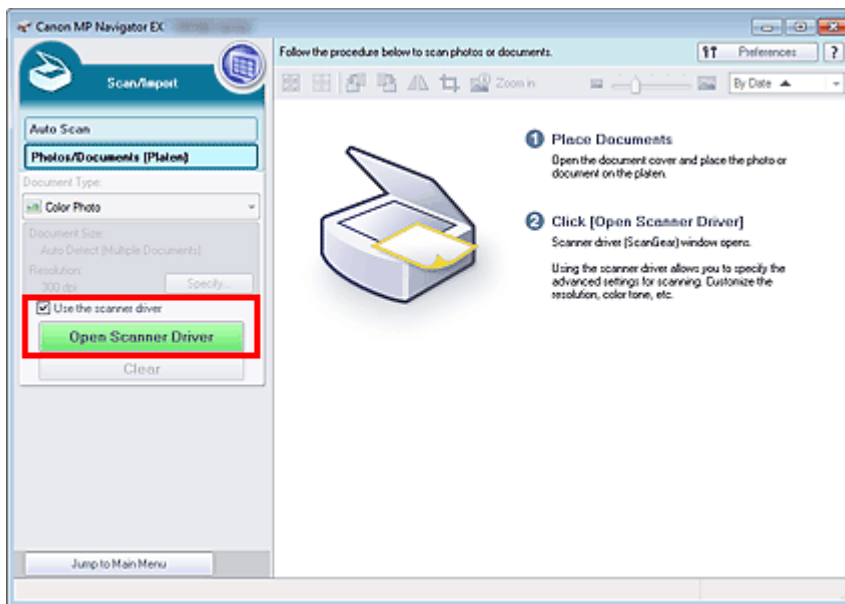

The ScanGear screen appears.

One-click Mode Screen

Follow these steps to start ScanGear from the One-click Mode screen of MP Navigator EX.

1. Start MP Navigator EX and open the One-click Mode screen.
➡ Starting MP Navigator EX
2. Click the corresponding icon.
The corresponding dialog box opens.

3. Select the Use the scanner driver checkbox in Scan Settings, then click Scan.

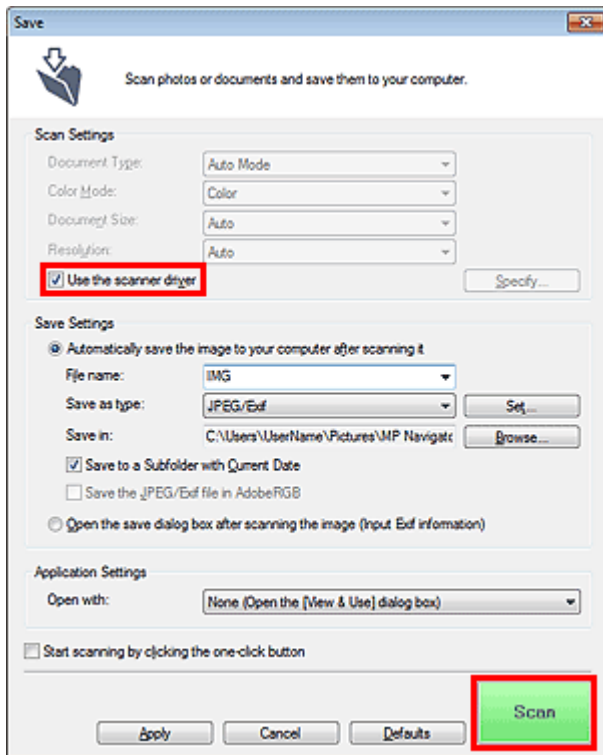

The ScanGear screen appears.

Important

- Use the scanner driver is not displayed in the Auto Scan dialog box or PDF dialog box.

Starting from an Application

Follow these steps (example) to start ScanGear from an application.

The procedure varies depending on the application. For details, refer to the application's manual.

1. Start the application.
2. On the File menu of the application, select Select Source and select the machine.
3. Select the command to scan a document (Scan/Import, Acquire image, etc.).

The ScanGear screen appears.

Advanced Guide

Advanced Guide > Scanning > Scanning with Other Application Software > Scanning with Advanced Settings Using ScanGear (Scanner Driver) > Scanning in Basic Mode

S203



Scanning in Basic Mode

Use the Basic Mode tab to scan easily by following the on-screen steps.

This section explains how to scan a single document.

See "[Scanning Multiple Documents at One Time with ScanGear \(Scanner Driver\)](#) " to scan multiple documents at one time.

Important

- The following types of documents may not be cropped correctly. In that case, click  (Thumbnail) on the Toolbar to switch to whole image view and scan.
 - Photos that have a whitish border
 - Documents printed on white paper, hand-written text, business cards, etc.
 - Thin documents
 - Thick documents
- The following types of documents cannot be cropped correctly.
 - Documents smaller than 1.18 inches (3 cm) square
 - Photos that have been cut to various shapes

1. Place the document on the Platen, then start ScanGear (scanner driver).

➔ [Placing Documents](#)

➔ [Starting ScanGear \(Scanner Driver\)](#)

2. Set Select Source according to the document placed on the Platen.

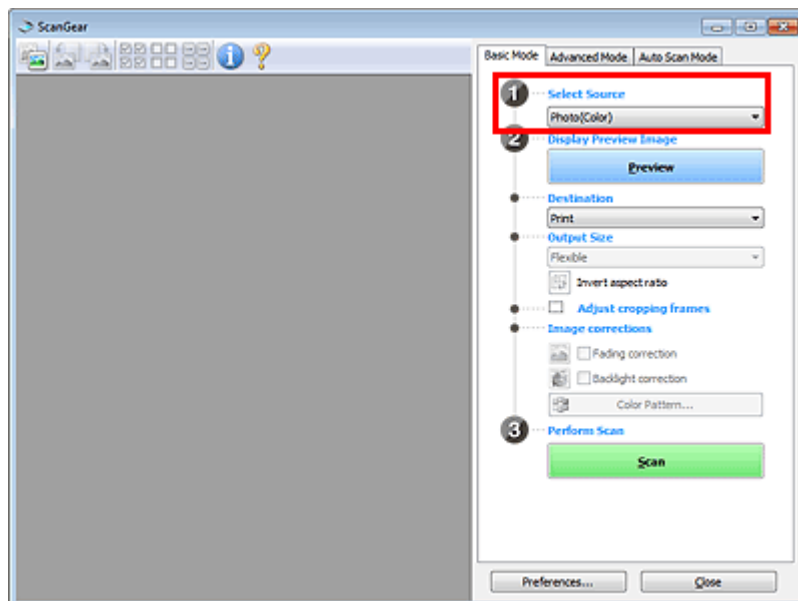

Note

- To scan magazines containing many color photos, select Magazine(Color).

3. Click Preview.

Preview image appears in the Preview area.

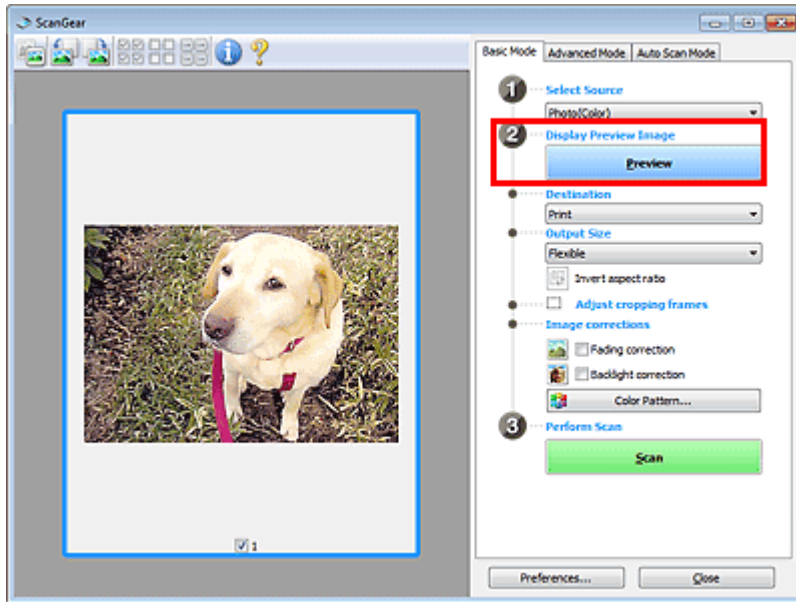

Note

- Colors are adjusted based on the document type selected in Select Source.

4. Set Destination.

5. Set Output Size.

Output size options vary by the item selected in Destination.

6. Adjust the scan area (cropping frame) as required.

Adjust the size and position of the cropping frame (scan area) on the preview image.

➔ [Adjusting Cropping Frames](#)

7. Set Image corrections as required.

8. Click Scan.

Starts scanning.

Note

- Click  (Information) to open a dialog box in which you can check the current scan settings (document type, etc.).
 - ScanGear's response after scanning can be specified in Status of ScanGear dialog after scanning on the Scan tab of the Preferences dialog box.
- ➔ [Scan Tab](#)

Related Topic

► [Basic Mode Tab](#)

Advanced Guide

Advanced Guide > Scanning > Scanning with Other Application Software > Scanning with Advanced Settings Using ScanGear (Scanner Driver) > Scanning in Advanced Mode

S205



Scanning in Advanced Mode

Use the Advanced Mode tab to specify the color mode, output resolution, image brightness, color tone, etc. when scanning.

This section explains how to scan a single document.

See "[Scanning Multiple Documents at One Time with ScanGear \(Scanner Driver\)](#)" to scan multiple documents at one time.

Important

- The following types of documents may not be cropped correctly. In that case, click  (Thumbnail) on the Toolbar to switch to whole image view and scan.
 - Photos that have a whitish border
 - Documents printed on white paper, hand-written text, business cards, etc.
 - Thin documents
 - Thick documents
- The following types of documents cannot be cropped correctly.
 - Documents smaller than 1.18 inches (3 cm) square
 - Photos that have been cut to various shapes

1. Place the document on the Platen, then start ScanGear (scanner driver).

- ➔ [Placing Documents](#)
- ➔ [Starting ScanGear \(Scanner Driver\)](#)

2. Click the Advanced Mode tab.

The Advanced Mode tab appears.

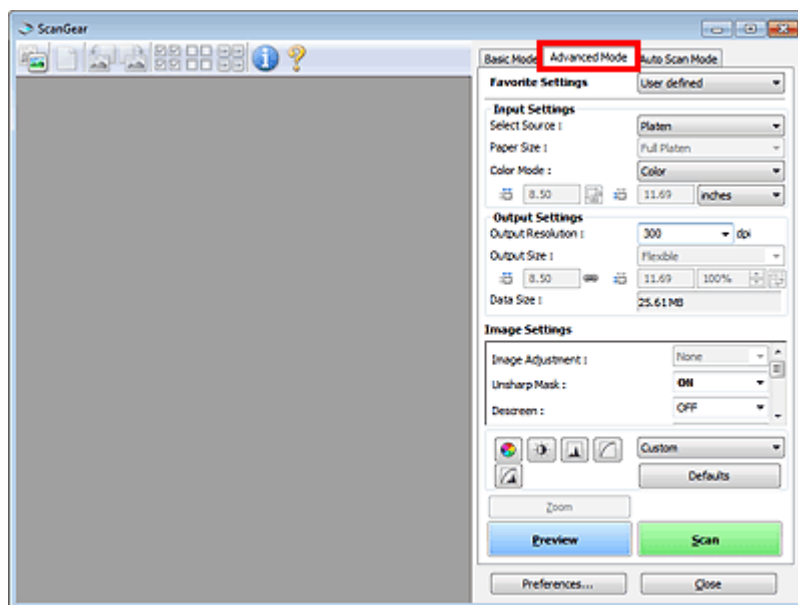

Note

- Settings are not retained when you switch modes.

3. Set Input Settings.

➔ [Input Settings](#)

4. Click Preview.

Preview image appears in the Preview area.

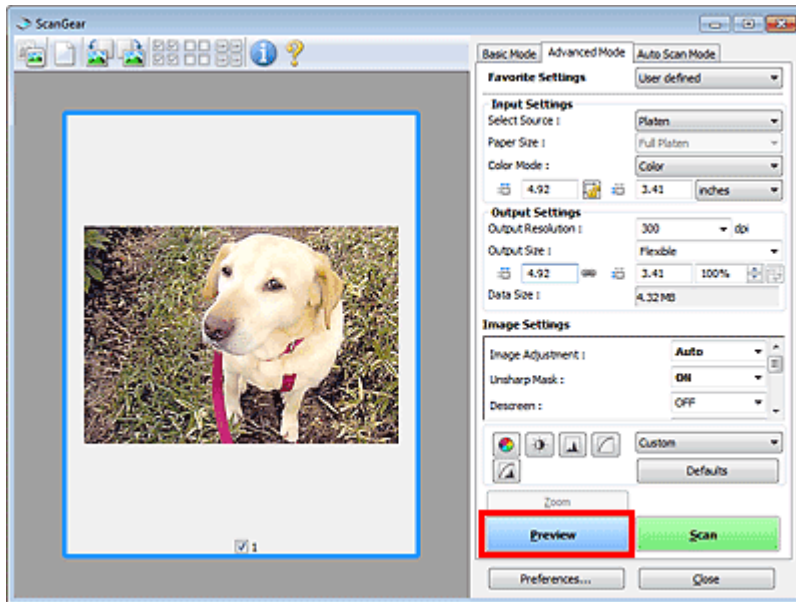
**Note**

- If you scan without preview, the show-through reduction function will be active. This function is useful when scanning magazines. However, when scanning photos, the color tone of the scanned image may differ from the source due to the show-through reduction function. In that case, use preview first.

5. Set Output Settings.

➔ [Output Settings](#)

6. Adjust the cropping frame (scan area), correct image and adjust colors as required.

- ➔ [Adjusting Cropping Frames](#)
- ➔ [Image Settings](#)
- ➔ [Color Adjustment Buttons](#)

7. Click Scan.

Starts scanning.

Note

- Click  (Information) to open a dialog box in which you can check the current scan settings (document type, etc.).
 - ScanGear's response after scanning can be specified in Status of ScanGear dialog after scanning on the Scan tab of the Preferences dialog box.
- ➔ [Scan Tab](#)

Related Topic

▶ [Advanced Mode Tab](#)

Advanced Guide

Advanced Guide > Scanning > Scanning with Other Application Software > Scanning with Advanced Settings Using ScanGear (Scanner Driver) > Scanning in Auto Scan Mode

S207



Scanning in Auto Scan Mode

Use the Auto Scan Mode tab to scan easily by automatically detecting the type of document placed on the Platen.

Important

- Supported document types are photos, postcards, business cards, magazines, newspapers, text documents and BD/DVD/CD. To scan other documents, specify the document type on the Basic Mode tab or the Advanced Mode tab.
 - ➔ [Scanning in Basic Mode](#)
 - ➔ [Scanning in Advanced Mode](#)

1. Place the document on the Platen, then start ScanGear (scanner driver).

- ➔ [Placing Documents](#)
- ➔ [Starting ScanGear \(Scanner Driver\)](#)

2. Click the Auto Scan Mode tab.

The Auto Scan Mode tab appears.

Note

- Select the Execute recommended image correction checkbox to apply suitable corrections automatically according to the type of document to be scanned.

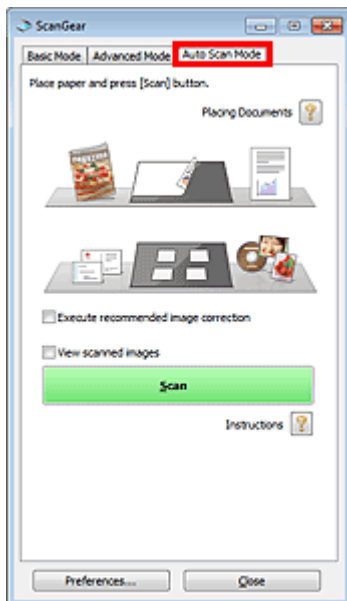

3. Click Scan.

Starts scanning.

Note

- ScanGear's response after scanning can be specified in Status of ScanGear dialog after scanning on the Scan tab of the Preferences dialog box.
 - ➔ [Scan Tab](#)

Related Topic

▶ [Auto Scan Mode Tab](#)

[Page top](#)↑

Advanced Guide

Advanced Guide > Scanning > Scanning with Other Application Software > Scanning with Advanced Settings Using ScanGear (Scanner Driver) > Scanning Multiple Documents at One Time with ScanGear (Scanner Driver)

S208

ScanGear

Scanning Multiple Documents at One Time with ScanGear (Scanner Driver)

You can scan two or more photos (small documents) on the Platen at one time on the Basic Mode tab and Advanced Mode tab of ScanGear (scanner driver).

This section explains how to scan multiple documents from the Basic Mode tab.

Important

- To scan multiple documents as a single image, scan in whole image view.
- The following types of documents may not be cropped correctly. In that case, adjust the cropping frames (scan areas) in whole image view and scan.
 - Photos that have a whitish border
 - Documents printed on white paper, hand-written text, business cards, etc.
 - Thin documents
 - Thick documents
- ➔ [Scanning Multiple Documents in Whole Image View](#)
- The following types of documents cannot be cropped correctly.
 - Documents smaller than 1.18 inches (3 cm) square
 - Photos that have been cut to various shapes

Note

- See "[Scanning in Auto Scan Mode](#)" to scan easily by automatically detecting the document type.
- You can also scan multiple documents at one time from the Advanced Mode tab. Use the Advanced Mode tab to make advanced scan settings such as the color mode, output resolution, image brightness and color tone.
- See the corresponding sections below for details on the Basic Mode tab and Advanced Mode tab.
 - ➔ [Basic Mode Tab](#)
 - ➔ [Advanced Mode Tab](#)

1. Place the document on the Platen, then start ScanGear.

- ➔ [Placing Documents](#)
- ➔ [Starting ScanGear \(Scanner Driver\)](#)

2. Set Select Source according to the document placed on the Platen.

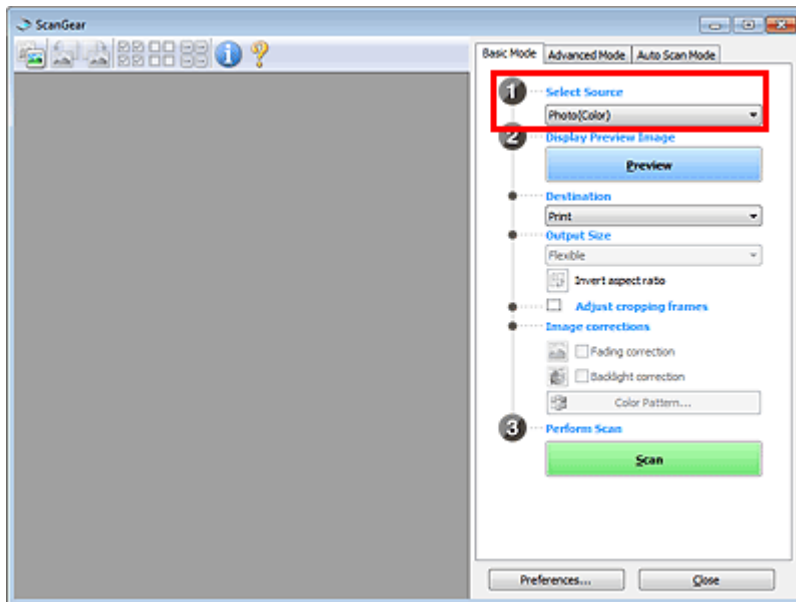

3. Click Preview.

Thumbnails of the preview images appear in the Preview area. Images are cropped (scan areas are specified) automatically according to the document size.

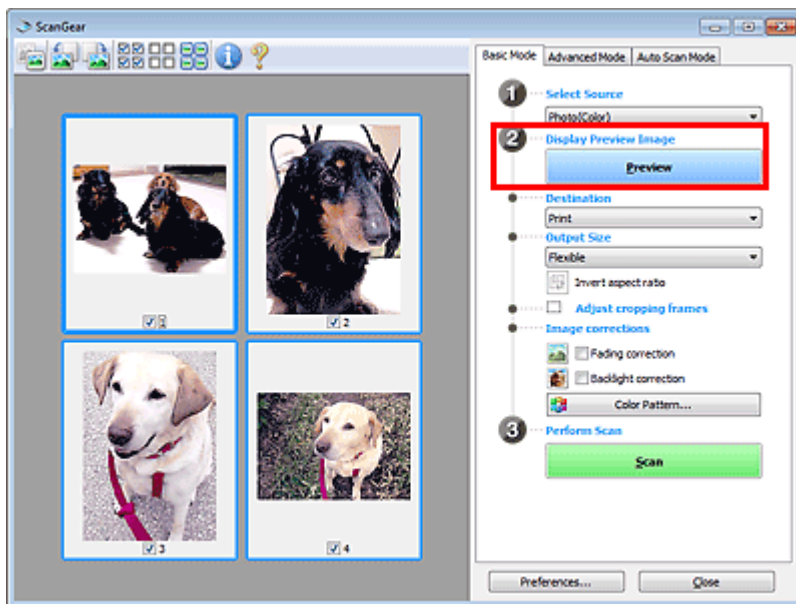

4. Set Destination.

5. Set Output Size.

6. Adjust the scan areas (cropping frames) and set Image corrections as required.

Note

- You can correct each image separately. Select the frame you want to correct.
- In thumbnail view, you can only create one cropping frame (scan area) per image. To create multiple cropping frames in an image, scan in whole image view.
 - ➔ [Scanning Multiple Documents in Whole Image View](#)

7. Select the images you want to scan.

Select the checkboxes of the images you want to scan.

- Click Scan.

Scanning Multiple Documents in Whole Image View

Follow these steps if thumbnails are not displayed correctly when previewed or if you want to scan multiple documents as a single image.

Note

- Positions of slanted documents are not corrected in whole image view.

- After previewing images, click  (Thumbnail) on the Toolbar. Switch to whole image view.

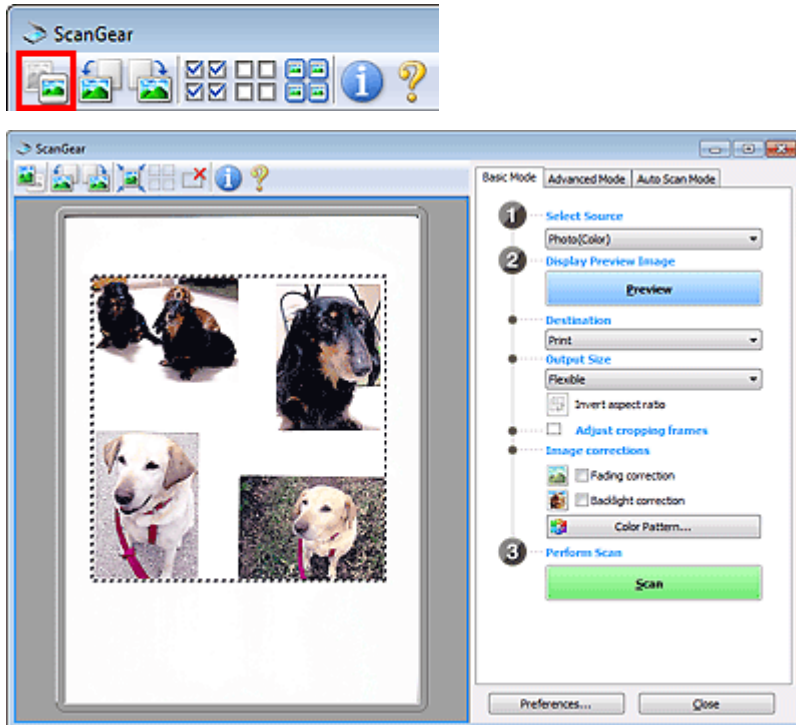

Note

- When the whole image is displayed, the icon changes to  (Whole Image).

- Adjust the scan areas (cropping frames).

Adjust the size and position of the cropping frame (scan area) on the preview image. You can also create two or more cropping frames.

If an area is not specified, the document will be scanned at the document size (Auto Crop). If an area is specified, only the portion in the specified area will be scanned.

➔ Adjusting Cropping Frames

- Set Destination.
- Set Output Size.
- Set Image corrections as required.
- Click Scan.

Areas framed by broken lines are scanned.

 **Note**

- ScanGear's response after scanning can be specified in Status of ScanGear dialog after scanning on the Scan tab of the Preferences dialog box.

[➔ Scan Tab](#)

[Page top](#) 

Advanced Guide

[Advanced Guide](#) > [Scanning](#) > [Scanning with Other Application Software](#) > [Correcting Images and Adjusting Colors with ScanGear \(Scanner Driver\)](#)

S300

ScanGear

Correcting Images and Adjusting Colors with ScanGear (Scanner Driver)

The following sections provide you with tips and know-how on advanced scanning techniques involving color/brightness adjustment, etc.

- **Sharpening out-of-focus photos, reducing dust and scratches, and correcting faded colors**
 - ➔ [Correcting Images \(Unsharp Mask, Reduce Dust and Scratches, Fading Correction, etc.\)](#)
- **Previewing and changing the color tone of the entire image to scan**
 - ➔ [Adjusting Colors Using a Color Pattern](#)
- **Brightening colors that have faded with time or due to colorcast**
 - ➔ [Adjusting Saturation and Color Balance](#)
- **Adjusting images that are too dark or bright, or too flat due to lack of contrast**
 - ➔ [Adjusting Brightness and Contrast](#)
- **Adjusting the color tone using histogram (a graph showing brightness distribution)**
 - ➔ [Adjusting Histogram](#)
- **Adjusting the image brightness using tone curve (a graph of brightness balance)**
 - ➔ [Adjusting Tone Curve](#)
- **Sharpening characters in text documents or reducing show-through effects**
 - ➔ [Setting Threshold](#)

[Page top](#) ↕

Advanced Guide

Advanced Guide > Scanning > Scanning with Other Application Software > Correcting Images and Adjusting Colors with ScanGear (Scanner Driver) > Correcting Images (Unsharp Mask, Reduce Dust and Scratches, Fading Correction, etc.)

S308

ScanGear

Correcting Images (Unsharp Mask, Reduce Dust and Scratches, Fading Correction, etc.)

The Image Settings functions on the Advanced Mode tab of ScanGear (scanner driver) allow you to enhance the outline of the subjects, reduce dust/scratches and correct faded colors when scanning images.

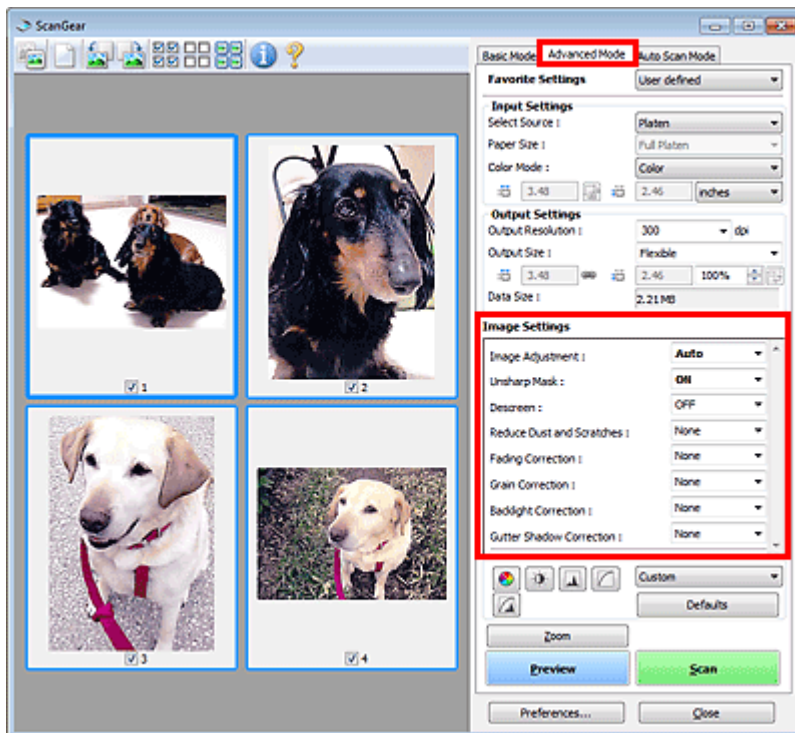

Setting Items

Click  (Arrow) of a function and select an item from the pull-down menu.

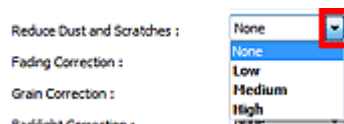

Important

- Do not apply these functions to images without moire, dust/scratches or faded colors. The color tone may be adversely affected.
- See "Image Settings" for details and precautions on each function.

Note

- See "Scanning in Advanced Mode" to start the Advanced Mode tab of ScanGear and scan.

Adjusting the image brightness and color tone

Set Image Adjustment to Auto, Photo, Magazine, Newspaper or Document according to the document type.



Sharpening slightly out-of-focus images

Set Unsharp Mask to ON.

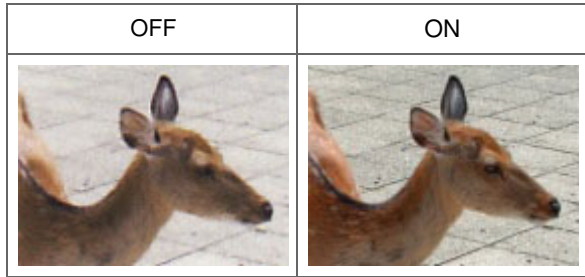

Reducing gradations and stripe patterns

Set Descreen to ON.

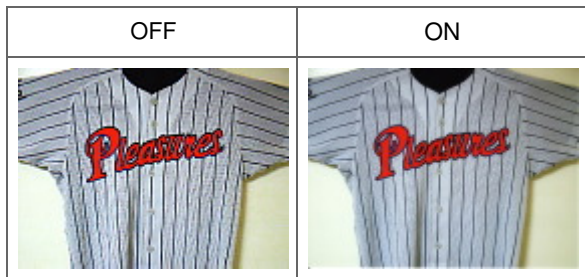

Note

- Printed photos and pictures are displayed as a collection of fine dots. "Moire" is a phenomenon where uneven gradation or a stripe pattern appears when such photos or pictures printed with fine dots are scanned. Descreen is the function for reducing this moire effect.

Reducing dust and scratches

Set Reduce Dust and Scratches to Low, Medium or High according to the degree of dust and scratches.

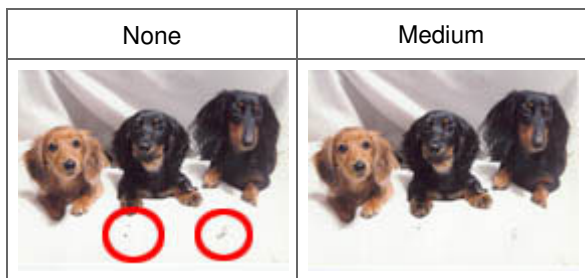

Correcting photos that have faded with time or due to colorcast

Set Fading Correction to Low, Medium or High according to the degree of fading or colorcast.

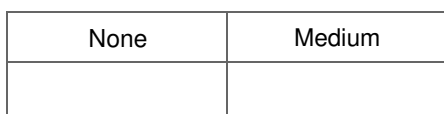



Reducing graininess

Set Grain Correction to Low, Medium or High according to the degree of graininess.

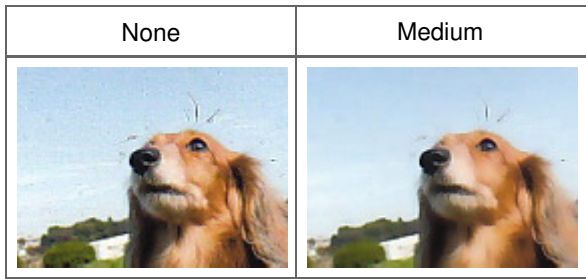

Correcting backlit images

Set Backlight Correction to Low, Medium or High according to the degree of backlight.



Correcting shadows that appear between pages when scanning open booklets

Set Gutter Shadow Correction to Low, Medium or High according to the degree of shadows.

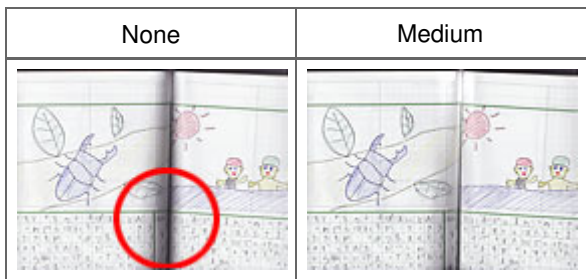

Advanced Guide

Advanced Guide > Scanning > Scanning with Other Application Software > Correcting Images and Adjusting Colors with ScanGear (Scanner Driver) > Adjusting Colors Using a Color Pattern

S301

ScanGear

Adjusting Colors Using a Color Pattern

You can preview color changes and reproduce natural colors by using the color pattern function in ScanGear (scanner driver)'s Basic Mode tab.

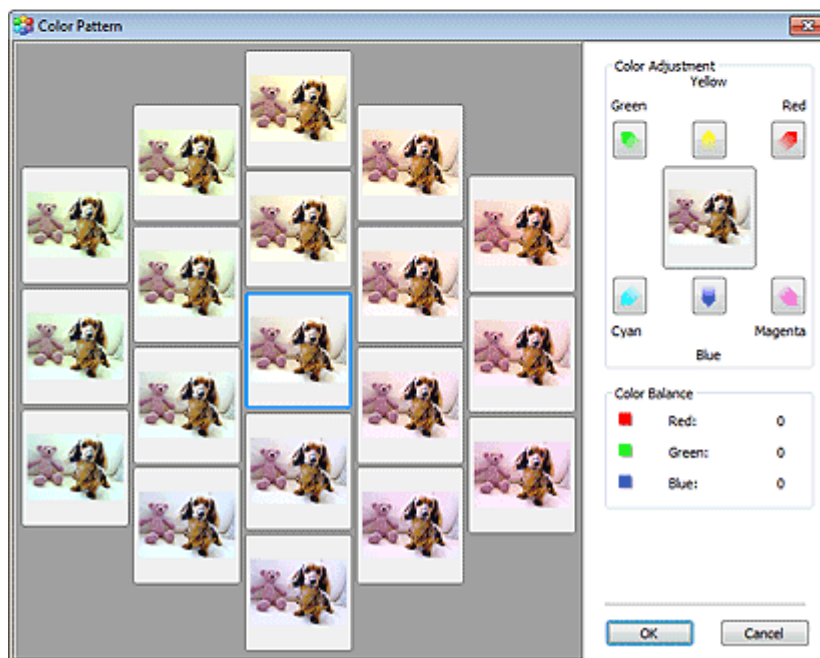
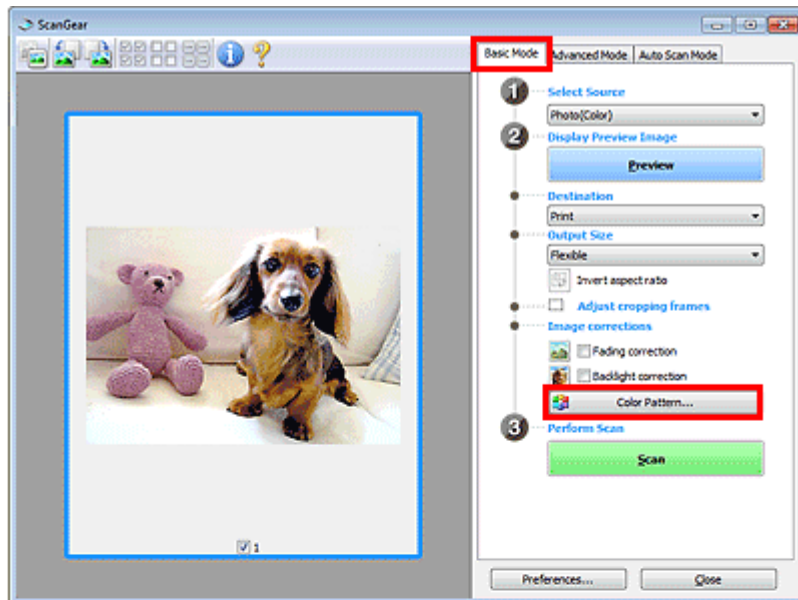

Color Adjustment

Correct colors that have faded with time or due to colorcast. "Colorcast" is a phenomenon where a specific color affects the entire picture due to the weather or ambient strong colors.

Click an arrow in Color Adjustment to emphasize the corresponding color.

Cyan & red, magenta & green and yellow & blue are complementary color pairs (each pair produces a shade of gray when mixed). You can reproduce the natural colors of the scene by reducing the cast color and increasing the complementary color.

It is recommended that you find a portion in the image where it should be white, and adjust the colors so that the portion turns white.

Preview image appears in the center. Preview image colors change as you adjust them.

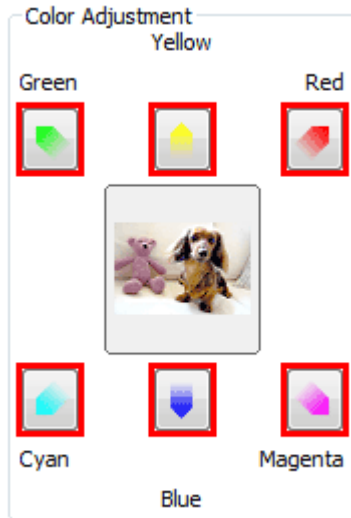

Below is an example of correcting a bluish image.

Since Blue and Green are too strong, click the Yellow and Magenta arrows to correct.



Note

- Color adjustments are applied only to the scan area (cropping frame) or the frame selected in thumbnail view.
You can select multiple frames or cropping frames by clicking them while pressing the Ctrl key.
- You can also select a color tone from the color pattern displayed on the left of the Color Pattern screen.
- You can also use this function to add a specific tint to an image. Increase the magenta to add a warm tint, and increase the blue to add a cool tint.

Advanced Guide

Advanced Guide > Scanning > Scanning with Other Application Software > Correcting Images and Adjusting Colors with ScanGear (Scanner Driver) > Adjusting Saturation and Color Balance

S303



Adjusting Saturation and Color Balance

In ScanGear (scanner driver)'s Advanced Mode tab, click  (Saturation/Color Balance).

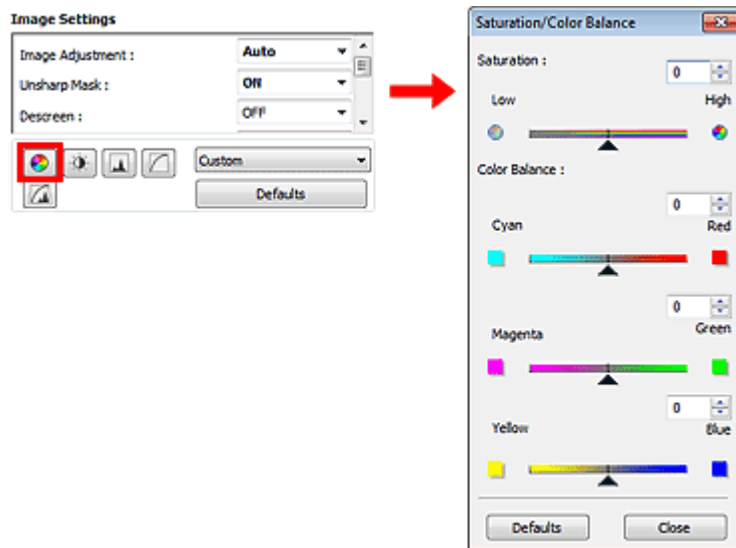

Note

- Click Defaults to reset all adjustments in the current window.

Saturation

Adjust the image's saturation (vividness). You can brighten colors that have faded with time, etc.

Move  (Slider) under Saturation to the left to decrease the saturation (darken the image), and to the right to increase the saturation (brighten the image). You can also enter a value (-127 to 127).

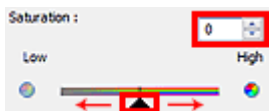

Note

- The natural color tone of the original image may be lost if you increase saturation too much.

Color Balance

Adjust images that have a colorcast. "Colorcast" is a phenomenon where a specific color affects the

entire picture due to the weather or ambient strong colors.

Move ▲ (Slider) under Color Balance to the left or right to emphasize the corresponding color.

Cyan & Red

Magenta & Green

Yellow & Blue

These are complementary color pairs (each pair produces a shade of gray when mixed). You can reproduce the natural colors of the scene by reducing the cast color and increasing the complementary color.

It is usually difficult to correct the image completely by adjusting only one color pair. It is recommended that you find a portion in the image where it should be white, and adjust all three color pairs so that the portion turns white.

You can also enter a value (-127 to 127).

Below is an example of an image in which the "Cyan & Red" pair has been adjusted.



Advanced Guide

Advanced Guide > Scanning > Scanning with Other Application Software > Correcting Images and Adjusting Colors with ScanGear (Scanner Driver) > Adjusting Brightness and Contrast

S304



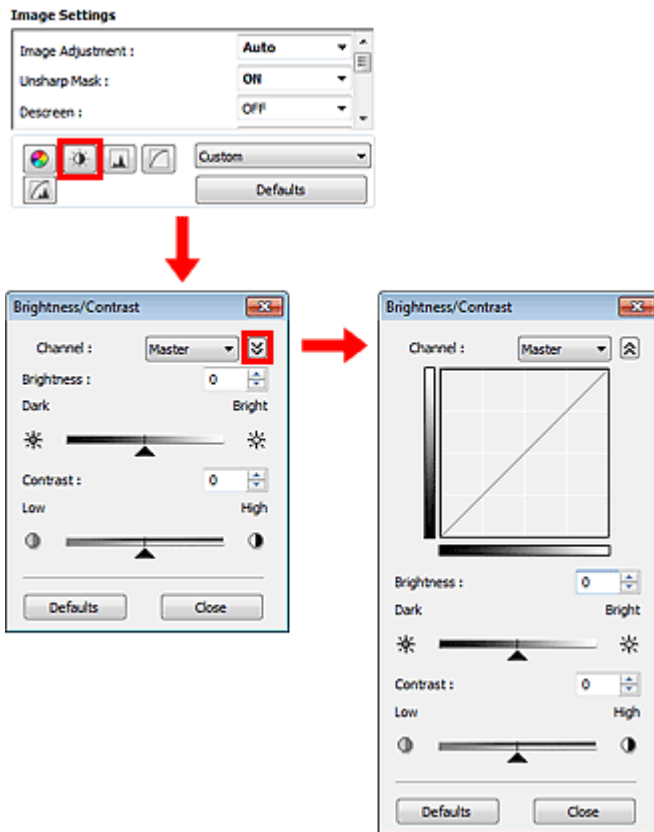

Adjusting Brightness and Contrast

In ScanGear (scanner driver)'s Advanced Mode tab, click  (Brightness/Contrast).



Note

- Click  (Down arrow) to switch to detailed view. Click  (Up arrow) to return to the previous view.
- Click Defaults to reset all adjustments in the current window.

Channel

Each dot of an image is a mixture of Red, Green and Blue in various proportions (gradation). These colors can be adjusted individually as a "channel."

- **Master**
Adjust the Red, Green and Blue combined.
- **Red**
Adjust the Red channel.
- **Green**
Adjust the Green channel.
- **Blue**
Adjust the Blue channel.

Note

- Only Grayscale will be displayed in Channel when Color Mode is Grayscale.

Brightness

Adjust the image brightness. Move ▲ (Slider) under Brightness to the left to darken and right to brighten the image. You can also enter a value (-127 to 127).



Note

- Highlights may be lost if you brighten the image too much, and shadows may be lost if you darken the image too much.

Contrast

"Contrast" is the degree of difference between the brighter and darker parts of an image. Increasing contrast will increase the difference, thus sharpening the image. Decreasing contrast will decrease the difference, thus softening the image.

Move ▲ (Slider) under Contrast to the left to decrease and right to increase the contrast of the image. You can also enter a value (-127 to 127).



Note

- Increasing the contrast is effective in adding a three-dimensional feel to soft images. However, shadows and highlights may be lost if you increase the contrast too much.

Advanced Guide

Advanced Guide > Scanning > Scanning with Other Application Software > Correcting Images and Adjusting Colors with ScanGear (Scanner Driver) > Adjusting Histogram

S305



Adjusting Histogram

In ScanGear (scanner driver)'s Advanced Mode tab, click  (Histogram).

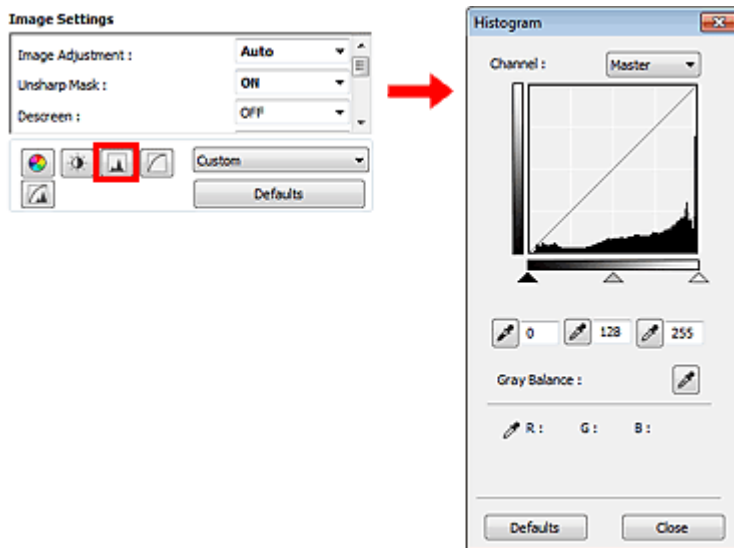

Note

- Click Defaults to reset all adjustments in the current window.

Channel

Each dot of an image is a mixture of Red, Green and Blue in various proportions (gradation). These colors can be adjusted individually as a "channel."

- Master**
 Adjust the Red, Green and Blue combined.
- Red**
 Adjust the Red channel.
- Green**
 Adjust the Green channel.
- Blue**
 Adjust the Blue channel.

Note

- Only Grayscale will be displayed in Channel when Color Mode is Grayscale.

Reading Histograms

You can see the histogram of a specified area for each Channel. The higher the histogram peak, the more data is distributed to that level.



(1) Bright area	(2) Dark area	(3) Whole image
More data is distributed to the highlight side.	More data is distributed to the shadow side.	Data is widely distributed between the highlight and shadow.

Adjusting Histograms (Using the Slider)

Select a Channel, then move ▲ (Black-point Slider) or △ (White-point Slider) to specify the level to be set as the shadow or highlight.

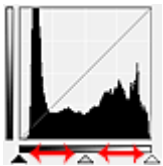

- All parts to the left of ▲ (Black-point Slider) will be black (level 0).
- The parts at △ (Mid-point Slider) will turn to the color exactly between the black-point and white-point.
- All parts to the right of △ (White-point Slider) will turn white (level 255).

When Image Adjustment is set to anything but None, the adjustments shown below are performed automatically.

Moving the Black-point and White-point Sliders

Move the Black-point Slider or White-point Slider to adjust brightness.

Images with more data distributed to the highlight side

Move the Black-point Slider toward the highlight side.

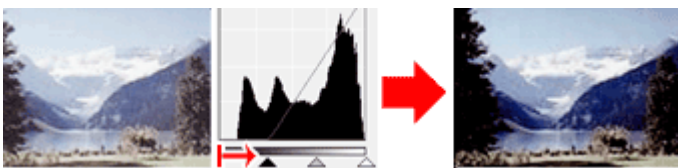

Images with more data distributed to the shadow side

Move the White-point Slider toward the shadow side.

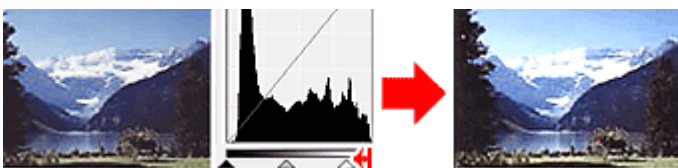

Images with widely distributed data

Move the Black-point Slider toward the highlight side, and White-point Slider toward the shadow side.

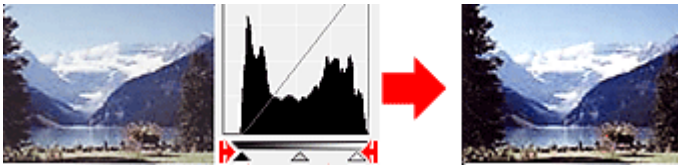

Moving the Mid-point Slider

Move the Mid-point Slider to specify the level to be set as the middle of the tonal range.

Images with more data distributed to the highlight side

Move the Mid-point Slider toward the highlight side.

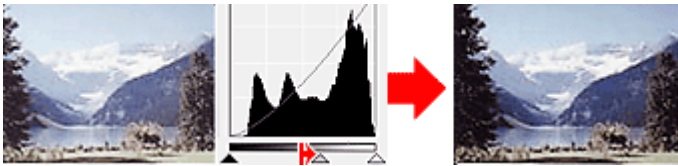

Images with more data distributed to the shadow side

Move the Mid-point Slider toward the shadow side.

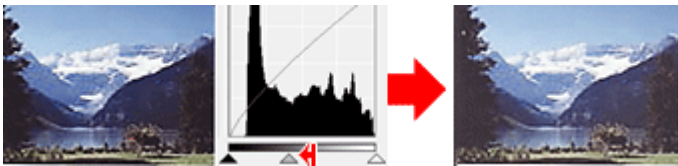

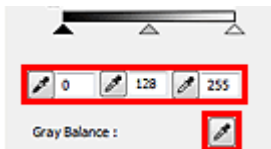

Adjusting Histograms (Using the Droppers)

When you select a Channel and click the Black-point, Mid-point or White-point Dropper, the mouse pointer on the preview image changes to a dropper. Click a Dropper displayed below the histogram to change the setting.



- The point clicked with  (Black-point Dropper) will be the darkest point. You can also enter a value (0 to 245).

- The point clicked with  (Mid-point Dropper) will be the middle of the tonal range. You can also enter a value (5 to 250).

- The point clicked with  (White-point Dropper) will be the brightest point. You can also enter a value (10 to 255).

- Click  (Dropper) for Gray Balance and click the area you want to adjust the color in the preview image.

The clicked point will be set as the achromatic color reference, and the rest of the image is adjusted accordingly. For instance, if snow in a photo appears bluish, click the bluish part to adjust the whole image and reproduce natural colors.

Advanced Guide

Advanced Guide > Scanning > Scanning with Other Application Software > Correcting Images and Adjusting Colors with ScanGear (Scanner Driver) > Adjusting Tone Curve

S306

ScanGear

Adjusting Tone Curve

In ScanGear (scanner driver)'s Advanced Mode tab, click  (Tone Curve Settings).

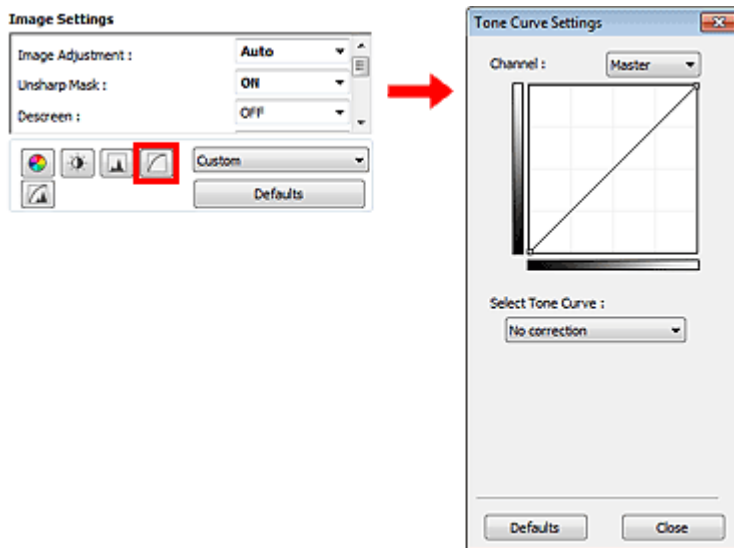

Note

- Click Defaults to reset all adjustments in the current window.

Channel

Each dot of an image is a mixture of Red, Green and Blue in various proportions (gradation). These colors can be adjusted individually as a "channel."

- Master**
 Adjust the Red, Green and Blue combined.
- Red**
 Adjust the Red channel.
- Green**
 Adjust the Green channel.
- Blue**
 Adjust the Blue channel.

Note

- Only Grayscale will be displayed in Channel when Color Mode is Grayscale.

Reading Tone Curves

With ScanGear, scanning images via a scanner is the input, and displaying to a monitor is the output. "Tone Curve" shows the balance of tone input and output for each Channel.

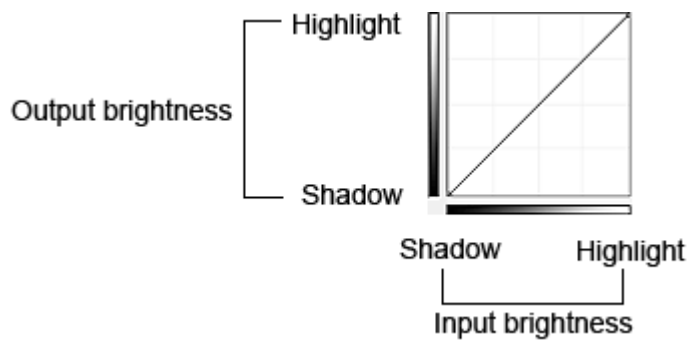

Adjusting Tone Curve

In Select Tone Curve, select a tone curve from No correction, Overexposure, Underexposure, High contrast, Reverse the negative/positive image and Edit custom curve.

No correction (No adjustment)

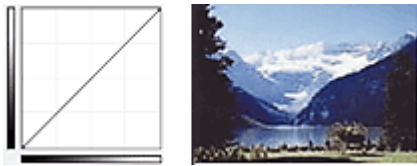

Overexposure (Convex curve)

The midtone data of the input side is stretched toward the highlight of the output side, resulting in a bright-toned image when viewed on a monitor.



Underexposure (Concave curve)

The midtone data of the input side is stretched toward the shadow of the output side, resulting in a dark-toned image when viewed on a monitor.

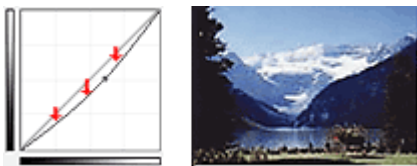

High contrast (S curve)

The highlight and shadow of the input side are enhanced, resulting in a high-contrast image.

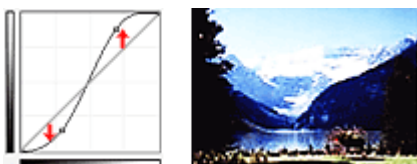

Reverse the negative/positive image (Downward-sloping line)

The input and output sides are reversed, resulting in a negative-positive inverted image.

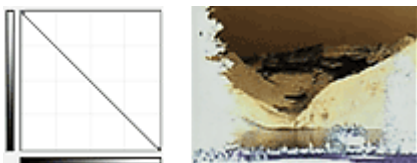

Edit custom curve

You can drag specific points on the Tone Curve to freely adjust the brightness of the corresponding areas.

[Page top](#) ↕

Advanced Guide

Advanced Guide > Scanning > Scanning with Other Application Software > Correcting Images and Adjusting Colors with ScanGear (Scanner Driver) > Setting Threshold

S307



Setting Threshold

The brightness of color and grayscale images is expressed in a value between 0 and 255. However, in creating black and white images, all colors are mapped to either black (0) or white (255). "Threshold" is the borderline value that determines a color as black or white. By adjusting the threshold level, you can sharpen text in a document or reduce show-through in newspapers.

This function is available when Color Mode is Black and White.

In ScanGear (scanner driver)'s Advanced Mode tab, click  (Threshold).

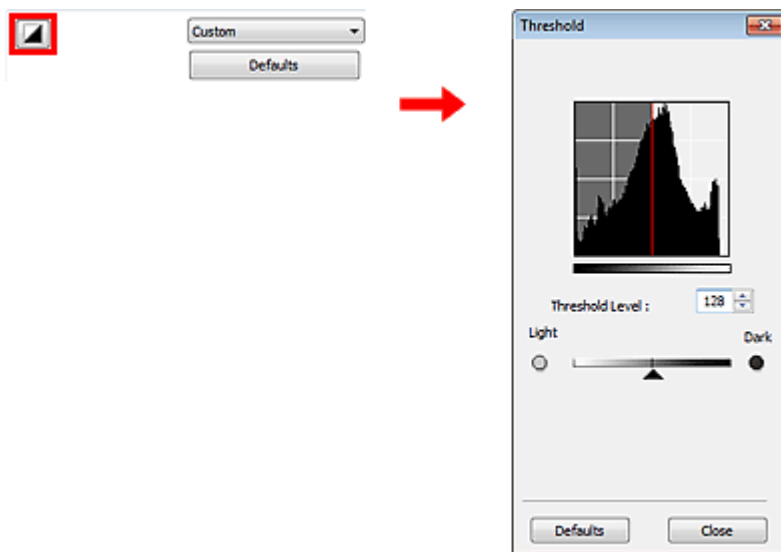

Note

- Click Defaults to reset all adjustments in the current window.

Adjusting Threshold

Move  (Slider) to the right to increase the threshold value and thus increase the black areas. Move the slider to the left to decrease the value and thus increase the white areas. You can also enter a value (0 to 255).



[Page top](#)

Advanced Guide

[Advanced Guide](#) > [Scanning](#) > [Scanning with Other Application Software](#) > [ScanGear \(Scanner Driver\) Screens](#)

S800

ScanGear

ScanGear (Scanner Driver) Screens

The following sections describe ScanGear (scanner driver)'s screens and functions, and how to use ScanGear.

- ➔ Basic Mode Tab
- ➔ Advanced Mode Tab
 - Input Settings
 - Output Settings
 - Image Settings
 - Color Adjustment Buttons
- ➔ Auto Scan Mode Tab
- ➔ Preferences Dialog Box
 - Scanner Tab
 - Preview Tab
 - Scan Tab
 - Color Settings Tab

[Page top](#) ↕

Advanced Guide

Advanced Guide > Scanning > Scanning with Other Application Software > ScanGear (Scanner Driver) Screens > Basic Mode Tab

S801

ScanGear

Basic Mode Tab

This mode allows you to scan easily by following the on-screen steps.

This section describes the settings and functions available on the Basic Mode tab.

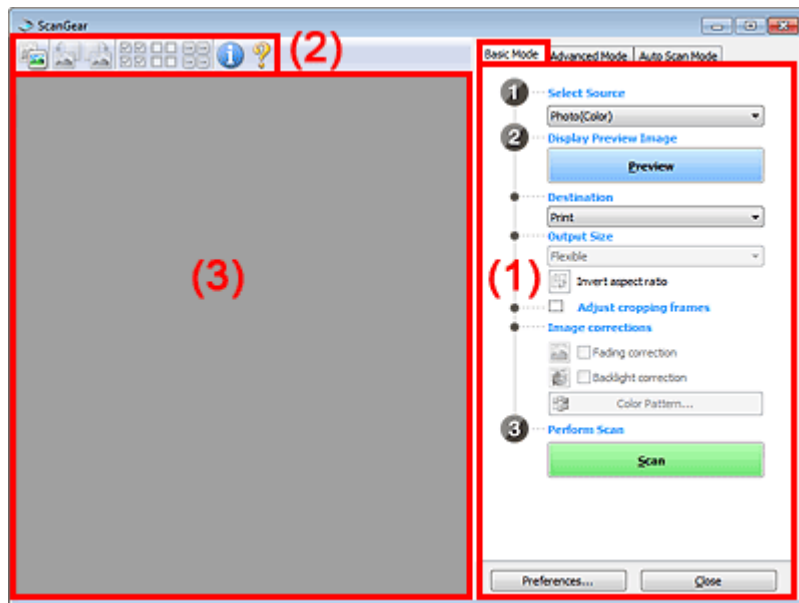

(1) Settings and Operation Buttons

(2) Toolbar

(3) Preview Area

Note

- The displayed items vary by document type and how the screen was opened.

Settings and Operation Buttons

- **Select Source**
 - **Photo(Color)**
Scan color photos.
 - **Magazine(Color)**
Scan color magazines.
 - **Newspaper(Grayscale)**
Scan text and line drawings in black and white.
 - **Document(Grayscale)**
Scan documents and photos in black and white.
Select this mode to create high-resolution black and white images.

Note

- When you select a document type, the unsharp mask function will be active. The image adjustment function which adjusts images based on the document type will also be active.
- If you select Magazine(Color), the descreen function will be active.

- **Display Preview Image**

- **Preview**

Performs a trial scan.

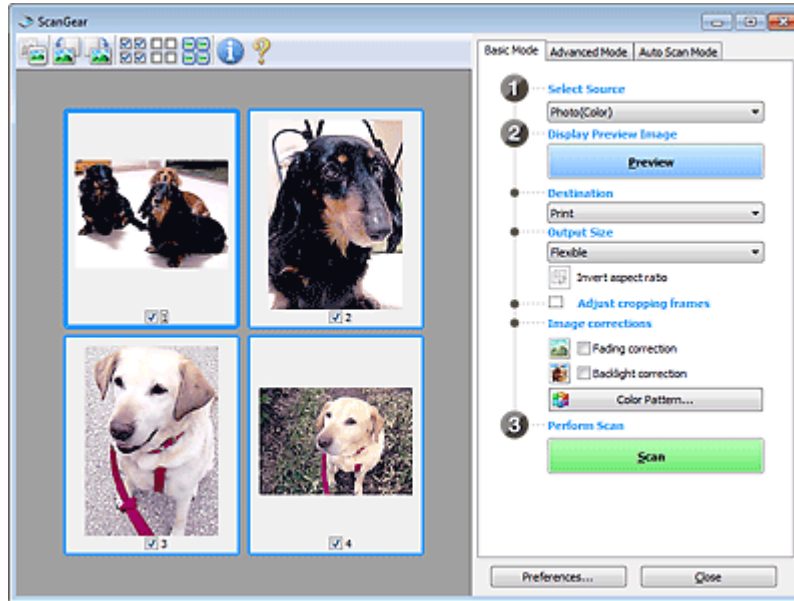

Note

- When using the machine for the first time, scanner calibration starts automatically. Wait a while until the preview image appears.

- **Destination**

Select what you want to do with the scanned image.

- **Print**

Select this to print the scanned image on a printer.

- **Image display**

Select this to view the scanned image on a monitor.

- **OCR**

Select this to use the scanned image with OCR software.

"OCR software" is software that converts text scanned as an image into text data that can be edited in word processors and other programs.

- **Output Size**

Select an output size.

Output size options vary by the item selected in Destination.

- **Flexible**

Allows you to freely adjust the cropping frames.

In thumbnail view

Drag the mouse over a thumbnail to display a cropping frame. When a cropping frame is displayed, the portion within the cropping frame will be scanned. When no cropping frame is displayed, each frame is scanned individually.

In whole image view

When no cropping frame is displayed, the entire Preview area will be scanned. When a cropping frame is displayed, the portion within the cropping frame will be scanned.

- **Paper Size (L, A4, etc.)**

Select an output paper size. The portion within the cropping frame will be scanned at the size of the selected paper size. You can drag the cropping frame to enlarge/reduce it while maintaining the aspect ratio.

- **Monitor Size (1024 x 768 pixels, etc.)**

Select an output size in pixels.

A cropping frame of the selected monitor size will be displayed and the portion within the cropping frame will be scanned. You can drag the cropping frame to enlarge/reduce it while maintaining the aspect ratio.

- **Add/Delete...**

Opens the Add/Delete the Output Size dialog box, in which you can specify custom output sizes. You can select this option when Destination is Print or Image display.

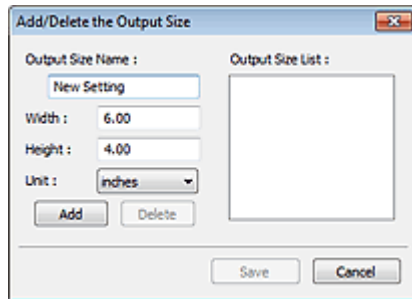

In the Add/Delete the Output Size dialog box, you can specify multiple output sizes and save them at one time. Saved items will be registered to the Output Size list and can be selected, along with the predefined items.

Add

To add a size, enter Output Size Name, Width and Height, then click Add. For Unit, you can select inches or mm when Destination is Print but you can only select pixels when Destination is Image display. The name of the added size appears in Output Size List. Click Save to save the items listed in Output Size List.

Delete

To delete an item, select it in Output Size List and click Delete. Click Save to save the items listed in Output Size List.

Important

- You cannot delete predefined output sizes such as A4 and 1024 x 768 pixels.

Note

- Save up to 10 items.
- An error message appears when you enter a value outside the setting range. Enter a value within the setting range.

Note

- For details on whether or how the cropping frame is initially displayed on a preview image, see Cropping Frame on Previewed Images in " [Preview Tab](#)" (Preferences dialog box).

-  **Invert aspect ratio**

This button is available when Output Size is set to anything but Flexible.

Click this button to rotate the cropping frame. Click again to return it to the original orientation.

- **Adjust cropping frames**

You can adjust the scan area within the Preview area.

If an area is not specified, the document will be scanned at the document size (Auto Crop). If an area is specified, only the portion in the cropping frame will be scanned.

➔ [Adjusting Cropping Frames](#)

- **Image corrections**

Allows you to apply corrections to images.

Important

- Available functions vary by the document type selected in Select Source.
- Auto Document Fix, Fading correction and Backlight correction are available when Recommended is selected on the Color Settings tab of the Preferences dialog box.

- **Auto Document Fix**

Sharpens text in a document or magazine for better readability.

Important

- When this checkbox is selected in ScanGear (scanner driver) started from MP Navigator EX, the files can be saved in JPEG/Exif or PDF format only.
- Scanning may take longer than usual when this checkbox is selected.
- The color tone may change from the source image due to corrections. In that case, deselect the checkbox and scan.
- Auto Document Fix may not be effective if the scan area is too small.

- **Fading correction**

Corrects and scans photos that have faded with time or have a colorcast.

- **Backlight correction**

Corrects photos that have been shot against light.

- **Gutter shadow correction**

Corrects shadows that appear between pages when scanning open booklets.

Important

- For precautions on using this function, see "[Gutter Shadow Correction](#)."

- **Color Pattern...**

Allows you to adjust the image's overall color. You can correct colors that have faded due to colorcast, etc. and reproduce natural colors while previewing color changes.

➔ [Adjusting Colors Using a Color Pattern](#)

Important

- This setting is not available when you select Color Matching on the Color Settings tab of the Preferences dialog box.

- **Perform Scan**

- **Scan**

Scanning starts.

Note

- When scanning starts, the progress will be displayed. Click Cancel to cancel the scan.

- **Preferences...**

The Preferences dialog box opens and you can make scan/preview settings.

➔ [Preferences Dialog Box](#)

- **Close**

Closes ScanGear.

Toolbar

- **Toolbar**













You can adjust or rotate preview images. The buttons displayed on the Toolbar vary by view.

In thumbnail view



In whole image view



-  (Thumbnail) /  (Whole Image)
Switches the view in the Preview area.
➔ [Preview Area](#)
-  (Rotate Left)
Rotates the preview image 90 degrees counter-clockwise.
- The result will be reflected in the scanned image.
- The image returns to its original state when you preview again.
-  (Rotate Right)
Rotates the preview image 90 degrees clockwise.
- The result will be reflected in the scanned image.
- The image returns to its original state when you preview again.
-  (Auto Crop)
Displays and adjusts the cropping frame automatically to the size of the document displayed in the Preview area. The scan area is reduced every time you click this button if there are croppable areas within the cropping frame.
-  (Check All Frames)
This button is available when two or more frames are displayed.
Selects the checkbox of the image in thumbnail view.
-  (Uncheck All Frames)
This button is available when two or more frames are displayed.
Deselects the checkbox of the image in thumbnail view.
-  (Select All Frames)
This button is available when two or more frames are displayed.
Selects the image in thumbnail view and the image will be outlined in blue.
-  (Select All Cropping Frames)
This button is available when there are two or more cropping frames.
All cropping frames will be displayed in thick broken lines. The settings will be applied to all the cropping frames.
-  (Remove Cropping Frame)
Removes the selected cropping frame.
-  (Information)
Displays the version of ScanGear and the current scan settings (document type, etc.).
-  (Open Guide)
This page appears.

Preview Area



- **Preview Area**
This is where a trial image is displayed after you click Preview. You can also check the results of the settings (image corrections, color adjustments, etc.) made in " [Settings and Operation Buttons](#) ."

When  (Thumbnail) is displayed on the Toolbar

Thumbnails of images cropped to the document size are displayed. Only the images with the checkbox selected will be scanned.



Note

- When multiple images are previewed, different outlines indicate different selection status.
 - Focus Frame (thick blue outline): The displayed settings will be applied.
 - Selected Frame (thin blue outline): The settings will be applied to the Focus Frame and Selected Frames simultaneously. You can select multiple images by clicking them while pressing the Ctrl key.
 - Unselected (no outline): The settings will not be applied.
- Double-click a frame to zoom in on the image. Click   (Frame Advance) at the bottom of the screen to display the previous or next frame. Double-click the frame again to return the display to its non-magnified state.

When (Whole Image) is displayed on the Toolbar

Items on the Platen are scanned and displayed as a single image. All portions in the cropping frames will be scanned.

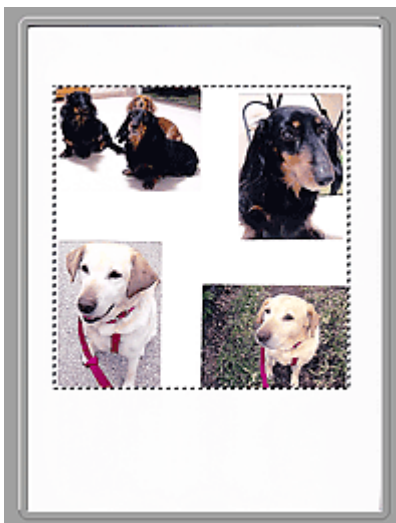

Note

- You can specify the scan area (cropping frame) on the displayed image. In thumbnail view, you can only create one cropping frame per image. In whole image view, you can create multiple cropping frames.

➔ [Adjusting Cropping Frames](#)

Related Topic

▶ [Scanning in Basic Mode](#)

[Page top](#) ↕

Advanced Guide

Advanced Guide > Scanning > Scanning with Other Application Software > ScanGear (Scanner Driver) Screens > Advanced Mode Tab

S803



Advanced Mode Tab

This mode allows you to make advanced scan settings such as the color mode, output resolution, image brightness and color tone.

This section describes the settings and functions available on the Advanced Mode tab.

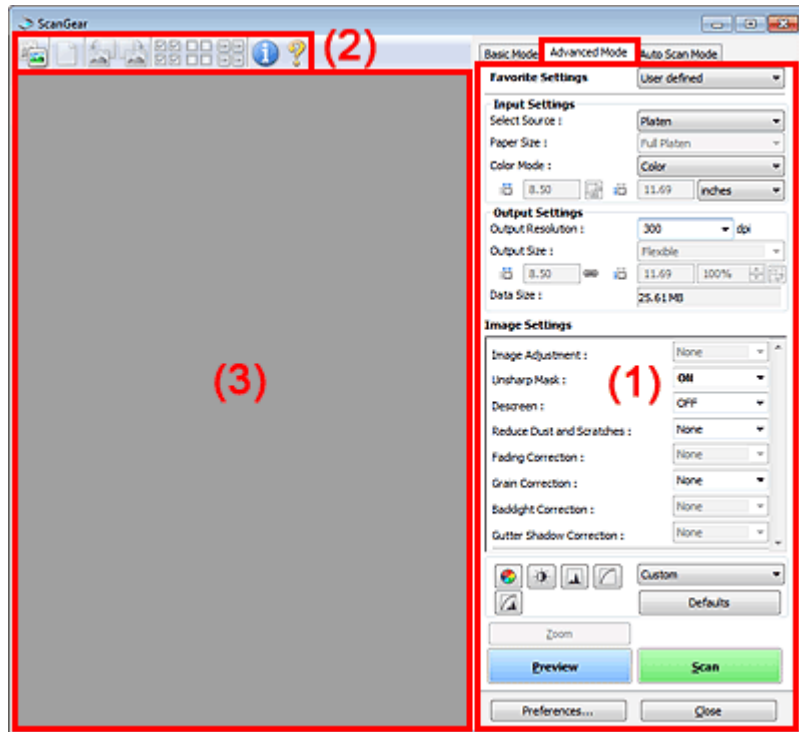

- (1) Settings and Operation Buttons
- (2) Toolbar
- (3) Preview Area

Note

- The displayed items vary by document type and how the screen was opened.

Settings and Operation Buttons

• Favorite Settings

You can name and save a group of settings (Input Settings, Output Settings, Image Settings and Color Adjustment Buttons) on Advanced Mode tab, and load it as required. It is convenient to save a group of settings if you will be using it repeatedly. You can also use this to reload the default settings.

Select Add/Delete... from the pull-down menu and the Add/Delete Favorite Settings dialog box opens.

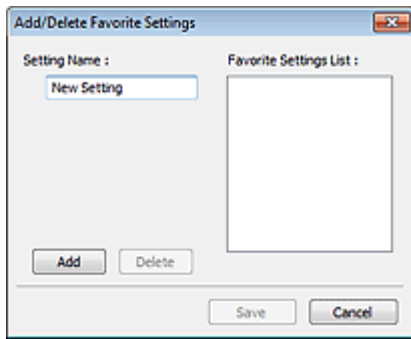

Enter Setting Name and click Add. The name appears in Favorite Settings List.

When you click Save, the item appears in the Favorite Settings list and can be selected, along with the predefined items.

To delete an item, select it in Favorite Settings List and click Delete. Click Save to save settings displayed in Favorite Settings List.

Note

- You can set Add/Delete... in Favorite Settings after preview.
- Save up to 10 items.

● Input Settings

Specify the input settings such as the document type and size.

➔ [Input Settings](#)

● Output Settings

Specify the output settings such as the output resolution and size.

➔ [Output Settings](#)

● Image Settings

Enable/disable various image correction functions.

➔ [Image Settings](#)

● Color Adjustment Buttons

These buttons can be used to make fine corrections to the image brightness and color tones. You can adjust the image's overall brightness or contrast, and adjust its highlight and shadow values (histogram) or balance (tone curve).

➔ [Color Adjustment Buttons](#)

● Zoom

Zooms in on an image or the portion within the cropping frame. When the image is zoomed in, Zoom changes to Undo. Click Undo to return the display to its non-magnified state.

In thumbnail view

When multiple images are displayed in thumbnail view, clicking this button zooms in on the selected frame. Click  (Frame Advance) at the bottom of the screen to display the previous or next frame.

Note

- You can also zoom in on an image by double-clicking the frame. Double-click the frame again to return the display to its non-magnified state.

In whole image view

Rescans the portion within the cropping frame at higher magnification.

Note

- Zoom rescans the image and displays high-resolution image in Preview.
-  (Enlarge/Reduce) on the Toolbar zooms in on the preview image quickly. However, the resolution of the displayed image will be low.

- **Preview**

Performs a trial scan.

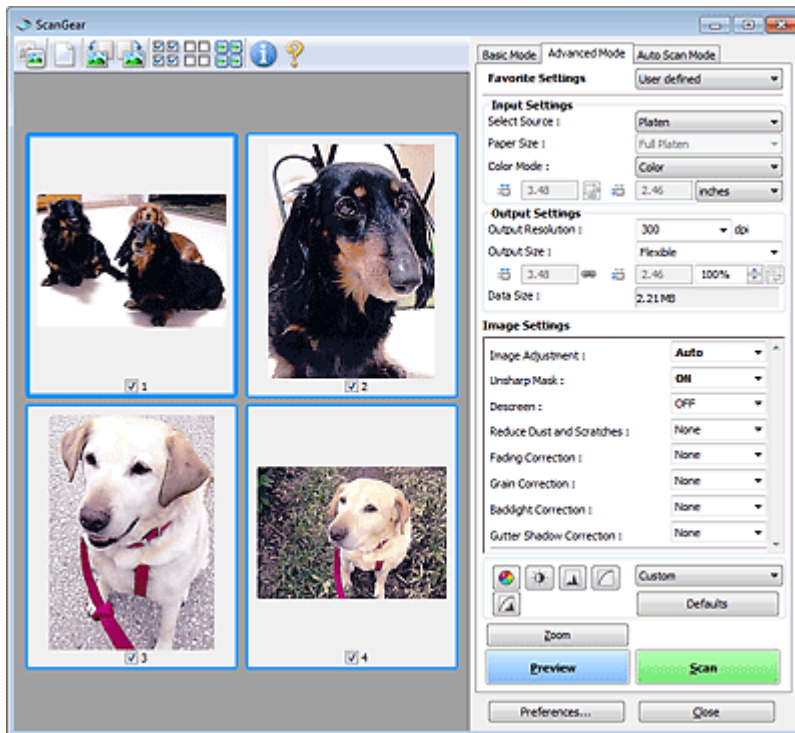

- **Scan**

Scanning starts.

Note

- When scanning starts, the progress will be displayed. Click Cancel to cancel the scan.
- When scanning is completed, a dialog box prompting you to select the next action may open. Follow the prompt to complete. For details, see Status of ScanGear dialog after scanning in "Scan Tab" (Preferences dialog box).
- It will take time to process the images if the total size of the scanned images exceeds a certain size. In that case, a warning message appears. It is recommended that you reduce the total size. To continue, scan in whole image view.

- **Preferences...**

The Preferences dialog box opens and you can make scan/preview settings.

➔ [Preferences Dialog Box](#)

- **Close**

Closes ScanGear (scanner driver).

Toolbar

- **Toolbar**

You can adjust or rotate preview images. The buttons displayed on the Toolbar vary by view.

In thumbnail view





In whole image view





- 

• **(Thumbnail)/ (Whole Image)**
Switches the view in the Preview area.
➔ [Preview Area](#)
- 

• **(Clear)**
Click this button to delete the preview image.
It also resets the Toolbar and color adjustment settings.
- 

• **(Crop)**
Allows you to specify the scan area by dragging the mouse.
- 

• **(Move Image)**
If an enlarged image is too large to fit in the Preview area, you can click this button and drag the image across the screen until the part you want to see is displayed. You can also move the image using the scroll bars.
- 

• **(Enlarge/Reduce)**
Click this button then click on the image to enlarge it (zoom in). Right-click on the image to reduce it (zoom out).
- 

• **(Rotate Left)**
Rotates the preview image 90 degrees counter-clockwise.
- The result will be reflected in the scanned image.
- The image returns to its original state when you preview again.
- 

• **(Rotate Right)**
Rotates the preview image 90 degrees clockwise.
- The result will be reflected in the scanned image.
- The image returns to its original state when you preview again.
- 

• **(Auto Crop)**
Displays and adjusts the cropping frame automatically to the size of the document displayed in the Preview area. The scan area is reduced every time you click this button if there are croppable areas within the cropping frame.
- 

• **(Check All Frames)**
This button is available when two or more frames are displayed.
Selects the checkbox of the image in thumbnail view.
- 

• **(Uncheck All Frames)**
This button is available when two or more frames are displayed.
Deselects the checkbox of the image in thumbnail view.
- 

• **(Select All Frames)**
This button is available when two or more frames are displayed.
Selects the image in thumbnail view and the image will be outlined in blue.
- 

• **(Select All Cropping Frames)**
This button is available when there are two or more cropping frames.
All cropping frames will be displayed in thick broken lines. The settings will be applied to all the cropping frames.
- 

• **(Remove Cropping Frame)**

Removes the selected cropping frame.

-  **(Information)**

Displays the version of ScanGear and the current scan settings (document type, etc.).

-  **(Open Guide)**

This page appears.

Preview Area

- **Preview Area**

This is where a trial image is displayed after you click Preview. You can also check the results of the settings (image corrections, color adjustments, etc.) made in " [Settings and Operation Buttons](#) ."

When **(Thumbnail) is displayed on the Toolbar**

Thumbnails of images cropped to the document size are displayed. Only the images with the checkbox selected will be scanned.



Note

- When multiple images are previewed, different outlines indicate different selection status.
 - Focus Frame (thick blue outline): The displayed settings will be applied.
 - Selected Frame (thin blue outline): The settings will be applied to the Focus Frame and Selected Frames simultaneously. You can select multiple images by clicking them while pressing the Ctrl key.
 - Unselected (no outline): The settings will not be applied.

When **(Whole Image) is displayed on the Toolbar**

Items on the Platen are scanned and displayed as a single image. All portions in the cropping frames will be scanned.



Note

- You can specify the scan area (cropping frame) on the displayed image. In thumbnail view, you can only create one cropping frame per image. In whole image view, you can create multiple cropping frames.
[➔ Adjusting Cropping Frames](#)

Related Topic

- ▶ [Scanning in Advanced Mode](#)

[Page top](#) 

Advanced Guide

Advanced Guide > Scanning > Scanning with Other Application Software > ScanGear (Scanner Driver) Screens > Input Settings

S804



Input Settings

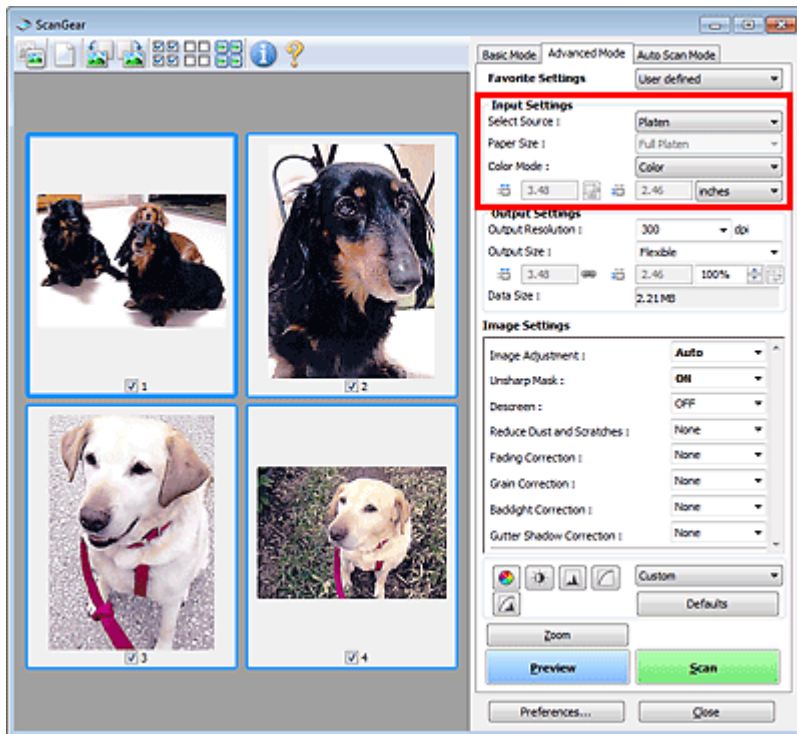

Input Settings allows you to set the following items:

- **Select Source**

The type of document to be scanned is displayed.



- **Paper Size**

Select the size of the document to be scanned. This setting is available in whole image view only. When you select a size, the Preview area size changes accordingly.

Important

- Some applications have a limit to the amount of scan data they can receive. ScanGear (scanner driver) can scan data that is of:
 - 21000 pixels x 30000 pixels or less
- If you change Paper Size after previewing, the preview image will be deleted.

Note

- If you are not sure which size you should select for Paper Size, set Paper Size to Full Platen, then measure the size of the document and enter the values into  (Width) and  (Height).

- **Color Mode**

Select how to scan the document.

- **Color**

Select this mode to scan color documents or to create color images. This mode renders the image in 256 levels (8 bit) of R(ed), G(reen), and B(lue).

- **Grayscale**

Select this mode to scan black and white photos, or to create black and white images. This mode renders the image in 256 levels (8 bit) of black and white.

- **Black and White**



Select this mode to scan photos and documents in black and white. This mode renders the image in black and white. The contrast in the image is divided at certain levels (threshold level)



into black and white and is rendered in two colors. The threshold level can be set with  (Threshold).

- **Input Size**

In thumbnail view, the cropped document size is displayed after preview.

In whole image view, the Paper Size is displayed before preview, and the cropping frame (scan area) size is displayed after preview.

You can adjust the cropping frame size by entering the values into  (Width) and  (Height).

Click  (Change Aspect Ratio) and change it to  (Keep Aspect Ratio) to maintain the aspect ratio when you specify the cropping frame size.

Important

- Input size settings are available only when Output Size in Output Settings is Flexible. If you select a size other than Flexible, a cropping frame calculated from Output Size and Output Resolution is displayed, and its aspect ratio is fixed.

Note

- The values you can enter will be within the range of the selected document size. The minimum size is 96 pixels x 96 pixels when Output Resolution is 600 dpi, scaled at 100%.
- When Auto Crop is performed in whole image view, the aspect ratio will not be maintained since the size will be prioritized.
- See "[Adjusting Cropping Frames](#)" for details on cropping frames.

Advanced Guide

Advanced Guide > Scanning > Scanning with Other Application Software > ScanGear (Scanner Driver) Screens > Output Settings

S805



Output Settings

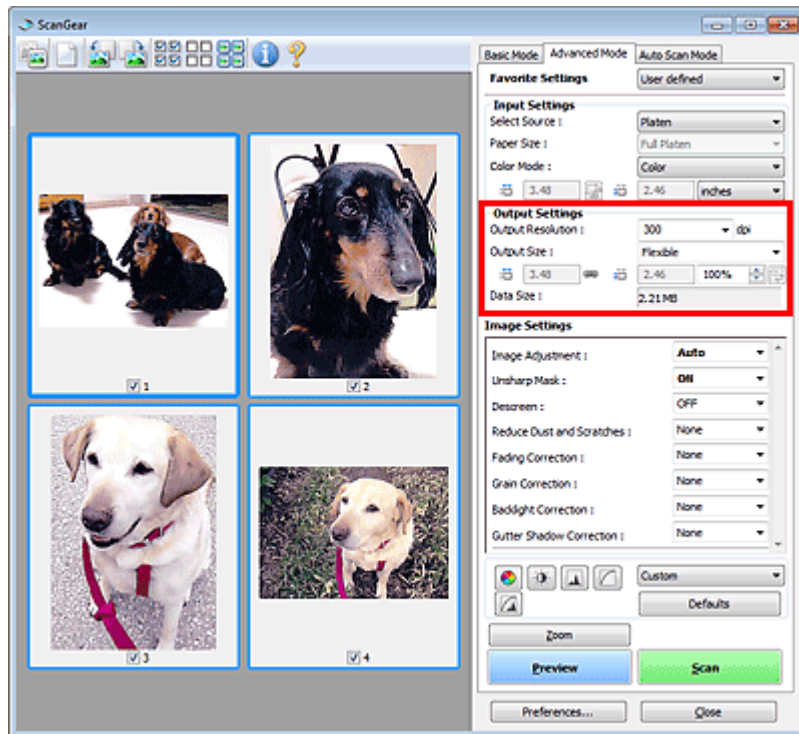

Output Settings allows you to set the following items:

- **Output Resolution**

Select the resolution to scan at.

The higher the resolution (value), the more detail in your image.

Select a resolution from the options displayed by clicking the button, or enter a value within the range of 25 dpi to 19200 dpi (in 1 dpi increments).

➔ Resolution

- **Output Size**

Select an output size.

Select Flexible to set custom sizes or select a size for printing or displaying. Select Add/Delete... to set custom size and save it as a new output size option.

- **Flexible**

You can specify the output resolution and scale, and adjust the cropping frame.

In thumbnail view

Drag the mouse over a thumbnail to display a cropping frame. When a cropping frame is displayed, the portion within the cropping frame will be scanned. When no cropping frame is displayed, each frame is scanned individually.

In whole image view



When no cropping frame is displayed, the entire Preview area will be scanned. When a cropping frame is displayed, the portion within the cropping frame will be scanned.

Note

- To enlarge/reduce the scanned image, enter values into  (Width) and  (Height) in

Output Settings or specify a value (by 1%) for %. The maximum value available for % depends on the Output Resolution. % can be specified for up to 19200 dpi (the maximum available output resolution).

- **Paper Size (L, etc.) & Monitor Size (1024 x 768 pixels, etc.)**

 (Width),  (Height) and scale cannot be specified. The preview image will be cropped according to the selected output size and resolution. The portion within the cropping frame will be scanned at the size of the selected paper/monitor size. You can drag the cropping frame to enlarge, reduce or move it while maintaining the aspect ratio.

- **Add/Delete...**

Opens the Add/Delete the Output Size dialog box, in which you can specify custom output sizes.

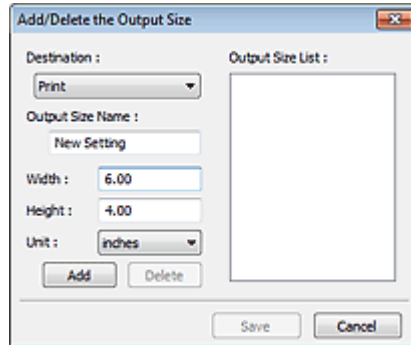

In the Add/Delete the Output Size dialog box, you can specify multiple output sizes and save them at one time. Saved items will be registered to the Output Size list and can be selected, along with the predefined items.

Add

To add a size, select Print or Image display for Destination, then enter Output Size Name, Width, and Height then click Add. For Unit, you can select inches or mm when Destination is Print but you can only select pixels when Destination is Image display. The name of the added size appears in Output Size List.

Click Save to save the items listed in Output Size List.

Delete

To delete an item, select it in Output Size List and click Delete. Click Save to save the items listed in Output Size List.

Important

- You cannot delete predefined output sizes such as A4 and 1024 x 768 pixels.

Note

- Save up to 10 items for each destination.
- An error message appears when you enter a value outside the setting range. Enter a value within the range displayed in the message.

Note

- See "[Adjusting Cropping Frames](#)" for details on cropping frames.
- For details on whether or how the cropping frame is initially displayed on a preview image, see Cropping Frame on Previewed Images in "[Preview Tab](#)" (Preferences dialog box).

-  (Switch Aspect Ratio)

This button is available when Output Size is set to anything but Flexible. Click this button to rotate the cropping frame. Click again to return it to the original orientation.

- **Data Size**

The file size of the preview image when saved in BMP format is displayed.

Note

- When the file size exceeds a certain size, the value appears in red. In that case, a warning

message appears when you click Scan. It is recommended that you adjust the settings to reduce Data Size. To continue, scan in whole image view.

[Page top](#) ↕

Advanced Guide

Advanced Guide > Scanning > Scanning with Other Application Software > ScanGear (Scanner Driver) Screens > Image Settings

S806



Image Settings

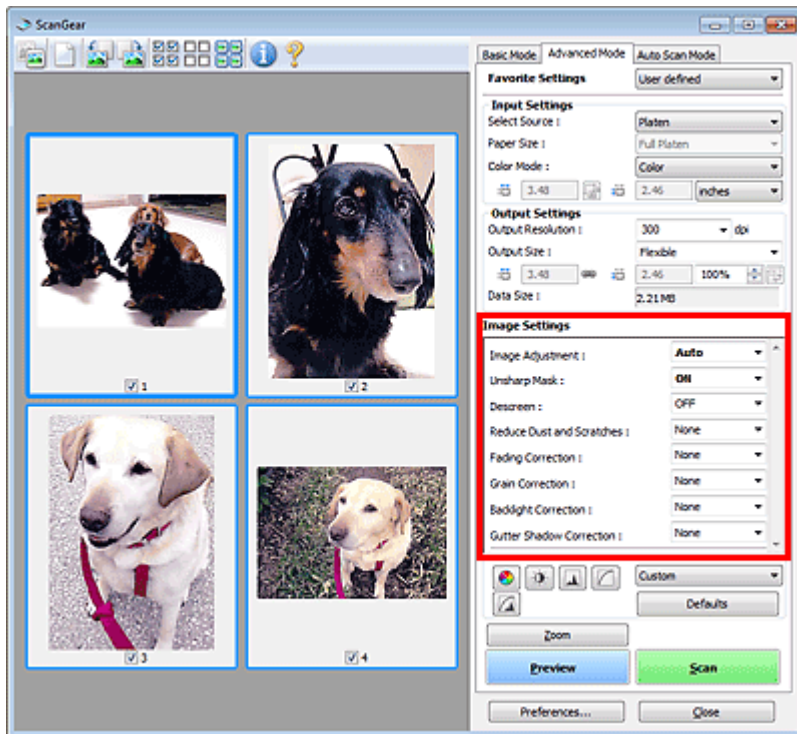

Important

- Do not apply these functions to images without moire, dust/scratches or faded colors. The color tone may be adversely affected.
- Image correction results may not be reflected in the preview image.

Note

- Selectable settings depend on color mode settings.
- Scanning may take longer when you use Image Settings.

Image Settings allows you to set the following items:

• Image Adjustment

When Image Adjustment is set, the brightness of the specified portion of the image is optimized. Images can be adjusted according to the automatically detected document type or the specified document type. The result of the adjustment will be reflected in the entire image.

• None

Image Adjustment will not be applied.

• Auto

Applies Image Adjustment by automatically detecting the document type. It is recommended that you normally select this setting.

• Photo

Applies Image Adjustment suitable for photos.

• Magazine

Applies Image Adjustment suitable for magazines.

- **Newspaper**

Applies Image Adjustment suitable for newspapers.

- **Document**

Applies Image Adjustment suitable for text documents.

Important

- You can set Image Adjustment after preview.
- You can set this setting when Recommended is selected on the Color Settings tab of the Preferences dialog box.

Note

- If the image is not adjusted properly with Auto, specify the document type.
- The color tone may change from the source image due to the Image Adjustment. In that case, set Image Adjustment to None.

- **Unsharp Mask**

When this is set to ON, the outline of the subjects is emphasized to sharpen the image.

- **Descreen**

Printed photos and pictures are displayed as a collection of fine dots. "Moire" is a phenomenon where uneven gradation or a stripe pattern appears when such photos or pictures printed with fine dots are scanned. Descreen is the function for reducing this moire effect.

Note

- Even if Descreen is set to ON, some moire effects may remain if Unsharp Mask is set to ON. In that case, set Unsharp Mask to OFF.
- Selecting Magazine(Color) in Select Source on the Basic Mode tab has the same effect as setting Descreen to ON on the Advanced Mode tab.

- **Reduce Dust and Scratches**

Scanned photos may contain white dots caused by dust or scratches. Use this function to reduce such noise.

- **None**

Dust and scratches will not be reduced.

- **Low**

Select this to reduce small dust particles and scratches. Large ones may remain.

- **Medium**

It is recommended that you normally select this setting.

- **High**

Select this to reduce small/large dust particles and scratches. Evidence of the reduction process may remain and may also remove delicate parts of the image.

Important

- This function may not be effective for some types of photos.

Note

- It is recommended that you select None when scanning printed materials.

- **Fading Correction**

Use this function to correct photos that have faded with time or have a colorcast. "Colorcast" is a phenomenon where a specific color affects the entire picture due to the weather or ambient strong colors.

- **None**

Fading correction will not be applied.

- **Low**

Select this to correct a small amount of fading and colorcast.

- **Medium**

It is recommended that you normally select this setting.

- **High**

Select this to correct a large amount of fading and colorcast. This can affect the tone of the image.

Important

- You can set Fading Correction after preview.
- You can set this setting when Recommended is selected on the Color Settings tab of the Preferences dialog box.
- Fading Correction may not be effective if the scan area is too small.

- **Grain Correction**

Use this function to reduce graininess (roughness) in photos taken with high-speed or sensitized film.

- **None**

Graininess will not be reduced.

- **Low**

Select this when the photo is slightly grainy.

- **Medium**

It is recommended that you normally select this setting.

- **High**

Select this when the photo is very grainy. This can affect the gradation and sharpness of the image.

Important

- Grain Correction may not be effective if the scan area is too small.

- **Backlight Correction**

Use this function to correct photos that have been shot against light.

When you change the Backlight Correction setting, the result will be reflected in the preview image.

- **None**

Backlight correction will not be applied.

- **Low**

Select this to correct slightly backlit photos. This will not affect the image contrast.

- **Medium**

It is recommended that you normally select this setting.

- **High**

Select this to correct strongly backlit photos. This can affect the image contrast.

Important

- You can set Backlight Correction after preview.
- You can set this setting when Recommended is selected on the Color Settings tab of the Preferences dialog box.
- Backlight Correction may not be effective if the scan area is too small.

Note

- Noise patterns may appear when Backlight Correction is applied. Applying Grain Correction and setting Unsharp Mask to OFF may reduce the noise patterns.

- **Gutter Shadow Correction**

Use this function to correct shadows that appear between pages when scanning open booklets. When you set the Gutter Shadow Correction setting in the preview image, the result will be reflected. Preview the effects before scanning, as results vary depending on the type of document and how it is pressed.

Unclear or blurred text/lines caused by curved pages are not corrected.

- **None**

Gutter shadow will not be corrected.

- **Low**

Select this when the effect level is too strong with the medium setting.

- **Medium**

It is recommended that you normally select this setting.

- **High**

Select this when the effect level is too weak with the medium setting.

Important

- Do not place items that weigh 4.4 lbs (2.0 kg) or more on the Platen. Also, do not press on the document with a force exceeding 4.4 lbs (2.0 kg). If you press heavily, the scanner may not work correctly or you might break the glass.
- Align the document with the edge of the Platen. If not, the shadow will not be corrected properly.



- Shadows may not be corrected properly depending on the document. If the page background is not white, shadows may not be detected correctly or may not be detected at all.
- While scanning, press down on the spine with the same amount of pressure you used to preview the scan. If the binding part is not even, the shadow will not be corrected properly.



- How to place the document depends on your model and the document to be scanned.

Note

- Cover the document with black cloth if white spots, streaks, or colored patterns appear in scan results due to ambient light entering between the document and the Platen.
- If the shadow is not corrected properly, adjust the cropping frame on the preview image.

➔ [Adjusting Cropping Frames](#)

Advanced Guide

Advanced Guide > Scanning > Scanning with Other Application Software > ScanGear (Scanner Driver) Screens > Color Adjustment Buttons

S807



Color Adjustment Buttons

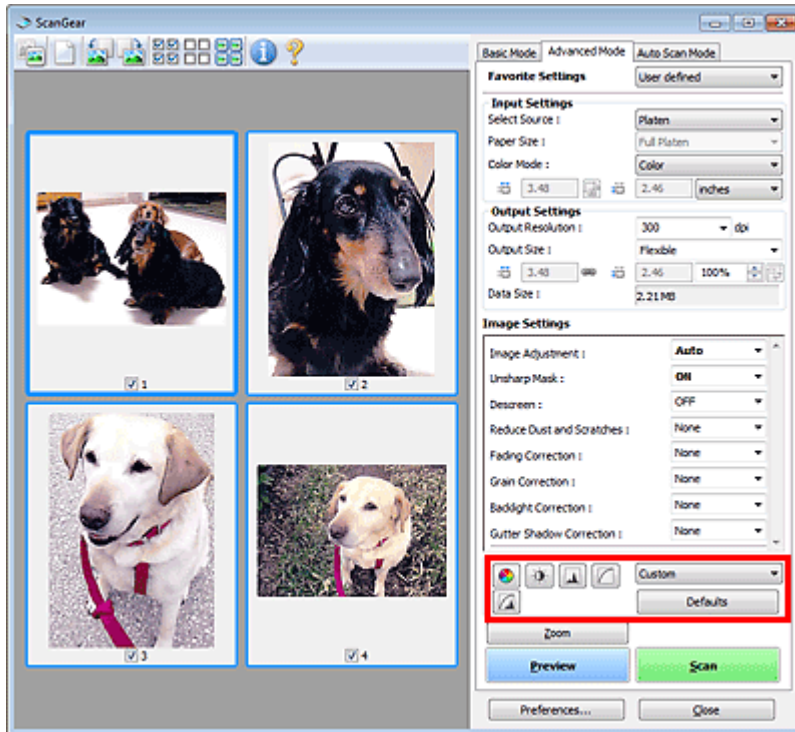

The Color Adjustment Buttons allow you to make fine corrections to the image brightness and color tones. You can adjust the image's overall brightness or contrast, and adjust its highlight and shadow values (histogram) or balance (tone curve).

Important

- The Color Adjustment Buttons are not available when you select Color Matching on the Color Settings tab of the Preferences dialog box.

Note

- Selectable settings depend on color mode settings.
- When you adjust the image via the Color Adjustment Buttons, the results will be reflected in the preview image.

Click a Color Adjustment Button to set the following items:

-  **(Saturation/Color Balance)**

Adjust the saturation (vividness) and color tone of the image. Use this function to brighten colors that have faded with time or due to colorcast. "Colorcast" is a phenomenon where a specific color affects the entire picture due to the weather or ambient strong colors.

➔ [Adjusting Saturation and Color Balance](#)

-  **(Brightness/Contrast)**

Adjust the brightness and contrast of the image. If the image is too dark or too bright, or if the image quality is flat due to lack of contrast, you can adjust the levels of brightness and contrast.

➔ [Adjusting Brightness and Contrast](#)

-  **(Histogram)**

A histogram allows you to see the data concentration at each brightness level of an image. You can specify the darkest level (shadow) and brightest level (highlight) within an image, cut the levels and expand the middle of the tonal range of the image.

➔ [Adjusting Histogram](#)

-  **(Tone Curve Settings)**

Adjust the brightness of an image by selecting the type of graph (tone curve) showing the balance of tone input and output. You can make fine adjustments to the brightness of a specific area.

➔ [Adjusting Tone Curve](#)

-  **(Final Review)**

Make a final check of color adjustments. The final synthesized tone curve and the histogram derived from the subsequent image processing will be displayed. There are no settings to make in this screen.

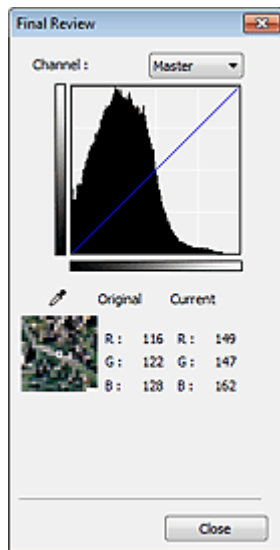

- For a color image, select a color in Channel to check either Red, Green or Blue, or select Master to check three colors together.
- If you place the cursor on the preview image, the portion will be enlarged and its RGB values (only L when Color Mode is Grayscale) before and after the adjustments will be displayed.

-  **(Threshold)**

Set the boundary (threshold) at which black and white are divided. By adjusting the threshold level, you can sharpen text in a document or reduce show-through in newspapers.

➔ [Setting Threshold](#)

- **Custom**

You can name and save a set of tone curve and threshold settings of the Color Adjustment Buttons. Select Add/Delete... from the pull-down menu. When Color Mode is set to anything but Black and White, the Add/Delete Tone Curve Settings dialog box opens. When Color Mode is Black and White, the Add/Delete Threshold Settings dialog box opens.

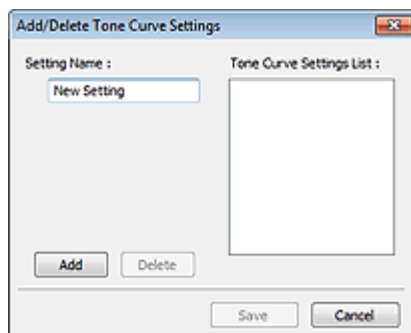

Enter Setting Name and click Add. The name appears in Tone Curve Settings List or Threshold Settings List.

Click Save to save.

You can load and apply the saved tone curve/threshold settings to a preview image. To load the settings, select the saved item from the pull-down menu.

To delete an item, select it in Tone Curve Settings List or Threshold Settings List and click Delete. Click Save to save settings displayed in Tone Curve Settings List or Threshold Settings List.

Note

- Save up to 20 items.
-

• Defaults

Reset all adjustments (saturation/color balance, brightness/contrast, histogram and tone curve).

[Page top](#)↑

Advanced Guide

Advanced Guide > Scanning > Scanning with Other Application Software > ScanGear (Scanner Driver) Screens > Auto Scan Mode Tab

S813



Auto Scan Mode Tab

This mode allows you to scan easily by simply placing documents on the Platen and clicking a button. On the Auto Scan Mode tab, documents are automatically detected. You do not need to specify cropping frames or make image corrections.

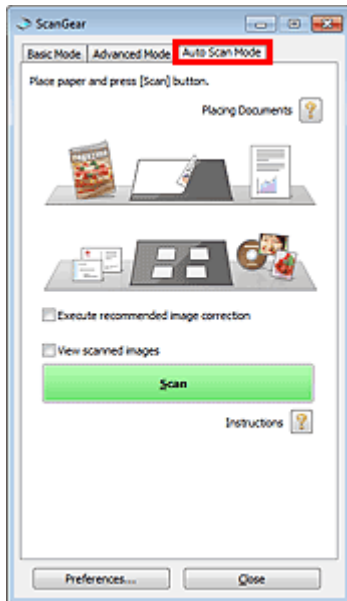

• Supported Documents

Photos, postcards, business cards, magazines, newspapers, text documents and BD/DVD/CD.

▶ Important

- The following types of documents cannot be scanned correctly. In that case, specify the document type or size on the Basic Mode tab or the Advanced Mode tab and scan.
 - A4 size photos
 - Text documents smaller than 2L (5 inches x 7 inches) (127 mm x 178 mm), such as paperback pages with the spine cut off
 - Documents printed on thin white paper
 - Long narrow documents such as panoramic photos
 - ➔ Scanning in Basic Mode
 - ➔ Scanning in Advanced Mode
- Reflective disc labels may not be scanned properly.
- Place documents correctly according to the type of document to be scanned. Otherwise, documents may not be scanned correctly. See "Placing Documents" for details on how to place documents.

📖 Note

- Scan from the "Basic Mode Tab" or "Advanced Mode Tab" to reduce moire.

• Placing Documents

"Placing Documents" appears.

• Execute recommended image correction

Select this checkbox to apply suitable corrections automatically based on the document type.

Important

- When this checkbox is selected in ScanGear (scanner driver) started from MP Navigator EX, the files can be saved in JPEG/Exif or PDF format only.
- Scanning may take longer than usual when this checkbox is selected.
- You can set this setting when Recommended is selected on the Color Settings tab of the Preferences dialog box.
- The color tone may change from the source image due to corrections. In that case, deselect the checkbox and scan.

● View scanned images

Select this checkbox to display the thumbnails of scanned images in a different window.

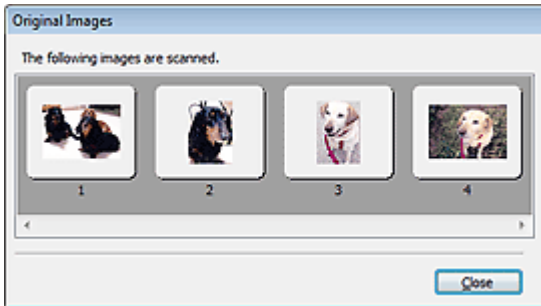

● Scan

Scanning starts.

Note

- When scanning starts, the progress will be displayed. Click Cancel to cancel the scan.
- When scanning is completed, a dialog box prompting you to select the next action may open. Follow the prompt to complete. For details, see Status of ScanGear dialog after scanning in "[Scan Tab](#)" (Preferences dialog box).

● Instructions

This page appears.

● Preferences...

The Preferences dialog box opens and you can make scan/preview settings.

[➔ Preferences Dialog Box](#)

● Close

Closes ScanGear.

Related Topic

[▶ Scanning in Auto Scan Mode](#)

[Page top](#)

Advanced Guide

Advanced Guide > Scanning > Scanning with Other Application Software > ScanGear (Scanner Driver) Screens > Preferences Dialog Box

S808

ScanGear

Preferences Dialog Box

Click Preferences... in the ScanGear (scanner driver) screen to open Preferences dialog box.

In the Preferences dialog box, you can make advanced settings to ScanGear functions via the Scanner, Preview, Scan and Color Settings tabs.

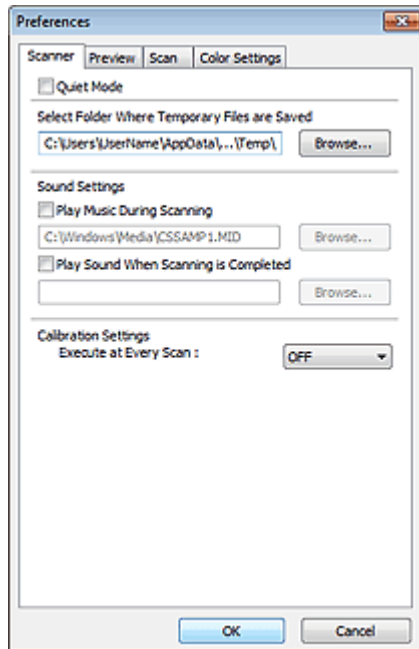

Scanner Tab

Allows you to specify a folder to save images temporarily and a music file to play during or at the end of a scan.

➡ [Scanner Tab](#)

Preview Tab

Allows you to select what to do with Preview when ScanGear is started and how to display cropping frames after previewing images. You can also select the cropping size for thumbnails of scanned documents.

➡ [Preview Tab](#)

Scan Tab

Allows you to select what to do with ScanGear after scanning images.

➡ [Scan Tab](#)

Color Settings Tab

Allows you to select how to adjust color, and specify the monitor gamma value.

➡ [Color Settings Tab](#)

[Page top](#)↑

Advanced Guide

Advanced Guide > Scanning > Scanning with Other Application Software > ScanGear (Scanner Driver) Screens > Scanner Tab

S812

ScanGear

Scanner Tab

On the Scanner tab, you can specify the following settings.

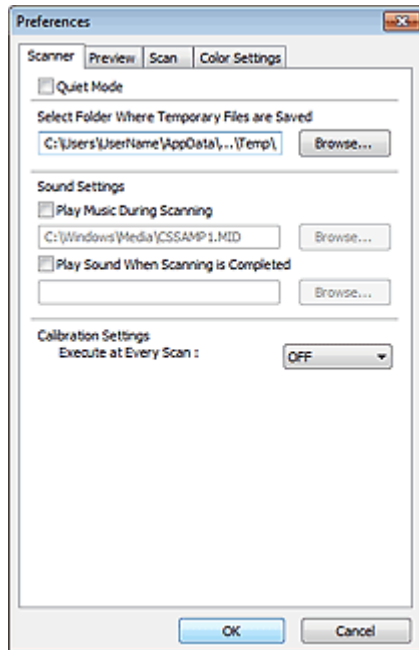

- **Quiet Mode**

Select this checkbox to reduce scanner sound by slowing down the scanner head when previewing or scanning documents.

Note

- Scanning takes longer than usual when you enable this function.

- **Select Folder Where Temporary Files are Saved**

Displays the folder in which to save images temporarily. To change the folder, click Browse... to specify another one.

- **Sound Settings**

You can set the machine to play music during/at the end of a scan.

Select the Play Music During Scanning or Play Sound When Scanning is Completed checkbox, then click Browse... and specify a sound file.

You can specify the following files.

- MIDI file (*.mid, *.rmi, *.midi)
- Audio file (*.wav, *.aif, *.aiff)
- MP3 file (*.mp3)

- **Calibration Settings**

When you set Execute at Every Scan to ON, the scanner will be calibrated every time before previewing and scanning, to reproduce correct color tones in scanned images.

Note

- Even when Execute at Every Scan is set to OFF, the scanner may be calibrated automatically in some cases (such as immediately after you turn the machine on).
- Calibration may take time depending on your computer.

[Page top](#) 

Advanced Guide

Advanced Guide > Scanning > Scanning with Other Application Software > ScanGear (Scanner Driver) Screens > Preview Tab

S809

ScanGear

Preview Tab

On the Preview tab, you can specify the following settings.

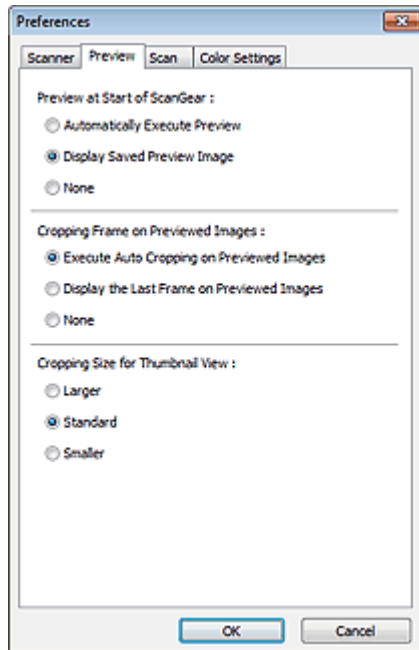

- **Preview at Start of ScanGear**

Select what to do with Preview when ScanGear (scanner driver) is started.

- **Automatically Execute Preview**

ScanGear will automatically start previewing at startup.

- **Display Saved Preview Image**

The previously previewed image will be displayed.

The Color Adjustment Button settings, the Toolbar settings, and the Advanced Mode tab settings are also saved.

- **None**

No preview image will be displayed at startup.

Note

- Select None if you do not want to save the preview image.

- **Cropping Frame on Previewed Images**

Select how to display cropping frames after previewing images.

- **Execute Auto Cropping on Previewed Images**

The cropping frame will automatically be displayed in the document size after previewing.

- **Display the Last Frame on Previewed Images**

A cropping frame of the same size as the last used cropping frame will be displayed after previewing.

- **None**

No cropping frame will be displayed after previewing.

- **Cropping Size for Thumbnail View**

Select the cropping size for thumbnails of scanned documents.

- **Larger**

Displays 105% (in width and height) of the area displayed for the standard size.

- **Standard**

The standard size.

- **Smaller**

Displays 95% (in width and height) of the area displayed for the standard size.

Note

- When you change the Cropping Size for Thumbnail View setting, the preview images will be refreshed and cropped to the new size. As the preview images are refreshed, the color adjustments and other settings applied to them are reset.
-

[Page top](#)[↕]

Advanced Guide

Advanced Guide > Scanning > Scanning with Other Application Software > ScanGear (Scanner Driver) Screens > Scan Tab

S810

ScanGear

Scan Tab

On the Scan tab, you can specify the following settings.

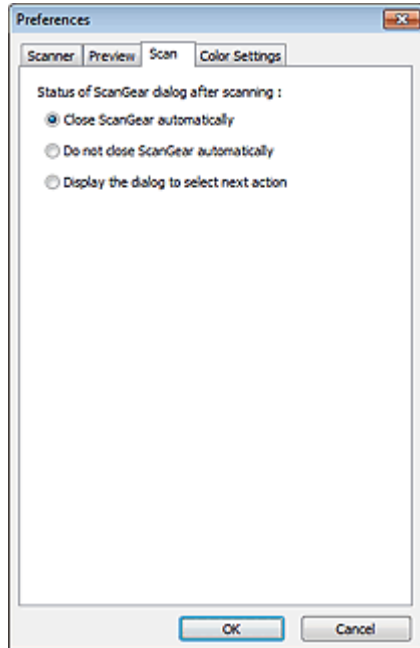

- **Status of ScanGear dialog after scanning**

Select what to do with ScanGear (scanner driver) after scanning images.

- **Close ScanGear automatically**

Select this to return to the original application when scanning is completed.

- **Do not close ScanGear automatically**

Select this to return to the ScanGear screen for another scan when scanning is completed.

- **Display the dialog to select next action**

Select this to open a screen and select what to do when scanning is completed.

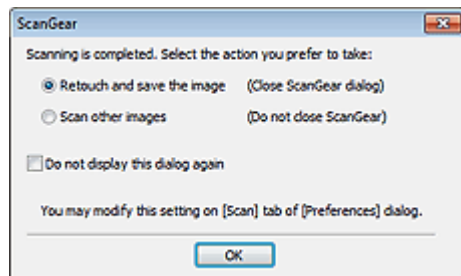

Note

- Even if Do not close ScanGear automatically or Display the dialog to select next action is set, some applications may not support it.

Advanced Guide

Advanced Guide > Scanning > Scanning with Other Application Software > ScanGear (Scanner Driver) Screens > Color Settings Tab

S811



Color Settings Tab

On the Color Settings tab, you can specify the following settings.

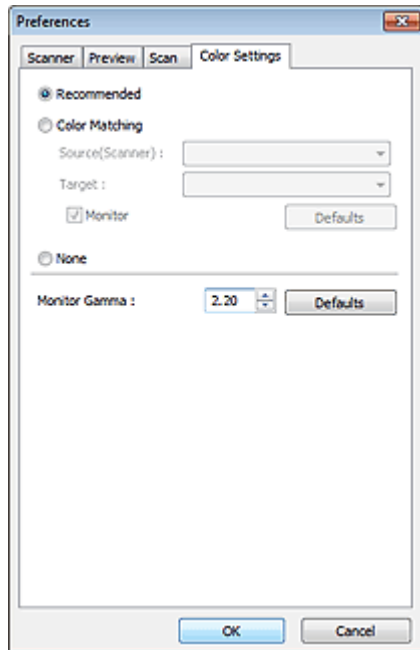

- **Color Adjustment**

Select either of the following.

You can select one when Color Mode is Color or Grayscale.

- **Recommended**

Select this to vividly reproduce the tone of a document on the screen. It is recommended that you normally select this setting.

- **Color Matching**

Select this to automatically match the scanner, monitor and color printer colors, thus reducing time and trouble to manually match the monitor and printer colors.

Color Adjustment Buttons will be disabled.

This function is available when Color Mode is Color.

- Source(Scanner): Select scanner profile.

- Target: Select target profile.

- Monitor: Select this to display preview image with optimum correction for monitor.

- Defaults: Returns to the default Color Matching settings.

- **None**

Select this to disable color correction provided by ScanGear (scanner driver).

Note

- Color Matching is available when ScanGear, monitor, color management-compliant application (such as Adobe Photoshop) and printer are set up correctly. Refer to the corresponding manual for the monitor, printer and application settings.

- **Monitor Gamma**

By setting the gamma value of a monitor, you can adjust the input data to the brightness

characteristics of the monitor. Adjust the value if your monitor's gamma value does not match the default value set in ScanGear, and the colors of the original image are not accurately reflected in the monitor.

Click Defaults to return to the default Monitor Gamma value (2.20).

Note

- Refer to the manual of your monitor to check its gamma value. If it is not written in the manual, contact the manufacturer.
-

[Page top](#) ↕

Advanced Guide

[Advanced Guide](#) > [Scanning](#) > [Scanning with Other Application Software](#) > [Appendix: Useful Information on Scanning](#)

S012

Appendix: Useful Information on Scanning

- **Adjusting the cropping frame (scan area)**
 - ➔ [Adjusting Cropping Frames](#)
- **Selecting the best resolution**
 - ➔ [Resolution](#)
- **Learning about file formats**
 - ➔ [File Formats](#)
- **Learning about Color Matching**
 - ➔ [Color Matching](#)
- **Matching the colors between the document and monitor**

See Monitor Gamma in the following section.

 - ➔ [Color Settings Tab](#)

[Page top](#)↑

Advanced Guide

Advanced Guide > Scanning > Scanning with Other Application Software > Appendix: Useful Information on Scanning > Adjusting Cropping Frames

S802

Adjusting Cropping Frames

You can specify the scan area by creating a cropping frame on the image displayed in the Preview area of the ScanGear (scanner driver) screen. When you click Scan, only the portion within the cropping frame will be scanned and passed to the application.

Cropping Frame Types



(1) Active Cropping Frame (rotating thick broken lines)

The settings on the Basic Mode tab or Advanced Mode tab will be applied.

(2) Selected Cropping Frame (stationary thick broken lines)

The settings will be applied to the Active Cropping Frame and Selected Cropping Frames simultaneously. You can select multiple cropping frames by clicking them while pressing the Ctrl key.

(3) Unselected Cropping Frame (stationary thin broken lines)

The settings will not be applied.

Note

- Active Cropping Frame and Selected Cropping Frames are displayed in whole image view.

Initial Cropping Frame

In thumbnail view

Cropping frame is not displayed initially. Drag the mouse over a frame to create a cropping frame.

In whole image view

A cropping frame (Active Cropping Frame) is displayed automatically around the preview image according to the document size. You can also create a cropping frame by dragging the mouse in the Preview area.

Note

- Cropping frames are set according to the document size (Auto Crop) by default. For details, see Cropping Frame on Previewed Images in "Preview Tab" (Preferences dialog box).

Adjusting a Cropping Frame





The cursor will change into  (Arrow) when it is positioned over a cropping frame. If you click and drag the mouse in the direction of the arrow, the cropping frame will expand or contract accordingly.



The cursor will change into  (Crosshair arrow) when it is positioned within a cropping frame. Click and drag the mouse to move the entire cropping frame.



Note

- In Advanced Mode tab, you can specify the cropping frame size by entering the values into  (Width) and  (Height) in Input Settings.
→ [Input Settings](#)
- You can rotate a cropping frame 90 degrees by clicking  (Switch Aspect Ratio). However,  (Switch Aspect Ratio) is not available when Output Size is Flexible.

Creating Multiple Cropping Frames

In thumbnail view

You can only create one cropping frame per image.

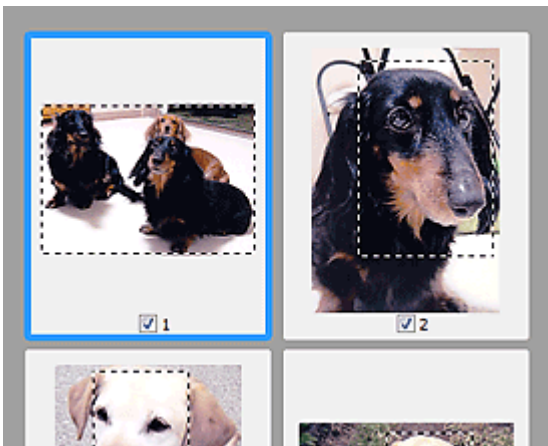

In whole image view

Click and drag the mouse in a space outside the existing cropping frame to create a new cropping frame in the Preview area. The new cropping frame will be the Active Cropping Frame, and the old cropping frame will be the Unselected Cropping Frame.

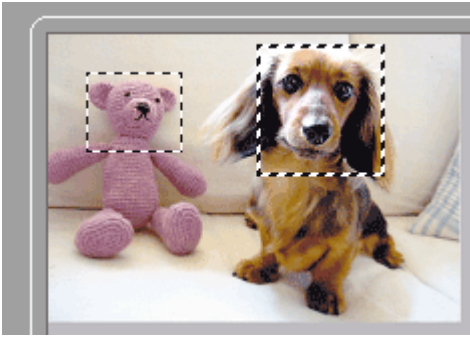

You can create multiple cropping frames and apply different scan settings to each cropping frame.

You can also select multiple cropping frames by clicking them while pressing the Ctrl key.

If you select multiple cropping frames and change the settings on a tab at the right of ScanGear, the settings will be applied to all the selected cropping frames.

When you create a new cropping frame, it retains the settings of the latest cropping frame.

Note

- Create up to 12 cropping frames.
- Scanning takes longer than usual when multiple cropping frames are selected.

Deleting Cropping Frames

In thumbnail view

To delete a cropping frame, click an area outside the cropping frame on an image.

In whole image view

To delete a cropping frame, select it and click  (Remove Cropping Frame) on the Toolbar. Alternatively, press the Delete key.

When there are multiple cropping frames, all the selected cropping frames (Active Cropping Frame and Selected Cropping Frames) are deleted simultaneously.

[Page top](#) 

Advanced Guide

Advanced Guide > Scanning > Scanning with Other Application Software > Appendix: Useful Information on Scanning > Resolution

S309

Resolution

What is Resolution?

The data in the image you have scanned is a collection of dots carrying information about brightness and color. The density of these dots is called "resolution", and resolution will determine the amount of detail your image contains. The unit of resolution is dots per inch (dpi). Dpi is the number of dots per inch (2.54 cm).

The higher the resolution (value), the more detail in your image; the lower the resolution (value), the less detail.

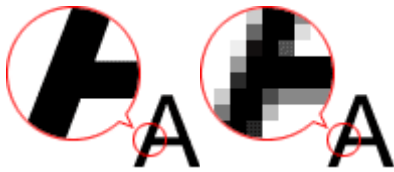

Setting the Resolution in MP Navigator EX

In MP Navigator EX, you can specify the resolution with Scanning Resolution in the Scan Settings dialog box.

Images for Display on a Monitor

Paper/photographs to be viewed on a display should be scanned at 150 dpi, which is close to ordinary monitor resolution.

Images for Printing

Images to be printed should be scanned at a resolution that corresponds to the resolution of the printer.



For example, if you want to print using a 600 dpi black and white printer, you should set the resolution to 600 dpi.

With a color printer, specifying the resolution at half the resolution of the printer should be fine. For example, if you want to print scanned paper/photos using a 600 dpi color printer, you should set the resolution to 300 dpi. However, with a high-resolution printer, printing takes longer than usual if you set the resolution to half the resolution of the printer.

Example of Appropriate Resolution when Printing to Scale

If you print a document at twice the size both vertically and horizontally, the resolution of the document will be reduced by half. If the resolution of the original document is 300 dpi, the resolution of the enlarged document will be 150 dpi. If you print the document with a 600 dpi color printer, the lack of detail in the image may be obvious. In that case, if you scan at the Scanning Resolution of 600 dpi, the resolution will be 300 dpi even if you double the size of document and you can print the document with sufficient quality. Conversely, if you print a document at half scale, it should be sufficient to scan at half the resolution.

When Printing Color Photos at Twice the Size

		
<p>Document resolution: 300 dpi Scanning resolution: 600</p>	<p>Print at twice the size Scanning resolution/actual scanning resolution: 600 dpi</p>	<p>Printing resolution: 300 dpi</p>

dpi Scale: 200%		
--------------------	--	--



Setting the Resolution in ScanGear (Scanner Driver)

In ScanGear, you can specify the resolution with Output Resolution in Output Settings on the Advanced Mode tab.

Example of Appropriate Resolution when Printing to Scale

The scanning resolution is automatically set so that the value set in Output Resolution will be the resolution of the scanned image. If you set Output Resolution to 300 dpi and scan at twice the size, the document will be automatically scanned at 600 dpi, and the resolution of the scanned image will be 300 dpi. You can print the document with sufficient quality using a 600 dpi color printer.

When Printing L Size (3.5 inches x 5 inches) (89 mm x 127 mm) Photos at Twice the Size

		
Document resolution: 300 dpi Output resolution: 300 dpi Scale: 200%	Scan at twice the size Actual scanning resolution: 600 dpi	Image resolution/printing resolution: 300 dpi

Appropriate Resolution Settings

Set the resolution according to the use of the scanned image.

Note

- Although you can change Output Resolution in ScanGear, it is recommended that you scan at the default value.

For displaying on a monitor: 150 dpi

For printing: 300 dpi

When Output Size is set to Flexible in ScanGear's Advanced Mode tab (Select Source is Platen and the scale is 100%)

Document	Use	Color Mode	Output Resolution
Color photo	Copying (Printing)	Color	300 dpi
	Creating a postcard	Color	300 dpi
	Saving to a computer	Color	75 dpi - 300 dpi
	Using on a website or attaching to e-mail	Color	75 dpi - 150 dpi
Black and white photo	Saving to a computer	Grayscale	75 dpi - 300 dpi
	Using on a website or attaching to e-mail	Grayscale	75 dpi - 150 dpi
Text document	Copying	Color, Grayscale or Black and White	300 dpi
	Attaching to e-mail	Color, Grayscale or Black and White	150 dpi
	Scanning text using OCR	Color or Grayscale	300 dpi - 400

			dpi
--	--	--	-----

Important

- If you double the resolution, the file size quadruples. If the file is too large, the processing speed will slow down significantly, and you will experience inconvenience such as lack of memory. Set the minimum required resolution according to the use of the image.

[Page top](#)

Advanced Guide

Advanced Guide > Scanning > Scanning with Other Application Software > Appendix: Useful Information on Scanning > File Formats

S310

File Formats

You can select a file format when saving scanned images. You should specify the most suitable format according to how you want to use the image on which application.

Available file formats vary by application and computer (Windows or Macintosh).

See below for the characteristics of each image file format.

BMP (Standard File Extension: .bmp)

A standard file format for Windows.

BMP is often selected for images that are used only on Windows.

JPEG (Standard File Extension: .jpg)

A file format often used on websites and for digital camera images.

JPEG features high compression rates. JPEG images slightly degrade every time they are saved, and cannot be returned to their original state.

JPEG is not available for black and white images.

Exif (Standard File Extension: .jpg)

A file format supported by many digital cameras.

It adds information such as the date of image capture, camera model, shutter speed, shooting mode and comments to JPEG files.

The file format version must be Exif 2.2 or later in order to print on a Direct Print compatible printer.

TIFF (Standard File Extension: .tif)

A file format featuring a relatively high compatibility between various computers and applications. (Some TIFF files are incompatible.) TIFF is suitable for editing saved images.



Note

- MP Navigator EX supports the following TIFF file formats.
 - Uncompressed, black and white binary
 - Uncompressed, RGB (8 bits per channel)
 - Uncompressed, YCC (8 bits per component)
 - Uncompressed, RGB (16 bits per channel)
 - Uncompressed, YCC (16 bits per component)
 - Uncompressed, Grayscale
-

PDF (Standard File Extension: .pdf)

A file format developed by Adobe Systems. It can be used on various computers and operating systems. Therefore, PDF files can be exchanged between people who use different operating systems, fonts, etc. regardless of the differences.



Important

- Only PDF files created with MP Navigator EX are supported. PDF files created or edited in other applications are not supported.
-

Advanced Guide

Advanced Guide > Scanning > Scanning with Other Application Software > Appendix: Useful Information on Scanning > Color Matching

S815

Color Matching

Color Matching adjusts devices as shown below to match the colors of an image displayed on a monitor or a printed image with the colors of the original document.

Example: When sRGB is selected as the output profile (target)

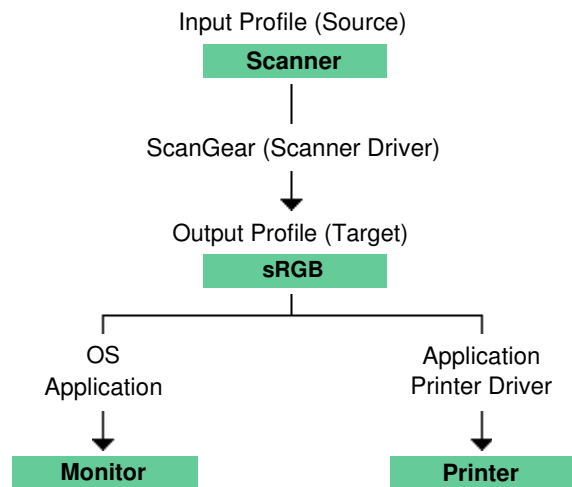

ScanGear converts the image's color space from the scanner's color space to sRGB.

When displaying on a monitor, the image's color space is converted from sRGB to the monitor's color space based on the operating system's monitor settings and the application's working space settings.

When printing, the image's color space is converted from sRGB to the printer's color space based on the application's print settings and the printer driver's settings.

[Page top](#)

Advanced Guide

[Advanced Guide](#) > [Scanning](#) > [Other Scanning Methods](#)

Other Scanning Methods

- ➡ [Scanning with WIA Driver](#)
- ➡ [Scanning Using the Control Panel \(Windows XP Only\)](#)

[Page top](#) ↕

Advanced Guide

Advanced Guide > Scanning > Other Scanning Methods > Scanning with WIA Driver

S604

Scanning with WIA Driver

You can scan an image from a WIA-compliant application and use the image in that application.

Windows Image Acquisition (WIA) is a driver model implemented in Windows XP or later. It allows you to scan documents without using an application. Scan documents from a TWAIN-compliant application to specify advanced settings for scanning.

The procedure varies depending on the application. The following procedures are examples only.

For details, refer to the application's manual.

Scanning with WIA Driver 2.0

The following is an example of scanning using "Windows Fax and Scan."

1. Place the document on the Platen.

➔ [Placing Documents](#)

2. Click Scan... from New on the File menu.

The scan setting screen appears.

3. Specify the settings.

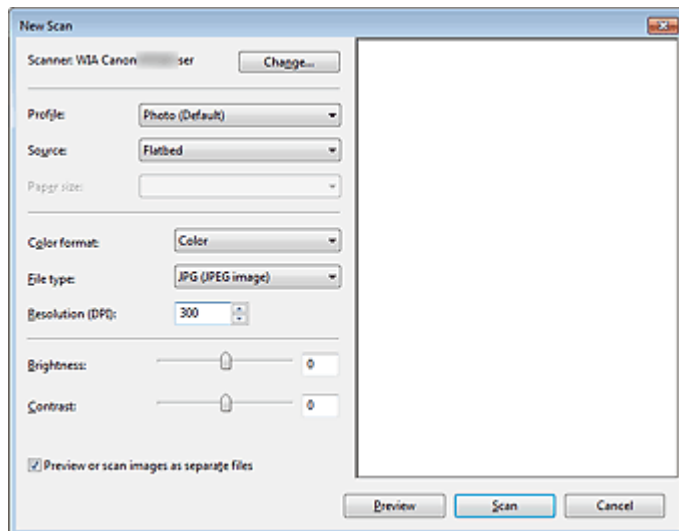

- **Scanner**

The currently set product name is displayed. To change the scanner, click Change... and select the product you want to use.

- **Profile**

Select Photo (Default) or Documents according to the document to be scanned. To save a new Profile, select Add profile.... You can specify the details in the Add New Profile dialog box.

- **Source**

Select a scanner type.

- **Paper size**

This setting is not available for this machine.

- **Color format**

Select how to scan the document.

- **File type**
Select a file format from JPEG, BMP, PNG and TIFF.
- **Resolution (DPI)**
Enter the resolution. Specify a value between 50 dpi and 600 dpi. 300 dpi is set by default.
➔ [Resolution](#)
- **Brightness**
Move the slider to adjust the brightness. Move it to the left to darken and right to brighten the image. You can also enter a value (-100 to 100).
- **Contrast**
Move the slider to adjust the contrast. Moving it to the left will decrease the contrast of the image, thus softening the image. Moving it to the right will increase the contrast of the image, thus sharpening the image. You can also enter a value (-100 to 100).
- **Preview or scan images as separate files**
Select this checkbox to preview or scan multiple images as separate files.

4. Click Preview to preview the image.

The preview image appears on the right.

5. Click Scan.

When scanning is completed, the scanned image appears in the application.

Scanning with WIA Driver 1.0

The following is an example of scanning using "Paint."

1. Place the document on the Platen.

➔ [Placing Documents](#)

2. Click From scanner or camera from . (Select the command to scan a document in the application.)

3. Select an image type according to the document to be scanned.

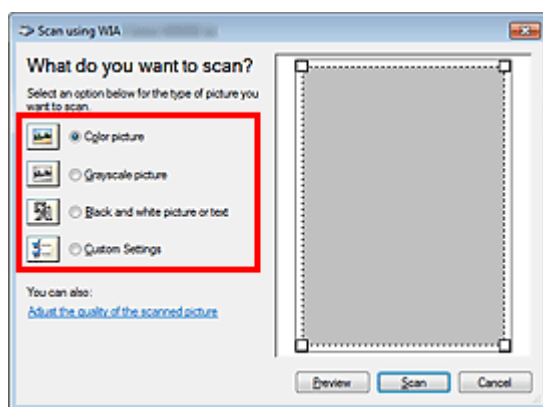

Note

- To scan with the values previously set in Adjust the quality of the scanned picture, select Custom Settings.

4. Click Adjust the quality of the scanned picture and set the preferences as required.

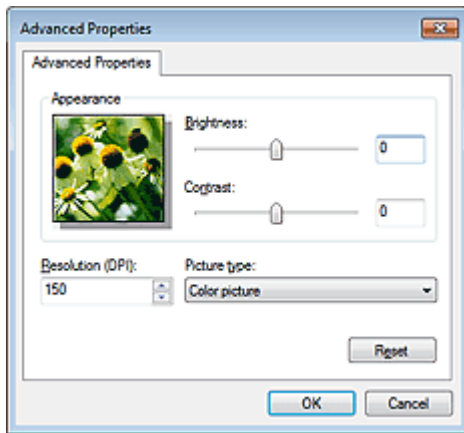

- **Brightness**

Move the slider to adjust the brightness. Move it to the left to darken and right to brighten the image. You can also enter a value (-127 to 127).

- **Contrast**

Move the slider to adjust the contrast. Moving it to the left will decrease the contrast of the image, thus softening the image. Moving it to the right will increase the contrast of the image, thus sharpening the image. You can also enter a value (-127 to 127).

- **Resolution (DPI)**

Enter the resolution. Specify a value between 50 dpi and 600 dpi.

➔ Resolution

- **Picture type**

Select the type of scan you want for your document.

- **Reset**

Click to restore the original settings.

5. Click Preview to preview the image.

The preview image appears on the right. Drag to specify the scan area.

6. Click Scan.

When scanning is completed, the scanned image appears in the application.

Advanced Guide

Advanced Guide > Scanning > Other Scanning Methods > Scanning Using the Control Panel (Windows XP Only)

S605

Scanning Using the Control Panel (Windows XP Only)

You can scan images via the Control Panel of Windows XP using the WIA driver.

1. From the Start menu, select Control Panel.
2. Click Printers and Other Hardware > Scanners and Cameras, then double-click WIA Canon (model name).

The Scanner and Camera Wizard dialog box opens.

3. Click Next.
4. Select Picture type according to the document to be scanned.

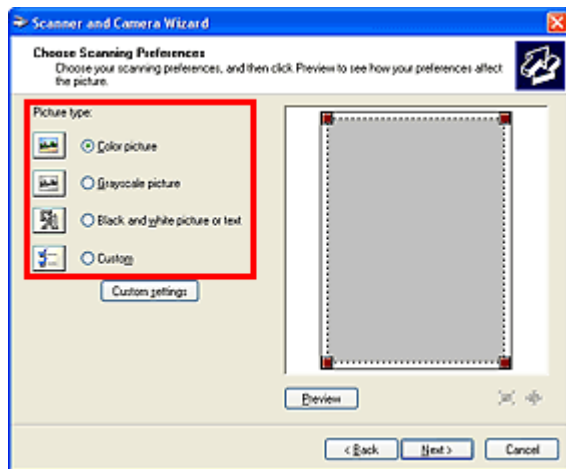

Note

- To scan with the values previously set in Custom settings, select Custom.

5. Click Custom settings to set the preferences as required.

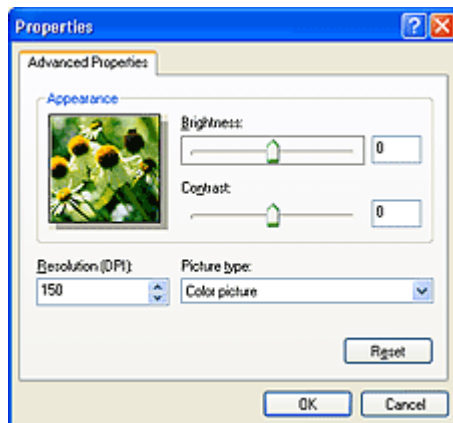

- **Brightness**

Move the slider to adjust the brightness. Move it to the left to darken and right to brighten the image. You can also enter a value (-127 to 127).

- **Contrast**

Move the slider to adjust the contrast. Moving it to the left will decrease the contrast of the image, thus softening the image. Moving it to the right will increase the contrast of the image, thus sharpening the image. You can also enter a value (-127 to 127).

- **Resolution (DPI)**

Enter the resolution. Specify a value between 50 dpi and 600 dpi.

➡ Resolution

- **Picture type**

Select the type of scan you want for your document.

- **Reset**

Click to restore the original settings.

6. Click Preview to preview the image.

The preview image appears on the right. Drag  to specify the scan area.

7. Click Next and follow the instructions.

[Page top](#)↑

Advanced Guide

Advanced Guide > Maintenance

Maintenance

- ➔ [Cleaning Your Machine](#)
- ➔ [Aligning the Print Head](#)
- ➔ [Performing Maintenance from a Computer](#)

[Page top](#) ↑

Advanced Guide

[Advanced Guide](#) > [Maintenance](#) > [Cleaning Your Machine](#)

Cleaning Your Machine

- ➔ [Cleaning](#)
- ➔ [Cleaning the Exterior of the Machine](#)
- ➔ [Cleaning the Platen Glass and Document Cover](#)

[Page top](#) ↑

Advanced Guide

[Advanced Guide](#) > [Maintenance](#) > [Cleaning Your Machine](#) > [Cleaning](#)

U059

Cleaning

This section describes the cleaning procedure that is needed to maintain your machine.

Important

- Do not use tissue paper, paper towels, rough-textured cloth, or similar materials for cleaning the exterior of the machine so as not to scratch the surface. Be sure to use a soft cloth.
- Never use volatile liquids such as thinners, benzene, acetone, or any other chemical cleaner to clean the machine, as this may cause a malfunction or damage the machine's surface.

➔ [Cleaning the Exterior of the Machine](#)

➔ [Cleaning the Platen Glass and Document Cover](#)

[Page top](#) ↑

Advanced Guide

[Advanced Guide](#) > [Maintenance](#) > [Cleaning Your Machine](#) > [Cleaning the Exterior of the Machine](#)

U060

Cleaning the Exterior of the Machine

Be sure to use a soft cloth such as eyeglasses cleaning cloth and wipe off dirt on the surface gently. Smooth out wrinkles on the cloth if necessary before cleaning.

Important

- Be sure to turn off the power and disconnect the power plug before cleaning the machine.
- Do not use tissue paper, paper towels, rough-textured cloth, or similar materials, as this may scratch the surface.

[Page top](#) ↑

Advanced Guide

Advanced Guide > Maintenance > Cleaning Your Machine > Cleaning the Platen Glass and Document Cover

U061

Cleaning the Platen Glass and Document Cover

▶ Important

- Be sure to turn off the power and disconnect the power plug before cleaning the machine.

With a clean, soft, lint-free cloth, wipe the Platen Glass (A) and the inner side of the Document Cover (white sheet) (B) gently. Be sure not to leave any residue, especially on the Platen Glass.



▶ Important

- The inner side of the Document Cover (white sheet) (B) is easily damaged, so wipe it gently.

[Page top ↑](#)

Advanced Guide

[Advanced Guide](#) > [Maintenance](#) > [Aligning the Print Head](#)

Aligning the Print Head

➔ [Aligning the Print Head](#)

[Page top](#) ↑

Advanced Guide

Advanced Guide > Maintenance > Aligning the Print Head > Aligning the Print Head

U096

Aligning the Print Head

If printed ruled lines are misaligned or print results are otherwise unsatisfactory, adjust the print head position.

Note

- If the remaining ink level is low, the print head alignment sheet will not be printed correctly. Replace the FINE Cartridge whose ink is low.

➔ Routine Maintenance

1. Make sure that the power is turned on.
2. Load a sheet of A4 or Letter-sized plain paper in the Rear Tray.
3. Open the Paper Output Tray gently, and open the Output Tray Extension.
4. Print the print head alignment sheet.
 1. Press the **Maintenance** button repeatedly until the LED displays as follows.



2. Press the **Black** or **Color** button.

The print head alignment sheet will be printed.

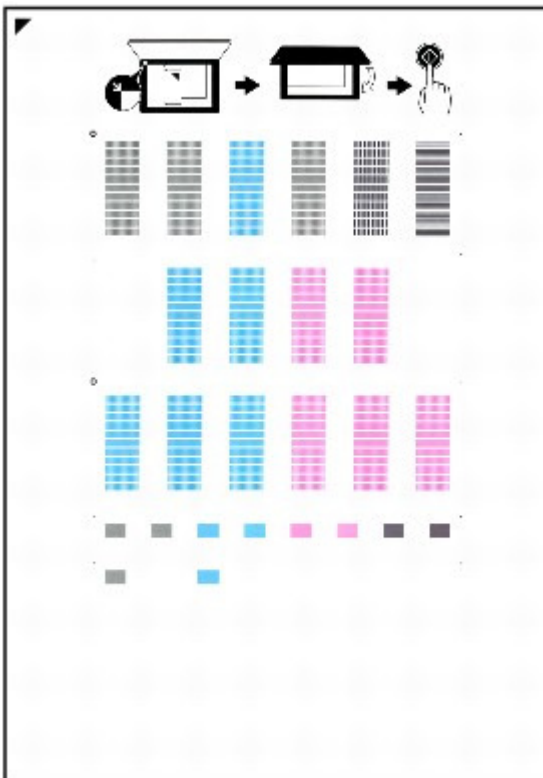



Important

- Do not touch any printed part on the print head alignment sheet.
- Be careful not to get the print head alignment sheet dirty. If the sheet is stained or wrinkled,

it may not be scanned properly.

5. Scan the print head alignment sheet to adjust the print head position.

1. Load the print head alignment sheet on the Platen Glass.

Load the print head alignment sheet WITH THE PRINTED SIDE FACING DOWN and align the mark  on the upper left corner of the sheet with the alignment mark ().



2. Close the Document Cover gently, make sure that the LED displays as follows, and press the **Black** or **Color** button.



The machine starts scanning the print head alignment sheet, and the print head position will be adjusted automatically.

When adjusting the print head position is completed, the LED returns to the copy standby mode. Remove the sheet on the Platen Glass.

Important

- Do not open the Document Cover or move the loaded print head alignment sheet until scanning is completed.
- If adjusting the auto print head position has failed, the error code will appear on the LED.
➔ [An Error Code Is Displayed on the LED](#)

Note

- If the print results are still not satisfactory after adjusting the print head position as described above, adjust the print head position manually from the computer.
➔ [Aligning the Print Head Position](#)
- To print the current head position adjustment values, display the LED as follows, then press the **Black** or **Color** button.



Advanced Guide

Advanced Guide > Maintenance > Performing Maintenance from a Computer

Performing Maintenance from a Computer

- ➔ Cleaning the Print Heads
- ➔ Cleaning the Paper Feed Rollers
- ➔ Aligning the Print Head Position
- ➔ Checking the Print Head Nozzles
- ➔ Cleaning Inside the Machine

[Page top](#) ↕

Advanced Guide

Advanced Guide > Maintenance > Performing Maintenance from a Computer > Cleaning the Print Heads

P026

Cleaning the Print Heads

The print head cleaning function allows you to unclog clogged nozzles in the print head. Perform print head cleaning if printing is faint or a specific color fails to print, even though there is enough ink.

The procedure for cleaning the print heads is as follows:



Cleaning

1. Open the **printer driver setup window**

2. Click Cleaning on the Maintenance tab

The Print Head Cleaning dialog box opens. Follow the instruction shown in the dialog box. Click Initial Check Items to display the items you need to check before performing Cleaning.

3. Execute cleaning

Make sure that the machine is on and then click Execute.

Print head cleaning starts.

4. Complete cleaning

The Nozzle Check dialog box opens after the confirmation message.

5. Check the results

To check whether the print quality has improved, click Print Check Pattern. To cancel the check process, click Cancel.

If cleaning the head once does not resolve the print head problem, clean it once more.



Deep Cleaning

Deep Cleaning is more thorough than cleaning. Perform deep cleaning when two Cleaning attempts do not resolve the print head problem.

1. Open the **printer driver setup window**

2. Click Deep Cleaning on the Maintenance tab

The Deep Cleaning dialog box opens. Follow the instruction shown in the dialog box.

Click Initial Check Items to display the items you need to check before performing Deep Cleaning.

3. Execute deep cleaning

Make sure that the machine is on and then click Execute.

Click OK when the confirmation message appears.

Print head deep cleaning starts.

4. Complete deep cleaning

The Nozzle Check dialog box opens after the confirmation message.

5. Check the results

To check whether the print quality has improved, click Print Check Pattern. To cancel the check process, click Cancel.

Important

- Cleaning consumes a small amount of ink. Deep Cleaning consumes a larger amount of ink than Cleaning. Cleaning the print heads frequently will rapidly deplete your printer's ink supply. Consequently, perform cleaning only when necessary.

Note

- If there is no sign of improvement after Deep Cleaning, switch off the machine, wait 24 hours, and then perform Deep Cleaning again. If there is still no sign of improvement, see "[Machine Moves But Ink Is Not Ejected.](#)"

Related Topic

[➔ Checking the Print Head Nozzles](#)

[Page top ↕](#)

Advanced Guide

[Advanced Guide](#) > [Maintenance](#) > [Performing Maintenance from a Computer](#) > [Cleaning the Paper Feed Rollers](#)

P027

Cleaning the Paper Feed Rollers

Cleans the paper feed roller. Perform feed roller cleaning when there are paper particles sticking to the paper feed roller and paper is not fed properly.

The procedure for performing the feed roller cleaning is as follows:

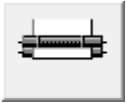

Roller Cleaning

1. Prepare the machine

Remove all sheets of paper from the rear tray.

2. Open the [printer driver setup window](#)

3. Click Roller Cleaning on the Maintenance tab

The confirmation message appears.

4. Execute paper feed roller cleaning

Make sure that the machine is on and click OK.
Paper feed roller cleaning starts.

5. Complete paper feed roller cleaning

After the rollers have stopped, follow the instruction in the message, load three sheets of plain paper into the rear tray, and click OK.

Paper will be ejected and feed roller cleaning will be completed.

[Page top](#) ↑

Advanced Guide

Advanced Guide > Maintenance > Performing Maintenance from a Computer > Aligning the Print Head Position

P028

Aligning the Print Head Position

Print head alignment corrects the installation positions of the print head and improves deviated colors and lines.

This machine supports two head alignment methods: automatic head alignment and manual head alignment.

To perform automatic head alignment, refer to "Aligning the Print Head" in the manual: Basic Guide and then execute the function from the operation panel of the machine.

The procedure for performing manual print head alignment is as follows:



Print Head Alignment

- 1. Open the printer driver setup window**
- 2. Click Custom Settings on the Maintenance tab**
The Custom Settings dialog box opens.
- 3. Switch head alignment to manual**
Check the Align heads manually check box.
- 4. Transmit the settings**
Click Send and when the confirmation message appears, click OK.
- 5. Click Print Head Alignment on the Maintenance tab**
The Start Print Head Alignment dialog box opens.
- 6. Load paper in the machine**
Load three sheets of A4 size or Letter size plain paper into the rear tray.
- 7. Execute head alignment**
Make sure that the machine is on and click Align Print Head.
Follow the instruction in the message.
- 8. Check the printed pattern**
Enter the numbers of the patterns with the least amount of streaks in the associated boxes.
Clicking the patterns with the least amount of streaks in the preview window, will automatically set their numbers in the associated boxes.



When you have entered all the necessary values, click OK.

Note

- If it is difficult to pick the best pattern, pick the setting that produces the least noticeable vertical white streaks.



- (A) Less noticeable vertical white streaks
 (B) More noticeable vertical white streaks

- If it is difficult to pick the best pattern, pick the setting that produces the least noticeable horizontal white streaks.



- (A) Less noticeable horizontal white streaks
 (B) More noticeable horizontal white streaks

9. Confirm the displayed message and click OK

The second pattern is printed.

Important

- Do not open the Scanning Unit (Cover) while printing is in progress.

10. Check the printed pattern

Enter the numbers of the patterns with the least amount of streaks in the associated boxes. Clicking the patterns with the least amount of streaks in the preview window, will automatically set their numbers in the associated boxes.

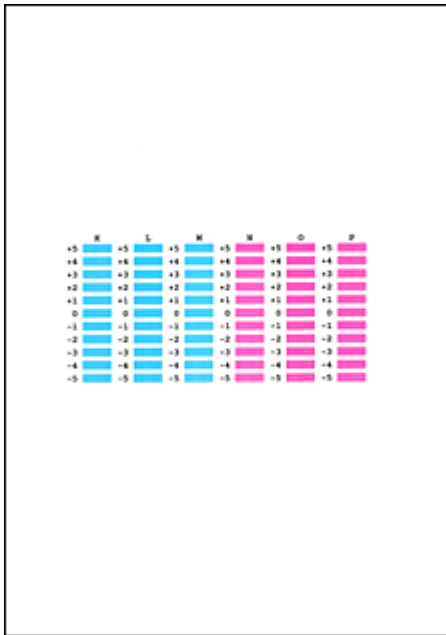

When you have entered all the necessary values, click OK.

Note

- If it is difficult to pick the best pattern, pick the setting that produces the least noticeable vertical white streaks.



- (A) Less noticeable vertical white streaks
 (B) More noticeable vertical white streaks

11. Confirm the displayed message and click OK

The third pattern is printed.

Important

- Do not open the Scanning Unit (Cover) while printing is in progress.

12. Check the printed pattern

Enter the numbers of the patterns with the least noticeable horizontal stripes in the associated boxes.

Clicking the patterns with the least noticeable horizontal stripes in the preview window, will automatically set their numbers in the associated boxes.

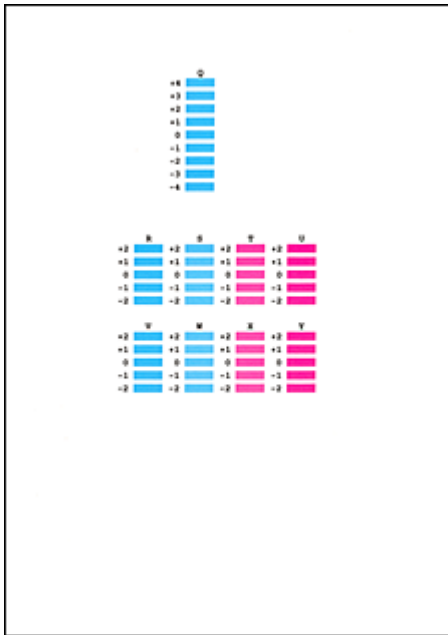

When you have entered all the necessary values, click OK.

Note

- If it is difficult to pick the best pattern, pick the setting that produces the least noticeable horizontal white stripes.



- (A) Less noticeable horizontal white stripes
- (B) More noticeable horizontal white stripes

Note

- To print and check the current setting, open the Start Print Head Alignment dialog box, and click Print Alignment Value.

Advanced Guide

[Advanced Guide](#) > [Maintenance](#) > [Performing Maintenance from a Computer](#) > [Checking the Print Head Nozzles](#)

P029

Checking the Print Head Nozzles

The nozzle check function allows you to check whether the print heads are working properly by printing a nozzle check pattern. Print the pattern if printing becomes faint, or if a specific color fails to print.

The procedure for printing a nozzle check pattern is as follows:



Nozzle Check

1. Open the printer driver setup window

2. Click Nozzle Check on the Maintenance tab

The Nozzle Check dialog box opens.

Click Initial Check Items to display the items that you need to check before printing the nozzle check pattern.

3. Load paper in the machine

Load a sheet of A4 size or Letter size plain paper into the rear tray.

4. Print a nozzle check pattern

Make sure that the machine is on and click Print Check Pattern.

Printing of the nozzle check pattern begins.

Click OK when the confirmation message appears.

The Pattern Check dialog box opens.

5. Check the print result

Check the print result. When the print result is normal, click Exit.

If the print result is smudged or if there are any unprinted sections, click Cleaning to clean the print head.

Related Topic

➔ [Cleaning the Print Heads](#)

Advanced Guide

[Advanced Guide](#) > [Maintenance](#) > [Performing Maintenance from a Computer](#) > [Cleaning Inside the Machine](#)

P030

Cleaning Inside the Machine

Perform bottom plate cleaning before you execute duplex printing to prevent smudges on the back side of the paper.

Also perform bottom plate cleaning if ink smudges caused by something other than print data appear on the printed page.

The procedure for performing bottom plate cleaning is as follows:



Bottom Plate Cleaning

1. Open the [printer driver setup window](#)
2. Click Bottom Plate Cleaning on the Maintenance tab

The Bottom Plate Cleaning dialog box opens.

3. Load paper in the machine

As instructed in the dialog box, fold the A4 size or Letter size plain paper in half horizontally, and then unfold the sheet.

Load the paper into the rear tray in the portrait orientation with the crest of the crease facing down.

4. Perform the bottom plate cleaning

Make sure that the machine is on and click Execute.

Bottom plate cleaning starts.

[Page top](#) ↑

Advanced Guide

Advanced Guide > Changing the Machine Settings

Changing the Machine Settings

➔ [Changing Machine Settings from Your Computer](#)

[Page top](#) ↑

Advanced Guide

[Advanced Guide](#) > [Changing the Machine Settings](#) > [Changing Machine Settings from Your Computer](#)

Changing Machine Settings from Your Computer

- ➔ [Changing the Print Options](#)
- ➔ [Registering a Frequently Used Printing Profile](#)
- ➔ [Setting the Ink Cartridge to be Used](#)
- ➔ [Managing the Machine Power](#)
- ➔ [Reducing the Machine Noise](#)
- ➔ [Changing the Machine Operation Mode](#)

[Page top](#) ↕

Advanced Guide

Advanced Guide > Changing the Machine Settings > Changing Machine Settings from Your Computer > Changing the Print Options

P413

Changing the Print Options

You change the detailed print driver settings for print data that is sent from an application software. Specify this option if you encounter print failures such as part of an image data being cut off.

The procedure for changing the print options is as follows:

1. Open the **printer driver setup window**
2. Click **Print Options...** on the **Page Setup** tab

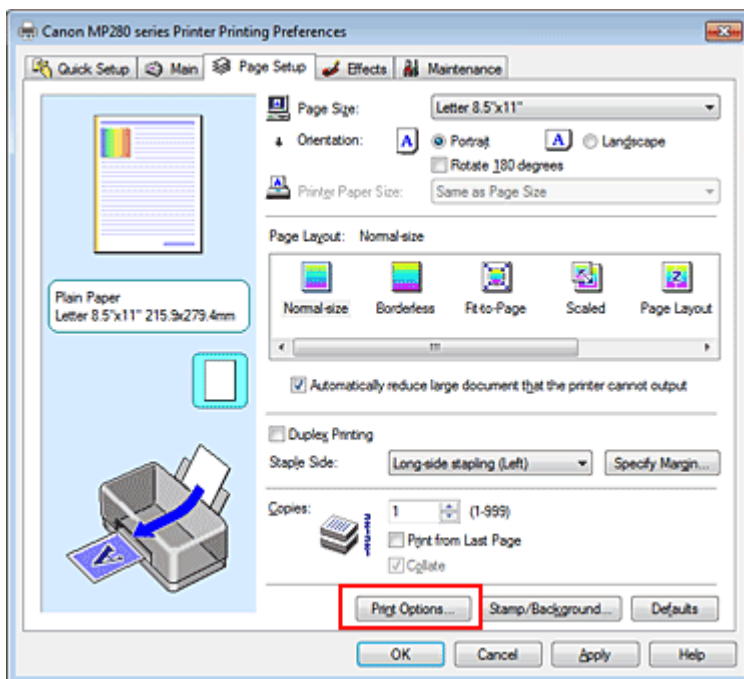

The Print Options dialog box opens.

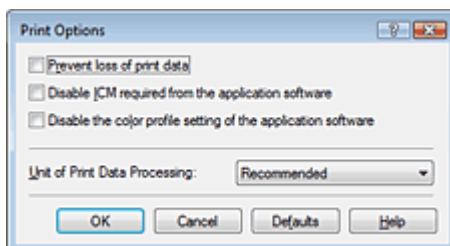

Note

- When the XPS printer driver is used, certain functions are not available.

3. Change the individual settings

If necessary, change the setting of each item, and then click OK.

The Page Setup tab is displayed again.

Advanced Guide

Advanced Guide > Changing the Machine Settings > Changing Machine Settings from Your Computer > Registering a Frequently Used Printing Profile

P417

Registering a Frequently Used Printing Profile

You can register the frequently used printing profile to Commonly Used Settings on the Quick Setup tab. Unnecessary printing profiles can be deleted at any time.

The procedure for registering a printing profile is as follows:

Registering a Printing Profile

1. Open the [printer driver setup window](#)
2. Set the necessary items

From Commonly Used Settings on the Quick Setup tab, select the printing profile to be used and if necessary, change the settings after Additional Features.

You can also register necessary items on the Main, Page Setup, and Effects tabs.

Note

- Effects tab cannot be used when the XPS printer driver is used.

3. Click Save...

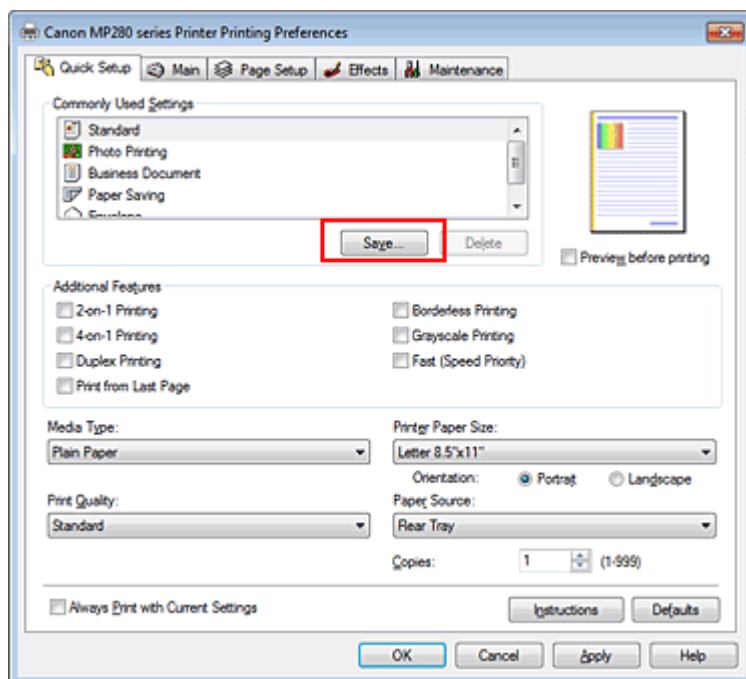

The Save Commonly Used Settings dialog box opens.

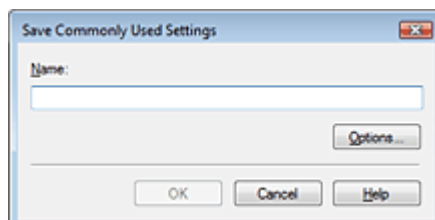

4. Save the settings

Enter a name in the Name field, and if necessary, set the items in Options.... Then click OK.
The printing profile is saved, and the Quick Setup tab is displayed again.
The name and icon are added to the Commonly Used Settings list.

Important

- To save the page size, orientation, and number of copies that was set in each sheet, click Options..., and check each item.

Note

- When you install the printer driver again or upgrade the version of the printer driver, the print settings you registered will be deleted from Commonly Used Settings.
Registered print settings cannot be saved and preserved. If a profile is deleted, register the print settings again.

Deleting Unnecessary Printing Profile

1. Select the printing profile to be deleted

Select the printing profile you want to delete from the Commonly Used Settings list on the Quick Setup tab.

2. Delete the printing profile

Click Delete. When the confirmation message appears, click OK.
The selected printing profile is deleted from the Commonly Used Settings list.

Note

- Printing profiles that are registered in the initial settings cannot be deleted.

Advanced Guide

[Advanced Guide](#) > [Changing the Machine Settings](#) > [Changing Machine Settings from Your Computer](#) > [Setting the Ink Cartridge to be Used](#)

P033

Setting the Ink Cartridge to be Used

This feature enables you to specify the most appropriate ink cartridge among installed cartridges according to an intended use.

When one of the ink cartridges becomes empty and cannot be replaced immediately by a new one, you can specify the other ink cartridge that still has ink and continue printing.

The procedure for specifying the ink cartridge is as follows:



Ink Cartridge Settings

1. Open the [printer driver setup window](#)
2. Click Ink Cartridge Settings on the Maintenance tab
The Ink Cartridge Settings dialog box appears.
3. Select the ink cartridge to be used
Select the ink cartridge to be used for printing and click OK.
The specified ink cartridge will be used from the next printing.

Important

- When the following settings are specified, Black Only does not function because the machine uses the color ink cartridge to print documents.
 - Other than Plain Paper, Hagaki A, Hagaki, or Envelope is selected for Media Type on the Main tab
 - Borderless is selected from the Page Layout list on the Page Setup tab
- Do not detach an ink cartridge that is not in use. Printing cannot be performed while either ink cartridge is detached.

[Page top](#) 

Advanced Guide

[Advanced Guide](#) > [Changing the Machine Settings](#) > [Changing Machine Settings from Your Computer](#) > [Managing the Machine Power](#)

P414

Managing the Machine Power

This function allows you to manage the machine power from the printer driver.

The procedure for managing the printer power is as follows:



Power Off

The Power Off function turns off the machine. When you use this function, you will not be able to turn the machine on from the printer driver.

1. Open the [printer driver setup window](#)

2. Execute power off

Click Power Off on the Maintenance tab. When the confirmation message appears, click OK.

The machine power switches off, and the Maintenance tab is displayed again.

[Page top](#) ↕

Advanced Guide

Advanced Guide > Changing the Machine Settings > Changing Machine Settings from Your Computer > Reducing the Machine Noise

P034

Reducing the Machine Noise

This function allows you to reduce the operating noise. Select when you wish to reduce the operating noise of the printer at night, etc.

Using this function may lower the print speed.

The procedure for using the quiet mode is as follows:



Quiet Mode

1. Open the [printer driver setup window](#)
2. Click Quiet Mode on the Maintenance tab
The Quiet Mode dialog box opens.
3. Set the quiet mode

If necessary, specify one of the following items:

Do not use quiet mode

The operating noise is at normal volume.

Always use quiet mode

Select this option when you wish to reduce the operating noise.

Use quiet mode within specified time

The operating noise can be reduced during a specified period of time.

Set the Start time and End time when you wish the quiet mode to be activated.

Important

- The time specified in Start time and in End time must be different.

4. Transmit the settings

Make sure that the machine is on and click Send.

Click OK when the confirmation message appears.

The settings are enabled hereafter.

Note

- Depending on print quality settings, effects of the quiet mode may be less.

Advanced Guide

Advanced Guide > Changing the Machine Settings > Changing Machine Settings from Your Computer > Changing the Machine Operation Mode

P035

Changing the Machine Operation Mode

If necessary, switch between various modes of machine operation.

The procedure for configuring Custom Settings is as follows:



Custom Settings

1. Open the [printer driver setup window](#)
2. Make sure that the machine is on, and then click Custom Settings on the Maintenance tab

The Custom Settings dialog box opens.

Note

- If the machine is off or bi-directional communication is disabled, a message may appear because the computer cannot collect the machine status.
If this happens, click OK to display the most recent settings specified on your computer.

3. If necessary, complete the following settings:

Prevent paper abrasion

The machine can increase the gap between the print head and the paper during high-density printing to prevent paper abrasion.

Check this check box to use this function.

Align heads manually

Usually, the Print Head Alignment function on the Maintenance tab is set to automatic head alignment, but you can change it to manual head alignment.

If the printing results are unsatisfactory even after you execute automatic head alignment, see "[Aligning the Print Head Position](#)," and execute manual head alignment.

Check this check box to perform the manual head alignment. Uncheck this check box to perform the automatic head alignment.

Ink Drying Wait Time

You can set the length of the machine rest time until printing of the next page begins. Moving the slider to the right increases the pause time and moving the slider to the left decreases the time.

If the paper gets stained because the next page is ejected before the ink on the printed page dries, increase the ink drying wait time.

Reducing the ink drying wait time speeds up printing.

4. Transmit the settings

Click Send, and click OK when the confirmation message appears.

The machine operates with the modified settings hereafter.

Advanced Guide

Advanced Guide > Troubleshooting

Troubleshooting

- ➔ [If an Error Occurs](#)
- ➔ [The Machine Cannot Be Powered On](#)
- ➔ [An Error Code Is Displayed on the LED](#)
- ➔ [LED Cannot Be Seen At All](#)
- ➔ [Cannot Install the MP Drivers](#)
- ➔ [Cannot Install the Application Program](#)
- ➔ [Cannot Connect to Computer with a USB Cable Properly](#)
- ➔ [Print Results Not Satisfactory](#)
- ➔ [Printing Does Not Start](#)
- ➔ [Copying/Printing Stops Before It Is Completed](#)
- ➔ [Machine Moves But Ink Is Not Ejected](#)
- ➔ [Printing Speed Is Not as Fast as Expected](#)
- ➔ [FINE Cartridge Holder Does Not Move to the Position for Replacing](#)
- ➔ [Paper Does Not Feed Properly](#)
- ➔ [Paper Jams](#)
- ➔ [Message Appears on the Computer Screen](#)
- ➔ [For Windows Users](#)
- ➔ [Problems with Scanning](#)
- ➔ [Software Problems](#)
- ➔ [MP Navigator EX Problems](#)
- ➔ [If You Cannot Resolve the Problem](#)
- ➔ [FAQs](#)
- ➔ [Instructions for Use \(Printer Driver\)](#)
- ➔ [General Notes \(Scanner Driver\)](#)

[Page top](#) ↕

Advanced Guide

Advanced Guide > Troubleshooting > If an Error Occurs

U302

If an Error Occurs

When an error occurs in printing such as the machine is out of paper or paper is jammed, a troubleshooting message is displayed automatically. Take the appropriate action described in the message. The message may vary depending on the version of your operating system.

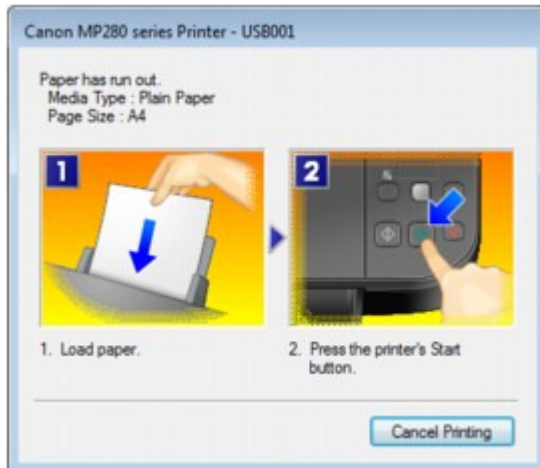

[Page top ↑](#)

Advanced Guide

[Advanced Guide](#) > [Troubleshooting](#) > [The Machine Cannot Be Powered On](#)

U303

The Machine Cannot Be Powered On

- **Check 1: Press the ON button.**
- **Check 2: Make sure that the power plug is securely plugged into the Power Cord Connector of the machine, then turn it back on.**
- **Check 3: Unplug the machine from the power supply, then plug the machine back in and turn the machine back on after leaving it for at least 2 minutes.**

If the problem is not resolved, contact the service center.

[Page top](#) ↑

Advanced Guide

Advanced Guide > Troubleshooting > An Error Code Is Displayed on the LED

U305



An Error Code Is Displayed on the LED

Alarm Lamp Is Lit Orange





When a machine error occurs, the **Alarm** lamp is lit orange and the error code as follows is displayed on the LED. Check the error code displayed on the LED and take the appropriate action to correct the error.



* Depending on the error occurred, the **Alarm** lamp is not lit.

Error Code	Cause	Action
E, 0, 2  (LED display)	The machine is out of paper./Paper does not feed.	Reload the paper on the Rear Tray correctly and press the Black or Color button.
E, 0, 3  (LED display)	Paper Output Tray is closed./Paper jam.	If the Paper Output Tray is closed, open it. The machine resumes printing. If opening the Paper Output Tray does not resolve the problem, or if the tray was open to begin with, the paper may be jammed. Remove the jammed paper, reload paper properly in the printer, then press the Black or Color button. ➔ Paper Jams
E, 0, 4 E, 0, 5  (LED display)	The FINE Cartridge cannot be recognized.	The FINE Cartridge may not be installed properly, or the Cartridge may not be compatible with this machine. Open the Scanning Unit (Cover) and install the appropriate FINE Cartridge. After that, push the Ink Cartridge Locking Cover until it clicks into place, then close the Scanning Unit (Cover). If the error is not resolved, contact the service center.
E, 0, 7	FINE Cartridge is not	Make sure that each FINE Cartridge

 <p>(LED display)</p>	<p>installed in the correct position.</p>	<p>is installed in the correct position. ➔ Routine Maintenance</p>
<p>E, 0, 8</p>  <p>(LED display)</p>	<p>Ink absorber is almost full.</p>	<p>Press the machine's Black or Color button to continue printing. Contact the service center.</p>
<p>E, 1, 3</p>  <p>(LED display)</p>	<p>The remaining ink level cannot be detected.</p>	<p>The ink may have run out. The function for detecting the remaining ink level will be disabled since the ink level cannot be correctly detected. If you want to continue printing without this function, press the machine's Stop (Reset) button for at least 5 seconds. Canon recommends to use new genuine Canon cartridges in order to obtain optimum qualities. Please be advised that Canon shall not be liable for any malfunction or trouble caused by continuation of printing under the ink out condition.</p>
<p>E, 1, 4</p>  <p>(LED display)</p>	<p>The FINE Cartridge cannot be recognized.</p>	<p>The FINE Cartridge may not be compatible with this printer. Install the appropriate FINE Cartridge. ➔ Routine Maintenance</p>
<p>E, 1, 5</p>  <p>(LED display)</p>	<p>The FINE Cartridge cannot be recognized.</p>	<p>The FINE Cartridge may not be installed properly. Open the Scanning Unit (Cover) and install the FINE Cartridge properly. ➔ Routine Maintenance</p>

<p>E, 1, 6</p>  <p>(LED display)</p>	<p>The ink has run out.</p>	<p>The ink has run out. Replace the ink cartridge and close the Scanning Unit (Cover). If printing is in progress and you want to continue printing, press the machine's Stop (Reset) button for at least 5 seconds with the ink cartridge installed. Then printing can continue under the ink out condition. The function for detecting the remaining ink level will be disabled. Replace the empty ink cartridge immediately after the printing. The resulting print quality is not satisfactory, if printing is continued under the ink out condition.</p>
<p>E, 3, 0</p>  <p>(LED display)</p>	<p>The size of the original cannot be correctly detected or the document is too small when the Fit-to-Page copying is selected.</p>	<ul style="list-style-type: none"> • Make sure that the original meets the requirements and is correctly loaded on the Platen Glass. • Check the position and direction of the original loaded on the Platen Glass.
<p>E, 3, 1</p>  <p>(LED display)</p>	<p>The machine is not connected with the computer.</p>	<p>Connect the machine and the computer with a USB cable.</p>
<p>E, 5, 0</p>  <p>(LED display)</p>	<p>Scanning the print head alignment sheet has failed.</p>	<p>Press the Stop/Reset button to dismiss the error, then take the actions described below.</p> <ul style="list-style-type: none"> • Make sure that the print head alignment sheet is set in the correct position and orientation on the Platen Glass. • Make sure the Platen Glass and the print head alignment sheet are not dirty. • Make sure the type and size of loaded paper is suitable for Automatic Print Head Alignment. For Automatic Print Head Alignment, always load one sheet of A4 or letter-sized plain paper. • Make sure if Print Head nozzles are clogged. Print the nozzle check pattern to check the status of the Print Head. ➔ Routine Maintenance <p>If the error is not resolved, connect the machine to the computer and</p>

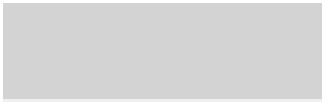



align the Print Head on the printer driver.

➔ [Aligning the Print Head Position](#)

POWER Lamp Flashes Green and Alarm Lamp Flashes Orange Alternately

When the **POWER** and **Alarm** lamps flash alternately as shown below, and the error code as follows is displayed on the LED, an error requiring servicing might have occurred.



Error Code	Action
<p>P, 0, 2</p>  <p>(LED display)</p>	<p>Cancel printing, turn off the machine. Then clear the jammed paper or protective material that is preventing the FINE Cartridge Holder from moving, and turn on the machine again.</p> <p>Important</p> <ul style="list-style-type: none"> Be careful not to touch the components inside the machine. The machine may not print out properly if you touch it. If the problem is not resolved, contact the service center.
<p>P, 1, 0</p>  <p>(LED display)</p>	<p>Turn off the machine, and unplug the power cord of the machine from the power supply. Contact the service center.</p>
<p>Other cases than above:</p>	<p>Turn off the machine, and unplug the power cord of the machine from the power supply. Plug the machine back in and turn the machine back on.</p> <p>If the problem is not resolved, contact the service center.</p>

Advanced Guide

[Advanced Guide](#) > [Troubleshooting](#) > LED Cannot Be Seen At All

U343

LED Cannot Be Seen At All

- **If the POWER lamp is off:**

The machine is not powered on. Connect the power cord and press the **ON** button.

- **If the POWER lamp is lit:**

The LED may be in the screen-saver mode. On the Operation Panel, press a button other than the **ON** button.

[Page top](#) ↑

Advanced Guide

Advanced Guide > Troubleshooting > Cannot Install the MP Drivers

U308

Cannot Install the MP Drivers

- If the installation does not start even after the *Setup CD-ROM* is inserted into your computer's disc drive:

Start the installation following the procedure below.

1. Click Start then Computer.

In Windows XP, click Start then My Computer.

2. Double-click the  CD-ROM icon on the displayed window.

If the contents of the CD-ROM are displayed, double-click MSETUP4.EXE.

Note

- If the CD-ROM icon is not displayed, try the following:
 - Remove the CD-ROM from your computer, then insert it again.
 - Restart your computer.
- If the icon is still not displayed, try different discs and see if they are displayed. If other discs are displayed, there is a problem with the *Setup CD-ROM*. In this case, contact the service center.

- If you are unable to proceed beyond the Printer Connection screen:



If you are unable to proceed beyond the Printer Connection screen, make sure that the USB cable is securely plugged into the USB port of the machine and is connected to the computer, and then follow the procedure below to reinstall the MP Drivers.

Note

-
- The printer is not detected. Check the connection. may be displayed depending on the computer you use. In this case, follow the procedure below to reinstall the MP Drivers.
-

1. Click Cancel.
2. Click Start Over on the Installation Failure screen.
3. Click Back on the screen that appears next.
4. Click Exit on the PIXMA XXX screen (where "XXX" is your machine's name), then remove the CD-ROM.
5. Turn the machine off.
6. Restart the computer.
7. Make sure that you have no application software running.
8. Insert the CD-ROM again, then perform Easy Install to install the MP Drivers.

- **In other cases:**

Follow the procedure described in your setup manual to reinstall the MP Drivers.

If the MP Drivers were not installed correctly, uninstall the MP Drivers, restart your computer, and then reinstall the MP Drivers.

➔ [Deleting the Unnecessary MP Drivers](#)

If you reinstall the MP Drivers, perform Custom Install on the *Setup CD-ROM*, then select MP Drivers.



Note

-
- If the installer was forced to be terminated due to a Windows error, the system may be in an unstable condition and you may not be able to install the drivers. Restart your computer before reinstalling.
-

Advanced Guide

Advanced Guide > Troubleshooting > Cannot Install the Application Program

U347

Cannot Install the Application Program

Easy-WebPrint EX Does Not Start up or Easy-WebPrint EX Menu Does Not Appear

If Easy-WebPrint EX does not start up or its menu does not appear on Internet Explorer, confirm the following.

Note

- You can use Easy-WebPrint EX with Internet Explorer 7 or later.

• **Check 1: Is Canon Easy-WebPrint EX is displayed on the Toolbars menu in the Internet Explorer's View menu?**

If Canon Easy-WebPrint EX is not displayed, Easy-WebPrint EX is not installed on your computer. Perform Custom Install on the *Setup CD-ROM*, then select Easy-WebPrint EX to install it onto your computer.

Note

- If Easy-WebPrint EX is not installed on your computer, a message asking you to install it may be displayed on the notification area on the taskbar. Click the message, then follow the instructions on the computer screen to install Easy-WebPrint EX.
- While the installation or download Easy-WebPrint EX is in progress, it is necessary to access the Internet. A connection charge is taken upon yourself.

• **Check 2: Is Canon Easy-WebPrint EX selected on the Toolbars menu in the Internet Explorer's View menu?**

If Canon Easy-WebPrint EX is not selected, Easy-WebPrint is disabled. Select Canon Easy-WebPrint EX to enable it.

[Page top](#) ↑

Advanced Guide

Advanced Guide > Troubleshooting > Cannot Connect to Computer with a USB Cable Properly

U309

Cannot Connect to Computer with a USB Cable Properly

Printing or Scanning Speed Is Slow/Hi-Speed USB Connection Does Not Work/"This device can perform faster" Message Is Displayed

If your system environment is not fully compatible with Hi-Speed USB, the machine will operate at a lower speed provided under USB 1.1. In this case, the machine operates properly but printing or scanning speed may slow down due to communication speed.

- **Check: Check the following to make sure that your system environment supports Hi-Speed USB connection.**
 - Does the USB port on your computer support Hi-Speed USB connection?
 - Does the USB cable or the USB hub support Hi-Speed USB connection?
Be sure to use a certified Hi-Speed USB cable. We recommend that the cable is no longer than around 10 feet / 3 meters.
 - Does the operating system of your computer support Hi-Speed USB connection?
Obtain and install the latest update for your computer.
 - Does the Hi-Speed USB driver operate properly?
Obtain the latest version of the Hi-Speed USB driver compatible with your hardware and reinstall it on your computer.

Important

- For details on Hi-Speed USB of your system environment, contact the manufacturer of your computer, USB cable, or USB hub.

[Page top ↑](#)

Advanced Guide

Advanced Guide > Troubleshooting > Print Results Not Satisfactory

U310

Print Results Not Satisfactory

If the print result is not satisfactory due to white streaks, misaligned lines, or uneven colors, confirm the paper and print quality settings first.

- **Check 1: Do the page size and media type settings match the size and type of the loaded paper?**

When these settings are incorrect, you cannot obtain a proper print result.

If you are printing a photograph or an illustration, incorrect paper type settings may reduce the quality of the printout color.

Also, if you print with an incorrect paper type setting, the printed surface may be scratched.

In borderless printing, uneven coloring may occur depending on the combination of the paper type setting and the loaded paper.

To copy by operating the machine	Confirm by using the Operation Panel on the machine. ➔ Copying
To print from a computer	Confirm by using the printer driver. ➔ Printing with Easy Setup

- **Check 2: Make sure that the appropriate print quality is selected using the printer driver.**

Select a print quality option suitable for the paper and image for printing. If you notice blurs or uneven colors, increase the print quality setting and try printing again.

You can confirm the print quality setting using the printer driver.

➔ [Changing the Print Quality and Correcting Image Data](#)

- **Check 3: If the problem is not resolved, there may be other causes.**

See also the sections below:

- ➔ [Cannot Print to End of Job](#)
- ➔ [No Printing Results/Printing Is Blurred/Colors Are Wrong/White Streaks](#)
- ➔ [Colors Are Unclear](#)
- ➔ [Lines Are Misaligned](#)
- ➔ [Printed Paper Curls or Has Ink Blots](#)
- ➔ [Paper Is Smudged/Printed Surface Is Scratched](#)
- ➔ [Back of the Paper Is Smudged](#)
- ➔ [Vertical Lines Are Printed on the Sides of the Printout](#)
- ➔ [Colors Are Uneven or Streaked](#)

Advanced Guide

[Advanced Guide](#) > [Troubleshooting](#) > [Print Results Not Satisfactory](#) > [Cannot Print to End of Job](#)

U311

Cannot Print to End of Job

- **Check 1: Is the size of the print data extremely large?**

Click Print Options on the Page Setup sheet. Then, select the Prevent loss of print data check box in the displayed dialog.

- **Check 2: Is the space of your computer's hard disk sufficient?**

Delete unnecessary files to free disk space.

[Page top](#) ↑

Advanced Guide

Advanced Guide > Troubleshooting > Print Results Not Satisfactory > No Printing Results/Printing Is Blurred/Colors Are Wrong/White Streaks

U313

No Printing Results/Printing Is Blurred/Colors Are Wrong/White Streaks

➤ No Printing Results



➤ Printing Is Blurred

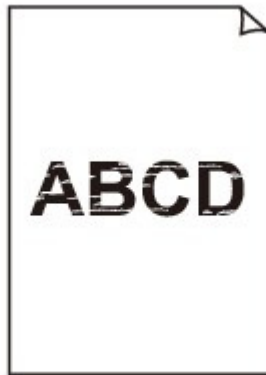

➤ Colors Are Wrong



➤ White Streaks

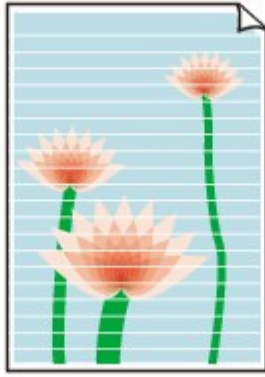

- **Check 1: Did you confirm the paper and print quality settings?**

➔ **Print Results Not Satisfactory**

- **Check 2: Is the FINE Cartridge installed properly?**

If the Ink Cartridge Locking Cover is not closed securely, ink may not be ejected correctly.

Open the Scanning Unit (Cover), open the Ink Cartridge Locking Cover, then close the Ink Cartridge Locking Cover.

When you close the Ink Cartridge Locking Cover, push the Ink Cartridge Locking Cover until it clicks into place.

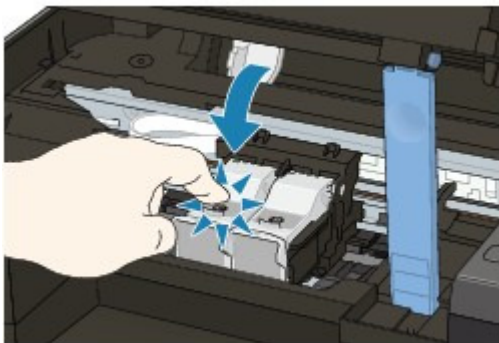

- **Check 3: Print the Nozzle Check Pattern and perform any necessary maintenance operations such as Print Head Cleaning.**

Print the Nozzle Check Pattern to determine whether the ink ejects properly from the print head nozzles.

Refer to [Routine Maintenance](#) for the Nozzle Check Pattern printing, Print Head Cleaning, and Print Head Deep Cleaning.

- If the Nozzle Check Pattern is not printed correctly:
After performing the Print Head Cleaning, print the Nozzle Check Pattern and examine the pattern.
- If the problem is not resolved after performing the Print Head Cleaning twice:
Perform the Print Head Deep Cleaning.
If the problem is not resolved after performing the Print Head Deep Cleaning, turn off the machine and perform another Print Head Deep Cleaning after 24 hours.
- If the problem is not resolved after performing the Print Head Deep Cleaning twice:
Ink may have run out. Replace the FINE Cartridge.

- **Check 4: When a FINE Cartridge runs out of ink, replace it with a new one.**

- **Check 5: When using paper with one printable surface, make sure that the paper is loaded with the printable side facing up.**

Printing on the wrong side of such paper may cause unclear prints or prints with reduced quality.

Refer to the instruction manual supplied with the paper for detailed information on the printable side.

- **Check 6: Is the Platen Glass dirty?**

Clean the Platen Glass.

➡ [Cleaning the Platen Glass and Document Cover](#)

- **When copying, see also the sections below:**

- **Check 7: Make sure that the original is properly loaded on the Platen Glass.**

➡ [Loading Paper / Originals](#)

- **Check 8: Is the original loaded with the side to be copied facing down on the Platen Glass?**

- **Check 9: Did you copy a printout done by this machine?**

Reprint from the computer.

If you copy a printout done by this machine, print quality may be reduced.

[Page top](#) ↑

Advanced Guide

Advanced Guide > Troubleshooting > Print Results Not Satisfactory > Colors Are Unclear

U314

Colors Are Unclear

- **Check 1: Enable color correction.**

When printing photographs or other graphics, enabling color correction in the printer driver may improve color.

Select Vivid Photo in the Effects sheet in the printer driver setup window.

- **Check 2: Is the FINE Cartridge installed properly?**

If the Ink Cartridge Locking Cover is not closed securely, ink may not be ejected correctly.

Open the Scanning Unit (Cover), open the Ink Cartridge Locking Cover, then close the Ink Cartridge Locking Cover.

When you close the Ink Cartridge Locking Cover, push the Ink Cartridge Locking Cover until it clicks into place.

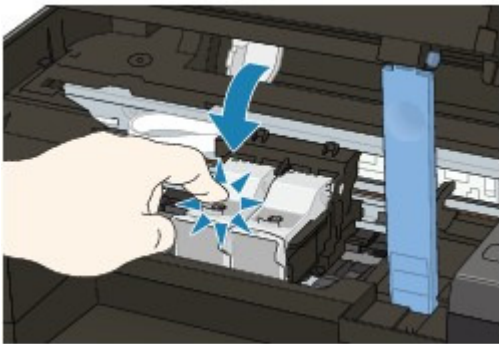

- **Check 3: When a FINE Cartridge runs out of ink, replace it with a new one.**

- **Check 4: Is the Nozzle Check Pattern printed properly?**

Print the Nozzle Check Pattern to determine whether the ink ejects properly from the print head nozzles.

Refer to [Routine Maintenance](#) for the Nozzle Check Pattern printing, Print Head Cleaning, and Print Head Deep Cleaning.

- If the Nozzle Check Pattern is not printed correctly:
After performing the Print Head Cleaning, print the Nozzle Check Pattern and examine the pattern.
- If the problem is not resolved after performing the Print Head Cleaning twice:
Perform the Print Head Deep Cleaning.
If the problem is not resolved after performing the Print Head Deep Cleaning, turn off the machine and perform another Print Head Deep Cleaning after 24 hours.
- If the problem is not resolved after performing the Print Head Deep Cleaning twice:
Ink may have run out. Replace the FINE Cartridge.

Note

- Printed colors may not match screen colors due to basic differences in the methods used to produce colors. Color control settings and environmental differences can also affect how colors appear on the screen. Therefore, colors of printing results may be different from those on the screen.

Advanced Guide

Advanced Guide > Troubleshooting > Print Results Not Satisfactory > Lines Are Misaligned

U315

Lines Are Misaligned



- **Check 1: Did you confirm the paper and print quality settings?**

➔ [Print Results Not Satisfactory](#)

- **Check 2: Perform Print Head Alignment.**

If printed lines are misaligned or print results are otherwise unsatisfactory, adjust the print head position.

➔ [Aligning the Print Head](#)



Note

- If the problem is not resolved after performing the Print Head Alignment, perform Print Head Alignment manually referring to [Aligning the Print Head Position](#).

- **Check 3: Is the size of the print data extremely large?**

Click Print Options on the Page Setup sheet. Then, select the Prevent loss of print data check box in the displayed dialog.

- **Check 4: Is the Page Layout Printing performed or the Binding margin function used?**

When the Page Layout Printing or Binding margin function is being used, thin lines may not be printed. Try thickening the lines in the document.

[Page top](#) ↑

Advanced Guide

Advanced Guide > Troubleshooting > Print Results Not Satisfactory > Printed Paper Curls or Has Ink Blots

U316

Printed Paper Curls or Has Ink Blots

Printed Paper Has Ink Blots

Printed Paper Curls



- **Check 1: Did you confirm the paper and print quality settings?**

➔ [Print Results Not Satisfactory](#)

- **Check 2: If the intensity is set high, reduce the Intensity setting in the printer driver and try printing again.**

If you are using plain paper to print images with high intensity, the paper may absorb too much ink and become wavy, causing paper abrasion.

You can confirm the intensity using the printer driver.

➔ [Adjusting Intensity](#)

- **Check 3: Is Photo Paper used for printing photographs?**

When printing data with high color saturation such as photographs or images in deep color, we recommend using Photo Paper Plus Glossy II or other Canon speciality paper.

➔ [Loading Paper / Originals](#)

[Page top](#) ↑

Advanced Guide

Advanced Guide > Troubleshooting > Print Results Not Satisfactory > Paper Is Smudged/Printed Surface Is Scratched

U317

Paper Is Smudged/Printed Surface Is Scratched

❖ Paper Is Smudged

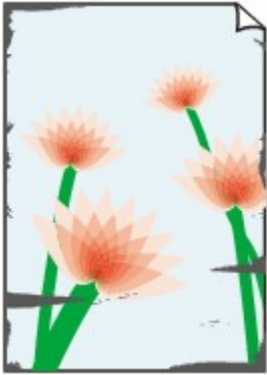

The Edges of Paper Are Smudged

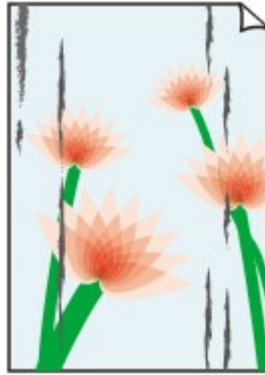

Printed Surface Is Smudged



❖ Printed Surface Is Scratched

- **Check 1: Did you confirm the paper and print quality settings?**

➔ [Print Results Not Satisfactory](#)

- **Check 2: Is the appropriate type of paper used? Check the followings:**

- Check to see if the paper you are printing on is suitable for your printing purpose.
 - ➔ [Loading Paper / Originals](#)
- When performing Borderless Printing, make sure that the paper you are using is suitable for Borderless Printing. If the paper you are using is not suitable for Borderless Printing, the print quality may be reduced at the top and bottom edges of the paper.
 - ➔ [Printing Area](#)

- **Check 3: Load the paper after correcting its curl.**

- **For Plain Paper**

Turn the paper over and reload it to print on the other side.

Leaving the paper loaded on the Rear Tray for a long time may cause the paper to curl. In this case, load the paper with the other side facing up. It may resolve the problem.

We recommend putting unused paper back into the package and keeping it on a level surface.

- **For Other Paper**

If the curl on the four corners of the paper is more than 0.1 inch / 3 mm (A) in height, the paper may be smudged or may not be fed properly. In such cases, follow the procedure described below to correct the paper curl.



1. Roll up the paper in the opposite direction to the paper curl as shown below.

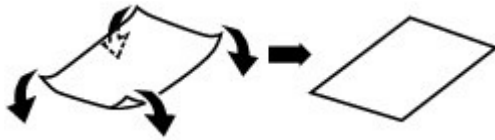

2. Check that the paper is now flat.
We recommend printing curl-corrected paper one sheet at a time.

Note

- Depending on the media type, the paper may be smudged or may not be fed properly even if it is not curled inward. In such cases, follow the procedure described below to curl the paper outward within 0.1 inch / 3 mm (B) in height before printing. This may improve the print result.

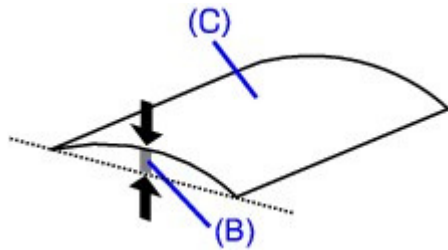

(C) Printing side

We recommend printing paper that has been curled outward one sheet at a time.

• **Check 4: If you are printing on thick paper, select the Prevent paper abrasion setting.**

Selecting the Prevent paper abrasion setting will widen the clearance between the Print Head and the loaded paper. If you notice abrasion even with the media type set correctly to match the loaded paper, set the machine to prevent paper abrasion by using the Operation Panel or the computer.

Print speed may be reduced if you are selecting the Prevent paper abrasion setting.

* Deactivate the Prevent paper abrasion setting once printing is complete. If not, this setting remains enabled for all subsequent print jobs.

• **To set by using the Operation Panel**

Press the **Maintenance** button repeatedly until the LED displays as follows, then press the **Black** button to enable the Prevent paper abrasion function.



To disable the Prevent paper abrasion function, press the **Maintenance** button repeatedly until the LED above appears, then press the **Color** button.

• **To set by using your computer**

Open the printer driver setup window, and in Custom Settings in the Maintenance sheet, select the Prevent paper abrasion check box, and then click Send.

To open the printer driver setup window, see [Opening the Printer Driver Setup Window](#).

• **Check 5: If the intensity is set high, reduce the Intensity setting in the printer driver and try printing again.**

If you are using plain paper to print images with high intensity, the paper may absorb too much ink

and become wavy, causing paper abrasion.

- When printing from your computer
Reduce the Intensity setting in the printer driver and try printing again.

1. Open the printer driver setup window.

➔ [Opening the Printer Driver Setup Window](#)



Click Here: [Printer Driver](#)

* Before clicking here to open the printer driver setup window, quit the running application software.

2. On the Main sheet, select Manual for Color/Intensity, and then click Set.

3. Drag the Intensity slide bar on the Color Adjustment sheet to adjust the intensity.

- **Check 6: Is printing performed beyond the recommended printing area?**

If you are printing beyond the recommended printing area of your printing paper, the lower edge of the paper may become stained with ink.

Resize your original document in your application software.

➔ [Printing Area](#)

- **Check 7: Is the Platen Glass dirty?**

Clean the Platen Glass.

➔ [Cleaning the Platen Glass and Document Cover](#)

- **Check 8: Is the Paper Feed Roller dirty?**

Clean the Paper Feed Roller.

➔ [Routine Maintenance](#)



Note

- Cleaning the Paper Feed Roller will wear the roller, so perform this procedure only when necessary.

- **Check 9: Is the inside of the machine dirty?**

When performing duplex printing, the inside of the machine may become stained with ink, causing the printout to become smudged.

Perform the Bottom Plate Cleaning to clean the inside of the machine.

➔ [Routine Maintenance](#)



Note

- To prevent the inside of the machine from stains, set the paper size correctly.

- **Check 10: Set Ink Drying Wait Time longer.**

Doing so gives the printed surface enough time to dry so that paper smudged and scratched are prevented.

1. Make sure that the machine is turned on.

2. Open the printer driver setup window.

➔ [Opening the Printer Driver Setup Window](#)

3. Click the Maintenance tab and then Custom Settings.
 4. Drag the Ink Drying Wait Time slide bar to set the wait time, and then click Send.
 5. Confirm the message and click OK.
- **Check 11: Is the paper scratched by other loaded paper?**

Depending on the media type, the paper may be scratched by other loaded paper when feeding from the Rear Tray. In this case, load one sheet at a time.

[Page top](#) ↑

Advanced Guide

Advanced Guide > Troubleshooting > Print Results Not Satisfactory > Back of the Paper Is Smudged

U318

Back of the Paper Is Smudged

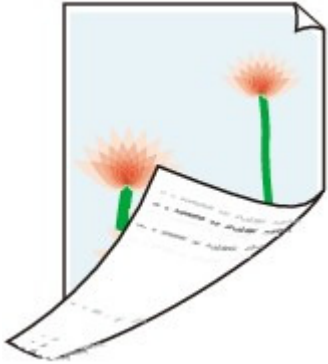

- **Check 1: Did you confirm the paper and print quality settings?**
 - ➔ [Print Results Not Satisfactory](#)
- **Check 2: Perform the Bottom Plate Cleaning to clean the inside of the machine.**
 - ➔ [Routine Maintenance](#)

Note

- When performing borderless printing, duplex printing, or too much printing, the inside may become stained with ink.

[Page top](#) ↑

Advanced Guide

Advanced Guide > Troubleshooting > Print Results Not Satisfactory > Vertical Lines Are Printed on the Sides of the Printout

U319

Vertical Lines Are Printed on the Sides of the Printout



- **Check 1: Did you confirm the paper type and print quality settings?**

➔ [Print Results Not Satisfactory](#)

- **Check 2: Is the size of the loaded paper correct?**

The vertical lines may be printed in the margin if the size of the loaded paper is larger than that you have specified.

Set the paper size correctly according to the paper you loaded.

➔ [Print Results Not Satisfactory](#)



Note

- The direction of the vertical line pattern may vary depending on the image data or the print setting.
- This machine performs automatic cleaning when necessary to keep printouts clean. A small amount of ink is ejected for cleaning. Although ink is usually ejected on the ink absorber, it may be ejected on the paper if you load paper larger than that you have specified.

[Page top](#) ↑

Advanced Guide

Advanced Guide > Troubleshooting > Print Results Not Satisfactory > Colors Are Uneven or Streaked

U320

Colors Are Uneven or Streaked

❖ Colors Are Uneven



❖ Colors Are Streaked



- **Check 1: Did you confirm the paper and print quality settings?**

➡ [Print Results Not Satisfactory](#)

- **Check 2: Print the Nozzle Check Pattern and perform any necessary maintenance operations such as Print Head Cleaning.**

Print the Nozzle Check Pattern to determine whether the ink ejects properly from the print head nozzles.

Refer to [Routine Maintenance](#) for the Nozzle Check Pattern printing, Print Head Cleaning, and Print Head Deep Cleaning.

- If the Nozzle Check Pattern is not printed correctly:
After performing the Print Head Cleaning, print the Nozzle Check Pattern and examine the pattern.
- If the problem is not resolved after performing the Print Head Cleaning twice:
Perform the Print Head Deep Cleaning.
If the problem is not resolved after performing the Print Head Deep Cleaning, turn off the machine and perform another Print Head Deep Cleaning after 24 hours.
- If the problem is not resolved after performing the Print Head Deep Cleaning twice:
Ink may have run out. Replace the FINE Cartridge.

- **Check 3: Perform Print Head Alignment.**

➔ [Aligning the Print Head](#)

 **Note**

-
- If the problem is not resolved after performing the Print Head Alignment, perform Print Head Alignment manually referring to [Aligning the Print Head Position](#) .
-

[Page top](#) ↑

Advanced Guide

Advanced Guide > Troubleshooting > Printing Does Not Start

U321

Printing Does Not Start

- **Check 1: Make sure that the power plug is securely plugged in, then turn the machine on.**

While the **POWER** lamp is flashing green, the machine is initializing. Wait until the **POWER** lamp stops flashing and remains lit green.



Note

- When printing large data such as a photo or graphics, it may take longer to start printing. While the **POWER** lamp is flashing green, the computer is processing data and sending it to the machine. Wait until printing starts.

- **Check 2: Make sure that the USB cable is securely plugged in to the machine and the computer.**

When the machine is connected to your computer with a USB cable, check the followings:

- If you are using a relay device such as a USB hub, disconnect it, connect the machine directly to the computer, and try printing again. If printing starts normally, there is a problem with the relay device. Consult the reseller of the relay device for details.
- There could also be a problem with the USB cable. Replace the USB cable and try printing again.

- **Check 3: Restart your computer if you are printing from the computer.**

If there are any unnecessary print jobs, delete them.

➔ [Deleting the Undesired Print Job](#)

- **Check 4: Make sure that your machine's name is selected in the Print dialog box.**

The machine will not print properly if you are using a printer driver for a different printer.

Make sure that your machine's name is selected in the Print dialog box.



Note

- To make the machine the one selected by default, select Set as Default Printer.

- **Check 5: Configure the printer port appropriately.**

Make sure that the printer port is configured appropriately.

1. Log on as a user account with administrator privilege.
2. Select Devices and Printers from the Start menu.
In Windows Vista, select the Start menu > Control Panel > Hardware and Sound > Printers.
In Windows XP, select the Start menu > Control Panel > Printers and Other Hardware > Printers and Faxes.
3. Right-click the Canon XXX Printer icon (where "XXX" is your machine's name), then select Printer properties.
In Windows Vista or Windows XP, right-click the Canon XXX Printer icon (where "XXX" is your machine's name), then select Properties.

4. Click the Ports tab to confirm the port settings.

Make sure that a port named USBnnn (where "n" is a number) with Canon XXX Printer appearing in the Printer column is selected for Print to the following port(s).

- If the setting is incorrect:
Reinstall the MP Drivers.
- Printing does not start even though the port named USBnnn is selected:
Launch Canon My Printer from the task tray, select Diagnose and Repair Printer. Follow the on-screen instructions to set the correct printer port, then select Canon XXX Printer. If the problem is not resolved, reinstall the MP Drivers.

• Check 6: Is the size of the print data extremely large?

Click Print Options on the Page Setup sheet. Then, select the Prevent loss of print data check box in the displayed dialog.

[Page top](#) ↑

Advanced Guide

Advanced Guide > Troubleshooting > Copying/Printing Stops Before It Is Completed

U322

Copying/Printing Stops Before It Is Completed

- **Check 1: Has the machine been printing continuously for a long period?**

If the machine has been printing continuously for a long time, the Print Head may overheat. To protect the Print Head, the machine may stop printing at a line break for a period of time and then resume printing.

In this case, interrupt your print session at a convenient time and turn the machine off for at least 15 minutes.

Additionally, if the machine has been printing graphics or photos with intense colors continuously over a period of time, the machine may stop printing to protect the Print Head. In this case, printing will not resume automatically. Turn the machine off for at least 15 minutes.

Caution

- The Print Head and the surrounding area can become extremely hot inside the machine. Never touch the Print Head or nearby components.

- **Check 2: Is the paper loaded?**

Make sure that paper is loaded in the Rear Tray.

If the machine has run out of paper, load paper.

- **Check 3: Do the printing documents have lots of photographs or illustrations?**

As printing large data such as photos or graphics takes time for the machine and the computer to process, the machine may appear to have stopped operating.

In addition, when printing data that uses a large amount of ink continuously on plain paper, the machine may pause temporarily. In either case, wait until the process is complete.

Note

- If you are printing a document with a large printing area or printing multiple copies of a document, printing may pause to allow the ink to dry.

- **Check 4: If copying stops before it is completed, try to copy again.**

If a certain time passes after some errors occurred while copying, the machine stops the operation.

[Page top ↑](#)

Advanced Guide

Advanced Guide > Troubleshooting > Machine Moves But Ink Is Not Ejected

U323

Machine Moves But Ink Is Not Ejected

- **Check 1: Are the Print Head nozzles clogged?**

Print the Nozzle Check Pattern to determine whether the ink ejects properly from the print head nozzles.

Refer to [Routine Maintenance](#) for the Nozzle Check Pattern printing, Print Head Cleaning, and Print Head Deep Cleaning.

- If the Nozzle Check Pattern is not printed correctly:
After performing the Print Head Cleaning, print the Nozzle Check Pattern and examine the pattern.
- If the problem is not resolved after performing the Print Head Cleaning twice:
Perform the Print Head Deep Cleaning.
If the problem is not resolved after performing the Print Head Deep Cleaning, turn off the machine and perform another Print Head Deep Cleaning after 24 hours.
- If the problem is not resolved after performing the Print Head Deep Cleaning twice:
Ink may have run out. Replace the FINE Cartridge.

- **Check 2: Is the FINE Cartridge installed properly?**

If the Ink Cartridge Locking Cover is not closed securely, ink may not be ejected correctly.

Open the Scanning Unit (Cover), open the Ink Cartridge Locking Cover, then close the Ink Cartridge Locking Cover.

When you close the Ink Cartridge Locking Cover, push the Ink Cartridge Locking Cover until it clicks into place.

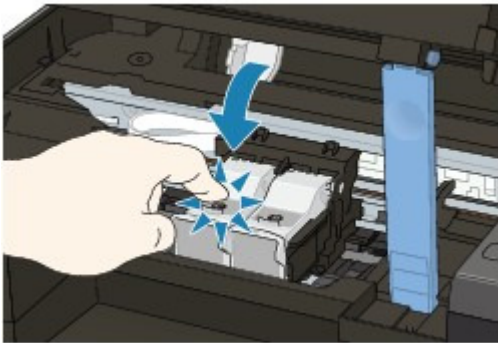

- **Check 3: When a FINE Cartridge runs out of ink, replace it with a new one.**

[Page top](#) ↑

Advanced Guide

Advanced Guide > Troubleshooting > Printing Speed Is Not as Fast as Expected

U324

Printing Speed Is Not as Fast as Expected

- **Check 1: Is printing performed in Quiet Mode?**

Print speed is reduced if you specified to print in Quiet Mode on the computer. For faster printing, do not print in Quiet Mode.

➔ [Reducing the Machine Noise](#)

- **Check 2: Is the print quality set too high?**

Increase the printing speed setting in the printer driver. Setting to prioritize speed makes printing faster.

1. Open the printer driver setup window.

➔ [Opening the Printer Driver Setup Window](#)



Click Here: [Printer Driver](#)

* Before clicking here to open the printer driver setup window, quit the running application software.

2. On the Main sheet, select Fast for the Print Quality setting.

Depending on the media type, the Fast option may not be available.

Note

- Setting to prioritize speed may reduce printing quality.
 - Printing speed may not improve noticeably by following the instructions above, depending on your system environment.
-

[Page top](#) ↑

Advanced Guide

Advanced Guide > Troubleshooting > FINE Cartridge Holder Does Not Move to the Position for Replacing

U325

FINE Cartridge Holder Does Not Move to the Position for Replacing

- **Check 1: Is the POWER lamp off?**

Check if the **POWER** lamp is lit green.

The FINE Cartridge Holder will not move unless the power is on. If the **POWER** lamp is off, close the Scanning Unit (Cover) and turn the machine on.

While the **POWER** lamp is flashing green, the machine is initializing. Wait until the **POWER** lamp stops flashing and remains lit green, and then open the Scanning Unit (Cover) again.

- **Check 2: Is an error code displayed on the LED?**

Close the Scanning Unit (Cover), confirm the error code is displayed, take the appropriate action to resolve the error, and then reopen it. For details on how to resolve the error, see [An Error Code Is Displayed on the LED](#).

- **Check 3: Has the Scanning Unit (Cover) been left open for 10 minutes or longer?**

If the Scanning Unit (Cover) is left open for more than 10 minutes, the FINE Cartridge Holder moves to the right to prevent the Print Head from drying out. Close and reopen the Scanning Unit (Cover) to return the FINE Cartridge Holder to the position for replacing.

- **Check 4: Has the machine been printing continuously for a long period?**

Close the Scanning Unit (Cover), wait a while, then reopen it.

If the machine has been printing continuously for a long time, the FINE Cartridge Holder may not move to the position for replacing since the Print Head may overheat.

Note

- Opening the Scanning Unit (Cover) while printing moves the FINE Cartridge Holder to the right. Close the Scanning Unit (Cover), and reopen it after printing is complete.

[Page top](#) ↑

Advanced Guide

Advanced Guide > Troubleshooting > Paper Does Not Feed Properly

U326

Paper Does Not Feed Properly

- **Check 1: Make sure of the following when you load paper.**

- When loading two or more sheets of paper, flip through the paper before loading.



- When loading two or more sheets of paper, align the edges of the sheets before loading.
- When loading two or more sheets of paper, make sure that the paper stack does not exceed the paper load limit.
However, proper feeding of paper may not be possible at this maximum capacity depending on the type of paper or environmental conditions (either very high or low temperature and humidity). In such cases, reduce the sheets of paper you load at a time to less than half of the paper load limit.
- Always load the paper in portrait orientation, regardless of the printing orientation.
- When you load the paper on the Rear Tray, load the paper with the print side facing UP and slide the Paper Guides to align with the both sides of the paper.

➔ [Loading Paper / Originals](#)

- **Check 2: Check to see if the paper you are printing on is not too thick or curled.**

➔ [Loading Paper / Originals](#)

- **Check 3: Make sure of the following when you load envelopes.**

When printing on envelopes, refer to [Loading Paper / Originals](#), and prepare the envelopes before printing.

Once you have prepared the envelopes, load them in portrait orientation. If the envelopes are placed in landscape orientation, they will not feed properly.

- **Check 4: Make sure that there are not any foreign objects in the Rear Tray.**



If the paper tears in the Rear Tray, see [Paper Jams](#) to remove it.

If there are any foreign objects in the Rear Tray, be sure to turn off the machine, unplug it from the power supply, then remove the foreign object.



- **Check 5: Clean the Paper Feed Roller.**

➔ Routine Maintenance

 **Note**

- Cleaning the Paper Feed Roller will wear the roller, so perform this procedure only when necessary.

Advanced Guide

Advanced Guide > Troubleshooting > Paper Jams

U328

Paper Jams

Note

- If you need to turn off the machine to remove jammed paper during printing, press the **Stop/Reset** button to cancel print jobs before turning off the machine.
-

➔ [Paper Is Jammed in the Paper Output Slot or the Rear Tray](#)

➔ [In Other Cases](#)

[Page top](#) ↑

Advanced Guide

Advanced Guide > Troubleshooting > Paper Jams > Paper Is Jammed in the Paper Output Slot or the Rear Tray

U349

Paper Is Jammed in the Paper Output Slot or the Rear Tray

Remove the paper following the procedure below.

1. Slowly pull the paper out, either from the Rear Tray or from the Paper Output Slot, whichever is easier.



Note

- If the paper tears and a piece remains inside the machine, turn the machine off, open the Scanning Unit (Cover), and remove the paper. Be careful not to touch the components inside the machine. After removing all paper, close the Scanning Unit (Cover), and turn the machine back on.
- If you cannot pull the paper out, turn the machine off and turn it back on. The paper may be ejected automatically.

2. Reload the paper, and press the **Stop/Reset** button on the machine.

If you turned off the machine in step 1, all print jobs in the queue are canceled. Reprint if necessary.

Note

- When reloading the paper, confirm that you are using the paper suited for printing and are loading it correctly.
➔ [Loading Paper / Originals](#)
- We recommend you use paper other than A5 sized one to print documents with photos or graphics; otherwise, the printout may curl and cause paper exit jams.

If you cannot remove the paper or the paper tears inside the machine, or if the paper jam error continues after removing the paper, contact the service center.

Advanced Guide

Advanced Guide > Troubleshooting > Paper Jams > In Other Cases

U353

In Other Cases

Make sure of the following:

- **Check 1: Are there any foreign objects around the Paper Output Slot?**
- **Check 2: Are there any foreign objects in the Rear Tray?**



If there are any foreign objects in the Rear Tray, be sure to turn off the machine, unplug it from the power supply, then remove the foreign object.

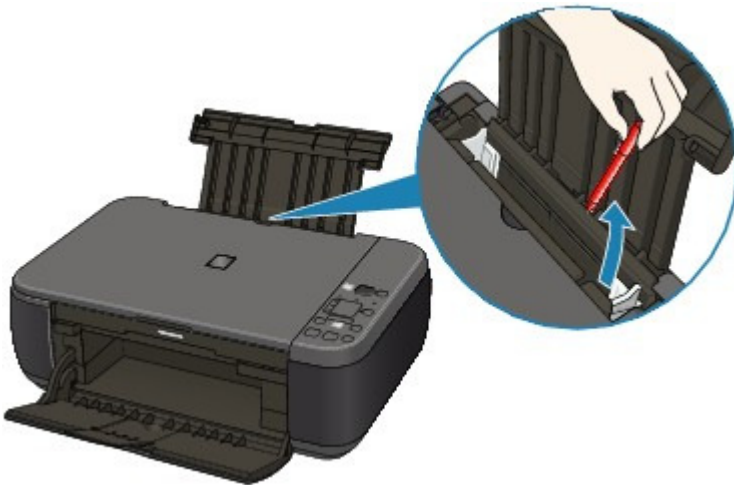

- **Check 3: Is the paper curled?**
 - ➔ Check 3: Load the paper after correcting its curl.

Advanced Guide

Advanced Guide > Troubleshooting > Message Appears on the Computer Screen

U331

Message Appears on the Computer Screen

- ➔ Error Number: B200 A printer error has occurred. Turn the printer off and unplug the power cord of the printer from the power supply. Then contact the service center. Is Displayed
- ➔ Error Number: **** A printer error has occurred. Turn the printer off and then on again. If this doesn't clear the error, see the user's guide for more detail. Is Displayed
- ➔ Error Regarding the Power Cord Being Unplugged Is Displayed
- ➔ Writing Error/Output Error/Communication Error
- ➔ Other Error Messages
- ➔ The Inkjet Printer/Scanner/Fax Extended Survey Program Screen Is Displayed

Error Number: B200 A printer error has occurred. Turn the printer off and unplug the power cord of the printer from the power supply. Then contact the service center. Is Displayed

Turn off the machine, and unplug the power cord of the machine from the power supply.
Contact the service center.

Error Number: ** A printer error has occurred. Turn the printer off and then on again. If this doesn't clear the error, see the user's guide for more detail. Is Displayed**

***** is displayed in the alphanumeric character and depends on the error occurred.

- **5100 Is Displayed**

Confirm the movement of the FINE Cartridge Holder blocked.

Cancel printing from your computer, turn off the machine. Then clear the jammed paper or protective material that is preventing the FINE Cartridge Holder from moving, and turn on the machine again.

Important

- Be careful not to touch the components inside the machine. The machine may not print out properly if you touch it.
- If the problem is not resolved, contact the service center.

- **Four-Digit Alphanumeric and "Printer error has occurred." Is Displayed**

Turn off the machine, and unplug the power cord of the machine from the power supply.

Plug the machine back in and turn the machine back on.

If the problem is not resolved, contact the service center.

Error Regarding the Power Cord Being Unplugged Is Displayed

The power cord may have been unplugged while the machine was still on.
Check the error message that appears on the computer, then click OK.
The machine starts printing.

See [Notice for Unplugging the Power Cord](#) for unplugging the power cord.

Writing Error/Output Error/Communication Error

- **Check 1: If the POWER lamp is off, make sure that the power plug is plugged in, then turn the machine on.**

While the **POWER** lamp is flashing green, the machine is initializing. Wait until the **POWER**

lamp stops flashing and remains lit green.

- **Check 2: Make sure that the printer port is configured appropriately in the printer driver.**

* In the following instructions, "XXX" signifies your machine's name.

- 1. Log on as a user account with administrator privilege.**

- 2. Select Devices and Printers from the Start menu.**

In Windows Vista, select the Start menu > Control Panel > Hardware and Sound > Printers.

In Windows XP, select the Start menu > Control Panel > Printers and Other Hardware > Printers and Faxes.

- 3. Right-click the Canon XXX Printer icon, then select Printer properties.**

In Windows Vista or Windows XP, right-click the Canon XXX Printer icon (where "XXX" is your machine's name), then select Properties.

- 4. Click the Ports tab to confirm the port settings.**

Make sure that a port named USBnnn (where "n" is a number) with Canon XXX Printer appearing in the Printer column is selected for Print to the following port(s).

- If the setting is incorrect:
Reinstall the MP Drivers.
- Printing does not start even though the port named USBnnn is selected:
Launch Canon My Printer from the task tray, select Diagnose and Repair Printer. Follow the on-screen instructions to set the correct printer port, then select Canon XXX Printer.
If the problem is not resolved, reinstall the MP Drivers.

- **Check 3: Make sure that the USB cable is securely plugged in to the machine and the computer.**

When the machine is connected to your computer with a USB cable, check the followings:

- If you are using a relay device such as a USB hub, disconnect it, connect the machine directly to the computer, and try printing again. If printing starts normally, there is a problem with the relay device. Consult the reseller of the relay device for details.
- There could also be a problem with the USB cable. Replace the USB cable and try printing again.

- **Check 4: Make sure that the MP Drivers are installed correctly.**

Uninstall the MP Drivers following the procedure described in [Deleting the Unnecessary MP Drivers](#), insert the *Setup CD-ROM* into the computer's disc drive and perform Custom Install and select MP Drivers to install again.

- **Check 5: Check the status of the device on your computer.**

Follow the procedure below to check the status of the device.

- 1. Click Control Panel, Hardware and Sound, then Device Manager.**

If the User Account Control screen is displayed, follow the on-screen instructions.

In Windows XP, click Control Panel, Performance and Maintenance, System, then click Device Manager on the Hardware sheet.

- 2. Double-click Universal Serial Bus controllers then USB Printing Support.**

If USB Printing Support is not displayed, make sure that the machine is correctly connected to the computer.

➡ **Check 3: Make sure that the USB cable is securely plugged in to the machine and the computer.**

3. Click the General tab and make sure that there is no indication of a problem with the device.

If a device error is displayed, refer to Windows help to resolve the error.

Other Error Messages

- **Check: If an error message is displayed outside the printer status monitor, check the following:**
 - "Could not spool successfully due to insufficient disk space"
Delete any unnecessary files to increase the amount of free space on the disk.
 - "Could not spool successfully due to insufficient memory"
Quit other running application softwares to increase available memory.
If you still cannot print, restart your computer and retry printing.
 - "Printer driver could not be found"
Uninstall the printer driver according to the procedure described in [Deleting the Unnecessary MP Drivers](#), and then reinstall it.
 - "Could not print Application name - File name"
Try printing again once the current job is complete.

The Inkjet Printer/Scanner/Fax Extended Survey Program Screen Is Displayed

If the Inkjet Printer/Scanner/Fax Extended Survey Program is installed, a confirmation screen asking for permission to send the printer and application software usage information will be displayed one month, three months, and then six months after the installation. After that, it will be displayed every six months for about four years.

Read the instructions on the screen and follow the procedure below.

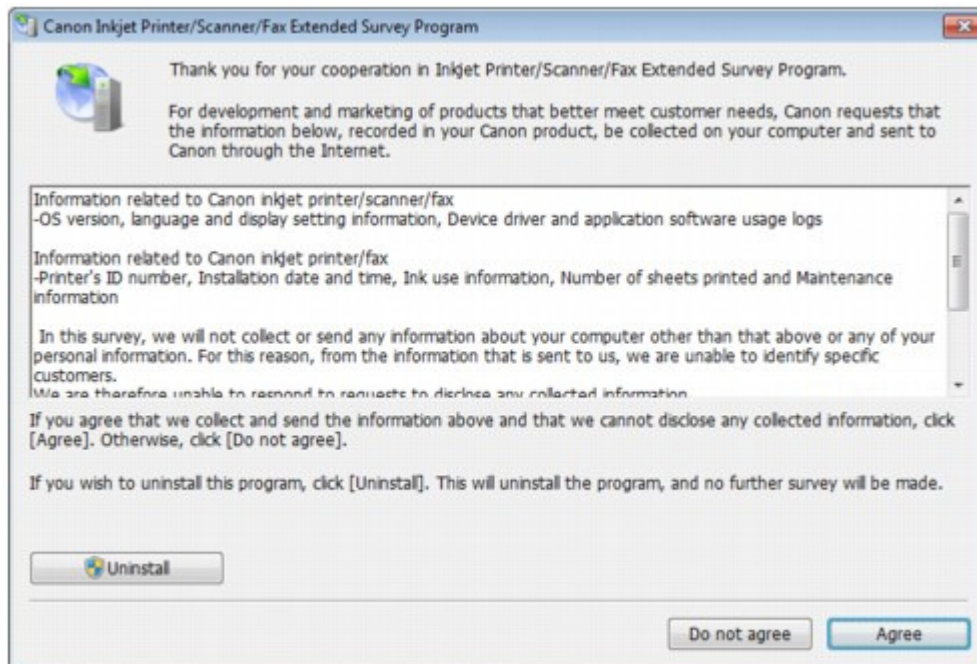

- **If you agree to participate in the survey program:**

Click Agree, then follow the on-screen instructions. The printer usage information will be sent via the Internet. If you have followed the on-screen instructions, the information will be sent automatically from the second time onward and the confirmation screen will not be displayed again.

Note

- When the information is being sent, a caution screen such as an Internet security screen may be displayed. In this case, confirm that the program name is "IJPLMJ.exe", then allow it.
- If you deselect the Send automatically from the next time check box, the information will

not be sent automatically from the second time onward and a confirmation screen will be displayed at the time of the next survey. To send the information automatically, see [Changing the confirmation screen setting:](#) .

- **If you do not agree to participate in the survey program:**

Click Do not agree. The confirmation screen will be closed, and the survey at that time is skipped. The confirmation screen will be displayed again two months later.

- **To uninstall the Inkjet Printer/Scanner/Fax Extended Survey Program:**

To uninstall the Inkjet Printer/Scanner/Fax Extended Survey Program, click Uninstall, then follow the on-screen instructions.

- **Changing the confirmation screen setting:**

1. Select items from the Start menu as shown below.

- In Windows 7 or Windows Vista, select the Start menu > Control Panel > Uninstall a program.
- In Windows XP, select the Start menu > Control Panel > Add or Remove Programs.

Note

- In Windows 7 or Windows Vista, a confirmation/warning dialog box may appear when installing, uninstalling or starting up software. This dialog box appears when administrative rights are required to perform a task. If you are logged on to an administrator account, follow the on-screen instructions.
-

2. Select Canon Inkjet Printer/Scanner/Fax Extended Survey Program.

3. Select Change.

If you select Yes after you have followed the on-screen instructions, the confirmation screen will be displayed at the time of the next survey.

If you select No, the information will be sent automatically.

Note

- If you select Uninstall (or Remove), the Inkjet Printer/Scanner/Fax Extended Survey Program is uninstalled. Follow the on-screen instructions.
-

Advanced Guide

Advanced Guide > Troubleshooting > For Windows Users

U333

For Windows Users

Printer Status Monitor Is Not Displayed

- **Check: Is the printer status monitor enabled?**

Make sure that Enable Status Monitor is selected on the Option menu of the printer status monitor.

- 1. Open the printer driver setup window.**

➡ [Opening the Printer Driver Setup Window](#)

- 2. On the Maintenance sheet, click View Printer Status.**

- 3. Select Enable Status Monitor on the Option menu if it is not selected.**

- **If you are using Windows 7 or Windows Vista:**

Launching MP Navigator EX Whenever Pressing the SCAN Button on the Machine

- **Check: Specify the response from pressing the SCAN button on the machine.**

Follow the procedure below to specify the response on your computer.

- **If you are using Windows 7:**

- 1. Log on as a user account with administrator privilege.**

- 2. Select Devices and Printers from the Start menu.**

- 3. Right-click the Canon XXX Printer icon (where "XXX" is your machine's name), then select Scan properties.**

If the User Account Control screen appears, click Yes.

- 4. Click the Events tab on the WIA Canon XXX ser Properties (where "XXX" is your machine's name) screen.**

- 5. Select Start this program for Actions, then select MP Navigator EX Ver4.0 from the pull-down menu.**

Choose an event from the Select an event pull-down menu, then select MP Navigator EX Ver4.0 to launch for each event. If MP Navigator EX Ver4.0 is already selected for each event, click Cancel.

- 6. Click OK.**

- **If you are using Windows Vista:**

- 1. Log on as a user account with administrator privilege.**

- 2. Select the Start menu > Control Panel > Hardware and Sound > Scanners and Cameras.**
- 3. Select WIA Canon XXX ser (where "XXX" is your machine's name), then click the Properties button.**
If the User Account Control screen appears, click Continue.
- 4. Click the Events tab on the WIA Canon XXX ser Properties (where "XXX" is your machine's name) screen.**
- 5. Select Start this program for Actions, then select MP Navigator EX Ver4.0 from the pull-down menu.**
Choose an event from the Select an event pull-down menu, then select MP Navigator EX Ver4.0 to launch for each event. If MP Navigator EX Ver4.0 is already selected for each event, click Cancel.
- 6. Click OK.**

[Page top](#) ↑

Advanced Guide

Advanced Guide > Troubleshooting > Problems with Scanning

S901

Problems with Scanning

- ➔ Scanner Does Not Work
- ➔ ScanGear (Scanner Driver) Does Not Start
- ➔ Error Message Appears and the ScanGear (Scanner Driver) Screen Does Not Appear
- ➔ Scan Quality (Image Displayed on the Monitor) Is Poor
- ➔ Scanned Image Is Surrounded by Extra White Areas
- ➔ Cannot Scan Multiple Documents at One Time
- ➔ Cannot Scan Properly in Auto Scan Mode
- ➔ Slow Scanning Speed
- ➔ "There is not enough memory." Message Is Displayed
- ➔ Computer Stops Operating during Scanning
- ➔ Scanner Does Not Work After Upgrading Windows

[Page top](#) ↕

Advanced Guide

[Advanced Guide](#) > [Troubleshooting](#) > [Problems with Scanning](#) > [Scanner Does Not Work](#)

S902

Scanner Does Not Work

Check 1: Make sure that the machine is turned on.

Check 2: Connect the USB cable to a different USB port on the computer.

Check 3: If the USB cable is connected to a USB hub, remove it from the USB hub and connect it to a USB port on the computer.

Check 4: Restart the computer.

[Page top](#)↑

Advanced Guide

[Advanced Guide](#) > [Troubleshooting](#) > [Problems with Scanning](#) > [ScanGear \(Scanner Driver\) Does Not Start](#)

S903

ScanGear (Scanner Driver) Does Not Start

Check 1: Make sure that the MP Drivers is installed.

If it is not installed, insert the *Setup CD-ROM* into the computer's disc drive, then select Custom Install and install MP Drivers.

Check 2: On the File menu of the application, select Select Source and select the machine.

Important

- Do not select the model name that includes WIA in it.

Note

- The operation may differ depending on the application.

Check 3: Start from a TWAIN-compliant application.

[Page top](#)[↕]

Advanced Guide

Advanced Guide > Troubleshooting > Problems with Scanning > Error Message Appears and the ScanGear (Scanner Driver) Screen Does Not Appear

S904

Error Message Appears and the ScanGear (Scanner Driver) Screen Does Not Appear

Check 1: Make sure that the machine is turned on.

Check 2: Turn off the machine, then reconnect the USB cable and replug the power cord.

Check 3: Connect the USB cable to a different USB port on the computer.

Check 4: If the USB cable is connected to a USB hub, remove it from the USB hub and connect it to a USB port on the computer.

Check 5: Make sure that the MP Drivers is installed.

If it is not installed, insert the *Setup CD-ROM* into the computer's disc drive, then select Custom Install and install MP Drivers.

Check 6: On the File menu of the application, select Select Source and select the machine.

Note

- The operation may differ depending on the application.
-

Check 7: Make sure that the application is TWAIN-compliant.

You cannot open ScanGear (scanner driver) from applications not supporting TWAIN.

Check 8: Exit ScanGear if it is running on another application.

[Page top](#)↑

Advanced Guide

Advanced Guide > Troubleshooting > Problems with Scanning > Scan Quality (Image Displayed on the Monitor) Is Poor

S905

Scan Quality (Image Displayed on the Monitor) Is Poor

Check 1: Increase the scanning resolution.

➔ [Resolution](#)

Check 2: Set the scale to 100%.

Some applications do not display images clearly if the image is too small.

Check 3: If moire (stripe pattern) appears, take the following measures and scan again.

- On the Basic Mode tab of ScanGear (scanner driver), select Magazine(Color) in Select Source.
➔ [Basic Mode Tab](#)
- On the Advanced Mode tab of ScanGear, set Descreen in Image Settings to ON.
➔ [Image Settings](#)

Note

- If moire appears when you scan a digital print photo, take the above measures and scan again.

- If you use MP Navigator EX, set Document Type to Magazine(Color) or enable Descreen in the Scan Settings dialog box and scan again.
➔ [Scan Settings Dialog Box \(Photos/Documents\)](#)

Check 4: Check the monitor's color depth.

- **Windows 7:**
From the Start menu, select Control Panel > Appearance and Personalization > Adjust screen resolution > Advanced settings.
On the Monitor tab of the displayed dialog box, set Colors to High Color (16 bit) or True Color (32 bit).
- **Windows Vista:**
From the Start menu, select Control Panel > Appearance and Personalization > Adjust screen resolution to open the Display Settings dialog box. Set the color depth to Medium (16 bit) or Highest (32 bit).
- **Windows XP:**
From the Start menu, select Control Panel > Display to open the Display Properties dialog box. On the Settings tab, set Color quality to Medium (16 bit) or Highest (32 bit).

Check 5: Clean the Platen and Document Cover.

➔ [Cleaning the Platen Glass and Document Cover](#)

Check 6: If the document is in poor condition (dirty, faded, etc.), use Reduce Dust and Scratches, Fading Correction, Grain Correction, etc. in Image Settings on the Advanced Mode tab of ScanGear.

➔ [Image Settings](#)

Check 7: If the color tone of images is different from the original document, take the following measures and scan again.

- On the Advanced Mode tab of ScanGear, set Image Adjustment in Image Settings to None.
➔ [Image Settings](#)
- On the Color Settings tab in the Preferences dialog box of ScanGear, set Color Matching.

[➔ Color Settings Tab](#)

[Page top](#) 

Advanced Guide

[Advanced Guide](#) > [Troubleshooting](#) > [Problems with Scanning](#) > [Scanned Image Is Surrounded by Extra White Areas](#)

S906

Scanned Image Is Surrounded by Extra White Areas

Check: Specify the scan area.



Click  (Auto Crop) in whole image view of ScanGear (scanner driver) to automatically display the cropping frame (scan area) according to the document size.

You can also manually specify the scan area in thumbnail view or when there are white margins along the document (for example, in photos), or when you want to create custom cropping frames.

➔ [Adjusting Cropping Frames](#)

[Page top](#) 

Advanced Guide

[Advanced Guide](#) > [Troubleshooting](#) > [Problems with Scanning](#) > [Cannot Scan Multiple Documents at One Time](#)

S907

Cannot Scan Multiple Documents at One Time

Check 1: Make sure that the documents are placed correctly on the Platen.

➔ [Placing Documents](#)

Check 2: Scan each item individually.

Some applications do not support multiple image scanning.

[Page top](#)↑

Advanced Guide

[Advanced Guide](#) > [Troubleshooting](#) > [Problems with Scanning](#) > [Cannot Scan Properly in Auto Scan Mode](#)

S916

Cannot Scan Properly in Auto Scan Mode

Check 1: Make sure that the documents are placed correctly on the Platen.

➔ [Placing Documents](#)

Check 2: Multiple image scanning may not be supported.

Some applications do not support multiple image scanning. In that case, scan each item individually.

[Page top](#)↑

Advanced Guide

[Advanced Guide](#) > [Troubleshooting](#) > [Problems with Scanning](#) > [Slow Scanning Speed](#)

S908

Slow Scanning Speed

Check 1: To view the image on a monitor, set the output resolution to around 150 dpi. To print, set it to around 300 dpi.

➡ [Resolution](#)

Check 2: Set Fading Correction, Grain Correction, etc. to None.

➡ [Image Settings](#)

Check 3: In MP Navigator EX, deselect the Correct slanted document / Detect the orientation of text documents and rotate images checkbox and scan again.

➡ [Scan Settings Dialog Box \(Photos/Documents\)](#)

➡ [Scan Settings Dialog Box \(One-click Mode Screen\)](#)

[Page top](#) ↕

Advanced Guide

[Advanced Guide](#) > [Troubleshooting](#) > [Problems with Scanning](#) > "There is not enough memory." Message Is Displayed

S909

"There is not enough memory." Message Is Displayed

Check 1: Exit other applications and try again.

Check 2: Reduce the resolution or output size and scan again.

➔ [Resolution](#)

[Page top](#) ↕

Advanced Guide

[Advanced Guide](#) > [Troubleshooting](#) > [Problems with Scanning](#) > [Computer Stops Operating during Scanning](#)

S910

Computer Stops Operating during Scanning

Check 1: Restart the computer, reduce the output resolution in ScanGear (scanner driver) and scan again.

Check 2: Delete unnecessary files to obtain sufficient free hard disk space, then scan again.

Error message may appear if there is not enough hard disk space to scan and save, when the image size is too large (such as when scanning a large document at high resolution.)

Check 3: For Location of Temporary Files in MP Navigator EX, specify a folder on a drive with sufficient free space.

➔ [General Tab](#)

Check 4: Multiple devices may be connected to USB ports.

Disconnect other devices.

[Page top](#)↑

Advanced Guide

[Advanced Guide](#) > [Troubleshooting](#) > [Problems with Scanning](#) > [Scanner Does Not Work After Upgrading Windows](#)

S911

Scanner Does Not Work After Upgrading Windows

Check: Disconnect the USB cable, then uninstall and reinstall the MP Drivers and MP Navigator EX.

- **Step 1: Uninstall the MP Drivers.**

See "[Deleting the Unnecessary MP Drivers](#)" for details.

- **Step 2: Uninstall MP Navigator EX.**

1. From the Start menu, select All Programs > Canon Utilities > MP Navigator EX 4.0 > MP Navigator EX Uninstall.



Note

- In Windows 7 or Windows Vista, a confirmation/warning dialog box may appear when installing, uninstalling or starting up software. This dialog box appears when administrative rights are required to perform a task. If you are logged on to an administrator account, follow the on-screen instructions.

2. When a confirmation appears, click Yes.

3. When uninstallation is complete, click OK.

MP Navigator EX is uninstalled.

- **Step 3: Reinstall the MP Drivers and MP Navigator EX.**

Insert the *Setup CD-ROM* into the computer's disc drive, then select Custom Install and reinstall the MP Drivers and MP Navigator EX.

[Page top](#)↑

Advanced Guide

Advanced Guide > Troubleshooting > Software Problems

S930

Software Problems

- E-mail Software Program You Want to Use Does Not Appear in the Screen for Selecting an E-mail Software Program
- Scanned Image Is Printed Enlarged (Reduced)
- Scanned Image Is Enlarged (Reduced) on the Computer Monitor
- Scanned Image Does Not Open

[Page top](#)↑

Advanced Guide

[Advanced Guide](#) > [Troubleshooting](#) > [Software Problems](#) > E-mail Software Program You Want to Use Does Not Appear in the Screen for Selecting an E-mail Software Program

S931

E-mail Software Program You Want to Use Does Not Appear in the Screen for Selecting an E-mail Software Program

Check 1: MP Navigator EX may not support the e-mail software program.

The following e-mail software programs are supported. (Images are attached to the mail message automatically.)

- Microsoft Outlook
- Windows Mail (Windows Vista)
- Outlook Express (Windows XP)

Check 2: If an e-mail software program does not operate properly, check that the program's MAPI is enabled.

To enable MAPI, refer to the manual of the e-mail software program.

Check 3: If using an e-mail software program other than the ones listed above, select None (Attach Manually) when prompted to select a program and attach the scanned image manually.

[Page top](#)↑

Advanced Guide

[Advanced Guide](#) > [Troubleshooting](#) > [Software Problems](#) > [Scanned Image Is Printed Enlarged \(Reduced\)](#)

S932

Scanned Image Is Printed Enlarged (Reduced)

Check: Set the printing size in the application.

[Page top](#)↑

Advanced Guide

[Advanced Guide](#) > [Troubleshooting](#) > [Software Problems](#) > [Scanned Image Is Enlarged \(Reduced\) on the Computer Monitor](#)

S933

Scanned Image Is Enlarged (Reduced) on the Computer Monitor

Check 1: Change the display setting in the application.

For details, refer to the application's manual. If you have any questions, contact the manufacturer of the application.

Note

- You cannot reduce the image size in Paint. To reduce the display size, open the images in an application.
-

Check 2: Change the resolution setting in ScanGear (scanner driver) and scan again.

The higher the resolution, the larger the resulting image will be.

➡ [Resolution](#)

[Page top](#)↑

Advanced Guide

[Advanced Guide](#) > [Troubleshooting](#) > [Software Problems](#) > [Scanned Image Does Not Open](#)

S934

Scanned Image Does Not Open

Check: If the file format is not supported by the application, scan the image again and save it in a popular file format such as JPEG.

For details, refer to the application's manual. If you have any questions, contact the manufacturer of the application.

[Page top](#) ↕

Advanced Guide

Advanced Guide > Troubleshooting > MP Navigator EX Problems

S940

MP Navigator EX Problems

- ➡ Cannot Scan at the Correct Size
- ➡ Position or Size of the Image Cannot be Detected Correctly When Scanning Using the Operation Panel
- ➡ Document Is Placed Correctly, but the Scanned Image Is Slanted
- ➡ Document Is Placed Correctly, but the Orientation Changes in the Scanned Image

[Page top](#) ↕

Advanced Guide

[Advanced Guide](#) > [Troubleshooting](#) > [MP Navigator EX Problems](#) > [Cannot Scan at the Correct Size](#)

S941

Cannot Scan at the Correct Size

Check 1: Make sure that the documents are placed correctly on the Platen.

➔ [Placing Documents](#)

Check 2: Set Document Size to the actual document size and scan again.

If the matching size is not found, scan at a larger size and trim the image.

See the Toolbar ( (Trimming)) in "Correct/Enhance Images Window" for details.

[Page top](#)↑

Advanced Guide

[Advanced Guide](#) > [Troubleshooting](#) > [MP Navigator EX Problems](#) > [Position or Size of the Image Cannot be Detected Correctly When Scanning Using the Operation Panel](#)

S942

Position or Size of the Image Cannot be Detected Correctly When Scanning Using the Operation Panel

Check 1: Make sure that the documents are placed correctly on the Platen.

➡ [Placing Documents](#)

Check 2: Check that the settings are correctly set according to the document.

If you cannot scan properly with Auto Scan, specify the document type and size.

➡ [Scanning Photos and Documents](#)

[Page top](#) ↕

Advanced Guide

[Advanced Guide](#) > [Troubleshooting](#) > [MP Navigator EX Problems](#) > [Document Is Placed Correctly, but the Scanned Image Is Slanted](#)

S943

Document Is Placed Correctly, but the Scanned Image Is Slanted

Check: In MP Navigator EX, deselect the Correct slanted document checkbox and scan again.

- ➡ [Scan Settings Dialog Box \(Photos/Documents\)](#)
- ➡ [Scan Settings Dialog Box \(One-click Mode Screen\)](#)

[Page top](#)↑

Advanced Guide

[Advanced Guide](#) > [Troubleshooting](#) > [MP Navigator EX Problems](#) > Document Is Placed Correctly, but the Orientation Changes in the Scanned Image

S944

Document Is Placed Correctly, but the Orientation Changes in the Scanned Image

Check: In MP Navigator EX, deselect the Detect the orientation of text documents and rotate images checkbox and scan again.

- ➔ [Scan Settings Dialog Box \(Photos/Documents\)](#)
- ➔ [Scan Settings Dialog Box \(One-click Mode Screen\)](#)

[Page top](#)↑

Advanced Guide

Advanced Guide > Troubleshooting > If You Cannot Resolve the Problem

U151

If You Cannot Resolve the Problem

If you cannot resolve the problem with any of the workarounds in this chapter, please contact the seller of the machine or the service center.

Canon support staff are trained to be able to provide technical support to satisfy customers.

Caution

- If the machine emits any unusual sound, smoke, or odor, turn it off immediately. Unplug the power cord from the outlet and contact the seller or the service center. Never attempt to repair or disassemble the machine yourself.
 - Attempts by customers to repair or take apart the machine will invalidate any warranty regardless of whether the warranty has expired.
-

Before contacting the service center, confirm the following:

- Product name:
 - * Your machine's name is located on the front cover of the setup manual.
- Serial number: please refer to the setup manual
- Details of the problem
- What you tried to solve the problem, and what happened

[Page top ↑](#)

Advanced Guide

Advanced Guide > Troubleshooting > FAQs

U340

FAQs

- ➔ No Printing Results/Printing Is Blurred/Colors Are Wrong/White Streaks
- ➔ Machine Moves But Ink Is Not Ejected
- ➔ Cannot Install the MP Drivers
- ➔ Printing Does Not Start
- ➔ Copying/Printing Stops Before It Is Completed
- ➔ Writing Error/Output Error/Communication Error
- ➔ Print Results Not Satisfactory
- ➔ Paper Jams
- ➔ Paper Does Not Feed Properly

[Page top ↑](#)

Advanced Guide

Advanced Guide > Troubleshooting > Instructions for Use (Printer Driver)

P036

Instructions for Use (Printer Driver)

This printer driver is subject to the following restrictions. Keep the following points in mind when using the printer driver.

Restrictions on the Printer Driver

- With some applications, the Copies setting in the Page Setup tab of the printer driver may not be enabled.
In this case, use the copies setting in the Print dialog box of the application software.
- If the selected Language in the About dialog box does not match the operating system interface language, the driver screen may not be displayed properly.
- Do not change the Advanced tab items of the printer properties. If you change any of the items, you will not be able to use the following functions correctly.
Also, if Print to file is selected in the Print dialog box of the application software and with applications that prohibit EMF spooling, such as Adobe Photoshop LE and MS Photo Editor, the following functions will not operate.
 - Preview before printing on the Main tab
 - Prevent loss of print data in the Print Options dialog box
 - Page Layout, Poster, Booklet, Duplex Printing, Specify Margin..., Print from Last Page, Collate, and Stamp/Background... (Stamp...) on the Page Setup tab
- Since the resolution in the preview display differs from the printing resolution, text and lines in the preview display may appear different from the actual print result.
- With some applications, the printing is divided into multiple print jobs.
To cancel printing, delete all divided print jobs.
- If image data is not printed correctly, display the Print Options dialog box from the Page Setup tab and change the setting of Disable ICM required from the application software. This may solve the problem.

Note

- Disable ICM required from the application software cannot be used when the XPS printer driver is used.

Points to Note with Applications

- There are following restrictions in Microsoft Word (Microsoft Corporation).
 - When Microsoft Word has the same printing functions as the printer driver, use Word to specify them.
 - When selecting Fit-to-Page, Scaled, or Page Layout from the Page Layout list on the Page Setup tab, the selected printing function may not be effective, depending on the version of Word.
If this happens, follow the procedure below.
 1. Open Word's Print dialog box.
 2. Open the printer driver setup window, specify Page Layout on the Page Setup tab, and click OK.
 3. Without starting printing, close the Print dialog box.

4. Open Word's Print dialog box again.
 5. Open the printer driver setup window again and click OK.
 6. Start printing.
- If bitmap printing is enabled in Adobe Illustrator (Adobe Systems Inc), printing may take time or some data may not be printed, printing may take time or some data may not be printed. Print after unchecking the Bitmap Printing check box in the Print dialog box.

[Page top](#) ↕

Advanced Guide

Advanced Guide > Troubleshooting > General Notes (Scanner Driver)

S004

General Notes (Scanner Driver)

ScanGear (scanner driver) is subject to the following restrictions. Keep these points in mind when using it.

Scanner Driver Restrictions

- When using the NTFS file system, the TWAIN data source may not be invoked. This is because the TWAIN module cannot be written to the winnt folder for security reasons. Contact the computer's administrator for help.
- Some computers (including laptops) connected to the machine may not resume correctly from standby mode. In that case, restart the computer.
- Do not connect two or more machines or multifunction printers with scanner function to the same computer simultaneously. If multiple scanning devices are connected, you cannot scan from the Operation Panel of the machine and also may experience errors while accessing the devices.
- Use the default display font size of the OS. Otherwise, software screens may not appear correctly.
- Scanning may fail if the computer has resumed from sleep or standby mode. In that case, follow these steps and scan again.
 1. Turn off the machine.
 2. Exit ScanGear, then disconnect the USB cable from the computer and reconnect it.
 3. Turn on the machine.
- ScanGear cannot be opened in multiple applications at the same time. Within an application, ScanGear cannot be opened for the second time when it is already open.
- Be sure to close the ScanGear window before closing the application.
- Make sure that you have adequate disk space available when scanning large images at high resolutions. For example, at least 300 MB of free space is required to scan an A4 document at 600 dpi in full-color.
- ScanGear and WIA driver cannot be used at the same time.
- Do not enter the computer into sleep or hibernate state during scanning.
- Calibration may take time if the machine is connected via USB 1.1.

Applications with Restrictions on Use

- If you start Media Center included in Windows XP Media Center Edition 2005, you may not be able to scan using the Operation Panel of the machine. In that case, restart the computer.
- You cannot scan images with Media Center included in Windows 7, Windows Vista and Windows XP Media Center Edition 2005. Scan with other applications such as MP Navigator EX.
- In some applications, if you select the View scanned images checkbox on the Auto Scan Mode tab of ScanGear, the window displaying the thumbnails of the scanned images may close automatically.
- Some applications may not display the TWAIN user interface. In that case, refer to the application's manual and change the settings accordingly.
- Some applications do not support continuous scanning of multiple documents. In some cases, only the first scanned image is accepted, or multiple images are scanned as one image.
- To import scanned images into Microsoft Office 2000, first save them using MP Navigator EX, then import the saved files from the Insert menu.
- When scanning platen size images into Microsoft Office 2003 (Word, Excel, PowerPoint, etc.), click

Custom Insert in the Insert Picture from Scanner or Camera screen. Otherwise, images may not be scanned correctly.

- When scanning images into Microsoft Office 2007 (Word, Excel, PowerPoint, etc.), use Microsoft Clip Organizer.
- Images may not be scanned correctly in some applications. In that case, increase the operating system's virtual memory and retry.
- When image size is too large (such as when scanning large images at high resolution), your computer may not respond or the progress bar may remain at 0% depending on the application. In that case, cancel the action (for example by clicking Cancel on the progress bar), then increase the operating system's virtual memory or reduce the image size/resolution and retry. Alternatively, scan the image via MP Navigator EX first, then save and import it into the application.

[Page top](#) ↕

Advanced Guide

Advanced Guide > Appendix

Appendix

- ➔ [Printing Area](#)
- ➔ [How to Detach/Attach the Document Cover](#)
- ➔ [Editing the Print Document or Reprinting from the Print History](#)
- ➔ [Deleting the Undesired Print Job](#)
- ➔ [Updating the MP Drivers](#)
- ➔ [Uninstalling the On-Screen Manuals](#)
- ➔ [Transporting the Machine](#)
- ➔ [Opening the Printer Driver Setup Window](#)
- ➔ [Notice for Unplugging the Power Cord](#)
- ➔ [Sharing the Printer on a Network](#)

[Page top](#) ↕

Advanced Guide

Advanced Guide > Appendix > Printing Area

U504

Printing Area

To ensure the best print quality, the machine allows a margin along each edge of media. The actual printable area will be the area inside these margins.

Recommended printing area : Canon recommends that you print within this area.

Printable area : The area where it is possible to print.

However, printing in this area can affect the print quality or the paper feed precision.

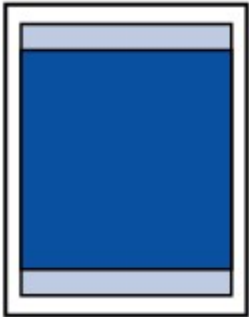

Note

■ Borderless Printing

- By selecting Borderless Printing option, you can make prints with no margins.
- When performing Borderless Printing, slight cropping may occur at the edges since the printed image is enlarged to fill the whole page.
- Duplex printing is not available when performing Borderless Printing.
- For Borderless Printing, use the following paper:
 - Glossy Photo Paper "Everyday Use" GP-501*
 - Photo Paper Glossy GP-502*
 - Photo Paper Plus Semi-gloss SG-201*
 - Photo Paper Pro Platinum PT-101*
 - Photo Paper Plus Glossy II PP-201
 - Matte Photo Paper MP-101*

* This paper can be used only when printing from your computer.

Performing Borderless Printing on any other type of paper may substantially reduce printing quality and/or result in printouts with altered color hues.

Borderless Printing on plain paper may result in printouts with reduced quality. Use them only for test printing. You can perform Borderless Printing on plain paper only when printing from your computer.

- Borderless Printing is not available for legal, A5, or B5 sized paper, or envelopes.
- Depending on the type of paper, Borderless Printing may reduce the print quality at the top and bottom edges of the paper or cause these parts to become smudged.

➡ Letter, Legal

➡ Envelopes

➡ Other Sizes than Letter, Legal, Envelopes

Advanced Guide

Advanced Guide > Appendix > Printing Area > Other Sizes than Letter, Legal, Envelopes

U502

Other Sizes than Letter, Legal, Envelopes

Size	Printable Area (width x height)
A5*	5.56 x 7.95 inches / 141.2 x 202.0 mm
A4	8.00 x 11.38 inches / 203.2 x 289.0 mm
B5*	6.90 x 9.80 inches / 175.2 x 249.0 mm
4" x 6" / 10 x 15 cm	3.73 x 5.69 inches / 94.8 x 144.4 mm
4" x 8" / 10 x 20 cm*	3.73 x 7.69 inches / 94.8 x 195.2 mm
5" x 7" / 13 x 18 cm*	4.73 x 6.69 inches / 120.2 x 169.8 mm
8" x 10" / 20 x 25 cm*	7.73 x 9.69 inches / 196.4 x 246.0 mm
Wide*	3.73 x 6.80 inches / 94.8 x 172.6 mm

* This page size can be used only when printing from your computer.

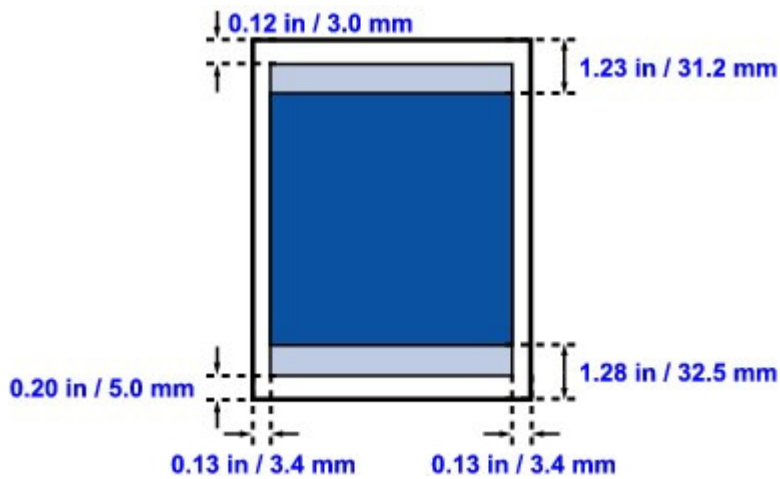

Recommended printing area

Printable area

[Page top](#) ↑

Advanced Guide

Advanced Guide > Appendix > Printing Area > Letter, Legal



U503

Letter, Legal

Size	Printable Area (width x height)
Letter	8.00 x 10.69 inches / 203.2 x 271.4 mm
Legal*	8.00 x 13.69 inches / 203.2 x 347.6 mm

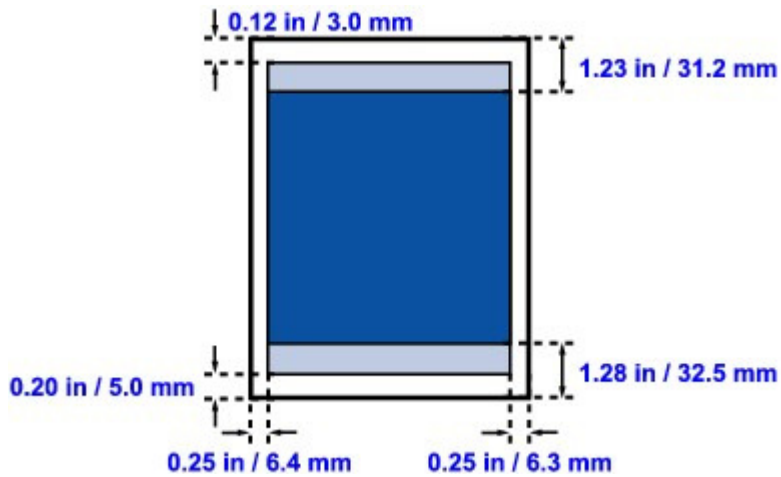
* This page size can be used only when printing from your computer.



-  Recommended printing area
-  Printable area

[Page top](#) ↑

Advanced Guide

Advanced Guide > Appendix > Printing Area > Envelopes

U505

Envelopes

Size	Recommended Printing Area (width x height)
European DL*	4.06 x 7.07 inches / 103.2 x 179.5 mm
US Comm. Env. #10*	3.86 x 7.91 inches / 98.0 x 200.8 mm

* This page size can be used only when printing from your computer.

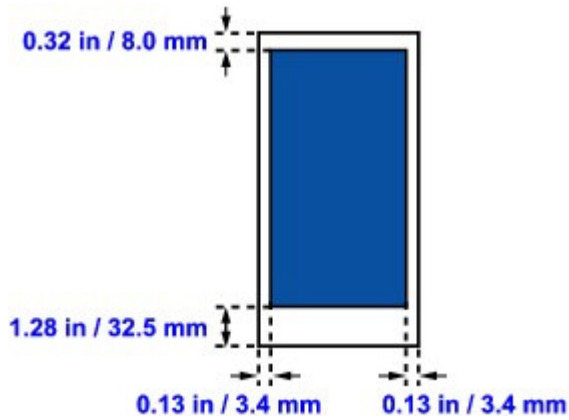

 Recommended printing area

[Page top](#) ↑

Advanced Guide

Advanced Guide > Appendix > How to Detach/Attach the Document Cover

U514

How to Detach/Attach the Document Cover

- **Detaching the Document Cover:**

Hold up the Document Cover vertically.

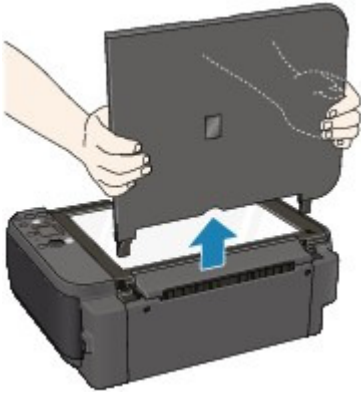

- **Attaching the Document Cover:**

As illustrated below, insert both hinges (A) of the Document Cover vertically into the holder (B) until they stop to attach the Document Cover .

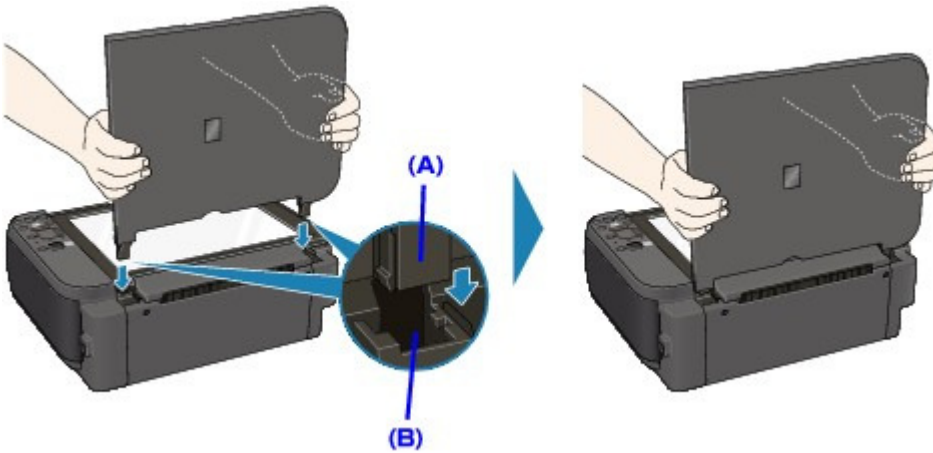

[Page top](#) ↑

Advanced Guide

Advanced Guide > Appendix > Editing the Print Document or Reprinting from the Print History

P048

Editing the Print Document or Reprinting from the Print History

This function is unavailable when the standard IJ printer driver is used.

In the Canon IJ XPS preview window, you can edit the print document or retrieve the document print history to print the document.

The procedure for using the Canon IJ XPS Preview is as follows:

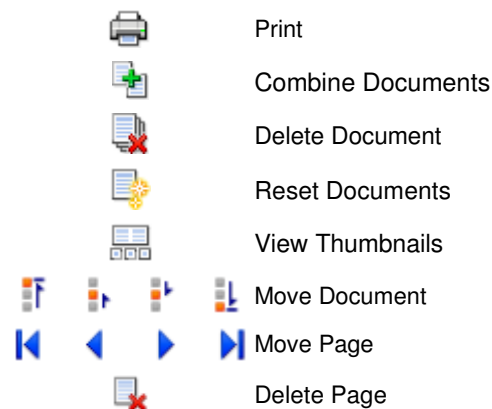
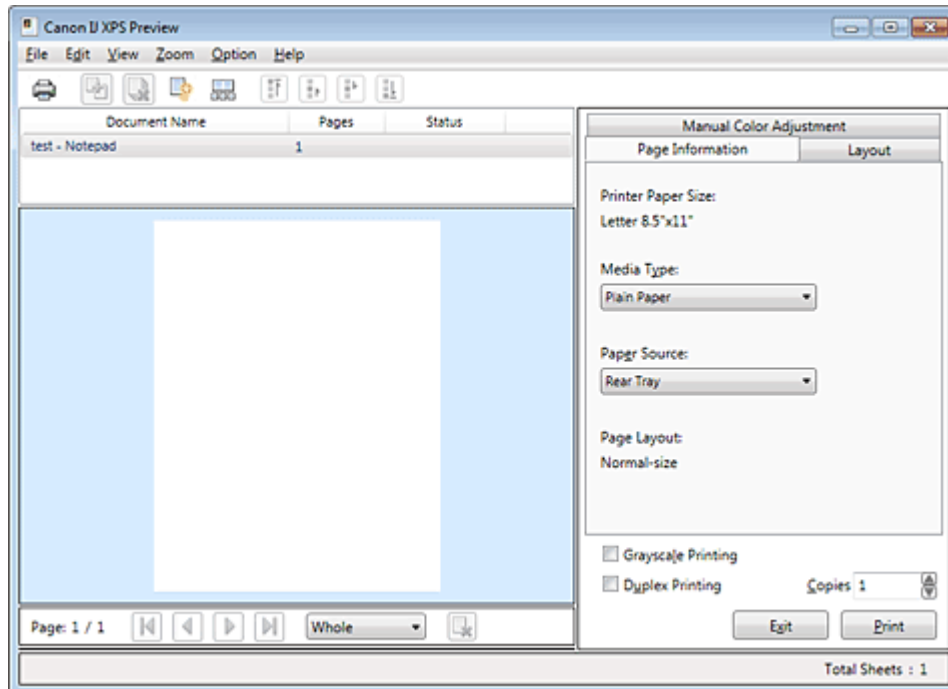

Note

- Click View Thumbnails to view all print pages of the print document selected from the Document Name list.

To hide the print pages, click View Thumbnails again.

Editing and Printing a Print Job

When printing multiple documents or pages, you can combine documents, change the print sequence of the documents or pages, or delete documents or pages.

1. Open the printer driver setup window

2. Set the preview

Check the Preview before printing check box on the Quick Setup tab or the Main tab.

3. Complete the setup

Click OK.

The Canon IJ XPS Preview will start and the print result will be displayed before printing.

4. Editing print documents and print pages

• Combining print documents

You can combine multiple print documents to form a single document.

To select multiple print documents, hold down the Ctrl key and click the documents to be merged, or hold down the Shift key and press the upper arrow or lower arrow key.

By combining print documents, you can prevent blank pages from being inserted when you execute duplex printing or page layout printing.

From the Document Name list, select the documents to be combined. On the Edit menu, select Combine Documents from Documents to combine the documents in the listed sequence. When you combine documents, the documents selected before the combining are deleted from the list and the combined document is added to the list.

• Changing the sequence of print documents or print pages

- To change the sequence of the print documents, go to the Document Name list, and select the print document to be moved. Next, on the Edit menu, select Move Document from Documents, and select the appropriate item.
- To change the sequence of the print pages, click View Thumbnails from the Option menu, and select the print page to be moved. Next, on the Edit menu, select Move Page from Pages, and select the appropriate item.

• Deleting print documents and print pages

- To delete a print document, select the target document from the Document Name list, and on the Edit menu, choose Document and then Delete Document.
- To delete a print page, click View Thumbnails from the Option menu, and select the print page to be deleted. Next, on the Edit menu, select Delete Page from Pages.

After editing the print documents or print pages, you can change the print settings on the Page Information, Layout and Manual Color Adjustment tabs as necessary.

Important

- To display the multiple documents in the list, open the preview and execute print again.
- To return the print documents to their original condition before they were edited in the preview, on the Edit menu, select Reset Documents from Documents.
- If the documents to be combined have different print settings, a message may be displayed. Check the contents of the displayed message before combining the documents.
- If the documents to be combined have different output paper sizes and duplex printing or page layout printing is to be performed, the printer may not produce the expected print results for certain print pages. Check the preview before printing.
- Depending on the print settings of the print document, some functions may not be available in the Canon IJ XPS preview.

Note

- You can rename Document Name to any name.

5. Executing print

Click Print.

When you execute print, the printer uses the specified settings to print the data.

Reprinting from the Print History

When you click Save Print History on the File menu to enable the setting, the document printed from the preview is saved, and you can reprint the document with the same settings.

1. Displaying the print history

Select the Start menu -> All Programs -> "Your model name" -> View Print History XPS.
The saved print document is displayed in the preview.

Important

- To limit the number of print history registrations, click History Entry Limit on the File menu.
- If the limit on the number of registration is exceeded, the print history registrations are deleted starting from the oldest one.

2. Selecting a print document

From the Document Name list, select the document to be printed.

3. Executing print

Click Print.

Related Topic

[➔ Displaying the Print Results before Printing](#)

[Page top ↕](#)

Advanced Guide

Advanced Guide > Appendix > Deleting the Undesired Print Job

P037

Deleting the Undesired Print Job

If you are using the XPS printer driver, replace "Canon IJ Status Monitor" with "Canon IJ XPS Status Monitor" when reading this information.

If the printer does not start printing, cancelled or failed print job data may be remaining. Delete the undesired print job by using the Canon IJ Status Monitor.

1. Display the Canon IJ Status Monitor

Click the button of the status monitor displayed on the task bar.
The Canon IJ Status Monitor appears.

2. Display the print jobs

Click Display Print Queue....
The print queue window opens.

3. Delete the print jobs

Select Cancel All Documents from the Printer menu.
When the confirmation message appears, click Yes.
The deletion of the print job is complete.

Important

- Users who have not been granted access permission for printer management cannot delete the print job of another user.

Note

- When you perform this operation, all print jobs are deleted. If the print queue list contained a necessary print job, start the printing process over from the beginning.

[Page top](#) 

Advanced Guide

Advanced Guide > Appendix > Updating the MP Drivers

Updating the MP Drivers

- ➔ [Obtaining the Latest MP Drivers](#)
- ➔ [Deleting the Unnecessary MP Drivers](#)
- ➔ [Before Installing the MP Drivers](#)
- ➔ [Installing the MP Drivers](#)

[Page top](#) ↕

Advanced Guide

[Advanced Guide](#) > [Appendix](#) > [Updating the MP Drivers](#) > [Obtaining the Latest MP Drivers](#)

P038

Obtaining the Latest MP Drivers

The MP Drivers include a printer driver and scanner driver (ScanGear).

By updating the MP Drivers to the latest version of the MP Drivers, unresolved problems may be solved.

Access our web site through the Internet and download the latest MP Drivers for your model.

Important

- You can download the MP Drivers for free, but any Internet access charges incurred are your responsibility.
- Before installing the latest MP Drivers, delete the previously installed version.
For information on how to delete the MP Drivers, see "[Deleting the Unnecessary MP Drivers](#)."

Related Topics

[➡ Before Installing the MP Drivers](#)

[➡ Installing the MP Drivers](#)

[Page top](#) 

Advanced Guide

Advanced Guide > Appendix > Updating the MP Drivers > Deleting the Unnecessary MP Drivers

P039

Deleting the Unnecessary MP Drivers

The MP Drivers which you no longer use can be deleted.
When deleting the MP Drivers, first exit all programs that are running.

The procedure to delete the unnecessary MP Drivers is as follows:

When There is an Uninstaller

1. Start the uninstaller

- If you are using Windows 7, Windows Vista, select the Start menu -> All Programs -> "Your model name" -> MP Drivers Uninstaller.
- If you are using Windows XP, select the start menu -> All Programs -> "Your model name" -> MP Drivers Uninstaller.

The MP Drivers Uninstaller dialog box is displayed.

Important

- In Windows 7 or Windows Vista, a confirmation/warning dialog box may appear when starting, installing or uninstalling software.
This dialog box appears when administrative rights are required to perform a task.
When you are logged on to an administrator account, click Yes (or Continue, Allow) to continue.
Some applications require an administrator account to continue. When you are logged on to a standard account, switch to an administrator account, and restart the operation from the beginning.

2. Execute the uninstaller

Click Execute. When the confirmation message appears, click Yes.
When all the files have been deleted, click Complete.

The deletion of the MP Drivers is complete.

Important

- Printer driver and scanner driver (ScanGear) will be deleted when you uninstall the MP Drivers.

When There is No Uninstaller

When there is no uninstaller in the Start menu of Windows 7 or Windows Vista, follow these steps:

1. Select the printer to be deleted

- If you are using Windows 7, select the Start menu -> Devices and Printers.
Click the model to delete, then press the Alt key on your keyboard. On the File menu, click Remove device.
- If you are using Windows Vista, select the Start menu -> Control Panel -> Hardware and Sound -> Printers.
Click the model to delete, then press the Alt key on your keyboard. On the File menu, click Delete.

2. Delete the printer

- If you are using Windows 7, when the confirmation message appears, click Yes. Then when the User Account Control dialog box appears, click Yes.
The icon is deleted.

- If you are using Windows Vista, when the User Account Control dialog box appears, click Continue. Then when the confirmation message appears, click Yes.
The icon is deleted.

3. Select the printer driver to be deleted

- If you are using Windows 7, click any icon in Printers and Faxes.
On the commandbar, click Print server properties, and then click the Drivers tab. If the Change Driver Settings button is displayed, click that button.
When the User Account Control dialog box appears, click Yes.
In the Installed printer drivers list, click the printer to delete.
- If you are using Windows Vista, press the Alt key. On the File menu, select Run as administrator, and then click Server Properties....
When the User Account Control dialog box appears, click Continue.
Click the Drivers tab. In the Installed printer drivers list, click the printer to delete.

4. Delete the printer driver

When you click Remove..., Remove Driver And Package dialog box is displayed.
Select Remove driver and driver package., and then click OK.
In the confirmation dialog box, click Yes.

When data collection is completed in the Remove Driver Package dialog box, click Delete.

5. Click OK

The deletion of the printer driver is complete.

Important

- You may not be able to delete the printer driver properly from the Installed printer drivers list.
If this happens, restart your computer, and then try again.

Advanced Guide

[Advanced Guide](#) > [Appendix](#) > [Updating the MP Drivers](#) > [Before Installing the MP Drivers](#)

P040

Before Installing the MP Drivers

This section describes the items that you should check before installing the MP Drivers. You should also refer to this section if the MP Drivers cannot be installed.

Checking the Machine Status

- Properly connect the personal computer and the machine. For details on connection instructions, refer to the "Install the Software" in the manual: Getting Started.
- Turn off the machine.

Checking the Personal Computer Settings

- Terminate all running applications.
- In Windows 7, Windows Vista, log on as a user who has the administrator account.
In Windows XP, log on as the computer administrator.

Important

- Before installing the latest MP Drivers, delete the previously installed version. For instructions on deleting the MP Drivers, see "[Deleting the Unnecessary MP Drivers](#)."

Related Topics

- ➔ [Obtaining the Latest MP Drivers](#)
- ➔ [Installing the MP Drivers](#)

[Page top](#) ↑

Advanced Guide

Advanced Guide > Appendix > Updating the MP Drivers > Installing the MP Drivers

P041

Installing the MP Drivers

You can access our web site through the Internet and download the latest MP Drivers for your model.

The procedure for installing the downloaded MP Drivers is as follows:

1. Turn off the machine

2. Start the installer

Double-click the icon of the downloaded file.
The installation program starts.

Important

- In Windows 7 or Windows Vista, a confirmation/warning dialog box may appear when starting, installing or uninstalling software.
This dialog box appears when administrative rights are required to perform a task.
When you are logged on to an administrator account, click Yes (or Continue, Allow) to continue. Some applications require an administrator account to continue. When you are logged on to a standard account, switch to an administrator account, and restart the operation from the beginning.

3. Install the MP Drivers

At the Welcome window, click Next.

When the License Agreement window is displayed, check the contents, and click Yes. If you do not agree to the terms of the Software License Agreement, you cannot install this software.

Installation of the MP Drivers begins.

After the Installation Complete window is displayed, check that the machine and the computer are connected through a cable.

To select the connection port for your machine manually, check the Select printer port check box, and click Manual Selection. At the Select Port window, select the connection destination, and then click OK.

4. Complete the installation

Click Complete.

Turn on the machine, and wait awhile until the connection is recognized.

The procedure for installing the MP Drivers is complete.

Depending on the environment you are using, a message prompting you to restart the computer may be displayed. To complete the installation properly, restart the computer.

Important

- You can download the MP Drivers for free, but any Internet access charges incurred are your responsibility.
- Before installing the latest MP Drivers, delete the previously installed version. For instructions on deleting the MP Drivers, see "[Deleting the Unnecessary MP Drivers](#)."

Related Topics

- ➔ [Obtaining the Latest MP Drivers](#)
- ➔ [Deleting the Unnecessary MP Drivers](#)
- ➔ [Before Installing the MP Drivers](#)

Advanced Guide

Advanced Guide > Appendix > Uninstalling the On-Screen Manuals

U509

Uninstalling the On-Screen Manuals

Follow the procedure below to uninstall all of the installed on-screen manuals from your computer.

Before uninstalling the on-screen manuals, exit all on-screen manuals that are opening.

1. Click Start > All Programs > Canon XXX Manual (where "XXX" is your machine's name) > Uninstall.
2. Click OK when the confirmation message appears.



Note

- When the message prompting you to restart your computer is displayed, click OK to restart your computer.
-

[Page top](#) ↑

Advanced Guide

Advanced Guide > Appendix > Transporting the Machine

U510

Transporting the Machine

When relocating the machine, pack the machine using the original packing materials.

If you do not have the original packing materials, pack the machine carefully using protective material and place it inside a sturdy box.

Important

- Do not transport or store the machine slanted, vertically, or upside-down, as the ink may leak and damage the machine.

1. Turn the machine off.
2. Confirm that the **POWER** lamp is off and unplug the machine.

Important

- Do not unplug the machine while the **POWER** lamp is lit or flashing green, as it may cause malfunction or damage to the machine, making the machine unable to print.

3. Retract the Paper Support and the Output Tray Extension, then close the Paper Output Tray.
4. Disconnect the printer cable from the computer and from the machine, then disconnect the power plug from the machine.
5. Use adhesive tape to secure all the covers on the machine to keep them from opening during transportation. Then pack the machine in the plastic bag.
6. Attach the protective material to the machine when packing the machine in the box.

Important

- Pack the machine with the FINE Cartridges left installed in the machine.

Note

- When you ask a shipping agent to transport the machine, clearly label the box as "FRAGILE" or "HANDLE WITH CARE".

Advanced Guide

Advanced Guide > Appendix > Opening the Printer Driver Setup Window

U511

Opening the Printer Driver Setup Window

The printer driver setup window can be displayed through the application software in use or the Start menu of the Windows.

Open the Printer Driver Setup Window through the Application Software

Follow the procedure below to configure print settings when printing.

1. Select the command you perform printing on the application software in use.

In general, select Print on the File menu to open the Print dialog box.

2. Select your model name and click Preferences (or Properties).

The printer driver setup window opens.

Note

- Depending on application software you use, command names or menu names may vary and there may be more steps. For details, refer to the user's manual of your application software.

Open the Printer Driver Setup Window through the Start Menu

Follow the procedure below to perform maintenance operations such as print head cleaning, or to configure print settings that are common for all application software.

1. Select items from the Start menu as shown below.

- In Windows 7, select Devices and Printers from the Start menu.
- In Windows Vista, select the Start menu > Control Panel > Hardware and Sound > Printers.
- In Windows XP, select the Start menu > Control Panel > Printers and Other Hardware > Printers and Faxes.

2. Right-click your model name icon and then select Printing Preferences from the displayed menu.

The printer driver setup window opens.

Important

- Opening the printer driver setup window through Printer properties (Windows 7) or Properties (Windows Vista or Windows XP) displays such tabs regarding the Windows functions as the Ports (or Advanced) tab. Those tabs do not appear when opening through Printing Preferences or application software. About tabs regarding Windows functions, refer to the user's manual for the Windows.

Advanced Guide

Advanced Guide > Appendix > Notice for Unplugging the Power Cord

U516

Notice for Unplugging the Power Cord

To unplug the power cord, follow the procedure below.

Important

- When you unplug the power cord, press the **ON** button, then confirm that the **POWER** lamp is off. Unplugging the power cord while the machine is still on may cause drying or clogging of the Print Head and print quality may be reduced.

1. Press the **ON** button to turn the machine off.



2. Confirm that the **POWER** lamp is off.



3. Unplug the power cord.

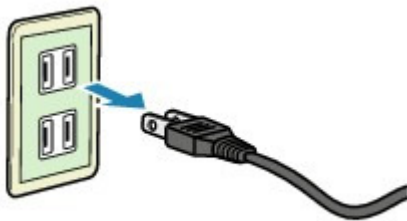

The specification of the power cord differs depending on the country or region of use.

Advanced Guide

Advanced Guide > Appendix > Sharing the Printer on a Network

P042

Sharing the Printer on a Network

When multiple computers are being used in the network environment, you can share the printer connected to one computer with the other computers. The Windows versions of the computers connected to the network do not necessarily have to be the same.

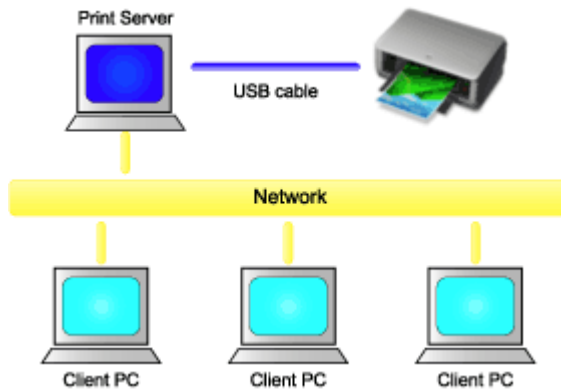

- **Settings on Print Server**

The procedure for setting up a computer directly connected to a printer with a USB cable is as follows:

- **Settings on Client PC**

The procedure for setting up those computers that will use this printer through the network is as follows:

When you execute print, the data is sent to the printer through the print server system.

Important

- In case an error occurred when a document is printed by the client system to a shared printer, the error message of Canon IJ Status Monitor will be displayed both on the client system and the print server system. For regular printing, Canon IJ Status Monitor will be displayed only on the client system.

Note

- Install the printer driver from the Setup CD-ROM that accompanies the machine on the print server system and each of the client systems according to the OS of each system.

Related Topic

➔ [Restrictions on Printer Sharing](#)



Page top 

Advanced Guide

Advanced Guide > Appendix > Sharing the Printer on a Network > Settings on Print Server

P043

Settings on Print Server

When you use the printer on a network, set up the printer driver for sharing on the server system.

The procedure for setting up the print server systems is as follows:

1. Install the printer driver on the print server system

For details on installation instructions, refer to the "Install the Software" in the manual: Getting Started.

2. Select items from the Start menu as shown below:

- If you are using Windows 7, select the Start menu -> Devices and Printers.
- If you are using Windows Vista, select the Start menu -> Control Panel -> Hardware and Sound -> Printers.
- If you are using Windows XP, select the start menu -> Control Panel -> Printers and Other Hardware -> Printers and Faxes.

The Devices and Printers window (Windows 7) or Printers window (Windows Vista) or Printers and Faxes window (Windows XP) is displayed.

3. Click the icon for the model name of printer to be shared

- If you are using Windows 7, press the Alt key on your keyboard and then select Printer properties -> Sharing tab from the displayed File menu.
- If you are using Windows Vista, press the Alt key on your keyboard and then select Run as administrator -> Sharing... from the displayed File menu.
- If you are using Windows XP, select Sharing... from the File menu.

Important

- In Windows 7 or Windows Vista, a confirmation/warning dialog box may appear when starting, installing or uninstalling software. This dialog box appears when administrative rights are required to perform a task. When you are logged on to an administrator account, click Yes (or Continue, Allow) to continue. Some applications require an administrator account to continue. When you are logged on to a standard account, switch to an administrator account, and restart the operation from the beginning.

Note

- Windows XP may display a message recommending the user to use the Network Setup Wizard to set up sharing. When this message appears, choose not to use the wizard and then set up sharing.

4. Set sharing

Select Share this printer on the Sharing tab to set a shared name if necessary, and click OK.

The setup on the print server system is complete. Next, set up the client systems.



Advanced Guide

Advanced Guide > Appendix > Sharing the Printer on a Network > Settings on Client PC

P044

Settings on Client PC

After setting up the print server system, set up the client system.

The procedure for setting up the client systems is as follows:

If you are using Windows 7 or Windows Vista

1. Install the printer driver on the client systems

For installation instructions, see " [Installing the MP Drivers.](#)"

Note

- During the installation, a screen prompting you to turn the printer on appears. Click Manual Selection and then select an appropriate port to complete your installation.

2. Start the wizard

- If you are using Windows 7, select the Start menu -> Devices and Printers -> Add a printer.
- If you are using Windows Vista, select the Start menu -> Network -> Add Printer.

The Add Printer window appears.

3. Add a printer

Select Add a network, wireless or Bluetooth printer, and click the icon for the printer that you have configured on the print server system to be shared, and then click Next.

Note

- If the icon for the printer is not displayed, check that the printer is actually connected to the print server.
- It may take some time for the icon for the printer to appear.

4. Complete the setup

Take the appropriate action as described on the screen and then click Finish.

- If you are using Windows 7, the icon for the shared printer will be created in the Devices and Printers window.
- If you are using Windows Vista, the icon for the shared printer will be created in the Printers window.

The setup on the client systems is complete. You can now share the printer in the network.

If you are using Windows XP

1. Install the printer driver on the client systems

For installation instructions, see " [Installing the MP Drivers.](#)"

Note

- During the installation, a screen prompting you to turn the printer on appears. Click Manual Selection and then select an appropriate port to complete your installation.

2. Start the wizard

Select the start menu -> Control Panel -> Printers and Other Hardware -> Printers and Faxes -> Add a printer.

When Welcome to the Add Printer Wizard screen appears, click Next.

3. Add a printer

Select A network printer, or a printer attached to another computer, then click Next.

On the Specify a Printer window, click Next and then search for the print server system.

Click the icon for the printer that you have configured on the print server system to be shared, and then click Next.



Note

- If the icon for the printer is not displayed, check that the printer is actually connected to the print server.

4. Complete the setup

Take the appropriate action as described on the screen and then click Finish.

The icon for the shared printer will be created in the Printers and Faxes window.

The setup on the client systems is complete. You can now share the printer in the network.



Advanced Guide

Advanced Guide > Appendix > Sharing the Printer on a Network > Restrictions on Printer Sharing

P415

Restrictions on Printer Sharing

If you are using the XPS printer driver, replace "Canon IJ Status Monitor" with "Canon IJ XPS Status Monitor" when reading this information.

These are restrictions that apply when you are using a printer in a network environment. Check the restrictions for the environment you are using.

When You Are Sharing a Printer in a Network

- A print completion message may be displayed. To disable the message to display, follow the procedure below.
 - **If you are using Windows 7:**

In the Devices and Printers window of the client, select the printer from Printers and Faxes, and open the displayed Print server properties.

Uncheck Show information notifications for network printers on the Advanced tab, and then restart the computer.
 - **If you are using Windows Vista:**

Press the Alt key from the Printers window on the client system. Open Run as administrator -> Server Properties... from the displayed File menu.

Uncheck Show informational notifications for network printers on the Advanced tab, and then restart the computer.
 - **If you are using Windows XP:**

Open Server Properties from the File menu of the Printer and Faxes window on the print server system.

Uncheck Notify when remote documents are printed on the Advanced tab, and then restart the computer.
- The bi-directional communication function is disabled and the correct printer status may not be recognized.

If a client user opens the printer driver properties (to display the properties when using Windows 7, press the Alt key, and select Printer properties from the displayed File menu) and then clicks OK with the Enable bidirectional support check box cleared on the Ports tab, the bidirectional communication function of the printer server may also be disabled.

In this case, check Enable bidirectional support check box on both the print server system and the client system.
- When you print from a client system, you cannot use Canon IJ Preview.
- When the functions on the Maintenance tab cannot be set properly from a client system, they may be grayed out. In this case, change the settings from the print server.

When you change the settings of the print server, you should delete the icon of the shared printer from the client system, and then specify the shared settings again in the client system.

When the Same Printer Driver is Installed in the Print Server System and the Client System as the Local Printer

- The net crawl function may automatically create a network printer icon on the client system.



Advanced Guide

Advanced Guide > Using Easy-PhotoPrint EX

A001

Easy-PhotoPrint EX

Using Easy-PhotoPrint EX

--- Transforming Your Photos into Creative Works of Art ---

Easy-PhotoPrint EX allows you to create albums, calendars and stickers easily using photos taken with digital cameras.

You can also print borderless photos easily.

Start Easy-PhotoPrint EX



Click Here: [Easy-PhotoPrint EX](#)

Note

- See the section below for details on how to use Easy-PhotoPrint EX.
 - ▶ [Printing with the Bundled Application Software](#)

Create a Personalized Photo Album

Creating a personalized photo album is an easy task if you use Easy-PhotoPrint EX!

All you need to do is select which photos to use, select a layout, then load paper into your printer and print. After you bind the printed sheets, you'll have the one and only album of your memories!



You can change the layout and background, and attach comments to photos.



You can also select the size and orientation.



You can arrange a photo across the left and right pages.

CHECK!

Select a theme (background design) to create a single-themed album.

Decorate Items with Text and Frames

You can add text and frames to photos. Attach a description of the photo in an album, and add a frame to enhance the photo's atmosphere.



CHECK!

Select Album to add text and frames. You cannot decorate photos with Photo Print.

Create a Calendar Using Your Favorite Photos

Create calendars easily with Easy-PhotoPrint EX. Create your own calendar using your favorite photos! It'll be exciting to turn the calendar pages.



You can use all kinds of photos.

You can also create 2-month, 6-month and 12-month calendars.

Create Stickers

Create stickers easily with Easy-PhotoPrint EX!

Create stickers of your favorite photos and share them with your friends!



CHECK!

You can add text to photos.

[Page top](#) 

Advanced Guide

Advanced Guide > Using MP Navigator EX

S001

MP Navigator EX

Using MP Navigator EX

MP Navigator EX is an application that enables you to easily scan photos and documents. It is suitable even for beginners.

Start MP Navigator EX



Click Here: [MP Navigator EX](#)

Note

- See "Let's Try Scanning" for details on how to scan images using MP Navigator EX.

Scan Photos and Documents

You can scan easily by navigating through MP Navigator EX screens. You can also save/print scanned images using MP Navigator EX.



Scan Small Documents at One Time

You can scan multiple small documents (photos, cards, etc.) at one time. It is useful as you do not need to scan multiple times.

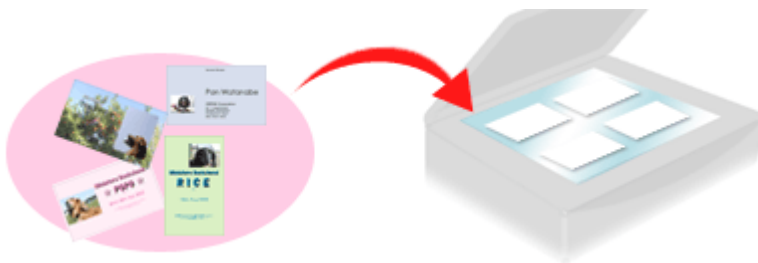

Scan Large Documents

You can easily scan documents that are larger than the Platen using MP Navigator EX. It allows you to scan the left and right halves of a document separately and combine them back into one image.



Scan with One-click

In One-click Mode, MP Navigator EX completes from scanning to saving, with a click of an icon. One-click Mode also allows you to scan and save images as PDF files or attach them to e-mail automatically.

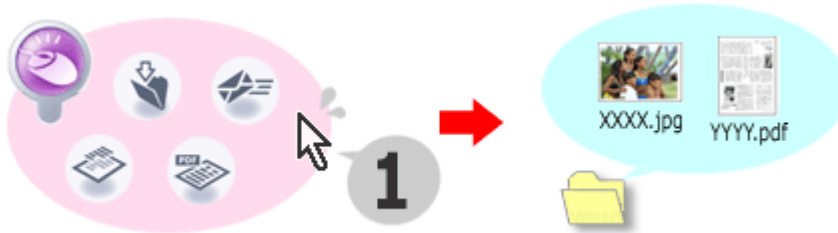

Scan and Correct/Enhance Photos

You can easily correct/enhance scanned photos using MP Navigator EX. You do not need to use other applications.

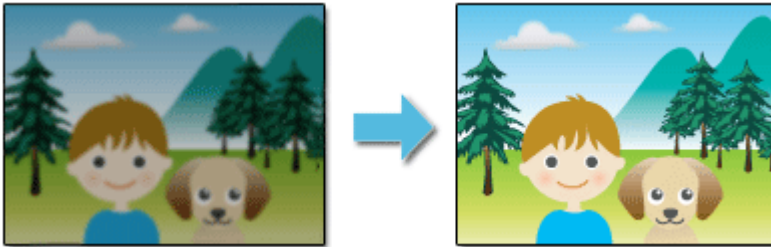

For details on how to use MP Navigator EX, refer to " [Scanning with the Bundled Application Software](#) ."