

Canon

How to Use This Manual
Printing This Manual

MP990 series

On-screen Manual

MC-4274-V1.00



Basic Guide

Describes the summary of this product.

Advanced Guide

Describes the detailed function of this product.

Troubleshooting

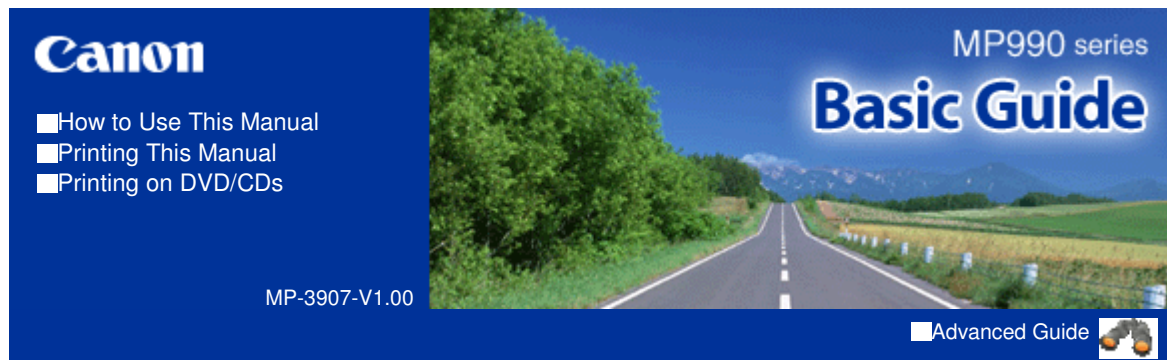

Contents

❖ Overview of the Machine

Main Components
How to Navigate Menus on the LCD

❖ Printing from a Memory Card

Printing Photos Saved on the Memory Card /
USB Flash Drive
Using Various Functions
Inserting the Memory Card
Inserting the USB Flash Drive

❖ Copying

Making Copies
Using Various Copy Functions

❖ Printing Photos from Printed Photos or Films

Reprinting Printed Photos
Printing Photos from Films
Loading the Films
Using Various Functions

❖ Scanning

Forwarding Scanned Data to the Computer
Using Various Scan Functions

❖ Printing from Your Computer

Printing Photos (Easy-PhotoPrint EX)
Printing Documents (Windows)
Printing Documents (Macintosh)

❖ Other Usages

Printing the Template Forms such as Notebook
Paper
Printing Photos Directly from Your Digital
Camera or Mobile Phone
Machine Settings
Useful Software Applications

❖ Loading Paper / Originals

Loading Paper
Loading Originals

❖ Routine Maintenance

Replacing an Ink Tank
When Printing Becomes Faint or Colors Are
Incorrect
Cleaning the Paper Feed Roller
Cleaning the Pad in the Cassette

❖ Appendix

Legal Limitations on Use of Your Product and
Use of Images
Tips on How to Use Your Machine

Overview of the Machine

This section shows the component names of the machine and describes the basic operations you need to know before using it.

Main Components

[Front View](#)

[Rear View](#)

[Inside View](#)

[Operation Panel](#)

How to Navigate Menus on the LCD

[Selecting Menus on the HOME Screen](#)

[Selecting Setting Items](#)

[Other Operations](#)



Main Components

- ➔ Front View
- ➔ Rear View
- ➔ Inside View
- ➔ Operation Panel

■ Front View

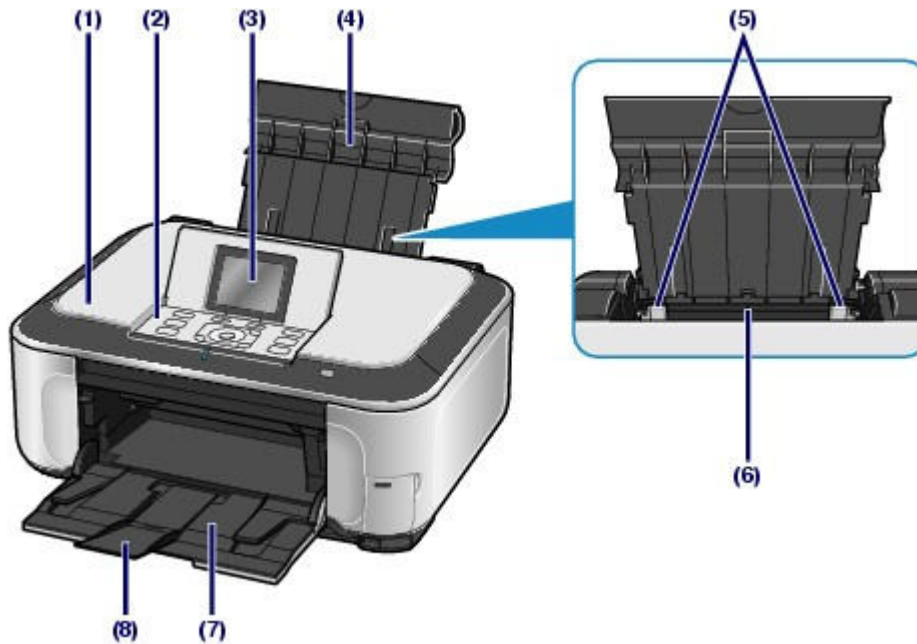

(1) Document Cover

Open to load an original on the Platen Glass.

(2) Operation Panel

Use to change the settings of the machine or to operate it.

See [Operation Panel](#).

(3) LCD (Liquid Crystal Display)

Displays messages, menu selections, and the operation status. You can also preview photos on the LCD before printing.

Note

- The LCD will turn off if the machine is not operated for about 5 minutes. To restore the display, press any button except the **ON** button or perform the print operation.

(4) Paper Support

Raise and tip back to load paper in the Rear Tray.

(5) Paper Guides

Slide to align with both sides of the paper stack.

(6) Rear Tray

Load photo paper or envelopes which you can use on the machine. Two or more sheets of the same size and type of paper can be loaded at the same time, and fed automatically one sheet at a time.

See [Loading Paper](#).

(7) Paper Output Tray

Opens automatically when printing or copying starts and printed paper is ejected.

(8) Output Tray Extension

Open to support the printouts. Open it when printing or copying.

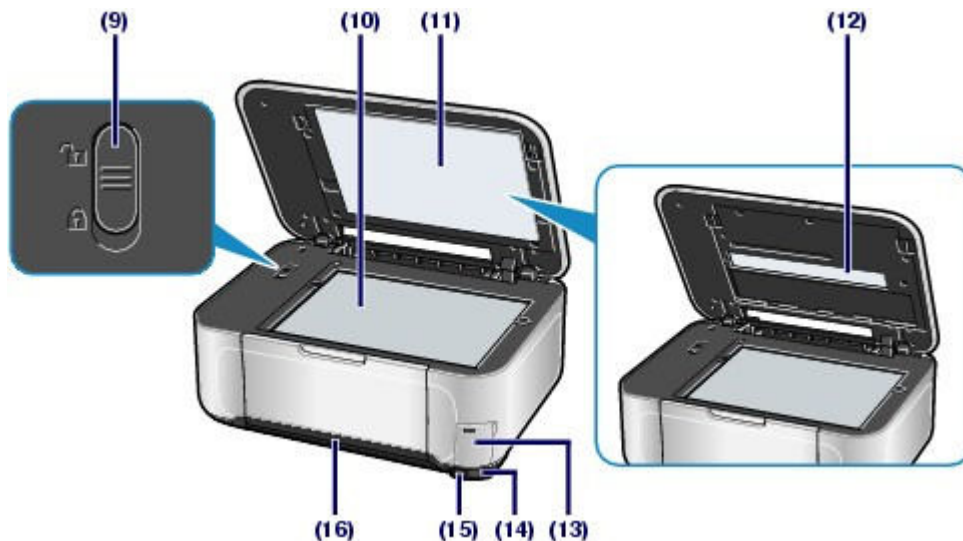
**(9) Scanner Lock Switch**

Locks the scanner to prevent sliding or damage when transporting the machine. Be sure to unlock it before turning the power on.

(10) Platen Glass

Load an original to copy or scan.

(11) FAU (Film Adapter Unit) Protective Sheet

Protects the FAU lamp and the Platen Glass. The Film Guide used for scanning film can be stored behind the FAU Protective Sheet.

See [Loading the Films](#).

(12) FAU (Film Adapter Unit) lamp

Lights up the film when scanning films.

(13) Card Slot Cover

Open to insert a memory card.

See [Inserting the Memory Card](#).

(14) Infrared Port

Use this port to print from a mobile phone with wireless infrared communication.

See [Printing Photos from a Wireless Communication Device](#).

(15) Direct Print Port

Connect a PictBridge compliant device such as a digital camera or the optional Bluetooth Unit BU-30* to print directly.

See [Printing Photos Directly from Your Digital Camera or Mobile Phone](#).

You can also insert a USB flash drive to this port.

See [Inserting the USB Flash Drive](#).

* The Bluetooth Unit is not available in some countries or regions depending on the local laws and regulations. For details, contact the service center.

⚠ Warning

- Do not connect any equipment other than PictBridge compliant devices, the optional Bluetooth Unit BU-30, and USB flash drives to the Direct Print Port of the machine. This may cause fire, electric shock, or damage to the machine.

▶ Important

- Do not touch the metal casing.
- Do not use the USB cable longer than around 10 feet / 3 meters to connect any PictBridge compliant device to the machine since it may affect the operation of other peripheral devices.

(16) Cassette

Load A4, B5, A5, or Letter-sized plain paper and insert it into the machine. Two or more sheets of the same size of plain paper can be loaded at the same time, and fed automatically one sheet at a time.

See [Loading Paper](#).

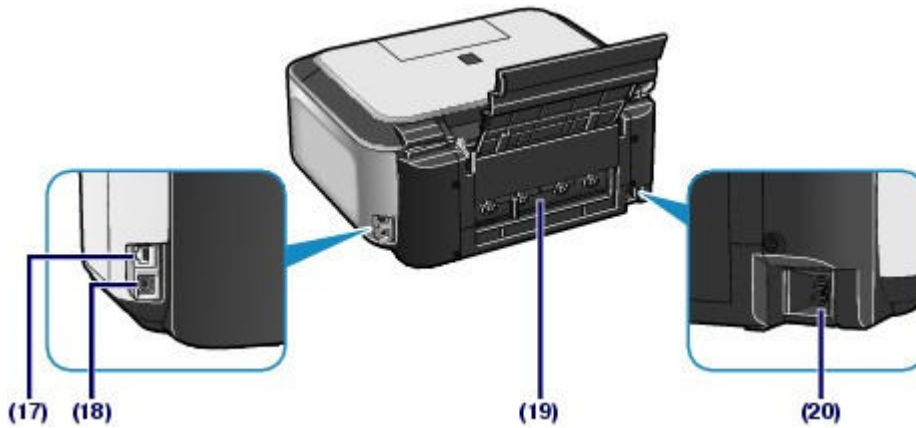
■ Rear View**(17) Wired LAN Connector**

Plug in the LAN cable to connect the machine to a LAN.

▶ Important

- Do not touch the metal casing.

📖 Note

- Remove the LAN connector cap before connecting the LAN cable.

(18) USB Port

Plug in the USB cable to connect the machine with a computer.

▶ Important

- Do not touch the metal casing.
- Do not plug in or unplug the USB cable while the machine is printing or scanning originals with the computer.

(19) Rear Cover

Detach to remove jammed paper.

(20) Power Cord Connector

Plug in the supplied power cord.

■ Inside View

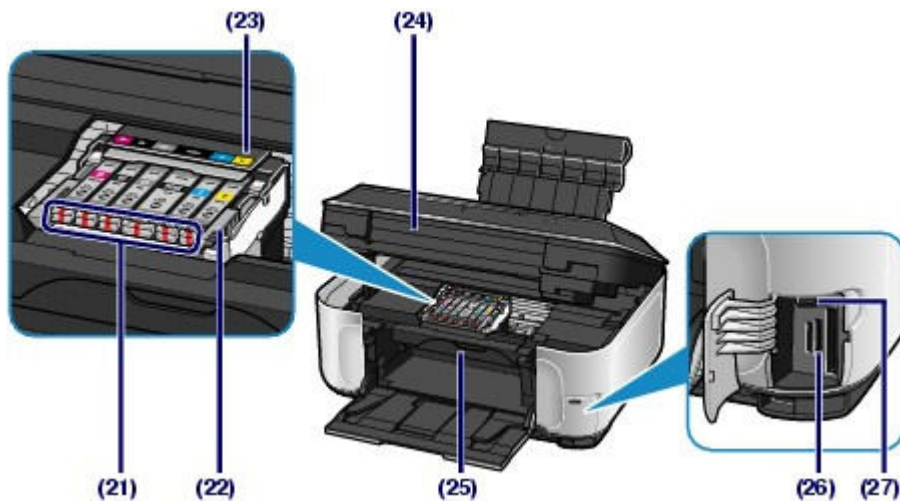
**(21) Ink lamps**

Light or flash red to indicate the ink tank status.

See [Checking the Ink Status](#).

(22) Print Head Lock Lever

Locks the Print Head into place.

 **Important**

- Do not raise this lever after installing the Print Head.

(23) Print Head Holder

Install the Print Head.

(24) Scanning Unit (Cover)

Scans originals. Open it to replace ink tanks, to check ink lamps, or to remove jammed paper inside the machine. When opening the Scanning Unit (Cover), lift it with the Document Cover closed.

(25) Inner Cover

Close it when printing on paper.

(26) Card Slot

Insert a memory card.

See [Inserting the Memory Card](#).

(27) Access lamp

Lights or flashes to indicate the memory card status.

See [Inserting the Memory Card](#).

 **Note**

- For details on installing the Print Head and ink tanks, refer to the printed manual: *Getting Started*.

■ Operation Panel

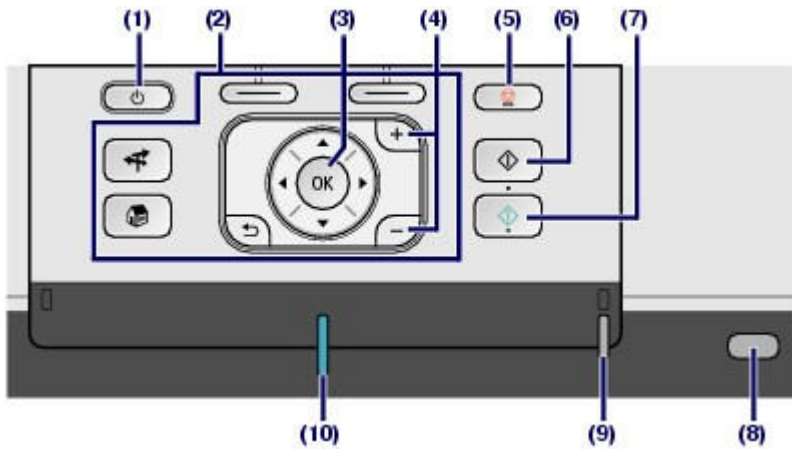

(1) ON button

Turns the power on or off. Before turning on the power, make sure that the Document Cover is closed.

▶ Important

Disconnecting the power plug

- When disconnecting the power plug after turning off the power, be sure to confirm that the **Power** lamp is not lit. If the power plug is disconnected from the wall outlet while the **Power** lamp is lit or flashing, the machine may become unable to print properly since the Print Head is not protected.

(2) Buttons to use when navigating menus on the LCD

See [How to Navigate Menus on the LCD](#).

(3) OK button

Selects a menu or setting item.

See [How to Navigate Menus on the LCD](#).

Resolves an error when printing is in progress or resumes the machine's normal operation after removing jammed paper.

(4) [+] [-] buttons

Specifies the number of copies to copy or print.

(5) Stop button

Cancels operation when a print, copy, or scan job is in progress.

(6) Black button

Starts black & white copying, scanning, etc.

(7) Color button

Starts color printing, copying, or scanning.

(8) Wi-Fi lamp

Lights or flashes blue to indicate the wireless LAN status.

Lights: Wireless LAN active is selected.

Flashes: Printing or scanning over wireless LAN. Also flashes while searching for wireless LAN access point during setup and when connecting to the access point.

(9) Alarm lamp

Lights or flashes orange when an error occurs, such as paper-out or ink-out.

(10) Power lamp

Lights blue after flashing when the power is turned on.



How to Navigate Menus on the LCD

This machine allows you to print photos on a memory card or USB flash drive, make copies, or scan an original without a computer. To operate the machine, you can turn around the **Easy-Scroll Wheel** on the Operation Panel or press the ▲, ▼, ◀, or ▶ button on the **Easy-Scroll Wheel** to navigate menus or select setting items on the LCD, then press the **OK** button.

This section describes the basic operation to navigate menus on the **HOME** screen and to select setting items necessary for printing.

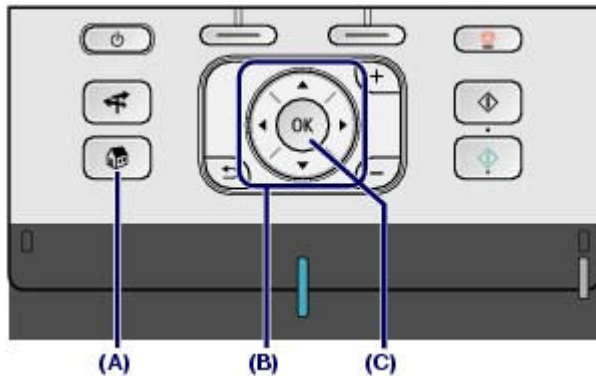

Using the Easy-Scroll Wheel (B)

The **Easy-Scroll Wheel** is used to select menus or setting items.

The **Easy-Scroll Wheel** can be used in two ways. You can operate the machine either way.

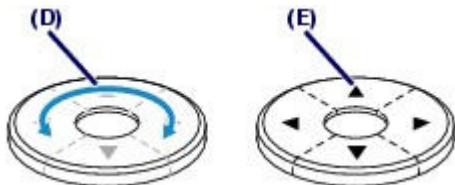

(D) Turn around the **Easy-Scroll Wheel** with your finger to select items.

Or

(E) Press the ▲, ▼, ◀, or ▶ button to select items.

When it is indicated in this guide that the ▲, ▼, ◀, or ▶ button can be used, it is also described in the operation procedure, i.e., "the **Easy-Scroll Wheel** (the ▲ or ▼ button)".

■ Selecting Menus on the HOME Screen

The **HOME** screen will appear when the power is turned on or when the **HOME** button is pressed.

To start printing photos on a memory card or USB flash drive, copying, or scanning, select menus on the **HOME** screen.

1. Press the **HOME** button (A).

The **HOME** screen will appear.



- Turn around the **Easy-Scroll Wheel** (B) to select the menu to use, and press the **OK** button (C).

You can also use the ◀ or ▶ button on the **Easy-Scroll Wheel** (B) to select the menu.

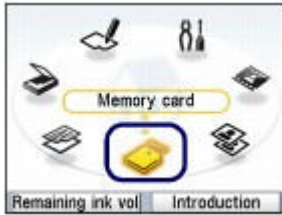

The selected menu screen will appear.

The following menus are available on the **HOME** screen.

Copy



:

You can change copy scale or erase dark frame or shade of bound part when copying a book. And also you can copy an original in various layouts.

See [Copying](#).

Memory card



:

You can print photos saved on a memory card of your digital camera or USB flash drive.

See [Printing from a Memory Card](#).

Easy photo reprint



:

You can scan printed photos and print them easily. You can specify the number of copies for each photo. You can also print photos on sticker paper.

See [Printing Photos from Printed Photos or Films](#).

Film print



:

You can scan images on the 35 mm film strip or mount films to print them.

See [Printing Photos from Printed Photos or Films](#).

Settings



:

You can maintain the condition of the machine, configure wireless LAN, change settings of the machine, or print the template forms such as notebook paper, etc.

See [When Printing Becomes Faint or Colors Are Incorrect](#), [Cleaning the Paper Feed Roller](#), [Machine Settings](#), or [Printing the Template Forms such as Notebook Paper](#).

For details on the wireless LAN setup, refer to the printed manual: *Getting Started*.

Photo index sheet



:

You can easily print photos on a memory card or USB flash drive using the Photo Index Sheet.

See [Using Photo Index Sheet to print](#).

Scan



:

You can forward scanned data to your computer or save them on a memory card or USB flash drive inserted into the machine with the Operation Panel.

See [Scanning](#).

■ Selecting Setting Items

The displayed screen varies depending on the menu you selected, but the operation is the same.

This section describes the procedure to select a setting item, using the operation to change the print quality on the print confirmation screen in Select and print of Memory card as an example.

- Use the **Easy-Scroll Wheel** (the ▲ or ▼ button) (B) to select Standard, and press the **OK** button (C).

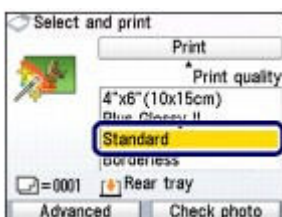

- Use the **Easy-Scroll Wheel** (the ▲ or ▼ button) to select High(quality-priority), and press the **OK** button.



The screen will return to the print confirmation screen in Select and print.



■ Other Operations

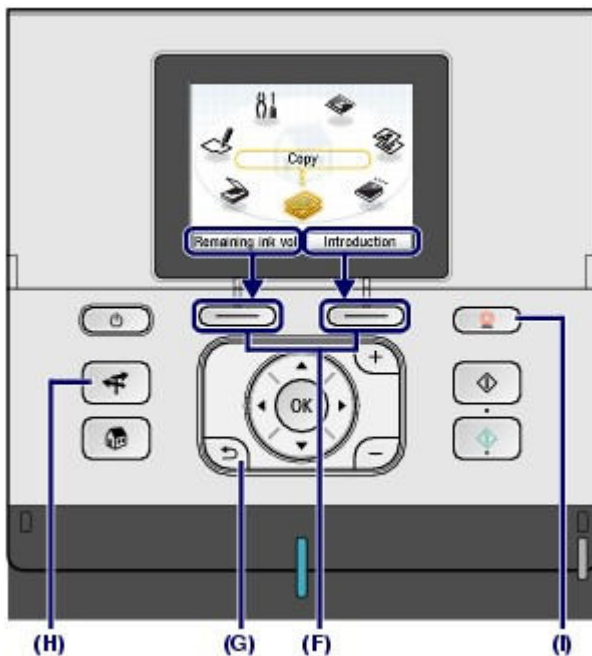

● Selecting Items at the Bottom of the LCD

You can use the two **Function** buttons (F) to select items displayed at the bottom of the LCD. You can press the right **Function** button to select the item on the right, and the left **Function** button to select the item on the left. The displayed items vary depending on the screen.

● Returning to the Previous Screen

You can press the **Back** button (G) to return to the previous screen.

● Performing the Frequently-Used Functions with Easy Operation

You can use the **NAVI** button (H) to perform the frequently-used functions easily, just by following the instructions displayed on the screen. You can also display the information on the functions or instructions on how to load paper.

- Press the **NAVI** button (H).

The NAVI screen will appear.

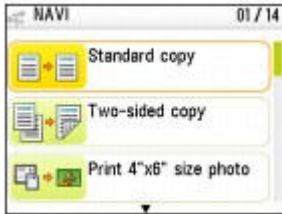

Note

- When you press the **Back** button while the NAVI screen appears, the **HOME** screen will appear.

2. Use the **Easy-Scroll Wheel** (the ▲ or ▼ button) to select the item, and press the **OK** button.

Follow the instructions on the LCD.

● Canceling Printing, Copying, or Scanning

You can press the **Stop** button (I) to cancel a print, copy, or scan job in progress.



[↑ Page top](#)

Printing from a Memory Card

You can preview each photo from a memory card or USB flash drive on the LCD, to select and print the desired photo.

You can also print your favorite photos in various layouts or use them for making a calendar or sticker.

Printing Photos Saved on the Memory Card / USB Flash Drive

[Changing the Settings](#)

Using Various Functions

[Printing Photos in Various Layouts](#)

[Changing the Display](#)

[Cropping Photos / Searching Photos by a Specified Date](#)

[Correcting Images](#)

[Printing Photos with Shot Date or File Number](#)

Inserting the Memory Card

[Before Inserting the Memory Card](#)

[Inserting the Memory Card](#)

[Removing the Memory Card](#)

Inserting the USB Flash Drive

[Inserting the USB Flash Drive](#)

[Removing the USB Flash Drive](#)



[↑ Page top](#)

Printing Photos Saved on the Memory Card / USB Flash Drive

Preview each photo from the memory card or USB flash drive on the LCD, to select and print the desired photo.

This section describes the procedure to print borderless photos on 4" x 6" / 10 x 15 cm photo paper.

For the operation, see the notes and operation procedure described in the reference page.



You need to prepare:

A memory card with saved photos. See [Before Inserting the Memory Card](#).



A USB flash drive with saved photos. See [Inserting the USB Flash Drive](#).



Paper for photo printing. See [Media Types You Can Use](#).



1. Prepare for printing.

(1) Turn on the power.

See [Operation Panel](#).

(2) Load paper.

See [Loading Paper](#).

Here we load 4" x 6" / 10 x 15 cm photo paper in the Rear Tray.



Note

- Load A4 or Letter-sized plain paper in the Cassette. Load other sizes or types of paper in the Rear Tray.

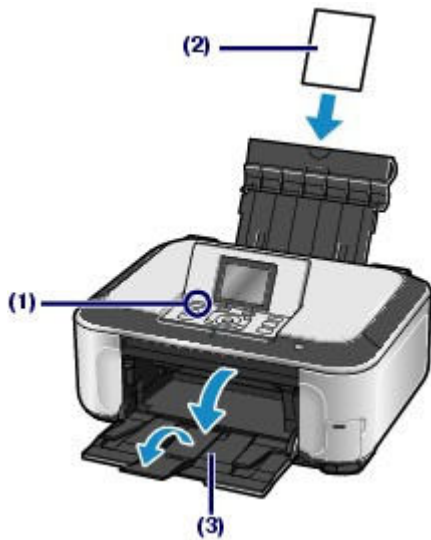
(3) Open the Paper Output Tray gently, and open the Output Tray Extension.



2. Insert a memory card or USB flash drive.

- (1) Select Memory card  on the **HOME** screen, and press the **OK** button.
See [Selecting Menus on the HOME Screen](#).
- (2) Select Select and print , and press the **OK** button.
- (3) Insert the memory card or USB flash drive.

Memory card:

Insert it WITH THE LABELED SIDE FACING TO THE LEFT into the Card Slot. For the types of memory card compatible with the machine and locations to insert them, see [Inserting the Memory Card](#).

USB flash drive:

Insert it into the Direct Print Port. See [Inserting the USB Flash Drive](#).

The photo selection screen will appear.

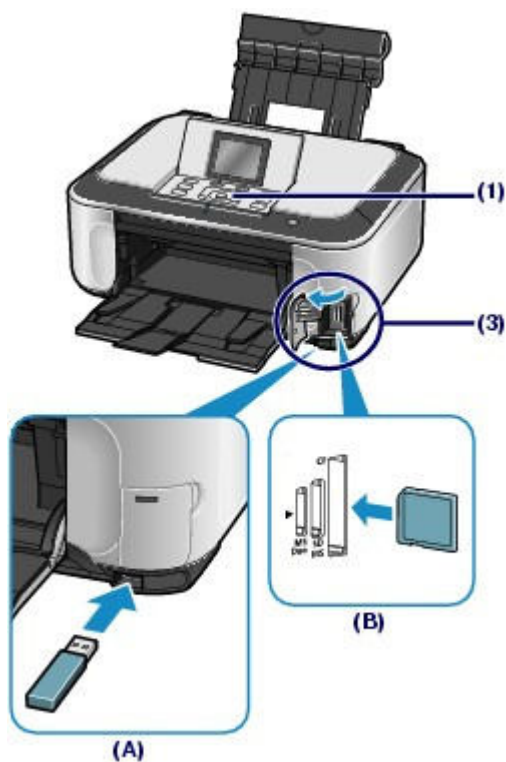

(A) USB flash drive

(B) Memory card

Note

- The screen can also be changed to the photo selection screen in Select and print of Memory card by inserting a memory card or USB flash drive while the **HOME** screen or any screen of Copy, Easy photo reprint, or Film print appears.
- You can also select useful printing functions other than Select and print. See [Using Various Functions](#) .
- Do not insert memory card and USB flash drive at the same time. Also do not insert two or more memory cards at the same time.
- When Read/write attribute is set to Writable from USB PC or Writable from LAN PC, you cannot print image data from the memory card using the Operation Panel on the machine. To print image data from the memory card, select Advanced settings in Device settings of Settings on the **HOME** screen, and set Read/write attribute to Not writable from PC. For details, refer to the on-screen manual: [Advanced Guide](#) .
* You can print image data from the USB flash drive regardless of the setting in Read/write attribute.

3. Select photos to print.**(1)** Use the **Easy-Scroll Wheel** (the ◀ or ▶ button) (C) to display the photo to print.**Note**

- ⏸ may appear on the LCD while reading photos. If you use the **Easy-Scroll Wheel** (the ◀ or ▶ button) to display the photo while ⏸ appears on the LCD, the desired photo may not be selected.

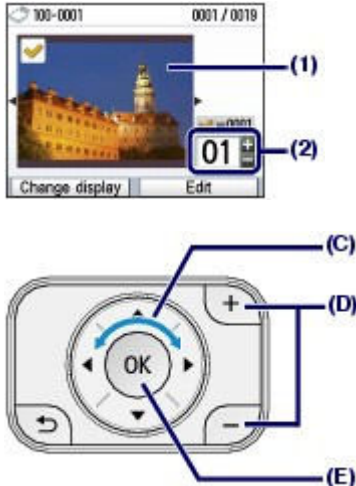
(2) Press the [+] or [-] button (D) to specify the number of copies.**(3)** Repeat the procedures of (1) and (2) to specify the number of copies for each photo.**Note****Other options**

- To change the display of photos, see [Changing the Display](#).
- To crop photos (Trimming), see [Cropping Photos / Searching Photos by a Specified Date](#) .
- To search photos by a specified date (Search), see [Cropping Photos / Searching Photos by a Specified Date](#) .

(4) Press the **OK** button (E).

The print confirmation screen will appear.

4. Start printing.

(1) Confirm the page size, media type, print quality, etc.

Here we confirm that 4"x6" (10x15cm) is selected for Page size and the type of loaded photo paper for Media type.

To change the settings, use the **Easy-Scroll Wheel** (the ▲ or ▼ button) (F) to select the item to change, and press the **OK** button (G).

See [Selecting Setting Items](#) and [Changing the Settings](#).

Note

- When Plain paper is selected for Media type and A4 or 8.5"x11" (LTR) for Page size, Cassette will appear for Paper source.
- When other sizes or types of paper are selected, Rear tray will appear.
- Confirm that the selected paper is loaded in the correct paper source.

(2) Confirm the number of sheets to be used for printing the selected photos.

(3) Press the right **Function** button (H) to select Check photo, and confirm the selected photos and number of copies for each photo.

Press the **OK** button (G) to return to the print confirmation screen.

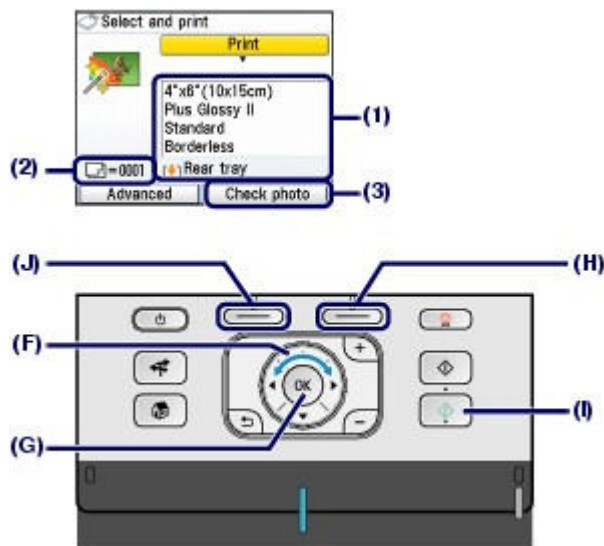

(4) Press the **Color** button (I).

The machine starts printing photos.

Note

- If you press the left **Function** button (J) to select Advanced, Date setting, File no. setting, and Auto photo fix will appear. You can correct photos automatically or manually if you select Auto photo fix. See [Using Various Functions](#).
- Press the **Stop** button to cancel printing.
- Printing does not start if you press the **Black** button.
- You can display the Memory card menu screen and select other useful printing functions, if you press the **Back** button after printing is completed. If you press the **HOME** button or remove the memory card or USB flash drive, the **HOME** screen will appear.
- To remove the memory card, see [Removing the Memory Card](#). To remove the USB flash drive, see [Removing the USB Flash Drive](#).

■ Changing the Settings

You can use the **Easy-Scroll Wheel** (the ▲ or ▼ button) to change the print settings such as page size, media type, or print quality to print.

For the setting operation, see [Selecting Setting Items](#).

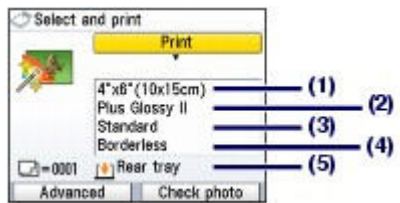

(1) Page size

Select the page size of the paper to print: 4"x6" (10x15cm), A4, etc.

(2) Media type

Select the media type of the paper to print: Plus Glossy II, Plain paper, etc.

Note

- If you do not select the page size and media type correctly, the machine may feed paper from the wrong paper source or may not print with the proper print quality.
See [Paper Source to Load Paper](#).

(3) Print quality

Adjust the print quality: High(quality-priority) or Standard.

(4) Borderless print

Select bordered or borderless print: Bordered or Borderless.

Note

- When Plain paper is selected for Media type, you cannot select Borderless.
- If the ratio of the height to the width differs from the image data when Borderless is selected, a portion of the image may not be printed depending on the size of the media used.

(5) Paper source

The paper source for the selected page size and media type appears on the screen.

When A4 or Letter-sized plain paper is selected, Cassette will appear.

When other sizes or types of paper are selected, Rear tray will appear.

Confirm that the selected paper is loaded in the paper source displayed on the screen.

For details on the paper source setting, refer to the on-screen manual: [Advanced Guide](#).

Note

- The settings of the page size, media type, print quality, image correction, borderless print, etc. are retained, and these settings will appear next time when Memory card menu is selected even if the power is turned off and on.
- Combination of some items cannot be specified depending on the function.

Using Photo Index Sheet to print

Thumbnails of photos on the memory card or USB flash drive are printed on A4 or Letter-sized paper (this printed sheet is called Photo Index Sheet). You can select photos, number of copies, page size, etc. on this sheet, and print them.

Select Photo index sheet  on the **HOME** screen, and Index sheet print .

For details on the operation, refer to the on-screen manual: [Advanced Guide](#).



[↑ Page top](#)

Basic Guide

■ [Advanced Guide](#) ■ [Troubleshooting](#)

[Contents](#) > [Printing from a Memory Card](#) > Using Various Functions

Using Various Functions

You can print photos in various ways when you select Memory card  on the **HOME** screen. You can also use the useful functions to print photos.

For details, refer to the on-screen manual: [Advanced Guide](#).

■ Printing Photos in Various Layouts

You can select various layouts on the Memory card menu screen. You can also select DPOF print.



Layout print



Sticker print

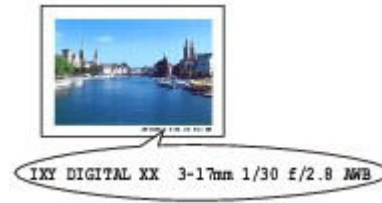

Captured info print



Photo index print



Print all photos



ID photo size print



Calendar print

■ Changing the Display

You can change the display of photos by pressing the left **Function** button when Change display appears at the bottom of the screen. You can also select Slide show.

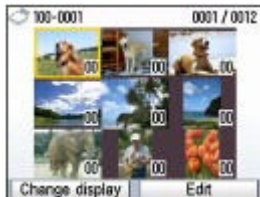

Thumbnail display



Full-screen display



Enlarged display

■ Cropping Photos / Searching Photos by a Specified Date

You can specify the function by pressing the right **Function** button when Edit appears at the bottom of the screen.

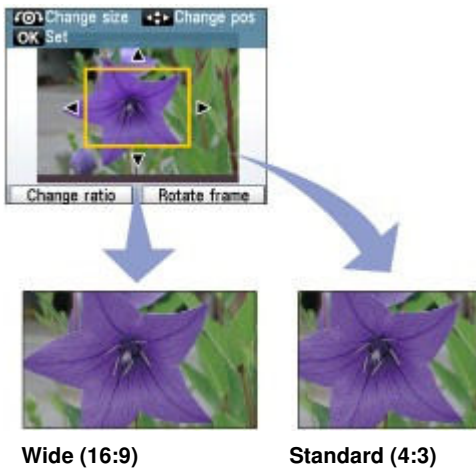

Trimming

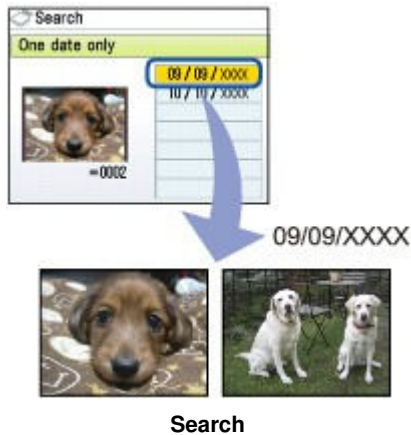

■ Correcting Images

You can correct images by pressing the left **Function** button to select Auto photo fix when Advanced appears at the bottom of the screen. You can correct images automatically or manually, such as adjusting brightness, contrast, and color hue, or add effects to images.



Auto photo fix ON (Default)

■ Printing Photos with Shot Date or File Number

You can print photos with shot date or file number by pressing the left **Function** button to select Date setting or File no. setting when Advanced appears at the bottom of the screen.





[↑ Page top](#)

Inserting the Memory Card



■ Before Inserting the Memory Card

The following types of memory cards and image data are compatible with the machine.

▶ Important

- If you took and saved photos on a type of memory card that does not guarantee the operation on your digital camera, the image data may be unreadable on the machine or damaged. For information on memory cards that your digital camera guarantees operation, refer to the instruction manual supplied with your digital camera.
- Format the memory card with a digital camera compliant with the Design rule for Camera File system (Exif 2.2/2.21 compliant), TIFF (Exif 2.2/2.21 compliant). The memory card may not be compatible with the machine if it is formatted on a computer.



● Memory Cards that Do Not Require a Card Adapter

	<ul style="list-style-type: none"> ● SD Secure Digital memory card ● SDHC memory card ● MultiMediaCard ● MultiMediaCard Plus
	<ul style="list-style-type: none"> ● Compact Flash (CF) Card Supports Type I/II (3.3 V) ● Microdrive
	<ul style="list-style-type: none"> ● Memory Stick ● Memory Stick PRO ● Memory Stick Duo ● Memory Stick PRO Duo

● Memory Cards that Require a Card Adapter

▶ Important

- Be sure to attach the special card adapters to the following memory cards before inserting to the Card Slot.
If one of the following memory cards is inserted without the card adapter, you may not be able to remove the memory card. In this case, refer to " [Troubleshooting](#)" in the on-screen manual: *Advanced Guide*.

	<ul style="list-style-type: none"> ● miniSD Card *1 ● miniSDHC Card *1
	<ul style="list-style-type: none"> ● microSD Card *1 ● microSDHC Card *1
	<ul style="list-style-type: none"> ● xD-Picture Card *2 ● xD-Picture Card Type M *2 ● xD-Picture Card Type H *2

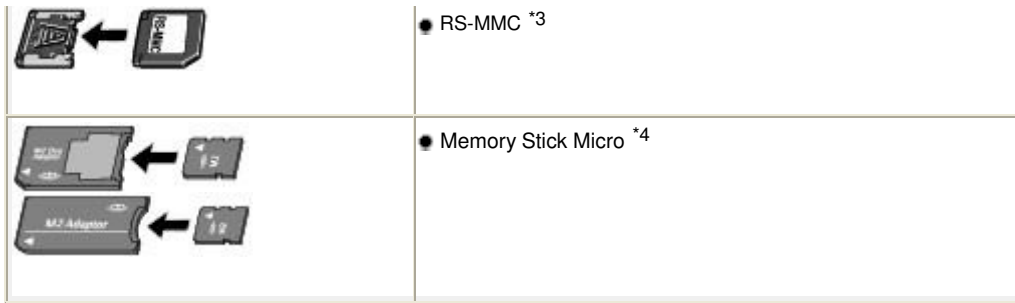

*1 Use the special "SD Card Adapter".

*2 Requires purchase of a separate compact flash card adapter for xD-Picture Card.

*3 Use the special card adapter.

*4 Use the special Duo size adapter or full size adapter.

● Printable Image Data

This machine accepts images taken with a camera compliant with the Design rule for Camera File system (Exif 2.2/2.21 compliant), TIFF (Exif 2.2/2.21 compliant). Other image or movie types such as RAW images cannot be printed.

■ Inserting the Memory Card

▶ Important

- When a memory card is inserted into the Card Slot, the **Access** lamp is lit. When the **Access** lamp is flashing, the machine is accessing the memory card. In this case, do not touch the area around the Card Slot.

📖 Note

- When Read/write attribute is set to Writable from USB PC or Writable from LAN PC, you cannot print image data from the memory card or save scanned data on the memory card using the Operation Panel of the machine. After using the Card Slot as the memory card drive of a computer, remove the memory card, select Advanced settings in Device settings of Settings on the **HOME** screen, then set Read/write attribute to Not writable from PC. For details, refer to the on-screen manual: [Advanced Guide](#).
- When you use a computer to edit or enhance photos saved on a memory card, be sure to print them from the computer. If you use the Operation Panel, the photos may not be printed properly.

1. Prepare your memory card.

Attach a special card adapter if your memory card requires one.

See [Memory Cards that Require a Card Adapter](#).

2. Turn on the power, and open the Card Slot Cover.



3. Insert only one memory card into the Card Slot.

The location to insert a memory card varies depending on each type of memory card. Insert your memory card straightforward WITH THE LABELED SIDE FACING TO THE LEFT into the Card Slot, according to the insert location in the figure below.

When the memory card is inserted properly, the **Access** lamp (A) will light up.

Be sure to attach the card adapter for memory card with the mark * (asterisk), and then insert it into the Card Slot as shown below.

For Memory Stick Duo, Memory Stick PRO Duo, or Memory Stick Micro (with the Duo size adapter) * :

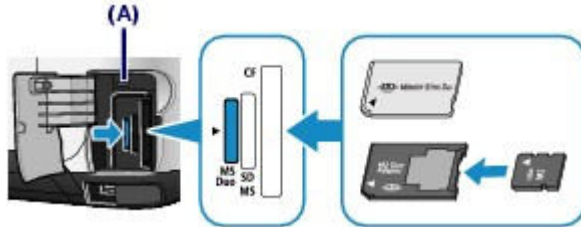

For SD Secure Digital memory card, SDHC memory card, MultiMediaCard, MultiMediaCard Plus, miniSD Card *, miniSDHC Card *, microSD Card *, microSDHC Card *, Memory Stick, Memory Stick PRO, Memory Stick Micro (with the full size adapter) *, or RS-MMC * :

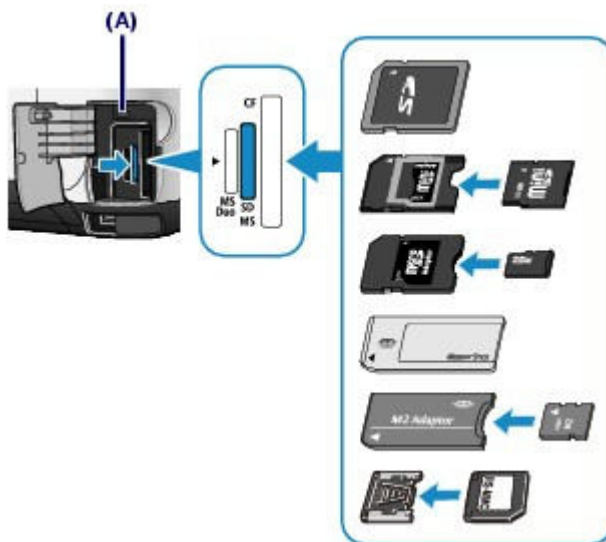

For Compact Flash (CF) Card, Microdrive, xD-Picture Card *, xD-Picture Card Type M *, or xD-Picture Card Type H * :

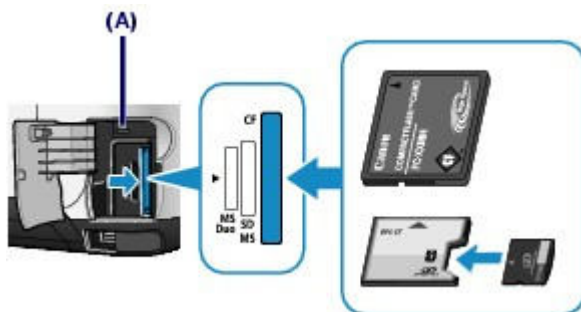

Important

- Part of the memory card will protrude from the Card Slot, but do not force it into the slot any further. This can damage the machine or the memory card.
- Make sure that the memory card is correctly oriented before inserting it into the Card Slot. If you force the memory card into the Card Slot in the wrong orientation, the memory card or the machine can be damaged.
- Do not insert more than one memory card at a time.

4. Close the Card Slot Cover.

■ Removing the Memory Card

▶ Important

- If you used the Card Slot as the memory card drive of a computer, you must perform the "safe removal" operation on your computer before physically removing the memory card from the machine.
 - In Windows, if you are connecting the machine with a USB cable, right-click the removable disk icon and click Eject. If Eject does not appear on the screen, make sure that the **Access** lamp is lit, and then remove the memory card.
If you used the Card Slot via the LAN, you do not need to perform the "safe removal" operation on your computer.
 - In Macintosh, drag  (Mount drive) into the Trash.

1. Open the Card Slot Cover.

2. Make sure that the **Access** lamp is lit, and remove the memory card.

Hold the part of the memory card that is protruding and remove it straightforward from the machine.

▶ Important

- Do not remove the memory card while the **Access** lamp is flashing. The **Access** lamp flashes while the machine is reading or writing data from/to the memory card. If you remove the memory card or turn off the power while the **Access** lamp is flashing, the data saved on the memory card can be damaged.

3. Close the Card Slot Cover.



Inserting the USB Flash Drive

■ Inserting the USB Flash Drive

Note

Before inserting the USB flash drive

- If your USB flash drive cannot be inserted into the Direct Print Port of the machine, you may be required to use an extension cable for the USB flash drive. Purchase it at electronics retail stores.
- Some USB flash drives may have recognition problem, and these devices may not guarantee proper operation of the machine.
- You may not be able to use USB flash drives with security function.
- For information on image data that can be printed with this machine, see [Printable Image Data](#) in "Before Inserting the Memory Card".

1. Insert the USB flash drive into the Direct Print Port.

Make sure that the USB flash drive is correctly oriented before inserting it straightforward into the Direct Print Port.



■ Removing the USB Flash Drive

1. Make sure that the machine is not reading or writing data from/to the USB flash drive.

Check if the reading or writing operation is completed on the LCD.

Important

- Do not remove the USB flash drive or turn off the power while the machine is operating.

Note

- If your USB flash drive has the access lamp, refer to the instruction manual supplied with the USB flash drive to check if the reading or writing operation is completed on the USB flash drive.

2. Remove the USB flash drive.

Hold the USB flash drive and remove it straightforward from the machine.



 [Page top](#)

Copying

You can copy in the various methods such as enlarging/reducing or copying two original pages onto a single sheet of paper.

Making Copies

[Changing the Settings](#)

Using Various Copy Functions



[↑ Page top](#)

Making Copies

This section describes the procedure to copy a document of A4 size on plain paper. For the operation, see the notes and operation procedure described in the reference page.

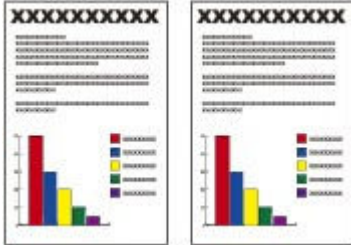

You need to prepare:

Originals to copy. See [Originals You Can Load](#).

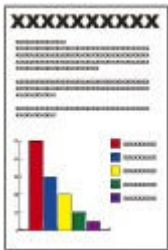

Paper for printing. See [Media Types You Can Use](#).

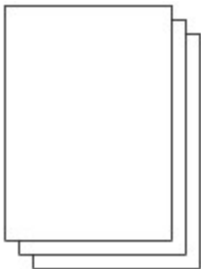

1. Prepare for copying.

(1) Turn on the power.

See [Operation Panel](#).

(2) Load paper.

See [Loading Paper](#).

Here we make sure that A4 plain paper is loaded in the Cassette.

Note

- Load A4, B5, A5, or Letter-sized plain paper in the Cassette. Load other sizes or types of paper in the Rear Tray.

(3) Open the Paper Output Tray gently, and open the Output Tray Extension.

(4) Select Copy on the **HOME** screen, and press the **OK** button.

See [Selecting Menus on the HOME Screen](#).



(5) Load an original on the Platen Glass.

See [Loading Originals](#).

Load the original WITH THE SIDE TO COPY FACING DOWN and align it with the alignment mark  as shown below.

Then close the Document Cover gently.

Note

- For details on the types and conditions of the original which can be copied, see [Originals You Can Load](#).
- Characters and lines written with a light colored pen or highlight pen may not be copied properly.



2. Start copying.

(1) Confirm the page size, media type, magnification, etc.

Here we confirm that 100% is selected for Magnification, A4 for Page size, and Plain paper for Media type.

To change the settings, use the **Easy-Scroll Wheel** (the ▲ or ▼ button) (A) to select the item to change, and press the **OK** button (B).

See [Selecting Setting Items](#) and [Changing the Settings](#).

Note

- When Plain paper is selected for Media type and A4, B5, A5, or 8.5"x11" (LTR) for Page size, Cassette will appear for Paper source.
When other sizes or types of paper are selected, Rear tray will appear.
Confirm that the selected paper is loaded in the correct paper source.
- You can check the preview of print result if you press the right **Function** button (C) to select Preview.
Refer to the on-screen manual: [Advanced Guide](#).
- You can select various copy functions, such as Two-sided copy, Borderless copy, 2-on-1 copy, and Frame erase, if you press the left **Function** button (D) to select Special copy.
See [Using Various Copy Functions](#).

- (2) Press the **[+]** or **[-]** button (E) to specify the number of copies.

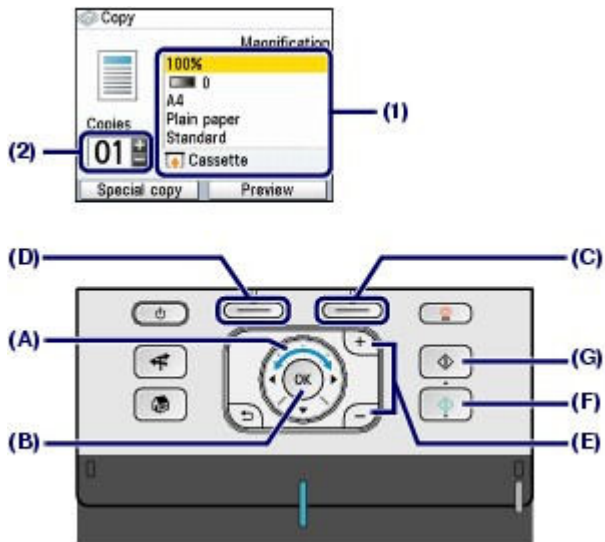

- (3) Press the **Color** button (F) for color copying, or the **Black** button (G) for black & white copying.

The machine starts copying.

Remove the original on the Platen Glass after copying is completed.

Important

- Do not stare at the light directly for an extended period of time when copying the original.
- Do not open the Document Cover or move the loaded original until copying is completed.

Note

- Press the **Stop** button to cancel copying.
- Repeat the procedures from (5) of step 1 to copy another original.
You can exit the Copy menu and display the **HOME** screen if you press the **HOME** button.

Changing the Settings

You can use the **Easy-Scroll Wheel** (the **▲** or **▼** button) to change the print settings such as page size, media type, or print quality to print.

For the setting operation, see [Selecting Setting Items](#).

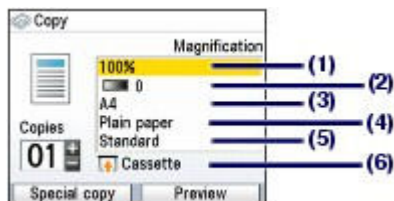

(1) Magnification

Specify the enlargement/reduction manner. You can specify the copy scale by selecting the optional number or the page size: A4 to A5, A4 to B5, etc. If you do not want to enlarge/reduce the page size, select 100%.

For details, refer to the on-screen manual: [Advanced Guide](#).

(2) Intensity

Specify the intensity when you want to make the darkened/lightened copy. You can also set the intensity to automatically adjust according to the original.

For details, refer to the on-screen manual: [Advanced Guide](#).

(3) Page size

Select the page size of the paper to print: A4, 8.5"x11" (LTR), etc.

(4) Media type

Select the media type of the paper to print: Plain paper, Plus Glossy II, etc.



Note

- If you do not select the page size and media type correctly, the machine may feed paper from the wrong paper source or may not print with the proper print quality. See [Paper Source to Load Paper](#).

(5) Print quality

Adjust the print quality according to the original to copy: High(quality-priority), Standard, etc. The available print quality settings depend on the paper selected for Media type.

(6) Paper source

The paper source for the selected page size and media type appears on the screen.

When A4, B5, A5, or Letter-sized plain paper is selected, Cassette will appear.

When other sizes or types of paper are selected, Rear tray will appear.

Confirm that the selected paper is loaded in the paper source displayed on the screen.

For details on the paper source setting, refer to the on-screen manual: [Advanced Guide](#).



Note

- If Two-sided copy is selected, select A4 or 8.5"x11" (LTR) for Page size and Plain paper for Media type.
- If 2-on-1 copy or 4-on-1 copy is selected, select A4 or 8.5"x11" (LTR) for Page size.
- If Borderless copy is selected, select 8.5"x11" (LTR), A4, 4"x6" (10x15cm), or 5"x7" (13x18cm) for Page size and any types of paper except Plain paper for Media type.
- If Borderless copy is selected, slight cropping may occur at the edges since the copied image is enlarged to fill the whole page.
- The settings of the page size, media type, print quality, automatic intensity, etc. are retained, and these settings will appear next time when the Copy menu is selected even if the power is turned off and on.
- Combination of some items cannot be specified depending on the function.
- If you select Fast (speed-priority) with the media type set to Plain paper and the quality is not as good as expected, select Standard or High(quality-priority) and then try copying again.



Basic Guide

[Advanced Guide](#) [Troubleshooting](#)
[Contents](#) > [Copying](#) > Using Various Copy Functions

Using Various Copy Functions

You can make various kinds of copies if you press the left **Function** button to select Special copy at the bottom of the Copy screen.

For details, refer to the on-screen manual: [Advanced Guide](#).

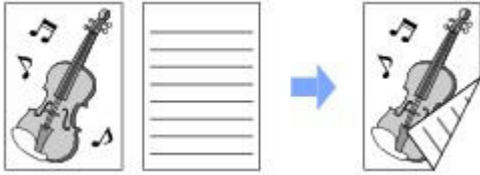

Two-sided copy

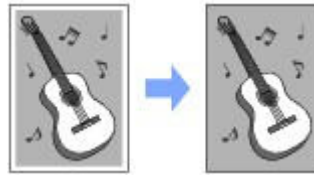

Borderless copy

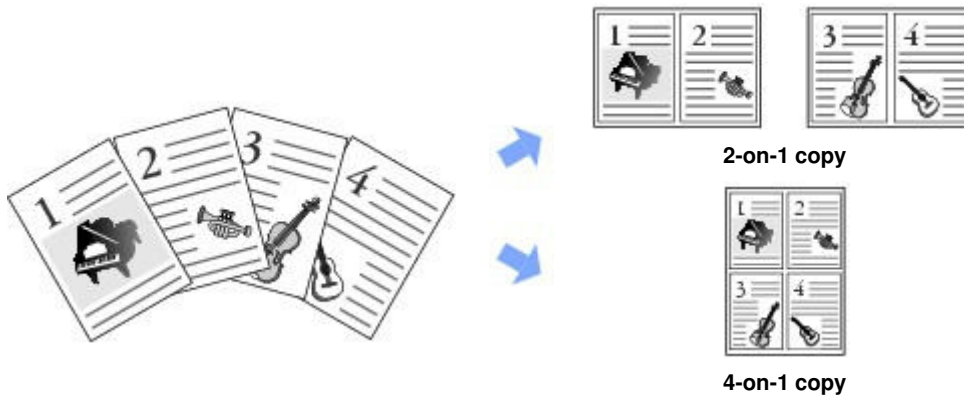

2-on-1 copy

4-on-1 copy

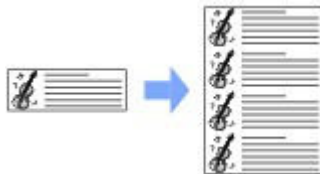
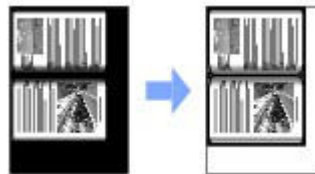
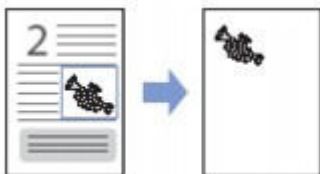

Image repeat



Frame erase



Trimming



Masking



Printing Photos from Printed Photos or Films

You can reprint printed photos or print photos from films without computer.

Reprinting Printed Photos

Printing Photos from Films

Loading the Films

- [Loading the Film Strip](#)
- [Loading the Mount Films](#)
- [Removing the Films](#)

Using Various Functions

- [Printing Photos in Various Layouts](#)
- [Correcting Images](#)



[↑ Page top](#)

Reprinting Printed Photos

Reprint printed photos.

This section describes the procedure to scan printed photos and print them on 4" x 6" / 10 x 15 cm photo paper.

Note

- You cannot save scanned images with this function.
To save scanned images on the computer, memory card, or USB flash drive, refer to the on-screen manual: [Advanced Guide](#).



You need to prepare:

Printed photos.



Paper for photo printing. See [Media Types You Can Use](#).



1. Prepare for reprinting printed photos.

(1) Turn on the power.

See [Operation Panel](#).

(2) Load paper.

See [Loading Paper in the Rear Tray](#).

Here we load 4" x 6" / 10 x 15 cm photo paper in the Rear Tray.

(3) Open the Paper Output Tray gently, and open the Output Tray Extension.

(4) Select Easy photo reprint on the **HOME** screen, and press the **OK** button.

(5) When the guidance screen appears, press the **OK** button again.

2. Load photos on the Platen Glass to scan.

(1) Open the Document Cover.

(2) Load the photos WITH THE SIDE TO SCAN FACING DOWN on the Platen Glass.

Glass.

See [Loading Originals](#).

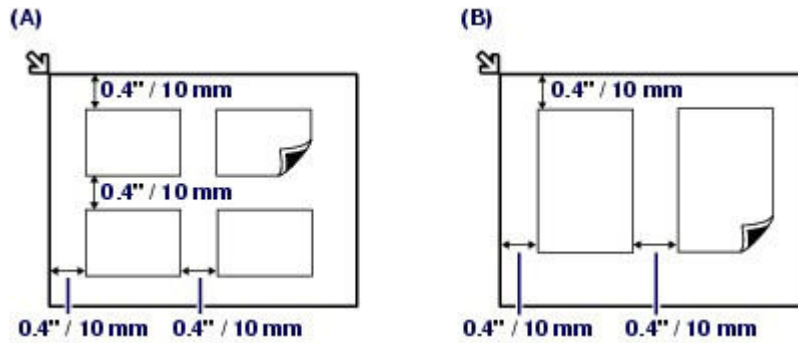

(A) To load four photos on the Platen Glass

(B) To load two photos on the Platen Glass

Note

- Place the photo(s) at least 0.4 inches / 10 mm away from and in square with the edges of the Platen Glass.
- When loading two or more photos at the same time, place them at least 0.4 inches / 10 mm apart from each other. If photos are placed closer, they may be scanned as a single image.
- The Skew Correction function automatically compensates for photos placed at an angle of up to approximately 10 degrees.
- Slanted photos with a long edge of 7.1 inches / 180 mm or more cannot be corrected.
- If  appears on the preview screen, check the followings and reset the photos properly to scan them again.
 - The slant is not too large.
 - The photos are not placed too close to the edge of the Platen Glass.
- Photos smaller than approximately 1 inch / 25 mm square will not be scanned properly.
- The types of photos listed below may not be scanned properly.
 - Photos that are non-rectangular or irregular shaped (such as cut out photos)
 - Photos that are entirely white
 - Photos that have white surrounds
- The borders of bordered photos may not be scanned properly. Crop photos if necessary. Refer to the on-screen manual: [Advanced Guide](#).

(3) Close the Document Cover gently, and press the **OK** button.

The machine starts scanning.

Important

- Do not stare at the light directly for an extended period of time when scanning photos.
- The photos are rescanned before printing starts. Do not open the Document Cover or move the loaded photos until printing is completed.

3. Select a menu option to print scanned photos.

(1) Select Select and print , and press the **OK** button.

Note

- You can also select useful printing functions other than Select and print. See [Using Various Functions](#).

(2) Use the **Easy-Scroll Wheel** (the ◀ or ▶ button) to display a photo to print.

- (3) Press the [+] or [-] button to specify the number of copies.

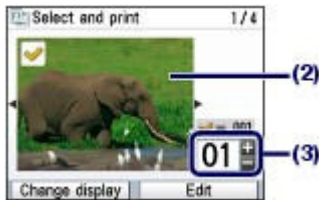

Note

- If  appears next to the photo on the screen, it may not have been scanned properly. Press the **Back** button, and press the left **Function** button to select Rescan. Confirm the message, and repeat the procedures from step 2 to scan the photo again.

Other options

- To change the display of photos, see [Changing the Display](#).
(You can also select Full-screen display and Enlarged display other than Normal screen display.)
- To crop photos (Trimming), see [Cropping Photos / Searching Photos by a Specified Date](#) .

- (4) Repeat the procedures of (2) and (3) to specify the number of copies for each photo.

- (5) Press the **OK** button.

4. Start printing.

- (1) Confirm the page size, media type, print quality, etc.

Here we confirm that 4"x6" (10x15cm) is selected for Page size and the type of loaded photo paper for Media type.

Note

- To change the settings, select each item, and press the **OK** button.
See [Changing the Settings](#).
- The settings of the page size, media type, print quality, etc. are retained, and these settings will appear next time when the Easy photo reprint menu is selected even if the power is turned off and on.

- (2) Confirm the number of sheets to be used for printing the selected photos.

Note

- You can correct photos automatically or manually, if you press the left **Function** button to select Advanced.
See [Using Various Functions](#) .



- (3) Press the **Color** button to print in color, or the **Black** button to print in black & white.

The machine starts printing.

Remove the photos on the Platen Glass after printing is completed.

Note

- Press the **Stop** button to cancel printing.

- You can exit the Easy photo reprint menu and display the **HOME** screen, if you press the **HOME** button after printing is completed. Confirm the message and select Yes to delete the scanned image data.
-



[↑ Page top](#)

Printing Photos from Films

Print photos from a 35 mm film strip or mount films (positive films for slides).



You need to prepare:

35 mm film strip (a series of six frames on a strip)



or

35 mm mount film (positive film for slide)



Paper for photo printing. See [Media Types You Can Use](#).

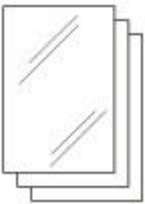

Note

- "Film strip" is a series of six frames on a strip after regular development. "Mount film" is each frame mounted on a slide mount.
- You cannot save scanned images with this function.
To save scanned images on the computer, refer to the on-screen manual: [Advanced Guide](#).

1. Prepare for printing photos from a film.

(1) Turn on the power.

See [Operation Panel](#).

(2) Load paper.

See [Loading Paper in the Rear Tray](#).

Here we load 4" x 6" / 10 x 15 cm photo paper in the Rear Tray.

(3) Open the Paper Output Tray gently, and open the Output Tray Extension.

(4) Select Film print on the **HOME** screen, and press the **OK** button.

(5) Select Color negative film, B&W negative film, Color positive film, or Mount (for

slides) according to your film, and press the **OK** button.

Here we select Color negative film.



2. Load the film strip or mount films on the Platen Glass.

If Color negative film, B&W negative film, or Color positive film is selected, see [Loading the Film Strip](#).

If Mount (for slides) is selected, see [Loading the Mount Films](#).

3. Close the Document Cover gently, and press the **Color** button.

The machine starts scanning the film.

Important

- Do not stare at the light directly for an extended period of time when scanning the film.

Note

- The film is rescanned before printing starts. Do not move the loaded film on the Platen Glass until the printing is completed.
- If the film is not scanned properly, refer to "[Troubleshooting](#)" in the on-screen manual: *Advanced Guide*.

4. Select a menu option to print scanned photos.

See [Select a menu option to print scanned photos](#) in "Reprinting Printed Photos".

Here we select Select and print, and specify the number of copies.

5. Start printing.

See [Start printing](#) in "Reprinting Printed Photos".

6. Remove the film and reattach the Film Guide, after all the printings are completed.

See [Removing the Films](#).

Note

- You can exit the Film print menu and display the **HOME** screen, if you press the **HOME** button after printing is completed. Confirm the message and select Yes to delete the scanned image data.



Loading the Films

You can use the Film Guide stored behind the Document Cover to load the films.

- ➔ [Loading the Film Strip](#)
- ➔ [Loading the Mount Films](#)
- ➔ [Removing the Films](#)

Film strip



See [Loading the Film Strip](#).



Mount films



See [Loading the Mount Films](#).



■ Loading the Film Strip

Mount the film strip in the Film Guide stored behind the Document Cover, and then load it on the Platen Glass. To scan the film strip with a computer, follow the same procedure below.

1. Remove the Film Guide from the FAU (Film Adapter Unit) Protective Sheet.

(1) Open the Document Cover, and remove the FAU Protective Sheet.



(2) Remove the Film Guide behind the FAU Protective Sheet.

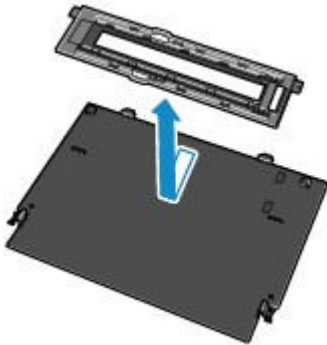

▶ Important

- When printing photos from the film strip, make sure that the FAU Protective Sheet is removed from the Document Cover. The film strip cannot be scanned if the FAU Protective Sheet remains attached.

2. Mount the film strip in the Film Guide (A).

(1) TURN THE SIDE SHOWING THE FILM MARK (B) UP, and open the Film Holder (C) by pinching the indentations (D) in the directions of the arrows as shown.

📖 Note

- Be sure to open the Film Holder so that the hinge parts (E) does not come off the Film Guide.

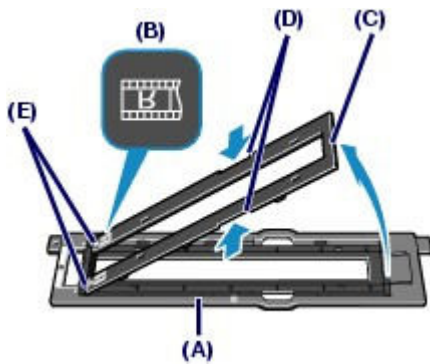

- (2) TURN OVER THE FILM STRIP** (with the correct image facing down) so that **THE IMAGES WILL BE UPSIDE DOWN**, and insert the edges of the film strip into the slots of the Film Strip Frame.

The film order must be **FROM LEFT TO RIGHT**.

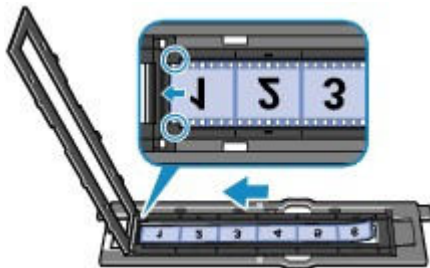

Note

- The film strip with up to six frames can be mounted in the Film Strip Frame.
- Mount the film strip so that the film runs from left to right in the same direction as the scanning direction. However, depending on the model or brand of your camera, the scanning order may differ from the frame order of the film strip.

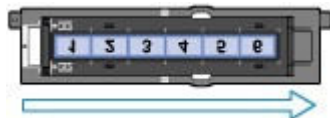

- (3) Close the Film Holder completely.**

Note

- If the Film Holder does not close completely, confirm that the film strip is mounted properly in the Film Strip Frame.
- If the Film Holder does not close completely, press the whole Film Holder gently downward to fit the protrusions in the slots of the Film Guide.

- (4) Make sure that the white lines on the Film Holder are aligned with the borderlines between frames of the film.**

Reconfirm the direction of the mounted film strip.

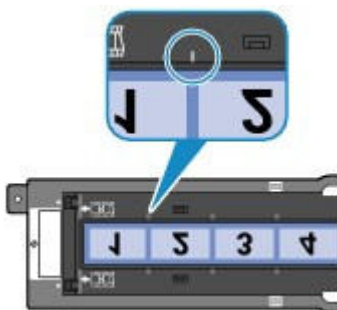

 **Note**

- Depending on your film, the borderlines between frames may not be aligned with the white line marks of the Film Holder when you insert the leading edge of the film strip into the slots of the Film Strip Frame. In this case, give priority to aligning the separation lines between frames with the white line marks.

3. Load the Film Guide to fit in the grooves on the right and left sides on the Platen Glass.

 **Note**

- When a film strip that is shorter than the Film Strip Frame is scanned, portion of an image near the open area may appear pale. Scan the film strip shield with black paper over the open area.
- Labels attached to areas of the film without images may be interpreted as images and will be included in the scan.



■ Loading the Mount Films

Load the Film Guide without the Film Strip Frame on the Platen Glass, and then mount the mount films in the Film Guide. To scan the mount films with a computer, follow the same procedure below.

1. Remove the Film Guide behind the FAU Protective Sheet.

- (1) Open the Document Cover, and remove the FAU Protective Sheet from the Document Cover.



- (2) Remove the Film Guide behind the FAU Protective Sheet.

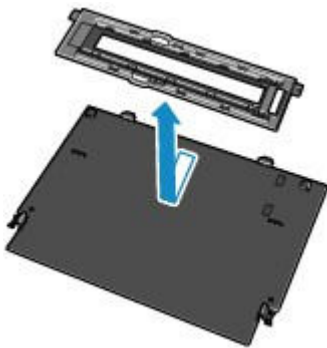

▶ Important

- When printing photos from the film, make sure that the FAU Protective Sheet is removed from the Document Cover. The mount films cannot be scanned if the FAU Protective Sheet remains attached.

2. Remove the Film Strip Frame (A) from the Film Guide (B).

- (1) Pinch the indentations (C) in the directions of the arrows as shown to open the Film Holder (D).
- (2) Pinch the indentations (E) in the directions of the arrows as shown to remove the Film Strip Frame (A) from the Film Guide (B).

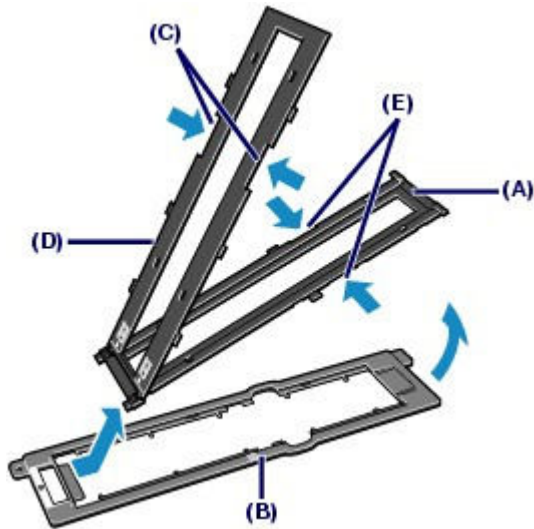

Note

- The Film Strip Frame is not necessary for mounting the mount films. Be sure to remove the Film Strip Frame.

3. Load the Film Guide to fit in the grooves on the right and left sides of the Platen Glass.

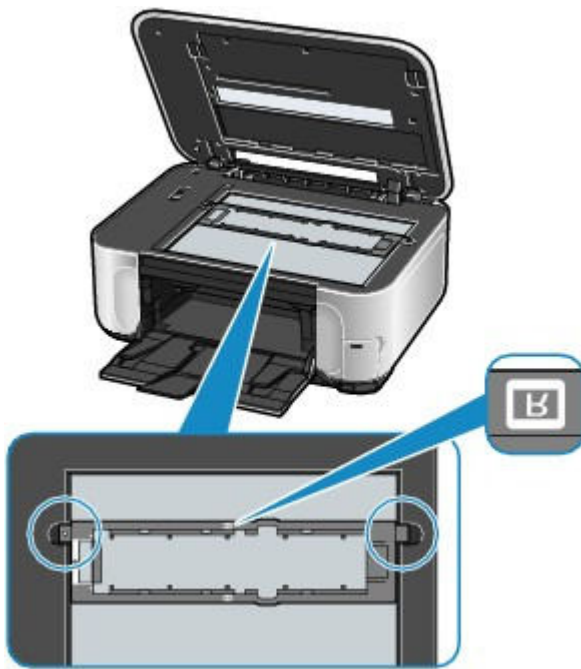

4. Mount the mount films in the Film Guide.

TURN OVER THE MOUNT FILMS (with the correct image facing down) so that THE IMAGES WILL BE UPSIDE DOWN, and mount the mount films in the film order FROM LEFT TO RIGHT.

Be sure to load the mount films properly in close contact with the Platen Glass.

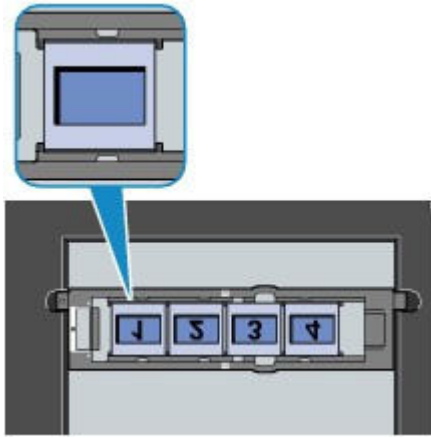

 **Note**

- Up to four mount films can be mounted in the Film Guide.



[↑ Page top](#)

■ Removing the Films

Remove the films from the Film Guide, and store the Film Guide onto the Document Cover again.

1. Open the Document Cover to remove the Film Guide.

2. Remove the film strip or mount films from the Film Guide.

For the mount films:

After the mount films are removed, reassemble the Film Strip Frame with the Film Guide.

(1) Align the alignment marks ◀ on the Film Strip Frame with the alignment marks ▶ on the Film Guide, and insert the tabs on the leading edge of the Film Strip Frame into the Film Guide.

(2) Push down to close the Film Holder completely.

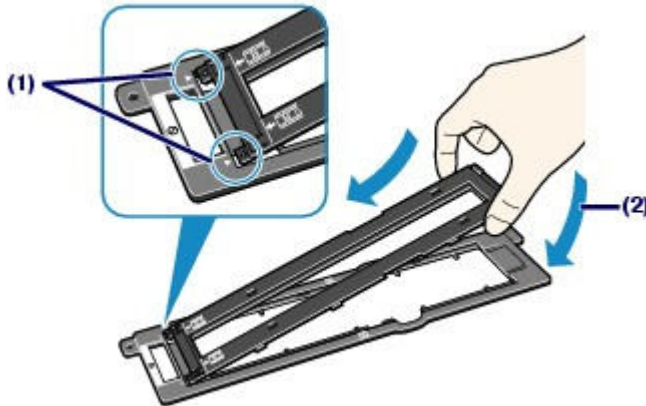

Note

- If the Film Holder does not close completely, push the whole Film Holder gently downward to fit the protrusions in the slots of the Film Guide.

3. Reattach the Film Guide.

(1) Reattach the Film Guide behind the FAU Protective Sheet.

Turn over the Film Guide and reattach it.



(2) Reattach the FAU Protective Sheet with the Film Guide to the Document Cover.

Insert the protrusions of the FAU Protective Sheet into the slots of the Document Cover, and press both sides at top of the FAU Protective Sheet to fit it in.



Important

- Once the photo printing from the film has been completed, be sure to store the removed Film Guide behind the FAU Protective Sheet and reattach the FAU Protective Sheet to the Document Cover. The FAU Protective Sheet should remain attached when copying or scanning originals other than films, such as documents or photos.



[↑ Page top](#)

Using Various Functions

This section introduces a few of the useful functions in the Easy photo reprint menu and the Film print menu screen.

For details, refer to the on-screen manual: [Advanced Guide](#).

■ Printing Photos in Various Layouts

You can select a layout and print photos other than Select and print.



Sticker print



Print all photos

■ Correcting Images

You can correct images by pressing the left **Function** button when Advanced appears at the bottom of the screen. You can correct images automatically or manually, such as adjusting brightness, contrast, and color hue, or apply the fade restoration.



Brightness



Contrast



Scanning

You can forward scanned data to your computer, and edit or process them with the supplied software application. You can also save scanned data on a memory card or USB flash drive inserted into the machine.

Forwarding Scanned Data to the Computer

[Preparing for Scanning with the Operation Panel](#)
[Forwarding Scanned Data to the Computer](#)

Using Various Scan Functions



[↑ Page top](#)

Forwarding Scanned Data to the Computer

You can forward scanned data to the computer with the USB cable or via a network.

This section describes the procedure to detect the type of original automatically with Auto scan, and forward the scanned data to the computer connecting with the USB cable, according to the settings specified with MP Navigator EX.

For other operations to save scanned data on a memory card or USB flash drive and to scan originals from the computer, refer to the on-screen manual: [Advanced Guide](#).

Important

- Please note that Canon shall not be liable for any damage or loss of the data for any reason whatsoever, even within the warranty period of the machine.

Note

- You can select Auto scan only when forwarding scanned data to the computer with the USB cable.
- The machine can detect the following types of originals with Auto scan: photo, postcard, business card, magazine, newspaper, text document, and DVD/CD. For other originals, use the computer to specify the type or size of originals and scan them.
For details, refer to the on-screen manual: [Advanced Guide](#).

■ Preparing for Scanning with the Operation Panel

Before scanning originals, check the following:

- Are the necessary software applications (MP Drivers and MP Navigator EX) installed?
Install MP Drivers and MP Navigator EX from the *Setup CD-ROM* when they have not been installed or have been uninstalled. To install MP Drivers and MP Navigator EX, select MP Drivers and MP Navigator EX in Custom Install.
- Are the type of original and processing method specified with MP Navigator EX?
When you forward scanned data to the computer with the Operation Panel, you can specify the settings such as the type of original and processing method in Preferences of MP Navigator EX. For details on the settings, refer to the on-screen manual: [Advanced Guide](#).
- Does the original to be scanned meet the requirements for the original to be loaded on the Platen Glass?
For details, see [Originals You Can Load](#).

● If the Machine Is Connected via USB or Wired LAN

Confirm that the connection with USB cable or LAN cable between the machine and the computer is physically secure.

Important

- Do not plug in or unplug the USB cable or LAN cable while the machine is scanning originals with the computer.

● If the Machine Is Connected over a Network

When you use a computer connected over a network, check the following:

- Is the machine selected in the settings screen of the Canon IJ Network Scan Utility (Windows) or Canon IJ Network Scanner Selector (Macintosh)?
For details on the setting procedure, refer to the on-screen manual: [Advanced Guide](#).
- Is the Canon IJ Network Scan Utility/Canon IJ Network Scanner Selector running?
For details, refer to the instructions for scanning over a network in the on-screen manual: [Advanced Guide](#).

● If You Are Using Mac OS X v.10.3.9

You need to set MP Navigator EX as the starting software application in Image Capture under Applications of Mac OS X.

- (1) Select Applications on the Go menu, and double-click the Image Capture icon.
- (2) Click Options at lower left of the scanner window, select MP Navigator EX 3 in Application to launch when scanner button is pressed, then click OK.
To quit Image Capture, select Quit Image Capture on the Image Capture menu.

Note

- If Options does not appear, select Preferences on the Image Capture menu, click Scanner, and click Use TWAIN software whenever possible to clear the option. Then quit Image Capture and restart it.

■ Forwarding Scanned Data to the Computer

1. Select the scan operation.

- (1) Turn on the power.

See [Operation Panel](#).

- (2) Select Scan  on the **HOME** screen, and press the **OK** button.

- (3) Use the **Easy-Scroll Wheel** (the ◀ or ▶ button) to select PC , and press the **OK** button.

The computer selection screen will appear.

- (4) Select the computer to forward scanned data, and press the **OK** button.

Here we select USB.

The original type selection screen will appear.

Note

- For the network connection, select the computer name to forward scanned data in the list.
- For the connection via USB only, only USB appears on the LCD.

- (5) Select the type of original, and press the **OK** button.

Here we select Auto scan.

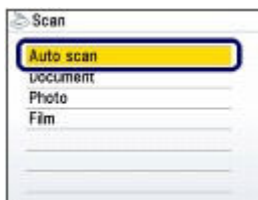

Note

- If the computer connected over a network is selected in (4), Auto scan does not appear on the LCD.
- The types of original other than Auto scan are Document, Photo, and Film. If you select other than Auto scan, you can save all scanned data in a PDF file, attach it to mail, or open it with a software application.
For details, refer to the on-screen manual: [Advanced Guide](#).

2. Load an original on the Platen Glass.

Make sure to load the original correctly according to the type of original that you have selected.
See [Loading Originals](#).

Note

- Characters and lines written with a light colored pen or highlight pen may not be scanned properly.

3. Press the **Color** or **Black** button to start scanning.

MP Navigator EX will be started, the original will be scanned according to the settings specified with MP Navigator EX, and then the scanned data will be forwarded to the computer.

Scanning... will appear while scanning the original.

If you want to scan another original, load it on the Platen Glass, and press the **Color** or **Black** button again.

Remove the original on the Platen Glass after scanning is completed.

Important

- Do not stare at the light directly for an extended period of time when scanning originals or photos.
- Do not turn off the power while the machine is operating.
- Do not open the Document Cover or move the loaded original until scanning is completed.

Note

- Press the **HOME** button to exit the Scan menu and display the **HOME** screen.
- The position or size of the original may not be scanned correctly depending on the type of original.
If the scan is not performed correctly, refer to the on-screen manual: [Advanced Guide](#) to change the settings in Document Type and Document Size of MP Navigator EX to match the original and scan it again.

When the program selection screen appears:

- The program selection screen may appear after performing step 3.
If the program selection screen appears, select MP Navigator EX Ver3.0 and click OK.
To start MP Navigator EX automatically without displaying the program selection screen, follow the procedure below.
 - For Windows Vista users, refer to "For Windows Users" in "[Troubleshooting](#)" of the on-screen manual: *Advanced Guide*.
 - For Windows XP users, select MP Navigator EX Ver3.0 as the software application to be used in the program selection screen, select Always use this program for this action, then click OK.



Using Various Scan Functions

You can forward the data scanned with the machine to a computer, and also save them on a USB flash drive or memory card inserted into the machine.

For details, refer to the on-screen manual: [Advanced Guide](#).

● Selecting a Device to Save the Scanned Data

Scanned data can be saved on the USB flash drive or memory card inserted into the machine. You can specify the document type (Document or Photo) and data format (PDF or JPEG) for the data to be scanned.

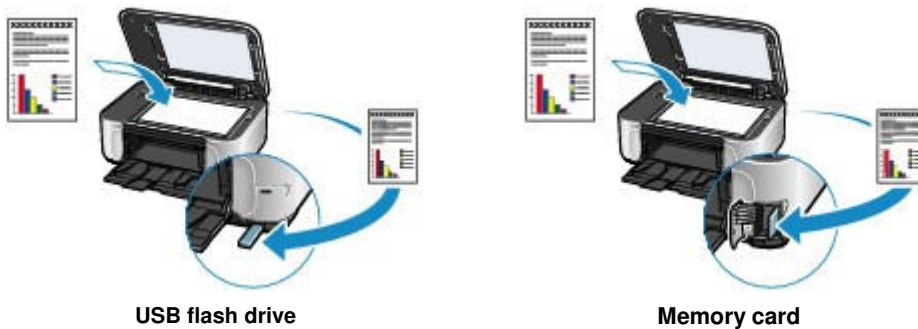

● Selecting Various Processing Methods

To forward the scanned data to the computer, you can select the processing method for scanned data if other than Auto scan is selected for the type of original.



Note

- Options for scan operation can be specified with MP Navigator EX. For details, refer to the on-screen manual: [Advanced Guide](#).



[↑ Page top](#)

Printing from Your Computer

This section describes the procedure to print documents or photos with a computer.

You can easily print photos taken with your digital camera by using Easy-PhotoPrint EX supplied with the machine.

This section also introduces the supplied plug-in application, such as Easy-PhotoPrint Pro, that performs photo editing and printing at the professional level.

Printing Photos (Easy-PhotoPrint EX)

[Using Various Functions of Easy-PhotoPrint EX](#)

[Using Various Functions of Easy-PhotoPrint Pro](#)

Printing Documents (Windows)

Printing Documents (Macintosh)

[For Mac OS X v.10.5.x](#)

[For Mac OS X v.10.4.x or Mac OS X v.10.3.9](#)



Printing Photos (Easy-PhotoPrint EX)

Print image data saved on your computer by using Easy-PhotoPrint EX supplied with the machine. This section describes the procedure to print borderless photos on 4" x 6" / 10 x 15 cm photo paper. For details on Easy-PhotoPrint EX, refer to the on-screen manual: [Advanced Guide](#).

Note

- The screens used in this section are for printing with Windows. The operations are also the same for printing with Macintosh.
- Install Easy-PhotoPrint EX from the *Setup CD-ROM* when it has not been installed or has been uninstalled. To install Easy-PhotoPrint EX, select Easy-PhotoPrint EX in Custom Install.

1. Prepare for printing.

(1) Make sure that the machine is turned on.

See [Operation Panel](#).

(2) Load paper.

See [Loading Paper](#).

Here we load 4" x 6" / 10 x 15 cm photo paper in the Rear Tray.

Note

- Load A4 or Letter-sized plain paper in the Cassette and other sizes or types of paper such as photo paper in the Rear Tray.

(3) Open the Paper Output Tray gently, and open the Output Tray Extension.



2. Start Easy-PhotoPrint EX, and select Photo Print.

(1) Start Easy-PhotoPrint EX.



Double-click  (Easy-PhotoPrint EX) on the desktop.





Click Here: [Easy-PhotoPrint EX](#)



Macintosh

Select the Go menu, Applications, Canon Utilities, Easy-PhotoPrint EX, then double-click Easy-PhotoPrint EX.

Note**Windows**

- To start Easy-PhotoPrint EX from Solution Menu, double-click  (Solution Menu) on the desktop and click  (Print photos or albums, etc.). See [Solution Menu](#).
- To start Easy-PhotoPrint EX from the Start menu, select All Programs (or Programs), Canon Utilities, Easy-PhotoPrint EX, then Easy-PhotoPrint EX.

Macintosh

- To start Easy-PhotoPrint EX from Solution Menu, click  (Solution Menu) in the Dock and click  (Print photos or albums, etc.). See [Solution Menu](#).



(2) Click Photo Print.**Note**

- You can select Album, Calendar, Stickers, etc., besides Photo Print. See [Using Various Functions of Easy-PhotoPrint EX](#).

**3. Select a photo to print.****(1) Select the folder in which images are saved.****(2) Click the image to print.**

The number of copies appears as "1", and the image you selected appears in the selected image area (A). You can select two or more images at the same time.

Note

- To print two or more copies, click  (Up arrow) to change the number of copies.
- To cancel the selection, click the image to cancel in the selected image area and click  (Delete Imported Image). You can also use  (Down arrow) to change the number of copies to zero.
- You can also correct or enhance the selected image. See [Using Various Functions of Easy-PhotoPrint EX](#).

(3) Click Select Paper.



4. Select the loaded paper.

- (1) Make sure that your machine's name is selected in Printer.
- (2) Make sure that Automatically Select is selected in Paper Source.

Note

- For details on other settings for Paper Source, refer to the on-screen manual: [Advanced Guide](#).

- (3) Select the size and type of the loaded paper in Paper Size and Media Type.
Here we select 4"x6" 10x15cm in Paper Size and the type of the loaded photo paper in Media Type.

Note

- If you select A4 or Letter-sized plain paper when Automatically Select is selected in Paper Source, the machine feeds the paper from the Cassette. If you select other sizes or types of paper such as photo paper, the machine feeds the paper from the Rear Tray.
If you select the wrong page size or media type, the machine may feed paper from the wrong paper source or may not print with the proper print quality.

- (4) Click Layout/Print.

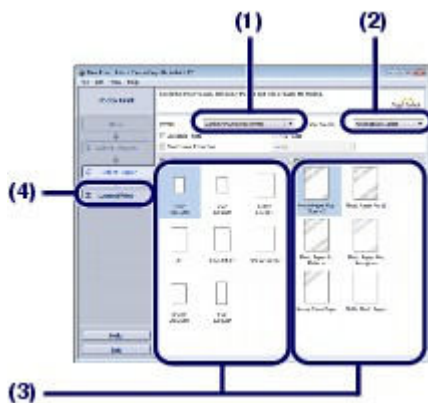

5. Select a layout and start printing.

- (1) Select the layout of the photo.
Here we select Borderless (full).

The preview will appear in the selected layout for confirmation of the required print result.

Note

- You can change the direction of photo or crop photos (trimming) to print.
For details on the operation, refer to the on-screen manual: [Advanced Guide](#).

(2) Click Print.



Note

Windows

- To cancel a print job in progress, press the **Stop** button on the machine or click Cancel Printing on the printer status monitor. After canceling the print job, blank sheets of paper may be ejected.
- To display the printer status monitor, click Canon XXX Printer (where " **XXX**" is your machine's name) on the taskbar.

Macintosh

- Click the printer icon in the Dock to display the list of print jobs in progress.
- To cancel a print job in progress, select the desired job in the Name list and click Delete.
- To temporarily stop a job in progress, click Hold. To temporarily stop all the jobs in the list, click Pause Printer (or Stop Jobs). After canceling the print job, blank sheets of paper may be ejected.



[↑ Page top](#)

[Contents](#) > [Printing from Your Computer](#) > [Printing Photos \(Easy-PhotoPrint EX\)](#) > Using Various Functions of Easy-PhotoPrint EX

■ Using Various Functions of Easy-PhotoPrint EX

This section introduces a few of the useful functions of Easy-PhotoPrint EX.
For details, refer to the on-screen manual: [Advanced Guide](#).

● Creating Your Own Prints

You can create an album or calendar using your photos.



Album



Calendar



Stickers



Layout Print

● Correcting Images

You can use Red-Eye Correction, Face Sharpener, Digital Face Smoothing, Brightness, Contrast, etc. to adjust, correct, or enhance images automatically or manually.



Brightness



Basic Guide

■ [Advanced Guide](#) ■ [Troubleshooting](#)

[Contents](#) > [Printing from Your Computer](#) > [Printing Photos \(Easy-PhotoPrint EX\)](#) > Using Various Functions of Easy-PhotoPrint Pro

■ Using Various Functions of Easy-PhotoPrint Pro

Easy-PhotoPrint Pro is a plug-in application started from Adobe Photoshop or Digital Photo Professional for Canon brand Single Lens Reflex camera.

Easy-PhotoPrint Pro allows easy performance of various photo prints, such as borderless print, index print, grayscale print, or print using Adobe RGB.

For details, refer to the on-screen manual: [Advanced Guide](#).

Note

- Easy-PhotoPrint Pro is a software plug-in for Canon Digital Photo Professional Ver. 2.1 or later, Adobe Photoshop CS4, CS3, CS2, CS and Adobe Photoshop Elements 6 and 7*.

* Windows only.

For updated compatibility, visit our website.



● Print in Various Layouts

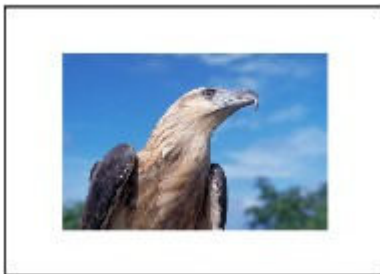

Bordered (full) print



Index print

● Color Management Function Compatible with Adobe RGB



Adobe RGB



sRGB

- Color Correction While Viewing a Sample Pattern



- Produce Retro Flavor by Grayscale Photos



Cool Tone

Black/White (Default)

Warm Tone



[↑ Page top](#)

Printing Documents (Windows)

This section describes the procedure to print a document of A4 size on plain paper.
For details, refer to the on-screen manual: [Advanced Guide](#).

Note

- Operations may vary depending on your software application. For details on the operation, refer to the instruction manual of your application.
- The screens used in this section are for printing with Windows Vista operating system Ultimate Edition (hereafter referred to as "Windows Vista").

1. Make sure that the machine is turned on.

See [Operation Panel](#).

2. Load paper.

See [Loading Paper](#).

Here we make sure that A4 plain paper is loaded in the Cassette.

Note

- Load A4, B5, A5, or Letter-sized plain paper in the Cassette and other sizes or types of paper such as photo paper in the Rear Tray.

3. Open the Paper Output Tray gently, and open the Output Tray Extension.

4. Create (or open) a document to print using an appropriate software application.

5. Open the printer driver setup window.

(1) Select Print on the File menu or the command bar in your software application.

The Print dialog box will appear.

(2) Make sure that your machine's name is selected.

Note

- If another printer's name is selected, click and select your machine's name.

(3) Click Preferences (or Properties).

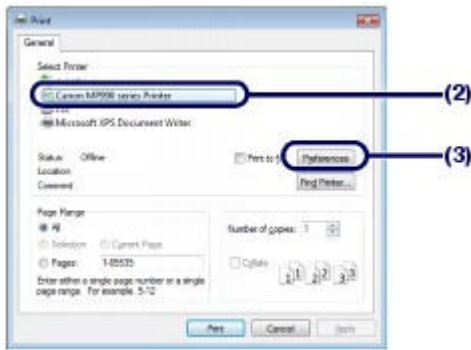

6. Specify the required print settings.

(1) Select Business Document in Commonly Used Settings.

Note

- When the print object such as Business Document or Photo Printing is selected in Commonly Used Settings, the items in Additional Features will be selected automatically. The settings suitable for the print object such as media type or print quality will also appear.
- When you specify two or more copies in Copies, the Collate check box will be selected.

(2) Make sure of the displayed settings.

Here we make sure that Plain Paper in Media Type, Standard in Print Quality, A4 in Printer Paper Size, and Automatically Select in Paper Source are selected.

Note

- The settings can be changed. However, after changing Printer Paper Size, confirm that the setting for Page Size on the Page Setup sheet matches the setting set in the software application. For details, refer to the on-screen manual: [Advanced Guide](#).
- If you select A4, B5, A5, or Letter-sized plain paper when Automatically Select is selected in Paper Source, the machine feeds the paper from the Cassette. If you select other sizes or types of paper such as photo paper, the machine feeds the paper from the Rear Tray. If you select the wrong page size or media type, the machine may feed paper from the wrong paper source or may not print with the proper print quality.

(3) Click OK.

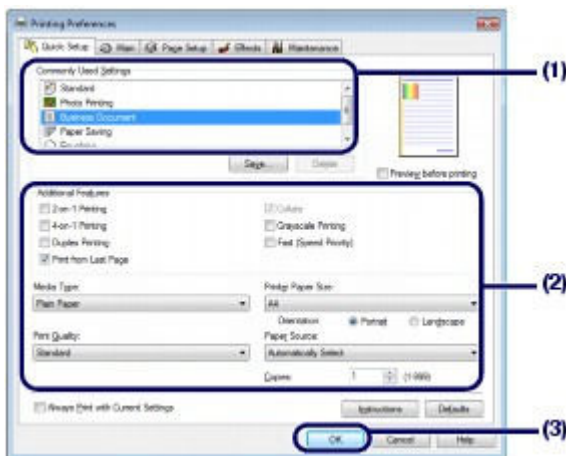

Note

- For details on the printer driver functions, click Help or Instructions to view the online help or the on-screen manual: *Advanced Guide*. The Instructions button appears on the Quick Setup, Main and Maintenance sheets if the on-screen manual is installed on your computer.

- You can name the changed settings and add to Commonly Used Settings.
For details, refer to the on-screen manual: [Advanced Guide](#) .
 - If the Always Print with Current Settings check box is selected, the current settings will be applied from the next print job onward. Some software applications may not have this function.
 - To display the preview to confirm the print result, select the Preview before printing check box. Some software applications may not have a preview function.
 - You can specify the detailed print settings on the Main sheet or Page Setup sheet.
For details, refer to the on-screen manual: [Advanced Guide](#) .
-

7. Start printing.

Click Print (or OK) to start printing.



Note

- To cancel a print job in progress, press the **Stop** button on the machine or click Cancel Printing on the printer status monitor. After canceling the print job, blank sheets of paper may be ejected.
To display the printer status monitor, click Canon XXX Printer (where " **XXX**" is your machine's name) on the taskbar.
 - If printed ruled lines are misaligned or print results are unsatisfactory, adjust the print head position.
See [Aligning the Print Head](#) .
-



Printing Documents (Macintosh)

This section describes the procedure to print a document of A4 size on plain paper.
For details, refer to the on-screen manual: [Advanced Guide](#).

Note

- Operations may vary depending on your software application. For details on the operation, refer to the instruction manual of your application.

■ For Mac OS X v.10.5.x

1. Make sure that the machine is turned on.

See [Operation Panel](#).

2. Load paper.

See [Loading Paper](#).

Here we make sure that A4 plain paper is loaded in the Cassette.

Note

- Load A4, B5, A5, or Letter-sized plain paper in the Cassette and other sizes or types of paper such as photo paper in the Rear Tray.

3. Open the Paper Output Tray gently, and open the Output Tray Extension.

4. Create (or open) a document to print using an appropriate software application.

5. Open the Print dialog box.

Select Print on the File menu in your software application.
The Print dialog box will appear.

Note

- If the dialog box below appears, click  (Down arrow).

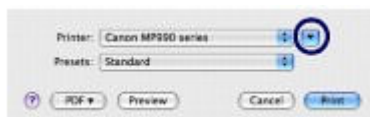

6. Specify the required print settings.

(1) Make sure that your machine's name is selected in Printer.

- (2) Select the page size of the loaded paper in Paper Size.

Here we select A4.

- (3) Select Quality & Media in the pop-up menu.

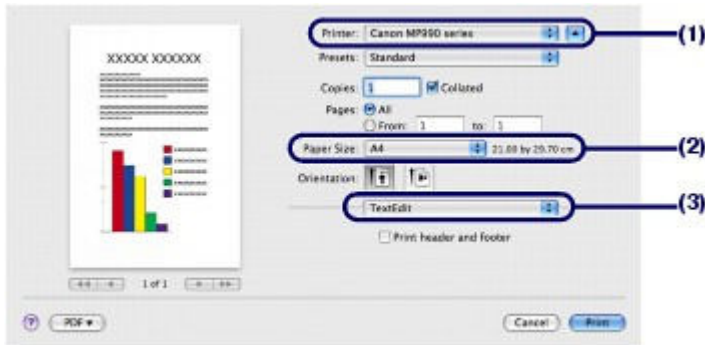

- (4) Select the media type of the loaded paper in Media Type.

Here we select Plain Paper.

Note

- If you select A4, B5, A5, or Letter-sized plain paper when Automatically Select is selected in Paper Source, the machine feeds the paper from the Cassette. If you select other sizes or types of paper such as photo paper, the machine feeds the paper from the Rear Tray. If you select the wrong page size or media type, the machine may feed paper from the wrong paper source or may not print with the proper print quality.

- (5) Make sure that Automatically Select is selected in Paper Source.

Note

- For details on other settings for Paper Source, refer to the on-screen manual: [Advanced Guide](#).

- (6) Select the print quality in Print Quality.

Here we select Standard.

Note

- For details on the print quality, refer to the on-screen manual: [Advanced Guide](#).

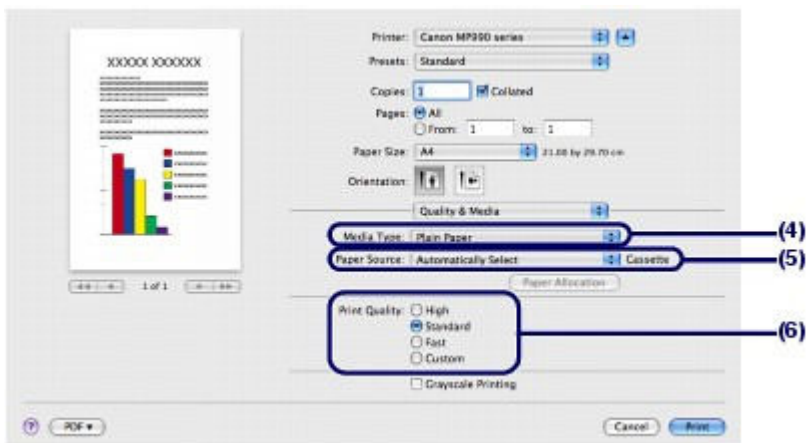

Note

- For details on the printer driver functions, click (Question) on the Quality & Media, Color Options, Borderless Printing, or Duplex Printing & Margin screen.
- The preview appears on the left of the dialog box to confirm the print result. Some software applications may not have a preview function.

7. Start printing.

Click Print to start printing.

Note

- Click the printer icon in the Dock to display the list of print jobs in progress.
 - To cancel a print job in progress, select the desired job in the Name list and click Delete. To temporarily stop a job in progress, click Hold. To temporarily stop all the jobs in the list, click Pause Printer. After canceling the print job, blank sheets of paper may be ejected.
 - If printed ruled lines are misaligned or print results are unsatisfactory, adjust the print head position.
See [Aligning the Print Head](#).
-

■ For Mac OS X v.10.4.x or Mac OS X v.10.3.9

Note

- The screens used in this section are for printing with Mac OS X v.10.4.x.
-

1. Make sure that the machine is turned on.

See [Operation Panel](#).

2. Load paper.

See [Loading Paper](#).

Here we make sure that A4 plain paper is loaded in the Cassette.

Note

- Load A4, B5, A5, or Letter-sized plain paper in the Cassette and other sizes or types of paper such as photo paper in the Rear Tray.
-

3. Open the Paper Output Tray gently, and open the Output Tray Extension.

4. Create (or open) a document to print using an appropriate software application.

5. Specify the page size.

(1) Select Page Setup on the File menu in your software application.

The Page Setup dialog box will appear.

(2) Make sure that your machine's name is selected in Format for.

(3) Select the page size of the loaded paper in Paper Size.

Here we select A4.

(4) Click OK.

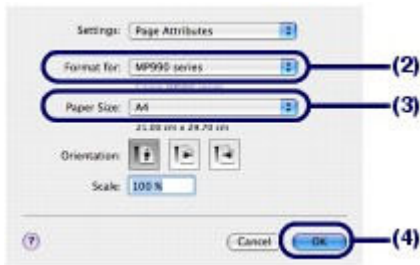

6. Specify the required print settings.

(1) Select Print on the File menu in your software application.

The Print dialog box will appear.

(2) Make sure that your machine's name is selected in Printer.

(3) Select Quality & Media in the pop-up menu.

(4) Select the media type of the loaded paper in Media Type.

Here we select Plain Paper.

Note

- If you select A4, B5, A5, or Letter-sized plain paper when Automatically Select is selected in Paper Source, the machine feeds the paper from the Cassette. If you select other sizes or types of paper such as photo paper, the machine feeds the paper from the Rear Tray. If you select the wrong page size or media type, the machine may feed paper from the wrong paper source or may not print with the proper print quality.

(5) Make sure that Automatically Select is selected in Paper Source.

Note

- For details on other settings for Paper Source, refer to the on-screen manual: [Advanced Guide](#).

(6) Select the print quality in Print Quality.

Here we select Standard.

Note

- For details on the print quality, refer to the on-screen manual: [Advanced Guide](#).



Note

- For details on the printer driver functions, click  (Question) on the Quality & Media, Color Options, Special Effects, Borderless Printing, or Duplex Printing & Margin screen.
- To display the preview to confirm the print result, click Preview. Some software applications may not have a preview function.

7. Start printing.

Click Print to start printing.

Note

- Click the printer icon in the Dock to display the list of print jobs in progress.
 - To cancel a print job in progress, select the desired job in the Name list and click Delete.
To temporarily stop a job in progress, click Hold. To temporarily stop all the jobs in the list, click Stop Jobs. After canceling the print job, blank sheets of paper may be ejected.
 - If printed ruled lines are misaligned or print results are unsatisfactory, adjust the print head position.
See [Aligning the Print Head](#) .
-



[↑ Page top](#)

Other Usages

This section introduces the procedure to print the template forms such as notebook paper, etc., the setting items of the machine, and the function to print directly from a digital camera or mobile phone. This section also introduces useful software applications you can use with the machine.

Printing the Template Forms such as Notebook Paper

[Printing the Various Template Forms](#)

Printing Photos Directly from Your Digital Camera or Mobile Phone

[Printing Photos from a PictBridge Compliant Device](#)

[Printing Photos from a Wireless Communication Device](#)

Machine Settings

Useful Software Applications

[Solution Menu](#)

[My Printer](#)

[Easy-WebPrint EX](#)



[↑ Page top](#)

Printing the Template Forms such as Notebook Paper

This section describes the procedure to select and print the template forms.

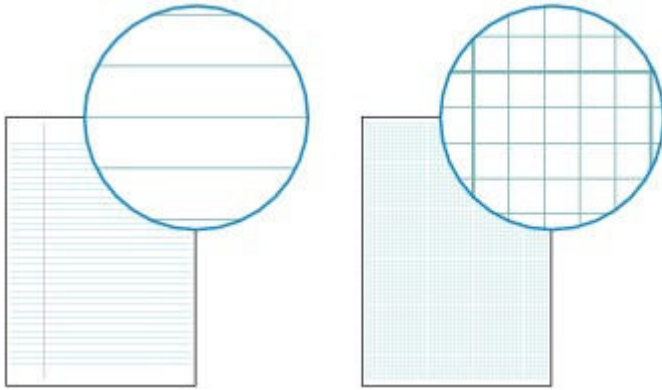

You need to prepare:

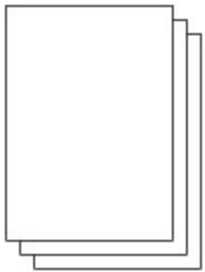

A4, B5, or Letter-sized plain paper. See [Media Types You Can Use](#).



1. Prepare for printing.

- (1) Turn on the power.
See [Operation Panel](#).
- (2) Make sure that A4, B5, or Letter-sized plain paper is loaded in the Cassette.
See [Loading Paper in the Cassette](#).
- (3) Open the Paper Output Tray gently, and open the Output Tray Extension.

2. Select a template form.

- (1) Select Settings  on the **HOME** screen, and press the **OK** button.
- (2) Select Template print , and press the **OK** button.
- (3) Use the **Easy-Scroll Wheel** (the ◀ or ▶ button) to select a template form to print, and press the **OK** button.

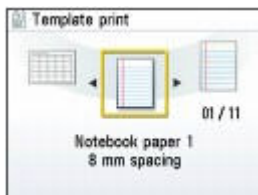

 **Note**

● For details on the available template forms, see [Printing the Various Template Forms](#).

3. Start printing.

(1) Confirm Page size and Duplex/simplex printing.

To change the setting, use the **Easy-Scroll Wheel** (the ▲ or ▼ button) to select the item to change, and press the **OK** button.

 **Note**

● You can only select A4, B5, or 8.5"x11" (LTR) for Page size. B5 may not be available depending on the selected template. The media type is limited to Plain paper and cannot be changed.

(2) Press the [+] or [-] button to specify the number of copies.

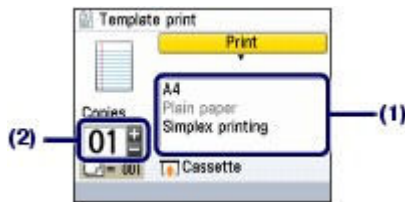

(3) Press the **Color** or **Black** button.

The machine starts printing.

■ Printing the Various Template Forms

You can print the following templates with Template print.

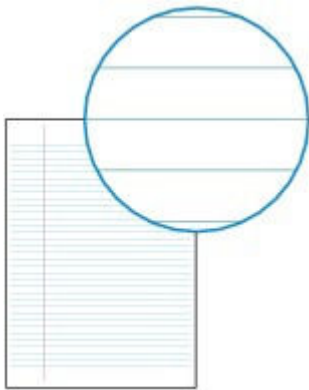

- Notebook paper 1
8 mm spacing
- Notebook paper 2
7 mm spacing
- Notebook paper 3
6 mm spacing

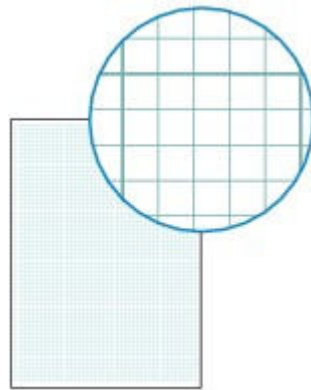

- Graph paper 1
Graph 5 mm
- Graph paper 2
Graph 3 mm

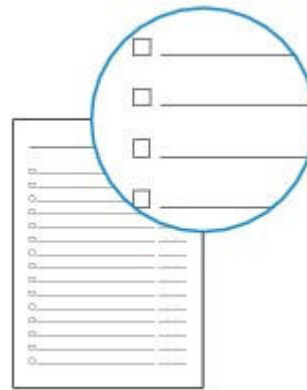

- Checklist
List with checkboxes



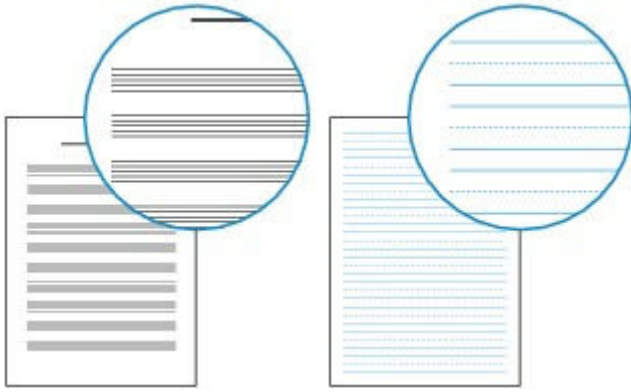

- Staff paper 1
Staff paper 10 staves
- Staff paper 2
Staff paper 12 staves
- Handwriting paper
Rows of three lines
- Weekly schedule
Vertical type

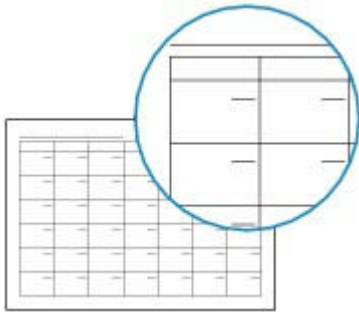

- Monthly schedule
Calendar type



[↑ Page top](#)

Printing Photos Directly from Your Digital Camera or Mobile Phone

■ Printing Photos from a PictBridge Compliant Device

You can connect the PictBridge compliant device to this machine with a USB cable that is recommended by the device's manufacturer, and print saved images directly.

For details on how to print saved images connecting the PictBridge compliant device, refer to the on-screen manual: [Advanced Guide](#).

For details on the print settings on the PictBridge compliant device, refer to the instruction manual supplied with the device.



Connectable devices:

Any PictBridge compliant device can be connected to this machine regardless of the manufacturer or model as long as it is compliant with the PictBridge Standard.

▶ Important

- Do not use the USB cable longer than around 10 feet / 3 meters to connect any PictBridge compliant device to the machine since it may affect the operation of other peripheral devices.

📖 Note

- PictBridge is the Standard to print your photos directly without using a computer, connecting a device such as a digital still camera, digital camcorder, or camera-equipped mobile phone.



(PictBridge) A device with this mark is PictBridge compliant.

Printable image data format:

This machine accepts images* taken with a camera compliant with the Design rule for Camera File system and PNG files.

* Exif 2.2/2.21 compliant

📖 Note

- When printing from the PictBridge compliant device, set the print quality with the Operation Panel on the machine. You cannot set the print quality on the PictBridge compliant device.

■ Printing Photos from a Wireless Communication Device

You can easily print image data with wireless infrared communication from your mobile phone. If the optional Bluetooth Unit BU-30 is connected to the machine, you can print image data with wireless communication from Bluetooth compatible mobile phones or computers. For details on the operation, refer to the on-screen manual: [Advanced Guide](#).



[↑ Page top](#)

Machine Settings

This section describes the items you can set or change in Device settings of the Settings menu. For details on setting or changing, refer to the on-screen manual: [Advanced Guide](#).

● Plain paper feed settings

Selects the paper source (Rear Tray or Cassette) in which you load plain paper. The machine feeds plain paper from the Cassette by default. Use this setting to change the paper source for plain paper to the Rear Tray.

● Print settings

Prevent paper abrasion

Use this setting only if the print surface becomes smudged.

Extended copy amount

Selects the amount of image that extends off the paper when making borderless copies.

Film print cutting range

Selects the cutting range of a film when scanning the 35 mm film in the film printing.

Auto Photo Fix setting

Selects whether or not to prioritize printing Exif information saved on a photo when Auto photo fix ON is selected.

● LAN settings

Change wireless/wired

Switches between wired LAN and wireless LAN. You can also disable LAN connection.

Wireless LAN setup

Configures the wireless LAN connection according to an access point or connection environment. If the access point supports the WPS (Wi-Fi Protected Setup), you can configure a wireless LAN easily. The access point settings can also be configured manually.

For details, refer to the printed manual: *Getting Started*.

Confirm LAN settings

Displays the wireless or wired LAN configurations of the machine on the LCD, or prints this information from the machine.

Other settings

Configures other network settings including the machine's network name, IPv4/IPv6 settings, memory card sharing, WSD (Web Services on Devices) setting, etc.

Reset LAN settings

Sets the machine network settings back to the default.

● Advanced settings

Date display

Selects the format of date that is printed or displayed on the screen.

Read/write attribute

Selects whether to use the Card Slot of the machine as the memory card drive of a computer.

Power save setting

Selects the length of wait time until the machine enters the Power save mode.

The machine enters the Power save mode if not operated for a certain time interval. In the Power save mode, the FAU (Film Adapter Unit) lamp will be turned off to reduce the power consumption of the machine.

The default setting is 15 minutes.

Quiet mode

Enables this function if you want to reduce the operating noise of the machine, such as when using the machine at night (when copying, printing from the memory card, printing from the PictBridge compliant device, printing with wireless communication, etc.).

Guide display settings

Changes the time interval before the guide display, such as Change set. and Copy, appears at the top of the LCD, or hides the guide display.

Key repeat

Enables to increase or decrease numbers rapidly by pressing and holding down the button when inputting numbers. When this setting is disabled, holding down the button is the same as pressing it once.

● Mobile phone print setting

Specifies paper or image correction when you print from the wireless communication device.

● Bluetooth settings

Changes the Bluetooth settings, such as the device name or passkey. This setting appears only when the optional Bluetooth Unit is connected to the machine.

● PictBridge print settings

Specifies paper, print quality, etc. when you print from the PictBridge compliant device.

● Language selection

Changes the language for LCD messages and menus.

● Reset setting

Sets the machine settings back to the default. (However, the settings configured in LAN settings, the values set for the print head alignment, the setting in Read/write attribute, and the language set in Language selection will not be reset.)



Useful Software Applications

The machine can be used with useful software applications such as Solution Menu, My Printer, and Easy-WebPrint EX.

■ Solution Menu

With Solution Menu, you can start the software applications supplied with the machine or display the operating instructions.



Double-click  (Solution Menu) on the desktop.



Click Here: [Solution Menu](#)



Click  (Solution Menu) in the Dock.

* The screens below are for Windows Vista.



Click the button of a function to use.



After starting Solution Menu, click the button on the title bar to reduce the window size.

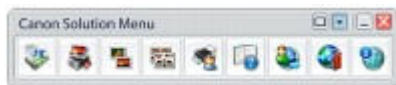

Note

- Install Solution Menu from the *Setup CD-ROM* when it has not been installed or has been uninstalled. To install Solution Menu, select Solution Menu in Custom Install.
- The buttons displayed on the screen may vary depending on the country or region of purchase.



- To start Solution Menu from the Start menu, select All Programs (or Programs), Canon Utilities, Solution Menu, then Solution Menu.



- To start Solution Menu from the menu bar, select the Go menu, Applications, Canon Utilities, Solution Menu, then double-click Solution Menu.

■ My Printer

With My Printer, you can display the printer driver setup window. It also provides you with the information on how to take an action when you have trouble with the operation.

My Printer is not available in Macintosh.



Double-click  (My Printer) on the desktop.



Note

- You can also start My Printer from Solution Menu or the taskbar.
- Install My Printer from the *Setup CD-ROM* when it has not been installed or has been uninstalled. To install My Printer, select My Printer in Custom Install.
- To start My Printer from the Start menu, select All Programs (or Programs), Canon Utilities, My Printer, then My Printer.

■ Easy-WebPrint EX

Easy-WebPrint EX provides quick and easy printing of web pages for Internet Explorer. You can print web pages automatically resized to fit the paper width without cutting off the sides of pages, or preview and select the desired web pages to print.

Easy-WebPrint EX is not available in Windows 2000 and Macintosh.

▶ Important

- It is unlawful to reproduce or edit the copyrighted work of another person without permission from the copyright holder, except for personal use, use within the home, or other use within the limited scope as defined by the copyright. Additionally, reproducing or editing photographs of people may infringe on portrait rights.

When Easy-WebPrint EX is installed, it adds a toolbar to your Internet Explorer screen. The toolbar is available whenever Internet Explorer is running.



The clip function, for example, allows you to clip desired parts of web pages and edit them to print.

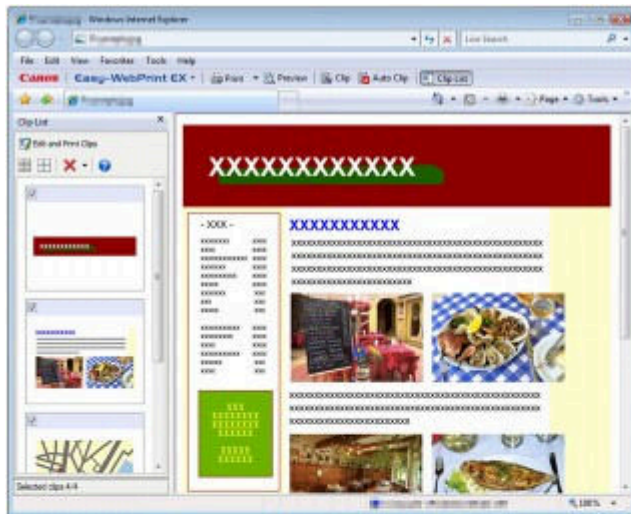

For details on printing web pages, click [?](#) (Help) to view the online help.

Note

Installing Easy-WebPrint EX

- If Easy-WebPrint EX is not installed, the guidance for installation of Easy-WebPrint EX may appear from the taskbar on the desktop.
To install Easy-WebPrint EX, click the displayed guidance and follow the instructions on the screen.
- You can also install Easy-WebPrint EX from the *Setup CD-ROM*.
To install Easy-WebPrint EX, select Easy-WebPrint EX in Custom Install.
- To install Easy-WebPrint EX on your computer, Internet Explorer 7 or later is required and the computer must be connected to the Internet.



Loading Paper / Originals

This section describes types of paper or originals you can load, how to load printing paper in the Rear Tray or Cassette, and how to load originals to copy or scan.

Loading Paper

- [Paper Source to Load Paper](#)
- [Loading Paper in the Cassette](#)
- [Loading Paper in the Rear Tray](#)
- [Media Types You Can Use](#)
- [Media Types You Cannot Use](#)

Loading Originals

- [Loading Originals](#)
- [How to Load Originals for Each Function](#)
- [Originals You Can Load](#)



Loading Paper

- ➔ [Paper Source to Load Paper](#)
- ➔ [Loading Paper in the Cassette](#)
- ➔ [Loading Paper in the Rear Tray](#)
- ➔ [Media Types You Can Use](#)
- ➔ [Media Types You Cannot Use](#)

■ Paper Source to Load Paper

The machine has two paper sources to feed paper; Cassette and Rear Tray. You can load paper in either one of the paper sources, depending on the page size and media type of paper. Paper is fed from the Cassette or Rear Tray depending on the selection of the page size or media type.

See [Media Types You Can Use](#).

Note

- When printing, select the correct page size and media type. If you select the wrong page size or media type, the machine may feed paper from the wrong paper source or may not print with the proper print quality. For details on how to load paper in each paper source, see [Loading Paper in the Cassette](#) or [Loading Paper in the Rear Tray](#).

● Loading Plain Paper in the Cassette

When you use A4, B5, A5, or Letter-sized plain paper, load it in the Cassette.

The machine feeds paper from the Cassette automatically by selecting plain paper (A4, B5, A5, or Letter size) in the print settings with the Operation Panel or the printer driver when printing.

For details on how to change the paper source setting, refer to the on-screen manual: [Advanced Guide](#).



● Loading Photo Paper in the Rear Tray

When you use photo paper, load it in the Rear Tray.

The machine feeds paper from the Rear Tray automatically by selecting the media types other than plain paper, such as photo paper, in the print settings with the Operation Panel or the printer driver when printing.

When you use plain paper other than A4, B5, A5, or Letter size, also load it in the Rear Tray.



[↑ Page top](#)

■ Loading Paper in the Cassette

You can load only A4, B5, A5, or Letter-sized plain paper in the Cassette.

Load other sizes or types of paper in the Rear Tray.

See [Media Types You Can Use](#).

Note

Advice for printing on plain paper

- We recommend Canon genuine photo paper for printing photos.
For details on the Canon genuine paper, see [Media Types You Can Use](#).
- You can use general copy paper.
For the page size and paper weight you can use for this machine, see [Media Types You Can Use](#).

1. Prepare paper.

Align the edges of paper. If paper is curled, flatten it.

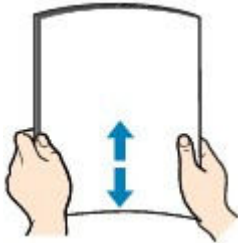

Note

- Align the edges of paper neatly before loading. Loading paper without aligning the edges may cause paper jams.
- If paper is curled, hold the curled corners and gently bend them in the opposite direction until the paper becomes completely flat.
For details on how to flatten curled paper, refer to "[Troubleshooting](#)" in the on-screen manual: *Advanced Guide*.

2. Load paper.

(1) Pull out the Cassette from the machine.



(2) Load the paper stack WITH THE PRINT SIDE FACING DOWN and THE LEADING EDGE TO THE FAR SIDE, and align it against the right side of the Cassette.

- (3) Slide the Paper Guide (A) to align with the mark of page size.
The Paper Guide (A) will stop when it aligns with the corresponding mark of page size.

Note

- There may be a little space between the Paper Guide (A) and the paper stack.

- (4) Slide the Paper Guide (B) on the left to align completely with the side of the paper stack.

Note

- Do not load sheets of paper higher than the Load Limit Mark (C).

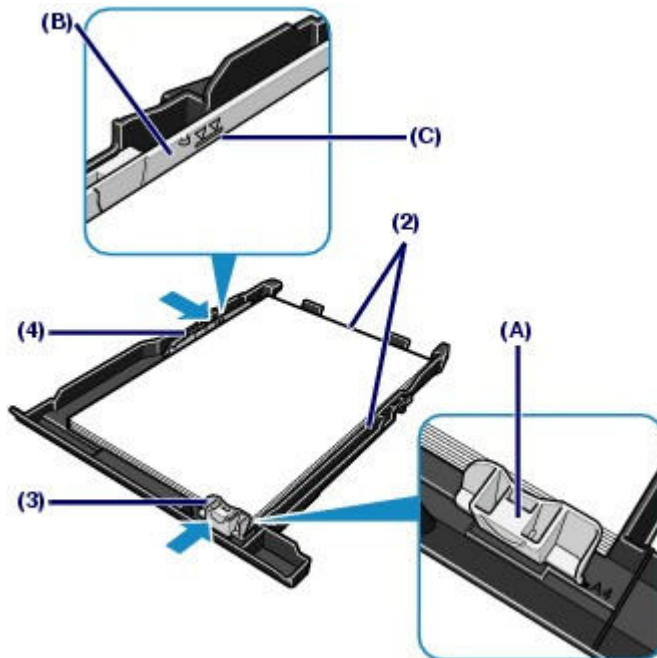

- (5) Insert the Cassette into the machine.
Push the Cassette all the way into the machine.



3. Open the Paper Output Tray gently, and open the Output Tray Extension.

Note

After loading paper

- When using the machine to copy or print without a computer, select the size and type of the loaded paper for Page size and Media type of the print settings in each menu of the **HOME** screen.
See [Changing the Settings](#) in "Printing Photos Saved on the Memory Card / USB Flash Drive" or [Changing the Settings](#) in "Making Copies".
- When printing with a computer, select the size and type of the loaded paper in Printer Paper

Size (or Paper Size) and Media Type in the printer driver.
See [Printing Documents \(Windows\)](#) or [Printing Documents \(Macintosh\)](#).



[↑ Page top](#)

■ Loading Paper in the Rear Tray

You can load photo paper or envelopes in the Rear Tray.

● Loading Photo Paper

▶ Important

- If you cut plain paper into small size such as 4" x 6" / 10 x 15 cm, 4" x 8" / 101.6 x 203.2 mm, 5" x 7" / 13 x 18 cm, or 2.16" x 3.58" / 55.0 x 91.0 mm (Card size) to perform trial print, it can cause paper jams.

1. Prepare paper.

See [Prepare paper](#). in "Loading Paper in the Cassette".

Align the edges of paper. If paper is curled, flatten it.

2. Load paper.

(1) Open the Paper Support, raise it, then tip it back.

(2) Open the Paper Output Tray gently, and open the Output Tray Extension.

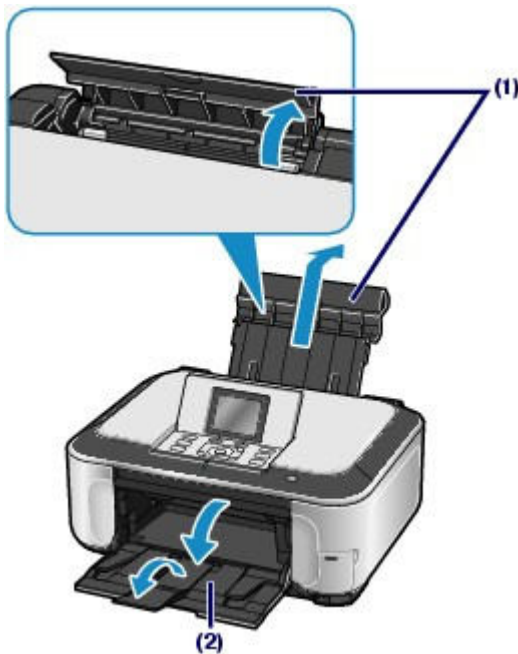

(3) Slide the Paper Guides (A) to open them, and load the paper in the center of the Rear Tray WITH THE PRINT SIDE FACING YOU.

▶ Important

- Always load paper in the portrait orientation (B). Loading paper in the landscape orientation (C) can cause paper jams.

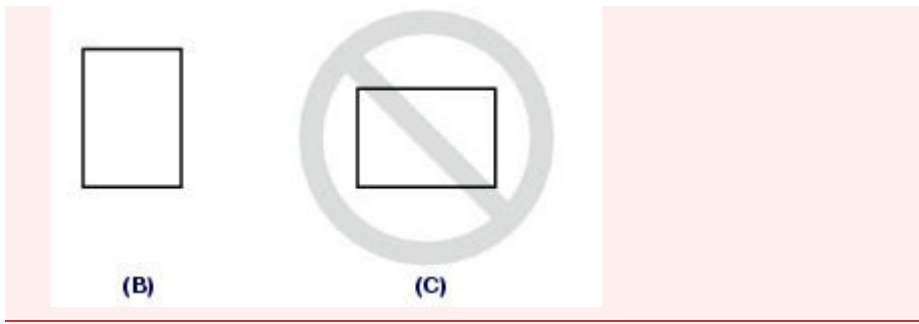

- (4) Slide the Paper Guides (A) to align them with both sides of the paper stack.
Do not slide the Paper Guides too hard. The paper may not be fed properly.

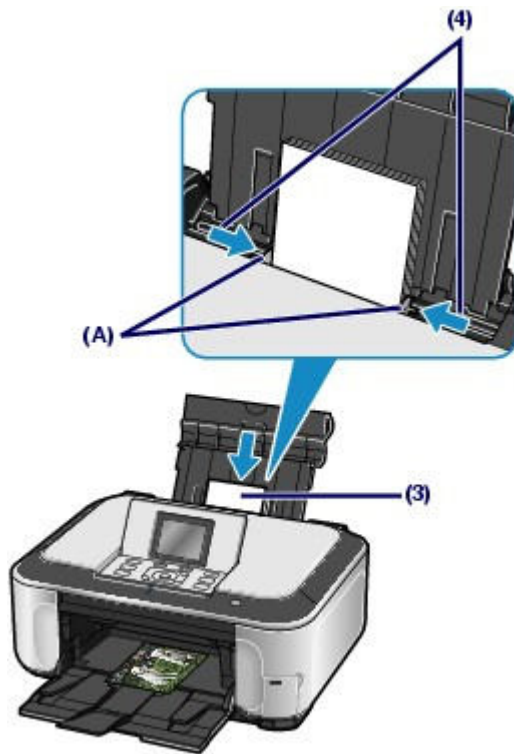

Note

- Do not load sheets of paper higher than the Load Limit Mark (D).

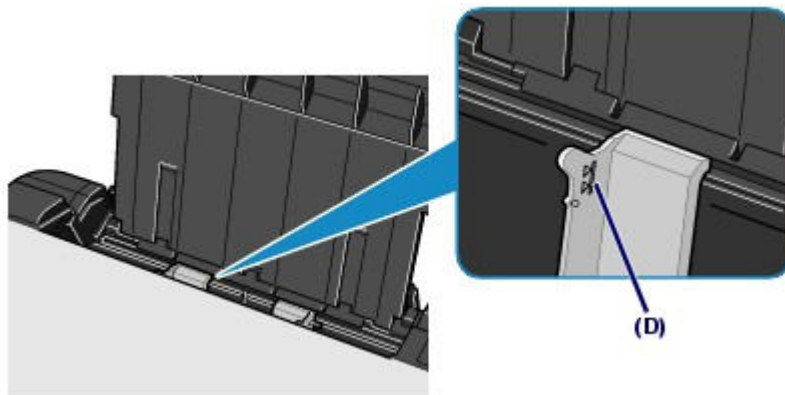

Note

After loading paper

- When using the machine to copy or print without a computer, select the size and type of the loaded paper for Page size and Media type of the print settings in each menu of the **HOME** screen.

See [Changing the Settings](#) in "Printing Photos Saved on the Memory Card / USB Flash Drive" or [Changing the Settings](#) in "Making Copies".

- When printing with a computer, select the size and type of the loaded paper in Printer Paper Size (or Paper Size) and Media Type in the printer driver.
See [Printing Documents \(Windows\)](#) or [Printing Documents \(Macintosh\)](#).

● Loading Envelopes

You can print on European DL and US Comm. Env. #10-sized envelopes.

The address is automatically rotated and printed according to the envelope's direction by specifying with the printer driver properly.

▶ Important

- You can only print on envelopes with the computer.
- Do not use the following envelopes. They could jam in the machine or cause the machine to malfunction.
 - Envelopes with an embossed or treated surface
 - Envelopes with a double flap (or sticker flaps)
 - Envelopes whose gummed flaps are already moistened and adhesive

1. Prepare envelopes.

- Press down on all four corners and edges of the envelopes to flatten them.

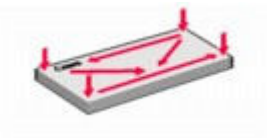

- If the envelopes are curled, hold the opposite corners and gently twist them in the opposite direction.

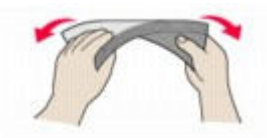

- If the corner of the envelope flap is folded, flatten it.
- Use a pen to press the leading edge in the inserting direction flat and sharpen the crease.

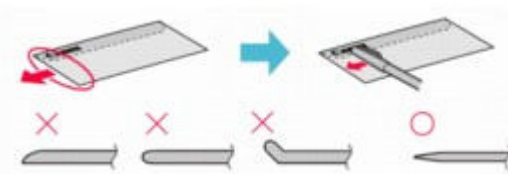

The figures above show a side view of the leading edge of the envelope.

▶ Important

- The envelopes may jam in the machine if they are not flat or the edges are not aligned. Make sure that no curl or puff exceeds 0.1 inches / 3 mm.

2. Load envelopes.

- (1) Open the Paper Support, raise it, then tip it back.

See [Load paper](#) in "Loading Photo Paper" of "Loading Paper in the Rear Tray".

- (2) Open the Paper Output Tray gently, and open the Output Tray Extension.

See [Load paper.](#) in "Loading Photo Paper" of "Loading Paper in the Rear Tray".

- (3)** Slide the Paper Guides (A) to open them, and load the envelopes in the center of the Rear Tray WITH THE ADDRESS SIDE FACING YOU.

The folded flap of the envelope will be faced down on the left side.

Up to 10 envelopes can be loaded at once.

- (4)** Slide the Paper Guides (A) to align them with both sides of the envelopes.

Do not slide the Paper Guides too hard. The envelopes may not be fed properly.

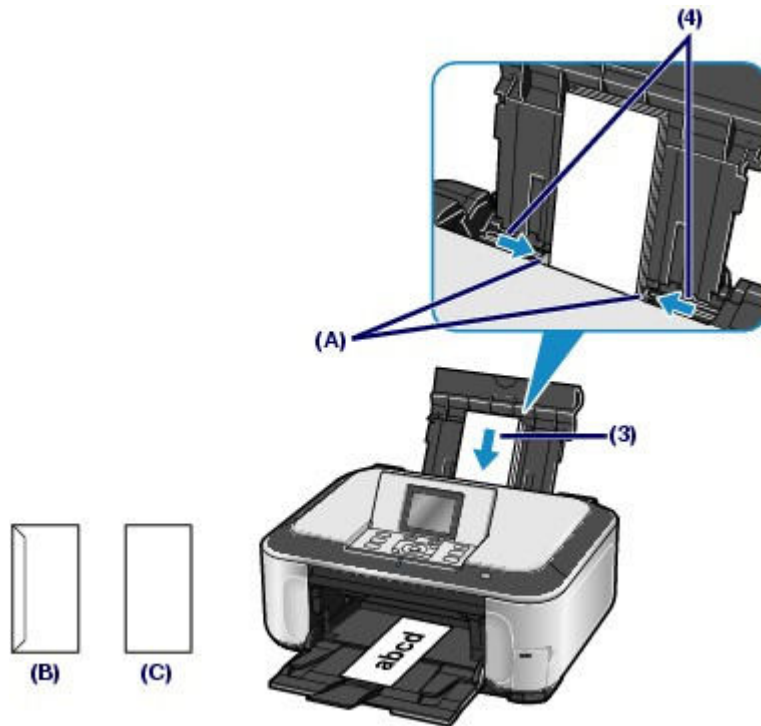

(B) Rear side

(C) Address side

3. Specify the settings with the printer driver.



- (1)** Select Envelope in Commonly Used Settings on the Quick Setup sheet.
- (2)** Select DL Env. or Comm. Env. #10 in the Envelope Size Setting window.
- (3)** Select Landscape in Orientation.



- (1)** Select Envelope in Media Type.
- (2)** Select DL Envelope or #10 Envelope in Paper Size.
- (3)** Select the landscape orientation in Orientation.

Important

- If you do not specify the envelope size or orientation properly, the address will be printed upside down or will be turned to 90 degrees.

Note

- In Windows, if the print result is upside down, open the printer driver setup window, select Envelope in Commonly Used Settings, then select the Rotate 180 degrees check box in Additional Features.

● For details on the printer driver settings, see [Printing Documents \(Windows\)](#) or [Printing Documents \(Macintosh\)](#).



[↑ Page top](#)

Basic Guide

[Advanced Guide](#)
[Troubleshooting](#)
[Contents](#) > [Loading Paper / Originals](#) > [Loading Paper](#) > Media Types You Can Use

Media Types You Can Use

Choose paper suitable for printing, for the best print results. Canon provides you various types of paper to enhance the fun of printing, such as stickers as well as papers for photo or document. We recommend the use of Canon genuine paper for printing your important photos.



Media Types

Commercially available papers

Name of Paper <Model No.> ^{*1}	Paper Load Limit		Paper Output Tray Load Limit	Settings in Media Type	
	Rear Tray	Cassette		Operation Panel	Printer Driver
Plain Paper (Recycled paper) ^{*2}	Approx. 150 sheets ^{*3}	A4, B5, A5, and Letter / 8.5" x 11": Approx. 150 sheets	Approx. 50 sheets	Plain paper	Plain Paper
Envelopes ^{*4}	10 envelopes	Not loadable ^{*5}	^{*6}	-	Envelope

Canon genuine papers

Name of Paper <Model No.> ^{*1}	Paper Load Limit		Paper Output Tray Load Limit	Settings in Media Type	
	Rear Tray	Cassette		Operation Panel	Printer Driver
For printing photos:					
					
Photo Paper Pro Platinum <PT-101> ^{*7}	A4, Letter / 8.5" x 11", 5" x 7" / 13 x 18 cm, and 8" x 10" / 20 x 25 cm: 10 sheets	Not loadable ^{*5}	^{*6}	Pro Platinum	Photo Paper Pro Platinum
Photo Paper Pro II <PR-201> ^{*7}				Pro II	Photo Paper Pro II
Glossy Photo Paper "Everyday Use" <GP-501> ^{*7}				Glossy Photo Paper	Glossy Photo Paper
Photo Paper Glossy <GP-502> ^{*7}				Glossy Photo Paper	Glossy Photo Paper
Photo Paper Plus Glossy II <PP-201> ^{*7}				Plus Glossy II	Photo Paper Plus Glossy II
Photo Paper Plus Semi-gloss <SG-201> ^{*7}				Plus Semi-gloss	Photo Paper Plus Semi-gloss
Matte Photo Paper				Matte Photo Paper	Matte Photo Paper

<MP-101>					
Fine Art Paper "Photo Rag" <FA-PR1> *4, *8	1 sheet			-	Fine Art "Photo Rag"
For printing business documents:					
					
High Resolution Paper <HR-101N>*4	80 sheets	Not loadable*5	50 sheets	-	High Resolution Paper
For creating your own prints:					
					
T-Shirt Transfers <TR-301>*4	1 sheet	Not loadable*5	*6	-	T-Shirt Transfers
Photo Stickers <PS-101>*9, *10	1 sheet			Glossy Photo Paper	Glossy Photo Paper

*1 Paper with a Model Number is Canon genuine paper. Refer to the instruction manual supplied with the paper for detailed information on the printable side and notes on handling paper. For information on the page sizes available for each Canon genuine paper, visit our website. You may not be able to purchase some Canon genuine papers depending on the country or region of purchase. Paper is not sold in the US by Model Number. Purchase paper by name.

*2 Proper feeding of paper may not be possible at the maximum capacity depending on the type of paper or environmental conditions (either very high or low temperature or humidity). In such cases, reduce the number of paper you load at a time to less than half (100% recycled paper can be used).

*3 A4, B5, A5, or Letter-sized plain paper can be loaded only when Rear tray is selected for Plain paper feed settings in Device settings of the Settings menu.

For details on the settings, refer to the on-screen manual: [Advanced Guide](#).

*4 Available only when printing from your computer.

*5 Feeding this paper from the Cassette can damage the machine. Always load in the Rear Tray.

*6 We recommend that you remove the previously printed sheet from the Paper Output Tray before continuously printing to avoid blurs and discoloration.

*7 When loading paper in stacks, the print side may become marked as it is fed or paper may not feed properly. In this case, load one sheet at a time.

*8 If you are using Fine Art Paper "Photo Rag", you cannot print in the 1.38 inches / 35 mm margin on the top and bottom edges according to the direction of printing. If you select a special page size for Fine Art Paper in the printer driver, a limit is set to prevent printing in the 1.38 inches / 35 mm margin on the top and bottom edges of the paper. We recommend checking the printing area in the preview screen before printing.

For details, refer to the on-screen manual: [Advanced Guide](#).

Canon genuine media is produced and managed to get optimal printing quality. We recommend using Canon genuine media.

*9 When scanning printed photos to print onto sticker paper, be sure to select Sticker print in Easy photo reprint. If Sticker print is selected, the type of paper cannot be selected.

See [Printing Photos in Various Layouts](#) .

When printing photos saved on a memory card or USB flash drive onto sticker paper, be sure to select Sticker print in Memory card menu. If Sticker print is selected, the type of paper cannot be selected.

See [Printing Photos in Various Layouts](#) .

When printing photos scanned from a film onto sticker paper, be sure to select Sticker print in Film print menu.

See [Printing Photos in Various Layouts](#) .

When printing photos saved on your mobile phone onto sticker paper, select Stickers for the page size in Mobile phone print setting.

Refer to the on-screen manual: [Advanced Guide](#).

*10 You can easily specify print settings for sticker paper with Easy-PhotoPrint EX provided on the *Setup CD-ROM*. Install it on your computer.

Note

- To specify the page size and media type when printing photos saved on a PictBridge compliant device or mobile phone, refer to the on-screen manual: [Advanced Guide](#).

● Page Sizes

You can use the following page sizes.

Note

- You can load plain paper of the following page sizes in the Cassette:
A4, B5, A5, and Letter sizes
Plain paper of other sizes cannot be loaded in the Cassette. Load them in the Rear Tray.
- In Macintosh, Choukei 3 and Choukei 4 are not available.

Standard sizes:

- Letter (8.50 x 11.00 inches / 215.9 x 279.4 mm)
- Legal (8.50 x 14.00 inches / 215.9 x 355.6 mm)
- A5 (5.83 x 8.27 inches / 148.0 x 210.0 mm)
- A4 (8.27 x 11.69 inches / 210.0 x 297.0 mm)
- B5 (7.17 x 10.12 inches / 182.0 x 257.0 mm)
- 4" x 6" (4.00 x 6.00 inches / 10 x 15 cm)
- 4" x 8" (4.00 x 8.00 inches / 101.6 x 203.2 mm)
- 5" x 7" (5.00 x 7.00 inches / 13 x 18 cm)
- 8" x 10" (8.00 x 10.00 inches / 20 x 25 cm)
- L (3.50 x 5.00 inches / 89.0 x 127.0 mm)
- 2L (5.00 x 7.01 inches / 127.0 x 178.0 mm)
- Hagaki (3.94 x 5.83 inches / 100.0 x 148.0 mm)
- Hagaki 2 (7.87 x 5.83 inches / 200.0 x 148.0 mm)
- Comm. Env. #10 (4.12 x 9.50 inches / 104.6 x 241.3 mm)
- DL Env. (4.33 x 8.66 inches / 110.0 x 220.0 mm)
- Choukei 3 (4.72 x 9.25 inches / 120.0 x 235.0 mm)
- Choukei 4 (3.54 x 8.07 inches / 90.0 x 205.0 mm)
- Youkei 4 (4.13 x 9.25 inches / 105.0 x 235.0 mm)
- Youkei 6 (3.86 x 7.48 inches / 98.0 x 190.0 mm)
- Card (2.16 x 3.58 inches / 55.0 x 91.0 mm)
- Wide (4.00 x 7.10 inches / 101.6 x 180.6 mm)
- Fine Art Letter (8.50 x 11.00 inches / 215.9 x 279.4 mm)
- Fine Art A4 (8.27 x 11.69 inches / 210.0 x 297.0 mm)

Non-standard sizes:

You can also specify a custom size within the following range.

- Minimum size: 2.17 x 3.58 inches / 55.0 x 91.0 mm (Rear Tray)
5.83 x 8.27 inches / 148.0 x 210.0 mm (Cassette)
- Maximum size: 8.50 x 26.61 inches / 215.9 x 676.0 mm (Rear Tray)
8.50 x 11.69 inches / 215.9 x 297.0 mm (Cassette)

● Paper Weight

17 to 28 lb / 64 to 105 g/m² (except for Canon genuine paper)

Do not use heavier or lighter paper (except for Canon genuine paper), as it could jam in the machine.

● Notes on Storing Paper

- Take out only the necessary number of paper from the package, just before printing.
- To avoid curling, when you do not print, put unused paper back into the package and keep it on a level surface. And also, store it avoiding heat, humidity, and direct sunlight.

● Notes on Paper for Full-page Borderless Printing

- You cannot use A5, B5, and Legal-sized paper, and envelopes for full-page borderless printing.
- You can use plain paper for full-page borderless printing only when printing from a computer. However, this may result in lower print quality. We recommend using plain paper for a trial print.



[↑ Page top](#)

■ Media Types You Cannot Use

Do not use the following types of paper. Using such paper will cause not only unsatisfactory results, but also the machine to jam or malfunction.

- Folded, curled, or wrinkled paper
- Damp paper
- Paper that is too thin (weighing less than 17 lb / 64 g/m²)
- Paper that is too thick (weighing more than 28 lb / 105 g/m², except for Canon genuine paper)
- Paper thinner than a postcard, including plain paper or notepad paper cut to a small size (when printing on paper smaller than A5)
- Picture postcards
- Postcards affixed with photos or stickers
- Envelopes with a double flap (or sticker flaps)
- Envelopes with an embossed or treated surface
- Envelopes whose gummed flaps are already moistened and adhesive
- Any type of paper with holes
- Paper that is not rectangular
- Paper bound with staples or glue
- Paper with adhesives
- Paper decorated with glitter, etc.



Loading Originals

- ➔ [Loading Originals](#)
- ➔ [How to Load Originals for Each Function](#)
- ➔ [Originals You Can Load](#)

This section describes the procedure to load originals on the Platen Glass. You may have to load the original in a different position depending on the function you selected in Copy, Easy photo reprint, or Scan. Load the original in the correct position according to the selected function. If you do not load the original correctly, it may not be scanned properly.

▶ Important

- After loading the original on the Platen Glass, be sure to close the Document Cover before starting to copy or scan.

📖 Note

- For details on loading films, see [Loading the Films](#).

■ Loading Originals

You can load originals to copy or scan on the Platen Glass.

1. Load an original on the Platen Glass.

(1) Open the Document Cover.

▶ Important

- Do not place any object on the Document Cover. It will fall into the Rear Tray when the Document Cover is opened and cause the machine to malfunction.
- Do not hold the LCD or the Operation Panel.

(2) Load the original WITH THE SIDE TO COPY OR SCAN FACING DOWN on the Platen Glass.

Make sure of the proper position to load the original for each function.

See [How to Load Originals for Each Function](#).



▶ Important

- Be sure to observe the following when loading the original on the Platen Glass.
 - Do not place any objects weighing 4.4 lb / 2.0 kg or more on the Platen Glass.
 - Do not put any pressure of 4.4 lb / 2.0 kg or more on the Platen Glass, such as pressing down the original.
- Failure to observe the above may cause the scanner to malfunction or the Platen Glass to

break.

2. Close the Document Cover gently.



[↑ Page top](#)

■ How to Load Originals for Each Function

- Load originals to make copy
- Select in the Scan menu
 - USB flash drive or Memory card to scan originals
 - PC to scan magazine, newspaper, or text document
- Select the Photo index sheet menu to scan the Photo Index Sheet
- Scan magazine, newspaper, or text document with a software application on a computer

Load the original WITH THE SIDE TO SCAN FACING DOWN to be aligned with the alignment mark



▶ Important

- The machine cannot scan the shaded area (A) (0.04 inches / 1 mm from the edges of the Platen Glass).

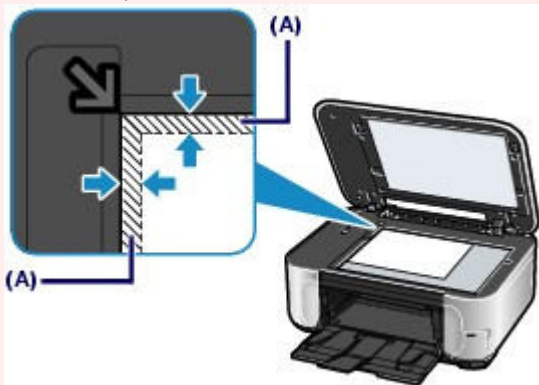

- Load printed photos in Easy photo reprint
- Select PC in the Scan menu and scan printed photo, postcard, business card, or DVD/CD
- Scan printed photo, postcard, business card, or DVD/CD with a software application on a computer

Load the original WITH THE SIDE TO SCAN FACING DOWN in an appropriate way according to the number of originals.

Load only one original

Load the original at least 0.4 inches / 10 mm away from the edges of the Platen Glass.

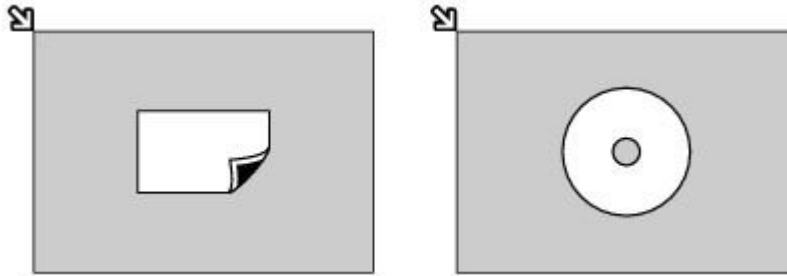

Load two or more originals

Place two or more originals at least 0.4 inches / 10 mm away from the edges of the Platen Glass and at least 0.4 inches / 10 mm apart from each other.

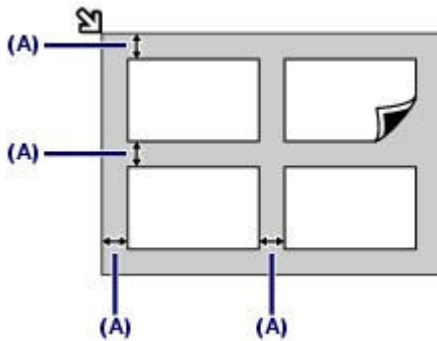

(A) 0.4 inches / 10 mm

Note

- The Skew Correction function automatically compensates for the originals placed at an angle of up to approximately 10 degrees.
- Slanted photos with a long edge of 7.1 inches / 180 mm or more cannot be corrected.



[↑ Page top](#)

■ Originals You Can Load

You can copy or scan the following originals.

Types of originals: Text document, magazine, or newspaper
Printed photo, postcard, business card, or DVD/CD
Film (positive/negative 35 mm film strip and 35 mm mount film)

Size (W x L): Max. 8.5 x 11.7 inches / 216 x 297 mm



[↑ Page top](#)

Routine Maintenance

This section describes the procedure to replace ink tanks when they run out of ink, to clean the machine when the print result is faint, or to take an action when paper does not feed properly.

Replacing an Ink Tank

- [Replacing Procedure](#)
- [Checking the Ink Status](#)

When Printing Becomes Faint or Colors Are Incorrect

- [Printing the Nozzle Check Pattern](#)
- [Examining the Nozzle Check Pattern](#)
- [Cleaning the Print Head](#)
- [Cleaning the Print Head Deeply](#)
- [Aligning the Print Head](#)

Cleaning the Paper Feed Roller

Cleaning the Pad in the Cassette



Replacing an Ink Tank

When ink runs out while printing is in progress, an error message will appear on the LCD or your computer screen. Make sure which ink tank has run out of ink and replace it with a new one.

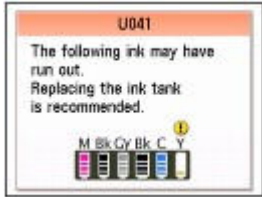

Note

- If the error message appears, confirm the displayed message and take an appropriate action. For details, refer to "An Error Message Is Displayed on the LCD" in "[Troubleshooting](#)" of the on-screen manual: *Advanced Guide*.
- For information on the compatible ink tanks, refer to the printed manual: *Getting Started*.
- If print results become faint or white streaks appear despite sufficient ink levels, see [When Printing Becomes Faint or Colors Are Incorrect](#).

Replacing Procedure

When the ink tanks run out of ink, follow the procedure below to replace them.

Important

Handling ink

- To maintain optimal print quality, we recommend the use of specified Canon brand ink tanks. Refilling the ink is not recommended.
- If you remove an ink tank, replace it immediately. Do not leave the machine with ink tanks removed.
- Use new ink tanks for replacement. Installing used ink tanks may cause the nozzles to clog. Furthermore, with such ink tanks, the machine will not be able to inform you when to replace the ink tanks properly.
- Once an ink tank has been installed, do not remove it from the machine and leave it out in the open. This will cause the ink tank to dry out, and the machine may not operate properly when it is reinstalled. To maintain optimal printing quality, use an ink tank within six months of first use.

Note

- Color ink may be consumed even when printing a black-and-white document or when black-and-white printing is specified. Every ink is also consumed in the standard cleaning and deep cleaning of the Print Head, which may be necessary to maintain the machine's performance. When an ink tank is out of ink, replace it immediately with a new one.

1. Make sure that the power is turned on, and open the Paper Output Tray gently.

2. Lift the Scanning Unit (Cover) until it stops.

The Print Head Holder moves to the replacement position.



⚠ Caution

- Do not hold the Print Head Holder to stop or move it forcibly. Do not touch the Print Head Holder until it stops completely.

▶ Important

- Do not place any object on the Document Cover. It will fall into the Rear Tray when the Document Cover is opened and cause the machine to malfunction.
- Be sure to lift the Scanning Unit (Cover) with the Document Cover closed.
- Do not hold the LCD or the Operation Panel.
- Do not touch the metallic parts or other parts inside the machine.
- If the Scanning Unit (Cover) is left open for more than 10 minutes, the Print Head Holder moves to the right. In this case, close and reopen the Scanning Unit (Cover).

📖 Note

- The machine may make operating noise when the Print Head Holder moves to the replacement position.

3. Remove the ink tank with the lamp flashing fast.

Push the tab (A) and lift the ink tank to remove.

Do not touch the Print Head Lock Lever (B).

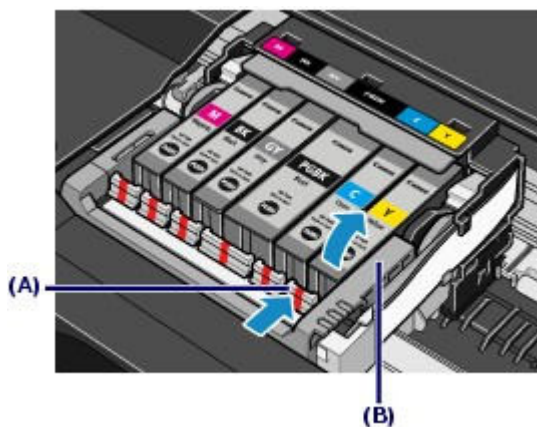

▶ Important

- Handle the ink tank carefully to avoid staining of clothing or the surrounding area.
- Discard the empty ink tank according to the local laws and regulations regarding disposal of consumables.

📖 Note

- Do not remove two or more ink tanks at the same time. Be sure to replace ink tanks one by one

when replacing two or more ink tanks.

- For details on ink lamp flashing speed, see [Checking the Ink Status](#).

4. Prepare the new ink tank.

- (1) Take a new ink tank out of its package, pull the orange tape (1) in the direction of the arrow to peel it off, then remove the film (2).

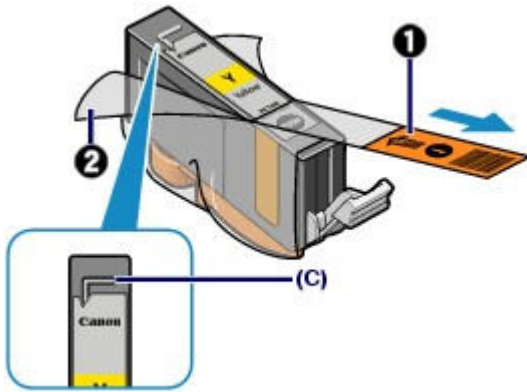

Important

- Make sure that the film is completely removed from the air hole (C).
If the air hole is blocked with the remaining film, ink may leak out or may not eject properly.

- (2) Hold the orange protective cap (D) as indicated in the figure below, then twist and remove it from the bottom of the ink tank.

Remove the protective cap while holding it to prevent the ink from staining your fingers.

Discard the protective cap once it is removed.

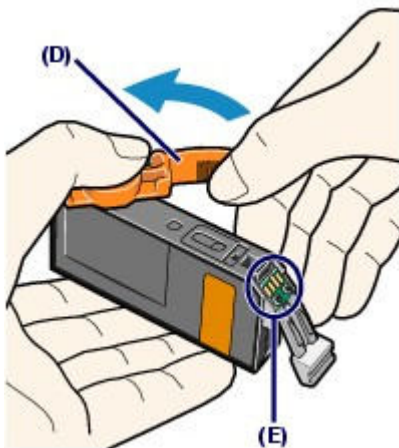

Important

- Do not touch the electrical contacts (E) on the ink tank. It can cause the machine to malfunction or become unable to print.

Important

- If you shake the ink tank, the ink may spill out and stain your hands and the surrounding area. Be careful to handle the ink tank.
- Do not squeeze the side of ink tanks as this may cause the ink to leak out.
- Be careful not to stain your hands and the surrounding area with ink on the removed protective cap.
- Do not reattach the protective cap once you have removed it. Discard it according to the local laws and regulations regarding disposal of consumables.

- Do not touch the open ink port once the protective cap is removed, as this may prevent the ink from being ejected properly.

5. Install the new ink tank.

- Insert the front end of ink tank into the Print Head at a slant.
Make sure that the position of the ink tank matches the label.

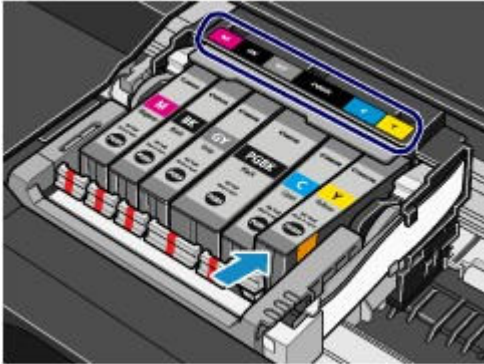

- Press the mark  (Push) on the ink tank until the ink tank snaps firmly into place.
Make sure that the ink lamp lights up red.

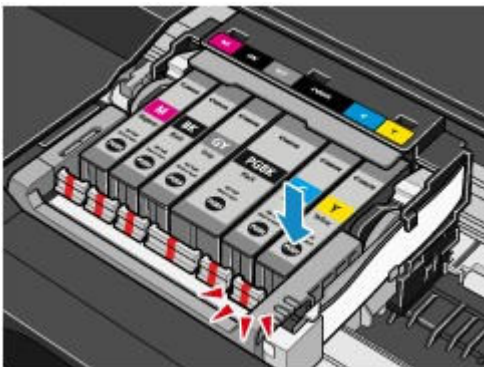

Important

- You cannot print if the ink tank is installed in the wrong position. Be sure to install the ink tank in the correct position according to the label on the Print Head Holder.
- You cannot print unless all the ink tanks are installed. Be sure to install all the ink tanks.

6. Close the Scanning Unit (Cover) gently.

Caution

- Be sure to hold the Scanning Unit (Cover) firmly using both hands, and be careful not to get your fingers caught.

Important

- Do not hold the LCD or the Operation Panel.

Note

- If the error message appears after the Scanning Unit (Cover) is closed, refer to "[Troubleshooting](#)" in the on-screen manual: *Advanced Guide*.
- When you start printing after replacing the ink tank, the machine starts cleaning the Print Head automatically. Do not perform any other operations until the machine completes the cleaning of

the Print Head.

- If printed ruled lines are misaligned or the print head position is misaligned, adjust the print head position.

See [Aligning the Print Head](#).

- The machine may make noise during operation.
-



[↑ Page top](#)

■ Checking the Ink Status

You can check the ink status on the LCD or with the ink lamps.

● With the LCD on the Machine

(1) Make sure that the power is turned on, and press the **HOME** button.

(2) Press the left **Function** button.

Check if any symbol (A) appears on the remaining ink volume screen.

Sufficient ink is left for printing if no symbol appears.



The ink with  (Ink low) is low. Prepare a new ink tank.

Note

- You can also check the ink status on a screen of the LCD displayed while printing.

● With the Ink Lamps

(1) Make sure that the power is turned on, and open the Paper Output Tray gently.

(2) Lift the Scanning Unit (Cover) until it stops.

See [Lift the Scanning Unit \(Cover\) until it stops.](#) in "Replacing Procedure".

(3) Check the ink lamps.

Close the Scanning Unit (Cover) after confirming the ink lamp status.

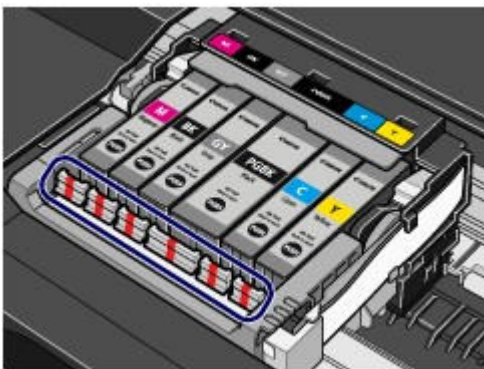

● Ink lamp is on

The ink tank is correctly installed and there is sufficient ink left for printing.

● Ink lamp is flashing

Flashing slowly (at around 3-second intervals)



Ink is low. Prepare a new ink tank.

Flashing fast (at around 1-second intervals)



The ink tank is installed in the wrong position or it is empty. Make sure that the ink tank is installed in the correct position as indicated by the label on the Print Head Holder. If the position is correct but the lamp flashes, there has been an error and the machine cannot print. Check the error message displayed on the LCD.

Refer to "[Troubleshooting](#)" in the on-screen manual: *Advanced Guide*.

● Ink lamp is off

The ink tank is not installed properly or the function for detecting the remaining ink level is disabled. If the ink tank is not installed properly, press the mark  (Push) on the ink tank until the ink tank clicks into place. If it does not click into place, make sure that the orange protective cap has been removed from the bottom of the ink tank.

If the ink lamp is still off after reinstalling the ink tank, there has been an error and the machine cannot print. Check the error message displayed on the LCD.

Refer to "[Troubleshooting](#)" in the on-screen manual: *Advanced Guide*.



[↑ Page top](#)

When Printing Becomes Faint or Colors Are Incorrect

If print results are blurred or colors are not printed correctly, the print head nozzles are probably clogged. Follow the procedure below to print the nozzle check pattern, check the print head nozzle condition, then clean the Print Head.

If printed ruled lines are misaligned or print results are otherwise unsatisfactory, aligning the Print Head may improve print quality.

Important

- Do not rinse or wipe the Print Head and ink tanks. This can cause trouble with the Print Head and ink tanks.

Note

Before performing maintenance

- Open the Scanning Unit (Cover) and make sure that all lamps on the ink tanks are lit red. If not, see [Checking the Ink Status](#) and take an appropriate action.
- Increasing the print quality in the printer driver settings may improve the print result. For details, refer to the on-screen manual: [Advanced Guide](#).

● When the Print Results Are Blurred or Uneven:

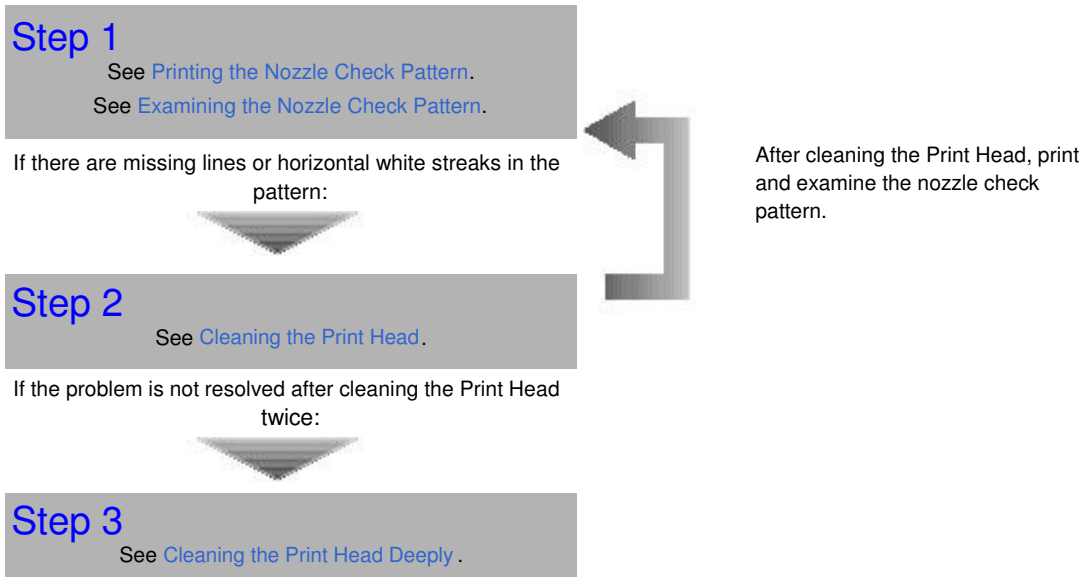

Note

- When you have performed the procedure until step 3 and the problem has not been resolved, turn off the power and clean the Print Head deeply again after 24 hours. If the problem is still not resolved, the Print Head may be damaged. Contact the service center.

● When the Print Results Are Not Even such as the Ruled Lines Are Misaligned:

See [Aligning the Print Head](#).

 **Note**

- You can also perform the maintenance operations from your computer.
For details, refer to the on-screen manual: [Advanced Guide](#).
-



 [Page top](#)

Basic Guide

Advanced Guide Troubleshooting

[Contents](#) > [Routine Maintenance](#) > [When Printing Becomes Faint or Colors Are Incorrect](#) > [Printing the Nozzle Check Pattern](#)

■ Printing the Nozzle Check Pattern

Print the nozzle check pattern to determine whether the ink ejects properly from the print head nozzles.

You need to prepare: a sheet of A4 or Letter-sized plain paper



Note

- If the remaining ink level is low, the nozzle check pattern will not be printed correctly. Replace the ink tank whose ink is low. See [Replacing an Ink Tank](#).

1. Make sure that the power is turned on.
2. Make sure that one or more sheets of A4 or Letter-sized plain paper are loaded in the Cassette.
3. Open the Paper Output Tray gently, and open the Output Tray Extension.

Important

- If the Inner Cover is open, close it.

4. Print the nozzle check pattern.
 - (1) Select Settings  on the **HOME** screen, and press the **OK** button.
The Settings screen will appear.
 - (2) Select Maintenance , and press the **OK** button.
The Maintenance screen will appear.
 - (3) Select Nozzle check pattern, and press the **OK** button.



The pattern print confirmation screen will appear.

- (4) Select Yes, and press the **OK** button.
The nozzle check pattern will be printed and two pattern confirmation screens will appear on the LCD.

5. Examine the nozzle check pattern.
See [Examining the Nozzle Check Pattern](#).



[↑ Page top](#)

Basic Guide

Advanced Guide
 Troubleshooting

[Contents](#) > [Routine Maintenance](#) > [When Printing Becomes Faint or Colors Are Incorrect](#) > Examining the Nozzle Check Pattern

■ Examining the Nozzle Check Pattern

Examine the nozzle check pattern, and clean the Print Head if necessary.

1. Check if there are missing lines in the pattern (1) or horizontal white streaks in the pattern (2).

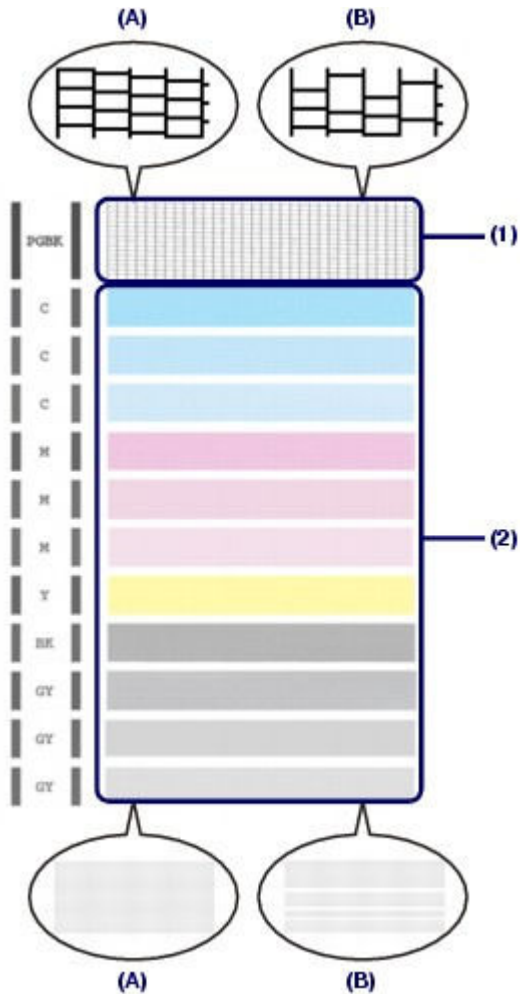

- (A) No missing lines/No horizontal white streaks
 (B) Lines are missing/Horizontal white streaks are present

2. Select the pattern that is closer to the printed nozzle check pattern on the confirmation screen.

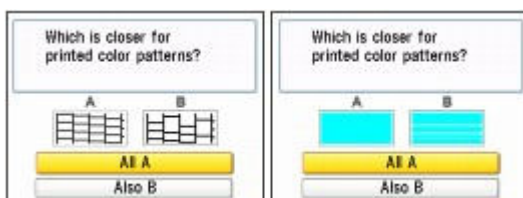

For (A) (no missing lines or no horizontal white streaks) in both (1) and (2):

(1) The cleaning is not required. Select All A and press the **OK** button.

(2) Confirm the message and press the **OK** button.

The screen will return to the Maintenance screen.



Note

- Press the **HOME** button to exit the Settings menu and display the **HOME** screen.

For (B) (lines are missing or horizontal white streaks are present) in (1) or (2), or in both (1) and (2):

(1) The cleaning is required. Select Also B and press the **OK** button.

The cleaning confirmation screen will appear.

(2) Select Yes and press the **OK** button.

The machine starts cleaning the Print Head.

See [Cleaning the Print Head](#).



[↑ Page top](#)

■ Cleaning the Print Head

Clean the Print Head if lines are missing or if horizontal white streaks are present in the printed nozzle check pattern. Cleaning unclogs the nozzles and restores the print head condition. Cleaning the Print Head consumes ink, so clean the Print Head only when necessary.

You need to prepare: a sheet of A4 or Letter-sized plain paper

1. Make sure that the power is turned on.
2. Make sure that one or more sheets of A4 or Letter-sized plain paper are loaded in the Cassette.
3. Open the Paper Output Tray gently, and open the Output Tray Extension.

▶ Important

- If the Inner Cover is open, close it.

4. Clean the Print Head.

- (1) Select Settings  on the **HOME** screen, and press the **OK** button.

The Settings screen will appear.

- (2) Select Maintenance , and press the **OK** button.

The Maintenance screen will appear.

- (3) Select Cleaning, and press the **OK** button.



The confirmation screen will appear.

- (4) Select Yes, and press the **OK** button.

The machine starts cleaning the Print Head.

Do not perform any other operations until the machine completes the cleaning of the Print Head. This takes about 1 minute.

The pattern print confirmation screen will appear.

- (5) Select Yes, and press the **OK** button.

The nozzle check pattern will be printed.

5. Examine the nozzle check pattern.

See [Examining the Nozzle Check Pattern](#).

 **Note**

- Press the **HOME** button to exit the Settings menu and display the **HOME** screen.
 - If the problem is not resolved after cleaning the Print Head twice, clean the Print Head deeply.
See [Cleaning the Print Head Deeply](#).
-

[↑ Page top](#)

■ Cleaning the Print Head Deeply



If print quality does not improve by the standard cleaning of the Print Head, clean the Print Head deeply. Cleaning the Print Head deeply consumes more ink than the standard cleaning of the Print Head, so clean the Print Head deeply only when necessary.

You need to prepare: a sheet of A4 or Letter-sized plain paper

1. Make sure that the power is turned on.
2. Make sure that one or more sheets of A4 or Letter-sized plain paper are loaded in the Cassette.
3. Open the Paper Output Tray gently, and open the Output Tray Extension.

▶ Important

- If the Inner Cover is open, close it.

4. Clean the Print Head deeply.
 - (1) Select Settings  on the **HOME** screen, and press the **OK** button.
The Settings screen will appear.
 - (2) Select Maintenance , and press the **OK** button.
The Maintenance screen will appear.
 - (3) Select Deep cleaning, and press the **OK** button.



The confirmation screen will appear.

- (4) Select Yes, and press the **OK** button.
The machine starts cleaning the Print Head deeply.

Do not perform any other operations until the machine completes the deep cleaning of the Print Head. This takes about 3 minutes.

The pattern print confirmation screen will appear.
- (5) Select Yes, and press the **OK** button.
The nozzle check pattern will be printed.

5. Examine the nozzle check pattern.

See step 1 in [Examining the Nozzle Check Pattern](#).

If a particular color is not printed properly, replace the ink tank of that color.

See [Replacing an Ink Tank](#).

If the problem is not resolved, turn off the power and clean the Print Head deeply again after 24 hours.

If the problem is still not resolved, the Print Head may be damaged. Contact the service center.

Note

- Press the **HOME** button to exit the Settings menu and display the **HOME** screen.



[↑ Page top](#)

■ Aligning the Print Head

If printed ruled lines are misaligned or print results are otherwise unsatisfactory, adjust the print head position.

You need to prepare: a sheet of A4 or Letter-sized Canon Matte Photo Paper MP-101

Note

- If the remaining ink level is low, the print head alignment pattern will not be printed correctly. Replace the ink tank whose ink is low. See [Replacing an Ink Tank](#).
- The print head alignment pattern is printed in black and blue.
- If you run out of the supplied paper (Canon Matte Photo Paper MP-101) or the specified Canon genuine paper is not immediately available or obtainable, you can use plain paper and align the Print Head manually. For details, refer to the on-screen manual: [Advanced Guide](#).

1. Make sure that the power is turned on.
2. Load a sheet of supplied paper or A4 or Letter-sized Canon Matte Photo Paper MP-101 in the Rear Tray.
Load the paper with the print side (whiter side) facing you in the Rear Tray.



Important

- You cannot use the Cassette to align the Print Head automatically. Be sure to load paper in the Rear Tray.

3. Open the Paper Output Tray gently, and open the Output Tray Extension.

Important

- If the Inner Cover is open, close it.

4. Print the print head alignment pattern.
 - (1) Select Settings  on the **HOME** screen, and press the **OK** button.
The Settings screen will appear.
 - (2) Select Maintenance , and press the **OK** button.
The Maintenance screen will appear.
 - (3) Select Auto head align, and press the **OK** button.



The confirmation screen will appear.

(4) Select **Yes**, and press the **OK** button.

The print head alignment pattern will be printed and the print head position will be adjusted automatically.

This takes about 7 minutes.



Note

- Press the **HOME** button to exit the Settings menu and display the **HOME** screen.
 - If the automatic adjustment of the print head position has failed, the error message "Auto head align has failed." appears on the LCD.
For details, refer to "[Troubleshooting](#)" in the on-screen manual: *Advanced Guide*.
 - If the print results are still not satisfactory after adjusting the print head position as described above, adjust the print head position manually.
For details, refer to the on-screen manual: [Advanced Guide](#).
-



Cleaning the Paper Feed Roller



If the Paper Feed Roller is dirty or paper powder is attached to it, paper may not be fed properly. In this case, clean the Paper Feed Roller. Cleaning will wear out the Paper Feed Roller, so perform this only when necessary.

You need to prepare: three sheets of A4 or Letter-sized plain paper

1. Make sure that the power is turned on.
2. Open the Paper Output Tray gently, and open the Output Tray Extension.

Important

- If the Inner Cover is open, close it.

3. Select Roller cleaning.
 - (1) Select Settings  on the **HOME** screen, and press the **OK** button.
The Settings screen will appear.
 - (2) Select Maintenance , and press the **OK** button.
The Maintenance screen will appear.
 - (3) Select Roller cleaning, and press the **OK** button.



The confirmation screen will appear.

- (4) Select Yes, and press the **OK** button.
 - (5) Select the paper source to clean (Rear tray or Cassette), and press the **OK** button.
4. Clean the Paper Feed Roller without paper.
 - (1) Follow the message to remove paper in the paper source you selected in (5) of step 3.
 - (2) Press the **OK** button.
The Paper Feed Roller will rotate as it is cleaned.
5. Clean the Paper Feed Roller with paper.
 - (1) Make sure that the Paper Feed Roller has stopped rotating, then follow the

message to load three or more sheets of A4 or Letter-sized plain paper in the paper source you selected in (5) of step 3.

(2) Press the **OK** button.

The machine starts cleaning. The cleaning will be completed after the paper is ejected.



Note

- Press the **HOME** button to exit the Settings menu and display the **HOME** screen.
-

If the problem is not resolved after cleaning the Paper Feed Roller, contact the service center.



[↑ Page top](#)

Cleaning the Pad in the Cassette

If the Pad in the Cassette is smeared with paper powder or dirt, two or more sheets of paper may be ejected. Follow the procedure below to clean the Pad in the Cassette.

You need to prepare: cotton swab

1. Pull out the Cassette from the machine, and remove all the papers.
2. Clean the Pad (A) sideways with a moistened cotton swab.

Important

- After cleaning the smeared Pad, dry it completely.

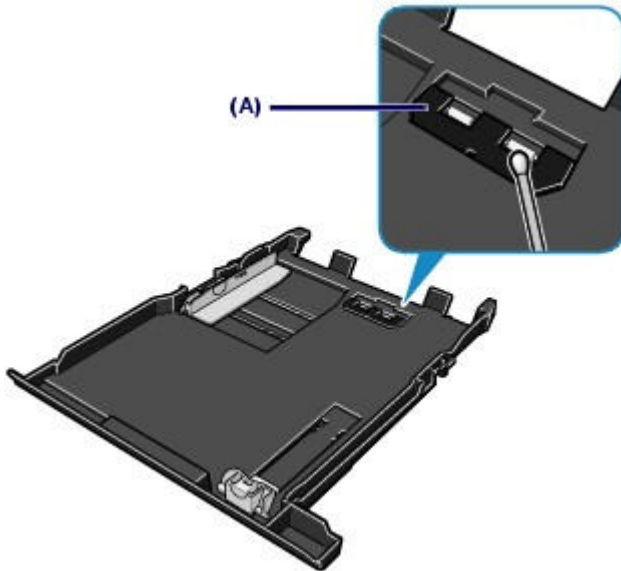

If the problem is not resolved, contact the service center.



Appendix

[Legal Limitations on Use of Your Product and Use of Images](#)

[Tips on How to Use Your Machine](#)



[↑ Page top](#)

Legal Limitations on Use of Your Product and Use of Images

It may be unlawful to make copies of, scan, print, or use reproductions of the following documents. The list provided is non-exhaustive. When in doubt, check with a legal representative in your jurisdiction.

- Paper money
- Money orders
- Certificates of deposit
- Postage stamps (canceled or uncanceled)
- Identifying badges or insignias
- Selective service or draft papers
- Checks or drafts issued by governmental agencies
- Motor vehicle licenses and certificates of title
- Traveler's checks
- Food stamps
- Passports
- Immigration papers
- Internal revenue stamps (canceled or uncanceled)
- Bonds or other certificates of indebtedness
- Stock certificates
- Copyrighted works/works of art without permission of copyright owner



[↑ Page top](#)

Tips on How to Use Your Machine

This section introduces the tips on how to use your machine and for printing with optimal quality.

■ Ink is used for various purposes.

● How is ink used for various purposes other than printing?

Ink may be used for purposes other than printing. Ink is not only used for printing, but also for cleaning the Print Head to maintain the optimal printing quality.

The machine has the function to automatically clean the ink jet nozzles to prevent clogging. In the cleaning procedure, ink is pumped out from the nozzles. Used ink for nozzle cleaning is limited to a small amount.

● Does black-and-white printing use color ink?

Black-and-white printing may use ink other than black ink depending on the type of printing paper or the settings of the printer driver. So, color ink is consumed even when printing in black-and-white.

● Why does the machine have two black ink tanks?

There are two kinds of black ink in the machine: dye ink (BK) and pigment ink (PGBK).

The dye ink is used mainly for printing photos, illustration, etc., and the pigment ink is used for text-based documents. Each has different purposes so that even if one runs out, another will not be used instead. If either of them runs out, the ink tank replacement is required.

These two inks are automatically used depending on the type of printing paper or the settings of the printer driver. You cannot change the usage of these inks yourself.

● Ink lamp indicates when ink is running low.

The inside of the ink tank consists of (A) the part where ink is preserved and (B) the sponge with absorbed ink.

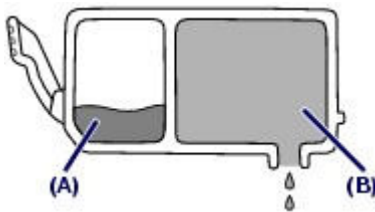

When the ink (A) runs out, the ink lamp flashes slowly to indicate that the ink is running low. Then, when the ink (B) runs out, the ink lamp flashes fast to indicate that the ink tank needs to be replaced with a new one.

See [Replacing an Ink Tank](#).

■ Printing on special paper: How to print with optimal quality!?

● Tip!: Check the machine status before printing!

● Is the Print Head OK?

If print head nozzles are clogged, print will be faint and papers will be wasted. Print the nozzle check pattern to check the Print Head.

See [When Printing Becomes Faint or Colors Are Incorrect](#).

- **Is the inside of the machine smeared with ink?**

After printing large quantities of paper or performing borderless printing, the area where papers go through may get smeared with ink. Clean the inside of your machine with the Bottom Plate Cleaning.

Refer to the on-screen manual: [Advanced Guide](#).

- **Tip!: Check how to load the paper correctly!**

- **Is the paper loaded in the correct orientation?**

When loading paper in the Rear Tray or Cassette, make sure the orientation of paper.



Rear Tray



Cassette

- To load paper in the Rear Tray, load paper with the printing side facing you.
- To load paper in the Cassette, load paper with the printing side facing down.

- **Is the paper curled?**

The curled paper causes paper jam. Flatten the curled paper, then reload it.

Refer to "[Troubleshooting](#)" in the on-screen manual: *Advanced Guide*.

- **Tip!: After loading paper, be sure to specify the paper settings!**

After loading paper, be sure to select the loaded paper for Media type with the Operation Panel or Media Type with the printer driver. If the type of paper is not selected, you may not be able to get the satisfactory print result.

See [Loading Paper](#).

There are various types of paper: paper with special coating on the surface for printing photos with optimal quality and paper suitable for documents. Media type of the Operation Panel or Media Type of the printer driver has different settings for each type of paper in advance (such as using ink, ejecting ink, or distance from nozzles) so that you can print on each paper with the optimal image quality. You can print with different settings in Media type (or Media Type) suitable for each type of loaded paper.

- **Use the Stop button to cancel printing!**

- **Tip!: Never press the ON button!**

If you press the **ON** button while printing is in progress, the print data sent from the computer queues in the machine and you may not be able to continue to print.

Press the **Stop** button to cancel printing.

 **Note**

- If you cannot cancel printing by pressing the **Stop** button while printing from a computer, open the printer driver setup window to delete the unnecessary print jobs from the printer status monitor (Windows).

- **Does the machine need to be handled with care when using or transporting?**

- **Tip!: Do not use or transport the machine vertically or slanted!**

If the machine is used or transported vertically or slanted, the machine may become damaged or ink may leak from the machine.
Be sure not to use or transport the machine vertically or slanted.

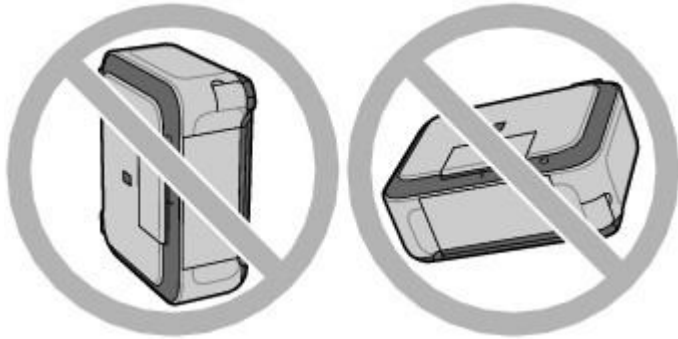

- **Tip!: Do not place any object on the Document Cover!**

Do not place any object on the Document Cover. It will fall into the Rear Tray when the Document Cover is opened and cause the machine to malfunction.
Also, place the machine where objects will not fall on it.

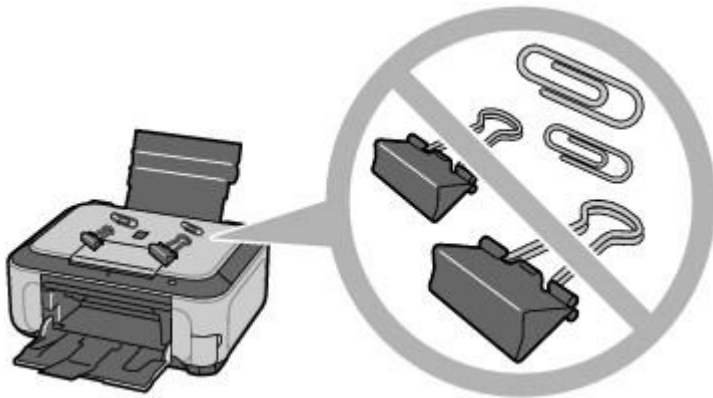

- **Tip!: Carefully choose the area to place the machine!**

- **Note when you place the machine near other electrical appliances such as fluorescent lamps**

Place the machine at least 5.91 inches / 15 cm away from other electrical appliances such as fluorescent lamps. If the machine is placed closer to those, it may not be able to work properly due to fluorescent noises.

- **Note when you use the machine on wireless LAN**

Since the microwave oven and the wireless LAN system use the same frequency bandwidth, the microwave oven can be the potential source of interference when the microwave oven is on. Placing this machine close to microwave oven may result in the poor status of radio.

■ How to maintain the optimal printing quality?

The key to printing with the optimal printing quality is to prevent the Print Head from drying or clogging. Always follow the following steps for optimal printing quality.

- **Follow the procedure below to disconnect the power plug.**

1. Press the **ON** button on the machine to turn it off.
2. Make sure that the **Power** lamp is not lit.
3. Disconnect the power plug from the wall outlet, or turn off the extender cable connector.

If you press the **ON** button to turn off the power, the machine caps the Print Head (nozzles) automatically to prevent from drying. If you disconnect the power plug from the wall outlet or turn off the extender cable connector before the **Power** lamp is turned off, the Print Head will not be capped properly and this will cause drying or clogging.

To disconnect the power plug, be sure to follow this procedure.

- **Print periodically!**

Just as the tip of a felt pen becomes dry and unusable if it has not been used for a long time, even if it is capped, the Print Head too, may become dried or clogged if the machine has not been used for a long time.

We recommend you to use the machine at least once a month.

Note

- Depending on the type of paper, ink may blur if you trace the printed area with a highlight pen or paint-stick, or bleed if water or sweat comes in contact with the printed area.

■ Colors are uneven, and print results are blurred.

- **Tip!:** Print the nozzle check pattern to check if the nozzles are clogged.

If the print head nozzles are clogged, colors may become uneven or the print results may be blurred.



In this case



Print the nozzle check pattern

Check the printed check pattern to see if the nozzles are clogged.

See [When Printing Becomes Faint or Colors Are Incorrect](#) .





Printing
Scanning
Copying
Troubleshooting
How to Use This Manual
Printing This Manual
Printing on DVD/CDs
Maintenance
About Bluetooth Communication
Changing the Machine Settings
Appendix
About Network Communication

When you display this on-screen manual in a language environment other than English, some English descriptions may be displayed.

Printing

Printing from a Computer

Printing with the Bundled Application Software

What Is Easy-PhotoPrint EX?

Printing Photos

Starting Easy-PhotoPrint EX

Selecting a Photo

Selecting the Paper

Printing

Creating an Album

Starting Easy-PhotoPrint EX

Selecting the Paper and Layout

Selecting a Photo

Editing

Printing

Printing a DVD/CD

Printing Calendars

Starting Easy-PhotoPrint EX

Selecting the Paper and Layout

Selecting a Photo

Editing

Printing

Printing Stickers

Starting Easy-PhotoPrint EX

Selecting the Paper and Layout

Selecting a Photo

Editing

Printing

Printing Layout

Starting Easy-PhotoPrint EX

Selecting the Paper and Layout

Selecting a Photo

Editing

Printing

Correcting and Enhancing Photos

Using the Auto Photo Fix Function

Using the Red-Eye Correction Function

- Using the Face Brightener Function
- Using the Face Sharpener Function
- Using the Digital Face Smoothing Function
- Using the Blemish Remover Function
- Adjusting Images
- Correct/Enhance Images Window

Questions and Answers

- How Can I Move (or Copy) the Saved File?
- Which Side of the Displayed Image Does the Printing Start from?
- How Do I Print with Even Margins?
- What Is "C1" or "C4"?

Photo Print Settings

- Printing on a DVD/CD
- Printing Photos in Grayscale
- Printing Vivid Photos
- Reducing Photo Noise
- Cropping Photos (Photo Print)
- Printing Dates on Photos (Photo Print)
- Printing Multiple Photos on One Page
- Printing an Index
- Printing ID Photos (ID Photo Print)
- Printing Photo Information
- Saving Photos
- Opening Saved Files

Other Settings

- Changing Layout
- Changing Background
- Adding Photos
- Swapping Positions of Photos
- Replacing Photos
- Changing Position, Angle and Size of Photos
- Cropping Photos
- Framing Photos
- Printing Dates on Photos
- Attaching Comments to Photos
- Adding Text to Photos
- Saving
- Setting Holidays
- Setting Calendar Display
- Opening Saved Files

What Is Easy-PhotoPrint Pro?

Printing Beautiful Photos

- Printing with ICC Profiles (Adobe RGB, sRGB)
- Printing with Canon's Unique Color Tones

Let's Start Printing with Easy-PhotoPrint Pro

- Starting Easy-PhotoPrint Pro

- Selecting a Photo
- Selecting the Paper and Layout
- Printing
- Adjust the Colors of Photo
 - Printing Photos in Grayscale
 - Adjusting the Color Balance
 - Adjusting Color Balance Using Sample Patterns
 - Adjusting Brightness/Contrast
 - Adjusting Brightness/Contrast Using Sample Patterns
- Easy-PhotoPrint Pro Settings
 - Printing Borderless Photos
 - Printing an Index
 - Printing Contact Sheets
 - Printing Advanced Information
 - Cropping Photos
 - Printing with Adjusted Print Size
 - Saving Print Settings
- Printing with Other Application Software
 - Various Printing Methods
 - Printing with Easy Setup
 - Setting a Page Size and Orientation
 - Setting the Number of Copies and Printing Order
 - Setting the Stapling Margin
 - Borderless Printing
 - Fit-to-Page Printing
 - Scaled Printing
 - Page Layout Printing
 - Poster Printing
 - Booklet Printing
 - Duplex Printing
 - Stamp/Background Printing
 - Registering a Stamp
 - Registering Image Data to be Used as a Background
 - Printing an Envelope
 - Switching the Paper Source to Match the Purpose
 - Displaying the Print Results before Printing
 - Setting Paper Dimensions (Custom Size)
 - Changing the Print Quality and Correcting Image Data
 - Selecting a Combination of the Print Quality Level and a Halftoning Method
 - Printing a Color Document in Monochrome
 - Adjusting Tone
 - Specifying Color Correction
 - Optimal Photo Printing of Image Data
 - Adjusting Colors with the Printer Driver
 - Printing with ICC Profiles

- Adjusting Color Balance
- Adjusting Brightness
- Adjusting Intensity
- Adjusting Contrast
- Simulating an Illustration
- Representing Image Data with a Single Color
- Presenting Image Data with Vivid Colors
- Smoothing Jagged Outlines
- Changing Color Properties to Improve Coloration
- Reducing Photo Noise
- Overview of the Printer Driver
 - Printer Driver Operations
 - Canon IJ Printer Driver
 - How to Open the Printer Driver Setup Window
 - Maintenance Tab
 - Canon IJ Status Monitor
 - Canon IJ Preview

Printing Using the Operation Panel of the Machine

- Printing Lined Paper or Graph Paper
 - Printing Template Forms Such As Lined Paper or Graph Paper
- Printing from a Memory Card
 - Printing Photographs Saved on a Memory Card
 - Setting Items
 - Printing by Using the Photo Index Sheet
- Using Useful Printing Functions
 - Printing Memory Card Photos in Various Layouts
 - Settings for Printing a Photo on a Memory Card
 - Printing Several Photos on a Single Sheet of Paper (Layout Print)
 - Printing on Stickers (Sticker Print)
 - Print all photos
 - Photo index print
 - DPOF print
 - Captured info print
 - Printing ID Photo-ID photo size print
 - Creating a Calendar-Calendar print
- Using Useful Display Functions
 - Changing the Display
 - Printing a Specified Area (Trimming)
 - Searching for Photos with the Shooting Date (Search)
- Setting Up the Card Slot as the Memory Card Drive of the Computer
- Printing from a USB Flash Drive
 - Printing Photographs Saved on a USB Flash Drive
 - Setting Items

- Printing by Using the Photo Index Sheet

- Using Useful Printing Functions

- Printing USB Flash Drive Photos in Various Layouts

- Settings for Printing a Photo on a USB Flash Drive

- Printing Several Photos on a Single Sheet of Paper (Layout Print)

- Printing on Stickers (Sticker Print)

- Print all photos

- Photo index print

- DPOF print

- Captured info print

- Printing ID Photo-ID photo size print

- Creating a Calendar-Calendar print

- Using Useful Display Functions

- Changing the Display

- Printing a Specified Area (Trimming)

- Searching for Photos with the Shooting Date (Search)

- Photo Printing from Printed Photo or Film

- Printing from Printed Photo or Film

- Setting Items

- Using Useful Printing Functions

- Special Printing of Photo

- Settings for Printing a Scanned Photo

- Settings for Printing a Scanned Film

- Printing on Stickers (Sticker Print)

- Printing All Photos (Print All Photos)

- Using Useful Display Functions

- Changing the Display

- Printing a Specified Area (Trimming)

Printing Photographs Directly from a Compliant Device or a Wireless Communication Device

- Printing Photographs Directly from a Compliant Device

- Printing Photographs Directly from a Compliant Device

- About PictBridge Print Settings

- Settings on a PictBridge Compliant Device

- Settings on the Machine

- Printing Photographs from a Wireless Communication Device

- Printing Photographs from a Wireless Communication Device

- Printing via Infrared Communication

- Printing via Bluetooth Communication

- Printing through Bluetooth Communication

- Changing the Bluetooth Settings

- Setting the Page Size, Media Type, and Layout When Printing from a Mobile Phone

- Displaying the Mobile phone print setting screen

Scanning

Scanning

Scanning Images

- Scanning Images

- Before Scanning

- Placing Documents

- Placing Film

Saving Scanned Data on the USB Flash Drive/Memory Card Using the Operation Panel of the Machine

- Saving Scanned Data on the USB Flash Drive/Memory Card Using the Operation Panel of the Machine

- Setting Items

- Deleting Scanned Data on USB Flash Drive/Memory Card

Forwarding Scanned Data to PC Using the Operation Panel of the Machine

- Forwarding Scanned Data to PC Using the Operation Panel of the Machine

Appendix: Various Scan Settings

- Network Scan Settings

- Selecting a Response to Commands from the Operation Panel Using MP Navigator EX

Scanning with the Bundled Application Software

- What Is MP Navigator EX (Supplied Scanner Software)?

- Let's Try Scanning

- Starting MP Navigator EX

- Scanning Photos and Documents

- Scanning Film

- Scanning Multiple Documents at One Time

- Scanning Images Larger than the Platen (Stitch Assist)

- Easy Scanning with One-click

Useful MP Navigator EX Functions

- Correcting/Enhancing Images Automatically

- Correcting/Enhancing Images Manually

- Adjusting Images

- Searching Images

- Classifying Images into Categories

Utilizing Images in MP Navigator EX

- Saving

- Saving as PDF Files

- Creating/Editing PDF Files

- Printing Documents

- Printing Photos

- Sending via E-mail

- Editing Files

- Setting Passwords for PDF Files

- Opening/Editing Password-protected PDF Files

MP Navigator EX Screens

- Navigation Mode Screen
- Scan/Import Documents or Images Tab
- View & Use Images on your Computer Tab
- Custom Scan with One-click Tab
- Photos/Documents (Platen) Screen (Scan/Import Window)
- Scan Settings Dialog Box (Photos/Documents)
- Film Screen (Scan/Import Window)
- Scan Settings Dialog Box (Film)
- Save Dialog Box
- Save as PDF file Dialog Box
- PDF Settings Dialog Box
- Memory Card Screen (Scan/Import Window)
- View & Use Window
- Create/Edit PDF file Window
- Print Document Dialog Box
- Print Photo Dialog Box
- Send via E-mail Dialog Box
- Correct/Enhance Images Window
- One-click Mode Screen
- Auto Scan Dialog Box
- Save Dialog Box (One-click Mode Screen)
- Scan Settings Dialog Box
- Save Dialog Box
- Exif Settings Dialog Box
- PDF Dialog Box
- Save as PDF file Dialog Box
- Mail Dialog Box
- Film Dialog Box
- OCR Dialog Box
- Custom Dialog Box
- Preferences Dialog Box
- General Tab
- Scanner Button Settings Tab (Save)
- Scanner Button Settings Tab (Attach to E-mail)
- Scanner Button Settings Tab (Open with Application)

Appendix: Opening Files Other than Scanned Images

- Importing Images Saved on a Memory Card
- Opening Images Saved on a Computer

Scanning with Other Application Software

- What Is ScanGear (Scanner Driver)?
- Scanning with Advanced Settings Using ScanGear (Scanner Driver)
 - Starting ScanGear (Scanner Driver)
 - Scanning in Basic Mode
 - Scanning in Advanced Mode

- Scanning in Auto Scan Mode
- Scanning Film in Advanced Mode
- Scanning Multiple Documents at One Time with ScanGear (Scanner Driver)
- Correcting Images and Adjusting Colors with ScanGear (Scanner Driver)
 - Correcting Images (Unsharp Mask, Reduce Dust and Scratches, Fading Correction, etc.)
 - Adjusting Colors Using a Color Pattern
 - Adjusting Saturation and Color Balance
 - Adjusting Brightness and Contrast
 - Adjusting Histogram
 - Adjusting Tone Curve
 - Setting Threshold
- ScanGear (Scanner Driver) Screens
 - Basic Mode Tab
 - Advanced Mode Tab
 - Input Settings
 - Output Settings
 - Image Settings
 - Color Adjustment Buttons
 - Auto Scan Mode Tab
 - Preferences Dialog Box
 - Scanner Tab
 - Preview Tab
 - Scan Tab
 - Color Settings Tab
- Appendix: Useful Information on Scanning
 - Adjusting Cropping Frames
 - Resolution
 - File Formats
 - Color Matching
- Canon IJ Network Scan Utility Screens
 - Canon IJ Network Scan Utility Menu and Setting Screen
- Other Scanning Methods
 - Scanning with WIA Driver
 - Scanning Using the Control Panel (Windows XP Only)

Copying

Printing Using the Operation Panel of the Machine

- Copying
 - Making Copies
 - Setting Items
 - Reducing or Enlarging a Copy
 - Changing Intensity Setting
 - Displaying the Preview Screen
 - Using Useful Copy Functions

- Special Copy
- Settings for Special Copy
- Copying onto Both Sides of the Paper (Two-Sided Copy)
- Copying Two Pages to Fit onto a Single Page (2-on-1 Copy)
- Copying Four Pages to Fit onto a Single Page (4-on-1 Copy)
- Copying without Borders (Borderless Copy)
- Repeating an Image on a Page (Image Repeat)
- Copying Thick Originals Such as Books (Frame Erase)
- Copying a Specified Area (Trimming)
- Copying Images with Erasing a Part (Masking)

Troubleshooting

Troubleshooting

- Troubleshooting

- If an Error Occurs

- The Machine Cannot Be Powered On

- An Error Message Is Displayed on the LCD

- LCD Cannot Be Seen At All

- An Unintended Language Is Displayed on the LCD

- Cannot Install the MP Drivers

- Cannot Install the Application Program

- Easy-PhotoPrint Pro Does Not Start up or Easy-PhotoPrint Pro Menu Does Not Appear

- Cannot Connect to Computer with a USB Cable Properly

- Printing or Scanning Speed Is Slow/Hi-Speed USB Connection Does Not Work/"This device can perform faster" Message Is Displayed

- Print Results Not Satisfactory

- Cannot Print to End of Job

- Part of the Page Is Not Printed

- No Printing Results/Printing Is Blurred/Colors Are Wrong/White Streaks

- Lines Are Misaligned

- Printed Paper Curls or Has Ink Blots

- Paper Is Smudged/Printed Surface Is Scratched

- Back of the Paper Is Smudged

- Vertical Lines Are Printed on the Sides of the Printout

- Colors Are Uneven or Streaked

- Printing Does Not Start

- Copying/Printing Stops Before It Is Completed

- Machine Moves But Ink Is Not Ejected

- Printing Speed Is Not as Fast as Expected

- Print Head Holder Does Not Move to the Position for Replacing

- Paper Does Not Feed Properly

Paper Does Not Feed from the Paper Source Specified in the Printer Driver

Paper Jams

Paper Is Jammed in the Paper Output Slot or the Rear Tray

Paper Is Jammed inside the Machine at the Transport Unit

Jammed Paper Is Not Removed out When Automatic Duplex Printing

In Other Cases

Message Appears on the Computer Screen

Error Number: B200 A printer error has occurred. Turn the printer off and unplug the power cord of the printer from the power supply. Then contact the service center. Is Displayed

Error Number: **** A printer error has occurred. Turn the printer off and then on again. If this doesn't clear the error, see the user's guide for more detail. Is Displayed

Writing Error/Output Error/Communication Error

Error Regarding Automatic Duplex Printing Is Displayed

Error Regarding Automatic Print Head Alignment Is Displayed

Error Number: 300 Is Displayed

Error Number: 1700 Is Displayed

Ink Info Number: 1600 Is Displayed

Ink Info Number: 1683 Is Displayed

Ink Info Number: 1688 Is Displayed

Error Number: 1851 Is Displayed

Error Number: 1856 Is Displayed

Error Number: 2001 Is Displayed

Error Number: 2002 Is Displayed

Error Number: 2500 Is Displayed

Other Error Messages

The Inkjet Printer/Scanner/Fax Extended Survey Program Screen Is Displayed

The Inkjet Printer/Scanner/Fax Extended Survey Program Icon Appears

Cannot Print Properly with Automatic Duplex Printing

For Windows Users

Printer Status Monitor Is Not Displayed

Launching MP Navigator EX Whenever Pressing the Color or Black Button on the Machine

Error Message Appears on a PictBridge Compliant Device

Cannot Print Properly from a Wireless Communication Device

Cannot Print Properly from a Photo Index Sheet

Failed to scan Photo Index Sheet. Is Displayed

Cannot print the selected photo. Is Displayed/Differ Photo or Blank Is Printed out/Paper Feeds Before Printing Is Complete

Cannot Remove a Memory Card

Problems with Scanning

Scanner Does Not Work

ScanGear (Scanner Driver) Does Not Start

Error Message Appears and the ScanGear (Scanner Driver) Screen Does Not Appear

Scan Quality (Image Displayed on the Monitor) Is Poor

Scanned Image Is Surrounded by Extra White Areas

Cannot Scan Multiple Documents at One Time

Cannot Scan Properly in Auto Scan Mode

Slow Scanning Speed

"There is not enough memory." Message Is Displayed

Computer Stops Operating during Scanning

Scanner Does Not Work After Upgrading Windows

Problems with Scanning/Printing Film

Cannot Scan Film

Scan Quality Is Poor or Colors Are Scanned Incorrectly

Image Becomes Too Dark or Too Bright When a Cropping Frame Is Moved, Enlarged or Reduced

Frames Are Not Detected Correctly

Scanner Stops Operating during Scanning, or "There is not enough memory." Message Is Displayed

Colors Are Different between the Film and the Printed Photos (Reddish/Bluish)

Software Problems

E-mail Software Program You Want to Use Does Not Appear in the Screen for Selecting an E-mail Software Program

Scanned Image Is Printed Enlarged (Reduced)

Scanned Image Is Enlarged (Reduced) on the Computer Monitor

Scanned Image Does Not Open

MP Navigator EX Problems

Cannot Scan at the Correct Size

Position or Size of the Image Cannot be Detected Correctly When Scanning Using the Operation Panel

Document Is Placed Correctly, but the Scanned Image Is Slanted

Document Is Placed Correctly, but the Orientation Changes in the Scanned Image

If You Cannot Resolve the Problem

FAQs

Instructions for Use (Printer Driver)

General Notes (Scanner Driver)

Using Easy-PhotoPrint EX

Using MP Navigator EX

About Solution Menu

Advanced Guide

[Advanced Guide](#) > [How to Use This Manual](#)

How to Use This Manual

- ➔ [Operating the Contents Pane](#)
- ➔ [Operating the Explanation Window](#)
- ➔ [Printing This Manual](#)
- ➔ [Using Keywords to Find a Document](#)
- ➔ [Registering Documents to My Manual](#)
- ➔ [Symbols Used in This Document](#)
- ➔ [Trademarks](#)

[Page top](#) ↑

Advanced Guide

Advanced Guide > How to Use This Manual > Operating the Contents Pane

Operating the Contents Pane

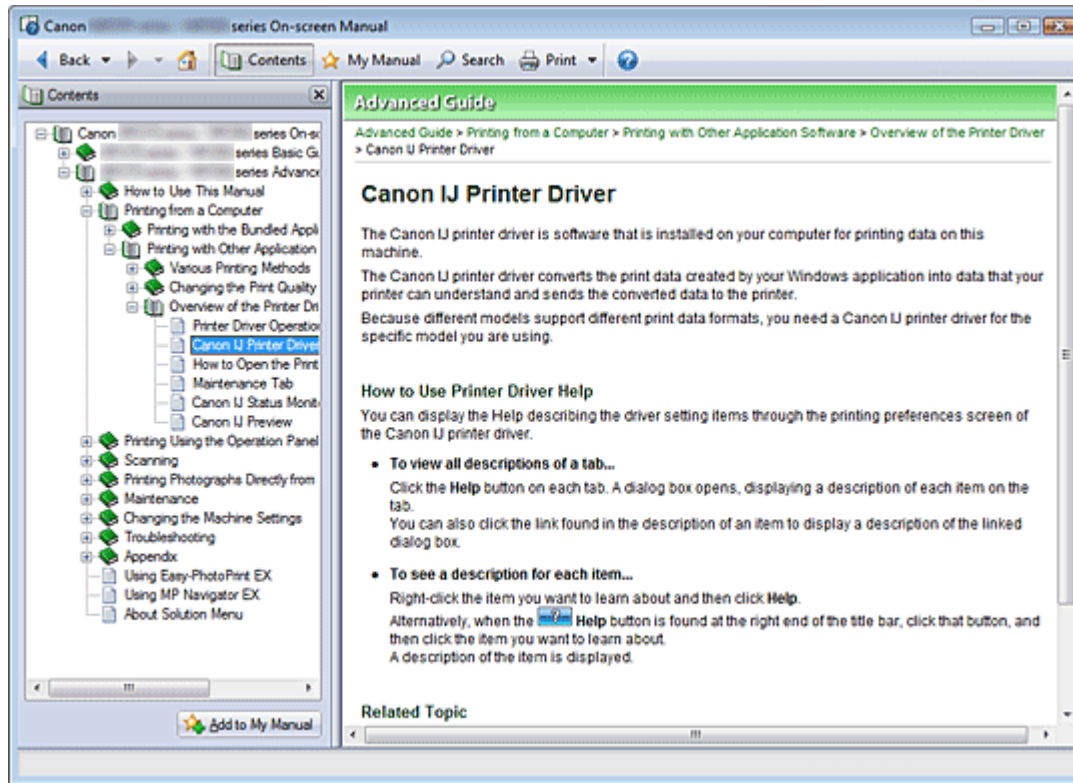

When you click a document title displayed in the contents pane found to the left of the on-screen manual, the documents of that title are displayed in the explanation window on the right side.

When you click  found to the left of , the document titles found in the lower hierarchies are displayed.

Note

- Click  to close or display the contents pane.

Advanced Guide

Advanced Guide > How to Use This Manual > Operating the Explanation Window

Operating the Explanation Window

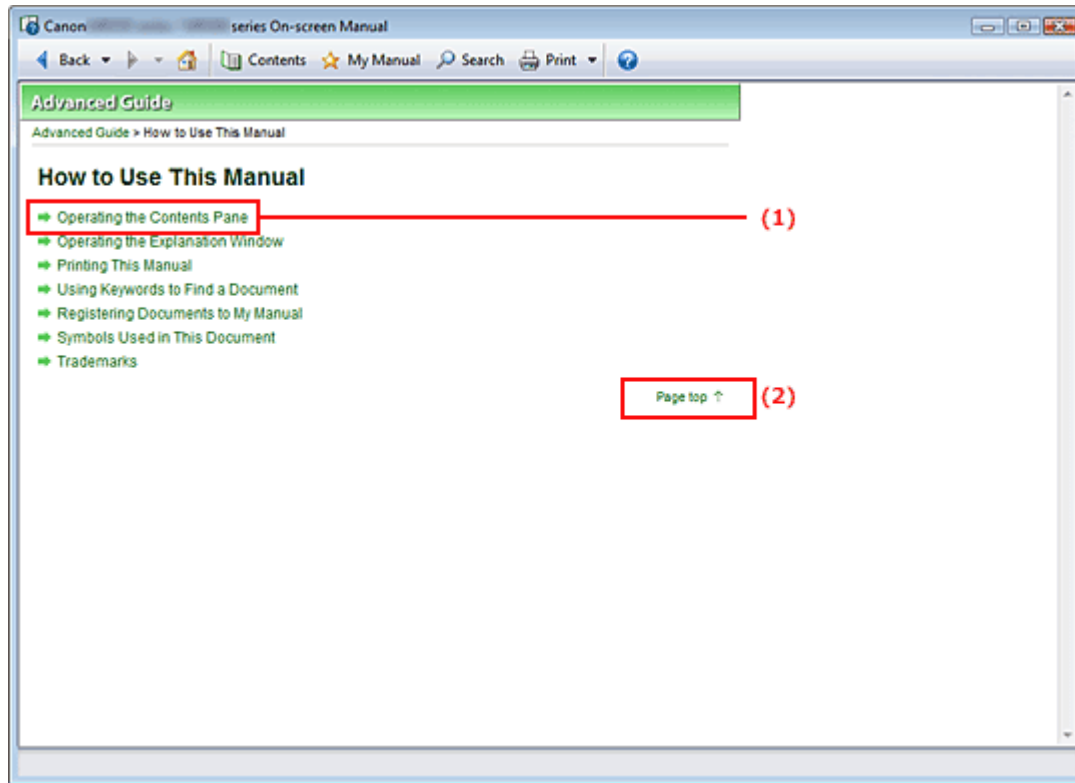

(1) Click the green characters to jump to the corresponding document.

(2) The cursor jumps to the top of this document.

Page top ↑

Advanced Guide



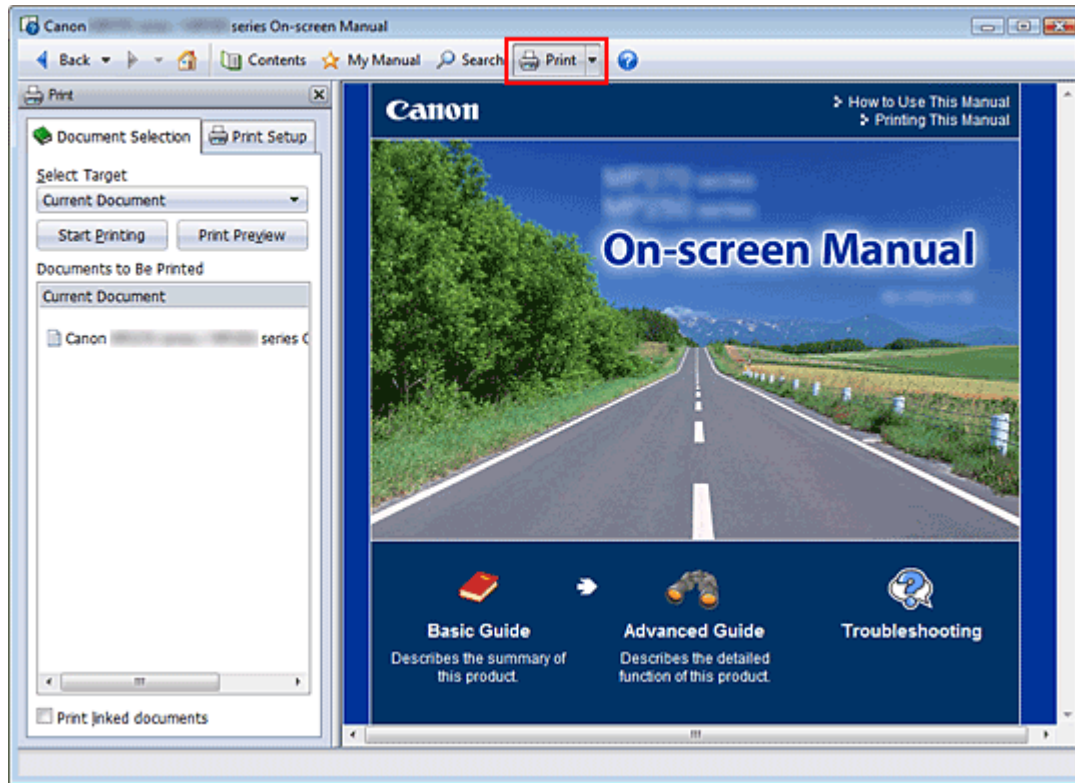

Advanced Guide > How to Use This Manual > Printing This Manual

Printing This Manual



Click  to display the print pane to the left of the on-screen manual.

Note

- Click  to close or display the print pane.
- When you click  and then click Page Setup, the Page Setup dialog box appears. You can then easily set up the paper to be used for printing.
- Click  and then click Print Settings to display the Print dialog box. When the dialog box is displayed, select the printer to be used for printing. The Print Setup tab also allows you to select the printer to be used.
After selecting the printer to be used, click Properties... to specify the print settings.
- Click  and then click Option Settings to display the Option Settings dialog box. You can then set up the printing operation.
 - Print document title and page number
When this check box is checked, the manual name and the page number are printed in the header (top of the document).
 - Print background color and images
When this check box is checked, the background color and the image are printed. Some images are printed regardless of whether this check box is checked or not.
 - Check number of pages to be printed before printing
When this check box is checked, the Print Page Count Confirmation dialog box is displayed before printing starts. This dialog box allows you to check how many pages will be printed.

On the Document Selection tab, select the method for printing the document. The following four methods of printing are available:

- [Print Current Document](#)
- [Print Selected Documents](#)
- [Print My Manual](#)

- [Print All Documents](#)

Note

- You can select the type to be printed, and then easily specify print settings on the Print Setup tab.
-

Print Current Document

You can print the currently displayed document.

1. From Select Target, select Current Document

The title of the currently displayed document is displayed in the Documents to Be Printed list.

Note

- By selecting Print linked documents, you can also print documents that are linked to the current document. The linked documents are added to the Documents to Be Printed list.
 - Click Print Preview to display and check what the print results will look like before you actually print the document.
-

2. Click Print Setup tab

On the Page Setup tab, select the printer to be used and specify simple print settings, as necessary.

3. Click Start Printing

A message confirming the number of print pages is displayed.

4. Execute print

Confirm the number of pages to be printed, and then click Yes.

The documents that are currently displayed are printed.

Print Selected Documents

You can select and print the documents that you want printed.

1. From Select Target, select Selected Documents

The titles of all documents are displayed in the Documents to Be Printed list.

2. Select the documents to be printed

From the Documents to Be Printed list, select the title check boxes of the documents to be printed.

Note

- When you select the Automatically select documents in lower hierarchies check box, the check boxes of all document titles found in the lower hierarchies are selected.
 - Click Select All to select the check boxes of all document titles.
Click Clear All to clear the check boxes of all document titles.
 - Click Print Preview to display and check what the print results will look like before you actually print the document.
-

3. Click Print Setup tab

On the Page Setup tab, select the printer to be used and specify simple print settings, as necessary.

4. Click Start Printing

A message confirming the number of print pages is displayed.

5. Execute print

Confirm the number of pages to be printed, and then click Yes.

All documents with selected check boxes are printed.

Print My Manual

You can select and print documents registered in My Manual.

For details about My Manual, see " [Registering Documents to My Manual](#) ."

1. From Select Target, select My Manual

The titles of the documents that have been registered to My Manual are displayed in the Documents to Be Printed list.

2. Select the documents to be printed

From the Documents to Be Printed list, select the title check boxes of the documents to be printed.



Note

- Click Select All to select the check boxes of all document titles.
Click Clear All to clear the check boxes of all document titles.
 - Click Print Preview to display and check what the print results will look like before you actually print the document.
-

3. Click Print Setup tab

On the Page Setup tab, select the printer to be used and specify simple print settings, as necessary.

4. Click Start Printing

A message confirming the number of print pages is displayed.

5. Execute print

Confirm the number of pages to be printed, and then click Yes.

All documents with selected check boxes are printed.

Print All Documents

You can print all documents of the on-screen manual.

1. From Select Target, select All Documents

The titles of all documents are displayed in the Documents to Be Printed list, and the check boxes are automatically selected.



Note

- When you uncheck the check box of a document title, that document is not printed.
 - Click Select All to select the check boxes of all document titles.
Click Clear All to clear the check boxes of all document titles.
 - Click Print Preview to display and check what the print results will look like before you actually print the document.
-

2. Click Print Setup tab

On the Page Setup tab, select the printer to be used and specify simple print settings, as necessary.

3. Click Start Printing

A message confirming the number of print pages is displayed.

4. Execute print

Confirm the number of pages to be printed, and then click Yes.

All documents are printed.

Important

- A large amount of paper is necessary to print all documents. Before printing, be sure to check the number of print pages displayed in the Print Page Count Confirmation dialog box.
- The Print Preview dialog box allows you to scale the printing to the paper width or to set the zoom rate. However, if the print data extends outside the paper because of the new zoom rate, that portion of the document will not be printed on the paper.

[Page top](#) ↑

Advanced Guide

Advanced Guide > How to Use This Manual > Using Keywords to Find a Document

Using Keywords to Find a Document

You can enter a keyword to search for a target document.

All documents in the currently displayed on-screen manual are searched.

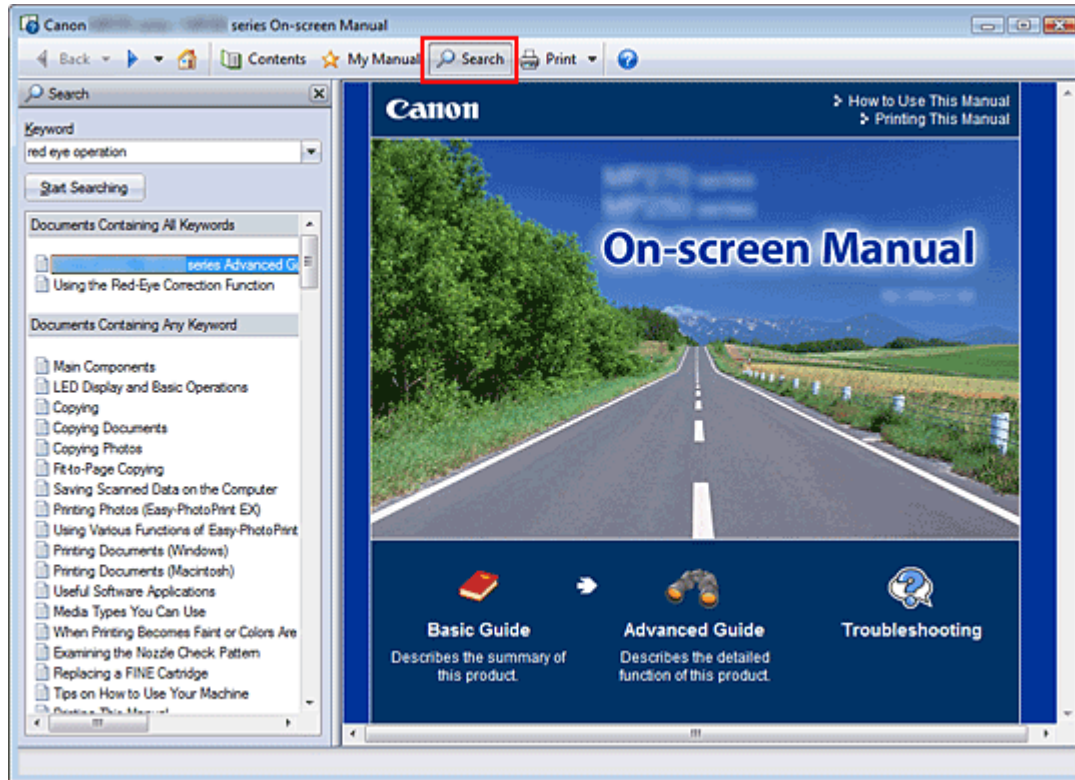

1. Click

The search pane is displayed to the left of the on-screen manual.

Note

- Click  to close or display the search pane.

2. Enter a keyword

In Keyword, enter a keyword for the item to be checked.

When you want to enter multiple keywords, insert a space between the keywords.

Note

- You can enter up to 10 search keywords or up to 255 characters.
- Uppercase and lowercase are not discriminated.
- The program can also search for keywords that contain spaces.
- A convenient way of quickly finding a document to be read is to enter keywords as described below.
 - To learn how to operate a function you are using:
Enter the menu name displayed on the operation panel of this machine or on the computer (for example, frame erase copy).
 - To find an explanation of the operation for a specific purpose:
Enter function + item to be printed (for example, print calendar).

3. Click Start Searching

The search is started, and the titles of documents containing the keyword are displayed in the search results list.

When you execute a search by entering multiple keywords, the search results are displayed as shown below.

[Documents Containing Perfect Match]

Documents containing the entire search character string (including spaces) exactly as entered (perfect match)

[Documents Containing All Keywords]

Documents containing all keywords that were entered

[Documents Containing Any Keyword]

Documents containing at least one of the keywords that were entered

4. Display the document that you want to read

From the search results list, double-click (or select and press Enter key) the title of the document you want to read.

When the documents of that title are displayed, the keywords found on those documents are highlighted.

Note

- If you modify the keyword entry and perform multiple searches, a search history remains. To delete the search history, click  located to the right of Keyword, and select Clear History, which is displayed.
-

Advanced Guide

Advanced Guide > How to Use This Manual > Registering Documents to My Manual

Registering Documents to My Manual

Register frequently read documents as My Manual documents so that you can refer to those documents easily at any time.

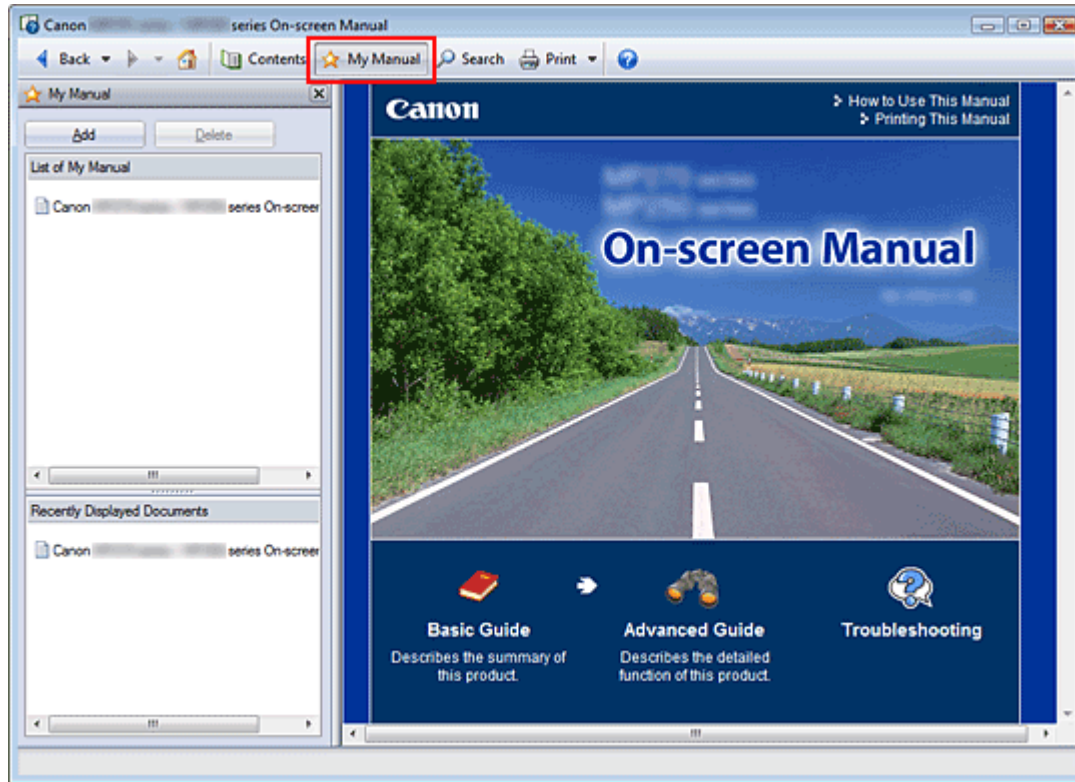

1. Display the document

Display the document to be added to My Manual.

2. Click

The My Manual pane is displayed to the left of the on-screen manual.

Note

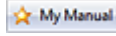
- Click  to close or display the My Manual pane.

3. Register the document to My Manual

Click Add.

The title of the currently displayed document is added to List of My Manual.

Note

- You can also add documents to My Manual by the following methods. If you add a document to My Manual, a  mark is displayed in the document icons in the contents pane.
 - From the Recently Displayed Documents list, double-click the document title that you want to add to My Manual (or select the document and press Enter key) to display the title, and then click Add.
 - Right-click the document title displayed in the contents pane or right-click the explanation window, and then select Add to My Manual from the right-click menu.
 - In the contents pane, select the document title that you want to add to My Manual, and then click Add to My Manual at the bottom right of the pane.

4. Display My Manual

When you double-click (or select and press Enter key) a document title displayed in List of My Manual, that document is displayed in the explanation window.

Note

- To delete a document from List of My Manual, select that document title from the list, and then click Delete (or press Delete key).
-

[Page top ↑](#)

Advanced Guide

[Advanced Guide](#) > [How to Use This Manual](#) > [Symbols Used in This Document](#)

Symbols Used in This Document

Warning

Instructions that, if ignored, could result in death or serious personal injury caused by incorrect operation of the equipment. These must be observed for safe operation.

Caution

Instructions that, if ignored, could result in personal injury or material damage caused by incorrect operation of the equipment. These must be observed for safe operation.

Important

Instructions including important information.
Be sure to read these indications.

Note

Instructions as notes for operation or additional explanations.

Windows

Indicates operations in Windows.

Macintosh

Indicates operations in Macintosh.

[Page top](#) ↑

Advanced Guide

[Advanced Guide](#) > [How to Use This Manual](#) > [Trademarks](#)

Trademarks

- Microsoft is a registered trademark of Microsoft Corporation.
- Windows is a trademark or registered trademark of Microsoft Corporation in the U.S. and/or other countries.
- Windows Vista is a trademark or registered trademark of Microsoft Corporation in the U.S. and/or other countries.
- Internet Explorer is a trademark or registered trademark of Microsoft Corporation in the U.S. and/or other countries.
- Macintosh, Mac, and AirPort are trademarks of Apple Inc., registered in the U.S. and other countries.
- Bonjour is a trademark of Apple Inc., registered in the U.S. and other countries.
- Adobe, Adobe Photoshop, Adobe Photoshop Elements, Adobe RGB and Adobe RGB (1998) are either registered trademarks or trademarks of Adobe Systems Incorporated in the United States and /or other countries.
- Photo Rag is a trademark of Hahnemühle FineArt GmbH.
- Bluetooth is a trademark of Bluetooth SIG, Inc., U.S.A. and licensed to Canon Inc.
- Ethernet is a trademark of Xerox Corporation.

Exif Print

This machine supports Exif Print.

Exif Print is a standard for enhancing the communication between digital cameras and printers. By connecting to an Exif Print-compliant digital camera, the camera's image data at the time of shooting is used and optimized, yielding extremely high quality prints.

[Page top](#) ↑

Advanced Guide

Advanced Guide > Printing from a Computer

Printing from a Computer

- ➔ [Printing with the Bundled Application Software](#)
- ➔ [Printing with Other Application Software](#)

[Page top](#) ↕

Advanced Guide

[Advanced Guide](#) > [Printing from a Computer](#) > [Printing with the Bundled Application Software](#)

Printing with the Bundled Application Software

- ➔ [What Is Easy-PhotoPrint EX?](#)
- ➔ [Printing Photos](#)
- ➔ [Creating an Album](#)
- ➔ [Printing a DVD/CD](#)
- ➔ [Printing Calendars](#)
- ➔ [Printing Stickers](#)
- ➔ [Printing Layout](#)
- ➔ [Correcting and Enhancing Photos](#)
- ➔ [Questions and Answers](#)
- ➔ [Photo Print Settings](#)
- ➔ [Other Settings](#)
- ➔ [What Is Easy-PhotoPrint Pro?](#)
- ➔ [Printing Beautiful Photos](#)
- ➔ [Let's Start Printing with Easy-PhotoPrint Pro](#)
- ➔ [Adjust the Colors of Photo](#)
- ➔ [Easy-PhotoPrint Pro Settings](#)

[Page top](#) ↕

Advanced Guide

Advanced Guide > Printing from a Computer > Printing with the Bundled Application Software > What Is Easy-PhotoPrint EX?

Easy-PhotoPrint EX

What Is Easy-PhotoPrint EX?

Easy-PhotoPrint EX allows you to create albums, calendars and stickers easily using photos taken with digital cameras.

You can also print borderless photos easily.

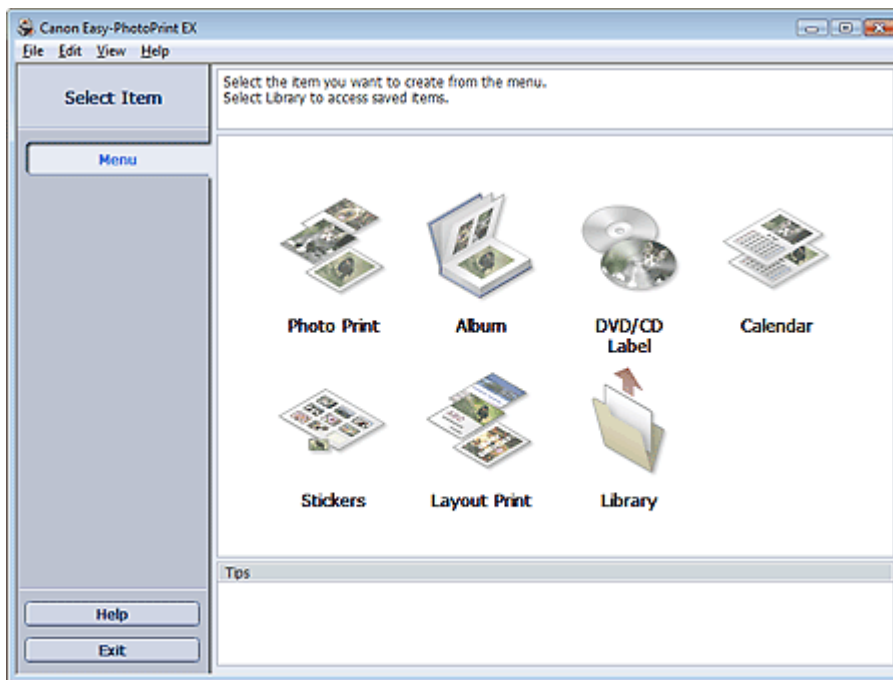

Important

- Easy-PhotoPrint EX does not support Windows 95, Windows 98, Windows Me, or Windows NT4.
- Easy-PhotoPrint EX can only be used with Canon inkjet printers. It does not support some printers, including Canon compact printers (SELPHY CP series).
- If a printer that supports Easy-PhotoPrint EX is not installed, you cannot print items you create.
- If Easy-PhotoPrint EX is installed on a computer that already has Easy-LayoutPrint installed, Easy-LayoutPrint will be replaced by Easy-PhotoPrint EX.

Note

- Printing on paper larger than A4 is available with supported printers only. See your printer manual for details.
- See Help of Easy-PhotoPrint EX for descriptions of Easy-PhotoPrint EX screens. Click Help in a screen or dialog box, or select Easy-PhotoPrint EX Help... from the Help menu. Help appears.

About Exif Print

Easy-PhotoPrint EX supports "Exif Print." Exif Print is a standard for enhancing the communication between digital cameras and printers.

By connecting to an Exif Print-compliant digital camera, the image data at the time of shooting is used and optimized, yielding extremely high quality prints.

Starting Easy-PhotoPrint EX from Other Applications

Easy-PhotoPrint EX can be started from other applications.

See the application's manual for details on the procedure for starting.

The Photo Print function is available with the following applications:

- MP Navigator EX Ver.1.00 or later
- ZoomBrowser EX Ver.6.0 or later
- Digital Photo Professional Ver.3.2 or later

Important

- Easy-PhotoPrint EX is subject to the following restrictions when started from Digital Photo Professional:
 - Menu does not appear in the step button area on the left side of the screen.
 - Images cannot be corrected/enhanced.
 - Image display order cannot be changed.
 - Edited images cannot be saved.
 - Options other than Enable ICC Profile cannot be selected for Color correction for printing on the Advanced tab of the Preferences dialog box. Therefore, you cannot use the Vivid Photo and Photo Noise Reduction functions.

The Album function is available with the following applications:

- MP Navigator EX Ver.1.00 or later
- ZoomBrowser EX Ver.5.8 or later

Supported Image File Formats (Extensions)

- BMP (.bmp)
- JPEG (.jpg, .jpeg)
- TIFF (.tif, .tiff)
- PICT (.pict, .pct)
- Easy-PhotoPrint image files (.epp)

Important

- When selecting an image, if there is a TIFF file in the selected folder, the image may not be displayed correctly or Easy-PhotoPrint EX may shut down depending on the TIFF format. In such cases, move the TIFF file to another folder or recreate the file in a different file format, and then select the folder again.

Note

- The thumbnails of files in unsupported formats are displayed as  (Question Mark).
- When Easy-PhotoPrint EX is started from Digital Photo Professional, all image files supported by Digital Photo Professional will be displayed.

File Formats (Extensions) Supported by Easy-PhotoPrint EX

- Easy-PhotoPrint EX Photo Print file (.el6)
- Easy-PhotoPrint EX Album file (.el1)
- Easy-PhotoPrint EX Stickers file (.el2)
- Easy-PhotoPrint EX Calendar file (.el4)
- Easy-PhotoPrint EX Layout file (.el5)
- CD-LabelPrint data (.cld)

Advanced Guide

Advanced Guide > Printing from a Computer > Printing with the Bundled Application Software > Printing Photos

Easy-PhotoPrint EX

Printing Photos

Easy-PhotoPrint EX allows you to print your favorite photos in a variety of layouts.

You can also create borderless photos easily.

Corrections suitable for photos will be applied automatically when printing.

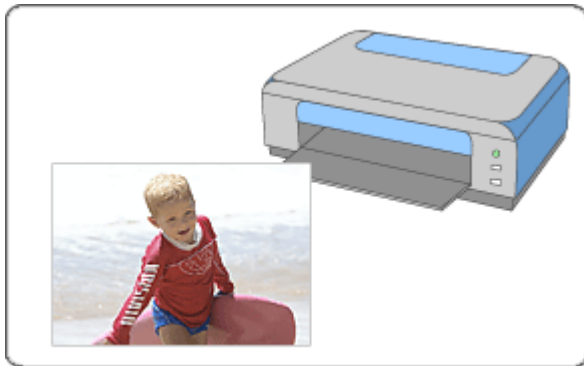

Steps

1. Starting Easy-PhotoPrint EX
2. Selecting a Photo
3. Selecting the Paper
4. Printing

Try This

- ➔ Correcting and Enhancing Photos
- ➔ Printing on a DVD/CD
- ➔ Printing Photos in Grayscale
- ➔ Printing Vivid Photos
- ➔ Reducing Photo Noise
- ➔ Cropping Photos (Photo Print)
- ➔ Printing Dates on Photos (Photo Print)
- ➔ Printing Multiple Photos on One Page
- ➔ Printing an Index
- ➔ Printing ID Photos (ID Photo Print)
- ➔ Printing Photo Information
- ➔ Saving Photos
- ➔ Opening Saved Files

Questions and Answers

- ➔ How Can I Move (or Copy) the Saved File?

- ➡ Which Side of the Displayed Image Does the Printing Start from?
- ➡ How Do I Print with Even Margins?

[Page top](#)↑

Advanced Guide

Advanced Guide > Printing from a Computer > Printing with the Bundled Application Software > Printing Photos > Starting Easy-PhotoPrint EX

Easy-PhotoPrint EX



Starting Easy-PhotoPrint EX

1. From the Start menu, select (All) Programs > Canon Utilities > Easy-PhotoPrint EX > Easy-PhotoPrint EX.

Easy-PhotoPrint EX starts and Menu appears.

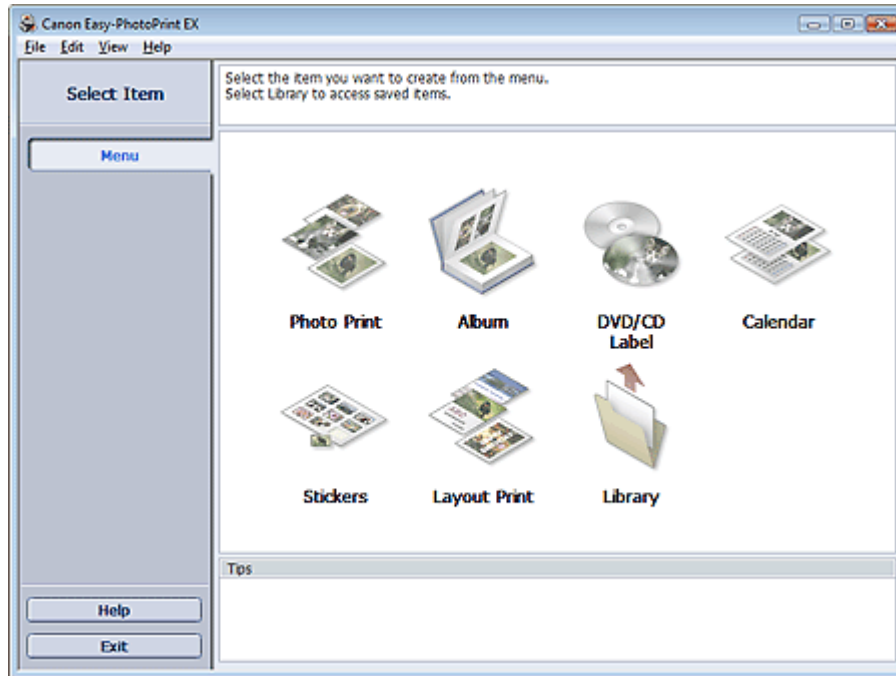

[Page top](#)

Advanced Guide

Advanced Guide > Printing from a Computer > Printing with the Bundled Application Software > Printing Photos > Selecting a Photo

Easy-PhotoPrint EX



Selecting a Photo

1. Click Photo Print from Menu.

The Select Images screen appears.

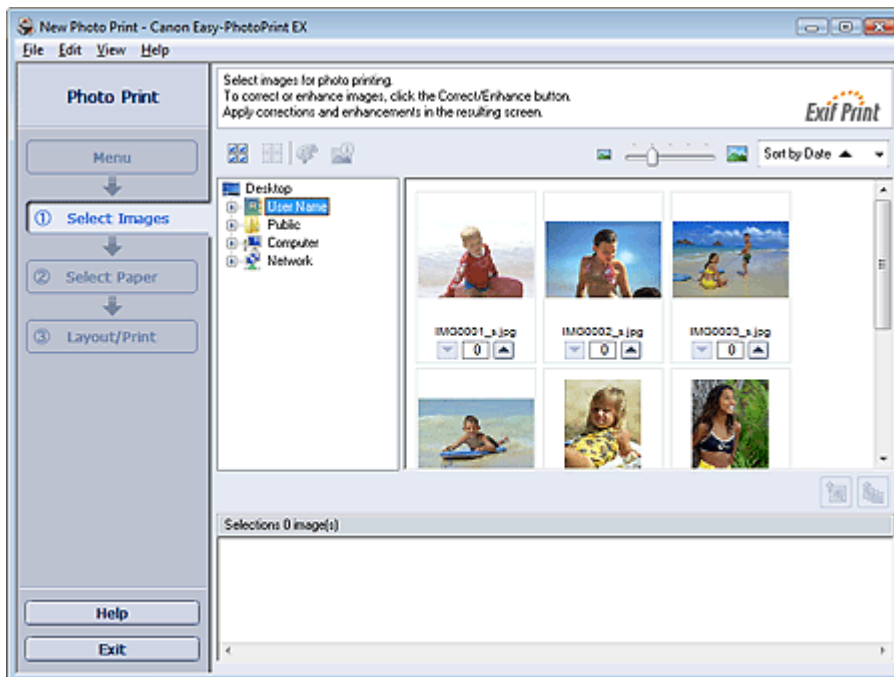

Important

- The thumbnails (reduced images) displayed in the screen may appear as follows:
 - A black line appears along an edge of the image.
 - An edge of the image appears cropped.
 However, such images will be displayed normally when enlarged or previewed, and print results will not be affected.

2. Select the folder that contains the image you want to print from the folder tree area.

The images in the folder will be displayed as thumbnails (miniatures).

Important

- If Easy-PhotoPrint EX is started from another application (MP Navigator EX, ZoomBrowser EX or Digital Photo Professional), the folder tree area will not be displayed. The images opened in the application will be displayed as thumbnails.

3. Click the image you want to print.

The number of copies appears as "1" below the clicked image, while the selected image itself will appear in the selected image area.

Note

- To delete an image in the selected image area, select the image you want to delete and click





(Delete Imported Image).

To delete all images from the selected image area, click



(Delete All Imported Images).

- To print two or more copies of an image, click  (Up arrow) until the number of copies you want is reached. To reduce the number of copies shown in the box, click  (Down arrow).
- You can change the order of photos using the list located at the top right corner of the screen. You can select the printing order from Sort by Date and Sort by Name.



Note

- You can correct or enhance the selected image before printing.
 - ➔ [Correcting and Enhancing Photos](#)
- See Help for details on the Select Images screen.



[Page top](#) 

Advanced Guide

Advanced Guide > Printing from a Computer > Printing with the Bundled Application Software > Printing Photos > Selecting the Paper

Easy-PhotoPrint EX



Selecting the Paper

1. Click Select Paper.

The Select Paper screen appears.

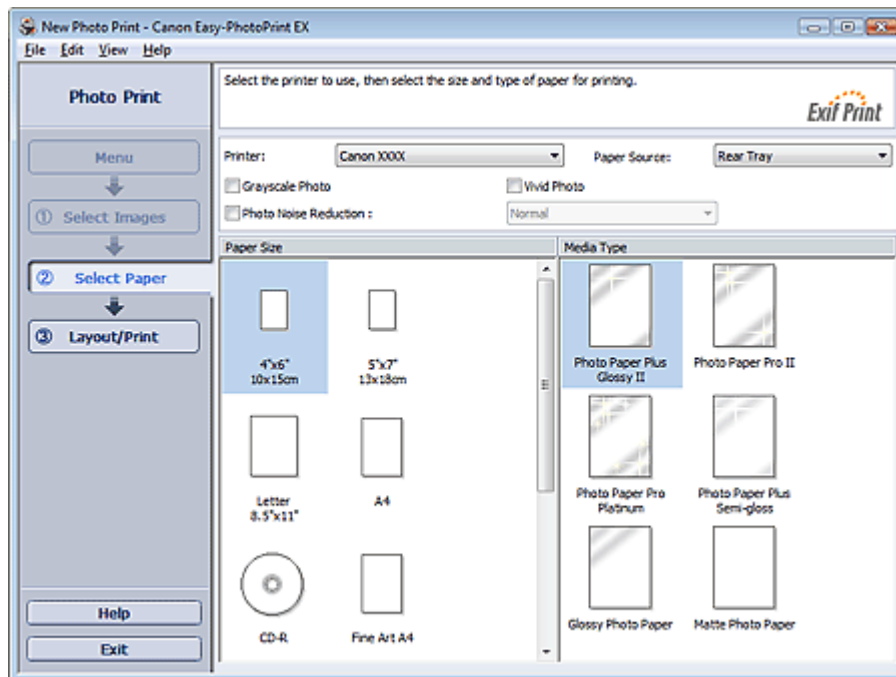

2. Set the following items according to the printer and paper to be used:

Printer

Paper Source

Paper Size

Media Type



Note

- The paper sizes and media types may vary depending on the printer. See Help for details.
- The paper sources may vary depending on the printer and the media type.

Important

- When Fine Art is selected for Paper Size, a 1.38 inch (35 mm) margin is automatically left at the top and bottom of the paper. It is recommended that you check the print range with the image shown in Preview before printing.

Note

- You can print directly on the DVD/CD surface by selecting CD-R for Paper Size.
 - ➔ Printing on a DVD/CD
- You can print photos in grayscale.
 - ➔ Printing Photos in Grayscale
- You can print photos with more vivid colors or you can reduce the photo noise.
 - ➔ Printing Vivid Photos

➔ Reducing Photo Noise

- See Help for details on the Select Paper screen.
-



[Page top](#)↑

Advanced Guide

Advanced Guide > Printing from a Computer > Printing with the Bundled Application Software > Printing Photos > Printing

Easy-PhotoPrint EX



Printing

1. Click Layout/Print.

The Layout/Print screen appears.

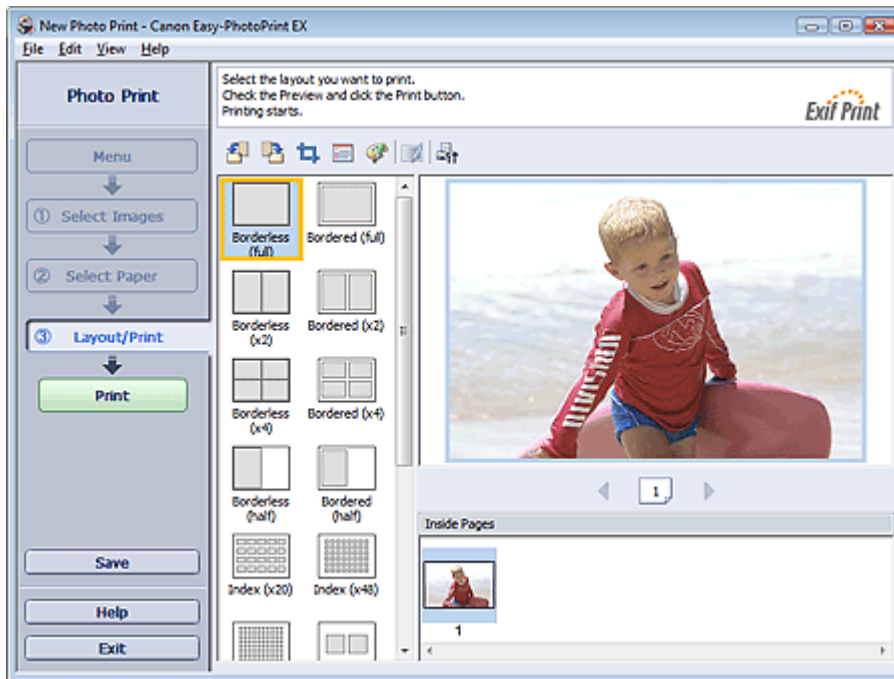

Important

- The thumbnails (reduced images) displayed in the screen may appear as follows:
 - A black line appears along an edge of the image.
 - An edge of the image appears cropped.
 However, such images will be displayed normally when enlarged or previewed, and print results will not be affected.

2. Select a layout you want to use.

Click a borderless layout to print borderless photos.

Note

- The layouts that can be selected may vary depending on the printer, paper size, and media type.

3. Click Print.

Important

- When you print on large size paper such as A3/A3+, some computers cannot print properly if you print more than one page or copy at a time. It is recommended that you print page by page when you print on such paper.
- While printing on paper larger than A4 or printing high-resolution images, data may be printed only to the middle if many images are printed at one time. In such cases, select the Spool print job page by page checkbox in the Preferences dialog box, and then print again.

To display the Preferences dialog box, click  (Settings) or select Preferences... from the File menu.

- When Fine Art is selected for Paper Size, a 1.38 inch (35 mm) margin is automatically left at the top and bottom of the paper.
- It is recommended that you check the print range with the image shown in Preview before printing.
- White streaks may appear at the top and bottom edges of grayscale photos. In that case, print with a 45 mm (1.77 inch) or more margin at the top and bottom edges.

If you select Bordered (Margin 45) from the layouts, images will be reduced when printing to allow a 45 mm (1.77 inch) margin at the top and bottom edges relative to the printing direction.

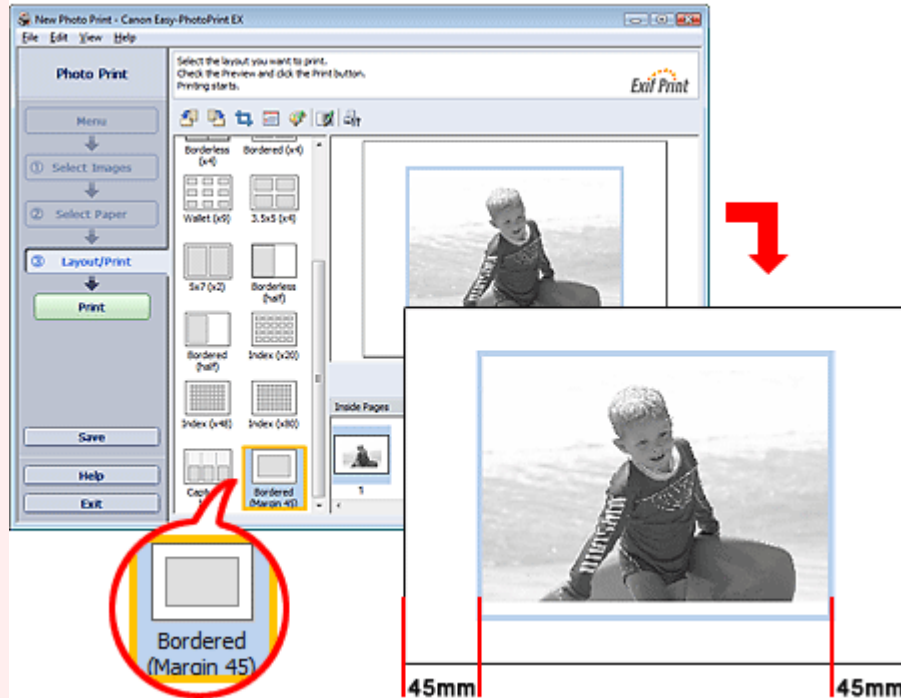

- The photo print settings will be discarded if you exit Easy-PhotoPrint EX without saving the settings. It is recommended that you save the printed image if you want to print it again.
 - ➔ [Saving Photos](#)
- When you print on a bordered layout, the margins on the left and right or the top and bottom may become wider than the other.
 - ➔ [How Do I Print with Even Margins?](#)

Note

- You can crop images or print dates on photos.
 - ➔ [Cropping Photos \(Photo Print\)](#)
 - ➔ [Printing Dates on Photos \(Photo Print\)](#)
- You can correct or enhance the selected image before printing.
 - ➔ [Correcting and Enhancing Photos](#)
- You can print photos in grayscale.
 - ➔ [Printing Photos in Grayscale](#)
- You can specify advanced Photo Print settings (number of copies, print quality, etc.) in the Preferences dialog box.

To display the Preferences dialog box, click  (Settings) or select Preferences... from the File menu.

- See Help for details on the Layout/Print screen.



Advanced Guide

Advanced Guide > Printing from a Computer > Printing with the Bundled Application Software > Creating an Album

Easy-PhotoPrint EX

Creating an Album

Easy-PhotoPrint EX allows you to create your own personalized photo album.

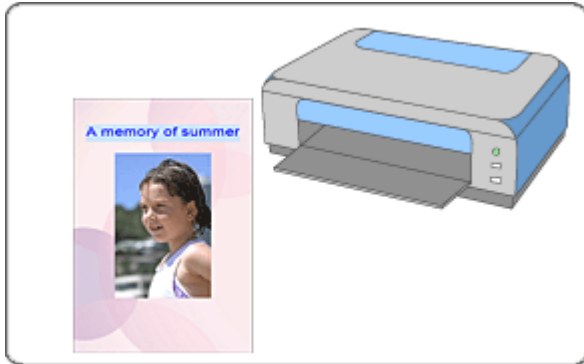

Steps

1. Starting Easy-PhotoPrint EX
2. Selecting the Paper and Layout
3. Selecting a Photo
4. Editing
5. Printing

Try This

- ➔ Correcting and Enhancing Photos
- ➔ Changing Layout
- ➔ Changing Background
- ➔ Adding Photos
- ➔ Swapping Positions of Photos
- ➔ Replacing Photos
- ➔ Changing Position, Angle and Size of Photos
- ➔ Cropping Photos
- ➔ Framing Photos
- ➔ Printing Dates on Photos
- ➔ Attaching Comments to Photos
- ➔ Adding Text to Photos
- ➔ Saving
- ➔ Opening Saved Files

Questions and Answers

- ➡ How Can I Move (or Copy) the Saved File?
- ➡ What Is "C1" or "C4"?

[Page top](#) ↕

Advanced Guide

Advanced Guide > Printing from a Computer > Printing with the Bundled Application Software > Creating an Album > Starting Easy-PhotoPrint EX

Easy-PhotoPrint EX



Starting Easy-PhotoPrint EX

1. From the Start menu, select (All) Programs > Canon Utilities > Easy-PhotoPrint EX > Easy-PhotoPrint EX.

Easy-PhotoPrint EX starts and Menu appears.

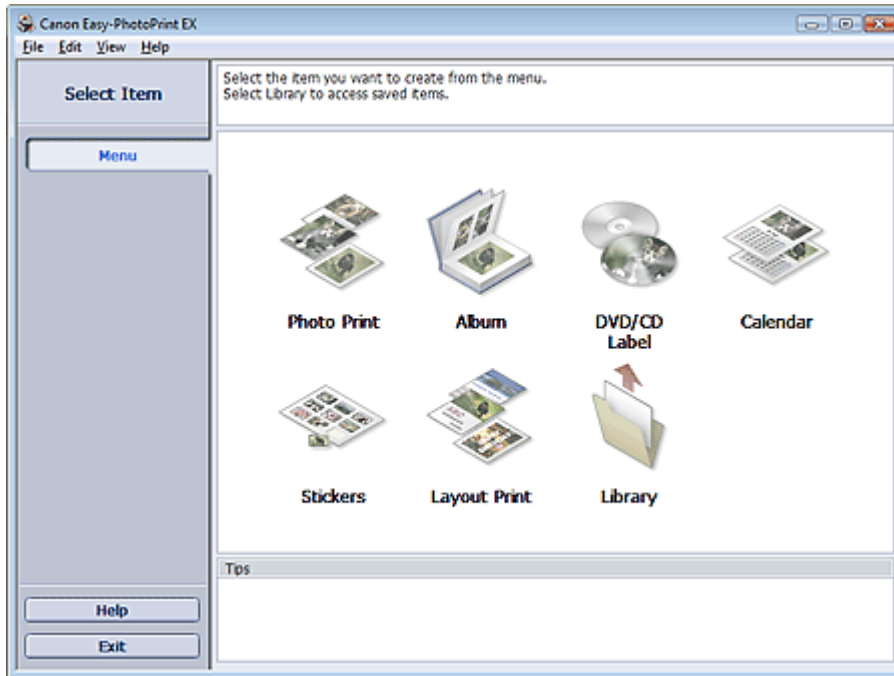

[Page top](#)

Advanced Guide

Advanced Guide > Printing from a Computer > Printing with the Bundled Application Software > Creating an Album > Selecting the Paper and Layout

Easy-PhotoPrint EX



Selecting the Paper and Layout

1. Click Album from Menu.

The Page Setup screen appears.

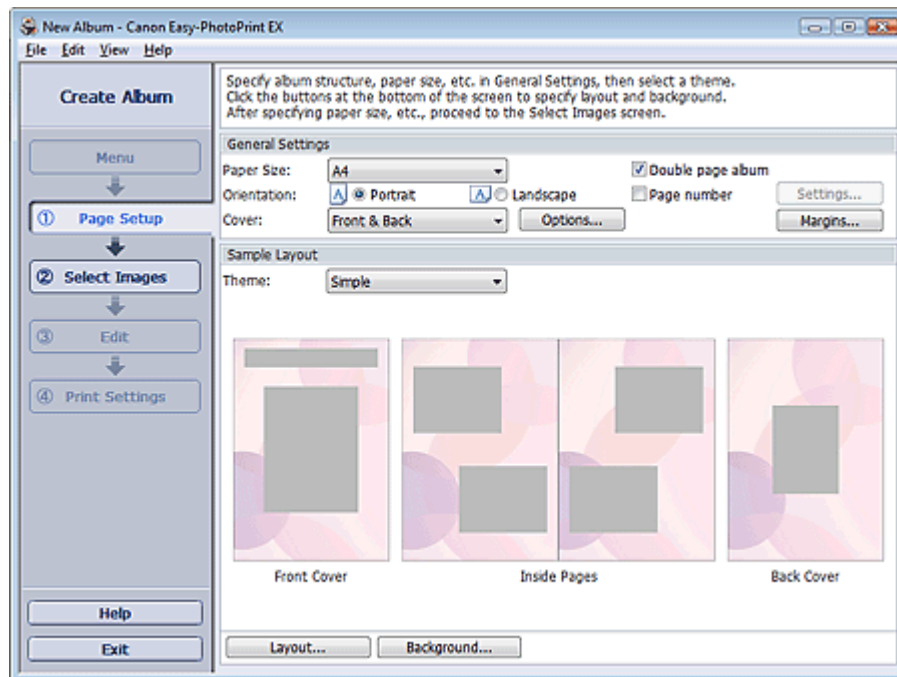

2. Set the following items in the General Settings section:

Paper Size

Orientation

Cover

Double page album

Page number



Note

- See Help on the paper size that can be selected.
- You can select whether to display images on the inside of the front and back covers in the Cover Options dialog box. To display the Cover Options dialog box, select Front or Front & Back for Cover and click Options....
- Select the Double page album checkbox to enable the spread page layout (consisting of two-page master). In a double-page album, you can arrange an image across the left and right pages.
- You can customize the page numbers (position, font size, etc.) in the Page Number Settings dialog box. To display the Page Number Settings dialog box, select the Page number checkbox and click Settings....
- You can customize the margins of the front cover, inside pages and back cover in the Margin Settings dialog box. To display the Margin Settings dialog box, click Margins....

3. Select the theme you want to use from Theme in Sample Layout.

4. If you want to change the layout, click Layout....

The Change Layout dialog box appears.

In the Change Layout dialog box, you can change the layout or select whether to print the date (on which the picture was taken) on the photo.

Note

- The layouts that can be selected may vary depending on the Paper Size, Orientation, Double page album, or the type of page selected (front cover, inside pages or back cover).
 - You can customize the date (position, size, color, etc.) in the Date Settings dialog box. To display the Date Settings dialog box, select the Print date checkbox in the Change Layout dialog box and click Date Settings....
-

5. If you want to change the background, click Background....

The Change Background dialog box appears.

In the Change Background dialog box, you can paint the background in a single color or paste an image file to it.

Note

- See Help for details on the Page Setup screen.
-



[Page top](#)[↕]

Advanced Guide

Advanced Guide > Printing from a Computer > Printing with the Bundled Application Software > Creating an Album > Selecting a Photo

Easy-PhotoPrint EX



Selecting a Photo

1. Click Select Images.

The Select Images screen appears.

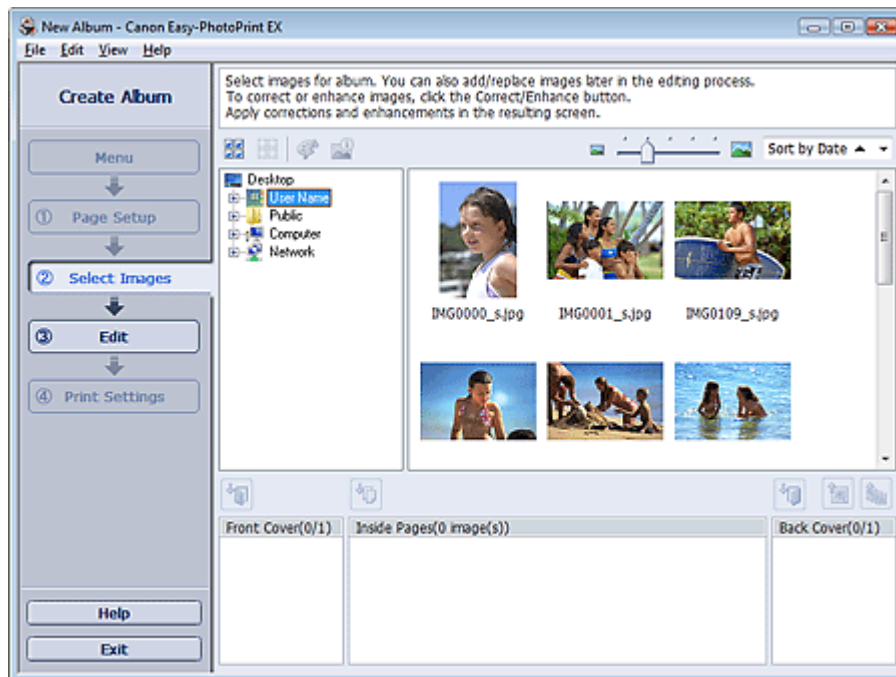

2. Select the folder that contains the image you want to print from the folder tree area.

The images in the folder will be displayed as thumbnails (miniatures).

Important

- If Easy-PhotoPrint EX is started from another application (MP Navigator EX or ZoomBrowser EX), the folder tree area will not be displayed. The images opened in the application will be displayed as thumbnails.

3. Select the image(s) you want to print, and click one of the buttons below.

To print on the front cover, click  (Import to Front Cover).

To print on the inside pages, click  (Import to Inside Pages).

To print on the back cover, click  (Import to Back Cover).

The selected image(s) are displayed in the selected image area.

You can also select the image(s) you want to print by dragging them into the selected image area.

Note

- To delete an image in the selected image area, select the image you want to delete and click

 (Delete Imported Image).

To delete all images from the selected image area, click  (Delete All Imported Images).

 **Note**

- See Help for details on the Select Images screen.
-



[Page top](#)[↕]

Advanced Guide

Advanced Guide > Printing from a Computer > Printing with the Bundled Application Software > Creating an Album > Editing

Easy-PhotoPrint EX



Editing

1. Click Edit.

The Edit screen appears.



2. Edit your album if necessary.

- ➔ Changing Layout
- ➔ Changing Background
- ➔ Adding Photos
- ➔ Swapping Positions of Photos
- ➔ Replacing Photos
- ➔ Changing Position, Angle and Size of Photos
- ➔ Cropping Photos
- ➔ Framing Photos
- ➔ Printing Dates on Photos
- ➔ Attaching Comments to Photos
- ➔ Adding Text to Photos

▶ Important

- The edit information will be discarded if you exit Easy-PhotoPrint EX without saving the edited album. It is recommended that you save the item if you want to edit it again.
- The page numbers on the front and back covers of the album are displayed as follows:

C1: Front cover

C2: Inside the front cover

C3: Inside the back cover

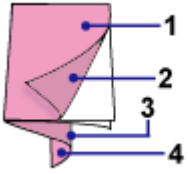

C4: Back cover

→ Saving

Note

- See Help for details on the Edit screen.



[Page top](#) 

Advanced Guide

Advanced Guide > Printing from a Computer > Printing with the Bundled Application Software > Creating an Album > Printing

Easy-PhotoPrint EX



Printing

1. Click Print Settings.

The Print Settings screen appears.

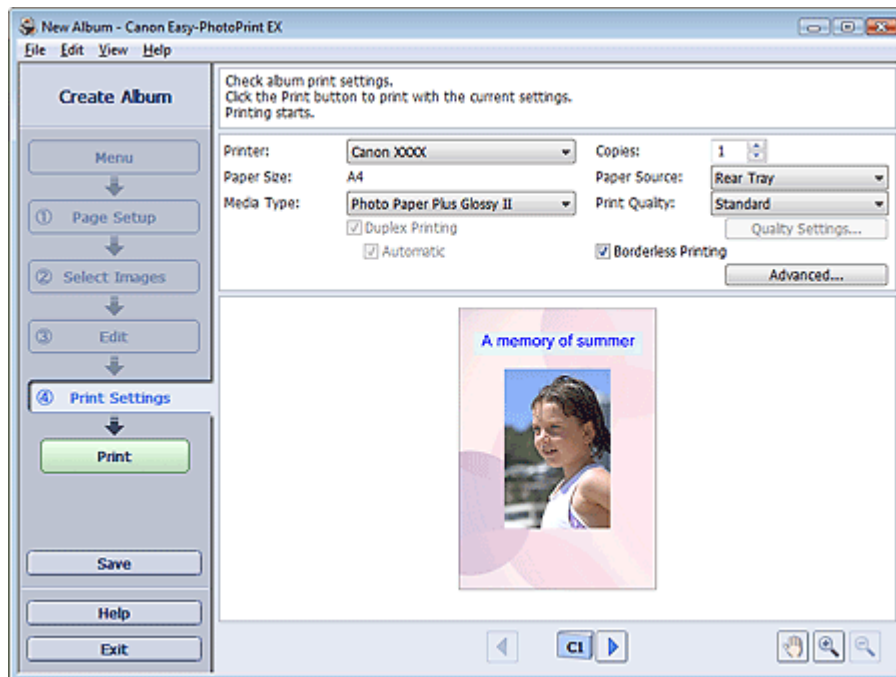

2. Set the following items according to the printer and paper to be used:

Printer

Media Type

Copies

Paper Source

Print Quality

Borderless Printing



Note

- The media types may vary depending on the printer and the paper size.
- Duplex Printing appears if the selected printer and media type support duplex printing. Select this checkbox to print on both sides of the paper.
- Automatic appears if you select the Duplex Printing checkbox after selecting a printer that supports automatic duplex printing and media type that supports duplex printing. Select this checkbox to print on both sides of the paper automatically.
- The paper sources may vary depending on the printer and the media type.
- You can set a custom print quality level in the Print Quality Settings dialog box. To display the Print Quality Settings dialog box, select Custom for Print Quality and click Quality Settings....
- Select the Borderless Printing checkbox to print borderless photos.
- You can specify the print range and the amount of extension for borderless printing in the Print Settings dialog box. To display the Print Settings dialog box, click Advanced....

3. Click Print.

 **Note**

-
- See Help for details on the Print Settings screen.
-



[Page top](#)[↕]

Advanced Guide

Advanced Guide > Printing from a Computer > Printing with the Bundled Application Software > Printing a DVD/CD

Easy-PhotoPrint EX

Printing a DVD/CD

Start Easy-PhotoPrint EX and select DVD/CD Label in Menu to start CD-LabelPrint. CD-LabelPrint allows you to print DVD/CD labels easily.

For details on how to use CD-LabelPrint, install CD-LabelPrint and refer to the application's manual as follows. From the Start menu, select (All) Programs > CD-LabelPrint > Manual.

Important

- DVD/CD Label is not displayed in Menu if CD-LabelPrint is not installed on your computer.

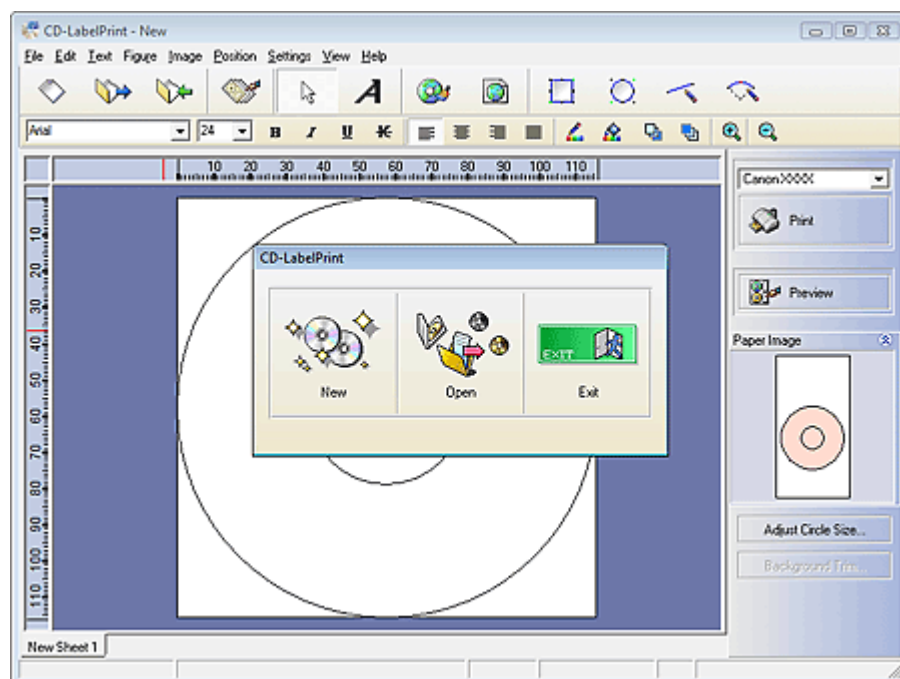

[Page top](#)

Advanced Guide

Advanced Guide > Printing from a Computer > Printing with the Bundled Application Software > Printing Calendars

Easy-PhotoPrint EX

Printing Calendars

Easy-PhotoPrint EX allows you to create your own calendar using your favorite photos.

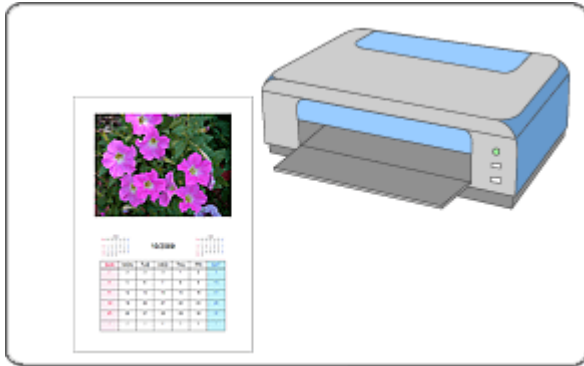

Steps

1. Starting Easy-PhotoPrint EX
2. Selecting the Paper and Layout
3. Selecting a Photo
4. Editing
5. Printing

Try This

- ➔ Correcting and Enhancing Photos
- ➔ Changing Layout
- ➔ Changing Background
- ➔ Adding Photos
- ➔ Swapping Positions of Photos
- ➔ Replacing Photos
- ➔ Changing Position, Angle and Size of Photos
- ➔ Cropping Photos
- ➔ Framing Photos
- ➔ Printing Dates on Photos
- ➔ Adding Text to Photos
- ➔ Setting Calendar Display
- ➔ Setting Holidays
- ➔ Saving
- ➔ Opening Saved Files

Questions and Answers

➡ How Can I Move (or Copy) the Saved File?

[Page top](#) ↕

Advanced Guide

Advanced Guide > Printing from a Computer > Printing with the Bundled Application Software > Printing Calendars > Starting Easy-PhotoPrint EX

Easy-PhotoPrint EX



Starting Easy-PhotoPrint EX

1. From the Start menu, select (All) Programs > Canon Utilities > Easy-PhotoPrint EX > Easy-PhotoPrint EX.

Easy-PhotoPrint EX starts and Menu appears.

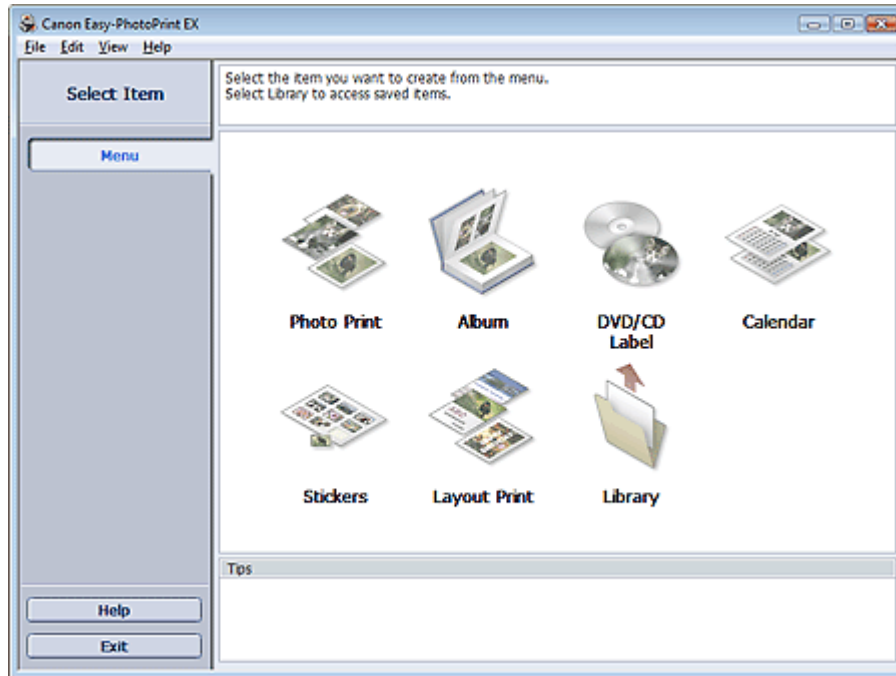

[Page top](#)

Advanced Guide

Advanced Guide > Printing from a Computer > Printing with the Bundled Application Software > Printing Calendars > Selecting the Paper and Layout

Easy-PhotoPrint EX



Selecting the Paper and Layout

1. Click Calendar from Menu.

The Page Setup screen appears.

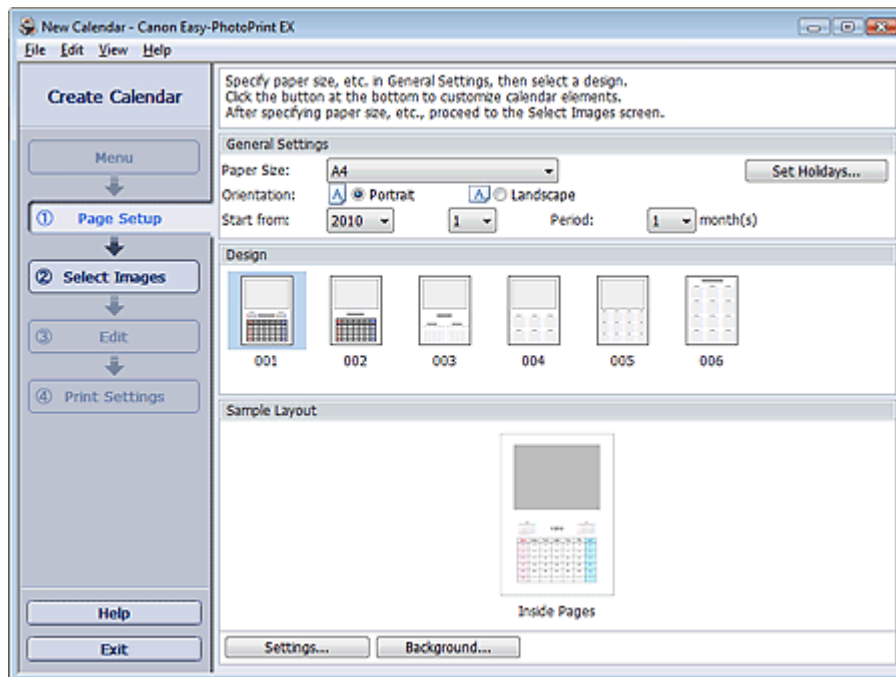

2. Set the following items in the General Settings section:

Paper Size

Orientation

Start from

Period



Note

- See Help on the paper size that can be selected.
- You can add holidays to your calendar.
➔ [Setting Holidays](#)

3. Select a layout for Design.

If necessary, make advanced settings on the calendar and set the background.



Note

- You can customize the calendar display (font colors of the dates and days of the week, position and size of the calendar, etc.).
➔ [Setting Calendar Display](#)
- You can paint the background in a single color or paste an image file to it in the Change Background dialog box. To display the Change Background dialog box, click Background....

- See Help for details on the Page Setup screen.
-



[Page top](#) 

Advanced Guide

Advanced Guide > Printing from a Computer > Printing with the Bundled Application Software > Printing Calendars > Selecting a Photo

Easy-PhotoPrint EX



Selecting a Photo

1. Click Select Images.

The Select Images screen appears.



2. Select the folder that contains the image you want to print from the folder tree area.

The images in the folder will be displayed as thumbnails (miniatures).

3. Select the image(s) you want to print and click (Import to Inside Pages).

The selected image(s) are displayed in the selected image area.

You can also select the image(s) you want to print by dragging them into the selected image area.

Note

- To delete an image in the selected image area, select the image you want to delete and click



(Delete Imported Image).

To delete all images from the selected image area, click



(Delete All Imported Images).

Note

- See Help for details on the Select Images screen.



Advanced Guide

Advanced Guide > Printing from a Computer > Printing with the Bundled Application Software > Printing Calendars > Editing

Easy-PhotoPrint EX



Editing

1. Click Edit.

The Edit screen appears.

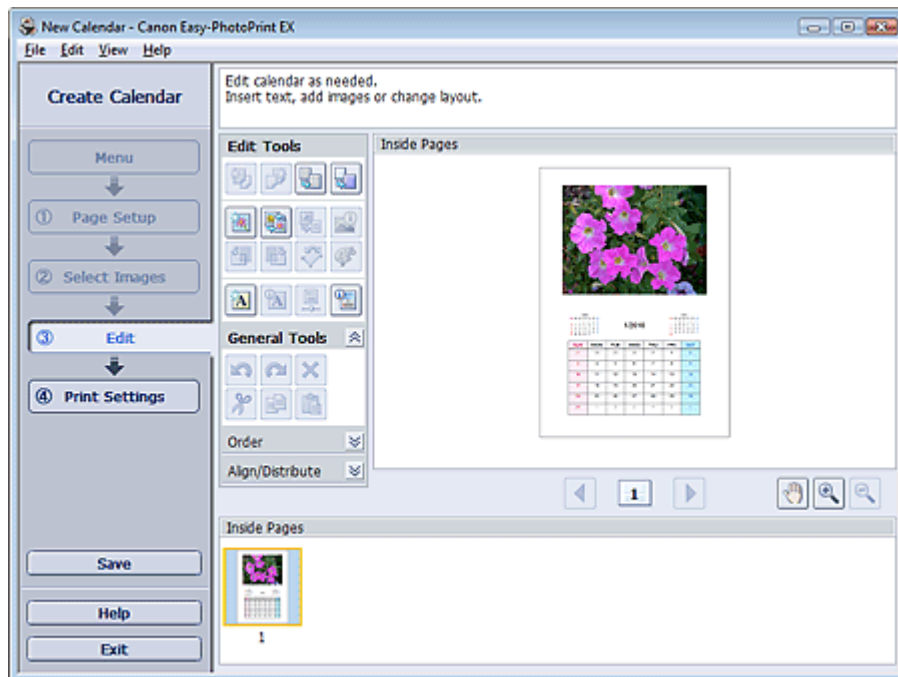

2. Edit the calendar if necessary.

- ➔ Changing Layout
- ➔ Changing Background
- ➔ Adding Photos
- ➔ Swapping Positions of Photos
- ➔ Replacing Photos
- ➔ Changing Position, Angle and Size of Photos
- ➔ Cropping Photos
- ➔ Framing Photos
- ➔ Printing Dates on Photos
- ➔ Adding Text to Photos
- ➔ Setting Calendar Display
- ➔ Setting Holidays

Important

- The edit information will be discarded if you exit Easy-PhotoPrint EX without saving the edited calendar. It is recommended that you save the item if you want to edit it again.
 - ➔ Saving

Note

- See Help for details on the Edit screen.
-



[Page top](#) 

Advanced Guide

Advanced Guide > Printing from a Computer > Printing with the Bundled Application Software > Printing Calendars > Printing

Easy-PhotoPrint EX



Printing

1. Click Print Settings.

The Print Settings screen appears.

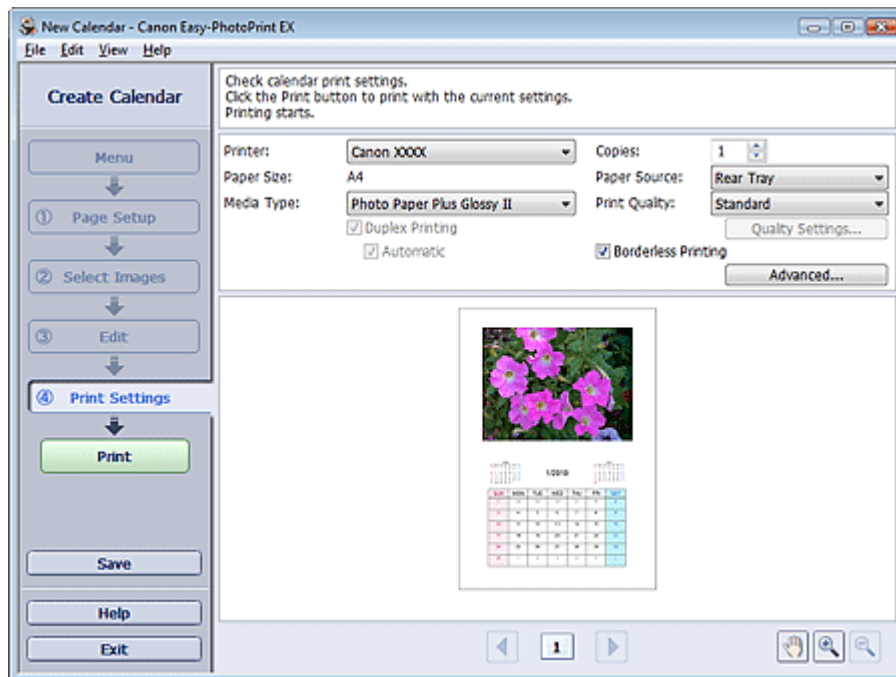

2. Set the following items according to the printer and paper to be used:

Printer

Media Type

Copies

Paper Source

Print Quality

Borderless Printing



Note

- The media types may vary depending on the printer and the paper size.
- Duplex Printing appears if the selected printer and media type support duplex printing. Select this checkbox to print on both sides of the paper.
- Automatic appears if you select the Duplex Printing checkbox after selecting a printer that supports automatic duplex printing and media type that supports duplex printing. Select this checkbox to print on both sides of the paper automatically.
- The paper sources may vary depending on the printer and the media type.
- You can set a custom print quality level in the Print Quality Settings dialog box. To display the Print Quality Settings dialog box, select Custom for Print Quality and click Quality Settings....
- You can specify the print range and the amount of extension for borderless printing in the Print Settings dialog box. To display the Print Settings dialog box, click Advanced....

3. Click Print.

 **Note**

- See Help for details on the Print Settings screen.
-



[Page top](#)

Advanced Guide

Advanced Guide > Printing from a Computer > Printing with the Bundled Application Software > Printing Stickers

Easy-PhotoPrint EX

Printing Stickers

You can print your favorite photos on compatible sticker sheets.



Steps

1. Starting Easy-PhotoPrint EX
2. Selecting the Paper and Layout
3. Selecting a Photo
4. Editing
5. Printing

Try This

- ➔ Correcting and Enhancing Photos
- ➔ Adding Photos
- ➔ Swapping Positions of Photos
- ➔ Replacing Photos
- ➔ Changing Position, Angle and Size of Photos
- ➔ Cropping Photos
- ➔ Framing Photos
- ➔ Adding Text to Photos
- ➔ Saving
- ➔ Opening Saved Files

Questions and Answers

- ➔ How Can I Move (or Copy) the Saved File?

Advanced Guide

Advanced Guide > Printing from a Computer > Printing with the Bundled Application Software > Printing Stickers > Starting Easy-PhotoPrint EX

Easy-PhotoPrint EX



Starting Easy-PhotoPrint EX

1. From the Start menu, select (All) Programs > Canon Utilities > Easy-PhotoPrint EX > Easy-PhotoPrint EX.

Easy-PhotoPrint EX starts and Menu appears.

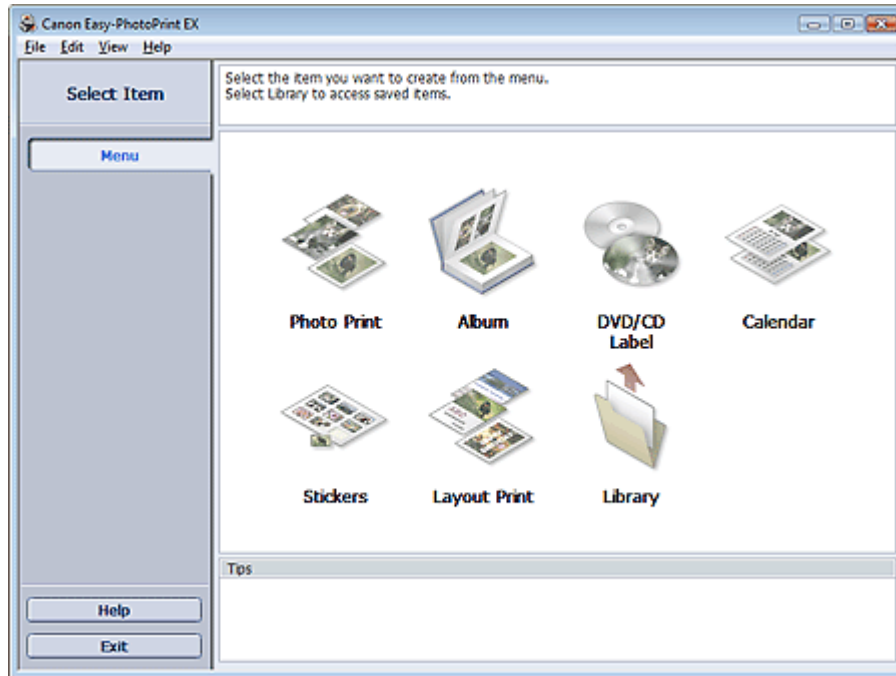

[Page top](#)

Advanced Guide

Advanced Guide > Printing from a Computer > Printing with the Bundled Application Software > Printing Stickers > Selecting the Paper and Layout

Easy-PhotoPrint EX



Selecting the Paper and Layout

1. Click Stickers from Menu.

The Page Setup screen appears.

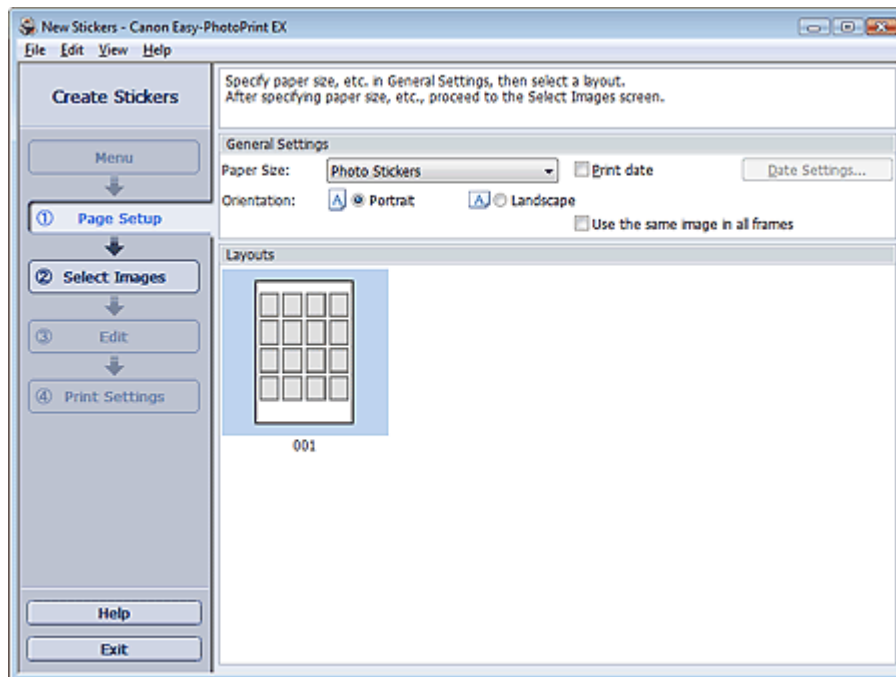

2. Set the following items in the General Settings section:

Paper Size

Orientation

Print date

Use the same image in all frames



Note

- Paper sizes other than Photo Stickers cannot be selected.
- Select the Use the same image in all frames checkbox to use the same image in all the frames on the page.
- You can customize the date (position, size, color, etc.) in the Date Settings dialog box. To display the Date Settings dialog box, select the Print date checkbox and click Date Settings....



Note

- See Help for details on the Page Setup screen.



Advanced Guide

Advanced Guide > Printing from a Computer > Printing with the Bundled Application Software > Printing Stickers > Selecting a Photo

Easy-PhotoPrint EX



Selecting a Photo

1. Click Select Images.

The Select Images screen appears.

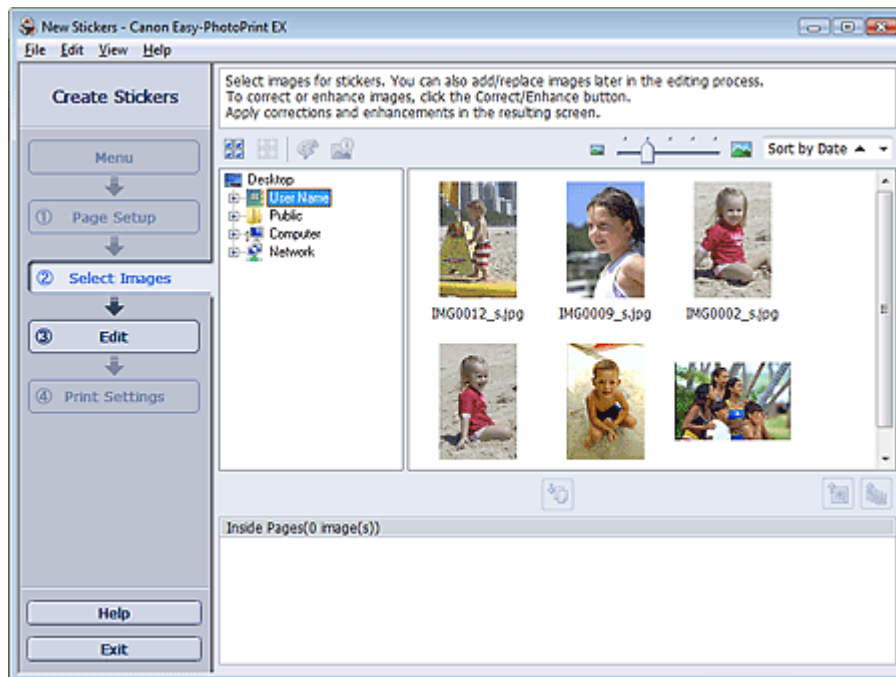

2. Select the folder that contains the image you want to print from the folder tree area.

The images in the folder will be displayed as thumbnails (miniatures).

3. Select the image(s) you want to print and click (Import to Inside Pages).

The selected image(s) are displayed in the selected image area.

You can also select the image(s) you want to print by dragging them into the selected image area.

Note

- To delete an image in the selected image area, select the image you want to delete and click



(Delete Imported Image).

To delete all images from the selected image area, click



(Delete All Imported Images).

Note

- See Help for details on the Select Images screen.



Advanced Guide

Advanced Guide > Printing from a Computer > Printing with the Bundled Application Software > Printing Stickers > Editing

Easy-PhotoPrint EX



Editing

1. Click Edit.

The Edit screen appears.

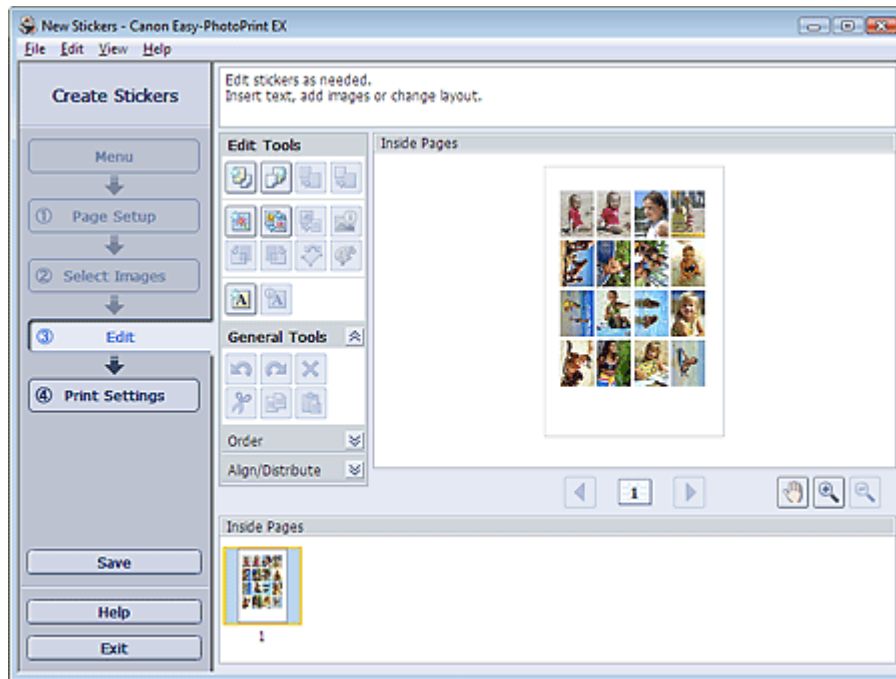

2. Edit the stickers if necessary.

- ➔ Adding Photos
- ➔ Swapping Positions of Photos
- ➔ Replacing Photos
- ➔ Changing Position, Angle and Size of Photos
- ➔ Cropping Photos
- ➔ Printing Dates on Photos
- ➔ Adding Text to Photos

Important

- The edit information will be discarded if you exit Easy-PhotoPrint EX without saving the edited stickers. It is recommended that you save the item if you want to edit it again.
 - ➔ Saving

Note

- See Help for details on the Edit screen.



Advanced Guide

Advanced Guide > Printing from a Computer > Printing with the Bundled Application Software > Printing Stickers > Printing

Easy-PhotoPrint EX



Printing

1. Click Print Settings.

The Print Settings screen appears.

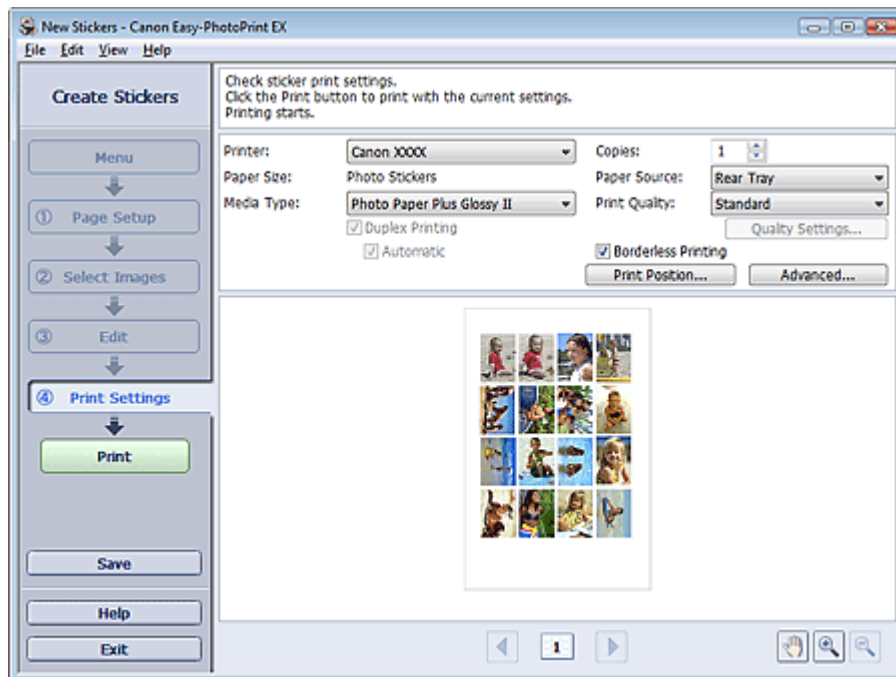

2. Set the following items according to the printer and paper to be used:

Printer

Media Type

Copies

Paper Source

Print Quality

Borderless Printing

Note

- The media types may vary depending on the printer and the paper size.
- The paper sources may vary depending on the printer and the media type.
- You can set a custom print quality level in the Print Quality Settings dialog box. To display the Print Quality Settings dialog box, select Custom for Print Quality and click Quality Settings....
- You can adjust the printing position in the Adjust Print Position dialog box. To display the Adjust Print Position dialog box, click Print Position....
- You can specify the print range and the amount of extension for borderless printing in the Print Settings dialog box. To display the Print Settings dialog box, click Advanced....

3. Click Print.

Note

- See Help for details on the Print Settings screen.



[Page top](#) 

Advanced Guide

Advanced Guide > Printing from a Computer > Printing with the Bundled Application Software > Printing Layout

Easy-PhotoPrint EX

Printing Layout

You can add text to your favorite photos and print them in a variety of layouts.



Steps

1. Starting Easy-PhotoPrint EX
2. Selecting the Paper and Layout
3. Selecting a Photo
4. Editing
5. Printing

Try This

- ➔ Correcting and Enhancing Photos
- ➔ Changing Layout
- ➔ Adding Photos
- ➔ Swapping Positions of Photos
- ➔ Replacing Photos
- ➔ Changing Position, Angle and Size of Photos
- ➔ Cropping Photos
- ➔ Printing Dates on Photos
- ➔ Adding Text to Photos
- ➔ Saving
- ➔ Opening Saved Files

Questions and Answers

- ➔ How Can I Move (or Copy) the Saved File?

Advanced Guide

Advanced Guide > Printing from a Computer > Printing with the Bundled Application Software > Printing Layout > Starting Easy-PhotoPrint EX

Easy-PhotoPrint EX



Starting Easy-PhotoPrint EX

1. From the Start menu, select (All) Programs > Canon Utilities > Easy-PhotoPrint EX > Easy-PhotoPrint EX.

Easy-PhotoPrint EX starts and Menu appears.

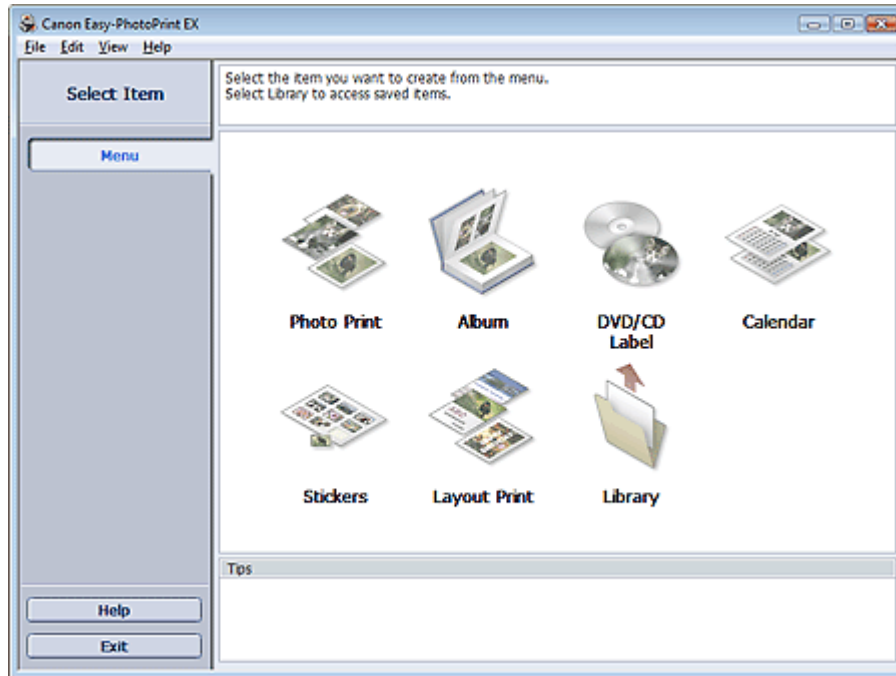

[Page top](#)

Advanced Guide

Advanced Guide > Printing from a Computer > Printing with the Bundled Application Software > Printing Layout > Selecting the Paper and Layout

Easy-PhotoPrint EX



Selecting the Paper and Layout

1. Click Layout Print from Menu.

The Page Setup screen appears.

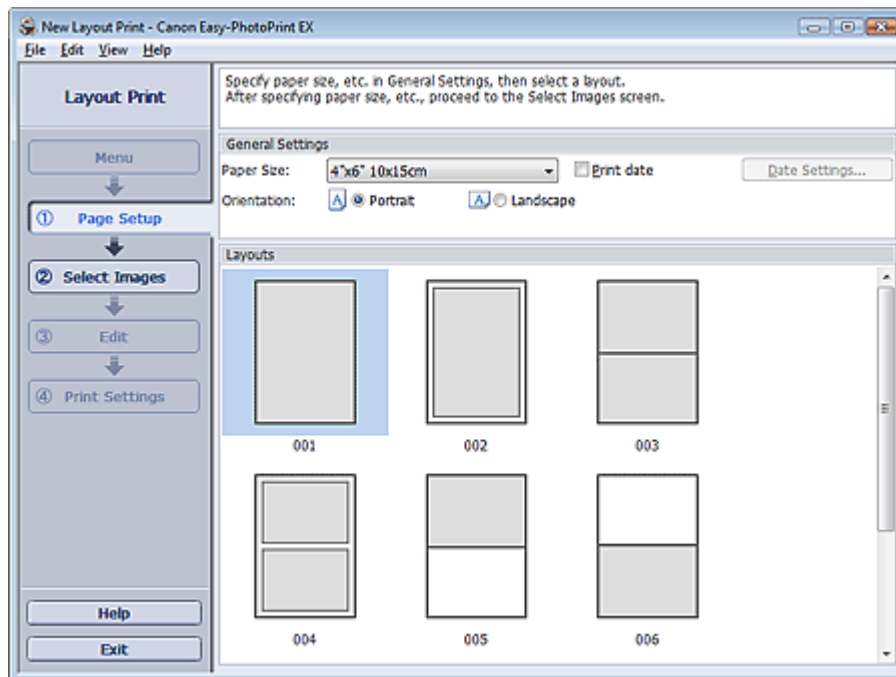

2. Set the following items in the General Settings section:

Paper Size

Orientation

Print date

Note

- See Help on the paper size that can be selected.
- You can customize the date (position, size, color, etc.) in the Date Settings dialog box. To display the Date Settings dialog box, select the Print date checkbox and click Date Settings....

3. Select a layout from Layouts.

Note

- The layouts may vary depending on the Orientation.

Note

- See Help for details on the Page Setup screen.



Advanced Guide

Advanced Guide > Printing from a Computer > Printing with the Bundled Application Software > Printing Layout > Selecting a Photo

Easy-PhotoPrint EX



Selecting a Photo

1. Click Select Images.

The Select Images screen appears.



2. Select the folder that contains the image you want to print from the folder tree area.

The images in the folder will be displayed as thumbnails (miniatures).

3. Select the image(s) you want to print and click (Import to Inside Pages).

The selected image(s) are displayed in the selected image area.

You can also select the image(s) you want to print by dragging them into the selected image area.

Note

- To delete an image in the selected image area, select the image you want to delete and click



(Delete Imported Image).

To delete all images from the selected image area, click



(Delete All Imported Images).

Note

- See Help for details on the Select Images screen.



Advanced Guide

Advanced Guide > Printing from a Computer > Printing with the Bundled Application Software > Printing Layout > Editing

Easy-PhotoPrint EX



Editing

1. Click Edit.

The Edit screen appears.

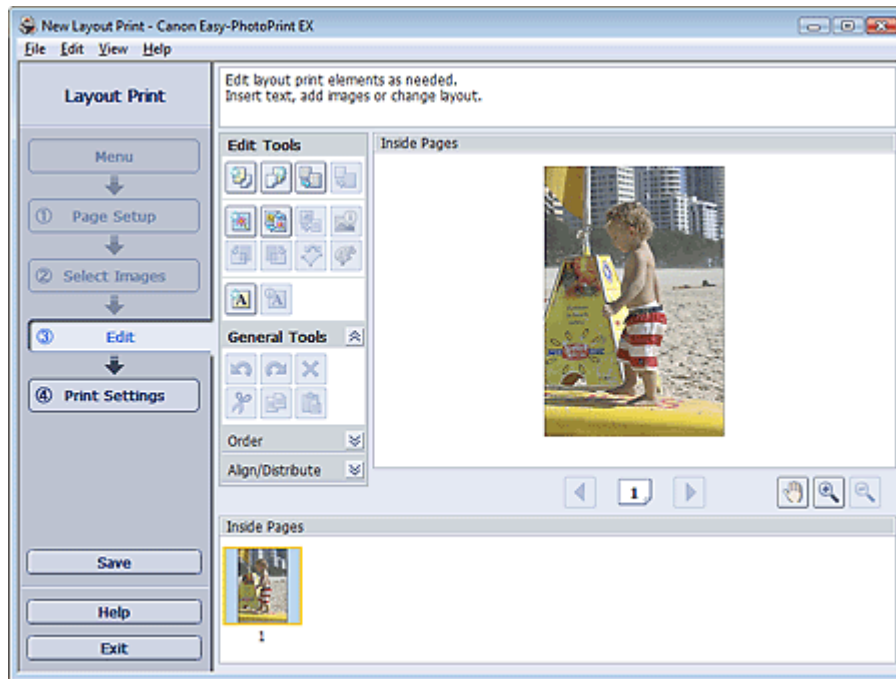

2. Edit the layout if necessary.

- ➔ Changing Layout
- ➔ Adding Photos
- ➔ Swapping Positions of Photos
- ➔ Replacing Photos
- ➔ Changing Position, Angle and Size of Photos
- ➔ Cropping Photos
- ➔ Printing Dates on Photos
- ➔ Adding Text to Photos

Important

- The edit information will be discarded if you exit Easy-PhotoPrint EX without saving the edited layout. It is recommended that you save the item if you want to edit it again.
 - ➔ Saving

Note

- See Help for details on the Edit screen.



Advanced Guide

Advanced Guide > Printing from a Computer > Printing with the Bundled Application Software > Printing Layout > Printing

Easy-PhotoPrint EX



Printing

1. Click Print Settings.

The Print Settings screen appears.

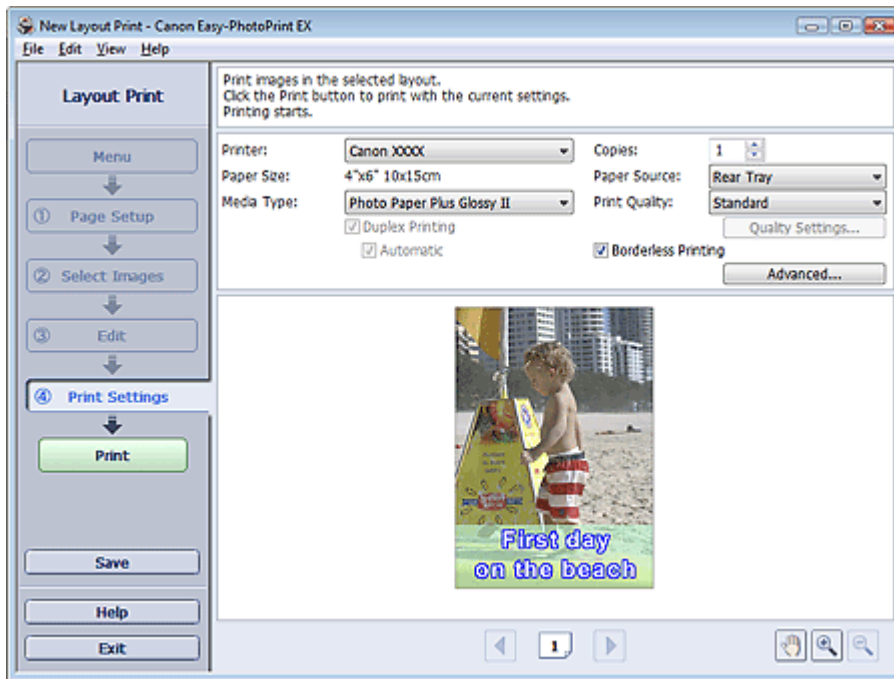

2. Set the following items according to the printer and paper to be used:

- Printer
- Media Type
- Copies
- Paper Source
- Print Quality
- Borderless Printing

Note

- The media types may vary depending on the printer and the paper size.
- Duplex Printing appears if the selected printer and media type support duplex printing. Select this checkbox to print on both sides of the paper.
- Automatic appears if you select the Duplex Printing checkbox after selecting a printer that supports automatic duplex printing and media type that supports duplex printing. Select this checkbox to print on both sides of the paper automatically.
- The paper sources may vary depending on the printer and the media type.
- You can set a custom print quality level in the Print Quality Settings dialog box. To display the Print Quality Settings dialog box, select Custom for Print Quality and click Quality Settings....
- Select the Borderless Printing checkbox to print borderless photos.
- You can specify the print range and the amount of extension for borderless printing in the Print Settings dialog box. To display the Print Settings dialog box, click Advanced....

3. Click Print.

 **Note**

- See Help for details on the Print Settings screen.
-



[Page top](#)[↕]

Advanced Guide

Advanced Guide > Printing from a Computer > Printing with the Bundled Application Software > Correcting and Enhancing Photos

Easy-PhotoPrint EX

Correcting and Enhancing Photos

You can correct and enhance images.

Click  (Correct/Enhance Images) in the Select Images or Edit screen, or in the Layout/Print screen of Photo Print. You can make the following corrections and enhancements in the Correct/Enhance Images window.

Important

- For Photo Print, if you select Enable ICC Profile in the Advanced tab of the Preferences dialog box, you cannot correct/enhance images.

Note

- See "[Correct/Enhance Images Window](#)" for details on the Correct/Enhance Images window.

Auto Photo Fix

This function will automatically analyze the captured scene and apply suitable corrections.

➡ [Using the Auto Photo Fix Function](#)

Red-Eye Correction Function

You can correct red eyes caused by a camera flash.

➡ [Using the Red-Eye Correction Function](#)

Face Brightener Function

You can brighten dark faces caused by bright background.

➡ [Using the Face Brightener Function](#)

Face Sharpener Function

You can sharpen out-of-focus faces in a photo.

➡ [Using the Face Sharpener Function](#)

Digital Face Smoothing Function

You can enhance skin beautifully by removing blemishes and wrinkles.

➡ [Using the Digital Face Smoothing Function](#)

Blemish Remover Function

You can remove moles.

➡ [Using the Blemish Remover Function](#)

Image Adjustment

You can adjust brightness and contrast or sharpen the entire image.

You can also blur the outline of the subjects or remove the base color.

➔ Adjusting Images

[Page top](#) ↕

Advanced Guide

Advanced Guide > Printing from a Computer > Printing with the Bundled Application Software > Correcting and Enhancing Photos > Using the Auto Photo Fix Function

Easy-PhotoPrint EX

Using the Auto Photo Fix Function

Apply optimum corrections automatically to the photos used for an album, calendar, etc.

Important

- The Auto Photo Fix function is not available for Photo Print. Photo Print allows you to automatically apply suitable corrections to all photos when printing, by selecting Auto Photo Fix in Color correction for printing on the Advanced tab of the Preferences dialog box. To display the Preferences dialog box, click  (Settings) in the Layout/Print screen or select Preferences... from the File menu.
- Once image is corrected with Auto Photo Fix and saved, it cannot be corrected again with Auto Photo Fix.
Also, Auto Photo Fix may not be available for images edited using an application, digital camera, etc. manufactured by other companies.

1. Select photos in the Select Images screen, then click  (Correct/Enhance Images).

The Correct/Enhance Images window appears.

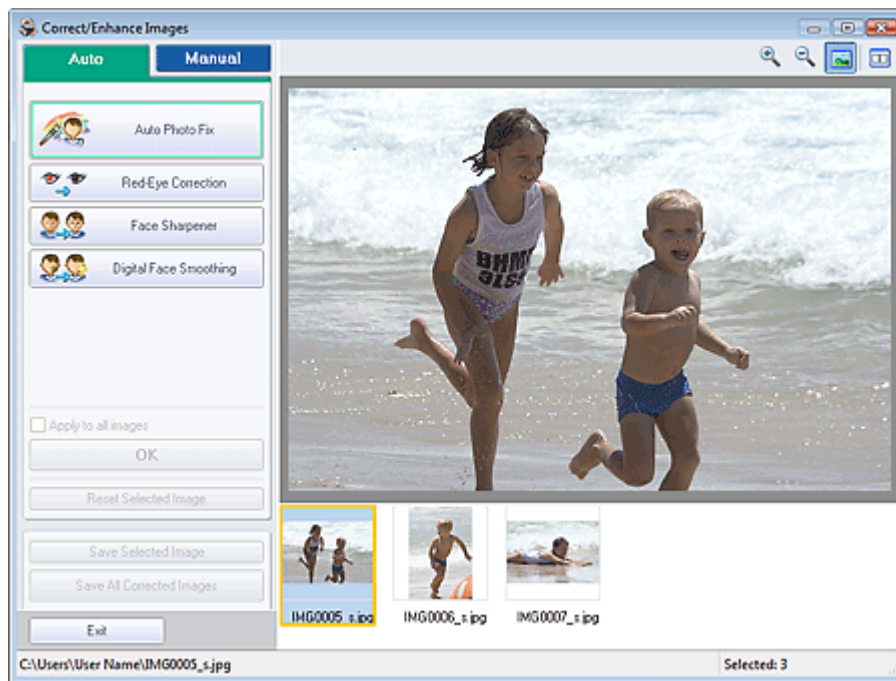

Note

- You can also display the Correct/Enhance Images window by clicking  (Correct/Enhance Images) in the Layout/Print or Edit screen. In that case, only the image displayed in Preview can be corrected/enhanced.
- See "[Correct/Enhance Images Window](#)" for details on the Correct/Enhance Images window.

2. Select the image you want to correct from the list displayed in the lower part of the Correct/Enhance Images window.

The image appears in Preview.

 **Note**

- If only one image is selected, the thumbnail does not appear below Preview.
-

3. Make sure that Auto is selected.

4. Click Auto Photo Fix, then click OK.

The entire photo is corrected automatically and the  (Correction/Enhancement) mark appears on the upper left of the image.

 **Note**

- Click  (Compare) to display the images before and after the correction side by side so that you can compare and check the result.
 - Click Reset Selected Image to undo the correction operation.
 - If you want to apply the correction to all the selected images at once, select the Apply to all images checkbox.
 - Select the Prioritize Exif Info checkbox to apply corrections primarily based on the settings made at the time of shooting. Deselect this checkbox to apply corrections based on the image analysis results. It is recommended that you normally select this setting.
-

5. Click Save Selected Image or Save All Corrected Images.

You can save corrected images as new files.

 **Note**

- To save only the image you like, click Save Selected Image. To save all images, click Save All Corrected Images.
 - Only JPEG/Exif file format is available for corrected images.
-

6. Click Exit.

 **Important**

- The corrections will be lost if you exit before saving corrected images.
-

Advanced Guide

Advanced Guide > Printing from a Computer > Printing with the Bundled Application Software > Correcting and Enhancing Photos > Using the Red-Eye Correction Function

Easy-PhotoPrint EX

Using the Red-Eye Correction Function

You can correct red eyes caused by a camera flash.

You can perform the Red-Eye Correction function either automatically or manually.

Note

- Photo Print allows you to automatically correct red eyes when printing. To correct automatically, select Enable Auto Photo Fix in Color correction for printing on the Advanced tab of the Preferences dialog box and select the Enable Red-Eye Correction checkbox.

- Select photos in the Select Images screen, then click  (Correct/Enhance Images).

The Correct/Enhance Images window appears.

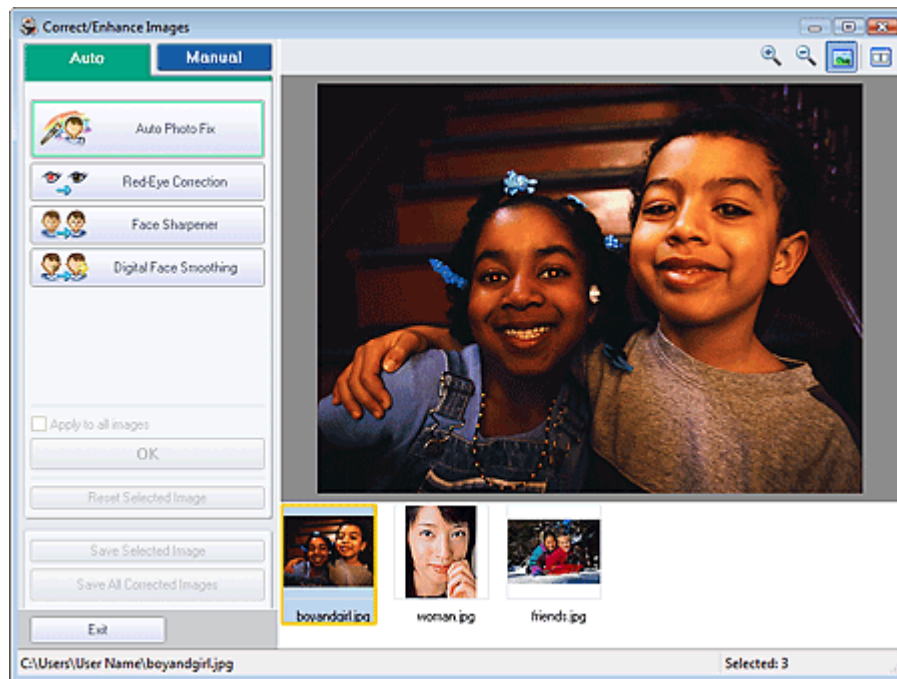

Note

- You can also display the Correct/Enhance Images window by clicking  (Correct/Enhance Images) in the Layout/Print or Edit screen. In that case, only the image displayed in Preview can be corrected/enhanced.
- See "[Correct/Enhance Images Window](#)" for details on the Correct/Enhance Images window.

- Select the image you want to correct from the list displayed in the lower part of the Correct/Enhance Images window.

The image appears in Preview.

Note

- If only one image is selected, the thumbnail does not appear below Preview.

Auto Correction

3. Make sure that Auto is selected.
4. Click Red-Eye Correction.
5. Click OK.

Red eyes are corrected and the  (Correction/Enhancement) mark appears on the upper left of the image.

Important

- Areas other than the eyes may be corrected depending on the image.

Note

- Click  (Compare) to display the images before and after the correction side by side so that you can compare and check the result.
- Click Reset Selected Image to undo the correction operation.
- If you want to apply the correction to all the selected images at once, select the Apply to all images checkbox.

Manual Correction

3. Click Manual, then click Correct/Enhance.
4. Click Red-Eye Correction.



Note

- Effect levels can be changed using the slider below Red-Eye Correction.
- Move the cursor over the image. The shape of the cursor changes to  (Paintbrush).

5. Drag to select the red area you want to correct, then click OK that appears over the image.



Red eye is corrected and the  (Correction/Enhancement) mark appears on the upper left of the image.

Note

- Click Undo to undo the preceding correction operation.

6. Click Save Selected Image or Save All Corrected Images.

You can save corrected images as new files.

Note

- To save only the image you like, click Save Selected Image. To save all images, click Save All Corrected Images.
- Only JPEG/Exif file format is available for corrected images.

7. Click Exit.

Important

- The corrections will be lost if you exit before saving corrected images.

Advanced Guide

Advanced Guide > Printing from a Computer > Printing with the Bundled Application Software > Correcting and Enhancing Photos > Using the Face Brightener Function

Easy-PhotoPrint EX

Using the Face Brightener Function

You can brighten dark faces caused by bright background.

Note

- You can brighten dark photos caused by bright background automatically by selecting Auto Photo Fix. If the correction had not been made sufficiently, applying Face Brightener function is recommended.
 ➔ [Using the Auto Photo Fix Function](#)

- Select photos in the Select Images screen, then click  (Correct/Enhance Images).

The Correct/Enhance Images window appears.

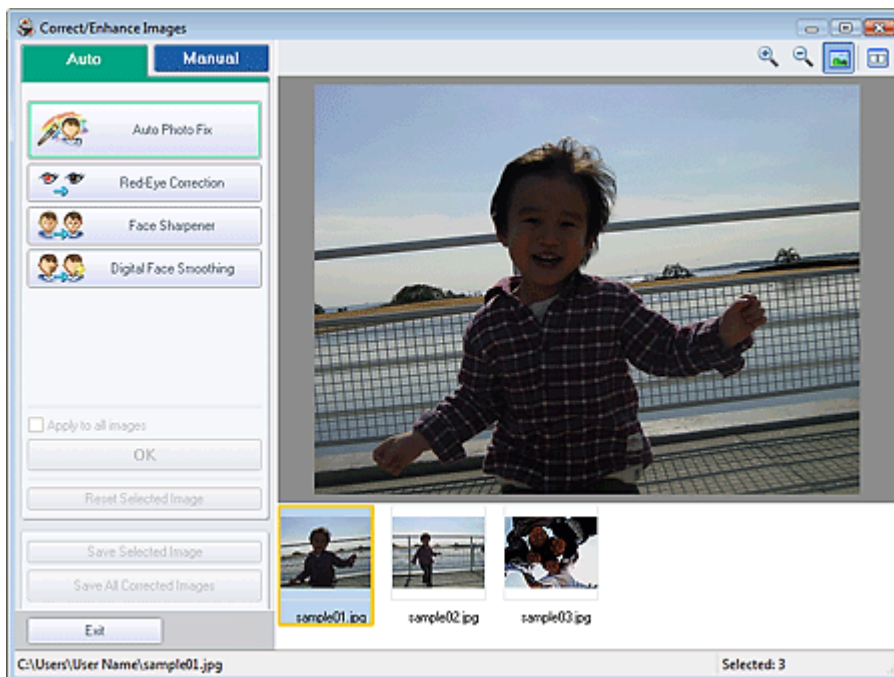

Note

- You can also display the Correct/Enhance Images window by clicking  (Correct/Enhance Images) in the Layout/Print or Edit screen. In that case, only the image displayed in Preview can be corrected/enhanced.
- See "[Correct/Enhance Images Window](#)" for details on the Correct/Enhance Images window.

- Select the image you want to correct from the list displayed in the lower part of the Correct/Enhance Images window.

The image appears in Preview.

Note

- If only one image is selected, the thumbnail does not appear below Preview.

- Click Manual, then click Correct/Enhance.

4. Click Face Brightener.



Note

- Effect levels can be changed using the slider below Face Brightener.
- Move the cursor over the image. The shape of the cursor changes to **+** (Cross).

5. Drag to select the area you want to correct, then click OK that appears over the image.

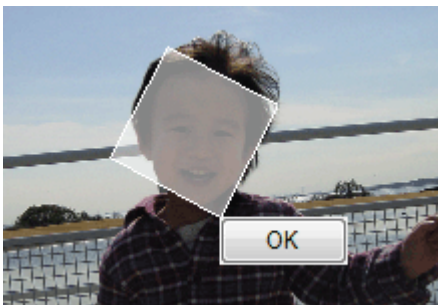

The entire image is corrected so that the selected area containing the face becomes brighter, and the  (Correction/Enhancement) mark appears on the upper left of the image.

Note

- You can also drag to rotate the selected area.
- Click Undo to undo the preceding correction operation.

6. Click Save Selected Image or Save All Corrected Images.

You can save corrected images as new files.

Note

- To save only the image you like, click Save Selected Image. To save all images, click Save All Corrected Images.
- Only JPEG/Exif file format is available for corrected images.

7. Click Exit.

Important

- The corrections will be lost if you exit before saving corrected images.

Advanced Guide

Advanced Guide > Printing from a Computer > Printing with the Bundled Application Software > Correcting and Enhancing Photos > Using the Face Sharpener Function

Easy-PhotoPrint EX

Using the Face Sharpener Function

You can sharpen out-of-focus faces in a photo.

You can perform the Face Sharpener function either automatically or manually.

1. Select photos in the Select Images screen, then click  (Correct/Enhance Images).

The Correct/Enhance Images window appears.

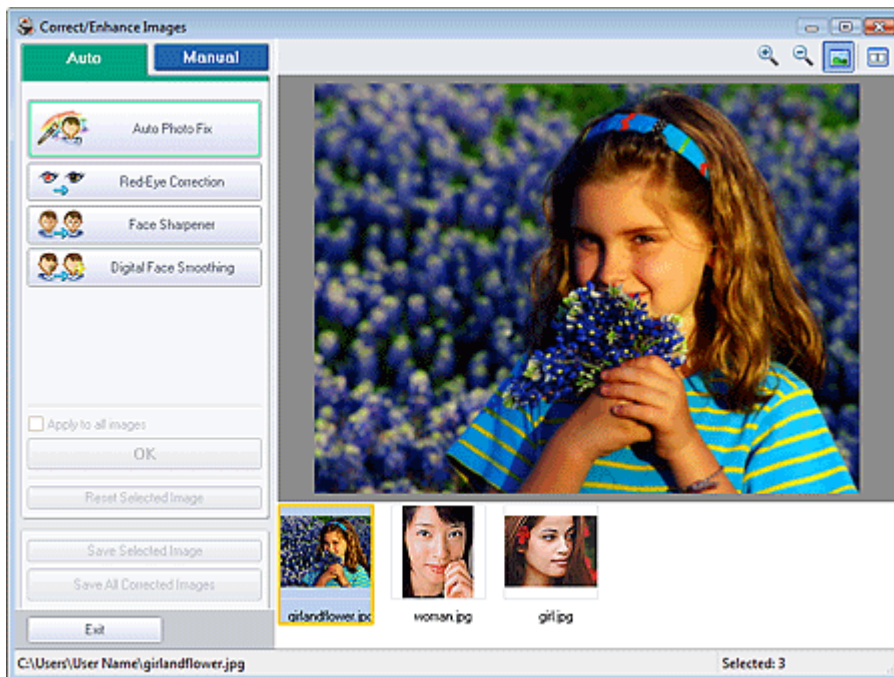

Note

- You can also display the Correct/Enhance Images window by clicking  (Correct/Enhance Images) in the Layout/Print or Edit screen. In that case, only the image displayed in Preview can be corrected/enhanced.
- See "[Correct/Enhance Images Window](#)" for details on the Correct/Enhance Images window.

2. Select the image you want to correct from the list displayed in the lower part of the Correct/Enhance Images window.

The image appears in Preview.

Note

- If only one image is selected, the thumbnail does not appear below Preview.

Auto Correction

3. Make sure that Auto is selected.

4. Click Face Sharpener.

Note

- Effect levels can be changed using the slider below Face Sharpener.

5. Click OK.

The face is sharpened and the  (Correction/Enhancement) mark appears on the upper left of the image.

Note

- Click  (Compare) to display the images before and after the correction side by side so that you can compare and check the result.
- Click Reset Selected Image to undo the correction operation.
- If you want to apply the correction to all the selected images at once, select the Apply to all images checkbox.

Manual Correction

3. Click Manual, then click Correct/Enhance.

4. Click Face Sharpener.

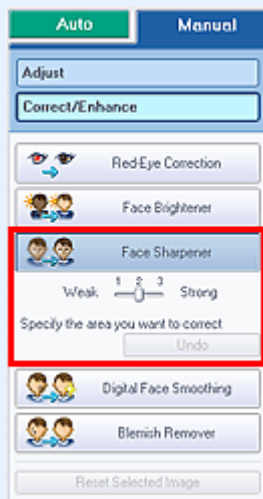

Note

- Effect levels can be changed using the slider below Face Sharpener.
- Move the cursor over the image. The shape of the cursor changes to  (Cross).

5. Drag to select the area you want to correct, then click OK that appears over the image.

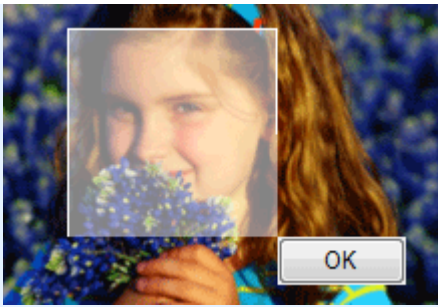

The facial area in and around the selected area is sharpened and the  (Correction/Enhancement) mark appears on the upper left of the image.

Note

- You can also drag to rotate the selected area.
- Click Undo to undo the preceding correction operation.

6. Click Save Selected Image or Save All Corrected Images.

You can save corrected images as new files.

Note

- To save only the image you like, click Save Selected Image. To save all images, click Save All Corrected Images.
- Only JPEG/Exif file format is available for corrected images.

7. Click Exit.

Important

- The corrections will be lost if you exit before saving corrected images.

Advanced Guide

Advanced Guide > Printing from a Computer > Printing with the Bundled Application Software > Correcting and Enhancing Photos > Using the Digital Face Smoothing Function

Easy-PhotoPrint EX

Using the Digital Face Smoothing Function

You can enhance skin beautifully by removing blemishes and wrinkles.

You can perform the Digital Face Smoothing function either automatically or manually.

1. Select photos in the Select Images screen, then click  (Correct/Enhance Images).

The Correct/Enhance Images window appears.



Note

- You can also display the Correct/Enhance Images window by clicking  (Correct/Enhance Images) in the Layout/Print or Edit screen. In that case, only the image displayed in Preview can be corrected/enhanced.
- See "[Correct/Enhance Images Window](#)" for details on the Correct/Enhance Images window.

2. Select the image you want to enhance from the list displayed in the lower part of the Correct/Enhance Images window.

The image appears in Preview.

Note

- If only one image is selected, the thumbnail does not appear below Preview.

Auto Enhancement

3. Make sure that Auto is selected.

4. Click Digital Face Smoothing.

Note

- Effect levels can be changed using the slider below Digital Face Smoothing.

5. Click OK.

Skin is enhanced beautifully and the  (Correction/Enhancement) mark appears on the upper left of the image.

Note

- Click  (Compare) to display the images before and after the enhancement side by side so that you can compare and check the result.
- Click Reset Selected Image to undo the enhancement operation.
- If you want to apply the enhancement to all the selected images at once, select the Apply to all images checkbox.

Manual Enhancement

3. Click Manual, then click Correct/Enhance.

4. Click Digital Face Smoothing.



Note

- Effect levels can be changed using the slider below Digital Face Smoothing.
- Move the cursor over the image. The shape of the cursor changes to  (Cross).

5. Drag to select the area you want to enhance, then click OK that appears over the image.

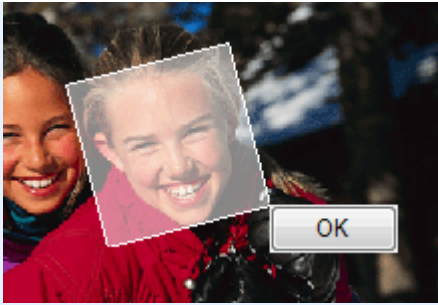

Skin in and around the selected area is enhanced beautifully and the  (Correction/Enhancement) mark appears on the upper left of the image.

Note

- You can also drag to rotate the selected area.
- Click Undo to undo the preceding enhancement operation.

6. Click Save Selected Image or Save All Corrected Images.

You can save enhanced images as new files.

Note

- To save only the image you like, click Save Selected Image. To save all images, click Save All Corrected Images.
- Only JPEG/Exif file format is available for enhanced images.

7. Click Exit.

Important

- The enhancements will be lost if you exit before saving enhanced images.

Advanced Guide

Advanced Guide > Printing from a Computer > Printing with the Bundled Application Software > Correcting and Enhancing Photos > Using the Blemish Remover Function

Easy-PhotoPrint EX

Using the Blemish Remover Function

You can remove moles.

1. Select photos in the Select Images screen, then click  (Correct/Enhance Images).

The Correct/Enhance Images window appears.

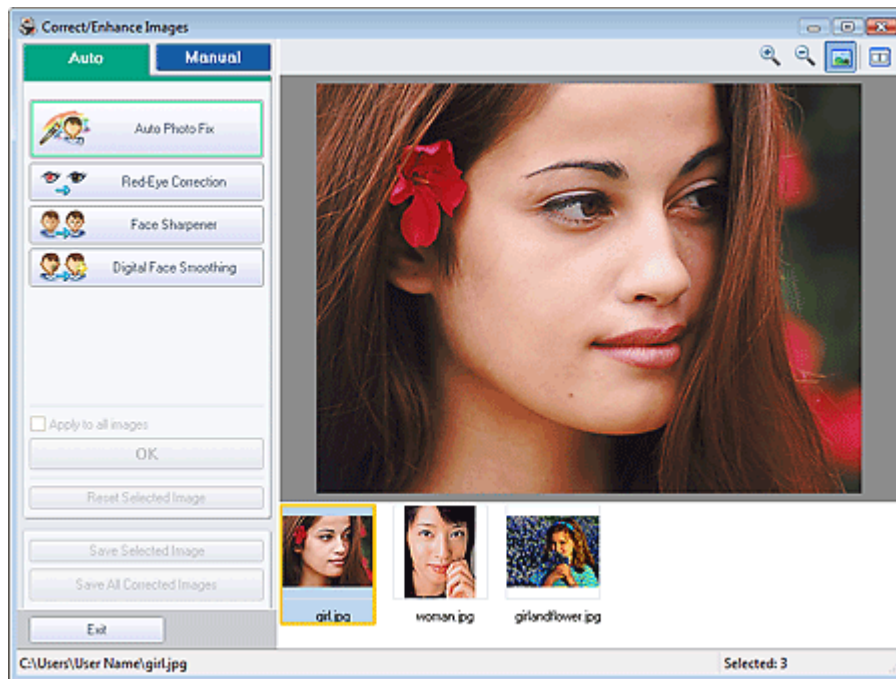

Note

- You can also display the Correct/Enhance Images window by clicking  (Correct/Enhance Images) in the Layout/Print or Edit screen. In that case, only the image displayed in Preview can be corrected/enhanced.
- See "[Correct/Enhance Images Window](#)" for details on the Correct/Enhance Images window.

2. Select the image you want to enhance from the list displayed in the lower part of the Correct/Enhance Images window.

The image appears in Preview.

Note

- If only one image is selected, the thumbnail does not appear below Preview.

3. Click Manual, then click Correct/Enhance.

4. Click Blemish Remover.



Note

- Move the cursor over the image. The shape of the cursor changes to **+** (Cross).

- Drag to select the area you want to enhance, then click OK that appears over the image.

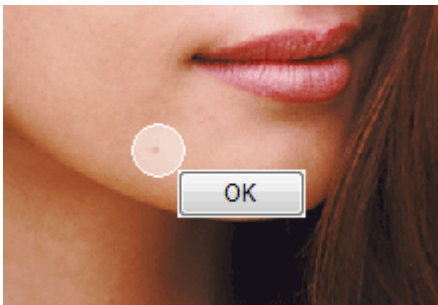

Moles in and around the selected area are removed and the  (Correction/Enhancement) mark appears on the upper left of the image.

Note

- Click Undo to undo the preceding enhancement operation.

- Click Save Selected Image or Save All Corrected Images.

You can save enhanced images as new files.

Note

- To save only the image you like, click Save Selected Image. To save all images, click Save All Corrected Images.
- Only JPEG/Exif file format is available for enhanced images.

- Click Exit.

Important

- The enhancements will be lost if you exit before saving enhanced images.

Advanced Guide

Advanced Guide > Printing from a Computer > Printing with the Bundled Application Software > Correcting and Enhancing Photos > Adjusting Images

Easy-PhotoPrint EX

Adjusting Images

You can make fine adjustments to the overall brightness, contrast, etc. of images.

1. Select photos in the Select Images screen, then click  (Correct/Enhance Images).

The Correct/Enhance Images window appears.

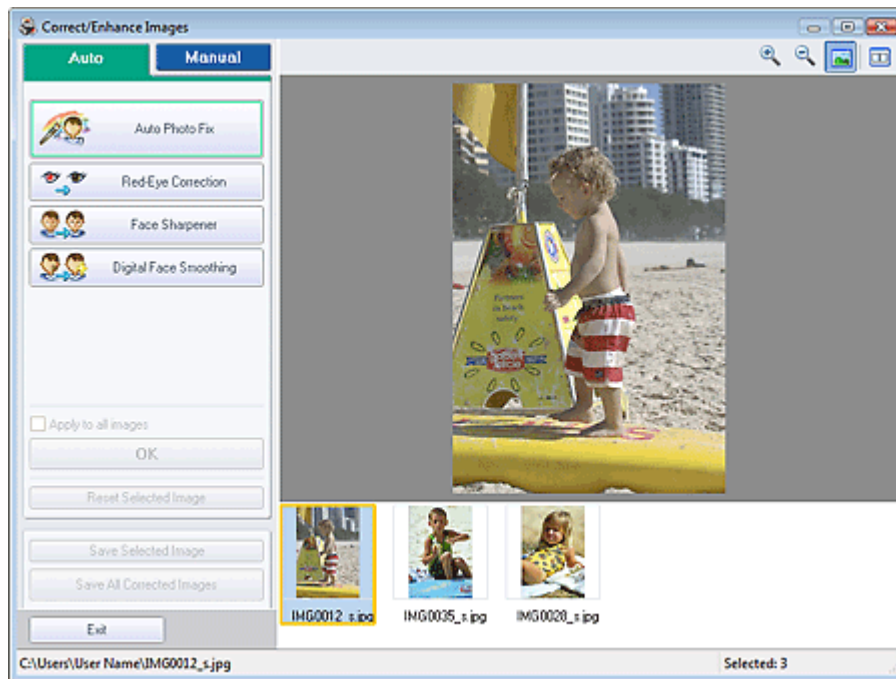

Note

- You can also display the Correct/Enhance Images window by clicking  (Correct/Enhance Images) in the Layout/Print or Edit screen. In that case, only the image displayed in Preview can be corrected/enhanced.
- See "[Correct/Enhance Images Window](#)" for details on the Correct/Enhance Images window.

2. Select the image you want to adjust from the list displayed in the lower part of the Correct/Enhance Images window.

The image appears in Preview.

Note

- If only one image is selected, the thumbnail does not appear below Preview.

3. Click Manual, then click Adjust.
4. Move the slider of the item you want to adjust and set the effect level.

The following adjustments are available:

Brightness

Contrast

Sharpness

Blur

Show-through Removal



Note

- Click Defaults to reset all adjustments.

5. Click Save Selected Image or Save All Corrected Images.

You can save adjusted images as new files.

Note

- To save only the image you like, click Save Selected Image. To save all images, click Save All Corrected Images.
- Only JPEG/Exif file format is available for adjusted images.

6. Click Exit.

Important

- The adjustments will be lost if you exit before saving adjusted images.

Advanced Guide

Advanced Guide > Printing from a Computer > Printing with the Bundled Application Software > Correcting and Enhancing Photos > Correct/Enhance Images Window

Easy-PhotoPrint EX

Correct/Enhance Images Window

You can correct/enhance images in this window.

To display the Correct/Enhance Images window, click  (Correct/Enhance Images) in the Select Images or Edit screen, or in the Layout/Print screen of Photo Print.

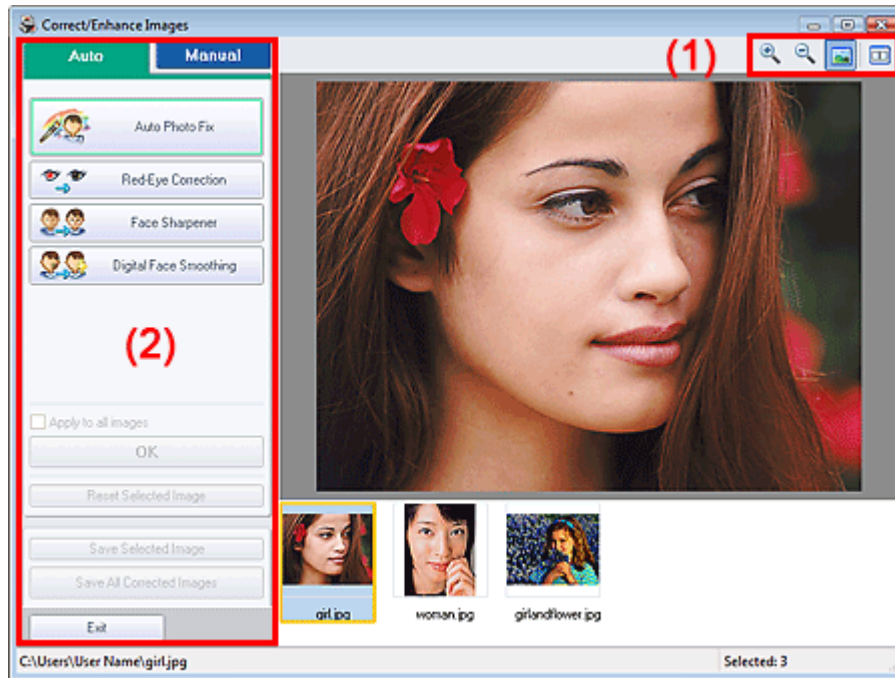

(1)Toolbar

Toolbar

(Zoom In/Zoom Out)

Displays the enlarged or reduced preview of the page.

(Full Screen)

Displays the entire image in Preview.

(Compare)

Displays the Compare Images window. You can compare the images before and after the correction/enhancement side by side.

The image before the correction/enhancement is displayed on the left, and the image after the correction/enhancement is displayed on the right.

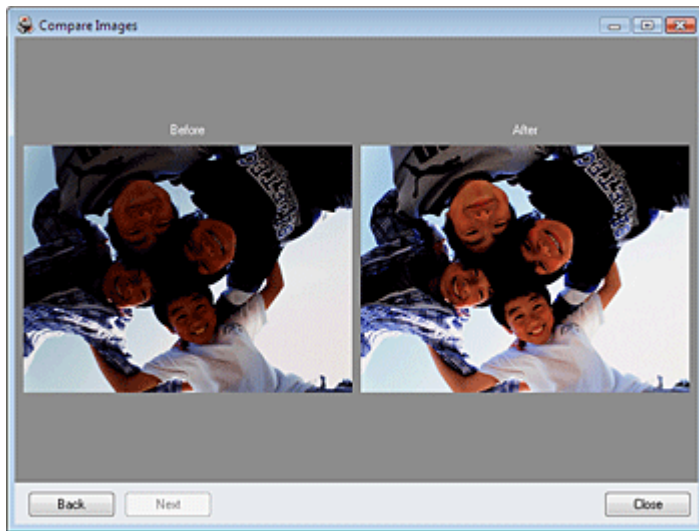

(2)Task Area

Available tasks and settings may vary between the Auto and Manual tabs.

Click Auto or Manual to display the corresponding tab.

Auto Tab

Select to correct automatically.

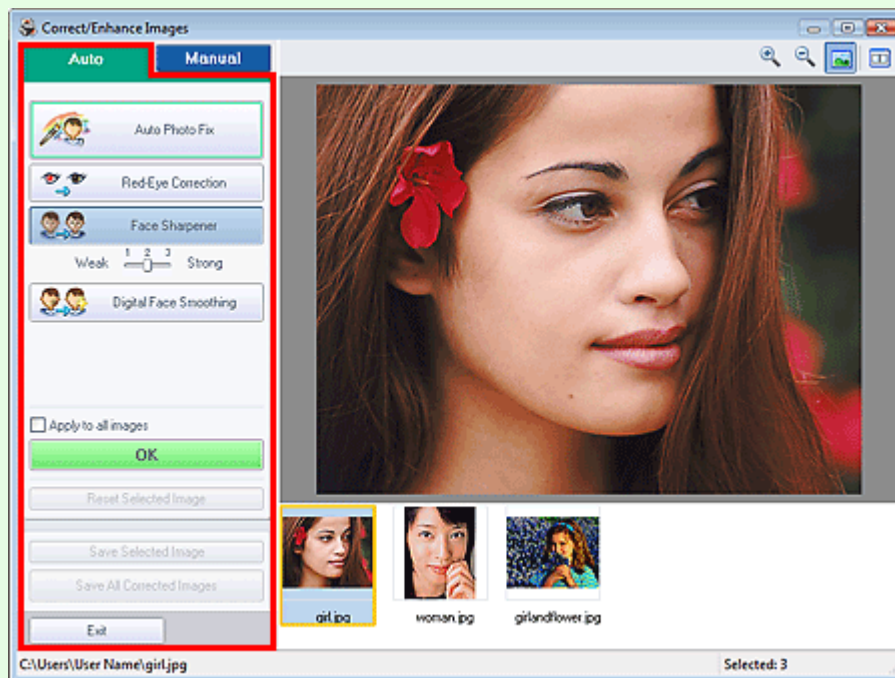

Auto Photo Fix

Applies automatic corrections suitable for photos.

Important

- The Auto Photo Fix function is not available for Photo Print. Photo Print allows you to automatically apply suitable corrections to all photos when printing. Select this option in Color correction for printing on the Advanced tab of the Preferences dialog box. To display the Preferences dialog box, click  (Settings) in the Layout/Print screen or select Preferences... from the File menu.

Prioritize Exif Info

Select this checkbox to apply corrections primarily based on the settings made at the time of

shooting.

Deselect this checkbox to apply corrections based on the image analysis results. It is recommended that you normally select this setting.



Note

- Exif is a standard format for embedding various shooting data in digital camera images (JPEG).
- For Photo Print, you can apply suitable corrections based on Exif information automatically by selecting Enable Auto Photo Fix in Color correction for printing on the Advanced tab of the Preferences dialog box and selecting the Prioritize Exif Info checkbox.

Red-Eye Correction

Corrects red eyes.



Note

- For Photo Print, you can also correct red eyes by selecting Enable Auto Photo Fix in Color correction for printing on the Advanced tab of the Preferences dialog box and selecting the Enable Red-Eye Correction checkbox.

Face Sharpener

Sharpens out-of-focus faces.

You can adjust the effect level using the slider.

Digital Face Smoothing

Enhances skin beautifully by removing blemishes and wrinkles.

You can adjust the effect level using the slider.

Apply to all images

Automatically corrects all the images displayed in the list.

OK

Applies the selected effect to the selected image or all images.

Reset Selected Image

Cancels all corrections and enhancements applied to the selected image.

Save Selected Image

Saves the selected image in the list that applied corrections and enhancements.

Save All Corrected Images

Saves all the images that applied corrections and enhancements displayed in the list.

Exit

Click to close the Correct/Enhance Images window.

Manual Tab

Select to correct manually.

Use Adjust to adjust brightness and contrast, or to sharpen the entire image.

Use Correct/Enhance to correct/enhance specific areas.

Adjust

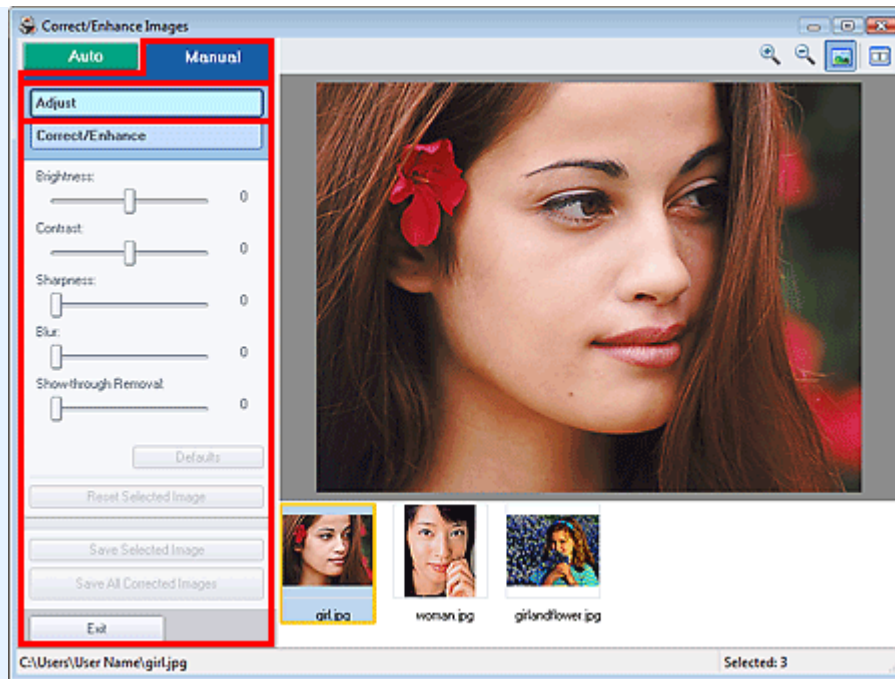

Brightness

Adjusts the overall image brightness.
Move the slider to the left to darken and right to brighten the image.

Contrast

Adjusts the contrast of the image. Adjust the contrast when the image is flat due to lack of contrast.
Move the slider to the left to decrease and right to increase the contrast of the image.

Sharpness

Emphasizes the outline of the subjects to sharpen the image. Adjust the sharpness when the photo is out of focus or text is blurred.
Move the slider to the right to sharpen the image.

Blur

Blurs the outline of the subjects to soften the image.
Move the slider to the right to soften the image.

Show-through Removal

Removes show-through of text from the reverse side or removes the base color. Adjust the show-through level to prevent text on the reverse side of thin document or the base color of the document from appearing on the image.
Move the slider to the right to increase the show-through removal effect.

Defaults

Resets each adjustment (brightness, contrast, sharpness, blur, and show-through removal).

Reset Selected Image

Cancels all adjustments applied to the selected image.

Save Selected Image

Saves the selected image in the list that applied adjustments.

Save All Corrected Images

Saves all the images that applied adjustments displayed in the list.

Exit

Click to close the Correct/Enhance Images window.

Correct/Enhance



Red-Eye Correction

Corrects red eyes.

You can specify the area you want to apply the effect to. You can adjust the effect level using the slider.

Note

- For Photo Print, red eyes are automatically corrected when Enable Auto Photo Fix is selected in Color correction for printing on the Advanced tab of the Preferences dialog box and the Enable Red-Eye Correction checkbox is selected. To disable the automatic correction, deselect the checkbox.

Face Brightener

Corrects the entire image so that the selected facial area is brightened.

You can adjust the effect level using the slider.

Face Sharpener

Sharpens out-of-focus faces.

You can specify the area you want to apply the effect to. You can adjust the effect level using the slider.

Digital Face Smoothing

Enhances skin beautifully by removing blemishes and wrinkles.

You can specify the area you want to apply the effect to. You can adjust the effect level using the slider.

Blemish Remover

Removes moles.

You can specify the area you want to apply the effect to.

OK

Applies the selected effect to the specified area.

Undo

Cancels the latest correction/enhancement.

Reset Selected Image

Cancels all corrections and enhancements applied to the selected image.

Save Selected Image

Saves the selected image in the list that applied corrections and enhancements.

Save All Corrected Images

Saves all the images that applied corrections and enhancements displayed in the list.

Exit

Click to close the Correct/Enhance Images window.

[Page top](#) ↕

Advanced Guide

[Advanced Guide](#) > [Printing from a Computer](#) > [Printing with the Bundled Application Software](#) > [Questions and Answers](#)

Easy-PhotoPrint EX

Questions and Answers

- ➔ [How Can I Move \(or Copy\) the Saved File?](#)
- ➔ [Which Side of the Displayed Image Does the Printing Start from?](#)
- ➔ [How Do I Print with Even Margins?](#)
- ➔ [What Is "C1" or "C4"?](#)

[Page top](#)↑

Advanced Guide

Advanced Guide > Printing from a Computer > Printing with the Bundled Application Software > Questions and Answers
> How Can I Move (or Copy) the Saved File?

Easy-PhotoPrint EX



How Can I Move (or Copy) the Saved File?

If you want to move (or copy) a file created and saved with Easy-PhotoPrint EX from one folder to another, you need to move (or copy) the folder that was automatically created when originally saving that file as well.

For example, when you save a file named "MyAlbum.el1," a folder named "MyAlbum.el1.Data" is automatically created in the same folder that contains the "MyAlbum.el1" file. If you want to move (or copy) the "MyAlbum.el1" file to another folder, move (or copy) the "MyAlbum.el1.Data" folder as well. The "MyAlbum.el1.Data" folder contains the photos used in the album.

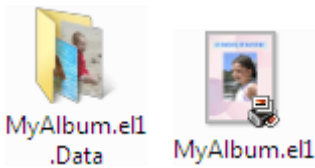

Note

- The icons may vary depending on the items.

Important

- Do not change the Data folder name; otherwise you will not be able to display the photos you edited with Easy-PhotoPrint EX.

[Page top](#)

Advanced Guide

Advanced Guide > Printing from a Computer > Printing with the Bundled Application Software > Questions and Answers
> Which Side of the Displayed Image Does the Printing Start from?

Easy-PhotoPrint EX



Which Side of the Displayed Image Does the Printing Start from?

As shown below, printing starts from the left side of the image displayed in the Layout/Print screen.



Outputs the paper in the direction as the arrow indicates.

See your printer manual for details on how to load paper (to print on the front/back, etc.).

[Page top](#)

Advanced Guide

[Advanced Guide](#) > [Printing from a Computer](#) > [Printing with the Bundled Application Software](#) > [Questions and Answers](#)
> [How Do I Print with Even Margins?](#)

Easy-PhotoPrint EX



How Do I Print with Even Margins?

When you print on a bordered layout, the margins on the left and right or the top and bottom may become wider than the other, depending on the image and printer.

To always print with even margins, select the Always crop images when selecting a layout with margins checkbox on the Advanced tab of the Preferences dialog box.

To display the Preferences dialog box, click  (Settings) in the Layout/Print screen or select Preferences... from the File menu.

Crop the photo to apply even margins individually.

➔ [Cropping Photos \(Photo Print\)](#)

Note

- This setting is available for Photo Print only.

[Page top](#)↑

Advanced Guide

Advanced Guide > Printing from a Computer > Printing with the Bundled Application Software > Questions and Answers
> What Is "C1" or "C4"?

Easy-PhotoPrint EX



What Is "C1" or "C4"?

When an album is printed, labels such as "C1" and "C4" are printed as page numbers.

The "C1" and "C4" represent the front cover and back cover, respectively.

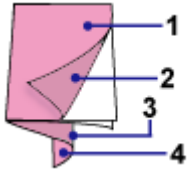

C1: Front cover

C2: Inside the front cover

C3: Inside the back cover

C4: Back cover

[Page top](#) ↕

Advanced Guide

[Advanced Guide](#) > [Printing from a Computer](#) > [Printing with the Bundled Application Software](#) > [Photo Print Settings](#)

Easy-PhotoPrint EX

Photo Print Settings

- ➔ [Printing on a DVD/CD](#)
- ➔ [Printing Photos in Grayscale](#)
- ➔ [Printing Vivid Photos](#)
- ➔ [Reducing Photo Noise](#)
- ➔ [Cropping Photos \(Photo Print\)](#)
- ➔ [Printing Dates on Photos \(Photo Print\)](#)
- ➔ [Printing Multiple Photos on One Page](#)
- ➔ [Printing an Index](#)
- ➔ [Printing ID Photos \(ID Photo Print\)](#)
- ➔ [Printing Photo Information](#)
- ➔ [Saving Photos](#)
- ➔ [Opening Saved Files](#)

[Page top](#)↑

Advanced Guide

Advanced Guide > Printing from a Computer > Printing with the Bundled Application Software > Photo Print Settings > Printing on a DVD/CD

Easy-PhotoPrint EX



Printing on a DVD/CD

You can print on a DVD/CD using Photo Print.

Select CD-R for Paper Size in the Select Paper screen, then select a layout and enter the title.

If you want to edit the details, return to Menu and select DVD/CD Label and edit/print using CD-LabelPrint.

Follow the steps for other items to complete image selection in the Select Images screen.

➔ Selecting a Photo

Important

- Do not attach the CD-R Tray until the message asking you to load the DVD/CD is displayed. Doing so can damage the printer.

1. Select CD-R for Paper Size in the Select Paper screen.

Set the Printer and Media Type according to the printer and DVD/CD to be used.

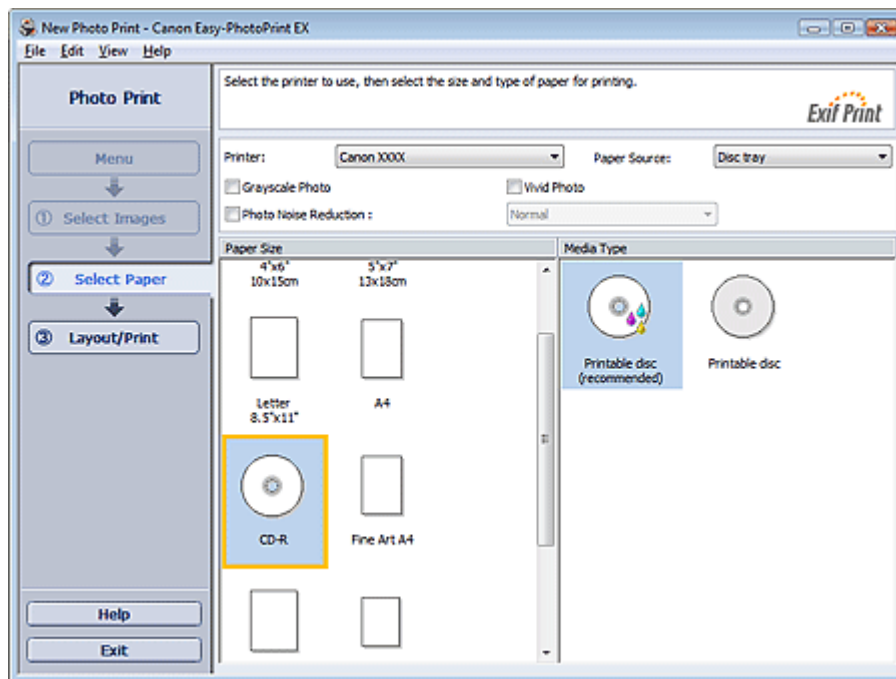

Note

- When CD-R is selected, only Disc tray will be selectable for Paper Source.

2. Click Layout/Print.

The Layout/Print screen appears.



3. Select a layout you want to use.
4. Enter the title(s) and specify the details of the layout in Advanced.

Note



- Items that can be set may vary depending on the selected layout.

5. Click Print.

Set a DVD/CD and print according to the message.

Printing starts from the top of the image displayed in Preview.

Note

- You can adjust the printing position on the DVD/CD in the Adjust dialog box. To display the Adjust dialog box, click  (Adjust Print Area/Print Position).
- You can specify advanced Photo Print settings (number of copies, print quality, etc.) in the Preferences dialog box. To display the Preferences dialog box, click  (Settings) or select Preferences... from the File menu.

Advanced Guide

Advanced Guide > Printing from a Computer > Printing with the Bundled Application Software > Photo Print Settings > Printing Photos in Grayscale

Easy-PhotoPrint EX



Printing Photos in Grayscale

Select the Grayscale Photo checkbox in the Select Paper screen to print photos in grayscale.

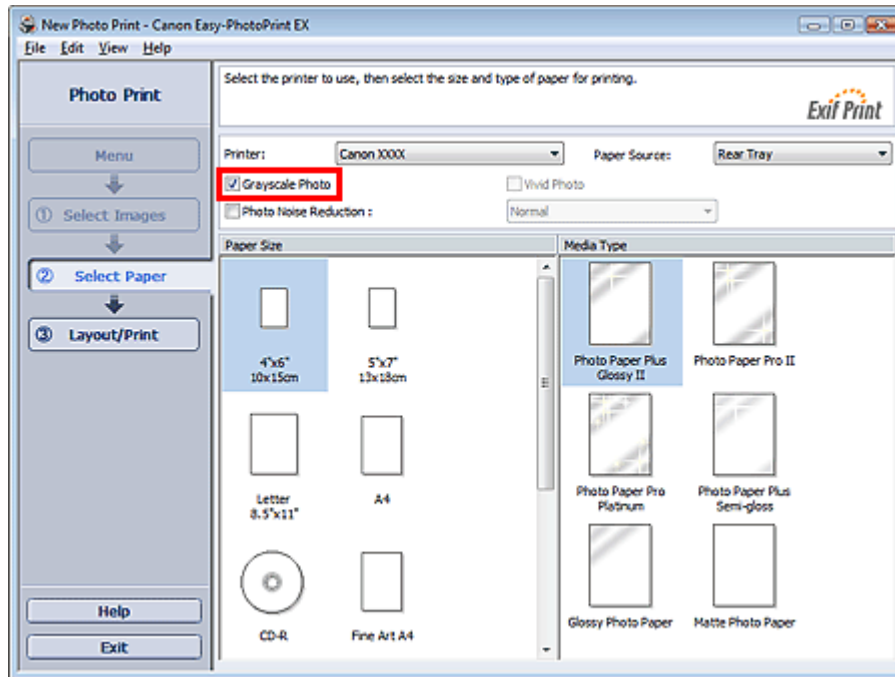

Important

- Vivid Photo is not available when the Grayscale Photo checkbox is selected.
 - White streaks may appear at the top and bottom edges of grayscale photos. In that case, print with a 45 mm (1.77 inch) or more margin at the top and bottom edges.
- If you select Bordered (Margin 45) from the layouts in the Layout/Print screen, images will be reduced when printing to allow a 45 mm (1.77 inch) margin at the top and bottom edges relative to the printing direction.

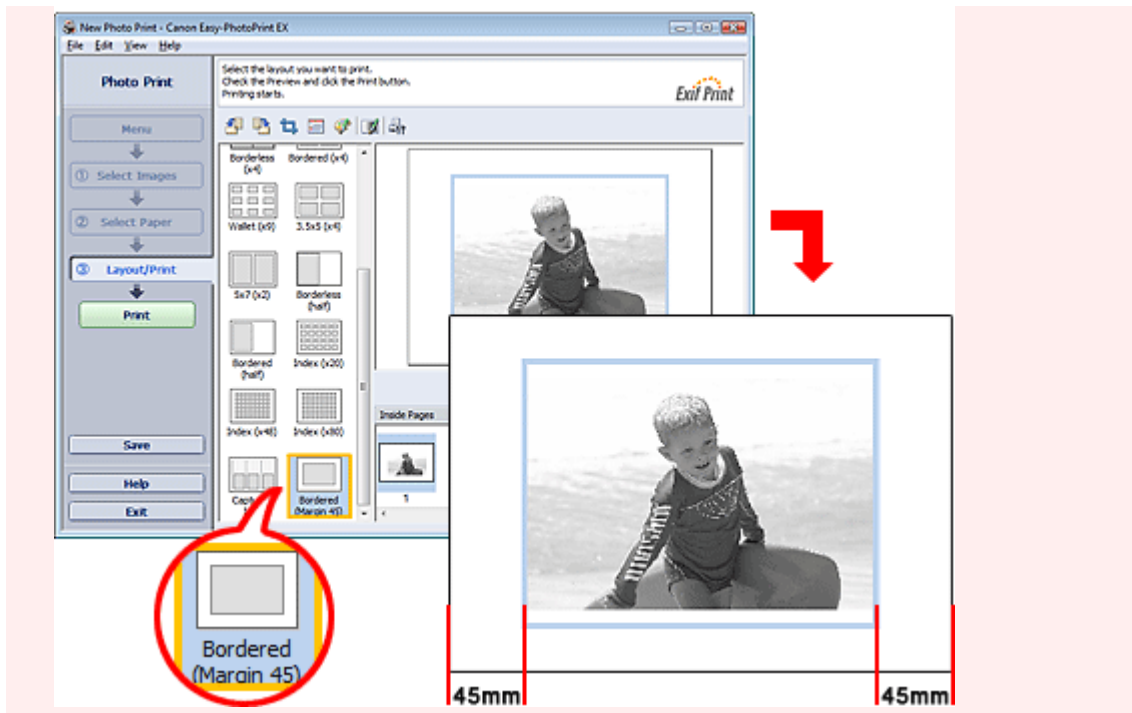

Note

- When the Grayscale Photo checkbox is selected, preview images appear in grayscale in the Layout/Print screen. However, they appear in color in the Correct/Enhance Images window.
- In the Adjust Grayscale window, you can adjust the black color tone of grayscale photos. To display the Adjust Grayscale window, select the Grayscale Photo checkbox in the Select Paper screen and click  (Adjust Grayscale) in the Layout/Print screen. See Help for details.

Advanced Guide

Advanced Guide > Printing from a Computer > Printing with the Bundled Application Software > Photo Print Settings > Printing Vivid Photos

Easy-PhotoPrint EX



Printing Vivid Photos

Select the Vivid Photo checkbox in the Select Paper screen to boost the colors in a photo before printing.

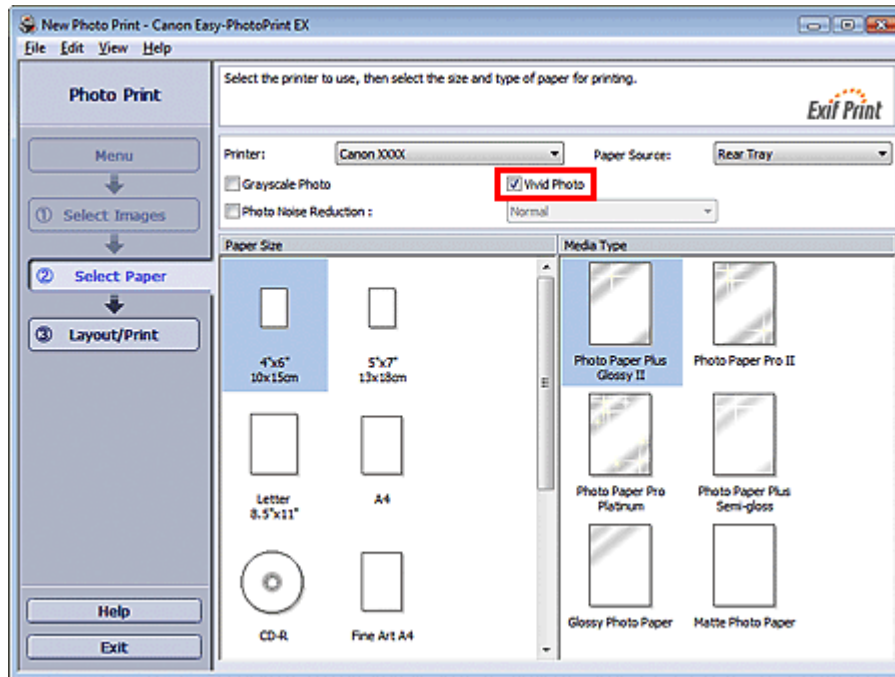

Important

- This function is available only with a printer that supports Vivid Photo.
- This function is not available when Enable ICC Profile is selected on the Advanced tab of the Preferences dialog box.

Note

- Even if you select the Vivid Photo checkbox, this effect applies only to the print result. The original image or preview image will not be affected.

[Page top](#)

Advanced Guide

Advanced Guide > Printing from a Computer > Printing with the Bundled Application Software > Photo Print Settings > Reducing Photo Noise

Easy-PhotoPrint EX



Reducing Photo Noise

When a photo is taken in a dark location such as night scene using digital camera, noise may appear in the image.

Select the Photo Noise Reduction checkbox in the Select Paper screen to reduce noise in the image and make the printed photos more vivid.

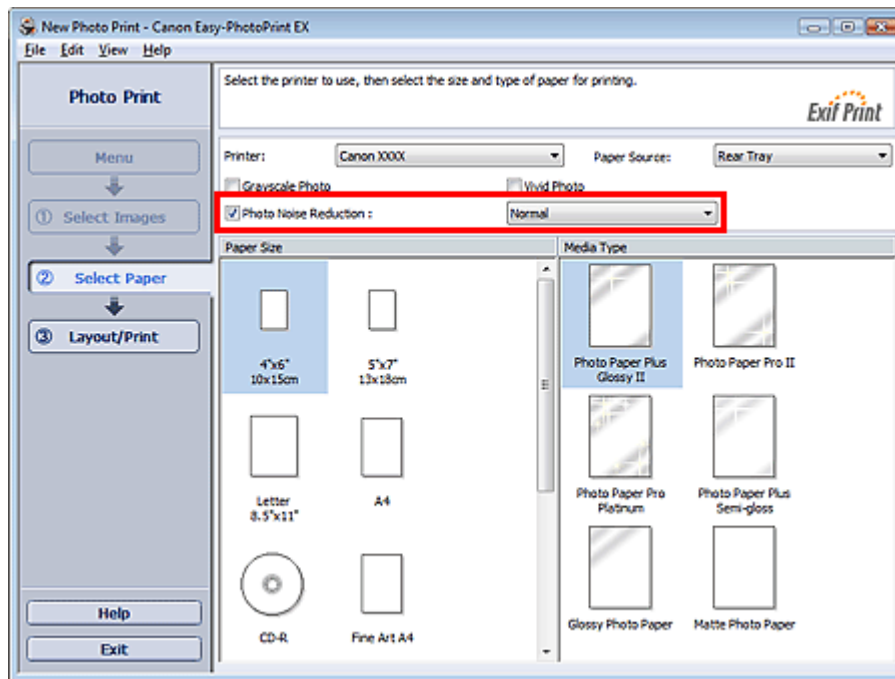

Important

- This function is not available when Enable ICC Profile is selected on the Advanced tab of the Preferences dialog box.

Note

- When the noise is severe, change Normal to Strong.
- The noise reduction effect applies only to the print result. The original image or preview image will not be affected.

Advanced Guide

Advanced Guide > Printing from a Computer > Printing with the Bundled Application Software > Photo Print Settings > Cropping Photos (Photo Print)

Easy-PhotoPrint EX



Cropping Photos (Photo Print)

Cropping a photo is the act of removing the unnecessary portions of the photo by selecting the necessary portions.

Click  (Crop Image) in the Layout/Print screen or double-click the preview image.

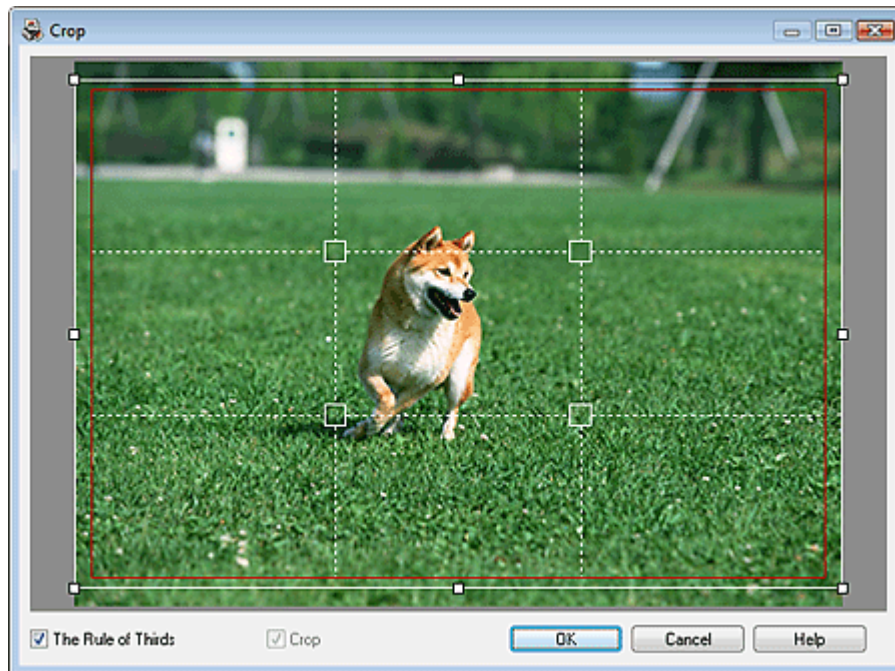

Move the white frame to the portion to print and click OK.

Note

- To move the cropping area, place the cursor within the white frame and drag it. Drag the white lines to enlarge/reduce the cropping area.
- Select the The Rule of Thirds checkbox to display white broken lines. To create a balanced composition, drag any of the intersecting points (white squares) or white broken lines over the main subject of the photo.

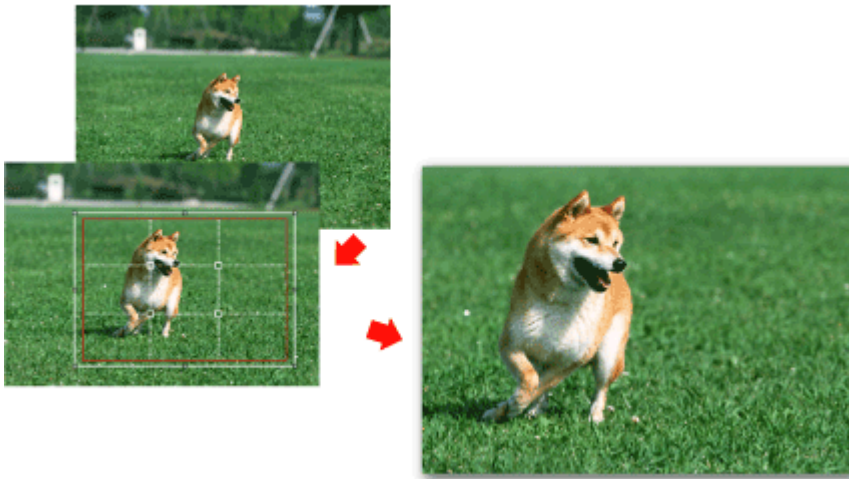

- The cropping effect applies only to the print result. The original image will not be cropped.
- See Help for details on the Crop window.

Advanced Guide

Advanced Guide > Printing from a Computer > Printing with the Bundled Application Software > Photo Print Settings > Printing Dates on Photos (Photo Print)

Easy-PhotoPrint EX



Printing Dates on Photos (Photo Print)

To print the date the photo was taken on the photo, click  (Date Settings) in the Layout/Print screen, then select the Print date checkbox in the Date Settings dialog box.

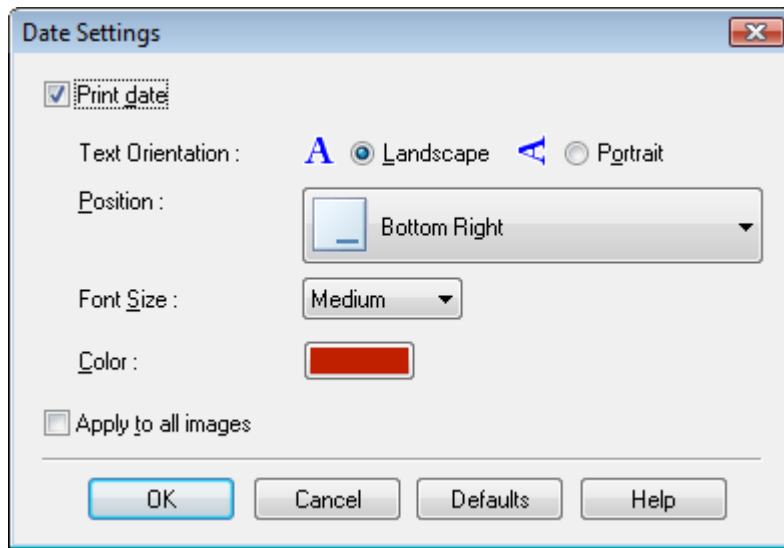

Note

- The date is displayed in the short date format (mm/dd/yyyy, etc.) specified in your operating system.
- See Help for details on setting dates.

[Page top](#)

Advanced Guide

Advanced Guide > Printing from a Computer > Printing with the Bundled Application Software > Photo Print Settings > Printing Multiple Photos on One Page

Easy-PhotoPrint EX



Printing Multiple Photos on One Page

You can print multiple photos on one page by selecting a multiple-photo layout in the Layout/Print screen.



Note

- See the following section for details on how to select photos.
 ➔ [Selecting a Photo](#)
- The available number of photos and layout may vary depending on the media type.
- Photos are arranged in the following order.

Example: Borderless (x4)

1	3
2	4

- You can change the printing order in Printing Order on the Print tab of the Preferences dialog box. You can select the printing order from By Date, By Name and By Selection.

To display the Preferences dialog box, click  (Settings) or select Preferences... from the File menu.

Advanced Guide

Advanced Guide > Printing from a Computer > Printing with the Bundled Application Software > Photo Print Settings > Printing an Index

Easy-PhotoPrint EX



Printing an Index

You can print an index of selected photos. An index print shows the thumbnails of the photos in one page. It is convenient for managing your photos.

To print an index, select Index from the layouts in the Layout/Print screen.

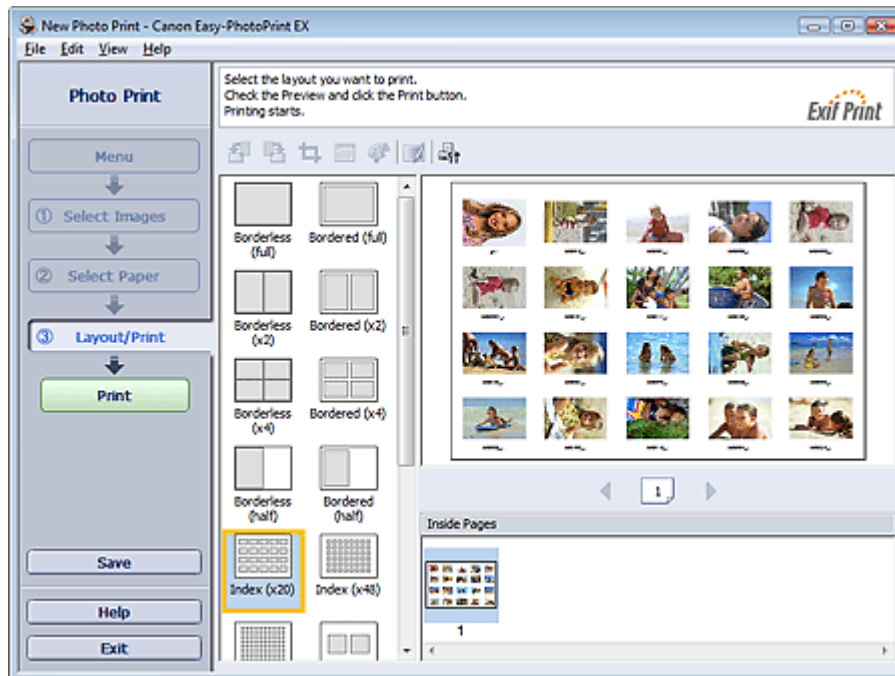

Important

- Index print will be disabled if you select any of the following paper sizes.
 - Credit Card
 - Fine Art A4
 - Fine Art Letter
 - CD-R
- You can print up to 80 images on one page.

Note

- See the following section for details on how to select photos.

➔ Selecting a Photo

- Photos are arranged in the following order.
Example: Index (x20)

1	2	3	4	5
6	7	8	9	10
11	12	13	14	15
16	17	18	19	20

- You can change the printing order in Printing Order on the Print tab of the Preferences dialog box. You can select the printing order from By Date, By Name, and By Selection.

To display the Preferences dialog box, click  (Settings) or select Preferences... from the File menu.

[Page top](#) 

Advanced Guide

Advanced Guide > Printing from a Computer > Printing with the Bundled Application Software > Photo Print Settings > Printing ID Photos (ID Photo Print)

Easy-PhotoPrint EX



Printing ID Photos (ID Photo Print)

You can print a variety of ID photos.

Important

- The photo may not qualify as an official ID photo depending on its use. For details, contact the party to whom you will be submitting the photo.

To print ID photos, select 4"x6" 10x15cm for Paper Size in the Select Paper screen, and select a layout of the ID photo from the layouts in the Layout/Print screen.

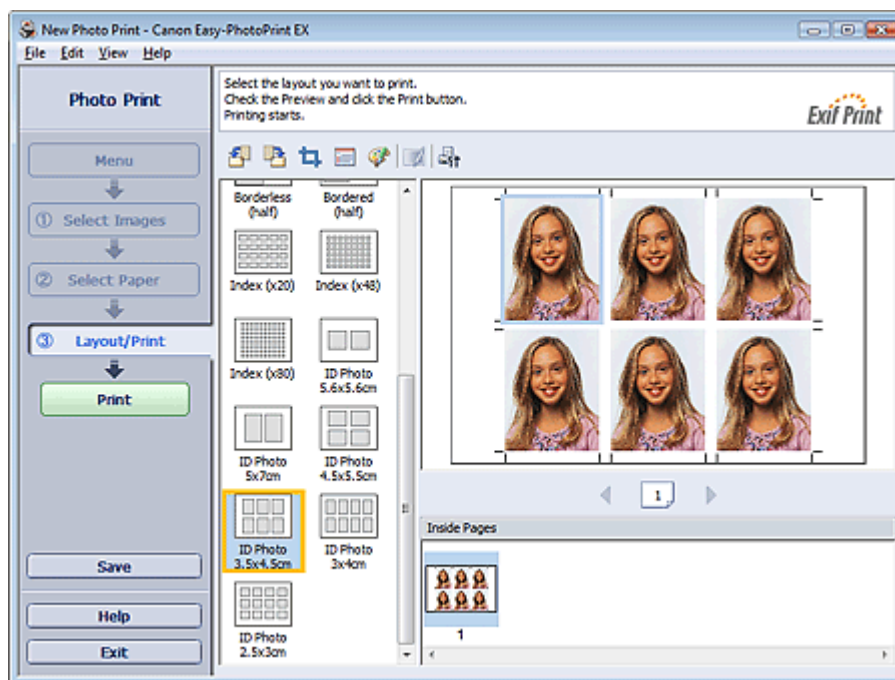

Note

- See the following section for details on how to select photos.
➔ [Selecting a Photo](#)
- Photos are arranged in the following order.
Example: ID Photo 3.5x4.5cm



- You can change the printing order in Printing Order on the Print tab of the Preferences dialog box. You can select the printing order from By Date, By Name, and By Selection.
To display the Preferences dialog box, click  (Settings) or select Preferences... from the File menu.
- ID photos can only be printed on 4"x6" 10x15cm paper.

[Page top](#) 

Advanced Guide

Advanced Guide > Printing from a Computer > Printing with the Bundled Application Software > Photo Print Settings > Printing Photo Information

Easy-PhotoPrint EX



Printing Photo Information

You can print the photo and the Exif information side by side.

To print them, select Letter 8.5"x11" or A4 for Paper Size in the Select Paper screen, and select Captured Info from the layouts in the Layout/Print screen.

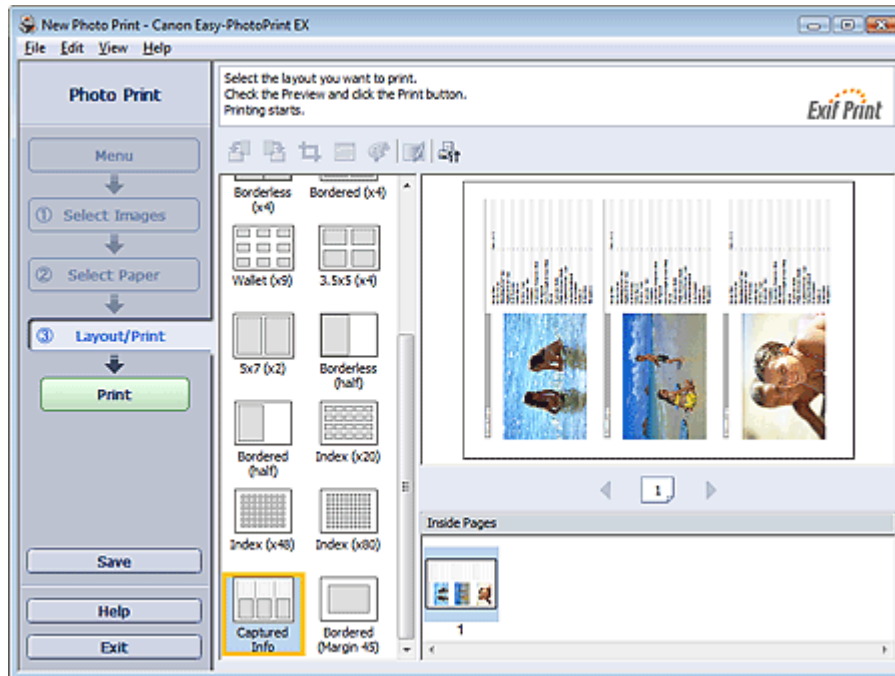

Note

- See the following section for details on how to select photos.
 - ➔ [Selecting a Photo](#)
- This function is available only on paper sizes Letter 8.5"x11" and A4.

[Page top](#)

Advanced Guide

Advanced Guide > Printing from a Computer > Printing with the Bundled Application Software > Photo Print Settings > Saving Photos

Easy-PhotoPrint EX



Saving Photos

You can save edited photos. The information of cropping and layout can be saved.

Click Save in the Layout/Print screen.

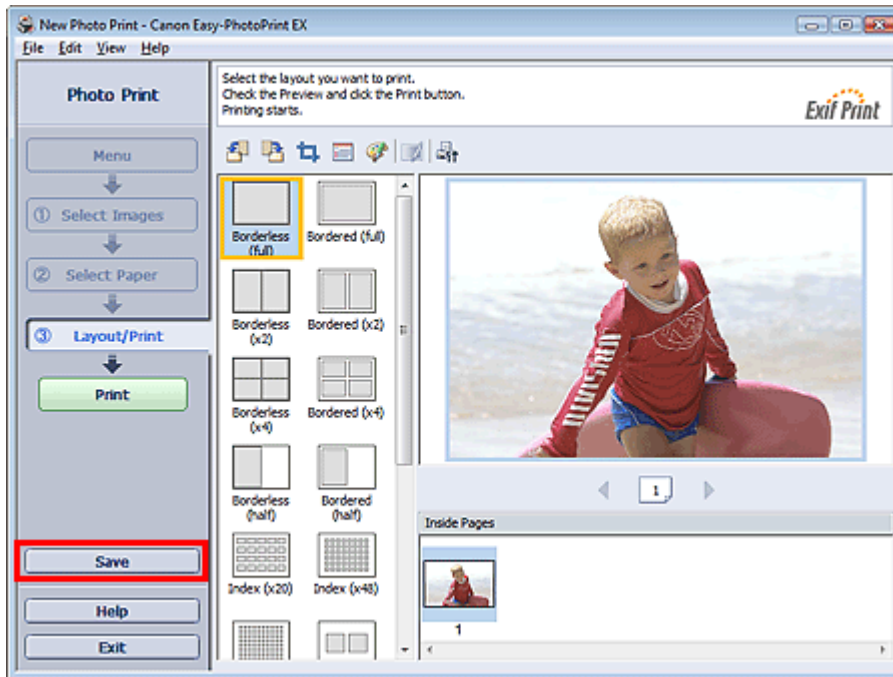

When the Save As dialog box appears, specify the save location and file name, then click Save.

Important

- If you edit a saved file and save it again, the file will be overwritten.
To save a file again with a new name or to a different location, select Save As... from the File menu and save.

Note

- Save will not be displayed in the Select Images or Select Paper screen.

[Page top](#)

Advanced Guide

Advanced Guide > Printing from a Computer > Printing with the Bundled Application Software > Photo Print Settings > Opening Saved Files

Easy-PhotoPrint EX



Opening Saved Files

You can open files created with Easy-PhotoPrint EX.

1. Click Library from Menu.

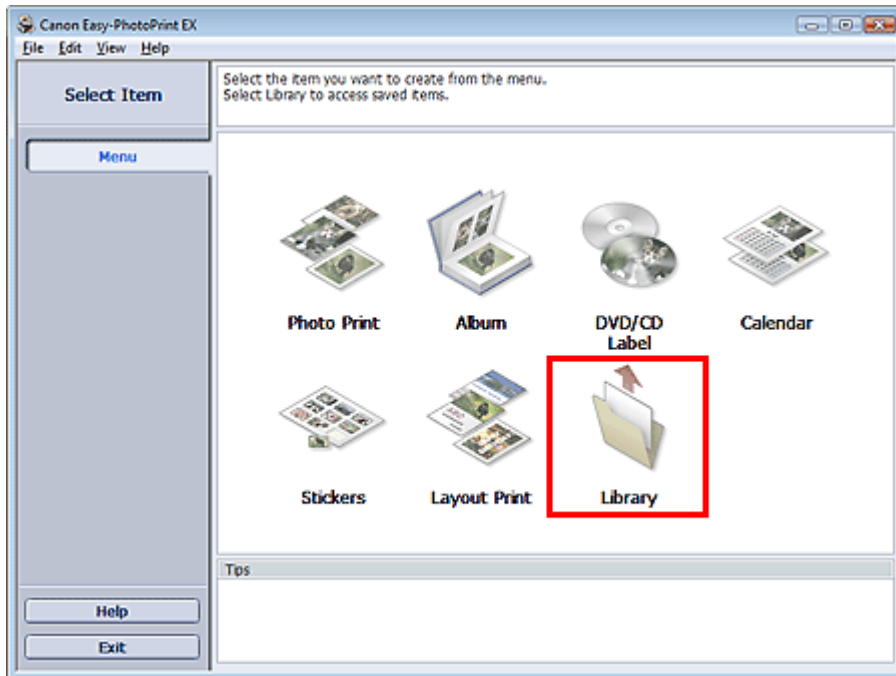

The Open dialog box appears.

You can check files created and saved with Easy-PhotoPrint EX by icon view (only for Windows Vista) or thumbnail view.

Important

- When using 64bit Edition of Windows Vista or Windows XP, the contents of files cannot be displayed on Explorer.

2. Select the file you want to open and click Open.

The Layout/Print screen appears.

Note

- Easy-PhotoPrint EX supports the following file format (extension).
 - Easy-PhotoPrint EX Photo Print file (.el6)

3. Edit the file if necessary.

Note

- You can open files created with Easy-PhotoPrint EX with the following methods, besides from Library in Menu.
 - Double-click or click the file.
 - From the File menu, click Open..., then select the file you want to edit.

- You can also open a recently used file by clicking the file name shown in the File menu.
-

[Page top](#) ↕

Advanced Guide

Advanced Guide > Printing from a Computer > Printing with the Bundled Application Software > Other Settings

Easy-PhotoPrint EX

Other Settings

- ➔ Changing Layout
- ➔ Changing Background
- ➔ Adding Photos
- ➔ Swapping Positions of Photos
- ➔ Replacing Photos
- ➔ Changing Position, Angle and Size of Photos
- ➔ Cropping Photos
- ➔ Framing Photos
- ➔ Printing Dates on Photos
- ➔ Attaching Comments to Photos
- ➔ Adding Text to Photos
- ➔ Saving
- ➔ Setting Holidays
- ➔ Setting Calendar Display
- ➔ Opening Saved Files

Page top↑

Advanced Guide

Advanced Guide > Printing from a Computer > Printing with the Bundled Application Software > Other Settings > Changing Layout

Easy-PhotoPrint EX



Changing Layout

You can change the layout of each page separately.

Select the page you want to change the layout of in the Edit screen, then click  (Change Layout).
Select the layout you want to use in the Change Layout dialog box and click OK.

Album

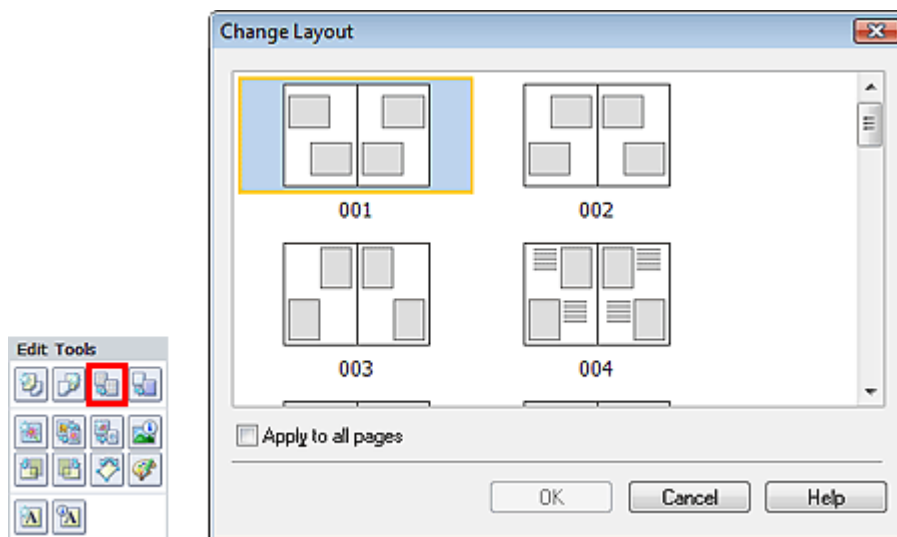

Important

- If the new layout has a different number of frames per page from the current layout, the following will happen:
 - If the number of layout frames is increased : Images will move from the subsequent pages to fill all the frames in the new layout.
 - If the number of layout frames is decreased : Pages with the new layout will be added until all the images on the pages with the current layout can be fitted.
- If you change the current layout for the front or back cover to one that has fewer layout frames, any image that does not fit in the new layout will be deleted, starting with the last image that was added to the former layout page.

Note

- The layouts that can be selected may vary depending on the Paper Size, Orientation, or the type of page selected (front cover, inside pages or back cover).
- Select the Apply to all pages checkbox to change the layouts of all pages to the one you newly selected.

Calendar

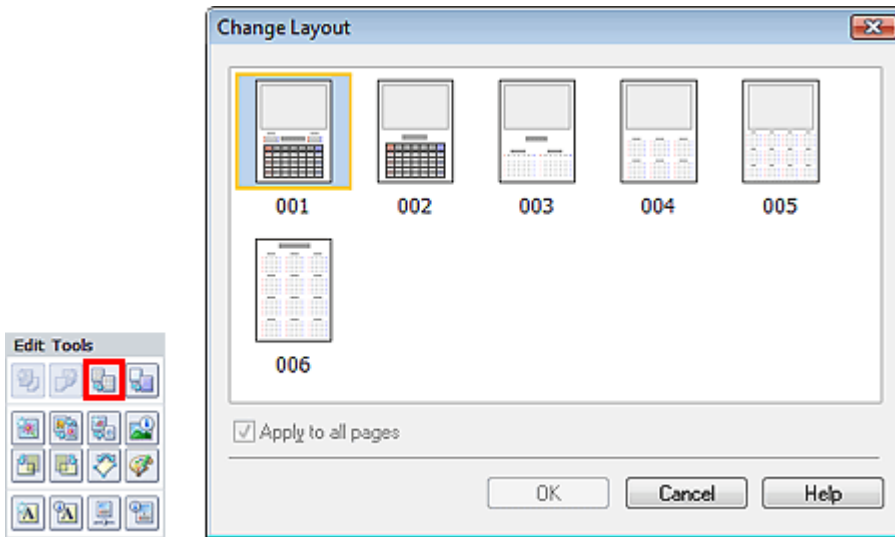

Important

- The layouts of all pages are changed to the selected layout.
- All images that do not fit in the new layout will be collected on the last page.

Note

- The layouts that can be selected may vary depending on the Paper Size and Orientation.

Layout Print

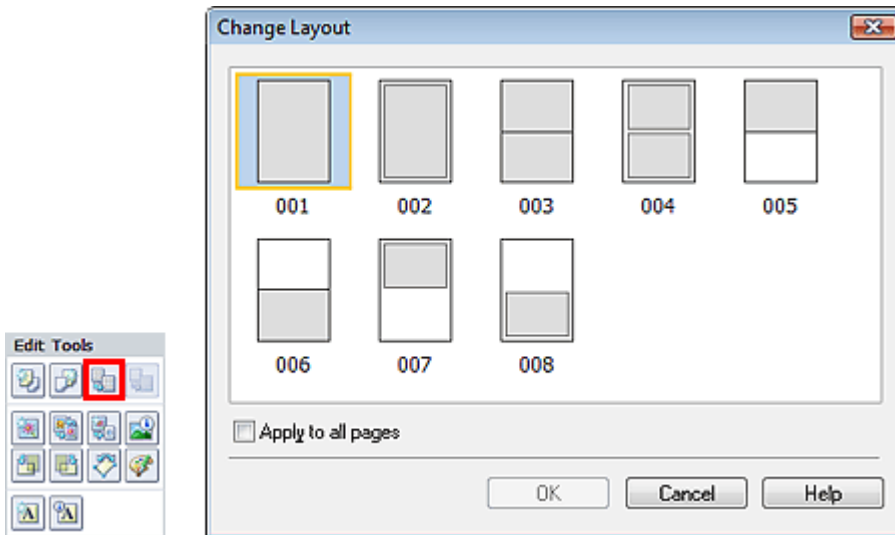

Important

- If the new layout has a different number of frames per page from the current layout, the following will happen:
 - If the number of layout frames is increased : Images will move from the subsequent pages to fill all the frames in the new layout.
 - If the number of layout frames is decreased : Pages with the new layout will be added until all the images on the pages with the current layout can be fitted.

Note

- The layouts that can be selected may vary depending on the Paper Size and Orientation.
- Select the Apply to all pages checkbox to change the layouts of all pages to the one you newly selected.

Advanced Guide

Advanced Guide > Printing from a Computer > Printing with the Bundled Application Software > Other Settings > Changing Background

Easy-PhotoPrint EX



Changing Background

You can change the background of each page.

Important

- You cannot change the background of the Photo Print, Stickers, and Layout Print.

Click Background... in the Page Setup screen or select the page you want to change the background of in the Edit screen, then click  (Change Background).

Note

- The screens for Album printing are used as examples in the following descriptions. The screens may vary depending on what you create.

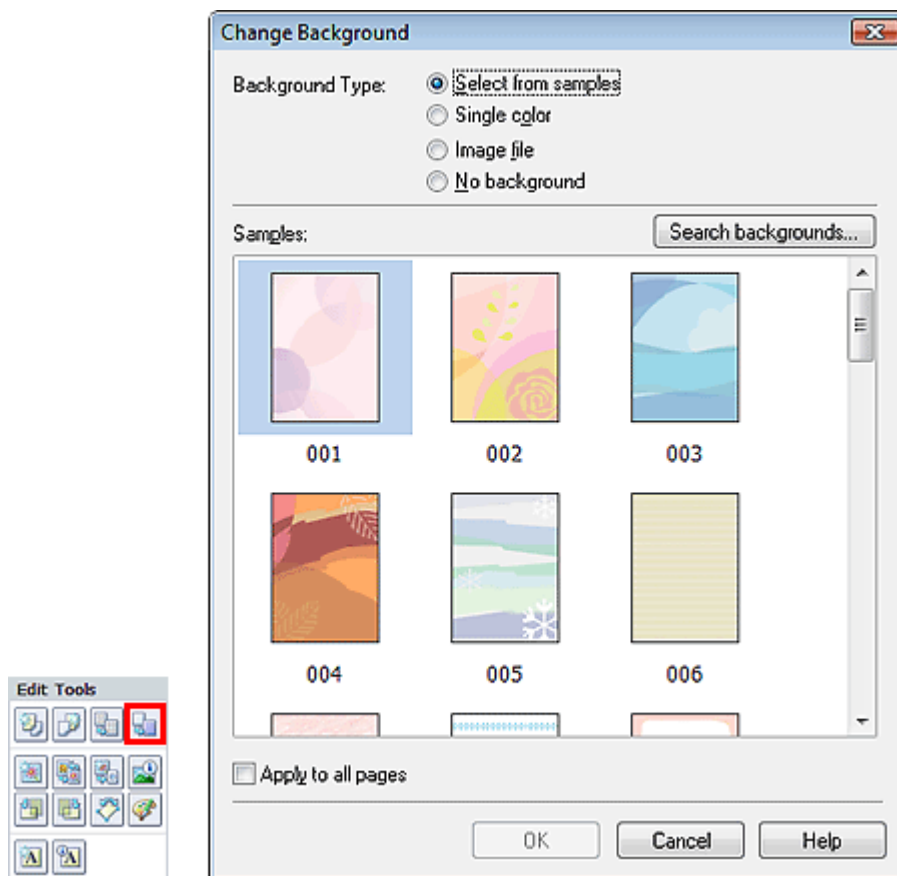

Select the type of background you want to use in the Change Background dialog box.

When Select from samples is Selected

Select the image you want to use from Samples and click OK.

Note

- Select from samples will be displayed only if Album has been selected.
- Various backgrounds are available on our website besides those saved in the application.

Click Search backgrounds... to access the Canon website from which you can download additional materials for free.

- Internet connection is required to access the website. Internet connection fees apply.
 - This function may not be available in some regions.
 - Exit Easy-PhotoPrint EX before installing backgrounds.
-

When Single color is Selected

Select the color you want to use from Standard color or Custom color and click OK.

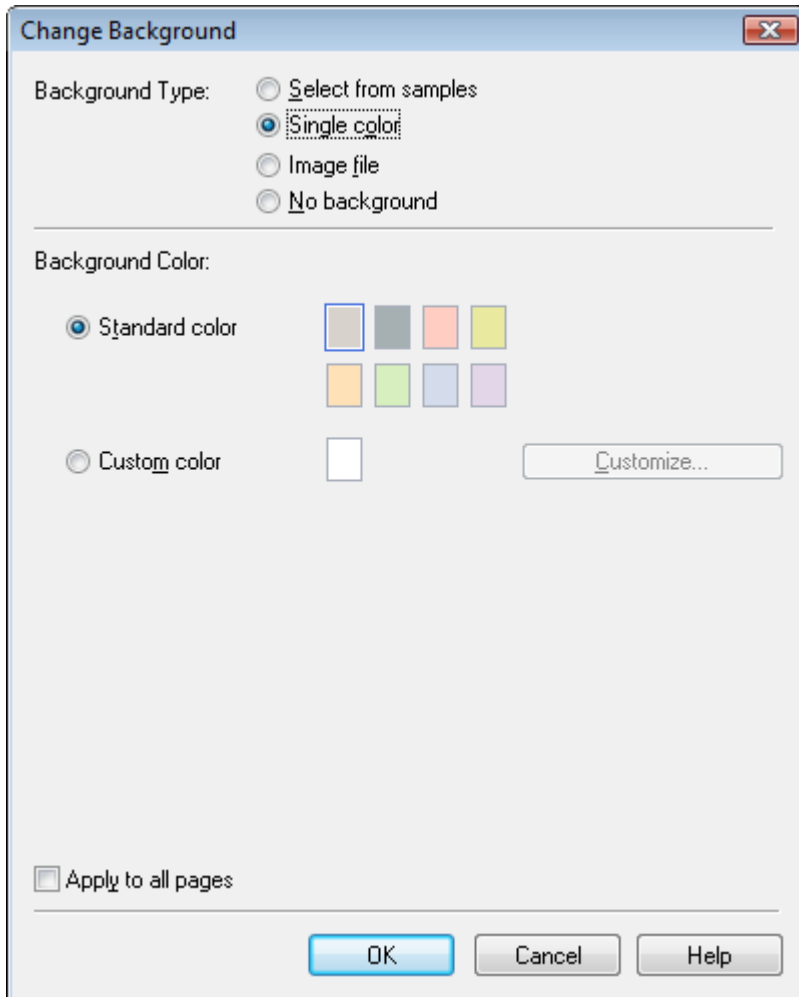

When Image file is Selected

Set Image File Path and Image Layout, then click OK.

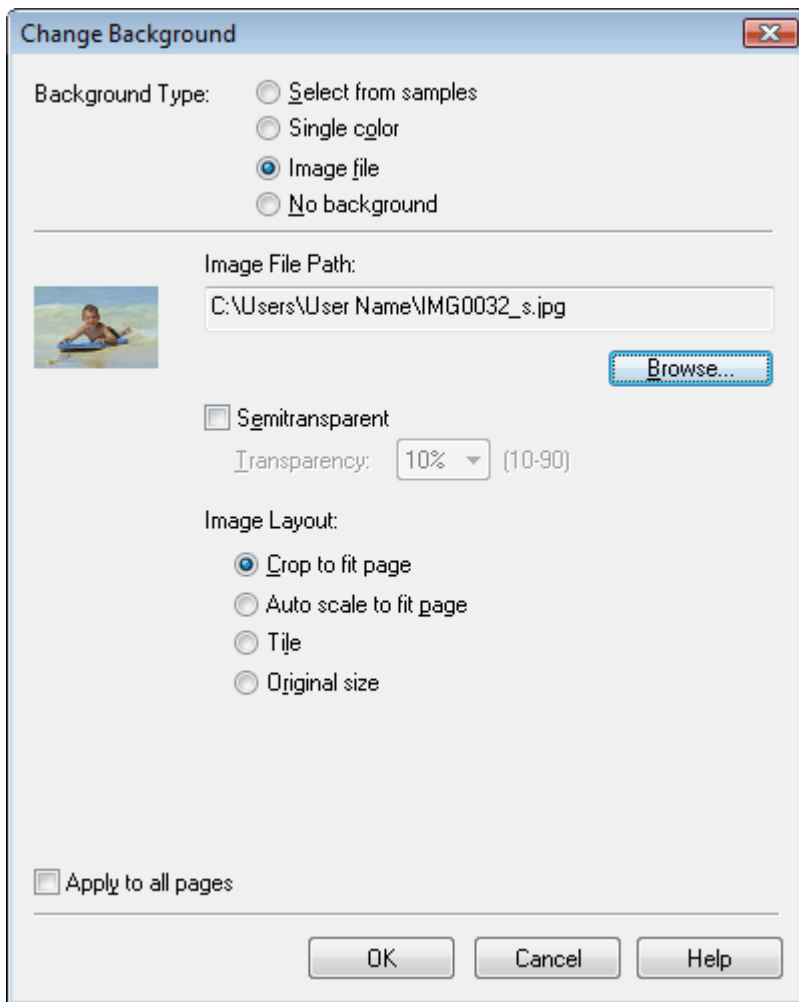

Note

- See Help for details on how to set the background in the Change Background dialog box.

Advanced Guide

Advanced Guide > Printing from a Computer > Printing with the Bundled Application Software > Other Settings > Adding Photos

Easy-PhotoPrint EX



Adding Photos

You can add images to pages.

Select the page you want to add photos in the Edit screen, then click  (Add Image).

Note

- The screens for Album printing are used as examples in the following descriptions. The screens may vary depending on what you create.

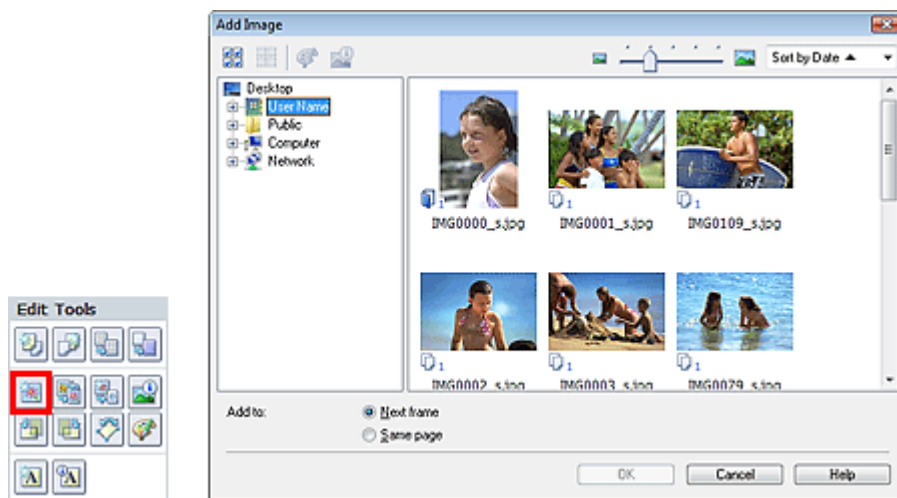

Select the folder containing the image you want to add from the folder tree area on the left of the Add Image dialog box, and select the image you want to add from the thumbnail window on the right.

Note

- Click an image to select it (background turns blue) or deselect it (background turns white). You can also select multiple images.

Select an option for Add to and click OK.

Important

- You can add up to 20 images at one time to a single page.
- Up to 99 of the same images can be added to all pages combined.
- You cannot add two or more of the same image at one time. Add it one at a time.
- When the number of pages increases due to added images, you cannot add images beyond page 400.

Note

- In the Add Image dialog box, you can select all images at one time or change the display size and order of the thumbnails. See Help for details.

Advanced Guide

Advanced Guide > Printing from a Computer > Printing with the Bundled Application Software > Other Settings > Swapping Positions of Photos

Easy-PhotoPrint EX



Swapping Positions of Photos

You can swap the positions of images.



Click  (Swap Image Positions) in the Edit screen.

Note

- The screens for Album printing are used as examples in the following descriptions. The screens may vary depending on what you create.



Select the target and source images you want to swap, then click Swap.

When you finish swapping all images you want to swap, click Back to Edit.

[Page top](#)

Advanced Guide

Advanced Guide > Printing from a Computer > Printing with the Bundled Application Software > Other Settings > Replacing Photos

Easy-PhotoPrint EX



Replacing Photos

You can replace an image with another image.



Select the image you want to replace in the Edit screen, then click  (Replace Selected Image).

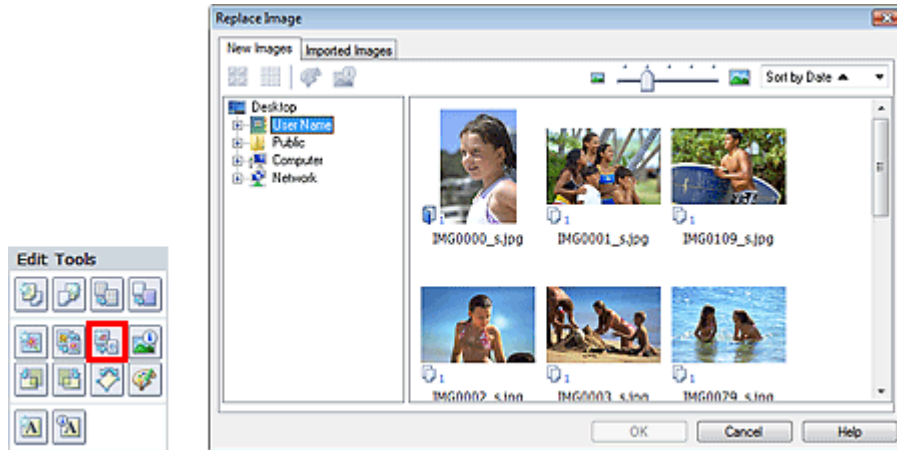

Select the folder containing the image you want to replace with from the folder tree area on the left of the Replace Image dialog box.

Select the image you want to replace with from the thumbnail window on the right of the screen and click OK.

If you want to select from the images already imported, click the Imported Images tab and select the image you want to replace with from the thumbnail window and click OK.

Important

- You cannot select multiple images in the Replace Image dialog box.

Note

- If you select multiple images in the Edit screen and use the replacement function, all the images selected in the Edit screen will be replaced with the image selected in the Replace Image dialog box.
- When images are replaced, the following settings of the old image are inherited to the new image.
 - Position
 - Size
 - Frame
 - Position and size of the date
 The cropping information and image orientation are not inherited.
- In the Replace Image dialog box, you can change the display size and order of the thumbnails. See Help for details.

Advanced Guide

Advanced Guide > Printing from a Computer > Printing with the Bundled Application Software > Other Settings > Changing Position, Angle and Size of Photos

Easy-PhotoPrint EX



Changing Position, Angle and Size of Photos

You can adjust the position, angle and size of images.

Select the image of which you want to change the position or size in the Edit screen and click  (Edit Image) or double-click the image.

Set the Center Position, Rotation and Size, then click OK.

Note

- You can also change the position and size of an image by dragging it in the Edit screen.
- Select an image in the Edit screen, then click  (Free Rotate) and drag a corner of the image to rotate it.
- See Help for details on the position and size of images.

Advanced Guide

Advanced Guide > Printing from a Computer > Printing with the Bundled Application Software > Other Settings > Cropping Photos

Easy-PhotoPrint EX



Cropping Photos

Cropping an image is the act of removing the unnecessary portions of the image by selecting the necessary portions.

Select the image you want to crop in the Edit screen and click  (Edit Image) or double-click the image.

Click the Crop tab in the Edit Image dialog box.

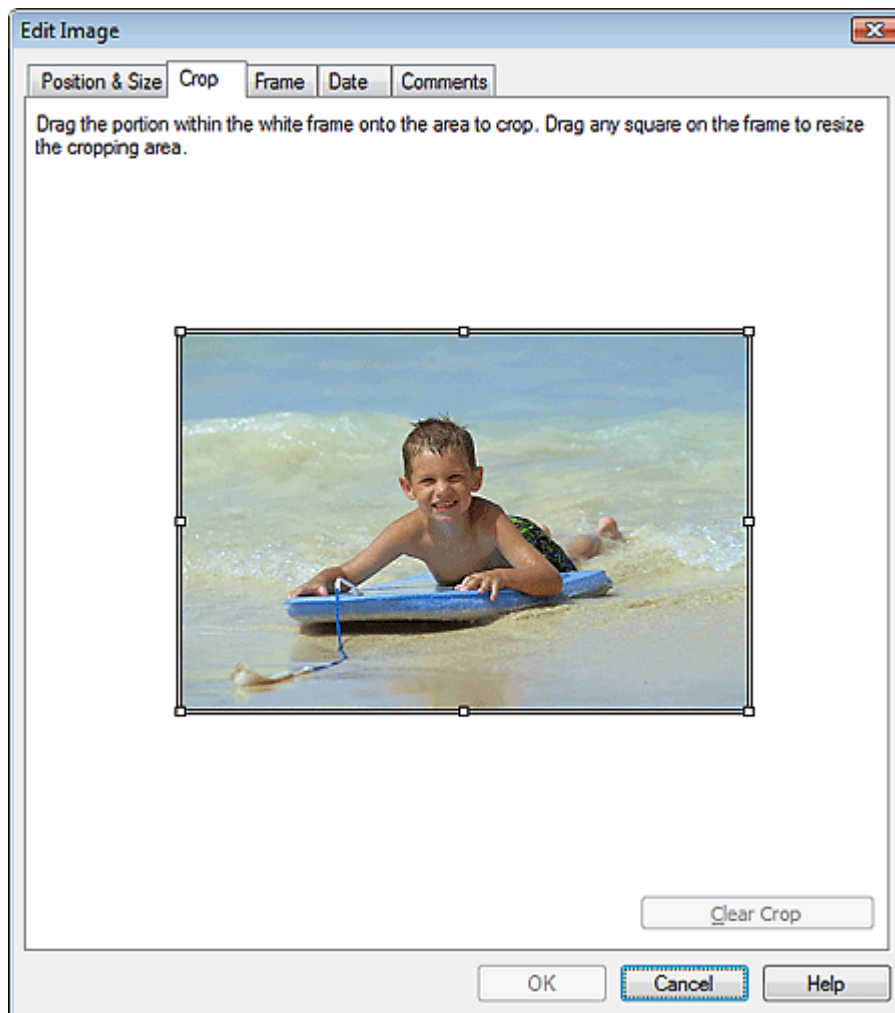

Drag the white squares on the image to change the area to be cropped and click OK.

Note

- See Help for details on cropping.

Advanced Guide

Advanced Guide > Printing from a Computer > Printing with the Bundled Application Software > Other Settings > Framing Photos

Easy-PhotoPrint EX



Framing Photos

You can add frames to images.

Important

- You cannot add frames to images in Photo Print, Stickers, and Layout Print.

Select the image you want to frame in the Edit screen and click  (Edit Image) or double-click the image.

Click the Frame tab in the Edit Image dialog box.

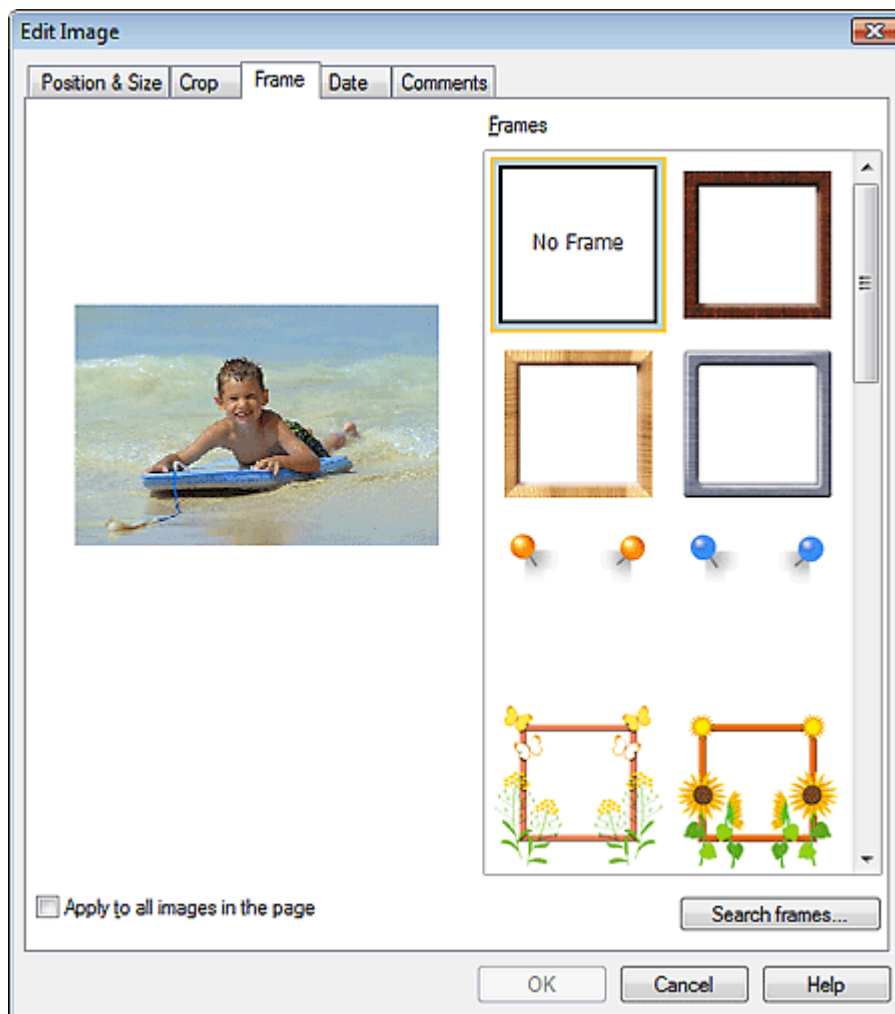

Select the frame you want to use from Frames and click OK.

Important

- You cannot print dates on framed photos.

Note

- Select the Apply to all images in the page checkbox to add the same frame to all the images on a

- selected page at one time.
- Various frames are available on our website besides those saved in the application. Click Search frames... to access the Canon website from which you can download additional materials for free.
 - Internet connection is required to access the website. Internet connection fees apply.
 - This function may not be available in some regions.
 - Exit Easy-PhotoPrint EX before installing frames.
 - Search frames... will be displayed only if Album has been selected.
 - See Help for details on frames.
-

[Page top](#) ↕

Advanced Guide

Advanced Guide > Printing from a Computer > Printing with the Bundled Application Software > Other Settings > Printing Dates on Photos

Easy-PhotoPrint EX



Printing Dates on Photos

You can print dates on images.

Select the image you want to print the date in the Edit screen and click  (Edit Image) or double-click the image.

Click the Date tab in the Edit Image dialog box.

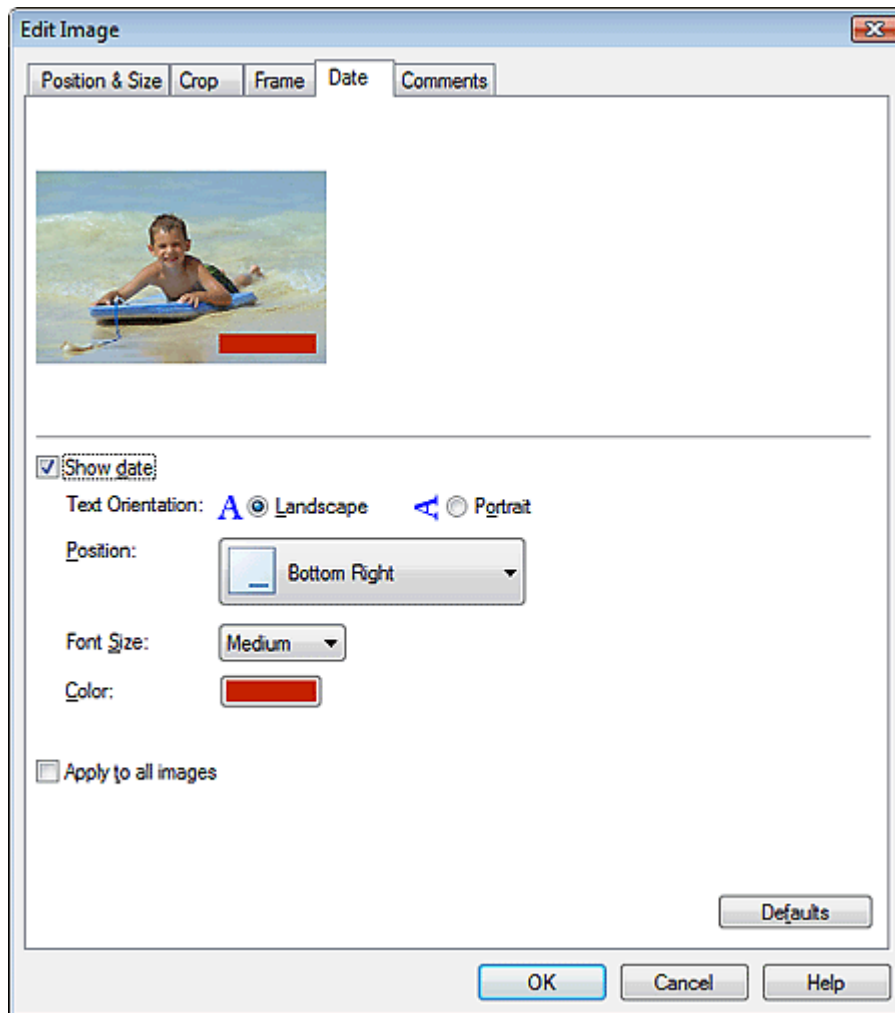

Select the Show date checkbox.

Set the Text Orientation, Position, Font Size and Color, then click OK.

Important

- You cannot print dates on framed images.

Note

- The date is displayed in the short date format (mm/dd/yyyy, etc.) specified in your operating system.
- See Help for details on setting dates.

[Page top](#) 

Advanced Guide

Advanced Guide > Printing from a Computer > Printing with the Bundled Application Software > Other Settings > Attaching Comments to Photos

Easy-PhotoPrint EX



Attaching Comments to Photos

You can attach comments to images and display them in your album. The photo name, shooting date and comments are displayed (from top to bottom) in a comment box.



Important

- You cannot attach comments to Photo Print, Calendar, Stickers, and Layout Print.

Select the image you want to attach comments to in the Edit screen and click  (Edit Image) or double-click the image.

Click the Comments tab in the Edit Image dialog box.

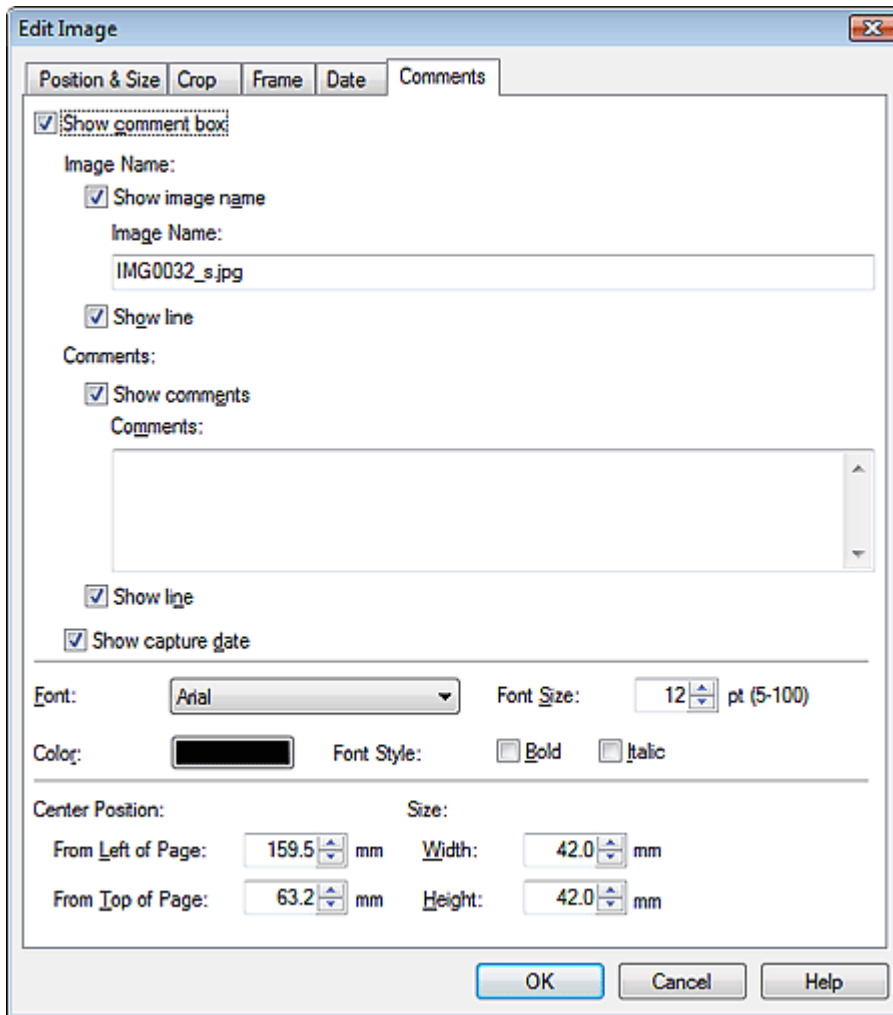

Select the Show comment box checkbox.

Select the checkboxes of the items you want to display, and enter comments.

Set the size and color of font, and position of the comments, etc., then click OK.

Note

- See Help for details on comments.

Advanced Guide

Advanced Guide > Printing from a Computer > Printing with the Bundled Application Software > Other Settings > Adding Text to Photos

Easy-PhotoPrint EX



Adding Text to Photos

You can add text to photos.



Click  (Add Text) in the Edit screen and drag the mouse over the area in which you want to add text.

Note

- The screens for Album printing are used as examples in the following descriptions. The screens may vary depending on what you create.

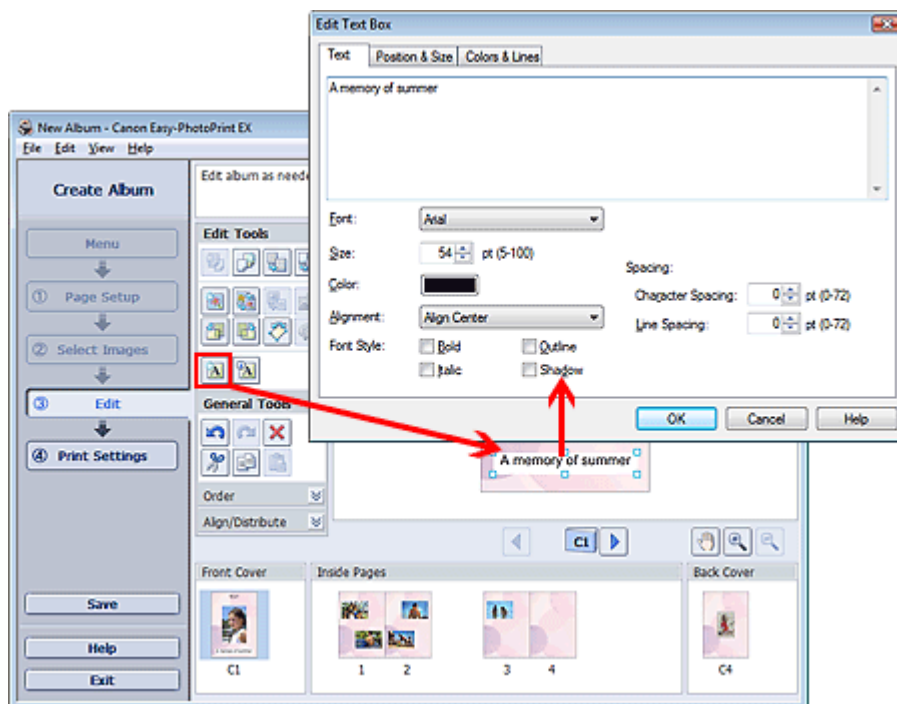

Select the Text tab in the Edit Text Box dialog box and enter text.

Note

- In the Edit Text Box dialog box, you can change the position, angle and size of the text. You can also set the color and line of the text box. See Help for details.
- To change the entered text, select it and click  (Edit Text Box). The Edit Text Box dialog box appears. You can change the text.

Advanced Guide

Advanced Guide > Printing from a Computer > Printing with the Bundled Application Software > Other Settings > Saving

Easy-PhotoPrint EX



Saving

You can save edited items.

Click Save in the Edit or Print Settings screen.

Note

- The screens for Album printing are used as examples in the following descriptions. The screens may vary depending on what you create.



When the Save As dialog box appears, specify the save location and file name, then click Save.

Important

- If you edit a saved file and save it again, the file will be overwritten.
To save a file again with a new name or to a different location, select Save As... from the File menu and save.

Note

- Save will not be displayed in the Page Setup or Select Images screen.

[Page top](#)

Advanced Guide

Advanced Guide > Printing from a Computer > Printing with the Bundled Application Software > Other Settings > Setting Holidays

Easy-PhotoPrint EX



Setting Holidays

You can add holidays to your calendar.

Click Set Holidays... in the Page Setup screen of Calendar, or click  (Setup Period/Holiday) in the Edit screen and click Set Holidays... in the Calendar General Settings dialog box to display the Holiday Settings dialog box.

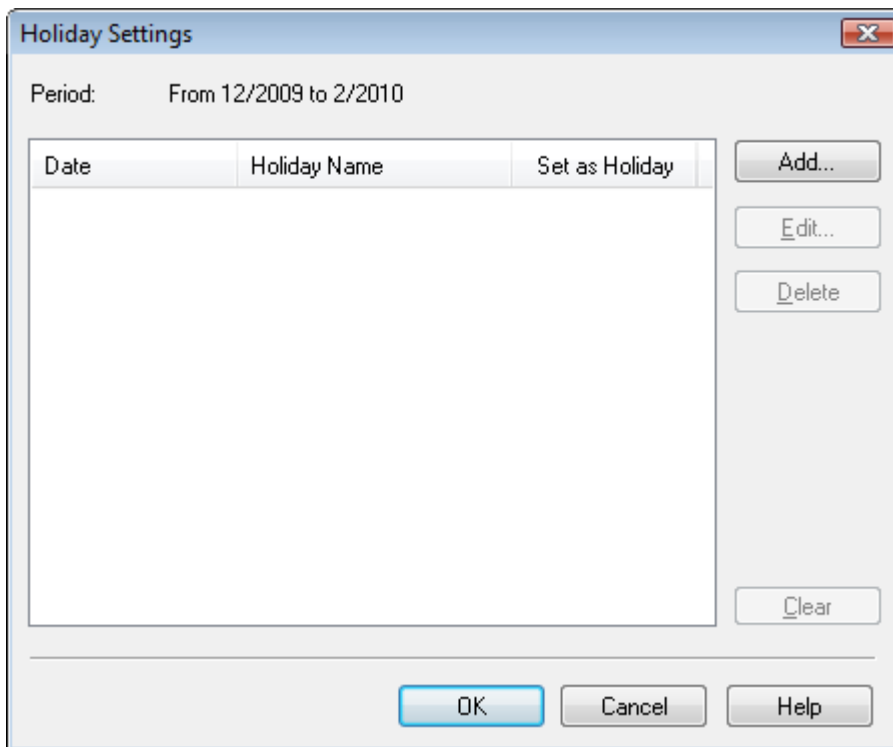

Date	Holiday Name	Set as Holiday
------	--------------	----------------

To add a holiday, click Add.... The Add/Edit Holiday dialog box appears. To edit a saved holiday, select it and click Edit....

To delete a holiday, select it and click Delete. To delete all the saved holidays within your calendar period, click Clear.

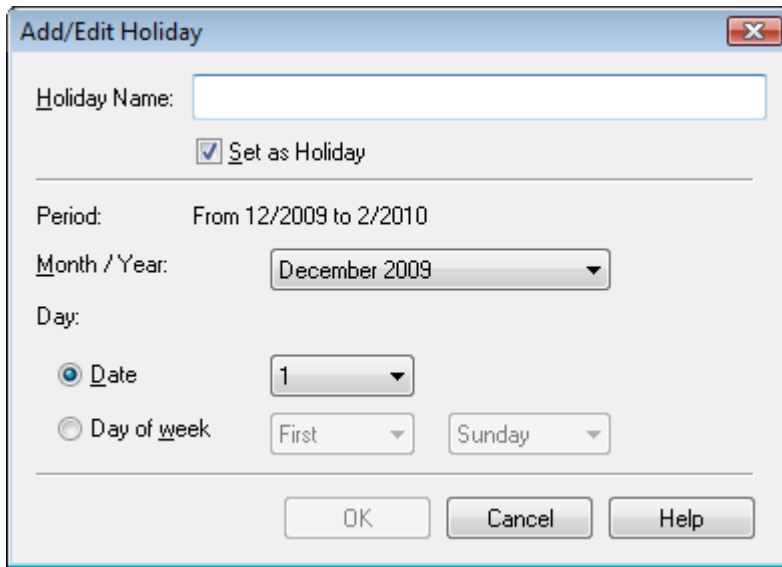

Add/Edit Holiday

Holiday Name:

Set as Holiday

Period: From 12/2009 to 2/2010

Month / Year:

Day:

Date

Day of week

Enter the name in Holiday Name and specify the date.

Select the Set as Holiday checkbox to display that day as a holiday in your calendar.

Note

- See Help for details on each dialog box.

Advanced Guide

Advanced Guide > Printing from a Computer > Printing with the Bundled Application Software > Other Settings > Setting Calendar Display

Easy-PhotoPrint EX



Setting Calendar Display

You can customize the calendar display (fonts, lines, colors, position, size, etc.).

Click Settings... in the Page Setup screen of Calendar, or select a calendar in the Edit screen and click



(Setup Calendar) to display the Calendar Settings dialog box.

Important

- The Position & Size tab is displayed only when the Calendar Settings dialog box is displayed from the Edit screen.

Calendar Settings

Style Options Color Position & Size

Style for Year and Month

Font: Arial

Fgmat: 1/2010

Style for Days of Week

Font: Arial

Week Starts on: Sunday

Style for Days

Font: Arial

Defaults

OK Cancel Help

Note

- See Help for details on the Calendar Settings dialog box.

Advanced Guide

Advanced Guide > Printing from a Computer > Printing with the Bundled Application Software > Other Settings > Opening Saved Files

Easy-PhotoPrint EX



Opening Saved Files

You can open files created with Easy-PhotoPrint EX.

1. Click Library from Menu.

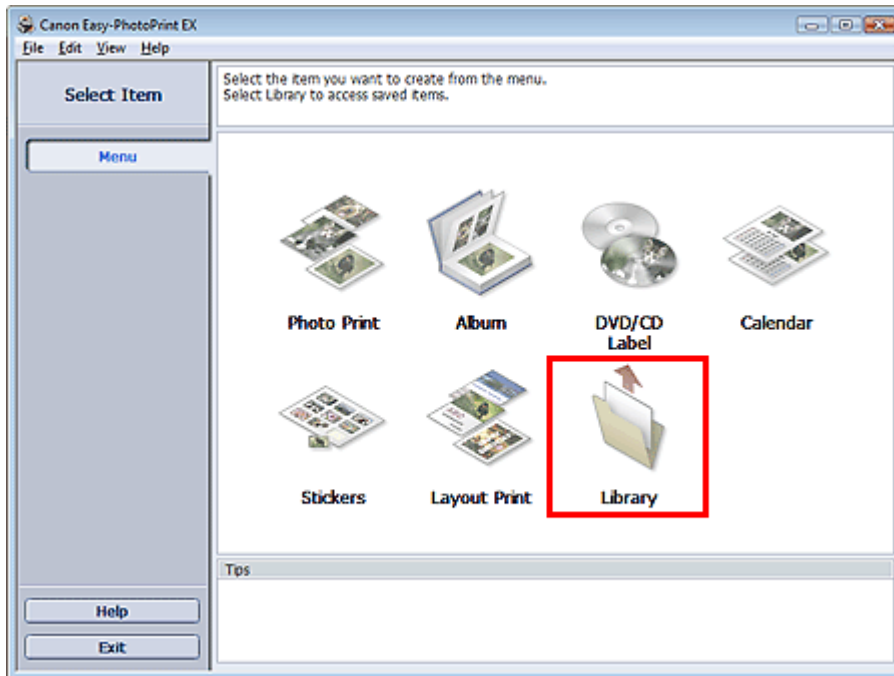

The Open dialog box appears.

You can check files created and saved with Easy-PhotoPrint EX by icon view (only for Windows Vista) or thumbnail view.

Important

- When using 64bit Edition of Windows Vista or Windows XP, the contents of files cannot be displayed on Explorer.

2. Select the file you want to open and click Open.

The Edit screen appears.

Note

- Easy-PhotoPrint EX supports the following file formats (extensions).
 - Easy-PhotoPrint EX Album file (.e1)
 - Easy-PhotoPrint EX Stickers file (.e2)
 - Easy-PhotoPrint EX Calendar file (.e4)
 - Easy-PhotoPrint EX Layout file (.e5)
 - CD-LabelPrint data (.cd)

3. Edit the file if necessary.

Note

- See the following sections for details on the editing procedures.
 - ➔ [Editing Album](#)
 - ➔ [Editing Calendar](#)
 - ➔ [Editing Stickers](#)
 - ➔ [Editing Layout Print](#)
-

Note

- You can open files created with Easy-PhotoPrint EX with the following methods, besides from Library in Menu.
 - Double-click or click the file.
 - From the File menu, click Open..., then select the file you want to edit.
 - You can also open a recently used file by clicking the file name shown in the File menu.
-

[Page top](#)[↕]

Advanced Guide

Advanced Guide > Printing from a Computer > Printing with the Bundled Application Software > What Is Easy-PhotoPrint Pro?

Easy-PhotoPrint Pro

What Is Easy-PhotoPrint Pro?

Easy-PhotoPrint Pro is a plug-in for Adobe Photoshop, Adobe Photoshop Elements and Digital Photo Professional, an application for Canon digital single-lens reflex cameras. Easy-PhotoPrint Pro allows you to print photos easily in various styles, including borderless full-page, index, grayscale, and Adobe RGB mode.



Important

- Easy-PhotoPrint Pro supports Adobe Photoshop CS, Photoshop CS2, Photoshop CS3, Photoshop CS4, Photoshop Elements 6, Adobe Photoshop Elements 7 and Digital Photo Professional Ver.2.1 or later only.
For updated compatibility, visit our website.
- Easy-PhotoPrint Pro does not support Windows 95, Windows 98, Windows Me, or Windows NT4.
- If a printer that supports Easy-PhotoPrint Pro is not installed, you cannot start Easy-PhotoPrint Pro.
- Although compatibility with Windows Vista and Windows XP has been confirmed, Easy-PhotoPrint Pro does not support the Fast User Switching feature of Windows Vista and Windows XP. It is recommended that you exit Easy-PhotoPrint Pro before using Fast User Switching.
- If Adobe Photoshop or Adobe Photoshop Elements is installed after installing Easy-PhotoPrint Pro, you cannot start Easy-PhotoPrint Pro as it does not appear in Adobe Photoshop or Adobe Photoshop Elements's menu.
In that case, follow these steps to install the Photoshop Plug-In.
 1. From the Start menu, select (All) Programs > Canon Utilities > Easy-PhotoPrint Pro > Photoshop Plug-In Installer.
 2. Follow the on-screen instructions to install.

Note

- See Help of Easy-PhotoPrint Pro for descriptions of Easy-PhotoPrint Pro screens.
Click Help in a dialog box, or select Help Topics from the Help menu. Help appears.
- In Windows Vista, using the XPS printer driver enables you to print in the High Dynamic Range (full 16-bit workflow).
See "[XPS Printer Driver](#)" for details on the XPS printer driver.

Supported Data Formats

- One color (8 or 16 bits) per pixel RGB data formats supported by Adobe Photoshop or Adobe Photoshop Elements
- One color (8 or 16 bits) per pixel RGB data formats supported by Digital Photo Professional

General Note

- The color tone of the image displayed on the display (monitor) is different from the print result.

[Page top](#) 

Advanced Guide

Advanced Guide > Printing from a Computer > Printing with the Bundled Application Software > Printing Beautiful Photos

Easy-PhotoPrint Pro

Printing Beautiful Photos

Easy-PhotoPrint Pro allows you to print images captured in Adobe RGB or sRGB mode, in colors that are close to their original colors by using ICC profiles. You can also print sRGB images with Canon's unique color tones (Canon Digital Photo Color).

By applying the suitable printing method, you can produce photos that meet your expectations.

The diagram below shows the flow of digital imaging from importing captured photo into Adobe Photoshop, Adobe Photoshop Elements or Digital Photo Professional to printing.

Operation varies depending on the purpose. Check the operational flow in the following diagram.

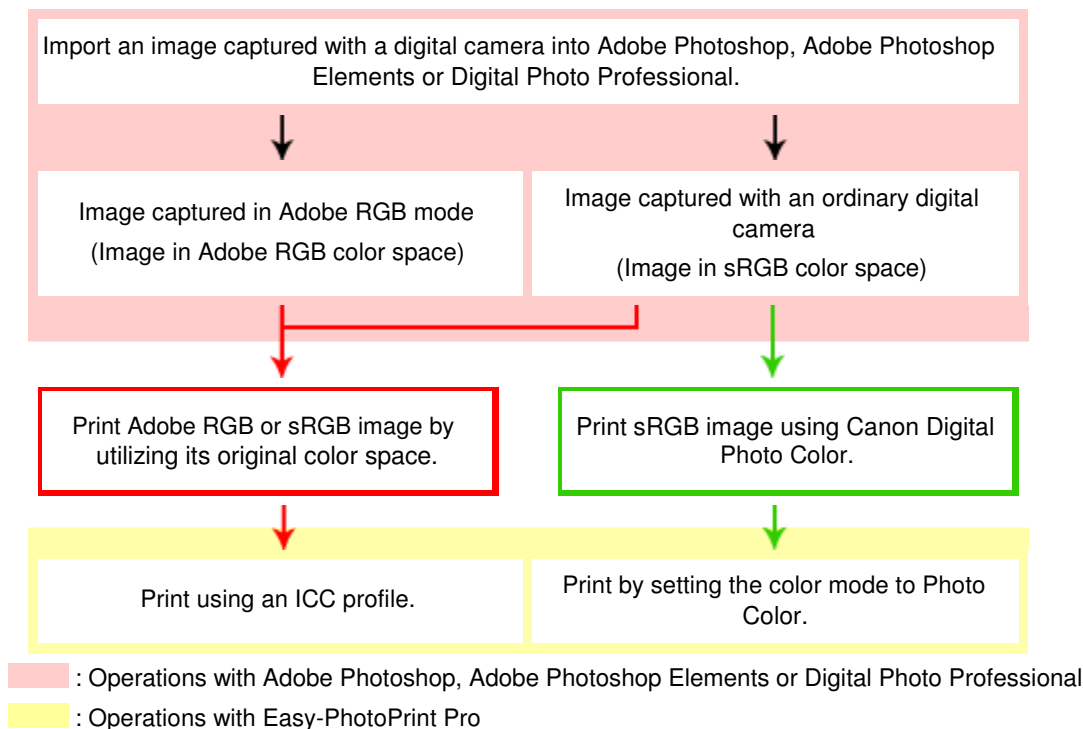

Detailed Operations

→ : Printing an Adobe RGB or sRGB image by utilizing its original color space

→ Printing with ICC Profiles (Adobe RGB, sRGB)

→ : Printing an sRGB image using Canon Digital Photo Color

→ Printing with Canon's Unique Color Tones

Color Management Terms

- **What is an ICC Profile?**

ICC profile is a data file that describes the color reproduction characteristics of individual devices to match the colors between input devices (scanners and digital cameras) and output devices (displays and printers).

- **What is sRGB?**

sRGB is an international standard color space, developed for the purpose of unifying the colors of digital cameras and displays.

- **What is Adobe RGB?**

Adobe RGB is a color space (which defines the range of colors) that is larger than sRGB. In printing, Adobe RGB can represent the range of colors between green and cyan that cannot be represented by sRGB.

- **What is Canon Digital Photo Color?**

Canon Digital Photo Color is Canon's unique image processing technology. This technology allows you to print images in popular, beautiful color tones by producing high contrast with sharp, three-dimensional feel while reproducing the genuine colors of the original image.

[Page top](#) ↕

Advanced Guide

Advanced Guide > Printing from a Computer > Printing with the Bundled Application Software > Printing Beautiful Photos
> Printing with ICC Profiles (Adobe RGB, sRGB)

Easy-PhotoPrint Pro

Printing with ICC Profiles (Adobe RGB, sRGB)

By specifying an ICC profile, you can print an image captured in Adobe RGB or sRGB mode by utilizing its original color space, or print in colors that are close to those corrected with Adobe Photoshop, Adobe Photoshop Elements or Digital Photo Professional.

1. Start Easy-PhotoPrint Pro and select the photo you want to print.

The photo appears in the bottom right area of the screen.

Note

- See "Selecting a Photo" for details on how to select photos.

2. In the Printer Settings window, click Color Adjustment....

The Color Adjustment dialog box appears.

3. Click the Color Management tab.

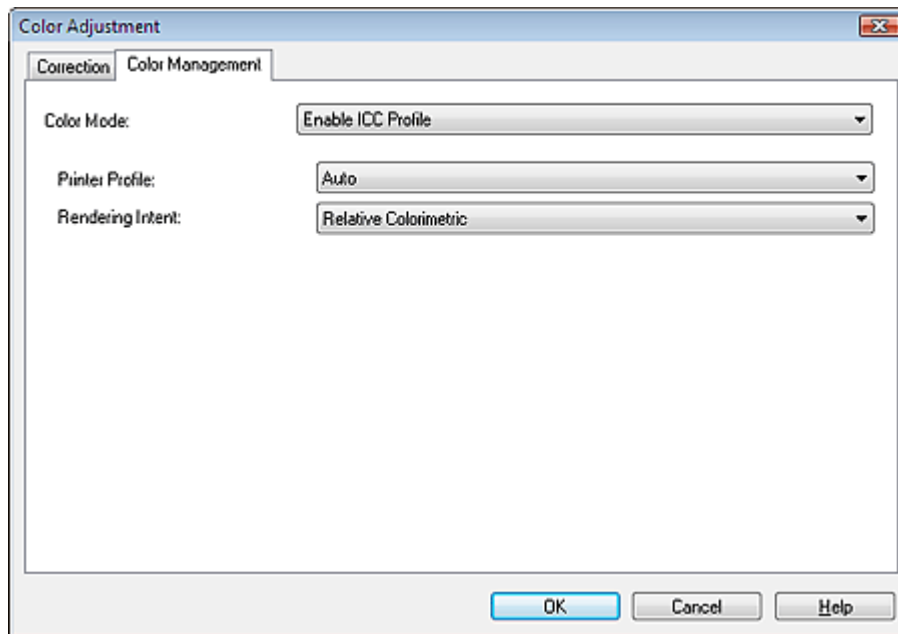

4. Select Enable ICC Profile for Color Mode.

5. Select Auto for Printer Profile.

Note

- For Auto, the most suitable profile is selected automatically based on the selected printer, paper and print quality.
- You can also select a specific ICC profile.

6. Select the desired matching method from Rendering Intent.

Note

- Relative Colorimetric: Converts the image to the printer color space in a way that the source colors within the color gamut of the target space are reproduced to the nearest level. Select this when you want to print in colors that are close to the original image.
 - Perceptual: Reproduces the image focusing on the use of popular color tones. Select this when you want to print the photo.
-

7. Click OK.

8. Click Print.

The Print dialog box appears.

9. Click OK.

Note

- You can also change the color balance, brightness and contrast of the image.
 - ➔ [Adjusting the Color Balance](#)
 - ➔ [Adjusting Brightness/Contrast](#)
-

[Page top](#) ↕

Advanced Guide

Advanced Guide > Printing from a Computer > Printing with the Bundled Application Software > Printing Beautiful Photos
> Printing with Canon's Unique Color Tones

Easy-PhotoPrint Pro

Printing with Canon's Unique Color Tones

You can print sRGB images using Canon Digital Photo Color.

Note

- Canon Digital Photo Color is Canon's unique image processing technology. This technology allows you to print images in popular, beautiful color tones by producing high contrast with sharp, three-dimensional feel while reproducing the genuine colors of the original image.

1. Start Easy-PhotoPrint Pro and select the photo you want to print.

The photo appears in the bottom right area of the screen.

Note

- See "[Selecting a Photo](#)" for details on how to select photos.

2. In the Printer Settings window, click Color Adjustment....

The Color Adjustment dialog box appears.

3. Click the Color Management tab.

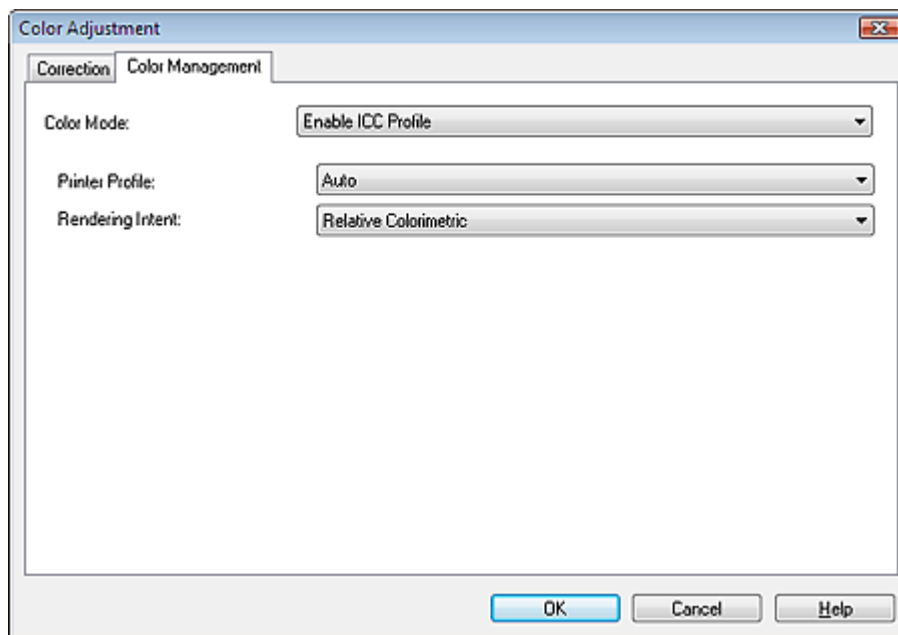

4. Select Photo Color for Color Mode.

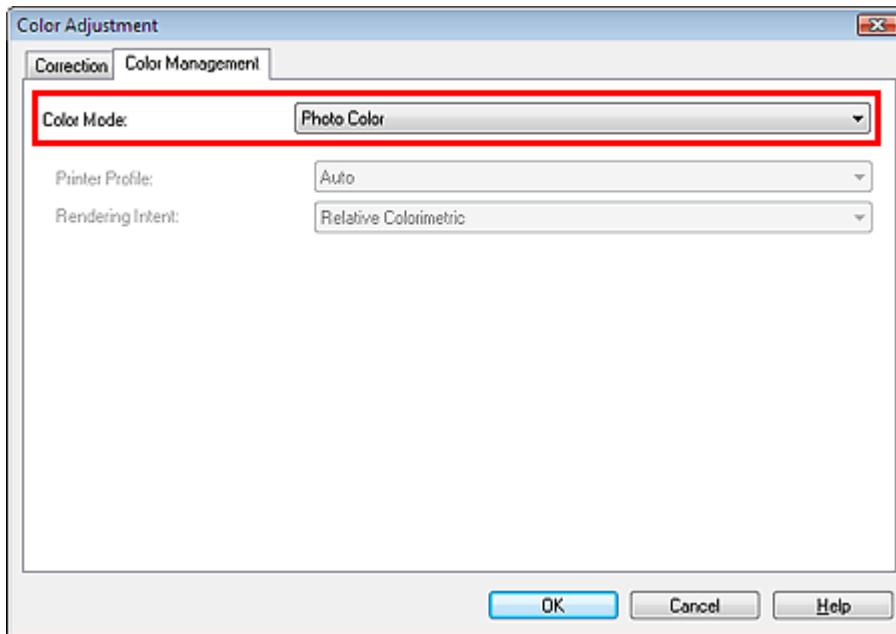

5. Click OK.

6. Click Print.

The Print dialog box appears.

7. Click OK.

Note

- You can also change the color balance, brightness and contrast of the image.
 - ➔ Adjusting the Color Balance
 - ➔ Adjusting Brightness/Contrast

Advanced Guide

Advanced Guide > Printing from a Computer > Printing with the Bundled Application Software > Let's Start Printing with Easy-PhotoPrint Pro

Easy-PhotoPrint Pro

Let's Start Printing with Easy-PhotoPrint Pro

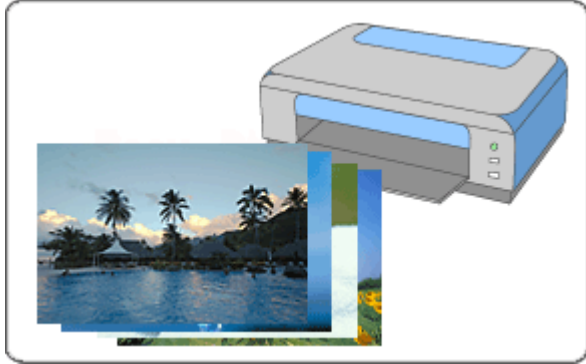

Steps

1. Starting Easy-PhotoPrint Pro
2. Selecting a Photo
3. Selecting the Paper and Layout
4. Printing

Adjust the Colors of Photo

- ➔ Printing Photos in Grayscale
- ➔ Adjusting the Color Balance
- ➔ Adjusting Color Balance Using Sample Patterns
- ➔ Adjusting Brightness/Contrast
- ➔ Adjusting Brightness/Contrast Using Sample Patterns

Try This

- ➔ Printing Borderless Photos
- ➔ Printing an Index
- ➔ Printing Contact Sheets
- ➔ Printing Advanced Information
- ➔ Cropping Photos
- ➔ Printing with Adjusted Print Size
- ➔ Saving Print Settings

Advanced Guide

Advanced Guide > Printing from a Computer > Printing with the Bundled Application Software > Let's Start Printing with Easy-PhotoPrint Pro > Starting Easy-PhotoPrint Pro

Easy-PhotoPrint Pro

Starting Easy-PhotoPrint Pro

Easy-PhotoPrint Pro can be started from Adobe Photoshop, Adobe Photoshop Elements or Digital Photo Professional.

Starting from Adobe Photoshop or Adobe Photoshop Elements

1. From the File menu of Adobe Photoshop or Adobe Photoshop Elements, select Automate > Canon Easy-PhotoPrint Pro....

Easy-PhotoPrint Pro starts.



Important

- Easy-PhotoPrint Pro cannot be started when no image is displayed in Adobe Photoshop or Adobe Photoshop Elements.
- If Easy-PhotoPrint Pro does not appear in Adobe Photoshop or Adobe Photoshop Elements's menu even after installing Easy-PhotoPrint Pro, follow these steps to install the Photoshop Plug-In.
 1. Exit Adobe Photoshop or Adobe Photoshop Elements.
 2. From the Start menu, select (All) Programs > Canon Utilities > Easy-PhotoPrint Pro > Photoshop Plug-In Installer.
 3. Follow the on-screen instructions to install.

*The Photoshop Plug-In will not be installed if Adobe Photoshop or Adobe Photoshop Elements has never been started.
- If you create or edit an image in Adobe Photoshop CS3 using the layer function, the image may not be displayed in Easy-PhotoPrint Pro. In this case, combine the image and the layer in Adobe Photoshop CS3.

Note

- The images displayed in Adobe Photoshop or Adobe Photoshop Elements appear in Easy-PhotoPrint Pro.

Starting from Digital Photo Professional

1. From the File menu of Digital Photo Professional, select Plug-in printing > Print with Easy-PhotoPrint Pro.

Easy-PhotoPrint Pro starts.

Important

- Easy-PhotoPrint Pro cannot be started when no image is displayed in Digital Photo Professional.

Note

- The images displayed in Digital Photo Professional appear in Easy-PhotoPrint Pro.



[Page top](#)

Advanced Guide

Advanced Guide > Printing from a Computer > Printing with the Bundled Application Software > Let's Start Printing with Easy-PhotoPrint Pro > Selecting a Photo



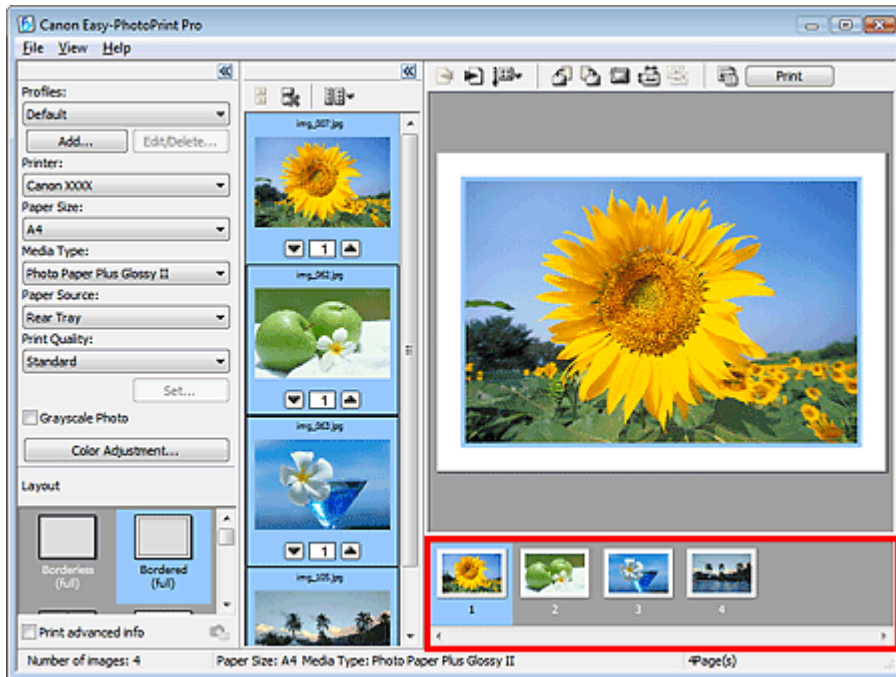

Easy-PhotoPrint Pro

Selecting a Photo

1. Check that the photo you want to print is displayed in the bottom right area of the screen.



Note

- To increase the number of copies, click  (Up arrow) below the thumbnail in the center of the screen until the number of copies you want is reached. To reduce the number of copies shown in the box, click  (Down arrow).
- You can select up to 99 copies per one image and 1,000 copies in total.
- You can change the printing order by clicking  (Specify Print Order) in the Print Preview window.
- You can resize the thumbnails by clicking  (Specify Thumbnail Size) in the thumbnail window.
- Click  (Clear Image Selection) to cancel all selections.



Page top↑

Advanced Guide

Advanced Guide > Printing from a Computer > Printing with the Bundled Application Software > Let's Start Printing with Easy-PhotoPrint Pro > Selecting the Paper and Layout

Easy-PhotoPrint Pro

Selecting the Paper and Layout

1. Set the following items according to the printer and paper to be used:

Printer

Paper Size

Media Type

Paper Source

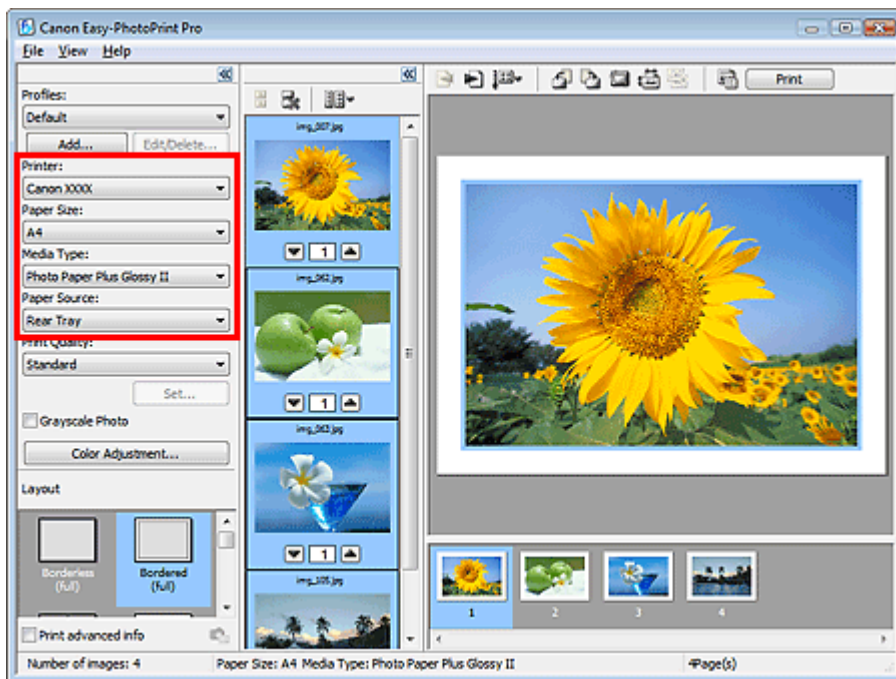

Important

- When Fine Art is selected for Paper Size, a 1.38 inch (35 mm) margin is automatically left at the top and bottom of the paper. It is recommended that you check the print range with the image shown in Preview before printing.

Note

- The paper sizes and media types may vary depending on the printer.
- The paper sources may vary depending on the printer and the media type.
- Select the XPS printer driver ("Your model name XPS") for Printer to print in the High Dynamic Range (full 16-bit workflow). See "XPS Printer Driver" for details on the XPS printer driver.

2. Select a print quality from Print Quality.

Note

- The available print quality options may vary depending on the printer and media type.

3. Select a layout from Layout.

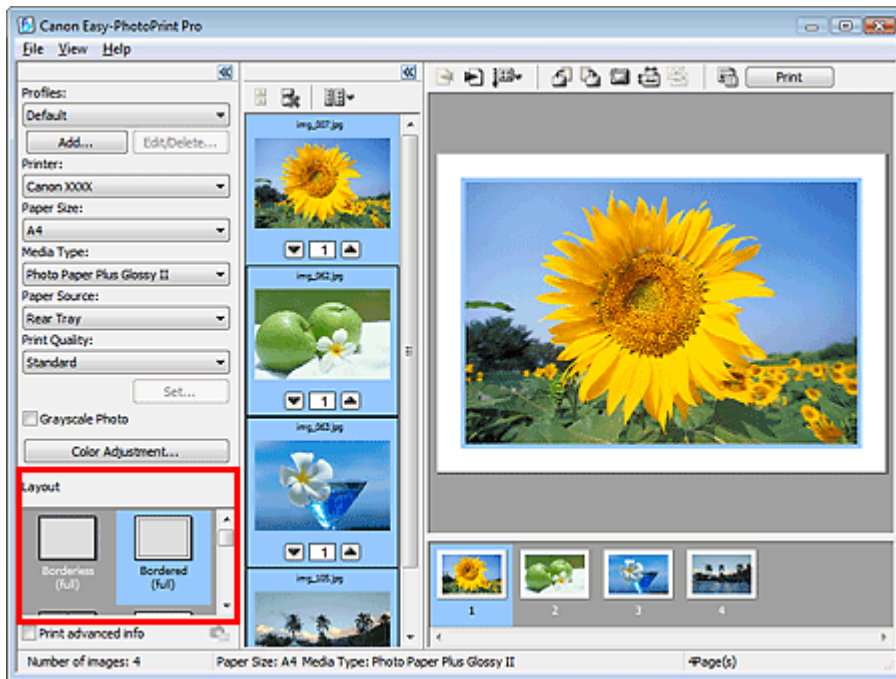

Important

- When Plain Paper is selected for Media Type and Bordered (full) is selected for Layout, the print result may be soft. In that case, change Media Type or Layout and print again.

Note

- The layouts may vary depending on the printer, paper size, and media type.

Note

- For borderless photos and index prints, you can make advanced settings such as the amount of extension and the arrangement of images. After selecting a layout, click Set... that appears to the right of Layout.
- When you select Bordered (full) for Layout, you can specify the print size and amount of margin.
 - ➔ Printing with Adjusted Print Size
- You can also change the color balance, brightness and contrast of the image.
 - ➔ Adjusting the Color Balance
 - ➔ Adjusting Brightness/Contrast



Advanced Guide

Advanced Guide > Printing from a Computer > Printing with the Bundled Application Software > Let's Start Printing with Easy-PhotoPrint Pro > Printing

Easy-PhotoPrint Pro

Printing

1. Click Print.



The Print dialog box appears.

Note

- You can change the printing order by clicking  (Specify Print Order) in the Print Preview window.

2. Click OK.

Important

- If "An error occurred during printing. Memory may be insufficient for printing." appears while printing with Easy-PhotoPrint Pro started from Adobe Photoshop or Adobe Photoshop Elements, increasing the memory allocation for Adobe Photoshop or Adobe Photoshop Elements may solve the problem.

Note

- Select the XPS printer driver for Printer to print in the High Dynamic Range (full 16-bit workflow). See "XPS Printer Driver" for details on the XPS printer driver.
- You can print photos in grayscale or crop photos. You can also print in various styles including index prints and contact sheets.
 - ➔ Printing Photos in Grayscale
 - ➔ Cropping Photos
 - ➔ Printing Borderless Photos
 - ➔ Printing an Index
 - ➔ Printing Contact Sheets
 - ➔ Printing Advanced Information



[Page top](#) 

Advanced Guide

[Advanced Guide](#) > [Printing from a Computer](#) > [Printing with the Bundled Application Software](#) > [Adjust the Colors of Photo](#)

Easy-PhotoPrint Pro

Adjust the Colors of Photo

- [Printing Photos in Grayscale](#)
- [Adjusting the Color Balance](#)
- [Adjusting Color Balance Using Sample Patterns](#)
- [Adjusting Brightness/Contrast](#)
- [Adjusting Brightness/Contrast Using Sample Patterns](#)

[Page top](#) ↕

Advanced Guide

Advanced Guide > Printing from a Computer > Printing with the Bundled Application Software > Adjust the Colors of Photo > Printing Photos in Grayscale

Easy-PhotoPrint Pro

Printing Photos in Grayscale

You can print color photos in grayscale photos.

Important

- You may not be able to print with this setting depending on the printer type.

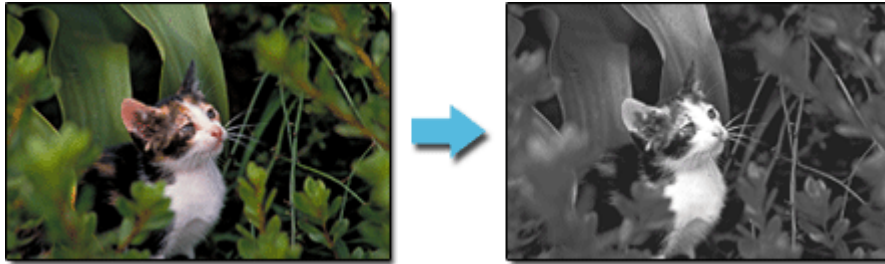

1. Check that the photo you want to print is displayed in the bottom right area of the screen.

Note

- See "[Selecting a Photo](#)" for details on how to select photos.

2. Select the Grayscale Photo checkbox in the Printer Settings window.

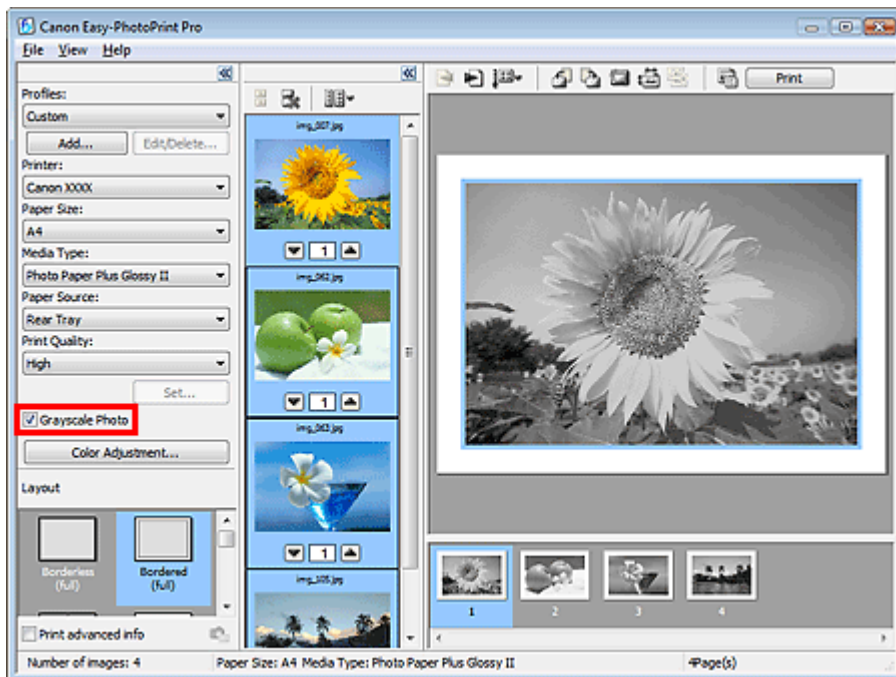

Important

- When you select the Grayscale Photo checkbox, all the selected images will be printed in grayscale.

Note

- You can adjust the black color tone in the Color Adjustment dialog box.
To display the Color Adjustment dialog box, select the Grayscale Photo checkbox in the Printer Settings window and click Color Adjustment.... See Help for details.

3. Click Print.

The Print dialog box appears.

4. Click OK.

Important

- White streaks may appear at the top and bottom edges of grayscale photos. In that case, print with a 45 mm (1.77 inch) or more margin at the top and bottom edges.
If you select Bordered (Margin 45) for Layout, images will be reduced when printing to allow a 45 mm (1.77 inch) margin at the top and bottom edges relative to the printing direction.

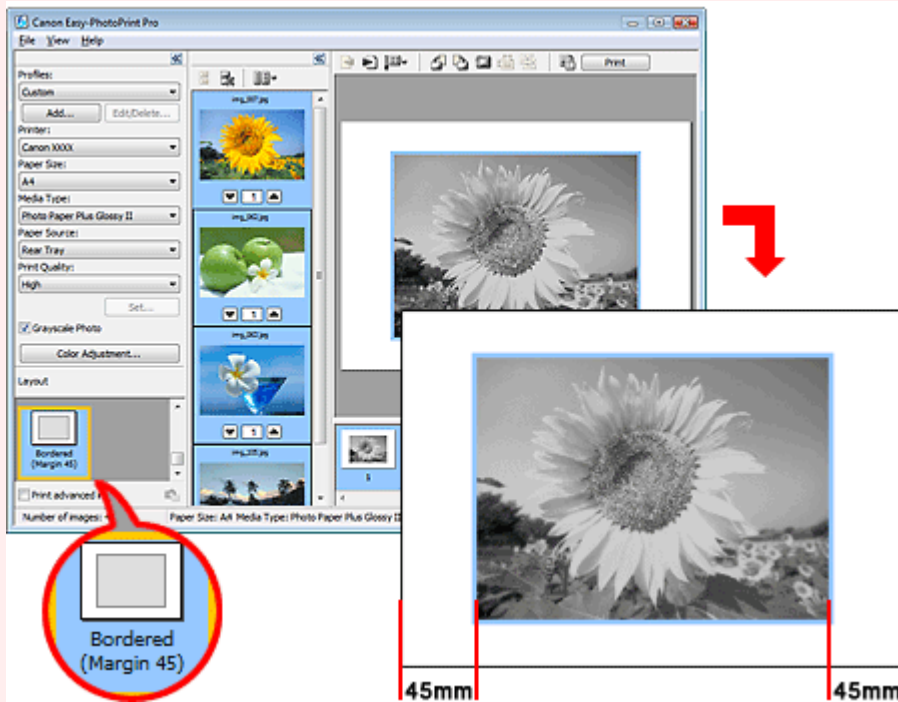

- If the print result after adjusting the color balance in the Color Adjustment dialog box is different from the preview image, print a color pattern and adjust the colors based on the pattern.

➡ [Adjusting Color Balance Using Sample Patterns](#)

Advanced Guide

Advanced Guide > Printing from a Computer > Printing with the Bundled Application Software > Adjust the Colors of Photo > Adjusting the Color Balance

Easy-PhotoPrint Pro

Adjusting the Color Balance

You can adjust the color balance of an image.

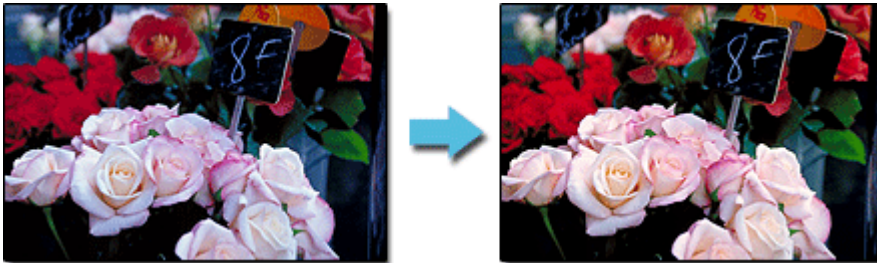

1. Check that the photo you want to print is displayed in the bottom right area of the screen.

Note

- See "Selecting a Photo" for details on how to select photos.

2. Click Color Adjustment... in the Printer Settings window.

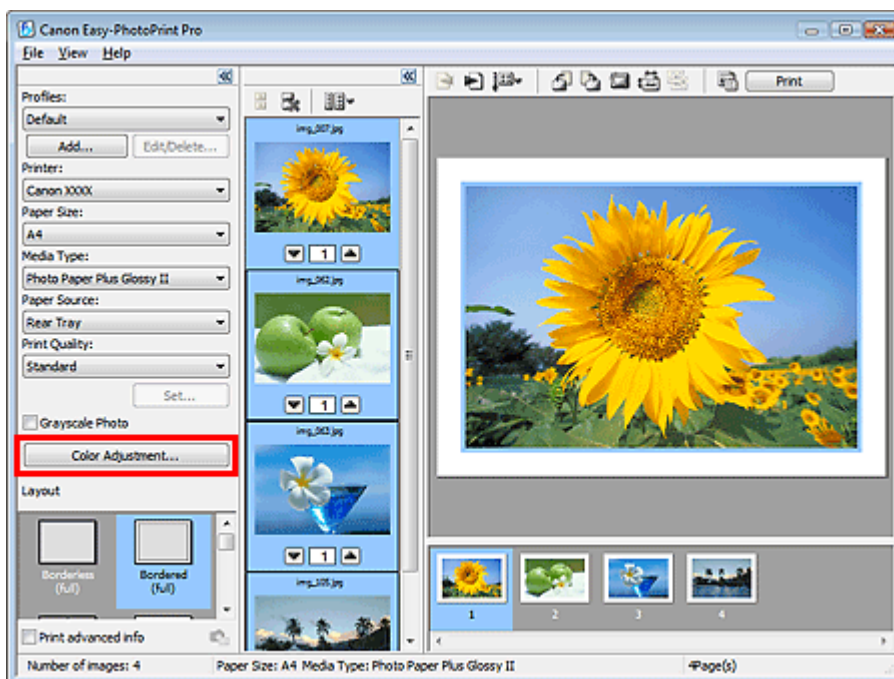

The Color Adjustment dialog box appears.

3. Adjust the intensity for Cyan, Magenta and Yellow in Color Balance.

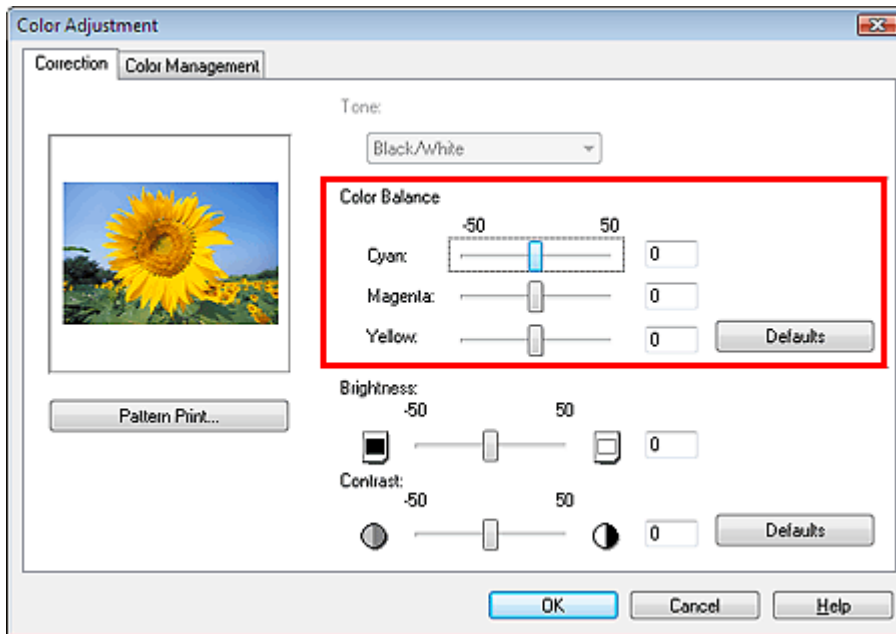

Important

- If the print result after adjusting the color balance is different from the preview image, print a color pattern and adjust the colors based on the pattern.
 - ➔ [Adjusting Color Balance Using Sample Patterns](#)
- The color balance adjustment applies to all images to print.

Note

- Move the slider to the right to increase and left to reduce intensity.

4. Click OK.

Advanced Guide

Advanced Guide > Printing from a Computer > Printing with the Bundled Application Software > Adjust the Colors of Photo > Adjusting Color Balance Using Sample Patterns

Easy-PhotoPrint Pro

Adjusting Color Balance Using Sample Patterns

You can print a pattern of an image and adjust the color balance of the image based on the pattern.

1. Check that the photo you want to print is displayed in the bottom right area of the screen.

Note

- See "[Selecting a Photo](#)" for details on how to select photos.

2. Click Color Adjustment... in the Printer Settings window.



The Color Adjustment dialog box appears.

3. Click Pattern Print....

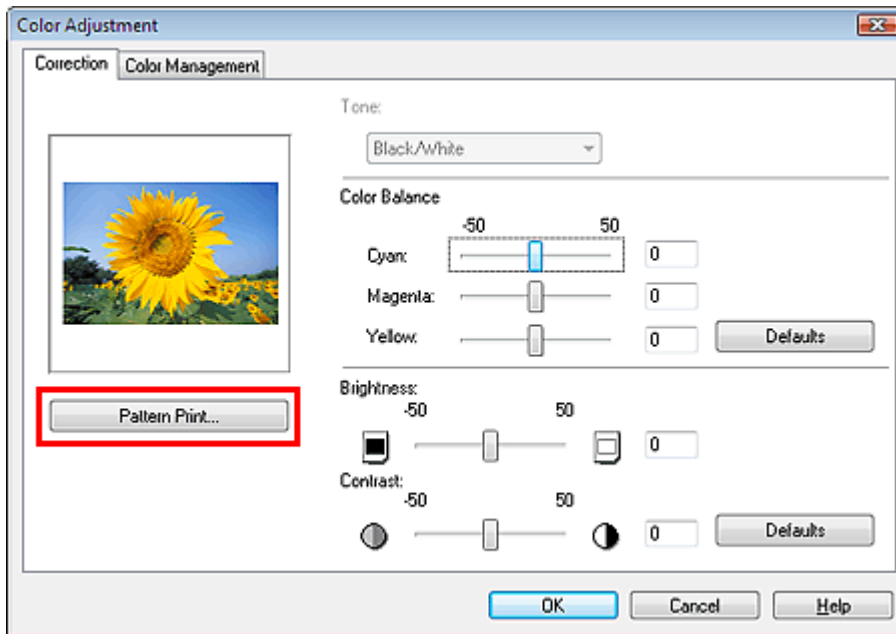

The Pattern Print window appears.

4. Select Color for Pattern Print, then select the color direction in which you want to adjust.

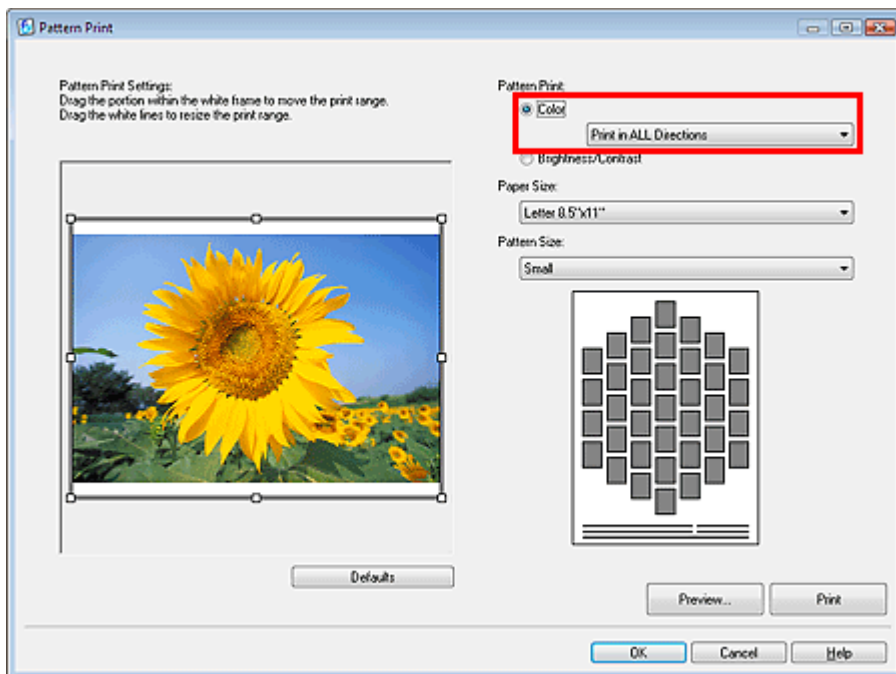

Note

- Select Print in ALL Directions to print a pattern of the image adjusted in the following six directions. (The image with the current color balance values is printed in the center.) Use the pattern to determine the color direction in which you want to adjust the color balance.

R (upper right) direction : Red

Y (upper) direction : Yellow

G (upper left) direction : Green

C (lower left) direction : Cyan

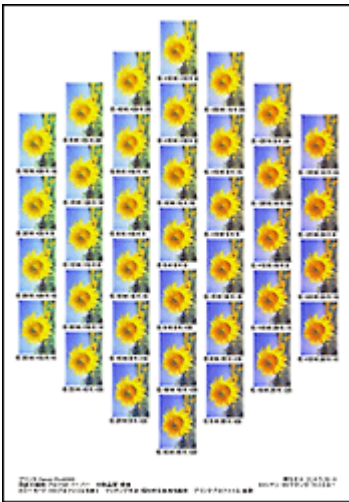

B (lower) direction : Blue

M (lower right) direction : Magenta

- Select a specific direction such as Print in Direction R to print a pattern of the image adjusted in the selected direction. (The image with the current color balance values is printed at the bottom left.) For example, select Print in Direction R to print a more detailed pattern of the portion in the R direction of the pattern for all directions (the portion outlined in red in the figure below). This allows you to check more variations than in all directions.

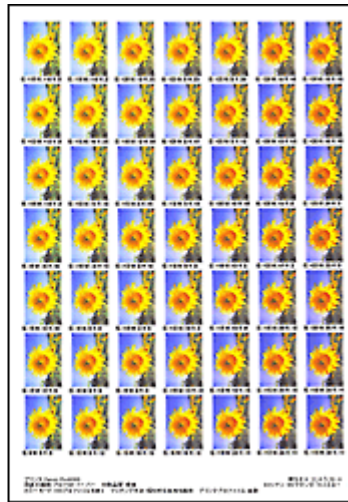
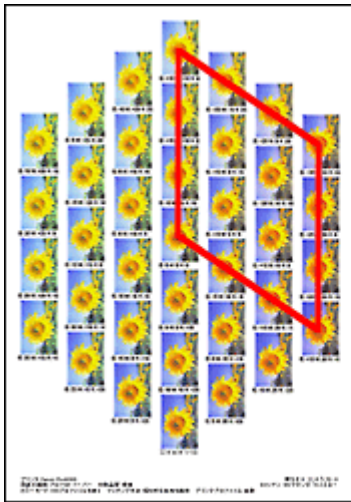

5. Select Paper Size and Pattern Size.

Note

- You can crop the image before printing the pattern. Move the white frame in Preview to change the cropping area.
- Click Preview... to display the print preview in a different window in which you can check the settings before printing.
- See Help for details on the Pattern Print window.

6. Click Print.

The pattern is printed.

7. Click OK.

8. Select the image with the desired color balance from the printed pattern and enter the values indicated below the image into Color Balance.

9. Click OK.

Advanced Guide

Advanced Guide > Printing from a Computer > Printing with the Bundled Application Software > Adjust the Colors of Photo > Adjusting Brightness/Contrast

Easy-PhotoPrint Pro

Adjusting Brightness/Contrast

You can adjust the brightness and contrast of an image.

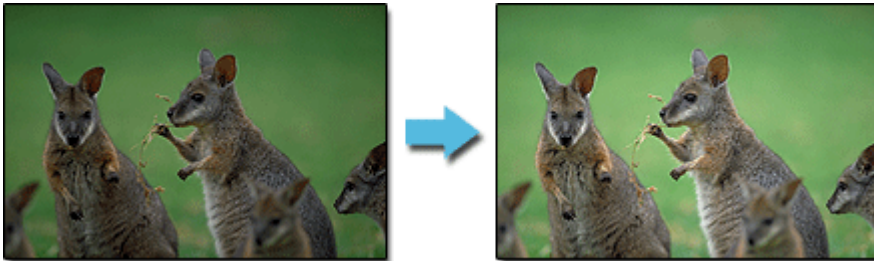

1. Check that the photo you want to print is displayed in the bottom right area of the screen.

Note

- See "Selecting a Photo" for details on how to select photos.

2. Click Color Adjustment... in the Printer Settings window.



The Color Adjustment dialog box appears.

3. Adjust Brightness and Contrast.

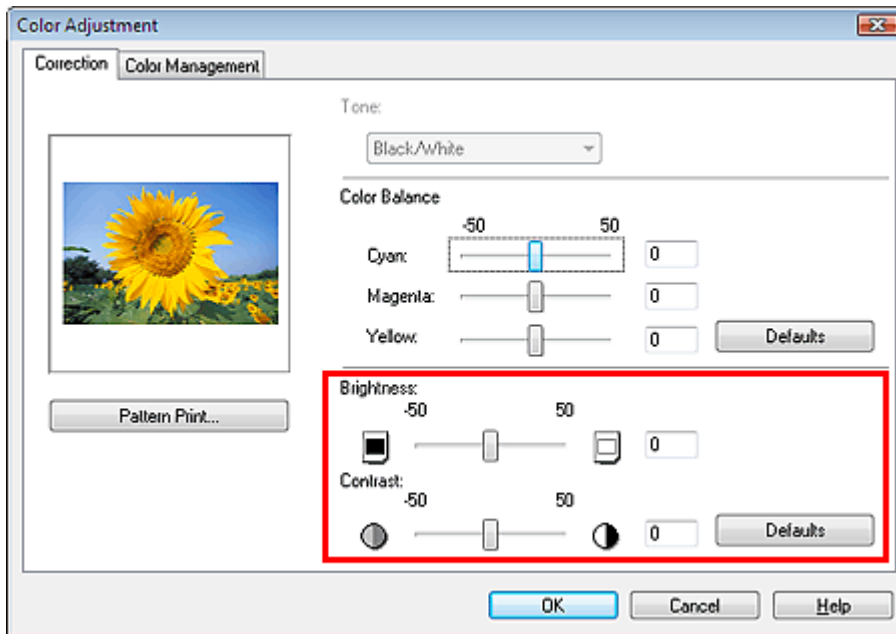

Important

- If the print result after adjusting the brightness and contrast is different from the preview image, print a color pattern and adjust the colors based on the pattern.
 - ➔ [Adjusting Brightness/Contrast Using Sample Patterns](#)
- The brightness/contrast adjustment applies to all images to print.

Note

- For Brightness, move the slider to the right to brighten and left to darken the image.
- For Contrast, move the slider to the right to increase and left to reduce the contrast of the image.

4. Click OK.

Advanced Guide

Advanced Guide > Printing from a Computer > Printing with the Bundled Application Software > Adjust the Colors of Photo > Adjusting Brightness/Contrast Using Sample Patterns

Easy-PhotoPrint Pro

Adjusting Brightness/Contrast Using Sample Patterns

You can print a pattern of an image and adjust the brightness/contrast of the image based on the pattern.

1. Check that the photo you want to print is displayed in the bottom right area of the screen.

Note

- See "Selecting a Photo" for details on how to select photos.

2. Click Color Adjustment... in the Printer Settings window.

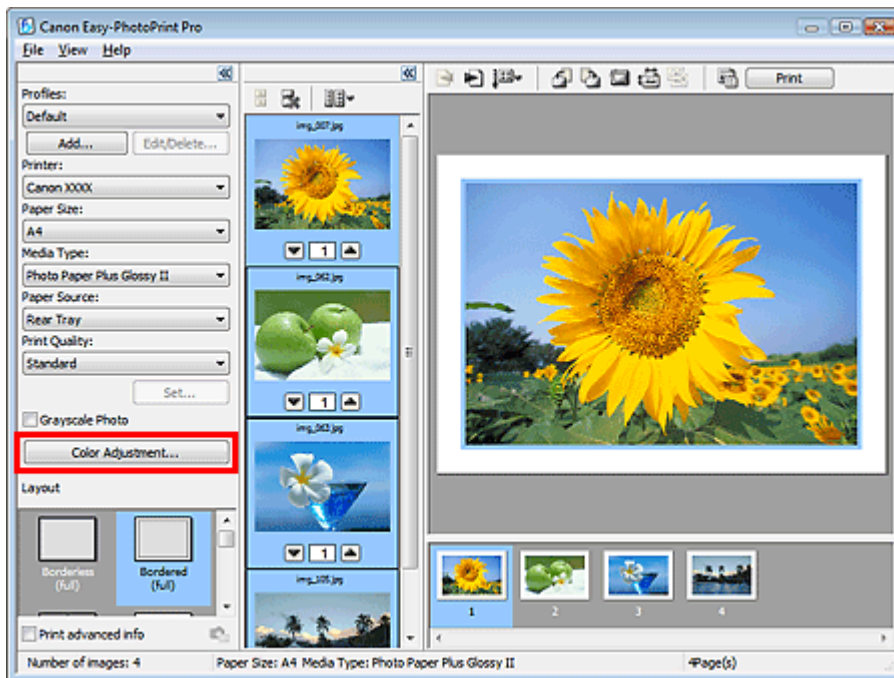

The Color Adjustment dialog box appears.

3. Click Pattern Print....

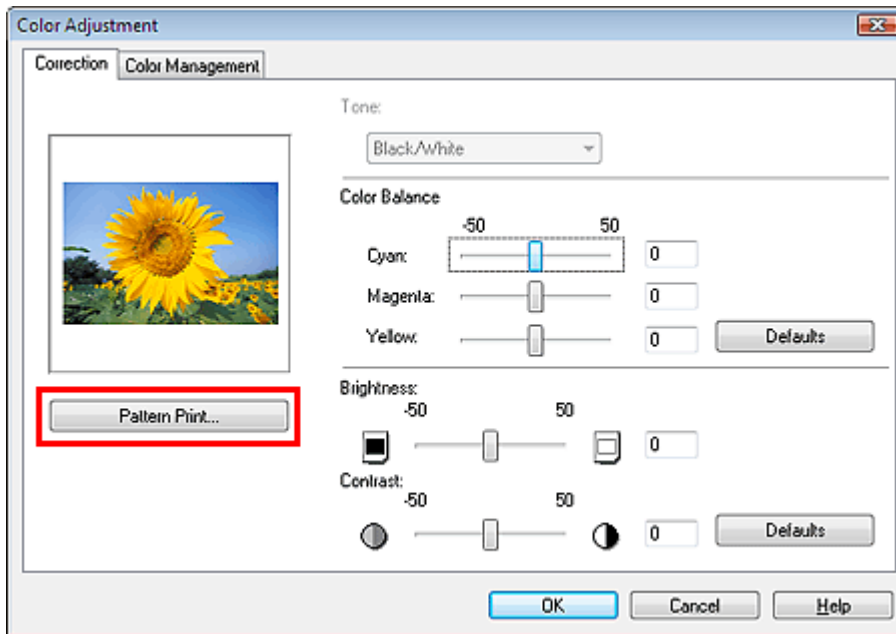

The Pattern Print window appears.

4. Select Brightness/Contrast for Pattern Print.

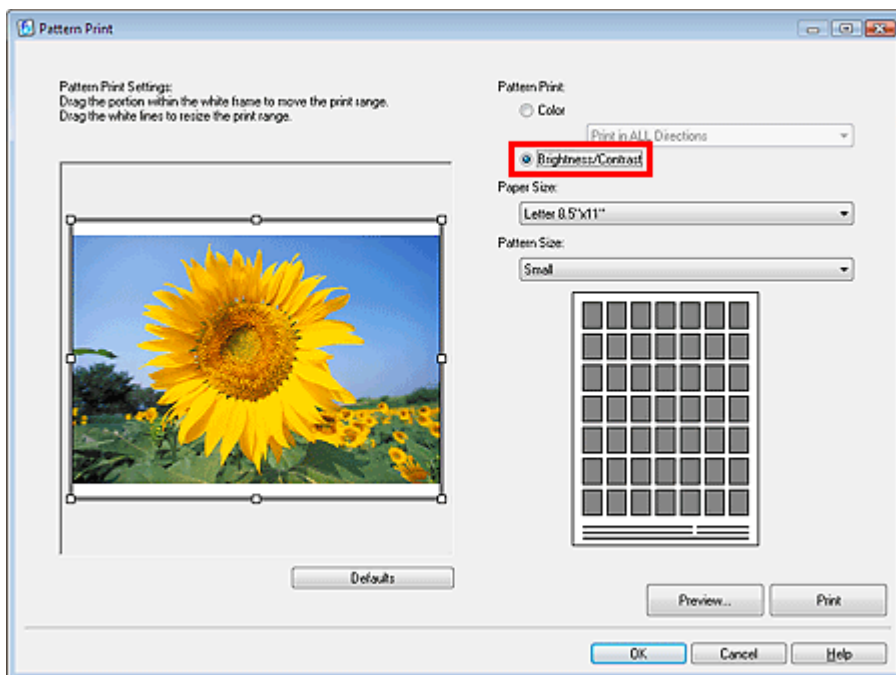

5. Select Paper Size and Pattern Size.

Note

- You can crop the image before printing the pattern. Move the white frame in Preview to change the cropping area.
- Click Preview... to display the print preview in a different window in which you can check the settings before printing.
- See Help for details on the Pattern Print window.

6. Click Print.

The pattern is printed.

Note

- The source image is printed in the center. Brightness increases from bottom to top. Contrast increases from left to right.
-

7. Click OK.

8. Select the image with the desired brightness/contrast from the printed pattern and enter the values indicated below the image into Brightness and Contrast.

9. Click OK.

[Page top](#) 

Advanced Guide

[Advanced Guide](#) > [Printing from a Computer](#) > [Printing with the Bundled Application Software](#) > [Easy-PhotoPrint Pro Settings](#)

[Easy-PhotoPrint Pro](#)

Easy-PhotoPrint Pro Settings

- ➔ [Printing Borderless Photos](#)
- ➔ [Printing an Index](#)
- ➔ [Printing Contact Sheets](#)
- ➔ [Printing Advanced Information](#)
- ➔ [Cropping Photos](#)
- ➔ [Printing with Adjusted Print Size](#)
- ➔ [Saving Print Settings](#)

[Page top](#) ↕

Advanced Guide

Advanced Guide > Printing from a Computer > Printing with the Bundled Application Software > Easy-PhotoPrint Pro Settings > Printing Borderless Photos

Easy-PhotoPrint Pro

Printing Borderless Photos

You can print borderless photos by selecting a borderless layout from Layout in the Printer Settings window.



Note

- Select a borderless layout and click Set... that appears to the right of Layout to display the Set Amount of Extension of Borderless Printing dialog box in which you can specify the amount of extension. See Help for details.

[Page top](#)

Advanced Guide

Advanced Guide > Printing from a Computer > Printing with the Bundled Application Software > Easy-PhotoPrint Pro Settings > Printing an Index

Easy-PhotoPrint Pro

Printing an Index

You can print an index of selected photos. An index print shows the thumbnails of the photos in one page. It is convenient for managing your photos.

To print an index, select Index for Layout in the Printer Settings window.



Important

- You can print up to 80 images on one page.

Note

- Index prints can only be printed on Letter 8.5"x11" and A4 paper.
- Select Index and click Set... that appears to the right of Layout to change the number of columns and rows, or add a header/footer.

[Page top](#)

Advanced Guide

Advanced Guide > Printing from a Computer > Printing with the Bundled Application Software > Easy-PhotoPrint Pro Settings > Printing Contact Sheets

Easy-PhotoPrint Pro

Printing Contact Sheets

You can print an index of photos with a design that looks like negative film strips.

To print a contact sheet, select Contact Sheet for Layout in the Printer Settings window.

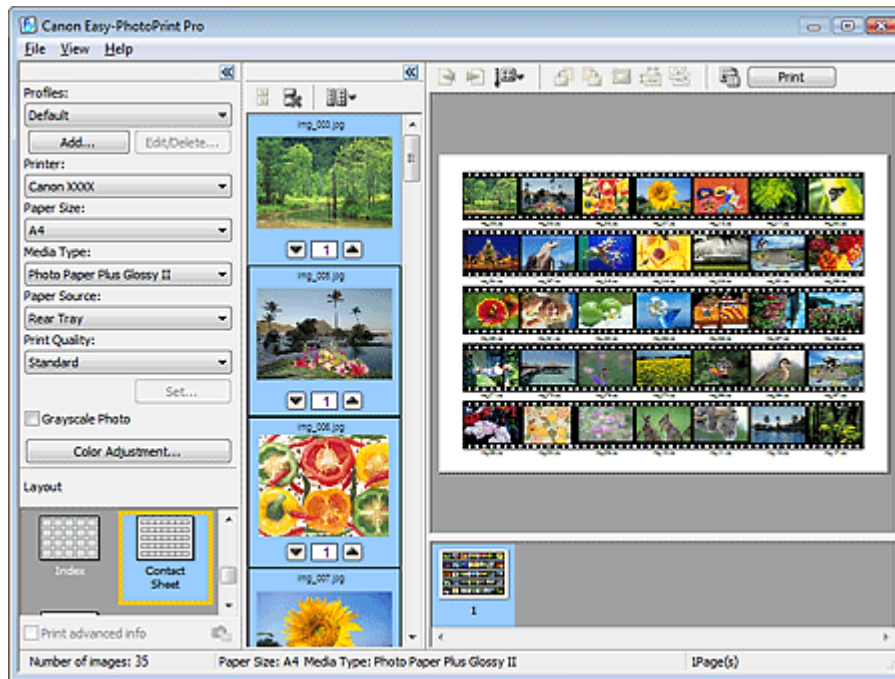

Note

- Contact sheets can only be printed on Letter 8.5"x11" and A4 paper.

[Page top](#)

Advanced Guide

Advanced Guide > Printing from a Computer > Printing with the Bundled Application Software > Easy-PhotoPrint Pro Settings > Printing Advanced Information



Printing Advanced Information

Select the Print advanced info checkbox in the Printer Settings window to print the photo with photo information or color correction information side by side.

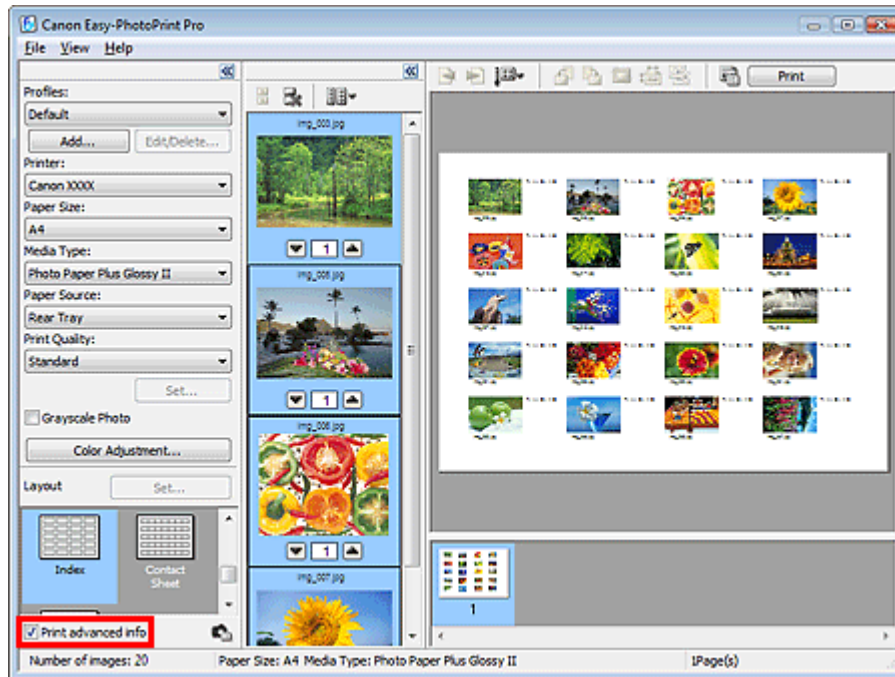

Note

- Displayed photo information items may vary depending on the application from which Easy-PhotoPrint Pro is started.
- Click  (Advanced Information Settings) to customize the information display (print position, item, etc.). See Help for details.
- The following combinations of layout and paper size are available for printing photo information or color correction information.

Layout	Paper Size
Bordered (full)	A4, Letter 8.5"x11", Fine Art A4, Fine Art Letter, 4"x6" 10x15cm, 5"x7" 13x18cm, 4"x8" 101.6x203.2mm, 8"x10" 20x25cm
Bordered (x2) Bordered (x4)	A4, Letter 8.5"x11", Fine Art A4, Fine Art Letter, 8"x10" 20x25cm
Index (*)	A4, Letter 8.5"x11"

*When Index is selected for Layout, only photo information is printed.

*When Index is selected for Layout, image arrangement is automatically changed to four columns and five rows.

- To change the print position of photo information for each image, select an image and click  (Change the photo information position for the image.).

Advanced Guide

Advanced Guide > Printing from a Computer > Printing with the Bundled Application Software > Easy-PhotoPrint Pro Settings > Cropping Photos

Easy-PhotoPrint Pro

Cropping Photos

Cropping a photo is the act of removing the unnecessary portions of the photo by selecting the necessary portions.

Click  (Crop) in the Print Preview window or double-click the preview image.

Move the white frame to the portion to crop and click OK.

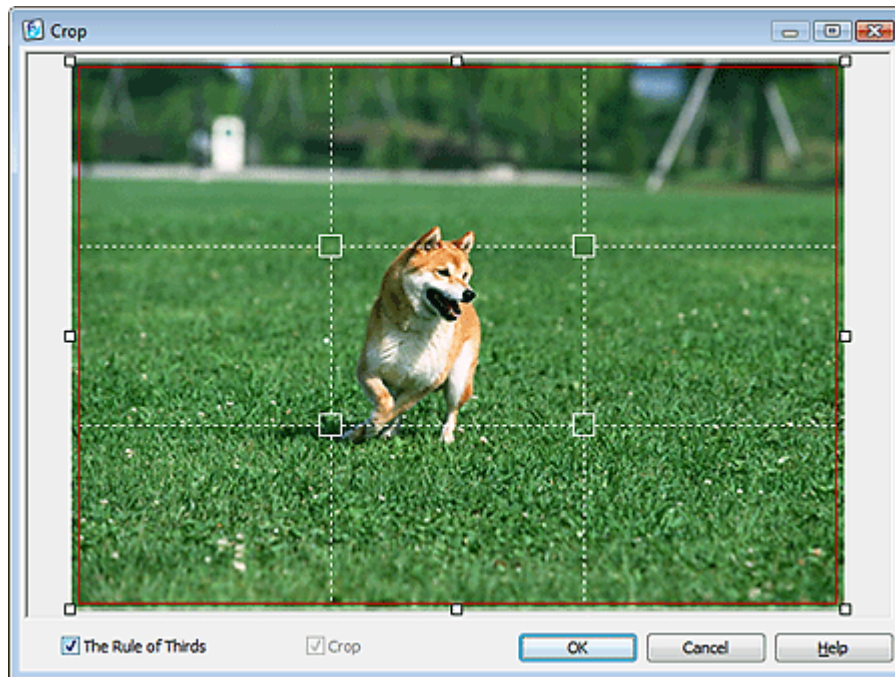

Note

- To move the cropping area, place the cursor within the white frame and drag it. Drag the white lines to enlarge/reduce the cropping area.
- Select the The Rule of Thirds checkbox to display white broken lines. To create a balanced composition, drag any of the intersecting points (white squares) or white broken lines over the main subject of the photo.

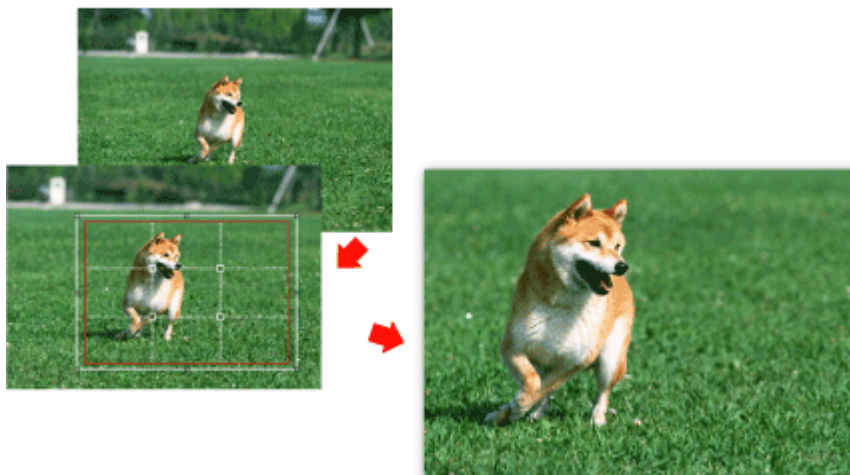

- The cropping effect applies only to the print result. The original image will not be cropped.
-

[Page top](#) ↕

Advanced Guide

Advanced Guide > Printing from a Computer > Printing with the Bundled Application Software > Easy-PhotoPrint Pro Settings > Printing with Adjusted Print Size

Easy-PhotoPrint Pro

Printing with Adjusted Print Size

Click  (Specify Print Size) in the Print Preview window to adjust the print size and amount of margin before printing.

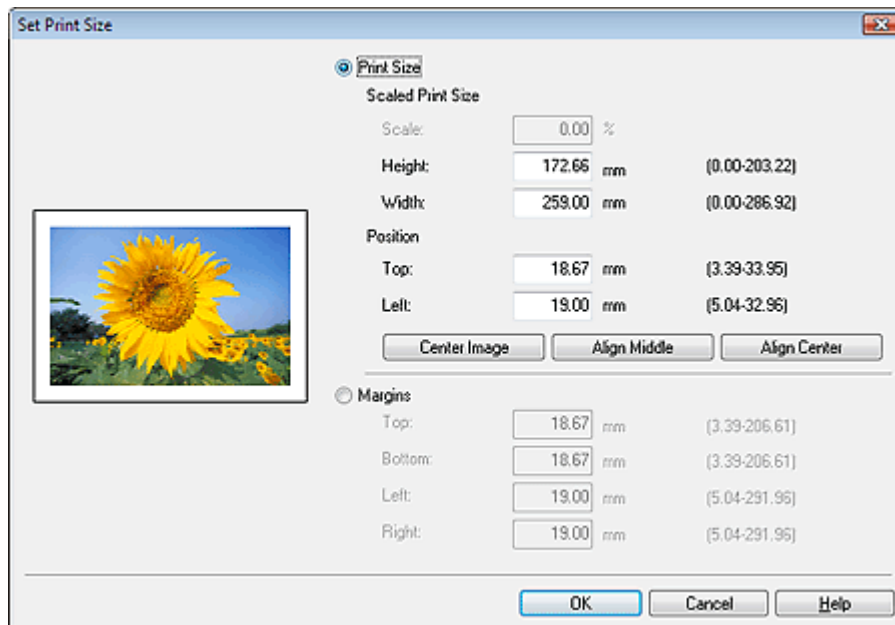

Important

- Set Printer, Paper Size and Layout before changing the values in Scale, Height, etc. in the Set Print Size dialog box. If you change Printer, Paper Size or Layout after changing the values, the original values return.
- To return the Scale, Height and other values in the Set Print Size dialog box to the original values, set the number of copies below the thumbnail to 0, then specify the number again.

Note

- Print size can be adjusted only when Bordered (full) is selected for Layout.
- Margins can be adjusted only when the image is cropped.

[Page top](#)

Advanced Guide

Advanced Guide > Printing from a Computer > Printing with the Bundled Application Software > Easy-PhotoPrint Pro Settings > Saving Print Settings

Easy-PhotoPrint Pro

Saving Print Settings

You can save frequently used combinations of paper size, media type, color adjustment, etc. as custom profiles. Saved profiles can be loaded from a list. This allows you to print photos instantly with your favorite settings.

Click Add... in the Printer Settings window to display the Add to Profiles dialog box. Enter Name and Description, then click OK.

Parameter	Setting
Printer	Canon XXXX
Paper Size	A4
Media Type	Photo Paper Plus Glossy II
Paper Source	Rear Tray
Print Quality	Standard
Grayscale Photo	OFF
Color Balance	Cyan: 0 Magenta: 0 Yellow: 0
Brightness	0
Contrast	0
Color Mode	Enable ICC Profile

Important

- Enter up to 64 characters in Name.
- "Default" or "Custom" cannot be used for Name.
- Enter up to 256 characters in Description.

Note

- Click Edit/Delete... in the Printer Settings window to edit names and descriptions or delete profiles.

Advanced Guide

[Advanced Guide](#) > [Printing from a Computer](#) > [Printing with Other Application Software](#)

Printing with Other Application Software

- ➔ [Various Printing Methods](#)
- ➔ [Changing the Print Quality and Correcting Image Data](#)
- ➔ [Overview of the Printer Driver](#)

[Page top](#) ↑

Advanced Guide

[Advanced Guide](#) > [Printing from a Computer](#) > [Printing with Other Application Software](#) > [Various Printing Methods](#)

Various Printing Methods

- ➔ [Printing with Easy Setup](#)
- ➔ [Setting a Page Size and Orientation](#)
- ➔ [Setting the Number of Copies and Printing Order](#)
- ➔ [Setting the Stapling Margin](#)
- ➔ [Borderless Printing](#)
- ➔ [Fit-to-Page Printing](#)
- ➔ [Scaled Printing](#)
- ➔ [Page Layout Printing](#)
- ➔ [Poster Printing](#)
- ➔ [Booklet Printing](#)
- ➔ [Duplex Printing](#)
- ➔ [Stamp/Background Printing](#)
- ➔ [Registering a Stamp](#)
- ➔ [Registering Image Data to be Used as a Background](#)
- ➔ [Printing an Envelope](#)
- ➔ [Switching the Paper Source to Match the Purpose](#)
- ➔ [Displaying the Print Results before Printing](#)
- ➔ [Setting Paper Dimensions \(Custom Size\)](#)

[Page top](#) ↑

Advanced Guide

Advanced Guide > Printing from a Computer > Printing with Other Application Software > Various Printing Methods > Printing with Easy Setup

Printing with Easy Setup

The simple setup procedure for carrying out appropriate printing on this machine, is as follows:

1. Open the [printer driver setup window](#)
2. Select a frequently used profile

In Commonly Used Settings on the Quick Setup tab, select a printing profile suited for the purpose. When you select a printing profile, the Additional Features, Media Type, and Printer Paper Size settings are automatically switched to the values that were preset.

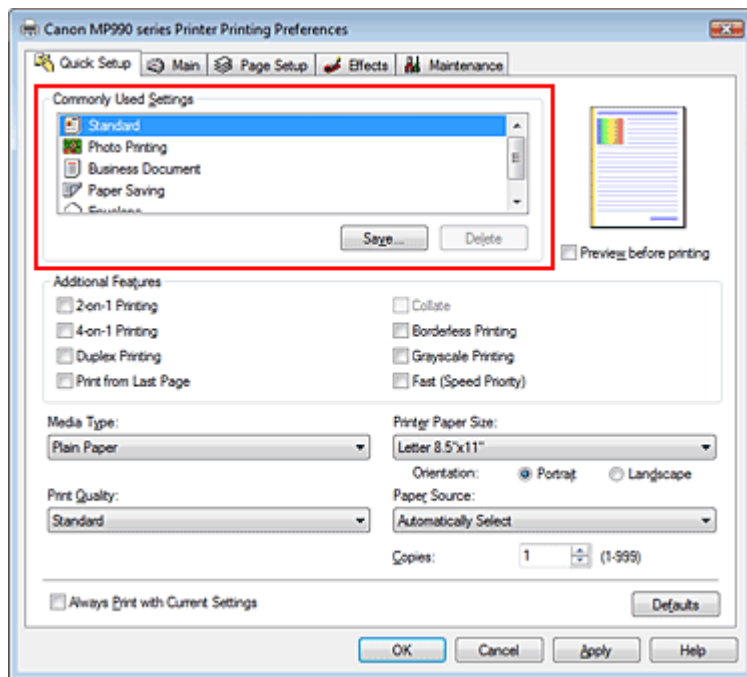

3. Select the print quality

Select High, Standard, or Fast that matches your purpose for Print Quality.

4. Select the paper source

Select Automatically Select, Rear Tray, Cassette, Continuous Autofeed, or Paper Allocation that matches your purpose for Paper Source.

Important

- The paper source settings that can be selected may differ depending on the paper type and size.

5. Complete the setup

Click OK.

When you execute print, the document is printed with settings that matches your purpose.

Important

- When you check the Always Print with Current Settings check box, all settings on the Quick Setup, Main, Page Setup, and Effects tabs are saved, and you can print with the same settings from the next time as well.

- Click Save... to register the specified settings. For instructions on registering settings, see "[Registering a Frequently Used Printing Profile.](#)"

[Page top](#) ↑

Advanced Guide

Advanced Guide > Printing from a Computer > Printing with Other Application Software > Various Printing Methods > Setting a Page Size and Orientation

Setting a Page Size and Orientation

The paper size and orientation are essentially determined by the application. When the page size and orientation set for Page Size and Orientation on the Page Setup tab are same as those set with the application, you do not need to select them on the Page Setup tab.

When you are not able to specify them with the application, the procedure for selecting a page size and orientation is as follows:

You can also set page size and Orientation on the Quick Setup tab.

1. Open the printer driver setup window

2. Select the paper size

Select a page size from the Page Size list on the Page Setup tab.

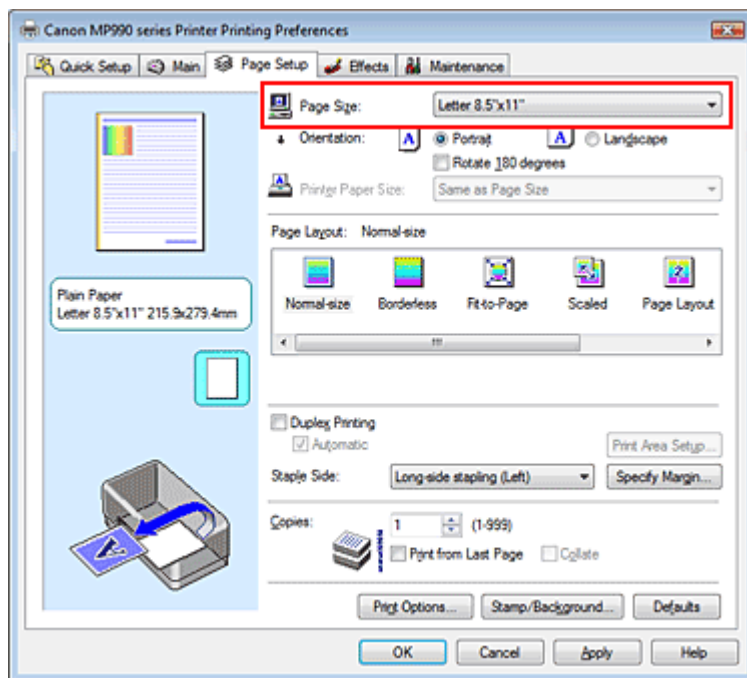

3. Set Orientation

Select Portrait or Landscape for Orientation. Check Rotate 180 degrees check box when you want to perform printing with the original being rotated 180 degrees.

4. Complete the setup

Click OK.

When you execute print, the document will be printed with the selected page size and the orientation.

Advanced Guide

Advanced Guide > Printing from a Computer > Printing with Other Application Software > Various Printing Methods > Setting the Number of Copies and Printing Order

Setting the Number of Copies and Printing Order

Default Setting



Print from Last Page

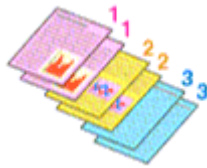

Collate

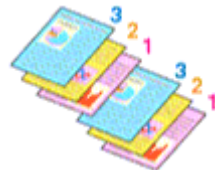

Print from Last Page + Collate

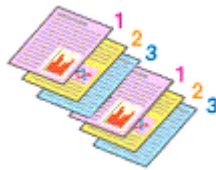

The procedure for specifying the number of copies and printing order is as follows:
You can also set the number of copies on the Quick Setup tab.

1. Open the printer driver setup window

2. Specify the number of copies to be printed

For Copies on the Page Setup tab, specify the number of copies to be printed.

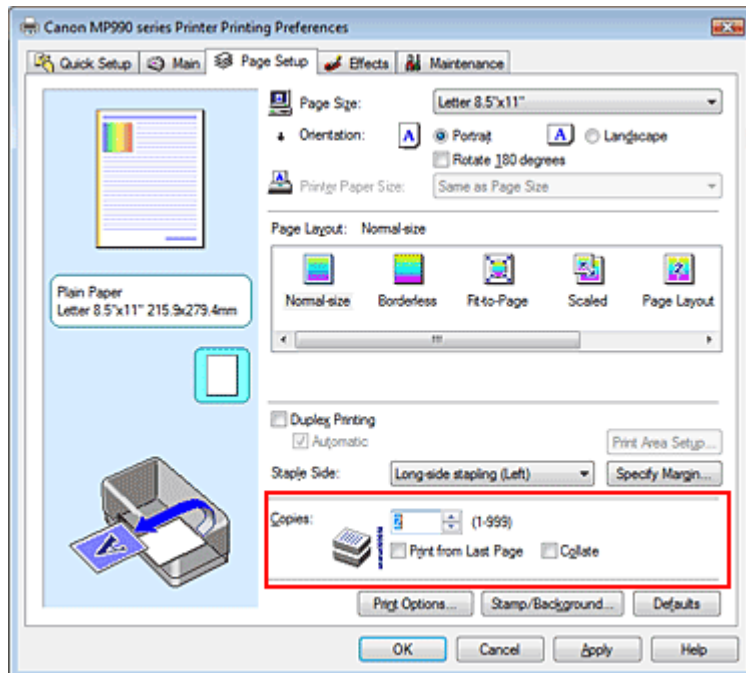

3. Specify the print order

Check the Print from Last Page check box when you want to print from the last page in order. When you do this, you do not need to sort pages into their correct order after printing.

4. Set up collated printing when you specify multiple copies in the Copies box

Check the Collate check box when you are specifying multiple copy together.

Uncheck this check box to print all pages with the same page number together.

5. Complete the setup

Click OK.

The specified number of copies will be printed with the specified printing order.

Important

- When the application software that you used to create the document has the same function, give priority to the printer driver settings. However, if the print results are not acceptable, specify the function settings on the application software. When you specify the number of copies and the printing order with both the application and this printer driver, the number of copies may be multiplied numbers of the two settings or the specified printing order may not be enabled.
- Print from Last Page and Collate appear grayed out and are unavailable when Booklet is selected for Page Layout.
- Print from Last Page appears grayed out and is unavailable when Poster is selected for Page Layout.

Note

- By setting both Print from Last Page and Collate, you can perform printing so that papers are collated one by one starting from the last page.
These settings can be used in combination with Borderless, Normal-size, Fit-to-Page, Scaled, Page Layout, and Duplex Printing.

[Page top ↕](#)

Advanced Guide

Advanced Guide > Printing from a Computer > Printing with Other Application Software > Various Printing Methods > Setting the Stapling Margin

Setting the Stapling Margin

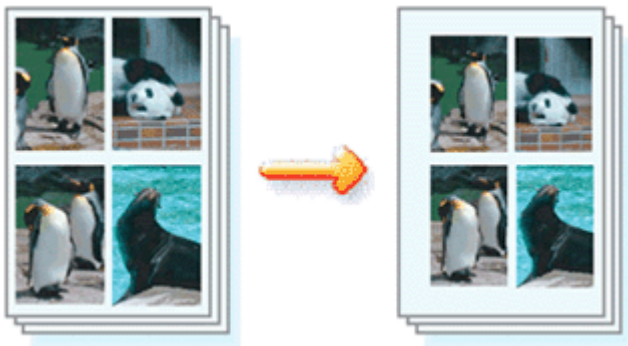

The procedure for setting the staple side and the margin width is as follows:

1. Open the **printer driver setup window**
2. Specify the side to be stapled

Check the position of the stapling margin from Staple Side on the Page Setup tab.

The printer analyzes the Orientation and Page Layout settings, and automatically selects the best staple position. When you want to change the setting, select from the list.

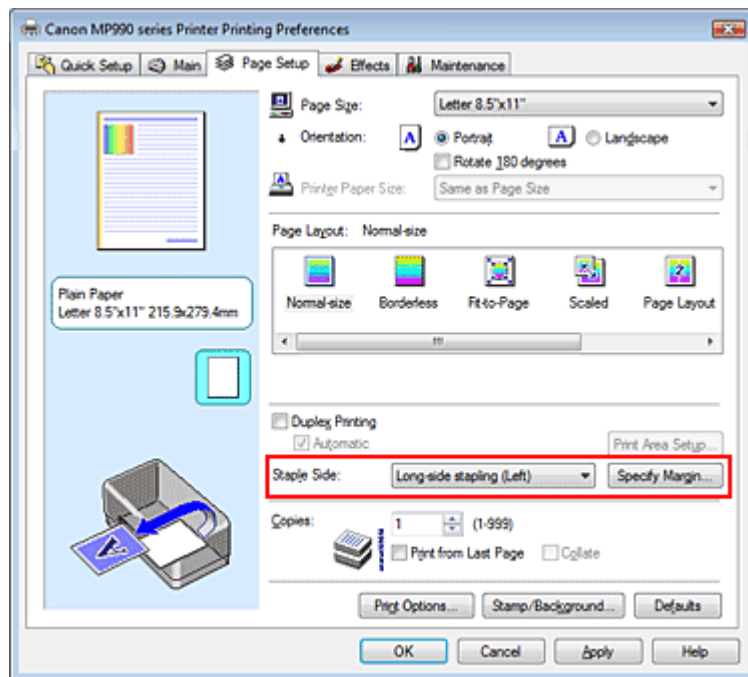

3. Set the margin width

If necessary, click Specify Margin... and set the margin width, and then click OK.



4. Complete the setup

Click OK on the Page Setup tab.

When you execute print, the data is printed with the specified staple side and margin width.

Important

- Staple Side and Specify Margin... appear grayed out and are unavailable when:
 - Borderless, Poster, or Booklet is selected for Page Layout.
 - Scaled is selected for Page Layout (When Duplex Printing is also selected, only Staple Side can be specified).

[Page top](#) 

Advanced Guide

Advanced Guide > Printing from a Computer > Printing with Other Application Software > Various Printing Methods > Borderless Printing

Borderless Printing

The borderless printing function allows you to print data without any margin by enlarging the data so that it extends slightly off the paper. Without the borderless printing function, a margin is provided around the printed data. When you want to print data such as a photo without providing any margin around it, select borderless printing.

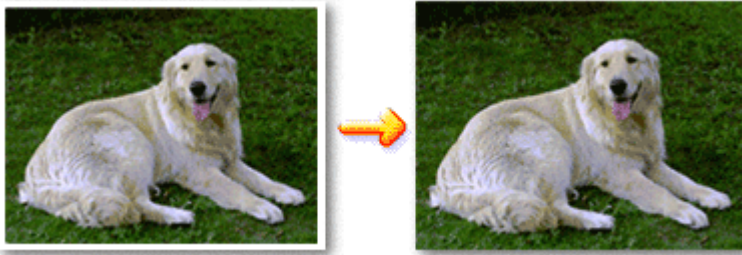

The procedure for performing borderless printing is as follows:

You can also set borderless printing in Additional Features on the Quick Setup tab.

Setting Borderless Printing

1. Open the **printer driver setup window**
2. Set borderless printing

Select Borderless from the Page Layout list on the Page Setup tab.

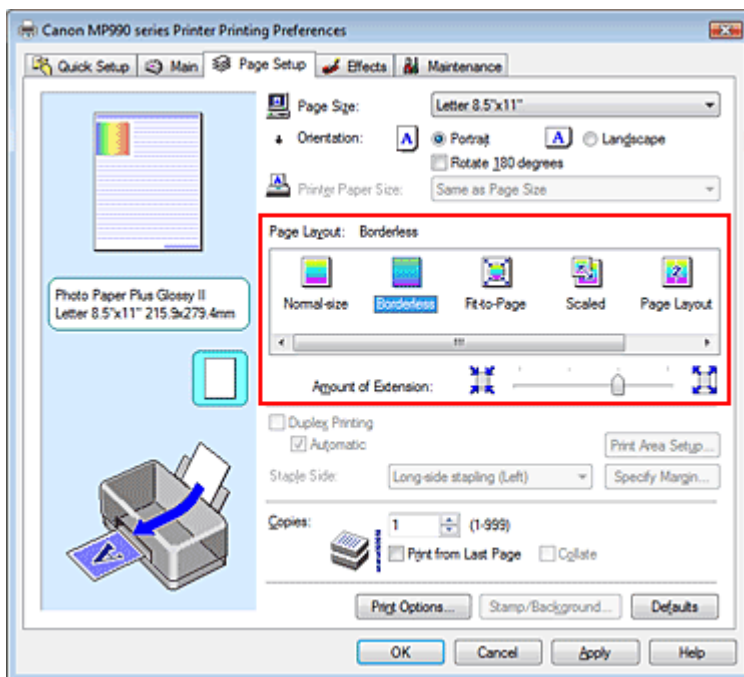

Click OK when the confirmation message appears.

When a message prompting you to change the media type appears, select a media type from the list and click OK.

3. Check the paper size

Check the Page Size list. When you want to change, select another page size from the list. The list displays only sizes that can be used for borderless printing.

4. Adjust the amount of extension from the paper

If necessary, adjust the amount of extension using the Amount of Extension slider.

Moving the slider to the right makes the amount larger and moving the slider to the left makes the amount smaller.

It is recommended to set the slider at the second position from the right for most cases.



Important

- When you set the slider at the rightmost position, the back side of the paper may become smudged.

5. Complete the setup

Click OK.

The data will be printed without any margins on the paper.

Important

- When a page size that cannot be used for borderless printing is selected, the size is automatically changed to the valid page sizes for borderless printing.
- When High Resolution Paper, Fine Art "Photo Rag", Other Fine Art Paper, T-Shirt Transfers, or Envelope is selected from the Media Type list on the Main tab, you cannot perform borderless printing.
- When Borderless is selected, the Printer Paper Size, Staple Side (when Duplex Printing is not selected) settings, and the Stamp/Background... button on the Page Setup tab appear grayed out and are unavailable.
- Print quality may deteriorate or the sheet may be stained at the top and bottom depending on the type of the media used.
- When the ratio of the height to the width differs from the image data, a portion of the image may not be printed depending on the size of the media used.
In this case, crop the image data with an application software according to the paper size.

Note

- When Plain Paper is selected for Media Type on the Main tab, borderless printing is not recommended, and therefore the dialog box for media selection appears.
When you are using plain paper for test printing, select Plain Paper, and click OK.

Expanding the Range of the Document to Print

Specifying a large amount of extension allows you to perform borderless printing with no problems. However, the portion of the document that extends off the paper range will not be printed. Subjects around the perimeter of a photo may not be printed.

Try borderless printing once. When you are not satisfied with the result of borderless printing, reduce the amount of extension. The extension amount becomes shorter as the Amount of Extension slider is moved to the left.

Important

- When the amount of extension is shortened, an unexpected margin may be produced on the print, depending on the size of the paper.

Note

- When the Amount of Extension slider is set to the leftmost position, image data will be printed in the full size.
- When Preview before printing is checked on the Main tab, you can confirm before printing whether there will be no border.

Advanced Guide

Advanced Guide > Printing from a Computer > Printing with Other Application Software > Various Printing Methods > Fit-to-Page Printing

Fit-to-Page Printing



The procedure for printing a document that is automatically enlarged or reduced to fit the page size to be used is as follows:

1. Open the printer driver setup window
2. Set fit-to-page printing

Select Fit-to-Page from the Page Layout list on the Page Setup tab.

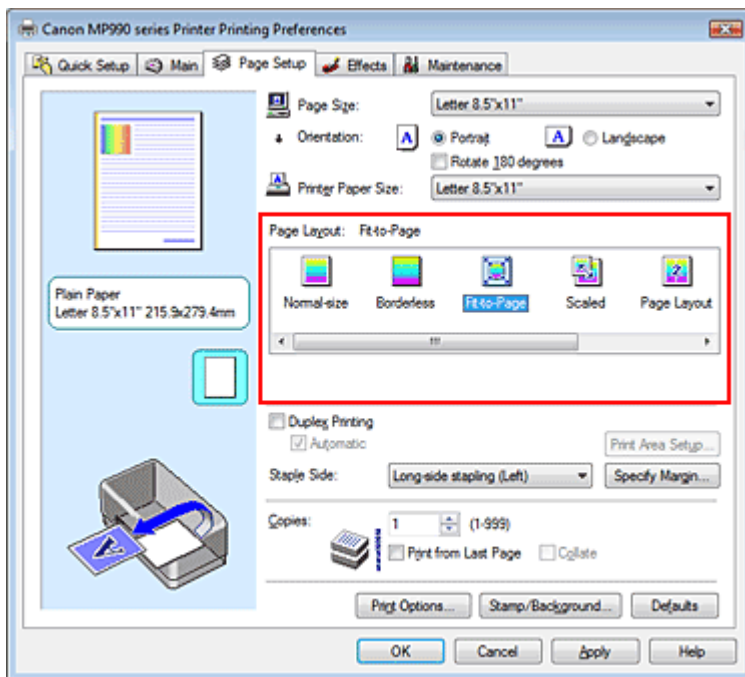

3. Select the paper size for the data

Using Page Size, select the page size that is set with your application.

4. Select the print paper size

Select the size of the paper loaded in the machine from the Printer Paper Size list. When the Printer Paper Size is smaller than the Page Size, the page image will be reduced. When the Printer Paper Size is larger than the Page Size, the page image will be enlarged.

The current settings are displayed in the settings preview on the left side of the printer driver.

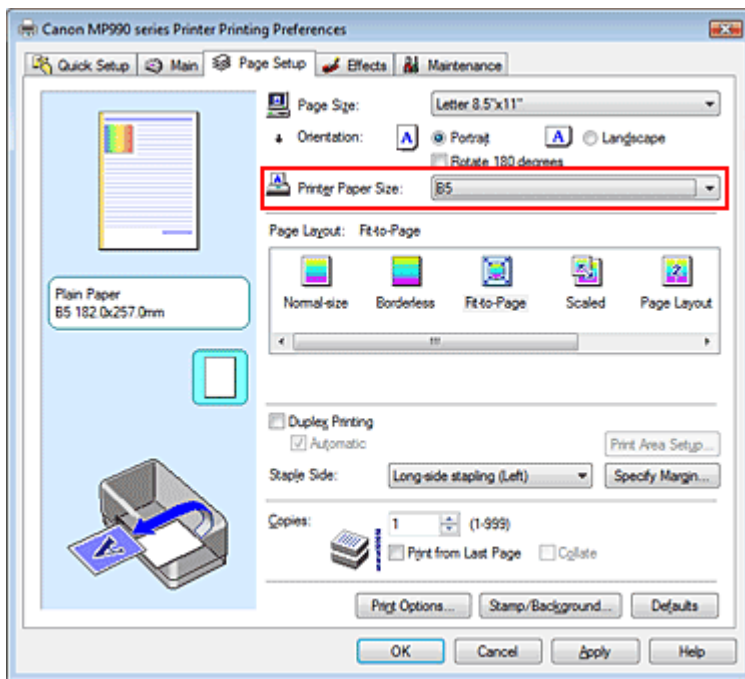

5. Complete the setup

Click OK.

When you execute print, the document will be enlarged or reduced to fit to the page size.

[Page top ↕](#)

Advanced Guide

Advanced Guide > Printing from a Computer > Printing with Other Application Software > Various Printing Methods > Scaled Printing

Scaled Printing



The procedure for printing a document with pages enlarged or reduced is as follows:

1. Open the printer driver setup window
2. Set scaled printing

Select Scaled from the Page Layout list on the Page Setup tab.

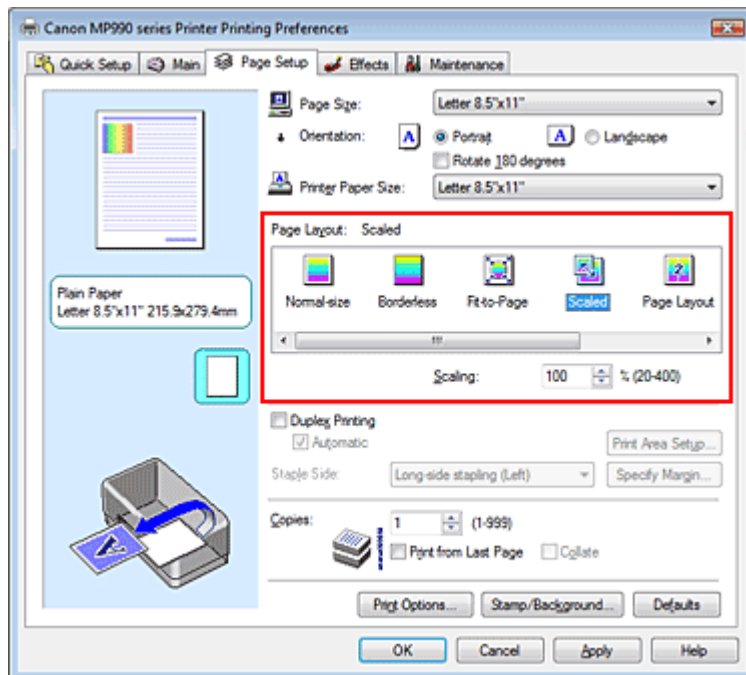

3. Select the paper size for the data
Using Page Size, select the page size that is set with your application.
4. Set the scaling rate by using one of the following methods:
 - **Select a Printer Paper Size**
When the printer paper size is smaller than the Page Size, the page image will be reduced.
When the printer paper size is larger than the Page Size, the page image will be enlarged.

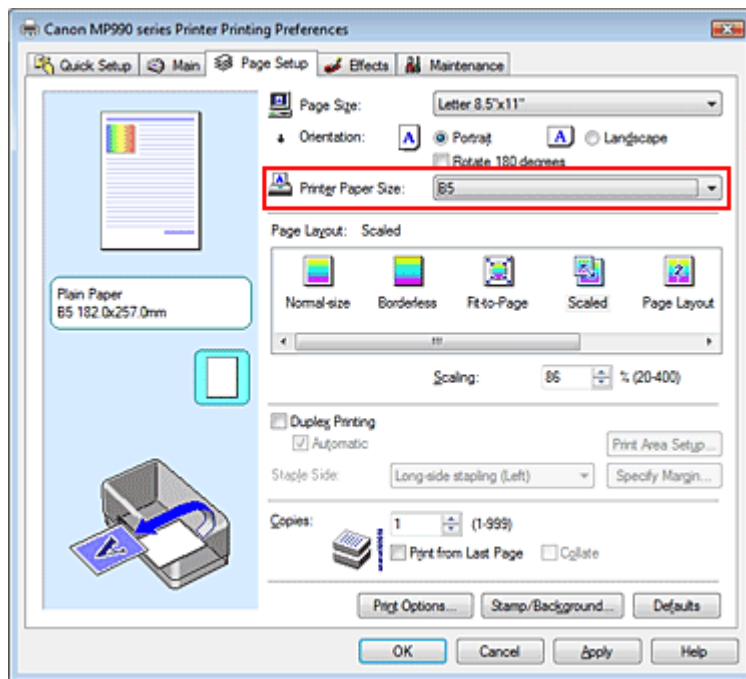

- **Specify a scaling factor**

Directly type in a value into the Scaling box.

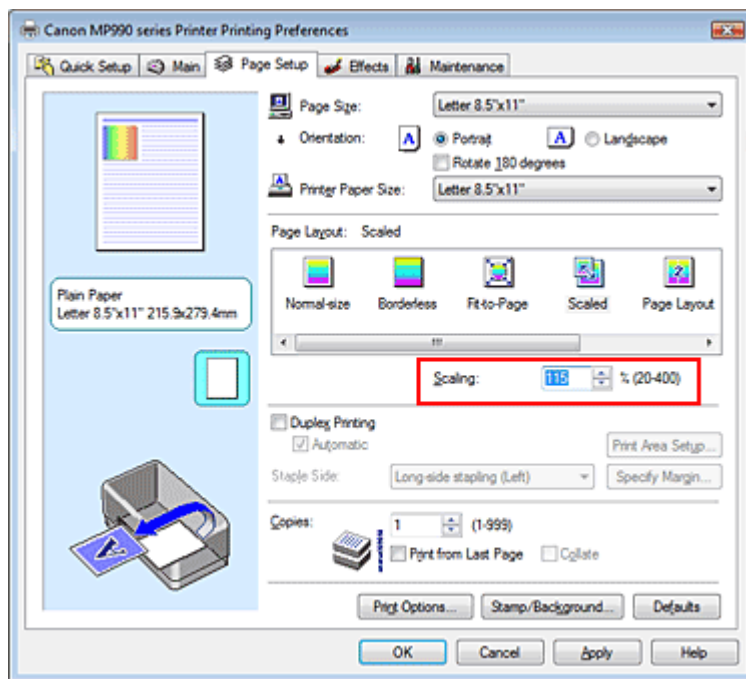

The current settings are displayed in the settings preview on the left side of the printer driver.

5. Complete the setup

Click OK.

When you execute print, the document will be printed with the specified scale.

Important

- When the application software with which you created the original has the scaled printing function, configure the settings on your application software. You do not need to configure the same setting in the printer driver.
- When Scaled is selected, the Staple Side list box appears grayed out and is unavailable (when Duplex Printing is not selected).

Note

- Selecting Scaled changes the printable area of the document.
-

[Page top](#) 

Advanced Guide

Advanced Guide > Printing from a Computer > Printing with Other Application Software > Various Printing Methods > Page Layout Printing

Page Layout Printing

The page layout printing function allows you to print more than one page image on a single sheet of paper.



The procedure for performing page layout printing is as follows:

1. Open the **printer driver setup window**
2. Set page layout printing

Select Page Layout from the Page Layout list on the Page Setup tab.

The current settings are displayed in the settings preview on the left side of the printer driver.

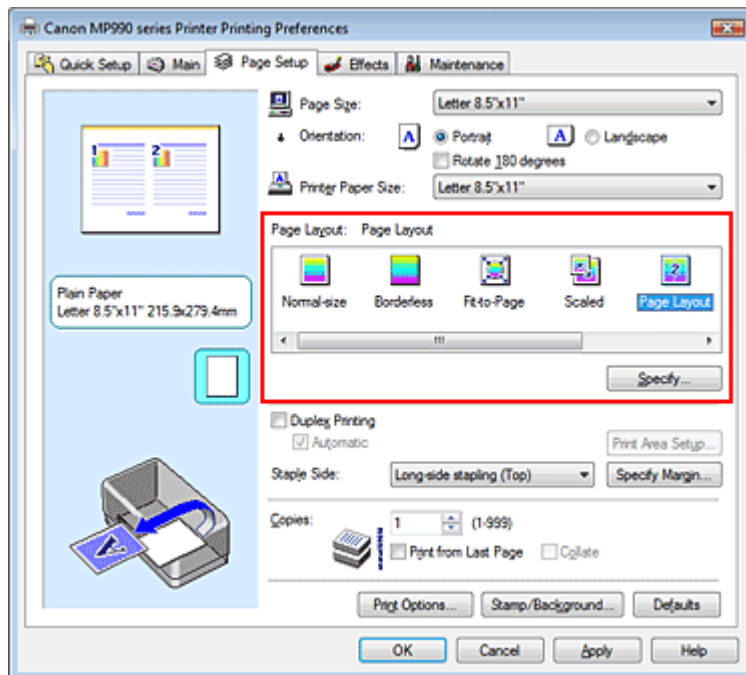

3. Select the print paper size

Select the size of the paper loaded in the machine from the Printer Paper Size list. Setting the layout of two pages of the document from left to right is complete.

4. Set the number of pages to be printed on one sheet and the page order

If necessary, click Specify..., specify the following settings in the Page Layout Printing dialog box, and click OK.

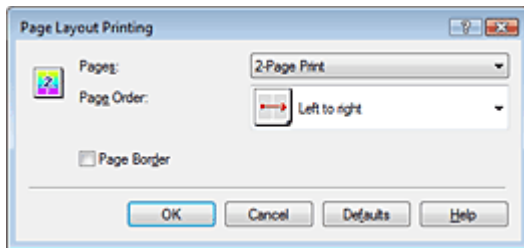
**Pages**

To increase the number of pages to be included on a single sheet of paper, select a desired number of pages from the list.

You can also set 2-Page Print or 4-Page Print on the Quick Setup tab.

Page Order

To change the page arrangement order, select an icon from the list to change the page placement order.

Page Border

To print a page border around each document page, check this check box.

5. Complete the setup

Click OK on the Page Setup tab.

When you execute print, the specified number of pages will be arranged on each sheet of paper in the specified order.

[Page top](#) ↕

Advanced Guide

Advanced Guide > Printing from a Computer > Printing with Other Application Software > Various Printing Methods > Poster Printing

Poster Printing

The poster printing function allows you to enlarge image data, divide it into several pages, and print these pages on separate sheets of paper. When the pages are pasted together, they form a large print like a poster.

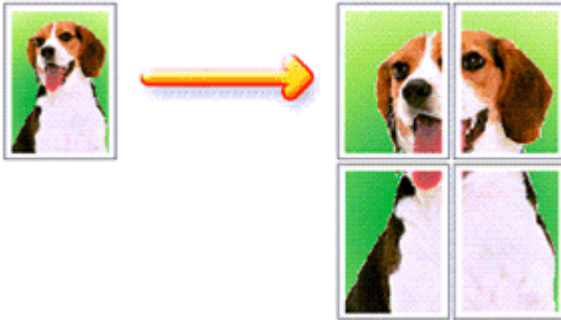

The procedure for performing poster printing is as follows:

Setting Poster Printing

1. Open the printer driver setup window
2. Set poster printing

Select Poster from the Page Layout list on the Page Setup tab.

The current settings are displayed in the settings preview on the left side of the printer driver.

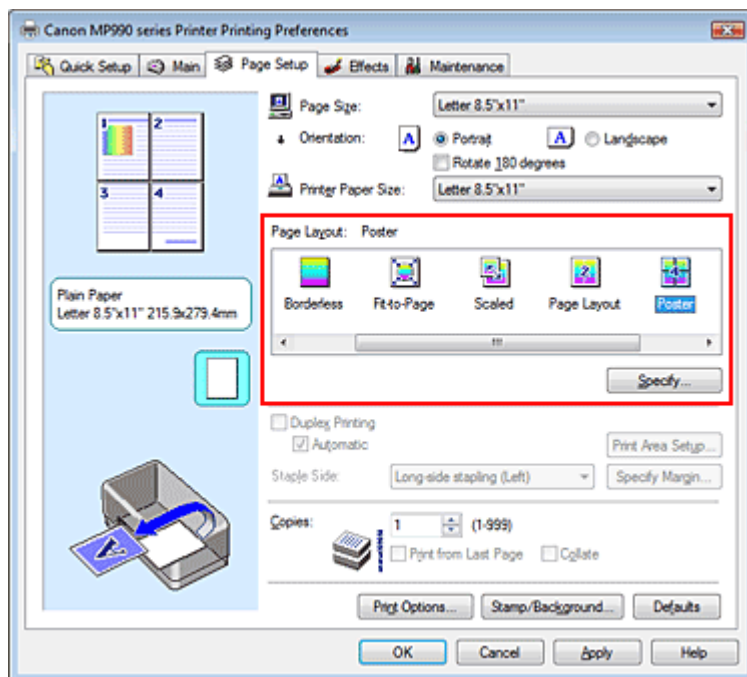

3. Select the print paper size

Select the size of the paper loaded in the machine from the Printer Paper Size list.

Setting 2 by 2-page poster printing is complete.

4. Set the number of image divisions and the pages to be printed

If necessary, click Specify..., specify the following settings in the Poster Printing dialog box, and then click OK.

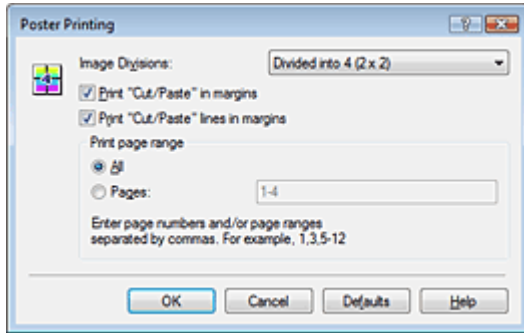

Image Divisions

Select the number of divisions (vertical x horizontal). As the number of divisions increases, the number of sheets used for printing increases, allowing you to create a larger poster.

Print "Cut/Paste" in margins

To leave out words "Cut" and "Paste", uncheck this check box.

Important

- This feature is unavailable when the 64-bit printer driver is used.

Print "Cut/Paste" lines in margins

To leave out cut lines, uncheck this check box.

Pages

To reprint only specific pages, enter the page number you want to print. To print multiple pages, specify by separating the pages with commas or entering a hyphen between the page numbers.

Note

- You can also specify the print range by clicking the pages in the settings preview.

5. Complete the setup

Click OK on the Page Setup tab.

When you execute print, the document will be divided into several pages during printing.

After all poster pages have been printed, paste the pages together to create a poster.

Printing Only Specific Pages

If ink becomes faint or runs out during printing, you can reprint specific pages by following the procedure below:

1. Set the print range

In the settings preview on the left of the Page Setup tab, click the pages that do not need to be printed.

The pages that were clicked are deleted, and only the pages to be printed are displayed.

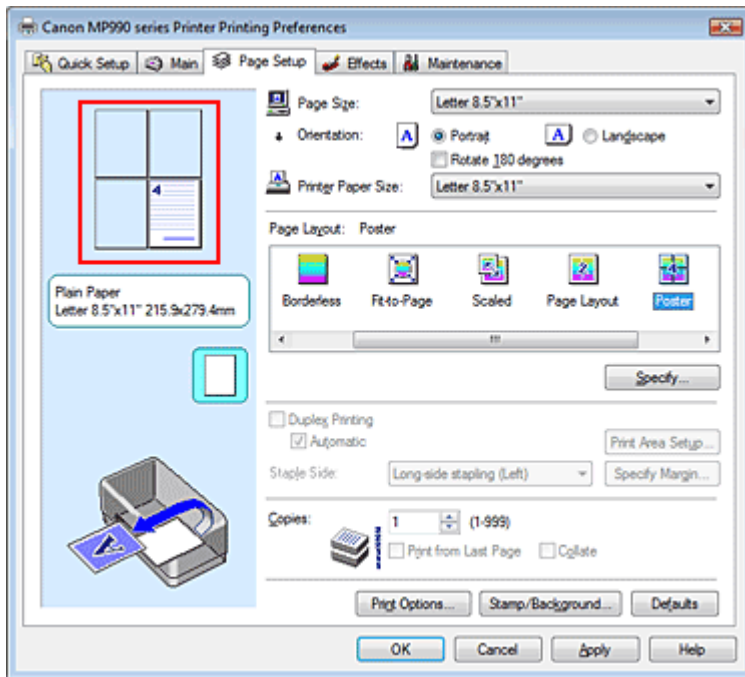

Note

- Click the deleted pages to display them again.
- Right-click the settings preview to select Print all pages or Delete all pages.

2. Complete the setup

After completing the page selection, click OK.

When you execute print, only specified pages will be printed.

Important

- When Poster is selected, the Duplex Printing, Staple Side and Print from Last Page appear grayed out and are unavailable.
- Since poster printing enlarges the document when printing it, the print results may become coarse.

Advanced Guide

Advanced Guide > Printing from a Computer > Printing with Other Application Software > Various Printing Methods > Booklet Printing

Booklet Printing

The booklet printing function allows you to print data for a booklet. Data is printed on both sides of the paper. This type of printing ensures that pages can be collated properly, in page number order, when the printed sheets are folded and stapled at the center.

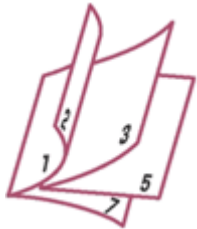

The procedure for performing booklet printing is as follows:

1. Open the **printer driver setup window**
2. Set booklet printing

Select Booklet from the Page Layout list on the Page Setup tab.

The current settings are displayed in the settings preview on the left side of the window.

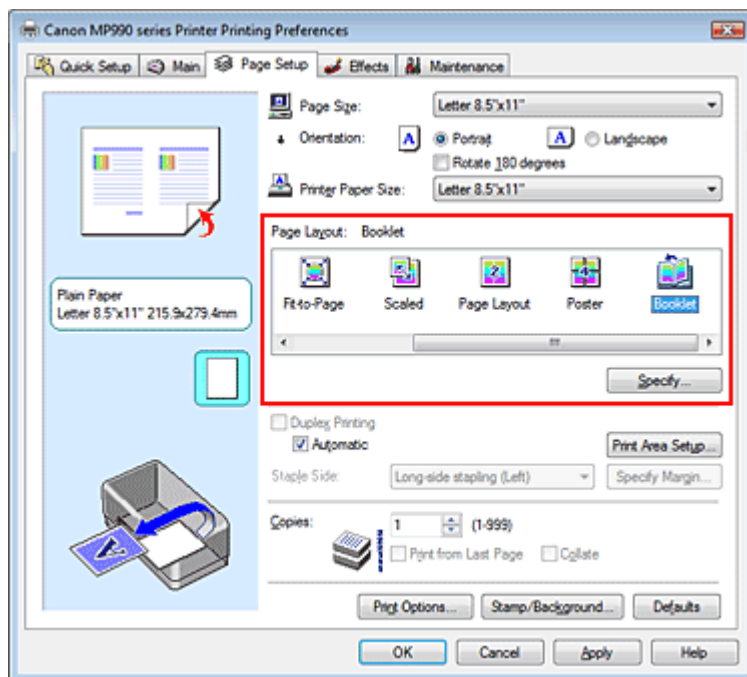

3. Select the print paper size

Select the size of the paper loaded in the machine from the Printer Paper Size list.

4. Set the margin for stapling and the margin width

Click Specify... and specify the following settings in the Booklet Printing dialog box, and then click OK.

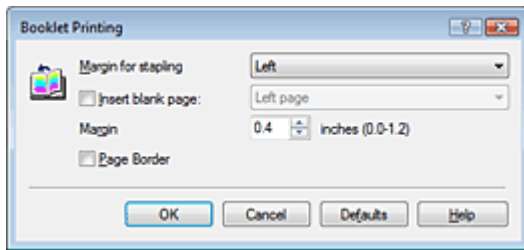
**Margin for stapling**

Select which side should the stapling margin be on when the booklet is completed.

Insert blank page

To leave one side of a sheet blank, check the check box, and select the page to be left blank.

Margin

Enter the margin width. The specified width from the center of the sheet becomes the margin width for one page.

Page Border

To print a page border around each document page, check the check box.

5. Complete the setup

Click OK on the Page Setup tab.

When you execute print, the document is automatically printed first on one side of a sheet of paper and then on the opposite side.

When the printing is complete, fold the paper at the center of the margin and make a booklet.

Important

- Booklet cannot be selected when a media type other than Plain Paper, Hagaki A or Hagaki is selected for Media Type.
- When Booklet is selected, Duplex Printing, Staple Side, Print from Last Page, and Collate appear grayed out and are unavailable.

Note

- The stamp and background are not printed on blank sheets inserted with the Insert blank page function of booklet printing.

Advanced Guide

Advanced Guide > Printing from a Computer > Printing with Other Application Software > Various Printing Methods > Duplex Printing

Duplex Printing

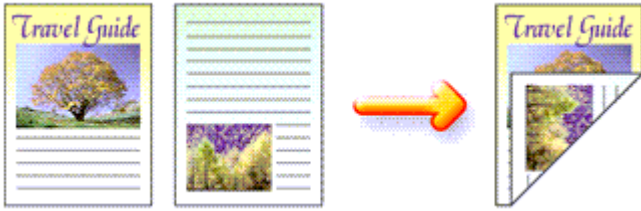

The procedure for printing data on both sides of a sheet of paper is as follows:
You can also set duplex printing in Additional Features on the Quick Setup tab.

Performing Automatic Duplex Printing

You can perform the duplex printing without having to turn over the paper.

1. Open the **printer driver setup window**
2. Set automatic duplex printing

Check the Duplex Printing check box on the Page Setup tab and confirm that Automatic is checked.

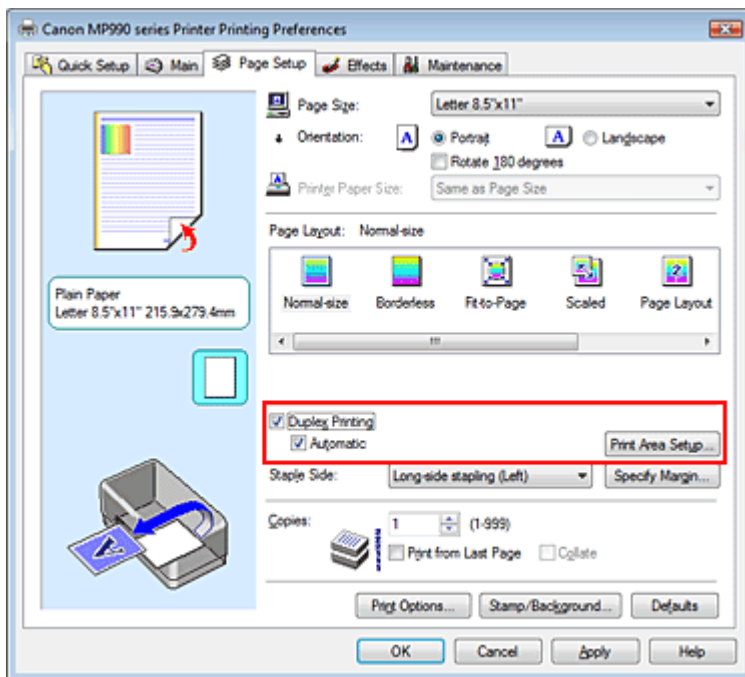

3. Select the layout

Select Normal-size (or Fit-to-Page, Scaled or Page Layout) from the Page Layout list.

4. Set the print area

When you perform duplex printing, the print area of the document becomes slightly narrower than usual and the document may not fit on one page.

Click Print Area Setup..., and select one of the following processing methods.

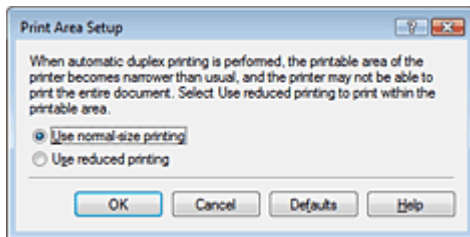

Use normal-size printing

Print without reducing the page.

Use reduced printing

Reduce the page slightly during printing.

5. Specify the side to be stapled

The machine analyzes the Orientation and Page Layout settings, and automatically selects the best Staple Side. When you want to change the setting, select another value from the list.

6. Set the margin width

If necessary, click Specify Margin... and set the margin width, and then click OK.

7. Complete the setup

Click OK on the Page Setup tab.

When you execute print, duplex printing will be started.

Performing Duplex Printing Manually

You can perform the duplex printing manually.

1. Open the printer driver setup window

2. Set duplex printing

Check the Duplex Printing check box and uncheck the Automatic check box on the Page Setup tab.

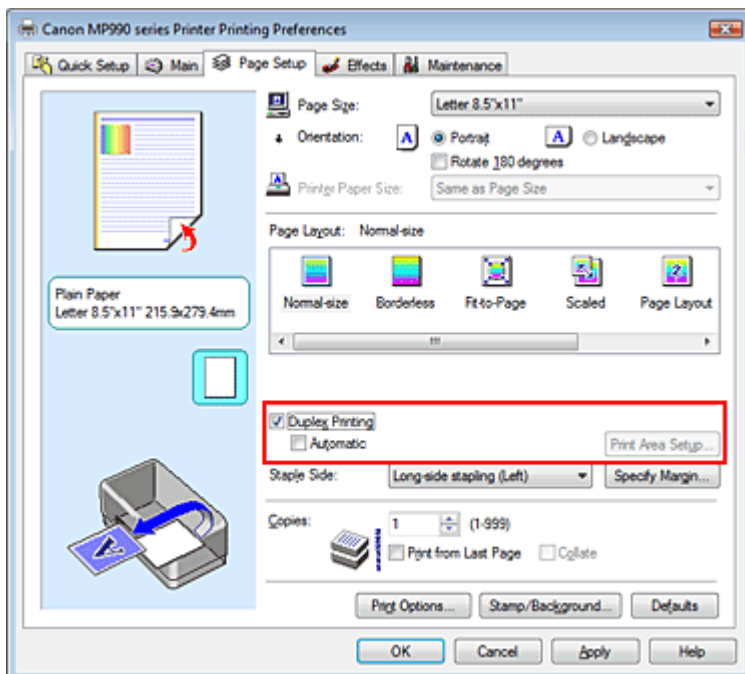

3. Select the layout

Select Normal-size (or Fit-to-Page, Scaled or Page Layout) from the Page Layout list.

4. Specify the side to be stapled

The machine analyzes the Orientation and Page Layout settings, and automatically selects the best Staple Side. When you want to change the setting, select another value from the list.

5. Set the margin width

If necessary, click Specify Margin... and set the margin width, and then click OK.

6. Complete the setup

Click OK on the Page Setup tab.

When you execute print, the document will be printed on one side of a sheet of paper. When the printing of one side is complete, load the paper correctly by following the message and click OK. The document will be printed on the opposite side.

Important

- Duplex Printing appears grayed out and is unavailable when:
 - A media type other than Plain Paper, Hagaki A or Hagaki is selected from the Media Type list.
 - Poster is selected from the Page Layout list.
- When Booklet is selected from the Page Layout list, Duplex Printing and Staple Side appear grayed out and are unavailable.
- After printing the front page, there is an ink drying wait time before starting to print the back page (Operation stops temporarily). Do not touch the paper during the time. You can change the ink drying wait time at Custom Settings on the Maintenance tab.
- When you perform the automatic duplex printing for Hagaki, print an address first and then print your message.

Note

- When you select borderless printing during duplex printing, a dialog box for media type selection may appear. If that happens, select Plain Paper.
- When performing the automatic duplex printing, do not use any plain paper smaller than A5. Also, do not select any type of paper other than Plain Paper, Hagaki A or Hagaki at Media Type.
- If the back side of the paper becomes smudged during duplex printing, perform Bottom Plate Cleaning in the Maintenance tab.

Related Topic

[➡ Cleaning Inside the Machine](#)

Advanced Guide

Advanced Guide > Printing from a Computer > Printing with Other Application Software > Various Printing Methods > Stamp/Background Printing

Stamp/Background Printing

This feature is unavailable when the 64-bit printer driver is used.

The Stamp function allows you to print a stamp text or a bitmap over or behind document data. It also allows you to print date, time and user name. The Background function allows you to print a light illustration behind the document data.

The procedure for performing stamp/background printing is as follows:

Printing a Stamp

"CONFIDENTIAL," "IMPORTANT," and other stamps that are used often in companies are pre-registered.

1. Open the **printer driver setup window**
2. Click Stamp/Background... on the Page Setup tab

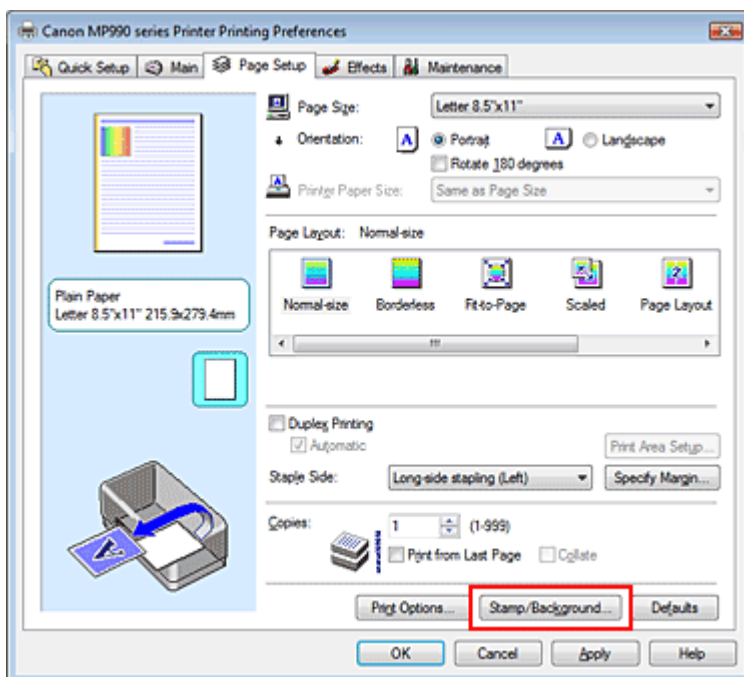

The Stamp/Background dialog box opens.

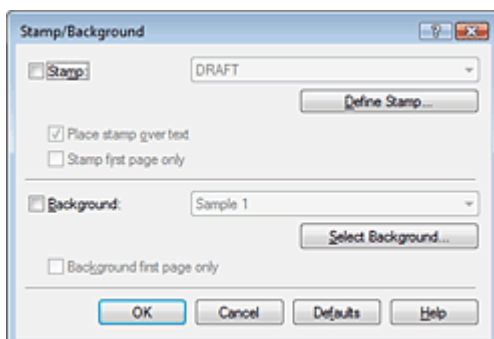

3. Select a stamp

Check the Stamp check box, and select a desired stamp from the list.

The current settings are displayed in the settings preview on the left side of the Page Setup tab.

4. Set the stamp details

If necessary, specify the following settings, and then click OK.

Place stamp over text

To print the stamp on the front of the document, check this check box.



Note

- The stamp is given priority because the stamp is printed over the document data in the sections where the stamp and the document data overlap. When this check box is unchecked, the stamp is printed behind the document data and may be hidden in the overlapping sections depending on the application used.

Stamp first page only

To print the stamp only on the first page, check this check box.

Define Stamp... button

To change the stamp text, bitmap, or position, click this (refer to "[Registering a Stamp](#)").

5. Complete the setup

Click OK on the Page Setup tab.

When you execute print, the data is printed with the specified stamp.

Printing a Background

Two bitmap files are pre-registered as samples.

1. Open the [printer driver setup window](#)

2. Click Stamp/Background... on the Page Setup tab

The Stamp/Background dialog box opens.

3. Select the background

Check the Background check box, and select a desired background from the list.

The current settings are displayed in the settings preview on the left side of the Page Setup tab.

4. Set the background details

If necessary, complete the following settings, and then click OK.

Background first page only

To print the background only on the first page, check this check box.

Select Background... button

To use another background or change the layout or density of a background, click this (refer to "[Registering Image Data to be Used as a Background](#)").

5. Complete the setup

Click OK on the Page Setup tab.

When you execute print, the data is printed with the specified background.

Important

- When Borderless is selected, the Stamp/Background... button appears grayed out and is unavailable.

Note

- The stamp and background are not printed on blank sheets inserted with the Insert blank page

function of booklet printing.

Related Topics

- ➔ [Registering a Stamp](#)
- ➔ [Registering Image Data to be Used as a Background](#)



[Page top](#) ↕

Advanced Guide

Advanced Guide > Printing from a Computer > Printing with Other Application Software > Various Printing Methods > Stamp/Background Printing > Registering a Stamp

Registering a Stamp

This feature is unavailable when the 64-bit printer driver is used.

You can create and register a new stamp. You can also change and register some of the settings of an existing stamp. Unnecessary stamps can be deleted at any time.

The procedure for registering a new stamp is as follows:

Registering a New Stamp

1. Open the printer driver setup window
2. Click Stamp/Background... on the Page Setup tab

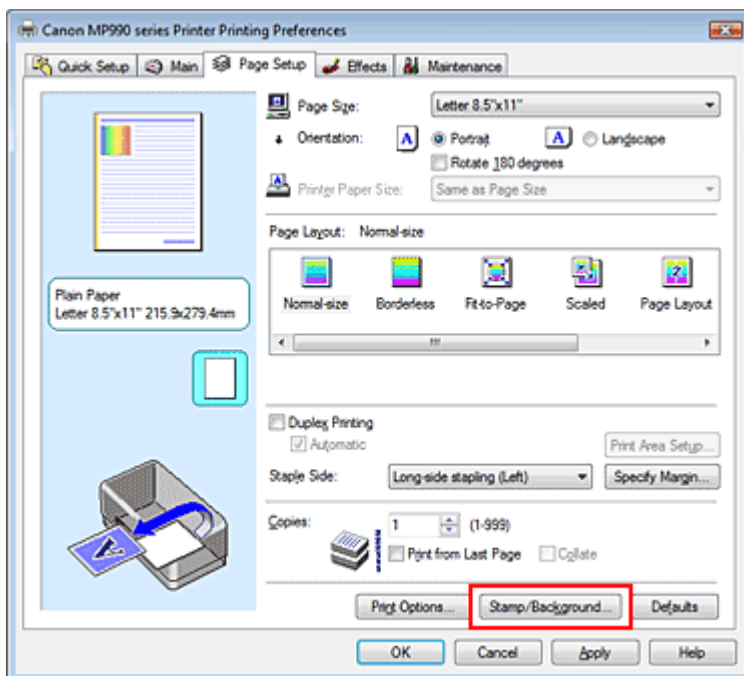

The Stamp/Background dialog box opens.

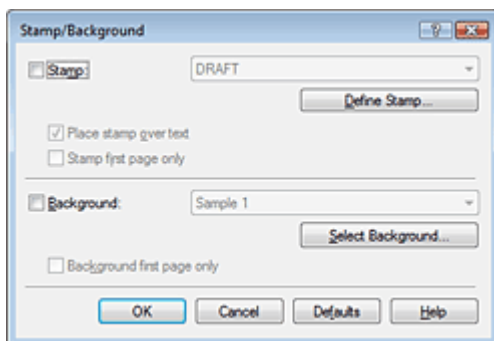

3. Click Define Stamp...

The Stamp Settings dialog box opens.

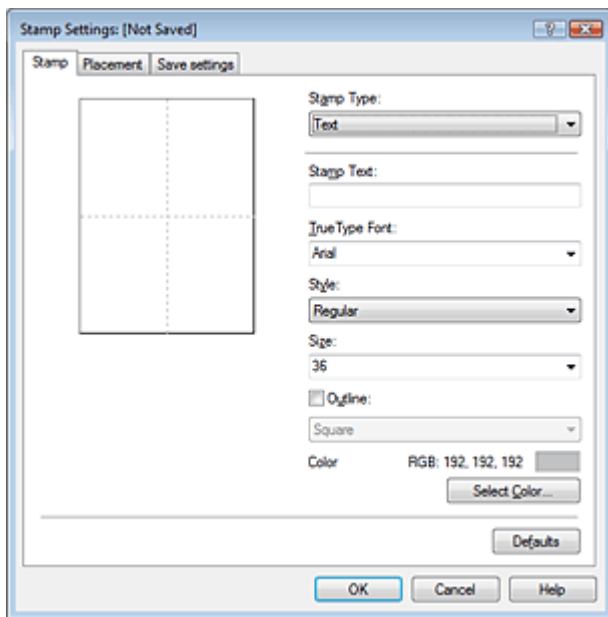

4. Configure the stamp while viewing the preview window

- **Stamp tab**

Select Text, Bitmap, or Date/Time/User Name that matches your purpose for Stamp Type.

- For Text registration, the characters must already be entered in Stamp Text. If necessary, change the TrueType Font, Style, Size, and Outline settings. You can select the color of the stamp by clicking Select Color....
- For Bitmap, click Select File... and select the bitmap file (.bmp) to be used. If necessary, change the settings of the Size and Transparent white area.
- For Date/Time/User Name, the creation date/time and user name of the printed object are displayed in Stamp Text. If necessary, change the settings of TrueType Font, Style, Size, and Outline. You can select the color of the stamp by clicking Select Color....

Important

- Stamp Text appears grayed out and is unavailable when Date/Time/User Name is selected.

- **Placement tab**

Select the stamp position from the Position list. You can also select Custom from the Position list and specify coordinates for X-Position and Y-Position.

You can also change the stamp position by dragging the stamp in the preview window.

To change the stamp position angle, type a value in the Orientation box directly.

5. Save the stamp

Click the Save settings tab and enter a title in the Title box, and then click Save. Click OK when the confirmation message appears.

6. Complete the setup

Click OK. The Stamp/Background dialog box opens again. The registered title appears in the Stamp list.

Changing and Registering Some of Stamp Settings

1. Select the stamp for which the settings are to be changed

Check the Stamp check box in the Stamp/Background dialog box, and then select the title of the stamp to be changed from the Stamp list.

2. Click Define Stamp...

The Stamp Settings dialog box opens.

3. Configure the stamp while viewing the preview window**4. Overwrite save the stamp**

Click Save overwrite on the Save settings tab.

When you want to save the stamp with a different title, type a new title in the Title box and click Save.

Click OK when the confirmation message appears.

5. Complete the setup

Click OK. The Stamp/Background dialog box opens again.

The registered title appears in the Stamp list.

Deleting an Unnecessary Stamp**1. Click Define Stamp... in the Stamp/Background dialog box**

The Stamp Settings dialog box opens.

2. Select the stamp to be deleted

Select the title of the stamp you want to delete from the Stamps list on the Save settings tab. Then click Delete.

Click OK when the confirmation message appears.

3. Complete the setup

Click OK. The Stamp/Background dialog box opens again.



Advanced Guide

Advanced Guide > Printing from a Computer > Printing with Other Application Software > Various Printing Methods > Stamp/Background Printing > Registering Image Data to be Used as a Background

Registering Image Data to be Used as a Background

This feature is unavailable when the 64-bit printer driver is used.

You can select a bitmap file (.bmp) and register it as a new background. You can also change and register some of the settings of an existing background. An unnecessary background can be deleted at any time.

The procedure for registering image data to be used as a background is as follows:

Registering New Background

1. Open the printer driver setup window
2. Click Stamp/Background... on the Page Setup tab

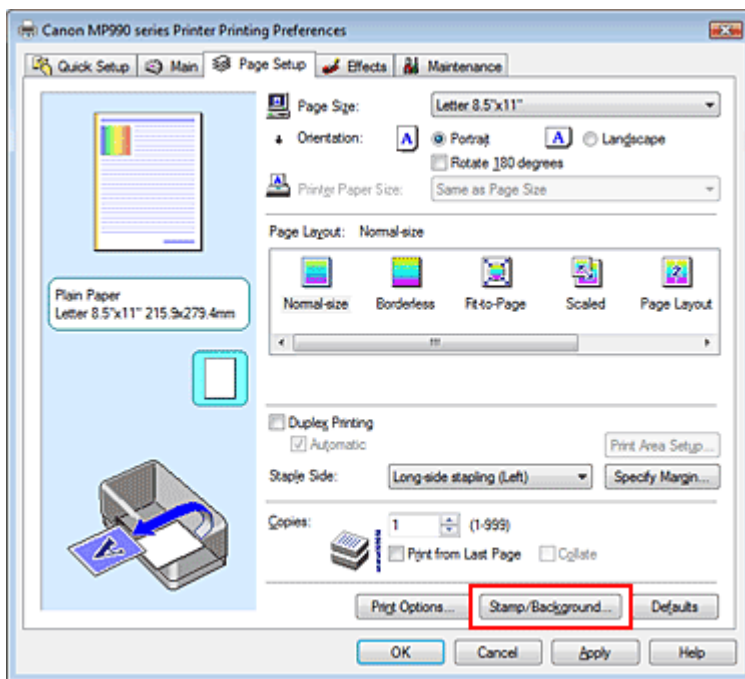

The Stamp/Background dialog box opens.

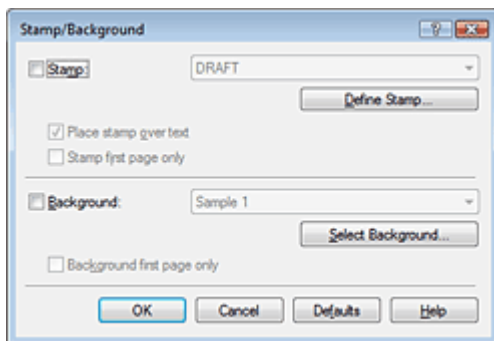

3. Click Select Background...

The Background Settings dialog box opens.

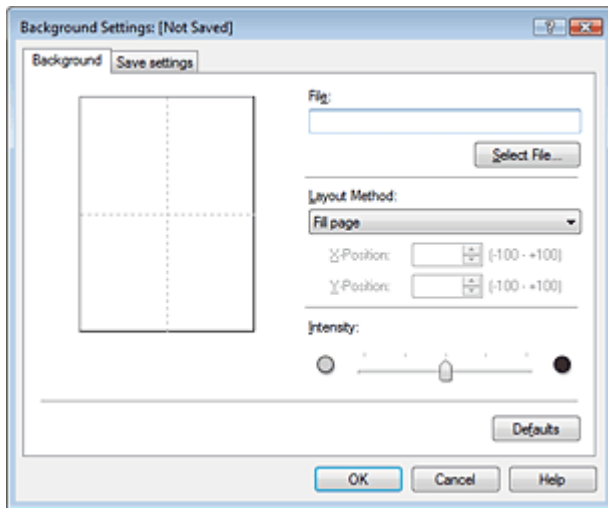

4. Select the image data to be registered to the background

Click Select File.... Select the target bitmap file (.bmp), and then click Open.

5. Specify the following settings while viewing the preview window

Layout Method

Select how the background image data is to be placed.

When Custom is selected, you can set coordinates for X-Position and Y-Position.

You can also change the background position by dragging the image in the preview window.

Intensity

Set the intensity of the background image data with the Intensity slider. To lighten the background, move the slider to the left. To darken the background, move the slider to the right. To print the background at the original bitmap intensity, move the slider to the rightmost position.

6. Save the background

Click the Save settings tab and enter a title in the Title box, and then click Save.

Click OK when the confirmation message appears.

7. Complete the setup

Click OK. The Stamp/Background dialog box opens again.

The registered title appears in the Background list.

Changing and Registering Some Background Settings

1. Select the background for which the settings are to be changed

Check the Background check box in the Stamp/Background dialog box, and then select the title of the background you want to change from the Background list.

2. Click Select Background...

The Background Settings dialog box opens.

3. Specify the items on the Background tab while viewing the preview window.

4. Save the background

Click Save overwrite on the Save settings tab. When you want to save the background with a different title, enter a new title in the Title box and click Save.

Click OK when the confirmation message appears.

5. Complete the setup

Click OK. The Stamp/Background dialog box opens again.
The registered title appears in the Background list.

Deleting an Unnecessary Background**1. Click Select Background... in the Stamp/Background dialog box**

The Background Settings dialog box opens.

2. Select the background to be deleted

Select the title of the background you want to delete from the Backgrounds list on the Save settings tab, and then click Delete.

Click OK when the confirmation message appears.

3. Complete the setup

Click OK. The Stamp/Background dialog box opens again.



[Page top](#) ↑

Advanced Guide

Advanced Guide > Printing from a Computer > Printing with Other Application Software > Various Printing Methods > Printing an Envelope

Printing an Envelope

For details on how to load an envelope into the machine, refer to "Loading Paper in the Rear Tray" in the manual: Basic Guide.

The procedure for performing envelope printing is as follows:

1. Load an envelope into the machine

Fold down the envelope flap.

Orient the envelope so that the flap is on the left and the folded surface is facing down, and load in the rear tray.

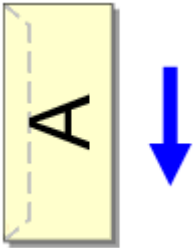

2. Open the printer driver setup window

3. Select the media type

Select Envelope from Commonly Used Settings on the Quick Setup tab.

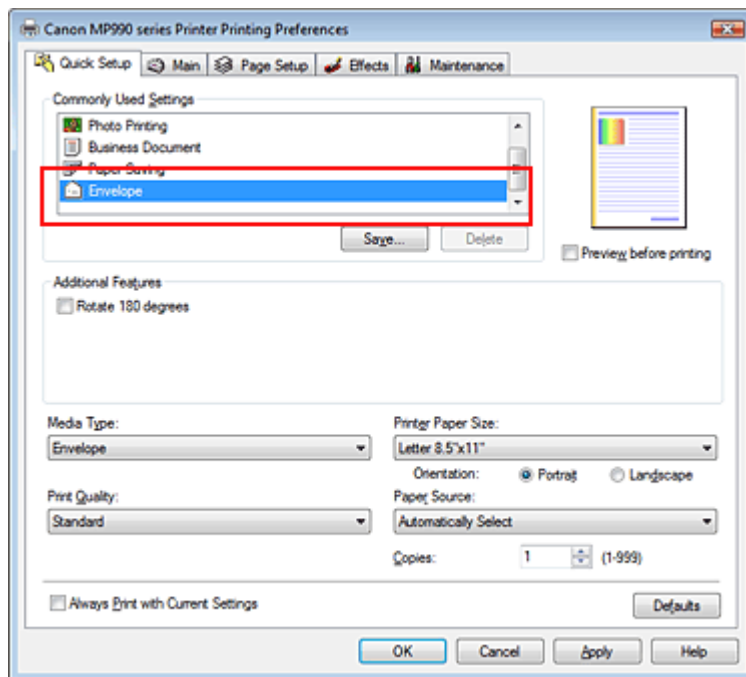

4. Select the paper size

Select Comm.Env. #10, DL Env., Youkei 4 105x235mm, or Youkei 6 98x190mm in the Envelope Size Setting dialog box, and then click OK.

5. Set the orientation

To print the addressee horizontally, select Landscape for Orientation.

6. Select the print quality

Select High or Standard that matches your purpose for Print Quality.

7. Complete the setup

Click OK.

When you execute print, the information is printed on the envelope.

Important

- When you execute envelope printing, guide messages are displayed.
To hide the guide messages, check the Do not show this message again. check box.
To show the guide again, click the View Printer Status... button on the Maintenance tab, and start the Canon IJ Status Monitor.
Then click Envelope Printing from Display Guide Message of the Option menu, and change the setting to on.

[Page top](#) 

Advanced Guide

Advanced Guide > Printing from a Computer > Printing with Other Application Software > Various Printing Methods > Switching the Paper Source to Match the Purpose

Switching the Paper Source to Match the Purpose

In this machine, there are two paper sources, a rear tray and a cassette.

You can facilitate printing by selecting a paper source setting that matches your print conditions or purpose.

The procedure for setting paper source is as follows:

You can also set the paper source on the Quick Setup tab.

1. Open the printer driver setup window

2. Select the paper source

From the Paper Source list on the Main tab, select the paper source that matches your purpose.

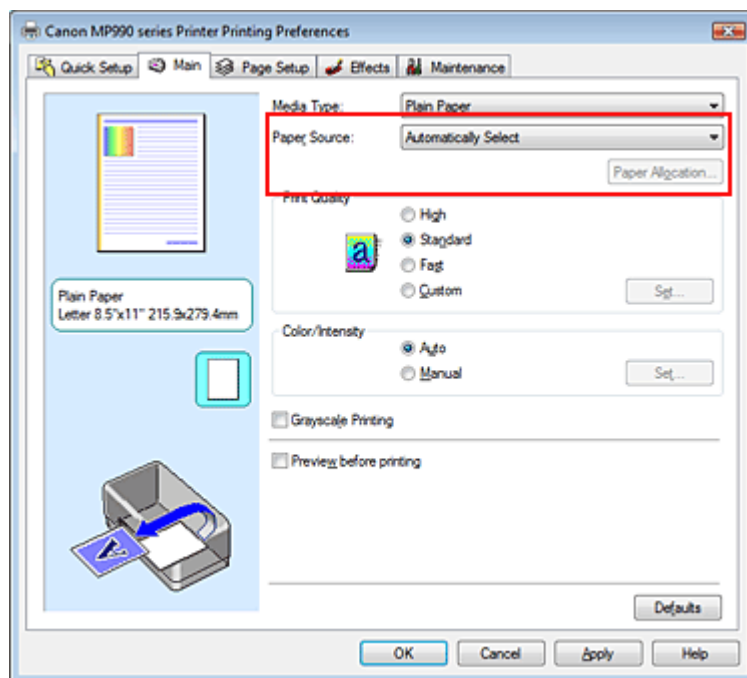

Automatically Select

Plain paper whose Page Size is Letter 8.5"x11", A5, A4, or B5 is fed from the cassette. Other sizes of plain paper and paper types other than plain paper are fed from the rear tray.

Rear Tray

Paper is always fed from the rear tray.

Cassette

Paper is always fed from the cassette.

Important

- Plain paper that is not Letter 8.5"x11", A5, A4, or B5 and paper types other than plain paper cannot be fed from the cassette.

Continuous Autofeed

When plain paper runs out in the specified paper source, the printer automatically switches the paper source.

When printing a large volume of data, load plain paper of the same size in both paper sources. You can therefore reduce the trouble of having to load paper because the printer automatically switches

the paper source when paper runs out in one paper source.

Important

- Continuous Autofeed is unavailable when paper other than Plain Paper is selected for Media Type.
- Since the printer feeds paper from the paper source that was being used the last time Continuous Autofeed was selected and printing ended, load the same paper in both the rear tray and the cassette.

Paper Allocation

When the media type for the print data is plain paper and the paper size matches the paper allocation setting, the printer automatically feeds paper from the cassette. If not, the printer feeds paper from the rear tray.

To change the paper allocation settings, click Paper Allocation..., specify the Paper Size to be loaded in the cassette, and then click OK.

When you load frequently used plain paper in the cassette, the printer feeds paper from the rear tray when the print data uses a different type of paper. You can therefore reduce the trouble of having to load different paper.

3. Complete the setup

Click OK.

When you execute print, the printer uses the specified paper source to print the data.

[Page top](#) 

Advanced Guide

Advanced Guide > Printing from a Computer > Printing with Other Application Software > Various Printing Methods > Displaying the Print Results before Printing

Displaying the Print Results before Printing

You can display and check the print result before printing.

The procedure for displaying the print result before printing is as follows:

You can also set the print results display on the Quick Setup tab.

1. Open the **printer driver setup window**
2. Set the preview

Check the Preview before printing check box on the Main tab.

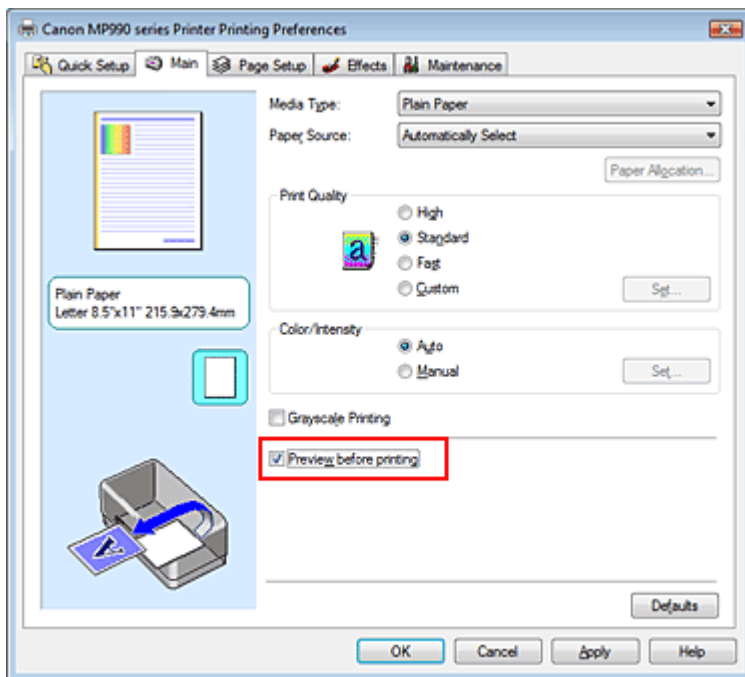

3. Complete the setup

Click OK.

The Canon IJ Preview will start and the print result will be displayed before printing.

Related Topic

➔ [Canon IJ Preview](#)

Advanced Guide

Advanced Guide > Printing from a Computer > Printing with Other Application Software > Various Printing Methods > Setting Paper Dimensions (Custom Size)

Setting Paper Dimensions (Custom Size)

You can specify the height and width of paper when its size cannot be selected from the Page Size. Such a paper size is called a custom size.

The procedure for specifying a custom size is as follows:

You can also set a custom size in Printer Paper Size on the Quick Setup tab.

1. Set the custom size in the application software

On your application's paper size feature, specify the custom size.

Important

- When the application software that created the document has a function for specifying the height and width values, use the application software to set the values. When the application software does not have such a function or if the document does not print correctly, use the printer driver to set the values.

2. Open the printer driver setup window

3. Select the paper size

Select Custom... for Page Size on the Page Setup tab.

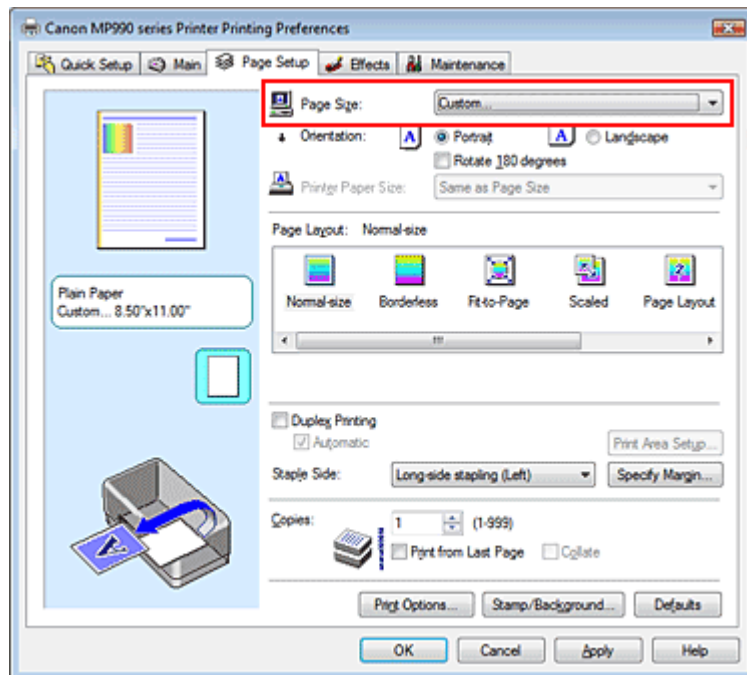

The Custom Paper Size dialog box opens.

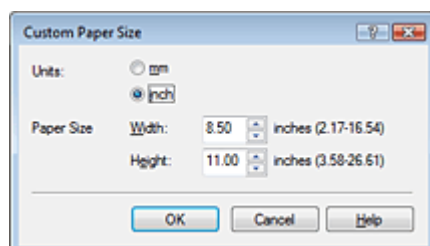

4. Set the custom paper size

Specify Units, and enter the Width and Height of the paper to be used. Then click OK.

5. Complete the setup

Click OK on the Page Setup tab.

When you execute print, the data is printed with the specified paper size.

[Page top](#) 

Advanced Guide

Advanced Guide > Printing from a Computer > Printing with Other Application Software > Changing the Print Quality and Correcting Image Data

Changing the Print Quality and Correcting Image Data

- [Selecting a Combination of the Print Quality Level and a Halftoning Method](#)
- [Printing a Color Document in Monochrome](#)
- [Adjusting Tone](#)
- [Specifying Color Correction](#)
- [Optimal Photo Printing of Image Data](#)
- [Adjusting Colors with the Printer Driver](#)
- [Printing with ICC Profiles](#)
- [Adjusting Color Balance](#)
- [Adjusting Brightness](#)
- [Adjusting Intensity](#)
- [Adjusting Contrast](#)
- [Simulating an Illustration](#)
- [Representing Image Data with a Single Color](#)
- [Presenting Image Data with Vivid Colors](#)
- [Smoothing Jagged Outlines](#)
- [Changing Color Properties to Improve Coloration](#)
- [Reducing Photo Noise](#)

[Page top ↑](#)

Advanced Guide

Advanced Guide > Printing from a Computer > Printing with Other Application Software > Changing the Print Quality and Correcting Image Data > Selecting a Combination of the Print Quality Level and a Halftoning Method

Selecting a Combination of the Print Quality Level and a Halftoning Method

You can individually set the combined representation method for the print quality level and the halftoning method.



The procedure for setting the print quality level and the halftoning method is as follows:

1. Open the printer driver setup window
2. Select the print quality

Select Custom for Print Quality on the Main tab, and click Set...

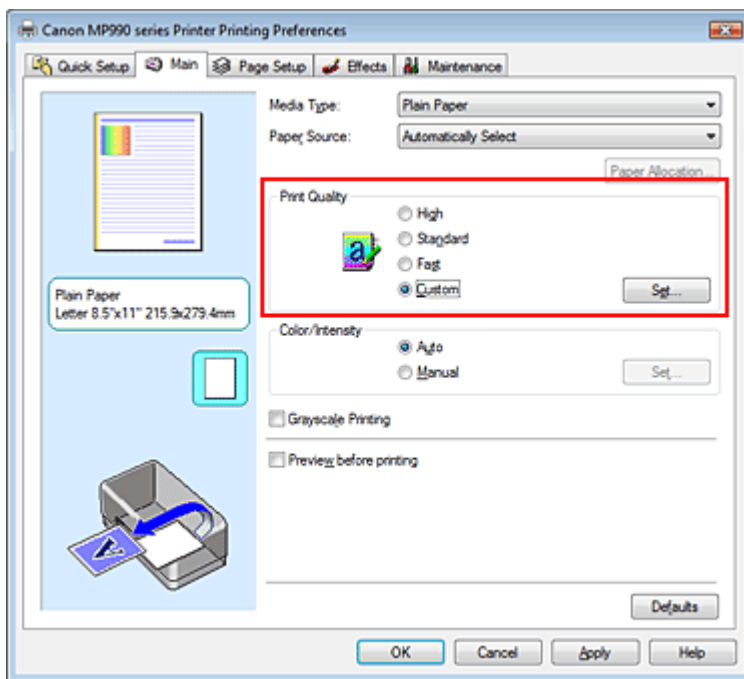

The Custom dialog box opens.

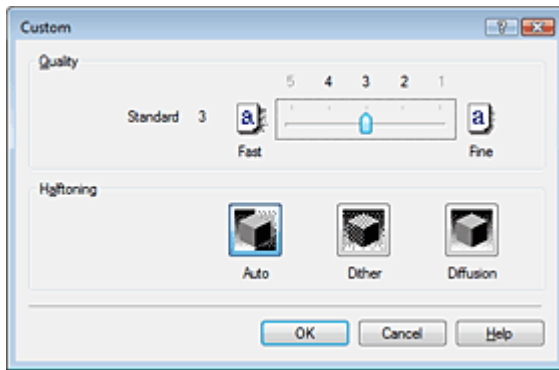

3. Setting the print quality and halftone expression method

Move the Quality slider to select the quality level.

Select the expression method in Halftoning and click OK.

Note

- Halftones refer to color shades between the darkest color and the brightest color. The printer replaces the color shades with a collection of small dots to express the halftones. Dither arranges the dots according to fixed rules to express the halftones. Diffusion places the dots randomly to express the halftones. When you select Auto, the data is printed with the optimal halftoning method for the selected print quality.

4. Complete the setup

Click OK on the Main tab.

When you execute print, the data is printed with the specified quality level and halftoning method.

Important

- Certain print quality levels and halftoning methods cannot be selected depending on the settings of Media Type.

Note

- When the part of the object is not printed, selecting Diffusion for Halftoning may solve the problem.

Related Topics

- ➔ [Specifying Color Correction](#)
- ➔ [Adjusting Color Balance](#)
- ➔ [Adjusting Brightness](#)
- ➔ [Adjusting Intensity](#)
- ➔ [Adjusting Contrast](#)

Advanced Guide

Advanced Guide > Printing from a Computer > Printing with Other Application Software > Changing the Print Quality and Correcting Image Data > Printing a Color Document in Monochrome

Printing a Color Document in Monochrome

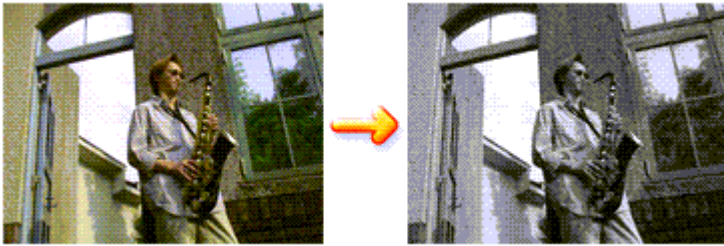

The procedure for printing a color document in monochrome is as follows:

You can also set a grayscale printing in Additional Features on the Quick Setup tab.

1. Open the printer driver setup window

2. Set grayscale printing

Check the Grayscale Printing check box on the Main tab.

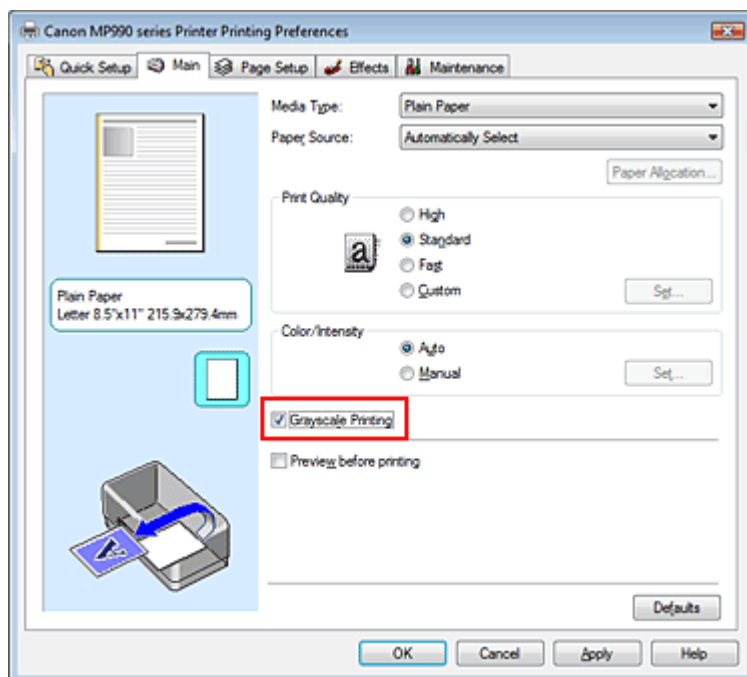

3. Complete the setup

Click OK.

When you execute print, the document is converted to grayscale data. It allows you to print the color document in monochrome.

Important

- When the Grayscale Printing check box is checked, the printer driver processes image data as sRGB data. In this case, actual colors printed may differ from those in the original image data. When using the grayscale printing function to print Adobe RGB data, convert the data to sRGB data using an application software.

Note

- During Grayscale Printing, gray ink or color inks may be used as well as black ink.
-

Related Topic

➔ [Adjusting Tone](#)

[Page top](#) ↕

Advanced Guide

Advanced Guide > Printing from a Computer > Printing with Other Application Software > Changing the Print Quality and Correcting Image Data > Adjusting Tone

Adjusting Tone

When printing black and white photos, you can produce the cooling effects of cool colors and the warming effects of warm colors.



Tone is set to Cool

Tone is set to standard

Tone is set to Warm

The procedure for adjusting tone is as follows:

1. Open the printer driver setup window

2. Select the media type

For Media Type on the Main tab, select Photo Paper Plus Glossy II, Photo Paper Pro II, Photo Paper Pro Platinum, Photo Paper Plus Semi-gloss, Hagaki P, Fine Art "Photo Rag" or Other Fine Art Paper.

3. Set grayscale printing

Check the Grayscale Printing check box.

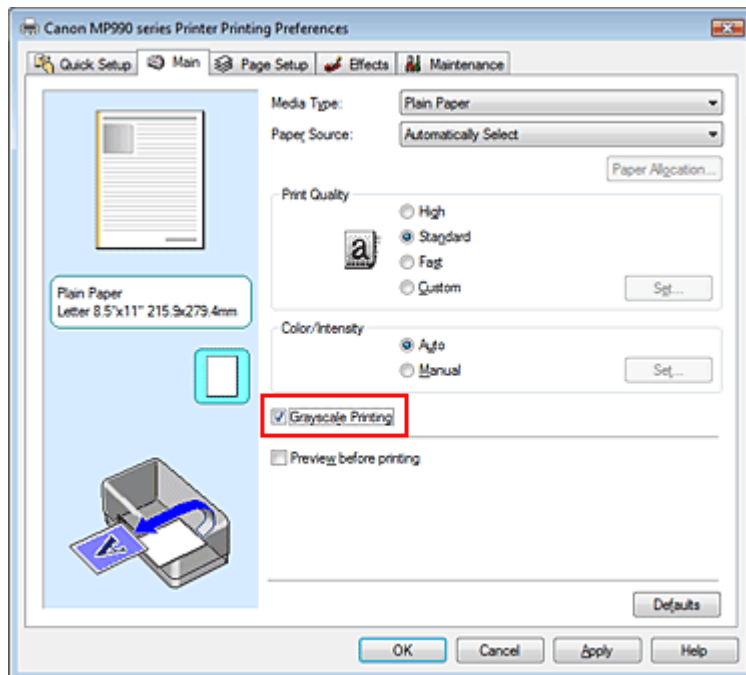

4. Select the manual color adjustment

Select Manual for Color/Intensity, and click Set....

The Manual Color Adjustment dialog box opens.

5. Adjusting monochrome tones

Moving the Tone slider to the right brings out the warm colors (Warm), and moving it to the left brings out the cool colors (Cool).

You can also directly enter a value linked to the slider. Enter a value in the range from -50 to 50. After adjusting the tones, click OK.

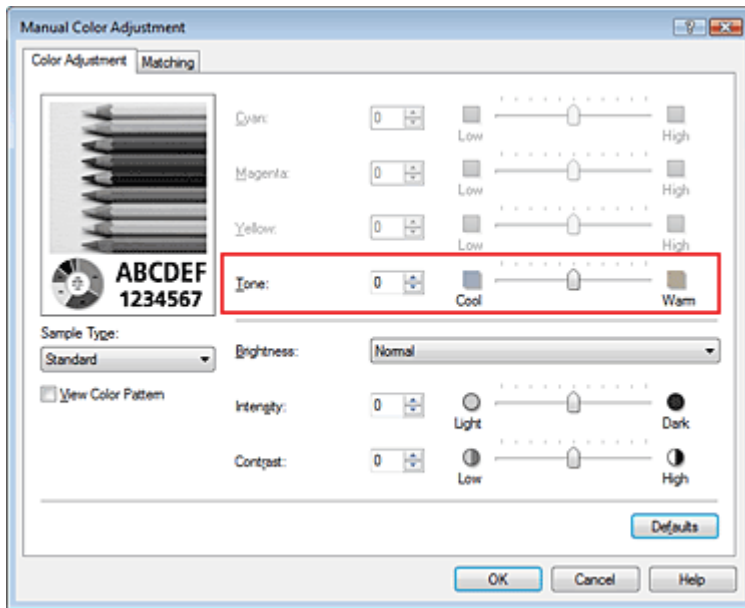

6. Complete the setup

Click OK on the Main tab.

When you execute print, the color document is converted to grayscale data with adjusted tones. It allows you to print the color document in monochrome.

Related Topics

- ➔ [Printing a Color Document in Monochrome](#)
- ➔ [Adjusting Brightness](#)
- ➔ [Adjusting Intensity](#)
- ➔ [Adjusting Contrast](#)

Advanced Guide

Advanced Guide > Printing from a Computer > Printing with Other Application Software > Changing the Print Quality and Correcting Image Data > Specifying Color Correction

Specifying Color Correction

You can specify the color correction method suited to the type of document to be printed.

Normally, the printer driver adjusts the colors by using Canon Digital Photo Color so that data is printed with color tints that most people prefer. This method is suitable for printing sRGB data.

When you want to print by using the color space (Adobe RGB or sRGB) of the image data effectively, select ICM. When you want to use an application software to specify a printing ICC profile, select None.

The procedure for specifying color correction is as follows:

You can also set color correction on the Quick Setup tab by choosing Photo Printing under Commonly Used Settings, and then choosing Color/Intensity Manual Adjustment under Additional Features.

1. Open the **printer driver setup window**
2. Select the manual color adjustment

On the Main tab, select Manual for Color/Intensity, and click Set....

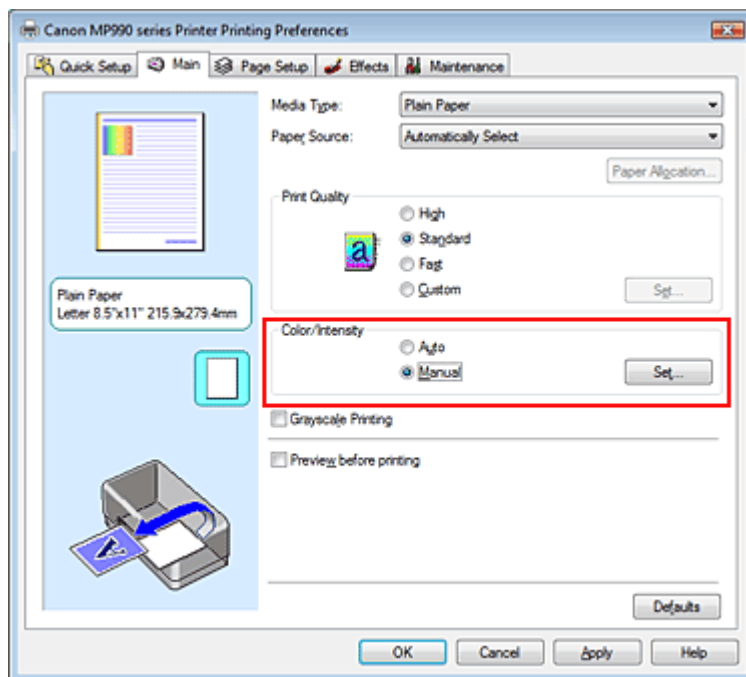

The Manual Color Adjustment dialog box opens.

3. Select color correction

Click Matching tab, select Color Correction setting that matches your purpose from the following, and click OK.

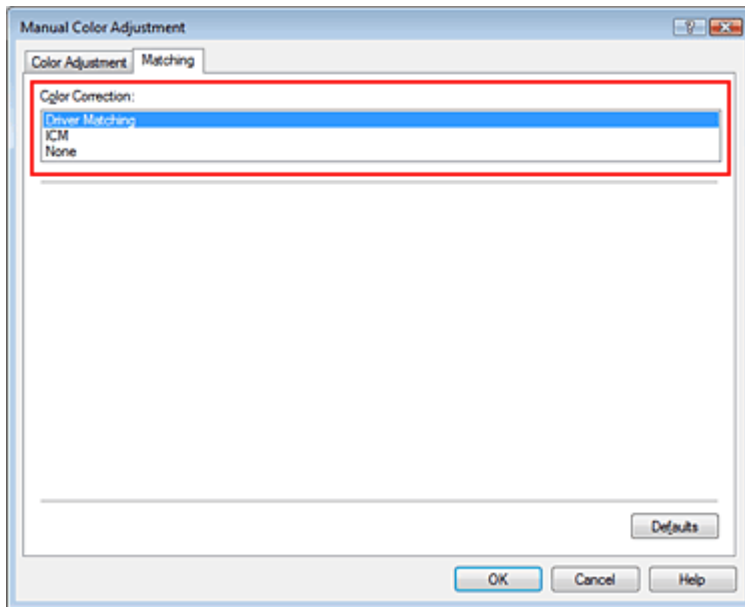

Driver Matching

By using Canon Digital Photo Color, you can print sRGB data with color tints that most people prefer. Driver Matching is the default setting for color correction.

ICM

You can print by using the color space (Adobe RGB or sRGB) of the image data effectively.

None

The printer driver does not perform color correction. Select this value when you are specifying an individually created printing ICC profile or a printing ICC profile for special Canon paper in an application software to print data.

4. Complete the setup

Click OK on the Main tab.

When you execute print, the data is printed with the specified color correction method.

Important

- When ICM is disabled in the application software, ICM is unavailable for Color Correction and the printer may not be able to print the image data properly.
- When the Grayscale Printing check box on the Main tab is checked, Color Correction appears grayed out and is unavailable.

Related Topics

- ➔ [Optimal Photo Printing of Image Data](#)
- ➔ [Adjusting Colors with the Printer Driver](#)
- ➔ [Printing with ICC Profiles](#)



Advanced Guide

[Advanced Guide](#) > [Printing from a Computer](#) > [Printing with Other Application Software](#) > [Changing the Print Quality and Correcting Image Data](#) > [Specifying Color Correction](#) > [Optimal Photo Printing of Image Data](#)

Optimal Photo Printing of Image Data

When people print images taken with digital cameras, they sometimes feel that the printed color tones differ from those of actual image or those displayed on the monitor.

To get the print results as close as possible to the desired color tones, you must select a printing method that is best suited to the application software used or to your purpose.

Color Management

Devices such as digital cameras, scanners, monitors, and printers handle color differently. Color management (color matching) is a method that manages device-dependent "colors" as a common color space. For Windows, a color management system called "ICM" is built into the operating system. Adobe RGB and sRGB are popularly used as common color spaces. Adobe RGB has a wider color space than sRGB.

ICC profiles convert device-dependent "colors" into a common color space. By using an ICC profile and carrying out color management, you can draw out the color space of the image data within the color reproduction area that the printer can express.

Selecting a Printing Method Suited to the Image Data

The recommended printing method depends on the color space (Adobe RGB or sRGB) of the image data or the application software to be used. There are two typical printing methods. Check the color space (Adobe RGB or sRGB) of the image data and the application software to be used, and then select the printing method suited to your purpose.

Adjusting Colors with the Printer Driver

Describes the procedure for printing sRGB data by using the color correction function of the printer driver.

- **To print using Canon Digital Photo Color**

The printer prints data with color tints that most people prefer, reproducing colors of the original image data and producing three-dimensional effects and high, sharp contrasts.

- **To print by directly applying editing and touch-up results of an application software**

When printing the data, the printer brings out subtle color difference between dark and light areas, while leaving the darkest and lightest areas intact.

When printing the data, the printer applies fine adjustment results, such as brightness adjustments made with an application software.

Printing with ICC Profiles

Describes the procedure for printing by using the color space of Adobe RGB or sRGB effectively.

You can print with a common color space by setting up the application software and the printer driver so that the color management matches the input ICC profile of the image data.

The method for setting up the printer driver differs depending on the application software to be used.



Advanced Guide

Advanced Guide > Printing from a Computer > Printing with Other Application Software > Changing the Print Quality and Correcting Image Data > Specifying Color Correction > Adjusting Colors with the Printer Driver

Adjusting Colors with the Printer Driver

You can specify the color correction function of the printer driver to print sRGB data with color tints that most people prefer through the use of Canon Digital Photo Color.

When printing from an application software that can identify ICC profiles and allows you to specify them, use a printing ICC profile in the application software, and select settings for color management.

The procedure for adjusting colors with the printer driver is as follows:

1. Open the printer driver setup window

2. Select the media type

Select the type of paper loaded in the machine from the Media Type list on the Main tab.

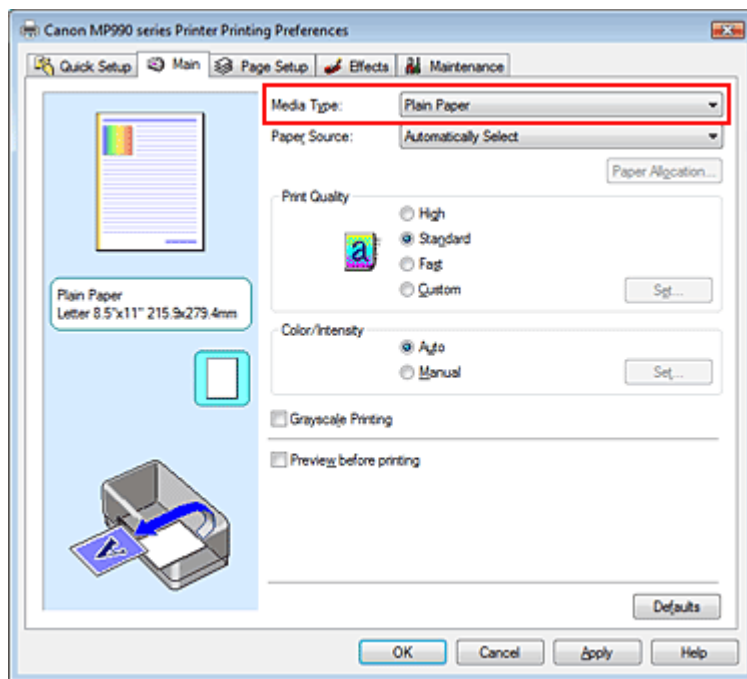

3. Select the print quality

Select High, Standard, or Fast that matches your purpose for Print Quality.

4. Select the manual color adjustment

Select Manual for Color/Intensity, and click Set....
The Manual Color Adjustment dialog box opens.

5. Select color correction

Click Matching tab, and select Driver Matching for Color Correction.

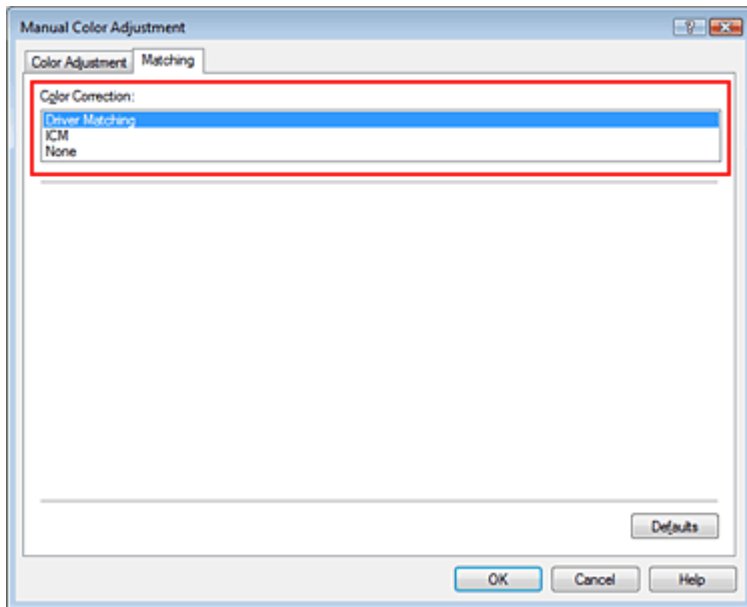

6. Set the other items

If necessary, click Color Adjustment tab, and adjust the color balance of Cyan, Magenta, Yellow, and adjust Brightness, Intensity, and Contrast settings, and then click OK.

7. Complete the setup

Click OK on the Main tab.

When you execute print, the printer driver adjusts the colors when printing the data.

Related Topics

- [Selecting a Combination of the Print Quality Level and a Halftoning Method](#)
- [Specifying Color Correction](#)
- [Adjusting Color Balance](#)
- [Adjusting Brightness](#)
- [Adjusting Intensity](#)
- [Adjusting Contrast](#)



Advanced Guide

Advanced Guide > Printing from a Computer > Printing with Other Application Software > Changing the Print Quality and Correcting Image Data > Specifying Color Correction > Printing with ICC Profiles

Printing with ICC Profiles

When the image data has a specified input ICC profile, you can print by using the color space (Adobe RGB or sRGB) of the data effectively.

The printer driver setting procedure varies depending on the application software used to print.

Specify an ICC Profile from the Application Software and Print the Data

When you print the editing and touch-up results of Adobe Photoshop, Canon Digital Photo Professional, or any application software that allows you to specify input and printing ICC profiles, you print by effectively using the color space of the input ICC profile specified in the image data.

To use this printing method, use your application software to select color management items and specify an input ICC profile and a printing ICC profile in the image data.

Even if you print using a printing ICC profile that you created yourself or one for special Canon paper from your application software, be sure to select color management items from your application software. For instructions, refer to the manual of the application software you are using.

1. Open the printer driver setup window

2. Select the media type

Select the type of paper loaded in the machine from the Media Type list on the Main tab.

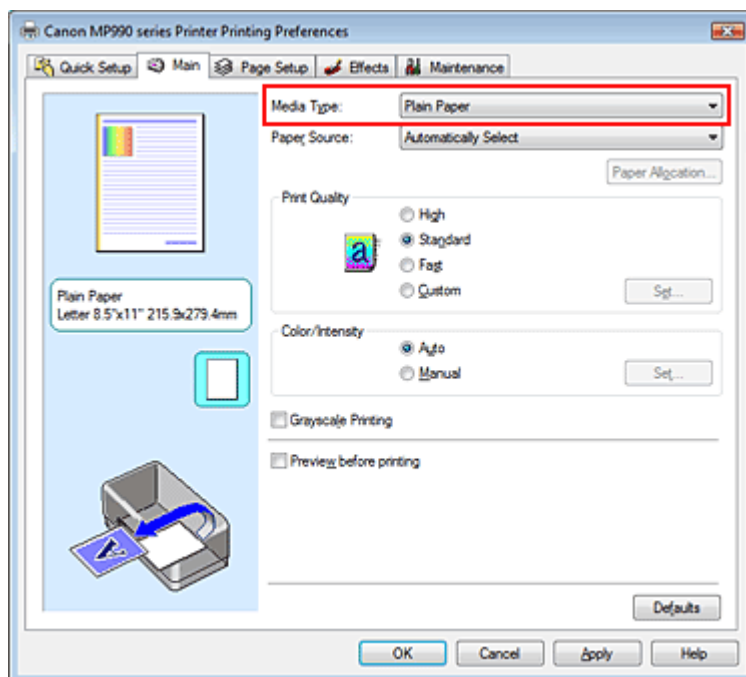

3. Select the print quality

Select High, Standard, or Fast that matches your purpose for Print Quality.

4. Select the manual color adjustment

Select Manual for Color/Intensity, and click Set....
The Manual Color Adjustment dialog box opens.

5. Select color correction

Click Matching tab, and select None for Color Correction.

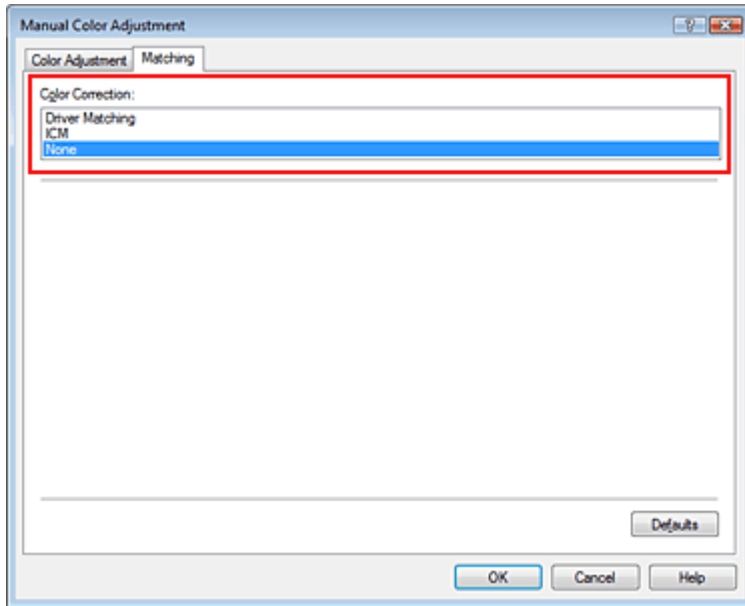

6. Set the other items

If necessary, click Color Adjustment tab, and adjust the color balance of Cyan, Magenta, Yellow, and adjust Brightness, Intensity, and Contrast settings, and then click OK.

7. Complete the setup

Click OK on the Main tab.

When you execute print, the printer uses the color space of the image data.

Specify an ICC Profile with the Printer Driver, and then Print

Print from a program that cannot identify input ICC profiles or does not allow you to specify one by specifying input ICC profiles from printer profiles of the printer driver. When printing Adobe RGB data, you can print the data with the Adobe RGB color space even if the application software does not support Adobe RGB.

1. Open the printer driver setup window

2. Select the media type

Select the type of paper loaded in the machine from the Media Type list on the Main tab.

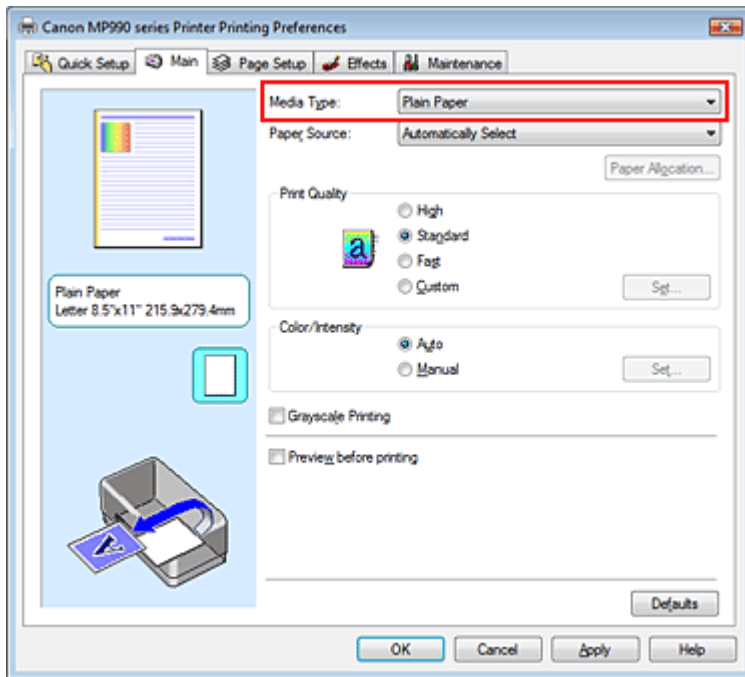

3. Select the print quality

Select High, Standard, or Fast that matches your purpose for Print Quality.

4. Select the manual color adjustment

Select Manual for Color/Intensity, and click Set....
Manual Color Adjustment dialog box opens.

5. Select color correction

Click Matching tab, and select ICM for Color Correction.

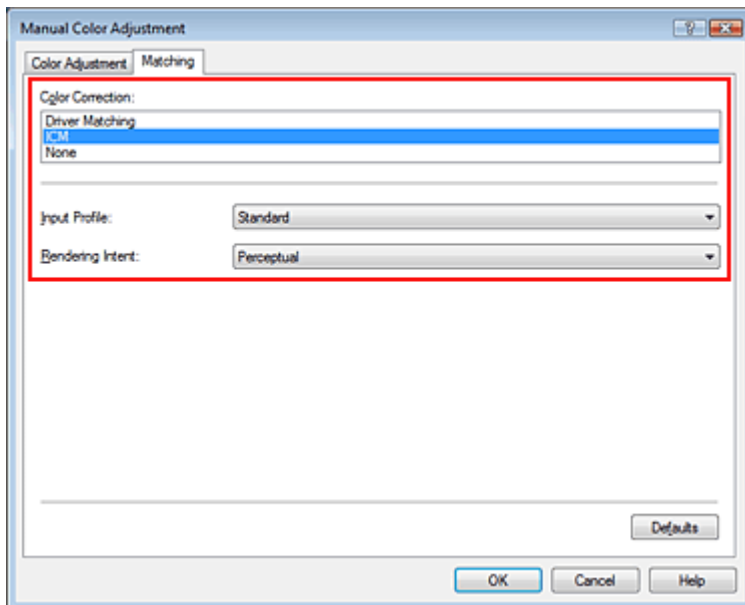

6. Select the input profile

Select an Input Profile that matches the color space of the image data.

- **For sRGB data or data without an input ICC profile:**
Select Standard.
- **For Adobe RGB data:**

Select Adobe RGB (1998).

Important

- When the application software specifies an input profile, the input profile setting of the printer driver becomes invalid.
- When no input ICC profiles are installed on your computer, Adobe RGB (1998) is not displayed. You can install ICC profiles from the Setup CD-ROM that accompanies the machine.

7. Select the rendering intent

Select the coloring adjustment method in Rendering Intent.

• Saturation

This method reproduces images even more vividly than the Perceptual method.

• Perceptual

This method reproduces images by focusing on color tints that most people prefer. Select this method to print photos.

• Relative Colorimetric

When image data is converted to the color space of the printer, this method converts the image data so the color reproduction approximates the shared color regions. Select this method to print image data with colors that are close to the original colors.

• Absolute Colorimetric

When Relative Colorimetric is selected, white spots are reproduced as white spots of the paper (background color). However, when Absolute Colorimetric is selected, how the white spots are reproduced depends on the image data.

Important

- When Windows XP SP2 or Windows XP SP3 is used, this function is disabled.

8. Set the other items

If necessary, click Color Adjustment tab, and adjust the color balance of Cyan, Magenta, Yellow, and adjust Brightness, Intensity, and Contrast settings, and then click OK.

9. Complete the setup

Click OK on the Main tab.

When you execute print, the data is printed with the color space of the selected image data.

Related Topics

- ➡ [Selecting a Combination of the Print Quality Level and a Halftoning Method](#)
- ➡ [Specifying Color Correction](#)
- ➡ [Adjusting Color Balance](#)
- ➡ [Adjusting Brightness](#)
- ➡ [Adjusting Intensity](#)
- ➡ [Adjusting Contrast](#)



Advanced Guide

Advanced Guide > Printing from a Computer > Printing with Other Application Software > Changing the Print Quality and Correcting Image Data > Adjusting Color Balance

Adjusting Color Balance

You can adjust the color tints when printing.

Since this function adjusts color balance of the output by changing the ink ratios of each color, it changes the total color balance of the document. Use the application software if you want to change the color balance significantly. Use the printer driver only when you want to adjust the color balance slightly.

The following sample shows the case when color balance is used to intensify cyan and to diminish yellow so that the overall colors are more uniform.



No adjustment

Adjust Color Balance

The procedure for adjusting color balance is as follows:

You can also set color balance on the Quick Setup tab by choosing Photo Printing under Commonly Used Settings, and then choosing Color/Intensity Manual Adjustment under Additional Features.

1. Open the printer driver setup window

2. Select the manual color adjustment

On the Main tab, select Manual for Color/Intensity, and click Set....

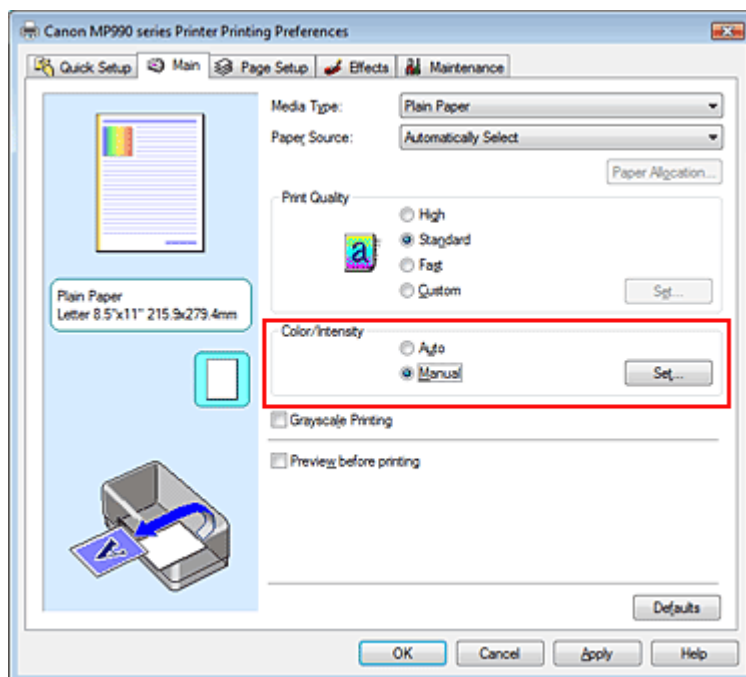

The Manual Color Adjustment dialog box opens.

3. Adjust color balance

There are individual sliders for Cyan, Magenta, and Yellow. Each color becomes stronger when the corresponding slider is moved to the right, and becomes weaker when the corresponding slider is

moved to the left. For example, when cyan becomes weaker, the color red becomes stronger. You can also directly enter a value linked to the slider. Enter a value in the range from -50 to 50.

After adjusting each color, click OK.

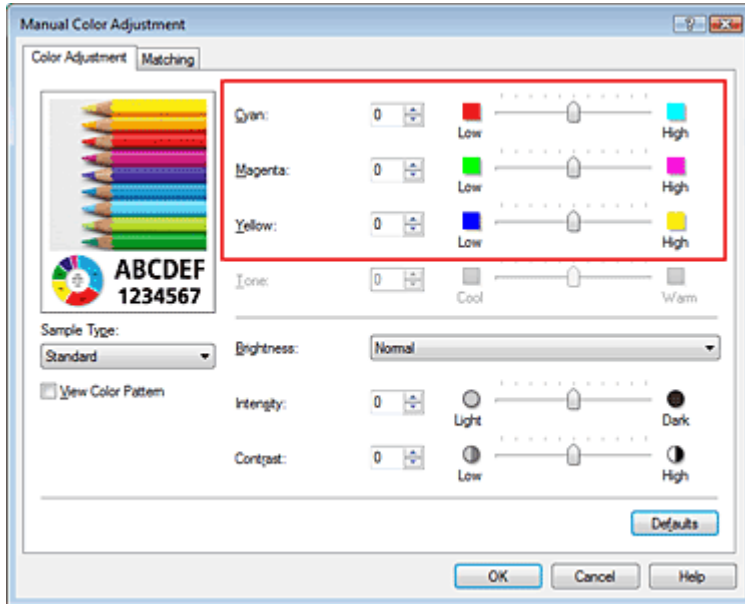

Important

- Adjust the slider gradually.

4. Complete the setup

Click OK on the Main tab.

When you execute print, the document is printed with the adjusted color balance.

Important

- When the Grayscale Printing check box on the Main tab is checked, Cyan, Magenta, and Yellow appear grayed out and are unavailable.

Related Topics

- ➔ Selecting a Combination of the Print Quality Level and a Halftoning Method
- ➔ Specifying Color Correction
- ➔ Adjusting Brightness
- ➔ Adjusting Intensity
- ➔ Adjusting Contrast

Advanced Guide

Advanced Guide > Printing from a Computer > Printing with Other Application Software > Changing the Print Quality and Correcting Image Data > Adjusting Brightness

Adjusting Brightness

You can change the brightness of the overall image data during printing.

This function does not change pure white or pure black but it changes the brightness of the intermediate colors.

The following sample shows the print result when the brightness specification is changed.



Light is selected

Normal is selected

Dark is selected

The procedure for adjusting brightness is as follows:

You can also set brightness on the Quick Setup tab by choosing Photo Printing under Commonly Used Settings, and then choosing Color/Intensity Manual Adjustment under Additional Features.

1. Open the printer driver setup window

2. Select the manual color adjustment

On the Main tab, select Manual for Color/Intensity, and click Set....

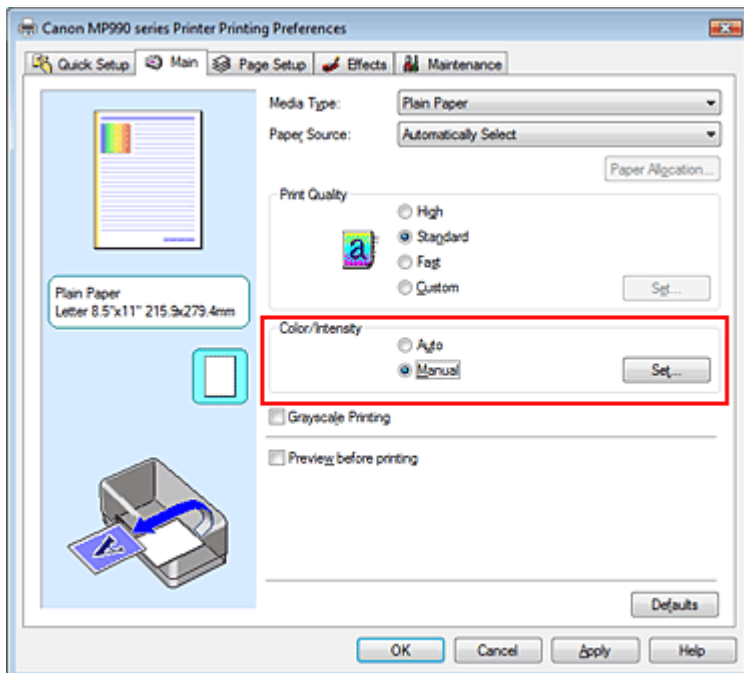

The Manual Color Adjustment dialog box opens.

3. Specify the brightness

Select Light, Normal, or Dark for Brightness, and click OK.

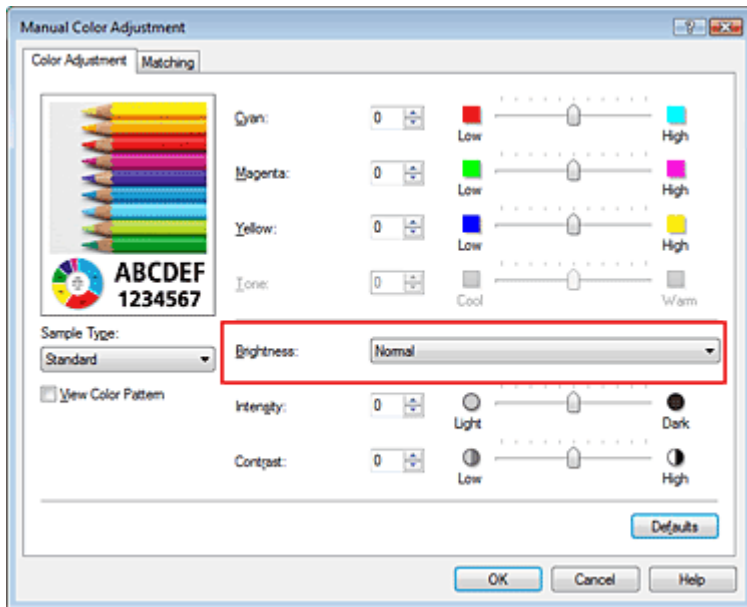

4. Complete the setup

Click OK on the Main tab.

When you execute print, the data is printed at the specified brightness.

Related Topics

- Selecting a Combination of the Print Quality Level and a Halftoning Method
- Specifying Color Correction
- Adjusting Color Balance
- Adjusting Intensity
- Adjusting Contrast

Advanced Guide

Advanced Guide > Printing from a Computer > Printing with Other Application Software > Changing the Print Quality and Correcting Image Data > Adjusting Intensity

Adjusting Intensity

You can dilute (brighten) or intensify (darken) the colors of the overall image data during printing. When you want to sharpen the print results, you should intensify the colors. The following sample shows the case when the intensity is increased so that all colors become more intense when the image data is printed.



No adjustment

Higher Intensity

The procedure for adjusting intensity is as follows:

You can also set intensity on the Quick Setup tab by choosing Photo Printing under Commonly Used Settings, and then choosing Color/Intensity Manual Adjustment under Additional Features.

1. Open the **printer driver setup window**
2. Select the manual color adjustment

Select Manual for Color/Intensity on the Main tab, and click Set...

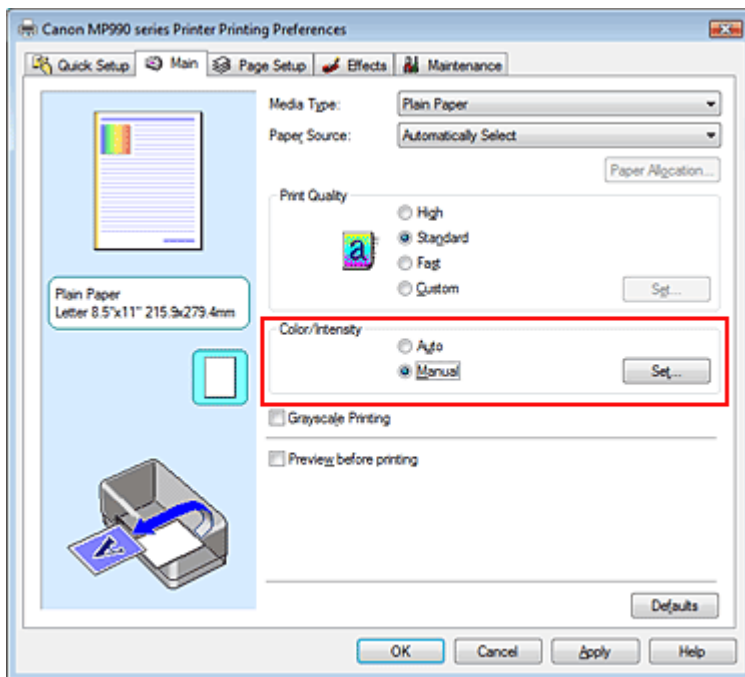

The Manual Color Adjustment dialog box opens.

3. Adjust intensity

Moving the Intensity slider to the right intensifies (darkens) the colors. Moving the slider to the left dilutes (brightens) the colors.

You can also directly enter a value linked to the slider. Enter a value in the range from -50 to 50.

After adjusting each color, click OK.

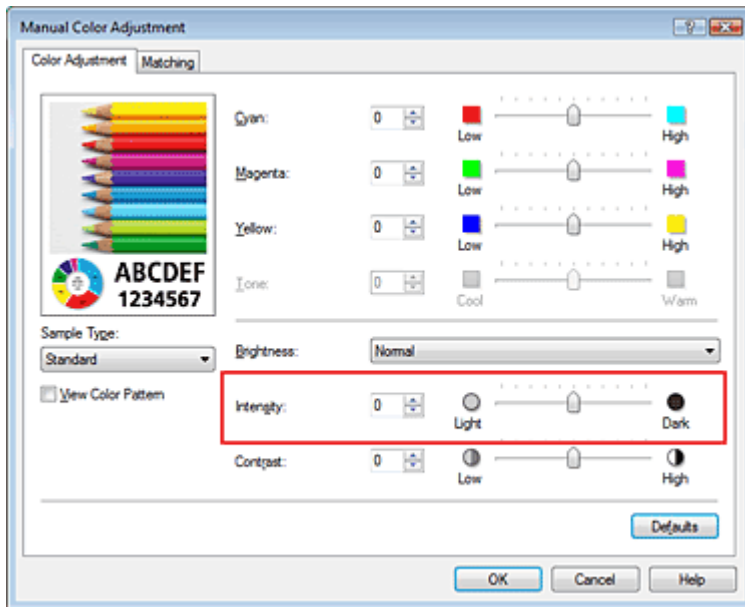

Important

- Adjust the slider gradually.

4. Complete the setup

Click OK on the Main tab.

When you execute print, the image data is printed with the adjusted intensity.

Related Topics

- ➔ [Selecting a Combination of the Print Quality Level and a Halftoning Method](#)
- ➔ [Specifying Color Correction](#)
- ➔ [Adjusting Color Balance](#)
- ➔ [Adjusting Brightness](#)
- ➔ [Adjusting Contrast](#)

[Page top](#) ↕

Advanced Guide

Advanced Guide > Printing from a Computer > Printing with Other Application Software > Changing the Print Quality and Correcting Image Data > Adjusting Contrast

Adjusting Contrast

You can adjust the image contrast during printing.

To make the differences between the light and dark portions of images greater and more distinct, increase the contrast. On the other hand, to make the differences between the light and dark portions of images smaller and less distinct, reduce the contrast.



No adjustment

Adjust the contrast

The procedure for adjusting contrast is as follows:

You can also set contrast on the Quick Setup tab by choosing Photo Printing under Commonly Used Settings, and then choosing Color/Intensity Manual Adjustment under Additional Features.

1. Open the [printer driver setup window](#)
2. Select the manual color adjustment

On the Main tab, select Manual for Color/Intensity, and click Set....

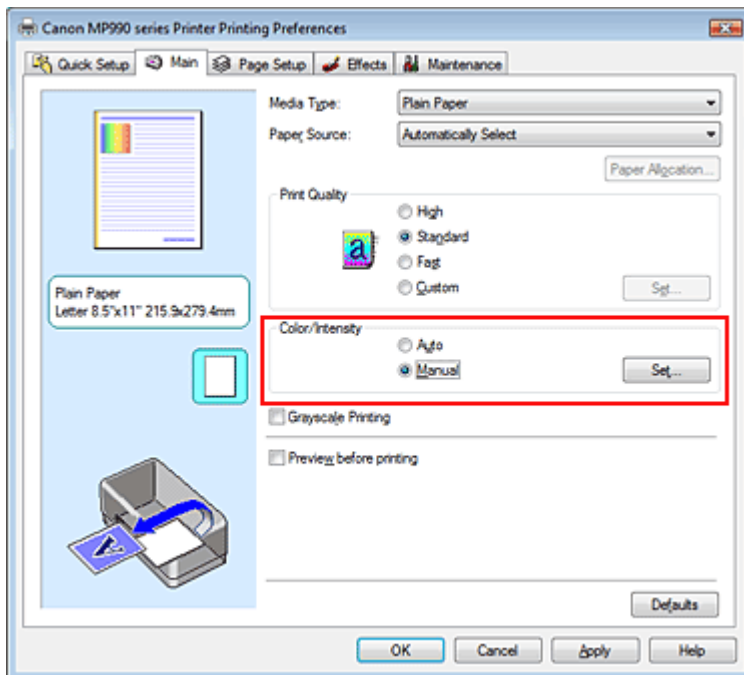

The Manual Color Adjustment dialog box opens.

3. Adjust the contrast

Moving the Contrast slider to the right increases the contrast, and moving it to the left decreases the contrast.

You can also directly enter a value linked to the slider. Enter a value in the range from -50 to 50.

After adjusting each color, click OK.

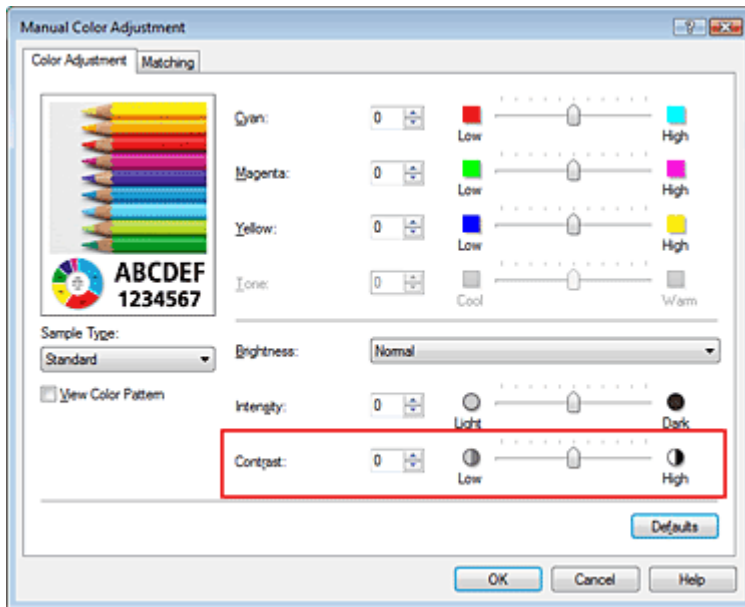

Important

- Adjust the slider gradually.

4. Complete the setup

Click OK on the Main tab.

When you execute print, the image is printed with the adjusted contrast.

Related Topics

- ➔ Selecting a Combination of the Print Quality Level and a Halftoning Method
- ➔ Specifying Color Correction
- ➔ Adjusting Color Balance
- ➔ Adjusting Brightness
- ➔ Adjusting Intensity

[Page top](#) ↕

Advanced Guide

Advanced Guide > Printing from a Computer > Printing with Other Application Software > Changing the Print Quality and Correcting Image Data > Simulating an Illustration

Simulating an Illustration

With the Simulate Illustration function, you can print full-color or 256-color image data so that it looks like a hand-drawn illustration. This function adds different effects to the original profile and colors.

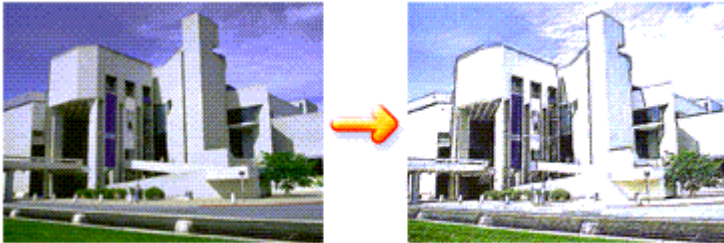

The procedure for performing Simulate Illustration is as follows:

1. Open the **printer driver setup window**
2. Set the Simulate Illustration

If necessary, check the Simulate Illustration check box on the Effects tab, and adjust the Contrast. Moving the slider to the right lightens the image data and moving the slider to the left darkens the image data.

The current settings are displayed in the settings preview on the left side of the printer driver.

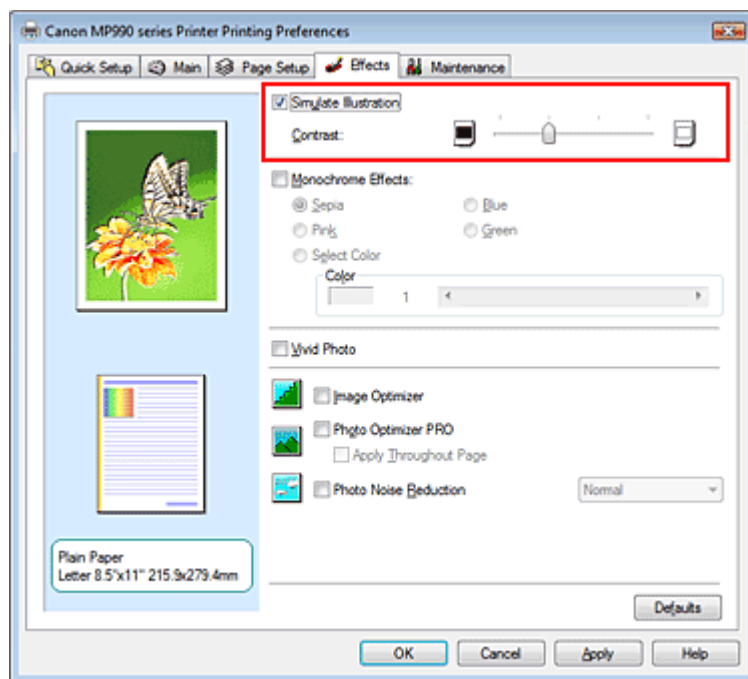

3. Complete the setup

Click OK.

When you execute print, the image will be printed so that it looks hand-drawn.

Advanced Guide

Advanced Guide > Printing from a Computer > Printing with Other Application Software > Changing the Print Quality and Correcting Image Data > Representing Image Data with a Single Color

Representing Image Data with a Single Color

With the Monochrome Effects function, you can benefit from coloring effects such as changing a photograph to a sepia tone image.

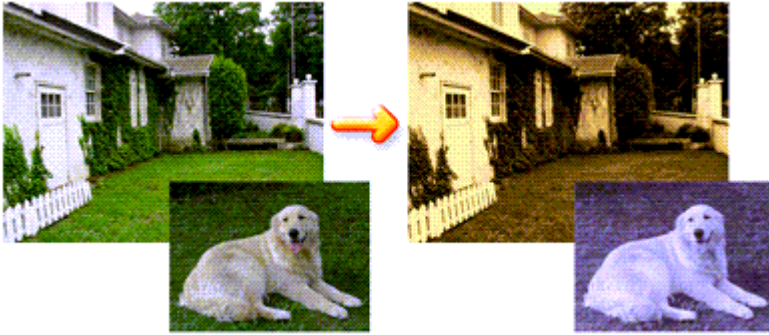

The procedure for performing Monochrome Effects is as follows:

1. Open the **printer driver setup window**
2. Set Monochrome Effects

Check the Monochrome Effects check box on the Effects tab and select your desired color.

When you use Select Color, move the Color slider to specify the color you want.

The current settings are displayed in the settings preview on the left side of the printer driver.

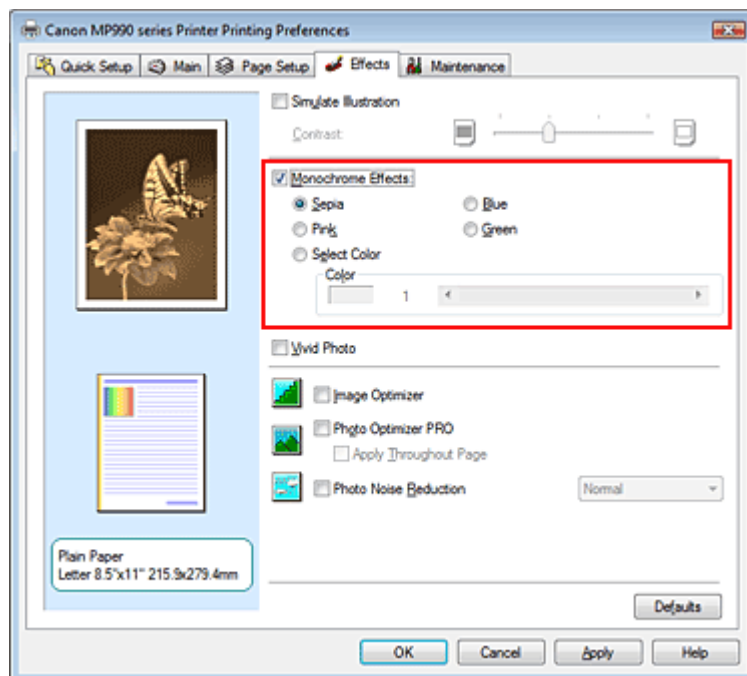

3. Complete the setup

Click OK.

When you execute print, the image will be printed with a single color.

Important

- When the Grayscale Printing check box on the Main tab is checked, Monochrome Effects appears

grayed out and is unavailable.

[Page top](#) 

Advanced Guide

Advanced Guide > Printing from a Computer > Printing with Other Application Software > Changing the Print Quality and Correcting Image Data > Presenting Image Data with Vivid Colors

Presenting Image Data with Vivid Colors

The Vivid Photo function allows you to print image data with vivid colors. The vivid photo function emphasizes the colors in background sceneries while maintaining the human skin color natural. By using this function, you can make vivid hues appear even more vivid.

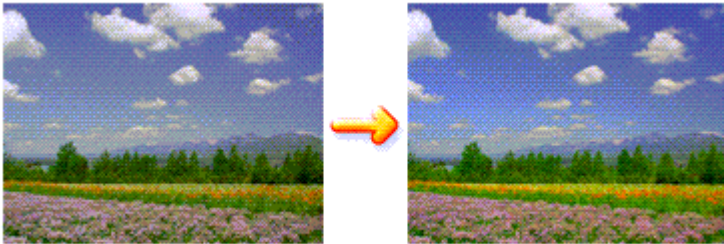

The procedure for performing Vivid Photo is as follows:

You can also set vivid photos on the Quick Setup tab by choosing Photo Printing under Commonly Used Settings, and then choosing Additional Features.

1. Open the printer driver setup window

2. Set Vivid Photo

Check the Vivid Photo check box on the Effects tab.

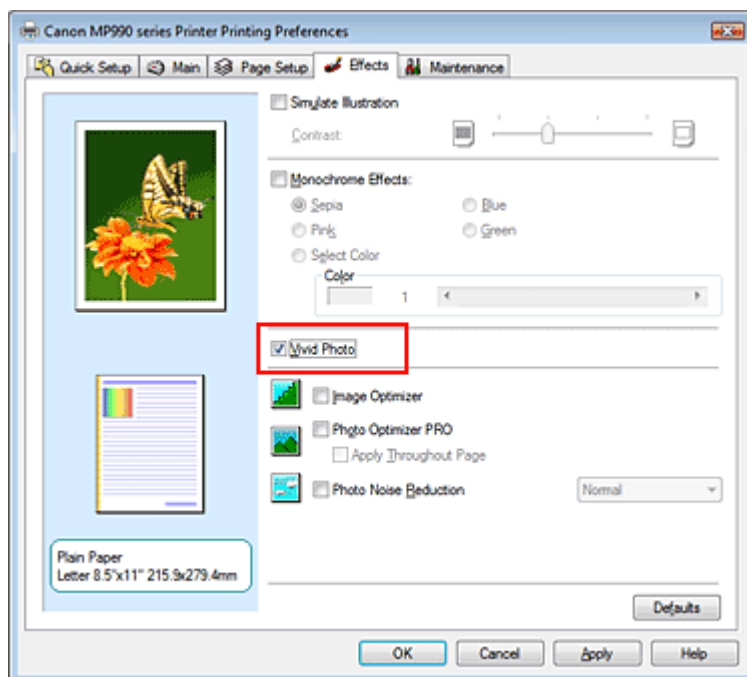

3. Complete the setup

Click OK.

When you execute print, the image will be printed with vivid colors.

Advanced Guide

Advanced Guide > Printing from a Computer > Printing with Other Application Software > Changing the Print Quality and Correcting Image Data > Smoothing Jagged Outlines

Smoothing Jagged Outlines

The Image Optimizer function allows you to smooth jagged outlines in photos and graphics that have been enlarged with your application. This feature is especially useful when printing low-resolution images from Web pages.

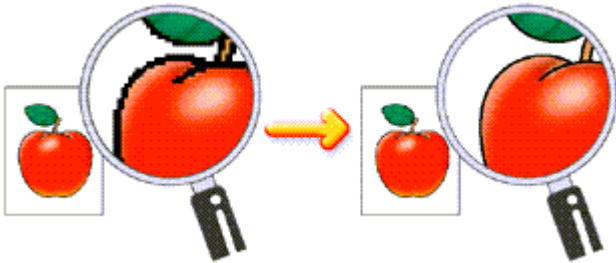

The procedure for performing Image Optimizer is as follows:

1. Open the **printer driver setup window**
2. Set image optimizer

Check the Image Optimizer check box on the Effects tab.

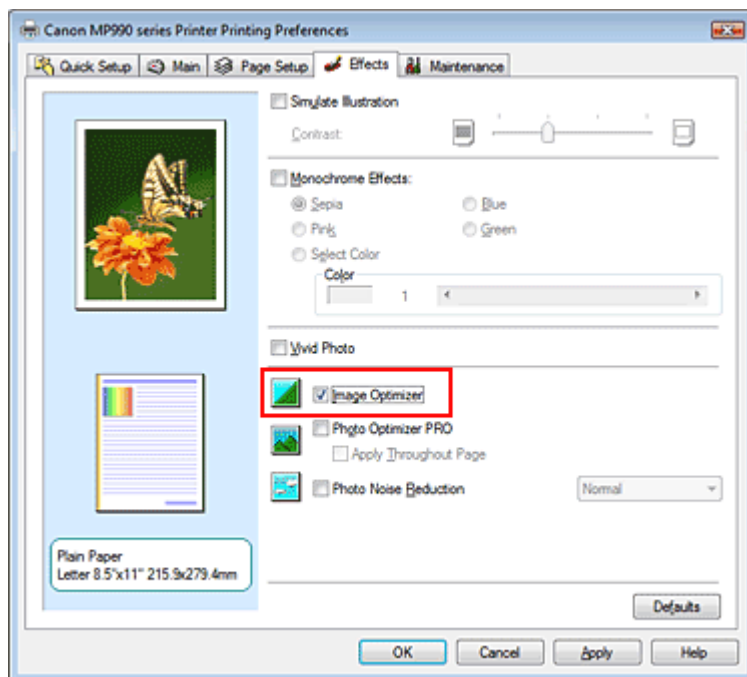

3. Complete the setup

Click OK.

The photos and graphics will be printed with jagged outlines smoothed.

Note

- Depending on application software or resolution of image data, the image optimizer may have no discernible effects.
- It may take longer to complete printing when the image optimizer is used.

Advanced Guide

Advanced Guide > Printing from a Computer > Printing with Other Application Software > Changing the Print Quality and Correcting Image Data > Changing Color Properties to Improve Coloration

Changing Color Properties to Improve Coloration

The Photo Optimizer PRO function corrects colors of digital camera images or scanned images. It is specially designed to compensate for color shift, overexposure, and underexposure.

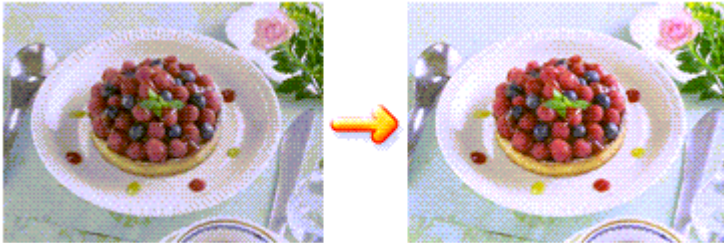

The procedure for performing Photo Optimizer PRO is as follows:

1. Open the **printer driver setup window**
2. Set Photo Optimizer PRO

Check the Photo Optimizer PRO check box on the Effects tab.

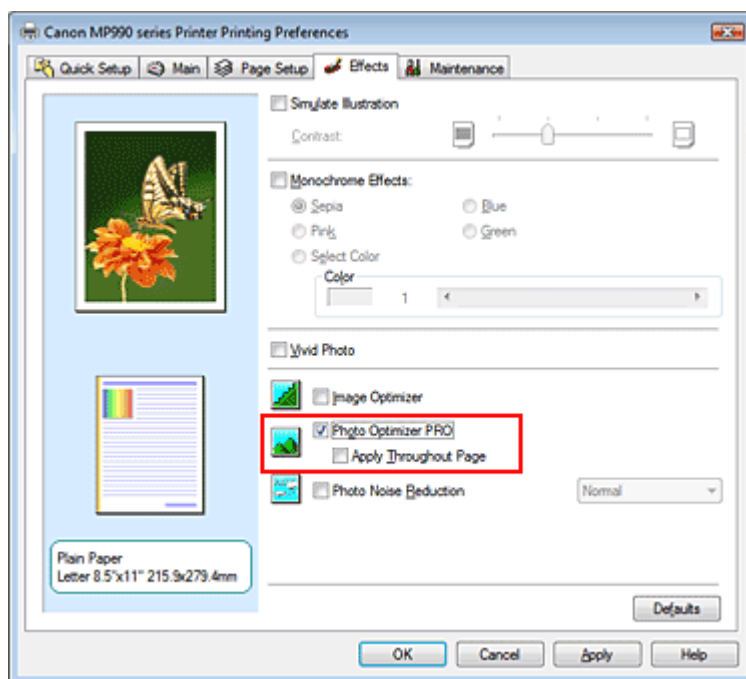

Normally there is no need to check the Apply Throughout Page check box. Images within each page are optimized on an image-by-image basis.

Note

- Check the Apply Throughout Page check box when printing image data that has been processed, such as being cropped or rotated. In this case the entire page will be treated as a single image to be optimized.

3. Complete the setup

Click OK.

When you execute print, the images will be printed with color compensation.

 **Important**

- Photo Optimizer PRO does not function when:
 - Background is set in the Stamp/Background dialog box on the Page Setup tab.
 - Define Stamp... is selected in the Stamp/Background dialog box on the Page Setup tab, and the bitmapped stamp is configured.

 **Note**

- Depending on images, the Photo Optimizer PRO may have no discernible effect.

[Page top](#) 

Advanced Guide

Advanced Guide > Printing from a Computer > Printing with Other Application Software > Changing the Print Quality and Correcting Image Data > Reducing Photo Noise

Reducing Photo Noise

With the Photo Noise Reduction function, you can reduce the digital camera noise and improve the image quality of the digital print.

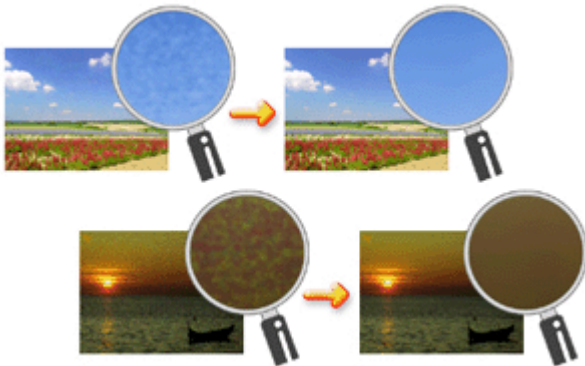

The procedure for performing Photo Noise Reduction is as follows:

1. Open the [printer driver setup window](#)
2. Set Photo Noise Reduction

Check the Photo Noise Reduction check box on the Effects tab and select Normal or Strong for the level.

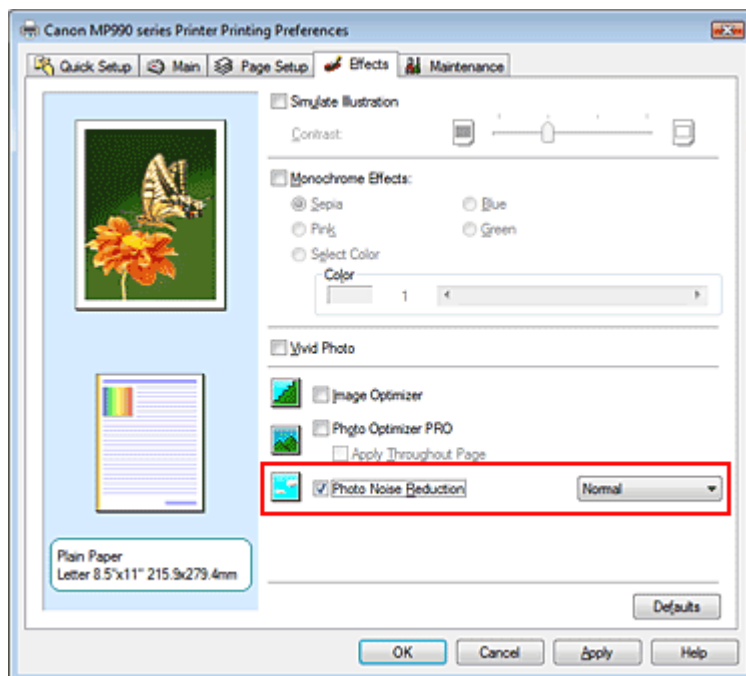

3. Complete the setup

Click OK.

When you execute print, the image will be printed with the digital camera noise being reduced.

Note

- It is recommended to select Normal for most cases. Select Strong if you have selected Normal and the noise still bothers you.

- Depending on application software or resolution of image data, effects of digital camera noise reduction may not be obvious.
 - When this function is used for other than photos taken by digital cameras, image may be distorted.
-

[Page top](#) ↕

Advanced Guide

[Advanced Guide](#) > [Printing from a Computer](#) > [Printing with Other Application Software](#) > [Overview of the Printer Driver](#)

Overview of the Printer Driver

- ➡ [Printer Driver Operations](#)
- ➡ [Canon IJ Printer Driver](#)
- ➡ [How to Open the Printer Driver Setup Window](#)
- ➡ [Maintenance Tab](#)
- ➡ [Canon IJ Status Monitor](#)
- ➡ [Canon IJ Preview](#)

[Page top](#) ↑



Printer Driver Operations

MA-5828-V1.00



| [Instructions for Use \(Printer Driver\)](#) | [How to Use This Manual](#) | [Printing This Manual](#) |
| [XPS Printer Driver](#) |

Various Printing Methods

- Printing with Easy Setup
- Setting a Page Size and Orientation
- Setting the Number of Copies and Printing Order
- Setting the Stapling Margin
- Borderless Printing
- Fit-to-Page Printing
- Scaled Printing
- Page Layout Printing
- Poster Printing
- Booklet Printing
- Duplex Printing
- Stamp/Background Printing
- Printing an Envelope
- Switching the Paper Source to Match the Purpose
- Displaying the Print Results before Printing
- Setting Paper Dimensions (Custom Size)

Changing the Print Quality and Correcting Image Data

- Selecting a Combination of the Print Quality Level and a Halftoning Method
- Printing a Color Document in Monochrome
- Adjusting Tone
- Specifying Color Correction
- Adjusting Color Balance
- Adjusting Brightness
- Adjusting Intensity
- Adjusting Contrast
- Simulating an Illustration
- Representing Image Data with a Single Color
- Presenting Image Data with Vivid Colors
- Smoothing Jagged Outlines
- Changing Color Properties to Improve Coloration
- Reducing Photo Noise

Changing Machine Settings from Your Computer

- Changing the Print Options
- Registering a Frequently Used Printing Profile
- Setting the Paper Source for Plain Paper
- Managing the Machine Power
- Reducing the Machine Noise
- Changing the Machine Operation Mode

Performing Maintenance from a Computer

- Cleaning the Print Heads
- Cleaning the Paper Feed Rollers
- Aligning the Print Head Position
- Checking the Print Head Nozzles
- Cleaning Inside the Machine

Overview of the Printer Driver

- Canon IJ Printer Driver
- How to Open the Printer Driver Setup Window
- Maintenance Tab
- Canon IJ Status Monitor
- Canon IJ Preview

Updating the MP Drivers

- Obtaining the Latest MP Drivers
- Deleting the Unnecessary MP Drivers Before Installing the MP Drivers
- Installing the MP Drivers

Appendix

- Deleting the Undesired Print Job

Advanced Guide

[Advanced Guide](#) > [Printing from a Computer](#) > [Printing with Other Application Software](#) > [Overview of the Printer Driver](#)
> [Canon IJ Printer Driver](#)

Canon IJ Printer Driver

The Canon IJ printer driver is software that is installed on your computer for printing data on this machine.

The Canon IJ printer driver converts the print data created by your Windows application into data that your printer can understand and sends the converted data to the printer.

Because different models support different print data formats, you need a Canon IJ printer driver for the specific model you are using.

How to Use Printer Driver Help

You can display the Help describing the driver setting items through the printing preferences screen of the Canon IJ printer driver.

- **To view all descriptions of a tab...**

Click the Help button on each tab. A dialog box opens, displaying a description of each item on the tab.

You can also click the link found in the description of an item to display a description of the linked dialog box.

- **To see a description for each item...**

Right-click the item you want to learn about and then click What's This?.

Alternatively, when the  Help button is found at the right end of the title bar, click that button, and then click the item you want to learn about.

A description of the item is displayed.

Related Topic

[➔ How to Open the Printer Driver Setup Window](#)



[Page top](#) 

Advanced Guide

Advanced Guide > Printing from a Computer > Printing with Other Application Software > Overview of the Printer Driver > Canon IJ Printer Driver > How to Open the Printer Driver Setup Window

How to Open the Printer Driver Setup Window

The printer driver setup window can be displayed through the application software in use or the Start menu of the Windows.

Note

- This guide mainly describes operations on the Windows Vista. Operations may differ depending on versions of the Windows.

Open the Printer Driver Setup Window through the Application Software

Follow the procedure below to configure printing profile when printing.

1. Select the command you perform printing on the application software in use

In general, select Print on the File menu to open the Print dialog box.

2. Select your model name and click Preferences (or Properties)

The printer driver setup window appears.

Note

- Depending on application software you use, command names or menu names may vary and there may be more steps. For details, refer to the user's manual of your application software.

Open the Printer Driver Setup Window through the Start Menu

Follow the procedure below to perform maintenance operations such as print head cleaning, or to configure printing profile that are common for all application software.

1. Select items from the Start menu as shown below:

- In Windows Vista, select the Start menu -> Control Panel -> Hardware and Sound -> Printers.
- In Windows XP, select the start menu -> Control Panel -> Printers and Other Hardware -> Printers and Faxes.
- In Windows 2000, select the Start menu -> Settings -> Printers.

2. Right-click your model name icon, and then select Printing Preferences... from the displayed menu

The printer driver setup window appears.

Important

- Opening the printer driver setup window through Properties displays such tabs regarding the Windows functions as the Ports (or Advanced) tab. Those tabs do not appear when opening through Printing Preferences... or application software. For tabs regarding Windows functions, refer to the user's manual for the Windows.



Advanced Guide

Advanced Guide > Printing from a Computer > Printing with Other Application Software > Overview of the Printer Driver > Canon IJ Printer Driver > Maintenance Tab

Maintenance Tab

The Maintenance tab allows you to perform machine maintenance or change the settings of the machine.

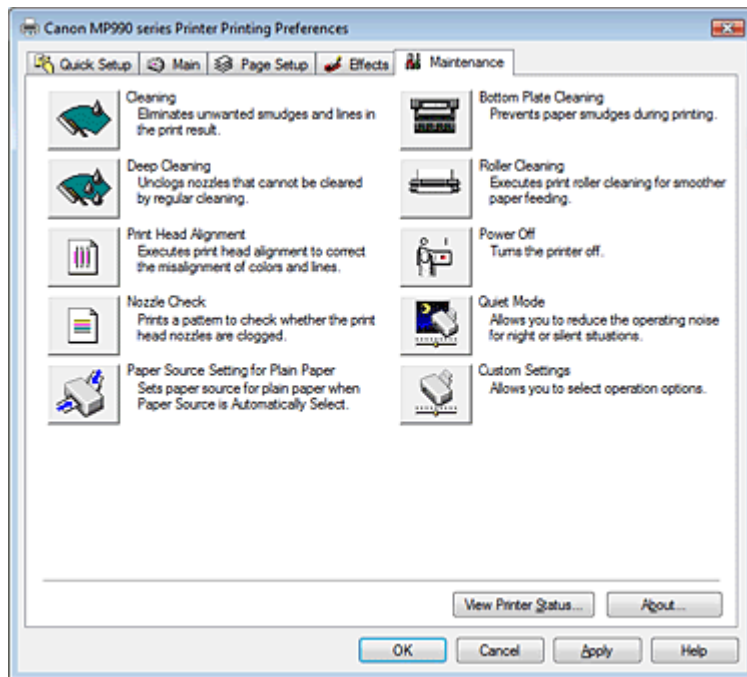

Features

- ➔ Cleaning the Print Heads
- ➔ Cleaning the Paper Feed Rollers
- ➔ Aligning the Print Head Position
- ➔ Checking the Print Head Nozzles
- ➔ Setting the Paper Source for Plain Paper
- ➔ Cleaning Inside the Machine
- ➔ Managing the Machine Power

Related Features

- ➔ Reducing the Machine Noise
- ➔ Changing the Machine Operation Mode



Advanced Guide

Advanced Guide > Printing from a Computer > Printing with Other Application Software > Overview of the Printer Driver > Canon IJ Status Monitor

Canon IJ Status Monitor

The Canon IJ Status Monitor is an application software that shows the status of the printer and the progress of printing on the Windows screen. You will know the status of the printer with graphics, icons, and messages.

Launching the Canon IJ Status Monitor

The Canon IJ Status Monitor launches automatically when data is sent to the printer. When launched, the Canon IJ Status Monitor appears as a button on the task bar.



Click the status monitor button displayed on the task bar. The Canon IJ Status Monitor appears.

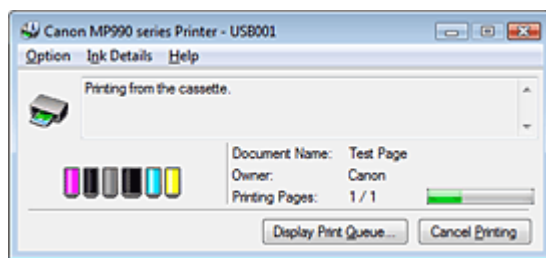

Note

- To open the Canon IJ Status Monitor when the printer is not printing, open the [printer driver setup window](#) and click View Printer Status... on the Maintenance tab.

When Errors Occur

The Canon IJ Status Monitor is automatically displayed if an error occurs (e.g., if the printer runs out of paper or if the ink is low).

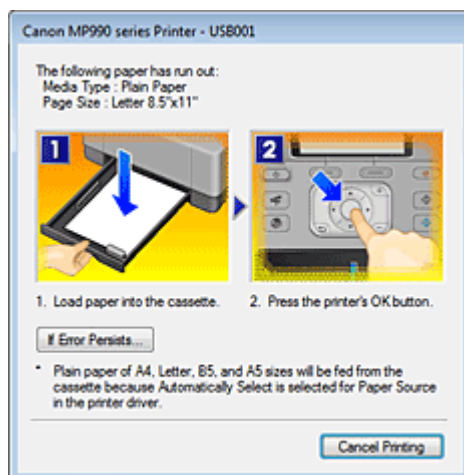

In such cases, take the appropriate action as described.

Advanced Guide

[Advanced Guide](#) > [Printing from a Computer](#) > [Printing with Other Application Software](#) > [Overview of the Printer Driver](#)
> [Canon IJ Preview](#)

Canon IJ Preview

The Canon IJ Preview is an application software that displays what the print result will look like before a document is actually printed.

The preview reflects the information that is set within the printer driver and allows you to check the document layout, print order, and number of pages. You can also change the media type and paper source settings.

When you want to display a preview before printing, open the [printer driver setup window](#) , click the Quick Setup tab or the Main tab, and check the Preview before printing check box.

When you do not want to display a preview before printing, uncheck the check box.

Related Topic

➡ [Displaying the Print Results before Printing](#)

[Page top](#) ↑

Advanced Guide

Advanced Guide > Printing Using the Operation Panel of the Machine

Printing Using the Operation Panel of the Machine

- ➔ Printing Lined Paper or Graph Paper
- ➔ Copying
- ➔ Printing from a Memory Card
- ➔ Printing from a USB Flash Drive
- ➔ Photo Printing from Printed Photo or Film

[Page top](#) ↕

Advanced Guide

[Advanced Guide](#) > [Printing Using the Operation Panel of the Machine](#) > [Printing Lined Paper or Graph Paper](#)

Printing Lined Paper or Graph Paper

➔ [Printing Template Forms Such As Lined Paper or Graph Paper](#)

[Page top](#) ↑

Advanced Guide



Advanced Guide > Printing Using the Operation Panel of the Machine > Printing Lined Paper or Graph Paper > Printing Template Forms Such As Lined Paper or Graph Paper

Printing Template Forms Such As Lined Paper or Graph Paper

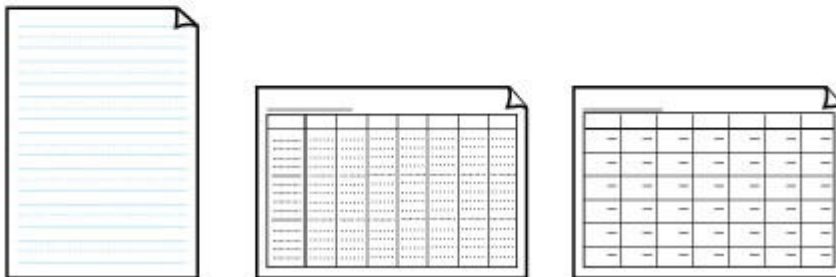
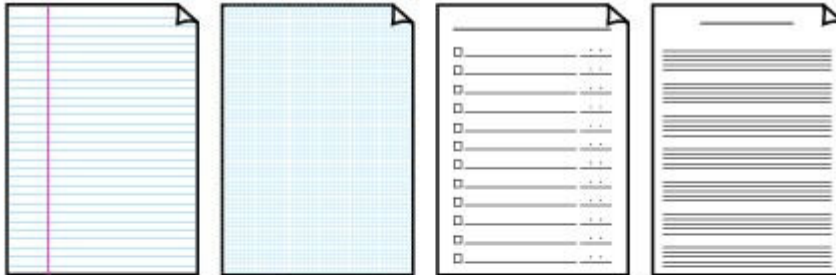
You can print a template form such as lined paper, graph paper, or check list, etc. on A4, B5, or Letter-sized plain paper.



Printing template forms

1. Make sure that the machine is turned on.
2. Load A4, B5, or Letter-sized plain paper in the Cassette.
3. Select  Settings on the HOME screen, then press the OK button.
4. Use the Easy-Scroll Wheel or the ◀▶ button to select  Template print, then press the OK button.
5. Use the Easy-Scroll Wheel or the ◀▶ button to select the template you want to print, then press the OK button.

The following templates are available:

- **Notebook paper**

You can select three line spacing formats.

- Notebook paper 1: 8 mm spacing
- Notebook paper 2: 7 mm spacing
- Notebook paper 3: 6 mm spacing

- **Graph paper**

You can select two square sizes.

- Graph paper 1: Graph 5 mm
- Graph paper 2: Graph 3 mm

- **Checklist**
You can print a notepad with checkboxes.

- **Staff paper**
You can print staff paper with 10 or 12 staves.
 - Staff paper 1: Staff paper 10 staves
 - Staff paper 2: Staff paper 12 staves

- **Handwriting paper**
You can print handwriting paper.

- **Weekly schedule**
You can print a weekly schedule form.

- **Monthly schedule**
You can print a monthly schedule form.



Note

- You cannot print Graph paper on B5 sized paper.
-

- 6. Use the ▲ ▼ button to specify the paper size, then press the OK button.**



Note

- Select Duplex printing for Duplex/simplex printing to print on both sides of paper.
-

- 7. Use the + or - button to specify the number of copies.**

- 8. Press the OK button to start printing.**

The machine starts template printing.

Advanced Guide

Advanced Guide > Printing Using the Operation Panel of the Machine > Copying

Copying

- ➔ Making Copies
- ➔ Using Useful Copy Functions

[Page top](#) ↕

Advanced Guide

Advanced Guide > Printing Using the Operation Panel of the Machine > Copying > Making Copies

Making Copies

For the basic procedure to make copies, refer to [Copying](#).

- ➔ [Setting Items](#)
- ➔ [Reducing or Enlarging a Copy](#)
- ➔ [Changing Intensity Setting](#)
- ➔ [Displaying the Preview Screen](#)
- ➔ [Using Useful Copy Functions](#)

1. Make sure that the machine is turned on.
2. Select  Copy on the HOME screen, then press the **OK** button.
3. Load paper.
4. Load the original on the Platen Glass.
5. Confirm the page size and media type.

Note

- To change the settings, select the item and press the **OK** button.
 - ➔ [Setting Items](#)
- Page size and media type settings are saved in each mode.
- When you make copies, you can specify various layouts on the screen that appears when you press the left Function button.
 - ➔ [Using Useful Copy Functions](#)

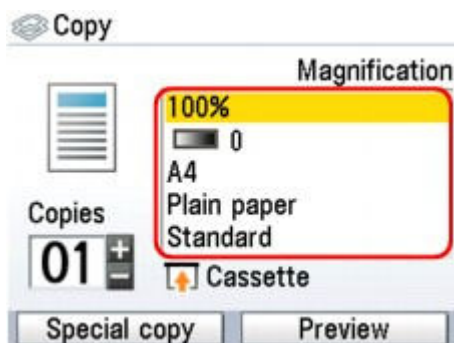

6. Press the **+** or **-** button to specify the number of copies.

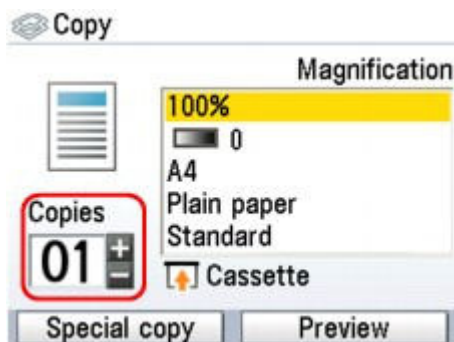

7. Press the **Color** button for color copying, or the **Black** button for black & white copying.

The machine starts copying.

Remove the original on the Platen Glass after copying is complete.



Important

- Do not open the Document Cover or remove the original from the Platen Glass until copying is complete.



Note

- When you press the right Function button while Preview is displayed on the screen, you can preview an image of the printout on the preview screen.
 - ➔ [Displaying the Preview Screen](#)
 - To cancel copying, press the **Stop** button.
-

Advanced Guide

Advanced Guide > Printing Using the Operation Panel of the Machine > Copying > Making Copies > Setting Items

Setting Items

Select  Copy on the HOME screen, then press the **OK** button to display the Copy screen.

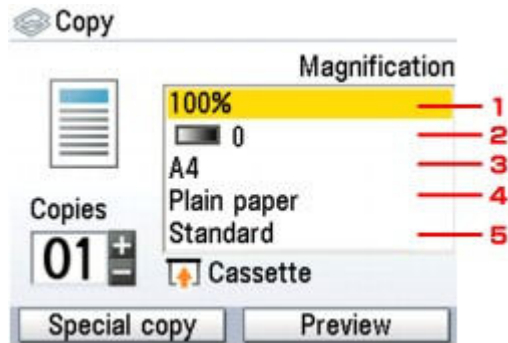

Note

- Page size and media type settings are saved in each mode.
- The settings of the page size, media type, etc. are retained even if the machine is turned off.
- Depending on the functions, some setting items cannot be specified in combination.

1. Magnification

Specify the reduction/enlargement method. ➔ [Reducing or Enlarging a Copy](#)

2. Intensity

Specify the intensity. ➔ [Changing Intensity Setting](#)

3. Page size

Select the page size of the loaded paper.

4. Media type

Select the media type of the loaded paper.

5. Print quality

Adjust print quality according to the original.

Important

- If you used Fast (speed-priority) with media type set to Plain paper and the quality is not as good as expected, select Standard or High(quality-priority) and try copying again.
- Select High(quality-priority) to copy in grayscale. Grayscale renders tones in a range of grays instead of black or white.

Advanced Guide

Advanced Guide > Printing Using the Operation Panel of the Machine > Copying > Making Copies > Reducing or Enlarging a Copy

Reducing or Enlarging a Copy

You can select from the following reduction/enlargement methods according to your purpose.

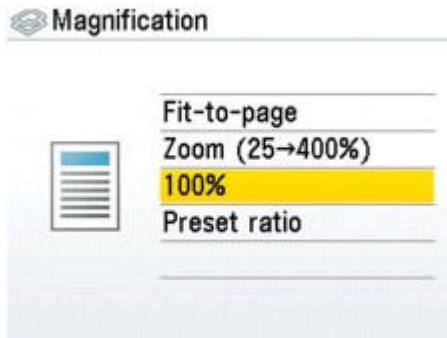

• Fit-to-page

The machine automatically reduces or enlarges the image to fit the page size.

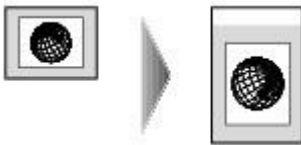

• Zoom (25 - 400%)

You can specify the copy ratio as a percentage to reduce or enlarge copies.

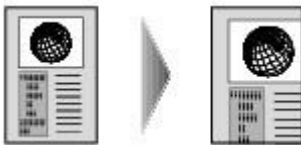

On the screen that appears when selecting Zoom (25 - 400%), change the ratio using the Easy-Scroll Wheel or the ▲ ▼ ◀ ▶ button, then press the **OK** button to finalize the setting.

• Preset ratio

You can select one of the preset ratios to reduce or enlarge copies.



On the screen that appears when selecting Preset ratio, select the ratio using the Easy-Scroll Wheel or the ▲ ▼ button, then press the **OK** button to finalize the setting.

Note

- When you select Fit-to-page, the document size may not be detected correctly depending on the original. In this case, select Preset ratio, Zoom (25 - 400%), or 100%.
- When you want to copy at the same size as the original, select 100%.

Advanced Guide

Advanced Guide > Printing Using the Operation Panel of the Machine > Copying > Making Copies > Changing Intensity Setting

Changing Intensity Setting

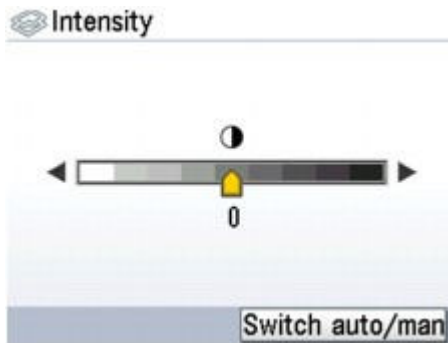

Turn the Easy-Scroll Wheel clockwise to increase intensity or counterclockwise to decrease it.

You can also use the ◀▶ button to perform settings.

Press the right Function button in the Intensity screen to automatically match the intensity to the original on the Platen Glass and then print the image.

The slide bar for the intensity adjustment on the LCD changes to Auto when it is done.

▶ Important

- While Auto is selected, you cannot change the intensity by using the Easy-Scroll Wheel. Press the right Function button to enable manual intensity settings again and then specify the intensity.

[Page top ↑](#)

Advanced Guide

Advanced Guide > Printing Using the Operation Panel of the Machine > Copying > Making Copies > Displaying the Preview Screen

Displaying the Preview Screen

When you press the right Function button while Preview is displayed on the screen, you can preview an image of the printout on the preview screen.

Important

- The original will be scanned to display the preview image. Therefore, do not open the Document Cover until the preview screen appears.
- Originals are rescanned after displaying the preview screen and before copying starts. Therefore, do not open the Document Cover or remove the original from the Platen Glass until copying is complete.

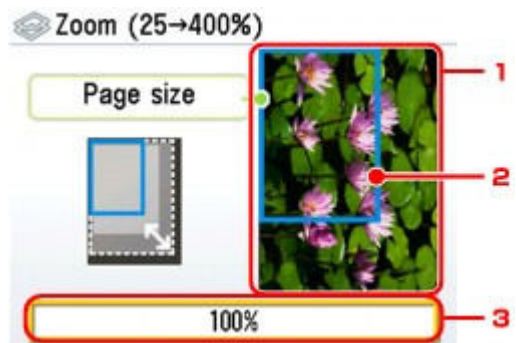

1. Preview of the original

The original that is set on the Platen Glass is displayed. If the displayed image is skewed, refer to [Loading Paper / Originals](#) and reset the original properly, then display the preview screen again and preview the original.

2. Page size

A frame showing the selected page size appears over the image. The inside of the frame will be printed.

3. Magnification

The magnification setting, which was set when the preview screen was displayed, is displayed. If Preset ratio, Zoom (25 - 400%), or 100% is selected, you can change the magnification setting on the preview screen.

Advanced Guide

Advanced Guide > Printing Using the Operation Panel of the Machine > Copying > Using Useful Copy Functions

Using Useful Copy Functions

Special Copy

Choose the copy method according to your purpose.

Note

- Refer to [Settings for Special Copy](#) for how to select the copy method.

• **Two-sided copy**

You can copy two original pages onto the both sides of a single sheet of paper.

➔ [Copying onto Both Sides of the Paper \(Two-Sided Copy\)](#)

• **Borderless copy**

You can copy images so that they fill the entire page without borders.

➔ [Copying without Borders \(Borderless Copy\)](#)

• **2-on-1 copy**

You can copy two original pages onto a single sheet of paper by reducing each image.

➔ [Copying Two Pages to Fit onto a Single Page \(2-on-1 Copy\)](#)

• **4-on-1 copy**

You can copy four original pages onto a single sheet of paper by reducing each image. Four different layouts are available.

➔ [Copying Four Pages to Fit onto a Single Page \(4-on-1 Copy\)](#)

• **Image repeat**

You can copy an image multiple times onto a single page. You can set the machine to automatically select the number of times it repeats the image, or you can specify the number.

➔ [Repeating an Image on a Page \(Image Repeat\)](#)

• **Frame erase**

When copying thick originals such as books, you can make a copy without black margins around the image and gutter shadows.

➔ [Copying Thick Originals Such as Books \(Frame Erase\)](#)

• **Trimming**

You can clip (trim) a necessary part of the original to copy.

➔ [Copying a Specified Area \(Trimming\)](#)

• **Masking**

You can erase (mask) a specified part of the original to copy.

➔ [Copying Images with Erasing a Part \(Masking\)](#)

Advanced Guide

Advanced Guide > Printing Using the Operation Panel of the Machine > Copying > Using Useful Copy Functions > Settings for Special Copy

Settings for Special Copy

1. Make sure that the machine is turned on.
2. Select  Copy on the HOME screen, then press the **OK** button.
3. Load paper.
4. Load the original on the Platen Glass.

Note

- For details on the types and conditions of originals which you can copy, refer to [Loading Paper / Originals](#).

5. Press the left Function button when the print settings confirmation screen is displayed.

The Special copy screen is displayed.

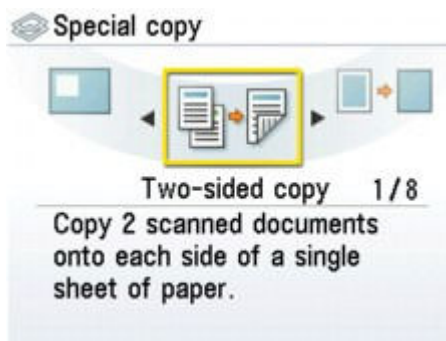

Note

- When you use these functions, you cannot select some of the options for the magnification/page size/media type settings.
If you perform the Special copy setting first, any unavailable options will be disabled or hidden in the basic copy settings screen.
If you perform the basic copy settings first, apply any Special copy setting, then return to the basic copy settings screen, any items that require modification will be corrected automatically or displayed with .
- To cancel Special copy settings, press the **Stop** button. If the number of copies or the intensity has been set already, press the **Stop** button twice.

Advanced Guide

Advanced Guide > Printing Using the Operation Panel of the Machine > Copying > Using Useful Copy Functions > Copying onto Both Sides of the Paper (Two-Sided Copy)

Copying onto Both Sides of the Paper (Two-Sided Copy)

You can copy two original pages onto the both sides of a single sheet of paper.



(A) Long-side stapling

(B) Short-side stapling

➔ [Settings for Special Copy](#)

1. Select  Two-sided copy, then press the **OK** button.

Follow the on-screen instructions.

2. Press the **Color** button for color copying, or the **Black** button for black & white copying.

Note

- You can skip scanning of the second page of originals and copy only the first page. After scanning the first page of originals by pressing the **Color** or **Black** button, press the left Function button to select Print front side on the screen that appears.
- If you are copying in black & white, print intensity of a Two-sided copy may differ from that of a single-sided copy.

Advanced Guide

Advanced Guide > Printing Using the Operation Panel of the Machine > Copying > Using Useful Copy Functions > Copying Two Pages to Fit onto a Single Page (2-on-1 Copy)

Copying Two Pages to Fit onto a Single Page (2-on-1 Copy)

You can copy two original pages (A) (B) onto a single sheet of paper (C) by reducing each image.

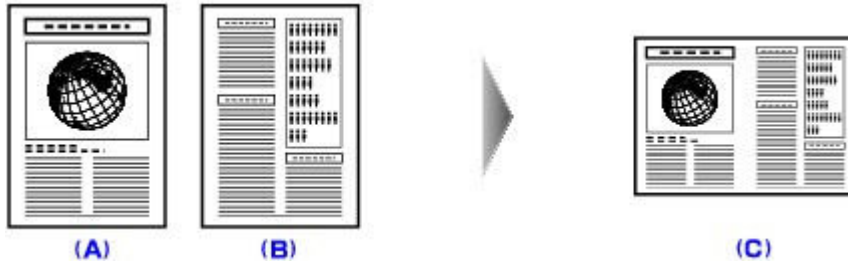

➔ Settings for Special Copy

1. Select  2-on-1 copy, then press the **OK** button.
Follow the on-screen instructions.
2. Press the **Color** button for color copying, or the **Black** button for black & white copying.

Note

- You can skip scanning of the second sheet of originals and copy only the first sheet. After scanning the first sheet of originals by pressing the **Color** or **Black** button, press the left Function button to select Print first sheet on the screen that appears.
- If Device memory is full, appears on the LCD when scanning, set the print quality to Standard and try copying. If the problem is not resolved, reduce the number of sheets of documents or set the print quality to Fast (speed-priority) and try copying again.

[Page top](#) ↑

Advanced Guide

Advanced Guide > Printing Using the Operation Panel of the Machine > Copying > Using Useful Copy Functions > Copying Four Pages to Fit onto a Single Page (4-on-1 Copy)

Copying Four Pages to Fit onto a Single Page (4-on-1 Copy)

You can copy four original pages onto a single sheet of paper by reducing each image. Four different layouts are available.

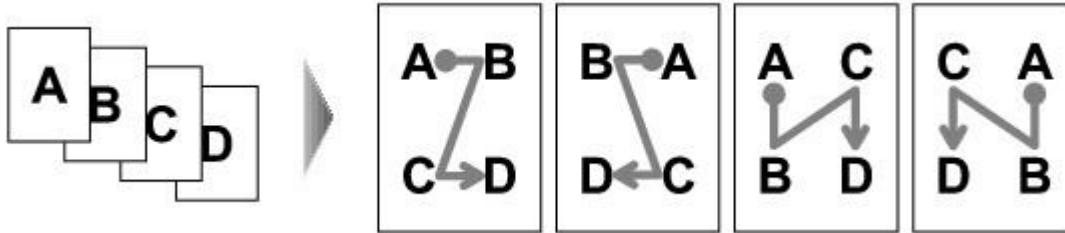

➔ Settings for Special Copy

1. Select  4-on-1 copy, then press the **OK** button.
Follow the on-screen instructions.
2. Press the **Color** button for color copying, or the **Black** button for black & white copying.

Note

- If you want to copy only 1, 2, or 3 pages, press the left Function button to select Print now after scanning the last page that you want to copy.
- If Device memory is full. appears on the LCD when scanning, set the print quality to Standard and try copying. If the problem is not resolved, reduce the number of sheets of documents or set the print quality to Fast (speed-priority) and try copying again.

[Page top ↑](#)

Advanced Guide



Advanced Guide > Printing Using the Operation Panel of the Machine > Copying > Using Useful Copy Functions > Copying without Borders (Borderless Copy)

Copying without Borders (Borderless Copy)

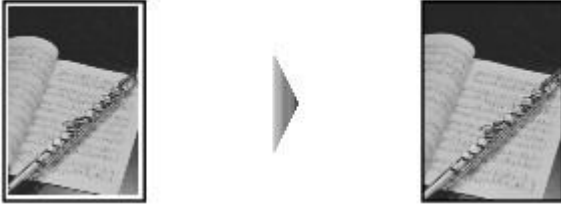
You can copy images so that they fill the entire page without borders.



➔ [Settings for Special Copy](#)

1. Select   Borderless copy, then press the **OK** button.
Follow the on-screen instructions.
2. Press the **Color** button for color copying, or the **Black** button for black & white copying.

Note

- Slight cropping may occur at the edges since the copied image is enlarged to fill the whole page. You can change the width to be cropped from the borders of the original image as needed. For details, see [Extended copy amount](#).
- For details on the paper size and the media type available for borderless copying, see [Printing Area](#).

[Page top](#) ↑

Advanced Guide

Advanced Guide > Printing Using the Operation Panel of the Machine > Copying > Using Useful Copy Functions > Repeating an Image on a Page (Image Repeat)

Repeating an Image on a Page (Image Repeat)

You can copy an image multiple times onto a single page. You can set the machine to automatically select the number of times it repeats the image, or you can specify the number.

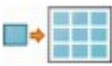

➔ Settings for Special Copy

1. Select  Image repeat, then press the **OK** button.
Follow the on-screen instructions.
2. Press the **Color** button for color copying, or the **Black** button for black & white copying.

Note

- The area scanned from the original depends on the reduction/enlargement setting.

Advanced Guide

Advanced Guide > Printing Using the Operation Panel of the Machine > Copying > Using Useful Copy Functions > Copying Thick Originals Such as Books (Frame Erase)

Copying Thick Originals Such as Books (Frame Erase)

When copying thick originals such as books, you can make a copy without black margins around the image and gutter shadows. Using this function, you can reduce unnecessary ink consumption.

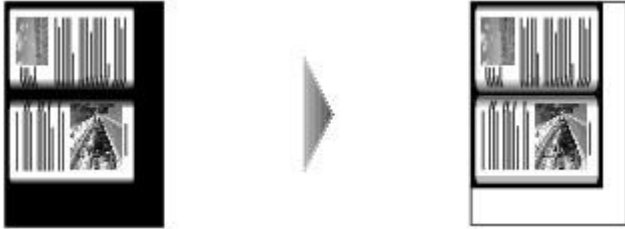

➔ Settings for Special Copy

1. Select  Frame erase, then press the **OK** button.

Follow the on-screen instructions.

2. Press the **Color** button for color copying, or the **Black** button for black & white copying.

Note

- Close the Document Cover.
- There may be a narrow black margin that appears around the image. This function removes the dark margins only. If a scanned book is too thin or when the machine is used near a window or in a bright environment, a faint black frame may remain. Also, if the color of an original is dark, the machine cannot distinguish the document color from the shadow and this may cause slight cropping or a shadow on the crease.
- When you press the right Function button while Preview is displayed on the screen, you can preview an image of the printout on the preview screen.

➔ Displaying the Preview Screen

Advanced Guide



Advanced Guide > Printing Using the Operation Panel of the Machine > Copying > Using Useful Copy Functions > Copying a Specified Area (Trimming)

Copying a Specified Area (Trimming)

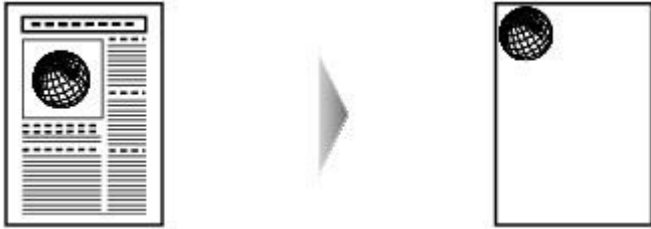
You can clip (trim) a necessary part of the original to copy.



➔ Settings for Special Copy

1. Select  Trimming, then specify the top left and bottom right of the trimming area using  button by following instructions on the LCD.
2. After specifying the trimming area, press the **OK** button.
You can preview an image of the printout on the preview screen.
3. Press the **Color** button for color copying, or the **Black** button for black & white copying.

Note

- If you press the left Function button after pressing the **OK** button on the Trimming image screen to display the print setting screen, you can redo the scanning of the original.

[Page top ↑](#)

Advanced Guide



Advanced Guide > Printing Using the Operation Panel of the Machine > Copying > Using Useful Copy Functions > Copying Images with Erasing a Part (Masking)

Copying Images with Erasing a Part (Masking)

You can erase (mask) a specified part of the original to copy.



➔ Settings for Special Copy

1. Select  Masking, then specify the top left and bottom right of the masking area using  button by following instructions on the LCD.
2. After specifying the masking area, press the **OK** button.
You can preview an image of the printout on the preview screen.
3. Press the **Color** button for color copying, or the **Black** button for black & white copying.

Note

- If you press the left Function button after pressing the **OK** button on the Masking image screen to display the print setting screen, you can redo the scanning of the original.

Advanced Guide

Advanced Guide > Printing Using the Operation Panel of the Machine > Printing from a Memory Card

Printing from a Memory Card

- ➔ [Printing Photographs Saved on a Memory Card](#)
- ➔ [Using Useful Printing Functions](#)
- ➔ [Using Useful Display Functions](#)
- ➔ [Setting Up the Card Slot as the Memory Card Drive of the Computer](#)

[Page top](#) ↕

Advanced Guide

[Advanced Guide](#) > [Printing Using the Operation Panel of the Machine](#) > [Printing from a Memory Card](#) > [Printing Photographs Saved on a Memory Card](#)

Printing Photographs Saved on a Memory Card

For the basic procedure to print from a memory card, refer to [Printing from a Memory Card](#).

- ➔ [Setting Items](#)
- ➔ [Printing by Using the Photo Index Sheet](#)
- ➔ [Using Useful Printing Functions](#)

[Page top](#) ↑

Advanced Guide

Advanced Guide > Printing Using the Operation Panel of the Machine > Printing from a Memory Card > Printing Photographs Saved on a Memory Card > Setting Items

Setting Items

Print Settings Confirmation Screen

In the Memory card mode, select the photo to print using the Easy-Scroll Wheel or the ◀▶ button, specify the number of copies using the + or - button, press the **OK** button, then the screen is displayed.

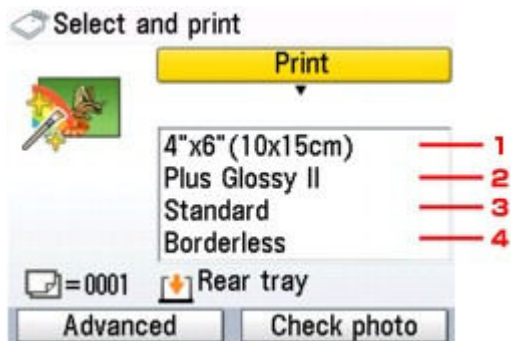

Note

- Depending on the functions, some setting items cannot be specified in combination.

1. Page size

Select the page size of the loaded paper.

2. Media type

Select the media type of the loaded paper.

3. Print quality

Adjust print quality according to the original.

4. Borderless print

Select bordered or borderless print.

Note

- When you select Plain paper for the media type, the photo will be printed with bordered even if you select Borderless.

Advanced Screen

When you press the left Function button in the print settings confirmation screen, the menu screen to select Date setting, File no. setting, or Auto photo fix is displayed.

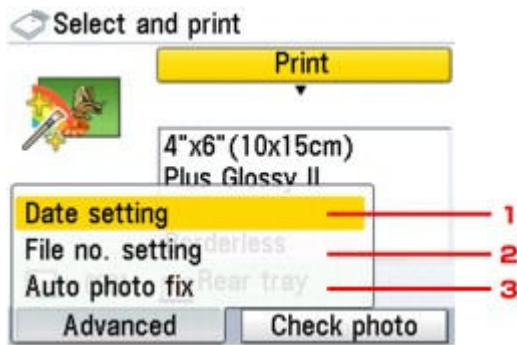

Use the Easy-Scroll Wheel or the ▲ ▼ button to select the setting item, then press the **OK** button to display the screen for the selected item.

1. Date setting

Activates/deactivates to print the shooting date on a photo.



2. File no. setting

Activates/deactivates to print the file number on a photo.



Note

- It is not possible to print both the shooting date and the file number when Layout print is selected as a print function in the memory card mode. Even if both Date ON and File no. ON are selected, only the shooting date will be printed. If you want to print the file number, select Date OFF.

3. Auto photo fix

When Auto photo fix ON is selected, the scene or person's face of a shot photo is recognized and the most suitable correction for each photo is made automatically. It makes a darkened face by backlight brighter to print. It also analyzes a scene such as scenery, night scene, person, etc. and corrects each scene with the most suitable color, brightness, or contrasts automatically to print.



Note

- As a default, Auto photo fix ON is applied when photos on a memory card are printed. When Auto photo fix ON is applied, you can specify only (1) Red-Eye correction below.
- If the print result with Auto photo fix ON selected is not satisfactory, select Manual correction, then specify each advanced setting item below.

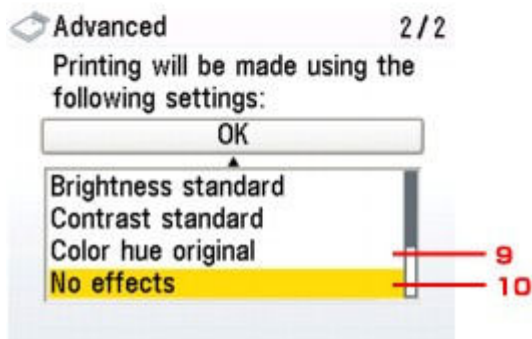
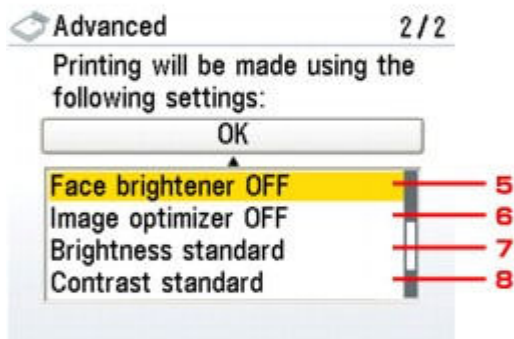
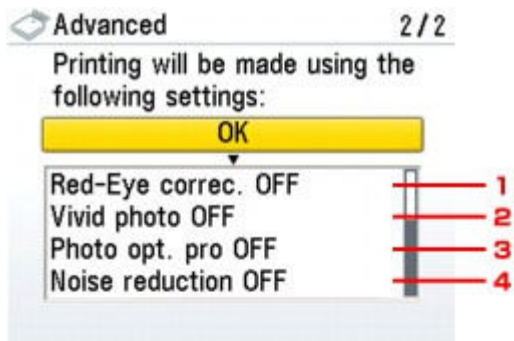

1. Red-Eye correction

Corrects red eyes in portraits caused by flash photography.

Depending on the type of the photo, red eyes may not be corrected or parts other than the eyes may be corrected.

Note

- This setting is available even if Auto photo fix ON is selected.

2. Vivid photo

Makes green and blue more lively.

3. Photo optimizer pro

Automatically optimizes brightness and tone of a photo.

4. Noise reduction

Reduces the noise on blue areas like the sky as well as on black areas.

5. Face brightener

Brightens a darkened face on the photo taken against the light.

6. Image optimizer

Corrects and smoothes the jagged contours for printing.

7. Brightness

Adjust brightness.

8. Contrast

Adjust contrast.

9. Color hue

Adjust color hue.

For example, you can increase red or yellow to adjust the skin tone.

10. Effects

Applies special effects to the photo, such as printing in sepia tones or with a sketch illustration like effect.

Advanced Guide

Advanced Guide > Printing Using the Operation Panel of the Machine > Printing from a Memory Card > Printing Photographs Saved on a Memory Card > Printing by Using the Photo Index Sheet



Printing by Using the Photo Index Sheet

Photo Index Sheet is an A4 or Letter-sized plain paper on which thumbnail images of photos saved on a memory card or a USB flash drive are printed. Print out a Photo Index Sheet, mark the images that you want to print, scan the sheet in, and the machine then prints the selected images. You can also specify other settings, such as the paper size and the media type, by using this sheet; you do not have to perform settings by using the Operation Panel on the machine.

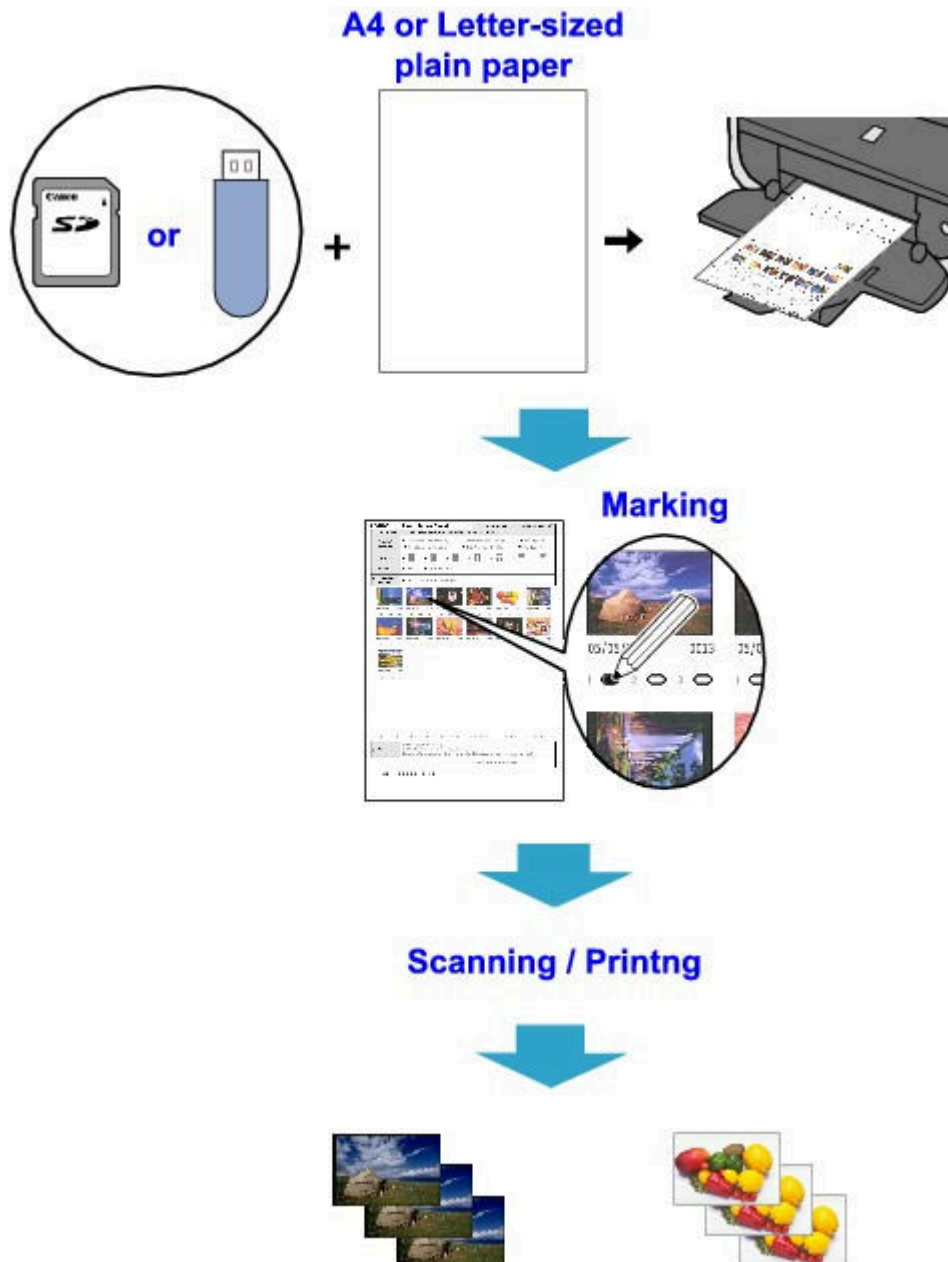
* The procedure below is applied both for printing photos on a memory card and for printing photos on a USB flash drive.



1. Make sure that the machine is turned on.
2. Load A4 or Letter-sized plain paper in the Cassette.

3. Select  Photo index sheet on the HOME screen, then press the **OK** button.
4. Make sure that  Index sheet print is selected, then press the **OK** button.
5. Insert a memory card or a USB flash drive following the instruction on the LCD.

Important

- You cannot insert both the memory card and the USB flash drive at the same time.
- Do not remove the memory card/USB flash drive until printing the Photo Index Sheet(s) is complete.

Note

- For information on how to insert a memory card/USB flash drive, refer to [Printing from a Memory Card](#).

6. Select a range of images included in the Photo Index Sheet, then press the **OK** button.

The following ranges can be selected.

Print all photos:

Prints all images.

Set no. of copies:

Prints the specified number of images from the newest one.

Search:

Prints images by specifying the shooting date range.

Note

- It may take a while to display the Search screen depending on the number of photos saved on the memory card/USB flash drive.

7. Press the **Color** button.

The Photo Index Sheet(s) will be printed.

Note

- If 31 or more images are selected, two or more Photo Index Sheets will be printed.

8. Fill in the appropriate circles in the Photo Index Sheet.

Fill in the appropriate circles () with a dark pencil or a black ink pen to select the photos to print and their print options.

- Good



- Bad



(a)



(b)



(c)

- (a) Check mark
 (b) Line only
 (c) Too light

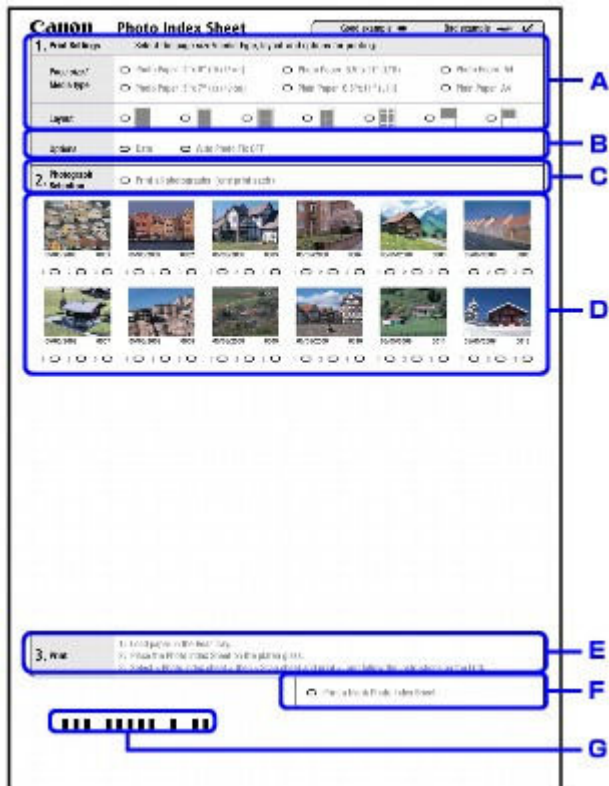

- A. Select the page size and other printing formats.
- B. Select "Date"/"Auto Photo Fix OFF" as necessary.
- C. Fill in this circle to print a copy of all photographs.
 - * If you fill in this circle, any other circles you filled in for the number of copies to print for each photograph will be disregarded, and one copy each of all photographs will be printed.
- D. Select the number of copies (fill in a circle under each photograph to print).
- E. Confirm and follow the described printing procedure.
- F. Fill in this circle to print the same Photo Index Sheet again.
 - * If you fill in this circle, all other filled settings will be disregarded.
- G. Be careful not to make the bar code dirty.
 - If the bar code is dirty or has wrinkles, the machine may not scan the Photo Index Sheet properly.

Important

- Be sure to fill in a circle for every setting item except options.
- If there are two or more Photo Index Sheets, fill in marks on each sheet.
- If the filled circles on the Photo Index Sheet are not dark or vast enough, the machine may not scan the Photo Index Sheet properly.

9. Load paper to print photos.

Make sure that the page size and media type of the loaded paper match those specified on the Photo Index Sheet.

Note

- When printing images using the Photo Index Sheet, you can select 4" x 6" (101.6 x 152.4 mm), 5" x 7" (127 x 177.8 mm), 8.5" x 11" (Letter), or A4 for the page size.

10. Make sure that  Scan sheet and print is selected, then press the **OK** button.

11. Place the Photo Index Sheet face-down on the Platen Glass, then press the **OK**

button.

When placing the Photo Index Sheet, place the front side down, align the upper left corner of it with the alignment mark as shown in the figure below, then close the Document Cover.



The Photo Index Sheet is scanned and the specified photos will be printed. Remove the Photo Index Sheet on the Platen Glass after printing is complete.

Important

- If Failed to scan Photo Index Sheet. is displayed on the LCD, press the **OK** button and confirm the following:
 - The Platen Glass and the Photo Index Sheet are not dirty
 - The Photo Index Sheet is placed in the correct position with its front side facing down
 - You have filled in all the necessary circles on the sheet
 - Only one option is selected for items that do not accept two or more selections
- Do not remove the memory card/USB flash drive while printing is in progress.

Note

- To cancel printing, press the **Stop** button.
- To continue to print photographs using subsequent Photo Index Sheets, repeat the procedure from step 10.
- If the memory card/USB flash drive has been removed and then reinserted before printing with the Photo Index Sheet, it may take some time before printing starts.

Advanced Guide

Advanced Guide > Printing Using the Operation Panel of the Machine > Printing from a Memory Card > Using Useful Printing Functions

Using Useful Printing Functions

Printing Memory Card Photos in Various Layouts

You can select the following printing methods according to your purpose.

Note

- For the procedure to select the printing method, see [Settings for Printing a Photo on a Memory Card](#).

• **Layout print**

You can paste photos of your choice in the specified layout.

➔ [Printing Several Photos on a Single Sheet of Paper \(Layout Print\)](#)

• **Sticker print**

You can print your favorite photo with a frame on Canon Photo Stickers.

➔ [Printing on Stickers \(Sticker Print\)](#)

• **DPOF print**

If you have specified Digital Print Order Format (DPOF) settings on your digital camera, you can print photos according to these settings.

➔ [DPOF print](#)

• **Captured info print**

You can print shooting information (Exif info) on the margin of the index of photos or selected individual photos.

➔ [Captured info print](#)

• **Photo index print**

You can print an index of all the photos saved on a memory card.

➔ [Photo index print](#)

• **Print all photos**

You can print all photos saved on the memory card.

➔ [Print all photos](#)

• **ID photo size print**

You can print a photo saved on a memory card in the ID photo size.

➔ [Printing ID Photo-ID photo size print](#)

• **Calendar print**

You can print a calendar using photos saved on a memory card.

➔ [Creating a Calendar-Calendar print](#)

Advanced Guide

Advanced Guide > Printing Using the Operation Panel of the Machine > Printing from a Memory Card > Using Useful Printing Functions > Settings for Printing a Photo on a Memory Card

Settings for Printing a Photo on a Memory Card

1. Make sure that the machine is turned on.
2. Load paper.
3. Select  Memory card on the HOME screen, then press the **OK** button.
4. Insert the memory card into the Card Slot.

The memory card menu is displayed.

Important

- If the USB flash drive is inserted in the Direct Print Port, remove the USB flash drive, then insert the memory card into the Card Slot.

Note

- For information on how to insert a memory card, refer to [Printing from a Memory Card](#).

Advanced Guide

Advanced Guide > Printing Using the Operation Panel of the Machine > Printing from a Memory Card > Using Useful Printing Functions > Printing Several Photos on a Single Sheet of Paper (Layout Print)

Printing Several Photos on a Single Sheet of Paper (Layout Print)

You can paste photos of your choice in the specified layout.

- ➔ Settings for Printing a Photo on a Memory Card
- ➔ Settings for Printing a Photo on a USB Flash Drive

* The procedure below is applied both for printing photos on a memory card and for printing photos on a USB flash drive.

1. Select  Layout print, then press the **OK** button.

Follow the on-screen instructions.

Note

- If you skip a selected frame without pasting a photo on it when selecting Paste one by one, press the left Function button on the photo layout screen.
- When Borderless is selected, the media type cannot be set to Plain paper.
- When Mixed 1, Mixed 2, or Mixed 3 is selected, you can select A4 or 8.5"x11"(LTR) for the page size.
- You cannot paste photos over multiple pages at one time. If you have photos for two or more pages, print each page as you finish pasting photos for the page.
- Even if both Date ON and File no. ON are selected, only the shooting date will be printed. If you want to print the file number, select Date OFF.
- Other Options
 - ➔ Printing a Specified Area (Trimming) (This function is available only when Paste one by one is selected.)
 - ➔ Searching for Photos with the Shooting Date (Search)

Advanced Guide

Advanced Guide > Printing Using the Operation Panel of the Machine > Printing from a Memory Card > Using Useful Printing Functions > Printing on Stickers (Sticker Print)

Printing on Stickers (Sticker Print)

You can print your favorite photo with a frame on Canon Photo Stickers.

➡ Settings for Printing a Photo on a Memory Card

➡ Settings for Printing a Photo on a USB Flash Drive

* The procedure below is applied both for printing photos on a memory card and for printing photos on a USB flash drive.

1. Select  Sticker print, then press the **OK** button.

Follow the on-screen instructions.

Note

- You cannot use the Cassette to print on stickers. Load stickers on the Rear Tray.
- You can load only one sheet of stickers at a time on the Rear Tray.
- Select the frame to print using the Easy-Scroll Wheel or the ◀▶ button.
- To print with no frame, press the left Function button when No frame is displayed on the screen.
- When the photo is upside down, use the ▲▼ button to rotate the frame by 180 degrees to orient it properly against the photo.
- To rotate the photo by 90 degrees to fit it within the frame, use the cropping edit screen to rotate the cropping area.
 - ➡ Printing a Specified Area (Trimming)
- Other Options
 - ➡ Using Useful Display Functions
 - ➡ Printing a Specified Area (Trimming)
 - ➡ Searching for Photos with the Shooting Date (Search)

Page top ↑

Advanced Guide

Advanced Guide > Printing Using the Operation Panel of the Machine > Printing from a Memory Card > Using Useful Printing Functions > Print all photos

Print all photos

You can print all photos saved on the memory card/USB flash drive.

- ➔ Settings for Printing a Photo on a Memory Card
- ➔ Settings for Printing a Photo on a USB Flash Drive

* The procedure below is applied both for printing photos on a memory card and for printing photos on a USB flash drive.

1. Select  Print all photos, then press the **OK** button.
Follow the on-screen instructions.

Note

- Other Options
 - ➔ Searching for Photos with the Shooting Date (Search)
-

[Page top ↑](#)

Advanced Guide

Advanced Guide > Printing Using the Operation Panel of the Machine > Printing from a Memory Card > Using Useful Printing Functions > Photo index print

Photo index print

You can print an index of all the photos saved on a memory card/USB flash drive.

- ➔ [Settings for Printing a Photo on a Memory Card](#)
- ➔ [Settings for Printing a Photo on a USB Flash Drive](#)

* The procedure below is applied both for printing photos on a memory card and for printing photos on a USB flash drive.

1. Select  Photo index print, then press the **OK** button.
2. Select All photos, then press the **OK** button.

Follow the on-screen instructions.

Note

- The following print methods are available:
 - Contact print: 35 mm film images are printed in its negative size as in contact print.
 - Standard: The number of photos printed on a single sheet of paper depends on the size of the paper.
 - A4/Letter: 80 photos, 8" x 10"/203.2 x 254.0 mm: 72 photos, 5" x 7"/127.0 x 177.8 mm: 35 photos, 4" x 6"/101.6 x 152.4 mm: 24 photos, Wide/101.6 x 180.6 mm: 28 photos
 - 4" x 6"/101.6 x 152.4 mm: 24 photos, Wide/101.6 x 180.6 mm: 28 photos
- You can search for photos to print with the shooting date.
 - Search with the shooting date.
 - ➔ [Searching for Photos with the Shooting Date \(Search\)](#)

Advanced Guide

Advanced Guide > Printing Using the Operation Panel of the Machine > Printing from a Memory Card > Using Useful Printing Functions > DPOF print

DPOF print

If you have specified Digital Print Order Format (DPOF) settings on your digital camera, you can print photos according to these settings.

- ➔ Settings for Printing a Photo on a Memory Card
- ➔ Settings for Printing a Photo on a USB Flash Drive

* The procedure below is applied both for printing photos on a memory card and for printing photos on a USB flash drive.

1. Select  DPOF print, then press the **OK** button.

Follow the on-screen instructions.

Note

- The machine supports the following DPOF functions:

Version:

Based on ver. 1.00

Supported image types:

Exif (TIFF) and JFIF

Print Style - Standard Print:

Prints photos that were specified as "Standard Print" with DPOF

Print Style - Index Print:

Prints an index of photos that were specified as "Index Print" with DPOF using the machine's index printing layout

Print Style - Multi-Image Print:

Prints a photo that was specified as "Multi-Image Print" with DPOF (with the specified number of copies and layout)

Print Photo Select:

Prints only photos specified with DPOF

Number of copies:

Prints the number of copies specified with DPOF

- Prints are automatically enlarged or reduced to match the page size. Edges of the photo may be clipped off depending on the page size.
- The shooting date order setting by which photos are sorted follows that of DPOF.
- DPOF is a standard format to record the specified information regarding images, such as which image or number of copies to print.

Advanced Guide

Advanced Guide > Printing Using the Operation Panel of the Machine > Printing from a Memory Card > Using Useful Printing Functions > Captured info print

Captured info print

You can print shooting information (Exif info) on the margin of the index of photos or selected individual photos.

- ➔ [Settings for Printing a Photo on a Memory Card](#)
- ➔ [Settings for Printing a Photo on a USB Flash Drive](#)

* The procedure below is applied both for printing photos on a memory card and for printing photos on a USB flash drive.

1. Select  Captured info print, then press the **OK** button.

Follow the on-screen instructions.

Note

- The following print methods are available:

Single photo:

Prints the information in the margin of selected individual photos.

List:

Prints the information in the margin of the Photo index print of all photos or selected photos. You can select photos to print by the shooting date.

- Other Options

- ➔ [Using Useful Display Functions](#) (This function can only be used when Single photo is selected.)
- ➔ [Printing a Specified Area \(Trimming\)](#) (This function is available only when Single photo is selected.)
- ➔ [Searching for Photos with the Shooting Date \(Search\)](#)

Advanced Guide





Advanced Guide > Printing Using the Operation Panel of the Machine > Printing from a Memory Card > Using Useful Printing Functions > Printing ID Photo-ID photo size print

Printing ID Photo-ID photo size print

You can print photos on a memory card/USB flash drive in a specified size such as an ID photo.

- ➔ [Settings for Printing a Photo on a Memory Card](#)
- ➔ [Settings for Printing a Photo on a USB Flash Drive](#)

* The procedure below is applied both for printing photos on a memory card and for printing photos on a USB flash drive.

1. Select   ID photo size print, then press the **OK** button.
2. Select the photo to print using the Easy-Scroll Wheel or the   button, then press the **OK** button.

Follow the on-screen instructions.

Note

- The following sizes are available.
Print on the paper larger than the size you specified.
 - 1.18"x0.98"(3.0x2.5 cm)
 - 1.57"x1.18"(4.0x3.0 cm)
 - 1.57"x1.57"(4.0x4.0 cm)
 - 1.57"x2.36"(4.0x6.0 cm)
 - 1.77"x1.38"(4.5x3.5 cm)
 - 1.77"x1.77"(4.5x4.5 cm)
 - 1.97"x1.97"(5.0x5.0 cm)
 - 2.17"x2.17"(5.5x5.5 cm)
 - 2.36"x1.77"(6.0x4.5 cm)
 - 4.72"x4.72"(12x12 cm)
 - 1"x1.43"(2.5x3.6 cm)
 - 1.43"x2"(3.6x5.1 cm)
 - 1.77"x2.17"(4.5x5.5 cm)
- Other Options
 - ➔ [Using Useful Display Functions](#)
 - ➔ [Searching for Photos with the Shooting Date \(Search\)](#)

Advanced Guide

Advanced Guide > Printing Using the Operation Panel of the Machine > Printing from a Memory Card > Using Useful Printing Functions > Creating a Calendar-Calendar print

Creating a Calendar-Calendar print

You can create an original calendar using your favorite photos and a calendar.

➔ [Settings for Printing a Photo on a Memory Card](#)

➔ [Settings for Printing a Photo on a USB Flash Drive](#)

* The procedure below is applied both for printing photos on a memory card and for printing photos on a USB flash drive.

1. Select  Calendar print, then press the **OK** button.

Follow the on-screen instructions.

Important

- Be sure to load the paper in portrait orientation.

Note

- The following layouts are available.
Paper: Portrait format Photo: Bottom (landscape)
Paper: Portrait format Photo: Top (landscape)
Paper: Landscape format Photo: Right (portrait)
Paper: Landscape format Photo: Left (portrait)
- Select the landscape format for a landscape-oriented photo or the portrait format for a portrait-oriented photo.
- Use the Easy-Scroll Wheel or the ◀▶ button to select the Photo. If the photo is upside-down, you can use the ▲▼ button to rotate the photo 180 degrees.
- To change the start of the week on the printed calendar, press the left Function button on the print settings confirmation screen, then select Start of the week.
- To confirm or change the settings such as brightness, press the left Function button on the print settings confirmation screen, then select Auto photo fix.
- Even if both Date ON and File no. ON are selected, only the shooting date will be printed. If you want to print the file number, select Date OFF.
- Other Options
 - ➔ [Printing a Specified Area \(Trimming\)](#)
 - ➔ [Searching for Photos with the Shooting Date \(Search\)](#)

Advanced Guide

Advanced Guide > Printing Using the Operation Panel of the Machine > Printing from a Memory Card > Using Useful Display Functions

Using Useful Display Functions

Changing the Display

When you press the left Function button when Change display is displayed on the screen, you can change the way photos are displayed.

* The display methods below are available both for printing photos on a memory card and for printing photos on a USB flash drive.

- **Normal screen display:**

Shows one photo.

- **Thumbnail display:**

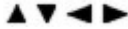
Shows nine photos at a time. Select the photo using the Easy-Scroll Wheel or the  button, then press the + or - button to specify the number of copies.

- **Full-screen display:**

Shows one photo at full-screen.

- **Enlarged display:**

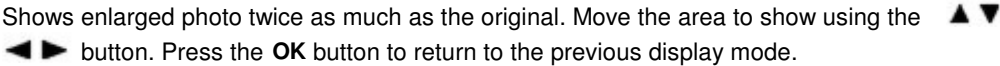
Shows enlarged photo twice as much as the original. Move the area to show using the  button. Press the **OK** button to return to the previous display mode.

- **Slide show:**

Shows next photos automatically. To stop the slide show, press the **Stop** button.

[Page top ↑](#)

Advanced Guide

Advanced Guide > Printing Using the Operation Panel of the Machine > Printing from a Memory Card > Using Useful Display Functions > Printing a Specified Area (Trimming)

Printing a Specified Area (Trimming)

You can edit images displayed on the LCD by cropping them.

* This function is available both for printing photos on a memory card and for printing photos on a USB flash drive.

Note

- Crop images after specifying the page size, media type, and bordered or borderless printing in the print settings screen. If you change the paper settings after cropping, the cropped area may be adjusted to match the paper, or be disabled completely.

1. Select the photo to crop.
2. Press the right Function button when Edit is displayed on the screen.
3. Select Trimming, then press the **OK** button.

The cropping edit screen is displayed.

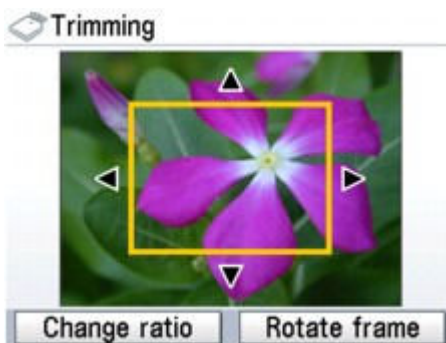

4. Choose the area to print.

▲, ▼, ◀, and ▶ buttons:

Position the cropping frame.

Easy-Scroll Wheel:

Sets the cropping frame size.

Turn the Easy-Scroll Wheel clockwise to enlarge the size of the cropping frame or counterclockwise to reduce it.

Left Function button:

Changes the aspect ratio of the cropping frame.

Right Function button:

Rotates the cropping frame.

To switch the cropping frame between portrait and landscape orientations, press this button.

5. Press the **OK** button to finalize your selection of cropping area.

The area to be cropped is specified, and the original photo is displayed.

Note

- The cropped image cannot be newly saved on the memory card/USB flash drive.
- The cropping area is displayed only for photos which have been cropped.
- To change the cropped area once it has been set, press the right Function button when Edit is displayed on the screen, select Trimming, then press the **OK** button.
- To cancel cropping after cropping has been complete, press the right Function button again

when Edit is displayed on the screen, select Cancel trimming, then press the **OK** button. Select Displayed images only or All images, then press the **OK** button.

[Page top ↑](#)

Advanced Guide

Advanced Guide > Printing Using the Operation Panel of the Machine > Printing from a Memory Card > Using Useful Display Functions > Searching for Photos with the Shooting Date (Search)

Searching for Photos with the Shooting Date (Search)

When there are a lot of photos saved on the memory card/USB flash drive, you can choose to display and print only photos shot on the specified date or within the specified range of dates.

* This function is available both for printing photos on a memory card and for printing photos on a USB flash drive.

Note

- If the number of copies to print is already specified for some photos before searching with the shooting date, or if some photos are already pasted on a layout, those photos will still be selected for printing even if they were not shot on the specified date or within the specified date range.

1. Display the search method screen.

- Setting in Edit:
 1. Press the right Function button when Edit is displayed on the screen.
 2. Select Search, then press the **OK** button.
The Search screen is displayed.
- Setting in Search in the Specify print range screen:
 1. Select Search, then press the **OK** button.
The Search screen is displayed.

2. Set the search method.

- To specify only one date for search:
Select One date only.
- To specify the date range for search:
Select Select date range.

3. Press the **OK** button.

The date input screen is displayed.

Note

- It may take a while for the date input screen to be displayed depending on the number of photos saved on the memory card/USB flash drive.

4. Specify the date range, then press the **OK** button.

- If you selected One date only:
 1. Specify the date to search, then press the **OK** button.
- If you selected Select date range:
 1. Specify the start date to search, then press the **OK** button.
 2. Specify the end date to search, then press the **OK** button.

Note

- The date to be specified is displayed according to the settings of Date display in Advanced settings under Device settings.
➡ [Changing the Machine Settings on the LCD](#)
- To cancel the selected date range, press the right Function button when Edit is displayed on the screen, select Cancel selected date, then press the **OK** button.

Advanced Guide

Advanced Guide > Printing Using the Operation Panel of the Machine > Printing from a Memory Card > Setting Up the Card Slot as the Memory Card Drive of the Computer

Setting Up the Card Slot as the Memory Card Drive of the Computer

The Card Slot of the machine can also be used as the memory card drive of the computer.

Note

- For details on using the Card Slot over a network, see [Using the Card Slot over a Network](#).
- In Macintosh, you cannot write data to a memory card in the Card Slot over a network.

Important

- When Read/write attribute in Advanced settings under Device settings is set to Writable from USB PC or Writable from LAN PC using the Operation Panel of the machine, you cannot print photos on a memory card using the Operation Panel of the machine. After using the Card Slot as the memory card drive of the computer, remove the memory card, then be sure to set Read/write attribute to Not writable from PC. When you turned off the machine, Writable from USB PC or Writable from LAN PC will be canceled and the setting is returned to Not writable from PC when you turn on the machine next time.

1. Make sure that the memory card is not set.

If the memory card is set, remove it from the Card Slot. For details, refer to [Printing from a Memory Card](#).

2. Select Settings on the HOME screen, then press the **OK** button.

3. Select Device settings, then press the **OK** button.

4. Select Advanced settings, then press the **OK** button.

5. Select Read/write attribute, then press the **OK** button.

6. Specify the read/write attribute.

Not writable from PC

The Card Slot is used only for reading. Be sure to select this mode when printing photos from a memory card.

Writable from USB PC

The Card Slot is used as the memory card drive of a computer connected to the machine via USB. Data can be written on the memory card from the computer.

Writable from LAN PC

The Card Slot is used as the memory card drive of a computer connected to the machine via a network. Data can be written on the memory card from the computer.

7. Press the **OK** button.

Important

- If you use the Card Slot as the memory card drive of the computer, you need to perform a "safe removal" operation on your computer before physically removing the memory card from your machine.
 - In Windows, right-click the  Removable Disk icon and click Eject. If Eject is not displayed on

the screen, confirm that the **Access** lamp is not flashing and remove the memory card.

- Over a network, the removal operation is not needed.



- On a Macintosh, drag the  Mount drive icon into the Trash.

[Page top](#) ↑

Advanced Guide

Advanced Guide > Printing Using the Operation Panel of the Machine > Printing from a USB Flash Drive

Printing from a USB Flash Drive

- ➔ Printing Photographs Saved on a USB Flash Drive
- ➔ Using Useful Printing Functions
- ➔ Using Useful Display Functions

[Page top](#) ↑

Advanced Guide

[Advanced Guide](#) > [Printing Using the Operation Panel of the Machine](#) > [Printing from a USB Flash Drive](#) > [Printing Photographs Saved on a USB Flash Drive](#)

Printing Photographs Saved on a USB Flash Drive

For the basic procedure to print from a USB flash drive, refer to [Printing from a Memory Card](#).

- ➡ [Setting Items](#)
- ➡ [Printing by Using the Photo Index Sheet](#)
- ➡ [Using Useful Printing Functions](#)

[Page top](#) ↑

Advanced Guide

Advanced Guide > Printing Using the Operation Panel of the Machine > Printing from a USB Flash Drive > Printing Photographs Saved on a USB Flash Drive > Setting Items

Setting Items

Print Settings Confirmation Screen

In the Memory card mode, select the photo to print using the Easy-Scroll Wheel or the ◀▶ button, specify the number of copies using the + or - button, press the **OK** button, then the screen is displayed.

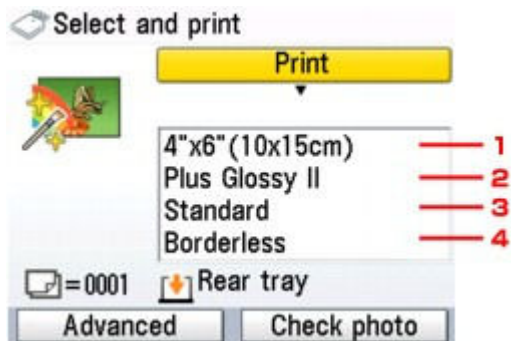

Note

- Depending on the functions, some setting items cannot be specified in combination.

1. Page size

Select the page size of the loaded paper.

2. Media type

Select the media type of the loaded paper.

3. Print quality

Adjust print quality according to the original.

4. Borderless print

Select bordered or borderless print.

Note

- When you select Plain paper for the media type, the photo will be printed with bordered even if you select Borderless.

Advanced Screen

When you press the left Function button in the print settings confirmation screen, the menu screen to select Date setting, File no. setting, or Auto photo fix is displayed.

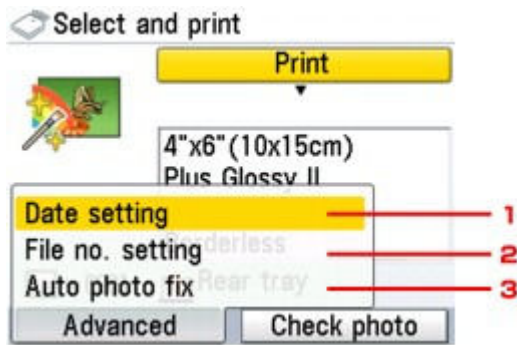

Use the Easy-Scroll Wheel or the ▲ ▼ button to select the setting item, then press the **OK** button to display the screen for the selected item.

1. Date setting

Activates/deactivates to print the shooting date on a photo.



2. File no. setting

Activates/deactivates to print the file number on a photo.



Note

- It is not possible to print both the shooting date and the file number when Layout print is selected as a print function in the memory card mode. Even if both Date ON and File no. ON are selected, only the shooting date will be printed. If you want to print the file number, select Date OFF.

3. Auto photo fix

When Auto photo fix ON is selected, the scene or person's face of a shot photo is recognized and the most suitable correction for each photo is made automatically. It makes a darkened face by backlight brighter to print. It also analyzes a scene such as scenery, night scene, person, etc. and corrects each scene with the most suitable color, brightness, or contrasts automatically to print.



Note

- As a default, Auto photo fix ON is applied when photos on a USB flash drive are printed. When Auto photo fix ON is applied, you can specify only (1) Red-Eye correction below.
- If the print result with Auto photo fix ON selected is not satisfactory, select Manual correction, then specify each advanced setting item below.

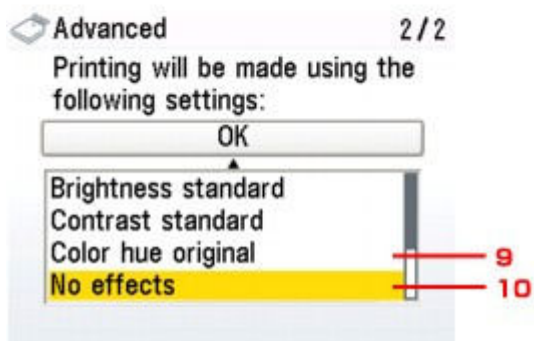
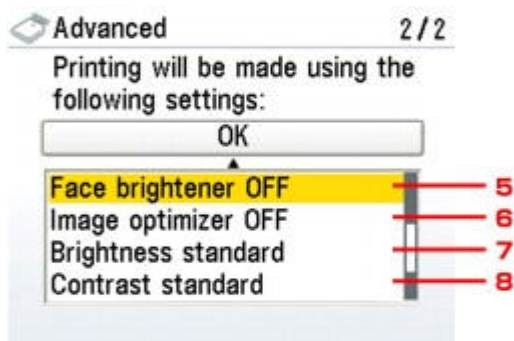
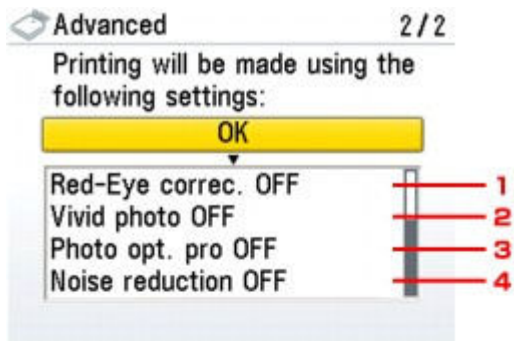

1. Red-Eye correction

Corrects red eyes in portraits caused by flash photography.

Depending on the type of the photo, red eyes may not be corrected or parts other than the eyes may be corrected.

Note

- This setting is available even if Auto photo fix ON is selected.

2. Vivid photo

Makes green and blue more lively.

3. Photo optimizer pro

Automatically optimizes brightness and tone of a photo.

4. Noise reduction

Reduces the noise on blue areas like the sky as well as on black areas.

5. Face brightener

Brightens a darkened face on the photo taken against the light.

6. Image optimizer

Corrects and smoothes the jagged contours for printing.

7. Brightness

Adjust brightness.

8. Contrast

Adjust contrast.

9. Color hue

Adjust color hue.

For example, you can increase red or yellow to adjust the skin tone.

10. Effects

Applies special effects to the photo, such as printing in sepia tones or with a sketch illustration like effect.

Advanced Guide

Advanced Guide > Printing Using the Operation Panel of the Machine > Printing from a Memory Card > Printing Photographs Saved on a Memory Card > Printing by Using the Photo Index Sheet



Printing by Using the Photo Index Sheet

Photo Index Sheet is an A4 or Letter-sized plain paper on which thumbnail images of photos saved on a memory card or a USB flash drive are printed. Print out a Photo Index Sheet, mark the images that you want to print, scan the sheet in, and the machine then prints the selected images. You can also specify other settings, such as the paper size and the media type, by using this sheet; you do not have to perform settings by using the Operation Panel on the machine.

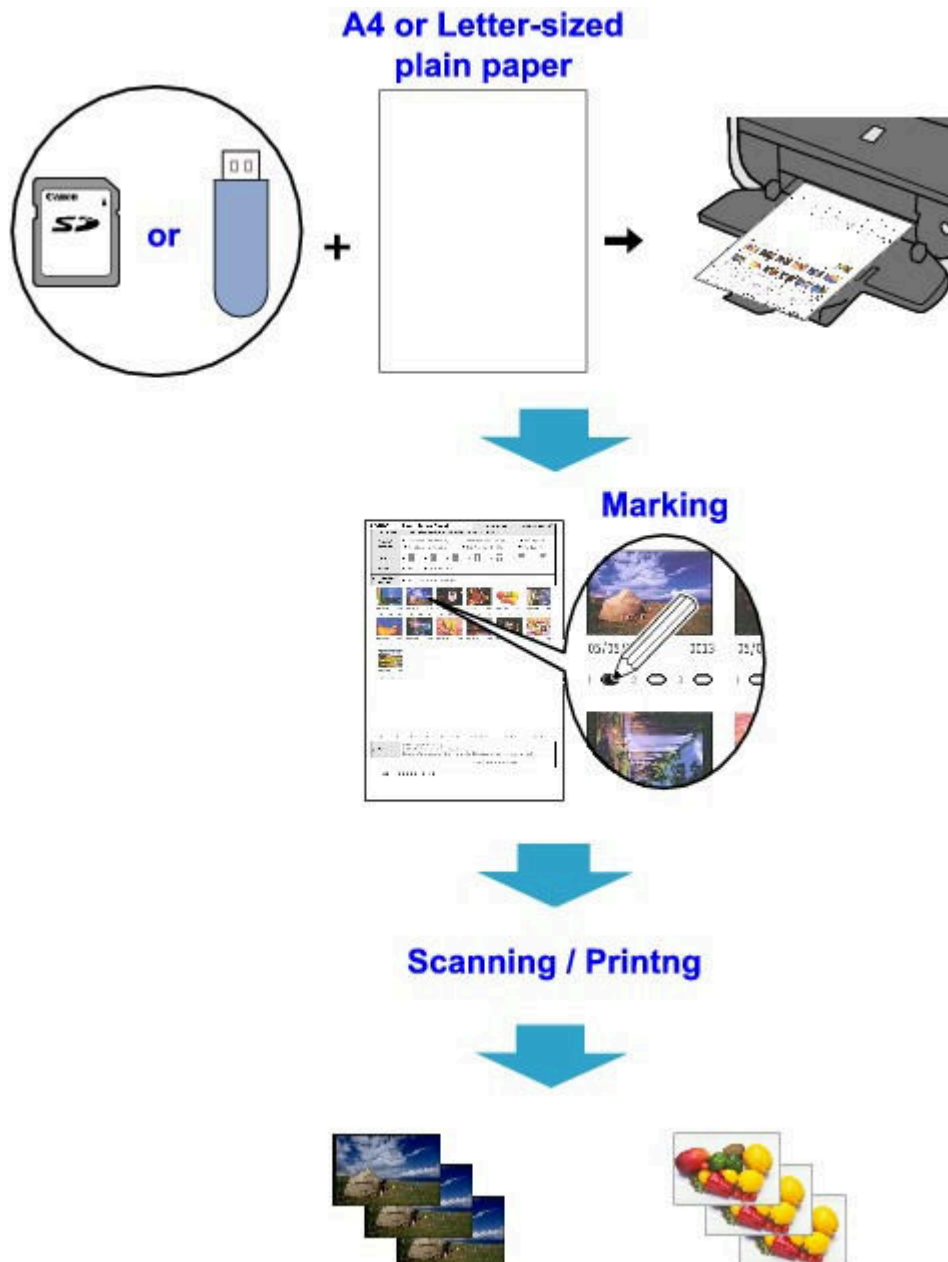
* The procedure below is applied both for printing photos on a memory card and for printing photos on a USB flash drive.



1. Make sure that the machine is turned on.
2. Load A4 or Letter-sized plain paper in the Cassette.

3. Select  Photo index sheet on the HOME screen, then press the **OK** button.
4. Make sure that  Index sheet print is selected, then press the **OK** button.
5. Insert a memory card or a USB flash drive following the instruction on the LCD.

 **Important**

- You cannot insert both the memory card and the USB flash drive at the same time.
- Do not remove the memory card/USB flash drive until printing the Photo Index Sheet(s) is complete.

 **Note**

- For information on how to insert a memory card/USB flash drive, refer to [Printing from a Memory Card](#).

6. Select a range of images included in the Photo Index Sheet, then press the **OK** button.

The following ranges can be selected.

Print all photos:

Prints all images.

Set no. of copies:

Prints the specified number of images from the newest one.

Search:

Prints images by specifying the shooting date range.

 **Note**

- It may take a while to display the Search screen depending on the number of photos saved on the memory card/USB flash drive.

7. Press the **Color** button.

The Photo Index Sheet(s) will be printed.

 **Note**

- If 31 or more images are selected, two or more Photo Index Sheets will be printed.

8. Fill in the appropriate circles in the Photo Index Sheet.

Fill in the appropriate circles () with a dark pencil or a black ink pen to select the photos to print and their print options.

- Good



- Bad



(a)



(b)



(c)

- (a) Check mark
- (b) Line only
- (c) Too light

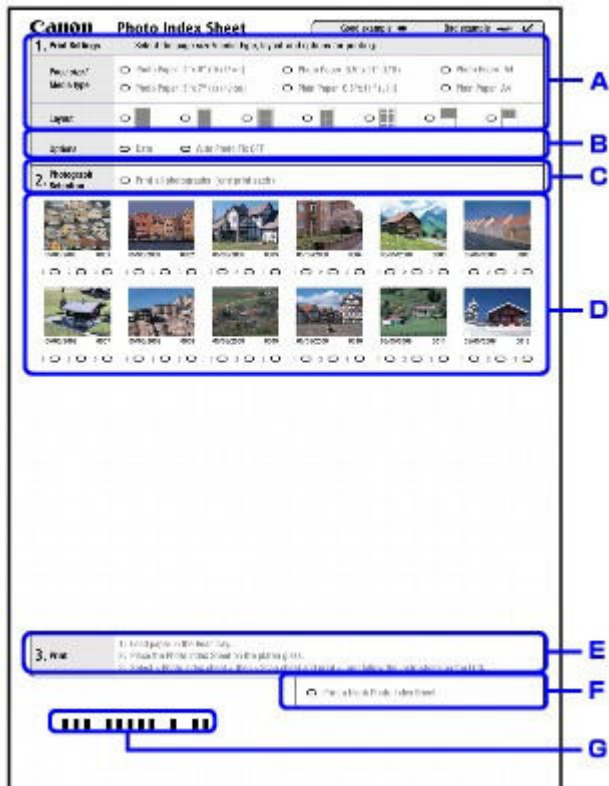

- A. Select the page size and other printing formats.
- B. Select "Date"/"Auto Photo Fix OFF" as necessary.
- C. Fill in this circle to print a copy of all photographs.
 - * If you fill in this circle, any other circles you filled in for the number of copies to print for each photograph will be disregarded, and one copy each of all photographs will be printed.
- D. Select the number of copies (fill in a circle under each photograph to print).
- E. Confirm and follow the described printing procedure.
- F. Fill in this circle to print the same Photo Index Sheet again.
 - * If you fill in this circle, all other filled settings will be disregarded.
- G. Be careful not to make the bar code dirty.
 - If the bar code is dirty or has wrinkles, the machine may not scan the Photo Index Sheet properly.

Important

- Be sure to fill in a circle for every setting item except options.
- If there are two or more Photo Index Sheets, fill in marks on each sheet.
- If the filled circles on the Photo Index Sheet are not dark or vast enough, the machine may not scan the Photo Index Sheet properly.

9. Load paper to print photos.

Make sure that the page size and media type of the loaded paper match those specified on the Photo Index Sheet.

Note

- When printing images using the Photo Index Sheet, you can select 4" x 6" (101.6 x 152.4 mm), 5" x 7" (127 x 177.8 mm), 8.5" x 11" (Letter), or A4 for the page size.

10. Make sure that  Scan sheet and print is selected, then press the **OK** button.

11. Place the Photo Index Sheet face-down on the Platen Glass, then press the **OK**

button.

When placing the Photo Index Sheet, place the front side down, align the upper left corner of it with the alignment mark as shown in the figure below, then close the Document Cover.



The Photo Index Sheet is scanned and the specified photos will be printed. Remove the Photo Index Sheet on the Platen Glass after printing is complete.

Important

- If Failed to scan Photo Index Sheet. is displayed on the LCD, press the **OK** button and confirm the following:
 - The Platen Glass and the Photo Index Sheet are not dirty
 - The Photo Index Sheet is placed in the correct position with its front side facing down
 - You have filled in all the necessary circles on the sheet
 - Only one option is selected for items that do not accept two or more selections
- Do not remove the memory card/USB flash drive while printing is in progress.

Note

- To cancel printing, press the **Stop** button.
- To continue to print photographs using subsequent Photo Index Sheets, repeat the procedure from step 10.
- If the memory card/USB flash drive has been removed and then reinserted before printing with the Photo Index Sheet, it may take some time before printing starts.

Advanced Guide

Advanced Guide > Printing Using the Operation Panel of the Machine > Printing from a USB Flash Drive > Using Useful Printing Functions

Using Useful Printing Functions

Printing USB Flash Drive Photos in Various Layouts

You can select the following printing methods according to your purpose.

Note

- For the procedure to select the printing method, see [Settings for Printing a Photo on a USB Flash Drive](#).

• **Layout print**

You can paste photos of your choice in the specified layout.

➔ [Printing Several Photos on a Single Sheet of Paper \(Layout Print\)](#)

• **Sticker print**

You can print your favorite photo with a frame on Canon Photo Stickers.

➔ [Printing on Stickers \(Sticker Print\)](#)

• **DPOF print**

If you have specified Digital Print Order Format (DPOF) settings on your digital camera, you can print photos according to these settings.

➔ [DPOF print](#)

• **Captured info print**

You can print shooting information (Exif info) on the margin of the index of photos or selected individual photos.

➔ [Captured info print](#)

• **Photo index print**

You can print an index of all the photos saved on a USB flash drive.

➔ [Photo index print](#)

• **Print all photos**

You can print all photos saved on a USB flash drive.

➔ [Print all photos](#)

• **ID photo size print**

You can print a photo saved on a USB flash drive in the ID photo size.

➔ [Printing ID Photo-ID photo size print](#)

• **Calendar print**

You can print a calendar using photos saved on a USB flash drive.

➔ [Creating a Calendar-Calendar print](#)

Advanced Guide

Advanced Guide > Printing Using the Operation Panel of the Machine > Printing from a USB Flash Drive > Using Useful Printing Functions > Settings for Printing a Photo on a USB Flash Drive

Settings for Printing a Photo on a USB Flash Drive

1. Make sure that the machine is turned on.
2. Load paper.
3. Select  Memory card on the HOME screen, then press the **OK** button.
4. Insert the USB flash drive into the Direct Print Port.

The memory card menu is displayed.

Important

- If the memory card is inserted in the Card Slot, remove the memory card, then insert the USB flash drive into the Direct Print Port.

Note

- For information on how to insert a USB flash drive, refer to [Printing from a Memory Card](#).

Advanced Guide

Advanced Guide > Printing Using the Operation Panel of the Machine > Printing from a Memory Card > Using Useful Printing Functions > Printing Several Photos on a Single Sheet of Paper (Layout Print)

Printing Several Photos on a Single Sheet of Paper (Layout Print)

You can paste photos of your choice in the specified layout.

- ➔ Settings for Printing a Photo on a Memory Card
- ➔ Settings for Printing a Photo on a USB Flash Drive

* The procedure below is applied both for printing photos on a memory card and for printing photos on a USB flash drive.

1. Select  Layout print, then press the **OK** button.

Follow the on-screen instructions.

Note

- If you skip a selected frame without pasting a photo on it when selecting Paste one by one, press the left Function button on the photo layout screen.
- When Borderless is selected, the media type cannot be set to Plain paper.
- When Mixed 1, Mixed 2, or Mixed 3 is selected, you can select A4 or 8.5"x11"(LTR) for the page size.
- You cannot paste photos over multiple pages at one time. If you have photos for two or more pages, print each page as you finish pasting photos for the page.
- Even if both Date ON and File no. ON are selected, only the shooting date will be printed. If you want to print the file number, select Date OFF.
- Other Options
 - ➔ Printing a Specified Area (Trimming) (This function is available only when Paste one by one is selected.)
 - ➔ Searching for Photos with the Shooting Date (Search)

Advanced Guide

Advanced Guide > Printing Using the Operation Panel of the Machine > Printing from a Memory Card > Using Useful Printing Functions > Printing on Stickers (Sticker Print)

Printing on Stickers (Sticker Print)

You can print your favorite photo with a frame on Canon Photo Stickers.

➡ Settings for Printing a Photo on a Memory Card

➡ Settings for Printing a Photo on a USB Flash Drive

* The procedure below is applied both for printing photos on a memory card and for printing photos on a USB flash drive.

1. Select  Sticker print, then press the **OK** button.

Follow the on-screen instructions.

Note

- You cannot use the Cassette to print on stickers. Load stickers on the Rear Tray.
- You can load only one sheet of stickers at a time on the Rear Tray.
- Select the frame to print using the Easy-Scroll Wheel or the ◀ ▶ button.
- To print with no frame, press the left Function button when No frame is displayed on the screen.
- When the photo is upside down, use the ▲ ▼ button to rotate the frame by 180 degrees to orient it properly against the photo.
- To rotate the photo by 90 degrees to fit it within the frame, use the cropping edit screen to rotate the cropping area.
 - ➡ Printing a Specified Area (Trimming)
- Other Options
 - ➡ Using Useful Display Functions
 - ➡ Printing a Specified Area (Trimming)
 - ➡ Searching for Photos with the Shooting Date (Search)

Page top ↑

Advanced Guide

Advanced Guide > Printing Using the Operation Panel of the Machine > Printing from a Memory Card > Using Useful Printing Functions > Print all photos

Print all photos

You can print all photos saved on the memory card/USB flash drive.

- ➔ Settings for Printing a Photo on a Memory Card
- ➔ Settings for Printing a Photo on a USB Flash Drive

* The procedure below is applied both for printing photos on a memory card and for printing photos on a USB flash drive.

1. Select  Print all photos, then press the **OK** button.

Follow the on-screen instructions.

Note

- Other Options
 - ➔ Searching for Photos with the Shooting Date (Search)
-

[Page top ↑](#)

Advanced Guide

Advanced Guide > Printing Using the Operation Panel of the Machine > Printing from a Memory Card > Using Useful Printing Functions > Photo index print

Photo index print

You can print an index of all the photos saved on a memory card/USB flash drive.

- ➔ [Settings for Printing a Photo on a Memory Card](#)
- ➔ [Settings for Printing a Photo on a USB Flash Drive](#)

* The procedure below is applied both for printing photos on a memory card and for printing photos on a USB flash drive.

1. Select  Photo index print, then press the **OK** button.
2. Select All photos, then press the **OK** button.

Follow the on-screen instructions.

Note

- The following print methods are available:
 - Contact print: 35 mm film images are printed in its negative size as in contact print.
 - Standard: The number of photos printed on a single sheet of paper depends on the size of the paper.
 - A4/Letter: 80 photos, 8" x 10"/203.2 x 254.0 mm: 72 photos, 5" x 7"/127.0 x 177.8 mm: 35 photos, 4" x 6"/101.6 x 152.4 mm: 24 photos, Wide/101.6 x 180.6 mm: 28 photos
 - 4" x 6"/101.6 x 152.4 mm: 24 photos, Wide/101.6 x 180.6 mm: 28 photos
- You can search for photos to print with the shooting date.
 - Search with the shooting date.
 - ➔ [Searching for Photos with the Shooting Date \(Search\)](#)

Advanced Guide

Advanced Guide > Printing Using the Operation Panel of the Machine > Printing from a Memory Card > Using Useful Printing Functions > DPOF print

DPOF print

If you have specified Digital Print Order Format (DPOF) settings on your digital camera, you can print photos according to these settings.

- ➔ Settings for Printing a Photo on a Memory Card
- ➔ Settings for Printing a Photo on a USB Flash Drive

* The procedure below is applied both for printing photos on a memory card and for printing photos on a USB flash drive.

1. Select  DPOF print, then press the **OK** button.

Follow the on-screen instructions.

Note

- The machine supports the following DPOF functions:

Version:

Based on ver. 1.00

Supported image types:

Exif (TIFF) and JFIF

Print Style - Standard Print:

Prints photos that were specified as "Standard Print" with DPOF

Print Style - Index Print:

Prints an index of photos that were specified as "Index Print" with DPOF using the machine's index printing layout

Print Style - Multi-Image Print:

Prints a photo that was specified as "Multi-Image Print" with DPOF (with the specified number of copies and layout)

Print Photo Select:

Prints only photos specified with DPOF

Number of copies:

Prints the number of copies specified with DPOF

- Prints are automatically enlarged or reduced to match the page size. Edges of the photo may be clipped off depending on the page size.
- The shooting date order setting by which photos are sorted follows that of DPOF.
- DPOF is a standard format to record the specified information regarding images, such as which image or number of copies to print.

Advanced Guide

Advanced Guide > Printing Using the Operation Panel of the Machine > Printing from a Memory Card > Using Useful Printing Functions > Captured info print

Captured info print

You can print shooting information (Exif info) on the margin of the index of photos or selected individual photos.

- ➔ [Settings for Printing a Photo on a Memory Card](#)
- ➔ [Settings for Printing a Photo on a USB Flash Drive](#)

* The procedure below is applied both for printing photos on a memory card and for printing photos on a USB flash drive.

1. Select  Captured info print, then press the **OK** button.

Follow the on-screen instructions.

Note

- The following print methods are available:

Single photo:

Prints the information in the margin of selected individual photos.

List:

Prints the information in the margin of the Photo index print of all photos or selected photos. You can select photos to print by the shooting date.

- Other Options

- ➔ [Using Useful Display Functions](#) (This function can only be used when Single photo is selected.)
- ➔ [Printing a Specified Area \(Trimming\)](#) (This function is available only when Single photo is selected.)
- ➔ [Searching for Photos with the Shooting Date \(Search\)](#)

Advanced Guide



Advanced Guide > Printing Using the Operation Panel of the Machine > Printing from a Memory Card > Using Useful Printing Functions > Printing ID Photo-ID photo size print

Printing ID Photo-ID photo size print

You can print photos on a memory card/USB flash drive in a specified size such as an ID photo.

- ➔ [Settings for Printing a Photo on a Memory Card](#)
- ➔ [Settings for Printing a Photo on a USB Flash Drive](#)

* The procedure below is applied both for printing photos on a memory card and for printing photos on a USB flash drive.

1. Select  ID photo size print, then press the **OK** button.
2. Select the photo to print using the Easy-Scroll Wheel or the  button, then press the **OK** button.

Follow the on-screen instructions.

Note

- The following sizes are available.
Print on the paper larger than the size you specified.
 - 1.18"x0.98"(3.0x2.5 cm)
 - 1.57"x1.18"(4.0x3.0 cm)
 - 1.57"x1.57"(4.0x4.0 cm)
 - 1.57"x2.36"(4.0x6.0 cm)
 - 1.77"x1.38"(4.5x3.5 cm)
 - 1.77"x1.77"(4.5x4.5 cm)
 - 1.97"x1.97"(5.0x5.0 cm)
 - 2.17"x2.17"(5.5x5.5 cm)
 - 2.36"x1.77"(6.0x4.5 cm)
 - 4.72"x4.72"(12x12 cm)
 - 1"x1.43"(2.5x3.6 cm)
 - 1.43"x2"(3.6x5.1 cm)
 - 1.77"x2.17"(4.5x5.5 cm)
- Other Options
 - ➔ [Using Useful Display Functions](#)
 - ➔ [Searching for Photos with the Shooting Date \(Search\)](#)

Advanced Guide

Advanced Guide > Printing Using the Operation Panel of the Machine > Printing from a Memory Card > Using Useful Printing Functions > Creating a Calendar-Calendar print

Creating a Calendar-Calendar print

You can create an original calendar using your favorite photos and a calendar.

➔ [Settings for Printing a Photo on a Memory Card](#)

➔ [Settings for Printing a Photo on a USB Flash Drive](#)

* The procedure below is applied both for printing photos on a memory card and for printing photos on a USB flash drive.

1. Select  Calendar print, then press the **OK** button.

Follow the on-screen instructions.

Important

- Be sure to load the paper in portrait orientation.

Note

- The following layouts are available.
Paper: Portrait format Photo: Bottom (landscape)
Paper: Portrait format Photo: Top (landscape)
Paper: Landscape format Photo: Right (portrait)
Paper: Landscape format Photo: Left (portrait)
- Select the landscape format for a landscape-oriented photo or the portrait format for a portrait-oriented photo.
- Use the Easy-Scroll Wheel or the ◀▶ button to select the Photo. If the photo is upside-down, you can use the ▲▼ button to rotate the photo 180 degrees.
- To change the start of the week on the printed calendar, press the left Function button on the print settings confirmation screen, then select Start of the week.
- To confirm or change the settings such as brightness, press the left Function button on the print settings confirmation screen, then select Auto photo fix.
- Even if both Date ON and File no. ON are selected, only the shooting date will be printed. If you want to print the file number, select Date OFF.
- Other Options
 - ➔ [Printing a Specified Area \(Trimming\)](#)
 - ➔ [Searching for Photos with the Shooting Date \(Search\)](#)

Advanced Guide

Advanced Guide > Printing Using the Operation Panel of the Machine > Printing from a Memory Card > Using Useful Display Functions

Using Useful Display Functions

Changing the Display

When you press the left Function button when Change display is displayed on the screen, you can change the way photos are displayed.

* The display methods below are available both for printing photos on a memory card and for printing photos on a USB flash drive.

- **Normal screen display:**

Shows one photo.

- **Thumbnail display:**

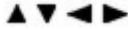
Shows nine photos at a time. Select the photo using the Easy-Scroll Wheel or the  button, then press the + or - button to specify the number of copies.

- **Full-screen display:**

Shows one photo at full-screen.

- **Enlarged display:**

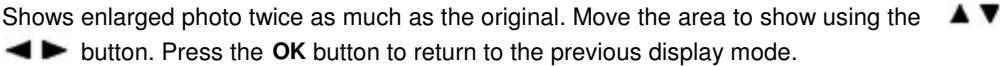
Shows enlarged photo twice as much as the original. Move the area to show using the  button. Press the **OK** button to return to the previous display mode.

- **Slide show:**

Shows next photos automatically. To stop the slide show, press the **Stop** button.

[Page top ↑](#)

Advanced Guide

Advanced Guide > Printing Using the Operation Panel of the Machine > Printing from a Memory Card > Using Useful Display Functions > Printing a Specified Area (Trimming)

Printing a Specified Area (Trimming)

You can edit images displayed on the LCD by cropping them.

* This function is available both for printing photos on a memory card and for printing photos on a USB flash drive.

Note

- Crop images after specifying the page size, media type, and bordered or borderless printing in the print settings screen. If you change the paper settings after cropping, the cropped area may be adjusted to match the paper, or be disabled completely.

1. Select the photo to crop.
2. Press the right Function button when Edit is displayed on the screen.
3. Select Trimming, then press the **OK** button.

The cropping edit screen is displayed.

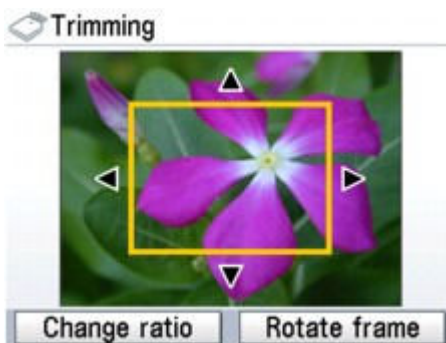

4. Choose the area to print.

▲, ▼, ◀, and ▶ buttons:

Position the cropping frame.

Easy-Scroll Wheel:

Sets the cropping frame size.

Turn the Easy-Scroll Wheel clockwise to enlarge the size of the cropping frame or counterclockwise to reduce it.

Left Function button:

Changes the aspect ratio of the cropping frame.

Right Function button:

Rotates the cropping frame.

To switch the cropping frame between portrait and landscape orientations, press this button.

5. Press the **OK** button to finalize your selection of cropping area.

The area to be cropped is specified, and the original photo is displayed.

Note

- The cropped image cannot be newly saved on the memory card/USB flash drive.
- The cropping area is displayed only for photos which have been cropped.
- To change the cropped area once it has been set, press the right Function button when Edit is displayed on the screen, select Trimming, then press the **OK** button.
- To cancel cropping after cropping has been complete, press the right Function button again

when Edit is displayed on the screen, select Cancel trimming, then press the **OK** button. Select Displayed images only or All images, then press the **OK** button.

[Page top ↑](#)

Advanced Guide

Advanced Guide > Printing Using the Operation Panel of the Machine > Printing from a Memory Card > Using Useful Display Functions > Searching for Photos with the Shooting Date (Search)

Searching for Photos with the Shooting Date (Search)

When there are a lot of photos saved on the memory card/USB flash drive, you can choose to display and print only photos shot on the specified date or within the specified range of dates.

* This function is available both for printing photos on a memory card and for printing photos on a USB flash drive.

Note

- If the number of copies to print is already specified for some photos before searching with the shooting date, or if some photos are already pasted on a layout, those photos will still be selected for printing even if they were not shot on the specified date or within the specified date range.

1. Display the search method screen.

- Setting in Edit:
 1. Press the right Function button when Edit is displayed on the screen.
 2. Select Search, then press the **OK** button.
The Search screen is displayed.
- Setting in Search in the Specify print range screen:
 1. Select Search, then press the **OK** button.
The Search screen is displayed.

2. Set the search method.

- To specify only one date for search:
Select One date only.
- To specify the date range for search:
Select Select date range.

3. Press the **OK** button.

The date input screen is displayed.

Note

- It may take a while for the date input screen to be displayed depending on the number of photos saved on the memory card/USB flash drive.

4. Specify the date range, then press the **OK** button.

- If you selected One date only:
 1. Specify the date to search, then press the **OK** button.
- If you selected Select date range:
 1. Specify the start date to search, then press the **OK** button.
 2. Specify the end date to search, then press the **OK** button.

Note

- The date to be specified is displayed according to the settings of Date display in Advanced settings under Device settings.
➡ [Changing the Machine Settings on the LCD](#)
- To cancel the selected date range, press the right Function button when Edit is displayed on the screen, select Cancel selected date, then press the **OK** button.

Advanced Guide

[Advanced Guide](#) > [Printing Using the Operation Panel of the Machine](#) > [Photo Printing from Printed Photo or Film](#)

Photo Printing from Printed Photo or Film

- ➔ [Printing from Printed Photo or Film](#)
- ➔ [Using Useful Printing Functions](#)
- ➔ [Using Useful Display Functions](#)

[Page top](#) ↑

Advanced Guide

[Advanced Guide](#) > [Printing Using the Operation Panel of the Machine](#) > [Photo Printing from Printed Photo or Film](#) > [Printing from Printed Photo or Film](#)

Printing from Printed Photo or Film

For the basic procedure for printing from a printed photo or film, refer to the [Printing Photos from Printed Photos or Films](#).

➔ [Setting Items](#)

[Page top](#) ↑

Advanced Guide

Advanced Guide > Printing Using the Operation Panel of the Machine > Photo Printing from Printed Photo or Film > Printing from Printed Photo or Film > Setting Items

Setting Items

Print Settings Confirmation Screen

In the Film print mode or the Easy photo reprint mode, select the photo to print using the Easy-Scroll Wheel or the ◀ ▶ button, specify the number of copies using the + or - button, press the OK button, then the screen is displayed.

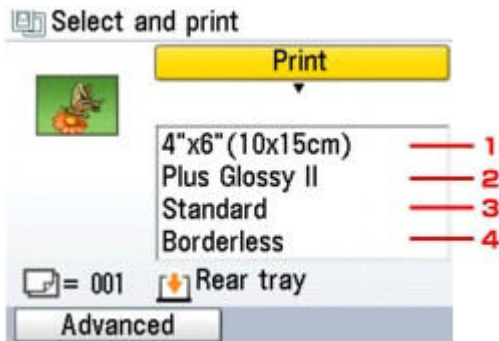

Note

- Depending on the functions, some setting items cannot be specified in combination.

1. Page size

Select the page size of the loaded paper.

2. Media type

Select the photo paper type to use.

3. Print quality

Adjust print quality according to the original.

4. Borderless print

Select bordered or borderless print.

Advanced Print Settings Screen

When you press the left Function button in the print settings confirmation screen, the Advanced screen is displayed.



When Auto photo fix ON is selected, the scene or person's face of a shot photo is recognized and the most suitable correction for each photo is made automatically. It makes a darkened face by

backlight brighter to print. It also analyzes a scene such as scenery, night scene, person, etc. and corrects each scene with the most suitable color, brightness, or contrasts automatically to print.

Note

- If the print result with Auto photo fix ON selected is not satisfactory, select Manual correction, then specify each advanced setting item below.

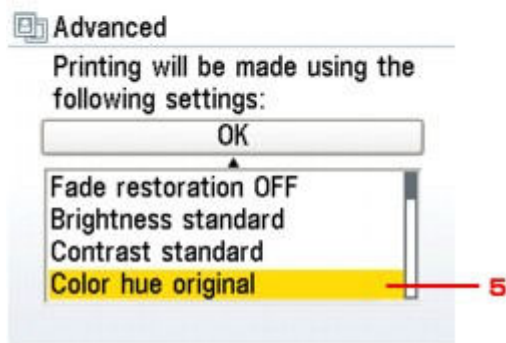
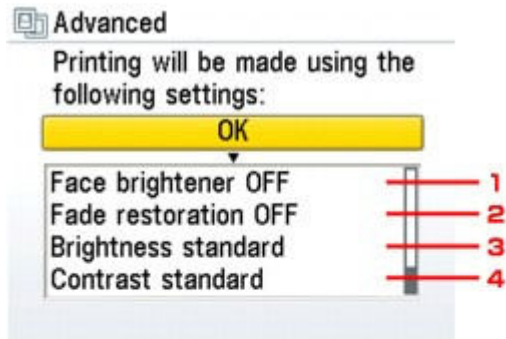

1. Face brightener

Brightens a darkened face on the photo taken against the light.

2. Fade restoration

Corrects the color when printing photos that have faded or color cast over time.

3. Brightness

Adjust brightness.

4. Contrast

Adjust contrast.

5. Color hue

Adjust color hue.

For example, you can increase red or yellow to adjust the skin tone.

Advanced Guide

Advanced Guide > Printing Using the Operation Panel of the Machine > Photo Printing from Printed Photo or Film > Using Useful Printing Functions

Using Useful Printing Functions

Special Printing of Photo

Choose the printing method according to your purpose.

Note

- Refer to [Settings for Printing a Scanned Photo](#) or [Settings for Printing a Scanned Film](#) for how to select the copy method.
-

- **Sticker print**

You can print your favorite photo on Canon Photo Stickers to create your own stickers.

➔ [Printing on Stickers \(Sticker Print\)](#)

- **Print all photos**

You can print all scanned photos.

➔ [Printing All Photos \(Print All Photos\)](#)

[Page top](#) ↑

Advanced Guide

Advanced Guide > Printing Using the Operation Panel of the Machine > Photo Printing from Printed Photo or Film > Using Useful Printing Functions > Settings for Printing a Scanned Photo

Settings for Printing a Scanned Photo

1. Make sure that the machine is turned on.
2. Select  Easy photo reprint on the HOME screen, then press the **OK** button.
3. Follow the on-screen instructions, then press the **OK** button to start scanning a printed photo.

The Easy photo reprint screen is displayed.

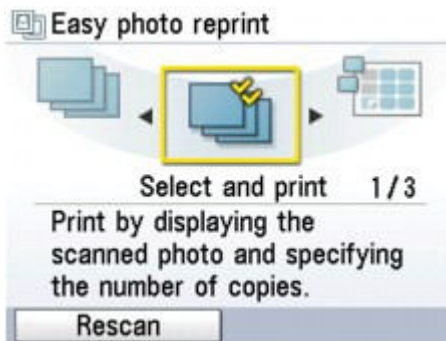

4. Load paper on the Rear Tray.

Note

- For the basic procedure for printing from a printed photo, refer to [Printing Photos from Printed Photos or Films](#).

Advanced Guide

Advanced Guide > Printing Using the Operation Panel of the Machine > Photo Printing from Printed Photo or Film > Using Useful Printing Functions > Settings for Printing a Scanned Film

Settings for Printing a Scanned Film

1. Make sure that the machine is turned on.
2. Select  Film print on the HOME screen, then press the **OK** button.
3. Select the type of film or slide to scan, then press the **OK** button to start scanning.
The Film print menu screen is displayed.

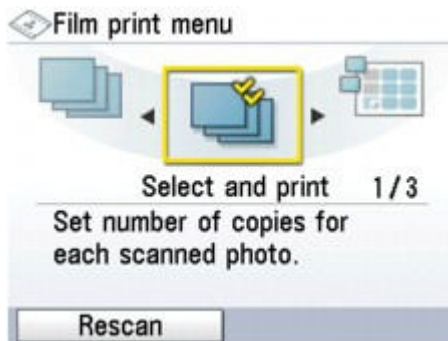

4. Load paper on the Rear Tray.

Note

- For the basic procedure for printing from a scanned film, refer to [Printing Photos from Printed Photos or Films](#).

Advanced Guide

Advanced Guide > Printing Using the Operation Panel of the Machine > Photo Printing from Printed Photo or Film > Using Useful Printing Functions > Printing on Stickers (Sticker Print)

Printing on Stickers (Sticker Print)

You can create your own stickers from a scanned photo, film, or slide using Canon Photo Stickers.

➔ Settings for Printing a Scanned Photo

➔ Settings for Printing a Scanned Film

1. Select  Sticker print, then press the **OK** button.

2. Select the layout, then press the **OK** button.

Follow the on-screen instructions.

Note

- You cannot use the Cassette to print on stickers. Load stickers on the Rear Tray.
- You can only load one sheet of stickers at a time on the Rear Tray.
- Other Options
 - ➔ Changing the Display
 - ➔ Printing a Specified Area (Trimming)

Advanced Guide

[Advanced Guide](#) > [Printing Using the Operation Panel of the Machine](#) > [Photo Printing from Printed Photo or Film](#) > [Using Useful Printing Functions](#) > [Printing All Photos \(Print All Photos\)](#)

Printing All Photos (Print All Photos)

You can print all scanned photos, film, or slide.

➔ [Settings for Printing a Scanned Photo](#)

➔ [Settings for Printing a Scanned Film](#)

1. Select  Print all photos, then press the **OK** button.
Follow the on-screen instructions.

[Page top](#) ↑

Advanced Guide

Advanced Guide > Printing Using the Operation Panel of the Machine > Photo Printing from Printed Photo or Film > Using Useful Display Functions

Using Useful Display Functions

Changing the Display

When you press the left Function button when Change display is displayed on the screen, you can change the way photos are displayed.

- **Normal screen display**

Shows one photo.

- **Full-screen display**

Shows one photo at full-screen.

- **Enlarged display**

Shows enlarged photo twice as much as the original. Move the area to show using the ▲▼ ◀▶ button. Press the **OK** button to return to the previous display mode.

Printing a Specified Area (Trimming)

You can edit images displayed on the LCD by cropping them.

1. Select the photo to crop.
2. Press the right Function button when Edit is displayed on the screen.
3. Select Trimming, then press the **OK** button.

The cropping edit screen is displayed.

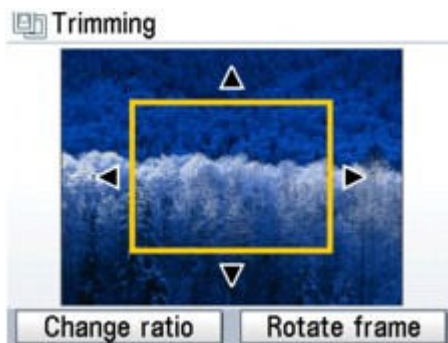

4. Choose the area to print.

▲, ▼, ◀, and ▶ buttons:

Position the cropping frame.

Easy-Scroll Wheel:

Sets the cropping frame size.

Turn the Easy-Scroll Wheel clockwise to enlarge the size of the cropping frame or counterclockwise to reduce it.

Left Function button:

Changes the aspect ratio of the cropping frame.

Right Function button:

Rotates the cropping frame.

To switch the cropping frame between portrait and landscape orientations, press this button.

5. Press the **OK** button to finalize your selection of cropping area.

The area to be cropped is specified, and the original photo is displayed.

 **Note**

- The cropping area is displayed only for photos which have been cropped.
- To change the cropped area once it has been set, press the right Function button again when Edit is displayed on the screen, select Trimming, then press the **OK** button.
- To cancel cropping after cropping has been set, press the right Function button again when Edit is displayed on the screen, select Cancel trimming, then press the **OK** button. Select Displayed images only or All images, then press the **OK** button.

Advanced Guide

Advanced Guide > Scanning

Scanning

- ➔ Scanning Images
- ➔ Saving Scanned Data on the USB Flash Drive/Memory Card Using the Operation Panel of the Machine
- ➔ Forwarding Scanned Data to PC Using the Operation Panel of the Machine
- ➔ Scanning with the Bundled Application Software
- ➔ Scanning with Other Application Software
- ➔ Canon IJ Network Scan Utility Screens
- ➔ Other Scanning Methods

[Page top](#) ↑

Advanced Guide

Advanced Guide > Scanning > Scanning Images

Scanning Images

- ➔ Scanning Images
- ➔ Before Scanning
- ➔ Placing Documents
- ➔ Placing Film

[Page top](#) ↑

Advanced Guide

Advanced Guide > Scanning > Scanning Images > Scanning Images

Scanning Images

You can scan images from the machine to a computer without printing them and save them in popular image data, such as JPEG, TIFF, bitmaps, or PDF. You can also save scanned images in a PDF or JPEG data format on the memory card or USB flash drive.

Important

- When you scan an image from film, save the scanned data to the computer. You cannot save the data from film on the memory card or USB flash drive.

Select the scanning method according to your purpose.

- ➡ [Saving Scanned Data on the USB Flash Drive/Memory Card Using the Operation Panel of the Machine](#)
- ➡ [Forwarding Scanned Data to PC Using the Operation Panel of the Machine](#)
- ➡ [Scanning with the Bundled Application Software](#)
- ➡ [Scanning with Other Application Software](#)

[Page top](#) ↑

Advanced Guide

[Advanced Guide](#) > [Scanning](#) > [Scanning Images](#) > [Before Scanning](#)

Before Scanning

Before scanning images, confirm the following:

- **Does the original to be scanned meet the requirements for an original to be set on the Platen Glass?**

If you save the data to PC, refer to [Placing Documents](#) for details.

If you save the data to the USB flash drive/memory card, refer to [Loading Paper / Originals](#) for details.

[Page top](#) ↑

Advanced Guide

Advanced Guide > Scanning > Scanning Images > Placing Documents

Placing Documents

Learn how to place documents on the machine's Platen. Place documents correctly according to the type of document to be scanned. Otherwise, documents may not be scanned correctly.

Important

- Do not place objects on the Document Cover. The objects may fall into the machine when the Document Cover is opened. This may damage the machine.
- Close the Document Cover when scanning.

Note

- See "Placing Film" to scan film.

Placing Documents

Place documents as described below to allow the machine to detect the document type or size automatically.

Important

- When scanning by specifying the document type or size in MP Navigator EX or ScanGear (scanner driver), align an upper corner of the document with the corner at the arrow (alignment mark) of the Platen.
- Photos that have been cut to various shapes and documents smaller than 1.18 inches (3 cm) square cannot be cropped accurately when scanning.
- Reflective CD/DVD labels may not be scanned properly.

When Scanning Photos, Postcards, Business Cards or CD/DVD	When Scanning Magazines, Newspapers or Text Documents
<div data-bbox="142 1218 646 1438"> </div> <p data-bbox="341 1354 446 1438">↓</p> <p data-bbox="113 1459 422 1491">Placing a Single Document</p> <p data-bbox="113 1501 657 1648">Place the document face-down on the Platen, with 3/8 inches (1 cm) or more space between the edges of the Platen and the document. Portions placed on the diagonally striped area cannot be scanned.</p> <div data-bbox="113 1648 617 2016"> </div>	<div data-bbox="763 1218 1144 1354"> </div> <p data-bbox="909 1354 1015 1438">↓</p> <p data-bbox="682 1449 1226 1596">Place the document face-down on the Platen and align an upper corner of the document with the corner at the arrow (alignment mark) of the Platen. Portions placed on the diagonally striped area cannot be scanned.</p> <div data-bbox="682 1596 1185 2016"> </div>

Important

- Large documents (such as A4 size photos) that cannot be placed away from the edges/arrow (alignment mark) of the Platen may be saved as PDF files. To save in a format other than PDF, scan by specifying the file format.

Placing Multiple Documents

Allow 3/8 inches (1 cm) or more space between the edges of the Platen and documents, and between documents. Portions placed on the diagonally striped area cannot be scanned.

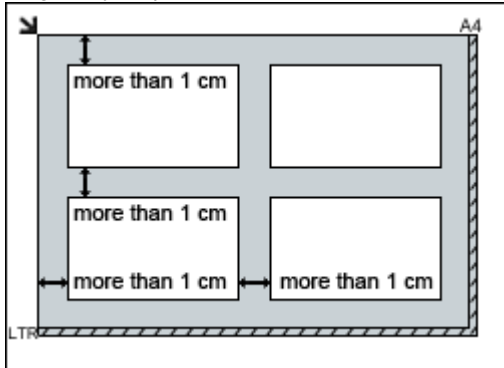

Note

- You can place up to 12 documents.
- You can place up to 4 documents when the Compress scanned images when transferring checkbox is selected on the General tab of the Preferences dialog box.
- Positions of slanted documents (10 degrees or less) are corrected automatically.

Important

- The portion within 1 mm inwards from the alignment mark cannot be scanned.

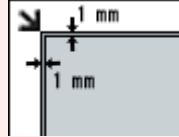

Advanced Guide

Advanced Guide > Scanning > Scanning Images > Placing Film

Placing Film

Preparation

Remove the Film Guide from the FAU (Film Adapter Unit) Protective Sheet.

1. Open the Document Cover and remove the FAU Protective Sheet.



2. Remove the Film Guide from the back of the FAU Protective Sheet.

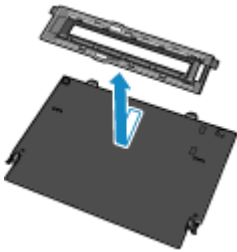

Important

- Film scanning is not available when the FAU Protective Sheet is attached to the Document Cover.

Film Strips	Mounted Slides
<p>Load the film strip into the Film Strip Frame on the Film Guide removed from the Document Cover and place it on the Platen.</p> <ol style="list-style-type: none"> 1. With the film mark (A) facing up, open the Film Holder by gently squeezing the indentations (B) in the directions shown by → ← (Arrows). <p>Note</p> <ul style="list-style-type: none"> ■ Be careful not to dislocate the joints (C) of the hinge when opening the Film Holder. 	<p>Load mounted slides into the Film Guide (with the Film Strip Frame removed) after placing it on the Platen.</p> <ol style="list-style-type: none"> 1. Open the Film Holder by gently squeezing the indentations (A) inward. 2. Remove the Film Strip Frame from the Film Guide (C) by gently squeezing the indentations (B) in the directions shown by → ← (Arrows).

- With the film facing down (the side on which images appear correctly) so that the images will be upside down, insert its left corners under the tabs on the Film Strip Frame.

The image order will be from left to right.

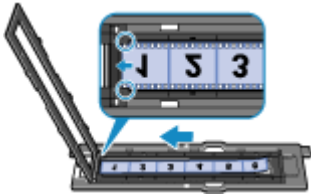

Note

- The Film Strip Frame holds one film strip of up to six frames at one time.
- Load the film from left to right, as this is the direction of the scan. However, film frames may not be scanned in the correct order depending on the camera model that was used to capture the images.



- Fully close the Film Holder.

Note

- If the holder does not close properly, check that the film is loaded correctly.
- If the holder is not closed flat, press down across the holder to fit the protrusions into the slots.

- Make sure that the spaces between frames are aligned with the white lines on the holder.

Double-check the orientation of the film.

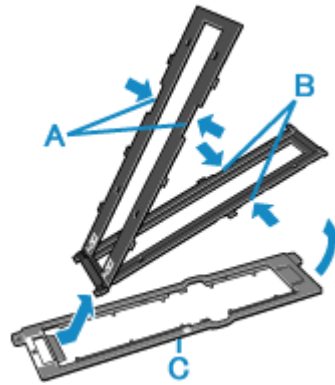

Note

- The Film Strip Frame is not used when loading mounted slides. Be sure to remove it.

- Align the tabs on the Film Guide with the indentations on the left and right sides of the Platen.

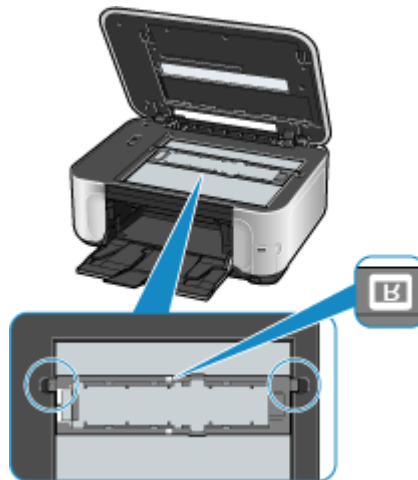

- With the film facing down (the side on which images appear correctly) so that the images will be upside down, load the slides from left to right.

Load the slides so that the film lies flat on the Platen.

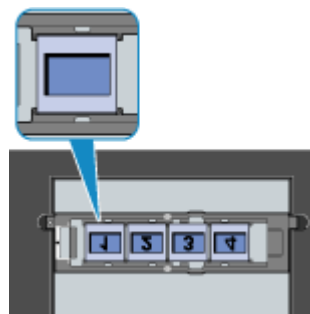

Note

- The Film Guide holds up to four mounted slides at one time.

Note

- Depending on the film in use, the spaces between frames may not align with the white lines on the Film Holder when the film corners are inserted under the tabs on the Film Strip Frame. In that case, prioritize the alignment of the spaces between frames with the white lines.

5. Align the tabs on the Film Guide with the indentations on the left and right sides of the Platen.

**Note**

- When a film strip shorter than the Film Strip Frame is scanned, the image of the frame next to the area without film may appear whitish. In that case, cover the area without film with black paper or the like.
- A sticker label attached to the margin of the film may be recognized as an image.

6. Gently close the Document Cover.

5. Gently close the Document Cover.

Advanced Guide

[Advanced Guide](#) > [Scanning](#) > Saving Scanned Data on the USB Flash Drive/Memory Card Using the Operation Panel of the Machine

Saving Scanned Data on the USB Flash Drive/Memory Card Using the Operation Panel of the Machine

➡ [Saving Scanned Data on the USB Flash Drive/Memory Card Using the Operation Panel of the Machine](#)

[Page top](#) ↕

Advanced Guide

Advanced Guide > Scanning > Saving Scanned Data on the USB Flash Drive/Memory Card Using the Operation Panel of the Machine > Saving Scanned Data on the USB Flash Drive/Memory Card Using the Operation Panel of the Machine

Saving Scanned Data on the USB Flash Drive/Memory Card Using the Operation Panel of the Machine

You can save scanned data on the USB flash drive or memory card using the Operation Panel.

Important

- Do not remove the USB flash drive or memory card from the machine under the following conditions:
 - While scanning is in progress
 - Before saving the scanned data
- You cannot use the USB flash drive and memory card at the same time. Be sure to use either of them as a media for saving scanned data.
- Scanned data saved on the USB flash drive or memory card cannot be printed in the memory card mode.
- For safety reasons, we recommend storing the scanned data saved on a USB flash drive or memory card to another media periodically to avoid unexpected accidents.
- We assume no responsibility for damage or loss of data for whatever reasons even within the warranty period.

1. Make sure that the machine is turned on.

2. Select  Scan on the HOME screen, then press the **OK** button.



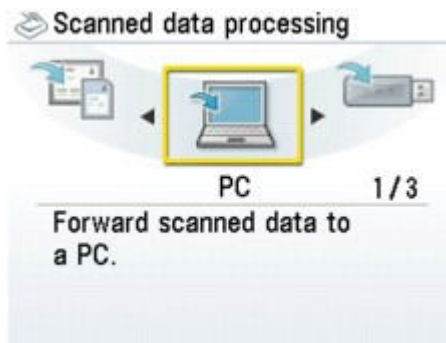

The screen for selecting to which you save the data is displayed.



3. Insert the USB flash drive into the Direct Print Port or the memory card into the Card Slot.

See [Inserting the USB Flash Drive](#) for how to insert the USB flash drive into the Direct Print Port. For how to insert the memory card into the Card Slot or information on the types of the memory card compatible with the machine, refer to [Printing from a Memory Card](#).

4. Select  USB flash drive or  Memory card, then press the **OK** button.

5. Select  Save to USB flash if you selected  USB flash drive in step 4, or  Save to memory card if you selected  Memory card, then press the **OK** button.

The scan setting screen is displayed.

6. Specify the necessary settings, then press the **OK** button.

➔ [Setting Items](#)

7. Load the original on the Platen Glass following the instruction on the LCD.

Note

- Refer to [Loading Paper / Originals](#) for how to load the original on the Platen Glass.

8. Press the **Color** button for color scanning, or the **Black** button for black & white scanning.

When Preview ON is selected, press the **OK** button after the preview screen is displayed on the LCD.

The machine starts scanning and scanned data is saved either on the USB flash drive or the memory card, which you select as the media for saving scanned data.

Remove the original on the Platen Glass after scanning is complete.

To remove the USB flash drive after scanning is complete, see [Removing the USB Flash Drive](#).

To remove the memory card after scanning is complete, refer to [Printing from a Memory Card](#).

Note

- You can scan images continuously only when selecting PDF. Continue scanning following the confirmation screen. You can save up to 100 pages of images in one PDF file.
- If the USB flash drive or the memory card becomes full while scanning images is in progress, only the images already scanned can be saved.
- You can save up to 2000 files of scanned data in both PDF and JPEG data format.
- The folder and file name of scanned data saved on the USB flash drive or the memory card is as follows:
 - Folder name: (file extension: PDF): CANON_SC\DOCUMENT\0001
 - Folder name: (file extension: JPG): CANON_SC\IMAGE\0001
 - File name: Running numbers, starting from SCN_0001
 - File date: 01/01/2009

- Importing the Scanned Data Saved on the Memory Card to the Computer

When you import the scanned data saved on the memory card to the computer, import the data after performing either of the operations below:

-Turning the machine off, then turn it back on.

-Removing the memory card, then reinsert it into the Card Slot.

You can optimize or print the scanned data saved on the memory card using MP Navigator EX. For details, refer to [Importing Images Saved on a Memory Card](#).

- Importing the Scanned Data Saved on the USB Flash Drive to the Computer



You can import the scanned data saved on the USB flash drive to the computer.

After scanning the data, connect the USB flash drive to the computer, then import the data using Windows Explorer.



You can import the scanned data saved on the USB flash drive to the computer.

After scanning the data, connect the USB flash drive to the computer, then import the data.

Inserting the USB Flash Drive

Important

- Before inserting the USB flash drive:**
 - You may need an extension cable if the USB flash drive cannot be inserted into the Direct Print Port of the machine. For details, ask an electronics store.
 - Depending on the type of USB flash drive, the operation may not be guaranteed.
 - Some USB flash drives with security settings may not be used.

1. Insert the USB flash drive into the Direct Print Port.

Make sure that the USB flash drive is correctly oriented before inserting it straightforward into

the Direct Print Port.



Removing the USB Flash Drive

1. Make sure that the machine is not writing data to the USB flash drive.

Check if the writing operation is complete on the LCD.

Important

- Do not remove the USB flash drive or turn off the power while the machine is operating.

Note

- If you use the USB flash drive with the access lamp, refer to the instruction manual supplied with the USB flash drive to check if the writing operation is complete on the USB flash drive.

2. Remove the USB flash drive.

Hold the USB flash drive and remove it from the machine straightforward.

Advanced Guide

Advanced Guide > Scanning > Saving Scanned Data on the USB Flash Drive/Memory Card Using the Operation Panel of the Machine > Saving Scanned Data on the USB Flash Drive/Memory Card Using the Operation Panel of the Machine > Setting Items

Setting Items

Scan setting screen

Perform settings in saving scanned data on the USB flash drive or memory card.

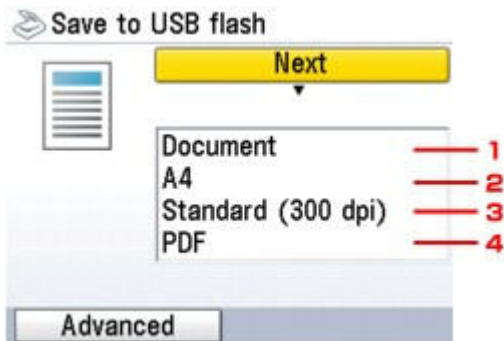

1. Document type

Select the type of the original on the Platen Glass.

2. Scan size

Select the size of the original on the Platen Glass.

3. Scan resolution

Select the resolution for scanning.

4. Data format

Select the data format of the scanned data.

Advanced screen

When you press the left Function button in the scan setting screen, the Advanced screen is displayed.

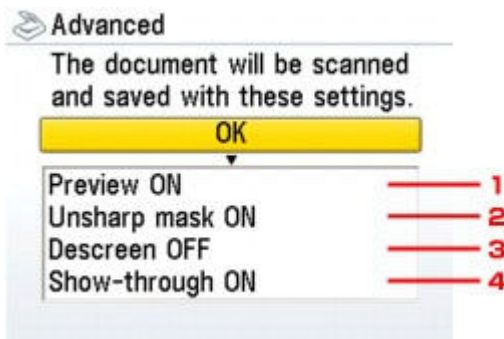

1. Preview

Select to preview the scanned data or not.

2. Unsharp mask

The outline of small characters or thin objects can be accentuated. Select Unsharp mask ON

if you want to accentuate the outline of the scanned data.

3. Descreen*

A printout consists of minute dots to make characters or graphs. Interfering with each dot may result in uneven shades or a striped pattern. Select Descreen ON if you notice any uneven shades or a striped pattern on the scanned image.

Note

- Some moire effects may remain if Unsharp mask ON and Descreen ON are selected at the same time. In that case, change Unsharp mask ON to Unsharp mask OFF.
-

4. Show-through*

Characters on the back may show through when scanning a thin document such as a newspaper. Select Show-through ON if characters seem to show through on the scanned document.

* Not available when scanning a photo.

[Page top](#) ↑

Advanced Guide

Advanced Guide > Scanning > Saving Scanned Data on the USB Flash Drive/Memory Card Using the Operation Panel of the Machine > Saving Scanned Data on the USB Flash Drive/Memory Card Using the Operation Panel of the Machine > Deleting Scanned Data on USB Flash Drive/Memory Card

Deleting Scanned Data on USB Flash Drive/Memory Card

You can delete scanned data on the USB flash drive or memory card using the Operation Panel.

1. Select  Scan on the HOME screen, then press the **OK** button.
2. Insert the USB flash drive into the Direct Print Port or the memory card into the Card Slot.

Important

- You cannot use the USB flash drive and memory card at the same time.

3. Select  USB flash drive or  Memory card, then press the **OK** button.

4. Select  Delete scanned data, then press the **OK** button.
The file list is displayed.

5. Select the file to delete, then press the **OK** button.

Note

- You can preview the file to delete or switch the file list between PDF and JPEG.
- Only the first page of the image is displayed on the LCD.

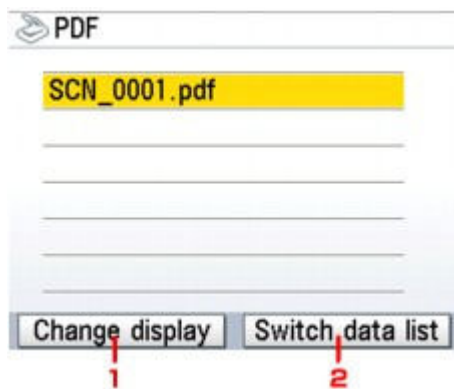

1. Change display
Switches the display between the list and the preview.
2. Switch data list
Switches the display between the PDF data list and the JPEG data list.

6. Select Yes on the confirmation screen, then press the **OK** button.

7. Select Yes, then press the **OK** button again.

The machine starts deleting the file.

Advanced Guide

[Advanced Guide](#) > [Scanning](#) > Forwarding Scanned Data to PC Using the Operation Panel of the Machine

Forwarding Scanned Data to PC Using the Operation Panel of the Machine

- ➡ [Forwarding Scanned Data to PC Using the Operation Panel of the Machine](#)
- ➡ [Appendix: Various Scan Settings](#)

[Page top](#) ↑

Advanced Guide

[Advanced Guide](#) > [Scanning](#) > [Forwarding Scanned Data to PC Using the Operation Panel of the Machine](#) > [Forwarding Scanned Data to PC Using the Operation Panel of the Machine](#)

Forwarding Scanned Data to PC Using the Operation Panel of the Machine

You can forward scanned data to PC using the Operation Panel of the machine.

Before forwarding scanned data to PC, confirm the following:

- **The necessary application software (MP Drivers and MP Navigator EX) are installed.**

If the application software (MP Drivers and MP Navigator EX) are not yet installed, insert the *Setup CD-ROM* into the computer's disc drive, then perform Custom Install and select MP Drivers and MP Navigator EX.

- **The machine is connected to a computer correctly.**

Make sure that the machine is connected to the computer correctly.

Do not plug or unplug the USB or LAN cable when scanning images with the machine, or when the computer is in sleep or standby mode.

If you perform scanning via the LAN connection, make sure that all the required settings have been specified. For details, refer to [Network Scan Settings](#).

- **The operation after scanning the original is specified in MP Navigator EX.**

MP Navigator EX enables you to specify the response resulting from pressing the **Color** or **Black** button on the machine. You can specify the response individually for each event. For details, refer to [Selecting a Response to Commands from the Operation Panel Using MP Navigator EX](#).

1. **Macintosh** Set the starting application.

If you are using Mac OS X v.10.5.x or Mac OS X v.10.4.x:

This operation is not necessary.

If you are using Mac OS X v.10.3.9:

You need to set MP Navigator EX as the starting application software in Image Capture under Applications of Mac OS X.

Select Applications on the Go menu, then double-click the Image Capture icon. Click Options at the lower left of the scanner window, select MP Navigator EX 3 in Application to launch when the scanner button is pressed:, then click OK. To quit Image Capture, select Quit Image Capture on the Image Capture menu.

Important

- If Options is not displayed, select Preferences on the Image Capture menu, click Scanner, and click Use TWAIN software whenever possible to clear the option. Then quit Image Capture and restart it.

2. Make sure that the machine is turned on.

3. Load the original on the Platen Glass.

Note

- Refer to [Placing Documents](#) for how to load the original on the Platen Glass.

4. Select  Scan on the HOME screen, then press the **OK** button.

The screen for selecting to which you forward the data is displayed.

5. Select  PC, then press the **OK** button.

6. Use the ▲▼ button to select the PC to forward the scanned data, then press the **OK** button.

Select USB for a USB connected computer, or select the PC to forward the scanned data for a LAN connected computer.

The document type selection screen is displayed.

Note

- The LAN connected PCs are displayed as "User's name PCs name".

7. Select the document type, then press the **OK** button.

Auto scan

This item is available only when the machine is connected to the computer using a USB cable. The machine detects the type of the original automatically and the image is forwarded in the optimized data.

Proceed to step 9.

Document

Scans the original on the Platen Glass applying the optimized settings for scanning a document.

Photo

Scans the original on the Platen Glass applying the optimized settings for scanning a photo.

Film

Scans the original on the Platen Glass applying the optimized settings for scanning a film.

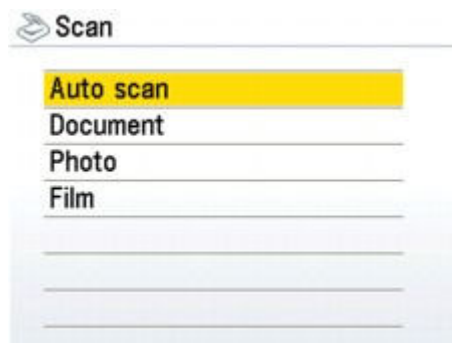

Important

- Make sure that the document has been loaded correctly according to the document type that you have selected. Refer to [Placing Documents](#) for how to load the original on the Platen Glass.

8. If you selected Document, Photo, or Film in step 7, select the file format, then press the **OK** button.

Save to PC

The original is scanned and saved.

Save as PDF file

The original is scanned and saved as a PDF file. This item can be selected only when Document has been selected on the Scan screen.

Attach to E-mail

The original is scanned, and the image is attached to an e-mail using the e-mail application software.

Open with application

The original is scanned and displayed on the registered application software.

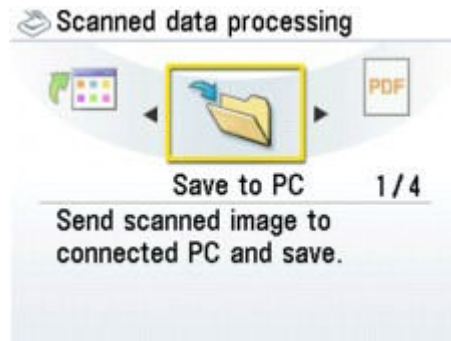
**Note**

- Options for scan operations can be specified in MP Navigator EX. For details, refer to [Selecting a Response to Commands from the Operation Panel Using MP Navigator EX](#).

9. Press the **Color or **Black** button.**

The settings configured by MP Navigator EX are applied when scanning.

Remove the original on the Platen Glass after scanning is complete.

Note

- When you select Save as PDF file as the operation, you can scan documents from the Platen Glass continuously. After scanning is complete, select Continue on the confirmation screen. Load the next document on the Platen Glass, then press the **Color** button for color scanning, or the **Black** button for black & white scanning. After scanning is complete, selecting End on the confirmation screen allows you to save the scanned documents in one PDF file.

10.  To specify MP Navigator EX 3.0**If you are using Windows Vista:**

The program selection screen may be displayed after pressing the **Color** or **Black** button. In this case, select MP Navigator EX Ver3.0 and click OK.

You can set MP Navigator EX to launch whenever pressing the **Color** or **Black** button. For details, see [For Windows Users](#).

If you are using Windows XP:

The program selection screen may be displayed after pressing the **Color** or **Black** button for the first time. In this case, specify MP Navigator EX Ver3.0 as the application software to use, select Always use this program for this action, then click OK. From the next time, MP Navigator EX is automatically started.

Important

- If the position or size of an image is not scanned correctly depending on the type of the original, refer to [Scanning Photos and Documents](#) and change Document Type and Document Size settings of MP Navigator EX to match the original being scanned.

Note

- The operation to be performed after scanning the original depends on the scan operation setting you have selected in step 8. For details on how to modify the operation settings, refer to [Selecting a Response to Commands from the Operation Panel Using MP Navigator EX](#).

• If You Want to Edit or Print the Scanned Images

MP Navigator EX enables you to edit the scanned images, such as optimizing or trimming.

You can also start application software from MP Navigator EX to edit or print the scanned images.

➡ [Let's Try Scanning](#)

• If You Want to Scan Originals with Advanced Settings

ScanGear enables you to scan originals with advanced settings such as the resolution.

➔ [Scanning with Advanced Settings Using ScanGear \(Scanner Driver\)](#)



Note

- You can use a TWAIN- or WIA- (Windows Vista and Windows XP only) compliant application software and the Control Panel (Windows Vista and Windows XP only) to scan originals with this machine.

For details, refer to [Other Scanning Methods](#).

[Page top](#) ↑

Advanced Guide

[Advanced Guide](#) > [Scanning](#) > [Saving Scanned Data to PC Using the Operation Panel of the Machine](#) > [Appendix: Various Scan Settings](#)

Appendix: Various Scan Settings

- **Enabling network scanning**
 - ➔ [Network Scan Settings](#)
- **Specifying how to respond when scanning using the Operation Panel of the machine**
 - ➔ [Selecting a Response to Commands from the Operation Panel Using MP Navigator EX](#)

[Page top](#) 

Advanced Guide

Advanced Guide > Scanning > Saving Scanned Data to PC Using the Operation Panel of the Machine > Appendix:
Various Scan Settings > Network Scan Settings

Network Scan Settings

You can connect the machine to a network to share it among multiple computers or scan images into a specified computer.

Important

- Multiple users cannot scan at the same time.

Note

- Complete the network settings of the machine beforehand. (Refer to the printed manual: *Getting Started*.)

Complete the following settings to enable scanning over a network.

Setting for Scanning with MP Navigator EX

To scan over a network using MP Navigator EX, follow the steps below and change the connection status between the computer and the machine.

- Start MP Navigator EX.
 - ➔ Starting MP Navigator EX
- Click Preferences.
- For network connection, select (model name) series (Network: XXXXXXXXXXXXX) for Product Name.

(Where XXXXXXXXXXXXX is the MAC address.)

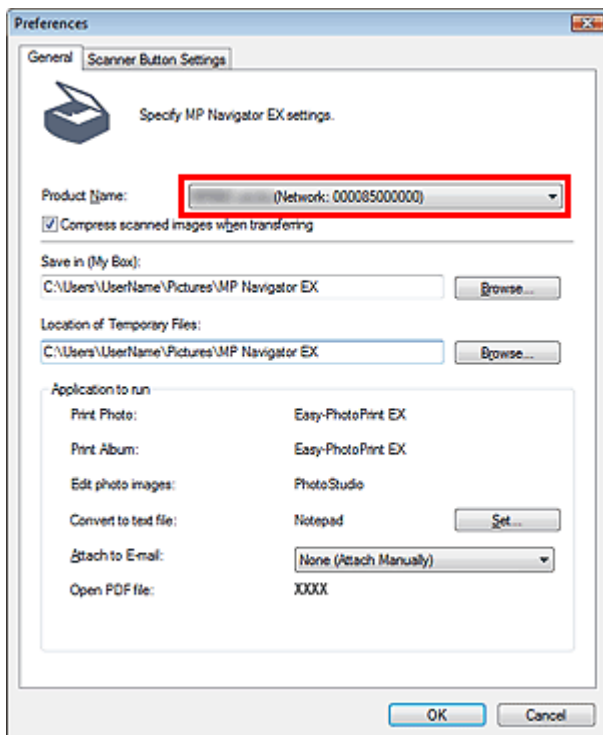

Note

- For USB connection, select (model name) series for Product Name.

4. Click OK.

The Preferences dialog box closes. You can now scan via a network connection.
Go to the Main Menu to check whether network scanning is enabled.

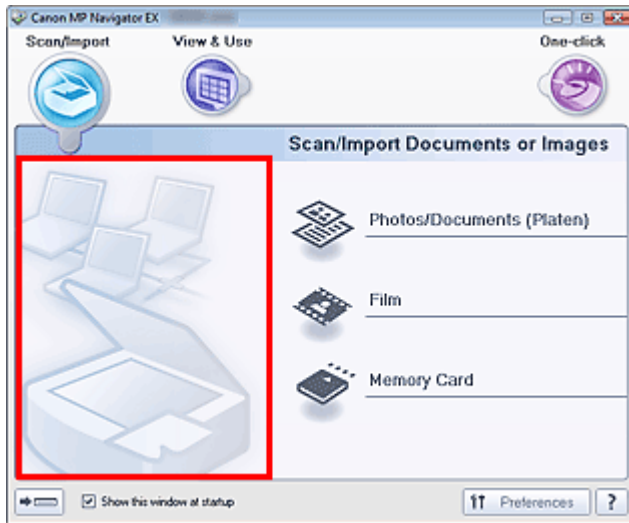

Setting for Scanning Using the Operation Panel

You can make settings for scanning using the Operation Panel of the machine.

1. Check that Canon IJ Network Scan Utility is running.

If Canon IJ Network Scan Utility is running, its icon appears in the notification area of the taskbar.

If Canon IJ Network Scan Utility is not running, from the Start menu, select (All) Programs > Canon IJ Network Utilities > Canon IJ Network Scan Utility > Canon IJ Network Scan Utility to start it.

2. In the notification area of the taskbar, right-click the Canon IJ Network Scan Utility icon and select Settings....

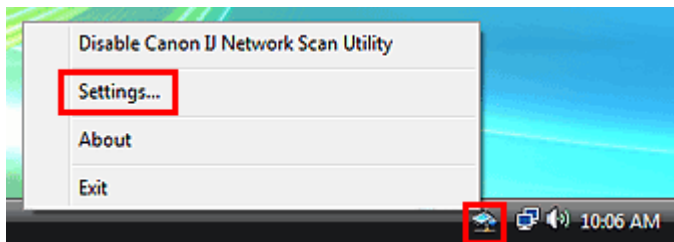

The Canon IJ Network Scan Utility dialog box opens.

3. Select Canon (model name) ser_XXXXXXXXXX and click OK.

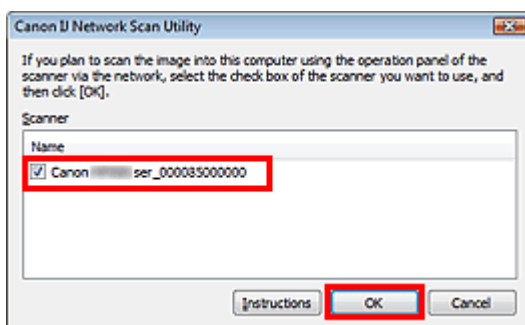

- When multiple scanners are connected via a network, you can select up to three scanners.
 - See "[Canon IJ Network Scan Utility Menu and Setting Screen](#) " for details on Canon IJ Network Scan Utility.
-

[Page top](#) 

Advanced Guide

Advanced Guide > Scanning > Saving Scanned Data to PC Using the Operation Panel of the Machine > Appendix: Various Scan Settings > Selecting a Response to Commands from the Operation Panel Using MP Navigator EX

MP Navigator EX

Selecting a Response to Commands from the Operation Panel Using MP Navigator EX

MP Navigator EX enables you to specify the response resulting from pressing a button for scanning on the Operation Panel of the machine. You can specify the response individually for each event.

1. Start MP Navigator EX.

➔ Starting MP Navigator EX

2. Click Preferences.

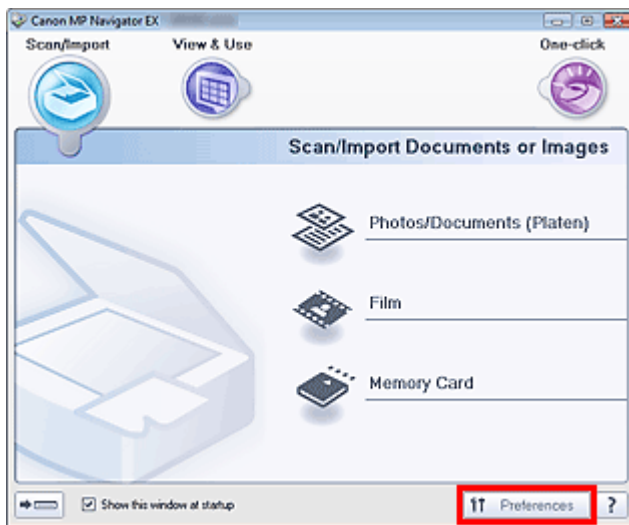

The Preferences dialog box opens.

Note

- The Preferences dialog box can also be opened by clicking Preferences in the One-click Mode screen.

3. On the Scanner Button Settings tab, specify Event and Actions.

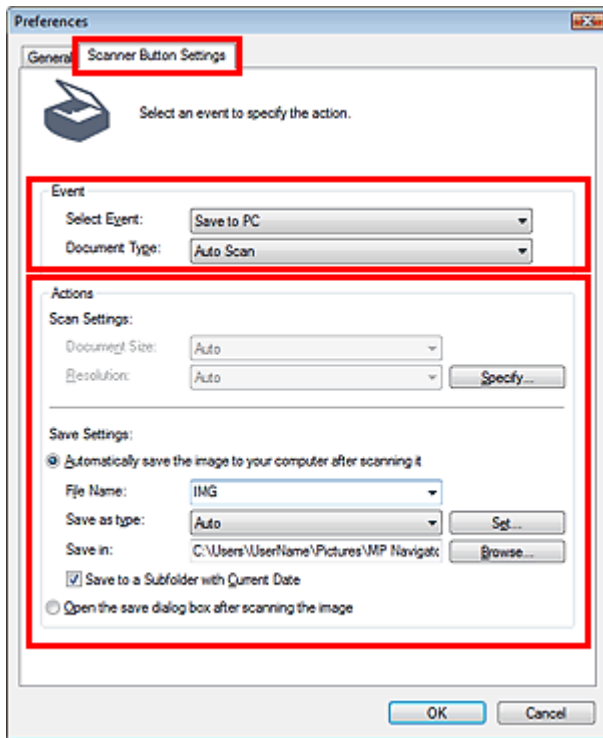

Note

- See the section below for details.
 - Scanner Button Settings Tab (Save)
 - Scanner Button Settings Tab (Attach to E-mail)
 - Scanner Button Settings Tab (Open with Application)

4. Click OK.

The operation will be performed according to the settings when you press the Color Start or Black Start button on the machine.

Advanced Guide

[Advanced Guide](#) > [Scanning](#) > [Scanning with the Bundled Application Software](#)

Scanning with the Bundled Application Software

- ➡ [What Is MP Navigator EX \(Supplied Scanner Software\)?](#)
- ➡ [Let's Try Scanning](#)
- ➡ [Useful MP Navigator EX Functions](#)
- ➡ [Utilizing Images in MP Navigator EX](#)
- ➡ [MP Navigator EX Screens](#)
- ➡ [Appendix: Opening Files Other than Scanned Images](#)

[Page top](#) ↕

Advanced Guide

Advanced Guide > Scanning > Scanning with the Bundled Application Software > What Is MP Navigator EX (Supplied Scanner Software)?

MP Navigator EX

What Is MP Navigator EX (Supplied Scanner Software)?

MP Navigator EX is an application that enables you to easily scan photos, documents and film. It is suitable even for beginners.

Important

- MP Navigator EX may not start from the Operation Panel of the machine. In that case, restart the computer.
- Use the default display font size of the OS. Otherwise, software screens may not appear correctly.

What You Can Do with This Software

This software allows you to scan multiple documents at one time, or scan images larger than the Platen. You can also save scanned images, attach them to e-mail or print them using the supplied applications.

Screens

Main Menus

There are two types of MP Navigator EX Main Menu: Navigation Mode screen and One-click Mode screen.

Navigation Mode Screen

You can start various tasks from the Navigation Mode screen, including simple scanning, scanning using ScanGear (scanner driver), and enhancing/correcting images.



One-click Mode Screen

You can complete from scanning to saving, etc. at one time by simply clicking the corresponding icon in the One-click Mode screen.



Scan/Import Window

Use the Scan/Import window to scan photos, documents and film, or import images saved on memory cards.

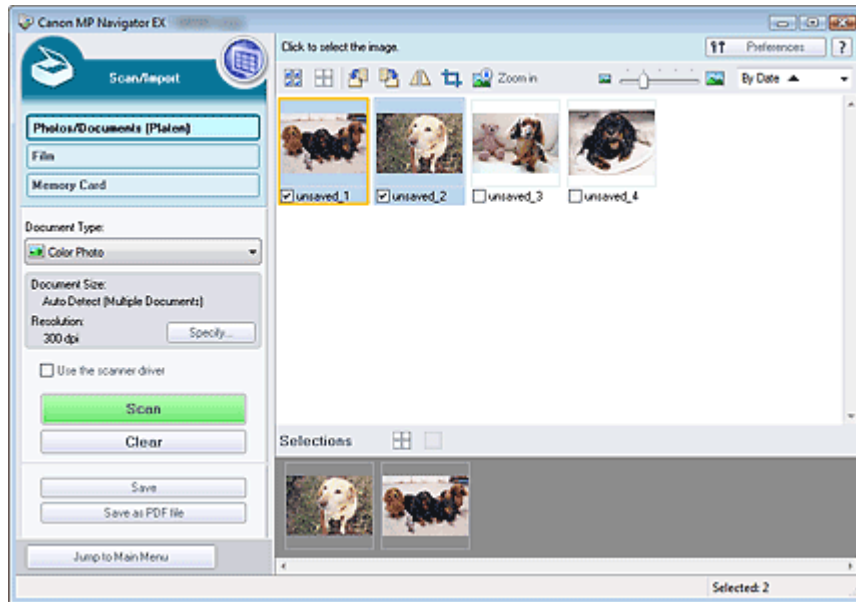

View & Use Window

Use the View & Use window to select what you want to do with the scanned images.

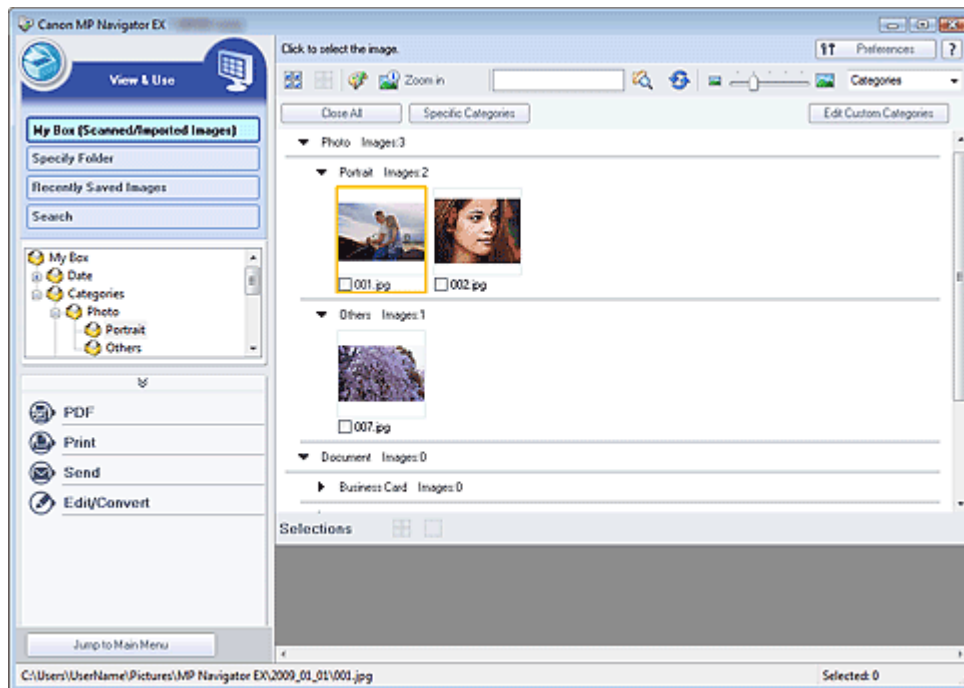

Advanced Guide

[Advanced Guide](#) > [Scanning](#) > [Scanning with the Bundled Application Software](#) > [Let's Try Scanning](#)

MP Navigator EX

Let's Try Scanning

Try scanning using MP Navigator EX.

- **Starting MP Navigator EX**
 - ➔ [Starting MP Navigator EX](#)
- **Scanning documents, photos, magazines, etc. from the Platen**
 - ➔ [Scanning Photos and Documents](#)
- **Scanning Film**
 - ➔ [Scanning Film](#)
- **Scanning two or more photos (small documents) at one time**
 - ➔ [Scanning Multiple Documents at One Time](#)
- **Scanning images larger than the Platen**
 - ➔ [Scanning Images Larger than the Platen \(Stitch Assist\)](#)
- **Scanning easily according to purpose (scan and save, attach to e-mail, etc.)**
 - ➔ [Easy Scanning with One-click](#)

[Page top](#)↑

Advanced Guide

Advanced Guide > Scanning > Scanning with the Bundled Application Software > Let's Try Scanning > Starting MP Navigator EX

MP Navigator EX

Starting MP Navigator EX

Note

- To scan via a network connection, start MP Navigator EX and set up the network environment before scanning.
➔ [Network Scan Settings](#)

Starting MP Navigator EX

1. Double-click  Canon MP Navigator EX 3.0 icon on the desktop.
MP Navigator EX starts.

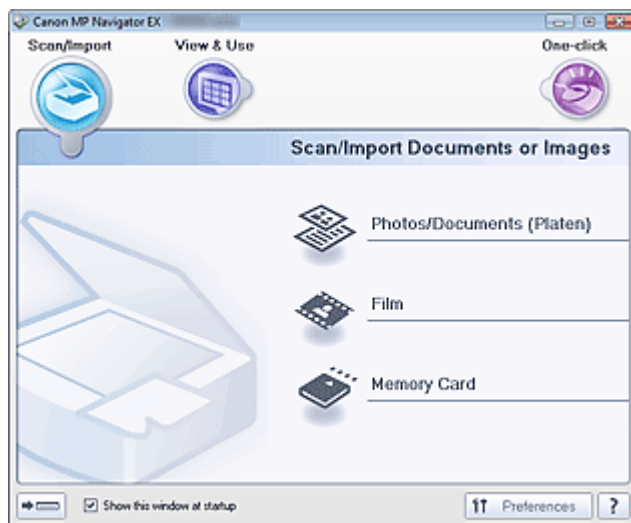

Note

- Alternatively, from the Start menu, select (All) Programs > Canon Utilities > MP Navigator EX 3.0 > MP Navigator EX 3.0.

Starting One-click Mode

1. Click  (Switch Mode) at the bottom left of the screen.

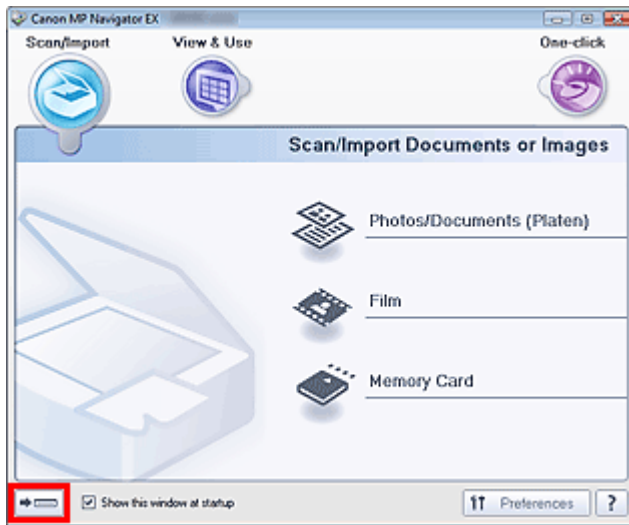

The One-click Mode screen appears.

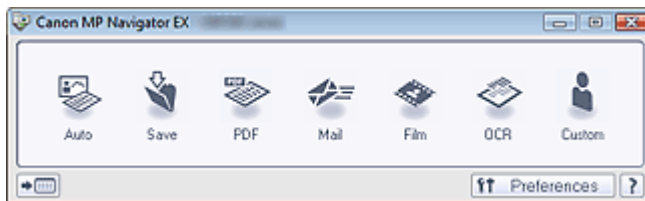

Note

- Select the Show this window at startup checkbox in the Navigation Mode screen to always open the Navigation Mode screen at startup. If this checkbox is not selected, the last used screen appears at startup.

Advanced Guide

Advanced Guide > Scanning > Scanning with the Bundled Application Software > Let's Try Scanning > Scanning Photos and Documents

MP Navigator EX

Scanning Photos and Documents

Scan photos and documents placed on the Platen.

1. Start MP Navigator EX and open the Navigation Mode screen.
 - ➔ Starting MP Navigator EX
2. Point to Scan/Import and click Photos/Documents (Platen).

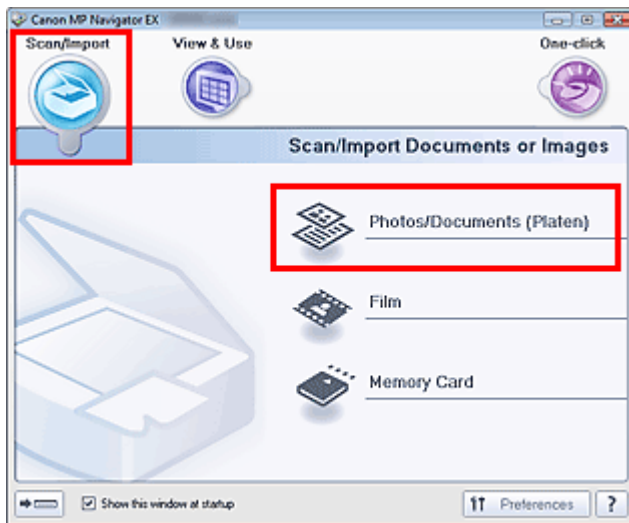

3. Place the document on the Platen, then select Document Type.
 - ➔ Placing Documents

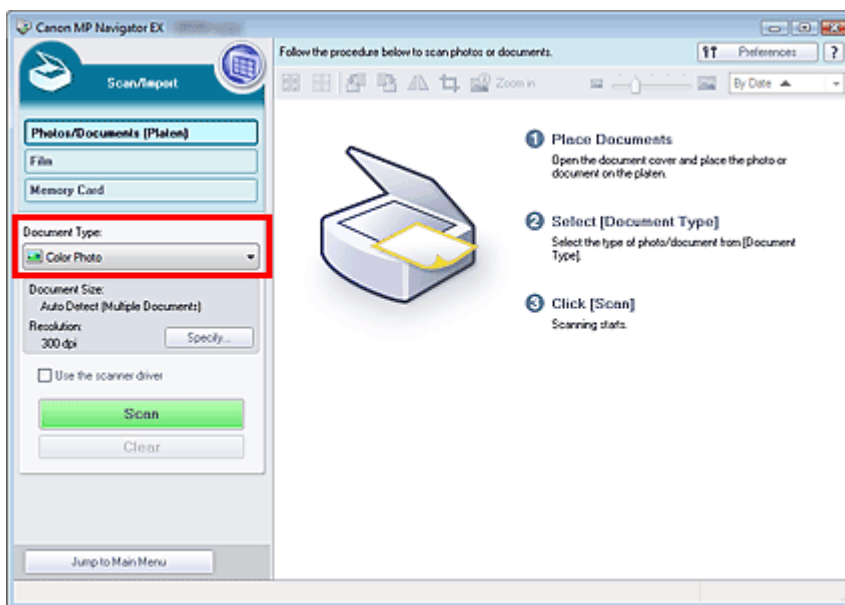

Note

- When you select Magazine(Color), the Descreen function will be enabled and scanning takes longer than usual. To disable the Descreen function, deselect the Descreen checkbox in the

- Scan Settings dialog box.
- Select Text(OCR) to extract the text in the image and convert to editable text data using MP Navigator EX. This setting is not available when the Compress scanned images when transferring checkbox is selected on the General tab of the Preferences dialog box.
- Color scanning is not available for Text(OCR). To scan in color, use OCR in One-click and scan with Color Mode set to Color.

4. Click Specify... to set the document size and scanning resolution as required.

When setting is completed, click OK.

➔ Scan Settings Dialog Box (Photos/Documents)

Important

- When scanning a large document (such as an A4 size photo), align its corner with the corner at the arrow (alignment mark) of the Platen and specify the document size in the Scan Settings dialog box.

5. Click Scan.

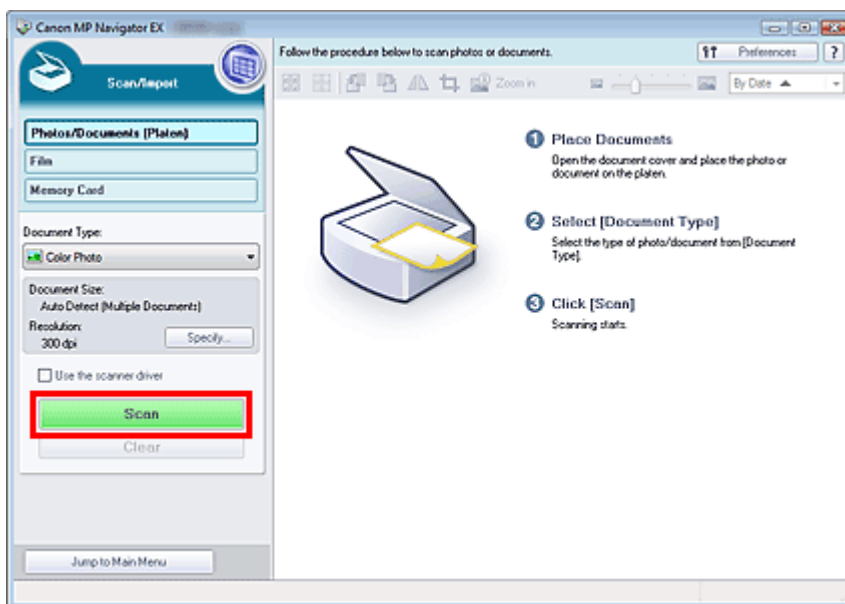

Scanning starts.

When scanning is completed, the Scan Complete dialog box opens. Select Scan or Exit. Select Scan to scan the next document, or select Exit to end.

The scanned images appear in the Thumbnail window.

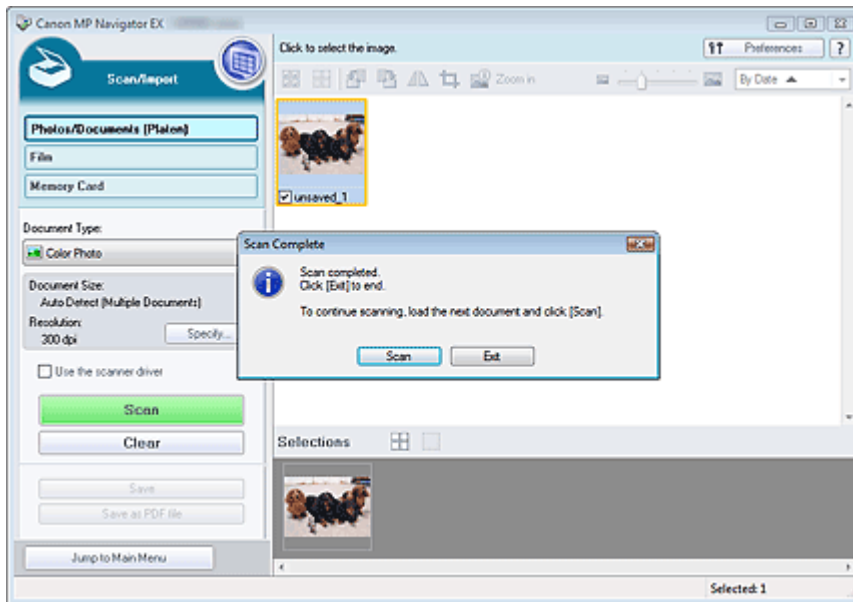

6. Edit the scanned images as required.

Use Edit Tools to rotate images, select a part of an image, etc.

See the Edit Tools in "Photos/Documents (Platen) Screen (Scan/Import Window) " for details.

Note

- First select images to edit. (Selected images are outlined in orange.) Drag the mouse or use Shift + arrow keys to select multiple images.

7. Save the scanned images.

- ➔ Saving
- ➔ Saving as PDF Files

[Page top](#)

Advanced Guide

Advanced Guide > Scanning > Scanning with the Bundled Application Software > Let's Try Scanning > Scanning Film

MP Navigator EX

Scanning Film

This machine supports 35 mm positive and negative film strips (standard state of developed film, with six frames in each strip) as well as 35 mm mounted positive slides (one frame per mounted slide).

Up to six film strip frames or four mounted slide frames can be scanned continuously.

Important

- To scan mounted negative slides, scan from the Advanced Mode tab of ScanGear (scanner driver), with Select Source set to negative film.

Note

- To scan at a resolution higher than 4800 dpi, scan from the Advanced Mode tab of ScanGear (scanner driver).
➔ [Scanning Film in Advanced Mode](#)



35 mm Film Strip



35 mm Mounted Slides

1. Start MP Navigator EX and open the Navigation Mode screen.
➔ [Starting MP Navigator EX](#)
2. Point to Scan/Import and click Film.

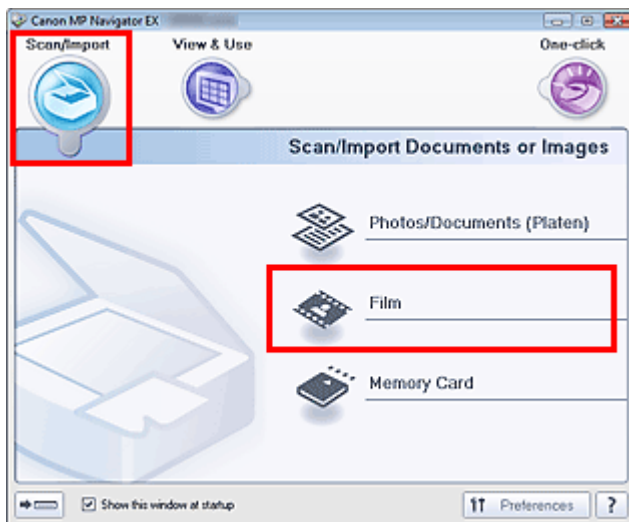

3. Place the film on the Platen.
➔ [Placing Film](#)
4. Click Specify... to set the document size and scanning resolution as required.
When setting is completed, click OK.
➔ [Scan Settings Dialog Box \(Film\)](#)

Important

- Film may not be scanned correctly when Film Type in the Scan Settings dialog box is set to Auto. In that case, select the type of film in Film Type and scan again.

Note

- To scan black and white film, it is recommended that you select Black and White Negative Film or Black and White Positive Film for Film Type in the Scan Settings dialog box.

5. Click Scan.

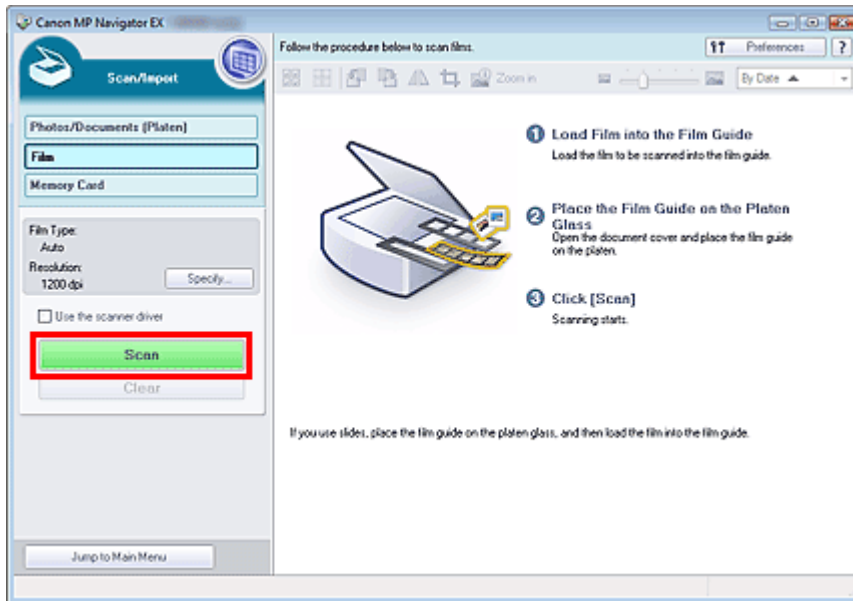

Preview scan starts.

When preview scan of the film is completed, the preview image appears.

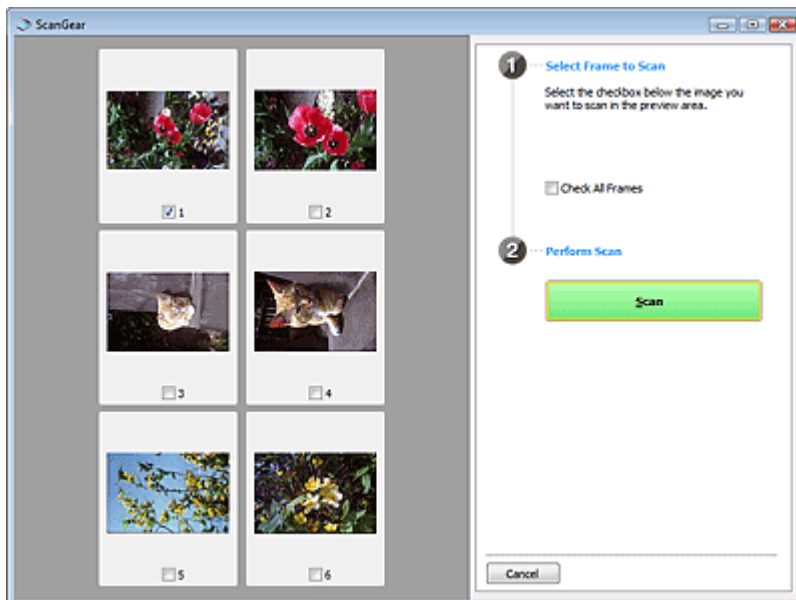

Note

- Preview images do not appear when the Preview before scanning checkbox is not selected in the Scan Settings dialog box. The scanned images appear directly in the Thumbnail window.
- If film cannot be scanned correctly, see "[Problems with Scanning/Printing Film](#)" in "Troubleshooting."

6. Select the checkboxes of the frames you want to scan, then click Scan.

When scanning is completed, the Scan Complete dialog box opens. Select Scan or Exit. Select Scan to scan the next film, or select Exit to end.

The scanned images appear in the Thumbnail window.

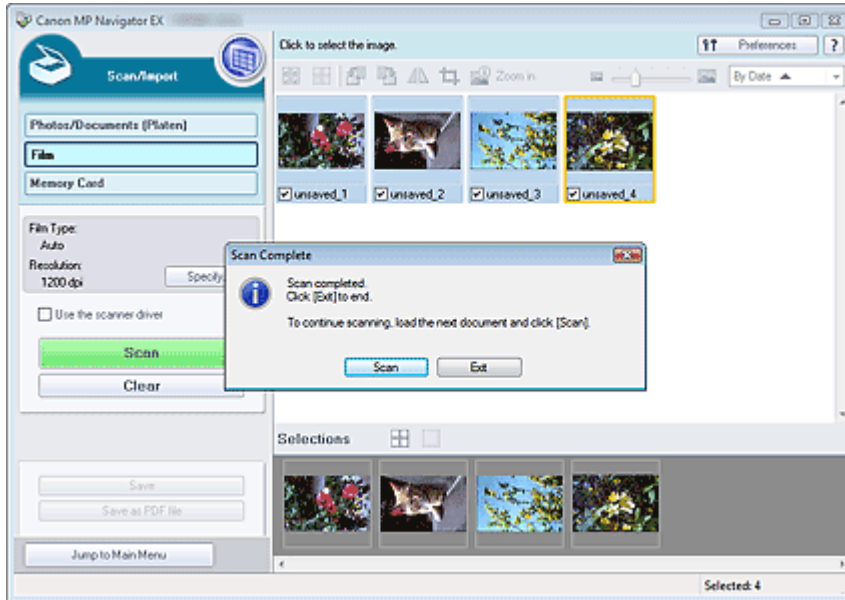

7. Edit the scanned images as required.

Use Edit Tools to rotate images, select a part of an image, etc.

See the Edit Tools in "Film Screen (Scan/Import Window)" for details.

Note

- First select images to edit. (Selected images are outlined in orange.) Drag the mouse or use Shift + arrow keys to select multiple images.

8. Save the scanned images.

➔ Saving

➔ Saving as PDF Files

Advanced Guide

Advanced Guide > Scanning > Scanning with the Bundled Application Software > Let's Try Scanning > Scanning Multiple Documents at One Time

MP Navigator EX

Scanning Multiple Documents at One Time

You can scan two or more photos (small documents) at one time by setting Document Size to Auto Detect (Multiple Documents) in the Scan Settings dialog box of MP Navigator EX.

Important

- The following types of documents may not be cropped correctly. In that case, start ScanGear (scanner driver), then adjust the cropping frames (scan areas) in whole image view and scan again.
 - Photos that have a whitish border
 - Documents printed on white paper, hand-written text, business cards, etc.
 - Thin documents
 - Thick documents
- ➔ [Scanning Multiple Documents in Whole Image View](#)

1. Place the document on the Platen.

➔ [Placing Documents](#)

2. Start MP Navigator EX and open the Navigation Mode screen.

➔ [Starting MP Navigator EX](#)

3. Point to Scan/Import and click Photos/Documents (Platen).

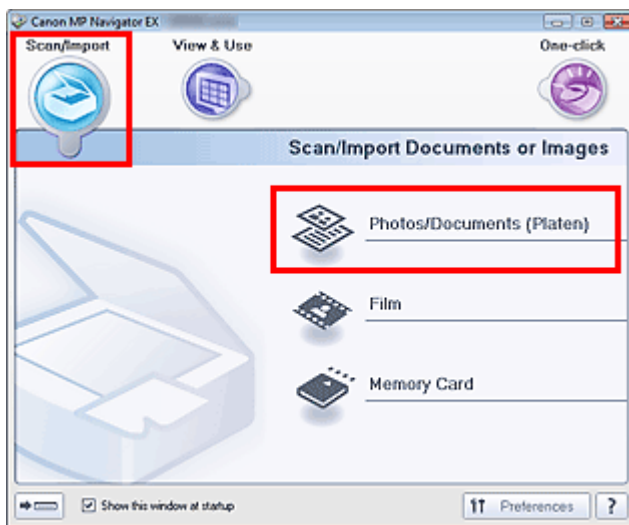

4. Select Document Type according to the document to be scanned.

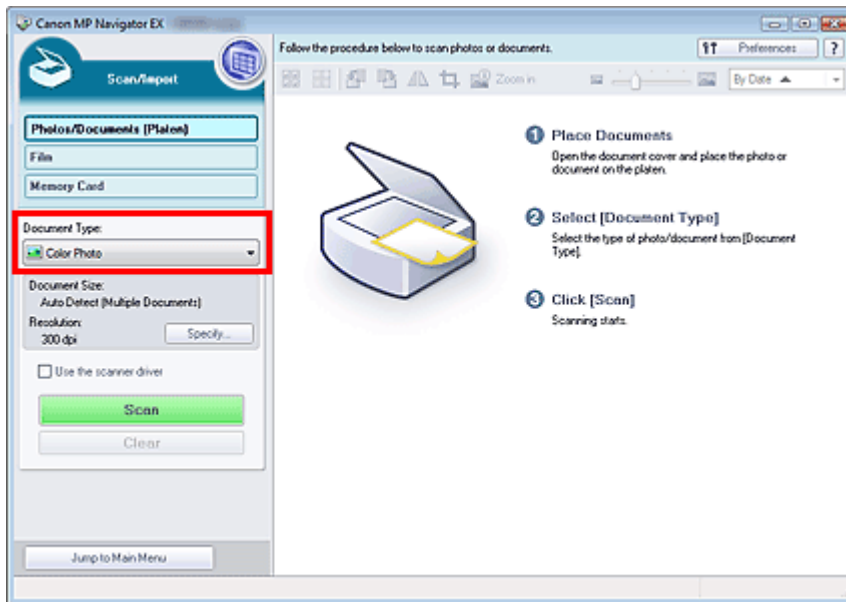

5. Click Specify....

Select Auto Detect (Multiple Documents) for Document Size.

When setting is completed, click OK.

➔ Scan Settings Dialog Box (Photos/Documents)

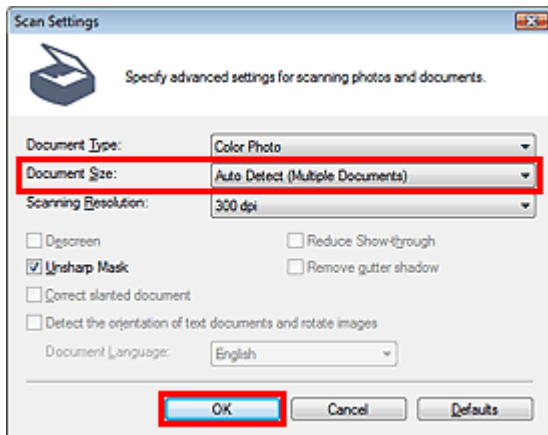

6. Click Scan.

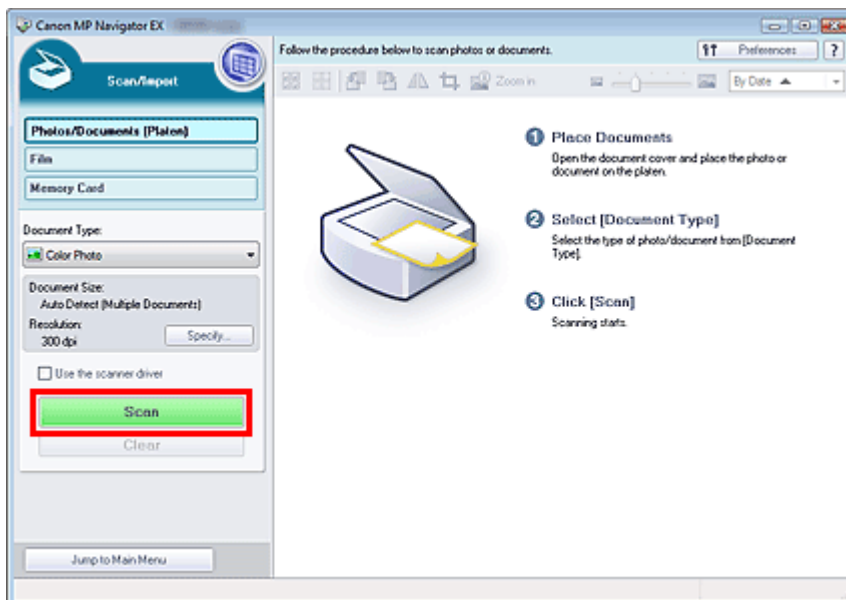

Multiple documents are scanned at one time.

When scanning is completed, the Scan Complete dialog box opens. Select Scan or Exit. Select Scan to scan the next document, or select Exit to end.

The scanned images appear in the Thumbnail window.

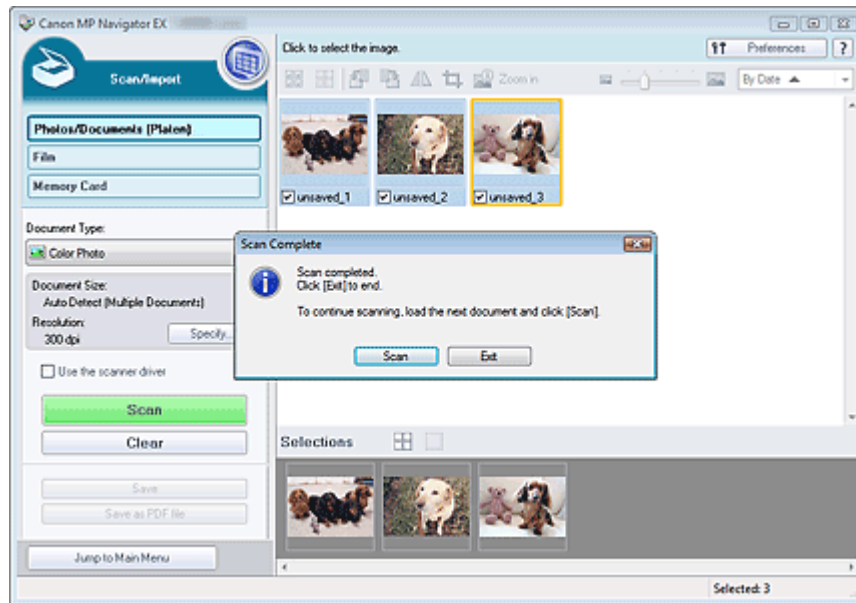

7. Edit the scanned images as required.

Use Edit Tools to rotate images, select a part of an image, etc.

See the Edit Tools in "Photos/Documents (Platen) Screen (Scan/Import Window) " for details.

Note

- First select images to edit. (Selected images are outlined in orange.) Drag the mouse or use Shift + arrow keys to select multiple images.

8. Save the scanned images.

➔ Saving

➔ Saving as PDF Files

Note

- If you want to preview the images before scanning, use ScanGear (scanner driver).
 - ➔ Scanning Multiple Documents at One Time with ScanGear (Scanner Driver)

Advanced Guide

Advanced Guide > Scanning > Scanning with the Bundled Application Software > Let's Try Scanning > Scanning Images Larger than the Platen (Stitch Assist)

MP Navigator EX

Scanning Images Larger than the Platen (Stitch Assist)

Stitch Assist allows you to scan the left and right halves of a large document separately and combine the scanned images back into one image. You can scan documents that are up to twice as large as the Platen.

1. Start MP Navigator EX and open the Navigation Mode screen.

➔ Starting MP Navigator EX

Note

- You can complete from scanning to saving, etc. at one time by simply clicking the corresponding icon in the One-click Mode screen. Stitch Assist is available from the One-click Mode screen as well, by changing the document size. Click the corresponding icon and select Stitch Assist for Document Size. Then skip ahead to Step 5.

2. Point to Scan/Import and click Photos/Documents (Platen).

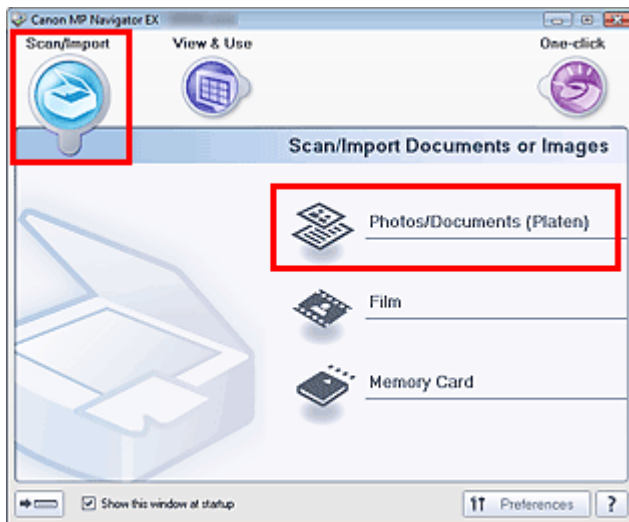

3. Select Document Type according to the document to be scanned.

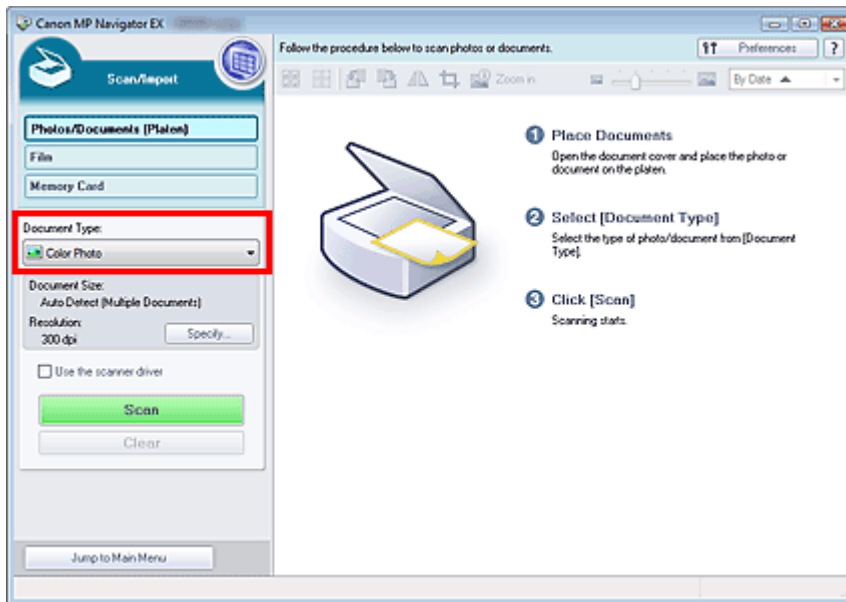

4. Click Specify....

Select Stitch Assist for Document Size, then specify the scanning resolution as required. When setting is completed, click OK.

➔ Scan Settings Dialog Box (Photos/Documents)

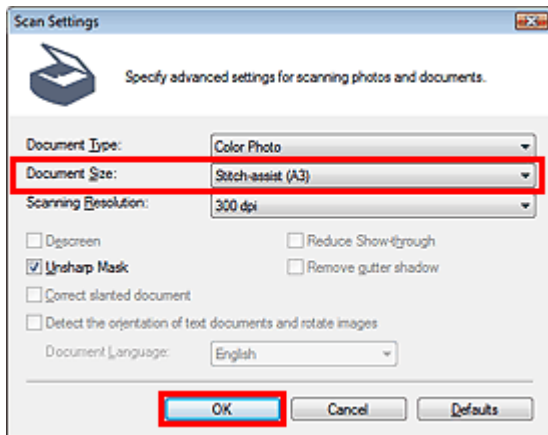

5. Click Scan.

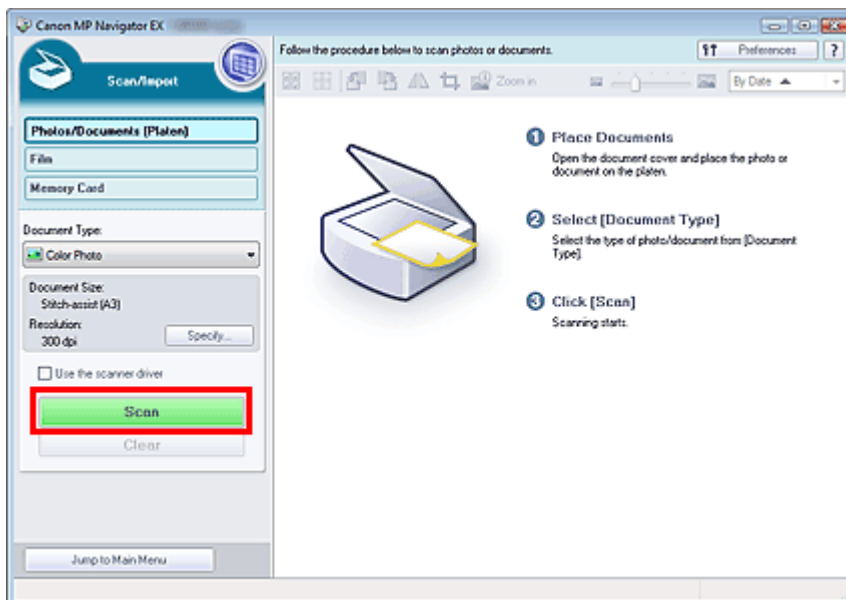

The Stitch-assist window opens.

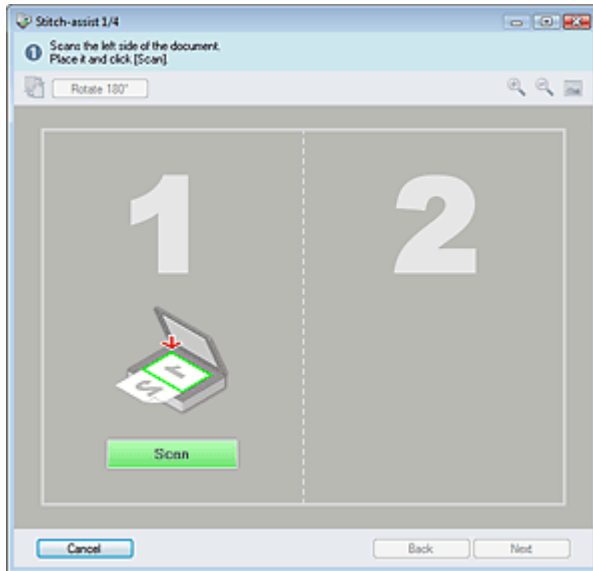

6. Place the left half of the document face-down on the Platen.

7. Click Scan.

The left half of the document is scanned and appears in the Stitch-assist window.



8. Place the right half of the document face-down on the Platen.

9. Click Scan.

The right half of the document is scanned.

10. Adjust the scanned image as required.

Use the icons to swap the left and right halves, rotate the image 180 degrees or enlarge/reduce the image.

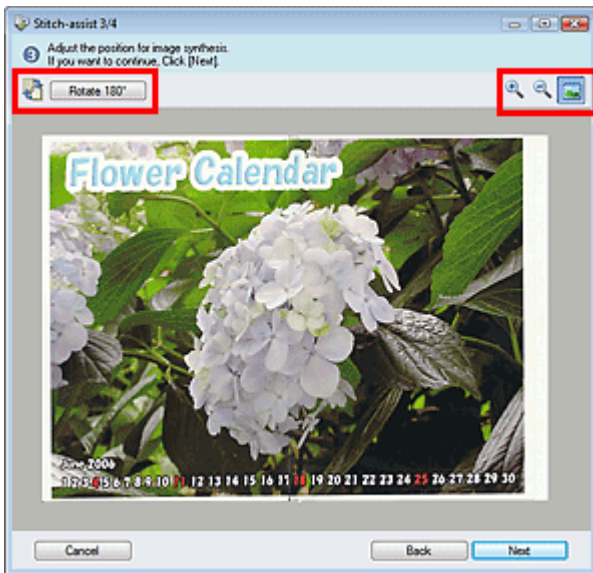

- 
(Swap Left & Right)
 Swaps the left and right halves.

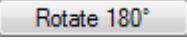

Important

- This function is not available while the image is enlarged/reduced.

- 
Rotate 180°
 Rotates right half of the image 180 degrees.

Important

- This function is not available while the image is enlarged/reduced.

- 
(Enlarge)
 Enlarges the displayed image.
- 
(Reduce)
 Reduces the displayed image.
- 
(Full-screen)
 Enlarges/reduces the image to display it full-screen.

Note

- Enlarge/Reduce does not affect the actual size of the scanned image.
- When the document is scanned upside down, the image displayed in the Stitch-assist window will also be upside down. Click Rotate 180° to rotate the image to the correct orientation.
- You can drag the right half of the image from right to left or up and down to adjust the position.
- If the left and right halves do not match due to a slanted document, place the document correctly and click Back, then scan again.

11. Click Next.

12. Drag the mouse to specify the area to be saved, then click OK.

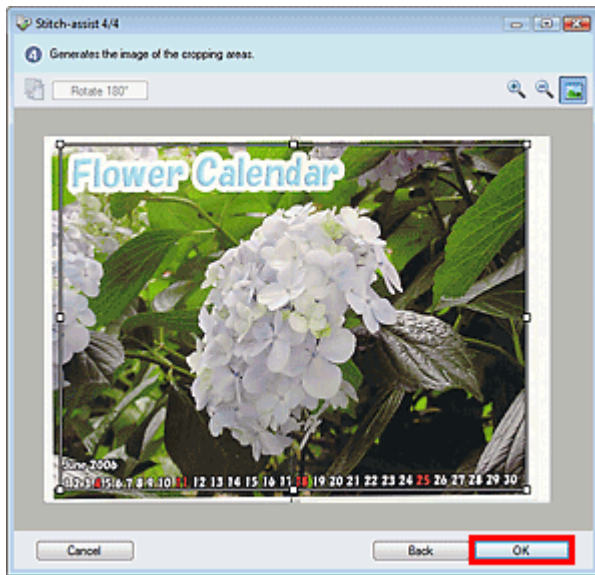

The combined image appears in the Thumbnail window.

When scanning is completed, the Scan Complete dialog box opens. Select Scan or Exit. Select Scan to scan the next document, or select Exit to end.

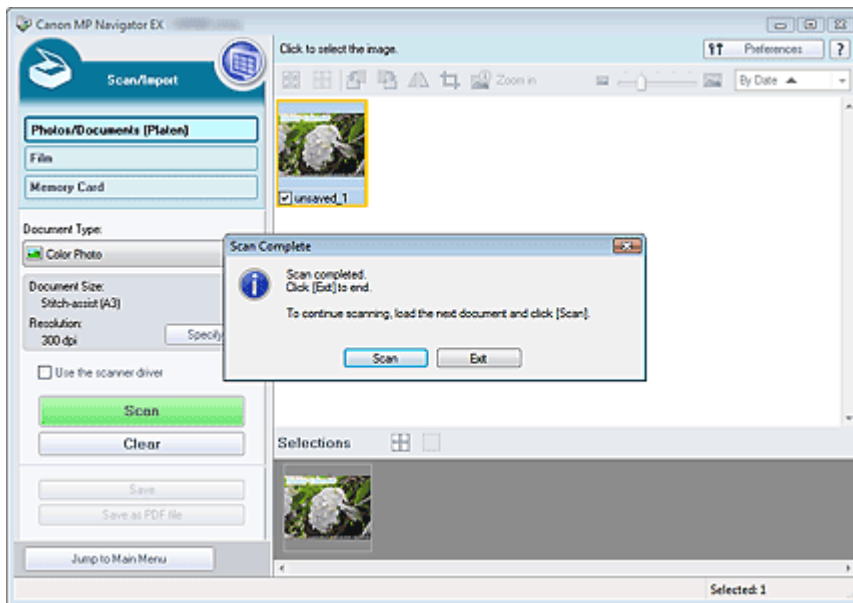

13. Save the scanned images.

- ➔ Saving
- ➔ Saving as PDF Files

Advanced Guide

Advanced Guide > Scanning > Scanning with the Bundled Application Software > Let's Try Scanning > Easy Scanning with One-click

MP Navigator EX

Easy Scanning with One-click

You can complete from scanning to saving, etc. at one time by simply clicking the corresponding icon.

1. Place the document on the Platen.

➔ Placing Documents

2. Start MP Navigator EX.

➔ Starting MP Navigator EX

The MP Navigator EX Navigation Mode screen or One-click Mode screen appears.

Navigation Mode Screen



One-click Mode Screen

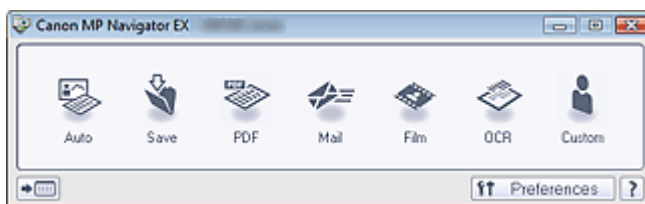

Note

- Skip ahead to Step 4 if One-click Mode screen is open.

3. Point to One-click.

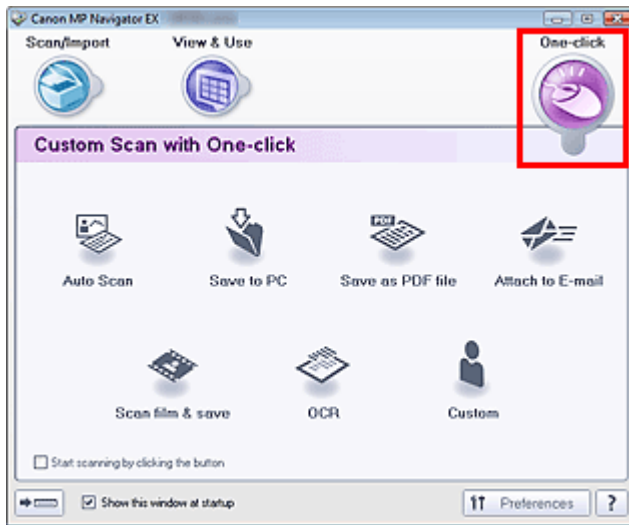

4. Click the corresponding icon.
 - ➔ Custom Scan with One-click Tab
 - ➔ One-click Mode Screen
5. Select Document Type according to the document to be scanned.
6. Set the document size and scanning resolution as required.
7. Start scanning.

Scanning starts.

Advanced Guide

[Advanced Guide](#) > [Scanning](#) > [Scanning with the Bundled Application Software](#) > [Useful MP Navigator EX Functions](#)

MP Navigator EX

Useful MP Navigator EX Functions

With MP Navigator EX, you can correct/enhance scanned images beautifully, and search saved images quickly.

- **Correcting/enhancing images automatically**
 - ➔ [Correcting/Enhancing Images Automatically](#)
- **Correcting/enhancing images manually**
 - ➔ [Correcting/Enhancing Images Manually](#)
- **Adjusting color characteristics such as brightness and contrast**
 - ➔ [Adjusting Images](#)
- **Searching for lost images**
 - ➔ [Searching Images](#)
- **Classifying and sorting images**
 - ➔ [Classifying Images into Categories](#)

[Page top](#)↑

Advanced Guide

Advanced Guide > Scanning > Scanning with the Bundled Application Software > Useful MP Navigator EX Functions > Correcting/Enhancing Images Automatically

MP Navigator EX

Correcting/Enhancing Images Automatically

MP Navigator EX will analyze and correct/enhance scanned images automatically.

1. Scan documents into MP Navigator EX and save them, then open the View & Use window from the Navigation Mode screen and select the photos you want to correct/enhance.

Note

- See "Let's Try Scanning" to scan images into MP Navigator EX.
- You can also select images saved on a memory card or computer.
 - ➔ Importing Images Saved on a Memory Card
 - ➔ Opening Images Saved on a Computer

2. Click Edit/Convert, then click Fix photo images on the list.

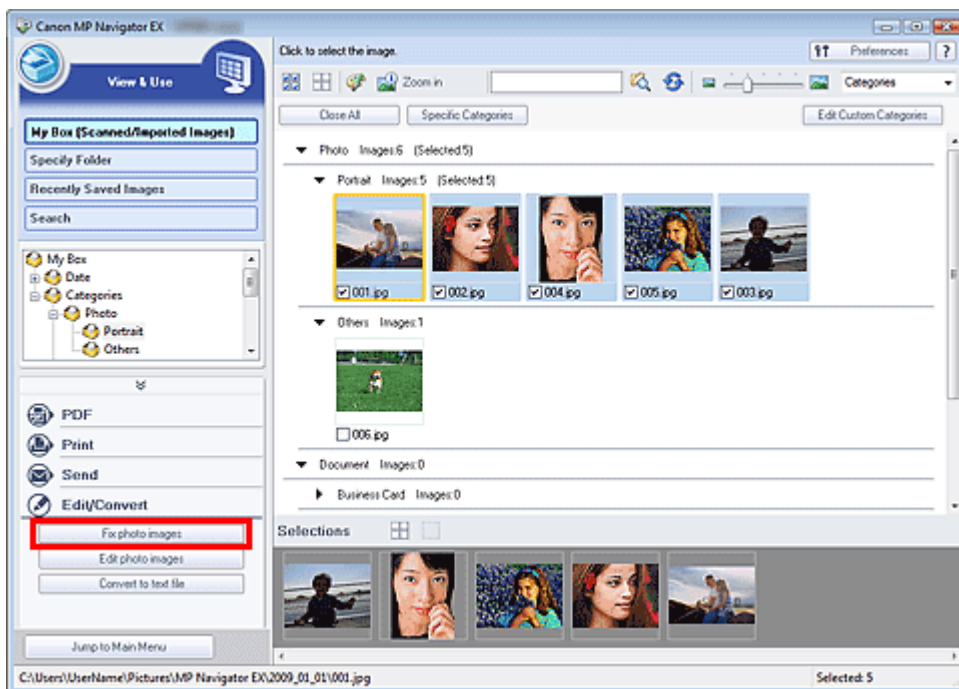

The Correct/Enhance Images window opens.

Note

- The Correct/Enhance Images window can also be opened by clicking  (Image Correction/Enhancement) on the Toolbar or in the Zoom in dialog box. In that case, only the target image (outlined in orange) can be corrected/enhanced.
- See "Correct/Enhance Images Window" for details on the Correct/Enhance Images window.

3. Select the image you want to correct/enhance from the thumbnail list.

The selected image appears in Preview.



Note

- If you selected only one image in the View & Use window, the thumbnail list does not appear and only the preview image appears.

4. Make sure that Auto is selected.
5. Click Auto Photo Fix, Face Sharpener or Digital Face Smoothing.

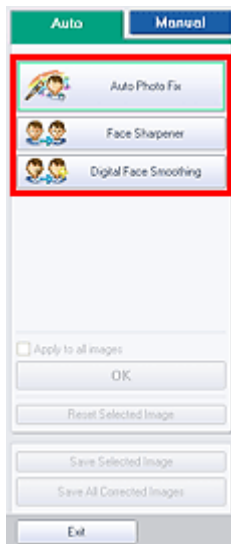

Important

- Once image is corrected with Auto Photo Fix and saved, it cannot be corrected again with Auto Photo Fix. Auto Photo Fix may not be available for images edited using an application, digital camera, etc. manufactured by other companies.

Note

- The Face Sharpener and Digital Face Smoothing effect levels can be changed using the slider that appears by clicking the corresponding buttons.
- When you apply Auto Photo Fix, dark backlit photos will be corrected automatically. If the image is not corrected enough using Auto Photo Fix, it is recommended that you apply Face Brightener on the Manual tab.

➔ [Correcting/Enhancing Images Manually](#)

6. Click OK.

The entire image is corrected/enhanced automatically and  (Correct/Enhance) appears on the upper left of the thumbnail and preview image.

Note

- Click Reset Selected Image to undo the correction/enhancement.
 - Select the Apply to all images checkbox to correct/enhance all selected images.
-

7. Click Save Selected Image or Save All Corrected Images.

You can save corrected/enhanced images as new files.

Note

- To save only the images you like, select them and click Save Selected Image. To save all images, click Save All Corrected Images.
 - The file format of corrected/enhanced images is JPEG/Exif.
 - Adobe RGB images are saved as sRGB images.
-

8. Click Exit.

Important

- The corrections/enhancements will be lost if you exit before saving corrected/enhanced images.

Advanced Guide

Advanced Guide > Scanning > Scanning with the Bundled Application Software > Useful MP Navigator EX Functions > Correcting/Enhancing Images Manually

MP Navigator EX

Correcting/Enhancing Images Manually

You can correct/enhance scanned images manually.

1. Scan documents into MP Navigator EX and save them, then open the View & Use window from the Navigation Mode screen and select the photos you want to correct/enhance.

Note

- See "Let's Try Scanning" to scan images into MP Navigator EX.
- You can also select images saved on a memory card or computer.
 - ➔ Importing Images Saved on a Memory Card
 - ➔ Opening Images Saved on a Computer

2. Click Edit/Convert, then click Fix photo images on the list.

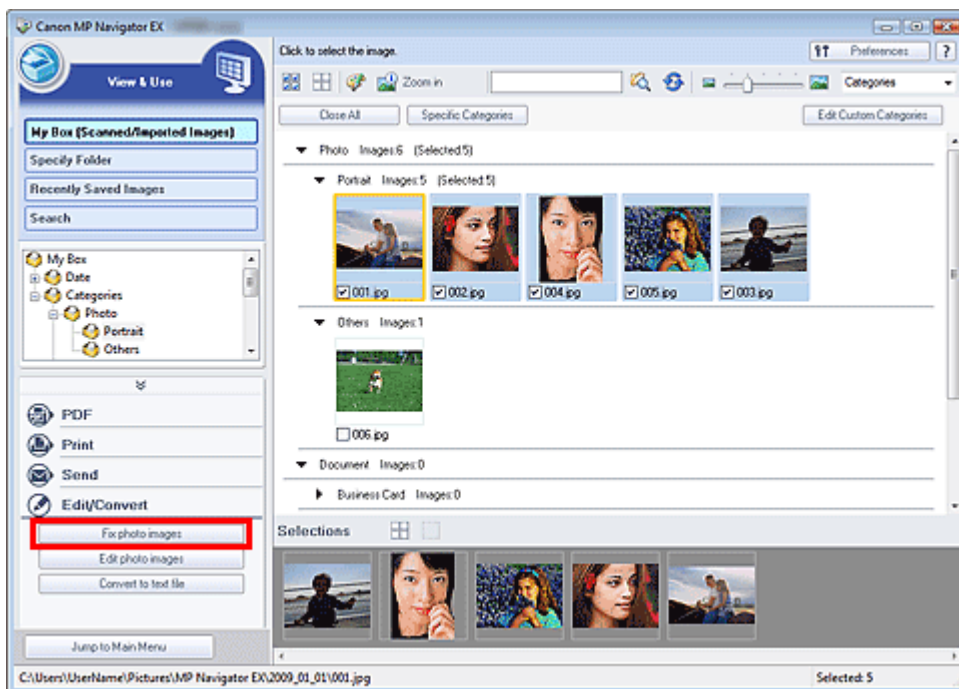

The Correct/Enhance Images window opens.

Note

- The Correct/Enhance Images window can also be opened by clicking  (Image Correction/Enhancement) on the Toolbar or in the Zoom in dialog box. In that case, only the target image (outlined in orange) can be corrected/enhanced.
- See "Correct/Enhance Images Window" for details on the Correct/Enhance Images window.

3. Select the image you want to correct/enhance from the thumbnail list.

The selected image appears in Preview.

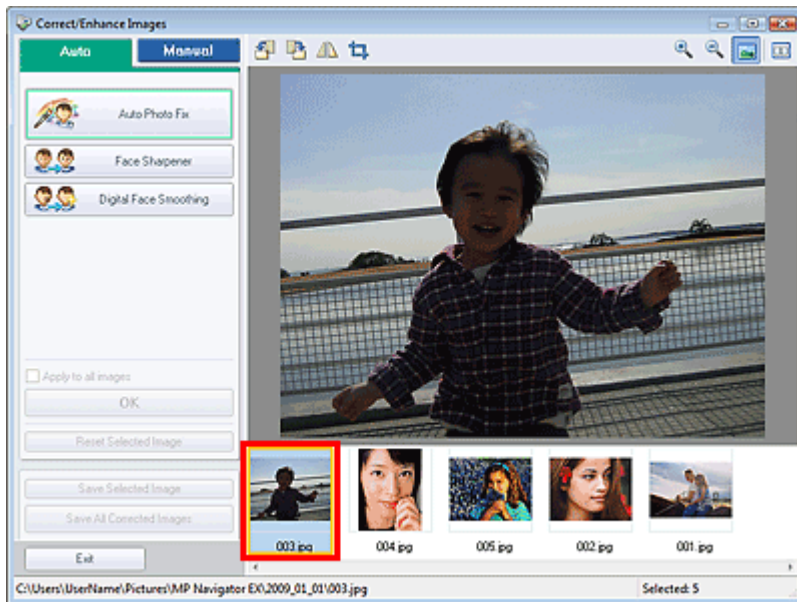

Note

- If you selected only one image in the View & Use window, the thumbnail list does not appear and only the preview image appears.

4. Click Manual, then click Correct/Enhance.
5. Click Face Brightener, Face Sharpener, Digital Face Smoothing or Blemish Remover.

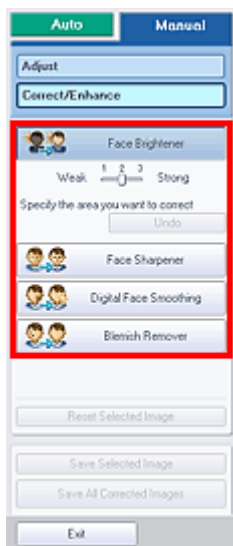

Note

- The Face Brightener, Face Sharpener and Digital Face Smoothing effect levels can be changed using the slider that appears by clicking the corresponding buttons.
- Move the cursor over the image. The shape of the cursor changes to **+** (Cross).

6. Drag to select the area you want to correct/enhance, then click OK that appears over the image.

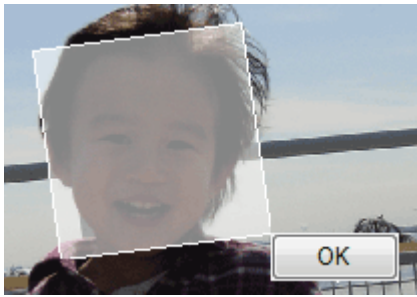

The portion in and around the selected area is corrected/enhanced and  (Correct/Enhance) appears on the upper left of the thumbnail and preview image.

Note

- You can also drag to rotate the rectangle.
 - Click Undo to undo the latest correction/enhancement.
 - Click Reset Selected Image to cancel all corrections, enhancements and adjustments applied to the selected image.
-

7. Click Save Selected Image or Save All Corrected Images.

You can save corrected/enhanced images as new files.

Note

- To save only the images you like, select them and click Save Selected Image. To save all images, click Save All Corrected Images.
 - The file format of corrected/enhanced images is JPEG/Exif.
-

8. Click Exit.

Important

- The corrections/enhancements will be lost if you exit before saving corrected/enhanced images.
-

Advanced Guide

Advanced Guide > Scanning > Scanning with the Bundled Application Software > Useful MP Navigator EX Functions > Adjusting Images

MP Navigator EX

Adjusting Images

You can make fine adjustments to the overall brightness, contrast, etc. of images.

1. Scan documents into MP Navigator EX and save them, then open the View & Use window from the Navigation Mode screen and select the photos you want to adjust.

Note

- See "Let's Try Scanning" to scan images into MP Navigator EX.
- You can also select images saved on a memory card or computer.
 - ➔ Importing Images Saved on a Memory Card
 - ➔ Opening Images Saved on a Computer

2. Click Edit/Convert, then click Fix photo images on the list.

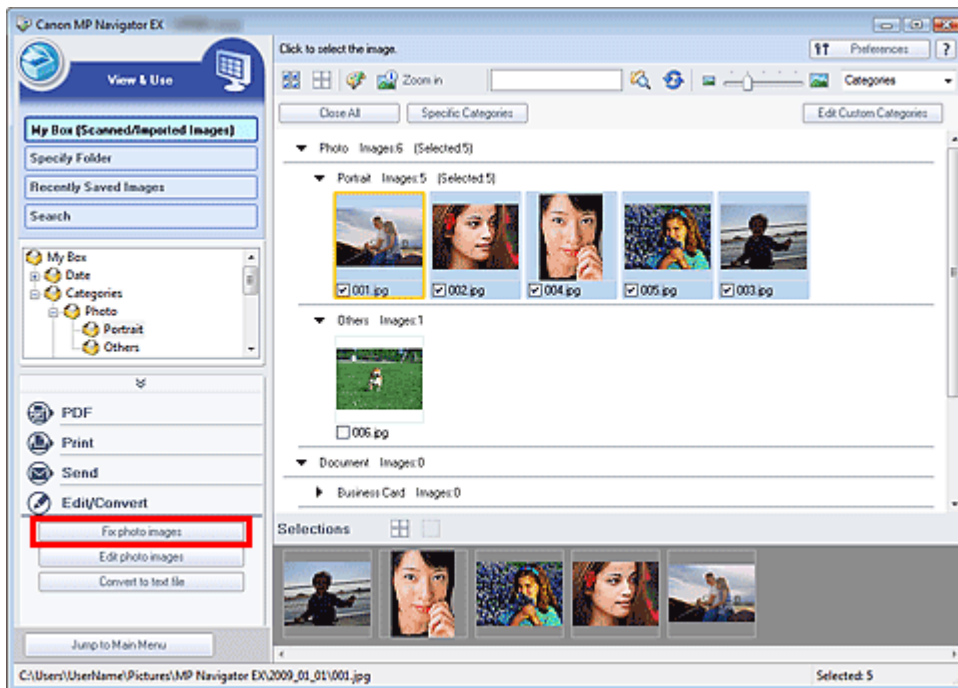

The Correct/Enhance Images window opens.

Note

- The Correct/Enhance Images window can also be opened by clicking  (Image Correction/Enhancement) on the Toolbar or in the Zoom in dialog box. In that case, only the target image (outlined in orange) can be corrected/enhanced.
- See "Correct/Enhance Images Window" for details on the Correct/Enhance Images window.

3. Select the image you want to adjust from the thumbnail list.

The selected image appears in Preview.



Note

- If you selected only one image in the View & Use window, the thumbnail list does not appear and only the preview image appears.

4. Click Manual, then click Adjust.

5. Move the slider of the item you want to adjust and set the effect level.

When you move a slider,  (Correct/Enhance) appears on the upper left of the thumbnail and preview image.

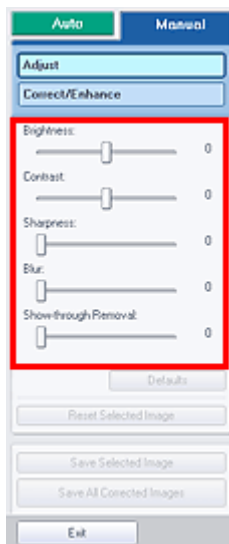

Note

- Click Defaults to reset all adjustments.
- Click Reset Selected Image to cancel all corrections, enhancements and adjustments applied to the selected image.

6. Click Save Selected Image or Save All Corrected Images.

You can save adjusted images as new files.

Note

- To save only the images you like, select them and click Save Selected Image. To save all images, click Save All Corrected Images.

- The file format of adjusted images is JPEG/Exif.
-

7. Click Exit.

Important

- The adjustments will be lost if you exit before saving adjusted images.

[Page top](#)[↕]

Advanced Guide

Advanced Guide > Scanning > Scanning with the Bundled Application Software > Useful MP Navigator EX Functions > Searching Images

MP Navigator EX

Searching Images



In the View & Use window of the Navigation Mode screen, you can search images saved on your computer and open them in MP Navigator EX. Opened images can be printed, edited, etc.

Note

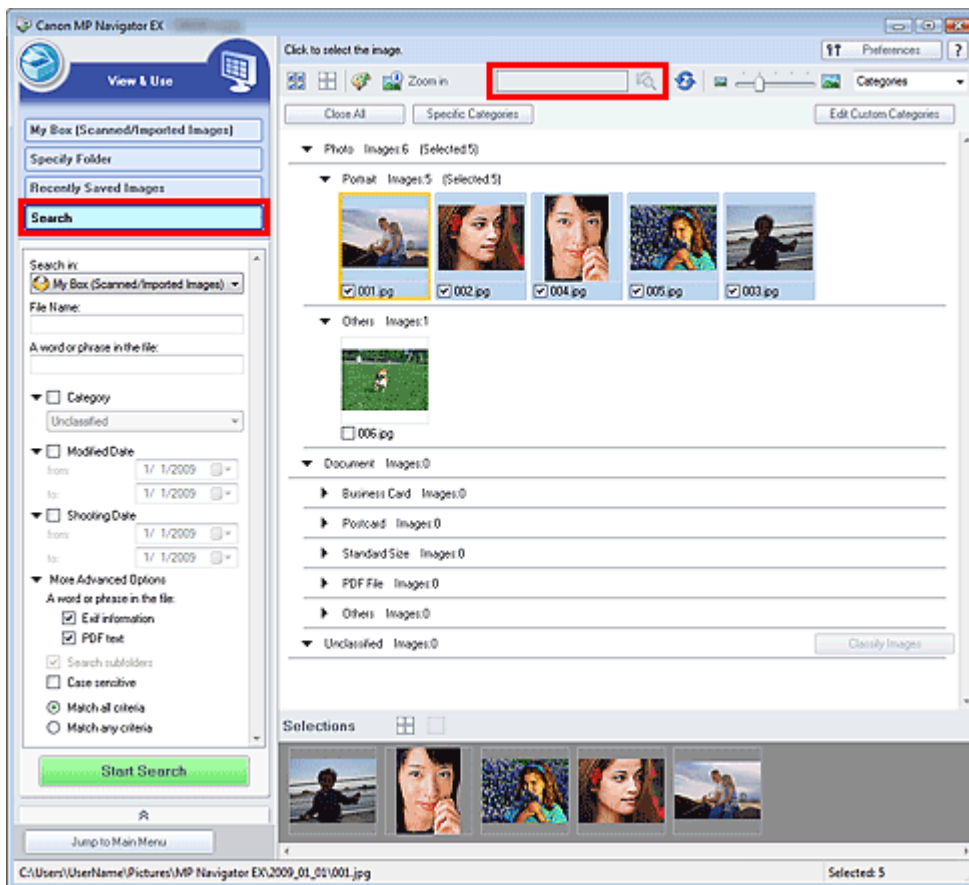
- Search images in My Box (Scanned/Imported Images), Recently Saved Images or a selected folder and its subfolders. You can also specify folder and search in Specify Folder.
- See "Starting MP Navigator EX" to start MP Navigator EX.



Quick Search

In  (Text box) on the Toolbar, enter a word or phrase included in the file name, Exif information or PDF text of the image you want to search for, then click  (Search button). For Exif information, text in Maker, Model, Description and User Comment is searched.

Advanced Search

Click Search on the left of the screen to open search options. Enter information of the image you want to search for, then click Start Search.

- **Search in**

If you know where to look for, select the drive, folder or network from Specify Folder.

- **File Name**

If you know the file name, enter it.

- **A word or phrase in the file**

Enter a word or phrase included in the items selected in More Advanced Options.

Important

- For PDF files, you can only search for those created with MP Navigator EX. You cannot search PDF files created or edited in other applications. Also, searching PDF files is available only when keyword search is set. For details of creating PDF files that enables keyword search, see "[PDF Settings Dialog Box.](#)"
- Password-protected PDF files cannot be searched.

- **Category**

You can search for images by category.

- **Modified Date**

To search for images that have been updated in a specific time period, enter the first and last dates of the period.

- **Shooting Date**

To search for images captured in a specific time period, enter the first and last dates of the period.

Note

- Captured date is the date and time of data creation, which are included in the document's Exif information.

- **More Advanced Options**

- **A word or phrase in the file**

In A word or phrase in the file, select the items to search. If you select the Exif information

checkbox, text in Maker, Model, Description and User Comment is searched. If you select the PDF text checkbox, text in PDF files is searched.

Important

- Text in password-protected PDF files cannot be searched.

- **Search subfolders**

Select this checkbox to search subfolders.

- **Case sensitive**

Select this checkbox to match case.

- **Match all criteria**

Searches for files that meet all the specified criteria.

- **Match any criteria**

Searches for files that meet any of the specified criteria.

- **Start Search**

Starts search.

Related Topic

▶ [View & Use Window](#)

[Page top](#) 

Advanced Guide

Advanced Guide > Scanning > Scanning with the Bundled Application Software > Useful MP Navigator EX Functions > Classifying Images into Categories

MP Navigator EX

Classifying Images into Categories

Display images scanned with MP Navigator EX by category. You can classify unclassified images automatically, and also create custom categories. You can drag and drop an image to move it from one category to another.

Note

- If you have classified the images in MP Navigator EX 2.0 or later and then upgrade MP Navigator EX to the latest version, the classification information on the second latest version is transferred upon initial startup. After the initial startup, the classification information cannot be transferred.

1. Scan documents into MP Navigator EX and save them, then open the View & Use window from the Navigation Mode screen.

Note

- See "Let's Try Scanning" to scan images into MP Navigator EX.
- You can also select images saved on a memory card or computer.
 - ➔ [Importing Images Saved on a Memory Card](#)
 - ➔ [Opening Images Saved on a Computer](#)

2. In (Sort by), select Categories.

Images are automatically sorted by category and appear in the Thumbnail window.

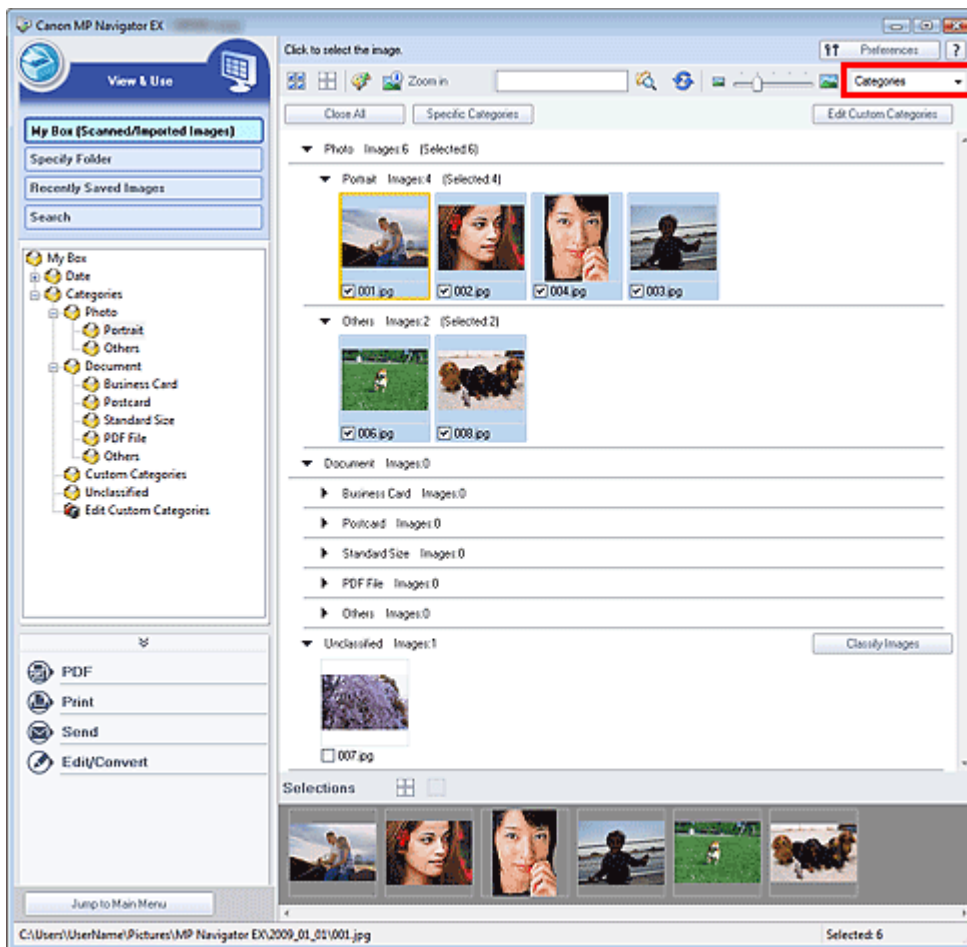

Images are sorted into the following categories.

Photos: Portrait, Others

Documents: Business Card, Postcard, Standard Size, PDF File, Others

Custom categories: Displays your custom categories.

To create custom categories, see "[Creating Custom Categories](#)."

Unclassified: Displays images that have not yet been classified.

Note

- Click Classify Images to classify images displayed in Unclassified automatically. Click Cancel to stop.
- Classification may take time if there are many images to classify.

Important

- Even if you classify images saved in removable media such as USB flash drive and external hard disk, the classification information will be deleted once you remove the media. From the next time, the images are classified to Unclassified.
- Images cannot be classified when Recently Saved Images is selected in the View & Use window.

Note

- Some images may not be detected correctly and thus may be classified into wrong categories. In that case, drag and drop the image to the correct category.
- Images saved in network folders may not be classified.
- You can search for images by category. See "[Searching Images](#)" for details.

Creating Custom Categories

- In the View & Use window, sort images by category and click Edit Custom

Categories.

The Edit Custom Categories dialog box opens.

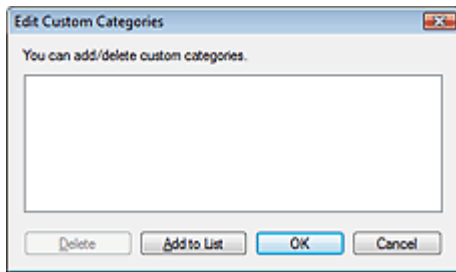

2. Click Add to List.

The Add Category dialog box opens.

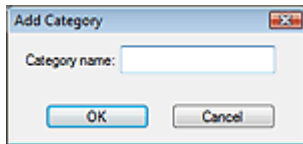

3. Enter Category name and click OK.

Note

- You can create up to 20 custom categories.
- Up to 50 single-byte characters can be used for a category name.
- Double-click a created category to open the Change Category Name dialog box in which you can change the category name.
- Select a custom category and click Delete to delete it.

Related Topic

► [View & Use Window](#)

[Page top](#) 

Advanced Guide

[Advanced Guide](#) > [Scanning](#) > [Scanning with the Bundled Application Software](#) > [Utilizing Images in MP Navigator EX](#)

MP Navigator EX

Utilizing Images in MP Navigator EX

You can scan images using MP Navigator EX and edit or print the saved images.

See the corresponding sections below for details on saving scanned images.

- **Saving scanned images to computer**
 - ➡ [Saving](#)
- **Saving scanned image as PDF Files**
 - ➡ [Saving as PDF Files](#)

See the corresponding sections below for details on using images/files.

- **Creating/editing PDF files from scanned images**
 - ➡ [Creating/Editing PDF Files](#)
- **Printing multiple scanned images at one time or printing at specific size, quality, etc.**
 - ➡ [Printing Documents](#)
- **Printing scanned photos**
 - ➡ [Printing Photos](#)
- **Sending scanned images via e-mail**
 - ➡ [Sending via E-mail](#)
- **Correcting/enhancing scanned images or converting them to text**
 - ➡ [Editing Files](#)
- **Setting passwords for created PDF files**
 - ➡ [Setting Passwords for PDF Files](#)
 - ➡ [Opening/Editing Password-protected PDF Files](#)

[Page top](#)↑

Advanced Guide

Advanced Guide > Scanning > Scanning with the Bundled Application Software > Utilizing Images in MP Navigator EX > Saving

MP Navigator EX

Saving

Save images scanned with MP Navigator EX to a computer.

1. Select the checkboxes of the images you want to save, then click Save.

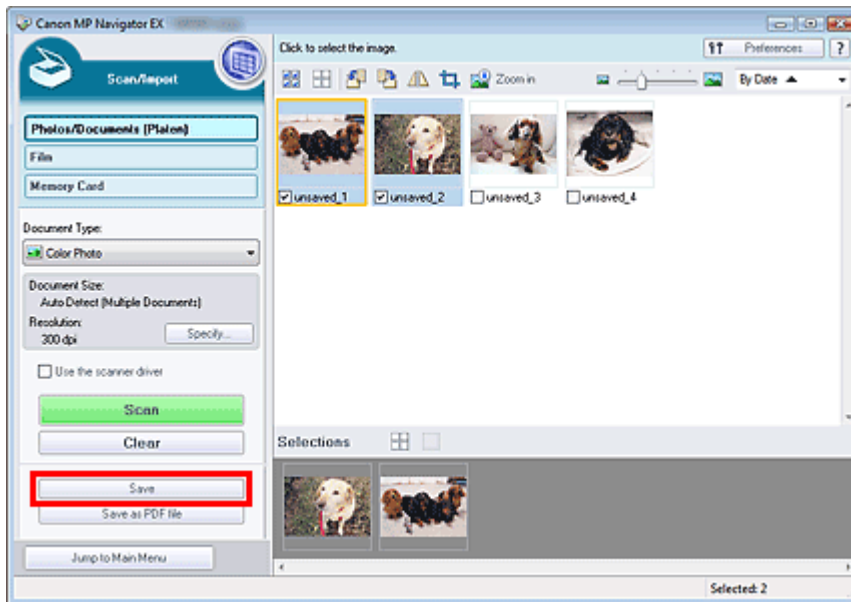

2. In the Save dialog box, specify the save settings.

Specify the destination folder, file name and file type.

➔ Save Dialog Box

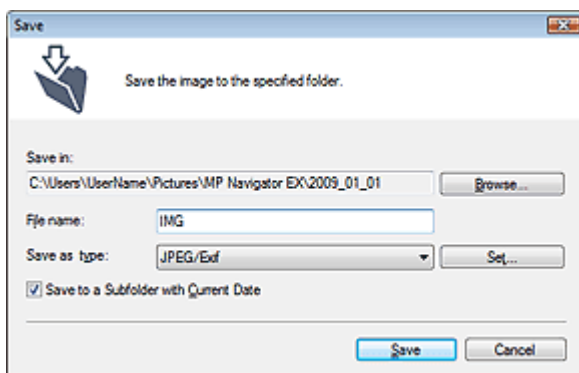

Important

- You cannot select JPEG/Exif when Document Type is Text(OCR).
- When saving 48 bit color or 16 bit grayscale images scanned with ScanGear (scanner driver), select TIFF. If you select a format other than TIFF, they will be saved as 24 bit color or 8 bit grayscale images.

Note

- By default, the following folders are specified as the destination folders.
Windows Vista: MP Navigator EX folder in Pictures folder
Windows XP: MP Navigator EX folder in My Pictures folder

3. Click Save.

Scanned images are saved according to the settings.

To further use/edit the scanned images on MP Navigator EX, click Open saved location in the Save Complete dialog box.

➔ [Creating/Editing PDF Files](#)

➔ [Printing Documents](#)

➔ [Printing Photos](#)

➔ [Sending via E-mail](#)

➔ [Editing Files](#)

[Page top](#)↑

Advanced Guide

Advanced Guide > Scanning > Scanning with the Bundled Application Software > Utilizing Images in MP Navigator EX > Saving as PDF Files

MP Navigator EX

Saving as PDF Files

Save images scanned with MP Navigator EX as PDF files.

1. Select the checkboxes of the images you want to save, then click Save as PDF file.

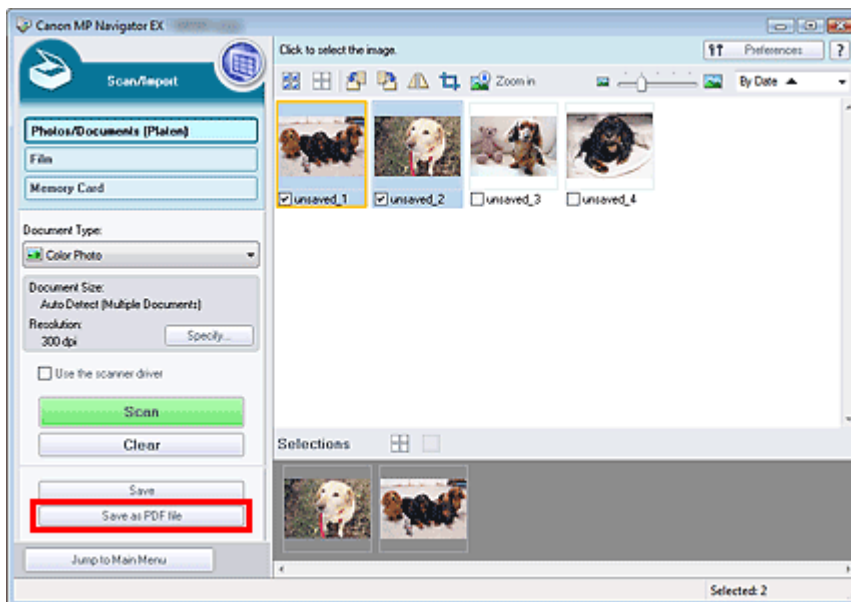

2. In the Save as PDF file dialog box, specify the save settings. Specify the file type, file name and destination folder.

➔ Save as PDF file Dialog Box

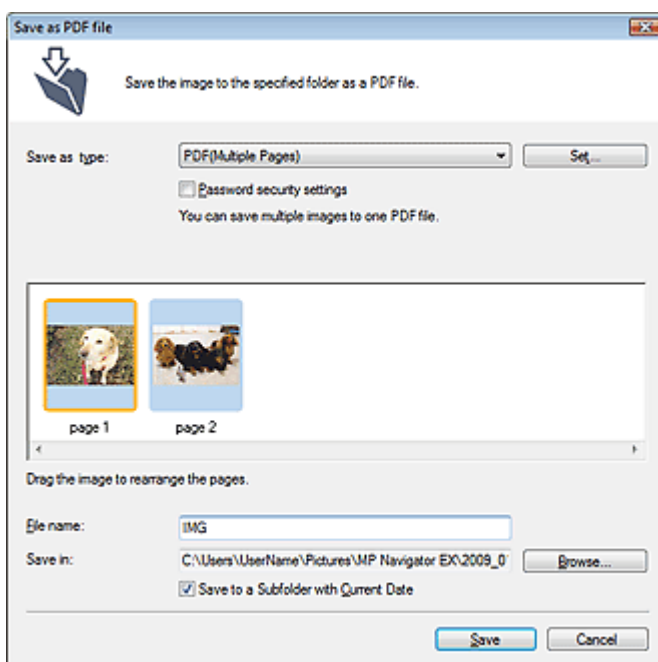

Select from the following PDF file types:

- PDF

Save each of the selected images as a separate PDF file.

- **PDF(Multiple Pages)**

Save multiple images in one PDF file.

Note

- PDF(Multiple Pages) is displayed when multiple images are selected.
-

- **PDF(Add Page)**

Add the scanned images to a PDF file. The images are added to the end of the PDF file. You cannot rearrange the pages of the PDF file to which the images are added.

Important

- Images can only be added to PDF files created with MP Navigator EX. You cannot specify PDF files created with other applications. PDF files edited in other applications cannot be specified as well.
 - If a password-protected PDF file is edited, the passwords will be deleted. Reset the passwords.
-

Note

- By default, the following folders are specified as the destination folders.
Windows Vista: MP Navigator EX folder in Pictures folder
Windows XP: MP Navigator EX folder in My Pictures folder
Windows 2000: MP Navigator EX folder in My Pictures folder
 - You can set passwords for PDF files.
➔ [Setting Passwords for PDF Files](#)
-

3. Click Save.

Scanned images are saved according to the settings.

To further use/edit the scanned images on MP Navigator EX, click Open saved location in the Save Complete dialog box.

- ➔ [Creating/Editing PDF Files](#)
- ➔ [Printing Documents](#)
- ➔ [Printing Photos](#)
- ➔ [Sending via E-mail](#)
- ➔ [Editing Files](#)

Advanced Guide

Advanced Guide > Scanning > Scanning with the Bundled Application Software > Utilizing Images in MP Navigator EX > Creating/Editing PDF Files

MP Navigator EX

Creating/Editing PDF Files

Create/edit PDF files using MP Navigator EX. After scanning documents and saving them, open the View & Use window to create PDF files and add/delete pages, rearrange the page order, etc.

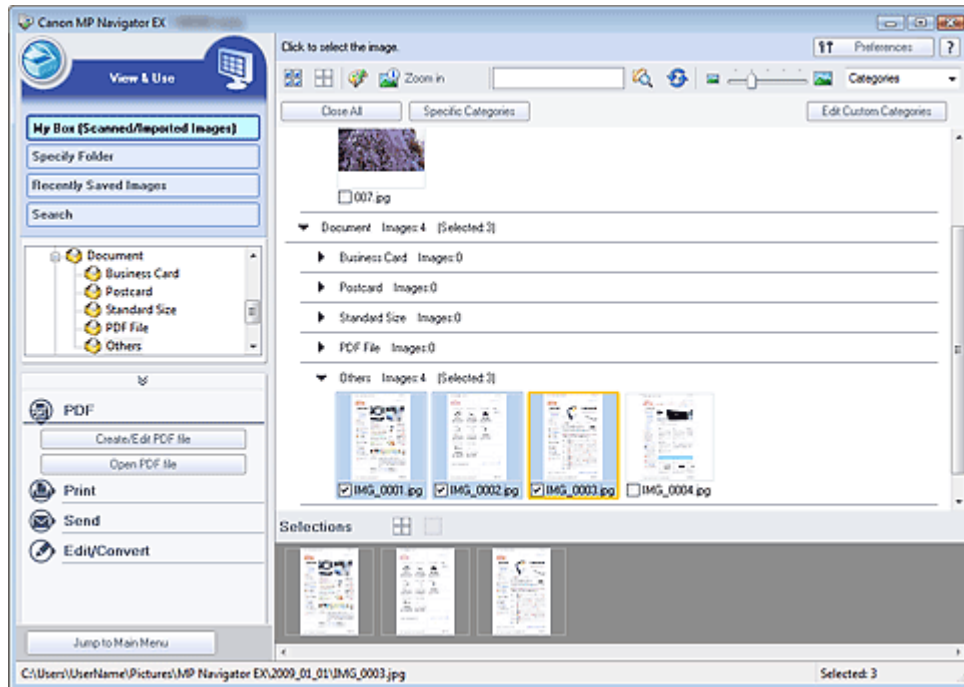

Important

- You can create or edit up to 99 pages using MP Navigator EX.

Note

- See "Let's Try Scanning" to scan images into MP Navigator EX.
- You can also select images saved on a memory card or computer.
 - ➔ Importing Images Saved on a Memory Card
 - ➔ Opening Images Saved on a Computer

Creating/Editing PDF Files with MP Navigator EX

- Select images and click PDF.

Note

- You can select PDF, JPEG, TIFF and BMP files.

- Click Create/Edit PDF file on the list.

Important

- For PDF files, you can only edit those created with MP Navigator EX. You cannot edit PDF files created with other applications. PDF files edited in other applications cannot be edited as well.

Note

- If a password-protected PDF file is selected, you will be prompted to enter the password.
 ➔ [Opening/Editing Password-protected PDF Files](#)

3. Add/delete pages as required.

To add an existing file, click Add Page and select the file. To delete a page, select it and click Delete Selected Pages.

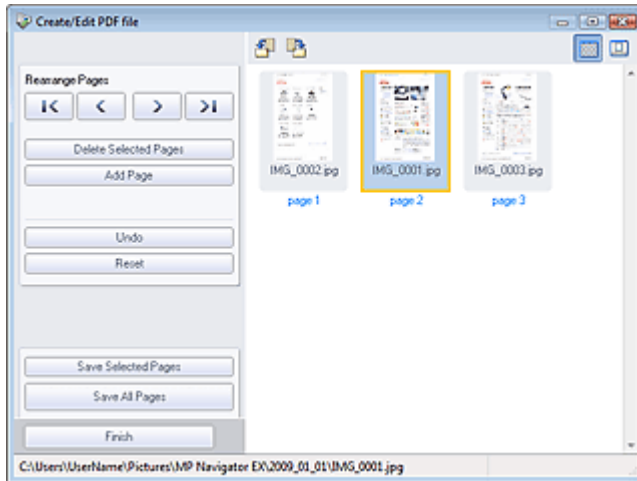

Note

- You can add PDF, JPEG, TIFF and BMP files.
- When adding a password-protected PDF file, you will be prompted to enter the password.

4. Rearrange the page order as required.

Use the icons to rearrange the order. Alternatively, drag and drop the thumbnail to the target location.

Note

- See "[Create/Edit PDF file Window](#)" for details on the Create/Edit PDF file window.

5. Click Save Selected Pages or Save All Pages.

The Save as PDF file dialog box opens.

➔ [Save as PDF file Dialog Box](#)

Important

- You cannot save images scanned at 10501 pixels or more in the vertical and horizontal directions.
- If a password-protected PDF file is edited, the passwords will be deleted. Reset the passwords in the Save as PDF file dialog box.
 ➔ [Setting Passwords for PDF Files](#)

6. Specify the save settings in the Save as PDF file dialog box, then click Save.

Images are saved according to the settings.

Opening PDF Files in an Application

You can open PDF files created with MP Navigator EX in an associated application and edit or print them.

1. Select PDF files and click PDF.

Important

- For PDF files, you can only select those created with MP Navigator EX. You cannot select PDF files created with other applications. PDF files edited in other applications cannot be selected as well.

2. Click Open PDF file on the list.

The application associated with the .pdf file extension by the operating system starts.

Important

- Password-protected PDF files cannot be opened in applications not supporting PDF security.
- Files may not open if an application that can be associated with PDF files is not installed.

3. Use the application to edit/print the file.

For details, refer to the application's manual.

Important

- In some applications, the commands (print, edit, etc.) restricted by Permissions Password may differ from those in MP Navigator EX.

[Page top](#)[↕]

Advanced Guide

Advanced Guide > Scanning > Scanning with the Bundled Application Software > Utilizing Images in MP Navigator EX > Printing Documents

MP Navigator EX

Printing Documents

You can print multiple scanned images at one time, print at specific quality, etc. using MP Navigator EX.

1. Scan documents into MP Navigator EX and save them, then open the View & Use window from the Navigation Mode screen and select images.

Note

- See "Let's Try Scanning" to scan images into MP Navigator EX.
- You can also select images saved on a memory card or computer.
 - ➔ Importing Images Saved on a Memory Card
 - ➔ Opening Images Saved on a Computer

2. Click Print, then click Print Document on the list.

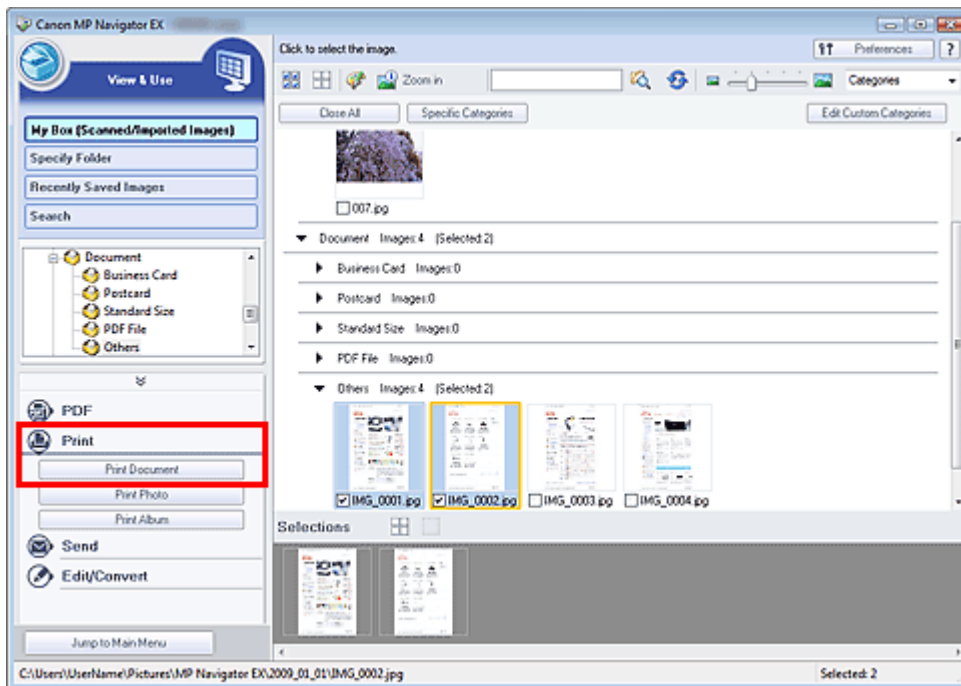

Important

- If a password-protected PDF file is selected, you will be prompted to enter the password.
 - ➔ Opening/Editing Password-protected PDF Files

3. Specify print settings as required.

In the displayed dialog box, specify print count, quality, scale, etc.

- ➔ Print Document Dialog Box

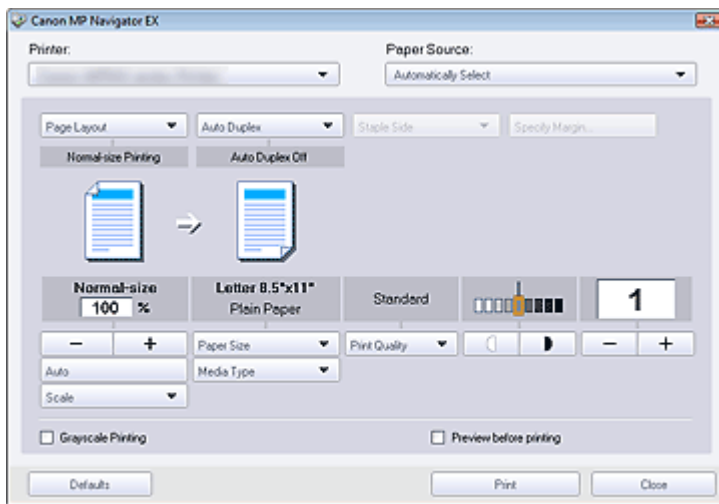

Important

- At normal-size (100%), some images may be printed small or with some portions cropped. In that case, select Auto to resize the print in proportion to the paper size.

4. Click Print.

Printing starts.

Note

- When printing a multiple-page PDF file via Print Document, printing may take time depending on your computer. In that case, follow these steps and change settings.
 1. From the Start menu, select Control Panel.
 2. Click Printers.
 3. Right-click the icon of your printer and click Properties.
The printer properties dialog box opens.
 4. Click the Advanced tab.
 5. Select Spool print documents so program finishes printing faster.
 6. Select Start printing after last page is spooled.
 7. After printing, return the setting on the Advanced tab to Start printing immediately.
- To cancel while spooling, click Cancel. To cancel while printing, click Cancel Printing in the confirmation window for the printer status. To open a confirmation window for the printer status, click printer icon on the taskbar.

Advanced Guide

Advanced Guide > Scanning > Scanning with the Bundled Application Software > Utilizing Images in MP Navigator EX > Printing Photos

MP Navigator EX

Printing Photos

You can print photos using MP Navigator EX or an application that accompanies the machine. After scanning documents and saving them, open the View & Use window to select how you want to print the photos.

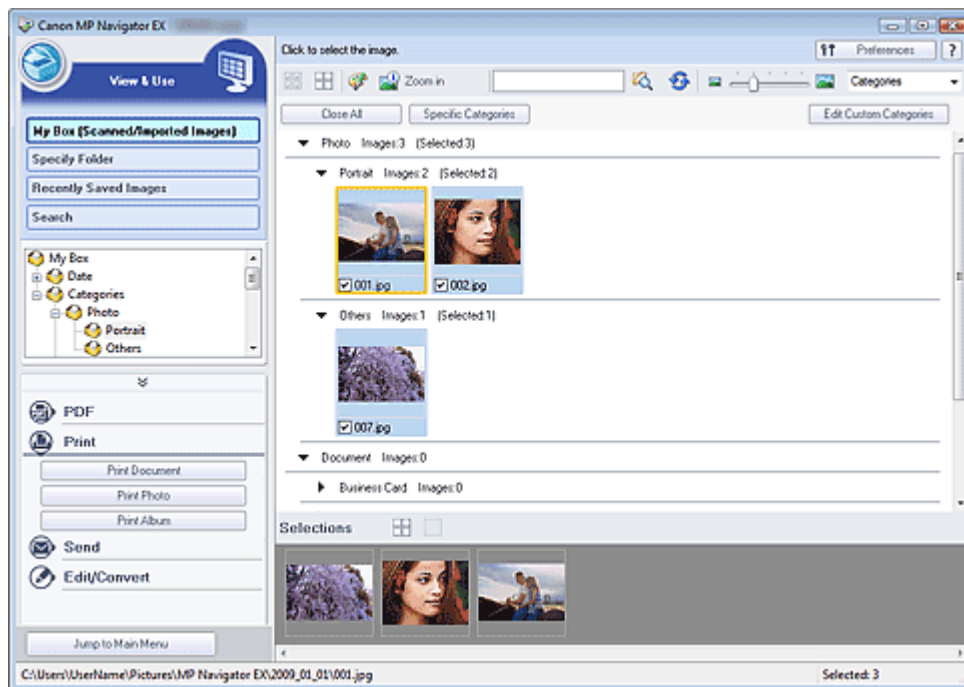

Note

- See "Let's Try Scanning" to scan images into MP Navigator EX.
- You can also select images saved on a memory card or computer.
 - ➡ Importing Images Saved on a Memory Card
 - ➡ Opening Images Saved on a Computer

When Printing Photos Using Easy-PhotoPrint EX

You can use Easy-PhotoPrint EX to print scanned photos at high quality or to layout and print images.

1. Select images and click Print.
2. Click Print Photo or Print Album on the list.
Easy-PhotoPrint EX starts. See "Printing Photos" for details.

Note

- If Easy-PhotoPrint EX is not installed, print with MP Navigator EX.

When Printing Photos Using MP Navigator EX

1. Select images and click Print.

2. Click Print Photo on the list.

3. Specify print settings as required.

In the displayed dialog box, specify paper size, print count, etc.

➔ Print Photo Dialog Box



4. Click Print.

Printing starts.

Note

- To cancel while spooling, click Cancel. To cancel while printing, click Cancel Printing in the confirmation window for the printer status. To open a confirmation window for the printer status, click printer icon on the taskbar.

[Page top](#) ↕

Advanced Guide

Advanced Guide > Scanning > Scanning with the Bundled Application Software > Utilizing Images in MP Navigator EX > Sending via E-mail

MP Navigator EX

Sending via E-mail

Send scanned images via e-mail.

Important

- MP Navigator EX is compatible with the following e-mail software programs:
 - Windows Mail (Windows Vista)
 - Outlook Express (Windows XP/Windows 2000)
 - Microsoft Outlook
 (If an e-mail software program does not operate properly, check that the program's MAPI is enabled. To enable MAPI, refer to the manual of the e-mail software program.)

1. Scan documents into MP Navigator EX and save them, then open the View & Use window from the Navigation Mode screen and select images.

Note

- See "Let's Try Scanning" to scan images into MP Navigator EX.
- You can also select images saved on a memory card or computer.
 - ➔ [Importing Images Saved on a Memory Card](#)
 - ➔ [Opening Images Saved on a Computer](#)

2. Click Send, then click Attach to E-mail on the list.

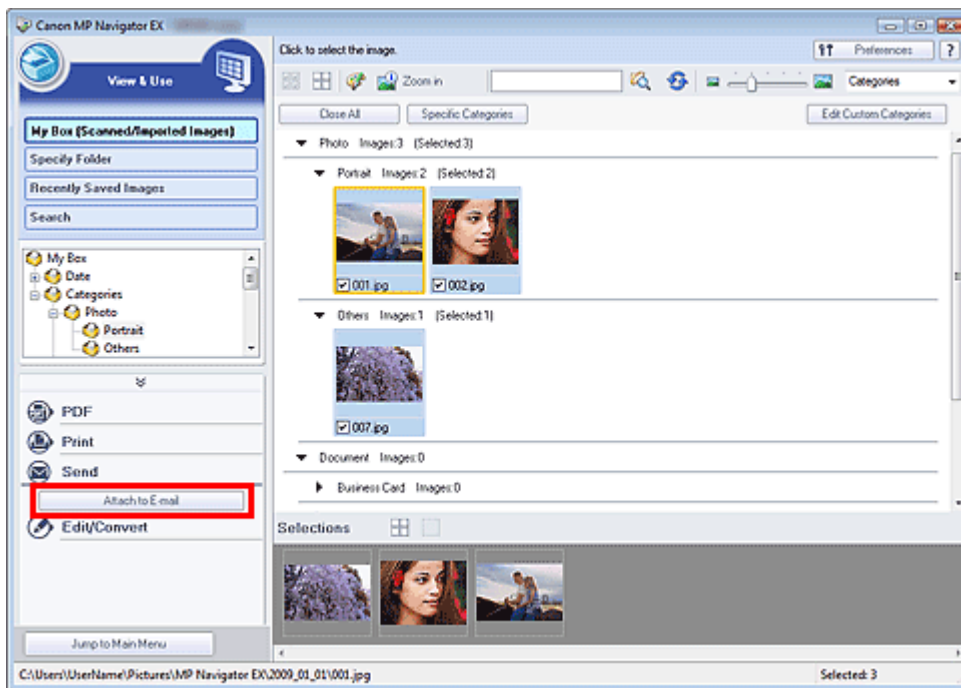

3. Set save options as required.
 - Specify the destination folder and file name.
 - ➔ [Send via E-mail Dialog Box](#)

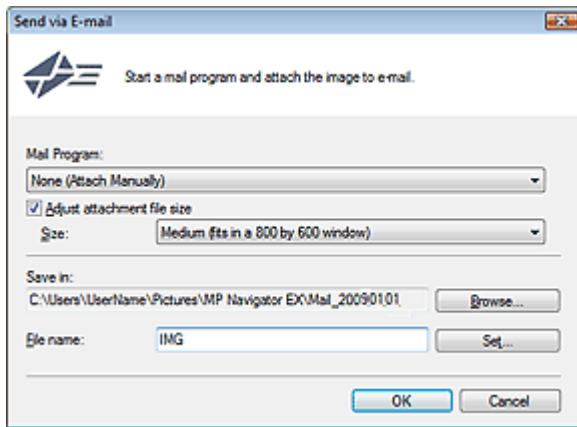

Note

- You can select a compression type when sending JPEG images via e-mail. Click Set... to open a dialog box and select a compression type from High(Low Compression), Standard or Low(High Compression).

4. Click OK.

Files are saved according to the settings, and the e-mail software program starts.

5. Specify the recipient, enter the subject and message, then send e-mail.

For details, refer to the manual of the e-mail software program.

[Page top](#)

Advanced Guide

Advanced Guide > Scanning > Scanning with the Bundled Application Software > Utilizing Images in MP Navigator EX > Editing Files

MP Navigator EX

Editing Files

You can edit images or convert them to text using MP Navigator EX or an application that accompanies the machine. After scanning documents and saving them, open the View & Use window to select what you want to do with the images.

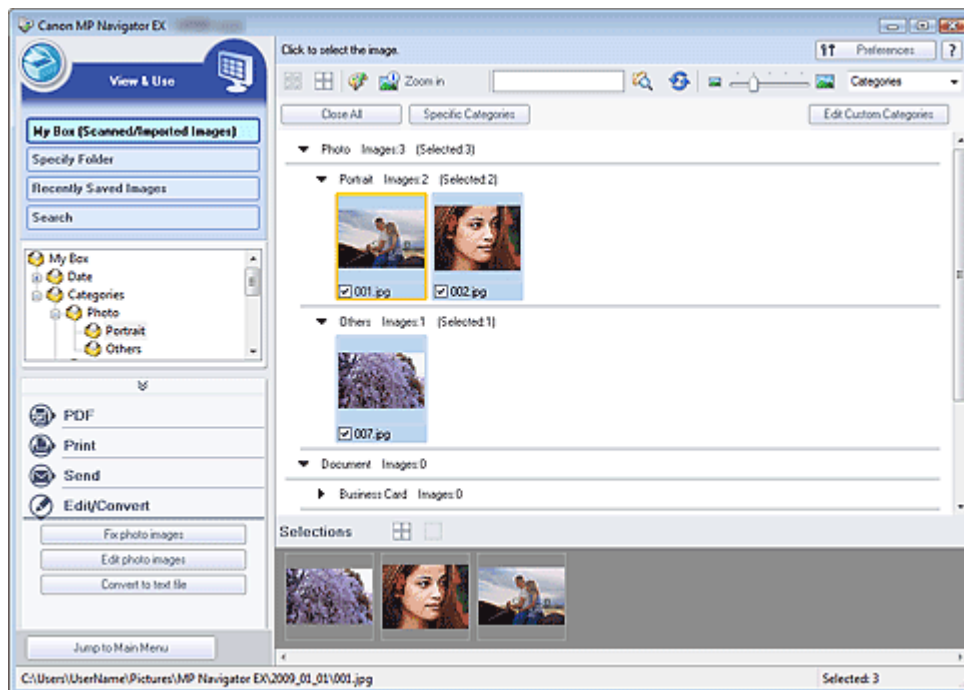

Note

- See "Let's Try Scanning" to scan images into MP Navigator EX.
- You can also select images saved on a memory card or computer.
 - ➡ Importing Images Saved on a Memory Card
 - ➡ Opening Images Saved on a Computer

Correcting Photo Images

You can correct/enhance images in the Correct/Enhance Images window.

1. Select images and click Edit/Convert.
2. Click Fix photo images on the list.
The Correct/Enhance Images window opens.
3. Correct/enhance images in the Correct/Enhance Images window.

Note

- See "Correct/Enhance Images Window" for details on the Correct/Enhance Images window.
- See the corresponding sections below for correcting/enhancing images.
 - ➡ Correcting/Enhancing Images Automatically
 - ➡ Correcting/Enhancing Images Manually

Editing Photograph Images

You can enhance images or correct colors using ArcSoft PhotoStudio.

© ArcSoft, Inc. All rights reserved for PhotoStudio.

1. Select images and click Edit/Convert.
2. Click Edit photo images on the list.
ArcSoft PhotoStudio starts.
3. Edit the images in ArcSoft PhotoStudio.
For details, refer to the ArcSoft PhotoStudio manual.

Converting Documents to Text

Scan text in scanned magazines and newspapers and display it in Notepad (included with Windows).

Important

- PDF files cannot be converted to text.

1. Select images and click Edit/Convert.
2. Click Convert to text file on the list.
Notepad (included with Windows) starts and editable text appears.

Note

- Only text written in languages that can be selected on the General tab can be extracted to Notepad (included with Windows). Click Set... on the General tab and specify the language according to the language of the document to be scanned.
When scanning multiple documents, you can collect the extracted text into one file.
[➔ General Tab](#)
- Text displayed in Notepad (included with Windows) is for guidance only. Text in the image of the following types of documents may not be detected correctly.
 - Documents containing text with font size outside the range of 8 points to 40 points (at 300 dpi)
 - Slanted documents
 - Documents placed upside down or documents with text in the wrong orientation (rotated characters)
 - Documents containing special fonts, effects, italics, or hand-written text
 - Documents with narrow line spacing
 - Documents with colors in the background of text
 - Documents containing multiple languages

Advanced Guide

Advanced Guide > Scanning > Scanning with the Bundled Application Software > Utilizing Images in MP Navigator EX > Setting Passwords for PDF Files

MP Navigator EX

Setting Passwords for PDF Files

Set passwords for opening, editing and printing PDF files.

You can set two passwords: one for opening the file and one for editing/printing it.

Important

- In Windows 2000, Internet Explorer 5.5 Service Pack 2 or later is required to use this function.
- You will not be able to open/edit the file if you forget the password. Record your passwords in a safe place for future reference.
- Password-protected PDF files cannot be opened in applications not supporting PDF security.
- In some applications, the commands (print, edit, etc.) restricted by Permissions Password may differ from those in MP Navigator EX.
- Password-protected PDF files cannot be searched by text from the "View & Use Window."

1. Scan documents into MP Navigator EX, then click Save as PDF file.
Alternatively, edit existing files in the Create/Edit PDF file window, then click Save Selected Pages or Save All Pages.

The Save as PDF file dialog box opens.

Important

- Passwords cannot be set when images are automatically saved after scanning, such as when scanning from the One-click Mode screen or scanning using the Operation Panel of the machine.

Note

- See "Let's Try Scanning" to scan images.
- See "Creating/Editing PDF Files" to create PDF files from existing images or to edit files.

2. Select the Password security settings checkbox.

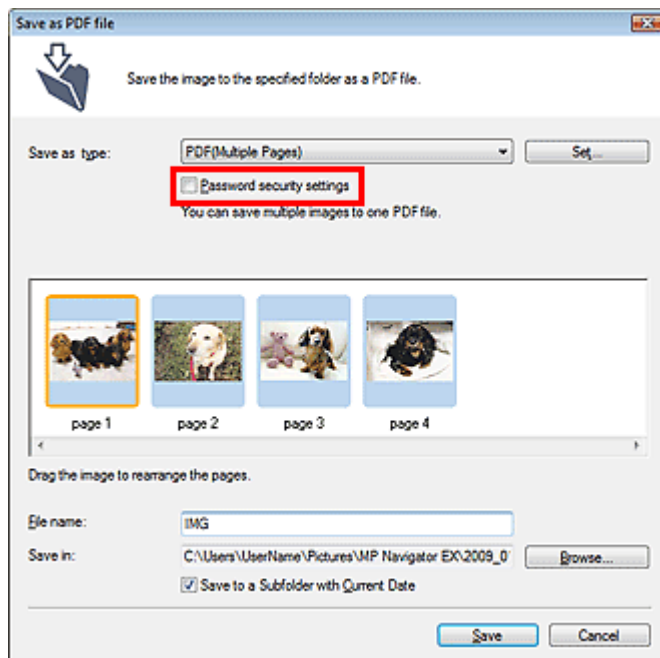

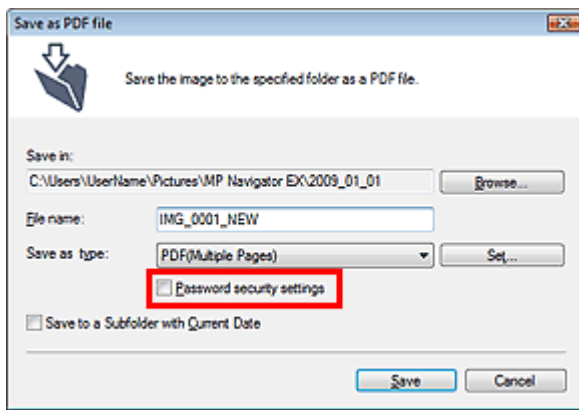

The Password Security -Settings dialog box opens.

Note

- You can also open the Password Security -Settings dialog box by clicking Set..., then selecting Password Security for Security in the PDF Settings dialog box.

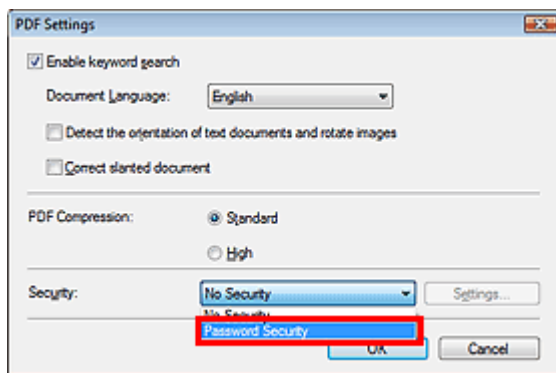

- Select the Require a password to open the document or Use a password to restrict printing and editing of the document and its security settings checkbox, then enter a password.

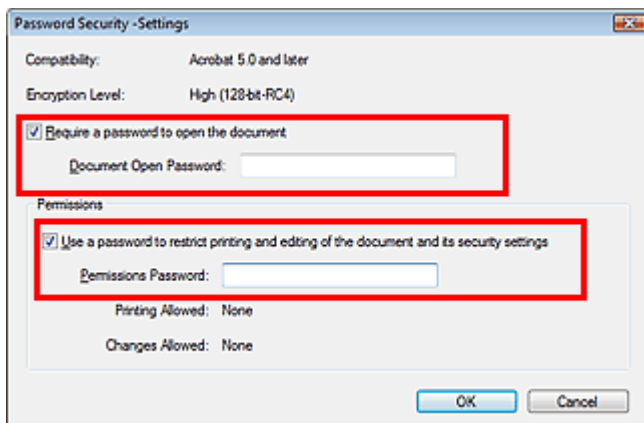

Important

- Up to 32 single-byte alphanumeric characters can be used for the password. Passwords are case sensitive.
- Select both checkboxes to set both Document Open Password and Permissions Password. You cannot use the same password for both.

- Click OK.

The Confirm Document Open Password or Confirm Permissions Password dialog box opens.

Document Open Password

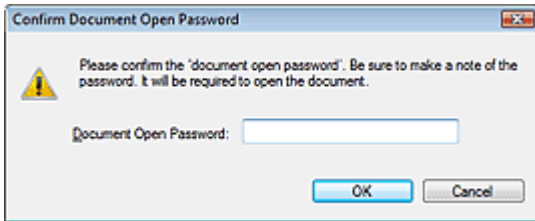

Permissions Password

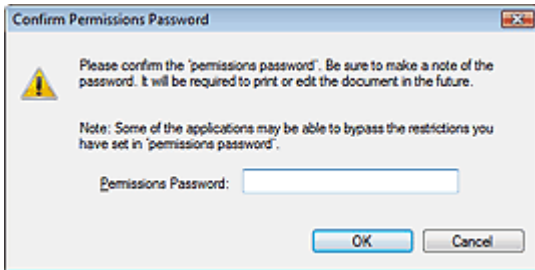

5. Re-enter the password and click OK.

The Save as PDF file dialog box returns.

Important

- If you close the Save as PDF file dialog box without clicking Save, the settings in the Password Security -Settings dialog box will be deleted.
- Passwords are deleted once the file is edited. Reset the passwords when saving edited files.

Note

- If you set the passwords via the PDF Settings dialog box, the PDF Settings dialog box returns. Click OK. The Save as PDF file dialog box returns.

6. Click Save.

Files are saved according to the settings.

Related Topic

- ▶ [Opening/Editing Password-protected PDF Files](#)

Advanced Guide

Advanced Guide > Scanning > Scanning with the Bundled Application Software > Utilizing Images in MP Navigator EX > Opening/Editing Password-protected PDF Files

MP Navigator EX

Opening/Editing Password-protected PDF Files

Enter a password to open or edit/print password-protected PDF files.

Password entry method varies by operation. The following procedures are examples only.

Important

- You can open, edit or print only PDF files whose passwords were set with MP Navigator EX. You cannot edit PDF files edited in other applications or whose passwords were set with other applications. Only MP Navigator EX version 1.1 and 2.0 or later supports opening, editing and printing password-protected PDF files.
- In Windows 2000, Internet Explorer 5.5 Service Pack 2 or later is required to open, edit or print password-protected PDF files.
- Passwords are case sensitive.
- You can create or edit up to 99 pages using MP Navigator EX.

Entering a Password to Open a File

1. In the View & Use window, select the PDF file you want to open and click  Zoom in.
Alternatively, double-click the PDF file.

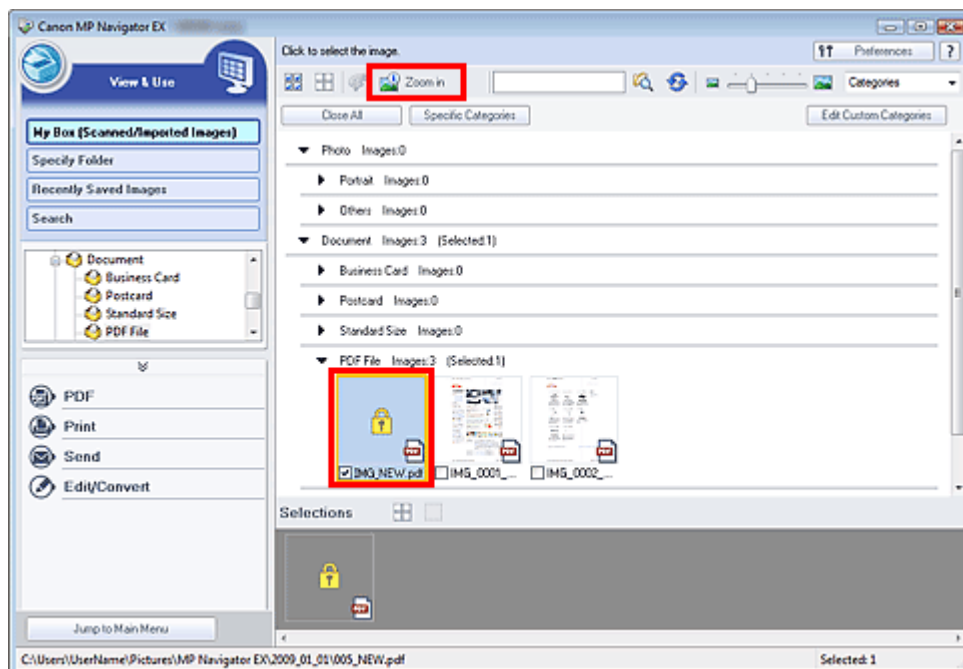

Note

- Only the Document Open Password will be required. The Permissions Password will not be required.
- If the Zoom in dialog box with a lock icon opens, click Enter Password.

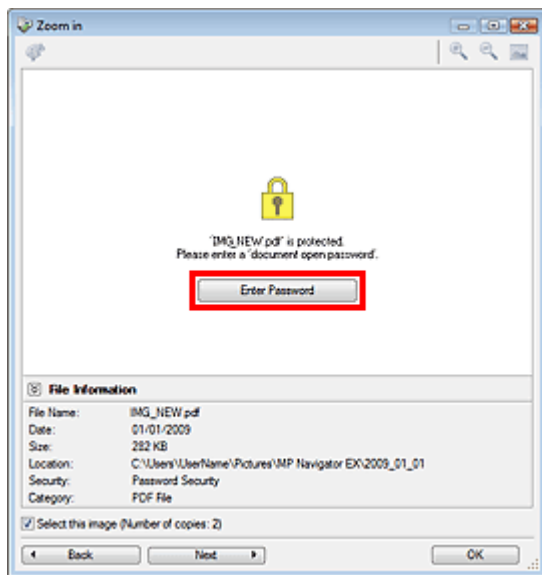

2. The Password dialog box opens. Enter the password and click OK.

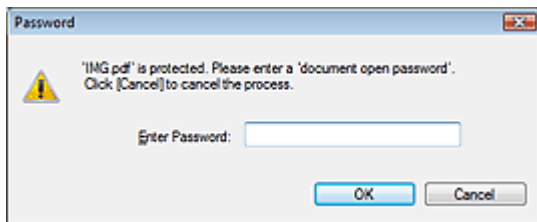

The PDF file opens in the Zoom in dialog box.

Note

- To reopen the file after closing the Zoom in dialog box, re-enter the password.

Entering a Password (Permissions Password) to Edit or Print a File

1. In the View & Use window, select PDF files and click PDF or Print.

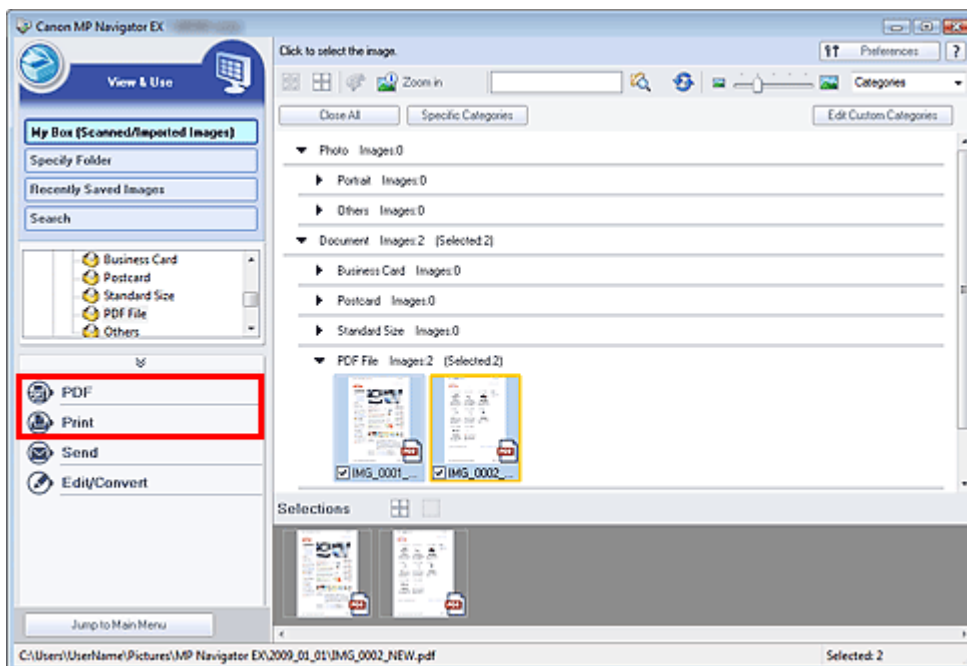

2. To create a PDF file or edit the file, select Create/Edit PDF file on the list. To print the file, click Print Document.

In the Password dialog box, you will be prompted to enter a password.

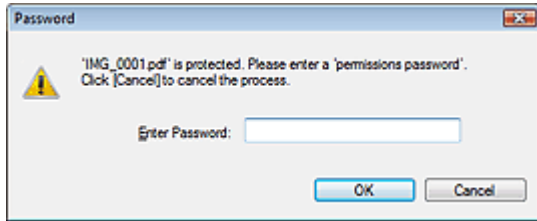

Note

- If the Document Open Password is set as well, the Document Open Password will be required, then the Permissions Password will be required.

3. Enter the password and click OK.

The corresponding dialog box opens.

Important

- If a password-protected PDF file is edited, the passwords will be deleted. Reset the passwords.
➔ [Setting Passwords for PDF Files](#)

Related Topic

- ▶ [Setting Passwords for PDF Files](#)

Advanced Guide

Advanced Guide > Scanning > Scanning with the Bundled Application Software > MP Navigator EX Screens

MP Navigator EX

MP Navigator EX Screens

Learn about the screens and functions of MP Navigator EX.

Scan/Import Documents or Images Tab

- ➡ Photos/Documents (Platen) Screen (Scan/Import Window)
 - Scan Settings Dialog Box (Photos/Documents)
 - Save Dialog Box
 - Save as PDF file Dialog Box
- ➡ Film Screen (Scan/Import Window)
 - Scan Settings Dialog Box (Film)
- ➡ Memory Card Screen (Scan/Import Window)

View & Use Images on your Computer Tab

- ➡ View & Use Window
 - Create/Edit PDF file Window
 - Print Document Dialog Box
 - Print Photo Dialog Box
 - Send via E-mail Dialog Box
 - Correct/Enhance Images Window

Custom Scan with One-click Tab / One-click Mode Screen

- ➡ Auto Scan Dialog Box
- ➡ Save Dialog Box (One-click Mode Screen)
- ➡ PDF Dialog Box
- ➡ Mail Dialog Box
- ➡ Film Dialog Box
- ➡ OCR Dialog Box
- ➡ Custom Dialog Box

Preferences Dialog Box

- ➡ General Tab
- ➡ Scanner Button Settings Tab (Save)
- ➡ Scanner Button Settings Tab (Attach to E-mail)
- ➡ Scanner Button Settings Tab (Open with Application)

Advanced Guide

Advanced Guide > Scanning > Scanning with the Bundled Application Software > MP Navigator EX Screens > Navigation Mode Screen

MP Navigator EX

Navigation Mode Screen

This is one of the startup screens of MP Navigator EX.

Point to the icon at the top of the screen to display each tab. Use each tab depending on what you want to do.

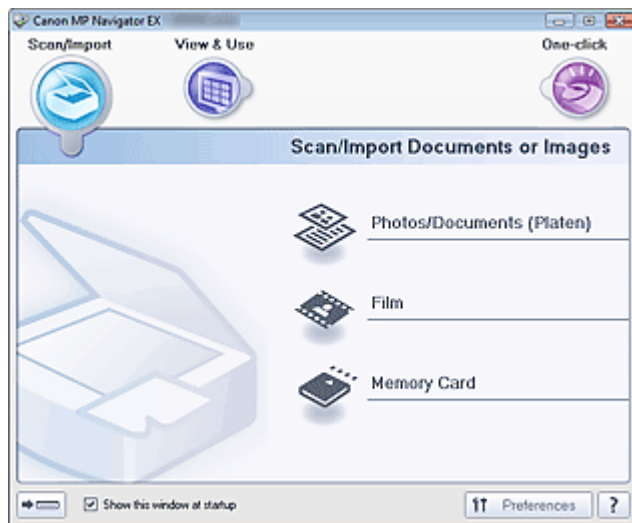

- **Scan/Import**

You can scan photos and documents, or import images saved on memory cards.

➔ [Scan/Import Documents or Images Tab](#)

- **View & Use**

You can open images saved on a computer and print them or attach them to e-mail. You can also edit them using an application that accompanies the machine.

➔ [View & Use Images on your Computer Tab](#)

- **One-click**

You can complete from scanning to saving, etc. at one time by simply clicking the corresponding icon.

➔ [Custom Scan with One-click Tab](#)



- **(Switch Mode)**

Switches to One-click Mode screen. In the One-click Mode screen, you can complete from scanning to saving, etc. at one time by simply clicking the corresponding icon.

➔ [One-click Mode Screen](#)

- **Show this window at startup**

Select this checkbox to open the Main Menu at startup. If this checkbox is not selected, the last used screen appears.



- **Preferences**

The Preferences dialog box opens. In the Preferences dialog box, you can make advanced settings to MP Navigator EX functions.

➔ [Preferences Dialog Box](#)



- **(Guide)**

Opens this guide.

Advanced Guide

Advanced Guide > Scanning > Scanning with the Bundled Application Software > MP Navigator EX Screens > Scan/Import Documents or Images Tab

MP Navigator EX

Scan/Import Documents or Images Tab

Point to Scan/Import in the Navigation Mode screen to display the Scan/Import Documents or Images tab.

You can scan photos, documents and film, or import images saved on memory cards.

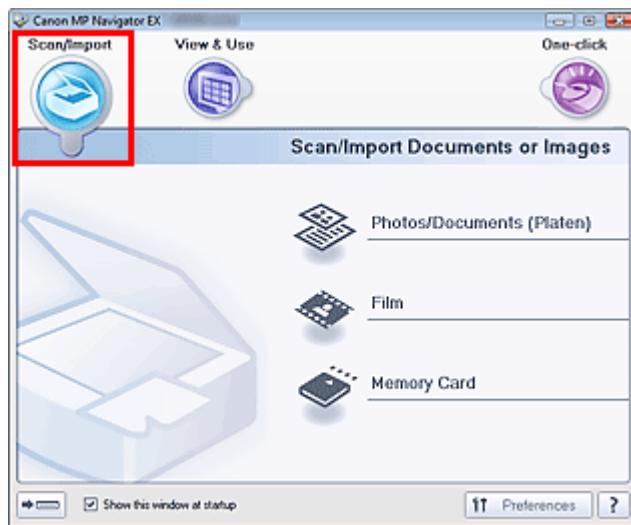

- **Photos/Documents (Platen)**

Opens the Scan/Import window. Scan photos and documents placed on the Platen.

➔ [Photos/Documents \(Platen\) Screen \(Scan/Import Window\)](#)

- **Film**

Opens the Scan/Import window. Scan film placed on the Platen.

➔ [Film Screen \(Scan/Import Window\)](#)

- **Memory Card**

Opens the Scan/Import window with Memory Card selected. Import images saved on memory cards.

➔ [Memory Card Screen \(Scan/Import Window\)](#)

-  **(Switch Mode)**

Switches to One-click Mode screen. In the One-click Mode screen, you can complete from scanning to saving, etc. at one time by simply clicking the corresponding icon.

➔ [One-click Mode Screen](#)

- **Show this window at startup**

Select this checkbox to open the Main Menu at startup. If this checkbox is not selected, the last used screen appears.

-  **Preferences**

The Preferences dialog box opens. In the Preferences dialog box, you can make advanced settings to MP Navigator EX functions.

➔ [Preferences Dialog Box](#)

-  **(Guide)**

Opens this guide.

Advanced Guide

Advanced Guide > Scanning > Scanning with the Bundled Application Software > MP Navigator EX Screens > View & Use Images on your Computer Tab

MP Navigator EX

View & Use Images on your Computer Tab

Point to View & Use in the Navigation Mode screen to display the View & Use Images on your Computer tab.

You can open images saved on a computer and print them or attach them to e-mail. You can also edit them using an application that accompanies the machine.

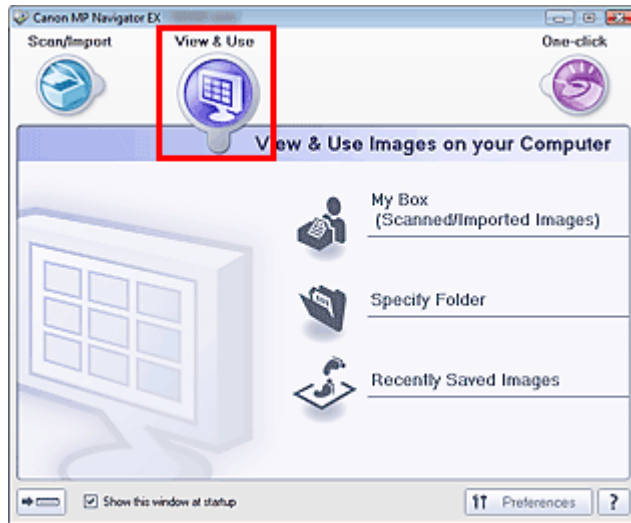

- **My Box (Scanned/Imported Images)**

Opens the View & Use window with My Box (Scanned/Imported Images) selected.

You can open and use images saved in My Box.

My Box is a specific folder for saving images scanned with MP Navigator EX.

Note

- The following folders are specified by default.
 - Windows Vista: MP Navigator EX folder in Pictures folder
 - Windows XP: MP Navigator EX folder in My Pictures folder
 - Windows 2000: MP Navigator EX folder in My Pictures folder

- **Specify Folder**

Opens the View & Use window with Specify Folder selected.

You can open and use images saved in specific folders.

- **Recently Saved Images**

Opens the View & Use window with Recently Saved Images selected.

You can open and use "Scanned/Imported Images" and images that have been "Attached to E-mail" or "Sent to Application" recently.

➔ [View & Use Window](#)

-  **(Switch Mode)**

Switches to One-click Mode screen. In the One-click Mode screen, you can complete from scanning to saving, etc. at one time by simply clicking the corresponding icon.

➔ [One-click Mode Screen](#)

- **Show this window at startup**

Select this checkbox to open the Main Menu at startup. If this checkbox is not selected, the last used screen appears.

-  **Preferences**

The Preferences dialog box opens. In the Preferences dialog box, you can make advanced settings to MP Navigator EX functions.

[➔ Preferences Dialog Box](#)

-  (Guide)

Opens this guide.

Related Topic

[▶ Opening Images Saved on a Computer](#)

[Page top](#) 

Advanced Guide

Advanced Guide > Scanning > Scanning with the Bundled Application Software > MP Navigator EX Screens > Custom Scan with One-click Tab

MP Navigator EX

Custom Scan with One-click Tab

Point to One-click in the Navigation Mode screen to display the Custom Scan with One-click tab.

You can complete from scanning to saving, etc. at one time by simply clicking the corresponding icon.

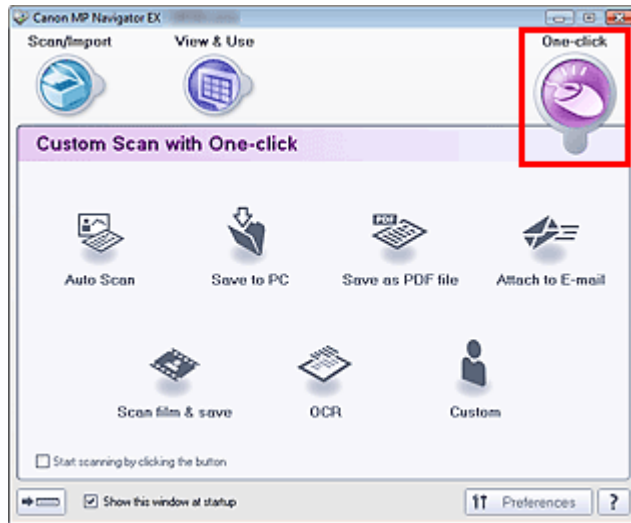

- **Auto Scan**

Scan documents by automatically detecting the document type. File format is automatically set. Files are saved to a computer. You can apply Auto Photo Fix as required.

When you click this icon, the Auto Scan dialog box opens and you can specify the save settings.

➔ [Auto Scan Dialog Box](#)

- **Save to PC**

Scan documents or photos and save them to a computer. The document type can be detected automatically.

When you click this icon, the Save dialog box opens and you can specify the scan/save settings.

➔ [Save Dialog Box \(One-click Mode Screen\)](#)

- **Save as PDF file**

Scan documents and save them as PDF files.

When you click this icon, the PDF dialog box opens and you can specify the scan/save and application settings.

➔ [PDF Dialog Box](#)

- **Attach to E-mail**

Scan documents or photos and attach them to e-mail.

When you click this icon, the Mail dialog box opens and you can specify the scan/save and e-mail software program settings.

➔ [Mail Dialog Box](#)

- **Scan film & save**

Scan film and save to a computer.

When you click this icon, the Film dialog box opens and you can specify the scan/save settings.

➔ [Film Dialog Box](#)

- **OCR**

Scan text documents then extract text in the image and display it in Notepad (included with Windows).

When you click this icon, the OCR dialog box opens and you can specify the scan/save settings.

➔ [OCR Dialog Box](#)

 **Note**

- For further procedures, refer to the application's manual.
-

- **Custom**

Scan documents and open them in a specified application. Document type is automatically detected. When you click this icon, the Custom dialog box opens and you can specify the scan/save and application settings.

➔ [Custom Dialog Box](#)

Note

- For further procedures, refer to the application's manual.
-

- **Start scanning by clicking the button**

Select this checkbox and click an icon to start scanning immediately.



- **(Switch Mode)**

Switches to One-click Mode. The One-click Mode screen appears.

➔ [One-click Mode Screen](#)

- **Show this window at startup**

Select this checkbox to open the Main Menu at startup. If this checkbox is not selected, the last used screen appears.



- **Preferences**

The Preferences dialog box opens. In the Preferences dialog box, you can make advanced settings to MP Navigator EX functions.

➔ [Preferences Dialog Box](#)



- **(Guide)**

Opens this guide.

Important

- The following restrictions apply when you scan with Document Type set to Auto Mode in the Save or Custom dialog box.
When you want to convert text in the scanned image to text data, specify Document Type (do not select Auto Mode).

Related Topic

▶ [Easy Scanning with One-click](#)

Advanced Guide

Advanced Guide > Scanning > Scanning with the Bundled Application Software > MP Navigator EX Screens > Photos/Documents (Platen) Screen (Scan/Import Window)

MP Navigator EX

Photos/Documents (Platen) Screen (Scan/Import Window)

Point to Scan/Import in the Navigation Mode screen and click Photos/Documents (Platen) to open the Photos/Documents (Platen) screen (Scan/Import window).

Open this window to scan documents from the Platen.

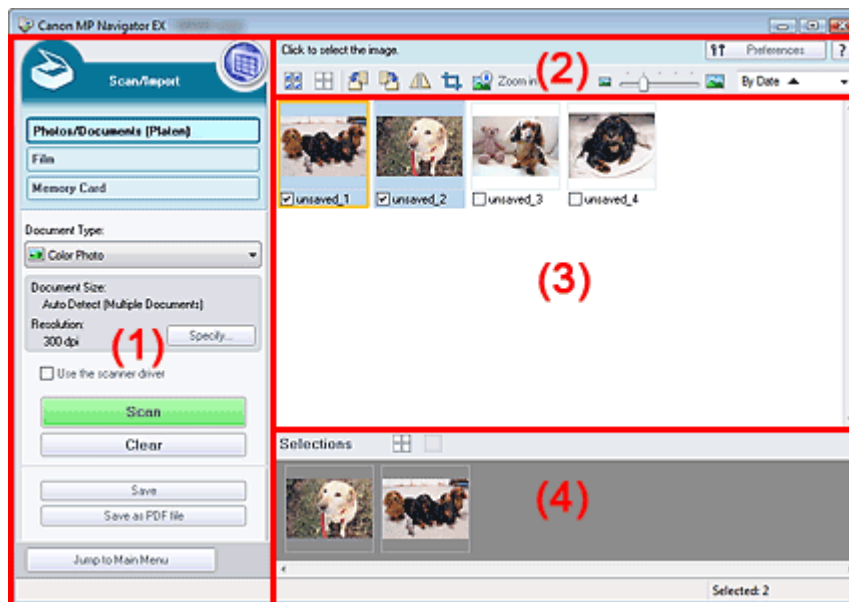

- (1) Settings and Operation Buttons
- (2) Toolbar
- (3) Thumbnail Window
- (4) Selected Images Area

Settings and Operation Buttons

-  **(View & Use)**
Click this when you want to open images and PDF files saved on your computer. The View & Use window opens.
➔ [View & Use Window](#)
- **Photos/Documents (Platen)**
Displays the screen for scanning photos, documents, magazines and other printed materials.
- **Film**
Click this when you want to scan film. The screen for scanning film appears.
➔ [Film Screen \(Scan/Import Window\)](#)
- **Memory Card**
Click this when you want to import images saved on a memory card. The screen for importing images from a memory card appears.
➔ [Memory Card Screen \(Scan/Import Window\)](#)
- **Document Type**
Select the type of document to be scanned.
Scanning photos: Color Photo or Black and White Photo

Scanning text documents: Color Document, Black and White Document or Text(OCR)
 Scanning magazines: Magazine(Color)

Important

- You cannot select Document Type if the Use the scanner driver checkbox is selected.

• Specify...

Specify the document size, resolution, and other advanced scan settings.

➔ [Scan Settings Dialog Box \(Photos/Documents\)](#)

Important

- Specify... is not available if the Use the scanner driver checkbox is selected.

• Use the scanner driver

Select this checkbox when you want to scan with ScanGear (scanner driver). Use ScanGear (scanner driver) to correct images and adjust colors when scanning.

• Scan

Scanning starts.

Note

- This button changes to Open Scanner Driver when you select the Use the scanner driver checkbox.

• Open Scanner Driver

ScanGear (scanner driver) starts.

See "[ScanGear \(Scanner Driver\) Screens](#)" for details on ScanGear (scanner driver) screens.

Note

- This button changes to Scan when you deselect the Use the scanner driver checkbox.

• Clear

Delete all images in the Thumbnail window.

Note

- Images not saved on a computer will be deleted. To keep important images, use Save or other methods to save them to a computer before clicking Clear.

• Save

Save the selected images. Click to open the Save dialog box and specify the save settings.

➔ [Save Dialog Box](#)

• Save as PDF file

Save the selected images as PDF files. Click to open the Save as PDF file dialog box and specify the save settings.

➔ [Save as PDF file Dialog Box](#)

• **Jump to Main Menu**

Jumps to the Main Menu.

Toolbar

• **Preferences**









The Preferences dialog box opens. In the Preferences dialog box, you can make advanced settings to MP Navigator EX functions.

➔ [Preferences Dialog Box](#)

• **(Guide)**

Opens this guide.

- **Edit Tools**

-  **(Select All)**
Selects all images in the Thumbnail window.
-  **(Cancel All)**
Cancels all image selections in the Thumbnail window.
-  **(Rotate Left)**
Rotates the target image (outlined in orange) 90 degrees counter-clockwise.
-  **(Rotate Right)**
Rotates the target image (outlined in orange) 90 degrees clockwise.
-  **(Invert)**
Inverts the target image (outlined in orange) horizontally.
-  **(Trimming)**
Trims the target image (outlined in orange) in the Thumbnail window. Trimming is the act of selecting the area you want to keep in a photo and discarding the rest. Click this button to open the Crop window and specify the trimming frame.
-  **Zoom in**
Enlarges the target image (outlined in orange). You can also enlarge the image by double-clicking it.
-  **(Display Size)**
Changes the size of images in the Thumbnail window.
-  **(Sort by)**
Sorts the images in the Thumbnail window by category or by date (ascending or descending).

Thumbnail Window

- **Thumbnail Window**

Scanned images are displayed.

When you select the checkbox of an image, the image appears in the Selected Images area.

Note

- Thumbnails may appear as "?" when there is not enough memory to display the images.

When Images are Sorted by Categories



- **Close All / Open All**

-  **Close All**
Hides all images.
-  **Open All**
Displays all images.

Note

- Click Close All to change to Open All.

Selected Images Area

-  **(Cancel All)**
Cancels the selection of all images in the Selected Images area.
-  **(Cancel Selection)**
Cancels the selection of the target image (outlined in orange) in the Selected Images area.
- **Selected Images Area**
Images selected in the Thumbnail window are displayed.

Related Topic

- ▶ [Scanning Photos and Documents](#)

[Page top](#) 

Advanced Guide

Advanced Guide > Scanning > Scanning with the Bundled Application Software > MP Navigator EX Screens > Scan Settings Dialog Box (Photos/Documents)

MP Navigator EX

Scan Settings Dialog Box (Photos/Documents)

The Scan Settings dialog box opens when you click Specify... in the Scan/Import window.

In the Scan Settings dialog box, you can make advanced scan settings.

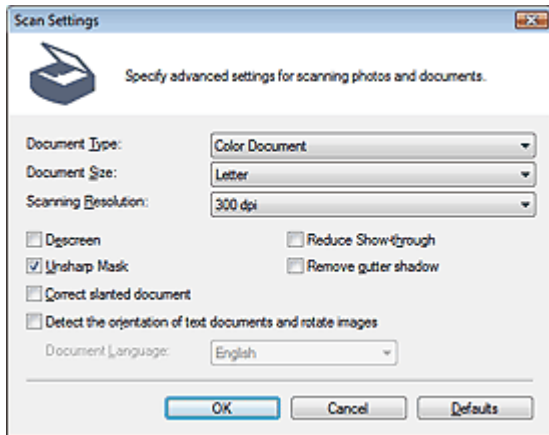

• Document Type

Select the type of document to be scanned.

Scanning photos: Color Photo or Black and White Photo

Scanning text documents: Color Document, Black and White Document or Text(OCR)

Scanning magazines: Magazine(Color)

▶ Important

- To scan correctly, select a document type that matches the document to be scanned.
- You cannot select Text(OCR) when Compress scanned images when transferring checkbox is selected on the "General Tab" of the Preferences dialog box.

• Document Size

Select the size of the document to be scanned.

When you select Custom, a screen in which you can specify the document size appears. Select a Units, then enter the Width and Height and click OK.

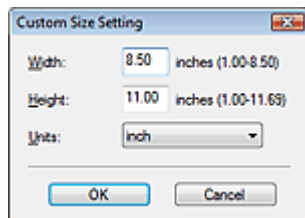

▶ Important

- When you select Auto Detect, the image may not be scanned at the correct position and size. In that case, change the size to the actual document size (A4, Letter, etc.) and align a corner of the document with the corner at the arrow (alignment mark) of the Platen.
- You cannot select Auto Detect (Multiple Documents) or Auto Detect when Document Type is Text(OCR).

• Scanning Resolution

Select the resolution at which to scan documents.

➔ Resolution

 **Note**

- The following scanning resolutions can be specified when Document Type is Text(OCR).
300 dpi / 400 dpi

- **Descreen**

Select this checkbox to reduce moire patterns.

Printed photos and pictures are displayed as a collection of fine dots. "Moire" is a phenomenon where uneven gradation or a stripe pattern appears when such photos or pictures printed with fine dots are scanned. Descreen is the function for reducing this moire effect.

 **Important**

- You cannot select this checkbox when Document Type is Color Photo, Black and White Photo or Text(OCR).

 **Note**

- Scanning takes longer than usual when you enable Descreen.

- **Reduce Show-through**

Select this checkbox to sharpen text in a document or reduce show-through in newspapers.

 **Important**

- You cannot select this checkbox when Document Type is Color Photo, Black and White Photo or Text(OCR).

 **Note**

- Select this checkbox when Document Type is text document and show-through is apparent in the scanned image.

- **Unsharp Mask**

Select this checkbox to emphasize the outline of the subjects and sharpen the image.

 **Important**

- You cannot select this checkbox when Document Type is Text(OCR).

- **Remove gutter shadow**

Select this checkbox to correct shadows that appear between pages when scanning open booklets.

 **Important**

- You cannot select this checkbox when Document Size is Auto Detect, Auto Detect (Multiple Documents) or Stitch Assist.
- You cannot select this checkbox when Compress scanned images when transferring checkbox is selected on the "**General Tab**" of the Preferences dialog box.
- Align the document correctly with the alignment mark on the Platen.

 **Note**

- Use ScanGear's Advanced Mode tab to correct gutter shadows when scanning non-standard size documents or when custom cropping frames are set.
For details, see Gutter Shadow Correction in "**Image Settings**" (ScanGear's Advanced Mode tab).

- **Correct slanted document**

Select this checkbox to detect the scanned text and correct the angle (within -0.1 to -10 degrees or +0.1 to +10 degrees) of the document.

 **Important**

- You cannot select this checkbox when Document Type is Color Photo or Black and White Photo.
- You cannot select this checkbox when Document Size is Stitch Assist.
- The inclination of the following types of documents may not be corrected, as the text cannot be detected correctly.

- Documents in which the text lines are inclined more than 10 degrees or the angles vary by line
- Documents containing both vertical and horizontal text
- Documents with extremely large or small fonts
- Documents with small amount of text
- Documents containing figures/images or hand-written text
- Documents containing both vertical and horizontal lines (tables)

Note

- Scanning takes longer than usual when you enable Correct slanted document.

• **Detect the orientation of text documents and rotate images**

Select this checkbox to detect the orientation of the document from the scanned text and rotate the scanned image to the correct orientation. Select the language of the document to be scanned in Document Language.

Important

- You cannot select this checkbox when Document Type is Color Photo or Black and White Photo.
- You cannot select this checkbox when Document Size is Stitch Assist.
- This function may not work properly depending on the document language. Only text documents written in languages that can be selected from Document Language are supported.
- The orientation of the following types of documents may not be corrected, as the text cannot be detected correctly. In that case, select the scanned image in the Thumbnail window of the " [Photos/Documents \(Platen\) Screen \(Scan/Import Window\)](#) " and rotate it with Edit Tools.
 - Resolution is outside the range of 300 dpi to 600 dpi
 - Font size is outside the range of 8 points to 48 points
 - Documents containing special fonts, effects, italics, or hand-written text
 - Documents with patterned backgrounds

Note

- Scanning takes longer than usual when you enable Detect the orientation of text documents and rotate images.

• **Document Language**

Select the language of the document to be scanned.

Important

- You cannot select this checkbox when Document Type is Color Photo or Black and White Photo.
- You cannot select this checkbox when Document Size is Stitch Assist.

• **Defaults**

Restores the default settings.

Advanced Guide

Advanced Guide > Scanning > Scanning with the Bundled Application Software > MP Navigator EX Screens > Film Screen (Scan/Import Window)

MP Navigator EX

Film Screen (Scan/Import Window)

Point to Scan/Import in the Navigation Mode screen and click Film, or click Film in the Scan/Import window to open the Film screen (Scan/Import window).

Open this window to scan film from the Platen.

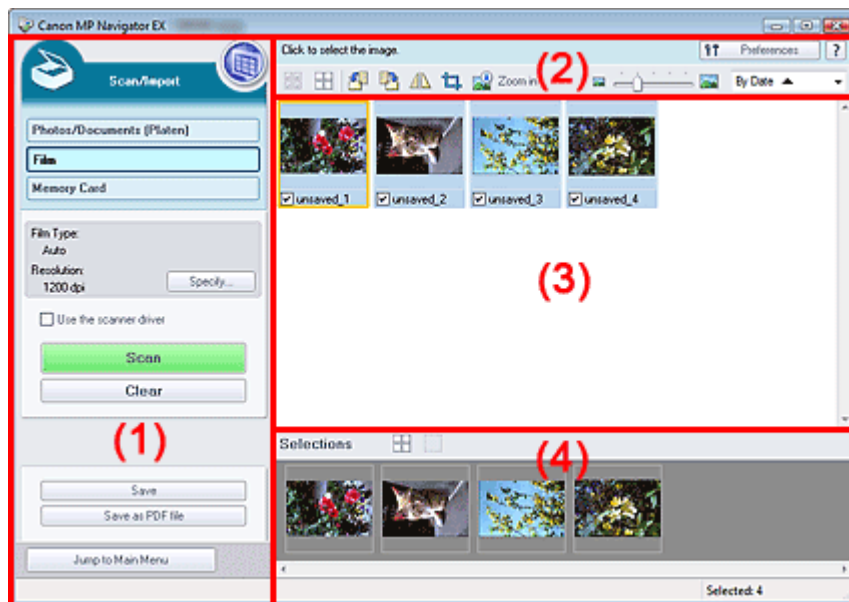

- (1) Settings and Operation Buttons
- (2) Toolbar
- (3) Thumbnail Window
- (4) Selected Images Area

Settings and Operation Buttons

-  **(View & Use)**
Click this when you want to open images and PDF files saved on your computer. The View & Use window opens.
➔ [View & Use Window](#)
- **Photos/Documents (Platen)**
Click this when you want to scan photos, documents, magazines and other printed materials. The screen for scanning photos and documents appears.
➔ [Photos/Documents \(Platen\) Screen \(Scan/Import Window\)](#)
- **Film**
Displays the screen for scanning film.
- **Memory Card**
Click this when you want to import images saved on a memory card. The screen for importing images from a memory card appears.
➔ [Memory Card Screen \(Scan/Import Window\)](#)
- **Specify...**
Specify the film type, resolution, and other advanced scan settings.

➔ [Scan Settings Dialog Box \(Film\)](#)

Important

- Specify... is not available if the Use the scanner driver checkbox is selected.

- **Use the scanner driver**

Select this checkbox when you want to scan with ScanGear (scanner driver). Use ScanGear (scanner driver) to correct images and adjust colors when scanning.

- **Scan**

Scanning starts.

Note

- This button changes to Open Scanner Driver when you select the Use the scanner driver checkbox.

- **Open Scanner Driver**

ScanGear (scanner driver) starts.

See "[ScanGear \(Scanner Driver\) Screens](#)" for details on ScanGear (scanner driver) screens.

Note

- This button changes to Scan when you deselect the Use the scanner driver checkbox.

- **Clear**

Delete all images in the Thumbnail window.

Note

- Images not saved on a computer will be deleted. To keep important images, use Save or other methods to save them to a computer before clicking Clear.

- **Save**

Save the selected images. Click to open the Save dialog box and specify the save settings.

➔ [Save Dialog Box](#)

- **Save as PDF file**

Save the selected images as PDF files. Click to open the Save as PDF file dialog box and specify the save settings.

➔ [Save as PDF file Dialog Box](#)

-  **Jump to Main Menu**

Jumps to the Main Menu.

Toolbar

-  **Preferences**

The Preferences dialog box opens. In the Preferences dialog box, you can make advanced settings to MP Navigator EX functions.

➔ [Preferences Dialog Box](#)

-  **(Guide)**

Opens this guide.







- **Edit Tools**

-  **(Select All)**

Selects all images in the Thumbnail window.

-  **(Cancel All)**

Cancels all image selections in the Thumbnail window.

-  **(Rotate Left)**
Rotates the target image (outlined in orange) 90 degrees counter-clockwise.
-  **(Rotate Right)**
Rotates the target image (outlined in orange) 90 degrees clockwise.
-  **(Invert)**
Inverts the target image (outlined in orange) horizontally.
-  **(Trimming)**
Trims the target image (outlined in orange) in the Thumbnail window. Trimming is the act of selecting the area you want to keep in a photo and discarding the rest. Click this button to open the Crop window and specify the trimming frame.
-  **Zoom in**
Enlarges the target image (outlined in orange). You can also enlarge the image by double-clicking it.
-  **(Display Size)**
Changes the size of images in the Thumbnail window.
-  **(Sort by)**
Sorts the images in the Thumbnail window by category or by date (ascending or descending).



Thumbnail Window

- **Thumbnail Window**
Scanned images are displayed.
When you select the checkbox of an image, the image appears in the Selected Images area.

Note

- Thumbnails may appear as "?" when there is not enough memory to display the images.



When Images are Sorted by Categories

- **Close All / Open All**
 -  **Close All**
Hides all images.
 -  **Open All**
Displays all images.

Note

- When you click Close All, the button changes to Open All.

Selected Images Area

-  **(Cancel All)**
Cancels the selection of all images in the Selected Images area.
-  **(Cancel Selection)**
Cancels the selection of the target image (outlined in orange) in the Selected Images area.
- **Selected Images Area**

Images selected in the Thumbnail window are displayed.

Related Topic

▶ [Scanning Film](#)

[Page top](#) ↕

Advanced Guide

Advanced Guide > Scanning > Scanning with the Bundled Application Software > MP Navigator EX Screens > Scan Settings Dialog Box (Film)

MP Navigator EX

Scan Settings Dialog Box (Film)

The Scan Settings dialog box opens when you click Specify... in the Scan/Import window.

In the Scan Settings dialog box, you can make advanced scan settings.

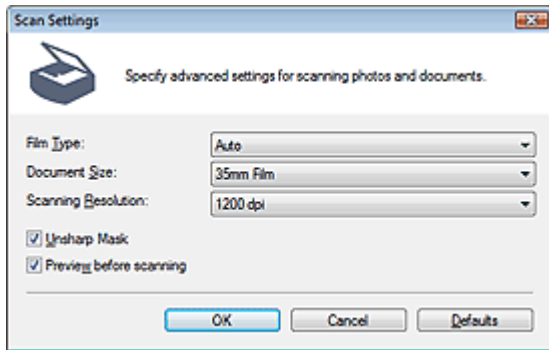

- **Film Type**

Select the type of film to be scanned.

Important

- Film may not be scanned correctly when Auto is selected. In that case, select the type of film and scan again.

Note

- To scan black and white film, it is recommended that you select Black and White Negative Film or Black and White Positive Film.

- **Document Size**

35mm Film is displayed.

Note

- To scan mounted negative slides, scan from the Advanced Mode tab of ScanGear (scanner driver).
[➔ Scanning Film in Advanced Mode](#)

- **Scanning Resolution**

Select the resolution at which to scan film.

[➔ Resolution](#)

- **Unsharp Mask**

Select this checkbox to emphasize the outline of the subjects and sharpen the image.

- **Preview before scanning**

Select this checkbox, then perform a scan to display preview image before scanning. In the preview screen, click Cancel to return to the MP Navigator EX screen, or click Scan to start scanning the selected frame.

- **Defaults**

Restores the default settings.

Advanced Guide

Advanced Guide > Scanning > Scanning with the Bundled Application Software > MP Navigator EX Screens > Save Dialog Box

MP Navigator EX

Save Dialog Box

The Save dialog box opens when you click Save in the Scan/Import window.

In the Save dialog box, you can make settings for saving images to a computer.

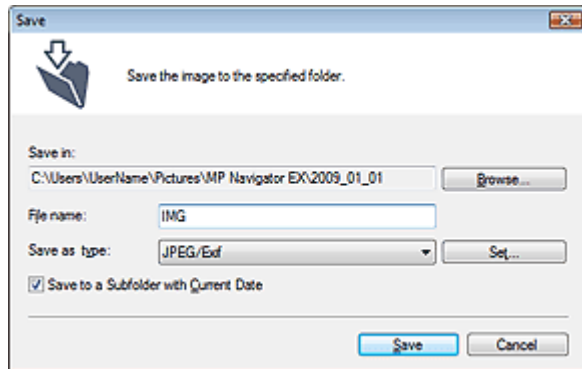

- **Save in**

Displays the folder in which to save the scanned images. To change the folder, click Browse... to specify another one.

The following folders are specified by default.

Windows Vista: MP Navigator EX folder in Pictures folder

Windows XP: MP Navigator EX folder in My Pictures folder

Windows 2000: MP Navigator EX folder in My Pictures folder

Important

- When saving to a memory card, enable writing on the Card Slot of the machine. For details on how to enable writing, refer to "[Setting Up the Card Slot as the Memory Card Drive of the Computer.](#)" With network connection, map the Card Slot as a network drive. See "[Using the Card Slot over a Network](#)" for details.

- **File name**

Enter the file name of the image to be saved (up to 64 characters). When saving multiple files, 4 digits are appended to each file name.

- **Save as type**

Select a file type to save the scanned images.

Select JPEG/Exif, TIFF or BMP.

Important

- You cannot select JPEG/Exif when Document Type is Text(OCR).
- When saving 48 bit color or 16 bit grayscale images scanned with ScanGear (scanner driver), select TIFF. If you select a format other than TIFF, they will be saved as 24 bit color or 8 bit grayscale images.

- **Set...**

When Save as type is JPEG/Exif

You can specify a compression type for JPEG files. Select High(Low Compression), Standard or Low(High Compression).

Important

- This setting is not available when the Compress scanned images when transferring checkbox is

selected on the General tab of the Preferences dialog box.

- **Save to a Subfolder with Current Date**

Select this checkbox to create a subfolder in the folder specified in Save in with the current date and save scanned files in it. A subfolder with a name such as "2009_01_01" (Year_Month_Date) will be created.

If this checkbox is not selected, files are saved directly in the folder specified in Save in.

[Page top](#) ↕

Advanced Guide

Advanced Guide > Scanning > Scanning with the Bundled Application Software > MP Navigator EX Screens > Save as PDF file Dialog Box

MP Navigator EX

Save as PDF file Dialog Box

In the Save as PDF file dialog box, you can make advanced settings for saving scanned images as PDF files. You can save multiple documents as one PDF file or add pages to a PDF file created with MP Navigator EX.

Important

- You cannot save images scanned at 10501 pixels or more in the vertical and horizontal directions.

Dialog box that opens when Save as PDF file in the Scan/Import window is clicked

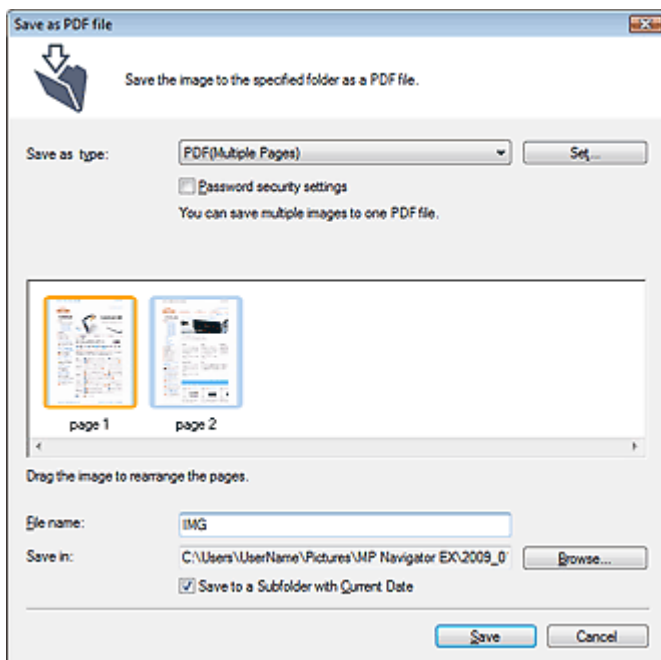

Dialog box that opens when Save Selected Pages or Save All Pages is clicked in the Create/Edit PDF file window

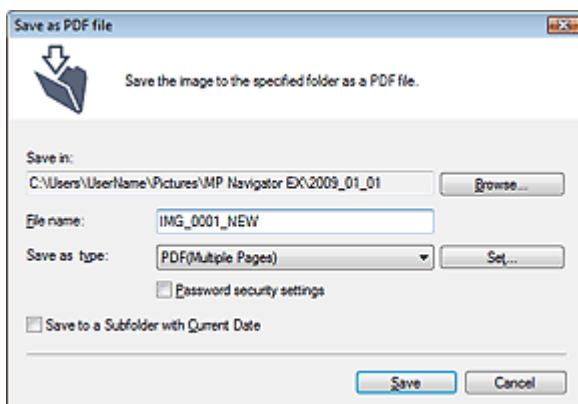

- Save as type**
 Select a PDF file type to save the scanned images.

- **PDF**

Save each of the selected images as a separate PDF file.

- **PDF(Multiple Pages)**

Save multiple images in one PDF file.



Note

- PDF(Multiple Pages) is displayed when multiple images are selected.

- **PDF(Add Page)**

Add the scanned images to a PDF file. The images are added to the end of the PDF file. You cannot rearrange the pages of the PDF file to which the images are added.



Important

- Images can only be added to PDF files created with MP Navigator EX. You cannot specify PDF files created with other applications. PDF files edited in other applications cannot be specified as well.
- If a password-protected PDF file is edited, the passwords will be deleted. Reset the passwords.
➔ [Setting Passwords for PDF Files](#)

- **Set...**

Make advanced settings for creating PDF files. See "[PDF Settings Dialog Box](#)" for details.

- **Password security settings**

Select this checkbox to open the Password Security -Settings dialog box in which you can set passwords for opening, editing and printing created PDF files.

➔ [Setting Passwords for PDF Files](#)

- **Add to**

This is displayed when you select PDF(Add Page) for Save as type and specify the PDF file to which images are added. To change the file, click Browse... to specify another one.



Important

- Images can only be added to PDF files created with MP Navigator EX. You cannot specify PDF files created with other applications. PDF files edited in other applications cannot be specified as well.

- **File name**

Enter the file name of the image to be saved (up to 64 characters). When saving multiple files, 4 digits are appended to each file name.

- **Save in**

Displays the folder in which to save the PDF files. To change the folder, click Browse... to specify another one.

The following folders are specified by default.

Windows Vista: MP Navigator EX folder in Pictures folder

Windows XP: MP Navigator EX folder in My Pictures folder

Windows 2000: MP Navigator EX folder in My Pictures folder

- **Save to a Subfolder with Current Date**

Select this checkbox to create a subfolder in the folder specified in Save in with the current date and save scanned files in it. A subfolder with a name such as "2009_01_01" (Year_Month_Date) will be created.

If this checkbox is not selected, files are saved directly in the folder specified in Save in.

Advanced Guide

Advanced Guide > Scanning > Scanning with the Bundled Application Software > MP Navigator EX Screens > PDF Settings Dialog Box

MP Navigator EX

PDF Settings Dialog Box

In the PDF Settings dialog box, you can specify the PDF compression type and other advanced settings for creating PDF files.

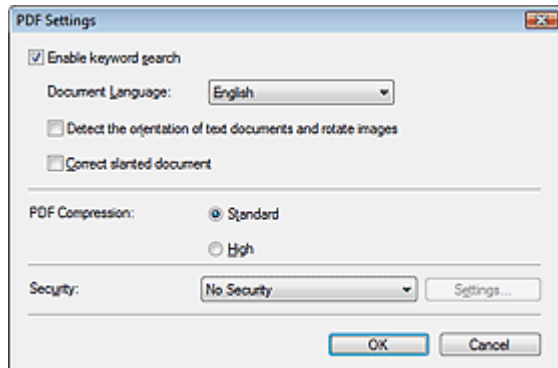

- **Enable keyword search**

Select this checkbox to convert characters in a document to text data. This will enable an easy search by keyword.

- **Document Language**

Select the language of the document to be scanned.

- **Detect the orientation of text documents and rotate images**

Select this checkbox to detect the orientation of the document from the scanned text and rotate the scanned image to the correct orientation.

Important

- This function may not work properly depending on the document language. Only text documents written in languages that can be selected from Document Language are supported.
- The orientation of the following types of documents may not be corrected, as the text cannot be detected correctly.
 - Resolution is outside the range of 300 dpi to 600 dpi
 - Font size is outside the range of 8 points to 48 points
 - Documents containing special fonts, effects, italics, or hand-written text
 - Documents with patterned backgrounds

- **Correct slanted document**

Select this checkbox to detect the scanned text and correct the angle (within -0.1 to -10 degrees or +0.1 to +10 degrees) of the document.

Important

- The inclination of the following types of documents may not be corrected, as the text cannot be detected correctly.
 - Documents in which the text lines are inclined more than 10 degrees or the angles vary by line
 - Documents containing both vertical and horizontal text
 - Documents with extremely large or small fonts
 - Documents with small amount of text
 - Documents containing figures/images or hand-written text
 - Documents containing both vertical and horizontal lines (tables)

- **PDF Compression**

Select a compression type for saving.

- **Standard**

It is recommended that you normally select this setting.

- **High**

Compresses the file size when saving, allowing you to reduce the load on your network/server.

 **Important**

- Highly compressed PDF images may degrade if you repeatedly save them with high compression.

 **Note**

- The following images can be compressed with high efficiency.
 - Images with resolutions within the range of 75 dpi to 600 dpi.

- **Security**

Set passwords for opening, editing and printing the created PDF files.

 **Important**

- In Windows 2000, Internet Explorer 5.5 Service Pack 2 or later is required to use this function.
- This function is not available when images are automatically saved after scanning, such as when scanning from the One-click Mode screen or scanning using the Operation Panel of the machine.

 **Note**

- Select Password Security and set passwords in the Password Security -Settings dialog box.
 - ➔ [Setting Passwords for PDF Files](#)

Advanced Guide

Advanced Guide > Scanning > Scanning with the Bundled Application Software > MP Navigator EX Screens > Memory Card Screen (Scan/Import Window)

MP Navigator EX

Memory Card Screen (Scan/Import Window)

Point to Scan/Import in the Navigation Mode screen and click Memory Card, or click Memory Card in the Scan/Import window to open the Memory Card screen (Scan/Import window).

Open this window to import images (including PDF files created via scanning using the Operation Panel) saved on a memory card.

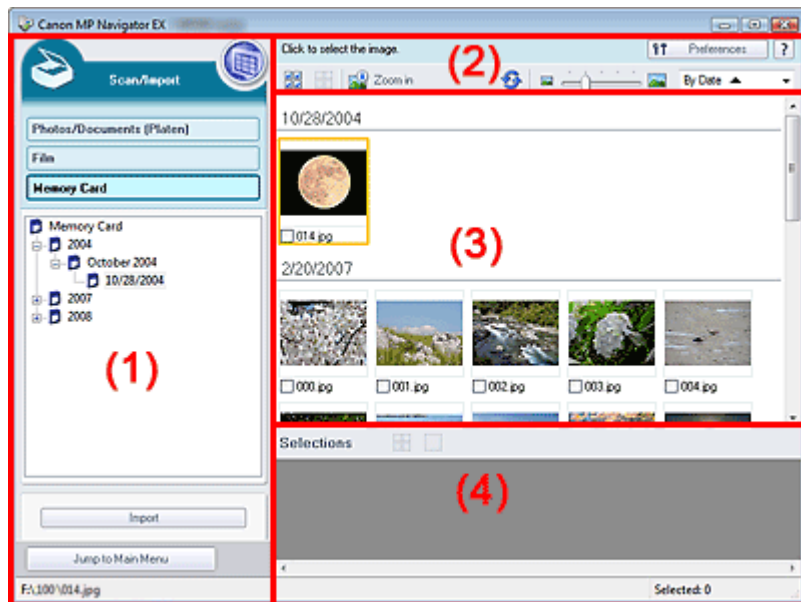

- (1) Settings and Operation Buttons
- (2) Toolbar
- (3) Thumbnail Window
- (4) Selected Images Area

Settings and Operation Buttons

-  **(View & Use)**
 Click this when you want to open images and PDF files saved on your computer. The View & Use window opens.
 ➔ [View & Use Window](#)
- **Photos/Documents (Platen)**
 Click this when you want to scan photos, documents, magazines and other printed materials. The screen for scanning photos and documents appears.
 ➔ [Photos/Documents \(Platen\) Screen \(Scan/Import Window\)](#)
- **Film**
 Click this when you want to scan film. The screen for scanning film appears.
 ➔ [Film Screen \(Scan/Import Window\)](#)
- **Memory Card**
 Displays folders of images and PDF files (grouped by year, month/year and month/date/year) on a memory card in tree view. Select a folder to display its contents in the Thumbnail window to the right. File date is the captured or updated date.

- **Import**

Imports the selected images and open them in the View & Use window.

➔ [View & Use Window](#)

-  **Jump to Main Menu**

Jumps to the Main Menu.

Toolbar

-  **Preferences**

The Preferences dialog box opens. In the Preferences dialog box, you can make advanced settings to MP Navigator EX functions.

➔ [Preferences Dialog Box](#)

-  **(Guide)**

Opens this guide.

- **Edit Tools**

-  **(Select All)**

Selects all images in the Thumbnail window.

-  **(Cancel All)**

Cancels all image selections in the Thumbnail window.

-  **Zoom in**

Enlarges the target image (outlined in orange). You can also enlarge the image by double-clicking it. You can check all pages when you select a PDF file.

-  **(Refresh)**

Refreshes the Thumbnail window contents.

-  **(Display Size)**

Changes the size of images in the Thumbnail window.

-  **(Sort by)**

Sorts the images in the Thumbnail window by date (ascending or descending).

Thumbnail Window

- **Thumbnail Window**

Images saved on the memory card are displayed by year or month/year.

When you select the checkbox of an image, the image appears in the Selected Images area.

Selected Images Area

-  **(Cancel All)**

Cancels the selection of all images in the Selected Images area.

-  **(Cancel Selection)**

Cancels the selection of the target image (outlined in orange) in the Selected Images area.

- **Selected Images Area**

Images selected in the Thumbnail window are displayed.

Related Topic

▶ [Importing Images Saved on a Memory Card](#)

[Page top](#) ↕

Advanced Guide

Advanced Guide > Scanning > Scanning with the Bundled Application Software > MP Navigator EX Screens > View & Use Window

MP Navigator EX

View & Use Window

Point to View & Use in the Navigation Mode screen and click My Box (Scanned/Imported Images), Specify Folder or Recently Saved Images to open the View & Use window.

Open this window to display or use scanned images or images saved on a computer.

Important

- For PDF files, only those created with MP Navigator EX are displayed. You cannot display PDF files created with other applications. PDF files edited in other applications cannot be displayed as well.

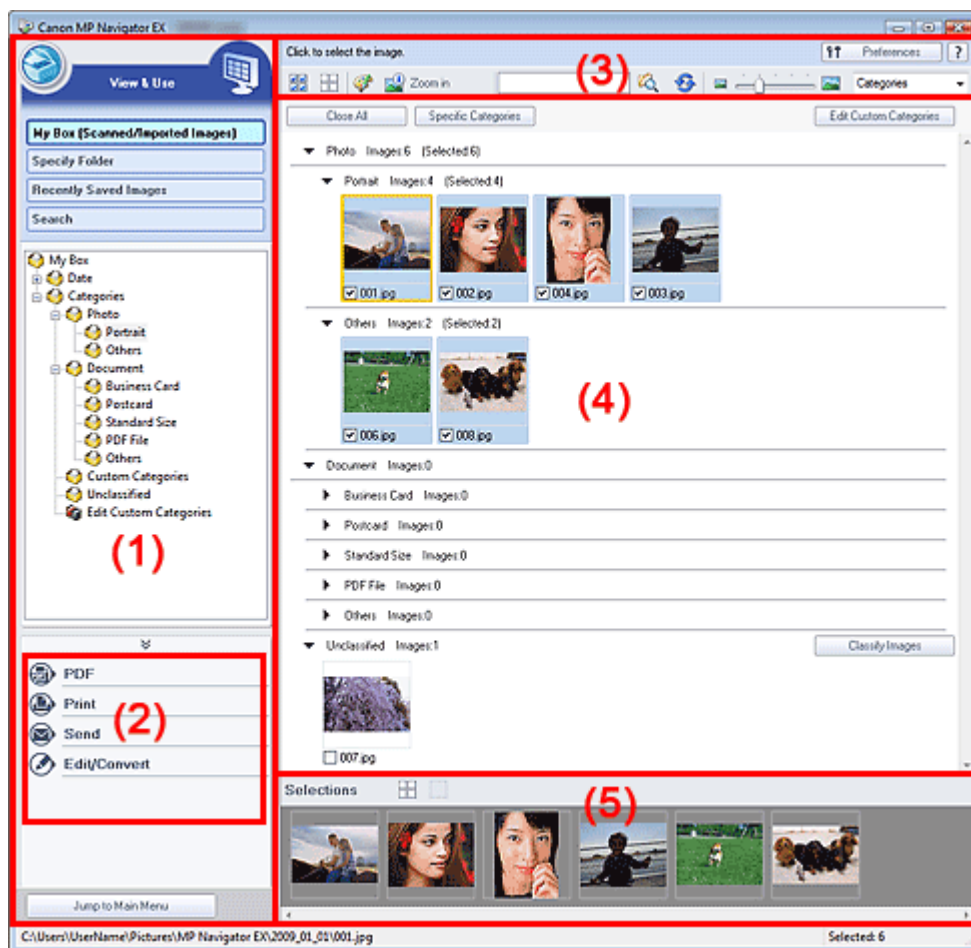

- (1) Display Setting Items
- (2) Image Handling Buttons
- (3) Toolbar
- (4) Thumbnail Window
- (5) Selected Images Area

Display Setting Items

-  (Scan/Import)

Click this when you want to scan photos, documents, magazines and other printed materials. The

Scan/Import window opens.

➔ [Photos/Documents \(Platen\) Screen \(Scan/Import Window\)](#)

- **My Box (Scanned/Imported Images)**

Displays folders of images (grouped by year, year/month and year/month/date) in My Box in tree view. Select a folder to display its contents in the Thumbnail window to the right. Image date is the scanned, captured or updated date.

- **Specify Folder**

Displays all hard disks and folders in tree view. Select a folder to display images in the Thumbnail window to the right.

Selecting a folder and clicking it highlights the folder name, allowing you to rename it.

- **Recently Saved Images**

"Scanned/Imported Images" and images that have been "Attached to E-mail" or "Sent to Application" recently are displayed in tree view by date. For "Scanned/Imported Images", "From Scanner" and "From Memory Card" are displayed separately. Select a Month/Date/Year folder to display images by date in the Thumbnail window to the right.

Image date is the scanned or sent date.

- **Search**

The advanced search options opens.

➔ [Searching Images](#)

-  **Jump to Main Menu**

Jumps to the Main Menu.

Image Handling Buttons

- **Image Handling Buttons**

Specify what to do with the selected images. See the corresponding sections below for details on each button.

➔ [Creating/Editing PDF Files](#)

➔ [Printing Documents](#)

➔ [Printing Photos](#)

➔ [Sending via E-mail](#)

➔ [Editing Files](#)



Note

- The buttons in Image Handling Buttons are displayed when the corresponding applications are installed.

Toolbar

-  **Preferences**

The Preferences dialog box opens. In the Preferences dialog box, you can make advanced settings to MP Navigator EX functions.

➔ [Preferences Dialog Box](#)

-  **(Guide)**

Opens this guide.

- **Edit Tools**



- **(Select All)**

Selects all images in the Thumbnail window.



- **(Cancel All)**

Cancels all image selections in the Thumbnail window.

-  **(Image Correction/Enhancement)**

Allows you to correct the target image (outlined in orange). Click this button to open the Correct/Enhance Images window in which you can correct/enhance images and also adjust the brightness, contrast, etc.

➔ [Correct/Enhance Images Window](#)

Important

- Image correction/enhancement cannot be applied to PDF files or black and white binary files.

-  **Zoom in**

Enlarges the target image (outlined in orange). You can also enlarge the image by double-clicking it. You can check all pages when you select a PDF file.

You can also check file information such as file name, date, size and security setting. A lock icon appears for PDF files with Document Open Password set.

➔ [Opening/Editing Password-protected PDF Files](#)

-  **(Search)**

Enter a word or phrase included in the file name, Exif information or PDF text of the image you

want to search for, then click  (Search button). For Exif information, text in Maker, Model, Description and User Comment is searched.

Note

- Search images in My Box (Scanned/Imported Images), Recently Saved Images or a selected folder and its subfolders.

-  **(Refresh)**

Refreshes the Thumbnail window contents.

-  **(Display Size)**

Changes the size of images in the Thumbnail window.

- (Sort by)**

Sorts the images in the Thumbnail window by category, date (ascending or descending) or name (ascending or descending).

Images can be sorted by category only when My Box (Scanned/Imported Images) or Specify Folder is displayed.

Thumbnail Window

- Thumbnail Window**

Scanned images are displayed.

When you select the checkbox of an image, the image appears in the Selected Images area.

Selecting an image and clicking the file name highlights the file name, allowing you to rename it.

Drag and drop an image to do the following things.

- Move from one category to another within the Thumbnail window
- Move to a category folder displayed in My Box (Scanned/Imported Images)
- Copy to a folder displayed in Specify Folder

Important

- In Windows 2000, Internet Explorer 5.5 Service Pack 2 or later is required to open password-protected PDF files.
- You cannot change the extension (.jpg, .pdf, etc.) when renaming a file.
- You cannot move or copy images to the date folders displayed in tree view in My Box (Scanned/Imported Images) or Recently Saved Images.

Note

- A lock icon appears for PDF files with Document Open Password set.
- Thumbnails may appear as "?" in the following cases.
 - Opening unsupported images
 - File size is too large and there is not enough memory to display the image
 - The file is corrupted

When Images are Sorted by Categories

Scanned images are displayed by category.

Note

- Some images may not be detected correctly and thus may be classified into wrong categories. In that case, drag and drop an image and move it from one category to another.

● Category name Images: N (Selected: n)

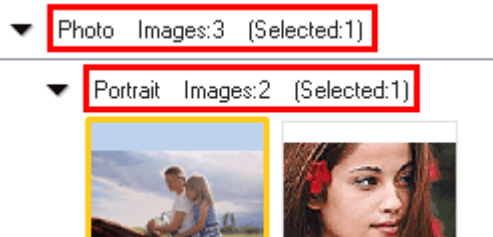

● Category name

The following categories are provided.

Photos: Portrait, Others

Documents: Business Card, Postcard, Standard Size, PDF File, Others

Custom categories: Displays your custom categories.

Unclassified: Displays images that have not yet been classified.

● Images: N

The number of images classified into the category is displayed.

● (Selected: n)

The number of images with the checkbox selected is displayed.

Note

- This portion is displayed only when one or more images are selected.

● Close All / Open All

-  **Close All**

Hides all images.

-  **Open All**

Displays all images.

Note

- Immediately after opening the View & Use window or sorting images, all images appear and Close All is displayed.
- Click Close All to change to Open All.

● Specific Categories / All Categories

You can narrow down the categories to display only those containing images. If you narrow down the categories, more images are displayed in the Thumbnail List area, allowing you to find or move images easily.

This button is displayed only when My Box (Scanned/Imported Images) or Specify Folder is displayed.

-  **Specific Categories**

Displays categories containing images, along with the contained images.

-  **All Categories**

Displays all categories and images.



Note

- Click Specific Categories to change to All Categories.
-

-  **Edit Custom Categories**

When My Box (Scanned/Imported Images) or Specify Folder is displayed, the Edit Custom Categories dialog box opens.

In the Edit Custom Categories dialog box, you can add/delete categories displayed in Custom Categories.

See "[Classifying Images into Categories](#)" for details.

-  **Classify Images**

Images imported from hard disks or memory cards appear in Unclassified. Click Classify Images to classify them automatically.

This button is displayed only when My Box (Scanned/Imported Images) or Specify Folder is displayed.



Note

- Classification may take time if there are many images to classify.
-

Selected Images Area

-  **(Cancel All)**

Cancels the selection of all images in the Selected Images area.

-  **(Cancel Selection)**

Cancels the selection of the target image (outlined in orange) in the Selected Images area.

- **Selected Images Area**

Images selected in the Thumbnail window are displayed.

Related Topic

- ▶ [Opening Images Saved on a Computer](#)

Advanced Guide

Advanced Guide > Scanning > Scanning with the Bundled Application Software > MP Navigator EX Screens > Create/Edit PDF file Window

MP Navigator EX

Create/Edit PDF file Window

Click PDF in the View & Use window, then click Create/Edit PDF file on the list to open the Create/Edit PDF file window.

In the Create/Edit PDF file window, you can add/delete pages and rearrange the page order of PDF files created with MP Navigator EX.

Important

- You cannot save images scanned at 10501 pixels or more in the vertical and horizontal directions.
- If a password-protected PDF file is edited, the passwords will be deleted. Reset the passwords.
 - ➔ [Setting Passwords for PDF Files](#)
- You can create or edit up to 99 pages using MP Navigator EX.

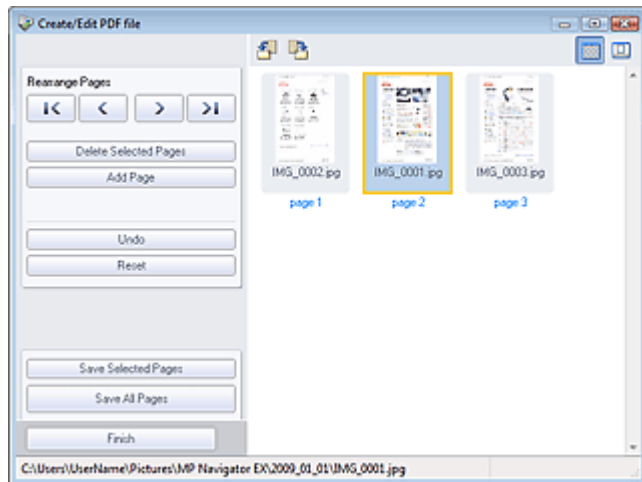

• Rearrange Pages

You can move the selected image (outlined in orange).



- Moves the selected image to the top.



- Moves the selected image up one page.



- Moves the selected image down one page.



- Moves the selected image to the end.

Note

- You can also drag and drop the image to rearrange the order.

• Delete Selected Pages

Deletes the selected image.

- **Add Page**

Allows you to select and add an existing PDF file.

Note

- A password will be required to add a password-protected PDF file.

- **Undo**

Cancels the latest change made.

- **Reset**

Cancels all the changes made.

- **Save Selected Pages**

Opens the Save as PDF file dialog box. Specify the save settings. Only the selected page is saved.

Note

- When multiple pages are selected, a multiple-page PDF file is created.
- See "[Save as PDF file Dialog Box](#) " for details on the Save as PDF file dialog box.

- **Save All Pages**

Opens the Save as PDF file dialog box. Specify the save settings. All PDF files in the list will be saved as one PDF file.

- **Finish**

Closes the Create/Edit PDF file window.

- **Toolbar**



- **(Rotate Left)**

Rotates the page 90 degrees counter-clockwise.



- **(Rotate Right)**

Rotates the page 90 degrees clockwise.



- **(Preview Mode)**

Switches to Preview Mode.
The selected file appears in Preview.

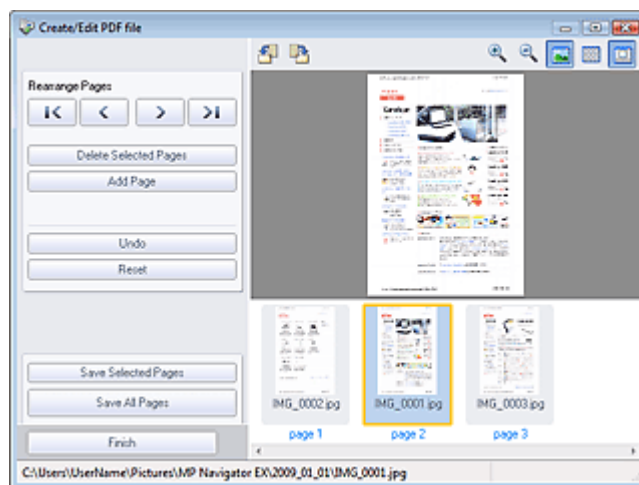



- **(Enlarge)**

Enlarges the image displayed in Preview.



- **(Reduce)**

Reduces the image displayed in Preview.

-  **(Full-screen)**
Enlarges/reduces the image to display it fully in Preview.
-  **(Thumbnail Mode)**
Switches to Thumbnail Mode. Thumbnails of files are displayed.

[Page top](#) ↕

Advanced Guide

Advanced Guide > Scanning > Scanning with the Bundled Application Software > MP Navigator EX Screens > Print Document Dialog Box

MP Navigator EX

Print Document Dialog Box

Click Print in the View & Use window, then click Print Document on the list to open the Print Document dialog box.

In the Print Document dialog box, you can make advanced settings for printing multiple scanned images at one time.

Note

- The setting items in the Print Document dialog box vary by printer.

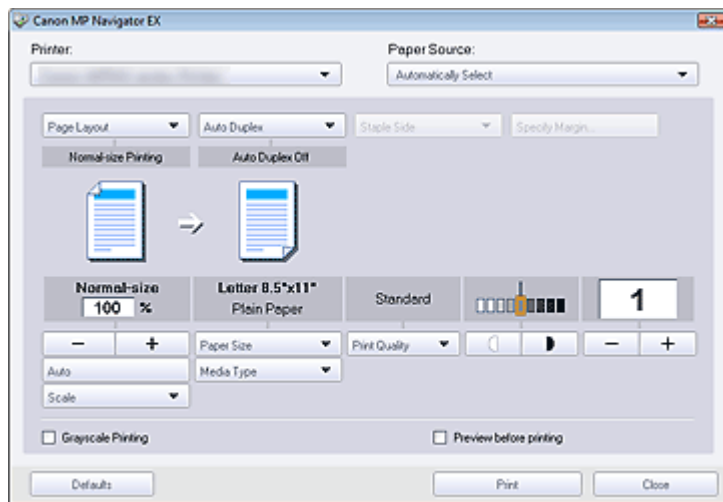

- **Printer**
Select the printer to use.
- **Paper Source**
Select paper source.
- **Page Layout**
Select a print type.
 - **Normal-size Printing**
Print one image per sheet.
 - **Scaled Printing**
Print images at the selected scale (enlarged or reduced).
 - **Fit-to-Page Printing**
Print an image at the paper size (enlarged or reduced).
 - **Borderless Printing**
Print the image on an entire sheet of paper without margins.
 - **Page Layout Printing (2 on 1)**
Layout and print two images on a sheet of paper.
 - **Page Layout Printing (4 on 1)**
Layout and print four images on a sheet of paper.
- **Auto Duplex**
Print on both sides of a sheet of paper automatically.

 **Note**

- Auto Duplex is displayed when Page Layout is Normal-size Printing or Scaled Printing, and available when Media Type is Plain Paper.

- **Staple Side**

Select a stapling side from the list.

 **Note**

- Staple Side is available when Auto Duplex On is set.

- **Specify Margin...**

Specify the width of the margin (0 mm to 30 mm).

 **Note**

- Specify Margin... is available when Auto Duplex On is set.
- If a page does not fit in one page due to the Specify Margin... setting, the document will be reduced for printing.

- **Enlarge/Reduce**

Enlarge or reduce images to print.

-  **(Enlarge/Reduce)**

Print a reduced or enlarged image by specifying a scale in increments of 1%.

- **Auto**

Scale is adjusted automatically according to the detected paper width and the selected paper size. Image may be printed rotated 90 degrees depending on its size.

- **Scale**

Select a scale from the list.

 **Important**

- At normal-size (100%), some images may be printed small or with some portions cropped. In that case, select Auto to resize the print in proportion to the paper size.

- **Paper Size**

Select the size of paper for printing. Match the size to the size of the paper set in the machine.

 **Note**

- Selectable paper sizes depend on the selected printer.

- **Media Type**

Select the type of paper for printing. Print quality may be fixed depending on the paper type.

 **Note**

- Selectable paper types depend on the selected printer.

- **Print Quality**

Select the print quality.

- **Density**

Click  (Density adjustment) to select the print density.

- **Copies**

Click  (Copy setting) to select the number of copies to be printed.

- **Grayscale Printing**

Select this checkbox to print the document in black and white.

- **Preview before printing**

Select this checkbox to display the print result before printing.

- **Defaults**

Restores the default settings.

- **Print**

Start printing with the specified settings.

 **Note**

- To cancel while spooling, click Cancel. To cancel while printing, click Cancel Printing in the confirmation window for the printer status. To open a confirmation window for the printer status, click printer icon on the taskbar.
-

[Page top](#) ↕

Advanced Guide

Advanced Guide > Scanning > Scanning with the Bundled Application Software > MP Navigator EX Screens > Print Photo Dialog Box

MP Navigator EX

Print Photo Dialog Box

Click Print in the View & Use window, then click Print Photo on the list to open the Print Photo dialog box.

Important

- The Print Photo dialog box will not open if Easy-PhotoPrint EX is installed. Easy-PhotoPrint EX starts instead.
- PDF files cannot be printed.

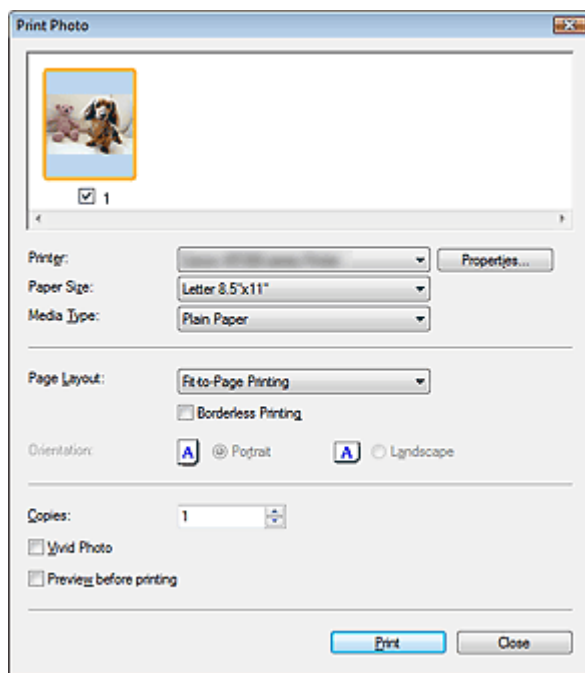

Note

- Double-click an image to display it in a different window.

• Printer

Select the printer to use.

• Properties...

Displays the selected printer's advanced setting screen.

• Paper Size

Select the size of paper for printing. Match the size to the size of the paper set in the machine.

• Media Type

Select the type of paper for printing. Print quality may be fixed depending on the paper type.

• Page Layout

Select a print type.

• Normal-size Printing

Print one image per sheet.

• Fit-to-Page Printing

Print an image at the paper size (enlarged or reduced).

• Borderless Printing

Select this checkbox to print the image on an entire sheet of paper without margins.

Important

- Page Layout setting will be disabled when you select Borderless Printing.
- This setting is only available with printers that support borderless printing.

• Orientation

Specify the print orientation.

Important

- This setting is available only when Page Layout is Normal-size Printing. For others, the image is automatically rotated according to the aspect ratio of the paper.

• Copies

Specify the number of copies to print.

• Vivid Photo

Select this checkbox to print the image in vivid colors.

• Preview before printing

Select this checkbox to display the print result before printing.

• Print

Starts printing.

Note

- Only the images in the Thumbnail window with the checkbox selected are printed.

• Close

Closes the dialog box without printing the photo.

[Page top](#)[↕]

Advanced Guide

Advanced Guide > Scanning > Scanning with the Bundled Application Software > MP Navigator EX Screens > Send via E-mail Dialog Box

MP Navigator EX

Send via E-mail Dialog Box

Click Send in the View & Use window, then click Attach to E-mail on the list to open the Send via E-mail dialog box.

In the Send via E-mail dialog box, you can make advanced settings for attaching images to e-mail.

Important

- MP Navigator EX is compatible with the following e-mail software programs:
 - Windows Mail (Windows Vista)
 - Outlook Express (Windows XP/Windows 2000)
 - Microsoft Outlook
 (If an e-mail software program does not operate properly, check that the program's MAPI is enabled. To enable MAPI, refer to the manual of the e-mail software program.)

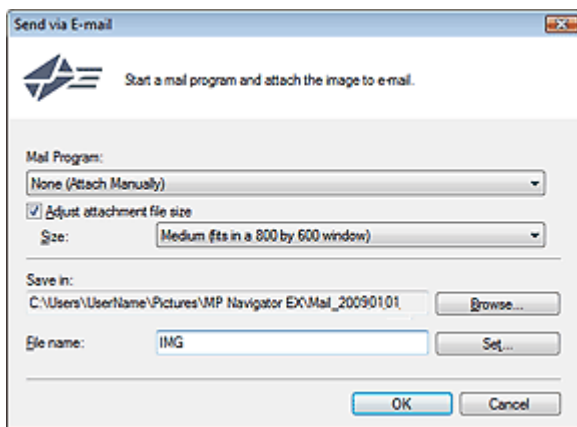

• Mail Program

The e-mail software program set up via Preferences in the Navigation Mode screen is displayed. Select the e-mail software program you want to use.

• Adjust attachment file size

When Save as type is JPEG, selecting this checkbox allows you to resize the images. Select a size from Size.

• Save in

Displays the folder in which to save the images. To change the folder, click Browse... to specify another one. If resized, the resized images are saved.

The following folders are specified by default.

Windows Vista: MP Navigator EX folder in Pictures folder
 Windows XP: MP Navigator EX folder in My Pictures folder
 Windows 2000: MP Navigator EX folder in My Pictures folder

• File name

Enter the file name of the image to be attached (up to 64 characters). When saving multiple files, 4 digits are appended to each file name.

• Set...

You can specify a compression type for JPEG files. Select High(Low Compression), Standard or Low(High Compression).

Advanced Guide

Advanced Guide > Scanning > Scanning with the Bundled Application Software > MP Navigator EX Screens > Correct/Enhance Images Window

MP Navigator EX

Correct/Enhance Images Window

Click  (Image Correction/Enhancement) in the View & Use window or click Fix photo images in the Task Button area to open the Correct/Enhance Images window.

In the Correct/Enhance Images window, you can make advanced settings including image correction/enhancement and brightness/contrast adjustment.

You can also display the source image and corrected image side by side for comparison.

Important

- Image correction/enhancement cannot be applied to PDF files or black and white binary files.

Note

- The Correct/Enhance Images window can also be opened by clicking  (Image Correction/Enhancement) in the Zoom in dialog box.
- It may take a while to correct large images.
- See "View & Use Window" for details on the View & Use window.

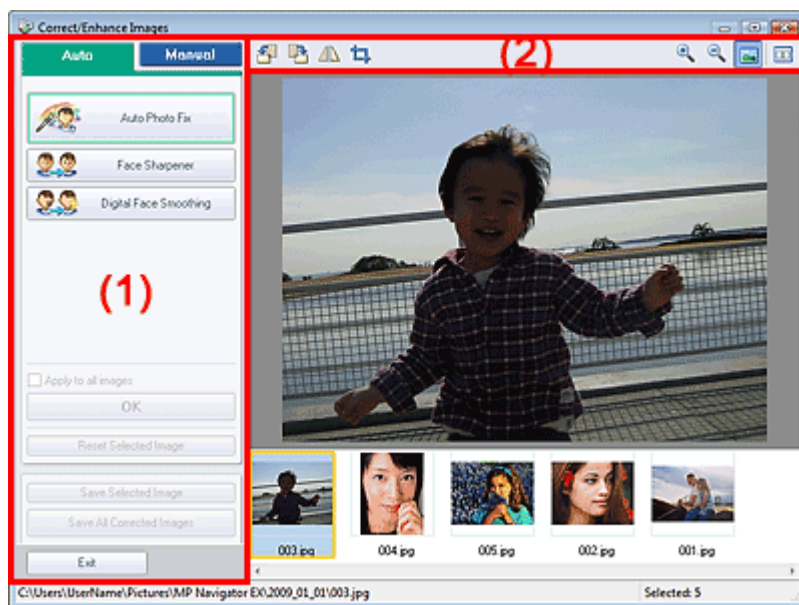

(1) Task Area

(2) Toolbar

Task Area

Available tasks and settings vary between the Auto and Manual tabs.

Click Auto or Manual to open the corresponding tab.

Auto Tab

Use the functions in the Auto tab to apply corrections and enhancements to the entire image.

See "Correcting/Enhancing Images Automatically " for details.

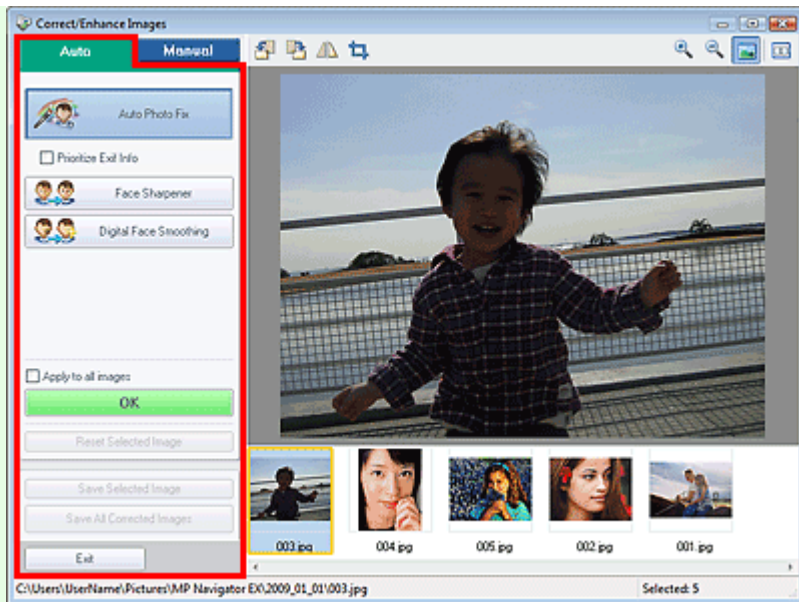

- **Auto Photo Fix**

Applies automatic corrections suitable for photos.

- **Prioritize Exif Info**

Select this checkbox to apply corrections primarily based on the settings made at the time of shooting.

Deselect this checkbox to apply corrections based on the image analysis results. It is recommended that you normally select this setting.



Note

- Exif is a standard format for embedding various shooting data in digital camera images (JPEG).

- **Face Sharpener**

Sharpens out-of-focus faces.

You can adjust the effect level using the slider.

- **Digital Face Smoothing**

Enhances skin beautifully by removing blemishes and wrinkles.

You can adjust the effect level using the slider.

- **Apply to all images**

Applies the correction to all images displayed in the thumbnail list.

- **OK**

Applies the selected effect to the selected image or all images.

- **Reset Selected Image**

Cancels all corrections and enhancements applied to the selected image.

- **Save Selected Image**

Saves the corrected images selected.

- **Save All Corrected Images**

Saves all the corrected images displayed in the thumbnail list.

- **Exit**

Closes the Correct/Enhance Images window.

Manual Tab

Use Adjust to adjust brightness and contrast, or to sharpen the entire image.

Use Correct/Enhance to correct/enhance specific areas.

See "[Correcting/Enhancing Images Manually](#)" for details.

Adjustment

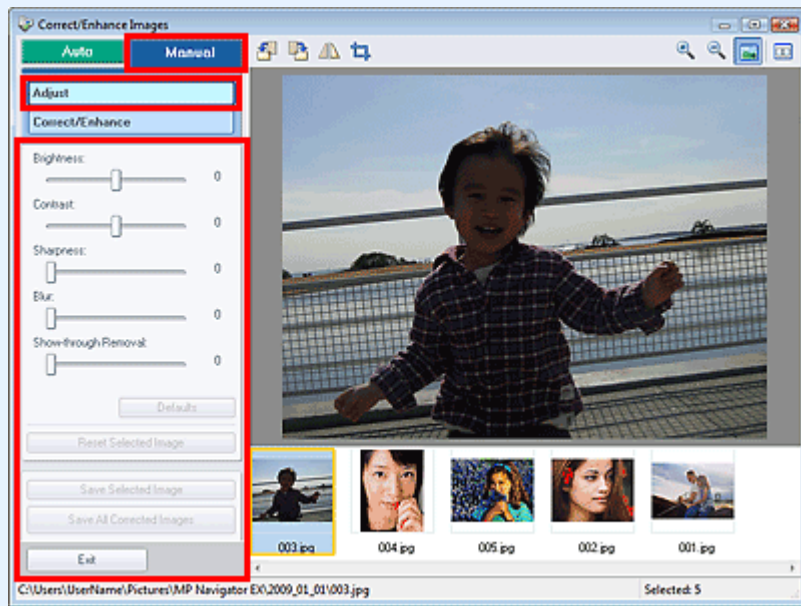

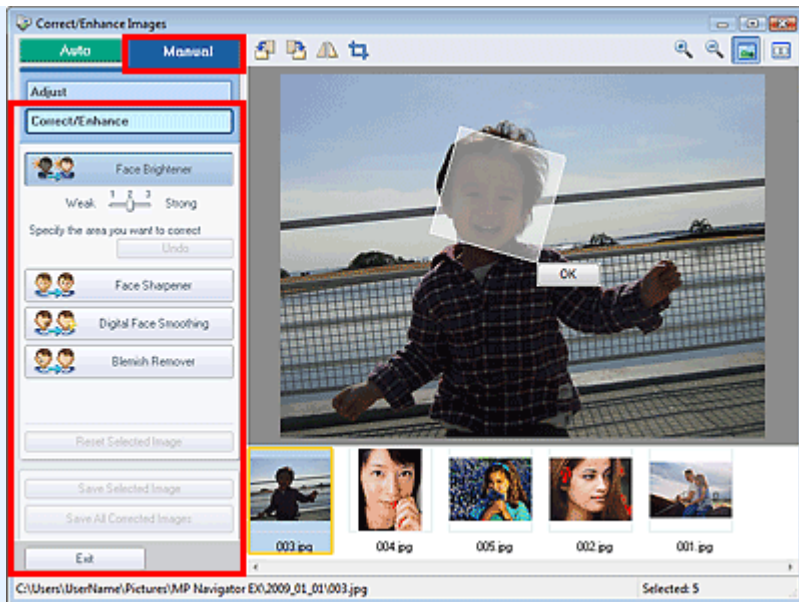

- **Brightness**
Adjusts the overall image brightness.
Move the slider to the left to darken and right to brighten the image.
- **Contrast**
Adjusts the contrast of the image. Adjust the contrast when the image is flat due to lack of contrast.
Move the slider to the left to decrease and right to increase the contrast of the image.
- **Sharpness**
Emphasizes the outline of the subjects to sharpen the image. Adjust the sharpness when the photo is out of focus or text is blurred.
Move the slider to the right to sharpen the image.
- **Blur**
Blurs the outline of the subjects to soften the image.
Move the slider to the right to soften the image.
- **Show-through Removal**
Removes show-through of text from the reverse side or removes the base color. Adjust the show-through level to prevent text on the reverse side of thin document or the base color of the document from appearing on the image.
Move the slider to the right to increase the show-through removal effect.
- **Defaults**
Resets all adjustments (brightness, contrast, sharpness, blur, and show-through removal).
- **Reset Selected Image**
Cancels all corrections, enhancements and adjustments applied to the selected image.
- **Save Selected Image**
Saves the corrected images selected.
- **Save All Corrected Images**
Saves all the corrected images displayed in the thumbnail list.
- **Exit**
Closes the Correct/Enhance Images window.

Correction/Enhancement



- **Face Brightener**
Corrects the entire image so that the selected facial area is brightened. You can adjust the effect level using the slider.
- **Face Sharpener**
Corrects the entire image to sharpen the face. You can specify the area you want to apply the effect to. You can adjust the effect level using the slider.
- **Digital Face Smoothing**
Enhances skin beautifully by removing blemishes and wrinkles. You can specify the area you want to apply the effect to. You can adjust the effect level using the slider.
- **Blemish Remover**
Removes moles. You can specify the area you want to apply the effect to.
- **OK**
Applies the selected effect to the specified area.
- **Undo**
Cancels the latest correction.
- **Reset Selected Image**
Cancels all corrections, enhancements and adjustments applied to the selected image.
- **Save Selected Image**
Saves the corrected images selected.
- **Save All Corrected Images**
Saves all the corrected images displayed in the thumbnail list.
- **Exit**
Closes the Correct/Enhance Images window.

Toolbar

- **Toolbar**
 -  **(Rotate Left)**
Rotates the image 90 degrees counter-clockwise.
 -  **(Rotate Right)**
Rotates the image 90 degrees clockwise.

-  **(Invert)**

Inverts the image horizontally.

-  **(Trimming)**

Trimming is the act of selecting the area you want to keep in a photo and discarding the rest. In the displayed window, drag the white frame to specify the trimming area. Move the cursor inside the white frame and drag to move the trimming area.

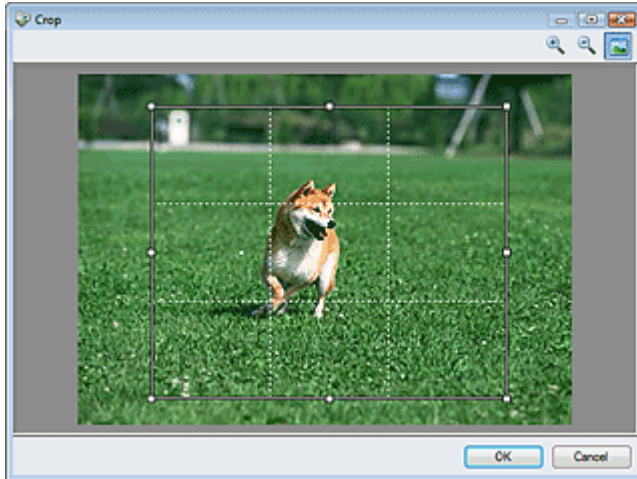

Note

- Place the main subjects along the broken white lines or at the intersections to create a balanced image.

-  **(Enlarge)**

Enlarges the displayed image.

-  **(Reduce)**

Reduces the displayed image.

-  **(Full-screen)**

Enlarges/reduces the image to display it full-screen.

-  **(Compare)**

Opens the source image for comparison. The source image appears on the left and the corrected image appears on the right.

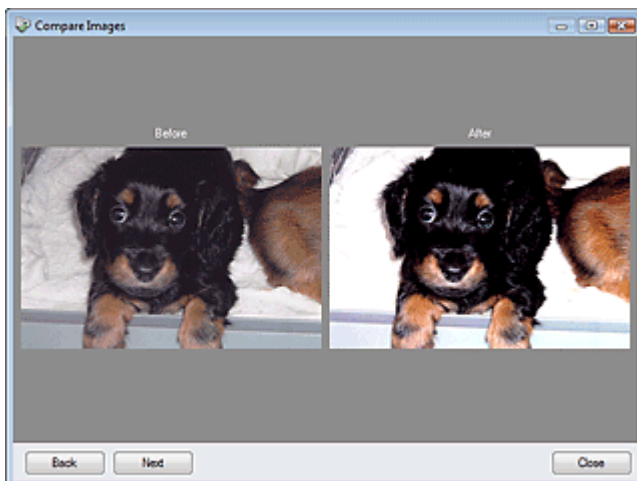

Advanced Guide

Advanced Guide > Scanning > Scanning with the Bundled Application Software > MP Navigator EX Screens > One-click Mode Screen

MP Navigator EX

One-click Mode Screen

Click  (Switch Mode) at the bottom left of the Navigation Mode screen to display the One-click Mode screen.

You can complete from scanning to saving, etc. at one time by simply clicking the corresponding icon.

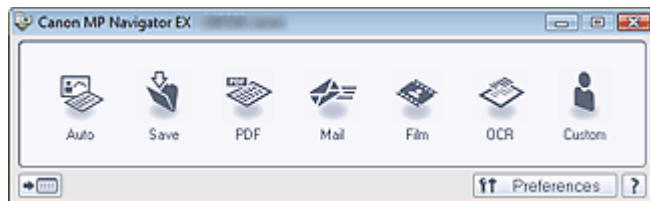

- **Auto**

Scan documents by automatically detecting the document type. File format is automatically set. Files are saved to a computer. You can apply Auto Photo Fix as required.

When you click this icon, the Auto Scan dialog box opens and you can specify the save settings.

➔ [Auto Scan Dialog Box](#)

- **Save**

Scan documents or photos and save them to a computer. The document type can be detected automatically.

When you click this icon, the Save dialog box opens and you can specify the scan/save settings.

➔ [Save Dialog Box \(One-click Mode Screen\)](#)

- **PDF**

Scan documents and save them as PDF files.

When you click this icon, the PDF dialog box opens and you can specify the scan/save and application settings.

➔ [PDF Dialog Box](#)

- **Mail**

Scan documents or photos and attach them to e-mail.

When you click this icon, the Mail dialog box opens and you can specify the scan/save and e-mail software program settings.

➔ [Mail Dialog Box](#)

- **Film**

Scan film and save to a computer.

When you click this icon, the Film dialog box opens and you can specify the scan/save settings.

➔ [Film Dialog Box](#)

- **OCR**

Scan text documents then extract text in the image and display it in Notepad (included with Windows).

When you click this icon, the OCR dialog box opens and you can specify the scan/save settings.

➔ [OCR Dialog Box](#)

Note

- For further procedures, refer to the application's manual.

- **Custom**

Scan documents and open them in a specified application. Document type is automatically detected.

When you click this icon, the Custom dialog box opens and you can specify the scan/save and application settings.

➔ [Custom Dialog Box](#)

 **Note**

- For further procedures, refer to the application's manual.

-  **(Switch Mode)**

Switches to Navigation Mode. The Navigation Mode screen appears.

➔ [Custom Scan with One-click Tab](#)

-  **Preferences**

The Preferences dialog box opens. In the Preferences dialog box, you can make advanced settings to MP Navigator EX functions.

➔ [Preferences Dialog Box](#)

-  **(Guide)**

Opens this guide.

 **Important**

- The following restrictions apply when you scan with Document Type set to Auto Mode in the Save or Custom dialog box.
When you want to convert text in the scanned image to text data, specify Document Type (do not select Auto Mode).

Related Topic

▶ [Easy Scanning with One-click](#)

[Page top](#) 

Advanced Guide

Advanced Guide > Scanning > Scanning with the Bundled Application Software > MP Navigator EX Screens > Auto Scan Dialog Box

MP Navigator EX

Auto Scan Dialog Box

Click Auto Scan on the Custom Scan with One-click tab or click Auto in the One-click Mode screen to open the Auto Scan dialog box.

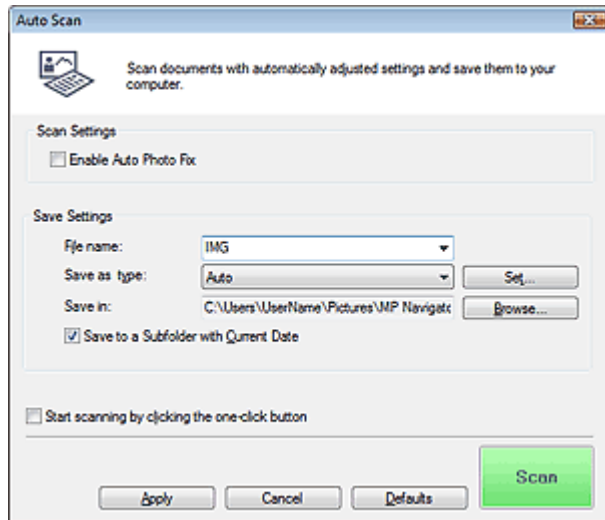

Important

- The following types of documents cannot be scanned correctly. In that case, click another icon in One-click Mode or on the Custom Scan with One-click tab and specify the document type or size.
 - Documents other than photos, postcards, business cards, magazines, newspapers, text documents, CD/DVD and film
 - A4 size photos
 - Text documents smaller than 2L (5 inches x 7 inches) (127 mm x 178 mm), such as paperback pages with the spine cut off
 - Documents printed on thin white paper
 - Long narrow documents such as panoramic photos
- Reflective CD/DVD labels may not be scanned properly.
- Film may not be scanned correctly. In that case, select the type of film in the Film dialog box and scan again.
- Place documents correctly according to the type of document to be scanned. Otherwise, documents may not be scanned correctly. See "[Placing Documents](#)" for details on how to place documents.

Note

- To reduce moire, click another icon in One-click Mode or on the Custom Scan with One-click tab and set Document Type to Magazine.

Scan Settings

● Enable Auto Photo Fix

Select this checkbox to analyze the photo image and apply suitable corrections automatically. This function is available when Auto or JPEG/Exif is selected for Save as type in Save Settings.

Important

- When Save as type is Auto, the base color tone of the following types of documents may change from the source since they are corrected as photos. In that case, deselect the checkbox

and scan.

- Postcards and business cards
- Text documents may not be scanned correctly since they may be corrected as photos depending on how you place the document. In that case, deselect the checkbox and scan.



Note

- If you select a format other than JPEG/Exif for Save as type and then select this checkbox, a message appears and Save as type will be set to Auto.

Save Settings

• File name

Enter the file name of the image to be saved (up to 64 characters). When saving multiple files, 4 digits are appended to each file name.

• Save as type

Select a file type to save the scanned images.
Select Auto, JPEG/Exif, TIFF, BMP or PDF.



Important

- When Save as type is Auto, the file format may differ depending on how you place the document.
See "[Placing Documents](#)" for details on how to place documents.
- Large documents (such as A4 size photos) that cannot be placed away from the edges/arrow (alignment mark) of the Platen may not be saved in the correct file format when Save as type is Auto. In that case, select a file format suitable for the document to be scanned.
- Images cannot be added to password-protected PDF files.



Note

- When Auto is selected, files are saved in the following formats according to the document type.
Photos, postcards, CD/DVD, business cards and film: JPEG
Magazines, newspapers and text documents: PDF
You can change the file format from Set....

• Set...

When Save as type is Auto

You can specify the file format in which to save images. Select a file format for Document and Photo each.



Important

- You cannot select a compression type for JPEG files when the Compress scanned images when transferring checkbox is selected on the General tab of the Preferences dialog box.

When Save as type is JPEG/Exif

You can specify a compression type for JPEG files. Select High(Low Compression), Standard or Low(High Compression).



Important

- This setting is not available when the Compress scanned images when transferring checkbox is selected on the General tab of the Preferences dialog box.

When Save as type is PDF

Make advanced settings for creating PDF files. See "[PDF Settings Dialog Box](#)" for details.

• Save in

Displays the folder in which to save the scanned images. To change the folder, click Browse... to specify another one.

The following folders are specified by default.

Windows Vista: MP Navigator EX folder in Pictures folder

Windows XP: MP Navigator EX folder in My Pictures folder

Windows 2000: MP Navigator EX folder in My Pictures folder

- **Save to a Subfolder with Current Date**

Select this checkbox to create a subfolder in the folder specified in Save in with the current date and save scanned files in it. A subfolder with a name such as "2009_01_01" (Year_Month_Date) will be created.

If this checkbox is not selected, files are saved directly in the folder specified in Save in.

- **Start scanning by clicking the one-click button**

Select this checkbox to start scanning when you click an icon.

- **Apply**

Saves and applies the specified settings.

Click Cancel instead of Apply to cancel the specified settings.

- **Cancel**

Cancels the specified settings. The current screen closes.

- **Defaults**

Returns all settings in the screen to their defaults.

- **Scan**

Scans and saves documents with the specified settings.

When Save as type is Auto, a confirmation appears. Click Open Manual to open this guide (if it is installed).

[Page top](#) ↕

Advanced Guide

Advanced Guide > Scanning > Scanning with the Bundled Application Software > MP Navigator EX Screens > Save Dialog Box (One-click Mode Screen)

MP Navigator EX

Save Dialog Box (One-click Mode Screen)

Click Save to PC on the Custom Scan with One-click tab or click Save in the One-click Mode screen to open the Save dialog box.

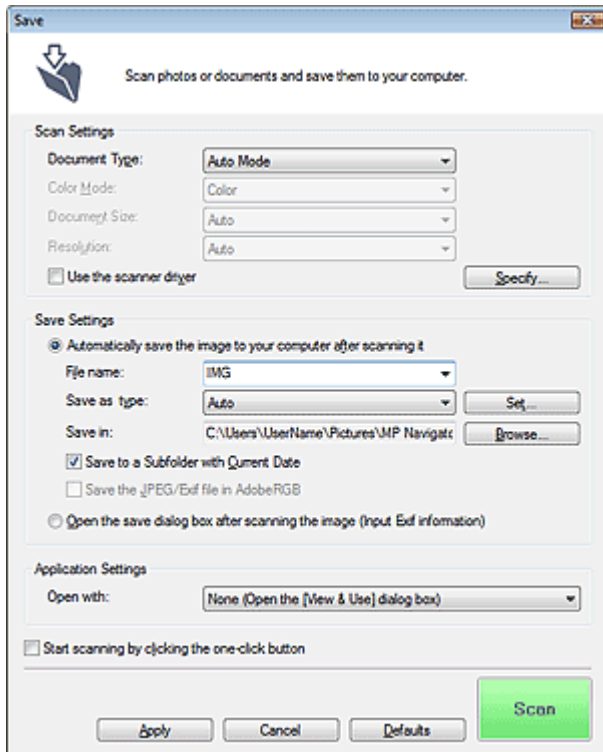

Scan Settings

- **Document Type**

Select the type of document to be scanned. When Auto Mode is selected, the document type is automatically detected. In that case, Color Mode, Document Size and Resolution are automatically set as well.

Important

- The following types of documents cannot be scanned correctly with Auto Mode. In that case, specify the document type or size.
 - Documents other than photos, postcards, business cards, magazines, newspapers, text documents, CD/DVD and film
 - A4 size photos
 - Text documents smaller than 2L (5 inches x 7 inches) (127 mm x 178 mm), such as paperback pages with the spine cut off
 - Documents printed on thin white paper
 - Long narrow documents such as panoramic photos
- Reflective CD/DVD labels may not be scanned properly.
- Film may not be scanned correctly when Auto Mode is selected. In that case, select the type of film in the Film dialog box and scan again.
- Place documents correctly according to the type of document to be scanned. Otherwise, documents may not be scanned correctly. See "Placing Documents" for details on how to place documents.

Note

- To reduce moire, set Document Type to Magazine.

• Color Mode

Select how to scan the document.

• Document Size

Select the size of the document to be scanned.

When you select Custom, a screen in which you can specify the document size appears. Select a Units, then enter the Width and Height and click OK.

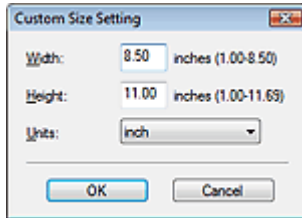

Important

- When you select Auto Detect, the image may not be scanned at the correct position and size. In that case, change the size to the actual document size (A4, Letter, etc.) and align a corner of the document with the corner at the arrow (alignment mark) of the Platen.

• Resolution

Select the resolution at which to scan documents.

➔ [Resolution](#)

• Use the scanner driver

Select this checkbox to display the ScanGear (scanner driver) screen and make advanced scan settings.

Color Mode, Document Size, Resolution and other settings in the Save dialog box will be disabled. Specify these settings in the ScanGear (scanner driver) screen.

• Specify...

Click to open the Scan Settings dialog box in which you can make advanced scan settings.

➔ [Scan Settings Dialog Box](#)

Save Settings

• Automatically save the image to your computer after scanning it

Select this to save the images to your computer as specified after scanning them.

The File name, Save as type and Save in settings will be displayed.

Important

- If you select this function, you will not be able to set passwords for PDF files.

• File name

Enter the file name of the image to be saved (up to 64 characters). When saving multiple files, 4 digits are appended to each file name.

• Save as type

Select a file type to save the scanned images.

Select Auto, JPEG/Exif, TIFF or BMP. Auto is displayed when Document Type is Auto Mode. When saving as PDF files, select PDF, PDF(Multiple Pages) or PDF(Add Page).

Important

- When Document Type is Auto Mode and Save as type is Auto, the file format may differ depending on how you place the document.
See "[Placing Documents](#)" for details on how to place documents.
- Large documents (such as A4 size photos) that cannot be placed away from the edges/arrow

(alignment mark) of the Platen may not be saved in the correct file format when Save as type is Auto. In that case, select a file format suitable for the document to be scanned.

- Images cannot be added to password-protected PDF files.
- You cannot select JPEG/Exif when Color Mode is Black and White.

Note

- When Auto is selected, files are saved in the following formats according to the document type.
Photos, postcards, CD/DVD, business cards and film: JPEG
Magazines, newspapers and text documents: PDF
You can change the file format from Set...
Images saved as PDF files may not open depending on the application. In that case, select an option other than Auto in Save as type.
- If you select JPEG/Exif when Document Type is not Auto Mode , the Save the JPEG/Exif file in AdobeRGB checkbox will be selectable.

● Set...

When Save as type is Auto

You can specify the file format in which to save images. Select a file format for Document and Photo each.

Important

- You cannot select a compression type for JPEG files when the Compress scanned images when transferring checkbox is selected on the General tab of the Preferences dialog box.

When Save as type is JPEG/Exif

You can specify a compression type for JPEG files. Select High(Low Compression), Standard or Low(High Compression).

Important

- This setting is not available when the Compress scanned images when transferring checkbox is selected on the General tab of the Preferences dialog box.

When Save as type is PDF, PDF(Multiple Pages) or PDF(Add Page)

Make advanced settings for creating PDF files. See "[PDF Settings Dialog Box](#)" for details.

● Save in

Displays the folder in which to save the scanned images. To change the folder, click Browse... to specify another one.

The following folders are specified by default.

Windows Vista: MP Navigator EX folder in Pictures folder

Windows XP: MP Navigator EX folder in My Pictures folder

Windows 2000: MP Navigator EX folder in My Pictures folder

● Save to a Subfolder with Current Date

Select this checkbox to create a subfolder in the folder specified in Save in with the current date and save scanned files in it. A subfolder with a name such as "2009_01_01" (Year_Month_Date) will be created.

If this checkbox is not selected, files are saved directly in the folder specified in Save in.

● Save the JPEG/Exif file in AdobeRGB

Select this checkbox to save the images in colors that correspond to Adobe RGB.

Important

- This function is available only when Save as type is JPEG/Exif and Document Type is not Auto Mode.
- This function is not available if the Adobe RGB profile is not installed.

Note

- You cannot select this setting if the Use the scanner driver checkbox is selected.

- When you save an image with the Save the JPEG/Exif file in AdobeRGB checkbox selected, an underscore is added to the beginning of the file name. (Example: _Image0001.jpg)

- **Open the save dialog box after scanning the image (Input Exif information)**

Select this to open the Save dialog box after scanning the images and specify the save settings such as destination folder, file name and Exif information.

➔ [Save Dialog Box](#)



Note

- To set passwords for PDF files, select Open the save dialog box after scanning the image (Input Exif information). After scanning, you can set the passwords in the Save dialog box.
➔ [Setting Passwords for PDF Files](#)
-

Application Settings

- **Open with**

You can select whether to open the View & Use window or Explorer after saving the images.

- **Start scanning by clicking the one-click button**

Select this checkbox to start scanning when you click an icon.

- **Apply**

Saves and applies the specified settings.

Click Cancel instead of Apply to cancel the specified settings.

- **Cancel**

Cancels the specified settings. The current screen closes.

- **Defaults**

Returns all settings in the screen to their defaults.

- **Scan**

Scans and saves documents with the specified settings.

When Save as type is Auto, a confirmation appears. Click Open Manual to open this guide (if it is installed).

[Page top](#)↑

Advanced Guide

Advanced Guide > Scanning > Scanning with the Bundled Application Software > MP Navigator EX Screens > Scan Settings Dialog Box

MP Navigator EX

Scan Settings Dialog Box

Make advanced settings for scanning with one-click or scanning using the Operation Panel of the machine.

The Scan Settings dialog box opens when you click Specify... in a dialog box for making scan settings.

For Photos/Documents (Platen)

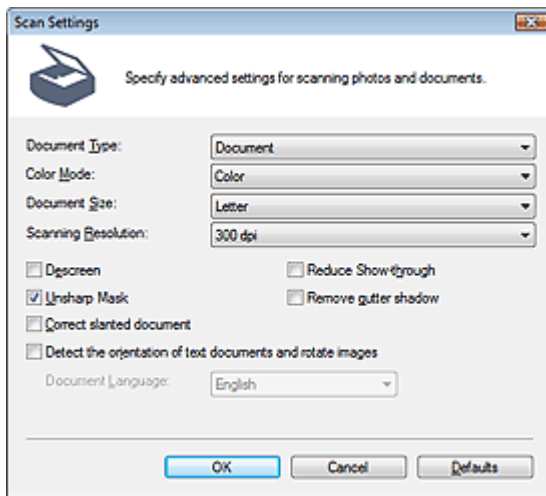

For Film

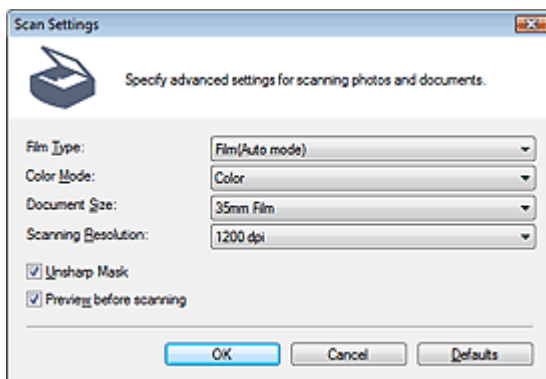

Note

- The displayed items vary by document type and how the screen was opened.
- The setting items vary in the Scan Settings dialog box that opens after clicking Specify... in the Film dialog box.

• Document Type

Select the type of document to be scanned. When Auto Mode or Auto Scan is selected, the document type is automatically detected.

In that case, Color Mode, Document Size, etc. are automatically set as well. When Film(Auto mode) is selected, the film type (negative or positive) is automatically detected.

► Important

- Film may not be scanned correctly when Auto Mode or Film(Auto mode) is selected. In that case,

select the type of film and scan again.

- To scan correctly, select a document type that matches the document to be scanned.
- When opened from the Scanner Button Settings tab in the Preferences dialog box, the Document Type specified in the Scanner Button Settings tab is displayed and cannot be changed in this dialog box.

- **Color Mode**

Select how to scan the document.

- **Color**

This mode renders the image in 256 levels (8 bit) of R(ed), G(reen), and B(lue).

- **Grayscale**

This mode renders the image in 256 levels (8 bit) of black and white.

 **Important**

- Grayscale cannot be selected when Film(Auto mode) is selected for Document Type.

- **Black and White**

This mode renders the image in black and white. The contrast in the image is divided at certain levels (threshold level) into black and white and is rendered in two colors.

 **Important**

- You cannot select Black and White if Document Type is film.

 **Note**

- Color Mode is not displayed in the Scan Settings dialog box opened from the Scanner Button Settings tab of the Preferences dialog box.

- **Document Size**

Select the size of the document to be scanned.

When you select Custom, a screen in which you can specify the document size appears. Select a Units, then enter the Width and Height and click OK.

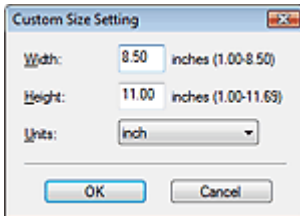

 **Important**

- When you select Auto Detect, the image may not be scanned at the correct position and size. In that case, change the size to the actual document size (A4, Letter, etc.) and align a corner of the document with the corner at the arrow (alignment mark) of the Platen.

- **Scanning Resolution**

Select the resolution at which to scan documents. The following scanning resolutions can be specified:

When Document Type is other than film: 75 dpi / 100 dpi / 150 dpi / 200 dpi / 300 dpi / 400 dpi / 600 dpi

When Document Type is film: 300 dpi / 400 dpi / 600 dpi / 1200 dpi / 2400 dpi / 4800 dpi

➔ Resolution

- **Descreen**

Select this checkbox to reduce moire patterns.

Printed photos and pictures are displayed as a collection of fine dots. "Moire" is a phenomenon where uneven gradation or a stripe pattern appears when such photos or pictures printed with fine dots are scanned. Descreen is the function for reducing this moire effect.

 **Note**

- Scanning takes longer than usual when you enable Descreen.

- **Reduce Show-through**

Select this checkbox to sharpen text in a document or reduce show-through in newspapers.

Note

- Select this checkbox when Document Type is text document and show-through is apparent in the scanned image.

- **Unsharp Mask**

Select this checkbox to emphasize the outline of the subjects and sharpen the image.

- **Remove gutter shadow**

Select this checkbox to correct shadows that appear between pages when scanning open booklets.

Important

- You cannot select this checkbox when Document Size is Auto Detect, Auto Detect (Multiple Documents) or Stitch Assist.
- Align the document correctly with the alignment mark on the Platen.

Note

- Use ScanGear's Advanced Mode tab to correct gutter shadows when scanning non-standard size documents or when custom cropping frames are set.
For details, see Gutter Shadow Correction in " [Image Settings](#) " (ScanGear's Advanced Mode tab).

- **Correct slanted document**

Select this checkbox to detect the scanned text and correct the angle (within -0.1 to -10 degrees or +0.1 to +10 degrees) of the document.

Important

- You cannot select this checkbox when Document Size is Stitch Assist.
- The inclination of the following types of documents may not be corrected, as the text cannot be detected correctly.
 - Documents in which the text lines are inclined more than 10 degrees or the angles vary by line
 - Documents containing both vertical and horizontal text
 - Documents with extremely large or small fonts
 - Documents with small amount of text
 - Documents containing figures/images or hand-written text
 - Documents containing both vertical and horizontal lines (tables)

Note

- Scanning takes longer than usual when you enable Correct slanted document.

- **Enable Auto Photo Fix (When scanning with Auto Scan using the Operation Panel)**

Select this checkbox to analyze the photo image and apply suitable corrections automatically.

This function is available when Auto or JPEG/Exif is selected for Save as type in Save Settings on the Scanner Button Settings tab of the Preferences dialog box.

Important

- When Save as type is Auto, the base color tone of the following types of documents may change from the source since they are corrected as photos. In that case, deselect the checkbox and scan.
 - Postcards and business cards
- Text documents may not be scanned correctly since they may be corrected as photos depending on how you place the document. In that case, deselect the checkbox and scan.

Note

- If you select a format other than JPEG/Exif for Save as type and then select this checkbox, a message appears and Save as type will be set to Auto.

- **Detect the orientation of text documents and rotate images**

Select this checkbox to detect the orientation of the document from the scanned text and rotate the scanned image to the correct orientation. Select the language of the document to be scanned in Document Language.

Important

- You cannot select this checkbox when Document Size is Stitch Assist.
- This function may not work properly depending on the document language. Only text documents written in languages that can be selected from Document Language are supported.
- The orientation of the following types of documents may not be corrected, as the text cannot be detected correctly.
 - Resolution is outside the range of 300 dpi to 600 dpi
 - Font size is outside the range of 8 points to 48 points
 - Documents containing special fonts, effects, italics, or hand-written text
 - Documents with patterned backgrounds

Note

- Scanning takes longer than usual when you enable Detect the orientation of text documents and rotate images.

• Document Language

Select the language of the document to be scanned.

Important

- You cannot select this checkbox when Document Size is Stitch Assist.

• Preview before scanning

Select this checkbox to display images after scanning film.

• Defaults

Restores the default settings.

[Page top](#)[↕]

Advanced Guide

Advanced Guide > Scanning > Scanning with the Bundled Application Software > MP Navigator EX Screens > Save Dialog Box

MP Navigator EX

Save Dialog Box

The Save dialog box opens when you scan from Save to PC on the Custom Scan with One-click tab or from Save in the One-click Mode screen after selecting Open the save dialog box after scanning the image (Input Exif information).

You can specify the file type and destination while viewing the thumbnails.

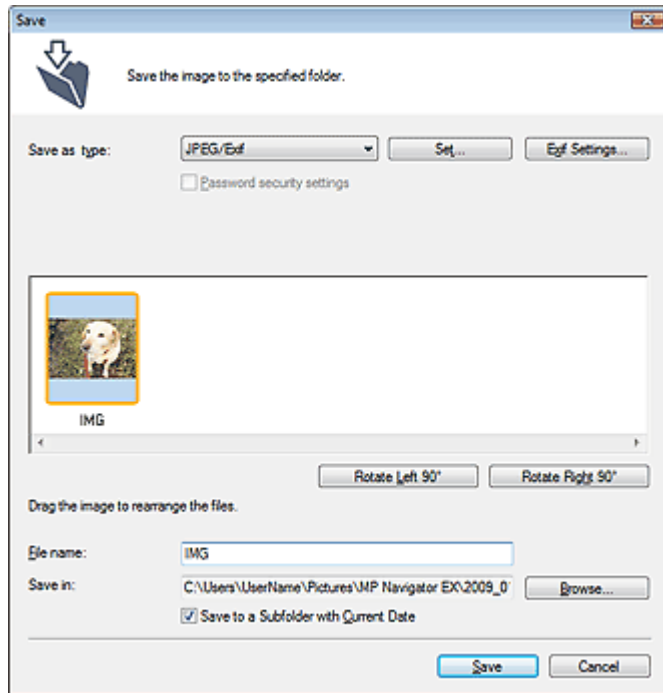

- **Save as type**

Select a file type to save the scanned images.

Select JPEG/Exif, TIFF, BMP, PDF, PDF(Multiple Pages) or PDF(Add Page).

- **PDF**

Save each of the selected images as a separate PDF file.

- **PDF(Multiple Pages)**

Save multiple images in one PDF file.

Note

- PDF(Multiple Pages) is displayed when multiple images are scanned.

- **PDF(Add Page)**

Add the scanned images to a PDF file. The images are added to the end of the PDF file. You cannot rearrange the pages of the PDF file to which the images are added.

Important

- Images can only be added to PDF files created with MP Navigator EX. You cannot specify PDF files created with other applications. PDF files edited in other applications cannot be specified as well.
 - If a password-protected PDF file is edited, the passwords will be deleted. Reset the passwords.

➔ [Setting Passwords for PDF Files](#)

 **Important**

- PDF, PDF(Multiple Pages) and PDF(Add Page) cannot be selected for images scanned using the Operation Panel of the machine.
- You cannot select JPEG/Exif when Color Mode is Black and White.

• Set...**When Save as type is JPEG/Exif**

You can specify a compression type for JPEG files. Select High(Low Compression), Standard or Low(High Compression).

 **Important**

- This setting is not available when the Compress scanned images when transferring checkbox is selected on the General tab of the Preferences dialog box.

When Save as type is PDF, PDF(Multiple Pages) or PDF(Add Page)

Make advanced settings for creating PDF files. See "[PDF Settings Dialog Box](#)" for details.

• Exif Settings...

When Save as type is JPEG/Exif, you can input Exif information into the file to be saved.

➔ [Exif Settings Dialog Box](#)

• Password security settings

Select this checkbox to open the Password Security -Settings dialog box in which you can set passwords for opening, editing and printing created PDF files.

➔ [Setting Passwords for PDF Files](#)

 **Note**

- This function is available only when Save as type is PDF, PDF(Multiple Pages) or PDF(Add Page).

• Add to

This is displayed when you select PDF(Add Page) for Save as type and specify the PDF file to which images are added. To change the file, click Browse... to specify another one.

 **Important**

- Images can only be added to PDF files created with MP Navigator EX. You cannot specify PDF files created with other applications. PDF files edited in other applications cannot be specified as well.

• Rotate Left 90°/Rotate Right 90°

Rotates scanned images 90 degrees counter-clockwise or clockwise.

Select the image you want to rotate and click Rotate Left 90° or Rotate Right 90°.

• File name

Enter the file name of the image to be saved (up to 64 characters). When saving multiple files, 4 digits are appended to each file name.

• Save in

Displays the folder in which to save the scanned images. To change the folder, click Browse... to specify another one.

The following folders are specified by default.

Windows Vista: MP Navigator EX folder in Pictures folder

Windows XP: MP Navigator EX folder in My Pictures folder

Windows 2000: MP Navigator EX folder in My Pictures folder

• Save to a Subfolder with Current Date

Select this checkbox to create a subfolder in the folder specified in Save in with the current date and save scanned files in it. A subfolder with a name such as "2009_01_01" (Year_Month_Date) will be created.

If this checkbox is not selected, files are saved directly in the folder specified in Save in.

Advanced Guide

Advanced Guide > Scanning > Scanning with the Bundled Application Software > MP Navigator EX Screens > Exif Settings Dialog Box

MP Navigator EX

Exif Settings Dialog Box

You can input Exif information into a file to be saved. Exif is a standard format for embedding various shooting data in digital camera images (JPEG). Embedding Exif information into scanned images allows you to organize and print them along with digital camera images.

The Exif Settings dialog box can be opened when Save as type is JPEG/Exif.

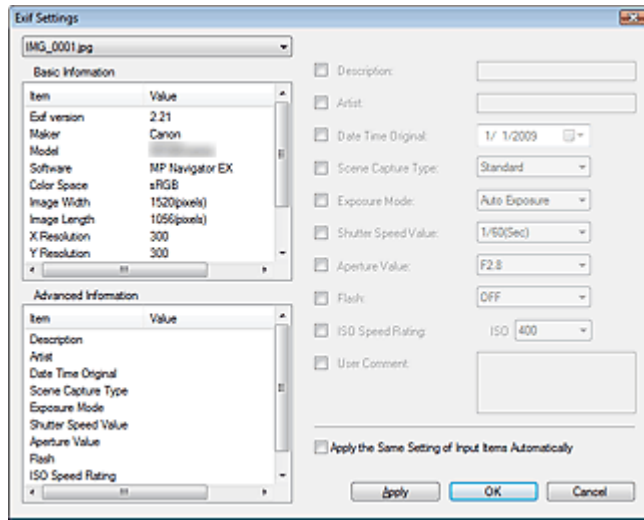

- **Basic Information**

Displays the information obtained automatically from the machine or software.

- **Advanced Information**

Displays the information specified on the right side of the screen.

- **Advanced Information Settings Area**

You can input Exif information such as the title and shooting data. Select the checkbox of the items you want to specify, and select or enter information.

- **Apply the Same Setting of Input Items Automatically**

Select this checkbox to automatically display the information you specified for the previous image.

- **Apply**

After specifying all the information you need, click Apply to embed it into the image. The information appears in Advanced Information.

- **OK**

Embeds the specified information into the image and closes the screen. The specified information is saved.

- **Cancel**

Cancels the settings and closes the screen. Information is embedded when Cancel is clicked after clicking Apply.

Advanced Guide

Advanced Guide > Scanning > Scanning with the Bundled Application Software > MP Navigator EX Screens > PDF Dialog Box

MP Navigator EX

PDF Dialog Box

Click Save as PDF file on the Custom Scan with One-click tab or click PDF in the One-click Mode screen to open the PDF dialog box.

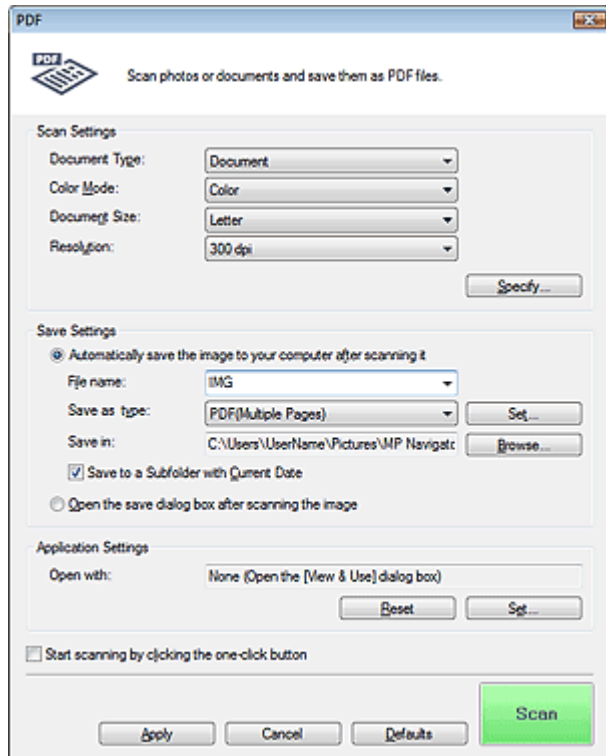

Scan Settings

- Document Type**
 Select the type of document to be scanned.
- Color Mode**
 Select how to scan the document.
- Document Size**
 Select the size of the document to be scanned.
 When you select Custom, a screen in which you can specify the document size appears. Select a Units, then enter the Width and Height and click OK.

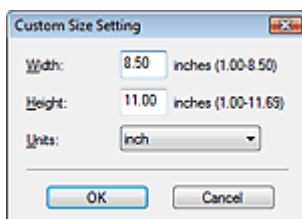

Important

- When you select Auto Detect, the image may not be scanned at the correct position and size. In that case, change the size to the actual document size (A4, Letter, etc.) and align a corner of the

document with the corner at the arrow (alignment mark) of the Platen.

- **Resolution**

Select the resolution at which to scan documents.

➔ [Resolution](#)

- **Specify...**

Click to open the Scan Settings dialog box in which you can make advanced scan settings.

➔ [Scan Settings Dialog Box](#)

Save Settings

- **Automatically save the image to your computer after scanning it**

Select this to save the images to your computer as specified after scanning them.

The File name, Save as type and Save in settings will be displayed.



Important

- If you select this function, you will not be able to set passwords for PDF files.

- **File name**

Enter the file name of the image to be saved (up to 64 characters). When saving multiple files, 4 digits are appended to each file name.

- **Save as type**

Select a file type to save the scanned images.

Select PDF, PDF(Multiple Pages) or PDF(Add Page).

- **PDF**

Save each of the selected images as a separate PDF file.

- **PDF(Multiple Pages)**

Save multiple images in one PDF file.

- **PDF(Add Page)**

Add the scanned images to a PDF file. The images are added to the end of the PDF file. You cannot rearrange the pages of the PDF file to which the images are added.



Important

- Images cannot be added to password-protected PDF files.



Note

- Click Set... to open the PDF Settings dialog box in which you can specify the PDF compression type and other advanced settings for creating PDF files.

➔ [PDF Settings Dialog Box](#)

- See "[Creating/Editing PDF Files](#)" to delete or rearrange the pages of saved PDF files.

- **Save in**

Displays the folder in which to save the scanned images. To change the folder, click Browse... to specify another one.

The following folders are specified by default.

Windows Vista: MP Navigator EX folder in Pictures folder

Windows XP: MP Navigator EX folder in My Pictures folder

Windows 2000: MP Navigator EX folder in My Pictures folder

- **Save to a Subfolder with Current Date**

Select this checkbox to create a subfolder in the folder specified in Save in with the current date and save scanned files in it. A subfolder with a name such as "2009_01_01" (Year_Month_Date) will be created.

If this checkbox is not selected, files are saved directly in the folder specified in Save in.

- **Open the save dialog box after scanning the image**

Select this to open the Save as PDF file dialog box after scanning the images and specify the save

settings such as destination folder and file name.

➔ [Save as PDF file Dialog Box](#)



Note

- To set passwords for PDF files, select Open the save dialog box after scanning the image. After scanning, you can set the passwords in the Save as PDF file dialog box.

➔ [Setting Passwords for PDF Files](#)

Application Settings

- **Open with**

Specify an application with which to open scanned images. Drag and drop the icon of an application that supports the file format displayed in Save as type. The specified application starts after images are scanned.



Important

- Depending on the specified application, the images may not appear correctly or the application may not start.

- **Reset**

Cancels the application setting.

- **Set...**

Allows you to select an application to start.

- **Start scanning by clicking the one-click button**

Select this checkbox to start scanning when you click an icon.

- **Apply**

Saves and applies the specified settings.

Click Cancel instead of Apply to cancel the specified settings.

- **Cancel**

Cancels the specified settings. The current screen closes.

- **Defaults**

Returns all settings in the screen to their defaults.

- **Scan**

Scans and saves documents as PDF files with the specified settings.

[Page top](#) ↕

Advanced Guide

Advanced Guide > Scanning > Scanning with the Bundled Application Software > MP Navigator EX Screens > Save as PDF file Dialog Box

MP Navigator EX

Save as PDF file Dialog Box

The Save as PDF file dialog box opens when you scan from Save as PDF file on the Custom Scan with One-click tab or from PDF in the One-click Mode screen after selecting Open the save dialog box after scanning the image.

In the Save as PDF file dialog box, you can make settings for saving images to a computer.

Important

- You cannot save images scanned at 10501 pixels or more in the vertical and horizontal directions.

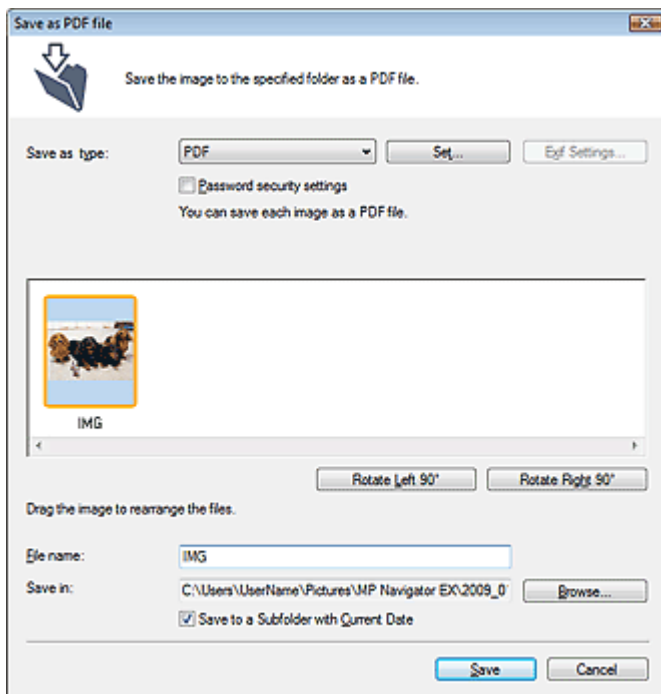

• Save as type

Select a PDF file type to save the scanned images.

- PDF**
 Save each of the selected images as a separate PDF file.
- PDF(Multiple Pages)**
 Save multiple images in one PDF file.

Note

- PDF(Multiple Pages) is displayed when multiple images are scanned.

• PDF(Add Page)

Add the scanned images to a PDF file. The images are added to the end of the PDF file. You cannot rearrange the pages of the PDF file to which the images are added.

Important

- Images can only be added to PDF files created with MP Navigator EX. You cannot specify PDF files created with other applications. PDF files edited in other applications cannot be specified as well.

- PDF(Add Page) cannot be selected for images scanned using the Operation Panel of the machine.
- If a password-protected PDF file is edited, the passwords will be deleted. Reset the passwords.
➔ [Setting Passwords for PDF Files](#)

- **Set...**

Make advanced settings for creating PDF files. See "[PDF Settings Dialog Box](#)" for details.

- **Password security settings**

Select this checkbox to open the Password Security -Settings dialog box in which you can set passwords for opening, editing and printing created PDF files.

➔ [Setting Passwords for PDF Files](#)

- **Rotate Left 90°/Rotate Right 90°**

Rotates scanned images 90 degrees counter-clockwise or clockwise.

Select the image you want to rotate and click Rotate Left 90° or Rotate Right 90°.

- **File name**

Enter the file name of the image to be saved (up to 64 characters). When saving multiple files, 4 digits are appended to each file name.

- **Save in**

Displays the folder in which to save the PDF files. To change the folder, click Browse... to specify another one.

The following folders are specified by default.

Windows Vista: MP Navigator EX folder in Pictures folder

Windows XP: MP Navigator EX folder in My Pictures folder

Windows 2000: MP Navigator EX folder in My Pictures folder

- **Save to a Subfolder with Current Date**

Select this checkbox to create a subfolder in the folder specified in Save in with the current date and save scanned files in it. A subfolder with a name such as "2009_01_01" (Year_Month_Date) will be created.

If this checkbox is not selected, files are saved directly in the folder specified in Save in.

[Page top](#) ↕

Advanced Guide

Advanced Guide > Scanning > Scanning with the Bundled Application Software > MP Navigator EX Screens > Mail Dialog Box

MP Navigator EX

Mail Dialog Box

Click Attach to E-mail on the Custom Scan with One-click tab or click Mail in the One-click Mode screen to open the Mail dialog box.

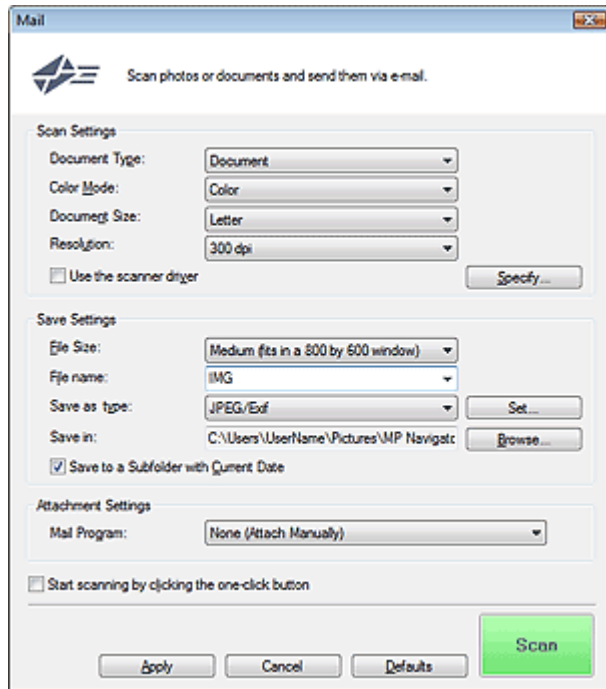

Scan Settings

- **Document Type**

Select the type of document to be scanned.

- **Color Mode**

Select how to scan the document.

- **Document Size**

Select the size of the document to be scanned.

When you select Custom, a screen in which you can specify the document size appears. Select a Units, then enter the Width and Height and click OK.

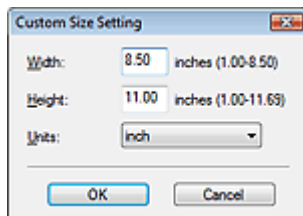

Important

- When you select Auto Detect, the image may not be scanned at the correct position and size. In that case, change the size to the actual document size (A4, Letter, etc.) and align a corner of the document with the corner at the arrow (alignment mark) of the Platen.

- **Resolution**

Select the resolution at which to scan documents.

➔ [Resolution](#)

- **Use the scanner driver**

Select this checkbox to display the ScanGear (scanner driver) screen and make advanced scan settings.

Color Mode, Document Size, Resolution and other settings in the Mail dialog box will be disabled.

Specify these settings in the ScanGear (scanner driver) screen.

- **Specify...**

Click to open the Scan Settings dialog box in which you can make advanced scan settings.

➔ [Scan Settings Dialog Box](#)

Save Settings

- **File Size**

Select a size from Small (fits in a 640 by 480 window), Medium (fits in a 800 by 600 window), Large (fits in a 1024 by 768 window) and Original.

- **File name**

Enter the file name of the image to be saved (up to 64 characters). When saving multiple files, 4 digits are appended to each file name.

- **Save as type**

Select a file type to save the scanned images.

Select JPEG/Exif, PDF or PDF(Multiple Pages).



Important

- You cannot set passwords for PDF files.
- You cannot select JPEG/Exif when Color Mode is Black and White.

- **Set...**

When Save as type is JPEG/Exif

You can specify a compression type for JPEG files. Select High(Low Compression), Standard or Low(High Compression).



Important

- This setting is not available when the Compress scanned images when transferring checkbox is selected on the General tab of the Preferences dialog box.

When Save as type is PDF or PDF(Multiple Pages)

Make advanced settings for creating PDF files. See "[PDF Settings Dialog Box](#)" for details.

- **Save in**

Displays the folder in which to save the scanned images. To change the folder, click Browse... to specify another one.

The following folders are specified by default.

Windows Vista: MP Navigator EX folder in Pictures folder

Windows XP: MP Navigator EX folder in My Pictures folder

Windows 2000: MP Navigator EX folder in My Pictures folder

- **Save to a Subfolder with Current Date**

Select this checkbox to create a subfolder in the folder specified in Save in with the current date and save scanned files in it. A subfolder with a name such as "2009_01_01" (Year_Month_Date) will be created.

If this checkbox is not selected, files are saved directly in the folder specified in Save in.

Attachment Settings

- **Mail Program**

Specify an e-mail software program.

 **Note**

- Select Add... to open the Select Mail Program dialog box in which you can select an e-mail software program. If the e-mail software program you want to use is not listed, click Add to List and select it.

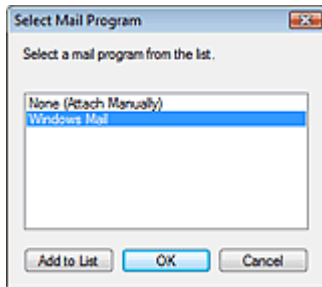

- **Start scanning by clicking the one-click button**

Select this checkbox to start scanning when you click an icon.

- **Apply**

Saves and applies the specified settings.

Click Cancel instead of Apply to cancel the specified settings.

- **Cancel**

Cancels the specified settings. The current screen closes.

- **Defaults**

Returns all settings in the screen to their defaults.

- **Scan**

Scans documents with the specified settings.

When scanning is completed, the e-mail software program starts automatically and a new message screen appears with the image attached.

Advanced Guide

Advanced Guide > Scanning > Scanning with the Bundled Application Software > MP Navigator EX Screens > Film Dialog Box

MP Navigator EX

Film Dialog Box

Click Scan film & save on the Custom Scan with One-click tab or click Film in the One-click Mode screen to open the Film dialog box.

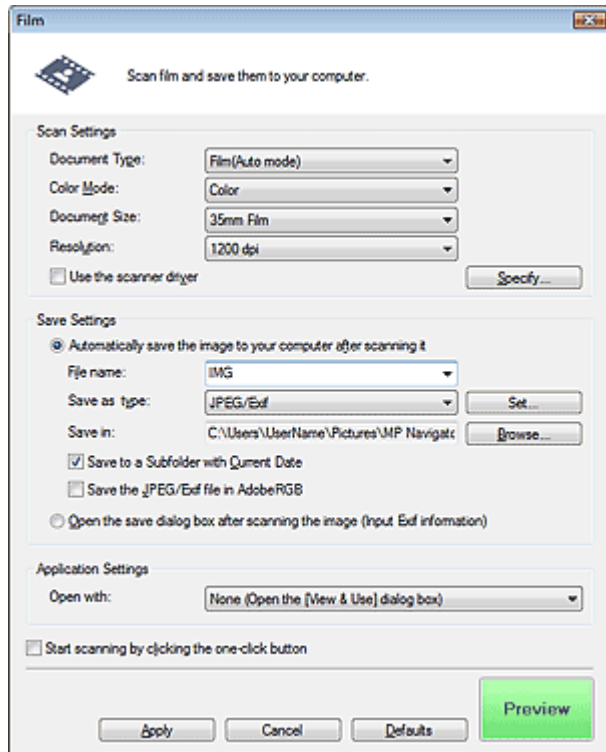

Scan Settings

- **Document Type**

Select the type of film to be scanned. When Film(Auto mode) is selected, the film type (negative or positive) is automatically detected.

▶ Important

- Film may not be scanned correctly when Film(Auto mode) is selected. In that case, select the type of film and scan again.

- **Color Mode**

Select how to scan the film.

▶ Important

- Grayscale cannot be selected when Film(Auto mode) is selected for Document Type.

- **Document Size**

35mm Film is displayed.

- **Resolution**

Select the resolution at which to scan film.

➡ Resolution

- **Use the scanner driver**

Select this checkbox to display the ScanGear (scanner driver) screen and make advanced scan settings.
Color Mode, Document Size, Resolution and other settings in the Film dialog box will be disabled.
Specify these settings in the ScanGear (scanner driver) screen.

- **Specify...**

Click to open the Scan Settings dialog box in which you can make advanced scan settings.

➔ [Scan Settings Dialog Box](#)

Save Settings

- **Automatically save the image to your computer after scanning it**

Select this to save the images to your computer as specified after scanning them.
The File name, Save as type and Save in settings will be displayed.

Important

- If you select this function, you will not be able to set passwords for PDF files.

- **File name**

Enter the file name of the image to be saved (up to 64 characters). When saving multiple files, 4 digits are appended to each file name.

- **Save as type**

Select a file type to save the scanned images.
Select JPEG/Exif, TIFF or BMP.

Note

- If you select JPEG/Exif, the Save the JPEG/Exif file in AdobeRGB checkbox will be selectable.

- **Set...**

When Save as type is JPEG/Exif

You can specify a compression type for JPEG files. Select High(Low Compression), Standard or Low(High Compression).

Important

- This setting is not available when the Compress scanned images when transferring checkbox is selected on the General tab of the Preferences dialog box.

- **Save in**

Displays the folder in which to save the scanned images. To change the folder, click Browse... to specify another one.

The following folders are specified by default.

Windows Vista: MP Navigator EX folder in Pictures folder

Windows XP: MP Navigator EX folder in My Pictures folder

Windows 2000: MP Navigator EX folder in My Pictures folder

- **Save to a Subfolder with Current Date**

Select this checkbox to create a subfolder in the folder specified in Save in with the current date and save scanned files in it. A subfolder with a name such as "2009_01_01" (Year_Month_Date) will be created.

If this checkbox is not selected, files are saved directly in the folder specified in Save in.

- **Save the JPEG/Exif file in AdobeRGB**

Select this checkbox to save the images in colors that correspond to Adobe RGB.

Important

- This function is available only when Save as type is JPEG/Exif.
- This function is not available if the Adobe RGB profile is not installed.

 **Note**

- You cannot select this setting if the Use the scanner driver checkbox is selected.
- When you save an image with the Save the JPEG/Exif file in AdobeRGB checkbox selected, an underscore is added to the beginning of the file name. (Example: _Image0001.jpg)

- **Open the save dialog box after scanning the image (Input Exif information)**

Select this to open the Save dialog box after scanning the images and specify the save settings such as destination folder, file name and Exif information.

➔ [Save Dialog Box](#)

 **Note**

- To set passwords for PDF files, select Open the save dialog box after scanning the image (Input Exif information). After scanning, you can set the passwords in the Save dialog box.

➔ [Setting Passwords for PDF Files](#)

Application Settings

- **Open with**

You can select whether to open the View & Use window or Explorer after saving the images.

- **Start scanning by clicking the one-click button**

Select this checkbox to start scanning when you click an icon.

- **Apply**

Saves and applies the specified settings.

Click Cancel instead of Apply to cancel the specified settings.

- **Cancel**

Cancels the specified settings. The current screen closes.

- **Defaults**

Returns all settings in the screen to their defaults.

- **Preview**

Displays the thumbnails of the photos on the film. Click Scan in the displayed screen to scan film and save as specified.

[Page top](#)↑

Advanced Guide

Advanced Guide > Scanning > Scanning with the Bundled Application Software > MP Navigator EX Screens > OCR Dialog Box

MP Navigator EX

OCR Dialog Box

Click OCR on the Custom Scan with One-click tab or in the One-click Mode screen to open the OCR dialog box.

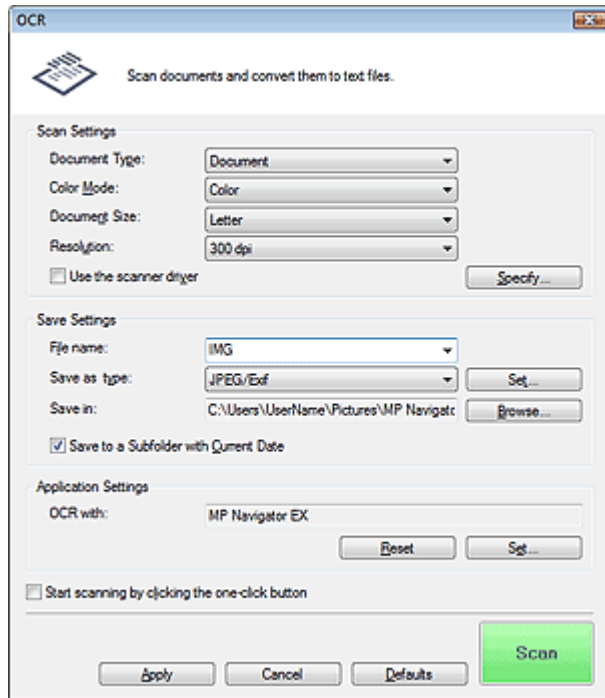

Scan Settings

- Document Type**
 Select the type of document to be scanned.
- Color Mode**
 Select how to scan the document.
- Document Size**
 Select the size of the document to be scanned.
 When you select Custom, a screen in which you can specify the document size appears. Select a Units, then enter the Width and Height and click OK.

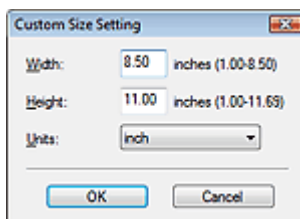

- Resolution**
 Select the resolution at which to scan documents.
 ➔ Resolution
- Use the scanner driver**
 Select this checkbox to display the ScanGear (scanner driver) screen and make advanced scan

settings.

Color Mode, Document Size, Resolution and other settings in the OCR dialog box will be disabled. Specify these settings in the ScanGear (scanner driver) screen.

- **Specify...**

Click to open the Scan Settings dialog box in which you can make advanced scan settings.

➔ [Scan Settings Dialog Box](#)



Note

- When scanning slanted documents, select the Correct slanted document checkbox to improve the text recognition accuracy.

Save Settings

- **File name**

Enter the file name of the image to be saved (up to 64 characters). When saving multiple files, 4 digits are appended to each file name.

- **Save as type**

Select a file type to save the scanned images.

Select JPEG/Exif, TIFF or BMP.



Important

- You cannot select JPEG/Exif when Color Mode is Black and White.

- **Set...**

When Save as type is JPEG/Exif

You can specify a compression type for JPEG files. Select High(Low Compression), Standard or Low(High Compression).



Important

- This setting is not available when the Compress scanned images when transferring checkbox is selected on the General tab of the Preferences dialog box.

- **Save in**

Displays the folder in which to save the scanned images. To change the folder, click Browse... to specify another one.

The following folders are specified by default.

Windows Vista: MP Navigator EX folder in Pictures folder

Windows XP: MP Navigator EX folder in My Pictures folder

Windows 2000: MP Navigator EX folder in My Pictures folder

- **Save to a Subfolder with Current Date**

Select this checkbox to create a subfolder in the folder specified in Save in with the current date and save scanned files in it. A subfolder with a name such as "2009_01_01" (Year_Month_Date) will be created.

If this checkbox is not selected, files are saved directly in the folder specified in Save in.

Application Settings

- **OCR with**

Specify an OCR application.

When MP Navigator EX is specified, after the image is scanned, the text in the image is extracted and appears in Notepad (included with Windows).



Note

- Only text written in languages that can be selected on the General tab can be extracted to Notepad (included with Windows). Click Set... on the General tab and specify the language according to the language of the document to be scanned.

When scanning multiple documents, you can collect the extracted text into one file.

➔ **General Tab**

- Text displayed in Notepad (included with Windows) is for guidance only. Text in the image of the following types of documents may not be detected correctly.
 - Documents containing text with font size outside the range of 8 points to 40 points (at 300 dpi)
 - Slanted documents
 - Documents placed upside down or documents with text in the wrong orientation (rotated characters)
 - Documents containing special fonts, effects, italics, or hand-written text
 - Documents with narrow line spacing
 - Documents with colors in the background of text
 - Documents containing multiple languages
-

- **Reset**

Cancels the application setting.

- **Set...**

Allows you to select an application.



Important

- Depending on the specified application, the text may not be extracted correctly or the application may not start.

- **Start scanning by clicking the one-click button**

Select this checkbox to start scanning when you click an icon.

- **Apply**

Saves and applies the specified settings.
Click Cancel instead of Apply to cancel the specified settings.

- **Cancel**

Cancels the specified settings. The current screen closes.

- **Defaults**

Returns all settings in the screen to their defaults.

- **Scan**

Scans documents with the specified settings.

Advanced Guide

Advanced Guide > Scanning > Scanning with the Bundled Application Software > MP Navigator EX Screens > Custom Dialog Box

MP Navigator EX

Custom Dialog Box

Click Custom on the Custom Scan with One-click tab or in the One-click Mode screen to open the Custom dialog box.

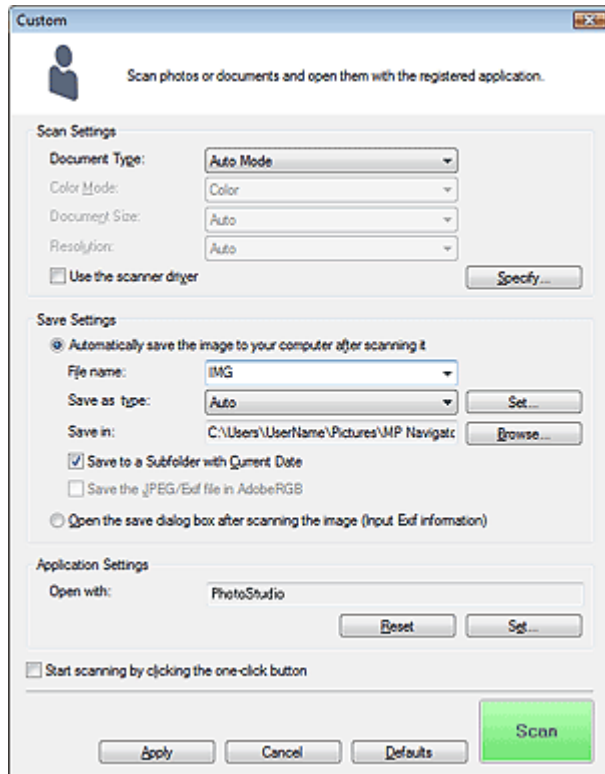

Scan Settings

- **Document Type**

Select the type of document to be scanned. When Auto Mode is selected, the document type is automatically detected. In that case, Color Mode, Document Size and Resolution are automatically set as well. When Film(Auto mode) is selected, the film type (negative or positive) is automatically detected.

Important

- The following types of documents cannot be scanned correctly with Auto Mode. In that case, specify the document type or size.
 - Documents other than photos, postcards, business cards, magazines, newspapers, text documents, CD/DVD and film
 - A4 size photos
 - Text documents smaller than 2L (5 inches x 7 inches) (127 mm x 178 mm), such as paperback pages with the spine cut off
 - Documents printed on thin white paper
 - Long narrow documents such as panoramic photos
- Reflective CD/DVD labels may not be scanned properly.
- Film may not be scanned correctly when Auto Mode or Film(Auto mode) is selected. In that case, select the type of film and scan again.
- Place documents correctly according to the type of document to be scanned. Otherwise, documents may not be scanned correctly.

See "Placing Documents" for details on how to place documents.

Note

- To reduce moire, set Document Type to Magazine.

• Color Mode

Select how to scan the document.

• Document Size

Select the size of the document to be scanned.

When you select Custom, a screen in which you can specify the document size appears. Select a Units, then enter the Width and Height and click OK.

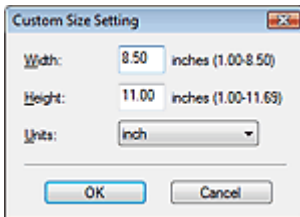

Important

- When you select Auto Detect, the image may not be scanned at the correct position and size. In that case, change the size to the actual document size (A4, Letter, etc.) and align a corner of the document with the corner at the arrow (alignment mark) of the Platen.

• Resolution

Select the resolution at which to scan documents. The following scanning resolutions can be specified:

When Document Type is other than film: 75 dpi / 100 dpi / 150 dpi / 200 dpi / 300 dpi / 400 dpi / 600 dpi

When Document Type is film: 300 dpi / 400 dpi / 600 dpi / 1200 dpi / 2400 dpi / 4800 dpi

➔ Resolution

• Use the scanner driver

Select this checkbox to display the ScanGear (scanner driver) screen and make advanced scan settings.

Color Mode, Document Size, Resolution and other settings in the Custom dialog box will be disabled. Specify these settings in the ScanGear (scanner driver) screen.

• Specify...

Click to open the Scan Settings dialog box in which you can make advanced scan settings.

➔ Scan Settings Dialog Box

Save Settings

• Automatically save the image to your computer after scanning it

Select this to save the images to your computer as specified after scanning them.

The File name, Save as type and Save in settings will be displayed.

Important

- If you select this function, you will not be able to set passwords for PDF files.

Note

- If an application to start is specified in Application Settings, the scanned image opens in the specified application.

• File name

Enter the file name of the image to be saved (up to 64 characters). When saving multiple files, 4 digits are appended to each file name.

- **Save as type**

Select a file type to save the scanned images.

Select Auto, JPEG/Exif, TIFF or BMP. Auto is displayed and selected by default when Document Type is Auto Mode.

Important

- When Document Type is Auto Mode and Save as type is Auto, the file format may differ depending on how you place the document.
See "[Placing Documents](#)" for details on how to place documents.
- Large documents (such as A4 size photos) that cannot be placed away from the edges/arrow (alignment mark) of the Platen may not be saved in the correct file format when Save as type is Auto. In that case, select a file format suitable for the document to be scanned.
- You cannot select JPEG/Exif when Color Mode is Black and White.

Note

- When Auto is selected, files are saved in the following formats according to the document type.
Photos, postcards, CD/DVD, business cards and film: JPEG
Magazines, newspapers and text documents: PDF
You can change the file format from Set...
Images saved as PDF files may not open depending on the application. In that case, select an option other than Auto in Save as type.
- If you select JPEG/Exif when Document Type is not Auto Mode, the Save the JPEG/Exif file in AdobeRGB checkbox will be selectable.

- **Set...**

When Save as type is Auto

You can specify the file format in which to save images. Select a file format for Document and Photo each.

Important

- You cannot select a compression type for JPEG files when the Compress scanned images when transferring checkbox is selected on the General tab of the Preferences dialog box.

When Save as type is JPEG/Exif

You can specify a compression type for JPEG files. Select High(Low Compression), Standard or Low(High Compression).

Important

- This setting is not available when the Compress scanned images when transferring checkbox is selected on the General tab of the Preferences dialog box.

- **Save in**

Displays the folder in which to save the scanned images. To change the folder, click Browse... to specify another one.

The following folders are specified by default.

Windows Vista: MP Navigator EX folder in Pictures folder

Windows XP: MP Navigator EX folder in My Pictures folder

Windows 2000: MP Navigator EX folder in My Pictures folder

- **Save to a Subfolder with Current Date**

Select this checkbox to create a subfolder in the folder specified in Save in with the current date and save scanned files in it. A subfolder with a name such as "2009_01_01" (Year_Month_Date) will be created.

If this checkbox is not selected, files are saved directly in the folder specified in Save in.

- **Save the JPEG/Exif file in AdobeRGB**

Select this checkbox to save the images in colors that correspond to Adobe RGB.

Important

- This function is available only when Save as type is JPEG/Exif and Document Type is not Auto Mode.
- This function is not available if the Adobe RGB profile is not installed.

Note

- You cannot select this setting if the Use the scanner driver checkbox is selected.
- When you save an image with the Save the JPEG/Exif file in AdobeRGB checkbox selected, an underscore is added to the beginning of the file name. (Example: _Image0001.jpg)

● **Open the save dialog box after scanning the image (Input Exif information)**

Select this to open the Save dialog box after scanning the images and specify the save settings such as destination folder, file name and Exif information.

➔ [Save Dialog Box](#)

Application Settings

● **Open with**

Specify an application with which to open scanned images. Drag and drop the icon of an application that supports the file format displayed in Save as type. The specified application starts after images are scanned.

Important

- Depending on the specified application, the images may not appear correctly or the application may not start.

● **Reset**

Cancels the application setting.

● **Set...**

Allows you to select an application to start.

● **Start scanning by clicking the one-click button**

Select this checkbox to start scanning when you click an icon.

● **Apply**

Saves and applies the specified settings.

Click Cancel instead of Apply to cancel the specified settings.

● **Cancel**

Cancels the specified settings. The current screen closes.

● **Defaults**

Returns all settings in the screen to their defaults.

● **Scan / Preview**

Scans and saves documents with the specified settings. When film is selected for Document Type, this button changes to Preview, and clicking it displays the thumbnails of the photos on the film. In the displayed dialog box, select the checkboxes of the images you want to scan, then click Scan. Starts scanning.

When Save as type is Auto, a confirmation appears. Click Open Manual to open this guide (if it is installed).

Advanced Guide

Advanced Guide > Scanning > Scanning with the Bundled Application Software > MP Navigator EX Screens > Preferences Dialog Box

MP Navigator EX

Preferences Dialog Box

Click Preferences to open the Preferences dialog box.

In the Preferences dialog box, you can make advanced settings to MP Navigator EX functions via the General and Scanner Button Settings tabs.

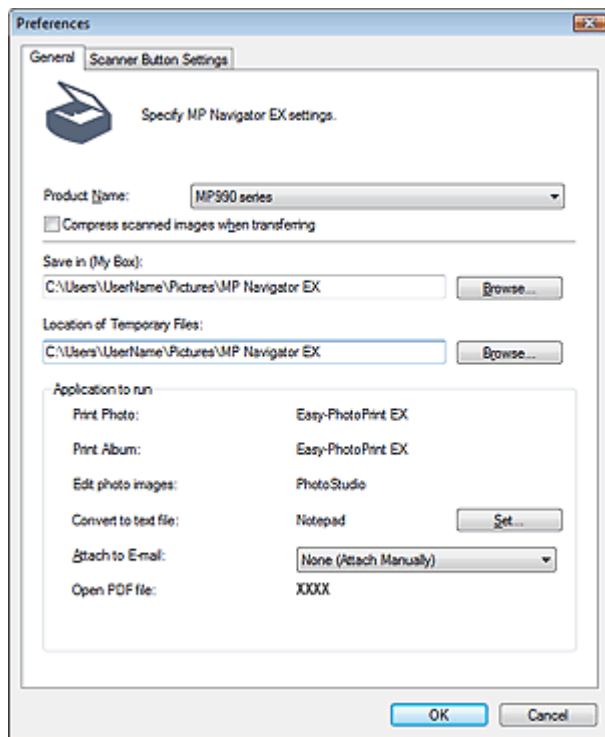

Note

- See the corresponding sections below for details on each tab.
 - ➔ General Tab
 - ➔ Scanner Button Settings Tab (Save)
 - ➔ Scanner Button Settings Tab (Attach to E-mail)
 - ➔ Scanner Button Settings Tab (Open with Application)

Advanced Guide

Advanced Guide > Scanning > Scanning with the Bundled Application Software > MP Navigator EX Screens > General Tab

MP Navigator EX

General Tab

On the General tab, you can specify general MP Navigator EX settings.

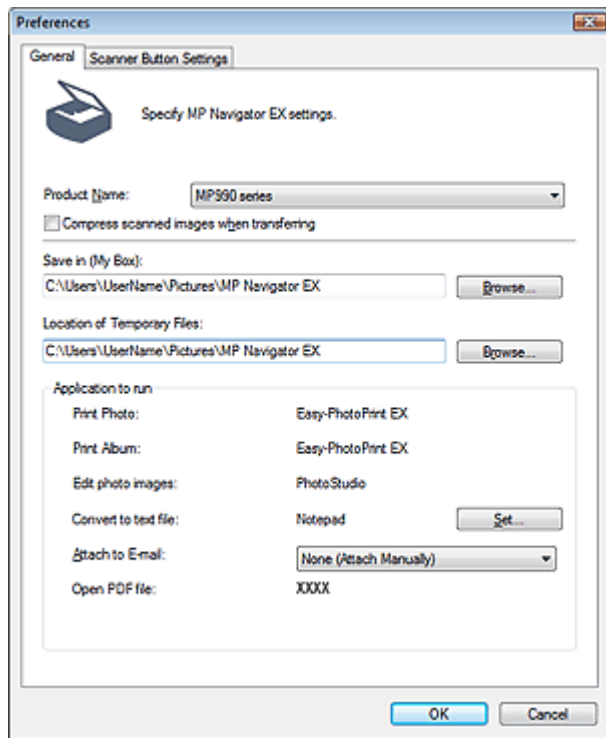

• Product Name

Displays the product name of the machine that MP Navigator EX is currently configured to use. If the displayed product is not the one you want to use, select the desired product from the list. For network connection, select one with (Network: XXXXXXXXXXXXX) after the product name. (Where XXXXXXXXXXXXX is the MAC address.) Use network connection to share the machine among multiple computers.

Note

- To set up a network environment, see "[Network Scan Settings](#)."

• Compress scanned images when transferring

Compress and transfer images scanned using MP Navigator EX or the Operation Panel of the machine. This is useful when the machine is connected via a slow interface such as USB 1.1 or a network. By default, this checkbox is selected when using a network connection. It is not selected when using a USB connection.

Important

- When Photo is selected for Document Type on the Scanner Button Settings tab, allow 3/8 inches (1 cm) or more space between the edges of the Platen and the document. If not, some images may not be scanned at the correct positions and sizes.
- Business cards, panorama photos and bordered photos may not be cropped accurately when scanned. In that case, deselect the Compress scanned images when transferring checkbox and scan again.
- The following restrictions apply when the Compress scanned images when transferring checkbox is selected.
 - Text(OCR) cannot be selected for Document Type in the Scan/Import window.

- Black and White cannot be selected in the color mode settings for One-click Mode.
- Remove gutter shadow is not available.
- Save the JPEG/Exif file in AdobeRGB for One-click Mode is not available.
- Available resolutions: 75 dpi / 150 dpi / 300 dpi / 600 dpi
- Maximum number of documents that can be scanned at one time: 4
- A compression type (image quality) cannot be selected when saving scanned images in JPEG.
- The following images are not compressed even when scanned with the Compress scanned images when transferring checkbox selected.
 - Film scanned images
 - Images scanned using the Operation Panel of the machine by automatically detecting the document type
 - Images scanned in One-click Mode by automatically detecting the document type
 - Images scanned using ScanGear (scanner driver)

Note

- It is recommended that you scan at 300 dpi or higher resolution when scanning multiple photos using this function.
- When the Compress scanned images when transferring checkbox is selected, Unsharp Mask is always applied.

● Save in (My Box)

Displays the folder in which to save scanned documents. To change the folder, click Browse... to specify another one.

The following folders are specified by default.

Windows Vista: MP Navigator EX folder in Pictures folder

Windows XP: MP Navigator EX folder in My Pictures folder

Windows 2000: MP Navigator EX folder in My Pictures folder

● Location of Temporary Files

Displays the folder in which to save images temporarily. To change the folder, click Browse... to specify another one.

Important

- An error may occur if you set the destination to the root directory of the drive on which the operating system is installed. Be sure to specify a folder.
- An error may occur if you set the destination to a network folder. Be sure to specify a local folder.

● Application to run

Displays the applications that can be started via MP Navigator EX. Install the applications from the *Setup CD-ROM* that accompanies the machine.

For Attach to E-mail, you can select an e-mail software program to start.

For Open PDF file, the application associated with the .pdf file extension by the operating system is displayed.

Important

- You can change which items are installed during installation from the *Setup CD-ROM* by selecting Custom Install. If you choose not to install some applications with Custom Install, the corresponding MP Navigator EX functions will be unavailable. To use those functions, install the corresponding applications.

Note

- For Convert to text file, Notepad (included with Windows) is displayed. Click Set... to open a dialog box, then specify Document Language and how to scan multiple documents.

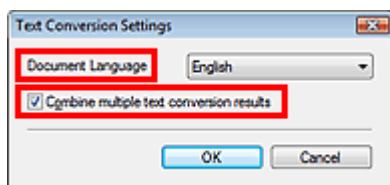

- Document Language
 - Specify the language according to the language of the document to be scanned. Only text

written in languages that can be selected in the Document Language can be extracted to Notepad.

- Combine multiple text conversion results

When scanning multiple documents, select the checkbox to collect the conversion results (text) into one file. This checkbox is selected by default.

When the checkbox is selected, you can scan up to 99 pages at one time.

Deselect the checkbox to display each conversion result (text) in a separate file.

When the checkbox is not selected, you can scan up to 10 pages at one time.

[Page top](#)↑

Advanced Guide

Advanced Guide > Scanning > Scanning with the Bundled Application Software > MP Navigator EX Screens > Scanner Button Settings Tab (Save)

MP Navigator EX

Scanner Button Settings Tab (Save)

On the Scanner Button Settings tab, you can specify the following settings.

This section describes the settings available when Select Event is Save to PC or Save as PDF file.

You can specify how to respond when scanning using the Operation Panel of the machine with the scan mode set to Save to PC or Save as PDF file.

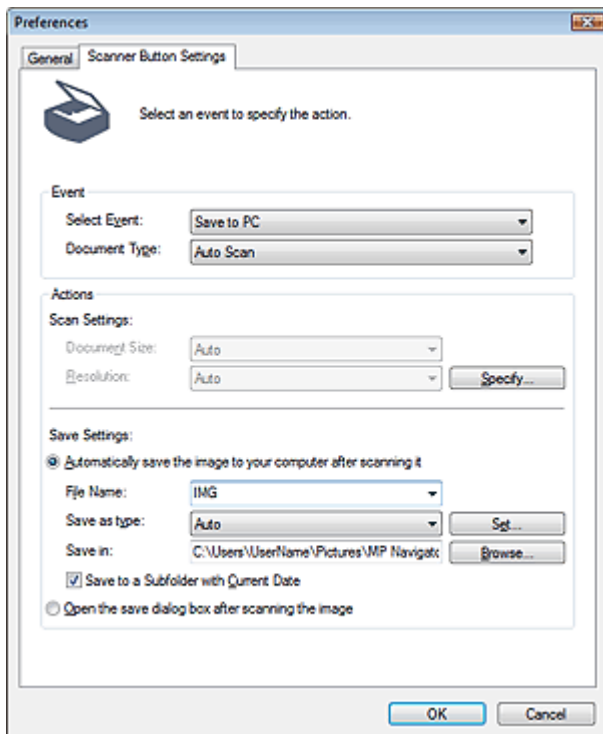

Event

- **Select Event**

Displays the scan modes that can be selected on the Operation Panel of the machine.

- **Save to PC**

Select this to specify the details for the scan mode Save to PC.

- **Save as PDF file**

Select this to specify the details for the scan mode Save as PDF file.

- **Document Type**

Select the type of document to be scanned.



Note

- Auto Scan can be selected only when the machine is connected via USB and Save to PC is selected for Select Event. When Auto Scan is selected, the document type is automatically detected. In that case, Document Size and Resolution are automatically set as well.



Important

- To scan correctly, select a document type that matches the document to be scanned.
- The following types of documents cannot be scanned correctly with Auto Scan. In that case,

specify the document type or size.

- Documents other than photos, postcards, business cards, magazines, newspapers, text documents, CD/DVD and film
 - A4 size photos
 - Text documents smaller than 2L (5 inches x 7 inches) (127 mm x 178 mm), such as paperback pages with the spine cut off
 - Documents printed on thin white paper
 - Long narrow documents such as panoramic photos
 - Reflective CD/DVD labels may not be scanned properly.
 - Place documents correctly according to the type of document to be scanned. Otherwise, documents may not be scanned correctly.
- See "[Placing Documents](#)" for details on how to place documents.

Actions

Scan Settings

• Document Size

Select the size of the document to be scanned.

When you select Custom, a screen in which you can specify the document size appears. Select a Units, then enter the Width and Height and click OK.

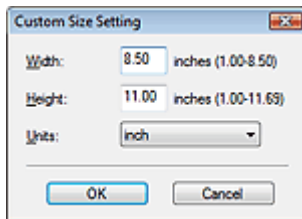

▶ Important

- When you select Auto Detect, the image may not be scanned at the correct position and size. In that case, change the size to the actual document size (A4, Letter, etc.) and align a corner of the document with the corner at the arrow (alignment mark) of the Platen.
- This setting is not available when Select Event is Save to PC with Document Type set to Auto Scan.

📖 Note

- Document Size will not be displayed if Film is selected for Document Type in Event. Document Type is displayed.

• Document Type

Select the type of film to be scanned. When Film(Auto mode) is selected, the film type (negative or positive) is automatically detected.

📖 Note

- To scan Black and White Positive Film, select Positive Film for Document Type and press Black Start button on the machine.

• Resolution

Select the resolution at which to scan documents. The following scanning resolutions can be specified:

When Document Type is other than film: 75 dpi / 100 dpi / 150 dpi / 200 dpi / 300 dpi / 400 dpi / 600 dpi

When Document Type is film: 300 dpi / 400 dpi / 600 dpi / 1200 dpi / 2400 dpi / 4800 dpi

➔ [Resolution](#)

▶ Important

- This setting is not available when Select Event is Save to PC with Document Type set to Auto Scan.

- **Specify...**

Click to open the Scan Settings dialog box in which you can make advanced scan settings.

➔ [Scan Settings Dialog Box](#)

Save Settings

- **Automatically save the image to your computer after scanning it**

Select this to save the images to your computer as specified after scanning them.

The File Name, Save as type and Save in settings will be displayed.

Important

- If you select this function, you will not be able to set passwords for PDF files.

- **File Name**

Enter the file name of the image to be saved (up to 64 characters).

- **Save as type**

Select a file type to save the scanned images.

When saving to a computer, select Auto, JPEG/Exif, TIFF or BMP. Auto is displayed and selected by default when Document Type is Auto Scan. When saving as PDF files, PDF(Multiple Pages) is set.

Important

- When Document Type is Auto Scan and Save as type is Auto, the file format may differ depending on how you place the document.
See "[Placing Documents](#)" for details on how to place documents.
- Large documents (such as A4 size photos) that cannot be placed away from the edges/ arrow (alignment mark) of the Platen may not be saved in the correct file format when Save as type is Auto. In that case, select a file format suitable for the document to be scanned.

Note

- If you select the Enable Auto Photo Fix checkbox in the Scan Settings dialog box and then select a format other than JPEG/Exif for Save as type, a message appears and the Enable Auto Photo Fix checkbox will be deselected.
- When Auto is selected, files are saved in the following formats according to the document type.
Photos, postcards, CD/DVD, business cards and film: JPEG
Magazines, newspapers and text documents: PDF
You can change the file format from Set....

- **Set...**

When Save as type is Auto

You can specify the file format in which to save images. Select a file format for saving Document and Photo each.

Important

- You cannot select a compression type for JPEG files when the Compress scanned images when transferring checkbox is selected on the General tab of the Preferences dialog box.

When Save as type is JPEG/Exif

You can specify a compression type for JPEG files. Select High(Low Compression), Standard or Low(High Compression).

Important

- This setting is not available when the Compress scanned images when transferring

checkbox is selected on the General tab of the Preferences dialog box.

When Save as type is PDF(Multiple Pages)

Make advanced settings for creating PDF files. See "[PDF Settings Dialog Box](#)" for details.

- **Save in**

Displays the folder in which to save the scanned images. To change the folder, click Browse... to specify another one.

The following folders are specified by default.

Windows Vista: MP Navigator EX folder in Pictures folder

Windows XP: MP Navigator EX folder in My Pictures folder

Windows 2000: MP Navigator EX folder in My Pictures folder

- **Save to a Subfolder with Current Date**

Select this checkbox to create a subfolder in the folder specified in Save in with the current date and save scanned files in it. A subfolder with a name such as "2009_01_01" (Year_Month_Date) will be created.

If this checkbox is not selected, files are saved directly in the folder specified in Save in.

- **Open the save dialog box after scanning the image**

Select this to open the save dialog box after scanning the images and specify the save settings such as destination folder, file name and Exif information.



Note

- See "[Save Dialog Box](#)" (when Select Event is Save to PC) or "[Save as PDF file Dialog Box](#)" (when Select Event is Save as PDF file) for details on each dialog box.
- To set passwords for PDF files, select Open the save dialog box after scanning the image. After scanning, you can set the passwords in the Save as PDF file dialog box.
 - ➔ [Setting Passwords for PDF Files](#)

Related Topic

- ▶ [Scanner Button Settings Tab \(Attach to E-mail\)](#)
- ▶ [Scanner Button Settings Tab \(Open with Application\)](#)

[Page top](#)[↕]

Advanced Guide

Advanced Guide > Scanning > Scanning with the Bundled Application Software > MP Navigator EX Screens > Scanner Button Settings Tab (Attach to E-mail)

MP Navigator EX

Scanner Button Settings Tab (Attach to E-mail)

On the Scanner Button Settings tab, you can specify the following settings.

This section describes the settings available when Select Event is Attach to E-mail.

You can specify how to respond when scanning using the Operation Panel of the machine with the scan mode set to Attach to E-mail.

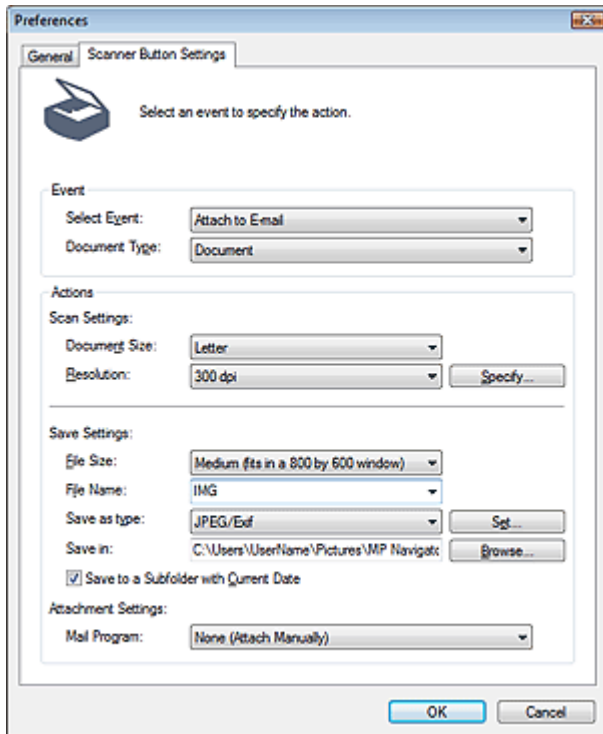

Event

- **Select Event**

Displays the scan modes that can be selected on the Operation Panel of the machine. Select Attach to E-mail.

- **Document Type**

Select the type of document to be scanned.

Important

- To scan correctly, select a document type that matches the document to be scanned.

Actions

Scan Settings

- **Document Size**

Select the size of the document to be scanned.

When you select Custom, a screen in which you can specify the document size appears. Select a Units, then enter the Width and Height and click OK.

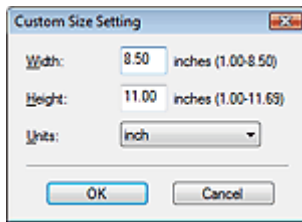

Important

- When you select Auto Detect, the image may not be scanned at the correct position and size. In that case, change the size to the actual document size (A4, Letter, etc.) and align a corner of the document with the corner at the arrow (alignment mark) of the Platen.

Note

- Document Size will not be displayed if Film is selected for Document Type in Event. Document Type is displayed.

• Document Type

Select the type of film to be scanned. When Film(Auto mode) is selected, the film type (negative or positive) is automatically detected.

Note

- To scan Black and White Positive Film, select Positive Film for Document Type and press Black Start button on the machine.

• Resolution

Select the resolution at which to scan documents. The following scanning resolutions can be specified:

When Document Type is other than film: 75 dpi / 100 dpi / 150 dpi / 200 dpi / 300 dpi / 400 dpi / 600 dpi

When Document Type is film: 300 dpi / 400 dpi / 600 dpi / 1200 dpi / 2400 dpi / 4800 dpi

 [Resolution](#)

• Specify...

Click to open the Scan Settings dialog box in which you can make advanced scan settings.

 [Scan Settings Dialog Box](#)

Save Settings

• File Size

Specify a size from Small (fits in a 640 by 480 window), Medium (fits in a 800 by 600 window), Large (fits in a 1024 by 768 window) and Original.

• File Name

Enter the file name of the image to be saved (up to 64 characters).

• Save as type

Select a file type to save the scanned images.
Select JPEG/Exif or PDF.

• Set...

When Save as type is JPEG/Exif

You can specify a compression type for JPEG files. Select High(Low Compression), Standard or Low(High Compression).

Important

- This setting is not available when the Compress scanned images when transferring checkbox is selected on the General tab of the Preferences dialog box.

When Save as type is PDF

Make advanced settings for creating PDF files. See "[PDF Settings Dialog Box](#)" for details.

- **Save in**

Displays the folder in which to save the scanned images. To change the folder, click Browse... to specify another one.

The following folders are specified by default.

Windows Vista: MP Navigator EX folder in Pictures folder

Windows XP: MP Navigator EX folder in My Pictures folder

Windows 2000: MP Navigator EX folder in My Pictures folder

- **Save to a Subfolder with Current Date**

Select this checkbox to create a subfolder in the folder specified in Save in with the current date and save scanned files in it. A subfolder with a name such as "2009_01_01" (Year_Month_Date) will be created.

If this checkbox is not selected, files are saved directly in the folder specified in Save in.

Attachment Settings

- **Mail Program**

Specify an e-mail software program.

Related Topic

- ▶ [Scanner Button Settings Tab \(Save\)](#)
- ▶ [Scanner Button Settings Tab \(Open with Application\)](#)

[Page top](#)↑

Advanced Guide

Advanced Guide > Scanning > Scanning with the Bundled Application Software > MP Navigator EX Screens > Scanner Button Settings Tab (Open with Application)

MP Navigator EX

Scanner Button Settings Tab (Open with Application)

On the Scanner Button Settings tab, you can specify the following settings.

This section describes the settings available when Select Event is Open with application.

You can specify how to respond when scanning using the Operation Panel of the machine with the scan mode set to Open with application.

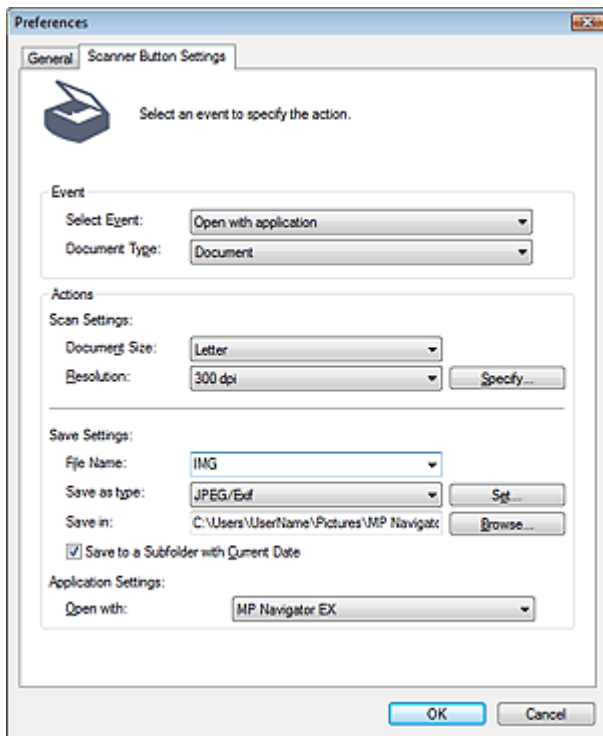

Event

- **Select Event**

Displays the scan modes that can be selected on the Operation Panel of the machine. Select Open with application.

- **Document Type**

Select the type of document to be scanned.

Important

- To scan correctly, select a document type that matches the document to be scanned.

Actions

Scan Settings

- **Document Size**

Select the size of the document to be scanned.

When you select Custom, a screen in which you can specify the document size appears. Select a Units, then enter the Width and Height and click OK.

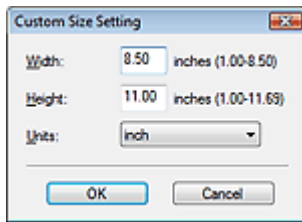

Important

- When you select Auto Detect, the image may not be scanned at the correct position and size. In that case, change the size to the actual document size (A4, Letter, etc.) and align a corner of the document with the corner at the arrow (alignment mark) of the Platen.

Note

- Document Size will not be displayed if Film is selected for Document Type in Event. Document Type is displayed.

● Document Type

Select the type of film to be scanned. When Film(Auto mode) is selected, the film type (negative or positive) is automatically detected.

Note

- To scan Black and White Positive Film, select Positive Film for Document Type and press Black Start button on the machine.

● Resolution

Select the resolution at which to scan documents. The following scanning resolutions can be specified:

When Document Type is other than film: 75 dpi / 100 dpi / 150 dpi / 200 dpi / 300 dpi / 400 dpi / 600 dpi

When Document Type is film: 300 dpi / 400 dpi / 600 dpi / 1200 dpi / 2400 dpi / 4800 dpi

➔ Resolution

● Specify...

Click to open the Scan Settings dialog box in which you can make advanced scan settings.

➔ Scan Settings Dialog Box

Save Settings

● File Name

Enter the file name of the image to be saved (up to 64 characters).

● Save as type

Select a file type to save the scanned images.

Select JPEG/Exif, TIFF or BMP.

● Set...

When Save as type is JPEG/Exif

You can specify a compression type for JPEG files. Select High(Low Compression), Standard or Low(High Compression).

Important

- This setting is not available when the Compress scanned images when transferring checkbox is selected on the General tab of the Preferences dialog box.

● Save in

Displays the folder in which to save the scanned images. To change the folder, click Browse... to specify another one.

The following folders are specified by default.

Windows Vista: MP Navigator EX folder in Pictures folder

Windows XP: MP Navigator EX folder in My Pictures folder

Windows 2000: MP Navigator EX folder in My Pictures folder

- **Save to a Subfolder with Current Date**

Select this checkbox to create a subfolder in the folder specified in Save in with the current date and save scanned files in it. A subfolder with a name such as "2009_01_01" (Year_Month_Date) will be created.

If this checkbox is not selected, files are saved directly in the folder specified in Save in.

Application Settings

- **Open with**

Specify an application with which to open scanned images. The specified application starts after images are scanned.

Related Topic

- ▶ [Scanner Button Settings Tab \(Save\)](#)
- ▶ [Scanner Button Settings Tab \(Attach to E-mail\)](#)

[Page top](#) ↕

Advanced Guide

[Advanced Guide](#) > [Scanning](#) > [Scanning with the Bundled Application Software](#) > [Appendix: Opening Files Other than Scanned Images](#)

MP Navigator EX

Appendix: Opening Files Other than Scanned Images

You can save or print data other than scanned images using MP Navigator EX.

- **Using images saved on a memory card**
 - ➔ [Importing Images Saved on a Memory Card](#)
- **Using images saved on a computer**
 - ➔ [Opening Images Saved on a Computer](#)

[Page top](#)↑

Advanced Guide

Advanced Guide > Scanning > Scanning with the Bundled Application Software > Appendix: Opening Files Other than Scanned Images > Importing Images Saved on a Memory Card

MP Navigator EX

Importing Images Saved on a Memory Card

You can import images (including PDF files created via scanning using the Operation Panel) saved on a memory card, and save them to a computer or print them using MP Navigator EX. You can also attach them to e-mail, or edit them using an application that accompanies the machine.

When saving PDF files, you can select whether to enable keyword search, and also specify the compression type and other advanced settings.

Important

- Do not remove or insert memory cards while they are being accessed or the Access Lamp of the machine is flashing.
- The machine can only detect one memory card at a time. Do not simultaneously insert multiple memory cards.
- When switching to another memory card of the same type or inserting another memory card in a different Card Slot, make sure that the Access Lamp of the machine is not flashing, then remove the memory card. Then, insert another memory card.
- The machine's Card Slot (memory card) may become inaccessible. In that case, restart the machine or turn it off and reconnect the USB cable.
- With network connection, check that the Card Slot is mapped as a network drive. See " [Using the Card Slot over a Network](#) " for details.

1. Insert a memory card containing images/PDF files into the machine's Card Slot.

For details on how to insert a memory card into the machine, refer to the on-screen manual: *Basic Guide*.

2. Start MP Navigator EX as follows.

➔ Windows Vista/Windows XP

➔ Windows 2000

• Windows Vista/Windows XP

The program selection screen appears. Click MP Navigator EX Ver3.0.

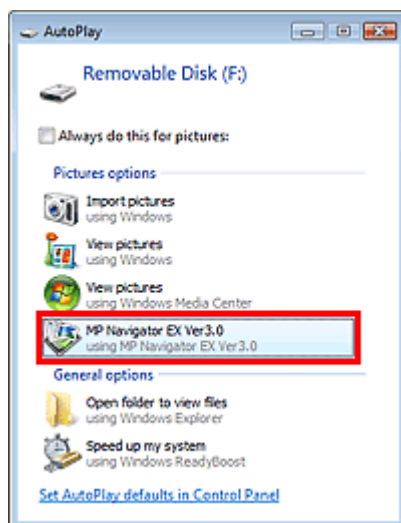

Note

- If you want to start MP Navigator EX every time a memory card is inserted into the machine, follow these steps.

Windows Vista:

Select the Always do this for pictures checkbox and click MP Navigator EX Ver3.0.

Windows XP:

Select MP Navigator EX Ver3.0, then select the Always do the selected action. checkbox and click OK.

The Memory Card screen of the Scan/Import window appears, and the images and PDF files saved on the memory card appear in the Thumbnail window.

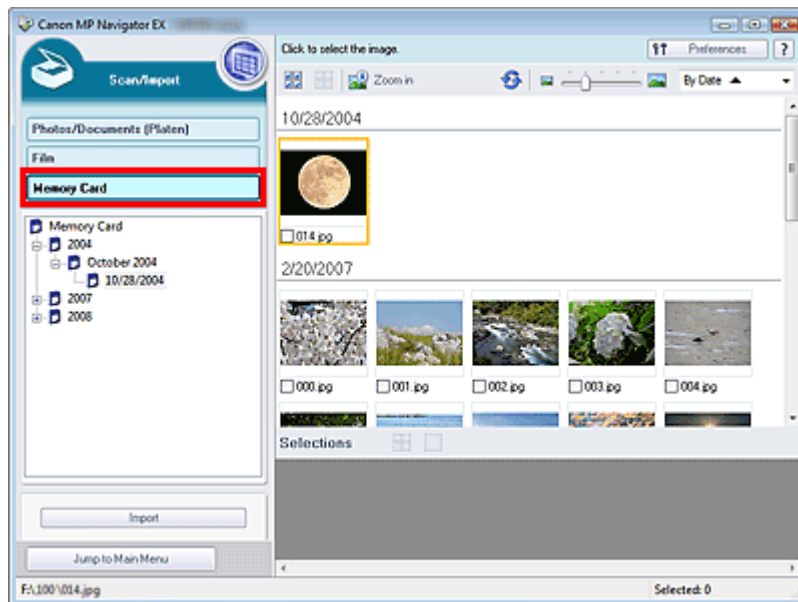

Note

- See "[Memory Card Screen \(Scan/Import Window\)](#)" for details on the Memory Card screen (Scan/Import window).

Windows 2000

Start MP Navigator EX and open the Navigation Mode screen.

➔ [Starting MP Navigator EX](#)

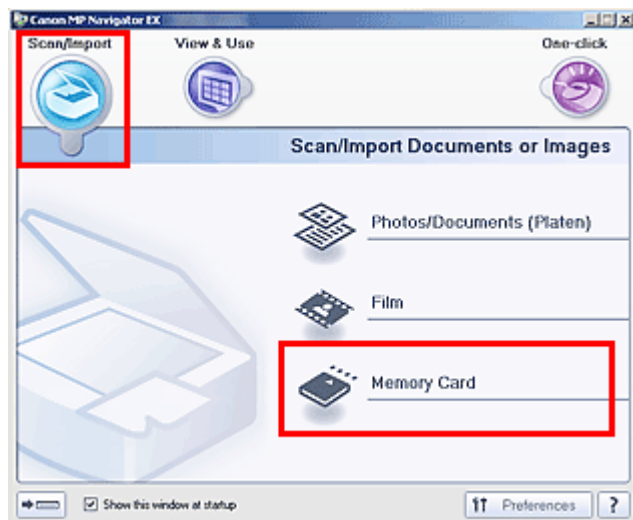

Point to Scan/Import and click Memory Card. The Memory Card screen of the Scan/Import window appears, and the images and PDF files saved on the memory card appear in the Thumbnail window.

Important

- If you cannot import images from memory cards via a network connection, see "[Using the Card Slot over a Network](#)."

Note

- With network connection, the Map Network Drive dialog box may open when a memory card is inserted into the machine for the first time. Specify a drive letter to map.

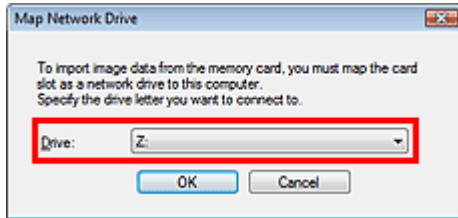

3. Select the checkboxes of the images and PDF files you want to import, then click Import.

The Import dialog box opens. Specify the folder in which to save the imported files.

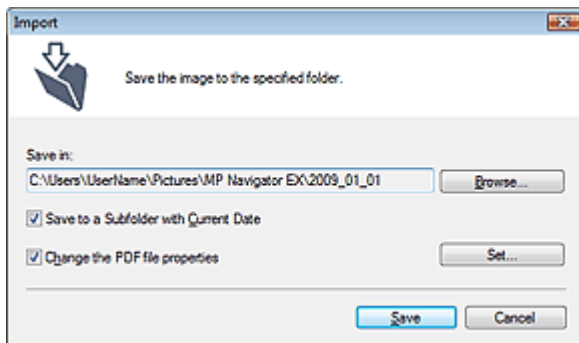

- **Save in**

Displays the folder in which to save the imported images and PDF files. To change the folder, click Browse... to specify another one.

The following folders are specified by default.

Windows Vista: MP Navigator EX folder in Pictures folder

Windows XP: MP Navigator EX folder in My Pictures folder

Windows 2000: MP Navigator EX folder in My Pictures folder

- **Save to a Subfolder with Current Date**

Select this checkbox to create a subfolder in the folder specified in Save in with the current date and save imported files in it. A subfolder with a name such as "2009_01_01" (Year_Month_Date) will be created.

If this checkbox is not selected, files are saved directly in the folder specified in Save in.

- **Change the PDF file properties**

This option is displayed when the memory card contains a PDF file.

Select this checkbox to change the PDF file settings. You can also change the settings of PDF files created via scanning using the Operation Panel. Click Set... to open a dialog box in which you can specify advanced settings. See "[PDF Settings Dialog Box](#)" for details.

4. Click Save.

The imported images and PDF files appear in the View & Use window.

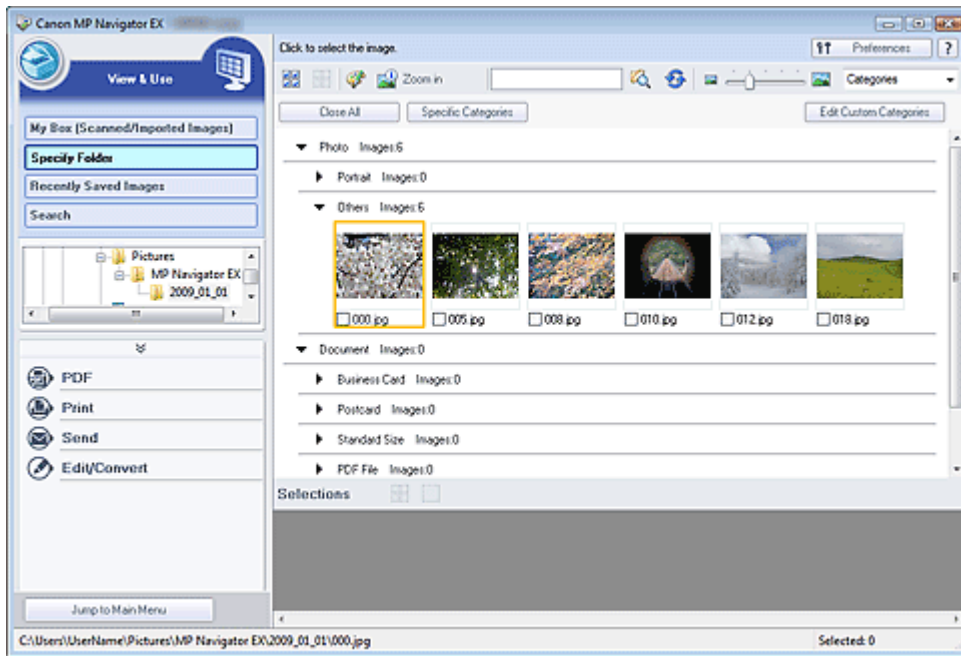

See the corresponding sections below for details on using the imported images and PDF files.

- ➔ [Creating/Editing PDF Files](#)
- ➔ [Printing Documents](#)
- ➔ [Printing Photos](#)
- ➔ [Sending via E-mail](#)
- ➔ [Editing Files](#)

[Page top](#) ↕

Advanced Guide

Advanced Guide > Scanning > Scanning with the Bundled Application Software > Appendix: Opening Files Other than Scanned Images > Opening Images Saved on a Computer

MP Navigator EX

Opening Images Saved on a Computer

You can open images saved on a computer and print them or attach them to e-mail using MP Navigator EX. You can also edit them using an application that accompanies the machine.

1. Start MP Navigator EX and open the Navigation Mode screen.

➔ Starting MP Navigator EX

2. In the Navigation Mode screen, point to View & Use and click My Box (Scanned/Imported Images), Specify Folder or Recently Saved Images.

Click My Box (Scanned/Imported Images) to open images saved in My Box (Scanned/Imported Images), click Specify Folder to open images saved in a specific folder, or click Recently Saved Images to open recently saved images.

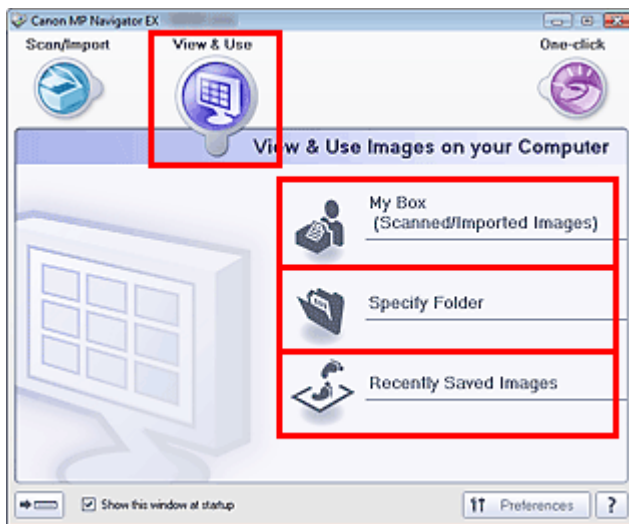

Note

- If the Show this window at startup checkbox is not selected, the last used screen appears. If the Scan/Import window is displayed, click  (View & Use) on the upper left of the screen. The View & Use window opens.
- See "View & Use Images on your Computer Tab" for details on the View & Use Images on your Computer tab.

3. Click the folder containing the images you want to open.

Images saved in the folder appear in the Thumbnail window.

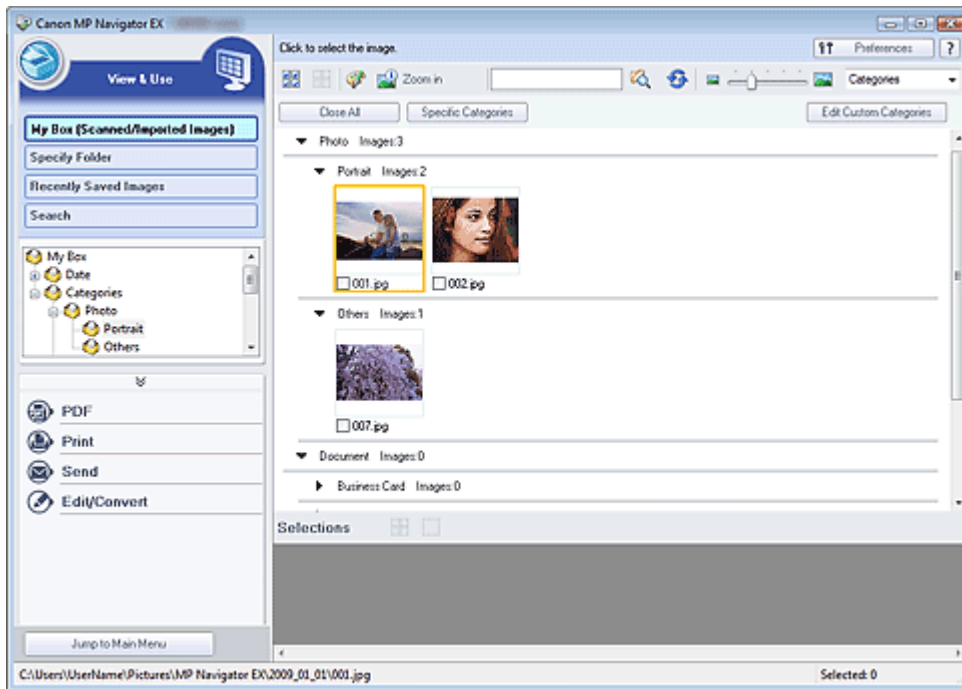

4. Select the images you want to use, then select what you want to do with them.

See the corresponding sections below for details on using images.

- ➔ [Creating/Editing PDF Files](#)
- ➔ [Printing Documents](#)
- ➔ [Printing Photos](#)
- ➔ [Sending via E-mail](#)
- ➔ [Editing Files](#)

Advanced Guide

[Advanced Guide](#) > [Scanning](#) > [Scanning with Other Application Software](#)

Scanning with Other Application Software

- ➔ [What Is ScanGear \(Scanner Driver\)?](#)
- ➔ [Scanning with Advanced Settings Using ScanGear \(Scanner Driver\)](#)
- ➔ [Correcting Images and Adjusting Colors with ScanGear \(Scanner Driver\)](#)
- ➔ [ScanGear \(Scanner Driver\) Screens](#)
- ➔ [Appendix: Useful Information on Scanning](#)

[Page top](#) ↕

Advanced Guide

Advanced Guide > Scanning > Scanning with Other Application Software > What Is ScanGear (Scanner Driver)?

ScanGear

What Is ScanGear (Scanner Driver)?

ScanGear (scanner driver) is software required for scanning documents and film. It enables you to specify the output size and make image corrections when scanning.

ScanGear (scanner driver) can be started from MP Navigator EX or from other applications that are compatible with a standard interface called TWAIN. (ScanGear (scanner driver) is a TWAIN-compatible driver.)

What You Can Do with This Software

This software enables you to preview scan results or set document type and output size, etc. when scanning documents and film. It is useful when you want to scan in a specific color tone, as it allows you to make various corrections and adjust brightness, contrast, etc.

Screens

There are three modes: Basic Mode, Advanced Mode and Auto Scan Mode.

Switch modes by clicking a tab on the upper right of the screen.

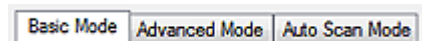

Note

- ScanGear (scanner driver) starts in the last used mode.
- Settings are not retained when you switch between modes.

Basic Mode

Use Basic Mode to scan easily by following three simple on-screen steps (**1** , **2** and **3**).

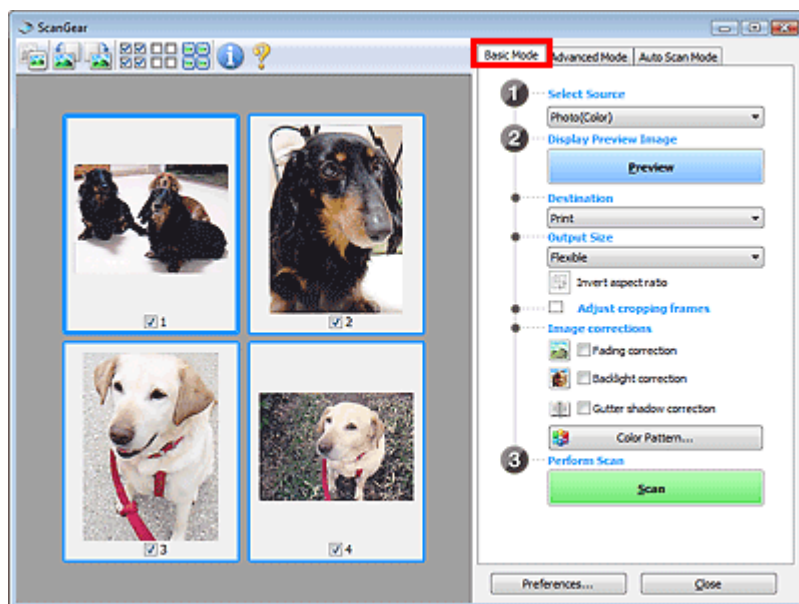

Advanced Mode

Use Advanced Mode to specify color mode, output resolution, image brightness, color tone, etc. when scanning.

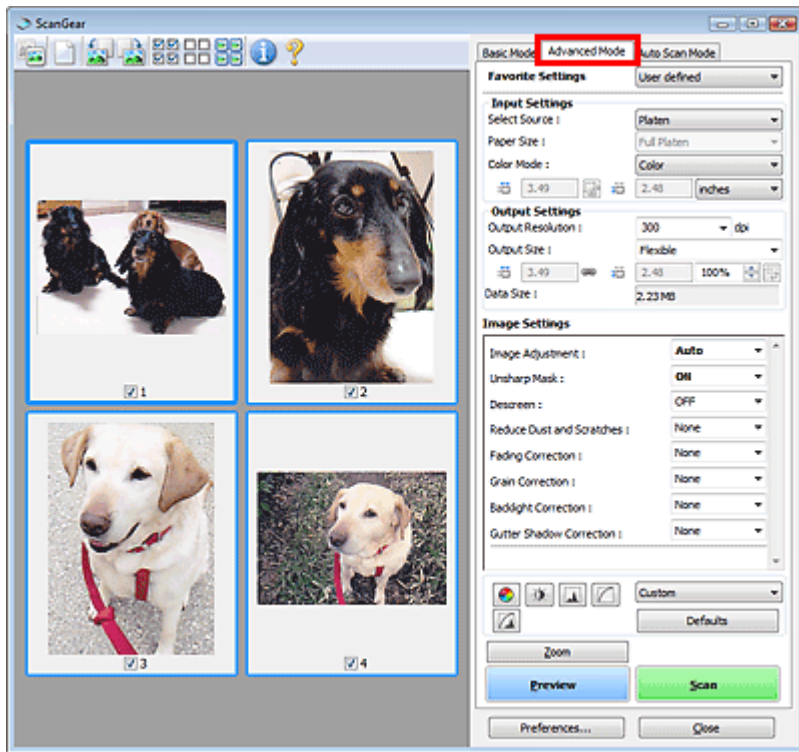

Auto Scan Mode

Use Auto Scan Mode to scan easily by simply placing the document on the Platen and clicking Scan.



Advanced Guide

[Advanced Guide](#) > [Scanning](#) > [Scanning with Other Application Software](#) > [Scanning with Advanced Settings Using ScanGear \(Scanner Driver\)](#)

ScanGear

Scanning with Advanced Settings Using ScanGear (Scanner Driver)

- **Starting ScanGear (scanner driver)**
 - ➔ [Starting ScanGear \(Scanner Driver\)](#)
- **Scanning documents after making simple image corrections**
 - ➔ [Scanning in Basic Mode](#)
- **Scanning documents after making advanced image corrections and brightness/color adjustments**
 - ➔ [Scanning in Advanced Mode](#)
 - ➔ [Scanning Film in Advanced Mode](#)
- **Scanning with a simple operation**
 - ➔ [Scanning in Auto Scan Mode](#)
- **Scanning multiple documents at one time after making image corrections and color adjustments**
 - ➔ [Scanning Multiple Documents at One Time with ScanGear \(Scanner Driver\)](#)

[Page top](#) ↕

Advanced Guide

Advanced Guide > Scanning > Scanning with Other Application Software > Scanning with Advanced Settings Using ScanGear (Scanner Driver) > Starting ScanGear (Scanner Driver)

ScanGear

Starting ScanGear (Scanner Driver)

Use ScanGear (scanner driver) to make image corrections and color adjustments when scanning. ScanGear (scanner driver) can be started from MP Navigator EX or an application.

Note

- To scan via a network connection, start ScanGear and set up the network environment before scanning.
➡ [Network Scan Settings](#)

Starting from MP Navigator EX

Navigation Mode Screen

Follow these steps to start ScanGear (scanner driver) from the Navigation Mode screen of MP Navigator EX.

1. Start MP Navigator EX and open the Navigation Mode screen.
➡ [Starting MP Navigator EX](#)
2. Point to Scan/Import and click Photos/Documents (Platen).
The Scan/Import window opens.
3. Select the Use the scanner driver checkbox, then click Open Scanner Driver.

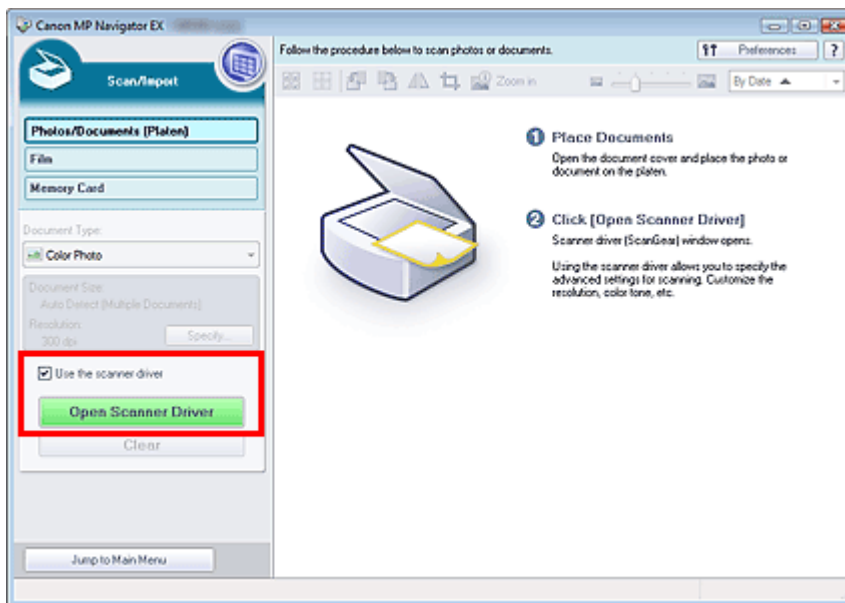

The ScanGear (scanner driver) screen appears.

One-click Mode Screen

Follow these steps to start ScanGear (scanner driver) from the One-click Mode screen of MP Navigator EX.

1. Start MP Navigator EX and open the One-click Mode screen.

➔ Starting MP Navigator EX

2. Click the corresponding icon.

The corresponding dialog box opens.

3. Select the Use the scanner driver checkbox in Scan Settings, then click Scan.

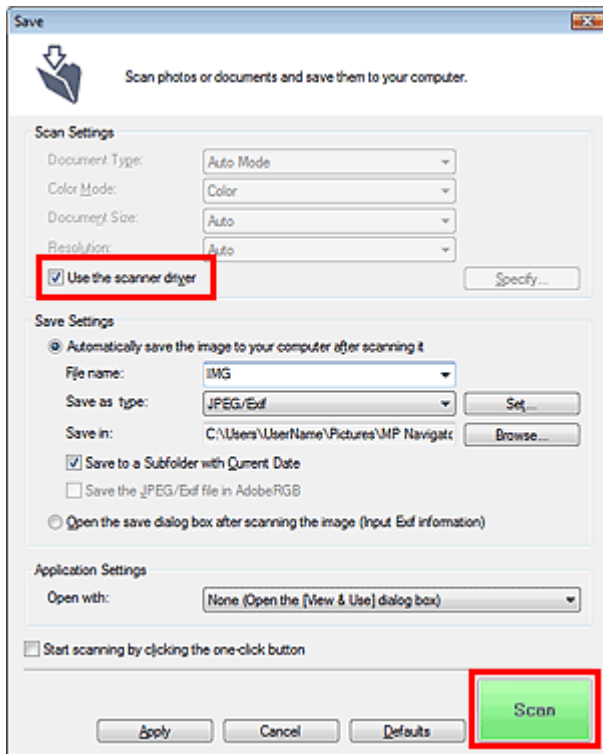

The ScanGear (scanner driver) screen appears.

Important

- Use the scanner driver is not displayed in the PDF dialog box or Auto Scan dialog box.

Starting from an Application

Follow these steps (example) to start ScanGear (scanner driver) from an application.

The procedure varies depending on the application. For details, refer to the application's manual.

1. Start the application.

2. On the File menu of the application, select Select Source and select the machine.

Important

- The scanner name to be selected in the application depends on whether you are scanning via a network connection or USB connection.

3. Select the command to scan a document (Scan/Import, Acquire image, etc.).

The ScanGear (scanner driver) screen appears.

Advanced Guide

Advanced Guide > Scanning > Scanning with Other Application Software > Scanning with Advanced Settings Using ScanGear (Scanner Driver) > Scanning in Basic Mode

ScanGear

Scanning in Basic Mode

In Basic Mode, you can scan easily by following the on-screen steps.

This section explains how to scan a single document and how to scan color film.

See "[Scanning Multiple Documents at One Time with ScanGear \(Scanner Driver\)](#)" to scan multiple documents at one time.

See "[Scanning Film in Advanced Mode](#)" to scan black and white film or mounted negative slides.

Important

- The following types of documents may not be cropped correctly. In that case, click  (Thumbnail) on the Toolbar to switch to whole image view and scan.
 - Photos that have a whitish border
 - Documents printed on white paper, hand-written text, business cards, etc.
 - Thin documents
 - Thick documents
- The following types of documents cannot be cropped correctly.
 - Documents smaller than 1.18 inches (3 cm) square
 - Photos that have been cut to various shapes

1. Place the document or film on the Platen, then start ScanGear (scanner driver).

➔ [Starting ScanGear \(Scanner Driver\)](#)

Important

- Place the document face-down on the Platen and align an upper corner of the document with the corner at the arrow (alignment mark) of the Platen. See "[Placing Film](#)" for details on how to place film.

2. Set Select Source according to the document or film placed on the Platen.

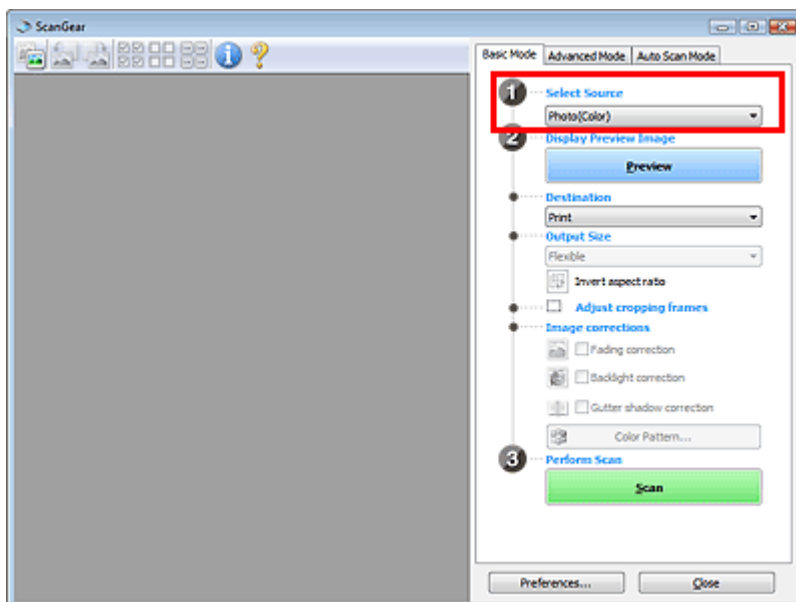

Note

- To scan magazines containing many color photos, select Magazine(Color).

3. Click Preview.

When Photo or Document is Previewed

Preview image appears in the Preview area.

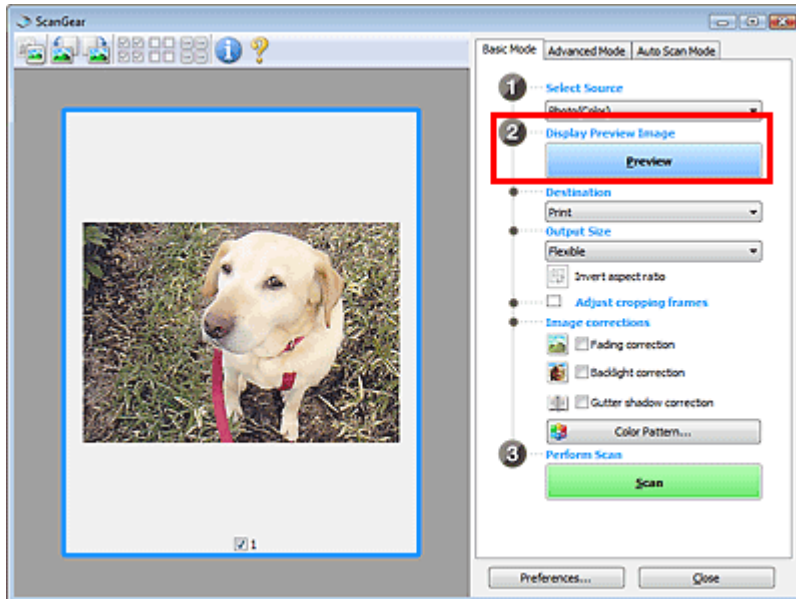

Note

- Colors are adjusted based on the document type selected in Select Source.

When Film is Previewed

Preview image appears in the Preview area. Images are cropped (scan areas are specified) automatically according to the film size.

Select the frames to scan.

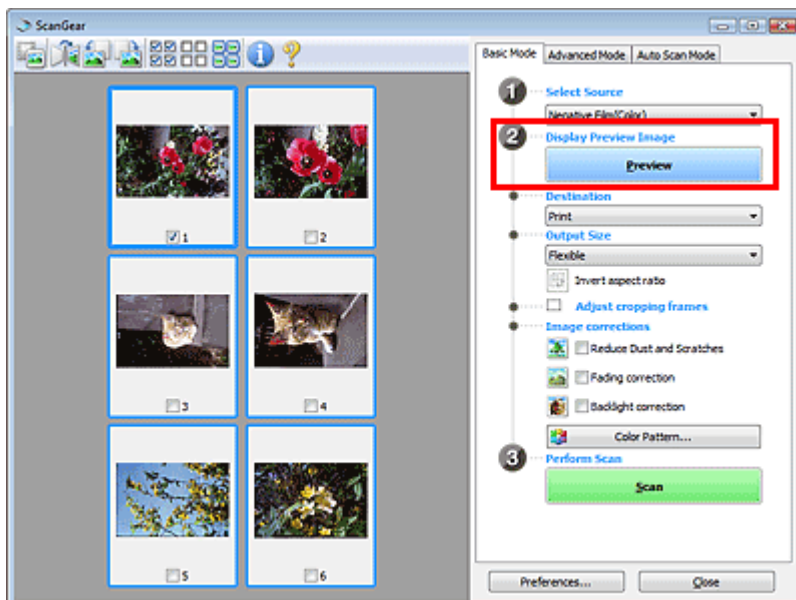

Important

- Film cannot be scanned without previewing.

4. Set Destination.**5.** Set Output Size.

Output size options vary by the items selected in Destination.

6. Adjust the scan area (cropping frame) as required.

Adjust the size and position of the cropping frame (scan area) on the preview image.

➔ [Adjusting Cropping Frames](#)

7. Set Image corrections as required.**8.** Click Scan.

Scanning starts.

 **Note**

- Click  (Information) to open a dialog box in which you can check the current scan settings (document type, etc.).
- ScanGear's response after scanning can be specified in Status of ScanGear dialog after scanning on the Scan tab of the Preferences dialog box.

➔ [Scan Tab](#)

Related Topic

▶ [Basic Mode Tab](#)

[Page top](#) ↕

Advanced Guide

Advanced Guide > Scanning > Scanning with Other Application Software > Scanning with Advanced Settings Using ScanGear (Scanner Driver) > Scanning in Advanced Mode



Scanning in Advanced Mode

In Advanced Mode, you can specify the color mode, output resolution, image brightness, color tone, etc. when scanning.

This section explains how to scan a single document.

See "Scanning Multiple Documents at One Time with ScanGear (Scanner Driver) " to scan multiple documents at one time.

See "Scanning Film in Advanced Mode" to scan film.

Important

- The following types of documents may not be cropped correctly. In that case, click  (Thumbnail) on the Toolbar to switch to whole image view and scan.
 - Photos that have a whitish border
 - Documents printed on white paper, hand-written text, business cards, etc.
 - Thin documents
 - Thick documents
- The following types of documents cannot be cropped correctly.
 - Documents smaller than 1.18 inches (3 cm) square
 - Photos that have been cut to various shapes

1. Place the document on the Platen, then start ScanGear (scanner driver).

➔ Starting ScanGear (Scanner Driver)

Important

- Place the document face-down on the Platen and align an upper corner of the document with the corner at the arrow (alignment mark) of the Platen.

2. Click Advanced Mode.

The Advanced Mode tab appears.

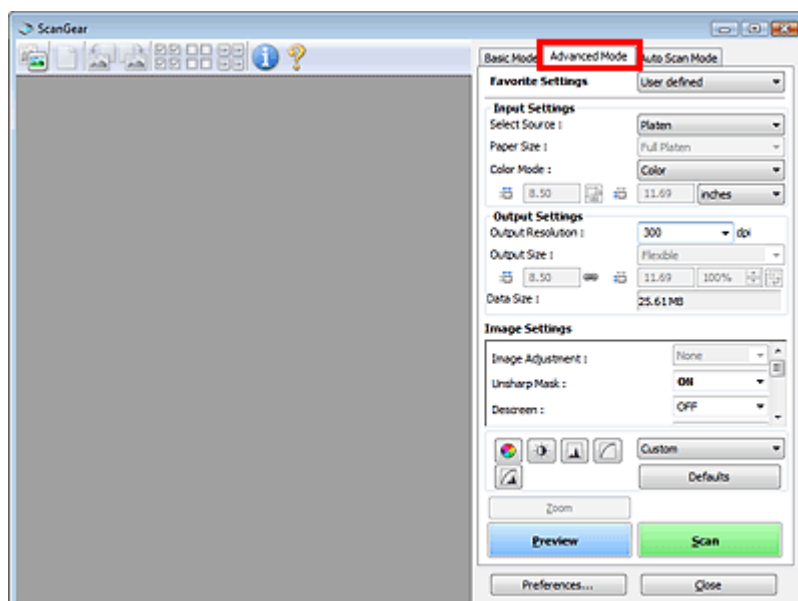

Note

- Settings are not retained when you switch between modes.

3. Set Color Mode.

➔ [Input Settings](#)

4. Click Preview.

Preview image appears in the Preview area.

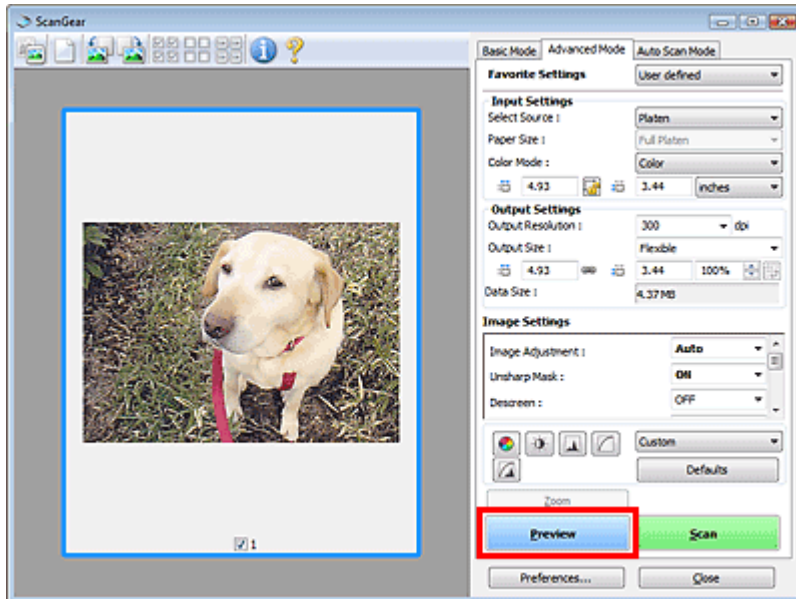

Note

- If you scan without preview, the show-through reduction function will be active. This function is useful when scanning magazines. However, when scanning photos, the color tone of the scanned image may differ from the source due to the show-through reduction function. In that case, use preview first.

5. Set Output Settings.

➔ [Output Settings](#)

6. Adjust the cropping frame (scan area), correct image and adjust colors as required.

➔ [Adjusting Cropping Frames](#)

➔ [Image Settings](#)

➔ [Color Adjustment Buttons](#)

7. Click Scan.

Scanning starts.

Note

- Click  (Information) to open a dialog box in which you can check the current scan settings (document type, etc.).
- ScanGear's response after scanning can be specified in Status of ScanGear dialog after scanning on the Scan tab of the Preferences dialog box.

➔ [Scan Tab](#)

Related Topic

▶ [Advanced Mode Tab](#)

[Page top](#) 

Advanced Guide

Advanced Guide > Scanning > Scanning with Other Application Software > Scanning with Advanced Settings Using ScanGear (Scanner Driver) > Scanning in Auto Scan Mode

ScanGear

Scanning in Auto Scan Mode

You can scan easily in Auto Scan Mode of ScanGear (scanner driver) by letting it automatically determine the type of document placed on the Platen.

Note

- Supported document types are photos, postcards, business cards, magazines, newspapers, text documents, CD/DVD and film. To scan other documents, specify the document type on the Basic Mode tab or the Advanced Mode tab.
 - ➔ [Scanning in Basic Mode](#)
 - ➔ [Scanning in Advanced Mode](#)
- To scan black and white film or mounted negative slides, scan in Advanced Mode tab of ScanGear (scanner driver).
 - ➔ [Scanning Film in Advanced Mode](#)

1. Place the document on the Platen, then start ScanGear (scanner driver).

- ➔ [Placing Documents](#)
- ➔ [Starting ScanGear \(Scanner Driver\)](#)

2. Click Auto Scan Mode.

The Auto Scan Mode tab appears.

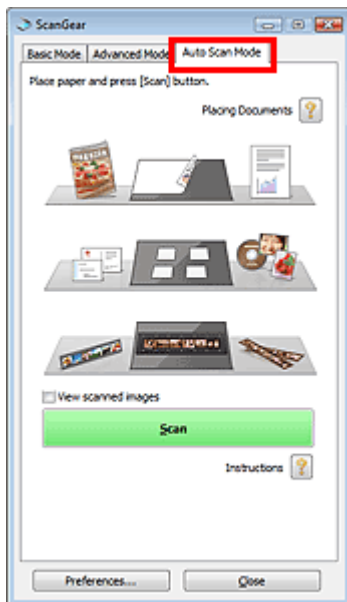

3. Click Scan.

Scanning starts.

Note

- ScanGear's response after scanning can be specified in Status of ScanGear dialog after scanning on the Scan tab of the Preferences dialog box.
 - ➔ [Scan Tab](#)

Related Topic

▶ [Auto Scan Mode Tab](#)

[Page top](#) ↕

Advanced Guide

Advanced Guide > Scanning > Scanning with Other Application Software > Scanning with Advanced Settings Using ScanGear (Scanner Driver) > Scanning Film in Advanced Mode

ScanGear

Scanning Film in Advanced Mode

In Advanced Mode, you can specify the color mode, output resolution, image brightness, color tone, etc. when scanning.

This section explains how to scan film.

1. Place the film on the Platen, then start ScanGear (scanner driver).

- ➔ Placing Film
- ➔ Starting ScanGear (Scanner Driver)

Important

- Some applications cannot receive images scanned in Color(48bit) or Grayscale(16bit), or may close when such images are received.

2. Click Advanced Mode and select film for Select Source.

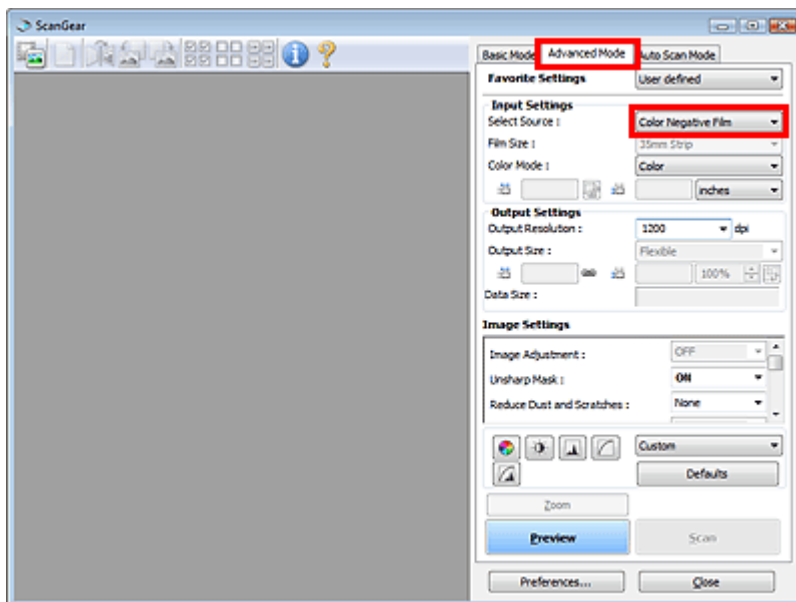

Note

- Settings are not retained when you switch between modes.

3. Set Select Source, Film Size and Color Mode.

- ➔ Input Settings

4. Click Preview.

Preview image appears in the Preview area. Images are cropped (scan areas are specified) automatically according to the film size.

Select the frames to scan.

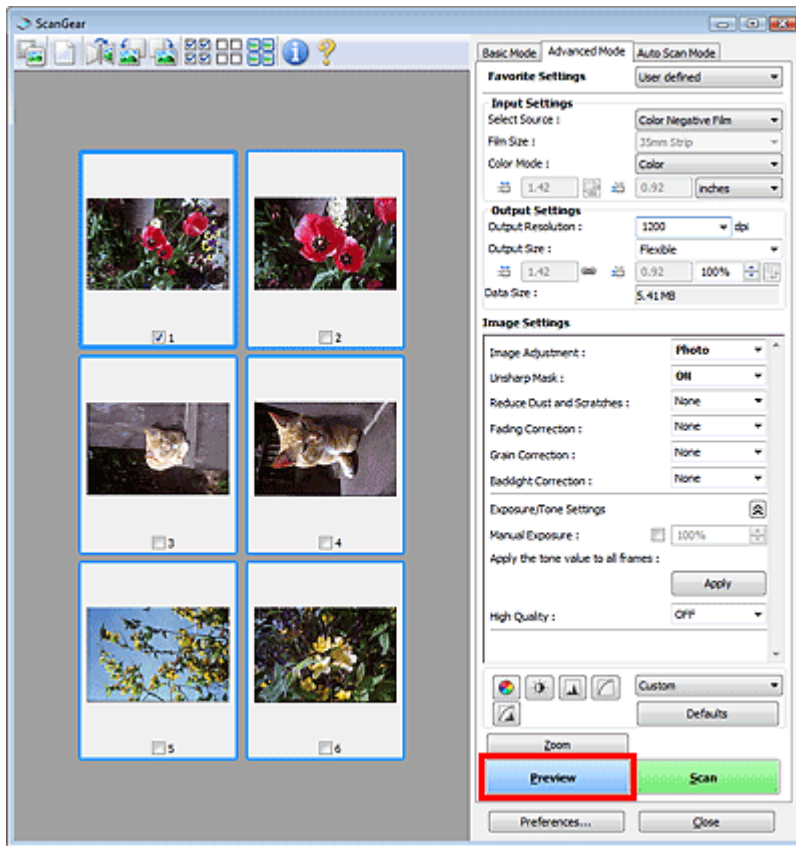

Note

- If mounted negative slides cannot be scanned correctly, adjust the cropping frames.

5. Set Output Settings.

➔ Output Settings

Note

- When the data size exceeds 1.8 GB, change the settings to reduce the size.

6. Adjust the cropping frame (scan area), correct image and adjust colors as required.

➔ Adjusting Cropping Frames

➔ Image Settings

➔ Color Adjustment Buttons

Note

- You can correct each image separately. Select the frame you want to correct.

7. Click Scan.

Scanning starts.

Note

- Click  (Information) to open a dialog box in which you can check the current scan settings (document type, etc.).
 - ScanGear's response after scanning can be specified in Status of ScanGear dialog after scanning on the Scan tab of the Preferences dialog box.
- ➔ Scan Tab

Related Topic

▶ [Advanced Mode Tab](#)

[Page top](#) 

Advanced Guide

Advanced Guide > Scanning > Scanning with Other Application Software > Scanning with Advanced Settings Using ScanGear (Scanner Driver) > Scanning Multiple Documents at One Time with ScanGear (Scanner Driver)

ScanGear

Scanning Multiple Documents at One Time with ScanGear (Scanner Driver)

You can scan two or more photos (small documents) on the Platen at one time in Basic Mode and Advanced Mode of ScanGear (scanner driver).

This section explains how to scan multiple documents from the Basic Mode tab.

Important

- To scan multiple documents as a single image, scan in whole image view.
- The following types of documents may not be cropped correctly. In that case, adjust the cropping frames (scan areas) in whole image view and scan.
 - Photos that have a whitish border
 - Documents printed on white paper, hand-written text, business cards, etc.
 - Thin documents
 - Thick documents
- ➔ [Scanning Multiple Documents in Whole Image View](#)
- The following types of documents cannot be cropped correctly.
 - Documents smaller than 1.18 inches (3 cm) square
 - Photos that have been cut to various shapes

Note

- See "[Scanning in Auto Scan Mode](#)" to scan easily by automatically detecting the document type.
- You can also scan multiple documents at one time from the Advanced Mode tab. Use the Advanced Mode tab to make advanced scan settings such as the color mode, output resolution, image brightness and color tone.
- See the corresponding sections below for details on the Basic Mode tab and Advanced Mode tab.
 - ➔ [Basic Mode Tab](#)
 - ➔ [Advanced Mode Tab](#)

1. Place the document on the Platen, then start ScanGear (scanner driver).

- ➔ [Placing Documents](#)
- ➔ [Starting ScanGear \(Scanner Driver\)](#)

2. Set Select Source according to the document placed on the Platen.

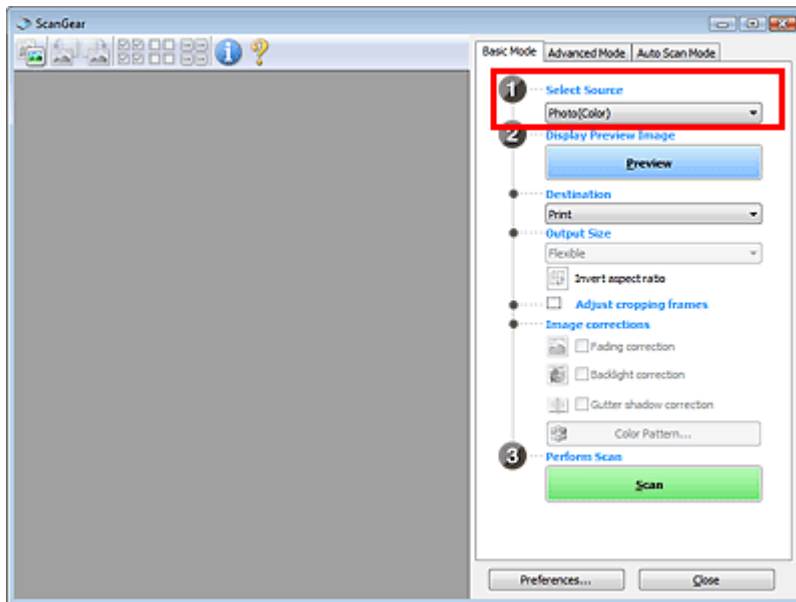

3. Click Preview.

Thumbnails of the preview images appear in the Preview area. Images are cropped (scan areas are specified) automatically according to the document size.

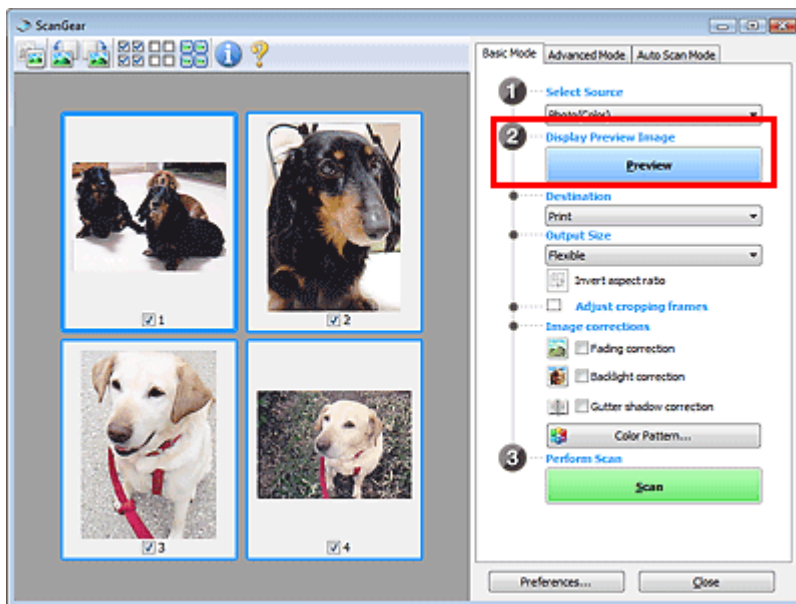

4. Set Destination.

5. Set Output Size.

6. Adjust the scan areas (cropping frames) and set Image corrections as required.

Note

- You can correct each image separately. Select the frame you want to correct.
- In thumbnail view, you can only create one cropping frame (scan area) per image. To create multiple cropping frames in an image, scan in whole image view.
 - ➔ [Scanning Multiple Documents in Whole Image View](#)

7. Select the images you want to scan.

Select the checkboxes of the images you want to scan.

- Click Scan.

Scanning Multiple Documents in Whole Image View

Follow these steps if thumbnails are not displayed correctly when previewed or if you want to scan multiple documents as a single image.

Note

- Positions of slanted documents are not corrected in whole image view.

- After previewing images, click  (Thumbnail) on the Toolbar. Switch to whole image view.

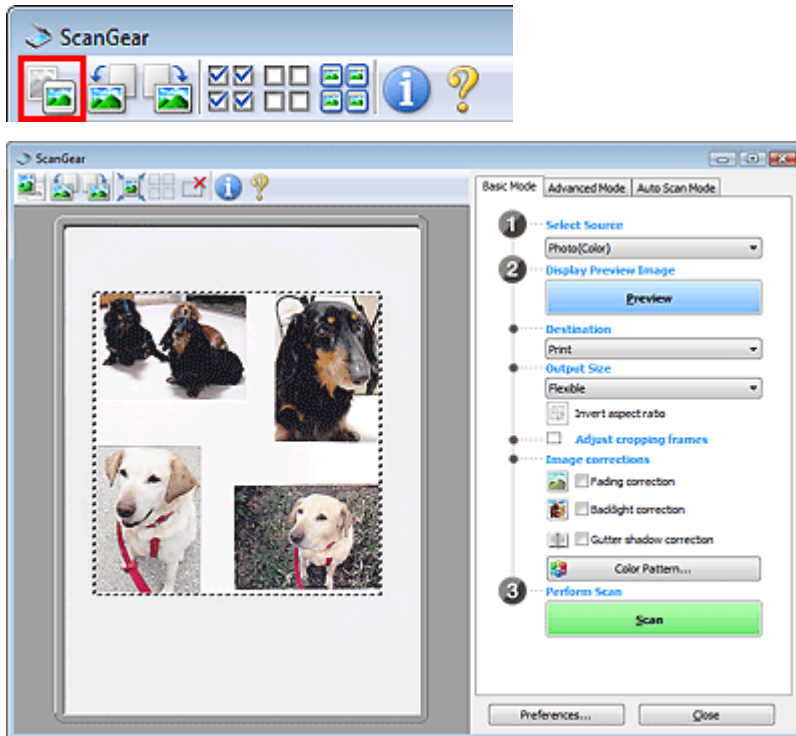

Note

- When the whole image is displayed, the icon changes to  (Whole Image).

- Adjust the scan areas (cropping frames).

Adjust the size and position of the cropping frame (scan area) on the preview image. You can also create two or more cropping frames.

If an area is not specified, the document will be scanned at the document size (Auto Crop). If an area is specified, only the portion in the specified area will be scanned.

➔ [Adjusting Cropping Frames](#)

- Set Destination.

- Set Output Size.

- Set Image corrections as required.

- Click Scan.

Areas framed by broken lines are scanned.

 **Note**

- ScanGear's response after scanning can be specified in Status of ScanGear dialog after scanning on the Scan tab of the Preferences dialog box.

[➔ Scan Tab](#)

[Page top](#) 

Advanced Guide

[Advanced Guide](#) > [Scanning](#) > [Scanning with Other Application Software](#) > [Correcting Images and Adjusting Colors with ScanGear \(Scanner Driver\)](#)

ScanGear

Correcting Images and Adjusting Colors with ScanGear (Scanner Driver)

The following sections provide you with tips and know-how on advanced scanning techniques involving color/brightness adjustment, etc.

- **Sharpening out-of-focus photos, reducing dust and scratches, and correcting faded colors**
 - ➔ [Correcting Images \(Unsharp Mask, Reduce Dust and Scratches, Fading Correction, etc.\)](#)
- **Previewing and changing the color tone of the entire image to scan**
 - ➔ [Adjusting Colors Using a Color Pattern](#)
- **Brightening colors that have faded with time or due to colorcast**
 - ➔ [Adjusting Saturation and Color Balance](#)
- **Adjusting images that are too dark or bright, or too flat due to lack of contrast**
 - ➔ [Adjusting Brightness and Contrast](#)
- **Adjusting the color tone using histogram (a graph showing brightness distribution)**
 - ➔ [Adjusting Histogram](#)
- **Adjusting the image brightness using tone curve (a graph of brightness balance)**
 - ➔ [Adjusting Tone Curve](#)
- **Sharpening characters in text documents or reducing show-through effects**
 - ➔ [Setting Threshold](#)

[Page top](#)↑

Advanced Guide

Advanced Guide > Scanning > Scanning with Other Application Software > Correcting Images and Adjusting Colors with ScanGear (Scanner Driver) > Correcting Images (Unsharp Mask, Reduce Dust and Scratches, Fading Correction, etc.)

ScanGear

Correcting Images (Unsharp Mask, Reduce Dust and Scratches, Fading Correction, etc.)

The Image Settings functions in Advanced Mode tab of ScanGear (scanner driver) allow you to enhance the outline of the subjects, reduce dust/scratches and correct faded colors when scanning images.

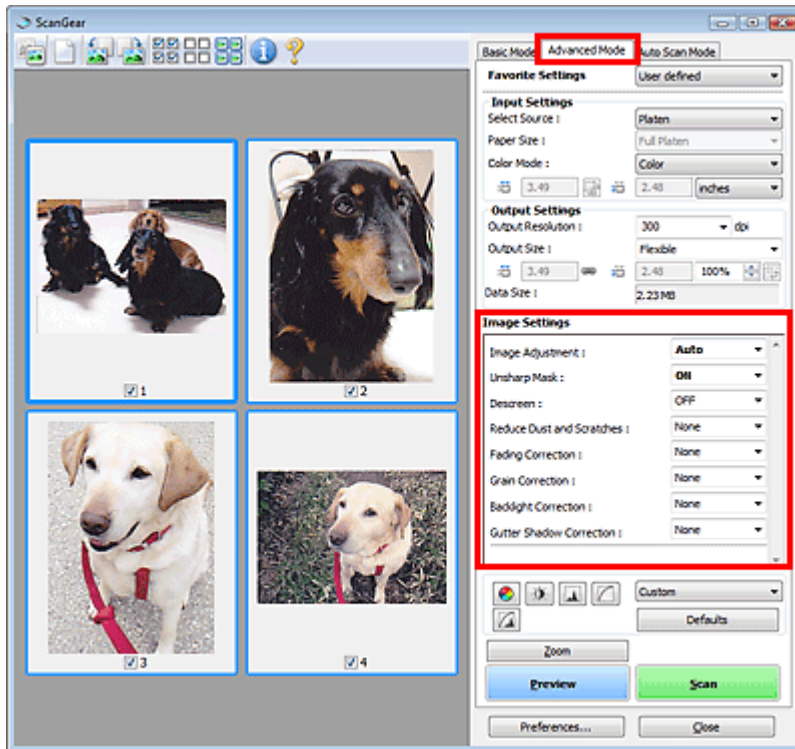

Setting Items

Click  (Arrow) of a function and select an item from the pull-down menu.



Important

- Do not apply these functions to images without moire, dust/scratches or faded colors. The color tone may be adversely affected.
- See "Image Settings" for details and precautions on each function.

Note

- See "Scanning in Advanced Mode" to start ScanGear (scanner driver) in Advanced Mode tab and scan.

Adjusting the image brightness and color tone

Set Image Adjustment to Auto, Photo, Magazine, Newspaper or Document according to the document type.



Sharpening slightly out-of-focus images

Set Unsharp Mask to ON.

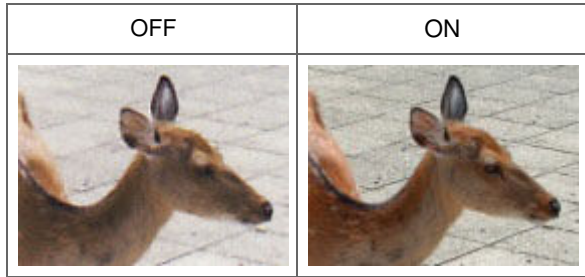

Reducing gradations and stripe patterns

Set Descreen to ON.

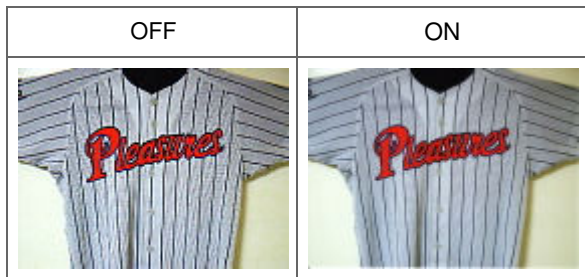

Note

- "Moire" is a phenomenon where uneven gradation or a stripe pattern appears when such photos or pictures printed with fine dots are scanned. Descreen is the function for reducing this moire effect.

Reducing dust and scratches

Set Reduce Dust and Scratches to Low, Medium or High according to the degree of dust and scratches.

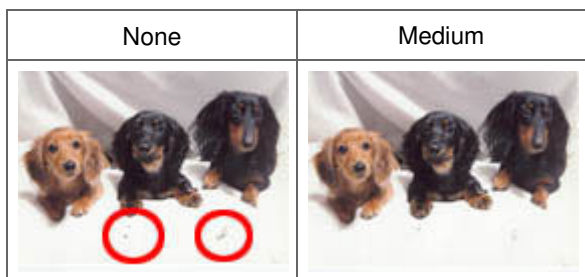

Note

- When the resolution is set to 4801 dpi or higher and Reduce Dust and Scratches checkbox is selected, images are scanned at an optical resolution of 4800 dpi then interpolated by the software to yield the specified resolution.

Correcting photos that have faded with time or due to colorcast

Set Fading Correction to Low, Medium or High according to the degree of fading or colorcast.

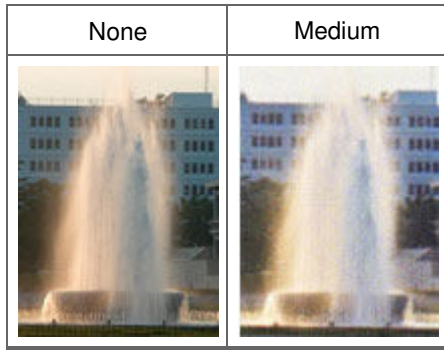

Reducing graininess

Set Grain Correction to Low, Medium or High according to the degree of graininess.

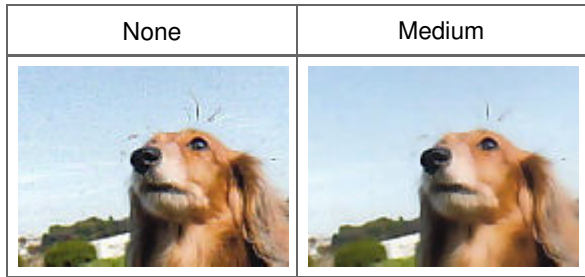

Correcting backlit images

Set Backlight Correction to Low, Medium or High according to the degree of backlight.



Correcting shadows that appear between pages when scanning open booklets

Set Gutter Shadow Correction to Low, Medium or High according to the degree of shadows.

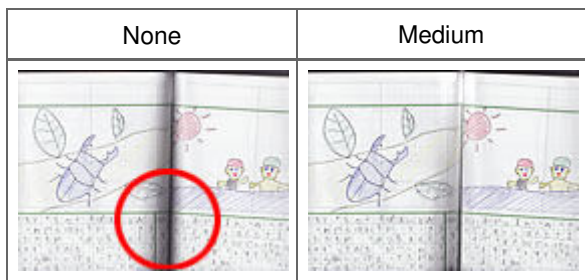

Adjusting the film exposure manually

Click  (Down arrow) of Exposure/Tone Settings.

Select the Manual Exposure checkbox and adjust the exposure within the range of 50% to 200%.

Before	After



Scanning film at high quality

Click  (Down arrow) of Exposure/Tone Settings and set High Quality to ON.

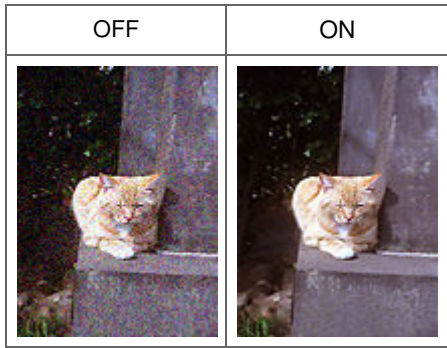

[Page top](#) 

Advanced Guide

Advanced Guide > Scanning > Scanning with Other Application Software > Correcting Images and Adjusting Colors with ScanGear (Scanner Driver) > Adjusting Colors Using a Color Pattern

ScanGear

Adjusting Colors Using a Color Pattern

You can preview color changes and reproduce natural colors by using the Color Pattern function in ScanGear's Basic Mode tab.

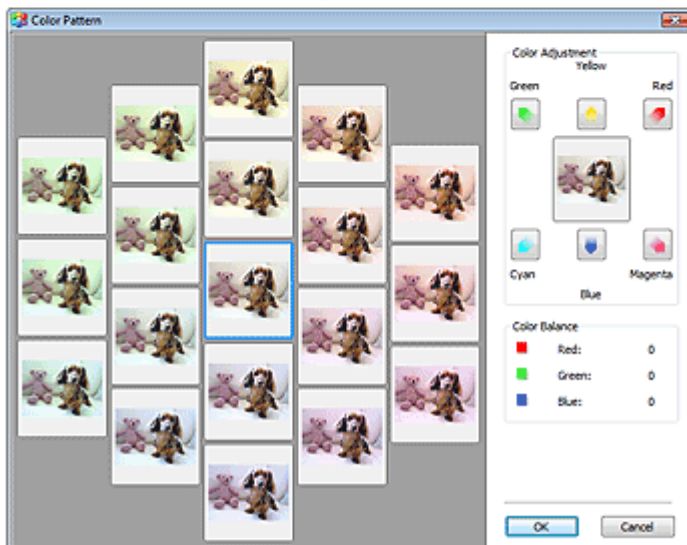
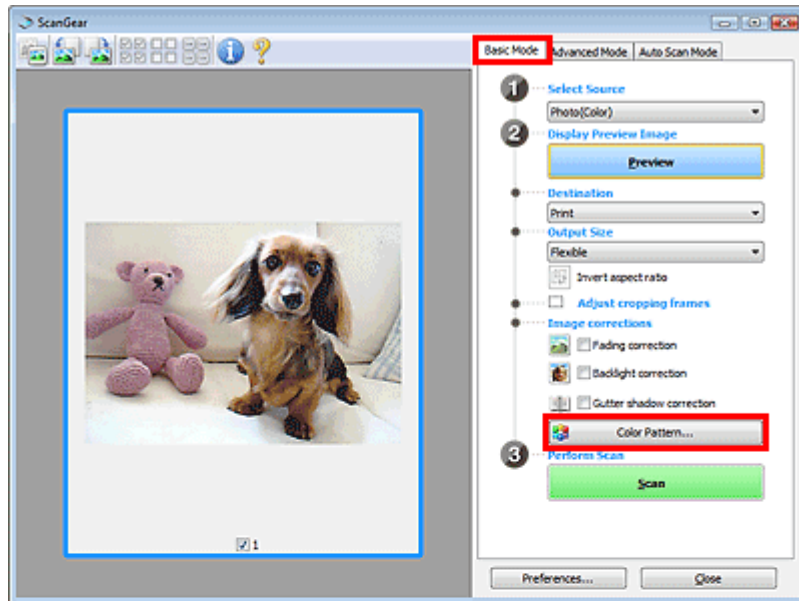

Color Adjustment

Correct colors that have faded with time or due to colorcast. Colorcast is a phenomenon where a specific color affects the entire picture due to the weather or ambient strong colors.

Click an arrow in Color Adjustment to emphasize the corresponding color.

Cyan & red, magenta & green and yellow & blue are complementary color pairs (each pair produces a shade of gray when mixed). You can reproduce the natural colors of the scene by reducing the cast color and increasing the complementary color.

It is recommended that you find a portion in the image where it should be white, and adjust the colors so that the portion turns white.

Preview image appears in the center. Preview image colors change as you adjust them.

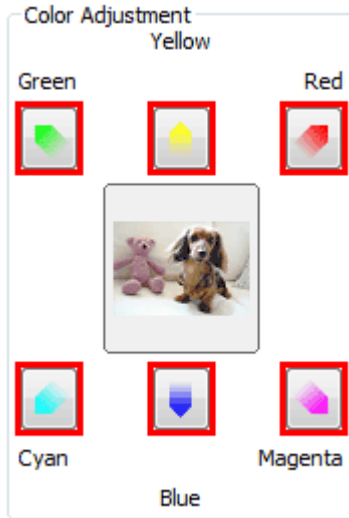

Below is an example of correcting a bluish image.

Since Blue and Green are too strong, click the Yellow and Magenta arrows to correct.

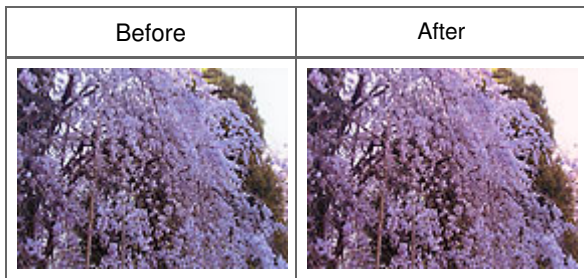

Note

- Color adjustments are applied only to the scan area (cropping frame) or the frame selected in thumbnail view.
You can select multiple frames or cropping frames by clicking them while pressing the Ctrl key.
- You can also select a color tone from the color pattern displayed on the left of the Color Pattern screen.
- You can also use this function to add a specific tint to an image. Increase the magenta to add a warm tint, and increase the blue to add a cool tint.

Advanced Guide

Advanced Guide > Scanning > Scanning with Other Application Software > Correcting Images and Adjusting Colors with ScanGear (Scanner Driver) > Adjusting Saturation and Color Balance

ScanGear

Adjusting Saturation and Color Balance

In ScanGear's Advanced Mode tab, click  (Saturation/Color Balance).

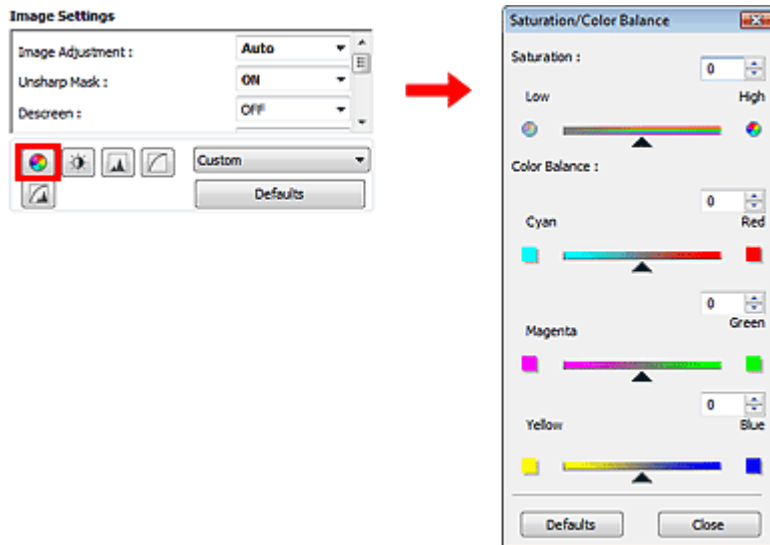

Note

- Click Defaults to reset all adjustments in the current window.

Saturation

Adjust the image's saturation (vividness). You can brighten colors that have faded with time, etc.

Move  (Slider) under Saturation to the left to decrease the saturation (darken the image), and to the right to increase the saturation (brighten the image). You can also enter a value (-127 to 127).

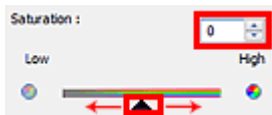

Note

- The natural color tone of the original image may be lost if you increase saturation too much.

Color Balance

Adjust images that have a colorcast. Colorcast is a phenomenon where a specific color affects the entire picture due to the weather or ambient strong colors.

Move ▲ (Slider) under Color Balance to the left or right to emphasize the corresponding color.

Cyan & Red

Magenta & Green

Yellow & Blue

These are complementary color pairs (each pair produces a shade of gray when mixed). You can reproduce the natural colors of the scene by reducing the cast color and increasing the complementary color.

It is usually difficult to correct the image completely by adjusting only one color pair. It is recommended that you find a portion in the image where it should be white, and adjust all three color pairs so that the portion turns white.

You can also enter a value (-127 to 127).

Below is an example of an image in which the "Cyan & Red" pair has been adjusted.



Advanced Guide

Advanced Guide > Scanning > Scanning with Other Application Software > Correcting Images and Adjusting Colors with ScanGear (Scanner Driver) > Adjusting Brightness and Contrast



ScanGear

Adjusting Brightness and Contrast

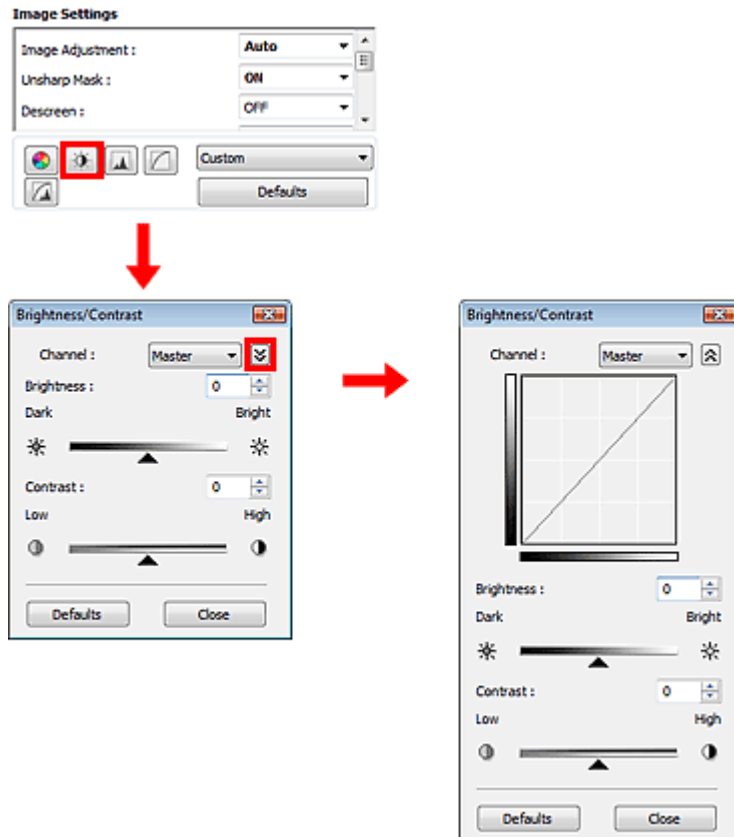
In ScanGear's Advanced Mode tab, click  (Brightness/Contrast).



Note

- Click  (Down arrow) to switch to detailed view. Click  (Up arrow) to return to the previous view.
- Click Defaults to reset all adjustments in the current window.

Channel

Each dot of an image is a mixture of Red, Green and Blue in various proportions (gradation). These colors can be adjusted individually as a "channel."

- **Master**
Adjust the Red, Green and Blue combined.
- **Red**
Adjust the Red channel.
- **Green**
Adjust the Green channel.
- **Blue**
Adjust the Blue channel.

Note

- Only Grayscale will be displayed in Channel when Color Mode is Grayscale or Grayscale(16bit).

Brightness

Adjust the image brightness. Move ▲ (Slider) under Brightness to the left to darken and right to brighten the image. You can also enter a value (-127 to 127).



Note

- Highlights may be lost if you brighten the image too much, and shadows may be lost if you darken the image too much.

Contrast

"Contrast" is the degree of difference between the brighter and darker parts of an image. Increasing contrast will increase the difference, thus sharpening the image. Decreasing contrast will decrease the difference, thus softening the image.

Move ▲ (Slider) under Contrast to the left to decrease and right to increase the contrast of the image. You can also enter a value (-127 to 127).



Note

- Increasing the contrast is effective in adding a three-dimensional feel to soft images. However, shadows and highlights may be lost if you increase the contrast too much.

Advanced Guide

Advanced Guide > Scanning > Scanning with Other Application Software > Correcting Images and Adjusting Colors with ScanGear (Scanner Driver) > Adjusting Histogram

ScanGear

Adjusting Histogram

In ScanGear's Advanced Mode tab, click  (Histogram).

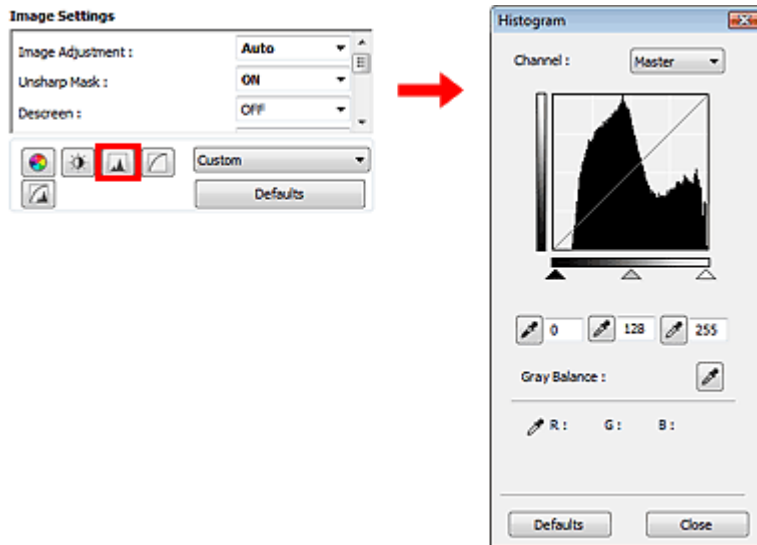

Note

- Click Defaults to reset all adjustments in the current window.

Channel

Each dot of an image is a mixture of Red, Green and Blue in various proportions (gradation). These colors can be adjusted individually as a "channel."

- Master**
 Adjust the Red, Green and Blue combined.
- Red**
 Adjust the Red channel.
- Green**
 Adjust the Green channel.
- Blue**
 Adjust the Blue channel.

Note

- Only Grayscale will be displayed in Channel when Color Mode is Grayscale or Grayscale(16bit).

Reading Histograms

You can open Histogram of a specified area for each Channel. The higher the Histogram peak, the more data is distributed to that level.



(1) Bright area	(2) Dark area	(3) Whole image
More data is distributed to the highlight side.	More data is distributed to the shadow side.	Data is widely distributed between the highlight and shadow.

Adjusting Histograms (Using the Slider)

Select a Channel, then move ▲ (Black-point Slider) or △ (White-point Slider) to specify the level to be set as the shadow or highlight.

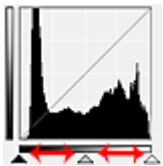

- All parts to the left of ▲ (Black-point Slider) will be black (level 0).
- The parts at △ (Mid-point Slider) will turn to the color exactly between the black-point and white-point.
- All parts to the right of △ (White-point Slider) will turn white (level 255).

Image Adjustment is Auto by default. Adjustments shown below are automatically performed.

Moving the Black-point and White-point Sliders

Move the Black-point Slider or White-point Slider to adjust brightness.

Images with more data distributed to the highlight side

Move the Black-point Slider toward the highlight side.

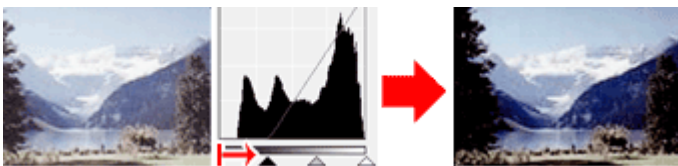

Images with more data distributed to the shadow side

Move the White-point Slider toward the shadow side.

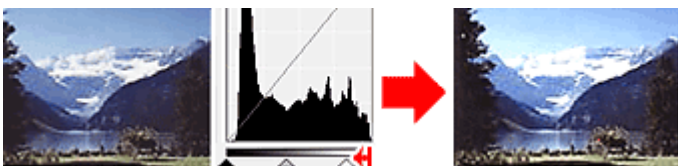

Images with widely distributed data

Move the Black-point Slider toward the highlight side, and White-point Slider toward the shadow side.

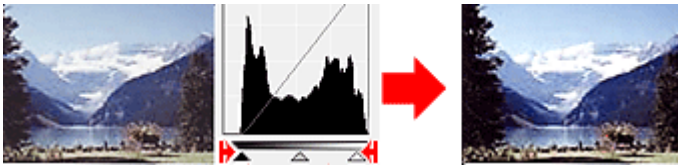

Moving the Mid-point Slider

Move the Mid-point Slider to specify the level to be set as the middle of the tonal range.

Images with more data distributed to the highlight side

Move the Mid-point Slider toward the highlight side.

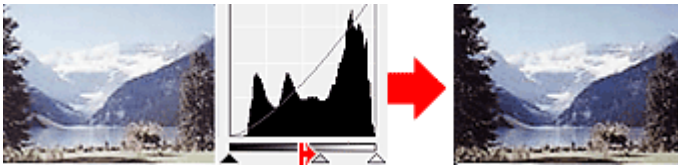

Images with more data distributed to the shadow side



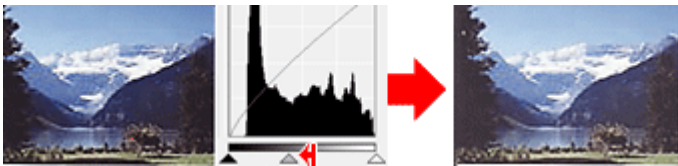

Move the Mid-point Slider toward the shadow side.

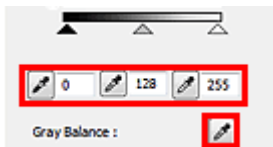

Adjusting Histograms (Using the Droppers)

When you select a Channel and click the Black-point, Mid-point or White-point Dropper, the mouse pointer on the preview image changes to a dropper. Click a Dropper displayed below the histogram to change the setting.



- The point clicked with  (Black-point Dropper) will be the darkest point. You can also enter a value (0 to 245).
- The point clicked with  (Mid-point Dropper) will be the middle of the tonal range. You can also enter a value (5 to 250).
- The point clicked with  (White-point Dropper) will be the brightest point. You can also enter a value (10 to 255).
- Click  (Dropper) for Gray Balance and click the area you want to adjust the color in the preview image.

The clicked point will be set as the achromatic color reference, and the rest of the image is adjusted accordingly. For instance, if snow in a photo appears bluish, click the bluish part to adjust the whole image and reproduce natural colors.

Advanced Guide

Advanced Guide > Scanning > Scanning with Other Application Software > Correcting Images and Adjusting Colors with ScanGear (Scanner Driver) > Adjusting Tone Curve

ScanGear

Adjusting Tone Curve

In ScanGear's Advanced Mode tab, click  (Tone Curve Settings).

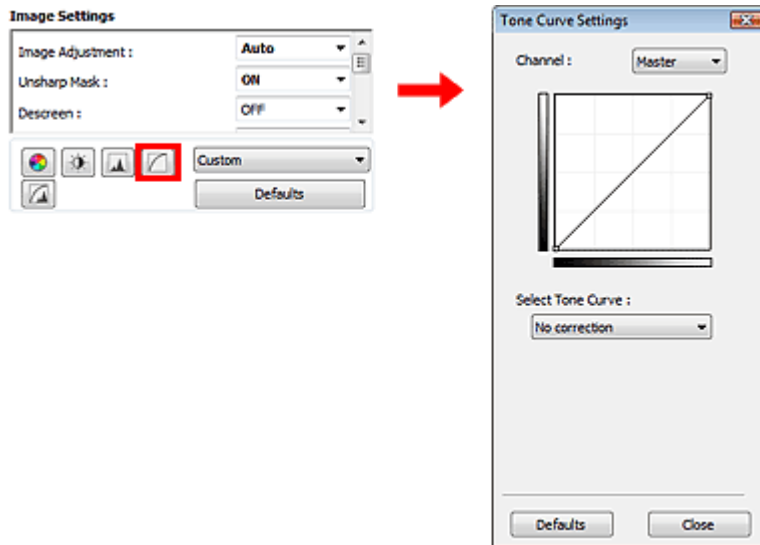

Note

- Click Defaults to reset all adjustments in the current window.

Channel

Each dot of an image is a mixture of Red, Green and Blue in various proportions (gradation). These colors can be adjusted individually as a "channel."

- Master**
 Adjust the Red, Green and Blue combined.
- Red**
 Adjust the Red channel.
- Green**
 Adjust the Green channel.
- Blue**
 Adjust the Blue channel.

Note

- Only Grayscale will be displayed in Channel when Color Mode is Grayscale or Grayscale(16bit).

Reading Tone Curves

With ScanGear (scanner driver), scanning images via a scanner is the input, and displaying to a monitor is the output. "Tone Curve" shows the balance of tone input and output for each Channel.

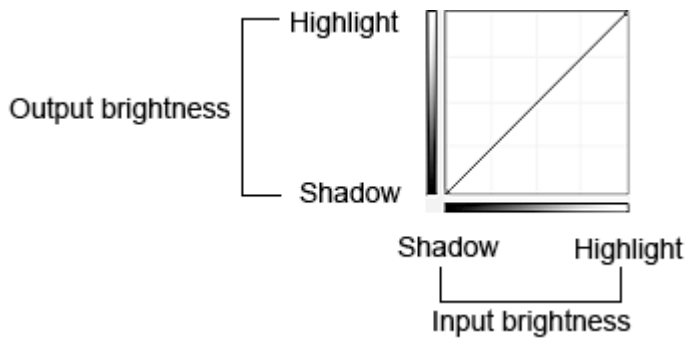

Adjusting Tone Curve

In Select Tone Curve, select a tone curve from No correction, Overexposure, Underexposure, High contrast, Reverse the negative/positive image and Edit custom curve.

No correction (No adjustment)

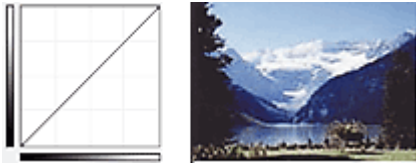

Overexposure (Convex curve)

The midtone data of the input side is stretched toward the highlight of the output side, resulting in a bright-toned image when viewed on a monitor.

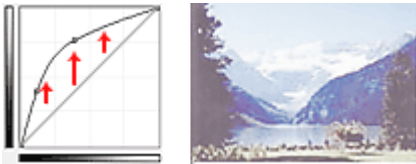

Underexposure (Concave curve)

The midtone data of the input side is stretched toward the shadow of the output side, resulting in a dark-toned image when viewed on a monitor.

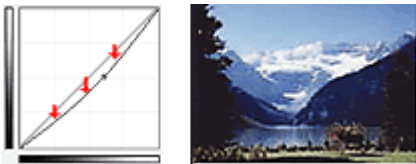

High contrast (S curve)

The highlight and shadow of the input side are enhanced, resulting in a high-contrast image.

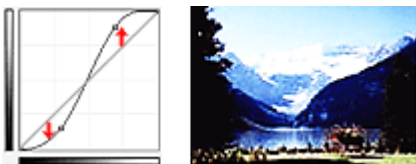

Reverse the negative/positive image (Downward-sloping line)

The input and output sides are reversed, resulting in a negative-positive inverted image.

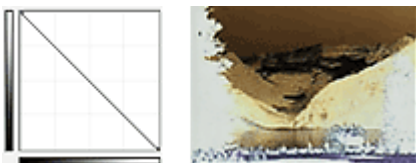

Edit custom curve

You can drag specific points on the Tone Curve to freely adjust the brightness of the corresponding areas.

[Page top](#)↑

Advanced Guide

Advanced Guide > Scanning > Scanning with Other Application Software > Correcting Images and Adjusting Colors with ScanGear (Scanner Driver) > Setting Threshold

ScanGear

Setting Threshold

The brightness of color and grayscale images is expressed in a value between 0 and 255. However, in creating black and white images, all colors are mapped to either black (0) or white (255). "Threshold" is the borderline value that determines a color as black or white. By adjusting the threshold level, you can sharpen text in a document or reduce show-through in newspapers.

This function is available when Color Mode is Black and White.

In ScanGear's Advanced Mode tab, click  (Threshold).

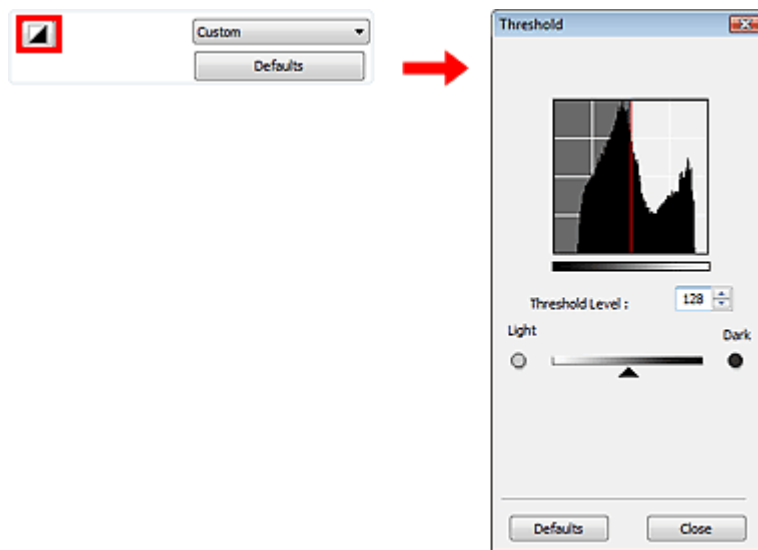

Note

- Click Defaults to reset all adjustments in the current window.

Adjusting Threshold

Move  (Slider) to the right to increase the threshold value and thus increase the black areas. Move the slider to the left to decrease the value and thus increase the white areas. You can also enter a value (0 to 255).



[Page top](#)

Advanced Guide

[Advanced Guide](#) > [Scanning](#) > [Scanning with Other Application Software](#) > [ScanGear \(Scanner Driver\) Screens](#)

ScanGear

ScanGear (Scanner Driver) Screens

The following sections describe ScanGear's screens and functions, and how to use ScanGear (scanner driver).

- ➔ Basic Mode Tab
- ➔ Advanced Mode Tab
 - Input Settings
 - Output Settings
 - Image Settings
 - Color Adjustment Buttons
- ➔ Auto Scan Mode Tab
- ➔ Preferences Dialog Box
 - Scanner Tab
 - Preview Tab
 - Scan Tab
 - Color Settings Tab

[Page top](#)↑

Advanced Guide

Advanced Guide > Scanning > Scanning with Other Application Software > ScanGear (Scanner Driver) Screens > Basic Mode Tab

ScanGear

Basic Mode Tab

This mode allows you to scan easily by following the on-screen steps.

This section describes the settings and functions available in Basic Mode.

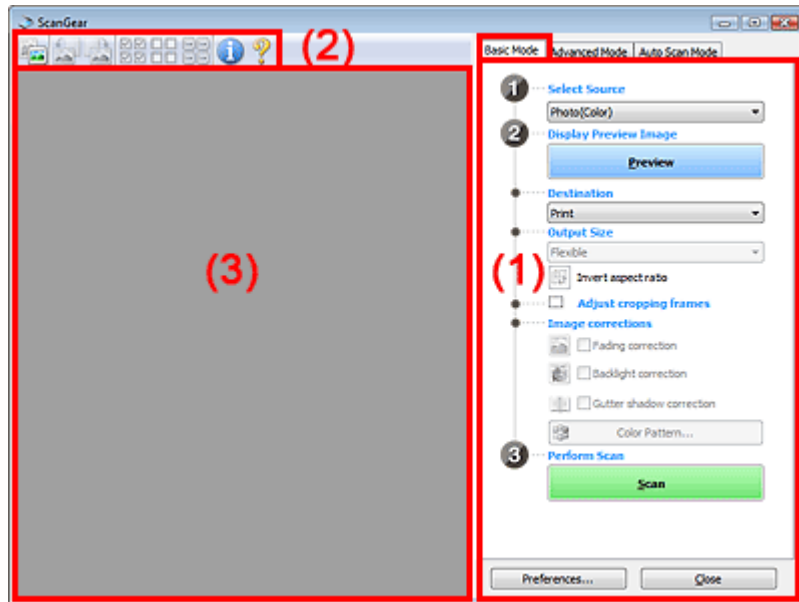

(1) Settings and Operation Buttons

(2) Toolbar

(3) Preview Area

Note

- The displayed items vary by document type and how the screen was opened.

Settings and Operation Buttons

- **Select Source**
 - **Photo(Color)**
Scan color photos.
 - **Magazine(Color)**
Scan color magazines.
 - **Newspaper(Grayscale)**
Scan text and line drawings in black and white.
 - **Document(Grayscale)**
Scan documents and photos in black and white.
Select this mode to create high-resolution black and white images.
 - **Negative Film(Color)**
Scan 35 mm color negative film in color.
 - **Positive Film(Color)**
Scan 35 mm color positive film in color.

Note

- To scan black and white film, scan from the Advanced Mode tab.
➔ **Scanning Film in Advanced Mode**
- When you select a document type, colors are adjusted based on the Unsharp Mask function or document type.
- If you select Magazine(Color), the Descreen function will be active.

● Display Preview Image

● Preview

Performs a trial scan.

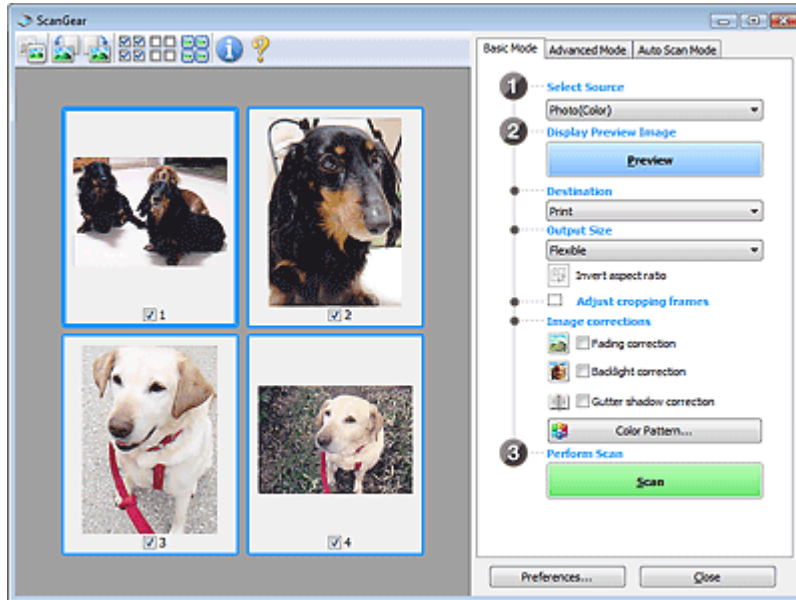

Note

- When using the machine for the first time, scanner calibration starts automatically. Wait a while until the preview image appears.

● Destination

Select what you want to do with the scanned image.

● Print

Select this to print the scanned image on a printer.

● Image display

Select this to view the scanned image on a monitor.

● OCR

Select this to use the scanned image with OCR software.

OCR software is software that converts text scanned as an image into text data that can be edited in word processors and other programs.

Important

- This option is not displayed when film is scanned.

● Output Size

Select an output size.

Output size options vary by the item selected in Destination.

● Flexible

Allows you to freely adjust the cropping frames.

In thumbnail view

Drag the mouse over a thumbnail to display a cropping frame. When a cropping frame is displayed, the portion within the cropping frame will be scanned. When no cropping frame is displayed, each frame is scanned individually.

In whole image view

When no cropping frame is displayed, the entire Preview area will be scanned. When a cropping frame is displayed, the portion within the cropping frame will be scanned.

- **Paper Size (L, A4, etc.)**

Select an output paper size. The portion within the cropping frame will be scanned at the size of the selected paper size. You can drag the cropping frame to enlarge/reduce it while maintaining the aspect ratio.

- **Monitor Size (1024 x 768 pixels, etc.)**

Select an output size in pixels.

A cropping frame of the selected monitor size will be displayed and the portion within the cropping frame will be scanned. You can drag the cropping frame to enlarge/reduce it while maintaining the aspect ratio.

- **Add/Delete...**

Opens the Add/Delete the Output Size dialog box, in which you can specify custom output sizes. You can select this option when Destination is Print or Image display.

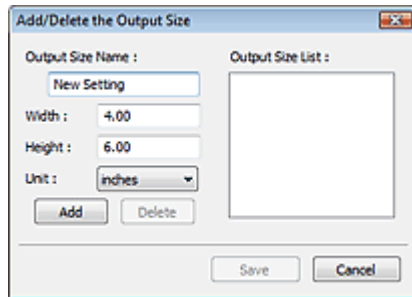

In the Add/Delete the Output Size dialog box, you can specify multiple output sizes and save them at one time. Saved items will be registered to the Output Size list and can be selected, along with the predefined items.

Add

To add a size, enter Output Size Name, Width and Height, then click Add. For Unit, you can select mm or inches when Destination is Print but you can only select pixels when Destination is Image display. The name of the added size appears in Output Size List. Click Save to save the items listed in Output Size List.

Delete

To delete an item, select it in Output Size List and click Delete. Click Save to save the items listed in Output Size List.

Important

- You cannot delete predefined output sizes such as A4 and 1024 x 768 pixels.

Note

- Save up to 10 items.
- An error message appears when you enter a value outside the setting range. Enter a value within the setting range.

Note

- Whether or how the cropping frame is initially displayed on a preview image can be specified on the Preview tab of the Preferences dialog box. See Cropping Frame on Previewed Images in "Preview Tab."

-  **Invert aspect ratio**

This button is available when Output Size is set to anything but Flexible.

Click this button to rotate the cropping frame. Click again to return it to the original orientation.

- **Adjust cropping frames**

You can adjust the scan area within the Preview area.

If an area is not specified, the document will be scanned at the document size (Auto Crop) or film

size. If an area is specified, only the portion in the cropping frame will be scanned.

➔ [Adjusting Cropping Frames](#)



- **Image corrections**

- **Reduce Dust and Scratches**

Reduces dust and scratches when scanning film.

Important

- This function is available only when film is scanned.

- **Fading correction**

Corrects and scans photos and film that have faded with time or have a colorcast.

- **Backlight correction**

Corrects photos and film that have been shot against light.

- **Gutter shadow correction**

Corrects shadows that appear between pages when scanning open booklets.

Important

- For precautions on using this function, see Gutter Shadow Correction in "[Image Settings](#)" (Advanced Mode tab).
- This function is not available when film is scanned.

- **Color Pattern...**

Allows you to adjust the image's overall color. You can correct colors that have faded due to colorcast, etc. and reproduce natural colors while previewing color changes.

➔ [Adjusting Colors Using a Color Pattern](#)

- **Perform Scan**

- **Scan**

Scanning starts.

Note

- When scanning starts, the progress will be displayed. Click Cancel to cancel the scan.

- **Preferences...**

The Preferences dialog box opens and you can make scan/preview settings.

➔ [Preferences Dialog Box](#)

- **Close**













Closes ScanGear (scanner driver).

Toolbar

- **Toolbar**

You can adjust or rotate preview images. The buttons displayed on the Toolbar vary by view.

When Select Source is other than film and in thumbnail view**When Select Source is other than film and in whole image view****When Select Source is film and in thumbnail view****When Select Source is film and in whole image view**

-  (Thumbnail) /  (Whole image)
 Switches the view in the Preview area when document type is other than film.
 Preview Area
-  (Film Thumbnail) /  (Whole Film Image)
 Switches the view in the Preview area when document type is film.
 Preview Area
-  (Mirror)
 Inverts the preview image horizontally.
 - The result will be reflected in the scanned image.
 - The image returns to its original state when you preview again.
-  (Rotate Left)
 Rotates the preview image 90 degrees counter-clockwise.
 - The result will be reflected in the scanned image.
 - The image returns to its original state when you preview again.
-  (Rotate Right)
 Rotates the preview image 90 degrees clockwise.
 - The result will be reflected in the scanned image.
 - The image returns to its original state when you preview again.
-  (Auto Crop)
 Displays and adjusts the cropping frame automatically to the size of the document displayed in the Preview area. The scan area is reduced every time you click this button if there are croppable areas within the cropping frame.
-  (Check All Frames)
 This button is available when two or more frames are displayed. Selects the checkbox of the image in thumbnail view.
-  (Uncheck All Frames)
 This button is available when two or more frames are displayed. Deselects the checkbox of the image in thumbnail view.
-  (Select All Frames)
 This button is available when two or more frames are displayed.

Selects the image in thumbnail view and the image will be outlined in blue.

- 
(Select All Cropping Frames)

This button is available when there are two or more cropping frames.

All cropping frames will be displayed in thick broken lines. The settings will be applied to all the cropping frames.

- 
(Remove Cropping Frame)

Removes the selected cropping frame.

- 
(Information)

Displays the version of ScanGear (scanner driver) and the current scan settings (document type, etc.).

- 
(Open Guide)

This page appears.

Preview Area

- ### Preview Area



This is where a trial image is displayed after you click Preview. You can also check the results of the settings (image corrections, color adjustments, etc.) made in " [Settings and Operation Buttons](#) ."

When  **(Thumbnail)** or  **(Film Thumbnail)** is displayed on the Toolbar

Thumbnails of images cropped to the document size are displayed. Only the images with the checkbox selected will be scanned.



Note

- When multiple images are previewed, different outlines indicate different selection status.
 - Focus Frame (thick blue outline): The displayed settings will be applied.
 - Selected Frame (thin blue outline): The settings will be applied to the Focus Frame and Selected Frames simultaneously. You can select multiple images by clicking them while pressing the Ctrl key.
 - Unselected (no outline): The settings will not be applied.
- Double-click a frame to zoom in on the image. Click   (Frame Advance) at the bottom of the screen to display the previous or next frame. Double-click the frame again to return the display to its non-magnified state.

When  **(Whole Image)** or  **(Whole Film Image)** is displayed on the Toolbar

When document type is other than film, items on the Platen are displayed as a single image. When document type is film, the whole film image is displayed. All portions in the cropping frames will be scanned.



Whole image view (Full Platen)

Whole film image view

Note

- If frames are not detected (for example, only four frames out of six frames are displayed) due to the image color of the film, display the whole image and scan.

Note

- You can specify the scan area (cropping frame) on the displayed image. In thumbnail view, you can only create one cropping frame per image. In whole image view, you can create multiple cropping frames.

[➔ Adjusting Cropping Frames](#)

Related Topic

[▶ Scanning in Basic Mode](#)

[Page top](#) 

Advanced Guide

Advanced Guide > Scanning > Scanning with Other Application Software > ScanGear (Scanner Driver) Screens > Advanced Mode Tab

ScanGear

Advanced Mode Tab

This mode allows you to make advanced scan settings such as the color mode, output resolution, image brightness and color tone.

This section describes the settings and functions available in Advanced Mode.

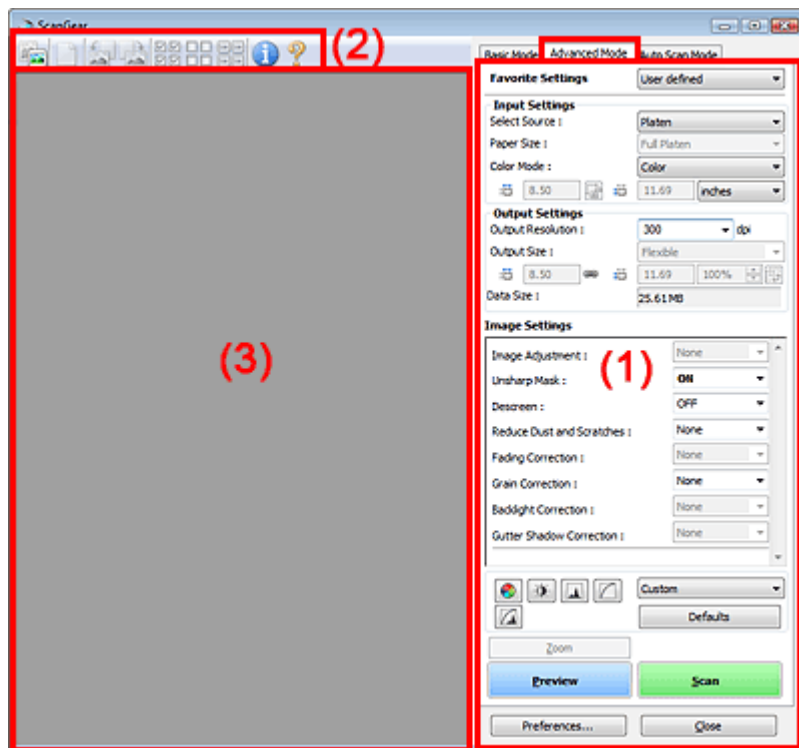

- (1) Settings and Operation Buttons
- (2) Toolbar
- (3) Preview Area

Note

- The displayed items vary by document type and how the screen was opened.

Settings and Operation Buttons

• Favorite Settings

You can name and save a group of settings (Input Settings, Output Settings, Image Settings and Color Adjustment Buttons) on Advanced Mode tab, and load it as required. It is convenient to save a group of settings if you will be using it repeatedly. You can also use this to reload the default settings.

Select Add/Delete... from the pull-down menu and the Add/Delete Favorite Settings dialog box opens.

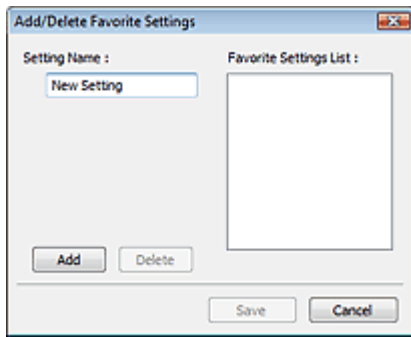

Enter Setting Name and click Add. The name appears in Favorite Settings List.

When you click Save, the item appears in the Favorite Settings list and can be selected, along with the predefined items.

To delete an item, select it in Favorite Settings List and click Delete. Click Save to save settings displayed in Favorite Settings List.

Note

- You can set Add/Delete... in Favorite Settings after preview.
- Save up to 10 items.

• Input Settings

Specify the input settings such as the document type and size.

➔ [Input Settings](#)

• Output Settings

Specify the output settings such as the output resolution and size.

➔ [Output Settings](#)

• Image Settings

Enable/disable various image correction functions.

➔ [Image Settings](#)

• Color Adjustment Buttons

These buttons can be used to make fine corrections to the image brightness and color tones. You can adjust the image's overall brightness or contrast, and adjust its highlight and shadow values (histogram) or balance (tone curve).

➔ [Color Adjustment Buttons](#)

• Zoom

Zooms in on an image or the portion within the cropping frame. When the image is zoomed in, Zoom changes to Undo. Click Undo to return the display to its non-magnified state.

In thumbnail view

Zooms in on the selected image. Click   (Frame Advance) at the bottom of the screen to display the previous or next frame.

Note

- You can also zoom in on an image by double-clicking the frame. Double-click the frame again to return the display to its non-magnified state.

In whole image view

Rescans the portion within the cropping frame at higher magnification.

Note

- Zoom rescans the image and displays high-resolution image in Preview.
-  (Enlarge/Reduce) on the Toolbar zooms in on the preview image quickly. However, the resolution of the displayed image will be low.

• Preview

Performs a trial scan.

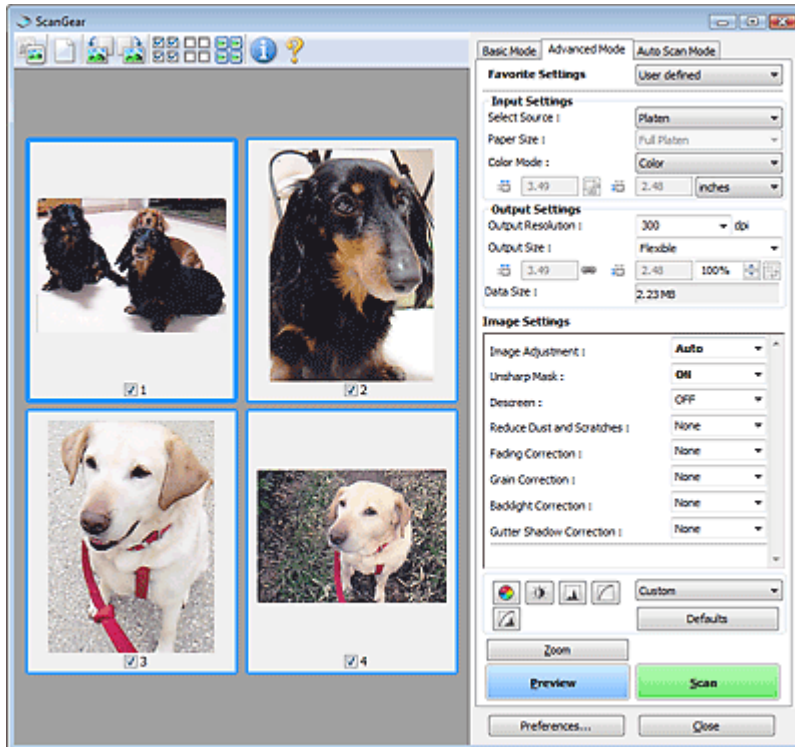

- **Scan**

Starts scanning.

Note

- When scanning starts, the progress will be displayed. Click Cancel to cancel the scan.
- When scanning is completed, a dialog box prompting you to select the next action may open. Follow the prompt to complete. For details, see Status of ScanGear dialog after scanning in " [Scan Tab](#)" (Preferences dialog box).
- It will take time to process the images if the total size of the scanned images exceeds a certain size. In that case, a warning message appears. It is recommended that you reduce the total size. To continue, scan in whole image view.

- **Preferences...**

The Preferences dialog box opens and you can make scan/preview settings.

➔ [Preferences Dialog Box](#)

- **Close**

Closes ScanGear (scanner driver).

Toolbar

- **Toolbar**

You can adjust or rotate preview images. The buttons displayed on the Toolbar vary by view.

When Select Source is Platen and in thumbnail view



When Select Source is Platen and in whole image view























When Select Source is film and in thumbnail view



When Select Source is film and in whole image view



-  **(Thumbnail)** /  **(Whole Image)**
 Switches the view in the Preview area when document type is Platen.
 → Preview Area
-  **(Film Thumbnail)** /  **(Whole Film Image)**
 Switches the view in the Preview area when document type is film.
 → Preview Area
-  **(Clear)**
 Click this button to delete the preview image.
 It also resets the Toolbar and color adjustment settings.
-  **(Crop)**
 Allows you to specify the scan area by dragging the mouse.
-  **(Move Image)**
 If an enlarged image is too large to fit in the Preview area, you can click this button and drag the image across the screen until the part you want to see is displayed. You can also move the image using the scroll bars.
-  **(Enlarge/Reduce)**
 Click this button then click on the image to enlarge it (zoom in). Right-click on the image to reduce it (zoom out).
-  **(Mirror)**
 Inverts the preview image horizontally.
 - The result will be reflected in the scanned image.
 - The image returns to its original state when you preview again.
-  **(Rotate Left)**
 Rotates the preview image 90 degrees counter-clockwise.
 - The result will be reflected in the scanned image.
 - The image returns to its original state when you preview again.
-  **(Rotate Right)**
 Rotates the preview image 90 degrees clockwise.
 - The result will be reflected in the scanned image.
 - The image returns to its original state when you preview again.
-  **(Auto Crop)**
 Displays and adjusts the cropping frame automatically to the size of the document displayed in the Preview area. The scan area is reduced every time you click this button if there are croppable areas within the cropping frame.
-  **(Check All Frames)**
 This button is available when two or more frames are displayed.
 Selects the checkbox of the image in thumbnail view.

- 
(Uncheck All Frames)
 This button is available when two or more frames are displayed.
 Deselects the checkbox of the image in thumbnail view.
- 
(Select All Frames)
 This button is available when two or more frames are displayed.
 Selects the image in thumbnail view and the image will be outlined in blue.
- 
(Display Film Cropping Frame)
 Displays the cropping frame according to the film selected in Film Size.
- 
(Select All Cropping Frames)
 This button is available when there are two or more cropping frames.
 All cropping frames will be displayed in thick broken lines. The settings will be applied to all the cropping frames.
- 
(Remove Cropping Frame)
 Removes the selected cropping frame.
- 
(Information)
 Displays the version of ScanGear (scanner driver) and the current scan settings (document type, etc.).
- 
(Open Guide)
 This page appears.

Preview Area

- Preview Area**
 This is where a trial image is displayed after you click Preview. You can also check the results of the settings (image corrections, color adjustments, etc.) made in " [Settings and Operation Buttons](#) ."

When  **(Thumbnail)** or  **(Film Thumbnail)** is displayed on the Toolbar

Thumbnails of images cropped to the document size are displayed. Only the images with the checkbox selected will be scanned.



Note

- When multiple images are previewed, different outlines indicate different selection status.

- Focus Frame (thick blue outline): The displayed settings will be applied.
- Selected Frame (thin blue outline): The settings will be applied to the Focus Frame and Selected Frames simultaneously. You can select multiple images by clicking them while pressing the Ctrl key.
- Unselected (no outline): The settings will not be applied.

When (Whole Image) or (Whole Film Image) is displayed on the Toolbar

When document type is Platen, items on the Platen are displayed as a single image. When document type is film, the whole film image is displayed. All portions in the cropping frames will be scanned.



Whole image view (Full Platen)

Whole film image view

Note

- If frames are not detected (for example, only four frames out of six frames are displayed) due to the image color of the film, display the whole image and scan.

Note

- You can specify the scan area (cropping frame) on the displayed image. In thumbnail view, you can only create one cropping frame per image. In whole image view, you can create multiple cropping frames.

➡ [Adjusting Cropping Frames](#)

Related Topic

- ▶ [Scanning in Advanced Mode](#)
- ▶ [Scanning Film in Advanced Mode](#)

Advanced Guide

Advanced Guide > Scanning > Scanning with Other Application Software > ScanGear (Scanner Driver) Screens > Input Settings

ScanGear

Input Settings

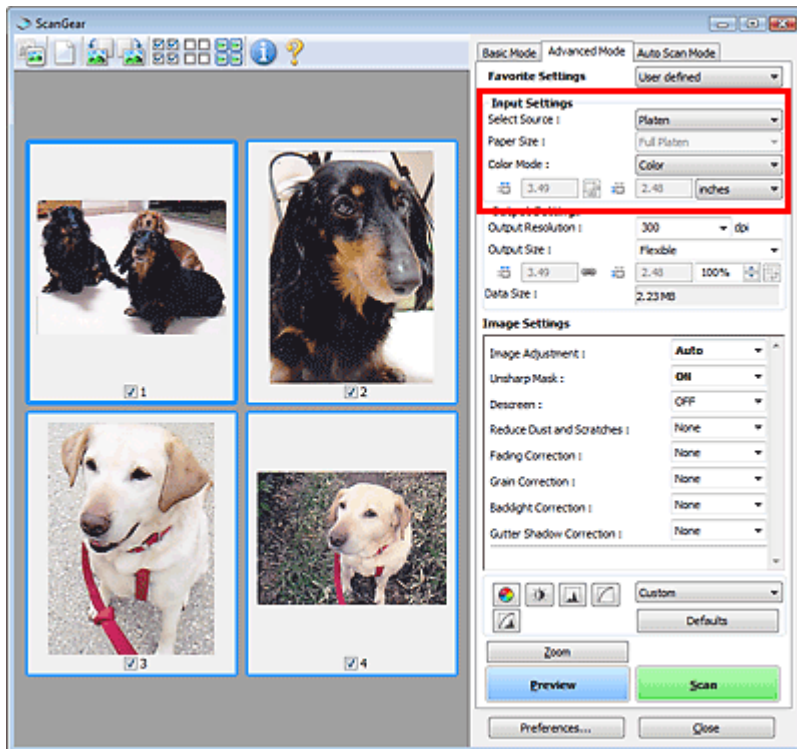

Input Settings allows you to set the following items:

- **Select Source**

The type of document to be scanned is displayed. Platen is set by default.



- **Paper Size**

Select the size of the document to be scanned. This setting is available in whole film image view only. When you select a size, the Preview area size changes accordingly.

Important

- Some applications have a limit to the amount of scan data they can receive. ScanGear (scanner driver) can scan data that is of:
 - 21000 pixels x 30000 pixels or less (and 1.8 GB or less in data size)
- If you change Paper Size after previewing, the preview image will be deleted.

Note

- If you are not sure which size you should select for Paper Size, set Paper Size to Full Platen, then measure the size of the document and enter the values into  (Width) and  (Height).

- **Film Size**

Select the size of the film to be scanned.

Note

- This setting is available in whole film image view only. In thumbnail view, click  (Film Thumbnail) on the Toolbar.

- **Color Mode**

Select how to scan the document.

- **Color**

Select this mode to scan color documents or film, or to create color images. This mode renders the image in 256 levels (8 bit) of R(ed), G(reen), and B(lue).

- **Color(48bit)**

Select this mode to scan color film. This mode renders the image in 65536 levels (16 bit) of R(ed), G(reen), and B(lue).

- **Grayscale**

Select this mode to scan black and white photos or film, or to create black and white images. This mode renders the image in 256 levels (8 bit) of black and white.

- **Grayscale(16bit)**

Select this mode to scan film in black and white. This mode renders the image in 65536 levels (16 bit) of black and white.

- **Black and White**

Select this mode to scan photos and documents in black and white. This mode renders the image in black and white. The contrast in the image is divided at certain levels (threshold level)

into black and white and is rendered in two colors. The threshold level can be set with (Threshold).



Important

- Some applications cannot display images scanned in Color(48bit) or Grayscale(16bit).
- Color(48bit) and Grayscale(16bit) are displayed only when the Enable 48/16 bit Output checkbox is selected on the Scan tab of the Preferences dialog box.

[➔ Scan Tab](#)

- **Input Size**

In thumbnail view, the cropped document size or film size is displayed after preview.

In whole image view, the Paper Size is displayed before preview, and the cropping frame (scan area) size or film size is displayed after preview.

You can adjust the cropping frame size by entering the values into  (Width) and  (Height).

Click  (Keep Aspect Ratio) and change it to  (Locked) to maintain the aspect ratio when you specify the cropping frame size.

Important

- Input size settings are available only when Output Size in Output Settings is Flexible. If you select a size other than Flexible, a cropping frame calculated from Output Size and Output Resolution is displayed, and its aspect ratio is fixed.

Note

- The values you can enter will be within the range of the selected document size. The minimum size is 96 pixels x 96 pixels when Output Resolution is 600 dpi, scaled at 100%.
- When Auto Crop is performed in whole image view, the aspect ratio will not be maintained since the size will be prioritized.
- See "[Adjusting Cropping Frames](#)" for details on cropping frames.

Advanced Guide

Advanced Guide > Scanning > Scanning with Other Application Software > ScanGear (Scanner Driver) Screens > Output Settings

ScanGear

Output Settings

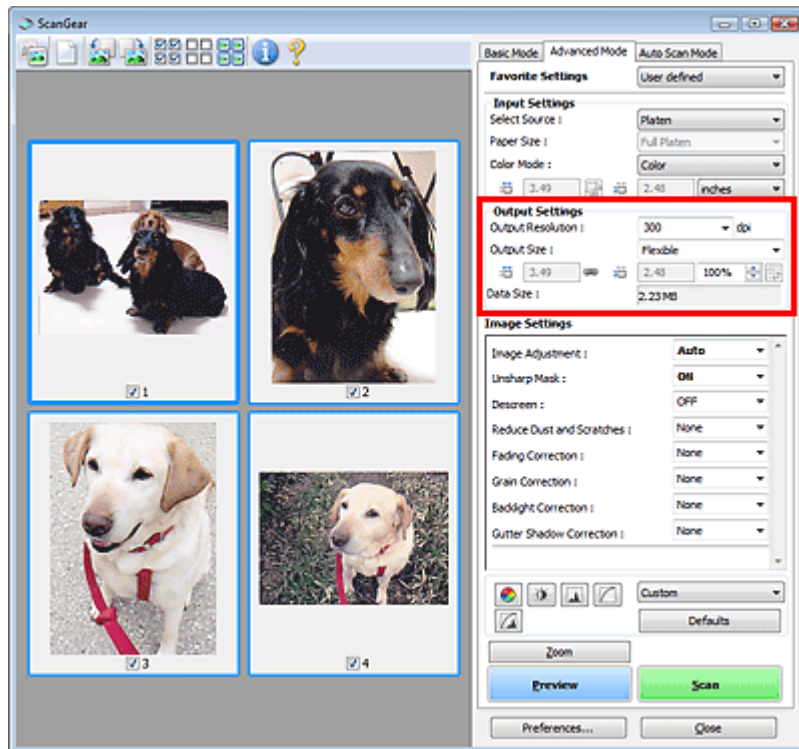

Output Settings allows you to set the following items:

- **Output Resolution**

Select the resolution to scan at.

The higher the resolution (value), the more detail in your image.

Select a resolution from the options displayed by clicking the button, or enter a value within the range of 25 dpi to 19200 dpi (in 1 dpi increments).

➔ Resolution

- **Output Size**

Select an output size.

Select Flexible to set custom sizes or select a size for printing or displaying. Select Add/Delete... to set custom size and save it as a new output size option.

- **Flexible**

You can specify the output resolution and scale, and adjust the cropping frame.

In thumbnail view

Drag the mouse over a thumbnail to display a cropping frame. When a cropping frame is displayed, the portion within the cropping frame will be scanned. When no cropping frame is displayed, each frame is scanned individually.

In whole image view

When no cropping frame is displayed, the entire Preview area will be scanned. When a cropping frame is displayed, the portion within the cropping frame will be scanned.

Note

- To enlarge/reduce the scanned image, enter values into  (Width) and  (Height) in

Output Settings or specify a value (by 1%) for %. The maximum value available for % depends on the Output Resolution. % can be specified for up to 19200 dpi (the maximum available output resolution).

- **Paper Size (L, etc.) & Monitor Size (1024 x 768 pixels, etc.)**

Width, height and scale cannot be specified. The preview image will be cropped according to the selected output size and resolution. The portion within the cropping frame will be scanned at the size of the selected paper/monitor size. You can drag the cropping frame to enlarge, reduce or move it while maintaining the aspect ratio.

- **Add/Delete...**

Opens the Add/Delete the Output Size dialog box, in which you can specify custom output sizes.

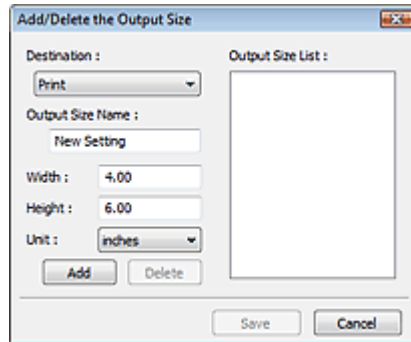

In the Add/Delete the Output Size dialog box, you can specify multiple output sizes and save them at one time. Saved items will be registered to the Output Size list and can be selected, along with the predefined items.

Add

To add a size, select Print or Image display for Destination, then enter Output Size Name, Width, and Height then click Add. The name of the added size appears in Output Size List. Click Save to save the items listed in Output Size List.

Delete

To delete an item, select it in Output Size List and click Delete. Click Save to save the items listed in Output Size List.

Important

- You cannot delete predefined output sizes such as A4 and 1024 x 768 pixels.

Note

- Save up to 10 items for each destination.
- An error message appears when you enter a value outside the setting range. Enter a value within the range displayed in the message.
- Unit varies by Destination. For Print, select mm or inches. For Image display, the unit is pixels.

Note

- See "[Adjusting Cropping Frames](#)" for details on cropping frames.
- Whether or how the cropping frame is initially displayed on a preview image can be specified on the Preview tab of the Preferences dialog box. See Cropping Frame on Previewed Images in "[Preview Tab](#)."

-  **(Switch Aspect Ratio)**

This button is available when Output Size is set to anything but Flexible. Click this button to rotate the cropping frame. Click again to return it to the original orientation.

- **Data Size**

An image file is created when the preview image is scanned. Its size when saved in BMP format is displayed.

Note

- When the file size exceeds a certain size, the value appears in red. In that case, a warning message appears when you click Scan. It is recommended that you adjust the settings to reduce Data Size. To continue, scan in whole image view.
-

[Page top](#) ↕

Advanced Guide

Advanced Guide > Scanning > Scanning with Other Application Software > ScanGear (Scanner Driver) Screens > Image Settings

ScanGear

Image Settings

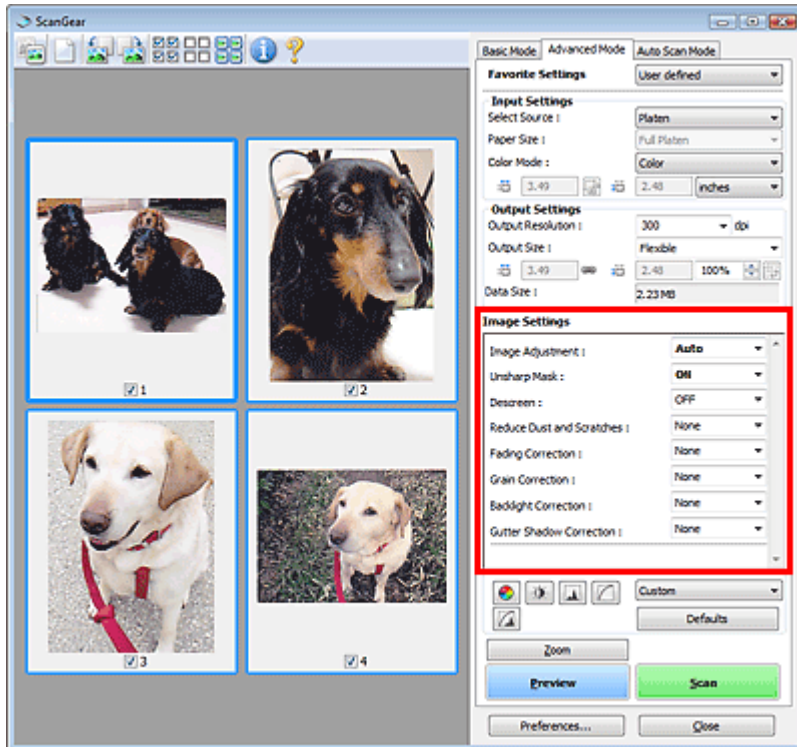

Important

- Do not apply these functions to images without moire, dust/scratches or faded colors. The color tone may be adversely affected.
- Image correction results may not be reflected in the preview image.

Note

- Selectable settings depend on color mode settings.
- Scanning may take longer when you use Image Settings.

Image Settings allows you to set the following items:

Note

- The setting items vary depending on whether Select Source is Platen or film.

Image Adjustment

When Image Adjustment is set, the brightness of the specified portion of the image is optimized. Images can be adjusted according to the automatically detected document type or the specified document type. The result of the adjustment will be reflected in the entire image. When Select Source is Platen, the default setting is Auto. When Select Source is film, the default settings is Photo.

None

Image Adjustment will not be applied.

Auto

Applies Image Adjustment by automatically detecting the document type. It is recommended that you normally select this setting.

- **Photo**
Select this to apply Image Adjustment to photos and film.
- **Magazine**
Select this to apply Image Adjustment to magazines.
- **Newspaper**
Select this to apply Image Adjustment to newspapers.
- **Document**
Select this to apply Image Adjustment to text documents.

Important

- You can set Image Adjustment after preview.
- You can set this setting when Recommended is selected on the Color Settings tab of the Preferences dialog box.

Note

- Only Photo and OFF are available when Select Source is film.
- If the image is not adjusted properly with Auto, specify the document type.
- The color tone may change from the source image due to the Image Adjustment. In that case, set Image Adjustment to None.

• **Unsharp Mask**

When this is set to ON, the outline of the subjects is emphasized to sharpen the image. This setting is ON by default.

• **Descreen**

Printed photos and pictures are displayed as a collection of fine dots. "Moire" is a phenomenon where uneven gradation or a stripe pattern appears when such photos or pictures printed with fine dots are scanned. Descreen is the function for reducing this moire effect. This setting is OFF by default.

Note

- Even if Descreen is set to ON, some moire effects may remain if Unsharp Mask is set to ON. In that case, set Unsharp Mask to OFF.
- Selecting Magazine(Color) in Select Source in Basic Mode tab has the same effect as setting Descreen to ON in Advanced Mode tab.

• **Reduce Dust and Scratches**

Scanned photos and film may contain white dots caused by dust or scratches. Use this function to reduce such noise. This setting is None by default.

- **None**
Dust and scratches will not be reduced.
- **Low**
Select this to reduce small dust particles and scratches. Large ones may remain.
- **Medium**
It is recommended that you normally select this setting.
- **High**
Select this to reduce small/large dust particles and scratches. Evidence of the reduction process may remain and may also remove delicate parts of the image.

Important

- This function may not be effective for some types of photos.

Note

- It is recommended that you select None when scanning printed materials.
- When the resolution is set to 4801 dpi or higher and Reduce Dust and Scratches checkbox is

selected, images are scanned at an optical resolution of 4800 dpi then interpolated by the software to yield the specified resolution.

- **Fading Correction**

Use this function to correct photos and film that have faded with time or have a colorcast. Colorcast is a phenomenon where a specific color affects the entire picture due to the weather or ambient strong colors. This setting is None by default.

- **None**

Fading correction will not be applied.

- **Low**

Select this to correct a small amount of fading and colorcast.

- **Medium**

It is recommended that you normally select this setting.

- **High**

Select this to correct a large amount of fading and colorcast. This can affect the tone of the image.

Important

- You can set Fading Correction after preview.
- You can set this setting when Recommended is selected on the Color Settings tab of the Preferences dialog box.
- Fading Correction may not be effective if the scan area is too small.

- **Grain Correction**

Use this function to reduce graininess (roughness) in photos taken with high-speed or sensitized film. This setting is None by default.

- **None**

Graininess will not be reduced.

- **Low**

Select this when the photo is slightly grainy.

- **Medium**

It is recommended that you normally select this setting.

- **High**

Select this when the photo is very grainy. This can affect the gradation and sharpness of the image.

Important

- Grain Correction may not be effective if the scan area is too small.

- **Backlight Correction**

Use this function to correct photos and film that have been shot against light. When you change the Backlight Correction setting, the result will be reflected in the preview image. This setting is None by default.

- **None**

Backlight correction will not be applied.

- **Low**

Select this to correct slightly backlit photos. This will not affect the image contrast.

- **Medium**

It is recommended that you normally select this setting.

- **High**

Select this to correct strongly backlit photos. This can affect the image contrast.

Important

- You can set Backlight Correction after preview.
- You can set this setting when Recommended is selected on the Color Settings tab of the Preferences dialog box.
- Backlight Correction may not be effective if the scan area is too small.

Note

- Noise patterns may appear when Backlight Correction is applied. Applying Grain Correction and setting Unsharp Mask to OFF may reduce the noise patterns.

• Gutter Shadow Correction

Use this function to correct shadows that appear between pages when scanning open booklets. When you set the Gutter Shadow Correction setting in the preview image, the result will be reflected. Preview the effects before scanning, as results vary depending on the type of document and how it is pressed.

Unclear or blurred text/lines caused by curved pages are not corrected. This setting is None by default.

- **None**
Gutter shadow will not be corrected.
- **Low**
Select this when the effect level is too strong with the medium setting.
- **Medium**
It is recommended that you normally select this setting.
- **High**
Select this when the effect level is too weak with the medium setting.

Important

- Do not place items that weigh 4.4 lbs (2.0 kg) or more on the Platen. Also, do not press on the document with a force exceeding 4.4 lbs (2.0 kg). If you press heavily, the scanner may not work correctly or you might break the glass.
- Align the document with the edge of the Platen. If not, the shadow will not be corrected properly.



- Shadows may not be corrected properly depending on the document. If the page background is not white, shadows may not be detected correctly or may not be detected at all.
- While scanning, press down on the spine with the same amount of pressure you used to preview the scan. If the binding part is not even, the shadow will not be corrected properly.



- How to place the document depends on your model and the document to be scanned.

 **Note**

- Cover the document with black cloth if white spots, streaks, or colored patterns appear in scan results due to ambient light entering between the document and the Platen.
- If the shadow is not corrected properly, adjust the cropping frame on the preview image.

[➔ Adjusting Cropping Frames](#)

- **Exposure/Tone Settings (Film only)**

- **Manual Exposure**

This function enables you to adjust the exposure data according to the film. This checkbox is not selected by default.

When this checkbox is not selected, the optimal exposure data (the exposure level for each RGB channel and compensation levels) is automatically set according to the color density of the portion within the cropping area of the film.

Select this checkbox if you intend to adjust the image using an application after it is scanned or to scan with an under-exposed or over-exposed effect.

After you select this checkbox, you can adjust the exposure in 1% increments within the range of 50% to 200%.

 **Important**

- This setting is not available when Apply the tone value to all frames (crops) is applied.

 **Note**

- Manual Exposure is not available in Basic Mode. To change exposure, select the Manual Exposure checkbox in Advanced Mode tab, then adjust the value and scan.
- When this checkbox is not selected, the time required for scanning varies by film since the exposure is automatically optimized according to the film.

- **Apply the tone value to all frames (crops)**

"All frames" is displayed in thumbnail view, and "All crops" is displayed in whole image view.

Click Apply to reflect the color adjustment data of the selected film frame or the portion within the selected cropping frame into other frames. This color adjustment data will be used in subsequent scans. It will remain in effect until you click Reset.

This is useful when you want to scan film of photos taken on the same day in the same place, in a consistent color tone.

- **High Quality**

Set to ON to improve the image quality and reduce noise when scanning film. This setting is OFF by default.

 **Important**

- Image quality may not change depending on the film type.
- This setting is not available when Apply the tone value to all frames (crops) is applied.

[Page top](#) 

Advanced Guide

Advanced Guide > Scanning > Scanning with Other Application Software > ScanGear (Scanner Driver) Screens > Color Adjustment Buttons

ScanGear

Color Adjustment Buttons

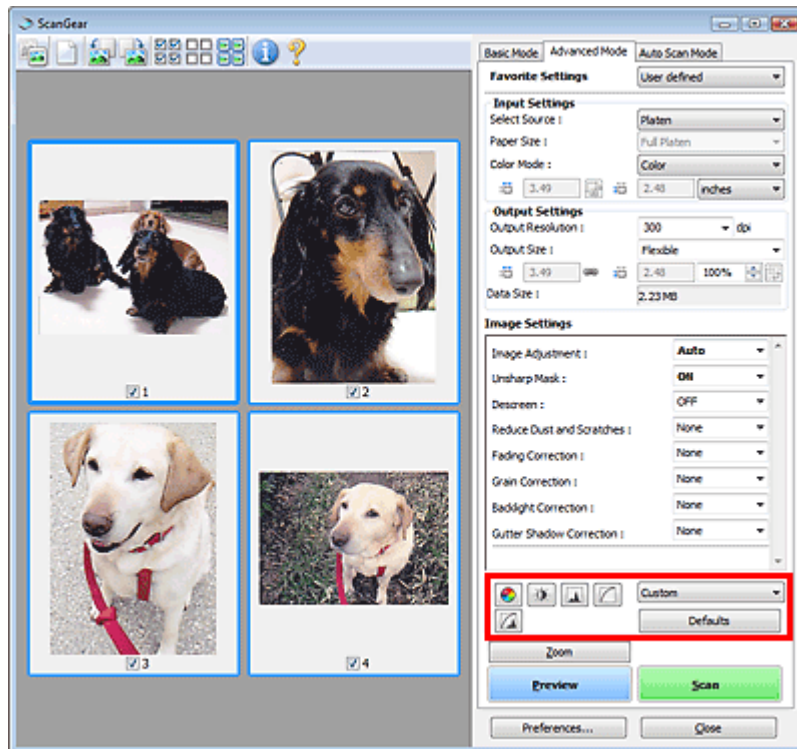

The Color Adjustment Buttons allow you to make fine corrections to the image brightness and color tones. You can adjust the image's overall brightness or contrast, and adjust its highlight and shadow values (histogram) or balance (tone curve).

Important

- The Color Adjustment Buttons are not available when you select Color Matching on the Color Settings tab of the Preferences dialog box.

Note

- Selectable settings depend on color mode settings.
- When you adjust the image via the Color Adjustment Buttons, the results will be reflected in the preview image.

Click a Color Adjustment Button to set the following items:

-  **(Saturation/Color Balance)**

Adjust the vividness and color tone of the image. Use this function to brighten colors that have faded with time or due to colorcast. Colorcast is a phenomenon where a specific color affects the entire picture due to the weather or ambient strong colors.

➔ [Adjusting Saturation and Color Balance](#)

-  **(Brightness/Contrast)**

Adjust the brightness and contrast of the image. If the image is too dark or too bright, or if the image quality is flat due to lack of contrast, you can adjust the levels of brightness and contrast.

➔ [Adjusting Brightness and Contrast](#)

-  **(Histogram)**

A histogram allows you to see the data concentration at each brightness level of an image. You can specify the darkest level (shadow) and brightest level (highlight) within an image, cut the levels and expand the middle of the tonal range of the image.

➔ [Adjusting Histogram](#)

-  **(Tone Curve Settings)**

Adjust the brightness of an image by selecting the type of graph (tone curve) showing the balance of tone input and output. You can make fine adjustments to the brightness of a specific area.

➔ [Adjusting Tone Curve](#)

-  **(Final Review)**

Make a final check of color adjustments. The final synthesized tone curve and the histogram derived from the subsequent image processing will be displayed. There are no settings to make in this screen.

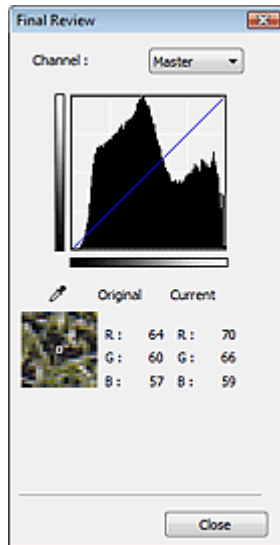

- For a color image, select a color in Channel to check either Red, Green or Blue, or select Master to check three colors together.
- If you place the cursor on the preview image, the portion will be enlarged and its RGB values (only L when Color Mode is Grayscale) before and after the adjustments will be displayed.

-  **(Threshold)**

Set the boundary (threshold) at which black and white are divided. By adjusting the threshold level, you can sharpen text in a document or reduce show-through in newspapers.

➔ [Setting Threshold](#)

- **Custom**

You can name and save a set of tone curve and threshold settings of the Color Adjustment Buttons. Select Add/Delete... from the pull-down menu. When Color Mode is set to anything but Black and White, the Add/Delete Tone Curve Settings dialog box opens. When Color Mode is Black and White, the Add/Delete Threshold Settings dialog box opens.

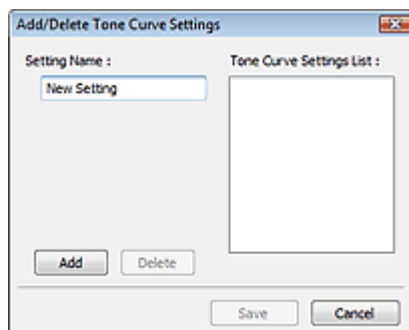

Enter Setting Name and click Add. The name appears in Tone Curve Settings List or Threshold Settings List.

Click Save to save.

You can load and apply the saved tone curve/threshold settings to a preview image. To load the settings, select the saved item from the pull-down menu.

To delete an item, select it in Tone Curve Settings List or Threshold Settings List and click Delete. Click Save to save settings displayed in Tone Curve Settings List or Threshold Settings List.



Note

- Save up to 20 items.
-

- **Defaults**

Reset all adjustments (saturation/color balance, brightness/contrast, histogram and tone curve).

[Page top](#) ↕

Advanced Guide

Advanced Guide > Scanning > Scanning with Other Application Software > ScanGear (Scanner Driver) Screens > Auto Scan Mode Tab



Auto Scan Mode Tab

This mode allows you to scan easily by simply placing documents on the Platen and clicking a button.

In Auto Scan Mode, documents are automatically detected. You do not need to specify cropping frames or make image corrections.



- **Supported Documents**

Photos, postcards, business cards, magazines, newspapers, text documents, CD/DVD and film.

Important

- The following types of documents cannot be scanned correctly. In that case, specify the document type or size on the Basic Mode tab or the Advanced Mode tab and scan again.
 - Documents other than photos, postcards, business cards, magazines, newspapers, text documents, CD/DVD and film
 - Text documents smaller than 2L (5 inches x 7 inches) (127 mm x 178 mm), such as paperback pages with the spine cut off
 - Documents printed on thin white paper
 - Long narrow documents such as panoramic photos
- ➔ Scanning in Basic Mode
- ➔ Scanning in Advanced Mode
- Reflective CD/DVD labels may not be scanned properly.
- Place documents correctly according to the type of document to be scanned. Otherwise, documents may not be scanned correctly. See "Placing Documents" for details on how to place documents.

Note

- Scan from the "Basic Mode Tab" or "Advanced Mode Tab" to reduce moire.

- **Placing Documents** 

"Placing Documents" appears.

- **View scanned images**

Select this checkbox to display the thumbnails of scanned images in a different window.

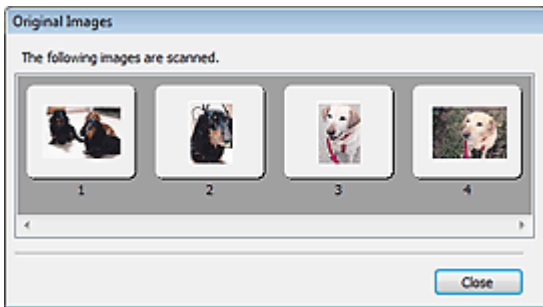

- **Scan**

Scanning starts.

Note

- When scanning starts, the progress will be displayed. Click Cancel to cancel the scan.
- When scanning is completed, a dialog box prompting you to select the next action may open. Follow the prompt to complete. For details, see Status of ScanGear dialog after scanning in "[Scan Tab](#)" (Preferences dialog box).

- **Instructions** 

This page appears.

- **Preferences...**

The Preferences dialog box opens and you can make scan/preview settings.

[➔ Preferences Dialog Box](#)

- **Close**

Closes ScanGear (scanner driver).

Related Topic

[▶ Scanning in Auto Scan Mode](#)

[Page top](#) 

Advanced Guide

Advanced Guide > Scanning > Scanning with Other Application Software > ScanGear (Scanner Driver) Screens > Preferences Dialog Box

ScanGear

Preferences Dialog Box

Click Preferences... in the ScanGear (scanner driver) screen to open Preferences dialog box.

In the Preferences dialog box, you can make advanced settings to ScanGear (scanner driver) functions via the Scanner, Preview, Scan and Color Settings tabs.

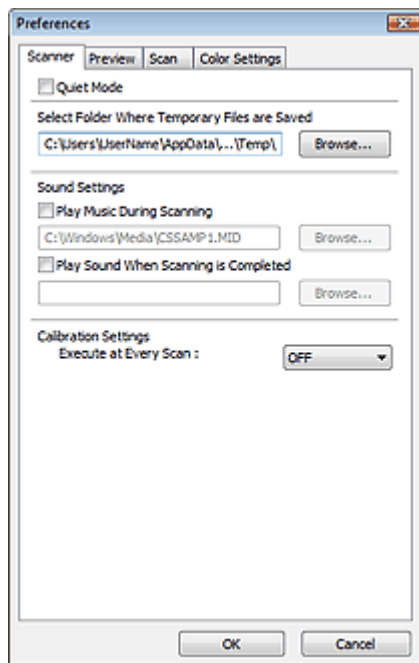

Scanner Tab

Allows you to specify a folder to save images temporarily and a music file to play during or at the end of a scan.

➔ [Scanner Tab](#)

Preview Tab

Allows you to select what to do with Preview when ScanGear (scanner driver) is started and how to display cropping frames after previewing images. You can also select the cropping size for thumbnails of scanned documents.

➔ [Preview Tab](#)

Scan Tab

Allows you to select what to do with ScanGear (scanner driver) after scanning, set the option for scanning film into applications that do not open the ScanGear (scanner driver) screen, and set the Color Mode (48/16 bit output) option for Advanced Mode tab.

➔ [Scan Tab](#)

Color Settings Tab

Allows you to select how to adjust color, and specify the monitor gamma value.

➔ [Color Settings Tab](#)

[Page top](#) ↕

Advanced Guide

Advanced Guide > Scanning > Scanning with Other Application Software > ScanGear (Scanner Driver) Screens > Scanner Tab

ScanGear

Scanner Tab

On the Scanner tab, you can specify the following settings.

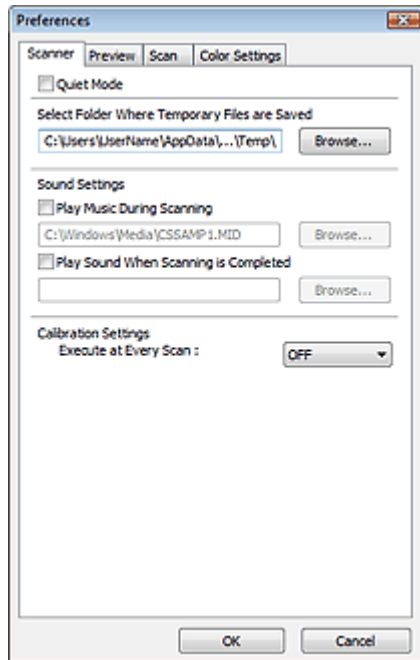

- **Quiet Mode**

Select this checkbox to reduce scanner sound by slowing down the scanner head when previewing or scanning documents. This checkbox is not selected by default.

Note

- Scanning takes longer than usual when you enable this function.

- **Select Folder Where Temporary Files are Saved**

Displays the folder in which to save images temporarily. To change the folder, click Browse... to specify another one.

- **Sound Settings**

You can set the machine to play music during/at the end of a scan.

Select the Play Music During Scanning or Play Sound When Scanning is Completed checkbox, then click Browse... and specify a sound file.

You can specify the following files.

- MIDI file (*.mid, *.rmi, *.midi)
- Audio file (*.wav, *.aif, *.aiff)
- MP3 file (*.mp3)

- **Calibration Settings**

When you set Execute at Every Scan to ON, the scanner will be calibrated every time before previewing and scanning, to reproduce correct color tones in scanned images. If you select film in Select Source, the scanner will be calibrated every time before previewing.

Note

- Even when Execute at Every Scan is set to OFF, the scanner may be calibrated automatically in some cases (such as immediately after you turn the machine on).
- Calibration may take time depending on your computer.

[Page top](#) 

Advanced Guide

Advanced Guide > Scanning > Scanning with Other Application Software > ScanGear (Scanner Driver) Screens > Preview Tab

ScanGear

Preview Tab

On the Preview tab, you can specify the following settings.

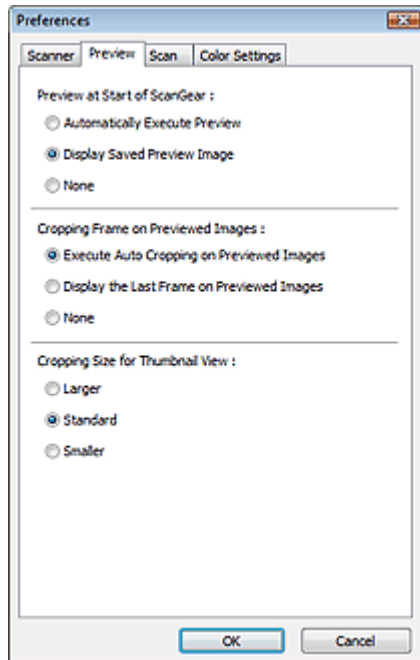

- **Preview at Start of ScanGear**

Select what to do with Preview when ScanGear (scanner driver) is started. Display Saved Preview Image is selected by default.

- **Automatically Execute Preview**

ScanGear (scanner driver) will automatically start previewing at startup.

- **Display Saved Preview Image**

The previously previewed image will be displayed.

The Color Adjustment Button settings, the Toolbar settings, and the Advanced Mode tab settings are also saved.

- **None**

No preview image will be displayed at startup.

Note

- Select None if you do not want to save the preview image.

- **Cropping Frame on Previewed Images**

Select how to display cropping frames after previewing images. Execute Auto Cropping on Previewed Images is selected by default.

- **Execute Auto Cropping on Previewed Images**

The cropping frame will automatically be displayed in the document size after previewing.

- **Display the Last Frame on Previewed Images**

A cropping frame of the same size as the last used cropping frame will be displayed after previewing.

- **None**

No cropping frame will be displayed after previewing.

- **Cropping Size for Thumbnail View**

Select the cropping size for thumbnails of scanned documents. Standard is selected by default.

- **Larger**

Displays 105% (in width and height) of the area displayed for the standard size.

- **Standard**

The standard size.

- **Smaller**

Displays 95% (in width and height) of the area displayed for the standard size.

Note

- When you change the Cropping Size for Thumbnail View setting, the preview images will be refreshed and cropped to the new size. As the preview images are refreshed, the color adjustments and other settings applied to them are reset.
-

[Page top](#)↑

Advanced Guide

Advanced Guide > Scanning > Scanning with Other Application Software > ScanGear (Scanner Driver) Screens > Scan Tab

ScanGear

Scan Tab

On the Scan tab, you can specify the following settings.

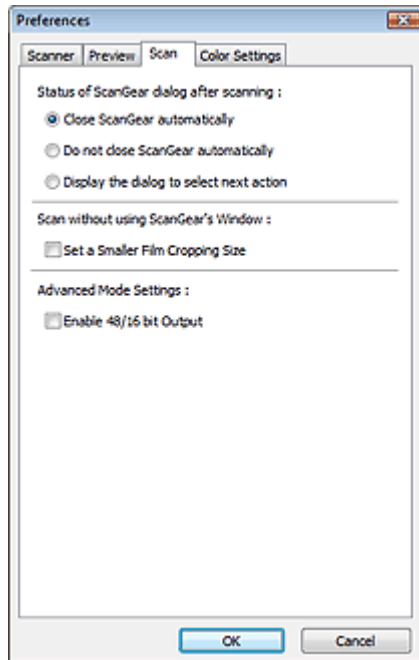

- **Status of ScanGear dialog after scanning**

Select what to do with ScanGear (scanner driver) after scanning images. Close ScanGear automatically is selected by default.

- **Close ScanGear automatically**

Select this to return to the original application when scanning is completed.

- **Do not close ScanGear automatically**

Select this to return to the ScanGear (scanner driver) screen for another scan when scanning is completed.

- **Display the dialog to select next action**

Select this to open a screen and select what to do when scanning is completed.

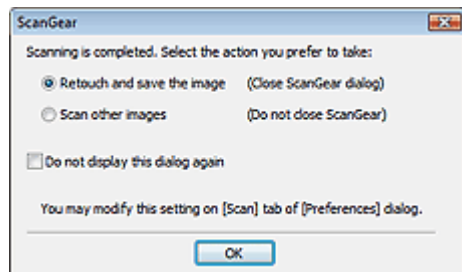

Note

- Even if Do not close ScanGear automatically or Display the dialog to select next action is set, some applications may not support it.

- **Scan without using ScanGear's Window**

Set the option for scanning film into applications that do not open the ScanGear (scanner driver) screen.

- **Set a Smaller Film Cropping Size**

Select this checkbox to display 95% (in width and height) of the area displayed for the standard film size.

Important

- This setting is not applied when scanning with the ScanGear (scanner driver) screen displayed.

- **Advanced Mode Settings**

When film is selected for Select Source on the Advanced Mode tab, select whether to display Color(48bit) and Grayscale(16bit) in Color Mode.

- **Enable 48/16 bit Output**

Select this checkbox to include Color(48bit) and Grayscale(16bit) in the Color Mode options. This checkbox is not selected by default.

Important

- Some applications cannot receive images scanned in Color(48bit) or Grayscale(16bit), or may close when such images are received.

Note

- When Color(48bit) or Grayscale(16bit) is selected for Color Mode, deselecting this checkbox changes Color(48bit) to Color and Grayscale(16bit) to Grayscale.

Advanced Guide

Advanced Guide > Scanning > Scanning with Other Application Software > ScanGear (Scanner Driver) Screens > Color Settings Tab

ScanGear

Color Settings Tab

On the Color Settings tab, you can specify the following settings.

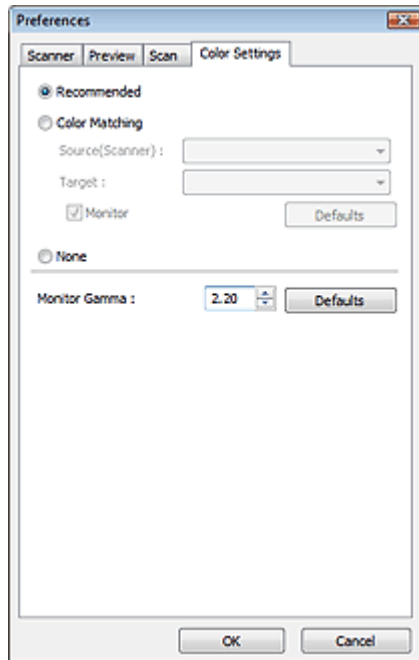

- **Color Adjustment**

Select either of the following. Recommended is selected by default.

This function is available when Color Mode is Color, Color(48bit), Grayscale or Grayscale(16bit).

- **Recommended**

Select this to vividly reproduce the tone of a document on the screen. It is recommended that you normally select this setting.

- **Color Matching**

Select this to automatically match the scanner, monitor and color printer colors, thus reducing time and trouble to manually match the monitor and printer colors.

Color Adjustment Buttons will be disabled.

This function is available when Color Mode is Color or Color(48bit).

- Source(Scanner): Select scanner profile.
- Target: Select target profile.
- Monitor: Select this to display preview image with optimum correction for monitor.
- Defaults: Returns to the default Color Matching settings.

- **None**

Select this to disable color correction provided by ScanGear (scanner driver).

Note

- Color Matching is available when ScanGear (scanner driver), monitor, color management-compliant application (such as Adobe Photoshop) and printer are set up correctly. Refer to the corresponding manual for the monitor, printer and application settings.

- **Monitor Gamma**

By setting the gamma value of a monitor, you can adjust the input data to the brightness characteristics of the monitor. Adjust the value if your monitor's gamma value does not match the

default value set in ScanGear (scanner driver), and the colors of the original image are not accurately reflected in the monitor.

Click Defaults to return to the default Monitor Gamma value (2.20).

 Note

- Refer to the manual of your monitor to check its gamma value. If it is not written in the manual, contact the manufacturer.
-

[Page top](#)[↕]

Advanced Guide

[Advanced Guide](#) > [Scanning](#) > [Scanning with Other Application Software](#) > [Appendix: Useful Information on Scanning](#)

Appendix: Useful Information on Scanning

- **Adjusting the cropping frame (scan area)**
 - ➔ [Adjusting Cropping Frames](#)
- **Selecting the best resolution**
 - ➔ [Resolution](#)
- **Learning about file formats**
 - ➔ [File Formats](#)
- **Learning about Color Matching**
 - ➔ [Color Matching](#)
- **Matching the colors between the document and monitor**

See Monitor Gamma in the following section.

 - ➔ [Color Settings Tab](#)

[Page top](#) ↕

Advanced Guide

Advanced Guide > Scanning > Scanning with Other Application Software > Appendix: Useful Information on Scanning > Adjusting Cropping Frames

Adjusting Cropping Frames

You can specify the scan area by creating a cropping frame on the image displayed in the Preview area of the ScanGear (scanner driver) screen. When you click Scan, only the portion within the cropping frame will be scanned and passed to the application.

Cropping Frame Types



(1) Focus Cropping Frame (rotating thick broken lines)

The settings in Basic Mode or Advanced Mode will be applied.

(2) Selected Cropping Frame (stationary thick broken lines)

The settings will be applied to the Focus Cropping Frame and Selected Cropping Frames simultaneously. You can select multiple cropping frames by clicking them while pressing the Ctrl key.

(3) Unselected Cropping Frame (stationary thin broken lines)

The settings will not be applied.

Note

- Focus Cropping Frame and Selected Cropping Frames are displayed in whole image view.

Initial Cropping Frame

In thumbnail view

Cropping frame is not displayed initially. Drag the mouse over a frame to create a cropping frame.

In whole image view

A cropping frame (Focus Cropping Frame) is displayed automatically around the preview image according to the document size. You can also create a cropping frame by dragging the mouse in the Preview area.

Note

- Cropping frames are set according to the document size (Auto Crop) by default. For details, see Cropping Frame on Previewed Images in " [Preview Tab](#)" (Preferences dialog box).

Adjusting a Cropping Frame





The cursor will change into  (Arrow) when it is positioned over a cropping frame. If you click and drag the mouse in the direction of the arrow, the cropping frame will expand or contract accordingly.



The cursor will change into  (Crosshair arrow) when it is positioned within a cropping frame. Click and drag the mouse to move the entire cropping frame.



Note

- In Advanced Mode, you can specify the cropping frame size by entering the values into  (Width) and  (Height) in Input Settings.
[➔ Input Settings](#)
- You can rotate a cropping frame 90 degrees by clicking  (Switch Aspect Ratio). However,  (Switch Aspect Ratio) is not available when Output Size is Flexible.

Creating Multiple Cropping Frames

In thumbnail view

You can only create one cropping frame per image.

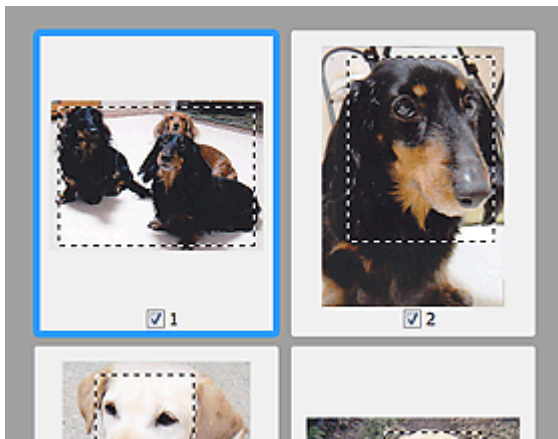

In whole image view

Click and drag the mouse in a space outside the existing cropping frame to create a new cropping frame in the Preview area. The new cropping frame will be the Focus Cropping Frame, and the old cropping frame will be the Unselected Cropping Frame.

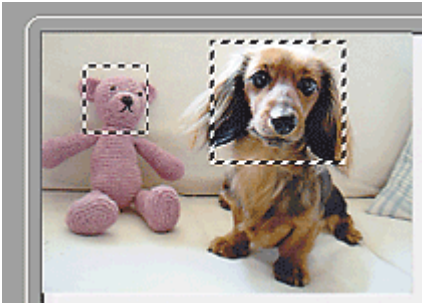

You can create multiple cropping frames and apply different scan settings to each cropping frame.

You can also select multiple cropping frames by clicking them while pressing the Ctrl key.

If you select multiple cropping frames and change the settings on a tab at the right of ScanGear (scanner driver), the settings will be applied to all the selected cropping frames.

When you create a new cropping frame, it retains the settings of the latest cropping frame.

Note

- The maximum numbers of cropping frames are as follows:
 - When document type is paper or photo: 12 frames
 - When document type is film: 30 frames
- Scanning takes longer than usual when multiple cropping frames are selected.

Deleting Cropping Frames

In thumbnail view

To delete a cropping frame, click an area outside the cropping frame on an image.

In whole image view

To delete a cropping frame, select it and click  (Remove Cropping Frame) on the Toolbar. Alternatively, press the Delete key.

When there are multiple cropping frames, all the selected cropping frames (Focus Cropping Frame and Selected Cropping Frames) are deleted simultaneously.

Advanced Guide

Advanced Guide > Scanning > Scanning with Other Application Software > Appendix: Useful Information on Scanning > Resolution

Resolution

What is Resolution?

The data in the image you have scanned is a collection of dots carrying information about brightness and color. The density of these dots is called "resolution", and resolution will determine the amount of detail your image contains. The unit of resolution is dots per inch (dpi). Dpi is the number of dots per square inch (2.54 cm square).

The higher the resolution (value), the more detail in your image; the lower the resolution (value), the less detail.

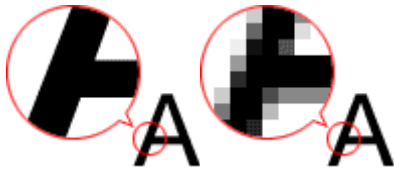

Setting the Resolution in MP Navigator EX

In MP Navigator EX, you can specify the resolution with Scanning Resolution in the Scan Settings dialog box.

Images for Printing

Images to be printed should be scanned at a resolution that corresponds to the resolution of the printer.



For example, if you want to print using a 600 dpi black and white printer, you should set the resolution to 600 dpi.

With a color printer, specifying the resolution at half the resolution of the printer should be fine. For example, if you want to print scanned paper/photos using a 600 dpi color printer, you should set the resolution to 300 dpi. However, with a high-resolution printer, printing takes longer than usual if you set the resolution to half the resolution of the printer.

Example of Appropriate Resolution when Printing to Scale

If you print a document at twice the size both vertically and horizontally, the resolution of the document will be reduced by half. If the resolution of the original document is 300 dpi, the resolution of the enlarged document will be 150 dpi. If you print the document with a 600 dpi color printer, the lack of detail in the image may be obvious. In that case, if you scan at the Scanning Resolution of 600 dpi, the resolution will be 300 dpi even if you double the size of document and you can print the document with sufficient quality. Conversely, if you print a document at half scale, it should be sufficient to scan at half the resolution.

When Printing Color Photos at Twice the Size

		
<p>Document resolution: 300 dpi Scanning resolution: 600 dpi Scale: 200%</p>	<p>Print at twice the size Scanning resolution/actual scanning resolution: 600 dpi</p>	<p>Printing resolution: 300 dpi</p>

Setting the Resolution in ScanGear (Scanner Driver)



In ScanGear (scanner driver), you can specify the resolution with Output Resolution in Output Settings on

the Advanced Mode tab.

Example of Appropriate Resolution when Printing to Scale

The scanning resolution is automatically set so that the value set in Output Resolution will be the resolution of the scanned image. If you set Output Resolution to 300 dpi and scan at twice the size, the document will be automatically scanned at 600 dpi, and the resolution of the scanned image will be 300 dpi. You can print the document with sufficient quality using a 600 dpi color printer.

When Printing L Size (8.9 cm x 12.7 cm) Photos at Twice the Size

		
Document resolution: 300 dpi Output resolution: 300 dpi Scale: 200%	Scan at twice the size Actual scanning resolution: 600 dpi	Image resolution/printing resolution: 300 dpi

Appropriate Resolution Settings

Set the resolution according to the use of the scanned image.

For displaying on a monitor: 150 dpi

For printing: 300 dpi

When Output Size is set to Flexible in ScanGear's Advanced Mode tab (Select Source is Platen and the scale is 100%):

Document	Use	Color Mode	Output Resolution
Color photo	Copying (Printing)	Color	300 dpi
	Creating a postcard	Color	300 dpi
	Saving to a computer	Color	75 dpi - 300 dpi
	Using on a website or attaching to e-mail	Color	75 dpi - 150 dpi
Black and white photo	Saving to a computer	Grayscale	75 dpi - 300 dpi
	Using on a website or attaching to e-mail	Grayscale	75 dpi - 300 dpi
Text document	Copying	Color, Grayscale or Black and White	300 dpi
	Attaching to e-mail	Color, Grayscale or Black and White	300 dpi

Important

- If you double the resolution, the file size quadruples. If the file is too large, the processing speed will slow down significantly, and you will experience inconvenience such as lack of memory. Set the minimum required resolution according to the use of the image.

Note

- Although you can change Output Resolution in ScanGear (scanner driver), it is recommended that you scan at the default value.

Advanced Guide

Advanced Guide > Scanning > Scanning with Other Application Software > Appendix: Useful Information on Scanning > File Formats

File Formats

You can select a file format when saving scanned images. You should specify the most suitable format according to how you want to use the image on which application.

Available file formats vary by application and computer (Windows or Macintosh).

See below for the characteristics of each image file format.

BMP (Standard File Extension: .bmp)

A standard file format for Windows.

BMP is often selected for images that are used only on Windows.

JPEG (Standard File Extension: .jpg)

A file format often used on websites and for digital camera images.

JPEG features high compression rates. JPEG images slightly degrade every time they are saved, and cannot be returned to their original state.

JPEG is not available for black and white images.

Exif (Standard File Extension: .jpg)

A file format supported by many digital cameras.

It adds information such as the date of image capture, camera model, shutter speed, shooting mode and comments to JPEG files.

The file format version must be Exif 2.2 or later in order to print on a Direct Print compatible printer.

TIFF (Standard File Extension: .tif)

A file format featuring a relatively high compatibility between various computers and applications. (Some TIFF files are incompatible.) TIFF is suitable for editing saved images.

Note

- MP Navigator EX supports the following TIFF file formats.
 - Uncompressed, black and white binary
 - Uncompressed, RGB (8 bits per channel)
 - Uncompressed, YCC (8 bits per component)
 - Uncompressed, RGB (16 bits per channel)
 - Uncompressed, YCC (16 bits per component)
 - Uncompressed, Grayscale
-

PDF (Standard File Extension: .pdf)

A file format developed by Adobe Systems. It can be used on various computers and operating systems. Therefore, PDF files can be exchanged between people who use different operating systems, fonts, etc. regardless of the differences.

Important

- Only PDF files created with MP Navigator EX are supported. PDF files created or edited in other applications are not supported.
-

Advanced Guide

[Advanced Guide](#) > [Scanning](#) > [Scanning with Other Application Software](#) > [Appendix: Useful Information on Scanning](#) > [Color Matching](#)

Color Matching

Color Matching adjusts devices as shown below to match the colors of an image displayed on a monitor or a printed image with the colors of the original document.

Example: When sRGB is selected as the output profile (target)

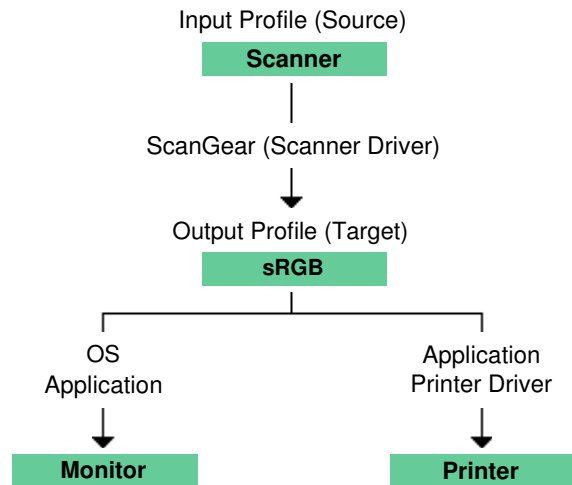

ScanGear (scanner driver) converts the image's color space from the scanner's color space to sRGB.

When displaying on a monitor, the image's color space is converted from sRGB to the monitor's color space based on the operating system's monitor settings and the application's working space settings.

When printing, the image's color space is converted from sRGB to the printer's color space based on the application's print settings and the printer driver's settings.

[Page top](#)↑

Advanced Guide

[Advanced Guide](#) > [Scanning](#) > Canon IJ Network Scan Utility Screens

Canon IJ Network Scan Utility Screens

➔ [Canon IJ Network Scan Utility Menu and Setting Screen](#)

[Page top](#) ↑

Advanced Guide

Advanced Guide > Scanning > Canon IJ Network Scan Utility Screens > Canon IJ Network Scan Utility Menu and Setting Screen

Canon IJ Network Scan Utility Menu and Setting Screen

Set up Canon IJ Network Scan Utility to scan images into a computer over a network using the Operation Panel of the machine.

After installation, Canon IJ Network Scan Utility appears in the notification area of the taskbar.

Note

- If  (Enabled) is not displayed in the notification area of the taskbar, from the Start menu, select (All) Programs > Canon IJ Network Utilities > Canon IJ Network Scan Utility > Canon IJ Network Scan Utility to start it.

Menu

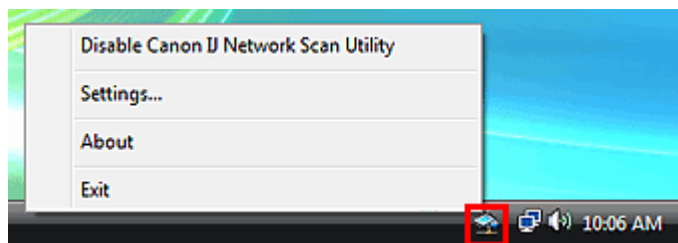

- **Disable Canon IJ Network Scan Utility or Enable Canon IJ Network Scan Utility**

Enables or disables Canon IJ Network Scan Utility.

When you select Disable Canon IJ Network Scan Utility, you will not be able to scan over a network using the Operation Panel.

Enabled: , Disabled: 

- **Settings...**

The Canon IJ Network Scan Utility dialog box opens. You can select the product you want to use.

- **About**

Displays the version information.

- **Exit**

Exits Canon IJ Network Scan Utility.  (Enabled) disappears from the notification area of the taskbar.

Canon IJ Network Scan Utility Dialog Box

The machine must be selected with Canon IJ Network Scan Utility before scanning over a network.

In the notification area of the taskbar, right-click the icon and select Settings... to open the Canon IJ Network Scan Utility dialog box.

Normally, the machine is already selected. In that case, you do not need to select it again.

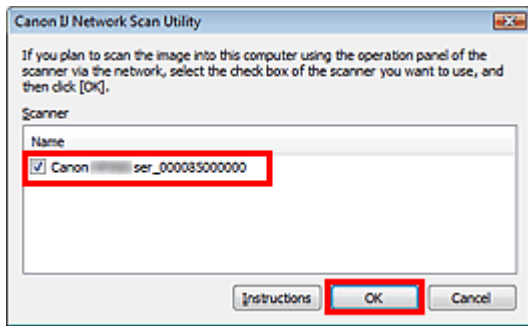

Select the product you want to use.

Scanners that are registered to the system are displayed. Select the checkbox of the product you want to use.

You can select up to three scanners.

Click Instructions to open this page.

Note

- If the scanner you want to use is not displayed, check the following conditions and click OK to close the dialog box, then reopen it and select the scanner.
 - The MP Drivers are installed
 - Network setup is completed after installing the MP Drivers
 - Network communication between the product and computer is enabledIf the scanner is still not displayed, see " [Troubleshooting](#)."
- You do not need to use this software when scanning via USB or from a computer. See " [Uninstalling the Canon IJ Network Tool/Canon IJ Network Scan Utility](#) " to delete it. You can scan via USB or from a computer even if it is not deleted.

Advanced Guide

[Advanced Guide](#) > [Scanning](#) > [Other Scanning Methods](#)

Other Scanning Methods

- ➡ [Scanning with WIA Driver](#)
- ➡ [Scanning Using the Control Panel \(Windows XP Only\)](#)

[Page top](#) ↕

Advanced Guide

Advanced Guide > Scanning > Other Scanning Methods > Scanning with WIA Driver

Scanning with WIA Driver

You can scan an image from a WIA-compliant application and use the image in that application. The procedure varies depending on the application. The following procedures are examples only. For details, refer to the application's manual.

Important

- In Windows 2000, you cannot scan using the WIA driver.
- In Windows XP, you cannot scan using the WIA driver via a network connection.
- You cannot scan film using the WIA driver.
- Complete the following settings to enable scanning over a network.
 1. From the Start menu, select Network.
 2. Right-click (model name) _MAC address in the displayed screen, then select Install.

Scanning with WIA Driver 2.0

The following is an example of scanning using Windows Photo Gallery.

1. Place the document on the Platen.

➔ [Placing Documents](#)

2. In File, click Import from Camera or Scanner..., then double-click WIA Canon (model name).

For network connection, double-click (model name) _MAC address from the list.

The scan setting screen appears.

3. Specify the settings.

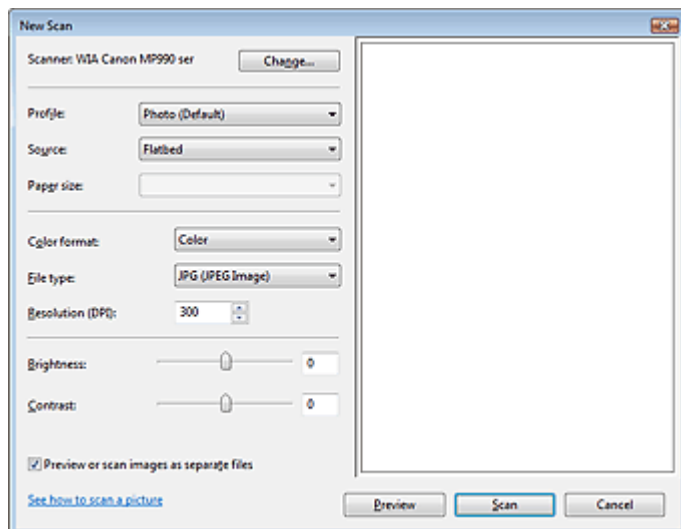

• **Scanner**

The currently set product name is displayed. To change the scanner, click Change... and select the product you want to use.

• **Profile**

Select Photo (Default) or Documents according to the document to be scanned. To save a new Profile, select Add profile.... You can specify the details in the Add New Profile dialog box.

• **Source**

Select a scanner type.

- **Paper size**

This setting is not available for this machine.

- **Color format**

Select how to scan the document.

- **File type**

Select a file format from JPEG, BMP, PNG and TIFF.

- **Resolution (DPI)**

Enter the resolution. Specify a value between 50 dpi and 600 dpi. 300 dpi is set by default.

➔ Resolution

- **Brightness**

Move the slider to adjust the brightness. Move it to the left to darken and right to brighten the image. You can also enter a value (-100 to 100).

- **Contrast**

Move the slider to adjust the contrast. Moving it to the left will decrease the contrast of the image, thus softening the image. Moving it to the right will increase the contrast of the image, thus sharpening the image. You can also enter a value (-100 to 100).

- **Preview or scan images as separate files**

Select this checkbox to preview or scan multiple images as separate files.

- **See how to scan a picture**

Click to open Windows Help and Support.

Note

- With network connection, you cannot specify Brightness and Contrast.

4. Click Preview to preview the image.

The preview image appears on the right.

5. Click Scan.

When scanning is completed, the scanned image appears in the application.

Scanning with WIA Driver 1.0

The following is an example of scanning using Paint.

1. Place the document on the Platen.

➔ Placing Documents

2. In File, click From Scanner or Camera.... (Select the command to scan a document in the application.)

3. Select an image type according to the document to be scanned.

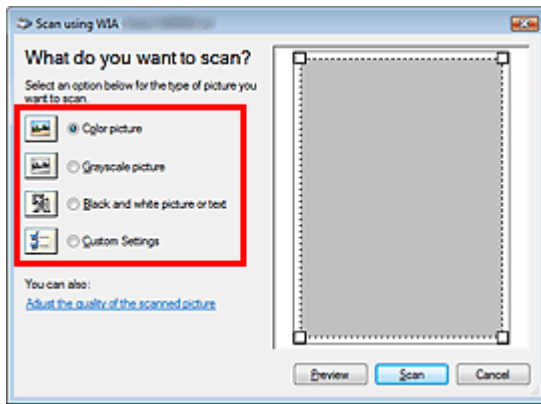

Note

- To scan with the values previously set in Adjust the quality of the scanned picture, select Custom Settings.

4. Click Adjust the quality of the scanned picture and set the preferences as required.

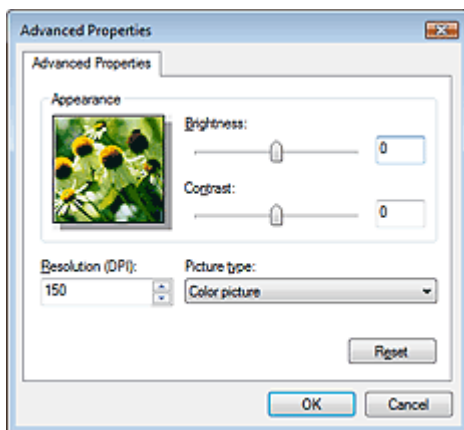

- **Brightness**

Move the slider to adjust the brightness. Move it to the left to darken and right to brighten the image. You can also enter a value (-127 to 127).

- **Contrast**

Move the slider to adjust the contrast. Moving it to the left will decrease the contrast of the image, thus softening the image. Moving it to the right will increase the contrast of the image, thus sharpening the image. You can also enter a value (-127 to 127).

- **Resolution (DPI)**

Enter the resolution. Specify a value between 50 dpi and 600 dpi.

➔ Resolution

- **Picture type**

Select the type of scan you want for your document.

- **Reset**

Click to restore the original settings.

Note

- With network connection, you cannot specify Brightness and Contrast.

5. Click Preview to preview the image.

The preview image appears on the right. Drag to specify the scan area.

6. Click Scan.

When scanning is completed, the scanned image appears in the application.

[Page top](#) ↕

Advanced Guide

Advanced Guide > Scanning > Other Scanning Methods > Scanning Using the Control Panel (Windows XP Only)

Scanning Using the Control Panel (Windows XP Only)

You can scan images via the Control Panel of Windows XP using the WIA driver.

Windows Image Acquisition (WIA) is a driver model implemented in Windows XP. It allows you to scan documents without using an application. Scan documents from a TWAIN-compliant application to specify advanced settings for scanning.

Important

- With network connection, you cannot scan using the WIA driver.
- You cannot scan film using the Control Panel.

1. From the Start menu, select Control Panel.
2. Click Printers and Other Hardware > Scanners and Cameras, then double-click WIA Canon (model name).
The Scanner and Camera Wizard dialog box opens.
3. Click Next.
4. Select Picture type according to the document to be scanned.

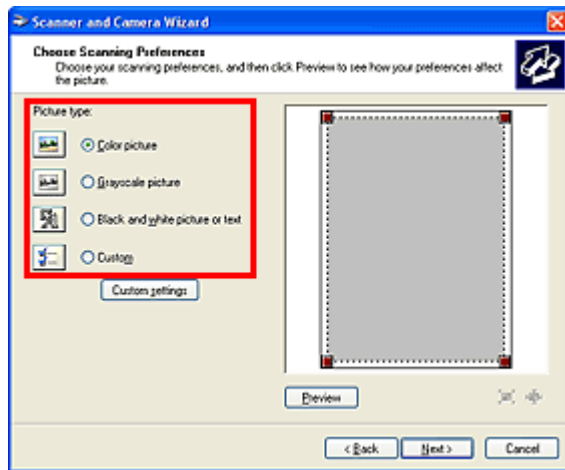

Note

- To scan with the values previously set in Custom Settings, select Custom.

5. Click Custom Settings to set the preferences as required.

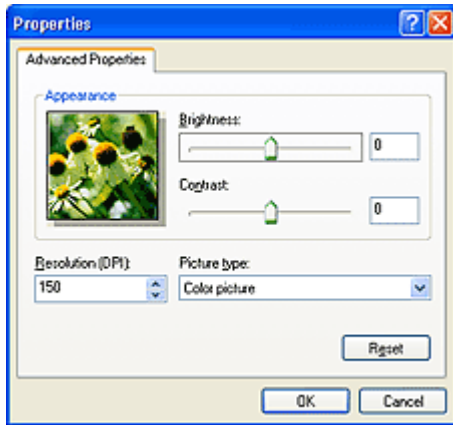

- **Brightness**

Move the slider to adjust the brightness. Move it to the left to darken and right to brighten the image. You can also enter a value (-127 to 127).

- **Contrast**

Move the slider to adjust the contrast. Moving it to the left will decrease the contrast of the image, thus softening the image. Moving it to the right will increase the contrast of the image, thus sharpening the image. You can also enter a value (-127 to 127).

- **Resolution (DPI)**

Enter the resolution. Specify a value between 50 dpi and 600 dpi.

➡ Resolution

- **Picture type**

Select the type of scan you want for your document.

- **Reset**

Click to restore the original settings.

6. Click Preview to preview the image.

The preview image appears on the right. Drag  to specify the scan area.

7. Click Next and follow the instructions.

[Page top](#) ↕

Advanced Guide

Advanced Guide > Printing on DVD/CDs

Printing on DVD/CDs

- ➔ [Printing on the Label Side of DVD/CDs](#)
- ➔ [Troubleshooting](#)

[Page top](#) ↕

Advanced Guide

Advanced Guide > Printing on DVD/CDs > Printing on the Label Side of DVD/CDs

Printing on the Label Side of DVD/CDs

- ➔ Items to Prepare
- ➔ Cautions When Printing on DVD/CDs
- ➔ Attaching/Removing the CD-R Tray
- ➔ Printing on the Label Side of DVD/CDs
- ➔ Printing from DVD/CD Label
- ➔ Printing from a Memory Card
- ➔ Printing from a USB Flash Drive
- ➔ Printing from Printed Photo
- ➔ Printing from Film (MP990 series)
- ➔ Printing with CD-LabelPrint from the Computer
- ➔ Printing from a PictBridge Compliant Device
- ➔ Printing Area

Page top ↕

Advanced Guide

Advanced Guide > Printing on DVD/CDs > Printing on the Label Side of DVD/CDs > Items to Prepare

Items to Prepare

The following items are needed to print on DVD/CDs:

- **CD-R Tray**



"G" is on the upper side.

- **8 cm CD-R Adapter**



Needed only when printing on 8 cm DVD/CDs.

Attached to the CD-R Tray when shipped.

Important

- You cannot print on 8 cm printable DVD/CDs in the DVD/CD print mode.

- **Printable DVD/CDs**

Obtain a 12 cm or 8 cm DVD/CD with a label surface compatible with inkjet printing.

A "printable disc" differs from regular DVD/CDs in that its label surface has been specially processed to be printed on by an inkjet printer.

[Page top](#) ↑

Advanced Guide

[Advanced Guide](#) > [Printing on DVD/CDs](#) > [Printing on the Label Side of DVD/CDs](#) > [Cautions When Printing on DVD/CDs](#)

Cautions When Printing on DVD/CDs

- Be sure to use the CD-R Tray supplied with this machine. It has an "G" on the upper side.
- Do not print on DVD/CDs that are not compatible with ink-jet printing. The ink will not dry and may cause problems with the disc itself or devices which the disc is loaded onto.
- Do not print on the DVD/CDs' recording surface. Doing so will make data recorded on DVD/CDs unreadable.
- Hold DVD/CDs by their edges. Do not touch either the label surface (printing surface) or recording surface.
- Remove any dirt from the CD-R Tray before placing DVD/CDs on the CD-R Tray. Loading discs in a dirty CD-R Tray may scratch the recording surface of the discs.
- After printing, allow the printing surface of the disc to dry naturally. Do not use hairdryers or expose the disc to direct sunlight to dry the ink. Do not touch the printing surface until the ink has dried.
- Do not attach the CD-R Tray while the machine is in operation.
- Do not remove the CD-R Tray while printing on DVD/CDs. Doing so may damage the machine, the CD-R Tray, or the disc.
- Do not get dirt or scratches on the reflectors of the CD-R Tray. The machine may not be able to recognize loading of the DVD/CD, or printing may become misaligned. If the reflectors on the CD-R Tray become dirty, wipe the reflector clean with a soft, dry cloth, taking care not to scratch the plate.
- The CD-R Tray may become dirty if software other than CD-LabelPrint or Easy-PhotoPrint EX is used.
- Always use the supplied 8 cm CD-R Adapter when printing on 8 cm DVD/CDs.
- Always close the Inner Cover after printing on DVD/CDs.
- To keep the print quality at an optimal level, it is recommended to stop printing discs once every ten discs when printing more than ten discs continuously.
To stop the printing operation, detach the CD-R Tray from the machine, then close the Inner Cover. After approximately three minutes have elapsed, open the Inner Cover, attach the CD-R Tray to the machine, then resume printing.

[Page top](#) ↑

Advanced Guide

Advanced Guide > Printing on DVD/CDs > Printing on the Label Side of DVD/CDs > Attaching/Removing the CD-R Tray

Attaching/Removing the CD-R Tray

The external appearance may differ depending on the machine you are using.

Attaching the CD-R Tray

Important

- Do not attach the CD-R Tray until the message asking you to load the DVD/CD is displayed. Doing so can damage the machine.

- Open the Paper Output Tray (A).
- Make sure that the message asking you to load the DVD/CD is displayed, then open the Inner Cover (B).

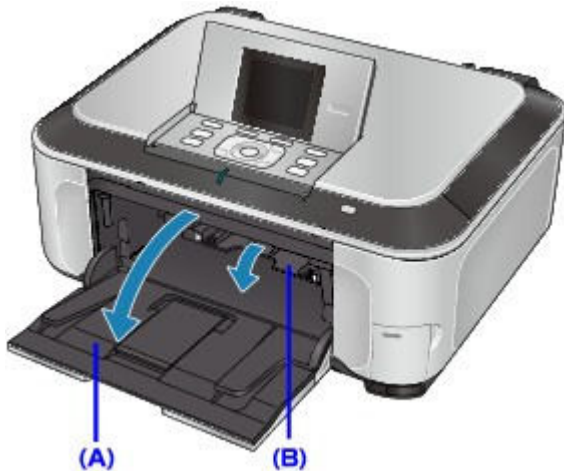

- Place the DVD/CD on the CD-R Tray.

Important

- Make sure that there is no dirt on the CD-R Tray before placing a DVD/CD on the CD-R Tray.
- When placing a DVD/CD on the CD-R Tray, do not touch the printing surface of the disc or the reflectors (C) on the CD-R Tray.

- 12 cm DVD/CD:

- Place the disc on the CD-R Tray with the printable surface facing up.

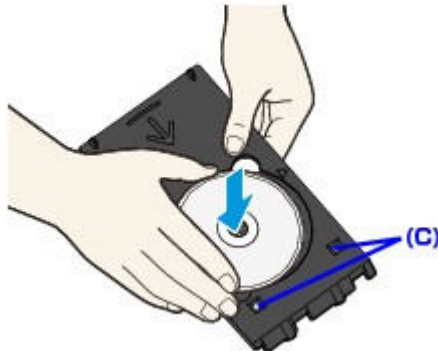

- 8 cm DVD/CD:

1. Align the protrusions on both edges of the 8 cm CD-R Adapter with indentations on the CD-R Tray.

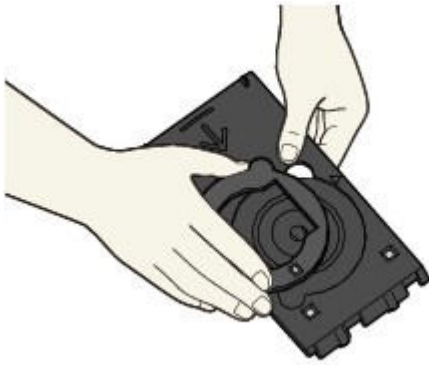

2. Place the 8 cm disc on the CD-R Tray with the printing surface facing up.

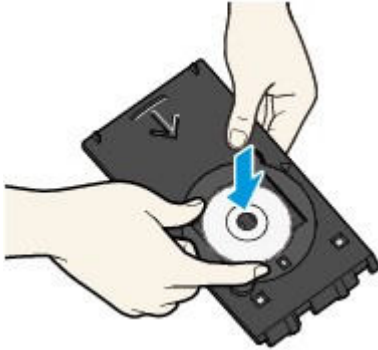

4. Attach the CD-R Tray to the machine.

Note

- The CD-R Tray may be ejected after a specified period of time has elapsed. In this case, follow the on-screen instructions to attach the CD-R Tray.

5. Insert the CD-R Tray straight until the arrow (▶) on the Inner Cover is almost aligned with the arrow (◀) on the CD-R Tray.

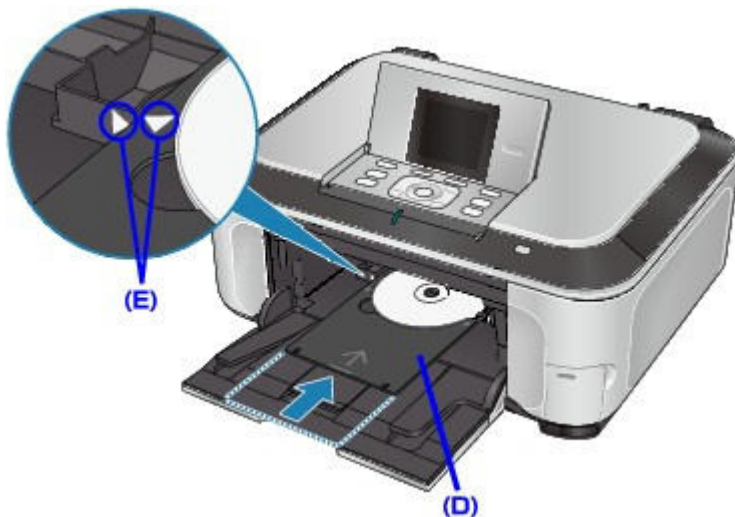

(D) Keep the CD-R Tray level when inserting it.

(E) Align the arrow (◀) on the CD-R Tray with the arrow (▶) on the Inner Cover.

Important

- Do not insert the CD-R Tray beyond the arrow (▶) on the Inner Cover.

Removing the CD-R Tray

1. Pull out the CD-R Tray.



2. Close the Inner Cover.

Important

- If the Inner Cover is opened, you cannot print on paper as it will not feed properly. Make sure that the Inner Cover is closed.



3. Remove the DVD/CD from the CD-R Tray.

Important

- Do not touch the printing surface when removing the disc from the CD-R Tray.

Note

- Dry the printing surface sufficiently before removing the disc. If you see printing on the CD-R Tray or the transparent parts on inner or outer diameter of DVD/CD, wipe them off after the printing surface has dried.

- **12 cm DVD/CD:**

1. Remove the disc from the CD-R Tray.

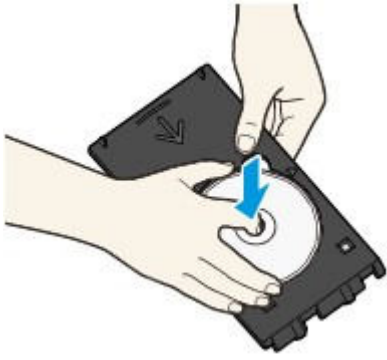

- **8 cm DVD/CD:**

1. Remove the 8 cm CD-R Adapter from the CD-R Tray.



2. Remove the 8 cm disc from the CD-R Tray.

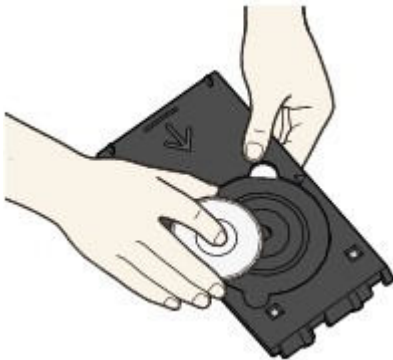

Important

- The CD-R Tray cannot be used if it becomes warped. Be sure to keep the CD-R Tray on a flat place.

Advanced Guide

Advanced Guide > Printing on DVD/CDs > Printing on the Label Side of DVD/CDs > Printing on the Label Side of DVD/CDs

Printing on the Label Side of DVD/CDs

The CD-R Tray (supplied) allows the printing of images on printable DVD/CDs.

This section describes how to print scanned photos or images on printable DVD/CDs.

Note

- We recommend that you test print on an unneeded printable DVD/CD first.

Printing on DVD/CDs

Choose either of the method below according to your purpose.

- **To print from DVD/CD label**

You can print the label side of the DVD/CD on a printable DVD/CD by loading it on the Platen Glass.

➔ [Printing from DVD/CD Label](#)

- **To print a DVD/CD label from photo data on a memory card**

You can print photo data on a memory card on a printable DVD/CD by loading the memory card on the Card Slot.

➔ [Printing from a Memory Card](#)

- **To print a DVD/CD label from photo data on a USB flash drive**

You can print photo data on a USB flash drive on a printable DVD/CD by loading the USB flash drive on the Direct Print Port.

➔ [Printing from a USB Flash Drive](#)

- **To print a DVD/CD label from a printed photo**

You can print a printed photo on a printable DVD/CD by loading it on the Platen Glass.

➔ [Printing from Printed Photo](#)

- **To print a DVD/CD label from film (MP990 series)**

You can print an image on a film (35 mm negative/positive (strip/slide)) on a printable DVD/CD by loading it on the Platen Glass.

➔ [Printing from Film \(MP990 series\)](#)

- **To print a DVD/CD label by using the supplied application**

CD-LabelPrint is bundled application software that allows you to edit and modify data before printing. Install it on your computer to use it.

➔ [Printing with CD-LabelPrint from the Computer](#)

Adjusting the Print Area

If the image was not printed on the intended area, follow the steps below to adjust the print area.

1. **Make sure that the machine is turned on.**

2. Select  **Settings on the HOME screen, then press the OK button.**

3. Select  **Device settings, then press the OK button.**

4. Select **Print settings**, then press the **OK** button.
5. Select **DVD/CD print area adjust**, then press the **OK** button.
6. Use the **▲ ▼** button to select **Right/left** or **Top/bottom** and use the **◀ ▶** button to adjust the print area.

You can adjust the printing area by 0.1 mm between -0.9 mm and +0.9 mm.

7. Press the **OK** button.

[Page top](#) ↑

Advanced Guide

Advanced Guide > Printing on DVD/CDs > Printing on the Label Side of DVD/CDs > Printing from DVD/CD Label

Printing from DVD/CD Label



Copy the label of an existing DVD/CD and print it on a printable DVD/CD.

Important

- You cannot print on 8 cm DVD/CDs.
- Do not attach the CD-R Tray until the message asking you to load the DVD/CD is displayed. Doing so can damage the machine.

Note

- If printing is misaligned, adjust the printing position. For information on how to adjust it, see [Adjusting the Print Area](#).

1. Make sure that the machine is turned on.
2. Select  DVD/CD label print on the HOME screen, then press the **OK** button.
3. Select  From DVD/CD label, then press the **OK** button.
The print area setting screen is displayed.
4. Use the **▲▼** button to select Outer circle or Inner circle and use the **◀▶** button to change the print area.
5. Press the **OK** button.

Note

- Measure the outer and inner diameters of the printing surface of the printable DVD/CD and make sure you set a value smaller than the measured value for the outer diameter, and a value larger than the measured value for the inner diameter.
- For information on printable discs, contact their manufacturers.

6. Use the **▲▼** button to select Recommended DVD/CD or Other DVD/CD, then press the **OK** button.

Note

- If your medium is the recommended DVD or CD, specify Recommended DVD/CD for the suitable density printing. If not, specify Other DVD/CD.

7. Load the copy source DVD/CD on the Platen Glass, then press the **OK** button.

Important

- Be sure to load the copy source DVD/CD with its label side down on the center of the Platen Glass. If you load it near the edge of the Platen Glass, part of the image may be cut off.

8. Check the print settings, then press the **OK** button.

The message for preparation is displayed.

Note

- Press the **Black** button for black & white copying.
 - To change print settings, press the **Back** button repeatedly until the screen for the setting item to change appears, then change the setting.
-

Important

- Do not see the light source directly while copying is in progress.

9. Set the printable DVD/CD.

Press the left Function button to see how to set the printable DVD/CD.

10. Press the **Color** button.

Note

- If you press the **Black** button in step 8, black & white copying will start even if you press the **Color** button.
 - To cancel copying, press the **Stop** button.
 - After printing, allow the printing surface of the disc to dry naturally. Do not use hairdryers or expose the disc to direct sunlight to dry the ink. Do not touch the printing surface until the ink has dried.
 - To keep the print quality at an optimal level, it is recommended to stop printing discs once every ten discs when printing more than ten discs continuously.
To stop the printing operation, detach the CD-R Tray from the machine, then close the Inner Cover. After approximately three minutes have elapsed, open the Inner Cover, attach the CD-R Tray to the machine, then resume printing.
-

Advanced Guide

Advanced Guide > Printing on DVD/CDs > Printing on the Label Side of DVD/CDs > Printing from a Memory Card

Printing from a Memory Card



Print an image on a memory card onto a printable DVD/CD.

Important

- You cannot print on 8 cm DVD/CDs.
- Do not attach the CD-R Tray until the message asking you to load the DVD/CD is displayed. Doing so can damage the machine.

Note



- If printing is misaligned, adjust the printing position. For information on how to adjust it, see [Adjusting the Print Area](#).

1. Make sure that the machine is turned on.
2. Select  DVD/CD label print on the HOME screen, then press the **OK** button.
3. Select  From photo data, then press the **OK** button.
4. Confirm the message, then insert the memory card into the Card Slot.

The print area setting screen is displayed.

Important

- If the USB flash drive is inserted in the Direct Print Port, remove the USB flash drive, then insert the memory card into the Card Slot.

5. Use the  button to select Outer circle or Inner circle and use the  button to change the print area.
6. Press the **OK** button.

Note

- Measure the outer and inner diameters of the printing surface of the printable DVD/CD and make sure you set a value smaller than the measured value for the outer diameter, and a value larger than the measured value for the inner diameter.
- For information on printable discs, contact their manufacturers.

7. Use the  button to select Recommended DVD/CD or Other DVD/CD, then press the **OK** button.

Note

- If your medium is the recommended DVD or CD, specify Recommended DVD/CD for the suitable density printing. If not, specify Other DVD/CD.

8. Use the  button to select the photo to print, then press the **OK** button.
9. Confirm the print image on the DVD/CD, then press the **OK** button.

 **Note**

- Other options
 - ➔ Printing a Specified Area (Trimming)
 - ➔ Searching for Photos with the Shooting Date (Search)
-

10. Check the print settings, then press the **OK** button.

The message for preparation is displayed.

 **Note**

- To change print settings, press the **Back** button repeatedly until the screen for the setting item to change appears, then change the setting.
-

11. Set the printable DVD/CD.

Press the left Function button to see how to set the printable DVD/CD.

12. Press the **Color** button.

 **Note**

- Printing will not start if you press the **Black** button.
 - To cancel copying, press the **Stop** button.
 - After printing, allow the printing surface of the disc to dry naturally. Do not use hairdryers or expose the disc to direct sunlight to dry the ink. Do not touch the printing surface until the ink has dried.
 - To keep the print quality at an optimal level, it is recommended to stop printing discs once every ten discs when printing more than ten discs continuously.
To stop the printing operation, detach the CD-R Tray from the machine, then close the Inner Cover. After approximately three minutes have elapsed, open the Inner Cover, attach the CD-R Tray to the machine, then resume printing.
-

Advanced Guide

Advanced Guide > Printing on DVD/CDs > Printing on the Label Side of DVD/CDs > Printing from a USB Flash Drive

Printing from a USB Flash Drive



Print an image on a USB flash drive onto a printable DVD/CD.

Important

- You cannot print on 8 cm DVD/CDs.
- Do not attach the CD-R Tray until the message asking you to load the DVD/CD is displayed. Doing so can damage the machine.



Note

- If printing is misaligned, adjust the printing position. For information on how to adjust it, see [Adjusting the Print Area](#).

1. Make sure that the machine is turned on.
2. Select  DVD/CD label print on the HOME screen, then press the **OK** button.
3. Select  From photo data, then press the **OK** button.
4. Confirm the message, then insert the USB flash drive into the Direct Print Port.
The print area setting screen is displayed.

Important

- If the memory card is inserted in the Card Slot, remove the memory card, then insert the USB flash drive into the Direct Print Port.

5. Use the  button to select Outer circle or Inner circle and use the  button to change the print area.
6. Press the **OK** button.

Note

- Measure the outer and inner diameters of the printing surface of the printable DVD/CD and make sure you set a value smaller than the measured value for the outer diameter, and a value larger than the measured value for the inner diameter.
- For information on printable discs, contact their manufacturers.

7. Use the  button to select Recommended DVD/CD or Other DVD/CD, then press the **OK** button.

Note

- If your medium is the recommended DVD or CD, specify Recommended DVD/CD for the suitable density printing. If not, specify Other DVD/CD.

8. Use the  button to select the photo to print, then press the **OK** button.
9. Confirm the print image on the DVD/CD, then press the **OK** button.

 **Note**

- Other options
 - ➔ Printing a Specified Area (Trimming)
 - ➔ Searching for Photos with the Shooting Date (Search)
-

10. Check the print settings, then press the **OK** button.

The message for preparation is displayed.

 **Note**

- To change print settings, press the **Back** button repeatedly until the screen for the setting item to change appears, then change the setting.
-

11. Set the printable DVD/CD.

Press the left Function button to see how to set the printable DVD/CD.

12. Press the **Color** button.

 **Note**

- Printing will not start if you press the **Black** button.
 - To cancel copying, press the **Stop** button.
 - After printing, allow the printing surface of the disc to dry naturally. Do not use hairdryers or expose the disc to direct sunlight to dry the ink. Do not touch the printing surface until the ink has dried.
 - To keep the print quality at an optimal level, it is recommended to stop printing discs once every ten discs when printing more than ten discs continuously.
To stop the printing operation, detach the CD-R Tray from the machine, then close the Inner Cover. After approximately three minutes have elapsed, open the Inner Cover, attach the CD-R Tray to the machine, then resume printing.
-

Advanced Guide

Advanced Guide > Printing on DVD/CDs > Printing on the Label Side of DVD/CDs > Printing from Printed Photo

Printing from Printed Photo



Print an image on a printed photo onto a printable DVD/CD.

Important

- You cannot print on 8 cm DVD/CDs.
- Do not attach the CD-R Tray until the message asking you to load the DVD/CD is displayed. Doing so can damage the machine.

Note

- If printing is misaligned, adjust the printing position. For information on how to adjust it, see [Adjusting the Print Area](#).

1. Make sure that the machine is turned on.
2. Select  DVD/CD label print on the HOME screen, then press the **OK** button.
3. Select  From printed photo, then press the **OK** button.
The print area setting screen is displayed.
4. Use the **▲▼** button to select Outer circle or Inner circle and use the **◀▶** button to change the print area.
5. Press the **OK** button.

Note

- Measure the outer and inner diameters of the printing surface of the printable DVD/CD and make sure you set a value smaller than the measured value for the outer diameter, and a value larger than the measured value for the inner diameter.
- For information on printable discs, contact their manufacturers.

6. Use the **▲▼** button to select Recommended DVD/CD or Other DVD/CD, then press the **OK** button.

Note

- If your medium is the recommended DVD or CD, specify Recommended DVD/CD for the suitable density printing. If not, specify Other DVD/CD.

7. Load the photos on the Platen Glass.

Press the **OK** button to scan the photos.

Important

- Do not see the light source directly while scanning is in progress.

8. Use the **◀▶** button to select the photo to print, then press the **OK** button.

Note

- If  appears on the preview screen, the photos may be not scanned properly. Press the

Back button, then repeat the procedure from step 7.

9. Confirm the print image on the DVD/CD, then press the **OK** button.

 **Note**

- Other options
 - ➔ "Printing a Specified Area (Trimming)" in [Using Useful Display Functions](#)
-

10. Check the print settings, then press the **OK** button.

The message for preparation is displayed.

 **Note**

- Press the **Black** button for black & white copying.
 - To change print settings, press the **Back** button repeatedly until the screen for the setting item to change appears, then change the setting.
-

11. Set the printable DVD/CD.

Press the left Function button to see how to set the printable DVD/CD.

12. Press the **Color** button.

 **Note**

- If you press the **Black** button in step 10, black & white copying will start even if you press the **Color** button.
 - To cancel copying, press the **Stop** button.
 - After printing, allow the printing surface of the disc to dry naturally. Do not use hairdryers or expose the disc to direct sunlight to dry the ink. Do not touch the printing surface until the ink has dried.
 - To keep the print quality at an optimal level, it is recommended to stop printing discs once every ten discs when printing more than ten discs continuously.
To stop the printing operation, detach the CD-R Tray from the machine, then close the Inner Cover. After approximately three minutes have elapsed, open the Inner Cover, attach the CD-R Tray to the machine, then resume printing.
-

Advanced Guide

Advanced Guide > Printing on DVD/CDs > Printing on the Label Side of DVD/CDs > Printing from Film (MP990 series)

Printing from Film (MP990 series)



Print an image on a film (35 mm negative/positive (strip/slide)) onto a printable DVD/CD.

Important

- You cannot print on 8 cm DVD/CDs.
- Do not attach the CD-R Tray until the message asking you to load the DVD/CD is displayed. Doing so can damage the machine.

Note

- If printing is misaligned, adjust the printing position. For information on how to adjust it, see [Adjusting the Print Area](#).

1. Make sure that the machine is turned on.
2. Select  DVD/CD label print on the HOME screen, then press the **OK** button.
3. Select  From film, then press the **OK** button.
The print area setting screen is displayed.
4. Use the **▲▼** button to select Outer circle or Inner circle and use the **◀▶** button to change the print area.
5. Press the **OK** button.

Note

- Measure the outer and inner diameters of the printing surface of the printable DVD/CD and make sure you set a value smaller than the measured value for the outer diameter, and a value larger than the measured value for the inner diameter.
- For information on printable discs, contact their manufacturers.

6. Use the **▲▼** button to select Recommended DVD/CD or Other DVD/CD, then press the **OK** button.

Note

- If your medium is the recommended DVD or CD, specify Recommended DVD/CD for the suitable density printing. If not, specify Other DVD/CD.

7. Select the type of film.

Note

- You can select Color negative film, B&W negative film, Color positive film, or Mount (for slides).

8. Load the film on the Platen Glass.

Press the left Function button to see how to load the film.
Press the **Color** button to scan the film.

Important

- Do not see the light source directly while scanning is in progress.

9. Use the ◀▶ button to select the photo to print, then press the **OK** button.

Note

- If  appears on the preview screen, the photos may be not scanned properly. Press the **Back** button, then repeat the procedure from step 8.

10. Confirm the print image on the DVD/CD, then press the **OK** button.

Note

- Other options
➔ "Printing a Specified Area (Trimming)" in [Using Useful Display Functions](#)

11. Check the print settings, then press the **OK** button.

The message for preparation is displayed.

Note

- Press the **Black** button for black & white copying.
- To change print settings, press the **Back** button repeatedly until the screen for the setting item to change is displayed, then change the setting.

12. Set the printable DVD/CD.

Press the left Function button to see how to set the printable DVD/CD.

13. Press the **Color** button.

Note

- If you press the **Black** button in step 11, black & white copying will start even if you press the **Color** button.
- To cancel copying, press the **Stop** button.
- After printing, allow the printing surface of the disc to dry naturally. Do not use hairdryers or expose the disc to direct sunlight to dry the ink. Do not touch the printing surface until the ink has dried.
- To keep the print quality at an optimal level, it is recommended to stop printing discs once every ten discs when printing more than ten discs continuously.
To stop the printing operation, detach the CD-R Tray from the machine, then close the Inner Cover. After approximately three minutes have elapsed, open the Inner Cover, attach the CD-R Tray to the machine, then resume printing.

Advanced Guide

Advanced Guide > Printing on DVD/CDs > Printing on the Label Side of DVD/CDs > Printing with CD-LabelPrint from the Computer

Printing with CD-LabelPrint from the Computer

- CD-LabelPrint is bundled application software that allows you to edit and modify data before printing. Install it on your computer to use it. To install this software, insert the *Setup CD-ROM* into the computer's disc drive, then perform Custom Install and select CD-LabelPrint.
- For details on how to print with CD-LabelPrint, refer to its manual.

If you are using a Windows computer, click Start > All Programs (or Programs in Windows 2000) > CD-LabelPrint > Manual.

If you are using a Macintosh, open the Applications folder in the location where the MP Drivers have been installed > CD-LabelPrint folder > Manual folder > double-click Manual.htm.

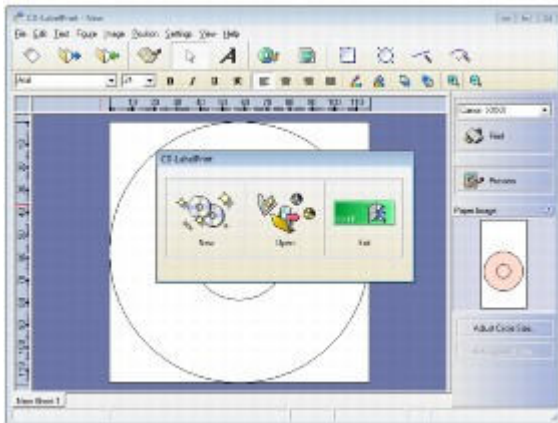

[Page top](#) ↑

Advanced Guide

Advanced Guide > Printing on DVD/CDs > Printing on the Label Side of DVD/CDs > Printing from a PictBridge Compliant Device

Printing from a PictBridge Compliant Device

This section describes how to print photos on DVD/CDs (printable discs) from a PictBridge compliant device.

Important

- Depending on your PictBridge compliant device, you may not be able to print on the label side of DVD/CDs.
For details, refer to your PictBridge compliant device's instruction manual .
- You cannot print on 8 cm DVD/CDs.

1. Make sure that the machine is turned on.
2. Connect the PictBridge compliant device to the machine using a USB cable recommended by the manufacturer of the device.
For details, refer to [Printing Photographs Directly from a Compliant Device](#) .
3. Specify the print settings as follows.
 - Paper size: 12cmDVD/CD
 - Paper type: Default
 - Layout: Bordered or Default

You can perform image optimize settings using the menu on the LCD of your PictBridge compliant device. For details, refer to [About PictBridge Print Settings](#).

Note

- If your PictBridge compliant device does not have setting menu, change the setting from the machine.
➔ [Specifying the PictBridge Print Settings on the Machine](#)

4. Set the printable DVD/CD.
➔ [Attaching/Removing the CD-R Tray](#)
5. Start printing from your PictBridge compliant device.

Specifying the PictBridge Print Settings on the Machine

You can specify the PictBridge print settings on the machine.

Note

- When a PictBridge compliant device is connected to the machine, the PictBridge print settings screen can also be displayed by pressing the left Function button.

1. Make sure that the machine is turned on.

2. Select  Settings on the HOME screen, then press the OK button.

The Settings screen is displayed.

3. Select  Device settings, then press the OK button.

The Device settings screen is displayed.

4. Select PictBridge print settings, then press the OK button.

The PictBridge print settings screen is displayed.

5. Select DVD/CD print setting, then press the OK button.

The screen to change the print area is displayed.

6. Use the ▲ ▼ button to select Outer circle or Inner circle and use the ◀ ▶ button to change the print area.

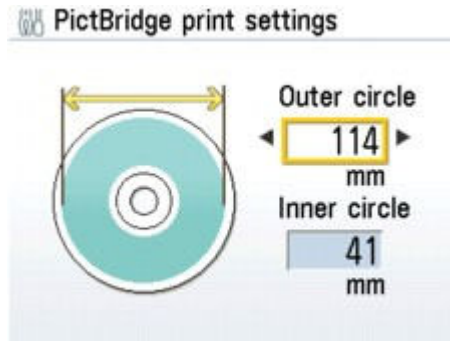

7. Press the OK button.

Note

- Measure the outer and inner diameters of the printing surface of the printable DVD/CD and make sure you set a value smaller than the measured value for the outer diameter, and a value larger than the measured value for the inner diameter.
- For information on printable discs, contact their manufacturers.

8. Use the ▲ ▼ button to select Recommended DVD/CD or Other DVD/CD, then press the OK button.

Note

- If your medium is the recommended DVD or CD, specify Recommended DVD/CD for the suitable density printing. If not, specify Other DVD/CD.

Advanced Guide

Advanced Guide > Printing on DVD/CDs > Printing on the Label Side of DVD/CDs > Printing Area

Printing Area

Printable DVD/CDs

The printing area of both printable DVDs and CDs is the area excluding the 1 mm area from the internal and external diameters of the label.

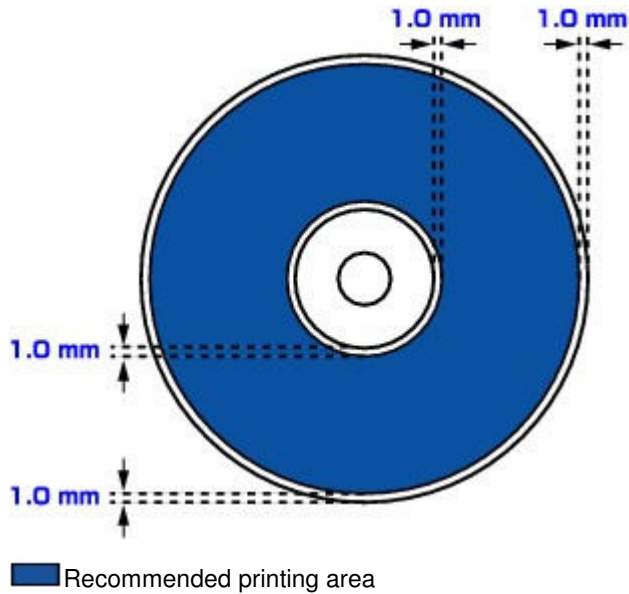

[Page top](#) ↑

Advanced Guide

[Advanced Guide](#) > [Printing on DVD/CDs](#) > [Troubleshooting](#)

Troubleshooting

- ➔ [An Error Message Is Displayed on the LCD](#)
- ➔ [Message Appears on the Computer Screen](#)
- ➔ [Cannot Print on DVD/CDs](#)
- ➔ [Error Message Appears on a PictBridge Compliant Device](#)

[Page top](#) ↕

Advanced Guide

[Advanced Guide](#) > [Printing on DVD/CDs](#) > [Troubleshooting](#) > [An Error Message Is Displayed on the LCD](#)

An Error Message Is Displayed on the LCD

If an error message is displayed on the LCD, take the corresponding action described below.

Message	Action
Open the inner cover, place the CD-R tray and press OK.	If the Inner Cover is closed when starting DVD/CD printing, open the Inner Cover with the Scanning Unit (Cover) closed, set the CD-R Tray, and then press the OK button on the machine. Do not open or close the Inner Cover while printing is in progress. Doing so may damage the machine.

[Page top](#) ↑

Advanced Guide

Advanced Guide > Printing on DVD/CDs > Troubleshooting > Message Appears on the Computer Screen

Message Appears on the Computer Screen

→  **Windows** Errors About DVD/CD Printing Are Displayed

→  **Macintosh** Message: 1001 Is Displayed

→  **Macintosh** Error Number: 1002 Is Displayed

→  **Macintosh** Message: 1850 Is Displayed

Windows Errors About DVD/CD Printing Are Displayed

- **Check 1: Is the CD-R Tray placed properly?**

Open the Inner Cover, properly place the CD-R Tray again, then press the **OK** button.

Make sure that you are using the CD-R Tray supplied with the machine ("G" is on the upper side).

For details on how to place the CD-R Tray, see [Attaching/Removing the CD-R Tray](#) .

- **Check 2: Is the DVD/CD placed on the CD-R Tray?**

Properly place the DVD/CD on the CD-R Tray, attach the CD-R Tray again, then press the **OK** button.

Make sure that you are using the CD-R Tray supplied with the machine ("G" is on the upper side).

For details on how to place the CD-R Tray, see [Attaching/Removing the CD-R Tray](#) .

- **Check 3: Unrecognizable DVD/CD may be placed.**

Canon recommends that you use DVD/CDs specially processed to be printed on by an inkjet printer.

- **Check 4: Is the DVD/CD on the CD-R Tray already printed?**

If you place a DVD/CD on which has already been printed on the CD-R Tray, the CD-R Tray may be ejected.

In this case, change the settings of the printer driver and try printing again.

- Clear the Detects a printable disc in the CD-R tray check box in Custom Settings on the Maintenance tab, then click Send.
When printing is over, select the Detects a printable disc in the CD-R tray check box and click Send.



Note

- If the Detects a printable disc in the CD-R tray check box is cleared, printing may start without the DVD/CD loaded. Selecting the check box prevents the CD-R Tray from getting dirty.

- **Check 5: Is the Inner Cover opened when starting printing on paper, or while printing is in progress?**

Close the Inner Cover, then press the **OK** button on the machine.

Do not open or close the Inner Cover while printing is in progress. This may damage the machine.

Macintosh Message: 1001 Is Displayed

- **Check: Place the CD-R Tray properly.**

Place the CD-R Tray properly then press the **OK** button.

Make sure that you are using the CD-R Tray supplied with the machine ("G" is on the upper side).

For details on how to place the CD-R Tray, see [Attaching/Removing the CD-R Tray](#) .

Error Number: 1002 Is Displayed

- **Check 1: Place the DVD/CD on the CD-R Tray properly.**

Place the DVD/CD on the CD-R Tray properly, then press the **OK** button on the machine.

Make sure that you are using the CD-R Tray supplied with the machine ("G" is on the upper side).

For details on how to place the CD-R Tray, see [Attaching/Removing the CD-R Tray](#) .

- **Check 2: Unrecognizable DVD/CD may be placed.**

Canon recommends that you use DVD/CDs specially processed to be printed on by an inkjet printer.

- **Check 3: Is the DVD/CD on the CD-R Tray already printed?**

If you place a DVD/CD on which has already been printed on the CD-R Tray, the CD-R Tray may be ejected.

In this case, change the settings of the printer driver and try printing again.

- Clear the Detects a printable disc in the CD-R tray check box in Custom Settings on the Canon IJ Printer Utility dialog box, then click Send.
When printing is over, select the Detects a printable disc in the CD-R tray check box and click Send.

Note

- If the Detects a printable disc in the CD-R tray check box is cleared, printing may start without the DVD/CD loaded. Selecting the check box prevents the CD-R Tray from getting dirty.

Message: 1850 Is Displayed

- **Check: Open the Inner Cover, then place the CD-R Tray properly.**

Open the Inner Cover, place the CD-R Tray properly, then press the **OK** button.

For details on how to place the CD-R Tray, see [Attaching/Removing the CD-R Tray](#) .

Advanced Guide

Advanced Guide > Printing on DVD/CDs > Troubleshooting > Cannot Print on DVD/CDs

Cannot Print on DVD/CDs

- ➔ DVD/CD Printing Does Not Start
- ➔ CD-R Tray Does Not Feed Properly
- ➔ CD-R Tray Jammed

DVD/CD Printing Does Not Start

- **Check 1: Is the CD-R Tray placed properly?**

Open the Inner Cover, properly place the CD-R Tray again, then press the **OK** button.

Use the CD-R Tray supplied with this machine ("G" is on the upper side).

For details on how to place the CD-R Tray, see [Attaching/Removing the CD-R Tray](#) .

- **Check 2: Is the DVD/CD placed on the CD-R Tray?**

Place the DVD/CD on the CD-R Tray properly, then press the **OK** button on the machine.

Make sure that you are using the CD-R Tray supplied with the machine ("G" is on the upper side).

For details on how to place the CD-R Tray, see [Attaching/Removing the CD-R Tray](#) .

- **Check 3: If DVD/CD printing stops before it is complete, try the operation again.**

If a certain period of time has elapsed while DVD/CD printing is in progress, the machine stops initializing.

If you press the **OK** button, the machine resumes initializing.

Try the operation again following the on-screen instructions.

CD-R Tray Does Not Feed Properly

- **Check 1: Is the CD-R Tray placed properly?**

Properly place the CD-R Tray again, then press the **OK** button.

Make sure that you are using the CD-R Tray supplied with the machine ("G" is on the upper side).

For details on how to place the CD-R Tray, see [Attaching/Removing the CD-R Tray](#) .

- **Check 2: Unrecognizable DVD/CD may be placed.**

Canon recommends that you use DVD/CDs specially processed to be printed on by an inkjet printer.

- **Check 3: Is the DVD/CD on the CD-R Tray already printed?**

If you place a DVD/CD on which has already been printed on the CD-R Tray, the CD-R Tray may be ejected.

In this case, change the settings of the printer driver and try printing again.



- Clear the Detects a printable disc in the CD-R tray check box in Custom Settings on the Maintenance tab, then click Send.
When printing is over, select the Detects a printable disc in the CD-R tray check box and click Send.



- Clear the Detects a printable disc in the CD-R tray check box in Custom Settings on the Canon IJ Printer Utility dialog box, then click Send.

When printing is over, select the Detects a printable disc in the CD-R tray check box and click Send.

Note

- If you left cleared Detects a printable disc in the CD-R tray check box and start printing another DVD/CD, printing may start without the DVD/CD loaded. Selecting the check box prevents the CD-R Tray from getting dirty.
-

CD-R Tray Jammed

Pull out the CD-R Tray gently.

If the CD-R Tray cannot be pulled out, turn the machine off, then turn the machine back on again. The CD-R Tray will automatically be ejected.

When the CD-R Tray is pulled out, place the CD-R Tray ("G" is on the upper side) again, then retry printing. Place the DVD/CD properly.

➔ [Attaching/Removing the CD-R Tray](#)

If the CD-R Tray is still jammed, check if there is a problem with the DVD/CD.

➔ [CD-R Tray Does Not Feed Properly](#)

[Page top](#) ↑

Advanced Guide

[Advanced Guide](#) > [Printing on DVD/CDs](#) > [Troubleshooting](#) > [Error Message Appears on a PictBridge Compliant Device](#)

Error Message Appears on a PictBridge Compliant Device

The following are the possible errors that may occur when printing directly from a PictBridge compliant device and the countermeasures to clear them.

Note

- For the errors indicated on the PictBridge compliant device and their solution, also refer to the instruction manual of the device. For other troubles on the device, contact the manufacturer.

Error Message on the PictBridge Compliant Device	Action
"No paper"	See Cannot Print on DVD/CDs and take the appropriate action.
"Paper Error"	See Cannot Print on DVD/CDs and take the appropriate action.

[Page top](#) ↑

Advanced Guide

[Advanced Guide](#) > [Printing Photographs Directly from a Compliant Device or a Wireless Communication Device](#)

Printing Photographs Directly from a Compliant Device or a Wireless Communication Device

- ➔ [Printing Photographs Directly from a Compliant Device](#)
- ➔ [Printing Photographs from a Wireless Communication Device](#)

[Page top](#) ↑

Advanced Guide

[Advanced Guide](#) > [Printing Photographs Directly from a Compliant Device or a Wireless Communication Device](#) > [Printing Photographs Directly from a Compliant Device](#)

Printing Photographs Directly from a Compliant Device

- ➔ [Printing Photographs Directly from a Compliant Device](#)
- ➔ [About PictBridge Print Settings](#)

[Page top](#) ↑

Advanced Guide

Advanced Guide > Printing Photographs Directly from a Compliant Device or a Wireless Communication Device > Printing Photographs Directly from a Compliant Device > Printing Photographs Directly from a Compliant Device

Printing Photographs Directly from a Compliant Device

You can connect a PictBridge compliant device such as a digital camera, camcorder, or mobile phone connect to the machine using a USB cable recommended by the device's manufacturer, and print recorded images directly without using a computer.

Important

- Do not use the USB cable longer than around 10 feet / 3 meters to connect any PictBridge compliant device to the machine since it may affect the operation of other peripheral devices.

Note

- When printing photos with the PictBridge compliant device connected to the machine, we recommend the use of the AC adapter supplied with the device. If you are using the device battery, be sure to charge it fully.
- Depending on the model or brand of your device, you may have to select a print mode compliant with PictBridge before connecting the device. You may also have to turn on the device or select Play mode manually after connecting the device to the machine.
Perform necessary operations on the PictBridge compliant device before connecting it to this machine according to instructions given in the device's instruction manual.

1. Make sure that the machine is turned on.
2. Load paper.
3. Make sure that the proper paper source is selected.
4. Make sure that the PictBridge compliant device is turned off.
5. Connect the PictBridge compliant device to the machine using a USB cable (A) recommended by the device's manufacturer.

The PictBridge compliant device turns on automatically.

If your device does not turn on automatically, turn it on manually.

When machine is correctly connected to the device, the message that the machine is connected will be displayed on the LCD of the device. Refer to the device's instruction manual.

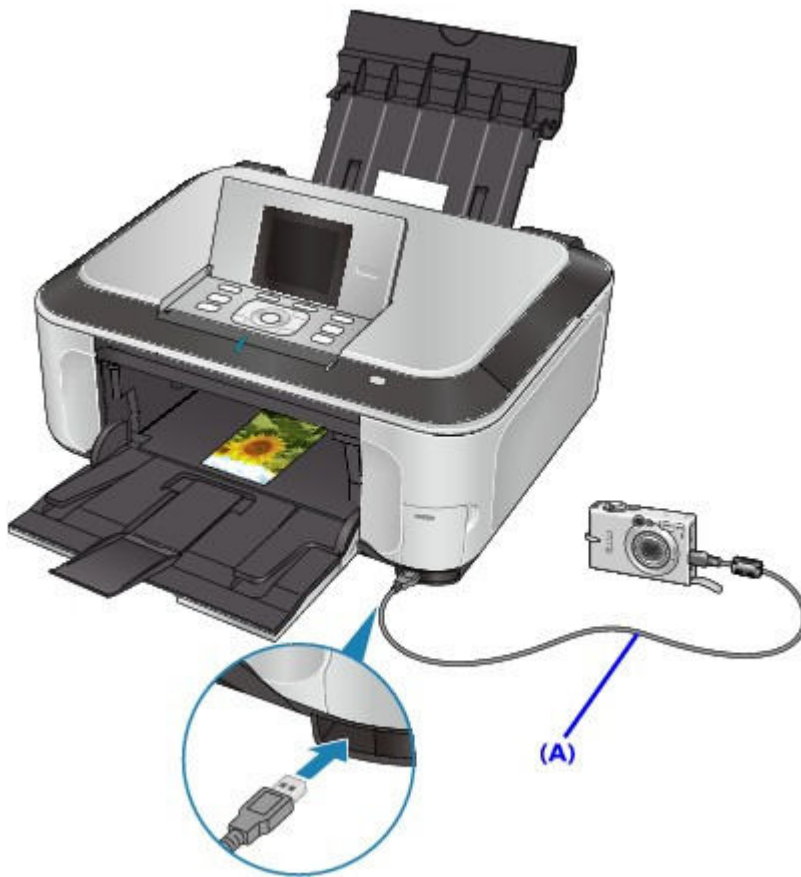

6. Specify the print settings such as the paper type and layout.

You can perform settings using the menu on the LCD of your PictBridge compliant device. Select the size and type of paper that you loaded in the machine.

➔ Settings on a PictBridge Compliant Device

If your PictBridge compliant device does not have a setting menu, change the setting from the machine.

➔ Settings on the Machine

7. Start printing from your PictBridge compliant device.

Important

- Never disconnect the USB cable during printing unless when explicitly allowed to by the PictBridge compliant device. When disconnecting the USB cable between the PictBridge compliant device and machine, follow the instructions given in the device's instruction manual.

Advanced Guide

Advanced Guide > Printing Photographs Directly from a Compliant Device or a Wireless Communication Device > Printing Photographs Directly from a Compliant Device > About PictBridge Print Settings

About PictBridge Print Settings

➔ Settings on a PictBridge Compliant Device

➔ Settings on the Machine

Settings on a PictBridge Compliant Device

This section describes the PictBridge function of the machine. For the print settings on a PictBridge compliant device, refer to the instructions given in the device's instruction manual.

Note

- In the following description, names of setting items are given according to those used in Canon-brand PictBridge compliant devices. Setting item names may be different depending on the brand or model of your device.
- Some setting items explained below may not be available on some devices. In this case, the settings made on the machine are applied. Also, when some items are set to Default on a PictBridge compliant device, the machine settings for these items are applied.

➔ Settings on the Machine

The following settings can be used when printing from a PictBridge compliant device.

Paper size	4" x 6"/10 x 15 cm, 5" x 7"*1, 8" x 10"/ 20 x 25 cm, A4, 8.5" x 11"(Letter), 4" x 7.1"/ 10.1 x 18 cm*2 *1 10x15 may appear on some PictBridge compliant device. *2 Hi Vision may appear on a non-Canon brand PictBridge compliant device.
Paper type	<ul style="list-style-type: none"> ● Default (Selections based on the machine setting) Photo: Photo Paper Plus Glossy II PP-201/Glossy Photo Paper "Everyday Use" GP-501 /Photo Paper Glossy GP-502/Photo Paper Plus Semi-gloss SG-201/Photo Stickers* * When printing on sticker paper, select 10 x 15 cm/4" x 6" in Paper size. Do not set Layout to Borderless. ● Fast Photo: Photo Paper Pro II PR-201 ● Plain: A4/Letter When Paper type is set to Plain, borderless printing will be disabled even when Layout is set to Borderless.
Layout	Default (Selections based on the machine setting), Index, Bordered, Borderless, N-up (2, 4, 9, 16)*1, 20-up*2, 35-up*3 *1 Layout compatible with A4 or Letter-sized paper and Canon-brand sticker above. A4/Letter: 4-up Photo Stickers: 2-up, 4-up, 9-up, 16-up. *2 With a Canon brand PictBridge compliant device, selecting items with "i" mark allows you to print shooting info (Exif Data) in list format (20-up) or on the margins of the specified data (1-up). (May not be available with some Canon-brand PictBridge compliant devices.) *3 Printed in 35 mm Film Style Layout (Contact Printing Layout). Available only with a Canon-brand PictBridge compliant device. (May not be available with some Canon-brand PictBridge compliant devices.)
Print date & file no.	Default (Off: No printing), Date, File No., Both, Off
Image optimize	Default (Selections based on the machine setting), On*1 (Exif Print), Off, NR (Noise Reduction)*2, VIVID*2, Face*2, Red-Eye*2 *1 Photos are optimized for printing using the Photo optimizer pro function. *2 Can be selected only on certain Canon-brand PictBridge compliant devices. (May not be selected depending on the device.)

Trimming	Default (Off: No trimming), On (follow the camera's setting), Off
----------	---

Settings on the Machine

You can change the PictBridge print settings from the PictBridge print settings screen. Set the print settings to Default on the PictBridge compliant device when you want to print according to the settings on the machine.

This section describes the procedure to display the PictBridge print settings screen. For setting items, see [PictBridge print settings](#).

1. Make sure that the machine is turned on.

2. Select  Settings on the HOME screen, then press the OK button.

3. Select  Device settings, then press the OK button.

4. Select PictBridge print settings, then press the OK button.

The PictBridge print settings screen is displayed.

[Page top](#) ↑

Advanced Guide

[Advanced Guide](#) > [Printing Photographs Directly from a Compliant Device or a Wireless Communication Device](#) > [Printing Photographs from a Wireless Communication Device](#)

Printing Photographs from a Wireless Communication Device

- [Printing Photographs from a Wireless Communication Device](#)
- [Printing via Infrared Communication](#)
- [Printing via Bluetooth Communication](#)
- [Setting the Page Size, Media Type, and Layout When Printing from a Mobile Phone](#)

[Page top](#) ↑

Advanced Guide

[Advanced Guide](#) > [Printing Photographs Directly from a Compliant Device or a Wireless Communication Device](#) > [Printing Photographs from a Wireless Communication Device](#) > [Printing Photographs from a Wireless Communication Device](#)

Printing Photographs from a Wireless Communication Device

You can print photographs from a mobile phone through infrared communication. Also, if the optional Bluetooth Unit BU-30 is connected to the machine, you can perform wireless printing from Bluetooth compatible mobile phones or computers.

Important

- To perform printing correctly from a mobile phone through Infrared communication, the following conditions should be satisfied.

Compatible devices: A mobile phone with an IrDA port that supports image data transmission through Infrared communication.

Printable data: Images shot with the mobile phone's camera.

- **When printing photos through Infrared Communication:**

- ➡ [Setting the Page Size, Media Type, and Layout When Printing from a Mobile Phone](#)
- ➡ [Printing via Infrared Communication](#)

- **When printing photos through Bluetooth communication:**

- ➡ [Setting the Page Size, Media Type, and Layout When Printing from a Mobile Phone](#)
- ➡ [Printing via Bluetooth Communication](#)

[Page top](#) ↑

Advanced Guide

Advanced Guide > Printing Photographs Directly from a Compliant Device or a Wireless Communication Device > Printing Photographs from a Wireless Communication Device > Printing via Infrared Communication

Printing via Infrared Communication

You can print photos saved on your mobile phone via infrared communication.

When printing through infrared communication, also refer to your mobile phone's instruction manual.

1. Make sure that the machine is turned on.
2. Load paper.
3. Set the print setting and layout.
 - ➔ [Setting the Page Size, Media Type, and Layout When Printing from a Mobile Phone](#)
4. Place the mobile phone so that its infrared port comes face to face to that of the machine at a distance of less than approximately 8 inches / 20 cm.

Note

- The effective angle of the IrDA Port (B) of the machine is about 10 degrees up, left, or right from the central axis (A). The effective range of communication with the machine depends on the mobile phone you are using. For details, refer to your mobile phone's instruction manual.

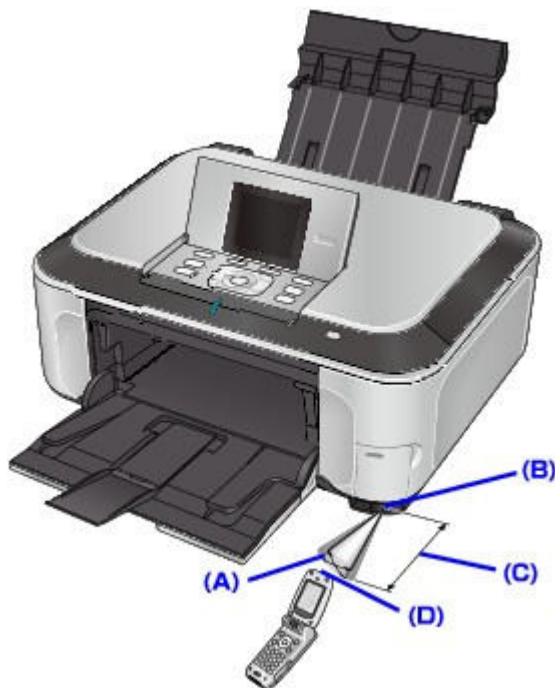

- (A) Effective angle: 10 degrees up, left, or right from the central axis
- (B) IrDA Port of the machine
- (C) Approximately 8 inches / 20 cm (Do not block with an object.)
- (D) IrDA Port of the mobile phone

5. Select the photo to print and send the data to the machine using the infrared communication function of the mobile phone.

Printing will start after receiving all data.

Note

- Do not place any obstacle between the infrared ports of the machine and mobile phone, as it

- will block data transmission.
 - During receiving data, be careful not to interrupt infrared communication with the machine. If it is interrupted, send the data from the mobile phone again.
 - Depending on your device, the print quality may be degraded due to the restriction on the infrared transfer capacity.
 - We recommend printing on sticker when the print quality on other types of paper is not fine.
 - Video files cannot be printed.
 - Depending on the size of a photo, it may take a while for this machine to start printing after starting infrared communication.
 - **About transmittable data**
 - Due to security settings on the mobile phone, downloaded content or photos downloaded from a URL attached to an E-mail cannot be printed.
 - Depending on the size of a photo, it may take a while for this machine to start printing after starting infrared communication.
 - Printed quality and orientation (portrait or landscape) are determined automatically according to the shot photo size.
 - Depending on the photo size shot on the mobile phone, the edges of the image may be cut off when performing borderless printing; the margin size may change when printing with borders.
 - If the photo file is over 1.8 MB in size, it may not be possible to send the file.
-

Advanced Guide

Advanced Guide > Printing Photographs Directly from a Compliant Device or a Wireless Communication Device > Printing Photographs from a Wireless Communication Device > Printing via Bluetooth Communication

Printing via Bluetooth Communication

This section describes the procedure to print photos through Bluetooth communication from a mobile phone with the optional Bluetooth Unit BU-30.

When printing from a mobile phone through Bluetooth communication, refer also to your product's instruction manual.

For the procedure to print through Bluetooth communication from the computer, refer to [About Bluetooth Communication](#).

Note

- Mobile phones supporting OPP (Object Push Profile) or BIP (Basic Imaging Profile) can be used to print photos. Depending on your mobile phone, you may not perform printing even if your mobile phone supports the profiles above. For information on the profiles your mobile phone supports, refer to your product's instruction manual.

Printing through Bluetooth Communication

- 1. Make sure that the machine is turned on.**
- 2. Load paper.**
- 3. Attach the optional Bluetooth Unit BU-30.**

Insert the Bluetooth Unit BU-30 to the Direct Print Port.



- 4. Set the page size and layout.**
 - ➡ [Setting the Page Size, Media Type, and Layout When Printing from a Mobile Phone](#)
- 5. Start printing from a mobile phone.**

- **For the device name, select the default value Canon XXX-1 (where "XXX" is your machine's name).**
- **If you are required to input a passkey, input the default value "0000".**

You can change the device name of the machine, passkey, and so on from the Bluetooth settings screen.

[➔ Changing the Bluetooth Settings](#)

Note

- Communication is possible in a range of up to about 33 ft. / 10 m depending on the conditions below. Printing speed may vary depending on the following conditions:
 - Presence of obstacles between the communication equipment, and radio conditions.
 - Presence of magnetic fields, static electricity, or electromagnetic interference.
 - Receiver sensitivity and antenna performance of the communication equipment.
 - Video files cannot be printed.
 - Depending on your device, data saved on a memory card may not be printed.
 - For the transmittable data, see [About transmittable data](#).
-

[Page top](#) ↑

Advanced Guide

Advanced Guide > Printing Photographs Directly from a Compliant Device or a Wireless Communication Device > Printing Photographs from a Wireless Communication Device > Printing via Bluetooth Communication > Changing the Bluetooth Settings

Changing the Bluetooth Settings

As preparation for printing through Bluetooth communication, you can change the settings such as the device name and passkey from the Bluetooth settings screen.

This section describes how to display the Bluetooth settings screen. For each setting item, see [Bluetooth settings](#).

1. Make sure that the machine is turned on.

2. Attach the optional Bluetooth Unit BU-30.

Insert the Bluetooth Unit BU-30 to the Direct Print Port.



3. Select  Settings on the HOME screen, then press the **OK** button.

4. Select  Device settings, then press the **OK** button.

5. Select Bluetooth settings, then press the **OK** button.

The Bluetooth settings screen is displayed.

➔ [Bluetooth Settings Screen](#)

Advanced Guide

[Advanced Guide](#) > [Printing Photographs Directly from a Compliant Device or a Wireless Communication Device](#) > [Printing Photographs from a Wireless Communication Device](#) > [Setting the Page Size, Media Type, and Layout When Printing from a Mobile Phone](#)

Setting the Page Size, Media Type, and Layout When Printing from a Mobile Phone

When printing from a mobile phone through Infrared communication or Bluetooth communication, select the page size, media type, layout, and borderless print setting on the Mobile phone print setting screen. For details on how to print from a computer through Bluetooth communication, refer to [About Bluetooth Communication](#).

* The default is borderless printing on 4" x 6" Photo Paper Plus Glossy II.

Displaying the Mobile phone print setting screen

This section describes how to display the Mobile phone print setting screen. For setting items, see [Mobile phone print setting](#).

1. Make sure that the machine is turned on.

2. Select  Settings on the HOME screen, then press the **OK** button.

3. Select  Device settings, then press the **OK** button.

4. Select Mobile phone print setting, then press the **OK** button.

The Mobile phone print setting screen is displayed. For the setting items, see [Mobile phone print setting](#).

[Page top](#) ↑

Advanced Guide

Advanced Guide > Maintenance

Maintenance

- ➔ [Cleaning Your Machine](#)
- ➔ [Aligning the Print Head Manually](#)
- ➔ [Performing Maintenance from a Computer](#)

[Page top](#) ↑

Advanced Guide

[Advanced Guide](#) > [Maintenance](#) > [Cleaning Your Machine](#)

Cleaning Your Machine

- ➔ [Cleaning](#)
- ➔ [Cleaning the Exterior of the Machine](#)
- ➔ [Cleaning the Platen Glass and Document Cover](#)
- ➔ [Cleaning the Inside of the Machine \(Bottom Plate Cleaning\)](#)
- ➔ [Cleaning the Protrusions Inside the Machine](#)

[Page top](#) ↕

Advanced Guide

[Advanced Guide](#) > [Maintenance](#) > [Cleaning Your Machine](#) > [Cleaning](#)

Cleaning

This section describes the cleaning procedure that is needed to maintain your machine.

Important

- Do not use tissue paper, paper towels, rough-textured cloth, or similar materials for cleaning so as not to scratch the surface. Paper tissue powder or fine threads may remain inside the machine and cause problems such as print head blockage and poor printing results. Be sure to use a soft cloth.
- Never use volatile liquids such as thinners, benzene, acetone, or any other chemical cleaner to clean the machine, as this may cause a malfunction or damage the machine's surface.

- ➔ [Cleaning the Exterior of the Machine](#)
- ➔ [Cleaning the Platen Glass and Document Cover](#)
- ➔ [Cleaning the Inside of the Machine \(Bottom Plate Cleaning\)](#)
- ➔ [Cleaning the Protrusions Inside the Machine](#)

[Page top](#) ↑

Advanced Guide

[Advanced Guide](#) > [Maintenance](#) > [Cleaning Your Machine](#) > [Cleaning the Exterior of the Machine](#)

Cleaning the Exterior of the Machine

Be sure to use a soft cloth such as eyeglasses cleaning cloth and wipe off dirt on the surface gently. Smooth out wrinkles on the cloth if necessary before cleaning.

Important

- Be sure to turn off the power and disconnect the power plug before cleaning the machine.
- Do not use tissue paper, paper towels, rough-textured cloth, or similar materials, as this may scratch the surface.

[Page top](#) ↑

Advanced Guide

Advanced Guide > Maintenance > Cleaning Your Machine > Cleaning the Platen Glass and Document Cover

Cleaning the Platen Glass and Document Cover

Important

- Be sure to turn off the power and disconnect the power plug before cleaning the machine.

With a clean, soft, lint-free cloth, wipe the Platen Glass (A), the FAU (Film Adapter Unit) Protective Sheet (white sheet) (B), and the FAU lamp (C) gently. Make sure not to leave any residue, especially on the Platen Glass.

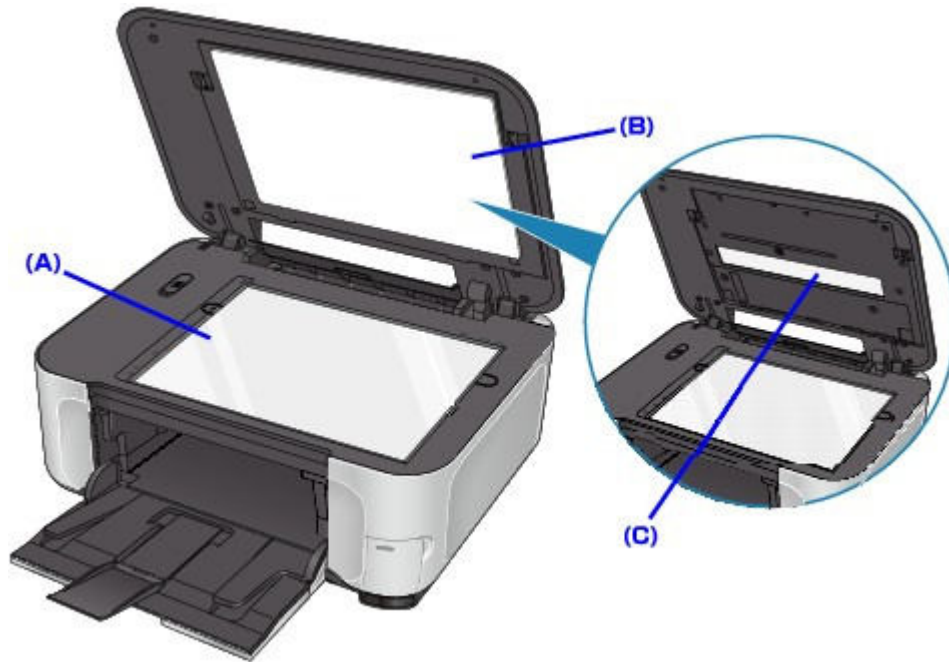

Important



- The FAU (Film Adapter Unit) Protective Sheet (white sheet) (B) is easily damaged, so wipe it gently.

Advanced Guide

Advanced Guide > Maintenance > Cleaning Your Machine > Cleaning the Inside of the Machine (Bottom Plate Cleaning)

Cleaning the Inside of the Machine (Bottom Plate Cleaning)

This section explains how to clean the inside of the machine. If the inside of the machine becomes dirty, printed paper may get dirty, so we recommend performing cleaning regularly.

1. Make sure that the machine is turned on.
2. Open the Paper Output Tray.
Open the Paper Output Tray gently.
3. Open the Output Tray Extension.
4. Select  Settings on the HOME screen, then press the **OK** button.
The Settings screen is displayed.
5. Select  Maintenance, then press the **OK** button.
The Maintenance screen is displayed.
6. Select Bottom plate cleaning, then press the **OK** button.
The confirmation screen is displayed.
7. Select Yes, then press the **OK** button.
8. Remove any paper from the Rear Tray, follow the on-screen instructions.
9. Fold a single sheet of A4 or Letter-sized plain paper in half widthwise, then unfold the paper, follow the on-screen instructions.
10. Load this and only this sheet of paper on the Rear Tray with the open side facing to the front, follow the on-screen instructions.



(A) Load the paper after unfolding it.

The paper cleans the inside of the machine as it feeds through the machine.

Check the folded part of the ejected paper. If it is smudged with ink, perform Bottom Plate Cleaning again.

If the problem is not resolved after performing cleaning again, the protrusions inside the machine may be stained. Clean them according to instructions.

➔ [Cleaning the Protrusions Inside the Machine](#)



Note

- When performing Bottom Plate Cleaning again, be sure to use a new sheet of paper.

Advanced Guide

[Advanced Guide](#) > [Maintenance](#) > [Cleaning Your Machine](#) > [Cleaning the Protrusions Inside the Machine](#)

Cleaning the Protrusions Inside the Machine

If protrusions inside the machine are stained, wipe off any ink from the protrusions using a cotton swab or the like.

Important

- Be sure to turn off the power and disconnect the power plug before cleaning the machine.

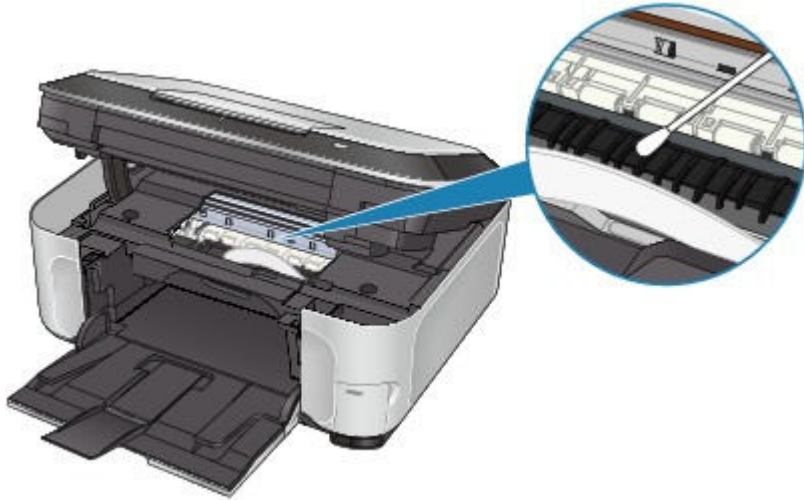

[Page top](#) ↑

Advanced Guide

[Advanced Guide](#) > [Maintenance](#) > [Aligning the Print Head Manually](#)

Aligning the Print Head Manually

➔ [Manual Print Head Alignment](#)

[Page top](#) ↑

Advanced Guide

Advanced Guide > Maintenance > Aligning the Print Head Manually > Manual Print Head Alignment

Manual Print Head Alignment

This section describes how to align the Print Head manually.

If the results of Automatic Print Head Alignment are not satisfactory, follow the procedure below to perform Manual Print Head Alignment to precisely align the Print Head.

For details on performing Automatic Print Head Alignment, see [Routine Maintenance](#).

Note

- Close the Inner Cover if it is open.
- The print head alignment pattern is printed in black and blue only.

1. Make sure that the printer is turned on.
2. Load three sheets of A4 or Letter-sized plain paper in the Cassette.
3. Open the Paper Output Tray and the Output Tray Extension.
4. Select  Settings on the HOME screen, then press the **OK** button.
The Settings screen is displayed.

5. Select  Maintenance, then press the **OK** button.
The Maintenance screen is displayed.

6. Select Manual head align, then press the **OK** button.
The confirmation screen is displayed.

Note

- To confirm the current setting, select Head alignment print and print the pattern.

7. Select Yes, then press the **OK** button.
The print head alignment pattern is printed.

Important

- Do not open the Scanning Unit (Cover) while printing is in progress.

8. When Did the patterns print correctly? is displayed, confirm that the pattern is printed correctly, select Yes, then press the **OK** button.
The input screen for the head position adjustment values is displayed.

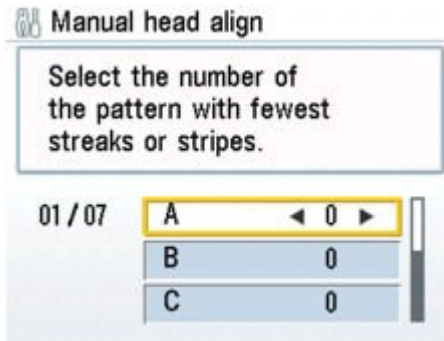

9. Check the printed patterns, and use the ◀▶ button to input the number of the pattern in column A that has the least noticeable vertical streaks.

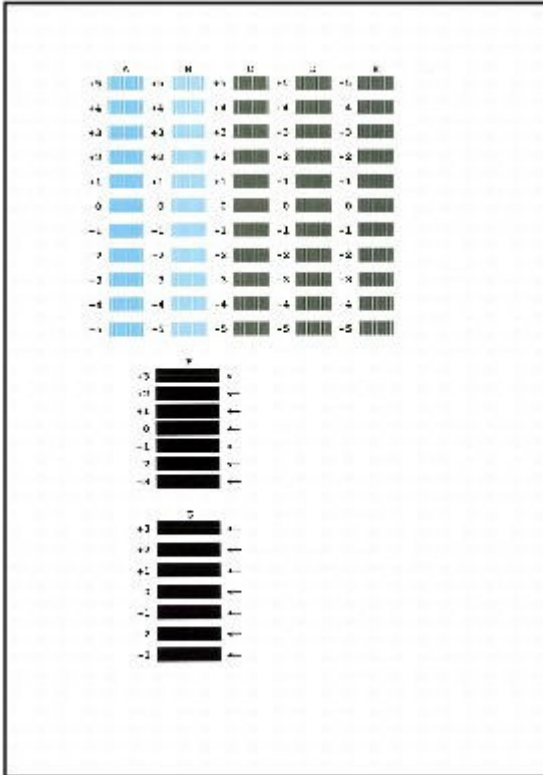

Note

- If it is difficult to pick the best pattern, pick the setting that produces the least noticeable vertical white streaks.



- (A) Less noticeable vertical white streaks
 (B) More noticeable vertical white streaks

10. Repeat the same procedure until you finish inputting the pattern number for columns B to G, then press the **OK** button.

For the column F and G, pick the setting pointed by an arrow that produces the least noticeable horizontal streaks.

Note

- If it is difficult to pick the best pattern, pick the setting that produces the least noticeable horizontal white streaks.



- (C) Less noticeable horizontal white streaks
 (D) More noticeable horizontal white streaks

11. Confirm the displayed message and press the **OK** button.

The second pattern is printed.

Important

- Do not open the Scanning Unit (Cover) while printing is in progress.

12. Check the printed patterns, and use the button to input the number of the pattern in column H that has the least noticeable vertical streaks.

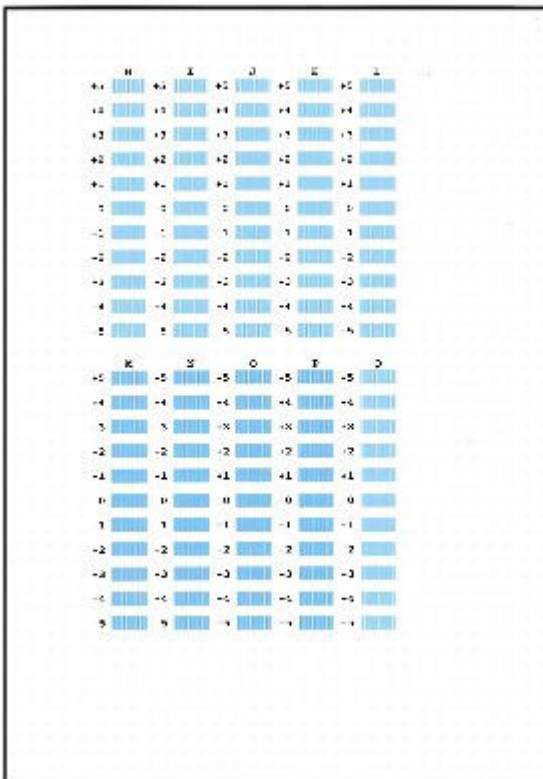

Note

- If it is difficult to pick the best pattern, pick the setting that produces the least noticeable vertical white streaks.





- (E) Less noticeable vertical white streaks
 (F) More noticeable vertical white streaks

13. Repeat the same procedure until you finish inputting the pattern number for columns l to Q, then press the **OK** button.
14. Confirm the displayed message and press the **OK** button.
The third pattern is printed.

Important

- Do not open the Scanning Unit (Cover) while printing is in progress.

15. Check the printed patterns, and use the   button to input the number of the pattern in column a that has the least noticeable horizontal streaks.

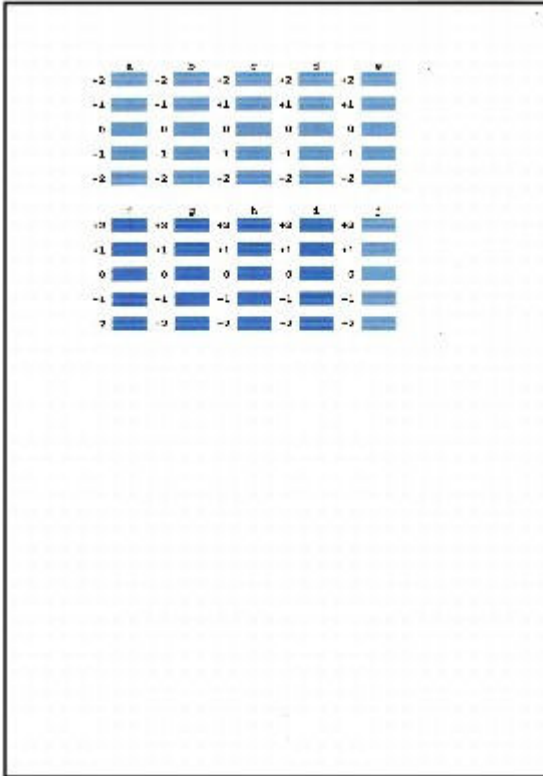

Note

- If it is difficult to pick the best pattern, pick the setting that produces the least noticeable horizontal white streaks.



- (G) Less noticeable horizontal white streaks
(H) More noticeable horizontal white streaks

16. Repeat the same procedure until you finish inputting the pattern number for columns b to j, then press the **OK** button.

Advanced Guide

Advanced Guide > Maintenance > Performing Maintenance from a Computer

Performing Maintenance from a Computer

- ➔ Cleaning the Print Heads
- ➔ Cleaning the Paper Feed Rollers
- ➔ Aligning the Print Head Position
- ➔ Checking the Print Head Nozzles
- ➔ Cleaning Inside the Machine

[Page top](#) ↕

Advanced Guide

Advanced Guide > Maintenance > Performing Maintenance from a Computer > Cleaning the Print Heads

Cleaning the Print Heads

The print head cleaning function allows you to unclog clogged nozzles in the print head. Perform print head cleaning if printing is faint or a specific color fails to print, even though there is enough ink.

The procedure for cleaning the print heads is as follows:



Cleaning

1. Open the [printer driver setup window](#)

2. Click Cleaning on the Maintenance tab

The Print Head Cleaning dialog box opens. Follow the instruction shown in the dialog box. Click Initial Check Items to display the items you need to check before performing Cleaning.

3. Execute cleaning

Make sure that the machine is on and then click Execute.
Print head cleaning starts.

4. Complete cleaning

The Nozzle Check dialog box opens after the confirmation message.

5. Check the results

To check whether the print quality has improved, click Print Check Pattern. To cancel the check process, click Cancel.

If cleaning the head once does not resolve the print head problem, clean it once more.



Deep Cleaning

Deep Cleaning is more thorough than cleaning. Perform deep cleaning when two Cleaning attempts do not resolve the print head problem.

1. Open the [printer driver setup window](#)

2. Click Deep Cleaning on the Maintenance tab

The Deep Cleaning dialog box opens. Follow the instruction shown in the dialog box. Click Initial Check Items to display the items you need to check before performing Deep Cleaning.

3. Execute deep cleaning

Make sure that the machine is on and then click Execute.
Click OK when the confirmation message appears.
Print head deep cleaning starts.

4. Complete deep cleaning

The Nozzle Check dialog box opens after the confirmation message.

5. Check the results

To check whether the print quality has improved, click Print Check Pattern. To cancel the check process, click Cancel.

Important

- Cleaning consumes a small amount of ink. Deep Cleaning consumes a larger amount of ink than Cleaning. Cleaning the print heads frequently will rapidly deplete your printer's ink supply. Consequently, perform cleaning only when necessary.

Note

- If there is no sign of improvement after Deep Cleaning, switch off the machine, wait 24 hours, and then perform Deep Cleaning again. If there is still no sign of improvement, the ink may have run out or the print head may be worn. For details on the remedial action to be taken, see "[Machine Moves But Ink Is Not Ejected.](#)"

Related Topic

[➔ Checking the Print Head Nozzles](#)

[Page top](#) 

Advanced Guide

[Advanced Guide](#) > [Maintenance](#) > [Performing Maintenance from a Computer](#) > [Cleaning the Paper Feed Rollers](#)

Cleaning the Paper Feed Rollers

Cleans the paper feed roller. Perform feed roller cleaning when there are paper particles sticking to the paper feed roller and paper is not fed properly.

The procedure for performing the feed roller cleaning is as follows:

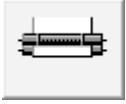

Roller Cleaning

- 1. Prepare the machine**
Remove all sheets of paper from the paper source from which paper could not be properly fed.
- 2. Open the [printer driver setup window](#)**
- 3. Click Roller Cleaning on the Maintenance tab**
The Roller Cleaning dialog box opens.
- 4. Select Rear Tray or Cassette, and click OK**
The confirmation message appears.
- 5. Execute paper feed roller cleaning**
Make sure that the machine is on and click OK.
Paper feed roller cleaning starts.
- 6. Complete paper feed roller cleaning**
After the rollers have stopped, follow the instruction in the message, load three sheets of plain paper into the selected paper source of the machine, and click OK.
Paper will be ejected and feed roller cleaning will be completed.

[Page top](#) ↕

Advanced Guide

Advanced Guide > Maintenance > Performing Maintenance from a Computer > Aligning the Print Head Position

Aligning the Print Head Position

Print head alignment corrects the installation positions of the print head and improves deviated colors and lines.

This machine supports two head alignment methods: automatic head alignment and manual head alignment. Normally, the machine is set for automatic head alignment. If the printing results of automatic print head alignment are not satisfactory, see " [Manual Print Head Alignment](#)," and perform manual head alignment. To change to the manual head alignment, click Custom Settings on the Maintenance tab, and then check the Align heads manually check box.

The procedure for performing print head alignment is as follows:



Print Head Alignment

1. Open the [printer driver setup window](#)
2. Click Print Head Alignment on the Maintenance tab

The Start Print Head Alignment dialog box opens.

3. Load paper in the machine

Load a sheet of A4 size or Letter size Matte Photo Paper (MP-101) into the rear tray.



Note

- The type of media and number of sheets to be used differ when you select the manual head alignment.

4. Execute head alignment

Make sure that the machine is on and click Align Print Head.

Follow the instruction in the message.



Note

- To print and check the current setting, open the Start Print Head Alignment dialog box, and click Print Alignment Value.

Advanced Guide

[Advanced Guide](#) > [Maintenance](#) > [Performing Maintenance from a Computer](#) > [Checking the Print Head Nozzles](#)

Checking the Print Head Nozzles

The nozzle check function allows you to check whether the print heads are working properly by printing a nozzle check pattern. Print the pattern if printing becomes faint, or if a specific color fails to print.

The procedure for printing a nozzle check pattern is as follows:

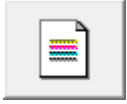

Nozzle Check

- 1. Open the printer driver setup window**
- 2. Click Nozzle Check on the Maintenance tab**

The Nozzle Check dialog box opens.
To display a list of items that you should check before printing the check pattern, click Initial Check Items.
- 3. Load paper in the machine**

Load a sheet of A4 size or Letter size plain paper into the cassette.
- 4. Print a nozzle check pattern**

Make sure that the machine is on and click Print Check Pattern.
The nozzle check pattern is printed.
Click OK when the confirmation message appears.
The Pattern Check dialog box opens.
- 5. Check the print result**

Check the print result. When the print result is normal, click Exit.
If the print result is smudged or if there are any unprinted sections, click Cleaning to clean the print head.

Related Topic

➔ [Cleaning the Print Heads](#)

[Page top](#) ↕

Advanced Guide

[Advanced Guide](#) > [Maintenance](#) > [Performing Maintenance from a Computer](#) > [Cleaning Inside the Machine](#)

Cleaning Inside the Machine

Perform bottom plate cleaning before you execute duplex printing to prevent smudges on the back side of the paper.

Also perform bottom plate cleaning if ink smudges caused by something other than print data appear on the printed page.

For details on how to load paper into the machine, see "[Cleaning the Inside of the Machine \(Bottom Plate Cleaning\)](#)."

The procedure for performing bottom plate cleaning is as follows:



Bottom Plate Cleaning

1. Open the [printer driver setup window](#)
2. Click Bottom Plate Cleaning on the Maintenance tab
The Bottom Plate Cleaning dialog box opens.
3. Load paper in the machine
As instructed in the dialog box, fold the A4 size or Letter size plain paper in half horizontally, and then unfold the sheet.
Load the paper into the rear tray in the portrait orientation with the crest of the crease facing down.
4. Perform the bottom plate cleaning
Make sure that the machine is on and click Execute.
Bottom plate cleaning starts.

[Page top](#) ↑

Advanced Guide

Advanced Guide > About Bluetooth Communication

About Bluetooth Communication

- ➔ [Handling Precautions](#)
- ➔ [Preparation to Use the Bluetooth Unit](#)
- ➔ [Printing Data via Bluetooth Communication](#)
- ➔ [Basic Procedure for Printing via Bluetooth Communication](#)
- ➔ [Bluetooth Settings](#)
- ➔ [Troubleshooting](#)
- ➔ [Specifications](#)

[Page top](#) ↑

Advanced Guide

[Advanced Guide](#) > [About Bluetooth Communication](#) > [Handling Precautions](#)

Handling Precautions

➔ [Shipping the Product](#)

[Page top](#) ↑

Advanced Guide

[Advanced Guide](#) > [About Bluetooth Communication](#) > [Handling Precautions](#) > [Shipping the Product](#)

Shipping the Product

This product may not be used in countries or regions other than the country or region where it was purchased due to local laws and regulations. Please note that the use of this product in such countries or regions may lead to penalties and that Canon should not be liable for such punishment.

[Page top](#) ↑

Advanced Guide

[Advanced Guide](#) > [About Bluetooth Communication](#) > [Preparation to Use the Bluetooth Unit](#)

Preparation to Use the Bluetooth Unit

- ➔ [Bluetooth Unit](#)
- ➔ [Attaching to and Removing from the Printer](#)

[Page top](#) ↕

Advanced Guide

[Advanced Guide](#) > [About Bluetooth Communication](#) > [Preparation to Use the Bluetooth Unit](#) > [Bluetooth Unit](#)

Bluetooth Unit

The Bluetooth Unit BU-30 (hereafter referred to as the Bluetooth unit) is an adaptor which can be used with a Canon IJ printer with Bluetooth interface.

By attaching the Bluetooth unit to a Canon IJ printer with Bluetooth interface, wireless printing from a Bluetooth enabled device, such as a computer or mobile phone, is possible.

Note

- Communication is possible in a range of up to about 33 ft. / 10 m depending on the conditions below. Printing speed may vary depending on the following conditions:
 - Presence of obstacles between the communication equipment and radio wave conditions.
 - Presence of magnetic fields, static electricity or electromagnetic interference.
 - Software and operating system to be used.
 - Receiver sensitivity and antenna performance of the communication equipment.
-

[Page top](#) ↑

Advanced Guide

Advanced Guide > About Bluetooth Communication > Preparation to Use the Bluetooth Unit > Attaching to and Removing from the Printer

Attaching to and Removing from the Printer

- ➔ Attaching the Bluetooth Unit to the Printer
- ➔ Removing the Bluetooth Unit from the Printer

Attaching the Bluetooth Unit to the Printer

Attach the Bluetooth unit to the Direct Print Port (A) of the printer in accordance with the following procedure.

The external appearance may differ depending on the printer you are using.

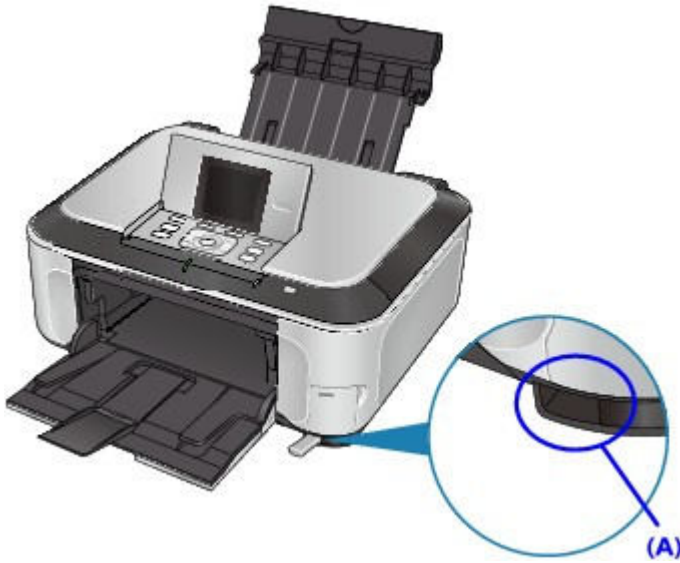

1. Make sure that the printer is turned on.

Make sure that the **Power** lamp is lit.

2. Insert the Bluetooth unit to the Direct Print Port of the printer.

Detach the cap from the Bluetooth unit. Store the cap in a safe location.



Note

- When the Bluetooth unit is properly attached to the printer, the **Power** lamp on the printer flashes twice.

Removing the Bluetooth Unit from the Printer

Remove the Bluetooth unit from the Direct Print Port of the printer in accordance with the following procedure.

1. Remove the Bluetooth unit from the Direct Print Port of the printer.

Important

- Make sure that the lamp on the Bluetooth unit is neither lit nor flashing before you remove the Bluetooth unit.



Important

- Store the Bluetooth unit with the cap attached.

Advanced Guide

[Advanced Guide](#) > [About Bluetooth Communication](#) > [Printing Data via Bluetooth Communication](#)

Printing Data via Bluetooth Communication

- ➔ [Preparation](#)
- ➔ [Installing the MP Drivers](#)
- ➔ [Setting the Printer](#)
- ➔ [Registering the Printer](#)
- ➔ [Deleting the Printer](#)

[Page top](#) ↕

Advanced Guide

Advanced Guide > About Bluetooth Communication > Printing Data via Bluetooth Communication > Preparation

Preparation

In order to print via Bluetooth communication with Windows, the following system requirements must be satisfied.

- **Computer**

A computer in which an internal Bluetooth module is installed or a computer to which an optional Bluetooth adapter (available from various manufacturers) is attached.

- **OS**

Microsoft Windows Vista (Satisfying any one of the following conditions is needed)

- **Bluetooth Devices is displayed in Hardware and Sound under Control Panel**

- **Bluetooth Stack for Windows by Toshiba Version 5.10.04 or later is installed**

Microsoft Windows XP (Satisfying any one of the following conditions is needed)

- **Windows XP SP2 or later is installed, and Bluetooth Devices is displayed in Printers and Other Hardware under Control Panel**

- **Bluetooth Stack for Windows by Toshiba Version 3.00.10 or later is installed**

For more information about how to confirm the version of Bluetooth Stack for Windows by Toshiba, see [Check 2: Is unsupported Bluetooth driver used?](#) .

In order to connect the Bluetooth unit and print via Bluetooth communication, the following steps are required.

1. Check that the Bluetooth unit is properly attached to the printer.

See [Attaching to and Removing from the Printer](#) .

2. Install the MP Drivers.

See [Installing the MP Drivers](#) .

3. Check the device name of the printer using the LCD.

See [Setting the Printer](#) .

4. Register the printer as a Bluetooth device using Bluetooth Devices.

- When using Windows Vista, and when Bluetooth Devices is displayed in Hardware and Sound under Control Panel
Authenticate the printer as a Bluetooth device on Bluetooth Devices in Hardware and Sound under Control Panel.
See [Registering the Printer](#) .
- When using Windows XP SP2 or later, and when Bluetooth Devices is displayed in Printers and Other Hardware under Control Panel
Authenticate the printer as a Bluetooth device on Bluetooth Devices in Printers and Other Hardware under Control Panel.
See [Registering the Printer](#) .
- When using a Toshiba Windows Vista or Windows XP computer
Authenticate the printer as a Bluetooth device using Bluetooth Settings*.

* When the computer which has Bluetooth Stack for Windows by Toshiba or the program attached to the Bluetooth adapter of the option manufactured by Toshiba is used, the computer can register a printer easily.

Bluetooth Settings can be started by clicking Start and selecting All Programs, TOSHIBA, Bluetooth, and Bluetooth Settings.

For details on Bluetooth Settings, refer to the software application's instruction manual.

The operations may vary depending on your operating program. In this case, refer to your computer's operation manual.

[Page top](#) ↑

Advanced Guide

[Advanced Guide](#) > [About Bluetooth Communication](#) > [Printing Data via Bluetooth Communication](#) > [Installing the MP Drivers](#)

Installing the MP Drivers

Note

- If you use the printer connecting with a computer, the MP Drivers have already been installed. In this case, move to the next step.
 - ➔ [Setting the Printer](#)
-

Before connecting the Bluetooth unit to the printer for wireless printing, first the USB cable must be connected between the printer and computer, and the MP Drivers must be installed.

If you reinstall the MP Drivers, perform Custom Install on the *Setup CD-ROM*, then select MP Drivers.

[Page top](#) ↑

Advanced Guide

Advanced Guide > About Bluetooth Communication > Printing Data via Bluetooth Communication > Setting the Printer

Setting the Printer

This section describes the procedures for checking the settings of the Bluetooth unit on the LCD of the printer in preparation for Bluetooth printing.

The screens may differ depending on the printer you are using.

If you need more information about the Bluetooth settings, see [Setting Bluetooth Printing](#).

1. Make sure that the Bluetooth unit is attached and the printer is turned on.

For information about how to attach the Bluetooth unit, see [Attaching to and Removing from the Printer](#).

2. Display the Bluetooth settings screen on the LCD.

For information about how to display the Bluetooth settings screen, refer to [Changing the Machine Settings on the LCD](#).

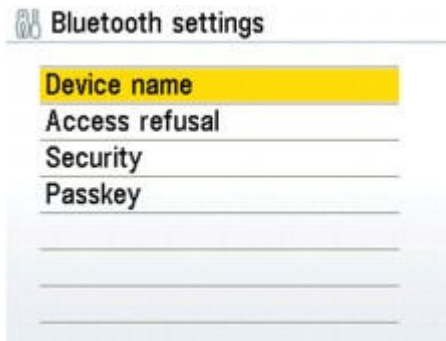

Note

- If the Bluetooth settings screen is not displayed on the LCD, the Bluetooth unit may not be attached correctly. Remove the Bluetooth unit from the printer and attach it once again.
- For details, see [Attaching to and Removing from the Printer](#).
- If the Bluetooth settings screen still is not displayed, the Bluetooth unit may be faulty. In this case, contact the service center.

3. Select Device name.

The Device name screen is displayed.

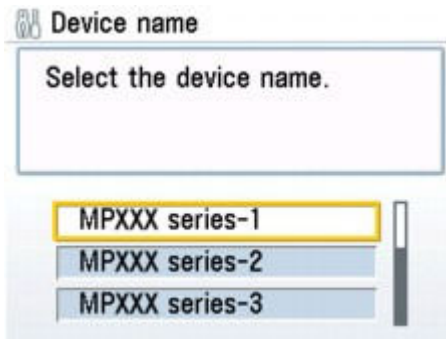

4. Check the device name.

The device name is necessary to register the printer as a Bluetooth device. Be sure to note the device name.

Note

- If multiple printer units with the same model name are connected to the system, assigning a

different device name to each printer is recommended for easy identification of the printer you will use. See [Bluetooth Settings Screen](#) .

After checking the device name, press the **OK** button on the printer.

After checking the Bluetooth settings using the LCD, register the printer on your computer.

➡ [Registering the Printer](#)

[Page top](#) ↑

Advanced Guide

Advanced Guide > About Bluetooth Communication > Printing Data via Bluetooth Communication > Registering the Printer

Registering the Printer

Register the printer as a Bluetooth device using Bluetooth Devices under Control Panel.

Note

- The following procedure is described assuming that Windows Vista has been installed in your computer.
- Before registering the printer on Bluetooth Devices under Control Panel, enable the Bluetooth function of your computer.
For more information, refer to your computer's operation manual.
- If you want to re-register the printer as a Bluetooth device, first delete the registered printer, and then re-register it.
See [Deleting the Printer](#).

1. Log into a user account with the administrator privilege.
2. Click Control Panel, then Bluetooth Devices under Hardware and Sound.
In non-Vista Windows, click Control Panel, Printers and Other Hardware, then Bluetooth Devices.
3. Click Add on the Devices sheet.

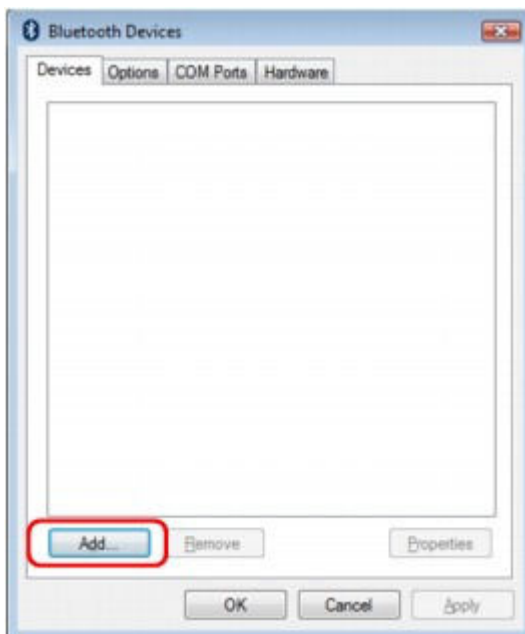

Add Bluetooth Device Wizard will start.

4. Make sure that the printer is turned on, check the My device is set up and ready to be found check box and then click Next.



5. Select the device name of the printer and click Next.

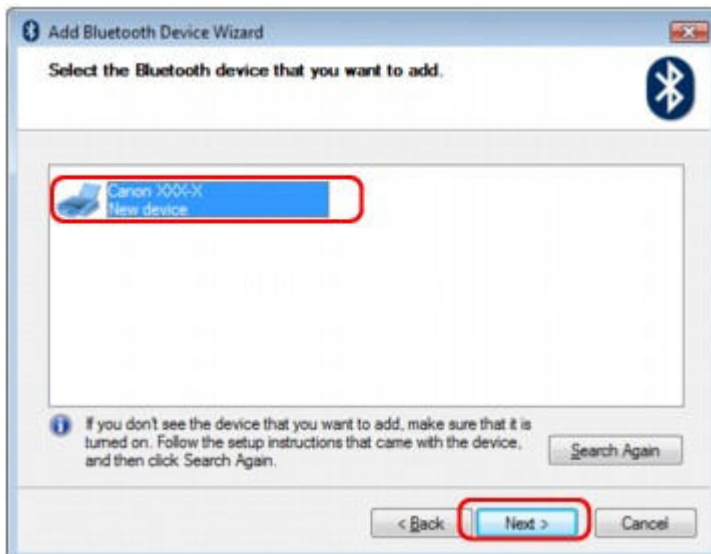

Select the same device name as that checked under [Setting the Printer](#).

Note

- If the device name is not displayed, see [Check 3: Is the printer name which you want to register displayed in Printer List?](#) .

6. Select Don't use a passkey, and then Next.

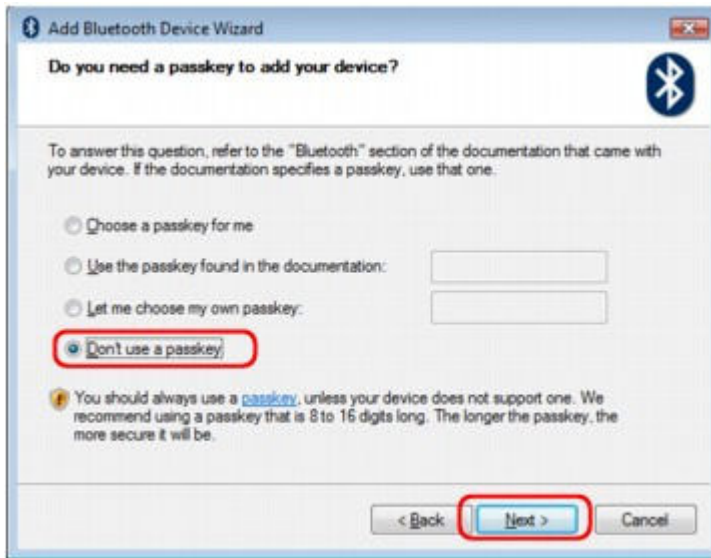

Note

- If you set a passkey on the printer, select Use the passkey found in the documentation and input the passkey then click Next.
For more information about a passkey, see [Bluetooth Settings Screen](#).

7. Click Finish.



8. Check that the device name selected at step 5 is registered on the Devices sheet, and click OK.

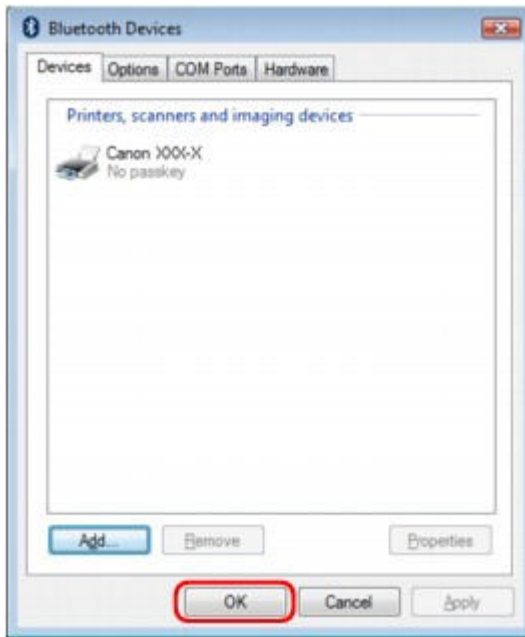

Now, the settings for printing via Bluetooth communication are ready.

Note

- In Windows Vista, the Windows needs to install driver software for your Bluetooth Peripheral Device screen may be displayed automatically. In this case, click Don't show this message again for this device.

Advanced Guide

[Advanced Guide](#) > [About Bluetooth Communication](#) > [Printing Data via Bluetooth Communication](#) > [Deleting the Printer](#)

Deleting the Printer

This section describes the procedure to delete the registered printer.

If you want to re-register the printer as a Bluetooth device, first follow the procedure below to delete the printer, and then re-register it.

For the procedure to re-register the printer, see [Registering the Printer](#).

- 1.** Log into a user account with the administrator privilege.
- 2.** Click Control Panel, then Printers under Hardware and Sound.
When using non-Vista Windows, click Control Panel, then Printers and Faxes under Printers and Other Hardware.
- 3.** Click the icon of the printer used for printing via Bluetooth communication.
- 4.** Select Delete from the Organize menu.
When using non-Vista Windows, select Delete from the File menu.

[Page top](#) ↑

Advanced Guide

[Advanced Guide](#) > [About Bluetooth Communication](#) > [Basic Procedure for Printing via Bluetooth Communication](#)

Basic Procedure for Printing via Bluetooth Communication

- ➡ [Printing with Computers](#)
- ➡ [Printing with Bluetooth Compliant Devices other than a Computer](#)

[Page top](#) ↕

Advanced Guide

Advanced Guide > About Bluetooth Communication > Basic Procedure for Printing via Bluetooth Communication > Printing with Computers

Printing with Computers

When using Bluetooth communication, also refer to the computer's instruction manual.

When printing from a Bluetooth compliant device other than a computer, see [Printing with Bluetooth Compliant Devices other than a Computer](#).

Note

- Depending on your application program, operations may differ. For details, refer to the instruction manual of your software application.
The steps described in this section are for printing in Windows Vista.
- Bluetooth communication distance: Approx. 33 ft./10 m in normal environment.
The distance may vary depending on the radio conditions or the communication equipment.

1. Turn on the printer and load paper.
2. Create a document or open a file to print using an appropriate application software.
3. Open the printer properties dialog box.
 1. Select Print on the application software's File menu.
The Print dialog box opens.
 2. Select the printer to which you attached the Bluetooth unit such as Canon XXX Printer (Copy X) from Select Printer.
 3. Click Preferences (or Properties).
The Quick Setup sheet of the Printing Preferences dialog box is displayed.

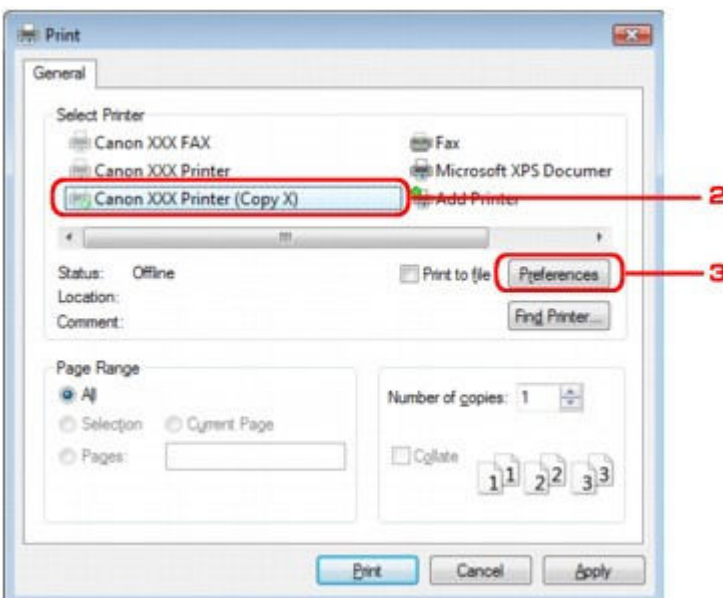

Note

- The printer registered on Bluetooth Devices is displayed as Canon XXX Printer (Copy X).
- "X" is a device name or a digit. The number of digits may differ depending on the printer.

4. Specify the required settings.

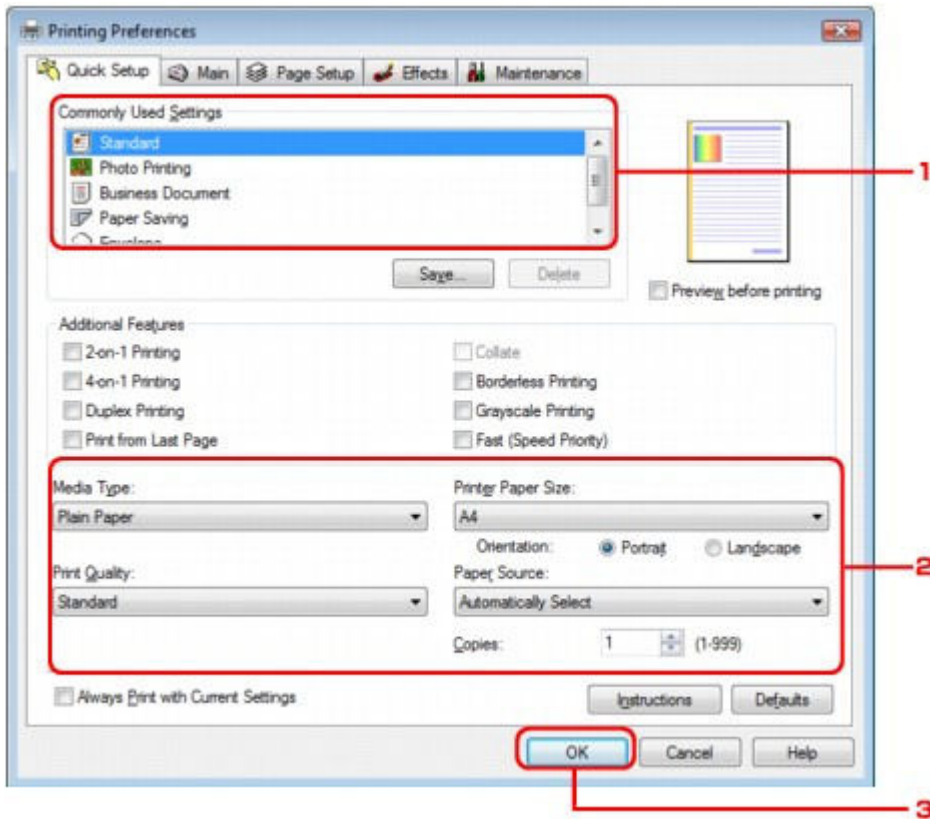

1. Select the print setting in Commonly Used Settings.
2. Confirm the required print settings in Media Type, Printer Paper Size, and so on.

Note

- You can specify the advanced print settings on Main sheet and Page Setup sheet. For details on the print settings, refer to [Various Printing Methods](#).

3. Click OK.
The Print dialog box is displayed.

5. Click Print (or OK) to print the document.

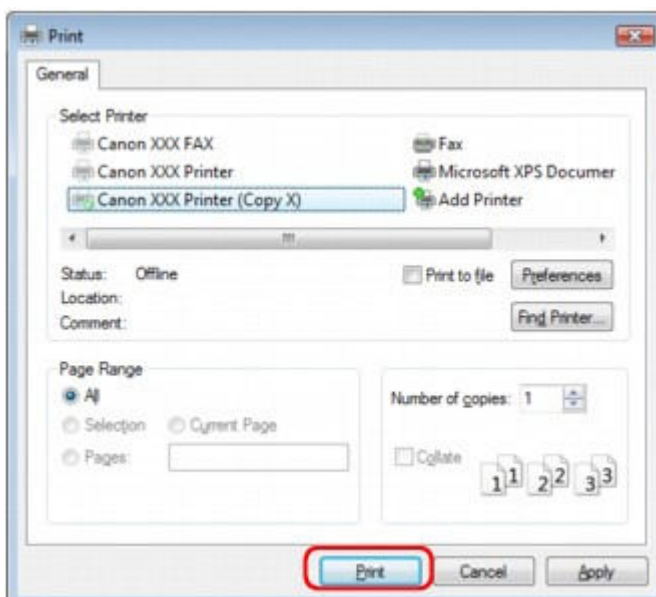

Printing begins.

Note

- When you use a USB cable for printing, select Canon XXX Printer from Select Printer.
 - To cancel a print job in progress, press the **Stop** button on the printer or click Cancel Printing on the printer status monitor. After printing is canceled, a sheet of paper may be ejected with no printing results.
To display the printer status monitor, click Canon XXX Printer (Copy X) on the taskbar.
 - "X" is a device name or a digit. The number of digits may differ depending on the printer.
-

Advanced Guide

[Advanced Guide](#) > [About Bluetooth Communication](#) > [Basic Procedure for Printing via Bluetooth Communication](#) > [Printing with Bluetooth Compliant Devices other than a Computer](#)

Printing with Bluetooth Compliant Devices other than a Computer

The LCD of the printer allows you to perform settings for printing using Bluetooth compliant devices other than a computer.

When you print with one of these devices, also refer to your product's instruction manual.

When printing from a computer, see [Printing with Computers](#) .

Note

- Mobile phones, PDAs and digital cameras supporting OPP (Object Push Profile) or BIP (Basic Imaging Profile) can print photos.
Depending on your product, you may not perform printing even if your product supports the profiles above. For details of profiles, refer to your product's instruction manual.

1. Turn on the printer and load paper.
2. Display the Mobile phone print settings screen on the LCD and set the media type and the paper size.
For information about how to display the Mobile phone print settings screen, refer to [Changing the Machine Settings on the LCD](#) .
3. Start printing from the Bluetooth compliant device.
When you select the device name, select the initial value of the printer "Canon XXX-1" (where "XXX" is your printer's name).
If you are required to input the passkey, input the initial value "0000".
You can change the device name of the printer or passkey on the Bluetooth settings screen on the LCD.

[➔ Setting Bluetooth Printing](#)

[Page top](#) ↑

Advanced Guide

Advanced Guide > About Bluetooth Communication > Bluetooth Settings

Bluetooth Settings

- ➔ [Setting Bluetooth Printing](#)
- ➔ [Bluetooth Settings Screen](#)

[Page top](#) ↕

Advanced Guide

Advanced Guide > About Bluetooth Communication > Bluetooth Settings > Setting Bluetooth Printing

Setting Bluetooth Printing

1. Make sure that the printer is turned on, and attach the Bluetooth unit.

Note

- When the Bluetooth unit is properly attached to the printer, the **Power** lamp on the printer flashes twice.
-

2. Display the Bluetooth settings screen on the LCD.

For information about how to display the Bluetooth settings screen, refer to [Changing the Machine Settings on the LCD](#).

3. Select the contents which you want to set on the LCD.

➡ [Bluetooth Settings Screen](#)

Note

- For information about how to set a media type and a paper size when printing from a mobile phone, refer to [Changing the Machine Settings on the LCD](#).
-

[Page top](#) ↑

Advanced Guide

Advanced Guide > About Bluetooth Communication > Bluetooth Settings > Bluetooth Settings Screen

Bluetooth Settings Screen

The screens may differ depending on the printer you are using.

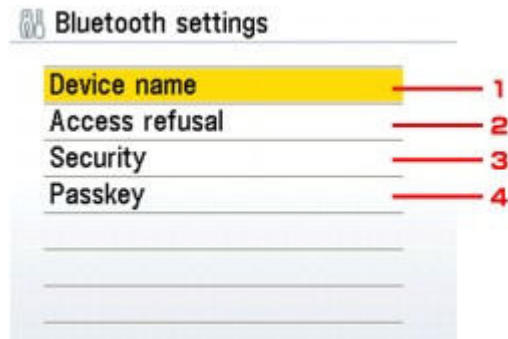

1. Device name

Displays the device name of the printer to which the Bluetooth unit is attached.

➔ [Device name Screen](#)

2. Access refusal

Selecting ON will disable searching of this printer by a Bluetooth-compatible device.

➔ [Access refusal Screen](#)

3. Security

Select Enable and then specify the security mode to activate the passkey set on the Passkey screen.

➔ [Security Screen](#)

4. Passkey

You can change the passkey. The passkey refers to an identification number to be determined. It is used to prevent unwanted access from other Bluetooth devices. The initial value is set to 0000.

➔ [Passkey Screen](#)

Device name Screen

Allows you to set the device name of the printer on a Bluetooth device.

Ex:

When you select MP990 series-2, the printer name displayed on the Bluetooth device is Canon MP990 series-2.

The initial value is set to MP990 series-1.

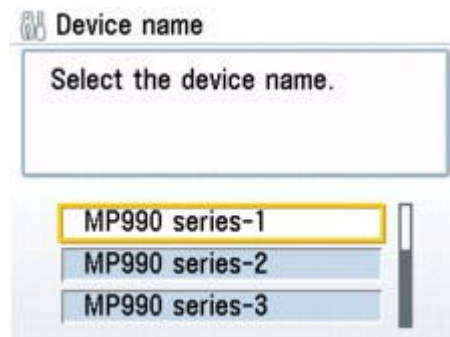

Access refusal Screen

When you search from a Bluetooth device, you can enable or disable the display of the printer name.

- **ON**
Disables searching from a Bluetooth device.
- **OFF (Default setting)**
Enables searching and printing from a Bluetooth device.

Security Screen

- **Enable**
Selecting Enable allows you to choose either of the security modes below.
 - **Mode 3(recommended)**
This mode is activated on link level enforced security.
The passkey will be required when a Bluetooth device communicates with the printer.
Normally select this mode.
 - **Mode 2**
This mode is activated on service level enforced security.
The passkey will be required when printing through the Bluetooth communication.After setting the security mode, we recommend making a trial print through Bluetooth communication. If printing does not start, change the security mode and try again.
Setting a passkey will prevent unwanted access from other Bluetooth devices. You can change the passkey on the Passkey screen.
- **Disable (Default setting)**
When you register the printer, you are not required to input a passkey.

Passkey Screen

When you select Enable on the Security screen, you are required to set a passkey to register the printer on other Bluetooth devices.

After you change the passkey, you may be asked to input the passkey on the Bluetooth devices you were able to print from before the passkey was changed. In this case, input the new passkey.

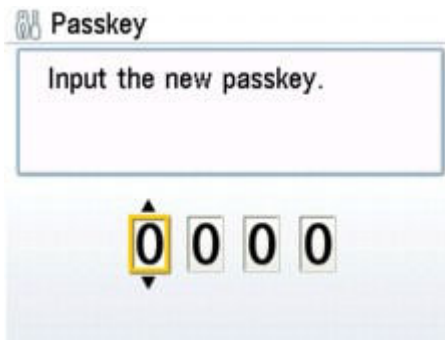

Advanced Guide

Advanced Guide > About Bluetooth Communication > Troubleshooting

Troubleshooting

- ➔ Troubleshooting
- ➔ Printer Cannot be Registered
- ➔ Printing Does Not Start

[Page top](#) ↑

Advanced Guide

[Advanced Guide](#) > [About Bluetooth Communication](#) > [Troubleshooting](#) > [Troubleshooting](#)

Troubleshooting

This section describes how to solve the problems occurred during the use of the Bluetooth unit.

Problems related to the printer's hardware, MP Drivers installation, and so on, are also described in [Troubleshooting](#).

[Page top](#) ↑

Advanced Guide

Advanced Guide > About Bluetooth Communication > Troubleshooting > Printer Cannot be Registered

Printer Cannot be Registered

• Check 1: Have MP Drivers been installed?

If MP Drivers are not yet installed, insert the *Setup CD-ROM* into the computer's disc drive, then perform Custom Install and select MP Drivers.

• Check 2: Is unsupported Bluetooth driver used?

Confirm that the Bluetooth driver installed on your computer is supported.

- Toshiba Windows Vista or Windows XP computer
In Windows Vista, click Start, and select All Programs, TOSHIBA, Bluetooth, then Bluetooth Settings.
On the Bluetooth Settings dialog, click the help button, the version number, then make sure that the version number is 5.10.04 or later.
In Windows XP, click Start, and select All Programs, TOSHIBA, Bluetooth, then Bluetooth Settings.
On the Bluetooth Settings dialog, click the help button, the version number, then make sure that the version number is 3.00.10 or later.
- Windows Vista (except for Toshiba Windows Vista computers)
Log into a user account with the administrator privilege, and click Control Panel, then Hardware and Sound.

Make sure that the  Bluetooth Devices icon is displayed in the dialog.

- Windows XP SP2 or later (except for Toshiba Windows XP computers)
Log into a user account with the administrator privilege, click Control Panel, then Printers and Other Hardware.

Make sure that the  Bluetooth Devices icon is displayed in the dialog.

The operations may vary depending on your operating program. In this case, refer to your computer's operation manual.

• Check 3: Is the printer name which you want to register displayed in

Printer List?

- Make sure that the printer is turned on.
Make sure that the **Power** lamp is lit.
- Make sure that the printer is not operating.
- Check whether the Bluetooth unit is usable.
Make sure that the Bluetooth settings screen can be displayed on the LCD of the printer. If the screen cannot be displayed, Bluetooth communication is disabled. Remove the Bluetooth unit from the printer and attach it again.
[➡ Attaching to and Removing from the Printer](#)
Make sure that the Bluetooth settings screen can be displayed on the LCD of the printer, and try to register again.
- Check whether access from a Bluetooth-compatible device is refused.
Check the printer access setting displaying the Bluetooth settings screen on the LCD of the printer.

1. Display the Bluetooth settings screen on the LCD of the printer.

For information about how to display the Bluetooth settings screen, refer to [Changing the Machine Settings on the LCD](#).

2. Select Access refusal.

3. Select OFF and press the **OK** button on the printer.

Advanced Guide

Advanced Guide > About Bluetooth Communication > Troubleshooting > Printing Does Not Start

Printing Does Not Start

• Check 1: Is Bluetooth unit ready for use?

Make sure that the Bluetooth settings screen can be displayed on the LCD of the printer. If the screen cannot be displayed, Bluetooth communication is disabled. Remove the Bluetooth unit from the printer and attach it once again.

➔ Attaching to and Removing from the Printer

Make sure that the Bluetooth settings screen can be displayed on the LCD of the printer, and try to print again.

If the Bluetooth settings screen still is not displayed after you remove the Bluetooth unit from the printer and attach it again, the Bluetooth unit may be faulty. In this case, contact the service center.

• Check 2: Is there a problem with the location of the printer or is the distance between the printer and computer too great?

The maximum communication distance between the printer and a computer is about 33 ft./10 m, but it varies depending on the following conditions:

- Presence of obstacles between the communication equipment and radio wave conditions
 - Location where magnetic fields, static electricity, or radio interference occurs
 - Type of software and operating system used
 - Receiver sensitivity and antenna performance of the communication equipment
- Change the printer installation place or move the printer closer to the computer.

• Check 3: Is the printer to be used selected correctly?

Follow the procedure described below to select the printer to which the Bluetooth unit is attached.

1. Log into a user account with the administrator privilege.

2. Click Control Panel, then Printers under Hardware and Sound.

When using non-Vista Windows, click Control Panel, then Printers and Faxes under Printers and Other Hardware.

3. Click the  icon of the printer to be used for printing via Bluetooth communication.

By default, the icon name is Canon XXX Printer (Copy X).



Note

- "X" is a device name or a digit. The number of digits may differ depending on the printer.

4. Select Properties from the Organize (File in non-Vista Windows) menu.

5. Click the Ports tab and select an applicable printer from Port.

It may vary depending on how you authenticate the printer.

When authenticating the printer as a Bluetooth device in Control Panel
BTHnnn (Canon XXX Printer (Copy X)) ("n" is a digit).

When authenticating the printer as a Bluetooth device using Bluetooth Settings built in the computer

TBPnnn (Canon XXX Printer (Copy X)) ("n" is a digit)

For more information about how to register the printer, see [Register the printer as a Bluetooth device using Bluetooth Devices.](#) in [Preparation.](#)

6. Click OK.

• **Check 4: Is the message "This document failed to print" displayed?**

- Do not retry printing. Check the error message on the LCD.
Clear the error according to [An Error Message Is Displayed on the LCD](#) .
- When you use a Microsoft Bluetooth driver, make sure that the Printing (HCRP) service is effective on your computer.
Click Control Panel, Bluetooth Devices under Hardware and Sound (Printers and Other Hardware in non-Vista Windows), then select the printer to be used for Bluetooth communication and click Properties.
Make sure that Printing (HCRP) on the Services sheet is checked.
If Printing (HCRP) is not checked or the Printing (HCRP) service is not detected, follow the procedure below and register the printer again.

1. Click Control Panel, then Printers under Hardware and Sound.

When using non-Vista Windows, click Control Panel, then Printers and Faxes under Printers and Other Hardware.

2. Click the  icon of the printer for printing via Bluetooth communication.

3. Select Delete from the Organize (File in non-Vista Windows) menu.

4. Authenticate the printer as a Bluetooth device on Bluetooth Devices in Control Panel.

For more information about the procedure, see [Registering the Printer](#) .

- This message is displayed when the print job is sent from the Bluetooth device while another print job through the USB port is being printed out.
Printing will begin automatically when the print queue is finished.
- Printing cannot be carried out with Bluetooth communication from more than one computer at the same time. In this case, this message is displayed on the computer during standing by.
Printing will begin automatically when the print queue is finished.

• **Check 5: Were the MP Drivers installed after printer registration on**

Bluetooth Devices?

If you have installed the MP Drivers after registering the printer as a Bluetooth device on Bluetooth Devices, delete the printer and then register it again.

For more information about the procedure, see [Preparation](#) .

Advanced Guide

Advanced Guide > About Bluetooth Communication > Specifications

Specifications

Communication method	Bluetooth v2.0
Maximum Speed	1.44 Mbps
Output	Bluetooth Power Class 2
Communication distance	Line-of-sight distance: approx. 33 ft./10 m * * It may vary depending on factors including the presence of obstacles between communication equipment, radio wave conditions, the presence of magnetic fields around microwave ovens and locations where electrostatic and radio interference occur, the types of software and operating systems used, and receiver sensitivity and antenna performance of communication equipment.
Profile	SPP (Serial Port Profile) OPP (Object Push Profile) BIP (Basic Imaging Profile) HCRP (Hardcopy Cable Replacement Profile)
Compatible PCs	A computer in which an internal Bluetooth module is installed or a computer to which an optional Bluetooth adapter (available from various manufacturers) is attached. OS/Software: Microsoft Windows Vista (Satisfying any one of the following conditions is needed) <ul style="list-style-type: none"> • Bluetooth Devices is displayed in Hardware and Sound under Control Panel • Bluetooth Stack for Windows by Toshiba Version 5.10.04 or later is installed Microsoft Windows XP (Satisfying any one of the following conditions is needed) <ul style="list-style-type: none"> • Windows XP SP2 or later is installed, and Bluetooth Devices is displayed in Printers and Other Hardware under Control Panel • Bluetooth Stack for Windows by Toshiba Version 3.00.10 or later is installed
Frequency band	2.4 GHz band (2.400 GHz to 2.4835 GHz)
Power supply	Supplied from the Direct Print Port on the printer, DC 4.4 V to 5.25 V
Maximum power consumption	500 mW (MAX)
Operating temperature	5 to 35°C (41 to 95°F)
Operating humidity	10 to 90% RH (no condensation)
Dimensions (Width x Depth x Height)	18.5 (W) x 47.5 (D) x 8.7 (H) mm (with cap attached) 0.73 (W) x 1.87 (D) x 0.35 (H) inches
Weight	Approx. 7 g (0.25 oz)

[Page top](#) ↑

Advanced Guide

Advanced Guide > Changing the Machine Settings

Changing the Machine Settings

- ➔ Changing the Machine Settings on the LCD
- ➔ Changing Machine Settings from Your Computer

[Page top](#) ↕

Advanced Guide

[Advanced Guide](#) > [Changing the Machine Settings](#) > [Changing the Machine Settings on the LCD](#)

Changing the Machine Settings on the LCD

- ➔ [Changing the Machine Settings on the LCD](#)
- ➔ [Plain paper feed settings](#)
- ➔ [Print settings](#)
- ➔ [LAN settings](#)
- ➔ [Advanced settings](#)
- ➔ [Mobile phone print setting](#)
- ➔ [Bluetooth settings](#)
- ➔ [PictBridge print settings](#)
- ➔ [Language selection](#)
- ➔ [Reset setting](#)

[Page top](#) ↕

Advanced Guide

Advanced Guide > Changing the Machine Settings > Changing the Machine Settings on the LCD > Changing the Machine Settings on the LCD

Changing the Machine Settings on the LCD

This section describes the procedure to change the settings in the Device settings screen, taking the steps to specify Extended copy amount as an example.

1. Make sure that the machine is turned on.
2. Select  Settings on the HOME screen, then press the **OK** button.
The Settings screen is displayed.

3. Select  Device settings, then press the **OK** button.
The Device settings screen is displayed.

4. Select the setting item, then press the **OK** button.

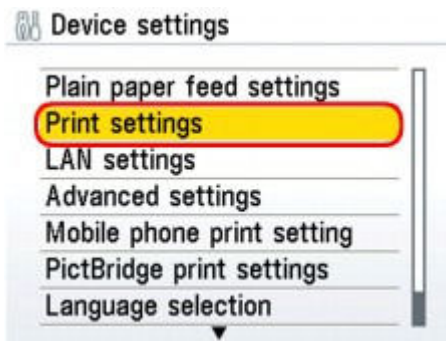

The setting screen for the selected item is displayed.

5. Select the menu, then press the **OK** button.

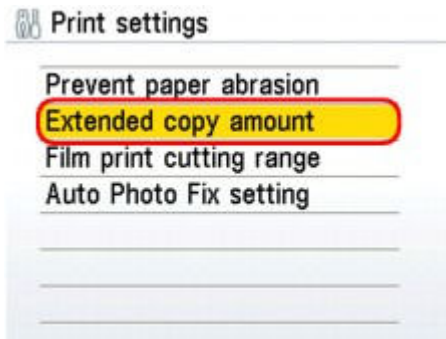

6. Select the setting item, then press the **OK** button.



- ➔ Plain paper feed settings
- ➔ Print settings
- ➔ LAN settings
- ➔ Advanced settings
- ➔ Mobile phone print setting
- ➔ Bluetooth settings
- ➔ PictBridge print settings
- ➔ Language selection
- ➔ Reset setting

[Page top ↑](#)

Advanced Guide

[Advanced Guide](#) > [Changing the Machine Settings](#) > [Changing the Machine Settings on the LCD](#) > Plain paper feed settings

Plain paper feed settings

Specifies the paper source for A4, Letter, A5, and B5 plain paper.

Note

- A4, Letter, A5, and B5 paper can be loaded in the Cassette. Load the other sizes of paper on the Rear Tray.
-

[Page top](#) ↑

Advanced Guide

Advanced Guide > Changing the Machine Settings > Changing the Machine Settings on the LCD > Print settings

Print settings

• Prevent paper abrasion

Use this setting only if the print surface becomes smudged.

Important

- Be sure to set this back to OFF after printing since it may result in lower printing speed or lower print quality.

• Extended copy amount

Selects the amount of image that extends off the paper when printing in borderless (full).

Important

- This setting can be applied only when copy or easy photo reprint mode is selected.

Note

- If printouts contain margins even though you are printing in Borderless, specifying Large for this setting may help solve the problem.

• Film print cutting range

Use this setting to specify the cutting range of the 35 mm film.

Important

- Select Undersize cut when the frame of film is scanned on the edge of the image.
- Select Oversize cut when the edge of image is not scanned.

• Auto Photo Fix setting

When ON is selected, you can select whether to print photos using the Exif information recorded in the image files in the following cases.

- Auto photo fix ON is selected when printing from a memory card
- When a Photo Index Sheet with "Auto Photo Fix OFF" not filled in is used for printing
- When printing with PictBridge compliant device that meets both the following conditions:
 - The print setting on the PictBridge compliant device is set to Default
 - Auto photo fix ON is selected for PictBridge print settings

Advanced Guide

Advanced Guide > Changing the Machine Settings > Changing the Machine Settings on the LCD > LAN settings

LAN settings

• Change wireless/wired

Activates/deactivates wireless LAN.

Note

- When you change the connection method (wired or wireless), set up the machine according to the method you will use. For details, refer to your setup manual.

• Wireless LAN setup

Selects the setting method for wireless LAN connection.

Note

- You can enter this setting menu by following the procedure below:
 - Select Settings on the HOME screen, then press the **OK** button.
 - Select Wireless LAN setup.
 In this case, activate wireless LAN.

- Easy settings
Select when you perform settings for wireless LAN manually.
- WPS settings
Select when you perform settings for wireless LAN using Wi-Fi Protected Setup (WPS). Select Push button method or PIN method according to the method your access point supports, then follow the on-screen instructions.
- WCN settings
Select when you perform settings for wireless LAN using Windows Connect Now (WCN) feature. You need a USB flash drive on which settings for wireless LAN are saved.

• Confirm LAN settings

The list of wireless/wired LAN settings of this machine is displayed on the LCD.

You can print the list from this setting menu.

- Wireless LAN setting list
The list of wireless LAN settings of this machine is displayed on the LCD.
The following setting items are displayed.

Items	Setting (IPv4)	Setting (IPv6)
Connection	Active/Inactive	Active/Inactive
SSID	XXXXXXXXXXXXXXXXXX XXXXXXXXXXXXXXXXXX	XXXXXXXXXXXXXXXXXX XXXXXXXXXXXXXXXXXX
Communication mode	Infrastructure	Infrastructure
Channel	XX	XX
Wireless LAN security	Disable/WEP(64bit)/WEP(128bit)/ WPA-PSK(TKIP)/WPA-PSK(AES)/ WPA2-PSK(TKIP)/WPA2-PSK(AES)	Disable/WEP(64bit)/WEP(128bit)/ WPA-PSK(TKIP)/WPA-PSK(AES)/ WPA2-PSK(TKIP)/WPA2-PSK(AES)
IP address	XXX. XXX. XXX. XXX	XXXX: XXXX: XXXX: XXXX: XXXX: XXXX: XXXX: XXXX
Subnet mask	XXX. XXX. XXX. XXX	-
Subnet prefix length	-	XXX
Default gateway	XXX. XXX. XXX. XXX	XXXX: XXXX: XXXX: XXXX: XXXX: XXXX: XXXX: XXXX

MAC address	XX:XX:XX:XX:XX:XX	XX:XX:XX:XX:XX:XX
IPsec setting	-	Enable (ESP)/Enable (ESP & AH)/ Enable (AH)/Disable
Pre-shared key	-	XXXXXXXXXXXX
Printer name	XXXXXXXXXXXXXXXX	XXXXXXXXXXXXXXXX
Bonjour service name	Canon MP990 series _XXXXXXXXXXXX	Canon MP990 series _XXXXXXXXXXXX

("X" represents an alphanumeric character ranging from 0 to 9 and A to F.)

- **Wired LAN setting list**

The list of wired LAN settings of this machine is displayed on the LCD.

The following setting items are displayed.

Items	Setting (IPv4)	Setting (IPv6)
Connection	Active/Inactive	Active/Inactive
IP address	XXX. XXX. XXX. XXX	XXXX: XXXX: XXXX: XXXX: XXXX: XXXX: XXXX: XXXX
Subnet mask	XXX. XXX. XXX. XXX	-
Subnet prefix length	-	XXX
Default gateway	XXX. XXX. XXX. XXX	XXXX: XXXX: XXXX: XXXX: XXXX: XXXX: XXXX: XXXX
MAC address	XX:XX:XX:XX:XX:XX	XX:XX:XX:XX:XX:XX
IPsec setting	-	Enable (ESP)/Enable (ESP & AH)/Enable (AH)/Disable
Pre-shared key	-	XXXXXXXXXXXX
Printer name	XXXXXXXXXXXXXXXX	XXXXXXXXXXXXXXXX
Bonjour service name	Canon MP990 series _XXXXXXXXXXXX	Canon MP990 series _XXXXXXXXXXXX

("X" represents an alphanumeric character ranging from 0 to 9 and A to F.)

- **Print LAN details**

You can print out the network settings of the machine such as its IP address and SSID.

For more information on the machine's network setting is printed out, refer to [Printing Out Network Setting Information](#).

Important

- This print out contains valuable information about your computer. Handle it with care.

- **Other settings**

- **Set printer name**

Specifies the printer name. You can use up to 15 characters for the name.

Note

- You cannot change this setting with the memory card inserted in the Card Slot.
- You cannot use the same printer name as that already used for other LAN connected devices.
- You cannot use a hyphen for the initial or last character of the printer name.

- **IPv4/IPv6 settings**

Selects the IP version (IPv4 or IPv6). It is recommended to use the machine with IPv4.

- **Set memory card sharing**

Selects whether to share the Card Slot with a LAN connected computer.

Note

- You cannot change this setting with the memory card inserted in the Card Slot.

- WSD settings
Activates/deactivates the WSD (one of the network protocols supported in Windows Vista) setting.

**Note**

- When you set WSD settings to Active, the printer icon is displayed on the Network Explorer in Windows Vista.

- LLTD setting
Activates/deactivates the Link Layer Topology Discovery (LLTD) setting.
- Bonjour settings

Enable/disable Bonjour

Selecting Enable allows you to use Bonjour to perform the network settings.

Service name

Specifies the Bonjour service name. You can use up to 48 characters for the name.

**Note**

- You cannot use the same service name as that already used for other LAN connected devices.

LPR service advertising

Selects whether to advertise the Line PRinter daemon protocol (LPR) service using Bonjour.

**Note**

- Select Enable for LPR protocol setting to activate this setting.

- LPR protocol setting
Activates/deactivates the LPR setting.

- **Reset LAN settings**

Initializes the network settings on the machine.

**Important**

- Note that initialization erases all connection settings with computers, and printing or scanning operation may become impossible. To use the machine over network, refer to your setup manual. Be careful when you initialize the network settings on the machine.

**Note**

- When you initialize the network settings using the Canon IJ Network Tool, refer to [Initializing the Network Settings of the Machine](#).

Advanced Guide

Advanced Guide > Changing the Machine Settings > Changing the Machine Settings on the LCD > Advanced settings

Advanced settings

• Date display

Changes the display format of shooting dates when printed.

Note

- When Date ON is selected on the advanced print settings screen in memory card mode, the shooting date is printed in the date display format you selected. For print settings, see [Setting Items](#).
- The shooting date format is as specified in the DPOF setting from DPOF printing.

• Read/write attribute

Selects whether to allow data to be written onto memory cards from a computer.

Important

- Remove the memory card before changing this setting. For details, see [Setting Up the Card Slot as the Memory Card Drive of the Computer](#).
- If you set this setting to Writable from USB PC or Writable from LAN PC, you cannot print photos on a memory card using the Operation Panel of the machine. After you finish operation of the memory card dedicated drive, be sure to set it back to Not writable from PC. When you turn off the machine, Writable from USB PC or Writable from LAN PC will be canceled and the setting is returned to Not writable from PC when you turn on the machine next time.

• Power save setting

The machine enters the Power save mode if not operated for a certain time interval*. In the Power save mode, the FAU (Film Adapter Unit) lamp is turned off to reduce the power consumption of the machine.

* You can set the wait time before the FAU lamp is turned off. Select from 5 minutes, 15 minutes, 1 hour, and 4 hours. The default setting is 15 minutes. If you scan films frequently, it is recommended to set the longer time interval (1 hour or 4 hours).

Note

- The machine enters the Power save mode if no operation is performed for the time interval set in Power save setting. The lamp inside the Platen Glass and the FAU lamp are turned off, then the machine is on standby.
- Press any button except for the **ON** button or perform printing to restore the machine.

• Quiet mode

Enables this function on the machine if you want to reduce the operating noise, such as when printing at night.

Enabling this function reduces the noises generated in the following cases:

- Copying
- Printing from a memory card/USB flash drive
- Printing from a PictBridge compliant device
- Printing from a wireless communication device
- Printing a template form

Important

- Operating speed may be reduced compared to when this setting is set to OFF.
- This function may not be so effective depending on the machine's setting. Furthermore, certain noise, such as when the machine is preparing for printing, is not reduced.

 **Note**

- The noises generated while scanning or printing from the computer can also be reduced. To reduce these noises, you need to configure the settings on the computer.
For the noises while scanning, refer to [Scanner Tab](#).
For the noises while printing from the computer, refer to [Reducing the Machine Noise](#).

• Guide display settings

Changes the time before the guidance is displayed on the LCD, or selects not to be displayed.

• Key repeat

Enables/Disables continuous input by pressing and holding down the ▲, ▼, ◀, ▶, +, or - button when setting the number of copies, changing the photo displayed on the LCD, setting the zoom ratio, etc.

[Page top](#) ↑

Advanced Guide

Advanced Guide > Changing the Machine Settings > Changing the Machine Settings on the LCD > Mobile phone print setting

Mobile phone print setting

When printing from a mobile phone through infrared communication or Bluetooth communication, select the print settings such as page size, media type, layout, and so on.

For details on how to print from a mobile phone through Bluetooth communication, see [Printing Photographs from a Wireless Communication Device](#) .



1. Select the page size for printing photos saved on a mobile phone.
2. Select the media type for printing photos saved on a mobile phone.
3. Select Image optimizer ON to correct and smooth out the jagged contours when printing.
4. Select the layout of the photos according to the paper for printing.

Sticker print:

Stickers x16, Stickers x9, Stickers x4, Stickers x2, Free-cut stickers 1, Free-cut stickers 2, Free-cut stickers 3, Free-cut stickers 4

Printing on paper other than sticker:

Bordered x 1, x 2, x 4, x 8

Borderless x 1, x 2, x 4, x 8

Mixed 1, 2, 3



Note

- Mixed 1, Mixed 2, or Mixed 3 can be selected only when the page size is set to A4 or 8.5"x11"(LTR).

Advanced Guide

[Advanced Guide](#) > [Changing the Machine Settings](#) > [Changing the Machine Settings on the LCD](#) > [Bluetooth settings](#)

Bluetooth settings

You can change the device name of the machine, passkey, and so on in the Bluetooth settings.

For details on how to print from a mobile phone through Bluetooth communication, see [Printing Photographs from a Wireless Communication Device](#) .

For details on how to print from a computer through Bluetooth communication, refer to [About Bluetooth Communication](#) .

Note

- This menu is displayed only when the optional Bluetooth Unit is attached.

• Device name

Specifies the name of this machine that is displayed on a Bluetooth-compatible device.

For example, if you set it to XXX-2, the machine will be displayed as "Canon XXX-2" on the Bluetooth device. The default value is XXX-1 (where "XXX" is your machine's name).

• Access refusal

Selecting ON will disable searching of this machine by a Bluetooth-compatible device.

• Security

When you select Enable, the passkey set on the Passkey screen becomes effective. Setting the passkey prevents unwanted access from other Bluetooth devices. You can choose either of the security modes below.

- Mode 2

This mode is activated on service level enforced security.

The passkey will be required when printing through the Bluetooth communication.

After setting the security mode, we recommend making a trial print through Bluetooth communication.

If printing does not start, change the security mode and try again.

- Mode 3(recommended)

This mode is activated on link level enforced security.

The passkey will be required when a Bluetooth device communicates with the machine.

Normally select this mode.

• Passkey

Changes the passkey. The passkey is a four-digit number used to prevent unwanted access from other Bluetooth devices.

The initial value is "0000".

After you change the passkey, you may be required to input the new passkey on a Bluetooth device, even though it had previous access to the machine. In this case, input the new passkey on the device.

Advanced Guide

Advanced Guide > Changing the Machine Settings > Changing the Machine Settings on the LCD > PictBridge print settings

PictBridge print settings

You can change the print settings when printing from a PictBridge compliant device.

Set the print settings to Default on the PictBridge compliant device when you want to print according to the settings on the machine.

See [Settings on a PictBridge Compliant Device](#) to change print settings from the PictBridge compliant device.

Photo print setting

Select the print quality, when printing directly from a PictBridge compliant device.

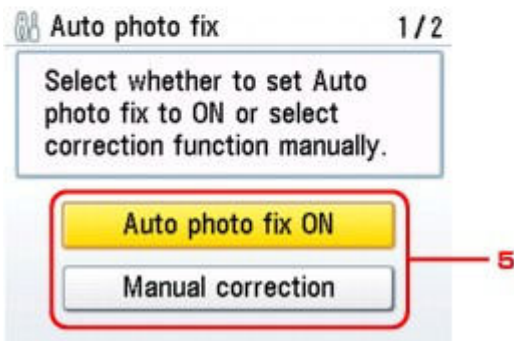
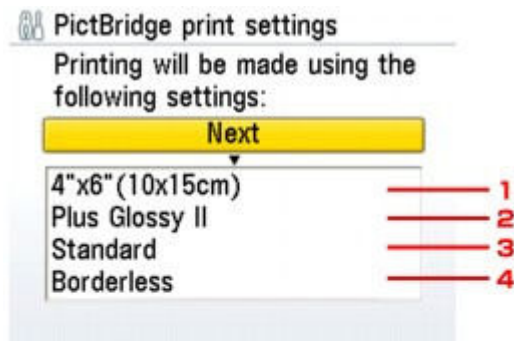

1. Select the paper size when printing directly from a PictBridge compliant device.

When you perform PictBridge settings from the machine, set Paper size to Default on the PictBridge compliant device.

2. Select the media type when printing directly from a PictBridge compliant device.

When you perform PictBridge settings from the machine, set Paper type to Default on the PictBridge compliant device.

3. Select the print quality when printing directly from a PictBridge compliant device.

4. Select bordered or borderless print.

When you perform PictBridge settings from the machine, set Layout to Default on the PictBridge compliant device.

5. Select automatic image correction or manual image correction.

When Auto photo fix ON is selected, the scene or person's face of a shot photo is recognized and the most suitable correction for each photo is made automatically. It makes a darkened face by backlight brighter to print. It also analyzes a scene such as scenery, night scene,

person, etc. and corrects each scene with the most suitable color, brightness, or contrasts automatically to print.

Note

- After selecting Auto photo fix ON, select Red-Eye correc. ON or Red-Eye correc. OFF.

When Manual correction is selected, the setting items 6 to 15 below can be specified.
Set Image optimize to Default on the PictBridge compliant device.

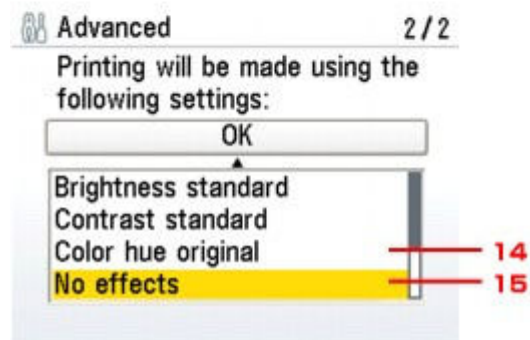
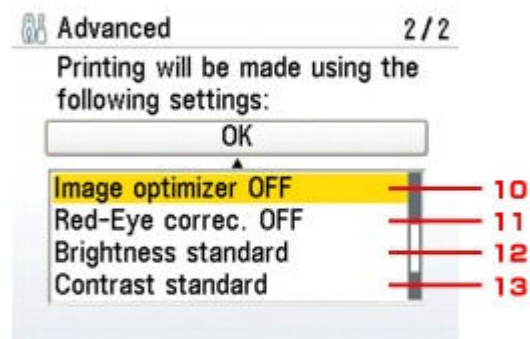
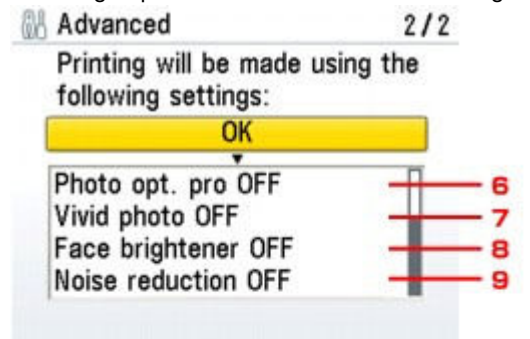

6. Photo optimizer pro

Automatically optimizes brightness and tone of a photo.

7. Vivid photo

Makes green and blue more lively.

8. Face brightener

Brightens a darkened face on the photo taken against the light.

9. Noise reduction

Reduces the noise on blue areas like the sky as well as on black areas.

10. Image optimizer

Corrects and smoothes the jagged contours for printing.

11. Red-Eye correction

Corrects red eyes in portraits caused by flash photography.

Depending on the type of the photo, red eyes may not be corrected or parts other than the eyes may be corrected.

12. Brightness

Adjust brightness.

13. Contrast

Adjust contrast.

14. Color hue

Adjust color hue. For example, you can increase red or yellow to adjust the skin tone.

15. Effects

Applies special effects to the photo, such as printing in sepia tones or with a sketch illustration like effect.

[Page top](#) ↑

Advanced Guide

[Advanced Guide](#) > [Changing the Machine Settings](#) > [Changing the Machine Settings on the LCD](#) > [Language selection](#)

Language selection

Changes the language for LCD messages and menus.

[Page top](#) ↑

Advanced Guide

[Advanced Guide](#) > [Changing the Machine Settings](#) > [Changing the Machine Settings on the LCD](#) > [Reset setting](#)

Reset setting

You can change the settings back to the default.

Note

- You cannot change the following setting items back to the default:
 - The language displayed on the LCD
 - The current position of the Print Head
 - The Read/write attribute setting
 - LAN settings*
 - * You can change LAN settings from Reset LAN settings under LAN settings.
-

[Page top](#) ↑

Advanced Guide

[Advanced Guide](#) > [Changing the Machine Settings](#) > [Changing Machine Settings from Your Computer](#)

Changing Machine Settings from Your Computer

- ➔ [Changing the Print Options](#)
- ➔ [Registering a Frequently Used Printing Profile](#)
- ➔ [Setting the Paper Source for Plain Paper](#)
- ➔ [Managing the Machine Power](#)
- ➔ [Reducing the Machine Noise](#)
- ➔ [Changing the Machine Operation Mode](#)

[Page top](#) ↕

Advanced Guide

Advanced Guide > Changing the Machine Settings > Changing Machine Settings from Your Computer > Changing the Print Options

Changing the Print Options

You change the detailed print driver settings for print data that is sent from an application software.

Check this check box if part of the image data is cut off, the paper source during printing differs from the driver settings, or printing fails.

The procedure for changing the print options is as follows:

1. Open the [printer driver setup window](#)
2. Click Print Options... on the Page Setup tab

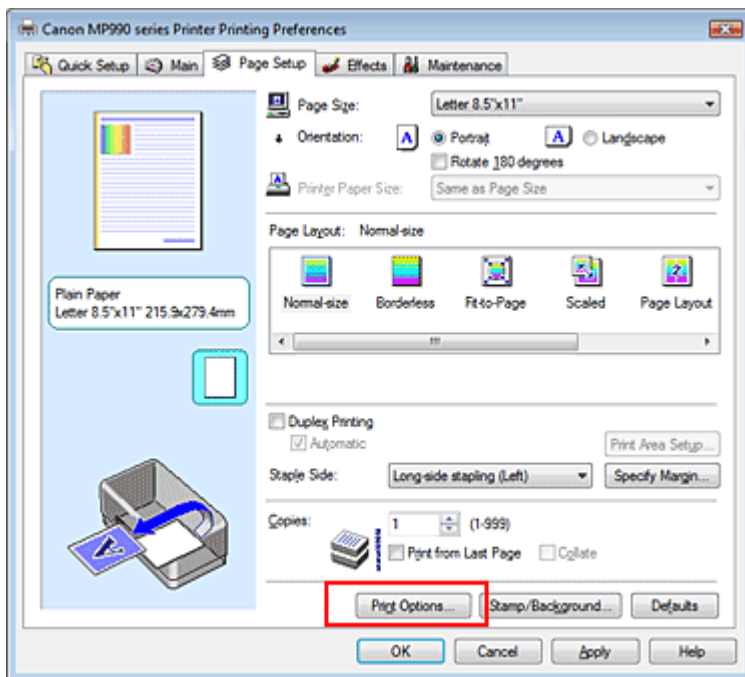

The Print Options dialog box opens.

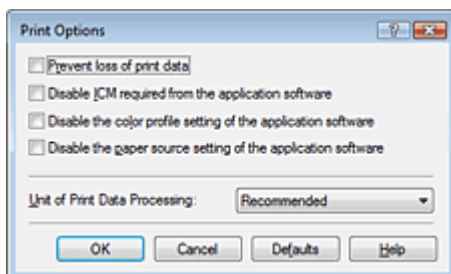

3. Change the individual settings

If necessary, change the setting of each item, and then click OK.

The Page Setup tab is displayed again.

Advanced Guide

Advanced Guide > Changing the Machine Settings > Changing Machine Settings from Your Computer > Registering a Frequently Used Printing Profile

Registering a Frequently Used Printing Profile

You can register the frequently used printing profile to Commonly Used Settings on the Quick Setup tab. Unnecessary printing profiles can be deleted at any time.

The procedure for registering a printing profile is as follows:

Registering a Printing Profile

1. Open the printer driver setup window

2. Set the necessary items

From Commonly Used Settings on the Quick Setup tab, select the printing profile to be used and if necessary, change the settings after Additional Features.

You can also set necessary items on the Main, Page Setup, and Effects tab.

3. Click Save...

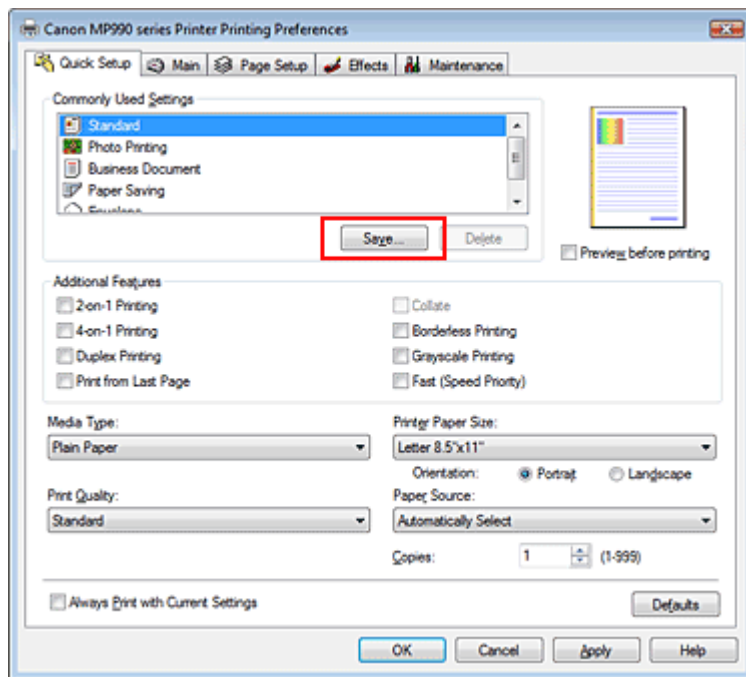

The Save Commonly Used Settings dialog box opens.

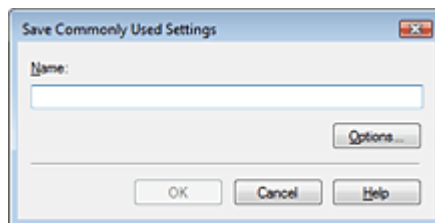

4. Save the settings

Set Name, then click OK. If necessary, set the items in Options.... The printing profile is saved, and the Quick Setup tab is displayed again.

The name and icon are added to the Commonly Used Settings list.

 **Important**

- To save the page size, orientation, and number of copies that was set in each sheet, click Options..., and check each item.

 **Note**

- When you install the printer driver again or upgrade the version of the printer driver, the print settings you registered will be deleted from Commonly Used Settings. Registered print settings cannot be saved and preserved. If a profile is deleted, register the print settings again.

Deleting Unnecessary Printing Profile

1. Select the printing profile to be deleted

Select the printing profile you want to delete from the Commonly Used Settings list on the Quick Setup tab.

2. Delete the printing profile

Click Delete. When the confirmation message appears, click OK.
The selected printing profile is deleted from the Commonly Used Settings list.

 **Note**

- Printing profiles that are registered in the initial settings cannot be deleted.

Advanced Guide

[Advanced Guide](#) > [Changing the Machine Settings](#) > [Changing Machine Settings from Your Computer](#) > [Setting the Paper Source for Plain Paper](#)

Setting the Paper Source for Plain Paper

When you select Automatically Select from Paper Source, you can use the printer driver to select the paper source for plain paper.

The procedure for setting the paper source is as follows:



Paper Source Setting for Plain Paper

1. Open the [printer driver setup window](#)
2. Click Paper Source Setting for Plain Paper on the Maintenance tab
The Paper Source Setting for Plain Paper dialog box opens.
3. Transmit the settings
Select the paper source for plain paper, and then click the Send button.
The selected settings are enabled hereafter.

Important

- The descriptions in the machine manual assume that the plain paper is supplied from the cassette. When you change the paper source setting, replace all instances of "cassette" with the new paper source.

Advanced Guide

[Advanced Guide](#) > [Changing the Machine Settings](#) > [Changing Machine Settings from Your Computer](#) > [Managing the Machine Power](#)

Managing the Machine Power

This function allows you to manage the machine power from the printer driver.

The procedure for managing the printer power is as follows:



Power Off

The Power Off function turns off the machine. When you use this function, you will not be able to turn the machine on from the printer driver.

1. Open the [printer driver setup window](#)
2. Execute power off

Click Power Off on the Maintenance tab. When the confirmation message appears, click OK.

The machine power switches off, and the Maintenance tab is displayed again.

[Page top](#) ↕

Advanced Guide

Advanced Guide > Changing the Machine Settings > Changing Machine Settings from Your Computer > Reducing the Machine Noise

Reducing the Machine Noise

This function allows you to reduce the operating noise of the machine. Select when you wish to reduce the operating noise of the printer at night, etc.

Using this function may lower the print speed.

The procedure for using the quiet mode is as follows:



Quiet Mode

1. Open the [printer driver setup window](#)
2. Click Quiet Mode on the Maintenance tab
The Quiet Mode dialog box opens.
3. Set the quiet mode

If necessary, specify one of the following items:

Do not use quiet mode

The operating noise of the machine is at normal volume.

Always use quiet mode

Select this option when you wish to reduce the operating noise of the machine.

Use quiet mode within specified time

The operating noise of the machine can be reduced during a specified period of time.

Set the Start time and End time when you wish the quiet mode to be activated.



Important

- The time specified in Start time and in End time must be different.

4. Transmit the settings

Make sure that the machine is on and click Send.

Click OK when the confirmation message appears.

The settings are enabled hereafter.



Note

- Depending on the paper source and the print quality settings, effects of the quiet mode may be less.

Advanced Guide

Advanced Guide > Changing the Machine Settings > Changing Machine Settings from Your Computer > Changing the Machine Operation Mode

Changing the Machine Operation Mode

If necessary, switch between various modes of machine operation.

The procedure for configuring settings is as follows:



Custom Settings

1. Open the [printer driver setup window](#)
2. Make sure that the machine is on, and then click Custom Settings on the Maintenance tab

The Custom Settings dialog box opens.



Note

- If the machine is off or bi-directional communication is disabled, a message may appear because the computer cannot collect the machine status. If this happens, click OK to display the most recent settings specified on your computer.

3. If necessary, complete the following settings:

Prevent paper abrasion

The machine can increase the gap between the print head and the paper during high-density printing to prevent paper abrasion.

Check this check box to use this function.

Align heads manually

The Print Head Alignment function on the Maintenance tab is normally set to automatic head alignment, but you can change it to manual head alignment.

If the printing results of automatic print head alignment are not satisfactory, see "[Manual Print Head Alignment](#)," and perform manual head alignment.

Check this check box to perform the manual head alignment.

Ink Drying Wait Time

You can set the length of the machine rest time until printing of the next page begins. Moving the slider to the right increases the pause time and moving the slider to the left decreases the time.

If the paper gets stained because the next page is ejected before the ink on the printed page dries, increase the ink drying wait time.

Reducing the ink drying wait time speeds up printing.

4. Transmit the settings

Click Send, and click OK when the confirmation message appears.

The machine operates with the modified settings hereafter.

Advanced Guide

Advanced Guide > Troubleshooting

Troubleshooting

- ➔ Troubleshooting
- ➔ If an Error Occurs
- ➔ The Machine Cannot Be Powered On
- ➔ An Error Message Is Displayed on the LCD
- ➔ LCD Cannot Be Seen At All
- ➔ An Unintended Language Is Displayed on the LCD
- ➔ Cannot Install the MP Drivers
- ➔ Cannot Install the Application Program
- ➔ Cannot Connect to Computer with a USB Cable Properly
- ➔ Print Results Not Satisfactory
- ➔ Printing Does Not Start
- ➔ Copying/Printing Stops Before It Is Completed
- ➔ Machine Moves But Ink Is Not Ejected
- ➔ Printing Speed Is Not as Fast as Expected
- ➔ Print Head Holder Does Not Move to the Position for Replacing
- ➔ Paper Does Not Feed Properly
- ➔ Paper Does Not Feed from the Paper Source Specified in the Printer Driver
- ➔ Paper Jams
- ➔ Message Appears on the Computer Screen
- ➔ Cannot Print Properly with Automatic Duplex Printing
- ➔ For Windows Users
- ➔ Error Message Appears on a PictBridge Compliant Device
- ➔ Cannot Print Properly from a Wireless Communication Device
- ➔ Cannot Print Properly from a Photo Index Sheet
- ➔ Cannot Remove a Memory Card
- ➔ Problems with Scanning
- ➔ Problems with Scanning/Printing Film
- ➔ Software Problems
- ➔ MP Navigator EX Problems
- ➔ If You Cannot Resolve the Problem
- ➔ FAQs
- ➔ Instructions for Use (Printer Driver)
- ➔ General Notes (Scanner Driver)

Page top 

Advanced Guide

[Advanced Guide](#) > [Troubleshooting](#) > [Troubleshooting](#)

Troubleshooting

This section describes troubleshooting tips for problems you may encounter when using the machine. For troubleshooting tips related to the setup, refer to the *Network Setup Troubleshooting*.

[Page top](#) ↑

Advanced Guide

Advanced Guide > Troubleshooting > If an Error Occurs

If an Error Occurs

When an error occurs in printing such as the machine is out of paper or paper is jammed, a troubleshooting message is displayed automatically. Take the appropriate action described in the message. The message may vary depending on the version of your operating system.

Windows

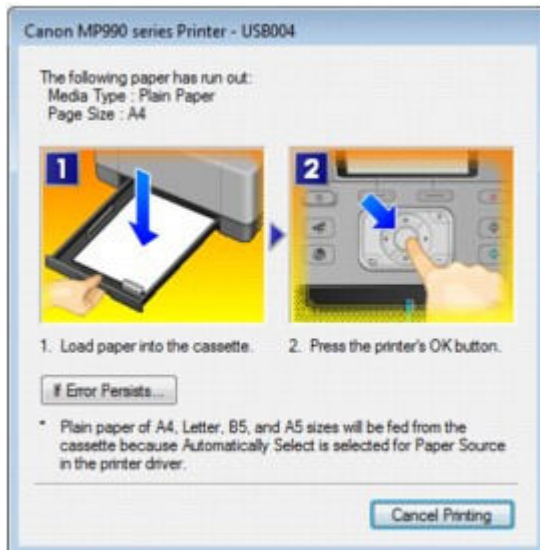

Macintosh

- In Mac OS X v.10.5.x:

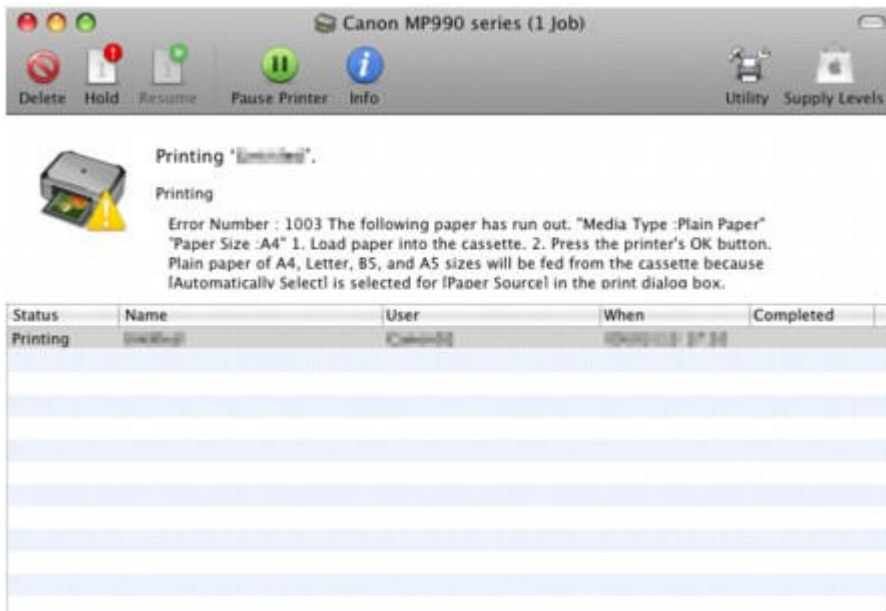

- In Mac OS X v.10.4.x or Mac OS X v.10.3.9:



Error Number : 1003
The following paper has run out.
"Media Type :Plain Paper"
"Paper Size :A4"
1. Load paper into the cassette. 2. Press the printer's OK button.
Plain paper of A4, Letter, B5, and A5 sizes will be fed from the cassette because [Automatically Select] is selected for [Paper Source] in the print dialog box.

[Delete Job](#) [Stop All Jobs](#) [Stop Job](#)

[Page top ↑](#)

Advanced Guide

[Advanced Guide](#) > [Troubleshooting](#) > [The Machine Cannot Be Powered On](#)

The Machine Cannot Be Powered On

- **Check 1: Press the ON button.**
- **Check 2: Make sure that the power plug is securely plugged into the Power Cord Connector of the machine, then turn it back on.**
- **Check 3: Unplug the machine from the power supply, then plug the machine back in and turn the machine back on after leaving it for at least 3 minutes.**

If the problem is not resolved, contact the service center.



[Page top](#) ↑



Advanced Guide

Advanced Guide > Troubleshooting > An Error Message Is Displayed on the LCD

An Error Message Is Displayed on the LCD

If an error message is displayed on the LCD, take the corresponding action described below.

Message	Action
<p>The following ink may have run out. Replacing the ink tank is recommended. U041</p>	<p>If the lamp on the ink tank is flashing, ink may have run out. Replacing the ink tank is recommended. If printing is in progress and you want to continue printing, press the machine's OK button with the ink tank installed. Then printing can continue. Replacing the ink tank is recommended after the printing. The machine may be damaged if printing is continued under the ink out condition. ➔ Routine Maintenance</p> <p> Note</p> <ul style="list-style-type: none"> If multiple ink lamps are flashing red, see Routine Maintenance and check the status of each ink tank.
<p>Print head is not installed. Install the print head. U051/ The type of print head is incorrect. Install the correct print head. U052</p>	<p>Follow the directions given in your setup sheet to install the Print Head. If the Print Head is already installed, remove the Print Head once and then reinstall it. If the error is not resolved, the Print Head may be damaged. Contact the service center.</p>
<p>Some ink tanks are not installed in place. U072/ More than one ink tank of the following color is installed. U071</p>	<ul style="list-style-type: none"> Some ink tanks are not installed in the correct position. (The lamp on the ink tank flashes.) More than one ink tanks of the same color are installed. (The lamp on the ink tank flashes.) <p>Confirm that the ink tanks are installed in the appropriate positions. ➔ Routine Maintenance</p>
<p>The remaining level of the following ink cannot be correctly detected. Replace the ink tank. U130</p>	<p>The remaining ink level cannot be correctly detected. (The lamp on the ink tank flashes.) Replace the ink tank and close the Scanning Unit (Cover). ➔ Routine Maintenance</p> <p>Printing with an ink tank that was once empty may damage the machine. If you want to continue printing in this condition, you need to release the function for detecting the remaining ink level. Press and hold the machine's Stop button for at least 5 seconds, and then release it. With this operation, releasing the function for detecting the remaining ink level is memorized. Please be advised that Canon shall not be liable for any machine malfunction or damage caused by refilled ink tanks.</p> <p> Note</p> <ul style="list-style-type: none"> If the function for detecting the remaining ink level is disabled, the ink tank in gray is displayed on the LCD when checking the current ink level. ➔ Routine Maintenance
<p>The following ink tank cannot be recognized. U043 U140</p>	<ul style="list-style-type: none"> The ink tank is not installed. Install the ink tank. ➔ Routine Maintenance The ink tank is not compatible with this machine. (The lamp on the ink tank is off.)

U150	<p>Install an appropriate ink tank.</p> <p>➔ Routine Maintenance</p> <ul style="list-style-type: none"> An ink tank error has occurred. (The lamp on the ink tank is off.) <p>Replace the ink tank.</p> <p>➔ Routine Maintenance</p>
<p>The following ink has run out. Replace the ink tank. U163</p>	<p>Ink has run out. (The lamp on the ink tank flashes.) Replace the ink tank and close the Scanning Unit (Cover).</p> <p>➔ Routine Maintenance</p> <p>Printing under the current condition may damage the machine.</p> <p>If you want to continue printing in this condition, you need to release the function for detecting the remaining ink level. Press and hold the machine's Stop button for at least 5 seconds, and then release it.</p> <p>With this operation, releasing the function for detecting the remaining ink level is memorized. Please be advised that Canon shall not be liable for any malfunction or trouble which may be caused by continuation of printing under the ink out condition.</p> <p> Note</p> <ul style="list-style-type: none"> If the function for detecting the remaining ink level is disabled, the ink tank in gray is displayed on the LCD when checking the current ink level. <p>➔ Routine Maintenance</p>
<p>There are no photos in memory card./ No photo data in USB flash drive.</p>	<ul style="list-style-type: none"> There is no image data saved on the memory card or the USB flash drive that can be read by this machine. The machine may not recognize the file if the file name or the folder path contains certain characters. Use only alphanumeric characters. Photo data edited or processed on a computer must be printed from the computer. <p> Note</p> <ul style="list-style-type: none"> When a photo was processed on a computer is selected, "?" is displayed on the LCD.
<p>The ink absorber is almost full. Press OK to continue printing. Contact the service center.</p>	<p>The ink absorber is almost full. Press the machine's OK button to continue printing. Contact the service center.</p>
<p>Printer error has occurred Contact the service center.</p>	<p>The machine error has occurred. Contact the service center.</p>
<p>Timeout error has occurred. Press OK.</p>	<p>Some errors occurred while copying and a certain time passed. Press the OK button to dismiss the error, and try to copy again.</p>
<p>The device may be incompatible. Remove the device and check the manual supplied with the connected device.</p>	<ul style="list-style-type: none"> Check the device connected to the Direct Print Port. Printing photos directly is possible with a PictBridge compliant device or the optional Bluetooth Unit BU-30, or a USB flash drive. A communication time out occurs if an operation takes too long or if it takes too much time to send data. This may cancel printing. In such cases, disconnect and reconnect the USB cable. <p>When printing from a PictBridge compliant device, depending on the model or brand of your device, you may have to select a PictBridge compliant print mode on the device before connecting it to the machine. You may also</p>

	<p>have to turn on your device or select Play mode manually after connecting the device to the machine. Perform necessary operations before connecting your device referring to its instruction manual.</p> <p>If the error is still not resolved, check if you can print another photograph.</p>
<p>Auto head align has failed. Press OK and repeat operation. <See manual></p>	<ul style="list-style-type: none"> ● Print Head nozzles are clogged. Press the OK button to dismiss the error, and print the nozzle check pattern to check the status of the Print Head. ➔ Routine Maintenance ● Paper of size other than A4 or Letter is loaded in the Rear Tray. Press the OK button on the machine to dismiss the error, then load a sheet of supplied paper (Paper For Print Head Alignment) or A4/Letter-sized Canon Matte Photo Paper MP-101 with the printing side (whiter side) facing UP in the Rear Tray. For Automatic Print Head Alignment, always load paper in the Rear Tray. ● The Paper Output Slot is exposed to strong light. Press the OK button to dismiss the error message, and then adjust your operating environment and/or the position of the machine so that the Paper Output Slot is not exposed directly to strong light. <p>After carrying out the above measures, if the problem continues after aligning the Print Head again, press the OK button to dismiss the error, and then perform Manual Print Head Alignment. ➔ Manual Print Head Alignment</p>
<p>An unsupported USB hub is connected. Remove the hub.</p>	<p>If a PictBridge compliant device is connected via a USB hub, remove the hub and connect it directly to the machine.</p>
<p>B200 Printer error has occurred. Unplug the power cord and contact the service center.</p>	<p>Turn off the machine, and unplug the power cord of the machine from the power supply. Contact the service center.</p>
<p>**** Printer error has occurred. Turn off power then back on again. If problem persists, see the manual.</p>	<p>***** is displayed in the alphanumeric character and depends on the error occurred.</p> <ul style="list-style-type: none"> ● 5100/5110 is displayed: Cancel printing, and turn off the machine. Then clear the jammed paper or protective material that is preventing the Print Head Holder from moving, and turn on the machine again. <p>Important</p> <ul style="list-style-type: none"> ■ Be careful not to touch the components inside the machine. The machine may not print out properly if you touch it. ■ If the problem is not resolved, contact the service center. <ul style="list-style-type: none"> ● 6000 is displayed: If any object is placed in front of the machine, remove it. Open the Paper Output Tray gently, then turn the power off and back on. ● In other cases: Turn off the machine, and unplug the power cord of the machine from the power supply. Plug the machine back in and turn the machine back on. If the problem is not resolved, contact the service center.
<p>Scanner is not operating correctly.</p>	<p>Turn off the machine, and unplug the power cord of the</p>

	<p>machine from the power supply. After a while, plug the power cord of the machine back in, and then turn on the machine. If the same error occurs, contact the service center.</p>
<p>Release the scanner lock switch and turn the power off and back on.</p>	<p>The Scanner Lock Switch is not released. Slide the Scanner Lock Switch to the release position () and press the ON button to turn the machine off. Then, turn the power back on. If this error still remains, contact the service center.</p>
<p>The card is currently writable from PC. Set to [Not writable from PC].</p>	<p>The Card Slot is set to Writable from USB PC or Writable from LAN PC. You cannot print from the memory card or save the scanned data to the memory card when the Card Slot is set to Writable from USB PC or Writable from LAN PC. After writing on the memory card, set to Not writable from PC again.</p>

[Page top ↑](#)

Advanced Guide

[Advanced Guide](#) > [Troubleshooting](#) > LCD Cannot Be Seen At All

LCD Cannot Be Seen At All

- **If the Power lamp is off:**

The machine is not powered on. Connect the power cord and press the **ON** button.

- **If the Power lamp is lit:**

The LCD may be in the screen-saver mode. On the Operation Panel, press a button other than the **ON** button.







[Page top](#) ↑

Advanced Guide

Advanced Guide > Troubleshooting > An Unintended Language Is Displayed on the LCD

An Unintended Language Is Displayed on the LCD

Select the language you want to be displayed according to the following procedure.

1. Press the **HOME** button and wait for about 5 seconds.
2. Select , and then press the **OK** button.
3. Press the  button to select , then press the **OK** button.
4. Press the  button 6 times, then press the **OK** button.
If the Bluetooth unit is connected to the machine, press the  button 7 times, and then press the **OK** button.
5. Use the  button to select the language for the LCD, then press the **OK** button.

[Page top](#) ↑

Advanced Guide

Advanced Guide > Troubleshooting > Cannot Install the MP Drivers

Cannot Install the MP Drivers

Important

- If you cannot install the MP Drivers when you use the machine over LAN, refer to the setup manual.

- **If the installation does not start even after the *Setup CD-ROM* is inserted into your computer's disc drive:**



Start the installation following the procedure below.

1. Click Start then Computer.

In Windows XP, click Start then My Computer.

In Windows 2000, double-click the  My Computer icon on the desktop.

2. Double-click the  CD-ROM icon on the displayed window.

If the contents of the CD-ROM are displayed, double-click MSETUP4.EXE.



Double-click the  CD-ROM icon on your desktop to start installation.

Note

- If the CD-ROM icon is not displayed, try the following:
 - Remove the CD-ROM from your computer, then insert it again.
 - Restart your computer.
- If the icon is still not displayed, try different discs and see if they are displayed. If other discs are displayed, there is a problem with the *Setup CD-ROM*. In this case, contact the service center.

- **If you are unable to proceed beyond the Printer Connection screen:**

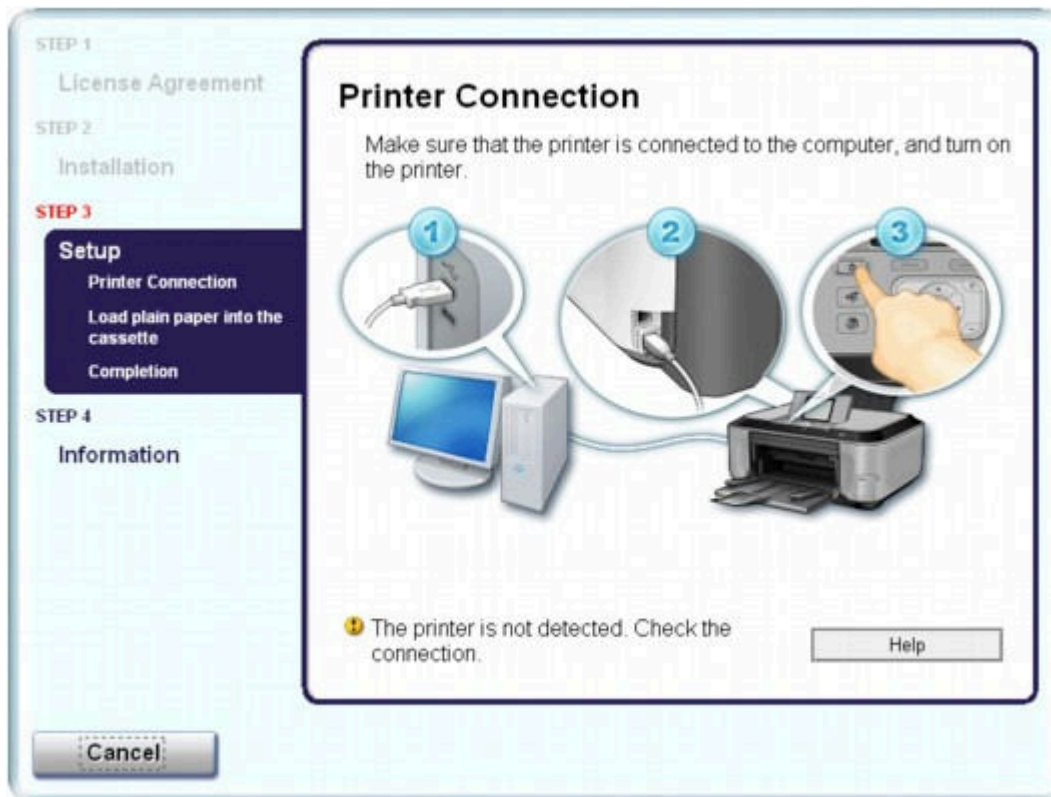

If you are unable to proceed beyond the Printer Connection screen, make sure that the USB cable is securely plugged into the USB port of the machine and is connected to the computer, and then follow the procedure below to reinstall the MP Drivers.

Note

- In Windows Vista, The printer is not detected. Check the connection. may be displayed depending on the computer you use. In this case, wait for a while. If you still cannot proceed to the next step, follow the procedure below to reinstall the MP Drivers.

1. Click Cancel on the Printer Connection screen.
2. Click Start Over on the Installation Failure screen.
3. Click Back on the screen that appears next.
4. Click Exit on the PIXMA XXX screen, then remove the CD-ROM.
5. Turn the machine off.
6. Restart the computer.
7. Make sure that you have no application software running.
8. Insert the CD-ROM again, then perform Easy Install to install the MP Drivers.

• In other cases:

Follow the procedure described in your setup manual to reinstall the MP Drivers.

If the MP Drivers were not installed correctly, uninstall the MP Drivers, restart your computer, and then reinstall the MP Drivers.

➔ [Deleting the Unnecessary MP Drivers](#)

If you reinstall the MP Drivers, perform Custom Install on the *Setup CD-ROM*, then select MP Drivers.



Note

- If the installer was forced to be terminated due to a Windows error, the system may be in an unstable condition and you may not be able to install the drivers. Restart your computer before reinstalling.
-

[Page top ↑](#)

Advanced Guide

Advanced Guide > Troubleshooting > Cannot Install the Application Program

Cannot Install the Application Program

Easy-PhotoPrint Pro Does Not Start up or Easy-PhotoPrint Pro Menu Does Not Appear

If the Easy-PhotoPrint Pro menu does not appear on Adobe Photoshop although you have installed Easy-PhotoPrint Pro, make sure that Adobe Photoshop is not running and install Adobe Photoshop Plug-In as described below.



1. Click Start, and select All Programs (or Programs), Canon Utilities, Easy-PhotoPrint Pro and then Photoshop Plug-In Installer.
2. Follow the on-screen instructions to install Adobe Photoshop Plug-In.



1. Select Applications from the Go menu, and double-click the Canon Utilities folder, the Easy-PhotoPrint Pro folder and then the Plug-In Installer icon.
2. Follow the on-screen instructions to install Adobe Photoshop Plug-In.



- If you have never started up Adobe Photoshop before, Adobe Photoshop Plug-In cannot be installed.
-

Advanced Guide

Advanced Guide > Troubleshooting > Cannot Connect to Computer with a USB Cable Properly

Cannot Connect to Computer with a USB Cable Properly

Printing or Scanning Speed Is Slow/Hi-Speed USB Connection Does Not Work/

"This device can perform faster" Message Is Displayed

If your system environment is not fully compatible with Hi-Speed USB, the machine will operate at a lower speed provided under USB 1.1. In this case, the machine operates properly but printing speed may slow down due to communication speed.

- **Check: Check the following to make sure that your system environment supports Hi-Speed USB connection.**
 - Does the USB port on your computer support Hi-Speed USB connection?
 - Do the USB cable, and the USB hub if you are using one, support Hi-Speed USB connection?
Be sure to use a certified Hi-Speed USB cable. We recommend that the cable is no longer than around 10 feet / 3 meters.
 - Does the operating system of your computer support Hi-Speed USB connection?
Obtain and install the latest update for your computer.
 - Does the Hi-Speed USB driver operate properly?
Obtain the latest version of the Hi-Speed USB driver compatible with your hardware and reinstall it on your computer.

Important

- For details on Hi-Speed USB of your system environment, contact the manufacturer of your computer, USB cable, or USB hub.

[Page top](#) ↑

Advanced Guide

Advanced Guide > Troubleshooting > Print Results Not Satisfactory

Print Results Not Satisfactory

If the print result is not satisfactory due to white streaks, misaligned lines, or uneven colors, confirm the paper and print quality settings first.

- **Check 1: Do the page size and media type settings match the size and type of the loaded paper?**

When these settings are incorrect, you cannot obtain a proper print result.

If you are printing a photograph or an illustration, incorrect paper type settings may reduce the quality of the printout color.

Also, if you print with an incorrect paper type setting, the printed surface may be scratched.

In borderless printing, uneven coloring may occur depending on the combination of the paper type setting and the loaded paper.

The method of confirming the paper and print quality settings differs depending on what you do with your machine.

To copy by operating the machine	Confirm by using the Operation Panel on the machine. ➔ Setting Items
To print from your memory card by operating the machine	Confirm by using the Operation Panel on the machine. ➔ Setting Items
To print from your USB flash drive by operating the machine	Confirm by using the Operation Panel on the machine. ➔ Setting Items
To print from printed photo or film by operating the machine	Confirm by using the Operation Panel on the machine. ➔ Setting Items
To print from a PictBridge compliant device	Confirm by using your PictBridge compliant device. ➔ Printing Photographs Directly from a Compliant Device Confirm by using the Operation Panel on the machine. ➔ Changing the Machine Settings on the LCD
To print from a wireless communication device	Confirm by using the Operation Panel on the machine. ➔ Changing the Machine Settings on the LCD
To print from a computer	Confirm by using the printer driver. ➔ Printing with Easy Setup

- **Check 2: Make sure that the appropriate print quality is selected according to the media type and printing data referring to the table in**

Check 1.

Select a print quality option suitable for the paper and image for printing. If you notice blurs or uneven colors, increase the print quality setting and try printing again.

Note

- When printing from a PictBridge compliant device, set the print quality setting by using the Operation Panel on the machine.
You cannot make this setting from a PictBridge compliant device.
- You cannot change the print quality setting when printing from a wireless communication

device.

- **Check 3: If the problem is not resolved, there may be other causes.**

See also the sections below:

- ➡ Cannot Print to End of Job
- ➡ Part of the Page Is Not Printed
- ➡ No Printing Results/Printing Is Blurred/Colors Are Wrong/White Streaks
- ➡ Lines Are Misaligned
- ➡ Printed Paper Curls or Has Ink Blots
- ➡ Paper Is Smudged/Printed Surface Is Scratched
- ➡ Back of the Paper Is Smudged
- ➡ Vertical Lines Are Printed on the Sides of the Printout
- ➡ Colors Are Uneven or Streaked

[Page top ↑](#)

Advanced Guide

[Advanced Guide](#) > [Troubleshooting](#) > [Print Results Not Satisfactory](#) > [Cannot Print to End of Job](#)

Cannot Print to End of Job

- **Check 1: Is the size of the print data extremely large?**



Click Print Options on the Page Setup sheet. Then, select the Prevent loss of print data check box in the displayed dialog.

- **Check 2: Is the space of your computer's hard disk sufficient?**

Delete unnecessary files to free disk space.

[Page top](#) ↑

Advanced Guide

Advanced Guide > Troubleshooting > Print Results Not Satisfactory > Part of the Page Is Not Printed

Part of the Page Is Not Printed

- **Check: When performing automatic duplex printing, the reason below is possible.**

When performing automatic duplex printing, the printable area at the top of the page will be 0.08 inches / 2 mm narrower than the usual.

For this reason, the bottom of the page may not be printed. To prevent this, select Use reduced printing from the printer driver.

Important

- Reduced printing may affect the layout depending on your document.

Windows

1. Open the printer properties dialog box.

➔ [Opening the Printer Properties Dialog Box \(Windows\)](#)



Click Here: [Printer Driver](#)

* Before clicking here to open the printer properties dialog box, quit the running application software.

2. Click Print Area Setup in the Page Setup sheet and select Use reduced printing.

Macintosh

1. Open the Print dialog box.

➔ [Opening the Page Setup and Print Dialog Box \(Macintosh\)](#)

2. Select Duplex Printing & Margin in the pop-up menu.

3. Select Automatic Duplex Printing.

4. Click Use reduced printing in Print Area.

Advanced Guide

Advanced Guide > Troubleshooting > Print Results Not Satisfactory > No Printing Results/Printing Is Blurred/Colors Are Wrong/White Streaks

No Printing Results/Printing Is Blurred/Colors Are Wrong/White Streaks

❖ No Printing Results



❖ Printing Is Blurred

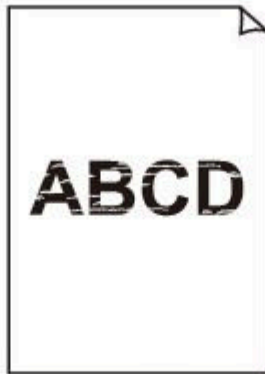

❖ Colors Are Wrong



❖ White Streaks

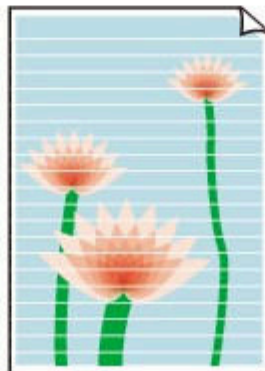

- **Check 1: Did you confirm the paper and print quality settings?**

➔ [Print Results Not Satisfactory](#)

- **Check 2: Check the status of ink tanks. Replace the ink tank if the ink has run out.**

➔ [Routine Maintenance](#)

- **Check 3: Is the orange tape or protective film remaining?**

Make sure that all of the protective film is peeled off and the air hole is exposed, as illustrated in (A).

If the orange tape is left as in (B), pull the orange tape and remove it.

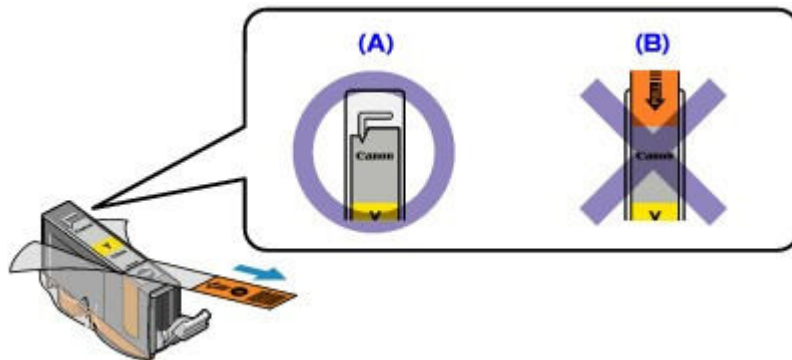

- **Check 4: Print the Nozzle Check Pattern and perform any necessary maintenance operations such as Print Head Cleaning.**

Print the Nozzle Check Pattern to determine whether the ink ejects properly from the print head nozzles.

Refer to [Routine Maintenance](#) for the Nozzle Check Pattern printing, Print Head Cleaning, and Print Head Deep Cleaning.

- If the Nozzle Check Pattern is not printed correctly:
Check to see if a particular color's ink tank is not empty.
If the Nozzle Check Pattern is not printed correctly though ink is sufficient, perform the Print Head Cleaning and try printing the Nozzle Check Pattern again.
- If the problem is not resolved after performing the Print Head Cleaning twice:
Perform the Print Head Deep Cleaning.
If the problem is not resolved after performing the Print Head Deep Cleaning, turn off the machine and perform another Print Head Deep Cleaning after 24 hours.
- If the problem is not resolved after performing the Print Head Deep Cleaning twice:
If Print Head Deep Cleaning does not resolve the problem, the Print Head may be damaged.
Contact the service center.

- **Check 5: When using paper with one printable surface, make sure that the paper is loaded with the printable side facing up.**

Printing on the wrong side of such paper may cause unclear prints or prints with reduced quality.

Refer to the instruction manual supplied with the paper for detailed information on the printable side.

- **Check 6: Is the Platen Glass dirty?**

Clean the Platen Glass.

➔ [Cleaning the Platen Glass and Document Cover](#)

- **When copying, see also the sections below:**

- **Check 7: Make sure that the original is properly loaded on the Platen**

Glass.[➡ Loading Paper / Originals](#)

- **Check 8: Is the original loaded with the side to be copied facing down on the Platen Glass?**
- **Check 9: Did you copy a printout done by this machine?**

Print from the memory card, from the USB flash drive, or from the digital camera directly, or reprint from the computer.

If you copy a printout done by this machine, print quality may be reduced.

[Page top ↑](#)

Advanced Guide

Advanced Guide > Troubleshooting > Print Results Not Satisfactory > Lines Are Misaligned

Lines Are Misaligned

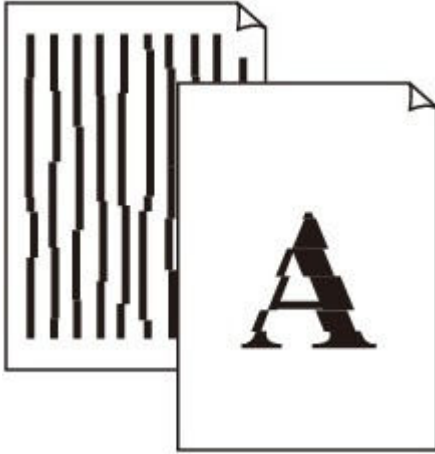

- **Check 1: Did you confirm the paper and print quality settings?**

➔ [Print Results Not Satisfactory](#)

- **Check 2: Perform Print Head Alignment.**

If you did not align the Print Head after installation, straight lines may be printed misaligned. Be sure to align the Print Head after you install it.

➔ [Routine Maintenance](#)



Note

- If the problem is not resolved after performing the Print Head Alignment, perform Print Head Alignment manually referring to [Manual Print Head Alignment](#).



- **Check 3: Is the size of the print data extremely large?**

Click Print Options on the Page Setup sheet. Then, select the Prevent loss of print data check box in the displayed dialog.

- **Check 4: Is the Page Layout Printing performed or the Binding margin function used?**

When the Page Layout Printing or Binding margin function is being used, thin lines may not be printed. Try thickening the lines in the document.

[Page top](#) ↑

Advanced Guide

Advanced Guide > Troubleshooting > Print Results Not Satisfactory > Printed Paper Curls or Has Ink Blots

Printed Paper Curls or Has Ink Blots

Printed Paper Curls



Printed Paper Has Ink Blots



- **Check 1: Did you confirm the paper and print quality settings?**

- ➔ [Print Results Not Satisfactory](#)

- **Check 2: If the intensity is set high, reduce the Intensity setting in the printer driver and try printing again.**

If you are using plain paper to print images with high intensity, the paper may absorb too much ink and become wavy, causing paper abrasion.

- When printing from your computer
Confirm the intensity using the printer driver.

- ➔ [Adjusting Intensity](#)

- When copying

- ➔ [Setting Items](#)

- **Check 3: Is Photo Paper used for printing photographs?**

When printing data with high color saturation such as photographs or images in deep color, we recommend using Photo Paper Plus Glossy II or other Canon speciality paper.

- ➔ [Loading Paper / Originals](#)

Advanced Guide

Advanced Guide > Troubleshooting > Print Results Not Satisfactory > Paper Is Smudged/Printed Surface Is Scratched

Paper Is Smudged/Printed Surface Is Scratched

▶ Paper Is Smudged

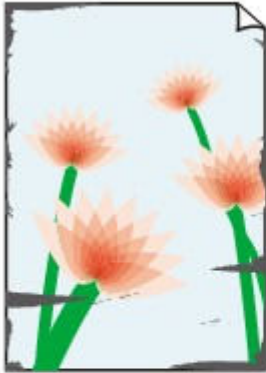

The Edges of Paper Are Smudged

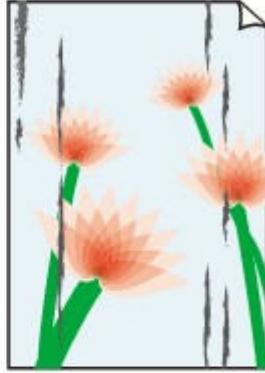

Printed Surface Is Smudged



▶ Printed Surface Is Scratched

- **Check 1: Did you confirm the paper and print quality settings?**
 - ➔ [Print Results Not Satisfactory](#)

- **Check 2: Is the appropriate type of paper used? Check the followings:**
 - Check to see if the paper you are printing on is suitable for your printing purpose.
 - ➔ [Loading Paper / Originals](#)
 - When performing Borderless Printing, make sure that the paper you are using is suitable for Borderless Printing.
If the paper you are using is not suitable for Borderless Printing, the print quality may be reduced at the top and bottom edges of the paper.
 - ➔ [Printing Area](#)

- **Check 3: Load the paper after correcting its curl.**
 - **For Plain Paper**
Turn the paper over and reload it to print on the other side.
Leaving the paper loaded on the Rear Tray for a long time may cause the paper to curl. In this case, load the paper with the other side facing up. It may resolve the problem.
We recommend putting unused paper back into the package and keeping it on a level surface.
 - **For Other Paper**
If the curl on the four corners of the paper is more than 0.1 inch / 3 mm (A) in height, the paper may be smudged or may not be fed properly. In such cases, follow the procedure described below to correct the paper curl.



1. Roll up the paper in the opposite direction to the paper curl as shown below.

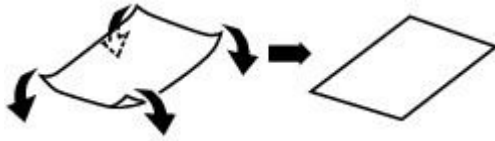

2. Check that the paper is now flat.

We recommend printing curl-corrected paper one sheet at a time.

Note

- Depending on the media type, the paper may be smudged or may not be fed properly even if it is not curled inward. In such cases, follow the procedure described below to curl the paper outward within 0.1 inch / 3 mm (B) in height before printing. This may improve the print result.

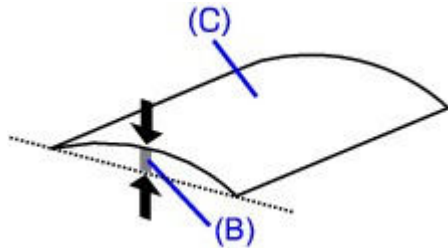

(C) Printing side

We recommend printing paper that has been curled outward one sheet at a time.

• Check 4: If you are printing on thick paper, select the Prevent paper abrasion setting.

Selecting the Prevent paper abrasion setting will widen the clearance between the Print Head and the loaded paper. If you notice abrasion even with the media type set correctly to match the loaded paper, set the machine to prevent paper abrasion by using the Operation Panel or the printer driver. Print speed is reduced if you are selecting the Prevent paper abrasion setting.

* Deactivate the Prevent paper abrasion setting once printing is complete. If not, this setting remains enabled for all subsequent print jobs.

• To set by using the Operation Panel

Press the **HOME** button, select Settings, Device settings, and Print settings in this order, and then set Prevent paper abrasion to ON.

➔ [Changing the Machine Settings on the LCD](#)

• To set by using the printer driver



Open the printer properties dialog box, and in Custom Settings in the Maintenance sheet, select the Prevent paper abrasion check box, and then click Send.

To open the printer properties dialog box, see [Opening the Printer Properties Dialog Box \(Windows\)](#).



In the Canon IJ Printer Utility, select Custom Settings in the pop-up menu, select the Prevent paper abrasion check box, and then click Send.

To open the Canon IJ Printer Utility, see [Opening the Canon IJ Printer Utility \(Macintosh\)](#).

• Check 5: If the intensity is set high, reduce the Intensity setting in the printer driver and try printing again.

If you are using plain paper to print images with high intensity, the paper may absorb too much ink and become wavy, causing paper abrasion.

- When printing from your computer

Reduce the Intensity setting in the printer driver and try printing again.



1. Open the printer properties dialog box.

➔ [Opening the Printer Properties Dialog Box \(Windows\)](#)



Click Here: [Printer Driver](#)

* Before clicking here to open the printer properties dialog box, quit the running application software.

2. On the Main sheet, select Manual for Color/Intensity, and then click Set.

3. Drag the Intensity slide bar on the Color Adjustment sheet to adjust the intensity.



1. Open the Print dialog box.

➔ [Opening the Page Setup and Print Dialog Box \(Macintosh\)](#)

2. Select Color Options in the pop-up menu.

3. Drag the Intensity slide bar to set the intensity.

- When copying
 - ➔ [Setting Items](#)

• **Check 6: Is printing performed beyond the recommended printing area?**

If you are printing beyond the recommended printing area of your printing paper, the lower edge of the paper may become stained with ink.

Resize your original document in your application software.

➔ [Printing Area](#)

• **Check 7: Is the Platen Glass dirty?**

Clean the Platen Glass.

➔ [Cleaning the Platen Glass and Document Cover](#)

• **Check 8: Is the Paper Feed Roller dirty?**

Clean the Paper Feed Roller.

➔ [Routine Maintenance](#)



Note

- Cleaning the Paper Feed Roller will wear the roller, so perform this procedure only when necessary.

• **Check 9: Is inside of the machine dirty?**

When performing duplex printing, the inside of the machine may become stained with ink, causing the printout to become smudged.

Perform the Bottom Plate Cleaning to clean the inside of the machine.

➔ [Cleaning the Inside of the Machine \(Bottom Plate Cleaning\)](#)



Note

- To prevent the inside of the machine from stains, set the paper size correctly.

- **Check 10: Set Ink Drying Wait Time longer.**

Doing so gives the printed surface enough time to dry so that paper smudged and scratched are prevented.



1. Make sure that the machine is turned on.
2. Open the printer properties dialog box.
 - ➔ [Opening the Printer Properties Dialog Box \(Windows\)](#)
3. Click the Maintenance tab and then Custom Settings.
4. Drag the Ink Drying Wait Time slide bar to set the wait time, and then click Send.
5. Confirm the message and click OK.



1. Make sure that the machine is turned on.
 2. Open the Canon IJ Printer Utility.
 - ➔ [Opening the Canon IJ Printer Utility \(Macintosh\)](#)
 3. Select Custom Settings in the pop-up menu.
 4. Drag the Ink Drying Wait Time slide bar to set the wait time, and then click Send.
 5. Confirm the message and click OK.
- **Check 11: Is the paper scratched by other loaded paper?**

Depending on the media type, the paper may be scratched by other loaded paper when feeding from the Rear Tray. In this case, load one sheet at a time.

Advanced Guide

[Advanced Guide](#) > [Troubleshooting](#) > [Print Results Not Satisfactory](#) > [Back of the Paper Is Smudged](#)

Back of the Paper Is Smudged

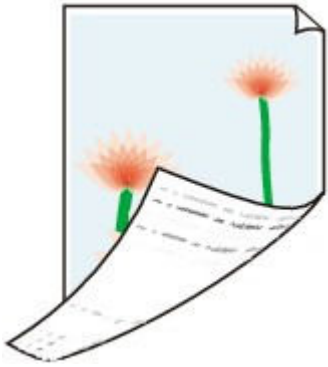

- **Check 1: Did you confirm the paper and print quality settings?**
 - ➔ [Print Results Not Satisfactory](#)
- **Check 2: Perform the Bottom Plate Cleaning to clean the inside of the machine.**
 - ➔ [Cleaning the Inside of the Machine \(Bottom Plate Cleaning\)](#)

Note

- When performing borderless printing, duplex printing, or too much printing, the inside may become stained with ink.

[Page top](#) ↑

Advanced Guide

Advanced Guide > Troubleshooting > Print Results Not Satisfactory > Vertical Lines Are Printed on the Sides of the Printout

Vertical Lines Are Printed on the Sides of the Printout



- **Check 1: Did you confirm the paper type and print quality settings?**

➔ [Print Results Not Satisfactory](#)

- **Check 2: Is the size of the loaded paper correct?**

The vertical lines may be printed in the margin if the size of the loaded paper is larger than that specified in the printer driver.

Set the paper size correctly according to the paper you loaded.

➔ [Print Results Not Satisfactory](#)



Note

- The direction of the vertical line pattern may vary depending on the image data or the print setting.
- This machine performs automatic cleaning when necessary to keep printouts clean. A small amount of ink is ejected for cleaning. Although ink is usually ejected on the ink absorber, it may be ejected on the paper if you load paper larger than that specified with the printer driver.

Advanced Guide

Advanced Guide > Troubleshooting > Print Results Not Satisfactory > Colors Are Uneven or Streaked

Colors Are Uneven or Streaked

▣ Colors Are Uneven



▣ Colors Are Streaked



- **Check 1: Did you confirm the paper and print quality settings?**

➔ [Print Results Not Satisfactory](#)

- **Check 2: Print the Nozzle Check Pattern and perform any necessary maintenance operations such as Print Head Cleaning.**

Print the Nozzle Check Pattern to determine whether the ink ejects properly from the print head nozzles.

Refer to [Routine Maintenance](#) for the Nozzle Check Pattern printing, Print Head Cleaning, and Print Head Deep Cleaning.

- If the Nozzle Check Pattern is not printed correctly:
 - Check to see if a particular color's ink tank is not empty.
 - If the Nozzle Check Pattern is not printed correctly though ink is sufficient, perform the Print Head Cleaning and try printing the Nozzle Check Pattern again.
- If the problem is not resolved after performing the Print Head Cleaning twice:
 - Perform the Print Head Deep Cleaning.
 - If the problem is not resolved after performing the Print Head Deep Cleaning, turn off the machine and perform another Print Head Deep Cleaning after 24 hours.
- If the problem is not resolved after performing the Print Head Deep Cleaning twice:
 - If Print Head Deep Cleaning does not resolve the problem, the Print Head may be damaged. Contact the service center.

- **Check 3: Perform Print Head Alignment.**

➔ Routine Maintenance

 **Note**

-
- If the problem is not resolved after performing the Print Head Alignment, perform Print Head Alignment manually referring to [Manual Print Head Alignment](#).
-

[Page top](#) ↑

Advanced Guide

Advanced Guide > Troubleshooting > Printing Does Not Start

Printing Does Not Start

- **Check 1: Make sure that the power plug is securely plugged in, then turn the machine on.**

While the **Power** lamp is flashing blue, the machine is initializing. Wait until the **Power** lamp stops flashing and remains lit blue.

Note

- When printing large data such as a photo or graphics, it may take longer to start printing. While the **Power** lamp is flashing blue, the computer is processing data and sending it to the machine. Wait until printing starts.

- **Check 2: Check the status of ink tanks. Replace the ink tank if ink has run out.**

- **Check 3: Open the Scanning Unit (Cover) and check to see if the ink lamps are flashing red.**

If there is still sufficient ink but its ink lamp is flashing red, an ink tank may not be installed in a right position.

➔ [Routine Maintenance](#)

- **Check 4: Open the Scanning Unit (Cover) and make sure that the ink lamps light up red.**

If the ink lamp is not lit, press the  mark on the ink tank until it clicks into place.

- **Check 5: Make sure that the machine is connected to your computer properly.**

When the machine is connected to your computer with a USB cable, make sure that the USB cable is securely plugged in to the machine and the computer, then check the followings:

- If you are using a relay device such as a USB hub, disconnect it, connect the machine directly to the computer, and try printing again. If printing starts normally, there is a problem with the relay device. Consult the reseller of the relay device for details.
- There could also be a problem with the USB cable. Replace the USB cable and try printing again.

When you use the machine over LAN, make sure that the machine is set up to be used over network correctly. For details, refer to your setup manual.

- **Check 6: Restart your computer if you are printing from the computer.**

If there are any unnecessary print jobs, delete them.

➔ [Deleting the Undesired Print Job](#)

- **Check 7: Make sure that the Inner Cover is closed.**

If the Inner Cover is opened, close the Inner Cover and press the **OK** button on the machine.

- **Check 8: Are the Media Type and the Page Size settings of the printer driver correct?**

When using Fine Art Paper "Photo Rag" or non Canon genuine specialty paper, be sure to select the

type of each media from Media Type and either Fine Art A4 or Fine Art Letter from Page Size or Paper size.

Confirm the settings following the procedure below, and try printing again.

1. Ensure that either Fine Art A4 or Fine Art Letter is selected in the application.
If the page size you want to use is not displayed, open the File menu of the application and select Print. Then make sure that the name of your printer is selected.
2. Make sure that the paper selected for Media Type in the Main sheet (Windows) or the Print dialog box (Macintosh) in the printer driver matches the paper loaded in the machine.
3. Ensure that the Page Size setting in the Page Setup tab (Windows) or the Paper size setting in the Page Setup dialog box (Macintosh) in the printer driver is the same as the size set in step 1.

- **Check 9: Make sure that your machine's name is selected in the Print dialog box.**

The machine will not print properly if you are using a driver for a different printer.

In Windows, make sure that your machine's name is selected in the Print dialog box.

In Macintosh, make sure that your machine's name is selected in Printer in the Print dialog box.



Note

- To make the machine the one selected by default, select Set as Default Printer (Windows), Default Printer or Make Default (Macintosh).



- **Check 10: Configure the printer port appropriately.**

Make sure that the printer port is configured appropriately in the printer driver.

1. Log on as a user account with administrator privilege.
2. Click Control Panel, then Printer under Hardware and Sound.
In Windows XP, click Control Panel, Printers and Other Hardware, then Printers and Faxes.
In Windows 2000, click Control Panel then Printers.
3. Right-click the Canon XXX Printer icon, then select Properties.
4. Click the Ports tab to confirm the port settings.

Make sure that a port named USBnnn (where "n" is a number) with Canon XXX Printer appearing in the Printer column is selected for Print to the following port(s).
If the setting is incorrect, reinstall the MP Drivers or change the printer port to the correct one.



Note

- When the machine is used over LAN, the port name of the machine is displayed as "CNBJNP_XXXXXXXX".
* "XXXXXXXX" is the character string generated from the MAC address or a character string specified by the user when setting up the machine.

- **Check 11: Is the size of the print data extremely large?**

Click Print Options on the Page Setup sheet. Then, select the Prevent loss of print data check box in the displayed dialog.

Advanced Guide

Advanced Guide > Troubleshooting > Copying/Printing Stops Before It Is Completed

Copying/Printing Stops Before It Is Completed

- **Check 1: Is the Inner Cover opened while printing on paper?**

Close the Inner Cover, then press the **OK** button on the machine.

A page of print data being sent at the time of the error will be erased, so print that page again.

- **Check 2: Has the machine been printing continuously for a long period?**

If the machine has been printing continuously for a long time, the Print Head may overheat. To protect the Print Head, the machine may stop printing at a line break for a period of time and then resume printing.

In this case, interrupt your print session at a convenient time and turn the machine off for at least 15 minutes.

Additionally, if the machine has been printing graphics or photos with intense colors continuously over a period of time, the machine may stop printing to protect the Print Head. In this case, printing will not resume automatically. Turn the machine off for at least 15 minutes.

Caution

- The Print Head and the surrounding area can become extremely hot inside the machine. Never touch the Print Head or nearby components.

- **Check 3: Is the paper loaded?**

Make sure that paper is loaded in the Rear Tray or Cassette.

Confirm the paper source, then reload paper.

- **Check 4: Do the printing documents have lots of photographs or illustrations?**

Printing large data such as photos or graphics takes time for the machine and the computer to process, during which the machine may appear to have stopped operating.

In addition, when printing data that uses a large amount of ink continuously on plain paper, the machine may pause temporarily. In either case, wait until the process is complete.

Note

- If you are printing a document with a large printing area or printing multiple copies of a document, printing may pause to allow the ink to dry.

Advanced Guide

Advanced Guide > Troubleshooting > Machine Moves But Ink Is Not Ejected

Machine Moves But Ink Is Not Ejected

• Check 1: Are the Print Head nozzles clogged?

Print the Nozzle Check Pattern to determine whether the ink ejects properly from the print head nozzles.

Refer to [Routine Maintenance](#) for the Nozzle Check Pattern printing, Print Head Cleaning, and Print Head Deep Cleaning.

- If the Nozzle Check Pattern is not printed correctly:
Check to see if a particular color's ink tank is not empty.
If the Nozzle Check Pattern is not printed correctly though ink is sufficient, perform the Print Head Cleaning and try printing the Nozzle Check Pattern again.
- If the problem is not resolved after performing the Print Head Cleaning twice:
Perform the Print Head Deep Cleaning.
If the problem is not resolved after performing the Print Head Deep Cleaning, turn off the machine and perform another Print Head Deep Cleaning after 24 hours.
- If the problem is not resolved after performing the Print Head Deep Cleaning twice:
If Print Head Deep Cleaning does not resolve the problem, the Print Head may be damaged.
Contact the service center.

• Check 2: Has the ink run out?

See [An Error Message Is Displayed on the LCD](#) to identify the ink error, and then take the appropriate action depending on the error condition.

• Check 3: Is the orange tape or protective film remaining?

Make sure that all of the protective film is peeled off and the air hole is exposed, as illustrated in (A).

If the orange tape is left as in (B), pull the orange tape and remove it.

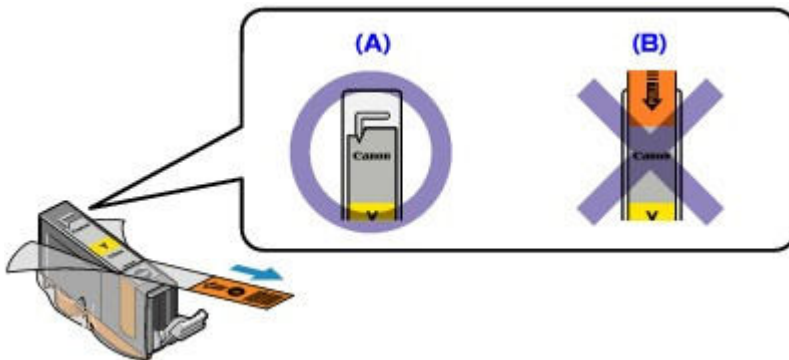

Advanced Guide

Advanced Guide > Troubleshooting > Printing Speed Is Not as Fast as Expected

Printing Speed Is Not as Fast as Expected

• Check 1: Is printing performed in Quiet Mode?

Print speed is reduced if you specified to print in Quiet Mode in the printer driver or Operation Panel. For faster printing, do not print in Quiet Mode.

For information on the printer driver settings, refer to [Reducing the Machine Noise](#).

For information to make setting on the Operation Panel, see [Changing the Machine Settings on the LCD](#).

• Check 2: Is the print quality set too high?

Increase the printing speed setting in the printer driver. Setting to prioritize speed makes printing faster.



1. Open the printer properties dialog box.

➔ [Opening the Printer Properties Dialog Box \(Windows\)](#)



Click Here: [Printer Driver](#)

* Before clicking here to open the printer properties dialog box, quit the running application software.

2. On the Main sheet, select Fast for the Print Quality setting.

Depending on the media type, the Fast option may not be available.



1. Open the Print dialog box.

➔ [Opening the Page Setup and Print Dialog Box \(Macintosh\)](#)

2. Select Quality & Media in the pop-up menu and then select Fast for the Print Quality setting.

Depending on the media type, the Fast option may not be available.

Note

- Printing speed may not improve noticeably by following the instructions above, depending on your system environment.

Advanced Guide

Advanced Guide > Troubleshooting > Print Head Holder Does Not Move to the Position for Replacing

Print Head Holder Does Not Move to the Position for Replacing

- **Check 1: Is the Power lamp off?**

Check if the **Power** lamp is lit blue.

The Print Head Holder will not move unless the power is on. If the **Power** lamp is off, close the Scanning Unit (Cover) and turn the machine on.

While the **Power** lamp is flashing blue, the machine is initializing. Wait until the **Power** lamp stops flashing and remains lit blue, and then open the Scanning Unit (Cover) again.

- **Check 2: Is an error message displayed on the LCD?**

Close the Scanning Unit (Cover), follow the directions displayed in the error message to resolve the error, and then reopen it. For details on how to resolve the error, see [An Error Message Is Displayed on the LCD](#).

- **Check 3: Has the Scanning Unit (Cover) been left open for 10 minutes or longer?**

If the Scanning Unit (Cover) is left open for more than 10 minutes, the Print Head Holder moves to the right to prevent the Print Head from drying out. Close and reopen the Scanning Unit (Cover) to return the Print Head Holder to the center.

- **Check 4: Has the machine been printing continuously for a long period?**

Close the Scanning Unit (Cover), wait a while, then reopen it.

If the machine has been printing continuously for a long time, the Print Head Holder may not move to the center since the Print Head may overheat.

Note

- Opening the Scanning Unit (Cover) while printing moves the Print Head Holder to the right. Close the Scanning Unit (Cover), and reopen it after printing finishes.

Advanced Guide

Advanced Guide > Troubleshooting > Paper Does Not Feed Properly

Paper Does Not Feed Properly

- **Check 1: Make sure of the following when you load paper.**

- When loading two or more sheets of paper, flip through the paper before loading.



- When loading two or more sheets of paper, align the edges of the sheets before loading.
- When loading two or more sheets of paper, make sure that the paper stack does not exceed the paper load limit.
However, proper feeding of paper may not be possible at this maximum capacity depending on the type of paper or environmental conditions (either very high or low temperature and humidity). In such cases, reduce the sheets of paper you load at a time to less than half of the paper load limit.
- Always load the paper in portrait orientation, either in the Rear Tray or the Cassette, regardless of the printing orientation.
- When you load the paper on the Rear Tray, load the paper with the print side facing UP and slide the Paper Guides to align with the both sides of the paper.
- When loading paper in the Cassette, load the paper with the print side facing DOWN. Align the right edge of the paper stack against the right edge of the Cassette and slide the Paper Guides against the left and bottom edges of the stack.

➔ [Loading Paper / Originals](#)

- **Check 2: Check to see if the paper you are printing on is not too thick or curled.**

➔ [Loading Paper / Originals](#)

- **Check 3: Make sure of the following when you load envelopes.**

When printing on envelopes, refer to [Loading Paper / Originals](#) , and prepare the envelopes before printing.

Once you have prepared the envelopes, load them in portrait orientation. If the envelopes are placed in landscape orientation, they will not feed properly.

- **Check 4: Confirm the paper source setting.**

* If the paper source setting is not changed since you purchased this machine, the paper source for plain paper is the Cassette.

- Setting with the Operation Panel on the machine:
 - ➔ [Changing the Machine Settings on the LCD](#)
- Setting with the printer driver:
 - ➔ [Switching the Paper Source to Match the Purpose](#)
- For information on the paper source for plain paper when the Paper Source on the printer driver is set to Automatically Select:
 - ➔ [Setting the Paper Source for Plain Paper](#)

- **Check 5: Remove the foreign object in the Cassette.**

- **Check 6: Make sure that there are not any foreign objects in the Rear Tray.**



If the paper tears in the Rear Tray, see [Paper Jams](#) to remove it.

If there are any foreign objects in the Rear Tray, be sure to turn off the machine, unplug it from the power supply, then remove the foreign object.



- **Check 7: Make sure that the Inner Cover is closed completely.**

Paper does not feed properly if the Inner Cover is even slightly open.

➔ [Overview of the Machine](#)

- **Check 8: Clean the Paper Feed Roller.**

➔ [Routine Maintenance](#)

Note

- Cleaning the Paper Feed Roller will wear the roller, so perform this procedure only when necessary.

- **Check 9: If two or more sheets of paper feed from the Cassette at once, clean the inside of the Cassette.**

For information on cleaning the inside of the Cassette, refer to [Routine Maintenance](#).

- **Check 10: Is the Rear Cover closed completely?**

Paper may be jammed if the Rear Cover is not closed completely. Push the Rear Cover until it is closed completely.

Refer to [Overview of the Machine](#) for the position of the Rear Cover.

[Page top](#) ↑

Advanced Guide

[Advanced Guide](#) > [Troubleshooting](#) > Paper Does Not Feed from the Paper Source Specified in the Printer Driver

Paper Does Not Feed from the Paper Source Specified in the Printer Driver



- **Check: Is the paper source setting inconsistent between the application program and the printer driver?**

Change the application software setting corresponding to the printer driver setting, or click the Print Options on the Page Setup sheet in the printer driver and select Disable the paper source setting of the application software on the Print Options screen.

When the paper source setting is inconsistent between an application program and the printer driver, the application software setting takes precedence.

[Page top](#) ↑

Advanced Guide

Advanced Guide > Troubleshooting > Paper Jams

Paper Jams

Note

- If you need to turn off the machine to remove jammed paper during printing, press the **Stop** button to cancel print jobs before turning off the machine.
-

- ➔ Paper Is Jammed in the Paper Output Slot or the Rear Tray
- ➔ Paper Is Jammed inside the Machine at the Transport Unit
- ➔ Jammed Paper Is Not Removed out When Automatic Duplex Printing
- ➔ In Other Cases

[Page top ↑](#)

Advanced Guide

Advanced Guide > Troubleshooting > Paper Jams > Paper Is Jammed in the Paper Output Slot or the Rear Tray

Paper Is Jammed in the Paper Output Slot or the Rear Tray

Remove the paper following the procedure below.

1. Slowly pull the paper out, either from the Rear Tray or from the Paper Output Slot, whichever is easier.



Note

- If the paper tears and a piece remains inside the machine, turn the machine off, open the Scanning Unit (Cover), and remove the paper. Be careful not to touch the components inside the machine. After removing all paper, close the Scanning Unit (Cover), and turn the machine back on.
- If you cannot pull the paper out, turn the machine off and turn it back on. The paper may be ejected automatically.

2. Reload the paper, and press the **OK** button on the machine.

If you turned off the machine in step 1, all print jobs in the queue are canceled. Reprint if necessary.

Note

- When reloading the paper, confirm that you are using the correct paper and are loading it correctly.
 - ➔ [Loading Paper / Originals](#)
- A5 sized paper is suited to printing documents consisting mainly of text. We do not recommend using such paper to print documents with photos or graphics, since the printout may curl and cause paper exit jams.

If you cannot remove the paper or the paper tears inside the machine, or if the paper jam error continues after removing the paper, contact the service center.

Advanced Guide

Advanced Guide > Troubleshooting > Paper Jams > Paper Is Jammed inside the Machine at the Transport Unit

Paper Is Jammed inside the Machine at the Transport Unit

Remove the paper following the procedure below.

1. Detach the Rear Cover.

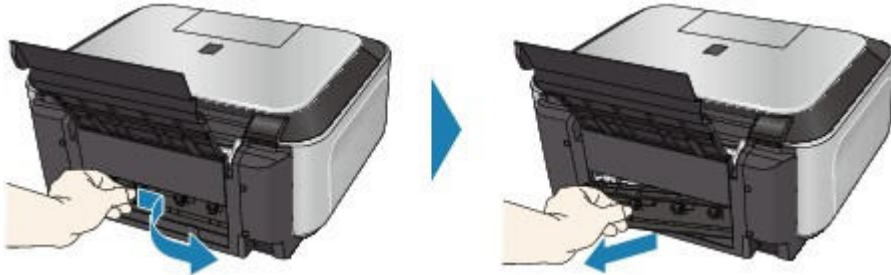

2. Pull the paper out slowly.

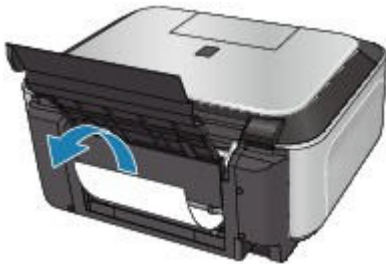

Note

- Be careful not to touch the components inside the machine.
- If you cannot pull the paper out, turn the machine off and turn it back on. The paper may be ejected automatically.

3. Attach the Rear Cover.

Push the left side of the Rear Cover until it is closed completely.



If you were not able to remove the paper out in step 2:

4. Remove the Cassette.

5. Pull the paper out slowly.



6. If any paper is sticking out of the Cassette, remove the paper, align and reload the paper in the Cassette.

If you did not remove the jammed paper out in step 1 to 5 when automatic duplex printing, check the duplex transport section.

➔ [Jammed Paper Is Not Removed out When Automatic Duplex Printing](#)

Note

- When reloading the paper into the machine, confirm that you are using the correct paper and are loading it into the machine correctly.
➔ [Loading Paper / Originals](#)
-

7. Insert the Cassette into the machine again, and press the **OK** button on the machine.

If you turned off the machine in step 2, all print jobs in queue are canceled. Reprint if necessary.

If you cannot remove the paper or if the paper tears inside the machine, or if the paper jam error continues after removing the paper, contact the service center.

Advanced Guide

Advanced Guide > Troubleshooting > Paper Jams > Jammed Paper Is Not Removed out When Automatic Duplex Printing

Jammed Paper Is Not Removed out When Automatic Duplex Printing

Before removing the jammed paper, see [Paper Is Jammed inside the Machine at the Transport Unit](#) to remove it from Transport Unit. If the paper jam error continues, remove the jammed paper following the procedure below.

1. Turn off the machine, and unplug the power cord of the machine from the power supply.
2. Remove the Cassette.
If the paper is loaded on the Rear Tray, remove the paper from the Rear Tray and retract the Paper Support.
3. Set the machine upright with the left side down.

Important

- When standing the machine, make sure that the Scanning Unit (Cover) is closed securely.

4. Slowly pull the jammed paper out so that the paper does not tear.



Note

- Set the machine back to its original position immediately after removing the jammed paper.

5. Align the paper, then reload it in the Cassette.

Reload paper in the Rear Tray, if necessary.

Note

- When reloading the paper into the machine, confirm that you are using the correct paper and are loading it into the machine correctly.
➔ [Loading Paper / Originals](#)

6. Insert the Cassette into the machine again.
7. Plug the machine back in and turn the machine back on.

All print jobs in queue are canceled. Reprint if necessary.

If you cannot remove the paper or the paper tears inside the machine, or if the paper jam error continues after removing the paper, contact the service center.

Advanced Guide

Advanced Guide > Troubleshooting > Paper Jams > In Other Cases

In Other Cases

Make sure of the following:

- **Check 1: Are there any foreign objects around the Paper Output Slot?**
- **Check 2: Are there any foreign objects in the Rear Tray?**



If there are any foreign objects in the Rear Tray, be sure to turn off the machine, unplug it from the power supply, then remove the foreign object.











- **Check 3: Is the Rear Cover closed completely?**
- **Check 4: Is the paper curled?**
 - ➔ Check 3: Load the paper after correcting its curl.

Advanced Guide

Advanced Guide > Troubleshooting > Message Appears on the Computer Screen

Message Appears on the Computer Screen

- ➔ Error Number: B200 A printer error has occurred. Turn the printer off and unplug the power cord of the printer from the power supply. Then contact the service center. Is Displayed
- ➔ Error Number: **** A printer error has occurred. Turn the printer off and then on again. If this doesn't clear the error, see the user's guide for more detail. Is Displayed
- ➔ Error Regarding Automatic Duplex Printing Is Displayed
- ➔ Error Regarding Automatic Print Head Alignment Is Displayed
- ➔  Writing Error/Output Error/Communication Error
- ➔  Error Number: 300 Is Displayed
- ➔  Error Number: 1700 Is Displayed
- ➔  Ink Info Number: 1600 Is Displayed
- ➔  Ink Info Number: 1683 Is Displayed
- ➔  Ink Info Number: 1688 Is Displayed
- ➔  Error Number: 1851 Is Displayed
- ➔  Error Number: 1856 Is Displayed
- ➔  Error Number: 2001 Is Displayed
- ➔  Error Number: 2002 Is Displayed
- ➔  Error Number: 2500 Is Displayed
- ➔  Other Error Messages
- ➔  The Inkjet Printer/Scanner/Fax Extended Survey Program Screen Is Displayed
- ➔  The Inkjet Printer/Scanner/Fax Extended Survey Program Icon Appears

Error Number: B200 A printer error has occurred. Turn the printer off and unplug the power cord of the printer from the power supply. Then contact the service center. Is Displayed

Turn off the machine, and unplug the power cord of the machine from the power supply.
Contact the service center.

Error Number: ** A printer error has occurred. Turn the printer off and then on again. If this doesn't clear the error, see the user's guide for more detail. Is Displayed**

"****" is displayed in the alphanumeric character and depends on the error occurred.

- **5100 or 5110 Is Displayed**

Confirm the movement of the Print Head Holder blocked.

Cancel printing from your computer and turn off the machine. Then clear the jammed paper or protective material that is preventing the Print Head Holder from moving, and turn on the machine again.

Important

- Be careful not to touch the components inside the machine. The machine may not print out properly if you touch it.
- If the problem is not resolved, contact the service center.

- **6000 Is Displayed**

If any object is placed in front of the machine, remove it.

Open the Paper Output Tray gently, then turn the power off and back on.

- **Four-Digit Alphanumeric and "Printer error has occurred." Is Displayed**

Turn off the machine, and unplug the power cord of the machine from the power supply.

Plug the machine back in and turn the machine back on.

If the problem is not resolved, contact the service center.

Error Regarding Automatic Duplex Printing Is Displayed

- **Check: See [Cannot Print Properly with Automatic Duplex Printing](#) and take the appropriate action.**

Error Regarding Automatic Print Head Alignment Is Displayed

- **Check: See [Auto head align has failed. in An Error Message Is Displayed on the LCD](#) and take the appropriate action.**

Writing Error/Output Error/Communication Error

- **Check 1: If the Power lamp is off, make sure that the power plug is plugged in, then turn the machine on.**

While the **Power** lamp is flashing blue, the machine is initializing. Wait until the **Power** lamp stops flashing and remains lit blue.

- **Check 2: Make sure that the printer port is configured appropriately in the printer driver.**

* In the following instructions, "XXX" signifies your machine's name.

- 1. Log on as a user account with administrator privilege.**

- 2. Click Control Panel, then Printer under Hardware and Sound.**

In Windows XP, click Control Panel, Printers and Other Hardware, then Printers and Faxes.

In Windows 2000, click Control Panel then Printers.

- 3. Right-click the Canon XXX Printer icon, then select Properties.**

- 4. Click the Ports tab to confirm the port settings.**

Make sure that a port named USBnnn (where "n" is a number) with Canon XXX Printer appearing in the Printer column is selected for Print to the following port(s).

If the port setting is not correct, reinstall the MP Drivers or change the port setting according to the interface you are using.

Note

- When the machine is used over LAN, the port name of the machine is displayed as "CNBJNP_XXXXXXXX".
* "XXXXXXXX" is the character string generated from the MAC address or a character string specified by the user when setting up the machine.

- **Check 3: Make sure that the machine is connected to your computer properly.**

When the machine is connected to your computer with a USB cable, make sure that the USB cable is securely plugged in to the machine and the computer, then check the followings:

- If you are using a relay device such as a USB hub, disconnect it, connect the machine directly to the computer, and try printing again. If printing starts normally, there is a problem with the relay device. Consult the reseller of the relay device for details.
- There could also be a problem with the USB cable. Replace the USB cable and try printing again.

When you use the machine over LAN, make sure that the machine is set up to be used over network correctly. For details, refer to your setup manual.

- **Check 4: Make sure that the MP Drivers are installed correctly.**

Uninstall the MP Drivers following the procedure described in [Deleting the Unnecessary MP Drivers](#), insert the *Setup CD-ROM* into the computer's disc drive and perform Custom Install and select MP Drivers to install again.

- **Check 5: When the machine is connected to your computer with a USB cable, check the status of the device on your computer.**

Follow the procedure below to check the status of the device.

- 1. Click Control Panel, Hardware and Sound, then Device Manager.**

If the User Account Control screen is displayed, follow the on-screen instructions.

In Windows XP, click Control Panel, Performance and Maintenance, System, then click Device Manager on the Hardware sheet.

In Windows 2000, click Control Panel, System, then Device Manager on the Hardware sheet.

- 2. Double-click Universal Serial Bus controllers then USB Printing Support.**

If USB Printing Support is not displayed, make sure that the machine is correctly connected to the computer.

➔ [Check 3: Make sure that the machine is connected to your computer properly.](#)

- 3. Click the General tab and make sure that there is no indication of a problem with the device.**

If a device error is displayed, refer to Windows help to resolve the error.

Macintosh Error Number: 300 Is Displayed

- **Check 1: If the Power lamp is off, make sure that the power plug is plugged in, then turn the machine on.**

While the **Power** lamp is flashing blue, the machine is initializing. Wait until the **Power** lamp stops flashing and remains lit blue.

- **Check 2: Make sure that the machine is connected to your computer properly.**

When the machine is connected to your computer with a USB cable, make sure that the USB cable is securely plugged in to the machine and the computer, then check the followings:

- If you are using a relay device such as a USB hub, disconnect it, connect the machine directly to the computer, and try printing again. If printing starts normally, there is a problem with the relay device. Consult the reseller of the relay device for details.
- There could also be a problem with the USB cable. Replace the USB cable and try printing again.

When you use the machine over LAN, make sure that the machine is set up to be used over network correctly. For details, refer to your setup manual.

- **Check 3: Make sure that your machine's name is selected in the Print dialog box.**

➔ [Opening the Page Setup and Print Dialog Box \(Macintosh\)](#)

Macintosh Error Number: 1700 Is Displayed

- Check: See **The ink absorber is almost full.** in **An Error Message Is Displayed on the LCD** and take the appropriate action.

Macintosh Ink Info Number: 1600 Is Displayed

- Check: See **The following ink may have run out.** in **An Error Message Is Displayed on the LCD** and take the appropriate action.

Macintosh Ink Info Number: 1683 Is Displayed

- Check: See **The remaining level of the following ink cannot be correctly detected.** in **An Error Message Is Displayed on the LCD** and take the appropriate action.

Macintosh Ink Info Number: 1688 Is Displayed

- Check: See **The following ink has run out.** in **An Error Message Is Displayed on the LCD** and take the appropriate action.

Macintosh Error Number: 1851 Is Displayed

- Check: Close the Inner Cover, then press the OK button on the machine.

Macintosh Error Number: 1856 Is Displayed

- Check: Close the Inner Cover, then press the OK button on the machine.
A page of print data being sent at the time of the error will be erased, so print that page again.

Macintosh Error Number: 2001 Is Displayed

- Check: See **The device may be incompatible.** in **An Error Message Is Displayed on the LCD** and take the appropriate action.

Macintosh Error Number: 2002 Is Displayed

- Check: See **An unsupported USB hub is connected.** in **An Error Message Is Displayed on the LCD** and take the appropriate action.

Macintosh Error Number: 2500 Is Displayed

- Check: See **Auto head align has failed.** in **An Error Message Is Displayed on the LCD** and take the appropriate action.

Windows Other Error Messages

- **Check: If an error message is displayed outside the printer status monitor, check the following:**
 - "Could not spool successfully due to insufficient disk space"
Delete any unnecessary files to increase the amount of free space on the disk.
 - "Could not spool successfully due to insufficient memory"
Quit other running applications to increase available memory.
If you still cannot print, restart your computer and retry printing.
 - "Printer driver could not be found"
Uninstall the printer driver according to the procedure described in [Deleting the Unnecessary MP Drivers](#), and then reinstall it.
 - "Could not print Application name - File name"
Try printing again once the current job is complete.

The Inkjet Printer/Scanner/Fax Extended Survey Program Screen Is Displayed

If the Inkjet Printer/Scanner/Fax Extended Survey Program is installed, a confirmation screen asking for permission to send the printer usage information will be displayed three months and then six months after the installation. After that, it will be displayed every six months for about four years.

Read the instructions on the screen and follow the procedure below.

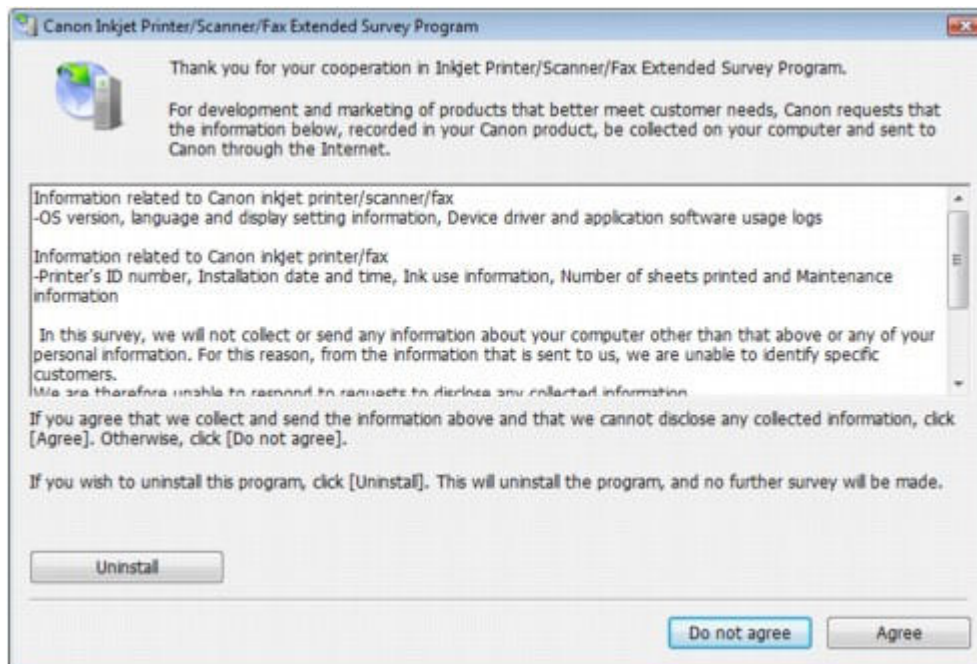

- **If you agree to participate in the survey program:**
Click Agree, then follow the on-screen instructions. The printer usage information will be sent via the Internet. If you have followed the on-screen instructions, the information will be sent automatically from the second time onward and the confirmation screen will not be displayed again.

Note

- When the information is being sent, a caution screen such as an Internet security screen may be displayed. In this case, confirm that the program name is "IJPLMU.exe", then allow it.
- If you deselect the Send automatically from the next time check box, the information will not be sent automatically from the second time onward and a confirmation screen will be displayed at the time of the next survey. To send the information automatically, see [Changing the confirmation screen setting:](#)

- **If you do not agree to participate in the survey program:**
Click Do not agree. The confirmation screen will be closed, and the survey at that time is skipped. The confirmation screen will be displayed again three months later.

- **To uninstall the Inkjet Printer/Scanner/Fax Extended Survey Program:**

To uninstall the Inkjet Printer/Scanner/Fax Extended Survey Program, click Uninstall, then follow the on-screen instructions.

- **Changing the confirmation screen setting:**

1. Select items the Start menu as shown below.
 - In Windows Vista, select the Start menu > Control Panel > Uninstall a program.
 - In Windows XP, select the Start menu > Control Panel > Add or Remove Programs.
 - In Windows 2000, select the Start menu > Settings > Control Panel > Add/Remove Programs.

 **Note**

- In Windows Vista, a confirmation/warning dialog box may appear when installing, uninstalling or starting up software. This dialog box appears when administrative rights are required to perform a task. If you are logged on to an administrator account, click Continue or Allow to continue.
-

2. Select Canon Inkjet Printer/Scanner/Fax Extended Survey Program.
3. Select Change.

If you select Yes after you have followed the on-screen instructions, the confirmation screen will be displayed at the time of the next survey.

If you select No, the information will be sent automatically.

 **Note**

- If you select Uninstall (or Remove), the Inkjet Printer/Scanner/Fax Extended Survey Program is uninstalled. Follow the on-screen instructions.
-

The Inkjet Printer/Scanner/Fax Extended Survey Program Icon Appears

If the Inkjet Printer/Scanner/Fax Extended Survey Program is installed, the printer usage information is scheduled to be sent three months and then six months after the installation. After that, it is scheduled to be sent every six months for about four years. The Inkjet Printer/Scanner/Fax Extended Survey Program icon appears in the Dock when it is time to send the printer usage information.

In Mac OS X v.10.3.9, the Inkjet Printer/Scanner/Fax Extended Survey Program is not installed.

Read the instructions on the screen after clicking the icon, then follow the procedure below.

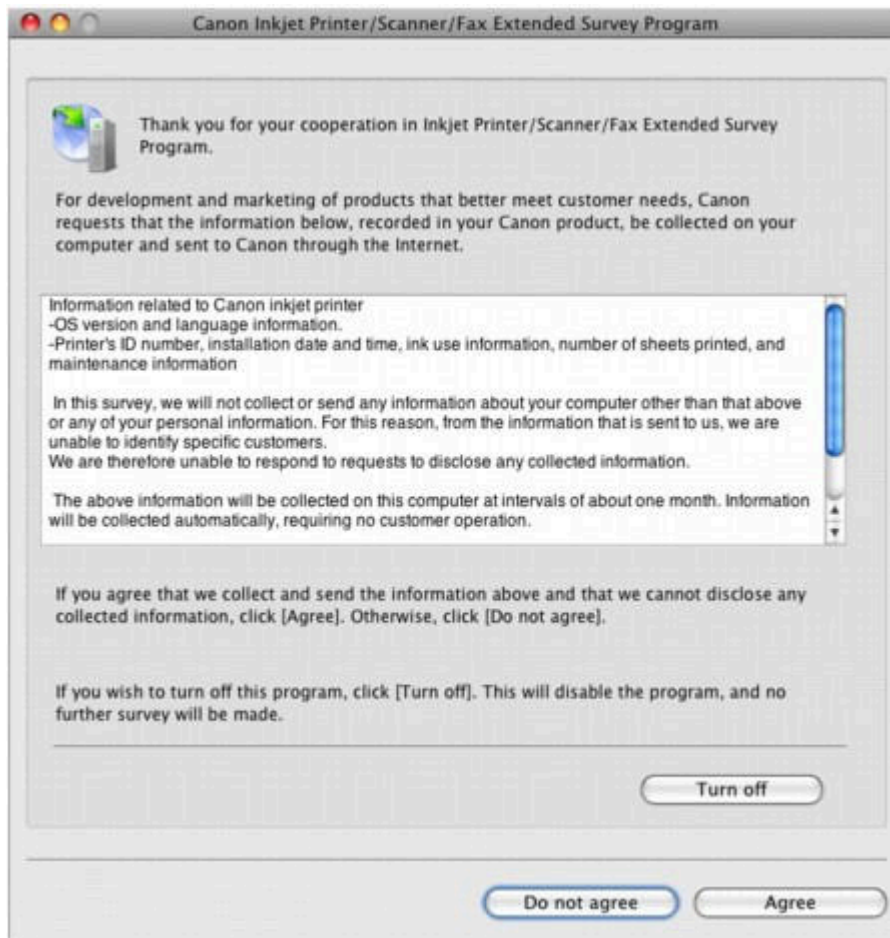

- **If you agree to participate in the survey program:**

Click Agree, then follow the on-screen instructions. The printer usage information will be sent via the Internet. If you have followed the on-screen instructions, the information will be sent automatically from the second time onward and the confirmation screen will not be displayed again.

Note

- If you deselect the Send automatically from the next time check box, the information will not be sent automatically from the second time onward and the Inkjet Printer/Scanner/Fax Extended Survey Program icon will appear in the Dock at the time of the next survey.

- **If you do not agree to participate in the survey program:**

Click Do not agree. The confirmation screen will be closed, and the survey at that time is skipped. The confirmation screen will be displayed again three months later.

- **To stop sending the information:**

Click Turn off. The Inkjet Printer/Scanner/Fax Extended Survey Program is stopped, and the information will not be sent. To resume the survey, see [Changing the setting:](#)

- **To uninstall the Inkjet Printer/Scanner/Fax Extended Survey Program:**

1. Stop the Inkjet Printer/Scanner/Fax Extended Survey Program.
 - ➔ [Changing the setting:](#)
2. Select Applications from the Go menu, and double-click the Canon Utilities folder, then the Inkjet Extended Survey Program folder.
3. Place the Canon Inkjet Printer/Scanner/Fax Extended Survey Program.app file into the Trash.
4. Restart the computer.
 - Empty the Trash and restart your computer.

- **Changing the setting:**

To display the confirmation screen every time the printer usage information is sent or to resume surveying, follow the procedure below.

1. Select Applications from the Go menu, and double-click the Canon Utilities folder, then the Inkjet Extended Survey Program folder.
2. Double-click the Canon Inkjet Printer/Scanner/Fax Extended Survey Program icon.

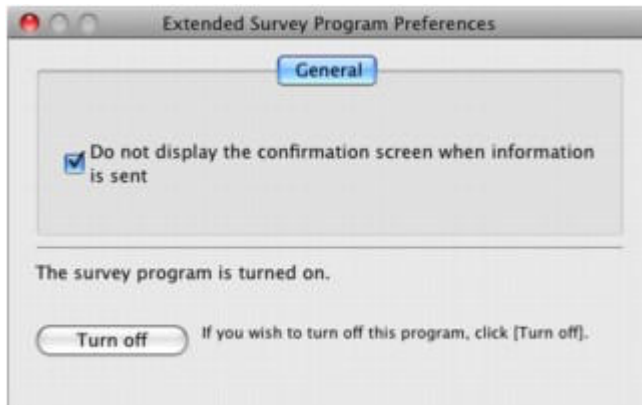

- Do not display the confirmation screen when information is sent:
If the check box is selected, the information will be sent automatically.
If the check box is not selected, the Inkjet Printer/Scanner/Fax Extended Survey Program icon will appear in the Dock at the time of the next survey. Click the icon, then follow the on-screen instructions.
- Turn off/Turn on button:
Click the Turn off button to stop the Inkjet Printer/Scanner/Fax Extended Survey Program.
Click the Turn on button to restart the Inkjet Printer/Scanner/Fax Extended Survey Program.

Advanced Guide

Advanced Guide > Troubleshooting > Cannot Print Properly with Automatic Duplex Printing

Cannot Print Properly with Automatic Duplex Printing

• Check: Is the paper size or media type appropriate?

- Make sure that the actual size of the paper is suitable for automatic duplex printing. The sizes of media suitable for automatic duplex printing are A4, Letter, A5, and 5" x 7". Load paper of suitable size, then press the **OK** button on the machine.
- Make sure that the Page Size or Paper Size setting matches the actual size of the paper with a size suitable for automatic duplex printing. First, check the Page Size setting in the application software you are printing from. Then, check the Page Size setting on the Page Setup sheet in the printer properties dialog box (Windows) or the Paper Size on the Page Setup dialog box (Macintosh).



Note

- Duplex printing may not be available depending on the version of the application software.

- Make sure that the type of loaded paper is suitable for automatic duplex printing on the Main sheet (Windows) or the Quality & Media sheet on the Print dialog box (Macintosh).

To switch to manual duplex printing, follow the procedure below.

Windows

Open the printer properties dialog box, clear the Automatic check box on the Page Setup sheet, and reprint.

When performing manual duplex printing, note the following.

- If you are printing three or more pages of a document with manual duplex printing, one side of all sheets of paper will be printed first. Turn over the paper and reload the paper in the machine, and then the reverse side of all sheets of paper will be printed. Be careful not to change the order of paper in the stack.
- The procedure for reversing the paper varies depending on the staple side and printing orientation. Follow the on-screen instructions.

Macintosh

Manual duplex printing is not available.

Advanced Guide

Advanced Guide > Troubleshooting > For Windows Users

For Windows Users

Printer Status Monitor Is Not Displayed

- **Check: Is the printer status monitor enabled?**

Make sure that Enable Status Monitor is selected on the Option menu of the printer status monitor.

1. **Open the printer properties dialog box.**
 - ➔ [Opening the Printer Properties Dialog Box \(Windows\)](#)
2. **On the Maintenance sheet, click View Printer Status.**
3. **Select Enable Status Monitor on the Option menu if it is not selected.**

- **If you are using Windows Vista:**

Launching MP Navigator EX Whenever Pressing the Color or Black Button on the Machine

- **Check: Specify the response from pressing the Color or Black button on the machine.**

Follow the procedure below to specify the response on your computer.

1. **Log on as a user account with administrator privilege.**
2. **Click Control Panel, Hardware and Sound, then Scanners and Cameras.**
3. **Select WIA Canon XXX ser, then click the Properties button.**

If the User Account Control screen appears, click Continue.
4. **Click the Events tab on the WIA Canon XXX ser Properties screen.**
5. **Select Start this program for Actions, then select MP Navigator EX Ver3.0 from the pull-down menu.**

Choose an event from the Select an event pull-down menu, then select MP Navigator EX Ver3.0 to launch for each event. If MP Navigator EX Ver3.0 is already selected for each event, click Cancel.
6. **Click OK.**

Advanced Guide

Advanced Guide > Troubleshooting > Error Message Appears on a PictBridge Compliant Device

Error Message Appears on a PictBridge Compliant Device

The following are the possible errors that may occur when printing directly from a PictBridge compliant device and the countermeasures to clear them.

Note

- This section describes errors that are indicated on Canon-brand PictBridge compliant devices. The error messages and operations may vary depending on the device you are using. For errors on non-Canon PictBridge compliant devices, check the error message on the LCD and take the appropriate action to clear the error. For details, see [An Error Message Is Displayed on the LCD](#).
- For the errors indicated on the PictBridge compliant device and their solution, also refer to the instruction manual of the device. For other troubles on the device, contact the manufacturer.

Error Message on the PictBridge Compliant Device	Action
"Printer in use"	If the machine is printing from the computer or warming up, wait until the job ends. When it is ready, the machine starts printing automatically.
"No paper"	Load paper on the Rear Tray, and select Continue* in the display on your PictBridge compliant device. * To resume printing, you can also press the OK button on the machine instead of selecting Continue on the device.
"Paper Error"	If the Inner Cover is opened, close it and select Stop in the display on your PictBridge compliant device to stop printing.
"Paper jam"	Select Stop in the display on your PictBridge compliant device to stop printing. Remove the jammed paper, load new paper, press the OK button on the machine, and try printing again.
"Printer cover open"	Close the Scanning Unit (Cover) on the machine.
"No print head"	The Print Head is defective or is not installed. Check: See Print head is not installed . in An Error Message Is Displayed on the LCD and take the appropriate action.
"Waste tank full"/"Ink absorber full"	The ink absorber is nearly full. Check: See The ink absorber is almost full . in An Error Message Is Displayed on the LCD and take the appropriate action.
"No ink"/"Ink cassette error"	The ink tank is not installed properly or empty. Check the error message on the LCD and take the appropriate action to resolve the error. ➡ An Error Message Is Displayed on the LCD
"Ink Error"	An ink tank that was once empty is installed. Check: See The remaining level of the following ink cannot be correctly detected . in An Error Message Is Displayed on the LCD and take the appropriate action.
"Hardware Error"	Ink tank errors have occurred. Replace the ink tank. ➡ Routine Maintenance

Advanced Guide

[Advanced Guide](#) > [Troubleshooting](#) > [Cannot Print Properly from a Wireless Communication Device](#)

Cannot Print Properly from a Wireless Communication Device

- **Does your mobile phones store IrDA compliant infrared communication ports?**

Printing through infrared communication cannot be performed by the mobile phones does not store IrDA compliant infrared communication ports.

➔ [Printing Photographs from a Wireless Communication Device](#)

- **Place the machine within around 8 inches / 20 cm from the mobile phone in a position that enables proper communication.**

When printing through infrared communication, confirm that the infrared ports on the machine and the mobile phone are placed face to face with each other at a proper angle and distance, and that there is nothing blocking them. Then, retry printing. Operational distance and angle vary depending on the specifications of your mobile phone and your operating environment.

➔ [Printing Photographs from a Wireless Communication Device](#)

- **Did you interrupt infrared communication with the machine during receiving data?**

If it is interrupted, send the data from the mobile phone again.

- **Check 4: Is printing possible through Bluetooth communication?**

➔ [Printing via Bluetooth Communication](#)

[Page top](#) ↑

Advanced Guide

Advanced Guide > Troubleshooting > Cannot Print Properly from a Photo Index Sheet

Cannot Print Properly from a Photo Index Sheet

Failed to scan Photo Index Sheet. Is Displayed

- **Check: Check the following, press the OK button, then perform the Scan sheet and print menu again.**
 - Did you set Photo Index Sheet in the correct position and orientation on the Platen Glass?
 - Are the Platen Glass and the Photo Index Sheet dirty?
 - Are all required circles on the Photo Index Sheet filled in?

Note

- If the filled circles on the Photo Index Sheet are not dark or vast enough, the machine may not scan the Photo Index Sheet properly.

Cannot print the selected photo. Is Displayed/Differ Photo or Blank Is Printed out/Paper Feeds Before Printing Is Complete

- **Check 1: Make sure that the photo you want to print is displayed on the LCD.**

Press the **HOME** button, select Memory card and Select and print in this order, then select the photo you want to print to make sure that it is saved on the memory card or USB flash drive.
- **Check 2: Reprint out the Photo Index Sheet.**

Note

- The machine may not scan the Photo Index Sheet properly even though Print a blank Photo Index Sheet circle is filled in. Press the **HOME** button, select Photo index sheet, follow the on-screen instructions to reprint out the Photo Index Sheet.

- **Check 3: Make sure that the photo saved on the memory card or USB flash drive can be read by this machine.**

➔ [Printing from a Memory Card](#)

- **Check 4: Was the photo saved on the memory card or USB flash drive processed on a computer?**

A photo processed on a computer may not be printed.

Note

- When a photo was processed on a computer is selected, "?" is displayed on the LCD.

- **Check 5: Did you make any changes to the memory card or USB flash drive after printing the Photo Index Sheet?**

If you added photos to or deleted photos from the memory card or USB flash drive, reprint out the Photo Index Sheet.

Important

- Do not rewrite the contents of the memory card or USB flash drive until printing and scanning of the Photo Index Sheet are complete.

- **Check 6: Did you remove the memory card or USB flash drive while printing?**

Do not remove the memory card or USB flash drive before printing is complete.

Important

- If the memory card or USB flash drive is removed while printing, the stored data may be damaged or the selected photo may not be printed as the reading of the photo on the memory card or USB flash drive and the printing of the photo are simultaneous.

[Page top](#) ↑

Advanced Guide

[Advanced Guide](#) > [Troubleshooting](#) > [Cannot Remove a Memory Card](#)

Cannot Remove a Memory Card

Contact the service center.

Important

- Never attempt to remove a memory card using a thin stick or tweezers. Doing so may damage the machine.

Note

- Exclusive adapters are required for the following memory cards. Insert these cards in the machine with adapters attached.
miniSD Card/miniSDHC Card/microSD Card/microSDHC Card/xD-Picture Card/xD-Picture Card Type M/xD-Picture Card Type H/Memory Stick Micro/RS-MMC

[Page top](#) 

Advanced Guide

[Advanced Guide](#) > [Troubleshooting](#) > [Problems with Scanning](#)

Problems with Scanning

- ➔ [Scanner Does Not Work](#)
- ➔ [ScanGear \(Scanner Driver\) Does Not Start](#)
- ➔ [Error Message Appears and the ScanGear \(Scanner Driver\) Screen Does Not Appear](#)
- ➔ [Scan Quality \(Image Displayed on the Monitor\) Is Poor](#)
- ➔ [Scanned Image Is Surrounded by Extra White Areas](#)
- ➔ [Cannot Scan Multiple Documents at One Time](#)
- ➔ [Cannot Scan Properly in Auto Scan Mode](#)
- ➔ [Slow Scanning Speed](#)
- ➔ ["There is not enough memory." Message Is Displayed](#)
- ➔ [Computer Stops Operating during Scanning](#)
- ➔ [Scanner Does Not Work After Upgrading Windows](#)

[Page top](#) ↕

Advanced Guide

[Advanced Guide](#) > [Troubleshooting](#) > [Problems with Scanning](#) > [Scanner Does Not Work](#)

Scanner Does Not Work

Check 1: Make sure that the machine is turned on.

Check 2: Connect the USB cable to a different USB port on the computer.

Check 3: If the USB cable is connected to a USB hub, remove it from the USB hub and connect it to a USB port on the computer.

Check 4: Restart the computer.

[Page top](#) ↕

Advanced Guide

Advanced Guide > Troubleshooting > Problems with Scanning > ScanGear (Scanner Driver) Does Not Start

ScanGear (Scanner Driver) Does Not Start

Check 1: Make sure that the MP Drivers is installed.

If it is not installed, insert the *Setup CD-ROM* into the computer's disc drive, then select Custom Install and install MP Drivers.

Check 2: On the File menu of the application, select Select Source and select the machine.

Important

- Do not select the model name that includes WIA in it.

Note

- The operation may differ depending on the application.

Check 3: Start from a TWAIN-compliant application.

[Page top](#)[↕]

Advanced Guide

Advanced Guide > Troubleshooting > Problems with Scanning > Error Message Appears and the ScanGear (Scanner Driver) Screen Does Not Appear

Error Message Appears and the ScanGear (Scanner Driver) Screen Does Not Appear

Check 1: Make sure that the machine is turned on.

Check 2: Connect the USB cable to a different USB port on the computer.

Check 3: If the USB cable is connected to a USB hub, remove it from the USB hub and connect it to a USB port on the computer.

Check 4: Make sure that the MP Drivers is installed.

If it is not installed, insert the *Setup CD-ROM* into the computer's disc drive, then select Custom Install and install MP Drivers.

Check 5: The machine may be locked.

Close the running software program and slide the Scanner Lock Switch to the release position (). Then, restart the machine.

Check 6: On the File menu of the application, select Select Source and select the machine.

Note

- The operation may differ depending on the application.
-

Check 7: Make sure that the application is TWAIN-compliant.

You cannot open ScanGear (scanner driver) from applications not supporting TWAIN.

Check 8: Exit ScanGear (scanner driver) if it is running on another application.

[Page top](#)[↕]

Advanced Guide

Advanced Guide > Troubleshooting > Problems with Scanning > Scan Quality (Image Displayed on the Monitor) Is Poor

Scan Quality (Image Displayed on the Monitor) Is Poor

Check 1: Increase the scanning resolution.

➔ Resolution

Check 2: Set the scale to 100%.

Some applications do not display images clearly if the image is too small.

Check 3: If moire (stripe pattern) appears, take the following measures and scan again.

- On the Basic Mode tab of ScanGear (scanner driver), select Magazine(Color) in Select Source.
➔ Basic Mode Tab
- On the Advanced Mode tab of ScanGear (scanner driver), set Descreen in Image Settings to ON.
➔ Image Settings

Note

- If moire appears when you scan a digital print photo, take the above measures and scan again.
- If you use MP Navigator EX, set Document Type to Magazine(Color) or enable Descreen in the Scan Settings dialog box and scan again.
➔ Scan Settings Dialog Box (Photos/Documents)

Check 4: Check the monitor's color depth.

From the Start menu, select Control Panel > Appearance and Personalization > Adjust screen resolution to open the Display Settings dialog box. Set the color depth to Medium (16 bit) or Highest (32 bit).

- **Windows XP:**
From the Start menu, select Control Panel > Display to open the Display Properties dialog box. On the Settings tab, set Colors to Medium (16 bit) or Highest (32 bit).
- **Windows 2000:**
From the Start menu, select Settings > Control Panel > Display to open the Display Properties dialog box. On the Settings tab, set Colors to High Color (16 bit) or True Color (32 bit).

Check 5: Clean the Platen and Document Cover.

➔ Cleaning the Platen Glass and Document Cover

Check 6: If the document is in poor condition (dirty, faded, etc.), use Reduce Dust and Scratches, Fading Correction, Grain Correction, etc. in Image Settings on the Advanced Mode tab of ScanGear (scanner driver).

➔ Image Settings

Check 7: If the color tone of images is different from the original document, take the following measures and scan again.

- On the Advanced Mode tab of ScanGear (scanner driver), set Image Adjustment in Image Settings to None.
➔ Image Settings
- Open the Preferences dialog box from the Advanced Mode tab of ScanGear (scanner driver) and set Color Matching on the Color Settings tab.
➔ Color Settings Tab

Advanced Guide

[Advanced Guide](#) > [Troubleshooting](#) > [Problems with Scanning](#) > [Scanned Image Is Surrounded by Extra White Areas](#)

Scanned Image Is Surrounded by Extra White Areas

Check: Specify the scan area.



Click  (Auto Crop) in ScanGear (scanner driver) to automatically display the cropping frame (scan area) according to the document size. You can also manually specify the scan area, for example when there are white margins along the document or when you want to create custom cropping frames.

➔ [Adjusting Cropping Frames](#)

[Page top](#) ↕

Advanced Guide

[Advanced Guide](#) > [Troubleshooting](#) > [Problems with Scanning](#) > [Cannot Scan Multiple Documents at One Time](#)

Cannot Scan Multiple Documents at One Time

Check 1: Make sure that the documents are placed correctly on the Platen.

➔ [Placing Documents](#)

Check 2: Scan each item individually.

Some applications do not support multiple image scanning.

[Page top](#)↑

Advanced Guide

[Advanced Guide](#) > [Troubleshooting](#) > [Problems with Scanning](#) > [Cannot Scan Properly in Auto Scan Mode](#)

Cannot Scan Properly in Auto Scan Mode

Check 1: Make sure that the documents are placed correctly on the Platen.

➔ [Placing Documents](#)

Check 2: Multiple image scanning may not be supported.

Some applications do not support multiple image scanning. In that case, scan each item individually.

[Page top](#)↑

Advanced Guide

[Advanced Guide](#) > [Troubleshooting](#) > [Problems with Scanning](#) > [Slow Scanning Speed](#)

Slow Scanning Speed

Check 1: To view the image on a monitor, set the output resolution to around 150 dpi. To print, set it to around 300 dpi.

➔ [Resolution](#)

Check 2: Set Fading Correction, Grain Correction, etc. to None.

➔ [Image Settings](#)

Check 3: In MP Navigator EX, deselect the Correct slanted document checkbox and scan again.

➔ [Scan Settings Dialog Box](#)

Check 4: In MP Navigator EX, deselect the Detect the orientation of text documents and rotate images checkbox and scan again.

➔ [Scan Settings Dialog Box](#)

[Page top](#)↑

Advanced Guide

[Advanced Guide](#) > [Troubleshooting](#) > [Problems with Scanning](#) > "There is not enough memory." Message Is Displayed

"There is not enough memory." Message Is Displayed

Check 1: Exit other applications and try again.

Check 2: Reduce the resolution or output size and scan again.

➔ [Resolution](#)

[Page top](#) ↕

Advanced Guide

[Advanced Guide](#) > [Troubleshooting](#) > [Problems with Scanning](#) > [Computer Stops Operating during Scanning](#)

Computer Stops Operating during Scanning

Check 1: Restart the computer, reduce the output resolution in ScanGear (scanner driver) and scan again.

Check 2: Delete unnecessary files to obtain sufficient free hard disk space, then scan again.

Error message may appear if there is not enough hard disk space to scan and save, when the image size is too large (such as when scanning a large document at high resolution.)

Check 3: For Location of Temporary Files in MP Navigator EX, specify a folder on a drive with sufficient free space.

➡ [General Tab](#)

Check 4: Multiple devices may be connected to USB ports.

Disconnect other devices.

[Page top](#)↑

Advanced Guide

[Advanced Guide](#) > [Troubleshooting](#) > [Problems with Scanning](#) > [Scanner Does Not Work After Upgrading Windows](#)

Scanner Does Not Work After Upgrading Windows

Check: Disconnect the machine from the computer, then uninstall and reinstall the MP Drivers and MP Navigator EX.

- **Step 1: Uninstall the MP Drivers.**

See "[Deleting the Unnecessary MP Drivers](#) " for details.

- **Step 2: Uninstall MP Navigator EX.**

1. From the Start menu, select (All) Programs > Canon Utilities > MP Navigator EX 3.0 > MP Navigator EX Uninstall.
2. When a confirmation appears, click Yes.
3. When uninstallation is complete, click OK.
MP Navigator EX is uninstalled.

- **Step 3: Reinstall the MP Drivers and MP Navigator EX.**

Insert the *Setup CD-ROM* into the computer's disc drive, then select Custom Install and reinstall the MP Drivers and MP Navigator EX.

[Page top](#)↑

Advanced Guide

Advanced Guide > Troubleshooting > Problems with Scanning/Printing Film

Problems with Scanning/Printing Film

- ➡ Cannot Scan Film
- ➡ Scan Quality Is Poor or Colors Are Scanned Incorrectly
- ➡ Image Becomes Too Dark or Too Bright When a Cropping Frame Is Moved, Enlarged or Reduced
- ➡ Frames Are Not Detected Correctly
- ➡ Scanner Stops Operating during Scanning, or "There is not enough memory." Message Is Displayed
- ➡ Colors Are Different between the Film and the Printed Photos (Reddish/Bluish)

[Page top](#) ↕

Advanced Guide

[Advanced Guide](#) > [Troubleshooting](#) > [Problems with Scanning/Printing Film](#) > [Cannot Scan Film](#)

Cannot Scan Film

Check 1: Make sure that the FAU (Film Adapter Unit) Protective Sheet is removed from the Document Cover.

Check 2: Make sure that the Film Guide is placed correctly on the Platen.

Check 3: Make sure that the calibration slot is not blocked.

Do not block the calibration slot on the Film Guide with film or other items.

Check 4: Make sure that the Document Cover is closed properly.

Check 5: The machine may be locked.

Close the running software program and slide the Scanner Lock Switch to the release position (). Then, restart the machine.

Check 6: Make sure that ScanGear (scanner driver) is set for scanning film.

In ScanGear (scanner driver), set Select Source in Basic Mode to Negative Film(Color) or Positive Film(Color), or set Select Source in Advanced Mode to Color Negative Film, Color Positive Film, Black and White Negative Film or Black and White Positive Film.

Check 7: In Preferences of MP Navigator EX, select your model and click OK.

Check 8: In the dialog box that opens by clicking an icon in the One-click Mode screen of MP Navigator EX, set Document Type to film or Film(Auto mode), then click Apply.

Check 9: Set the appropriate output resolution and scan again.

If the computer has stopped operating, restart it and scan again.

[Page top](#)[↕]

Advanced Guide

Advanced Guide > Troubleshooting > Problems with Scanning/Printing Film > Scan Quality Is Poor or Colors Are Scanned Incorrectly

Scan Quality Is Poor or Colors Are Scanned Incorrectly

If the quality of the image displayed on the monitor is poor, check Check 1 to Check 3.

Check 1: The Platen or the light source on the Document Cover may be dusty or dirty.

Remove dust and dirt from the Platen and the light source on the Document Cover.

➔ [Cleaning the Platen Glass and Document Cover](#)

Check 2: If the film is dusty, blow off the dust then set it in place.

Check 3: Light may reflect off white slide mounts into images. In that case, use black slide mounts or cover the white slide mounts with black frames.

Check 4: Recalibrate the scanner from the Scanner tab of the Preferences dialog box.

➔ [Scanner Tab](#)

Check 5: If the film is in poor condition (dirty, faded, etc.), use Reduce Dust and Scratches, Fading Correction, Grain Correction, etc. in Image Settings in Advanced Mode of ScanGear (scanner driver).

➔ [Image Settings](#)

Note

- If a print out of an image does not appear satisfactory or the same as what you see on the monitor, you may need to change the printer's settings. Or, there may be a problem with the printer. See "Print Results Not Satisfactory" for details.

Check 6: If circular stripe patterns (Newton's rings) appear, load the film face-up and click Preview, then click (Mirror) on the Toolbar of ScanGear (scanner driver) to invert the image, then click Scan.

Check 7: The film may be extremely dark or bright, or the spaces between frames are extremely narrow (2 mm is standard).

Scan again using ScanGear (scanner driver) if MP Navigator EX or the Operation Panel of the machine yielded less than satisfactory colors.

Check 8: Adjust the brightness, contrast, tone curve, etc. on the Advanced Mode tab if the colors of the ScanGear's preview scan was unsatisfactory.

➔ [Correcting Images and Adjusting Colors with ScanGear \(Scanner Driver\)](#)

Check 9: Adjust the saturation and color balance on the Advanced Mode tab of ScanGear (scanner driver) if the scanned image appears reddish or bluish.

➔ [Adjusting Saturation and Color Balance](#)

Advanced Guide

Advanced Guide > Troubleshooting > Problems with Scanning/Printing Film > Image Becomes Too Dark or Too Bright When a Cropping Frame Is Moved, Enlarged or Reduced

Image Becomes Too Dark or Too Bright When a Cropping Frame Is Moved, Enlarged or Reduced

Check: Follow these steps from the Advanced Mode tab of ScanGear (scanner driver).

1. Click Preview.

The preview images are refreshed.

When the whole film image is displayed, click  (Whole Film Image) on the Toolbar to display the thumbnails.

2. Select the frame you want to correct the colors of.

3. Click Apply in the Apply the tone value to all frames section.

If the Apply the tone value to all frames section is not displayed, click  (Down arrow) of Exposure/Tone Settings.

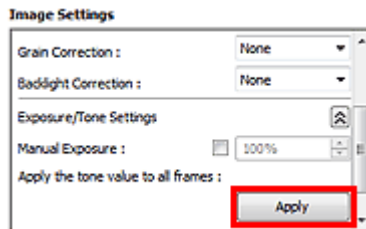

4. Specify a cropping frame and click Scan.

Scanning starts.

Advanced Guide

Advanced Guide > Troubleshooting > Problems with Scanning/Printing Film > Frames Are Not Detected Correctly

Frames Are Not Detected Correctly

Check 1: Film may be out of position.

➔ Placing Film

Check 2: The film may be extremely dark or bright, or the spaces between frames are extremely narrow (2 mm is standard).

Follow these steps if thumbnails are not displayed correctly when previewed in ScanGear (scanner driver).

The following is an example using the Advanced Mode tab.

1. Click  (Film Thumbnail) on the Toolbar.

The whole film image is displayed.

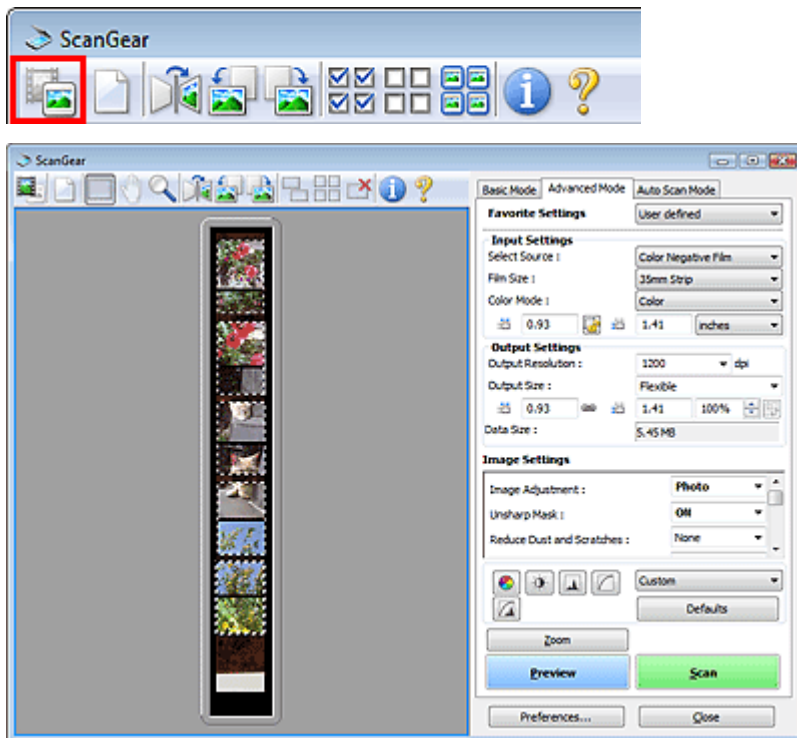



2. Select the frame that was not displayed correctly.

3. Select  (Enlarge/Reduce) and click on the image.

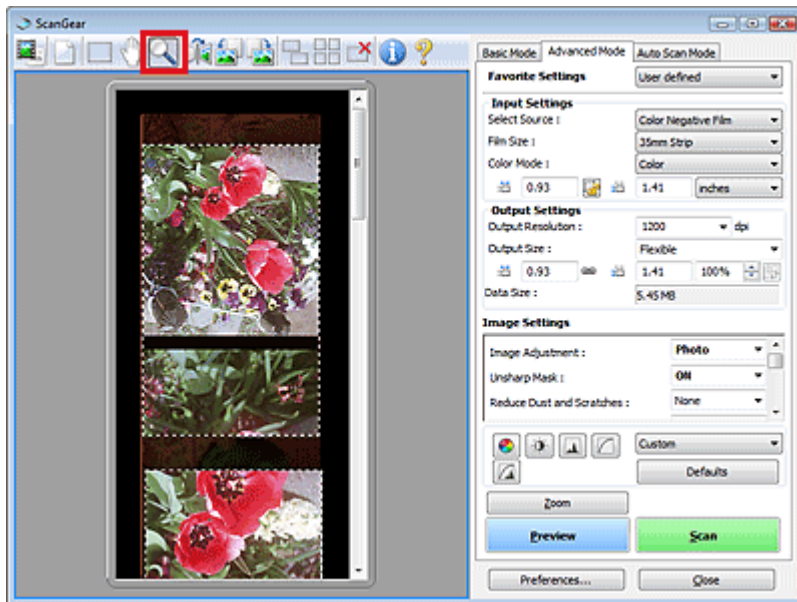
The Preview area is enlarged.



4. Click  (Crop) and adjust the cropping frame to the desired size.
5. Select  (Enlarge/Reduce) and right-click on the image.
The Preview area is reduced and the whole film image is displayed.
6. Select unnecessary frames and click  (Remove Cropping Frame).
The cropping frames are deleted. You can also delete the cropping frames by pressing the Delete key.
7. Click Scan.
Scanning starts.

Check 3: Check if there are frames that are not cropped even when the whole film image is displayed.

On the Advanced Mode tab of ScanGear (scanner driver), click  (Film Thumbnail) to display the cropping frames for all frames according to the film size. If the frame you want to scan is not cropped correctly, adjust the cropping frame. See the procedure in Check 2 to adjust the cropping frame.

Advanced Guide

[Advanced Guide](#) > [Troubleshooting](#) > [Problems with Scanning/Printing Film](#) > [Scanner Stops Operating during Scanning, or "There is not enough memory." Message Is Displayed](#)

Scanner Stops Operating during Scanning, or "There is not enough memory." Message Is Displayed

Check 1: Reduce the resolution or output size and scan again.

➡ [Resolution](#)

Check 2: Reduce the number of frames to scan or apply Image Settings (such as Backlight Correction) only to frames that require corrections.

[Page top](#)↑

Advanced Guide

[Advanced Guide](#) > [Troubleshooting](#) > [Problems with Scanning/Printing Film](#) > Colors Are Different between the Film and the Printed Photos (Reddish/Bluish)

Colors Are Different between the Film and the Printed Photos (Reddish/Bluish)

Check: Save the scanned image to a computer, then adjust the colors using an image editing application and print.

The printed colors may not be satisfactory even if you adjust them in the advanced settings for film printing, depending on the film.

For details, refer to the application's manual. If you have any questions, contact the manufacturer of the application.

[Page top](#)[↕]

Advanced Guide

[Advanced Guide](#) > [Troubleshooting](#) > [Software Problems](#)

Software Problems

- ➔ [E-mail Software Program You Want to Use Does Not Appear in the Screen for Selecting an E-mail Software Program](#)
- ➔ [Scanned Image Is Printed Enlarged \(Reduced\)](#)
- ➔ [Scanned Image Is Enlarged \(Reduced\) on the Computer Monitor](#)
- ➔ [Scanned Image Does Not Open](#)

[Page top](#) ↕

Advanced Guide

[Advanced Guide](#) > [Troubleshooting](#) > [Software Problems](#) > E-mail Software Program You Want to Use Does Not Appear in the Screen for Selecting an E-mail Software Program

E-mail Software Program You Want to Use Does Not Appear in the Screen for Selecting an E-mail Software Program

Check 1: MP Navigator EX may not support the e-mail software program.

The following e-mail software programs are supported. (Image are attached to the mail message automatically.)

- Windows Mail (Windows Vista)
- Outlook Express (Windows XP/Windows 2000)
- Microsoft Outlook

Check 2: If an e-mail software program does not operate properly, check that the program's MAPI is enabled.

To enable MAPI, refer to the manual of the e-mail software program.

Check 3: If using an e-mail software program other than the ones listed above, select None (Attach Manually) when prompted to select a program and attach the scanned image manually.

[Page top](#)↑

Advanced Guide

[Advanced Guide](#) > [Troubleshooting](#) > [Software Problems](#) > [Scanned Image Is Printed Enlarged \(Reduced\)](#)

Scanned Image Is Printed Enlarged (Reduced)

Check: Set the printing size in the application.

[Page top](#)↑

Advanced Guide

[Advanced Guide](#) > [Troubleshooting](#) > [Software Problems](#) > [Scanned Image Is Enlarged \(Reduced\) on the Computer Monitor](#)

Scanned Image Is Enlarged (Reduced) on the Computer Monitor

Check 1: Change the display setting in the application.

You cannot reduce the display size in "Paint." To reduce the display size, open the images in an application.

For details, refer to the application's manual. If you have any questions, contact the manufacturer of the application.

Check 2: Change the resolution setting in ScanGear (scanner driver) and scan again.

The higher the resolution, the larger the resulting image will be.

➔ [Resolution](#)

[Page top](#) ↕

Advanced Guide

[Advanced Guide](#) > [Troubleshooting](#) > [Software Problems](#) > [Scanned Image Does Not Open](#)

Scanned Image Does Not Open

Check: If the file format is not supported by the application, scan the image again and save it in a popular file format such as JPEG.

For details, refer to the application's manual. If you have any questions, contact the manufacturer of the application.

[Page top](#) ↕

Advanced Guide

Advanced Guide > Troubleshooting > MP Navigator EX Problems

MP Navigator EX Problems

- ➔ Cannot Scan at the Correct Size
- ➔ Position or Size of the Image Cannot be Detected Correctly When Scanning Using the Operation Panel
- ➔ Document Is Placed Correctly, but the Scanned Image Is Slanted
- ➔ Document Is Placed Correctly, but the Orientation Changes in the Scanned Image

[Page top](#) ↕

Advanced Guide

[Advanced Guide](#) > [Troubleshooting](#) > [MP Navigator EX Problems](#) > [Cannot Scan at the Correct Size](#)

Cannot Scan at the Correct Size

Check 1: Make sure that the documents are placed correctly on the Platen.

➔ [Placing Documents](#)

Check 2: Set Document Size to the actual document size and scan again.

If the matching size is not found, scan at a larger size and trim the image.

See the Toolbar (Trimming) in "[Correct/Enhance Images Window](#)" for details.

[Page top](#) ↕

Advanced Guide

[Advanced Guide](#) > [Troubleshooting](#) > [MP Navigator EX Problems](#) > [Position or Size of the Image Cannot be Detected Correctly When Scanning Using the Operation Panel](#)

Position or Size of the Image Cannot be Detected Correctly When Scanning Using the Operation Panel

Check 1: Make sure that the documents are placed correctly on the Platen.

➔ [Placing Documents](#)

Check 2: Check that the MP Navigator EX settings are correctly set according to the document.

If you cannot scan properly with Auto Scan using the Operation Panel, specify the document type on the Scanner Button Settings tab of the Preferences dialog box.

➔ [Scanner Button Settings Tab \(Save\)](#)

[Page top](#)↑

Advanced Guide

[Advanced Guide](#) > [Troubleshooting](#) > [MP Navigator EX Problems](#) > [Document Is Placed Correctly, but the Scanned Image Is Slanted](#)

Document Is Placed Correctly, but the Scanned Image Is Slanted

Check: In MP Navigator EX, deselect the Correct slanted document checkbox and scan again.

➡ [Scan Settings Dialog Box \(Photos/Documents\)](#)

[Page top](#)↑

Advanced Guide

[Advanced Guide](#) > [Troubleshooting](#) > [MP Navigator EX Problems](#) > Document Is Placed Correctly, but the Orientation Changes in the Scanned Image

Document Is Placed Correctly, but the Orientation Changes in the Scanned Image

Check: In MP Navigator EX, deselect the Detect the orientation of text documents and rotate images checkbox and scan again.

➔ [Scan Settings Dialog Box \(Photos/Documents\)](#)

[Page top](#)↑

Advanced Guide

[Advanced Guide](#) > [Troubleshooting](#) > [If You Cannot Resolve the Problem](#)

If You Cannot Resolve the Problem

If you cannot resolve the problem with any of the workarounds in this chapter, please contact the seller of the machine or the service center.

Canon support staff are trained to be able to provide technical support to satisfy customers.

Caution

- If the machine emits any unusual sound, smoke, or odor, turn it off immediately. Unplug the power cord from the outlet and contact the seller or the service center. Never attempt to repair or disassemble the machine yourself.
 - Attempts by customers to repair or take apart the machine will invalidate any warranty regardless of whether the warranty has expired.
-

Before contacting the service center, confirm the following:

- Product name:
 - * Your machine's name is located on the front cover of the setup manual.
- Serial number: please refer to the setup manual
- Details of the problem
- What you tried to solve the problem, and what happened

[Page top](#) ↑

Advanced Guide

Advanced Guide > Troubleshooting > FAQs

FAQs

- ➔ No Printing Results/Printing Is Blurred/Colors Are Wrong/White Streaks
- ➔ Machine Moves But Ink Is Not Ejected
- ➔ Cannot Install the MP Drivers
- ➔ Printing Does Not Start
- ➔ Copying/Printing Stops Before It Is Completed
- ➔  Writing Error/Output Error/Communication Error
- ➔ Print Results Not Satisfactory
- ➔ Paper Jams
- ➔ Paper Does Not Feed Properly

Page top 

Advanced Guide

Advanced Guide > Troubleshooting > Instructions for Use (Printer Driver)

Instructions for Use (Printer Driver)

This printer driver is subject to the following restrictions. Keep the following points in mind when using the printer driver.

Restrictions on the Printer Driver

- Depending on the document type to be printed, the paper feed method specified in the printer driver may not operate correctly.
If this happens, open the printer driver setup screen from the Print dialog box of the application software, and check the setting in the Paper Source field on the Main tab.
- With some applications, the Copies setting in the Page Setup tab of the printer driver may not be enabled.
In this case, use the copies setting in the Print dialog box of the application software.
- If the selected Language in the About dialog box does not match the operating system interface language, the driver screen may not be displayed properly.
- Do not change the Advanced tab items of the printer properties. If you change any of the items, you will not be able to use the following functions correctly.
Also, if Print to file is selected in the Print dialog box of the application software and with applications that prohibit EMF spooling, such as Adobe Photoshop LE and MS Photo Editor, the following functions will not operate.
 - Preview before printing on the Main tab
 - Prevent loss of print data in the Print Options dialog box
 - Page Layout, Poster, Booklet, Duplex Printing (manually), Specify Margin..., Print from Last Page, Collate, and Stamp/Background... on the Page Setup tab
- Since the resolution in the preview display differs from the printing resolution, text and lines in the preview display may appear different from the actual print result.
- With some applications, the printing is divided into multiple print jobs.
To cancel printing, delete all divided print jobs.
- If image data is not printed correctly, display the Print Options dialog box from the Page Setup tab and change the setting of Disable ICM required from the application software. This may solve the problem.
- When you use the Bluetooth option and perform one of the actions listed below, the print job may not end and "Printing" may remain displayed on the status monitor even after printing ends and the printout is ejected. If this happens, either click the Cancel Printing button on the status monitor or cancel that print job from the print job queue of the printer.
 - When you move the machine during printing to a location where radio waves cannot reach or when the radio wave status becomes poor
 - When you turn off the machine
- When you are using a Bluetooth printer and you cancel printing after a printer error occurs, you may not be able to execute subsequent printing operations. If this happens, turn off the machine and turn it back on again.
- When you are using Bluetooth, you cannot use the operation panel on the machine while the status monitor is displayed from View Printer Status... on the Maintenance tab.
- Software windows may not appear correctly on Windows Vista when fonts are set to Larger scale.
When you want to display the windows with Larger scale fonts, set the desktop theme to Windows Classic as follows:

1. Select Control Panel from the Start menu.
 2. Select Appearance and Personalization -> Personalization -> Theme.
The Theme Settings dialog box opens.
 3. At the Theme Settings dialog box, click the Themes tab, and select Windows Classic from Theme.
 4. Click OK.
Desktop changes to Windows Classic display.
- Do not start up the Canon IJ Network Tool while printing.
 - Do not print when the Canon IJ Network Tool is running.
 - The card slot (memory card) of the machine may become inaccessible. In such cases, restart the machine or turn it off and reconnect the USB cable.

Points to Note with Applications

- There are following restrictions in Microsoft Word (Microsoft Corporation).
 - When Microsoft Word has the same printing functions as the printer driver, use Word to specify them.
 - When selecting Scaled, Fit-to-Page, or Page Layout from the Page Layout list on the Page Setup tab, the selected printing function may not be effective, depending on the version of Word.
If this happens, follow the procedure below.
 1. Open Word's Print dialog box.
 2. Open the printer driver setup window, specify Page Layout on the Page Setup tab, and click OK.
 3. Without starting printing, close the Print dialog box.
 4. Open Word's Print dialog box again.
 5. Open the printer driver setup window again and click OK.
 6. Start printing.
- Illustrator/Adobe Systems Inc.
If bitmap printing takes effect, printing may take time or some data may not be printed. Print after unchecking the Bitmap Printing check box in the Print dialog box.

Advanced Guide

Advanced Guide > Troubleshooting > General Notes (Scanner Driver)

General Notes (Scanner Driver)

ScanGear (scanner driver) is subject to the following restrictions. Keep these points in mind when using it.

Scanner Driver Restrictions

- When using the NTFS file system, the TWAIN data source may not be invoked. This is because the TWAIN module cannot be written to the winnt folder for security reasons. Contact the computer's administrator for help.
- Some computers (including laptops) connected to the machine may not resume correctly from standby mode. In that case, restart the computer.
- Do not connect two or more machines or multifunction printers with scanner function to the same computer simultaneously. If multiple scanning devices are connected, you cannot scan from the Operation Panel of the machine and also may experience errors while accessing the devices.
- Software screens may not appear correctly on Windows Vista when font size is set to Larger scale. If you want to display the screens with Larger scale fonts, change the theme in Appearance and Personalization to Windows Classic as follows:
 1. From the Start menu, select Control Panel.
 2. Select Appearance and Personalization > Personalization > Theme.
The Theme Settings dialog box opens.
 3. On the Themes tab of the Theme Settings dialog box, select Windows Classic under Theme.
 4. Click OK.
Desktop changes to Windows Classic view.
- Use the default display font size of the OS. Otherwise, software screens may not appear correctly.
- Scanning may fail if the computer has resumed from sleep or standby mode. In that case, follow these steps and scan again.
 1. Turn off the machine.
 2. Exit ScanGear (scanner driver), then disconnect the USB cable from the computer and reconnect it.
 3. Turn on the machine.
- ScanGear (scanner driver) cannot be opened in multiple applications at the same time. Within an application, ScanGear (scanner driver) cannot be opened for the second time when it is already open.
- Be sure to close the ScanGear (scanner driver) window before closing the application.
- With network connection, the machine cannot be accessed from multiple computers at the same time.
- With network connection, scanning takes longer than usual.
- Make sure that you have adequate disk space available when scanning large images at high resolutions. For example, at least 300 MB of free space is required to scan an A4 document at 600 dpi in full-color.
- Thick documents may not be cropped correctly when scanned. In that case, crop each item individually or crop manually.
- ScanGear (scanner driver) and WIA driver cannot be used at the same time.
- Do not enter the computer into sleep or hibernate state during scanning.
- Calibration may take time if the machine is connected via USB 1.1.

Applications with Restrictions on Use

- If you start Media Center included in Windows XP Media Center Edition 2005, you may not be able to scan using the Operation Panel of the machine. In that case, restart the computer.
- You cannot scan images with Media Center included in Windows Vista and Windows XP Media Center Edition 2005. Scan with other applications such as MP Navigator EX.
- In some applications, you may encounter a problem when you switch to thumbnail view in the Advanced Mode tab of ScanGear (scanner driver). In that case, scan each document individually, changing Paper Size according to the document.
- In some applications, if you select the View scanned images checkbox in the Auto Scan Mode tab of ScanGear (scanner driver), the window displaying the thumbnails of the scanned images may close automatically.
- Some applications may not display the TWAIN user interface. In that case, refer to the application's manual and change the settings accordingly.
- Some applications do not support continuous scanning of multiple documents. In some cases, only the first scanned image is accepted, or multiple images are scanned as one image.
- When scanning platen size images into a Microsoft Office application (such as Word, Excel or PowerPoint), click Custom Insert in the Insert Picture from Scanner or Camera screen. Otherwise, images may not be scanned correctly.
- Images may not be scanned correctly in some applications. In that case, increase the operating system's virtual memory and retry.
- When image size is too large (such as when scanning large images at high resolution), your computer may not respond or the progress bar may remain at 0% depending on the application. In that case, cancel the action (for example by clicking Cancel on the progress bar), then increase the operating system's virtual memory or reduce the image size/resolution and retry. Alternatively, scan the image via MP Navigator EX first, then save and import it into the application.

[Page top](#)↑

Advanced Guide

Advanced Guide > Appendix

Appendix

- ➔ XPS Printer Driver
- ➔ Before Printing on Art Paper
- ➔ Printing Area
- ➔ Deleting the Undesired Print Job
- ➔ Updating the MP Drivers
- ➔ Uninstalling the On-Screen Manuals
- ➔ Transporting the Machine
- ➔ Opening the Printer Properties Dialog Box (Windows)
- ➔ Opening the Page Setup and Print Dialog Box (Macintosh)
- ➔ Opening the Canon IJ Printer Utility (Macintosh)
- ➔ ArcSoft PhotoStudio

[Page top](#) ↕

Advanced Guide

Advanced Guide > Appendix > XPS Printer Driver

XPS Printer Driver

The following two printer drivers can be installed on Windows Vista:

- IJ printer driver
- XPS printer driver

In this topic, the above drivers are indicated as "standard IJ printer driver" and "XPS printer driver" respectively.

Using the XPS printer driver enables you to print in the High Dynamic Range (full 16-bit workflow). Use the XPS printer driver only when printing in the High Dynamic Range.

Important

- To use the XPS printer driver, the standard IJ printer driver must already be installed on your computer.

Installing the XPS Printer Driver

Load the Setup CD-ROM that comes with the machine, and install the XPS printer driver from Custom Install.

Using the XPS Printer Driver

To use the XPS printer driver for printing, open the Print dialog box in application you are using, and select "your printer name XPS."

For detailed operating instructions, see Help of the XPS printer driver.

[Page top](#) 

Advanced Guide

Advanced Guide > Appendix > Before Printing on Art Paper

Before Printing on Art Paper

When using art paper, dust is liable to be generated. It is therefore recommended that paper dust be removed on art paper just before printing.

- **You will need a soft brush (or similar brush used to clean office automation equipment).**

The wider the brush, the more effective it will be.



OK - soft brush made from material such as polypropylene, polyethylene, horse hair or goat hair.

Important

- Be sure not to use brushes as shown below. The printing surface may be damaged.

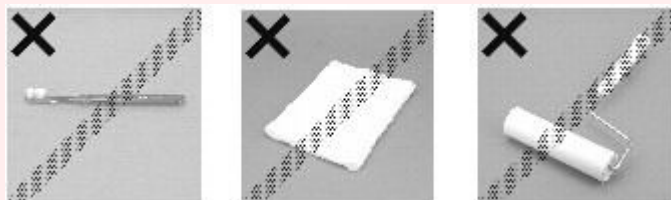

- Not OK - brush made from hard material, cloth or washcloth, sticky and abrasive materials.

- **Paper dust removal procedure:**

1. Check that the brush is not wet and free from dust or dirt.
2. Brush the overall printing surface carefully in one direction.

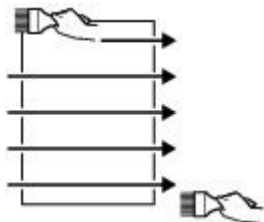

Important

- Be sure to brush all the way across the paper; do not start brushing at the middle or stop halfway.
- Be careful not to touch the printing surface as much as possible.

3. To complete the removal of paper dust, brush the paper in the other direction from top to bottom.

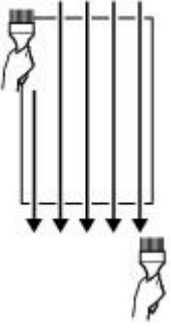

[Page top ↑](#)

Advanced Guide

Advanced Guide > Appendix > Printing Area

Printing Area

To ensure the best print quality, the machine allows a margin along each edge of media. The actual printable area will be the area inside these margins.

Recommended printing area : Canon recommends that you print within this area.

Printable area : The area where it is possible to print.

However, printing in this area can affect the print quality or the paper feed precision.

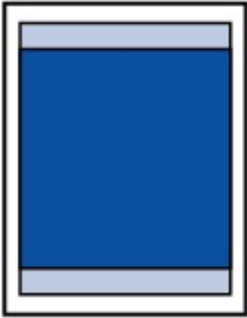

Note

- Borderless Printing
 - By selecting Borderless Printing option, you can make prints with no margins.
 - When performing Borderless Printing, slight cropping may occur at the edges since the printed image is enlarged to fill the whole page.
 - For Borderless Printing, use the following paper:
 - Glossy Photo Paper "Everyday Use" GP-501
 - Photo Paper Glossy GP-502
 - Photo Paper Plus Semi-gloss SG-201
 - Photo Paper Pro Platinum PT-101
 - Photo Paper Plus Glossy II PP-201
 - Photo Paper Pro II PR-201
 - Matte Photo Paper MP-101

Performing Borderless Printing on any other type of paper may substantially reduce printing quality and/or result in printouts with altered color hues.

Borderless Printing on plain paper may result in printouts with reduced quality. Use them only for test printing. You can perform Borderless Printing on plain paper only when printing from your computer.

- Borderless Printing is not available for legal, A5, or B5 sized paper, envelopes, or art paper.
- Depending on the type of paper, Borderless Printing may reduce the print quality at the top and bottom edges of the paper or cause these parts to become smudged.
- With performing Automatic Duplex Printing and Duplex (Two-sided) Copying, the printable area will be 0.08 inches / 2 mm smaller at the top margin.
- When performing Borderless Printing in copy or easy photo reprint mode, you can specify the amount of images that extends off the paper by Extended copy amount in Print settings under Device settings.

➔ [Changing the Machine Settings on the LCD](#)

- ➔ [Letter, Legal](#)
- ➔ [Envelopes](#)
- ➔ [Other Sizes than Letter, Legal, Envelopes](#)
- ➔ [Sizes for Art Paper](#)

Advanced Guide

Advanced Guide > Appendix > Printing Area > Other Sizes than Letter, Legal, Envelopes

Other Sizes than Letter, Legal, Envelopes

Size	Printable Area (width x height)
A5	5.56 x 7.95 inches / 141.2 x 202.0 mm
A4	8.00 x 11.38 inches / 203.2 x 289.0 mm
B5	6.90 x 9.80 inches / 175.2 x 249.0 mm
4" x 6" / 10 x 15 cm	3.73 x 5.69 inches / 94.8 x 144.4 mm
4" x 8" / 10 x 20 cm*	3.73 x 7.69 inches / 94.8 x 195.2 mm
5" x 7" / 13 x 18 cm	4.73 x 6.69 inches / 120.2 x 169.8 mm
8" x 10" / 20 x 25 cm	7.73 x 9.69 inches / 196.4 x 246.0 mm
Wide	3.73 x 6.80 inches / 94.8 x 172.6 mm

* This page size can be used only when printing from your computer.

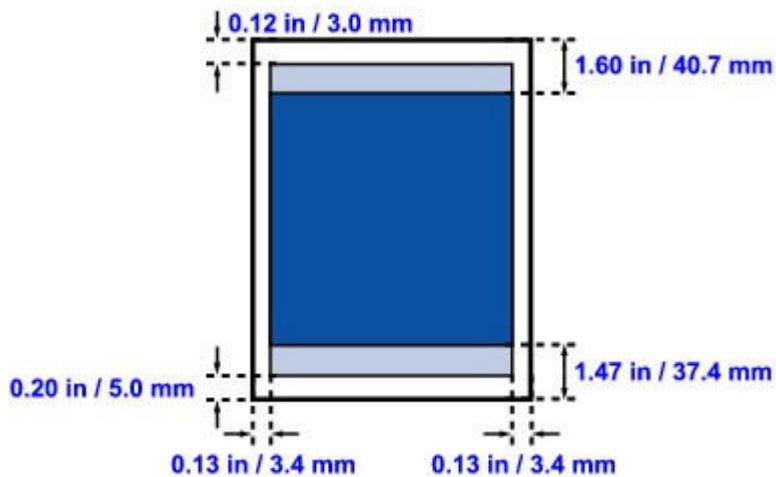

Recommended printing area

Printable area

[Page top](#) ↑

Advanced Guide

Advanced Guide > Appendix > Printing Area > Letter, Legal

Letter, Legal

Size	Printable Area (width x height)
Letter	8.00 x 10.69 inches / 203.2 x 271.4 mm
Legal*	8.00 x 13.69 inches / 203.2 x 347.6 mm

* This page size can be used only when printing from your computer.

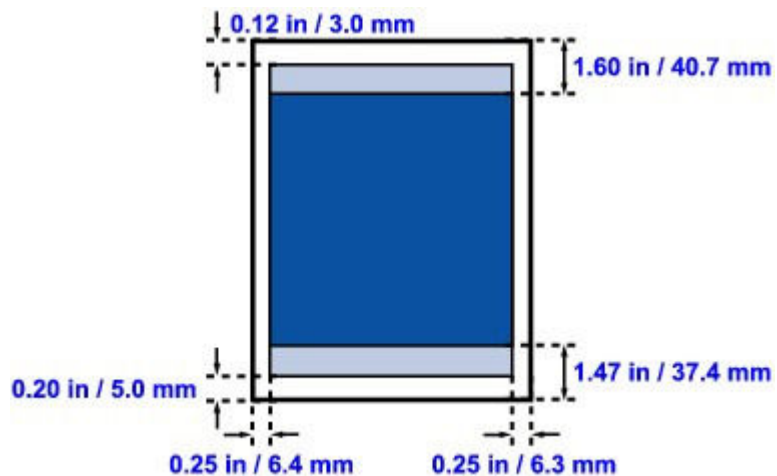

Recommended printing area

Printable area

[Page top](#) ↑

Advanced Guide

Advanced Guide > Appendix > Printing Area > Sizes for Art Paper

Sizes for Art Paper

When using Fine Art Paper "Photo Rag" or non Canon genuine specialty paper, printing is not done in a 1.38 inches / 35 mm margin along the top and bottom edges. A limit is set to prevent printing along a 1.38 inches / 35 mm margin on the top and bottom edges when a paper size for Art Paper is selected in the printer driver.

Fine Art A4

Size	Printable Area (width x height)
Fine Art A4	8.0 x 8.9 inches / 203.2 x 227.0 mm

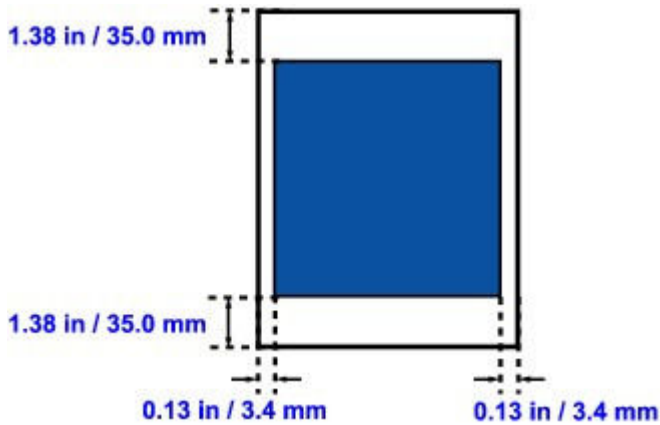

Recommended printing area

Fine Art Letter

Size	Printable Area (width x height)
Fine Art Letter	8.0 x 8.2 inches / 203.2 x 209.4 mm

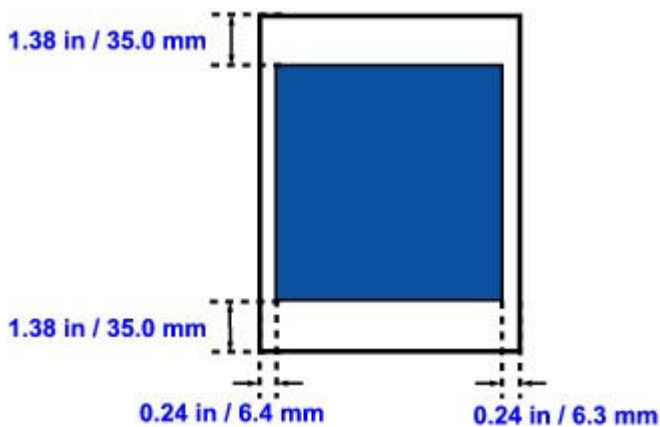

Recommended printing area

Advanced Guide

Advanced Guide > Appendix > Printing Area > Envelopes

Envelopes

Size	Recommended Printing Area (width x height)
European DL*	4.06 x 7.07 inches / 103.2 x 179.6 mm
US Comm. Env. #10*	3.86 x 7.91 inches / 98.0 x 200.9 mm

* This page size can be used only when printing from your computer.

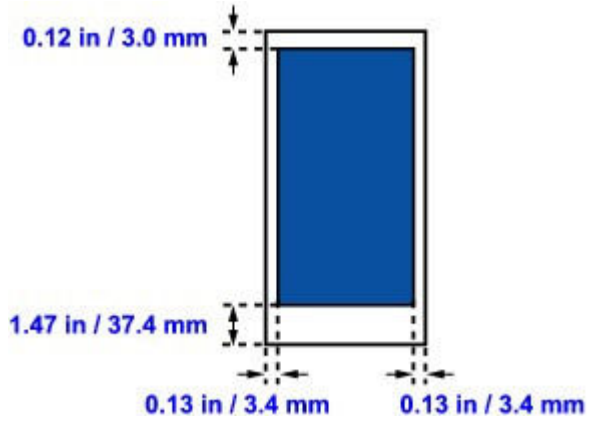

 Recommended printing area

[Page top ↑](#)

Advanced Guide

Advanced Guide > Appendix > Deleting the Undesired Print Job

Deleting the Undesired Print Job

If the printer does not start printing, the print job data cancelled or failed may be remaining. Delete the undesired print job by using the Canon IJ Status Monitor.

1. Display the Canon IJ Status Monitor

Click the status monitor button displayed on the task bar.
The Canon IJ Status Monitor appears.

2. Display the print jobs

Click Display Print Queue....
The print queue window opens.

3. Delete the print jobs

Select Cancel All Documents from the Printer menu.
When the confirmation message appears, click Yes.
The deletion of the print job is complete.

Important

- Users who have not been granted access permission for printer management cannot delete the print job of another user.

Note

- When you perform this operation, all print jobs are deleted. If the print queue list contained a necessary print job, start the printing process over from the beginning.

[Page top](#) 

Advanced Guide

Advanced Guide > Appendix > Updating the MP Drivers

Updating the MP Drivers

- ➔ Obtaining the Latest MP Drivers
- ➔ Deleting the Unnecessary MP Drivers
- ➔ Before Installing the MP Drivers
- ➔ Installing the MP Drivers

[Page top](#) ↕

Advanced Guide

[Advanced Guide](#) > [Appendix](#) > [Updating the MP Drivers](#) > [Obtaining the Latest MP Drivers](#)

Obtaining the Latest MP Drivers

The MP Drivers include a printer driver and scanner driver (ScanGear).

By updating the MP Drivers to the latest version of the MP Drivers, unresolved problems may be solved.

Access our web site through the Internet and download the latest MP Drivers for your model.

Important

- You can download the MP Drivers for free, but any Internet access charges incurred are your responsibility.
- Before installing the latest MP Drivers, delete the previously installed version.
For information on how to delete the MP Drivers, see "[Deleting the Unnecessary MP Drivers](#)."

Related Topics

- [➡ Before Installing the MP Drivers](#)
- [➡ Installing the MP Drivers](#)

[Page top](#) ↕

Advanced Guide

Advanced Guide > Appendix > Updating the MP Drivers > Deleting the Unnecessary MP Drivers

Deleting the Unnecessary MP Drivers

The MP Drivers you no longer use can be deleted.
When deleting the MP Drivers, first exit all programs that are running.

The procedure to delete the unnecessary MP Drivers is as follows:

When There is an Uninstaller

1. Start the uninstaller

- In Windows Vista, select the Start menu -> All Programs -> "Your model name" -> MP Drivers Uninstaller.
- In Windows XP, select the start menu -> All Programs -> "Your model name" -> MP Drivers Uninstaller.
- In Windows 2000, select the Start menu -> Programs -> "Your model name" -> MP Drivers Uninstaller.

The MP Drivers Uninstaller dialog box is displayed.

Important

- In Windows Vista, a confirmation/warning dialog box may appear when installing, uninstalling or starting software.
This dialog box appears when administrative rights are required to perform a task.
When you are logged on to an administrator account, click Continue or Allow to continue.
Some applications require an administrator account to continue. When you are logged on to a standard account, switch to an administrator account, and restart the operation from the beginning.

2. Execute the uninstaller

Click Execute. When the confirmation message appears, click Yes.
When all the files have been deleted, click Complete.

The deletion of the MP Drivers is complete.

Important

- Printer driver and scanner driver (ScanGear) will be deleted when you uninstall the MP Drivers.

When There is No Uninstaller

When there is no uninstaller in the Start menu of Windows Vista, follow these steps:

1. Select the printer to be deleted

Select the Start menu -> Control Panel -> Hardware and Sound -> Printers.
Click the model to delete, then press the Alt key on your keyboard. On the File menu, click Delete.

2. Delete the printer

When the User Account Control dialog box appears, click Continue. Then when the confirmation message appears, click Yes.
The icon is deleted.

3. Select the printer driver to be deleted

Press the Alt key. On the File menu, select Run as administrator, and then click Server Properties....

When the User Account Control dialog box appears, click Continue.

Click the Drivers tab. In the Installed printer drivers list, click the printer to delete.

4. Delete the printer driver

When you click Remove..., Remove Driver And Package dialog box is displayed.

Select Remove driver and driver package, and then click OK.

In the confirmation dialog box, click Yes.

When data collection is completed in the Remove Driver Package dialog box, click Delete.

5. Click OK

The deletion of the printer driver is complete.

Important

- You may not be able to delete the printer driver properly from the Installed printer drivers list. If this happens, restart your computer, and try again.

[Page top](#) 

Advanced Guide

[Advanced Guide](#) > [Appendix](#) > [Updating the MP Drivers](#) > [Before Installing the MP Drivers](#)

Before Installing the MP Drivers

This section describes the items that you should check before installing the MP Drivers. You should also refer to this section if the MP Drivers cannot be installed.

Checking the Machine Status

- Properly connect the personal computer and the machine. For details on connection instructions, refer to the "Setup the Machine and the Computer" in the manual: Getting Started.
- Turn off the machine.

Checking the Personal Computer Settings

- Terminate all running applications.
- In Windows Vista, log on as a user who has the administrator rights.
In Windows XP, log on as the computer administrator.
In Windows 2000, log on as a member of the Administrators group.



Note

- When an old version of the MP Drivers is already installed, first delete (uninstall) that version. For instructions on deleting the MP Drivers, see "[Deleting the Unnecessary MP Drivers](#)."
-

Related Topics

- ➔ [Obtaining the Latest MP Drivers](#)
- ➔ [Installing the MP Drivers](#)

[Page top](#) ↑

Advanced Guide

Advanced Guide > Appendix > Updating the MP Drivers > Installing the MP Drivers

Installing the MP Drivers

You can access our web site through the Internet and download the latest MP Drivers for your model.

The procedure for installing the downloaded MP Drivers is as follows:

1. Turn off the machine

Important

- When you turn on the computer while the machine is on, the Windows Plug and Play function is executed automatically, and the Found New Hardware window (Windows Vista) or Found New Hardware Wizard window (Windows XP, Windows 2000) is displayed. In this case, click Cancel.

2. Start the installer

Double-click the icon of the downloaded file.
The installation program starts.

Important

- In Windows Vista, a confirmation/warning dialog box may appear when installing, uninstalling or starting software.
This dialog box appears when administrative rights are required to perform a task.
When you are logged on to an administrator account, click Continue or Allow to continue.
Some applications require an administrator account to continue. When you are logged on to a standard account, switch to an administrator account, and restart the operation from the beginning.

3. Install the driver

At the Welcome window, click Next.

Read the contents of the License Agreement window. After checking the contents, click Yes.
Installation of the MP Drivers begins.

After the Installation Complete window is displayed, check that the machine and the computer are connected through a cable.

When the machine is connected directly to the network, follow the procedure below to select the connection destination.

1. Check the Select printer port check box, and click Manual Selection.
2. At the Select Port window, select printer output port (FILE) as connection destination, and then click OK.

4. Complete the installation

Click Complete.

Turn on the machine, and wait awhile until the connection is recognized.

When you are using a USB connection, the installation of the MP Drivers is complete.

Depending on the environment you are using, a message prompting you to restart the computer may be displayed. To complete the installation properly, restart the computer.

Important

- You can download the MP Drivers for free, but any Internet access charges incurred are your responsibility.

Related Topics

- ➔ [Obtaining the Latest MP Drivers](#)
- ➔ [Before Installing the MP Drivers](#)

[Page top](#) ↕

Advanced Guide

Advanced Guide > Appendix > Uninstalling the On-Screen Manuals

Uninstalling the On-Screen Manuals

Follow the procedure below to uninstall all of the installed on-screen manuals from your computer.

Before uninstalling the on-screen manuals, exit all on-screen manuals that are opening.



All of the installed on-screen manuals will be deleted at the same time.

1. Click Start > All Programs (Programs in Windows 2000) > Canon XXX Manual (where "XXX" is your machine's name) > Uninstall.
2. Click OK when the confirmation message appears.

Note

- When the message prompting you to restart your computer is displayed, click OK to restart your computer.
-



On-screen manuals other than printer driver's help and scanner driver's help are uninstalled at a time.

1. Select Applications on the Go menu.
2. Double-click the Canon Utilities folder, and then the IJ Manual folder.
3. Drag the folder of your machine's name into the trash.
4. Drag the  Canon XXX On-screen Manual icon (where "XXX" is your machine's name) on your desktop into the trash.

Advanced Guide

Advanced Guide > Appendix > Transporting the Machine

Transporting the Machine

When relocating the machine, pack the machine using the original packing materials.

If you do not have the original packing materials, pack the machine carefully using protective material and place it inside a sturdy box.

Important

- Do not transport or store the machine slanted, vertically, or upside-down, as the ink may leak and damage the machine.

1. Turn the machine off.
2. Confirm that the **Power** lamp is off and unplug the machine.

Important

- Do not unplug the machine while the **Power** lamp is lit or flashing blue, as it may cause malfunction or damage to the machine, making the machine unable to print.

3. Retract the Paper Support and the Output Tray Extension, close the Paper Output Tray, then close the Operation Panel.
4. Disconnect the printer cable from the computer and from the machine, and then disconnect the power plug from the machine.
5. Use adhesive tape to secure all the covers on the machine to keep them from opening during transportation. Then pack the machine in the plastic bag.
6. Attach the protective material to the machine when packing the machine.

Important

- Make sure to lock the Scanning Unit (Cover) by sliding the Scanner Lock Switch to the Lock position ().
- Pack the machine with the Print Head and ink tanks left installed in the machine.

Note

- Clearly label the box as "FRAGILE" or "HANDLE WITH CARE".

Advanced Guide

Advanced Guide > Appendix > Opening the Printer Properties Dialog Box (Windows)

Opening the Printer Properties Dialog Box (Windows)

The printer driver setup window can be displayed through the application software in use or the Start menu of the Windows.

Open the Printer Properties Dialog Box through the Application Software

Follow the procedure below to configure print settings when printing.

1. Select the command you perform printing on the application software in use.

In general, select Print on the File menu to open the Print dialog box.

2. Select your model name and click Preferences (or Properties).

The printer properties dialog box opens.

Note

- Depending on application software you use, command names or menu names may vary and there may be more steps. For details, refer to the user's manual of your application software.

Open the Printer Properties Dialog Box through the Start Menu

Follow the procedure below to perform maintenance operations such as print head cleaning, or to configure print settings that are common for all application software.

1. Select items from the Start menu as shown below.

- In Windows Vista, select the Start menu > Control Panel > Hardware and Sound > Printers.
- In Windows XP, select the Start menu > Control Panel > Printers and Other Hardware > Printers and Faxes.
- In Windows 2000, select the Start menu > Settings > Printers.

2. Right-click your model name icon and then select Printing Preferences from the displayed menu.

The printer properties dialog box opens.

Important

- Opening the printer properties dialog box through Properties displays such tabs regarding the Windows functions as the Ports (or Advanced) tab. Those tabs do not appear when opening through Printing Preferences or application software. About tabs regarding Windows functions, refer to the user's manual for the Windows.

Advanced Guide

[Advanced Guide](#) > [Appendix](#) > [Opening the Page Setup and Print Dialog Box \(Macintosh\)](#)

Opening the Page Setup and Print Dialog Box (Macintosh)

You can open the Page Setup dialog box and the Print dialog box from the application program you are using.

Opening the Page Setup Dialog Box

Open the Page Setup dialog box to specify page (paper) settings before printing.

- 1. Select Page Setup... on the File menu in your application program.**

The Page Setup dialog box opens.

Opening the Print Dialog Box

Open the Print dialog box to specify print settings before printing.

- 1. Select Print... on the File menu in your application program.**

The Print dialog box opens.

[Page top](#) ↑

Advanced Guide

Advanced Guide > Appendix > Opening the Canon IJ Printer Utility (Macintosh)

Opening the Canon IJ Printer Utility (Macintosh)

To open the Canon IJ Printer Utility, follow the procedure below.

In Mac OS X v.10.5.x

1. Select System Preferences on the Apple menu.
2. Click Print & Fax.
3. Select your machine's name in the Printers and click Open Print Queue....
The job list of your machine is displayed.
4. Click Utility.

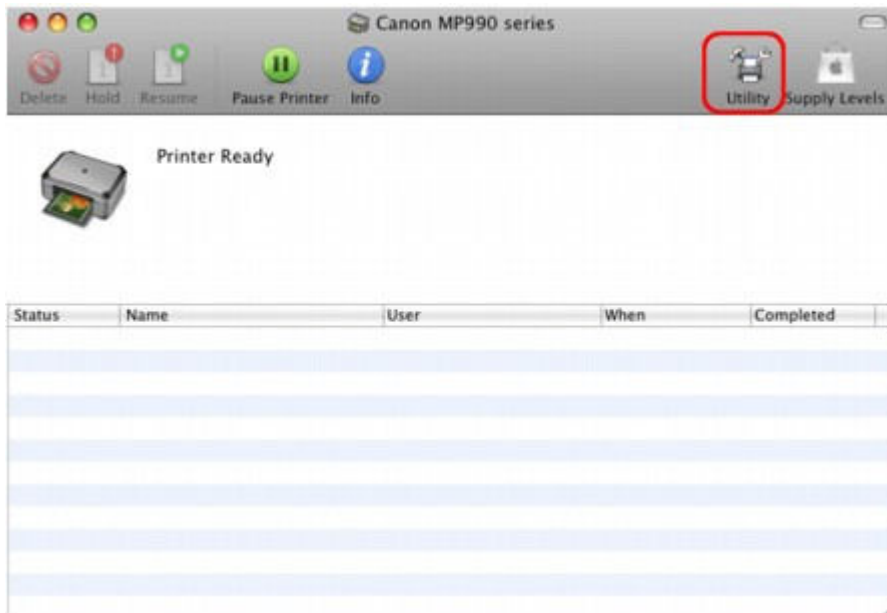

The Printer List opens.

5. Select your machine's name in the Product list and click Maintenance.

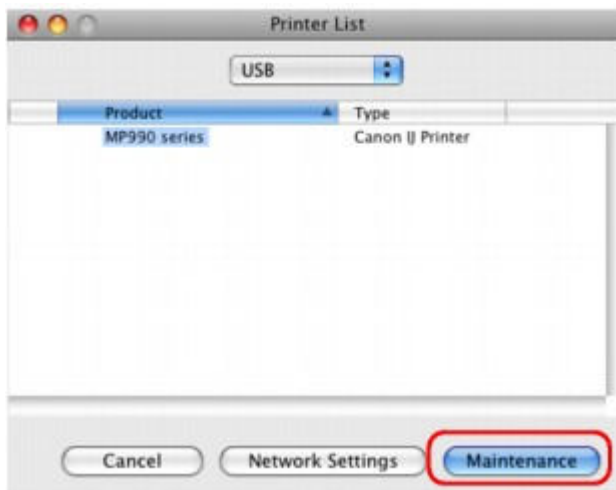

The Canon IJ Printer Utility starts up.

In Mac OS X v.10.4.x or Mac OS X v 10.3.9

1. Select Applications on the Go menu.
2. Double-click the Utilities folder, and then double-click the Printer Setup Utility icon.
The Printer List opens.
3. Select your machine's name in the Name list and click Utility.

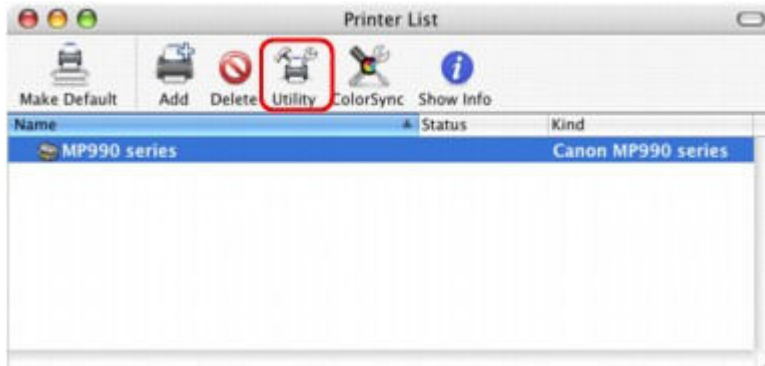

4. Select your machine's name in the Product list and click Maintenance.

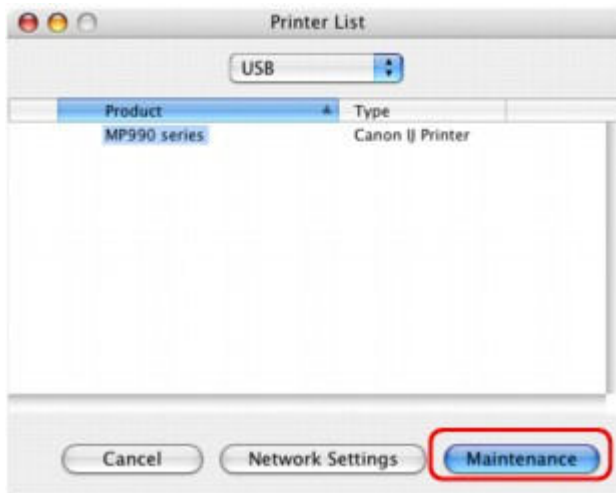

The Canon IJ Printer Utility starts up.

Advanced Guide

Advanced Guide > Appendix > ArcSoft PhotoStudio

ArcSoft PhotoStudio

ArcSoft PhotoStudio is software that offers image enhancement/editing tools and other functions for editing images. Inside a friendly user interface, the software is enriched with features such as Face Beautify, white balance adjustment, reference line drawing (on displayed image), multiple undo/redo, multiple layer control and text editing.

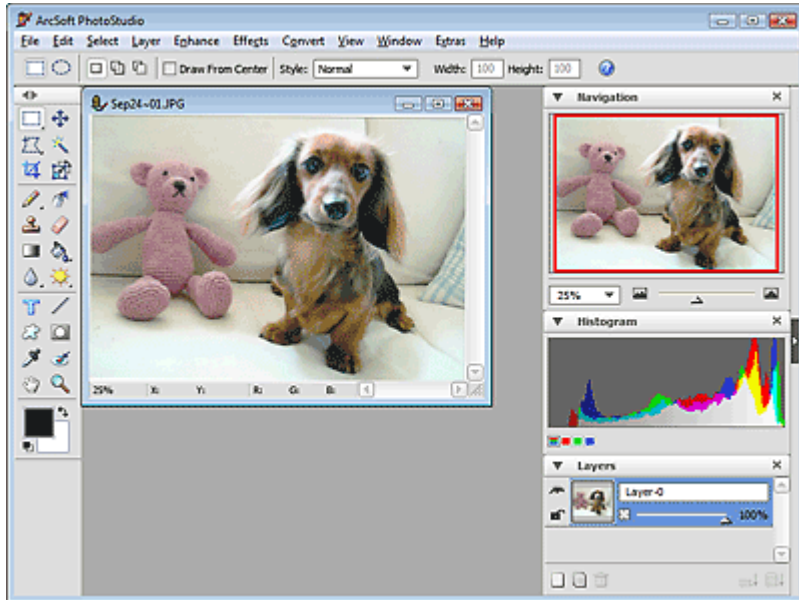

For details, refer to the ArcSoft PhotoStudio manual.

You can access the ArcSoft website from Extras menu and obtain the manual.

[Page top](#)

Advanced Guide

Advanced Guide > Using Easy-PhotoPrint EX

Easy-PhotoPrint EX

Using Easy-PhotoPrint EX

--- Transforming Your Photos into Creative Works of Art ---

Easy-PhotoPrint EX allows you to create albums, calendars and stickers easily using photos taken with digital cameras.

You can also print borderless photos easily.

Start Easy-PhotoPrint EX



Click Here: [Easy-PhotoPrint EX](#)

Note

- See the section below for details on how to use Easy-PhotoPrint EX.
 - ➔ [Printing with the Bundled Application Software](#)

Create a Personalized Photo Album

Creating a personalized photo album is an easy task if you use Easy-PhotoPrint EX!

All you need to do is select which photos to use, select a layout, then load paper into your printer and print. After you bind the printed sheets, you'll have the one and only album of your memories!



You can change the layout and background, and attach comments to photos.



You can also select the size and orientation.



You can arrange a photo across the left and right pages.

CHECK!

Select a theme (background design) to create a single-themed album.

Decorate Items with Text and Frames

You can add text and frames to photos. Attach a description of the photo in an album, and add a frame to enhance the photo's atmosphere.



CHECK!

Select Album to add text and frames. You cannot decorate photos with Photo Print.

Create a Calendar Using Your Favorite Photos

Create calendars easily with Easy-PhotoPrint EX. Create your own calendar using your favorite photos! It'll be exciting to turn the calendar pages.



You can use all kinds of photos.

You can also create 2-month, 6-month and 12-month calendars.

Create Stickers

Create stickers easily with Easy-PhotoPrint EX!

Create stickers of your favorite photos and share them with your friends!



CHECK!

You can add text to photos.

[Page top](#) 

Advanced Guide

Advanced Guide > Using MP Navigator EX

MP Navigator EX

Using MP Navigator EX

MP Navigator EX is an application that enables you to easily scan photos and documents. It is suitable even for beginners.

Start MP Navigator EX



Click Here: [MP Navigator EX](#)

Note

- See "Let's Try Scanning" for details on how to scan images using MP Navigator EX.

Scan Photos and Documents

You can scan easily by navigating through MP Navigator EX screens. You can also save/print scanned images using MP Navigator EX.



Scan Small Documents at One Time

You can scan multiple small documents (photos, cards, etc.) at one time. It is useful as you do not need to scan multiple times.

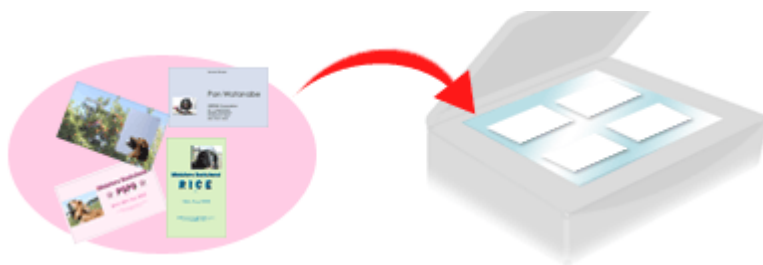

Scan Large Documents

You can easily scan documents that are larger than the Platen using MP Navigator EX. It allows you to scan the left and right halves of a document separately and combine them back into one image.



Scan with One-click

In One-click Mode, MP Navigator EX completes from scanning to saving, with a click of an icon. One-click Mode also allows you to scan and save images as PDF files or attach them to e-mail automatically.

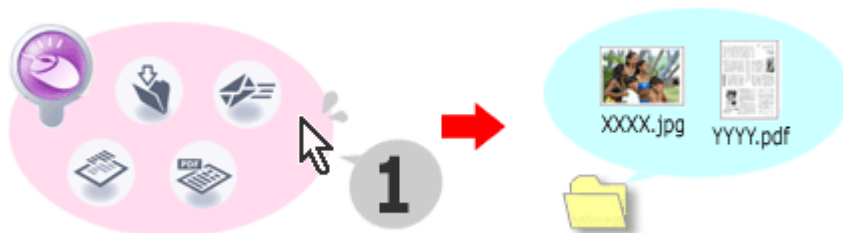

Scan and Correct/Enhance Photos

You can easily correct/enhance scanned photos using MP Navigator EX. You do not need to use other applications.

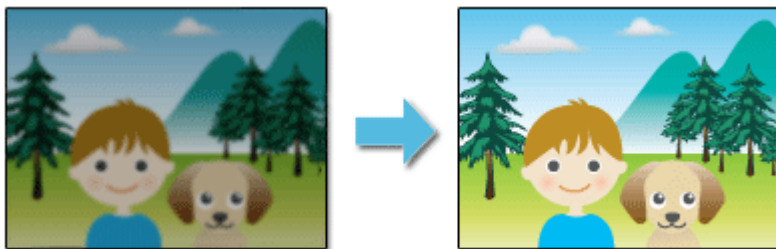

For details on how to use MP Navigator EX, refer to " [Scanning with the Bundled Application Software](#) ."

Advanced Guide

Advanced Guide > About Solution Menu

About Solution Menu

Quick Shortcut!! Solution Menu

Solution Menu is a menu window that provides quick access from your desktop to Canon applications, manuals, and online product information.

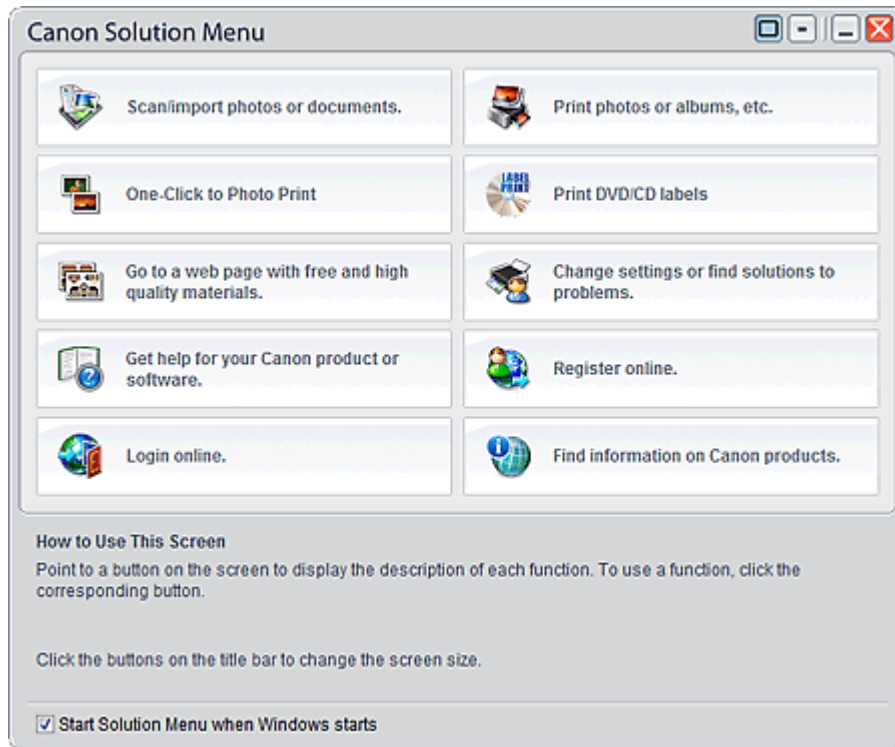

Important

- The number and types of buttons displayed in the window may vary depending on your printer and region.

Starting Solution Menu

 Click Here: [Solution Menu](#)

To start from desktop, see below.

Double-click the Canon Solution Menu icon on the desktop. Alternatively, from the Start menu, select (All) Programs > Canon Utilities > Solution Menu > Solution Menu.



From the next time, Solution Menu starts when Windows starts.

If the Start Solution Menu when Windows starts checkbox at the bottom left of the window is not selected, Solution Menu does not start when Windows starts.

Note

- Solution Menu will start automatically when you install it using the *Setup CD-ROM* that accompanies the printer.

Changing the Window Size

Click  (window size: large) or  (window size: small) on the title bar to change the window size

(large or small).

Solution Menu opens with the last used window size next time it is started.

- When screen size is small

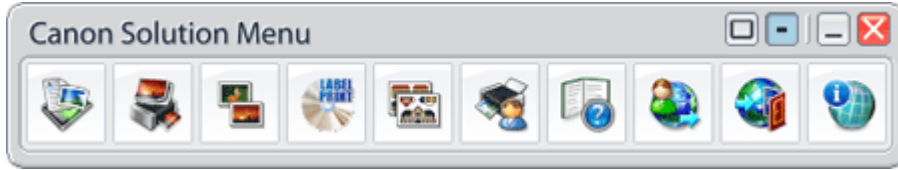

Starting an Application

1. Point to a button on the window to display the description of each application.
2. By clicking each button, the introduced application starts.

Follow the same steps to view the manuals or online product information.

Important

- Internet connection is required to access the online information. Internet connection fees apply.

Exiting Solution Menu

Click  (Close) on the title bar.

Restriction on Use of Solution Menu

This software is subject to the following restriction. Keep this point in mind when using it.

- All icons of the installed applications that support Solution Menu are displayed in the window. After the installation, you cannot rearrange the icons or delete only the icons.

[Page top](#)[↕]

Advanced Guide

[Advanced Guide](#) > [About Network Communication](#)

About Network Communication

- ➔ [Changing and Confirming Network Settings](#)
- ➔ [Troubleshooting](#)
- ➔ [Appendix](#)
- ➔ [Glossary](#)

[Page top](#) ↑

Advanced Guide

[Advanced Guide](#) > [About Network Communication](#) > [Changing and Confirming Network Settings](#)

Changing and Confirming Network Settings

- ➔ [Canon IJ Network Tool](#)
- ➔ [Canon IJ Network Tool Dialog Box](#)
- ➔ [Canon IJ Network Tool Menus](#)
- ➔ [Changing the Settings in the Wireless LAN Sheet](#)
- ➔ [Changing the WPA or WPA2 Detailed Settings](#)
- ➔ [Changing the Settings in the Wired LAN Sheet](#)
- ➔ [Changing the Settings in the Admin Password Sheet](#)
- ➔ [Monitoring Wireless Network Status](#)
- ➔ [Initializing the Network Settings of the Machine](#)
- ➔ [Viewing the Modified Settings](#)
- ➔ [Printing Out Network Setting Information](#)

[Page top](#) ↕

Advanced Guide

[Advanced Guide](#) > [About Network Communication](#) > [Changing and Confirming Network Settings](#) > [Canon IJ Network Tool](#)

Canon IJ Network Tool

The Canon IJ Network Tool is a utility that enables you to display and modify the machine network settings. It is installed when the machine is set up.

Important

- Do not start up the Canon IJ Network Tool while printing.
- Do not print when the Canon IJ Network Tool is running.
- If the firewall function of your security software is turned on, a message may appear warning that Canon software is attempting to access the network. If the warning message appears, set the security software to always allow access.
- Canon IJ Network Tool has been verified to work on Windows XP, however, it does not support Fast User Switching. It is recommended to exit Canon IJ Network Tool when switching users.

Starting up Canon IJ Network Tool

- 1. Double-click the  Canon IJ Network Tool shortcut icon on the desktop.**

Click Start and select All programs (or Programs), Canon IJ Network Utilities, Canon IJ Network Tool, and then Canon IJ Network Tool.

[Page top](#) ↑

Advanced Guide

Advanced Guide > About Network Communication > Changing and Confirming Network Settings > Canon IJ Network Tool Dialog Box

Canon IJ Network Tool Dialog Box

This section describes the items displayed on the Canon IJ Network Tool dialog box.

Important

- To use the machine over LAN, make sure you have the equipment necessary for the connection type, such as an access point or a LAN cable.

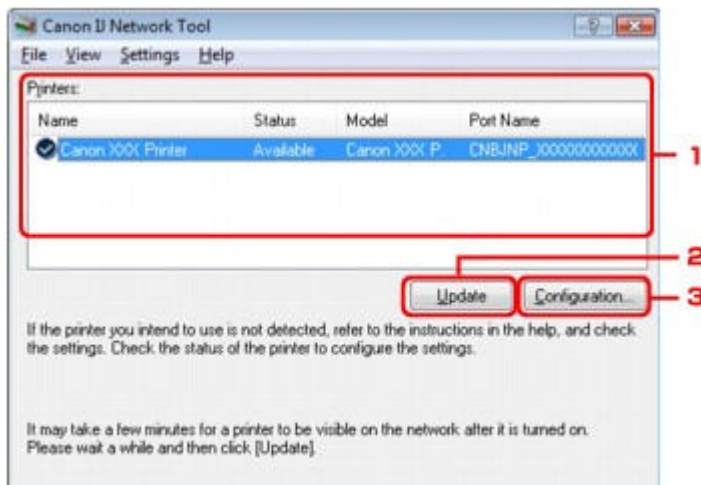

1. Printers

The printer name, status, printer model name, and port name are displayed. A check mark next to the printer in the Name list indicates it is set as the default printer. Configuration changes are applied to the selected printer.

2. Update

Performs printer detection again. Click this button if the target printer is not displayed.

Important

- To change the printer's network settings using the Canon IJ Network Tool, it must be connected via a LAN.
- If No Driver is displayed for the name, associate the port with the printer.
- If Not Found is displayed for the status, check the followings:
 - The access point is turned on.
 - When using wired LAN, the LAN cable is connected properly.
- If the printer on a network is not detected, make sure that the printer is turned on, then click Update. It may take several minutes to detect printers. If the printer is still detected, connect the machine and the computer with a USB cable, then click Update.
- If the printer is being used from another computer, a dialog box is displayed informing you of this condition.

Note

- This item has the same function as Refresh in the View menu.

3. Configuration

Click to configure settings of the selected printer.

Note

- You cannot configure a printer that has the status Not Found.

- This item has the same function as Configuration in the Settings menu.
-

[Page top ↑](#)

Advanced Guide

Advanced Guide > About Network Communication > Changing and Confirming Network Settings > Canon IJ Network Tool Menus

Canon IJ Network Tool Menus

This section describes the menus in the Canon IJ Network Tool dialog box.

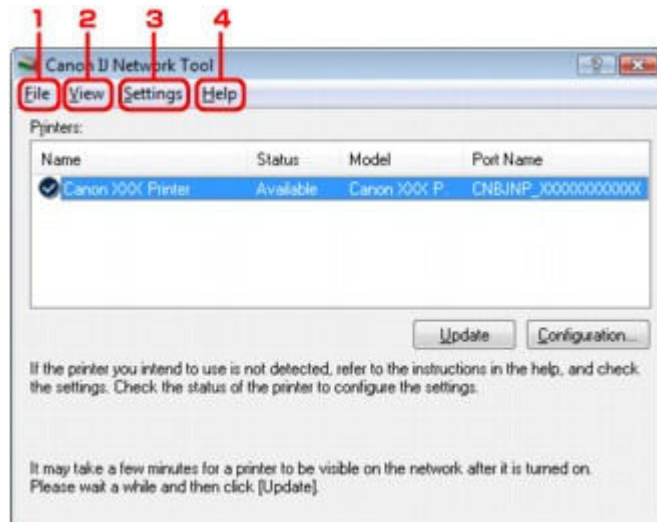

1. File menu

Exit

Exits the Canon IJ Network Tool.

2. View menu

Status

Displays the Status dialog box to confirm the printer connection status and wireless communication status.

Refresh

Updates and displays the contents of Printers to the latest information.

Important

- To change the printer's network settings using the Canon IJ Network Tool, it must be connected via a LAN.
- If No Driver is displayed for the name, associate the port with the printer.
- If Not Found is displayed for the status, check the followings:
 - The access point is turned on.
 - When using wired LAN, the LAN cable is connected properly.
- If the printer on a network is not detected, make sure that the printer is turned on, then click Update. It may take several minutes to detect printers. If the printer is still detected, connect the machine and the computer with a USB cable, then click Update.
- If the printer is being used from another computer, a dialog box is displayed informing you of this condition.

Note

- This item has the same function as Update in the Canon IJ Network Tool dialog box.

Network Information

Displays the Network Information dialog box to confirm the network settings of the printer and the computer.

Display Warning Automatically

Enables or disables automatic display of warnings.

When this menu is selected, a warning is displayed if one or more ports are unavailable for printing.

3. Settings menu

Configuration

Displays the Configuration dialog box to configure settings of the selected printer.

**Note**

- This item has the same function as Configuration in the Canon IJ Network Tool dialog box.
-

Associate Port

Displays the Associate Port dialog box and you can associate a port with the printer.

This menu is available when No Driver is displayed for the selected printer. Associating a port with the printer enables you to use it.

Maintenance

Displays the Maintenance dialog box to revert the network settings of the printer to factory default and to mount the Card Slot as the network drive.

4. Help menu

Help Topics

Displays the application's online help.

About

Displays the version of the Canon IJ Network Tool.

Advanced Guide

Advanced Guide > About Network Communication > Changing and Confirming Network Settings > Changing the Settings in the Wireless LAN Sheet

Changing the Settings in the Wireless LAN Sheet

To change the wireless network settings of the printer, connect the printer and the computer with a USB cable temporarily. If you modify the wireless network settings of the computer over wireless connection without USB connection, your computer may not be able to communicate with the machine after modifying the settings.

Note

- Select Wireless LAN active in the Change wireless/wired on the Operation Panel to change the settings in the Wireless LAN sheet.
➔ [Changing the Machine Settings on the LCD](#)

1. Start up the Canon IJ Network Tool.

➔ [Starting up Canon IJ Network Tool](#)

2. Select the printer in Printers.

3. Select Configuration from the Settings menu.

4. Click the Wireless LAN tab.

Click OK after changing configuration. A dialog box is displayed asking you for confirmation before the settings are sent to the printer. If you click Yes, the settings are sent to the printer and the Transmitted Settings dialog box is displayed.

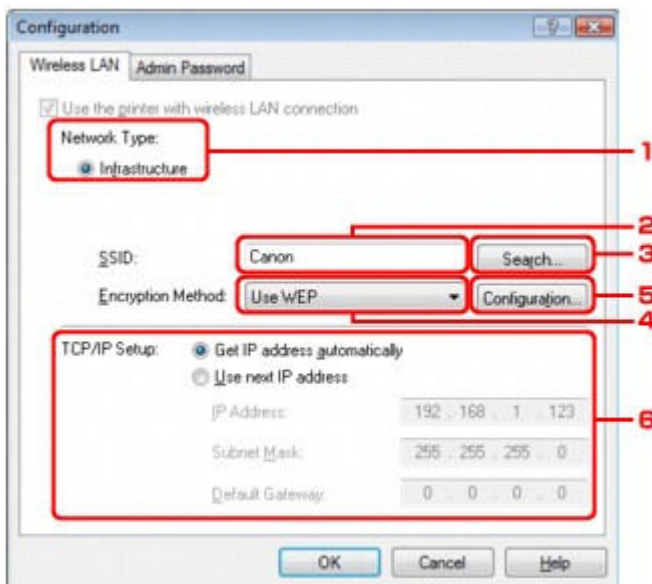

1. Network Type

Infrastructure

Connects the printer to the wireless LAN with an access point.

2. SSID

The SSID of the wireless LAN is displayed.

Note

- Enter the same SSID that the access point is configured to use. The SSID is case sensitive.

3. Search

The Search dialog box is displayed to select an access point to connect to.

➔ [Search dialog box](#)



Note

- When the Canon IJ Network Tool runs over a LAN, the button is grayed out and cannot be selected. Connect the printer and the computer with a USB cable temporarily to change the settings.

4. Encryption Method

Select the encryption method used over the wireless LAN.



Important

- If all encryption types of the access point, printer, or computer do not match, the printer cannot communicate with the computer. If the printer cannot communicate with the computer after the encryption type of the printer was switched, make sure that encryption types for the computer and the access point matches that set to the printer.
➔ [How to Set a WEP/WPA/WPA2 Key](#)
- If you connect to a network that is not protected with security measures, there is a risk of disclosing data such as your personal information to a third party.

Do not use

Select to disable encryption.

Use WEP

Transmission is encrypted using a WEP key you specified.

If a WEP key has not been set, the WEP Details dialog box is displayed automatically. To change WEP settings set before, click Configuration to display the dialog box.

➔ [WEP Details dialog box](#)

Use WPA/Use WPA2

Transmission is encrypted using a WPA or WPA2 key you specified.

The security has been strengthened more than WEP.

If a WPA or WPA2 key has not been set, the Authentication Type Confirmation dialog box is displayed automatically. To change WPA or WPA2 settings set before, click Configuration to display the WPA Details dialog box or WPA2 Details dialog box.

➔ [Changing the WPA or WPA2 Detailed Settings](#)

5. Configuration

The detailed settings dialog box is displayed. The WEP, the WPA, or the WPA2 key selected in Encryption Method can be confirmed and changed.

For details on WEP setting:

➔ [WEP Details dialog box](#)

For details on WPA or WPA2 setting:

➔ [Changing the WPA or WPA2 Detailed Settings](#)

6. TCP/IP Setup

Sets the IP address of the printer to be used over the LAN. Set a value appropriate for your network environment.

Get IP address automatically

Select this option to use an IP address automatically assigned by a DHCP server. DHCP server functionality must be enabled on your wireless LAN router or access point.

Use next IP address

If no DHCP server functionality is available in your setup where you use the printer or you want to use a particular IP address, select this option to use a fixed IP address.

• Search dialog box

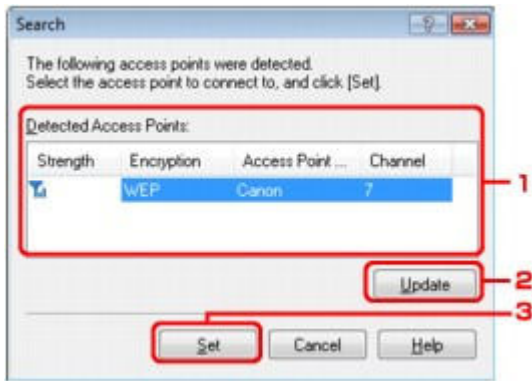



1. Detected Access Points

The signal strength from the access point, encryption type, name of access point, and the radio channel can be confirmed.

Important

- If you connect to a network that is not protected with security measures, there is a risk of disclosing data such as your personal information to a third party.

Note

- Signal strength is displayed as follows.
 -  : Good
 -  : Fair
 -  : Poor
- Type of encryption is displayed as follows.
 - Blank: No encryption
 - WEP: WEP is set
 - WPA: WPA is set
 - WPA2: WPA2 is set

2. Update

Click to update the list of access points when your target access point is not detected.
If the target access point is set to the stealth mode, click Cancel to return to the previous screen and enter the access point's Service Set Identifier in SSID.

Note

- Make sure that the access point is turned on.

3. Set

Click to set the access point's SSID in SSID on the Wireless LAN sheet.

Note

- Depending on your settings, WEP Details dialog box, WPA Details dialog box, or WPA2 Details dialog box appears when you click the Set button. In the dialog box, configure the details to use the same encryption settings set to the access point.
- Access points that cannot be used by this machine (including those configured to use different encryption methods) are displayed grayed out and cannot be configured.

• WEP Details dialog box

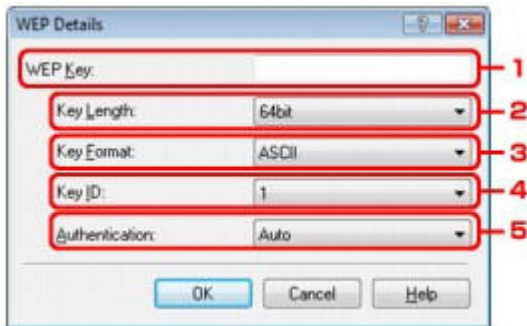

Specify the printer WEP settings. When changing the password (WEP key), the same change must be made to the password (WEP key) of the access point.

1. WEP Key

Enter the same key as the one set to the access point.

The number of characters and character type that can be entered differ depending on the key length and key format.

		Key Length	
		64 bit	128 bit
Key Format	ASCII	5 characters	13 characters
	Hexadecimal (Hex)	10 digits	26 digits

2. Key Length

Select either 64bit or 128bit.

3. Key Format

Select either ASCII or Hex.

4. Key ID

Select the Key ID (index) set to the access point.

5. Authentication

Select the authentication method to authenticate the printer's access to the access point.

Normally, select Auto. If you want to specify the method manually, select Open System or Shared Key according to the setting of the access point.

Important

- If the printer cannot communicate with the computer after the encryption type of the printer was switched, make sure that encryption types for the computer and the access point matches that set to the printer.

[➔ How to Set a WEP/WPA/WPA2 Key](#)

Advanced Guide

Advanced Guide > About Network Communication > Changing and Confirming Network Settings > Changing the WPA or WPA2 Detailed Settings

Changing the WPA or WPA2 Detailed Settings

To change the wireless network settings of the printer, connect the printer and the computer with a USB cable temporarily. If you modify the wireless network settings of the computer over wireless connection without USB connection, your computer may not be able to communicate with the machine after modifying the settings.

The example screenshots in this section refer to the WPA detailed settings.

1. Start up the Canon IJ Network Tool.

➔ [Starting up Canon IJ Network Tool](#)

2. Select the printer in Printers.

3. Select Configuration from the Settings menu.

4. Click the Wireless LAN tab.

5. Select Use WPA or Use WPA2 in Encryption Method and click Configuration.

Go to step 7 if encryption is not set to the printer.

6. Click Change Settings.

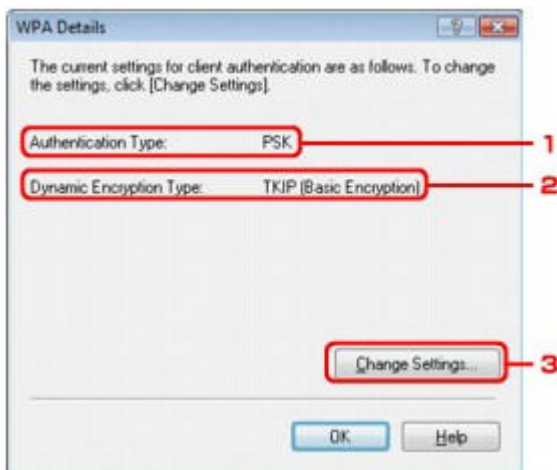

1. Authentication Type

Displays the type of authentication used for client authentication.
This machine supports the PSK authentication method.

2. Dynamic Encryption Type

Displays the dynamic encryption method as either TKIP (Basic Encryption), or AES (Secure Encryption).

3. Change Settings

Displays a dialog box to change WPA or WPA2 settings.

7. Check the client authentication type and click Next.

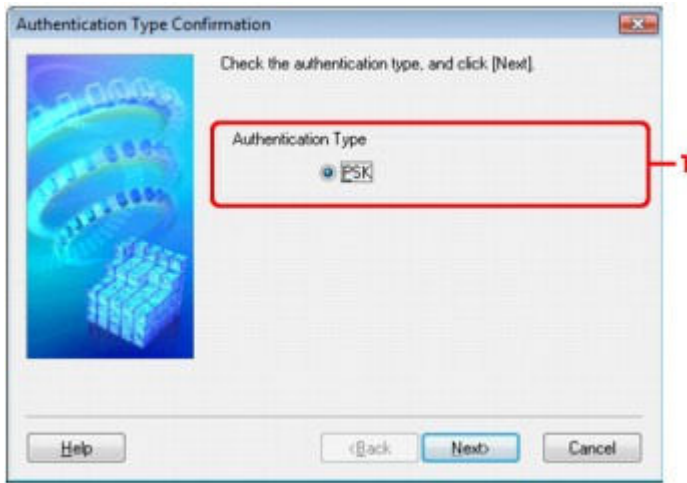

1. Authentication Type

Type of authentication used for client authentication is displayed.
This machine supports the PSK authentication method.

PSK

This authentication type uses a passphrase entered in the next screen.

8. Enter the passphrase, confirm the type of dynamic encryption and click Next.



1. Passphrase

Enter the passphrase set to the access point. The passphrase should be a string of 8 to 63 alphanumeric characters or a 64-digit hexadecimal value.

If you do not know the access point passphrase, refer to the manual provided with the access point or contact its manufacturer.

2. Dynamic Encryption Type

Select the dynamic encryption method from either TKIP (Basic Encryption), or AES (Secure Encryption).

9. Click Finish.

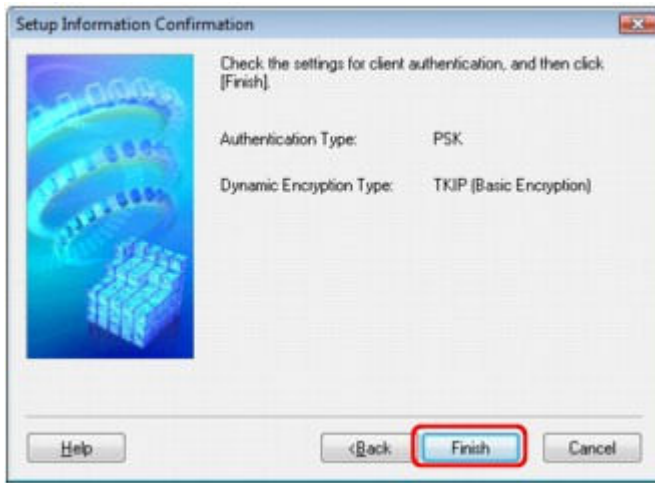

Important

- If the printer cannot communicate with the computer after the encryption type of the printer was switched, make sure that encryption types for the computer and the access point matches that set to the printer.
 - ➔ [How to Set a WEP/WPA/WPA2 Key](#)

Advanced Guide

Advanced Guide > About Network Communication > Changing and Confirming Network Settings > Changing the Settings in the Wired LAN Sheet

Changing the Settings in the Wired LAN Sheet

Note

- Select Wired LAN active in the Change wireless/wired on the Operation Panel to change the settings in the Wired LAN sheet.
 - ➔ [Changing the Machine Settings on the LCD](#)

1. Start up the Canon IJ Network Tool.
 - ➔ [Starting up Canon IJ Network Tool](#)
2. Select the printer in Printers.
3. Select Configuration from the Settings menu.
4. Click the Wired LAN tab.

Click OK after changing configuration. A dialog box is displayed asking you for confirmation before the settings are sent to the printer. If you click Yes, the settings are sent to the printer and the Transmitted Settings dialog box is displayed.

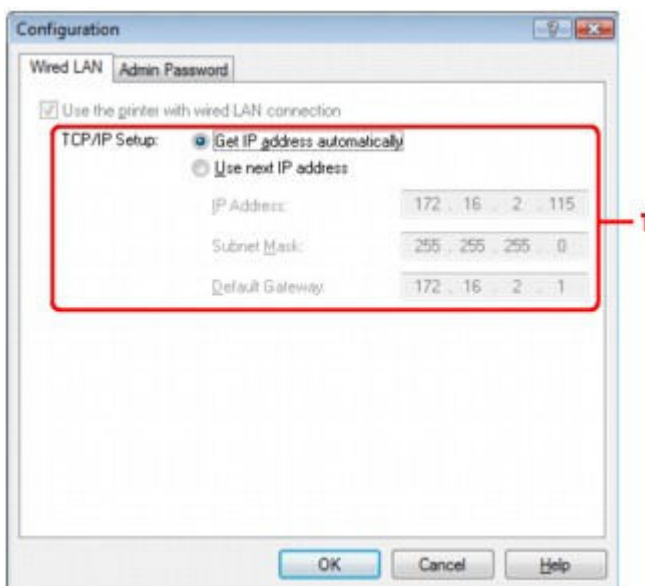

1. TCP/IP Setup

Sets the IP address of the printer to be used over the LAN. Set a value appropriate for your network environment.

Get IP address automatically

Select this option to use an IP address automatically assigned by a DHCP server. DHCP server functionality must be enabled on your wireless LAN router or access point.

Use next IP address

If no DHCP server functionality is available in your setup where you use the printer or you want to use a particular IP address, select this option to use a fixed IP address.

Advanced Guide

Advanced Guide > About Network Communication > Changing and Confirming Network Settings > Changing the Settings in the Admin Password Sheet

Changing the Settings in the Admin Password Sheet

1. Start up the Canon IJ Network Tool.
➔ Starting up Canon IJ Network Tool
2. Select the printer in Printers.
3. Select Configuration from the Settings menu.
4. Click the Admin Password tab.

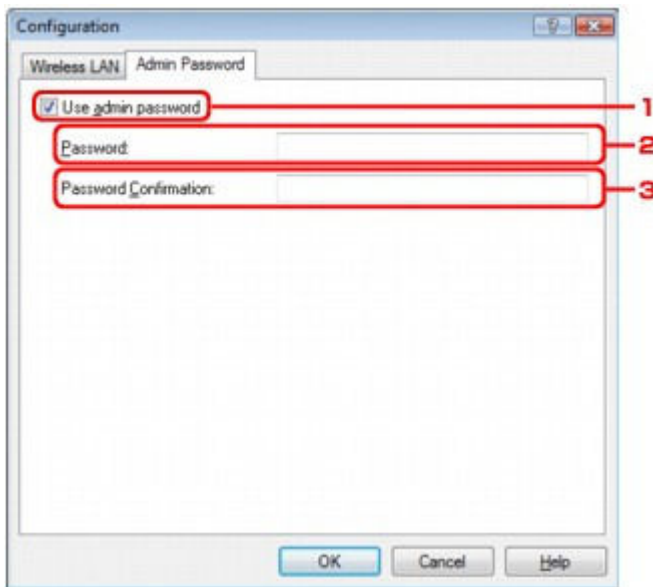

1. Use admin password

Set a password for the administrator with privileges to set up and change detailed options. To use this feature, select this check box and enter a password.

Important

- The password should consist of alphanumeric characters and be no longer than 32 characters. The password is case-sensitive. Do not forget the password you set.

2. Password
Enter the password to set.
3. Password Confirmation
Enter the password again for confirmation.

5. Click OK.

A dialog box is displayed asking you for confirmation before the settings are sent to the printer. If you click Yes, the settings are sent to the printer and the Transmitted Settings dialog box is displayed.

Advanced Guide

Advanced Guide > About Network Communication > Changing and Confirming Network Settings > Monitoring Wireless Network Status

Monitoring Wireless Network Status

Note

- When using the printer over the Wired LAN, Signal Strength, Link Quality, or Advanced Measurement is not available.

1. Start up the Canon IJ Network Tool.

➔ Starting up Canon IJ Network Tool

2. Select the printer in Printers.

3. Select Status from the View menu.

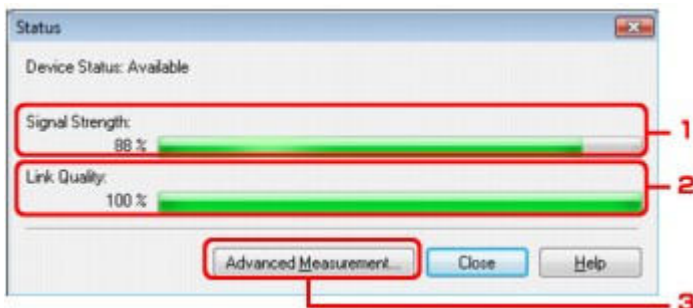

1. Signal Strength

Indicates the strength of the signal received by the printer, ranging from 0% to 100%.

2. Link Quality

Indicates the signal quality excluding the noise while communicating, ranging from 0% to 100%.

Important

- If the indicated value is low, move your printer closer to the wireless network device.

3. Advanced Measurement

Click to examine the connection performance between the printer and the access point. Follow the instructions on the screen to start measuring and display the status. Measurement takes a few minutes.

When  is displayed in Connection Performance between the Printer and the Access Point, the printer can communicate with the access point. Otherwise, refer to displayed comments and Help for improving the status of communication link.

Note

- If any messages appear on Overall Network Performance, move the machine and access point as instructed to improve the performance.

Advanced Guide

Advanced Guide > About Network Communication > Changing and Confirming Network Settings > Initializing the Network Settings of the Machine

Initializing the Network Settings of the Machine

Important

- Note that initialization erases all network settings on the machine, and printing or scanning operation from a computer over network may become impossible. To use the machine over network, refer to the setup manual of the machine to set up the machine again.

- Start up the Canon IJ Network Tool.
 - Starting up Canon IJ Network Tool
- Select the printer in Printers.
- Select Maintenance from the Settings menu.



- Setting Initialization

Initialize

Reverts all the network settings of the printer to factory default. Click Initialize to display the Initialize Settings dialog box and click Yes to initialize the network settings of the printer. Do not turn off the printer during initialization. Click OK when initialization is complete.

Performing initialization when connected over wireless LAN will break the connection, so refer to your setup manual of the machine to set up the machine again.

- Network Setup of the Card Slot

Displays the status of the Card Slot. For details on how to mount the Card Slot as a network drive, see [Using the Card Slot over a Network](#).

Note

- You can change the network settings of the printer using Canon IJ Network Tool with USB connection after initializing the LAN settings. To change the network settings using Canon IJ Network Tool, set Change wireless/wired in Device settings to Wireless LAN active or Wired LAN active.

Advanced Guide

Advanced Guide > About Network Communication > Changing and Confirming Network Settings > Viewing the Modified Settings

Viewing the Modified Settings

The Confirmation dialog box is displayed when you modified the printer settings on the Configuration dialog box. When you click Yes on the Confirmation dialog box, the following screen is displayed for confirming the modified settings.



1. Settings

A list of changes made in the Configuration dialog box is displayed.

[Page top](#) ↑

Advanced Guide



Advanced Guide > About Network Communication > Changing and Confirming Network Settings > Printing Out Network Setting Information

Printing Out Network Setting Information

You can print out the network settings of the machine such as its IP address and SSID.

Important

- This print out contains valuable information about your computer. Handle it with care.

1. Make sure that the machine is turned on.
2. Load a sheet of A4 or Letter-sized plain paper in the Cassette.
3. Select  Settings on the **HOME** screen, then press the **OK** button.
4. Select  Device settings, then press the **OK** button.
5. Select LAN settings, then press the **OK** button.
6. Select Confirm LAN settings, then press the **OK** button.
7. Select Print LAN details, then press the **OK** button.
8. Select Yes, then press the **OK** button.

The following information on the machine's network setting is printed out.

Item	Explanations of the item	Setting
Wireless LAN	Wireless LAN	Enable/Disable
Link Status	Status of the Wireless LAN	Active/Inactive
MAC Address	MAC Address	XX:XX:XX:XX:XX:XX
SSID	SSID	SSID of the wireless LAN
Connection Mode	Connection Mode	Infrastructure
Channel	Channel	XX (1 to 13)
Encryption	Method of the Encryption	none/WEP/TKIP/AES
WEP Key Length	WEP Key Length	Inactive/128/64
Authentication	Method of the Authentication	auto/open/shared/WPA-PSK/WPA2-PSK
Signal Strength	Signal Strength	0 to 100 [%]
TCP/IP Version	TCP/IP Version	IPv4/IPv6
IP Address	Selected IP Address	XXX.XXX.XXX.XXX
Default Gateway	Default Gateway	XXX.XXX.XXX.XXX
Subnet Mask*1	Subnet Mask	XXX.XXX.XXX.XXX
Subnet Prefix Length*2	Subnet Prefix Length	XXX
IPsec*3	IPsec setting	Active
Security Protocol*3	Method of the Security Protocol	ESP/ESP & AH/AH
Wired LAN	Wired LAN	Enable/Disable

Link Status	Status of the Wired LAN	Active/Inactive
MAC Address	MAC Address	XX:XX:XX:XX:XX:XX
TCP/IP Version	TCP/IP Version	IPv4/IPv6
IP Address	IP Address	XXX.XXX.XXX.XXX
Default Gateway	Default Gateway	XXX.XXX.XXX.XXX
Subnet Mask*1	Subnet Mask	XXX.XXX.XXX.XXX
Subnet Prefix Length*2	Subnet Prefix Length	XXX
IPsec*3	IPsec setting	Active
Security Protocol*3	Method of the Security Protocol	ESP/ESP & AH/AH
Printer Name	Printer name	Printer name (Up to 15 characters)
Shared Memory Card	Memory card sharing	Enable/Disable
WSD	WSD setting	Enable/Disable
WSD Timeout	Timeout	1/5/10/15/20 [min]
LLTD	LLTD setting	Enable/Disable
LPR Protocol	LPR protocol setting	Enable/Disable
Bonjour	Bonjour setting	Enable/Disable
Bonjour Service Name	Bonjour service name	Bonjour service name (Up to 52 characters)
Bonjour LPR Service	Bonjour LPR service advertising	Enable/Disable

("X" represents an alphanumeric character ranging from 0 to 9 and A to F.)

*1 Only when IPv4 is selected on IPv4/IPv6 settings, the status of the network is printed.

*2 Only when IPv6 is selected on IPv4/IPv6 settings, the status of the network is printed.

*3 Only when IPv6 is selected on IPv4/IPv6 settings and Active is selected on IPsec Settings, the status of the network is printed.

Advanced Guide

Advanced Guide > About Network Communication > Troubleshooting

Troubleshooting

- ➔ Troubleshooting
- ➔ How to Set a Network Key/Network Password
- ➔ Cannot Communicate With the Machine/Cannot Print from the Machine
- ➔ The Following Screen Is Displayed During Setup
- ➔ Printer Status Monitor of the Machine Does Not Operate
- ➔ Cannot Print, Scan, or Access the Card Slot from a Computer Connected to the Network
- ➔ It Takes a Long Time for Printing to Start
- ➔ The Admin Password Set to the Machine Was Forgotten
- ➔ Checking Information about the Network
- ➔ Restoring the Machine's Network Settings to Factory Default
- ➔ Updating the MP Drivers
- ➔ Uninstalling the Canon IJ Network Tool/Canon IJ Network Scan Utility
- ➔ Cannot Mount the Card Slot
- ➔ Cannot Use the Card Slot
- ➔ Cannot Access to the Memory Card in the Card Slot Using MP Navigator EX
- ➔ Cannot Access to the Card Slot Because of Some Security Settings on the Computer
- ➔ Date Modified of Files Changes When Saving Them on the Memory Card over Network

Page top 

Advanced Guide

[Advanced Guide](#) > [About Network Communication](#) > [Troubleshooting](#) > [Troubleshooting](#)

Troubleshooting

This section describes troubleshooting tips for problems you may encounter when using the machine. For troubleshooting tips related to the setup, refer to the *Network Setup Troubleshooting*.

[Page top](#) ↑

Advanced Guide

[Advanced Guide](#) > [About Network Communication](#) > [Troubleshooting](#) > [How to Set a Network Key/Network Password](#)

How to Set a Network Key/Network Password

➔ [Cannot Connect with an Access Point to Which a WEP/WPA/WPA2 Key Is Set \(You Forgot the WEP/WPA/WPA2 Key\)](#)

➔ [How to Set a WEP/WPA/WPA2 Key](#)

Cannot Connect with an Access Point to Which a WEP/WPA/WPA2 Key Is Set (You Forgot the WEP/WPA/WPA2 Key)

For information on how to set up the access point, refer to the manual provided with the access point or contact its manufacturer. Make sure that the computer and the access point can communicate with each other, then set up the machine to match the settings of the access point.

How to Set a WEP/WPA/WPA2 Key

Refer to the manual provided with the access point or contact its manufacturer and check the access point settings. Make sure that the computer and the access point can communicate with each other, then set up the machine to match the settings of the access point.

- **When using WEP**

The key length, key format, the key to use (out of 1 to 4), and the authentication method must match among the access point, the printer, and the computer.

For access points that use automatically generated WEP keys, use the hexadecimal key format for the machine.

Example:

Using 64 bit key length, when the string "canon" is entered, an access point generates the following codes.

Key 1: C9 42 28 B8 AE

Key 2: 87 C0 FB 05 6B

Key 3: 9A 15 FB F6 F3

Key 4: 62 56 67 58 44

In order to communicate with such an access point, you must configure the machine to use the key generated by the access point by entering it in hexadecimal format.

Normally, select Auto for the authentication method. Otherwise, select Open System or Shared Key according to the setting of the access point.

When the WEP Details dialog box appears after clicking Set on the Search dialog box, follow the on-screen instructions and set the key length, the key format, the key number, and the authentication to enter a WEP key.

For details, see [WEP Details dialog box](#).

- **When using WPA or WPA2**

The authentication method, passphrase, and dynamic encryption type must match on the access point, the machine, and the computer.

Enter the passphrase configured on the access point (a sequence of between 8 and 63 alphanumeric characters, or a 64-character hexadecimal number).

Select either TKIP (Basic Encryption) or AES (Secure Encryption) for the dynamic encryption method.

For details, see [Changing the WPA or WPA2 Detailed Settings](#).



Note

- This machine supports WPA-PSK (WPA-Personal) and WPA2-PSK (WPA2-Personal). WPA-Enterprise and WPA2-Enterprise are not supported.

Advanced Guide

Advanced Guide > About Network Communication > Troubleshooting > Cannot Communicate With the Machine/Cannot Print from the Machine

Cannot Communicate With the Machine/Cannot Print from the Machine

- ➔ Cannot Communicate with the Machine after Applying MAC/IP Address Filtering or Entering a WEP/WPA/WPA2 Key to the Access Point
- ➔ Cannot Communicate with the Machine After the Network Settings Are Changed
- ➔ Cannot Connect to the Target Access Point
- ➔ When Encryption Is Enabled, Cannot Communicate With the Machine After the Encryption Type Was Switched on the Access Point
- ➔ Cannot Communicate with the Machine with USB Connection
- ➔ Cannot Communicate with the Machine over the Network
- ➔ The Machine Cannot Be Detected in the Network

Cannot Communicate with the Machine after Applying MAC/IP Address Filtering or Entering a WEP/WPA/WPA2 Key to the Access Point

- **Check 1: Confirm the access point setting.**

Refer to the manual provided with the access point or contact its manufacturer to confirm the access point setting. Make sure that the computer and the access point can communicate with each other under this setting.

- **Check 2: If you are performing MAC address filtering at the access point, confirm that the MAC addresses for both the computer or the network device and the printer are registered.**

- **Check 3: If you are using a WEP/WPA/WPA2 key, make sure that the key for the computer or the network device and the printer matches that set to the access point.**

Besides the WEP key itself, the key length, key format, the key ID to use, and the authentication method must match among the machine, the access point, and the computer.

Normally, select Auto for the authentication method. If you want to specify the method manually, select Open System or Shared Key according to the setting of the access point.

➔ [How to Set a WEP/WPA/WPA2 Key](#)

Cannot Communicate with the Machine After the Network Settings Are Changed

Wait until the IP address is assigned to the computer. You may need to restart your computer.

Search for the printer again after confirming a valid IP address is assigned to the computer.

Cannot Connect to the Target Access Point

- **Check 1: Make sure that the SSID/network name of the target access point and the machine are identical.**

For the procedures to connect an access point and set it up, refer to the manual of your access point or contact its manufacturer.

For the procedures to set up the printer, see [Changing the Settings in the Wireless LAN Sheet](#).

- **Check 2: Make sure that Wireless LAN active is selected in the Change wireless/wired on the Operation Panel.**

➔ [Changing the Machine Settings on the LCD](#)

- **Check 3: If a network key is set to the access point, set the machine to match it.**

➔ [How to Set a WEP/WPA/WPA2 Key](#)

- **Check 4: Make sure that the valid wireless channel is used.**

The wireless channel to be used may be limited depending on wireless network devices installed in the computer. Refer to the manual provided with your computer or your wireless network device to specify the valid wireless channel.

- **Check 5: Make sure that the channel set to the access point is valid to communicate with the computer, confirmed in Check 4.**

If not, change the channel set to the access point.

- **For placement:**

Make sure that there is no barrier or obstacle between the access point and the machine.

- **When using the printer in a multiple access point setup, make sure that the access point to be used can communicate with the machine and the computer.**

Make sure that the wireless channel of the access point is far enough away with those of other access points.

Windows XP may automatically connect to an unintended access point. Follow the steps below to make your access point the highest priority.

- 1. Select Start and Connect To.**
- 2. Right click Wireless Network Connection and select Properties.**
- 3. Click the Wireless Networks tab and confirm that Use Windows to configure my wireless network settings is checked.**
- 4. Confirm that the target access point is displayed in the Preferred networks list.**

When Encryption Is Enabled, Cannot Communicate With the Machine After the Encryption Type Was Switched on the Access Point

If the printer cannot communicate with the computer after the encryption type of the printer was switched, make sure that encryption types for the computer and the access point matches that set to the printer.

➔ [Cannot Communicate with the Machine after Applying MAC/IP Address Filtering or Entering a WEP/WPA/WPA2 Key to the Access Point](#)

Cannot Communicate with the Machine with USB Connection

- **Check 1: Make sure that the machine is turned on.**
- **Check 2: Make sure that the USB cable is connected properly.**
Refer to the setup manual of the machine to connect the USB cable properly.
- **Check 3: Do not start up the Canon IJ Network Tool while printing.**
- **Check 4: Do not print while the Canon IJ Network Tool is running.**
- **Check 5: Make sure that Enable bidirectional support is selected in the Ports sheet of the properties dialog box of the printer driver.**

➔ [Opening the Printer Properties Dialog Box \(Windows\)](#)

Cannot Communicate with the Machine over the Network

- **Check 1: Make sure that the machine is turned on.**
- **Check 2: Is Change wireless/wired in Device settings set to Wireless LAN active or Wired LAN active?**
➔ [Changing the Machine Settings on the LCD](#)
- **Check 3: When using wired LAN, make sure that the LAN cable is connected properly.**
- **Check 4: When using wireless LAN, make sure that the network settings in the machine are identical with those of the access point.**
Refer to the manual provided with the access point or contact its manufacturer to check the access point settings, and then modify the machine settings.
➔ [How to Set a WEP/WPA/WPA2 Key](#)
- **Check 5: When using wireless LAN, make sure that the machine is not placed as far away from the access point.**
The access point is located indoors within the effective range for wireless communication. Locate the machine within 50 m from the access point.
- **Check 6: When using wireless LAN, make sure that there is no obstruction.**
Wireless communication between different rooms or floors is generally poor. Adjust the location of the devices.
- **Check 7: When using wireless LAN, make sure that there is no source of radio wave interference in your vicinity.**
There may be a device such as a microwave oven using the same frequency bandwidth as the wireless station. Place the wireless devices as far away from the interference source as possible.
- **Check 8: Make sure that the network settings of the computer are correct.**
For the procedures to connect a network device to the computer and set them up, refer to the manual of your network device or contact its manufacturer.
- **Check 9: Make sure that the radio status is good and adjust the installation positions while monitoring the radio status with Canon IJ Network Tool.**
➔ [Monitoring Wireless Network Status](#)
- **Check 10: Make sure that the valid wireless channel is used.**
The wireless channel to be used may be limited depending on wireless network devices installed in the computer. Refer to the manual provided with your computer or your wireless network device to specify the valid wireless channel.
- **Check 11: Make sure that the channel set to the access point is valid to communicate with the computer, confirmed in Check 10.**
If not, change the channel set to the access point.
- **Check 12: Make sure that the firewall of the security software is disabled.**
If the firewall function of your security software is turned on, a message may appear warning that Canon software is attempting to access the network. If the warning message appears, set the security software to always allow access.
If using any programs that switch the network environment, check their settings. Some programs will enable a firewall by default.
- **Check 13: When using a router, connect the printer and computer to the LAN side (same network segment).**

- **For placement:**

When using wireless LAN, make sure that there is no barrier or obstacle between the access

point and the machine.

The Machine Cannot Be Detected in the Network

- **Check 1: Make sure that the machine is turned on.**
- **Check 2: Make sure that the USB cable is connected properly.**
Refer to the setup manual of the machine to connect the USB cable properly.
- **Check 3: Make sure that the machine setup is completed.**
If not, refer to your setup manual of the machine to complete the machine setup.
- **Check 4: When using wired LAN, make sure that the LAN cable is connected properly.**
- **Check 5: When using Canon IJ Network Tool, click Update to search for the printer again.**
[➔ Canon IJ Network Tool Dialog Box](#)
- **Check 6: When searching for a printer over a network, make sure that the machine is associated with the port driver.**
When No Driver is displayed under Name in the Canon IJ Network Tool, there is no association. Select Associate Port on the Settings menu, then associate the port with the printer.
[➔ Canon IJ Network Tool Menus](#)
- **Check 7: When using wireless LAN, make sure that the network settings in the printer are identical with those of the access point.**
Refer to the manual provided with the access point or contact its manufacturer to check the access point settings, and then modify the machine settings.
[➔ How to Set a WEP/WPA/WPA2 Key](#)
- **Check 8: When using wireless LAN, make sure that there is no obstruction.**
Wireless communication between different rooms or floors is generally poor. Adjust the location of the devices.
- **Check 9: When using wireless LAN, make sure that the machine is not place as far away from the access point.**
The access point is located indoors within the effective range for wireless communication. Locate the machine within 50 m from the access point.
- **Check 10: When using wireless LAN, make sure that there is no source of radio wave interference in your vicinity.**
There may be a device such as a microwave oven using the same frequency bandwidth as the wireless station. Place the wireless devices as far away from the interference source as possible.
- **Check 11: Make sure that the network settings of the computer are correct.**
Make sure that the computer can communicate with the printer and the access point over the wireless LAN.
- **Check 12: Make sure that Enable bidirectional support is selected in the Ports sheet of the properties dialog box of the printer driver.**
[➔ Opening the Printer Properties Dialog Box \(Windows\)](#)
- **Check 13: Make sure that the firewall of the security software is disabled.**
If the firewall function of your security software is turned on, a message may appear warning that Canon software is attempting to access the network. If the warning message appears,

set the security software to always allow access.

If using any programs that switch the network environment, check their settings. Some programs will enable a firewall by default.

- **Check 14: When using a router, connect the printer and computer to the LAN side (same network segment).**

[Page top ↑](#)

Advanced Guide

Advanced Guide > About Network Communication > Troubleshooting > The Following Screen Is Displayed During Setup

The Following Screen Is Displayed During Setup

- ➔ The Enter Password Dialog Box Is Displayed During Setup
- ➔ The Dialog Box for Setting the Encryption Is Displayed After Selecting the Access Point in the Search Dialog Box
- ➔ "You are connecting the machine to the non encrypted wireless network" Is Displayed

The Enter Password Dialog Box Is Displayed During Setup

The following dialog box is displayed if an administrator password is set to the machine which has already been set up.



Enter the administrator password you have set.

- ➔ [Changing the Settings in the Admin Password Sheet](#)

The Dialog Box for Setting the Encryption Is Displayed After Selecting the Access Point in the Search Dialog Box

This dialog box is displayed automatically if the encryption settings are changed on the access point. You need to change the machine's encryption settings to match those of the access point.

For information on the encryption settings, see [Changing the Settings in the Wireless LAN Sheet](#).

"You are connecting the machine to the non encrypted wireless network" Is Displayed

Security is not configured on the access point. The machine can still be used, so continue the setup procedure to complete it.

Important

- If you connect to a network that is not protected with security measures, there is a risk of disclosing data such as your personal information to a third party.

Advanced Guide

[Advanced Guide](#) > [About Network Communication](#) > [Troubleshooting](#) > Printer Status Monitor of the Machine Does Not Operate

Printer Status Monitor of the Machine Does Not Operate

Use the printer driver with bidirectional communication.

Select Enable bidirectional support in the Ports sheet of the properties dialog box of the printer driver.

➡ [Opening the Printer Properties Dialog Box \(Windows\)](#)

[Page top](#) ↑

Advanced Guide

[Advanced Guide](#) > [About Network Communication](#) > [Troubleshooting](#) > Cannot Print, Scan, or Access the Card Slot from a Computer Connected to the Network

Cannot Print, Scan, or Access the Card Slot from a Computer Connected to the Network

- **Check 1: Make sure that the network settings of the computer are correct.**

For the procedures to set up the computer, refer to the manual of your computer or contact its manufacturer.

- **Check 2: If the MP Drivers is not installed, install the MP Drivers.**

Insert the *Setup CD-ROM* into the computer's disc drive and perform Custom Install and select MP Drivers to install again.

- **Check 3: When using wireless LAN, make sure that access control is not set to the access point.**

For the procedures to connect an access point and set it up, refer to the manual of your access point or contact its manufacturer.



Note

- Print out the network setting information of the computer to check whether the MAC address or the IP address is registered or not. For details, see [Checking the IP Address or the MAC Address of the Computer](#).
-

Advanced Guide

[Advanced Guide](#) > [About Network Communication](#) > [Troubleshooting](#) > [It Takes a Long Time for Printing to Start](#)

It Takes a Long Time for Printing to Start

- **Check 1: The machine may be printing out or scanning a large job issued from another computer.**
- **Check 2: Make sure that the radio status is good and adjust the installation positions while monitoring the radio status with Canon IJ**

Network Tool.

➡ [Monitoring Wireless Network Status](#)

Make sure that there is no barrier or obstacle between the access point and the machine. Wireless communication between different rooms or floors is generally poor. The metal, concrete, or timber including the metallic material, mud wall, or insulator may interrupt a wireless communication. If the machine cannot communicate with the computer over a Wireless LAN for the wall material, place the machine and the computer in the same room or floor.

- **Check 3: When using wireless LAN, make sure that there is no source of interference in your vicinity.**

Since a device such as a microwave oven uses the same frequency bandwidth, it may cause interference. Place the wireless devices as far away from the source of interference as possible.

[Page top](#) ↑

Advanced Guide

[Advanced Guide](#) > [About Network Communication](#) > [Troubleshooting](#) > [The Admin Password Set to the Machine Was Forgotten](#)

The Admin Password Set to the Machine Was Forgotten

Initialize the LAN settings.

➡ [Restoring the Machine's Network Settings to Factory Default](#)

After initializing the LAN settings, refer to your setup manual of the machine to set up the machine again.

[Page top](#) ↑

Advanced Guide

Advanced Guide > About Network Communication > Troubleshooting > Checking Information about the Network

Checking Information about the Network

- ➔ Checking the IP Address or the MAC Address of the Machine
- ➔ Checking the IP Address or the MAC Address of the Computer
- ➔ Checking If the Computer and the Machine, or Computer and the Access Point Can Communicate
- ➔ Checking the Network Setting Information

Checking the IP Address or the MAC Address of the Machine

To check the IP address or the MAC address of the machine, display the network setting information using the Operation Panel of the machine or print out the network setting information of the machine.

- ➔ Changing the Machine Settings on the LCD
- ➔ Printing Out Network Setting Information

To display the network setting information using the Canon IJ Network Tool, select Network Information on the View menu.

- ➔ Canon IJ Network Tool Menus

Checking the IP Address or the MAC Address of the Computer

To check the IP address or MAC address assigned to the computer, follow the procedure below.

- 1. Click Start > All Programs (or Programs) > Accessories > Command Prompt.**
- 2. Enter "ipconfig/all" and press the Enter key.**

The IP addresses and the MAC addresses of the network devices installed on your computer are displayed. When the network device is not connected to the network, the IP address is not displayed.

Checking If the Computer and the Machine, or Computer and the Access Point Can Communicate

To check that communication is available, perform the ping test.

- 1. Display the command prompt.**

Windows Vista or Windows XP

From the Start menu, select All Programs, Accessories, and Command Prompt.

Windows 2000

From the Start menu, select Programs, Accessories, and Command Prompt.

- 2. Type the ping command and the IP address of the target printer or the target access point, and then press the Enter key.**

```
ping XXX.XXX.XXX.XXX
```

"XXX.XXX.XXX.XXX" is the IP address of the target device.

If the communication is available, a message such as the following is displayed.

```
Reply from XXX.XXX.XXX.XXX: bytes=32 time=10ms TTL=255
```

When Request timed out is displayed, the communication is not available.

Checking the Network Setting Information

To check the IP address or the MAC address of the machine, display the network setting information using the Operation Panel of the machine or print out the network setting information

of the machine.

➔ [Changing the Machine Settings on the LCD](#)

➔ [Printing Out Network Setting Information](#)

[Page top ↑](#)

Advanced Guide

[Advanced Guide](#) > [About Network Communication](#) > [Troubleshooting](#) > [Restoring the Machine's Network Settings to Factory Default](#)

Restoring the Machine's Network Settings to Factory Default

Important

- Note that initialization erases all network settings on the machine, and printing or scanning operation from a computer over network may become impossible. To use the machine over network, refer to the setup manual of the machine to set up the machine again.

Select Reset LAN settings on the Operation Panel of the machine to initialize the network setting.

[➡ Changing the Machine Settings on the LCD](#)

[Page top](#) 

Advanced Guide

[Advanced Guide](#) > [About Network Communication](#) > [Troubleshooting](#) > [Updating the MP Drivers](#)

Updating the MP Drivers

Download the latest MP Drivers in advance.

After uninstalling the MP Drivers, install the latest MP Drivers according to the regular procedure. When the connection method selection screen is displayed, select Use the printer on network. The machine will be detected automatically in the network.

After making sure that the machine is detected, install the MP Drivers following the on-screen instructions.

Note

- You can use the machine over a LAN without performing setup again.
-

[Page top](#) ↑

Advanced Guide

[Advanced Guide](#) > [About Network Communication](#) > [Troubleshooting](#) > [Uninstalling the Canon IJ Network Tool/Canon IJ Network Scan Utility](#)

Uninstalling the Canon IJ Network Tool/Canon IJ Network Scan Utility

• Uninstalling the Canon IJ Network Tool

Follow the procedure below to uninstall the Canon IJ Network Tool from your computer.

Important

- Even if the Canon IJ Network Tool is uninstalled, you can print over network and scan from the computer. However, you cannot change the network settings and use the Card Slot of the machine over network.
- Log into a user account with administrator privilege.

1. Click Start > All Programs (or Programs) > Canon IJ Network Utilities > Canon IJ Network Tool > Uninstaller.

2. Click Yes when the confirmation message appears.

When the message prompting you to restart your computer is displayed, click OK to restart your computer.

Note

- You can also use Uninstall a program (or Add or Remove Programs, or Add/Remove Applications) on Control Panel to uninstall the Canon IJ Network Tool.

• Uninstalling the Canon IJ Network Scan Utility

Follow the procedure below to uninstall the Canon IJ Network Scan Utility from your computer.

Important

- Even if the Canon IJ Network Scan Utility is uninstalled, you can print and scan from a computer over network. However, you cannot scan over network using the Operation Panel on the machine.
- Log into a user account with administrator privilege.

1. Click Start > All Programs (or Programs) > Canon IJ Network Utilities > Canon IJ Network Scan Utility > Uninstaller.

2. Click Yes when the confirmation message appears.

When the message prompting you to restart your computer is displayed, click OK to restart your computer.

Note

- You can also use Uninstall a program (or Add or Remove Programs, or Add/Remove Applications) on Control Panel to uninstall the Canon IJ Network Scan Utility.

Advanced Guide

Advanced Guide > About Network Communication > Troubleshooting > Cannot Mount the Card Slot

Cannot Mount the Card Slot

- ➡ The Available Drive Letter Cannot Be Selected on the Network Setup of the Card Slot Dialog Box
- ➡ The Card Slot Cannot Be Mounted with the Canon IJ Network Tool

The Available Drive Letter Cannot Be Selected on the Network Setup of the Card Slot Dialog Box

On this dialog box, only D to Z can be selected as the network drive for the Card Slot.

When the Card Slot has been set up to be used over network, you cannot select a drive letter. If you want to assign another drive letter to the network drive for the Card Slot, disconnect it from the network, then set up the Card Slot again using the Canon IJ Network Tool.

➡ [Using the Card Slot over a Network](#)

The Card Slot Cannot Be Mounted with the Canon IJ Network Tool

If you cannot mount the Card Slot to use it over network with the Canon IJ Network Tool, follow the procedure below to mount the Card Slot manually.

- 1. Check the Default Name of the machine by selecting Network Information on the View menu of the Canon IJ Network Tool.**

- 2. Click Start > All Programs > Accessories > Run.**

In Windows XP and Windows 2000, click Start > Run.

- 3. Input "\\xxxxxxxxxxxx", then click OK.**

For example, if the Default Name is "0000000847B6\canon_memory", then input only "\\0000000847B6\".

Note

- If you cannot mount the Card Slot with the method above, input the IP address of the machine instead of the 12 alphanumeric characters of the Default Name, and try again. For example, "\\192.168.1.1\". If you mount the Card Slot with the IP address, you have to remount it whenever the machine's IP address changes.

- 4. When the  canon_memory icon appears, right-click the icon, then select Map Network Drive.**

- 5. Select the drive letter, then click Finish.**

Advanced Guide

Advanced Guide > About Network Communication > Troubleshooting > Cannot Use the Card Slot

Cannot Use the Card Slot

• Check 1: Is the icon of the Card Slot displayed?

To use the Card Slot over network, you have to mount the Card Slot as the network drive of the computer.

The canon_memory (\\xxxxxxxxxxx) (or canon_memory on `xxxxxxxxxxx`) icon with the mapped drive letter appears on Computer (or My Computer).

- "xxxxxxxxxxx" is a string of 12 alphanumeric characters.
- The icon name may vary depending on the language version of Windows you are using.

If the icon is not displayed, mount the Card Slot.

➡ [Mounting the Card Slot as the Network Drive](#)

• Check 2: Is the memory card inserted in the Card Slot?

Make sure that a memory card is inserted in the Card Slot. If it is not inserted, insert it. For information on how to insert a memory card, refer to [Printing from a Memory Card](#).

• Check 3: Is Read/write attribute set to Writable from USB PC?

When Read/write attribute in Device settings is set to Writable from USB PC, you cannot access the memory card over network. Set Read/write attribute to Writable from LAN PC to write data to the memory card over network.

➡ [Changing the Machine Settings on the LCD](#)

• Check 4: Is Read/write attribute set to Not writable from PC?

When Read/write attribute in Device settings is set to Not writable from PC, you can read data on the memory card, but cannot write data to it. To write data to the memory card in the Card Slot over network, set Read/write attribute to Writable from LAN PC.

➡ [Changing the Machine Settings on the LCD](#)

• Check 5: To share the printer's Card Slot with multiple computers over a network, set Set memory card sharing in Device settings to Enable.

➡ [Changing the Machine Settings on the LCD](#)

• Check 6: Is another computer writing data to the memory card?

While one computer is writing a file into the memory card, other computers cannot access the same file. Wait for a while, then try again.

Advanced Guide

[Advanced Guide](#) > [About Network Communication](#) > [Troubleshooting](#) > Cannot Access to the Memory Card in the Card Slot Using MP Navigator EX

Cannot Access to the Memory Card in the Card Slot Using MP Navigator EX

If "Cannot access the memory card" is displayed when you click Memory Card under Scan/Import Documents or Images on MP Navigator EX, confirm what the message says, then click Retry. If the message appears again, mount the Card Slot as the network drive. For details on how to mount the Card Slot, see [Mounting the Card Slot as the Network Drive](#). Confirm the icon for the Card Slot appears on Computer (or My Computer), and try to access using MP Navigator EX.

[Page top](#) ↑

Advanced Guide

Advanced Guide > About Network Communication > Troubleshooting > Cannot Access to the Card Slot Because of Some Security Settings on the Computer

Cannot Access to the Card Slot Because of Some Security Settings on the Computer

- **Check 1: Make sure that Read/write attribute in Device settings is set to Writable from LAN PC.**
➔ [Changing the Machine Settings on the LCD](#)
- **Check 2: Make sure that the memory card is inserted in the Card Slot.**
- **Check 3: To share the printer's Card Slot with multiple computers over a network, set Set memory card sharing in Device settings to Enable.**
➔ [Changing the Machine Settings on the LCD](#)
- **Check 4: Disable the Windows Firewall function, or open port 137:139 to allow communication with the machine following the procedure below.**

For information on other security software, refer to its instruction manual or manufacturer.

Important

- If you disabled the firewall function, disconnect your network from the Internet. You can do this by configuring your access point or router not to connect to the Internet or WAN.

• To disable the Windows Firewall:

1. Click Start > Control Panel > Security > Windows Firewall > Change settings.

In Windows XP, click Start > Control Panel > Security Center > Windows Firewall.

2. Select Off and click OK.

• To open port 137:139:

1. Click Start > Control Panel > Security > Windows Firewall > Change settings.

In Windows XP, click Start > Control Panel > Security Center > Windows Firewall.

2. Click the Exceptions tab, and click Add port.

3. On the Add a Port dialog box, input the following information, and click OK.

Name: Input any name for the port.

Port number: Input "137".

Protocol: Select TCP.

4. Repeat steps 2 and 3.

On the Add a Port dialog box, input the same information as you did in step 3 except for selecting UDP in Protocol.

5. Use the same procedure to open the other ports (138TCP, 138UDP, 139TCP, and 139UDP).
6. Confirm that the port names are added on the Exceptions sheet, and click OK.

- **Check 5: Change the workgroup name to "WORKGROUP" following the procedure below.**

1. Right-click Computer (or My Computer), select Properties, then click Change settings.

In Windows XP, right-click My Computer, then select Properties.

2. Click the Computer Name tab, then click Change.
3. Change the workgroup name to "WORKGROUP", then click OK.

- **Check 6: Disconnect the network drive for the Card Slot and mount it again following the procedure below.**

1. Right-click Computer (or My Computer), and select Disconnect Network Drive.
2. Select the network drive to disconnect, then click OK.
3. Remount the Card Slot using the Canon IJ Network Tool.

➡ Using the Card Slot over a Network

Advanced Guide

[Advanced Guide](#) > [About Network Communication](#) > [Troubleshooting](#) > Date Modified of Files Changes When Saving Them on the Memory Card over Network

Date Modified of Files Changes When Saving Them on the Memory Card over Network

- **Check: Does the Canon IJ Network Scan Utility run?**

If you write files to a memory card over a network when the Canon IJ Network Scan Utility is not running, the Date Modified of the files will change. Make sure to start up the Canon IJ Network Scan Utility before you write files to a memory card over the network.

[Page top](#) ↑

Advanced Guide

Advanced Guide > About Network Communication > Appendix

Appendix

- ➔ Restrictions
- ➔ Initial Values Set at Factory (Network)
- ➔ Using the Card Slot over a Network

Page top 

Advanced Guide

[Advanced Guide](#) > [About Network Communication](#) > [Appendix](#) > [Restrictions](#)

Restrictions

If you use a printer over the wireless LAN, the printer may recognize nearby wireless systems, you should set a network key (WEP, WPA, or WPA2) to the access point to encrypt wireless transmission. Wireless communication with a product that does not comply with the Wi-Fi standard cannot be guaranteed.

Connecting with too many computers may affect the printer performance, such as printing speed.

[Page top](#) ↑

Advanced Guide

Advanced Guide > About Network Communication > Appendix > Initial Values Set at Factory (Network)

Initial Values Set at Factory (Network)

Item	Initial Values
Change wireless/wired	Disable LAN
SSID	BJNPSETUP
Communication mode	Infrastructure
Wireless Security	Disable
IP address	Getting automatically
Printer name setting*	XXXXXXXXXXXXXXXX
IPv4/IPv6 setting	IPv4
Set memory card sharing	Enable
Enable/disable WSD (WSD settings)	Active
Timeout setting (WSD settings)	1 minute
LLTD setting	Enable
Enable/disable Bonjour (Bonjour settings)	Enable
Service name (Bonjour settings)*	Canon XXX series _XXXXXXXXXXXX
LPR service advertising (Bonjour settings)	OFF
LPR protocol setting	Enable

* The initial value in this item varies by machine. You can check the value in this item using the Operation Panel on the machine.

[Page top](#) ↑

Advanced Guide

Advanced Guide > About Network Communication > Appendix > Using the Card Slot over a Network

Using the Card Slot over a Network

- ➔ Confirming Whether the Card Slot is Mounted
- ➔ Mounting the Card Slot as the Network Drive
- ➔ Restrictions on Card Slot Use over a Network

Confirming Whether the Card Slot is Mounted

The Card Slot must be mounted to use it over a network.

When the Card Slot is mounted, the following icon appears on Computer (or My Computer). If the icon does not appear, see [Cannot Use the Card Slot](#).

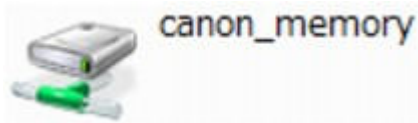

If these icons are not found, the network drive for the Card Slot is not mounted yet. For details on how to mount the Card Slot, see [Mounting the Card Slot as the Network Drive](#).

Mounting the Card Slot as the Network Drive

1. Start up the Canon IJ Network Tool.

Double-click the  Canon IJ Network Tool icon on the desktop. You can also click Start > All Programs (or Programs) > Canon IJ Network Utilities > Canon IJ Network Tool > Canon IJ Network Tool to start up the tool.

2. Select the machine.

3. Select Maintenance on the Settings menu.

4. Click Setup.



5. Specify the drive letter, then click OK.

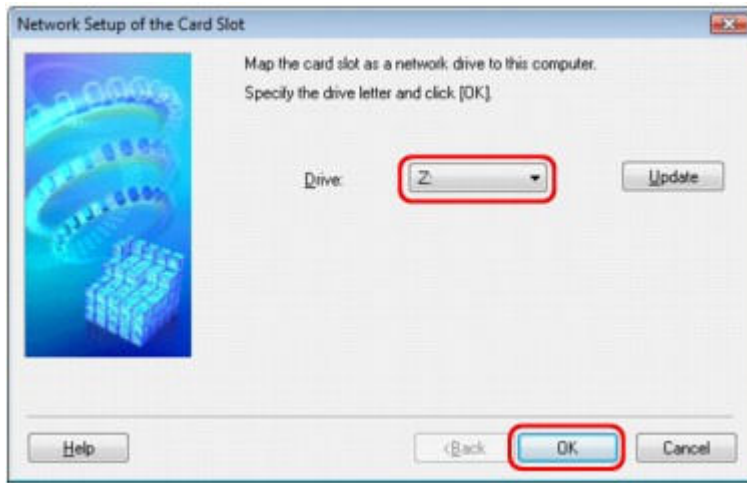

6. Confirm that the  canon_memory icon for the Card Slot appears on Computer (or My Computer).

Note

- If the Card Slot cannot be mounted properly, see [Cannot Mount the Card Slot](#).

Restrictions on Card Slot Use over a Network

- The Card Slot can be shared by multiple computers, if the machine is connected to a network. Multiple computers can read files from a memory card in the Card Slot at the same time. However, while one computer is writing a file into a memory card, other computers cannot access the same file.
- If your computer joins a domain, the Card Slot may not be mounted as the network drive.
- If you use the memory card stored the large size files or many files, a large amount of card access may be generated. In this case, the operation in the memory card may be impossible or slow. Operate after the Access lamp of the machine is lit.
- When you access the network drive for the Card Slot over the network, file names consisting of eight or less lowercase letters (not including its extension) may be shown in uppercase. For example, a file name such as "abcdefg.doc" will be "ABCDEFGG.DOC", while a name such as "AbcdeFG.doc" will appear the same. The file is not actually renamed, but merely appears to be changed.
- When the Read/write attribute setting of the machine is set to Writable from USB PC, you cannot access the network drive of the Card Slot. On the other hand, when this setting is set to Writable from LAN PC, the Card slot is not detected via USB. Make sure that the Read/write attribute setting is set properly depending on your connection type. Select Not writable from PC to read files from a memory card via USB and over a network, although you cannot write files to a memory card in either way with this setting. For details on how to change the machine setting, refer to [Changing the Machine Settings on the LCD](#).
- When the Read/write attribute setting of the machine is set to Writable from LAN PC, you can write files to a memory card from a computer connected to a network. Note that it may increase the risk that the data on the memory card is infected by computer viruses or accessed illegally. It is recommended to use the access control function of the machine or connect

to the Internet via a router. For information on using a router, contact your Internet service provider or a network device manufacturer.

- If you write files to a memory card over a network when the Canon IJ Network Scan Utility is not running, the Date Modified of the files may not be proper. Make sure to start up the Canon IJ Network Scan Utility before you write files to a memory card over the network. For details on how to use the Canon IJ Network Scan Utility, refer to the online help of the Canon IJ Network Scan Utility.

Note

- If the following occurs when using the network drive for the Card Slot over a network, see [Cannot Use the Card Slot](#).
 - Cannot access the Card Slot after the network setup of the Card Slot is complete
 - Can read the memory card in the Card Slot, but cannot write to it
 - The Card Slot is disconnected
 - The Date Modified of files changes when saving them in the network drive for the Card Slot
-

[Page top](#) ↑

Advanced Guide

[Advanced Guide](#) > [About Network Communication](#) > [Glossary](#)

Glossary

[➔ About Technical Terms](#)

[Page top](#) 

Advanced Guide

Advanced Guide > About Network Communication > Glossary > About Technical Terms

About Technical Terms

In this section, technical terms used in the manual are explained.

- ➔ A
- ➔ B
- ➔ C
- ➔ D
- ➔ F
- ➔ I
- ➔ K
- ➔ L
- ➔ M
- ➔ O
- ➔ P
- ➔ R
- ➔ S
- ➔ T
- ➔ U
- ➔ W

A

- **Access Point**

A wireless transceiver or base station that receives information from wireless clients/the machine and rebroadcasts it. Required in an infrastructure network.

- **Ad-hoc**

Client computer and machine setting where wireless communication occurs on a peer-to-peer basis, i.e., all clients in with the same SSID/network name communicate directly with each other. No access point is required. This machine does not support ad-hoc communication.

- **Admin Password**

Administration password in Canon IJ Network Tool to restrict access to network users. It must be entered to access the printer and change printer settings.

When the printer's network settings are factory default, the admin password does not have to be entered.

- **AES**

An encryption method. It is optional for WPA. Strong cryptographic algorithm adopted within U.S. government organizations for information processing.

- **Authentication Method**

The method that an access point uses to authenticate a printer through a wireless LAN. The methods are agreeable each other.

When using WEP as an encryption method, the authentication method is able to fix to Open System or Shared Key. (The default authentication method is Auto.)

For WPA/WPA2, authentication method is PSK.

- **Auto**

The printer automatically changes its authentication method to match the access

- point.
- **Open System**
In this authentication method, the communication partner is authenticated without using WEP key even if "Use WEP" is selected.
- **Shared Key**
In this authentication method, the communication partner is authenticated using the WEP key that was set for encryption.

B

- **Bonjour**
A service built into Mac OS X operating system to detect the connectable devices on a network automatically.

C

- **Channel**
Frequency channel for wireless communication. In the infrastructure mode, the channel is automatically adjusted to match that set to the access point. This machine supports channels 1 to 13. Note that the number of channels that can be used for your wireless LAN varies depending on the region or country.

D

- **Default Gateway**
A relay device to connect to another network such as a router or a computer.
- **DHCP server functionality**
The router or the access point assigns an IP address automatically whenever the printer or the personal computer on a network starts up.

F

- **Firewall**
It is a system that prevents an unlawful computer access in the network. To prevent, you can use the firewall function of a broadband router, the security software installed in the computer, or operation system for computer.

I

- **IEEE 802.11b**
International standard for wireless LAN using the 2.4 GHz frequency range with a throughput of up to 11 Mbps.
- **IEEE 802.11g**
International standard for wireless LAN using the 2.4 GHz frequency range with a throughput of up to 54 Mbps. Compatible with 802.11b.
- **Infrastructure**
Client computer and machine setup where all wireless communications pass through an access point.
- **IP Address**
A unique number with four parts separated by dots. Every network device that is connected to the Internet has an IP address. Example: 192.168.0.1
An IP address is usually assigned by an access point or a DHCP server of the router

automatically.

For the procedure to check the IP address of the printer, see [Checking the IP Address or the MAC Address of the Machine](#).

- **IPv4/IPv6**

They are internet-layer protocol used on the internet. IPv4 uses 32-bit addresses and IPv6 uses 128-bit addresses.

K

- **Key Format**

Select either ASCII or Hex as the WEP key format. The character that can be used for the WEP key differs depending on the selected key formats.

- ASCII
Specify with a 5 or 13-character string that can include alphanumeric and underscore "_" characters. It is case-sensitive.
- Hex
Specify a 10-digit or 26-digit string that can contain hexadecimal (0 to 9, A to F, and a to f).

- **Key Length**

Length of the WEP key. Select either 64 bits or 128 bits. Longer key length allows you to set a more complex WEP key.

L

- **Link Quality**

The status of connection between the access point and the printer excluding noise (interference) is indicated with a value from 0 to 100%.

- **LLTD**

A Link Layer protocol built in Windows Vista for network topology discovery and quality of service diagnostics.

LLTD is used by its Network Map feature to display a graphical representation of the local network.

- **LPR**

A platform-independent printing protocol used in TCP/IP networks. It is not supported bidirectional communication.

M

- **MAC Address**

Also known as the physical address. A unique and permanent hardware identifier that is assigned to network devices by its manufacturer. MAC addresses are 48 bits long and are written as a hexadecimal number separated by colons, i.e., 11:22:33:44:55:66. To check the MAC address of this machine, see [Checking the IP Address or the MAC Address of the Machine](#).

O

- **Operation Status**

Indicates the status on whether the printer can be used.

P

- **PSK**

An encryption method employed by WPA/WPA2.

R

- **Router**

A relay device to connect to another network.

S

- **Signal Strength**

The strength of the signal received by the printer from the access point is indicated with a value from 0 to 100%.

- **SSID**

Unique label for wireless LAN. It is often represented such as a network name or a access point name.

SSID distinguishes one wireless LAN from another to prevent interference.

The printer and all clients on a wireless LAN must use the same SSID in order to communicate with each other. The SSID can be up to 32 characters long, and is made up of alphanumeric characters. The SSID may also be referred to by its network name.

- **Stealth**

In the stealth mode, an access point hides itself by not broadcasting its SSID. The client must specify the SSID set to the access point to detect it.

- **Subnet Mask**

IP address has two components, the network address and the host address. Subnet Mask used to calculate the Subnet Mask address from the IP address. A Subnet Mask is usually assigned by an access point or a DHCP server of the router automatically.

Example:

IP Address: 192.168.127.123

Subnet Mask: 255.255.255.0

Subnet Mask Address: 192.168.127.0

T

- **TCP/IP**

Suite of communications protocols used to connect hosts on the Internet or the LAN. This protocol allows different terminals to communicate with each other.

- **TKIP**

An encryption protocol employed by WPA/WPA2.

U

- **USB**

Serial interface designed to enable you to "hot-swap" devices, i.e., by plugging and unplugging them without turning off the power.

W

- **WCN (Windows Connect Now)**

Users running Windows Vista can easily create network configuration settings and transmit them to the access point using the USB flash memory.

- **WEP/WEP Key**

An encryption method employed by IEEE 802.11. Shared security key used to encrypt and decrypt data sent over wireless networks. This printer supports key length of 64 bits or 128 bits, key format of ASCII code or Hexadecimal, and key number of 1 to 4.

- **Wi-Fi**

International association that certifies interoperability of wireless LAN products based on the IEEE 802.11 specification.

This machine is a Wi-Fi authorized product.

- **Wireless LAN**

A network that, instead of being connected by physical wires, is connected by a wireless technology, such as Wi-Fi.

- **WPA**

Security framework announced by the Wi-Fi Alliance in October 2002. The security has been strengthened more than WEP.

- Authentication

WPA defines the following authentication methods: PSK that can be used without an authentication server, plus WPA-802.1x that do require an authentication server.

This machine supports WPA-PSK.

- Passphrase

This encrypted key is used to perform WPA-PSK authentication.

The passphrase should be a string of 8 to 63 alphanumeric characters or a 64-digit hexadecimal value.

- **WPA2**

Security framework released by the Wi-Fi Alliance in September in 2004 as a later version of WPA. Provides a stronger encryption mechanism through Advanced Encryption Standard (AES).

- Authentication

WPA defines the following authentication methods: PSK that can be used without an authentication server, plus WPA2-802.1x that do require an authentication server.

This machine supports WPA2-PSK.

- Passphrase

This encrypted key is used to perform WPA2-PSK authentication.

The passphrase should be a string of 8 to 63 alphanumeric characters or a 64-digit hexadecimal value.

- **WPS (Wi-Fi Protected Setup)**

WPS is a standard for easy and secure establishment of a wireless network.

There are 2 primary methods used in the Wi-Fi Protected Setup:

PIN entry: a mandatory method of setup for all WPS certified devices

Push button configuration (PBC): an actual push button on the hardware or through a simulated push button in the software.