



User Guide



HP Color LaserJet Pro
3201-3204/3288 series

HP company notices

Copyright and License

THE INFORMATION CONTAINED HEREIN IS SUBJECT TO CHANGE WITHOUT NOTICE.

ALL RIGHTS RESERVED. REPRODUCTION, ADAPTATION, OR TRANSLATION OF THIS MATERIAL IS PROHIBITED WITHOUT PRIOR WRITTEN PERMISSION OF HP, EXCEPT AS ALLOWED UNDER THE COPYRIGHT LAWS. THE ONLY WARRANTIES FOR HP PRODUCTS AND SERVICES ARE SET FORTH IN THE EXPRESS WARRANTY STATEMENTS ACCOMPANYING SUCH PRODUCTS AND SERVICES. NOTHING HEREIN SHOULD BE CONSTRUED AS CONSTITUTING AN ADDITIONAL WARRANTY. HP SHALL NOT BE LIABLE FOR TECHNICAL OR EDITORIAL ERRORS OR OMISSIONS CONTAINED HEREIN.

© Copyright 2024 HP Development Company, L.P.

Trademark Credits

Microsoft and Windows are either registered trademarks or trademarks of Microsoft Corporation in the United States and/or other countries.

Mac, OS X, macOS, and AirPrint are trademarks of Apple Inc., registered in the U.S. and other countries.

ENERGY STAR and the ENERGY STAR mark are registered trademarks owned by the U.S. Environmental Protection Agency.

Android and Chromebook are trademarks of Google LLC.

iOS is a trademark or registered trademark of Cisco in the U.S. and other countries and is used under license.

Safety Information

Always follow basic safety precautions when using this product to reduce risk of injury from fire or electric shock.

- Read and understand all instructions in the documentation that comes with the printer.
- Observe all warnings and instructions marked on the product.
- Unplug this product from wall outlets before cleaning.
- Do not install or use this product near water, or when you are wet.
- Install the product securely on a stable surface.
- Install the product in a protected location where no one can step on or trip over the line cord, and the line cord cannot be damaged.
- If the product does not operate normally, see **Solve a problem** in this guide.
- There are no user-serviceable parts inside. Refer servicing to qualified service personnel.

Table of contents

| | |
|--|-----------|
| 1 Get started | 1 |
| Printer views | 1 |
| Front view | 1 |
| Rear view | 2 |
| Control panel features | 2 |
| Control panel view | 2 |
| How to use the control pad | 3 |
| Function icons | 3 |
| To install HP software and open the app | 4 |
| 2 Connect your printer | 5 |
| Connect to a Wi-Fi network | 5 |
| Connect to a Wi-Fi network/Wi-Fi Protected Setup using the control panel | 5 |
| Connect to a Wi-Fi network using the HP software | 5 |
| Check Wi-Fi status | 6 |
| Connect to an Ethernet network | 6 |
| Connect using a USB cable | 6 |
| Change the connection type | 7 |
| USB to Wi-Fi | 7 |
| Wi-Fi to USB | 7 |
| 3 Load media | 8 |
| Before you begin | 8 |
| Load paper to single-sheet slot tray 1 | 8 |
| Load letterhead or preprinted paper in tray 1 | 9 |
| Load paper to tray 2 | 10 |
| Load letterhead or preprinted paper in tray 2 | 12 |
| Portrait printing | 12 |
| Landscape printing | 13 |
| Load and print envelopes | 14 |
| Load envelopes into a tray | 15 |
| Print envelopes | 15 |
| Load and print labels | 16 |
| Load labels into a tray | 16 |
| Print labels | 16 |
| Change the default paper settings | 17 |
| 4 Configure your printer | 18 |
| Use HP software | 18 |

| | |
|--|-----------|
| Configure using the embedded web server (EWS) | 18 |
| Open the embedded web server (EWS) | 19 |
| View or change network settings | 19 |
| Manually change IPv4 and IPv6 TCP/IP parameters | 19 |
| Change printer settings..... | 20 |
| Assign or change the system password..... | 20 |
| Change energy-conservation settings | 20 |
| Update printer..... | 20 |
| Update printer using the control panel | 20 |
| Update printer using the embedded web server (EWS) | 21 |
| HP Web Jetadmin | 21 |
| 5 Print..... | 22 |
| Print from a Windows computer..... | 22 |
| Print from a Mac computer | 22 |
| Print from mobile devices..... | 23 |
| Print using Wi-Fi Direct..... | 23 |
| Tips for successful printing..... | 23 |
| Toner cartridge tips..... | 23 |
| Paper loading tips | 24 |
| 6 Supplies, accessories, and parts..... | 25 |
| Order supplies, accessories, and parts | 25 |
| Order | 25 |
| Supplies and accessories | 25 |
| Check estimated toner levels..... | 26 |
| Customer self-repair parts | 26 |
| Configure the HP toner-cartridge-protection supply settings..... | 27 |
| Enable or disable the Cartridge Policy feature | 27 |
| Replace toner cartridge..... | 27 |
| Cartridge low..... | 30 |
| Cartridge is low | 30 |
| Cartridge is very low | 30 |
| Change the “Very Low” settings | 30 |
| Order supplies..... | 31 |
| 7 Solve a problem | 32 |
| Jams and paper-feed issues..... | 32 |
| Possible jam locations..... | 32 |
| Remove jammed paper..... | 33 |
| Clear a paper jam from single sheet slot tray 1 | 33 |
| Clear a paper jam from tray 2 | 35 |
| Clear a paper jam from the rear access door..... | 37 |
| Clear a paper jam in the output bin..... | 38 |
| Solve paper-feed problems | 40 |

| | |
|--|-----------|
| Printing issues | 41 |
| Fix print quality issues..... | 41 |
| Print from a different software program | 41 |
| Check the paper-type setting for the print job..... | 41 |
| Check toner-cartridge status | 42 |
| Print a cleaning page | 42 |
| Visually inspect the toner cartridge | 42 |
| Check paper and the printing environment | 42 |
| Adjust color settings (Windows) | 44 |
| Adjust Print Density | 44 |
| Print and interpret the print quality page | 44 |
| Resolving print quality problems..... | 45 |
| Troubleshoot print quality problems..... | 45 |
| Network and connection issues..... | 50 |
| Fix Wi-Fi connection..... | 50 |
| Wi-Fi connectivity checklist | 51 |
| The printer does not print after the Wi-Fi configuration completes..... | 51 |
| The printer does not print, and the computer has a third-party firewall installed..... | 52 |
| The Wi-Fi connection does not work after moving the Wi-Fi router or printer..... | 52 |
| Cannot connect more devices to the Wi-Fi printer (Wi-Fi Direct) | 52 |
| The printer cannot print when your computer is on a VPN..... | 52 |
| The network does not appear in the wireless networks list | 52 |
| The Wi-Fi network is not functioning..... | 53 |
| Reduce interference on a wireless network..... | 53 |
| Fix Wi-Fi Direct connection | 53 |
| Fix Ethernet connection | 54 |
| Poor physical connection..... | 54 |
| The computer is using the incorrect IP address for the printer..... | 54 |
| The computer is unable to communicate with the printer..... | 54 |
| The printer is using incorrect link and duplex settings for the network | 55 |
| New software programs might be causing compatibility problems..... | 55 |
| The computer or workstation might be set up incorrectly..... | 55 |
| The printer is disabled, or other network settings are incorrect | 55 |
| Restore original network settings | 55 |
| Understand printer reports | 55 |
| Print a printer report..... | 56 |
| Print a report from EWS..... | 56 |
| EWS reports | 56 |
| Restore settings | 56 |
| Restore network settings | 57 |
| HP support | 57 |
| Contact HP..... | 58 |
| Register printer..... | 58 |
| Additional warranty options..... | 58 |
| Additional information | 58 |
| 8 HP EcoSolutions (HP and the Environment)..... | 59 |

| | |
|--|-----------|
| Power management..... | 59 |
| Appendix A Printer specifications | 60 |
| Technical specifications..... | 60 |
| System requirements | 60 |
| Supported operating systems | 60 |
| Printer hardware setup and software installation | 61 |
| Supported Wi-Fi band..... | 61 |
| Printer dimensions..... | 62 |
| Power consumption, electrical specifications, and acoustic emissions | 62 |
| Operating-environment range..... | 62 |
| Warning icons | 63 |
| Laser Warning..... | 63 |
| Appendix B Service and support..... | 64 |
| HP limited warranty statement | 64 |
| Country Specific Terms..... | 65 |
| Australia | 65 |
| New Zealand | 66 |
| UK, Ireland, and Malta..... | 67 |
| Austria, Belgium, Germany, and Luxemburg | 67 |
| Belgium, France, and Luxemburg..... | 68 |
| Italy..... | 69 |
| Spain..... | 69 |
| Denmark..... | 70 |
| Norway..... | 70 |
| Sweden | 70 |
| Portugal..... | 70 |
| Greece and Cyprus | 71 |
| Hungary | 71 |
| Czech Republic..... | 71 |
| Slovakia..... | 72 |
| Poland..... | 72 |
| Bulgaria..... | 72 |
| Romania..... | 73 |
| Belgium and the Netherlands | 73 |
| Finland | 73 |
| Slovenia | 73 |
| Croatia..... | 74 |
| Latvia..... | 74 |
| Lithuania..... | 74 |
| Estonia | 74 |
| Russia..... | 75 |
| HP's Premium Protection Warranty: LaserJet toner cartridge limited warranty statement..... | 75 |
| HP policy on non-Original HP supplies | 75 |

| | |
|---|-----------|
| HP anticounterfeit Web site..... | 76 |
| Data stored on the toner cartridge..... | 76 |
| End User License Agreement | 76 |
| Customer self-repair warranty service | 81 |
| Customer support..... | 81 |
| Appendix C Environmental product stewardship program | 83 |
| Protecting the environment | 83 |
| Ozone production..... | 83 |
| Power consumption..... | 83 |
| Paper use..... | 83 |
| Plastics..... | 84 |
| HP LaserJet print supplies | 84 |
| Paper | 84 |
| Material restrictions | 84 |
| Disposal of waste equipment by users (EU and India) | 84 |
| Electronic hardware recycling | 84 |
| Hardware recycling information (Brazil)..... | 85 |
| Chemical substances..... | 85 |
| Product Power Data per European Union Commission Regulation 1275/2008 | 85 |
| SEPA Ecolabel User Information (China)..... | 85 |
| The regulation of the implementation on China energy label for printer, and copier | 86 |
| Restriction of Hazardous Substances statement (India) | 86 |
| WEEE (Turkey)..... | 86 |
| The Table of Hazardous Substances/Elements and their Content (China) | 87 |
| Material Safety Data Sheet (MSDS) | 87 |
| EPEAT | 88 |
| Declaration of the Presence Condition of the Restricted Substances Marking (Taiwan) | 88 |
| For more information | 89 |
| Appendix D Regulatory information..... | 90 |
| Regulatory statements | 90 |
| European Union and United Kingdom Regulatory Notice..... | 90 |
| Regulatory model numbers | 90 |
| FCC regulations..... | 91 |
| Canada - Industry Canada ICES-003 Compliance Statement | 91 |
| Power cord instructions | 91 |
| Laser safety | 91 |
| Laser safety statement for EMEA..... | 92 |
| Laser statement for Finland..... | 92 |
| GS statement (Germany) | 92 |

| | |
|---|----|
| Nordic Statements (Denmark, Finland, Norway, Sweden)..... | 93 |
| Taiwan BSMI USB Port (Walk-up) Statement | 93 |
| Eurasian Conformity (Armenia, Belarus, Kazakhstan, Kirgizstan, Russia)..... | 93 |
| Производитель и дата производства | 93 |
| Өндіруші және өндіру мерзімі | 93 |
| Местные представители | 93 |
| Жергілікті өкілдіктері..... | 94 |
| Wireless statements | 94 |
| FCC compliance statement—United States..... | 94 |
| Australia statement | 94 |
| Belarus statement | 94 |
| Brazil ANATEL statement | 95 |
| Canadian statements | 95 |
| China CMIIT Wireless statements..... | 95 |
| Korean statement | 95 |
| Taiwan statement (Traditional Chinese)..... | 95 |
| Products with 5 GHz Operation Industry of Canada..... | 96 |
| Taiwan NCC Statement:(Only for 5GHz)..... | 96 |
| Exposure to Radio Frequency Radiation (Canada) | 96 |
| European regulatory notice..... | 96 |
| Notice for use in Russia..... | 96 |
| Mexico statement..... | 97 |
| Thailand statement | 97 |
| Vietnam Telecom..... | 97 |
| Dynamic Security Enabled Printers | 97 |

1 Get started

Learn about printer parts, control panel features, and other printer functionalities.

Printer views

Printer parts and their descriptions.

Front view

Printer parts on the front.

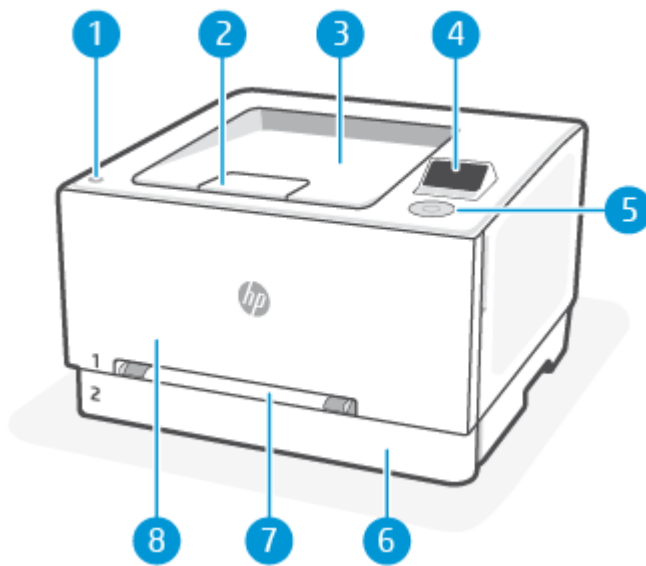

Table 1-1 Front view

| Feature | Description |
|---------|--|
| 1 | Power button |
| 2 | Output tray extension |
| 3 | Output tray |
| 4 | Control panel display |
| 5 | Control pad |
| 6 | Main Input tray / Tray 2 |
| 7 | Single-sheet priority feed slot tray 1 |
| 8 | Cartridge access door |

Rear view

Printer parts on the rear.

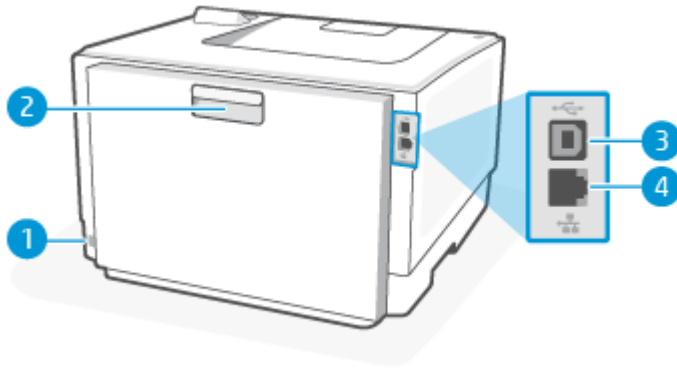

Table 1-2 Rear view

| Feature | Description |
|---------|-----------------------|
| 1 | Power connection |
| 2 | Rear access door |
| 3 | Rear USB port |
| 4 | Ethernet network port |

Control panel features

The control panel provides interaction through control pad to indicate status, errors, and more.

Control panel view



The control panel display provides access to the printer features.

 **NOTE:** The features that appear on the control panel and the order in which they appear can vary, depending on the printer configuration.

Figure 1-1 Control panel view



Table 1-3 Control panel buttons

| Buttons | Description |
|---|---|
| Back  | Use this button for the following actions: <ul style="list-style-type: none">• Exit the control-panel menus.• Scroll back to a previous menu in a submenu list.• Scroll back to a previous menu item in a submenu list (without saving changes to the menu item). |
| Home  | Press this button to view the Home screen on the control panel. |
| Cancel  | Press this button to cancel a print job or to exit the control panel menus. |

How to use the control pad

Press the up/down/left/right button to select or navigate through the options in the control panel and press **OK** on the control pad to confirm a selection.

Figure 1-2 Control pad

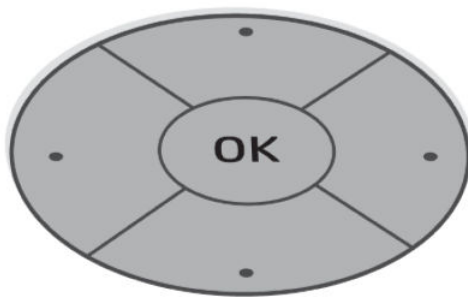

Function icons

The control panel display provides large icons to easily access the primary features of your printer.

Table 1-4 Function icons





| Function icons | Description |
|---|--|
| Menu  | Access printer functions, view and change printer settings, print reports, and get help information. |

Table 1-4 Function icons (continued)

| Function icons | Description |
|---|---|
|  Sign In/Sign Out | Provides access control to the printer. |
|  Trays | Check loaded paper size and type, and change paper settings if needed. |
|  Supplies | Check the estimated toner levels and cartridge information. |
|  Help | Check the contextual help content if it is available for the current operation. |

To install HP software and open the app

Complete the following steps to install and open HP software, connect your printer, and begin using the app.

1. Go to hpsmart.com/support to download and install HP software app on your device.



NOTE:

- **iOS, Android, Windows 10 and above, and macOS:** You can download HP software from the respective app stores for the device.
2. Open HP software after installation.
 - **iOS/Android:** From the mobile device desktop or app menu, tap HP software.
 - **Windows 10 and above:** From the computer desktop, click **Start**, and then select **HP software** from the app list.
 - **macOS:** From the Launchpad, select HP software.
 3. Sign in to the HP Smart app using the HP account created during setup.
See [Connect to a Wi-Fi network using the HP software](#).

2 Connect your printer

Learn about different ways to connect your printer.

Connect to a Wi-Fi network

Make sure your network is ready before connecting your printer to a Wi-Fi network.

- The printer is not connected to the network using an Ethernet cable.
- The printer Wi-Fi is turned on and the Wi-Fi network is set up and working properly.
- The printer and the devices that use the printer are on the same network (subnet). While connecting the printer, you might be prompted to enter the Wi-Fi network name (SSID) and a Wi-Fi password.



TIP:

- Visit hpsmart.com/wirelessprinting for more information about setting up and using the printer wirelessly.
 - If you run into any problem with Wi-Fi connect, see [Restore original network settings](#).
-

Connect to a Wi-Fi network/Wi-Fi Protected Setup using the control panel

Use the **Wi-Fi Setup** or **Wi-Fi Protected Setup** from the printer control panel to connect the printer wirelessly.



NOTE: If the printer has never been configured to connect to a Wi-Fi network before, turning on the Wi-Fi capability automatically starts the **Wi-Fi Setup**.

1. At the printer control panel, use the control pad to select **Menu** option, and press **OK** button to confirm.
2. Press the down button to select **Settings**, and press **OK** button to continue.
3. Select **Network settings** and press **OK**.
4. Select **Wi-Fi** and press **OK**.
5. Select **Wi-Fi Setup** or **Wi-Fi Protected Setup** and press **OK**.
6. Then follow the on-screen instructions to add the printer to your network.

After connecting the printer wirelessly, visit hpsmart.com/support to download and install the HP software on your device.

Connect to a Wi-Fi network using the HP software

Use the HP software on your computer or mobile device to set up or connect the printer to your Wi-Fi network.

See [Use HP software](#).



NOTE:

- HP software uses Bluetooth for printer setup. It does not support printing using Bluetooth.

- Turn on Bluetooth and location services on your mobile device.
 - Make sure your printer Wi-Fi is turned on and the printer is in Wi-Fi setup mode.
 - Make sure your computer or mobile device is connected to the same Wi-Fi network as the printer.
-
1. Open the HP software on your device.
If prompted, create or sign in to an HP account and register the printer.
 2. In the software, follow the on-screen instructions to add or connect the printer.

Check Wi-Fi status

View the status of the printer Wi-Fi connection from the printer control panel.

1. At the printer control panel, use the control pad to select **Menu** option, and press **OK** button to confirm.
2. Press the down button to select **Settings**, and press **OK** button to continue.
3. Select **Network settings** and press **OK**.
4. Select **Wi-Fi** and press **OK** to view Wi-Fi status.

Connect to an Ethernet network

You can connect your printer to an Ethernet network.



NOTE: The Wi-Fi connection is automatically disabled when you connect the Ethernet cable.

1. Connect your computer to the router.
2. Connect your printer and router using an Ethernet cable.
3. Open the HP software on your computer.
If prompted, create or sign in to an HP account and register the printer.
4. In HP software, add the printer, and then follow the on-screen instructions to add or connect the printer.

Connect using a USB cable

You can connect your printer using a USB cable.



NOTE: While you are setting up the printer for the first time and to use all the available features of this printer, complete setup using HP software and an Internet connection. After setup, you can print using a USB cable if needed.

1. Connect the printer and computer using a USB cable.
2. Open the HP software on your computer.
If prompted, create or sign in to an HP account and register the printer.
3. In HP software, add the printer, and then follow the on-screen instructions to add or connect the printer.

Change the connection type

If you have already connected your printer, you can change the connection from USB to Wi-Fi or from Wi-Fi to USB.

USB to Wi-Fi

Unplug the USB cable from the printer and connect the printer to your network.

See [Connect to a Wi-Fi network](#).

Wi-Fi to USB

Change the printer connection from Wi-Fi to USB.

1. Connect the printer and computer using a USB cable.
2. Open the HP software on your computer.
If prompted, create or sign in to an HP account and register the printer.
3. In HP software, add the printer, and then follow the on-screen instructions to add or connect the printer.

3 Load media

Learn how to load paper and change settings.

Before you begin

 NOTE:

- To protect the printer and avoid printing problems, be sure to select the correct paper settings from the HP software before printing.
 - For the tray capacity and list of supported paper sizes, visit www.support.hp.com. Select your country/region and language, find your printer, click **Product Information**, and check the product specifications for your printer.
 - Do not load paper while the printer is printing.
 - Remove any paper before loading a different paper type or size.
 - When loading the tray, do not fan the paper.
 - Use paper that is not wrinkled, folded, or damaged.
 - Use only one paper size. For example, do not place A5 paper over A4 size paper.
 - Straighten the stack of paper and adjust the paper guides to ensure paper does not slant/skew when printing.
-

Load paper to single-sheet slot tray 1

This tray holds 1 sheet of paper, use it to print single-page documents, documents that require multiple paper types, or envelopes.

1. Move the paper width guides in the single-sheet priority feed slot outward.



2. Place the top edge of the sheet at the opening, and then adjust the side guides so that they lightly touch the sheet, but do not bend it.

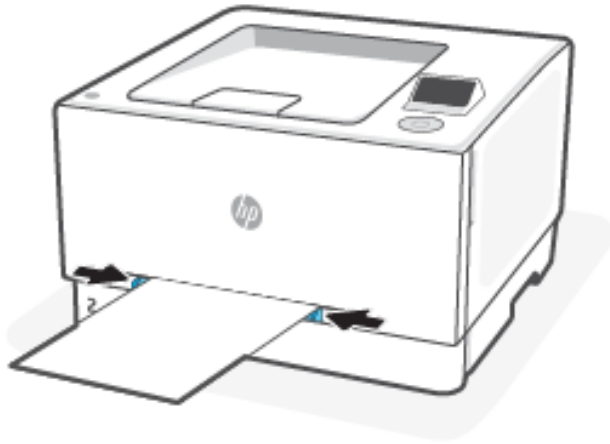

3. Insert the single sheet into the slot and hold it. The printer will pull the sheet partially into the paper path.

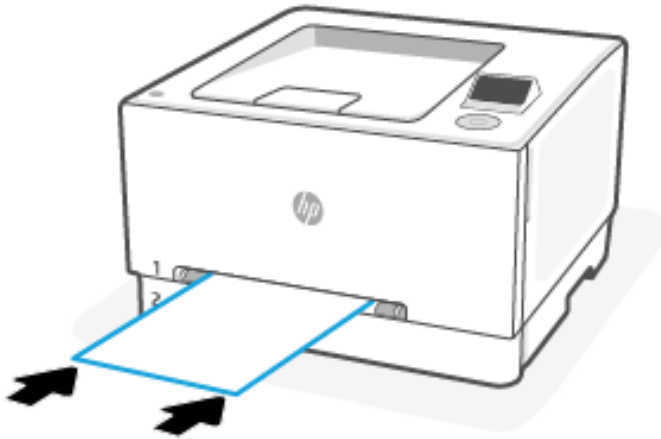

 **NOTE:** Depending on the size of the paper, you might need to support the sheet with two hands until the sheet advances into the printer.

4. At the computer, begin the printing process from the software application. Make sure that the driver is set to the correct paper type and size for the paper being printed from the single-sheet priority feed slot.

Load letterhead or preprinted paper in tray 1

Follow these steps to portrait printing.

- **1-sided printing:** Load the paper face-up with the top edge leading into the printer.

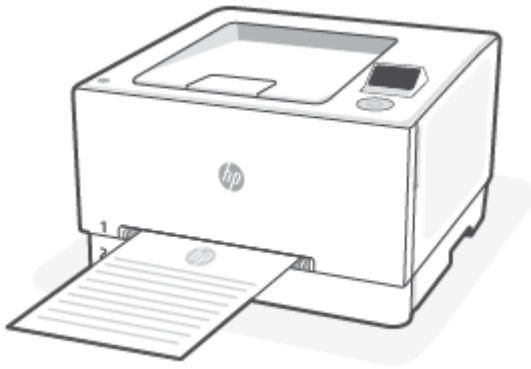

- **2-sided printing:** Load the paper face-down with the top edge leading into the printer.

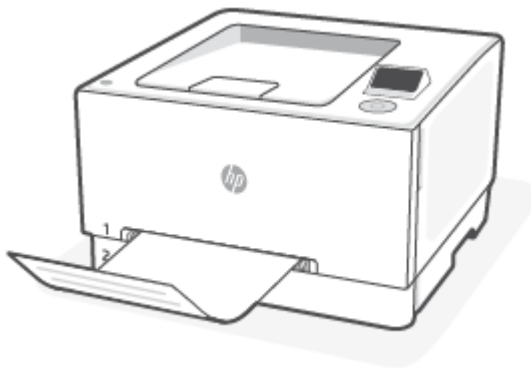

- **1-sided or 2-sided printing:** Load the prepunched paper with the holes towards the left side of the printer.

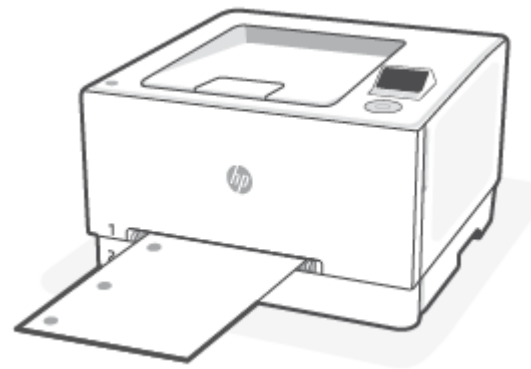

Load paper to tray 2

This tray holds up to 250 sheets of 75 g/m² (20 lb) paper.

1. Open the tray.

 **NOTE:** Do not open this tray while it is in use.



2. Adjust the paper guides by squeezing the adjustment latches and sliding the guides to the size of the paper being used.

 **NOTE:** To load legal-size paper, extend the tray front by pressing the blue latch and pulling the front of the tray. When loaded with legal-size paper, tray 2 extends from the front of the printer approximately 57.5 mm (2.2 in).

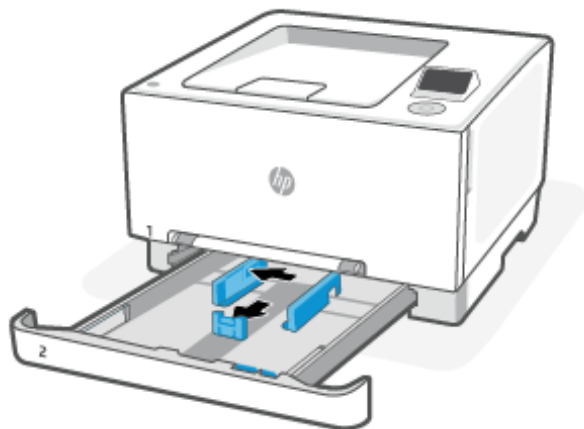

3. Load the paper into the tray.

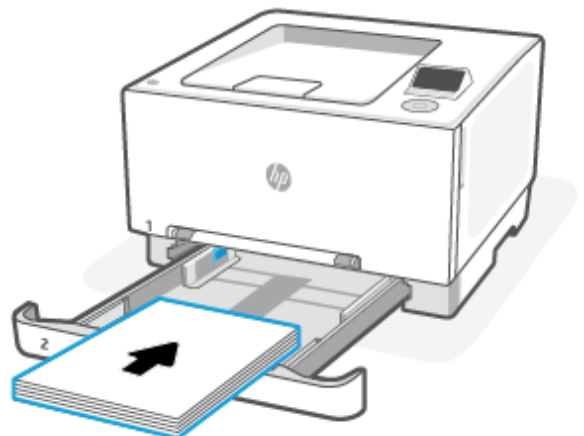

4. Adjust the guides so that they lightly touch the paper stack, but do not bend it.

 **NOTE:**

- Do not adjust the paper guides tightly against the paper stack.
- To prevent jams, adjust the paper guides to the correct size and do not overfill the tray.

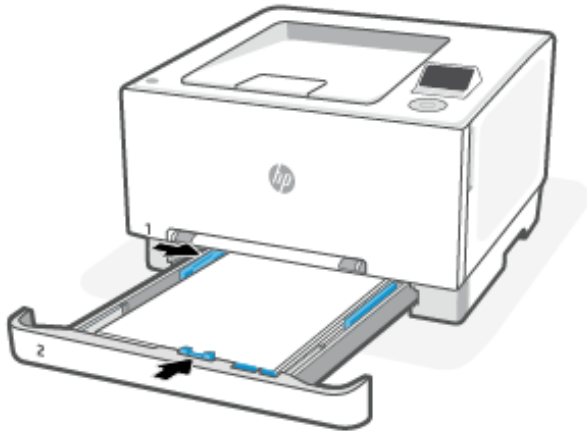

5. Close the tray.

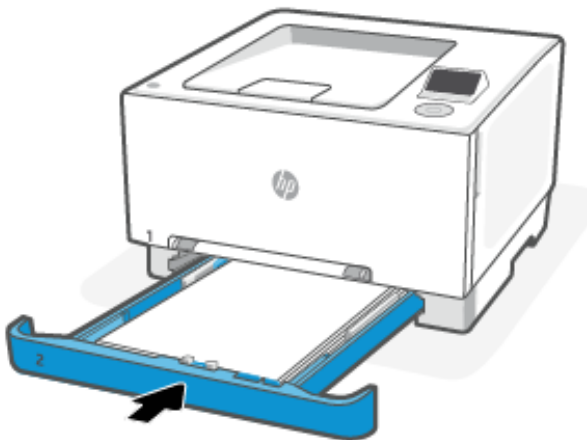

Load letterhead or preprinted paper in tray 2

Tray 2 can be used to print in either portrait or landscape mode on a letterhead or preprinted paper.

Portrait printing

Follow these steps to portrait printing.

- **1-sided printing:** Load the paper face-up with the top edge toward the back of the tray.

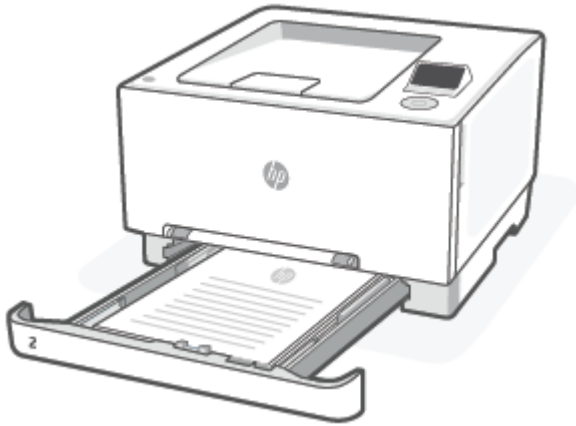

- **2-sided printing:** Load the paper face-down with the top edge toward the back of the tray.

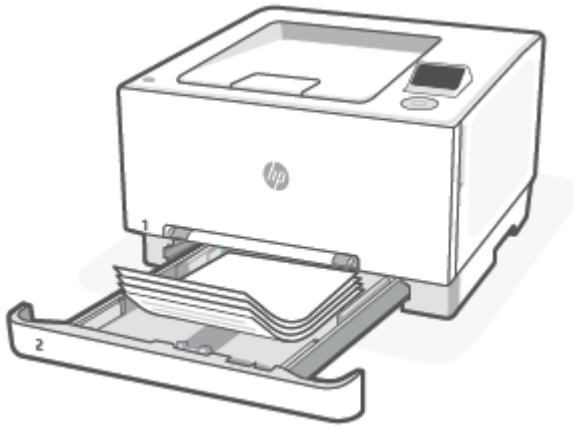

- **1-sided or 2-sided printing:** Load the prepunched paper face-up with the holes toward the left side of the tray.

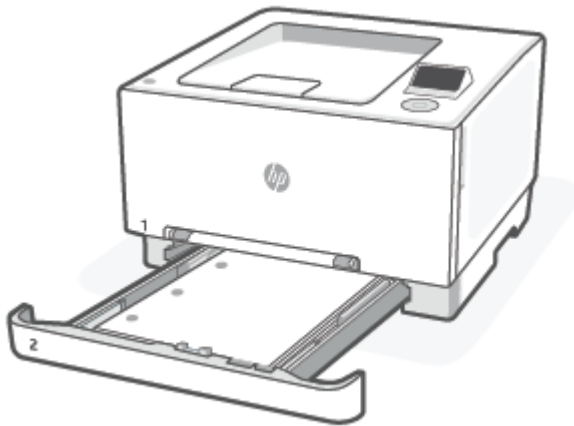

Landscape printing

Follow these steps to landscape printing.

- **1-sided printing:** Load the paper face-up with the top edge toward the back of the tray.

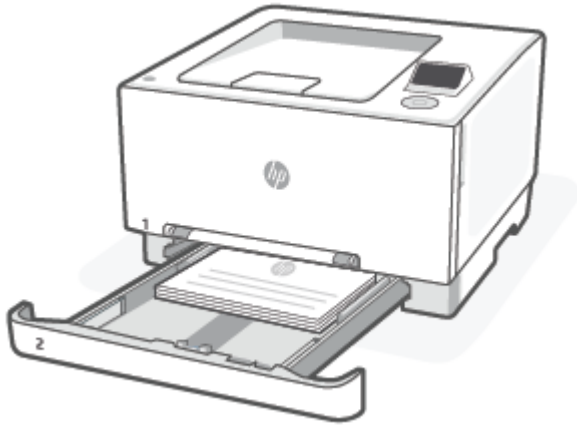

- **2-sided printing:** Load the paper face-down with the top edge toward the back of the tray.

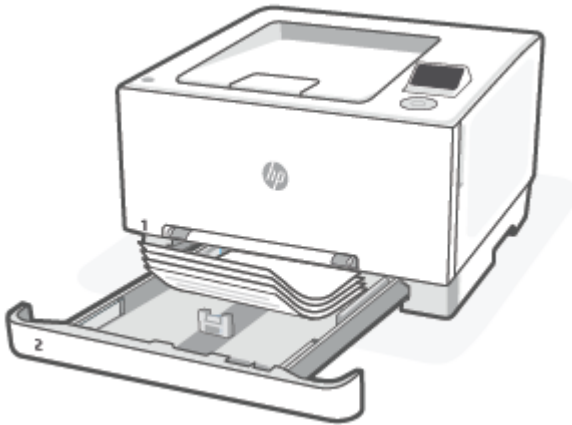

- **1-sided or 2-sided printing:** Load the prepunched paper face-up with the holes toward the front of the tray.

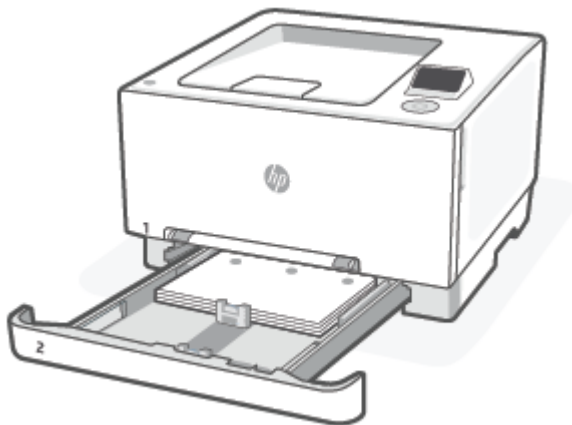

Load and print envelopes

Load envelopes into one of the two available paper trays. Make sure the envelopes are loaded face-up with the short, postage end leading into the printer.

Load envelopes into a tray

Load envelopes into one of the two available paper trays. Make sure the envelopes are loaded face-up with the short, postage end leading into the printer.

- **Tray 1:** Load one envelope into the single feed slot. Adjust the paper guides until they touch the edges of the envelope.

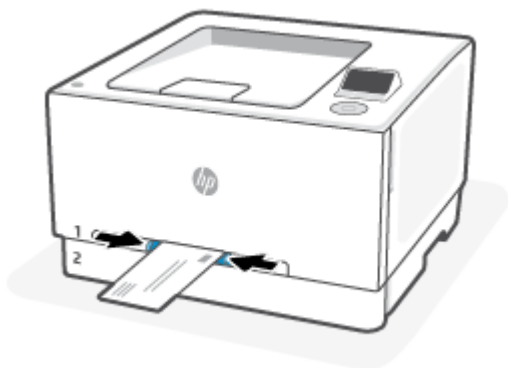

- **Tray 2:** Pull out tray 2 and load up to ten envelopes. Adjust the paper guides until they touch the edges of the envelopes, and then push the tray in.

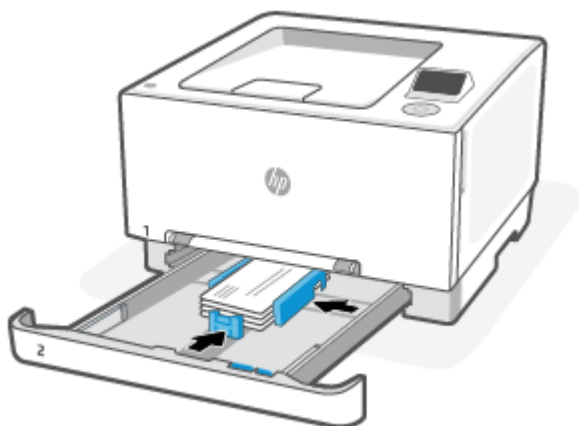

Print envelopes

Select the correct settings in the print driver before sending the print job to the printer.

1. Select the **Print** option from the software you want to print from.
2. Select the printer from the list of printers, and then click the **Properties** or **Preferences** button to open the print driver.
3. Click the **Paper/Quality** tab.
4. In the Paper size drop-down list, select the size of your envelopes.
5. In the Paper type drop-down list, select **Envelope**.
6. In the Paper source drop-down list, select **Tray 1** or **Manual feed** (Tray 2).
7. Click the **OK** button to close the **Document Properties** dialog box.

8. In the **Print** dialog box, click the **Print** button to print the job.

Load and print labels

Load labels into the printer and print the labels using proper print settings.

Load labels into a tray

Load labels into one of the two available paper trays. Make sure the labels are loaded face-up with the top edge leading into the printer.

- **Tray 1:** Load one label into the single feed slot. Adjust the paper guides until they touch the edges of the label.



- **Tray 2:** Pull out tray 2 and load up to fifty sheets of labels. Adjust the paper guides until they touch the edges of the labels, and then push the tray in.

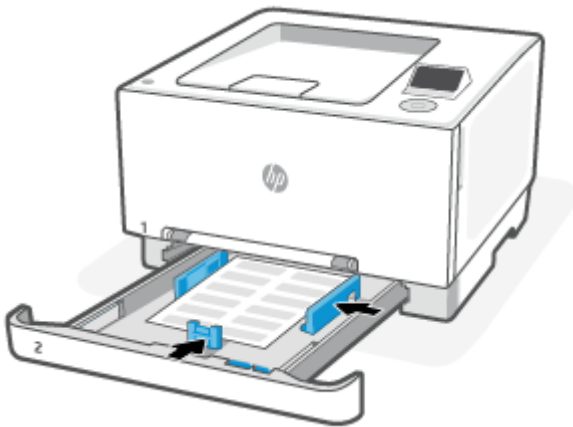

Print labels

Select the correct settings in the print driver before sending the print job to the printer.

1. Select the **Print** option from the software you want to print from.
2. Select the printer from the list of printers, and then click the **Properties** or **Preferences** button to open the print driver.
3. Click the **Paper/Quality** tab.

4. In the Paper size drop-down list, select the size of your labels.
5. In the Paper type drop-down list, select **Label**.
6. In the Paper source drop-down list, select **Tray 1** or **Manual feed** (Tray 2).
7. Click the **OK** button to close the **Document Properties** dialog box.
8. In the **Print** dialog box, click the **Print** button to print the job.

Change the default paper settings

The printer can automatically detect whether the input tray has paper loaded and detect whether the loaded paper is large, small, or medium width. You can change the default large, medium, or small paper size detected by the printer.

1. At the printer control panel, press the right button on the control pad to select **Trays** option.
2. Press **OK** button to confirm.
3. Select **Modify** and press **OK** to make the desired changes.

4 Configure your printer

Learn how to configure your printer using the HP software, printer control panel and the embedded web server (EWS).

Use HP software

HP software helps you perform printer tasks from a mobile device or computer.

- Set up and connect your printer.
- Print and scan documents and photos.
- Share documents through email and other applications.
- Manage printer settings, check printer status, print reports, and order supplies.



NOTE:

- You can download the HP software from the app store for your device.
- HP software supports mobile devices and computers running on certain versions of iOS, Android, Windows, and macOS.
Visit hp.com/support for more information on systems requirements.
- HP software is only available in some languages and only supports some file formats. Some features are only available on certain printers or models.

Install the HP software and create an HP account:

1. Visit hpsmart.com/support to download and install the HP software on your device.
2. Open the HP software.
If prompted, create or sign in to an HP account and register the printer.
3. Connect the printer.
See [Connect your printer](#).

Configure using the embedded web server (EWS)

The EWS is the printer homepage accessed through a web browser. Use the EWS to manage printer functions and settings from your computer or mobile device.

- View the printer status information.
- Check the information and status of the printing supplies.
- View and change the network and the printer settings.

Things to note when accessing the EWS.

- If the web browser displays a message indicating that the website is unsafe, select the option to continue. Accessing the website does not harm your device.
- Depending on how the printer is connected, some features in the EWS might not be available.
- For your security, some settings in the EWS are password-protected.
If prompted for password, enter the default printer PIN available on the label inside the printer access door. If you have changed the password, enter your new password.
- The EWS is not accessible beyond the network firewall.

Use the EWS to view or change IP configuration settings, and manually set an IPv4 address, subnet mask and default gateway.

Open the embedded web server (EWS)

Open a web browser and type the IP address or hostname of the printer.

 **NOTE:** For printer connected using the Wi-Fi Direct connection, use this IP address: 192.168.223.1

1. At the printer control panel, use the control pad to select **Menu** option, and press **OK** button to confirm.
2. Press the down button to select **Info**, and press **OK** to continue.
3. Select **Wi-Fi details** or **Ethernet details** and press **OK** to find the IP address.

If prompted for password, enter the default printer PIN available on the label inside the printer access door. If you have changed the password, enter your new password.

 **NOTE:** You can also open the EWS using the HP software.

View or change network settings

When troubleshooting or setting up your printer, it might be necessary to view or edit its network settings.

1. Open the EWS.
2. From the left menu, click **Network**:
 - To view network information, click **Network Summary**.
 - To change network settings, click **Network Settings**.

Manually change IPv4 and IPv6 TCP/IP parameters

It might be necessary to manually configure a printer IP address when the printer is not detected on your network.

1. Open the EWS.
2. From the left menu, click the **Network** tab, and then click the **Network Settings** tab.
3. Click **IP Settings**.

4. On the **IP Settings** page, click the **Protocols** drop-down menu, and then select one of the following:
 - IPv4 Only
 - IPv6 Only
 - Both IPv4 and IPv6

Change printer settings

Use the control panel to view or change printer settings. You can also change printer settings using the HP software or the embedded web server (EWS).

1. At the printer control panel, use the control pad to select **Menu** option, and press **OK** button to confirm.
2. Press the down button to select **Settings**, and press **OK** button to continue.
3. Select the desired option to make the necessary changes.

 **TIP:** Press Home  to return to the main screen.

Assign or change the system password

Assign an administrator password using the embedded web server (EWS) to prevent unauthorized users from changing the printer settings.

1. Open the EWS.
2. From the left menu, click **Security**, and then click **Password Settings**.
3. On the **Admin Account Password** page, enter the password in the **New Password*** field.
4. Re-enter the password in the **Confirm Password** field.
5. Click **Apply**.

 **NOTE:** Make note of the password and store it in a safe place.

Change energy-conservation settings

The printer includes several economy features to conserve energy and supplies.

See [Power management](#) for more information on printer energy-conservation settings.

Update printer

HP periodically releases firmware updates to enhance product functionality and fix issues. By default, if the printer is connected to the internet, the printer automatically checks for updates at regular intervals.

Update printer using the control panel

You can update your printer firmware manually using the control panel.

1. At the printer control panel, use the control pad to select **Menu** option, and press **OK** button to confirm.

2. Press the down button to select **Settings**, and press **OK** button to continue.
3. Select **Firmware Update** and press **OK** and then select any of the desired option:
 - **Auto Update (Recommended)**: The printer automatically checks and installs new firmware updates.
 - **Notify When Available**: The printer automatically checks for new firmware updates and displays a notification on the control panel when an update is available.
 - **Do Not Check**: The printer does not automatically check for any updates.

Update printer using the embedded web server (EWS)

You can update your printer firmware using the EWS.

1. Open the EWS.

See [Open the embedded web server \(EWS\)](#).

If prompted for password, enter the default printer PIN available on the label inside the printer access door. If you have changed the password, enter your new password.
2. From the left menu, click **General**, and then click **Firmware Update**.
3. On the **Firmware Information** page, click **Check for Update**.

If a printer update is available, the printer installs the update and restarts.

 **NOTE:** If prompted for proxy settings, follow the on-screen instructions to set up a proxy server. If you do not have the details, contact your network administrator or the person who set up the network.

HP Web Jetadmin

HP Web Jetadmin is an award-winning, industry-leading tool for efficiently managing a wide variety of networked HP products, including printers, multifunction printers, and digital senders. This single solution allows you to remotely install, monitor, maintain, troubleshoot, and secure your printing and imaging environment — ultimately increasing business productivity by helping you save time, control costs, and protect your investment.

HP Web Jetadmin upgrades are periodically made available to provide support for specific product features. Go to www.hp.com/go/webjetadmin for more information.

5 Print

Learn how to print from your computer or mobile device.

Install HP software on smartphone, laptop, desktop computer, or other devices to print, scan, and manage your printer.

 **NOTE:** If a multi-copy print job fails to print, the print job should be resubmitted with number of copies set to 1.

Print from a Windows computer

You can print from the file menu of most apps.

Make sure you have installed the HP software. See [Use HP software](#).

1. Open the document you wish to print.
2. From the **File** menu in your software program, select the **Print** option.

 **NOTE:** Make sure your printer is selected from the list of available printers.

3. Click the button that opens the **Properties** dialog box.

Depending on your software application, this button might be called **Properties**, **Options**, **Setup**, or **Preferences**.

4. Change any print settings if needed, and click **OK**.
5. Click **Print** or **OK** to print.

Print from a Mac computer

Use the Print command from any open file.

1. If you are printing for the first time, complete the following steps.
 - a. Open **System Preference**, and select **Printers & Scanners**.
 - b. Click the **Add** button/icon **+**, select the printer from the printer list, and then click **Add**.
2. Open the document you want to print and use the **Print** command.

Make sure your printer is selected from the list of available printers.
3. Change any print settings if needed.
4. Click **Print** to print.

Print from mobile devices

You can print documents and photos from your mobile devices using HP software, AirPrint, or the HP Print Service Plugin.

- **HP software:** Visit hp.com/mobileprinting for more information on mobile printing.
- **iOS:** Devices running iOS 4.2 or later have AirPrint preinstalled.
- **Android:** Download the HP Print Service Plugin (supported by most Android devices) from the Google Play Store and enable it on your device.

Print using Wi-Fi Direct

With Wi-Fi Direct, you can directly connect your computer or mobile device to the printer and print wirelessly without connecting to an existing wireless network.



NOTE:

- Up to 5 computers and mobile devices can connect to the printer using a Wi-Fi Direct connection.
 - Make sure to turn on Wi-Fi Direct on your printer before printing from your device. You can turn on Wi-Fi Direct using the printer control panel or the embedded web server (EWS).
-
1. At the printer control panel, use the control pad to select **Menu** option, and press **OK** button to confirm.
 2. Press the down button to select **Settings**, and press **OK** button to continue.
 3. Select **Network settings** and press **OK**.
 4. Select **Wi-Fi Direct** and press **OK**.
 5. Then follow the on-screen instructions to add the printer to your network.

Visit hp.com/go/wifidirectprinting to learn how to use Wi-Fi Direct and for troubleshooting information.

Tips for successful printing

To print successfully, make sure you have appropriate printer settings, sufficient toner in the HP cartridges, and paper loaded correctly in the trays.

You can check the printer settings in the HP software, the embedded web server (EWS), and your software applications.

Toner cartridge tips

Following are the tips for successful printing:

- If the print quality is not acceptable, see [Troubleshoot print quality problems](#).
- Use Original HP toner cartridges.

Original HP toner cartridges are designed and tested with HP printers and papers to help you easily produce great results, time after time.



NOTE:

- HP cannot guarantee the quality or reliability of non-Original HP supplies. Product service or repairs required as a result of using a non-Original HP supply will not be covered under warranty.
 - To determine if you have purchased Original HP cartridges, visit hp.com/go/anticounterfeit for more information.
-

- Make sure the toner cartridge is installed correctly.

For more information, see [Replace toner cartridge](#).

- Check the estimated toner level to make sure that there is sufficient toner.

For more information, see [Supplies and accessories](#).

Paper loading tips

Following are the paper loading tips for successful printing:

- Make sure that the paper is loaded in the main tray properly, and set the correct media size and media type. Upon loading paper in main tray, you will be prompted to set the media size and media type from the control panel.

See [Load media](#).

- Load a stack of paper (not just one page). All the paper in the stack must be of the same size and type to avoid a paper jam.
- Load paper with the print-side down.
- Make sure paper is loaded in the main tray lays flat and the edges are not bent or torn.
- Adjust the paper-width guides in the main tray to fit snugly against all paper. Make sure that the guides do not bend the paper in the tray.

6 Supplies, accessories, and parts

This section describes how to order supplies and manage accessories.

Order supplies, accessories, and parts

This topic describes how to order supplies, accessories, and parts.

Order

Table 6-1 Order

| Order supplies | Support sites |
|--|--|
| Order supplies and paper | www.hp.com/go/suresupply |
| Order genuine HP parts or accessories | www.hp.com/buy/parts |
| Order through service or support providers | Contact an HP-authorized service or support provider. |

Supplies and accessories

- A: Standard-capacity toner cartridge.
- X: High-capacity toner cartridge.

Table 6-2 List of supplies and accessories

| Cartridge name/number | Part number | Countries in use |
|---|-------------|-------------------------------------|
| HP 218A Black Original LaserJet Toner Cartridge | W2180A | North America and Greater Asia only |
| HP 218X Black Original LaserJet Toner Cartridge | W2180X | North America and Greater Asia only |
| HP 218A Cyan Original LaserJet Toner Cartridge | W2181A | North America and Greater Asia only |
| HP 218X Cyan Original LaserJet Toner Cartridge | W2181X | North America and Greater Asia only |
| HP 218A Yellow Original LaserJet Toner Cartridge | W2182A | North America and Greater Asia only |
| HP 218X Yellow Original LaserJet Toner Cartridge | W2182X | North America and Greater Asia only |
| HP 218A Magenta Original LaserJet Toner Cartridge | W2183A | North America and Greater Asia only |
| HP 218X Magenta Original LaserJet Toner Cartridge | W2183X | North America and Greater Asia only |
| HP 219A Black Original LaserJet Toner Cartridge | W2190A | UK, Ireland, and Europe only* |
| HP 219X Black Original LaserJet Toner Cartridge | W2190X | UK, Ireland, and Europe only* |
| HP 219A Cyan Original LaserJet Toner Cartridge | W2191A | UK, Ireland, and Europe only* |
| HP 219X Cyan Original LaserJet Toner Cartridge | W2191X | UK, Ireland, and Europe only* |
| HP 219A Yellow Original LaserJet Toner Cartridge | W2192A | UK, Ireland, and Europe only* |
| HP 219X Yellow Original LaserJet Toner Cartridge | W2192X | UK, Ireland, and Europe only* |

Table 6-2 List of supplies and accessories (continued)

| Cartridge name/number | Part number | Countries in use |
|---|-------------|---|
| HP 219A Magenta Original LaserJet Toner Cartridge | W2193A | UK, Ireland, and Europe only* |
| HP 219X Magenta Original LaserJet Toner Cartridge | W2193X | UK, Ireland, and Europe only* |
| HP 222A Black Original LaserJet Toner Cartridge | W2220A | Latin America, ISE, Greater Asia, India, and China only |
| HP 222X Black Original LaserJet Toner Cartridge | W2220X | Latin America, ISE, Greater Asia, India, and China only |
| HP 222A Cyan Original LaserJet Toner Cartridge | W2221A | Latin America, ISE, Greater Asia, India, and China only |
| HP 222X Cyan Original LaserJet Toner Cartridge | W2221X | Latin America, ISE, Greater Asia, India, and China only |
| HP 222A Yellow Original LaserJet Toner Cartridge | W2222A | Latin America, ISE, Greater Asia, India, and China only |
| HP 222X Yellow Original LaserJet Toner Cartridge | W2222X | Latin America, ISE, Greater Asia, India, and China only |
| HP 222A Magenta Original LaserJet Toner Cartridge | W2223A | Latin America, ISE, Greater Asia, India, and China only |
| HP 222X Magenta Original LaserJet Toner Cartridge | W2223X | Latin America, ISE, Greater Asia, India, and China only |

*The product is regionalized for the regions and countries listed above. However, nothing herein must be deemed as an authorization from HP to import products into the European Economic Area, Ireland, and the UK from any country outside that region.

Check estimated toner levels

You can check estimated toner levels using the printer control panel.

Alternatively, you can also check estimated toner levels using the HP software and the embedded web server (EWS).

1. At the printer control panel, press the right button on the control pad to select **Supplies** option, and press **OK** button to confirm.
2. Select **Cartridges** and press **OK**.



NOTE: Toner level alerts and indicators provide estimates for planning purposes only. When you receive a low-toner alert, consider having a replacement cartridge available to avoid possible printing delays. You do not have to replace the cartridges until prompted to do so.

Customer self-repair parts

Customer Self-Repair (CSR) parts are available for many HP LaserJet printers to reduce repair time. More information about the CSR program and benefits can be found at www.hp.com/go/csr-support and www.hp.com/go/csr-faq.

Genuine HP replacement parts can be ordered at www.hp.com/buy/parts or by contacting an HP-authorized service or support provider. When ordering, one of the following will be needed: part number, serial number (found on back of printer), product number, or printer name.

- Parts listed as **Mandatory** self-replacement are to be installed by customers, unless you are willing to pay HP service personnel to perform the repair. For these parts, on-site or return-to-depot support is not provided under the HP printer warranty.
- Parts listed as **Optional** self-replacement can be installed by HP service personnel at your request for no additional charge during the printer warranty period.

Table 6-3 Customer self-repair parts

| Item | Description | Self-replacement options | Part number |
|--------------------------------------|---|--------------------------|--------------|
| Single-sheet priority feed slot tray | Replacement tray for single-sheet priority feed slot tray 1 | Mandatory | RM2-3080-000 |
| 250-sheet paper input tray | Replacement cassette for tray 2 | Mandatory | RM2-3072-000 |

Configure the HP toner-cartridge-protection supply settings

Use HP Cartridge Policy and Cartridge Protection to control which cartridges are installed in the printer and protect the cartridges that are installed from theft.

- **Cartridge Policy:** This feature protects the printer from counterfeit toner cartridges by allowing only genuine HP cartridges to be used with the printer. Using genuine HP cartridges ensures the best possible print quality. When someone installs a cartridge that is not a genuine HP cartridge, the printer control panel displays a message that the cartridge is unauthorized and it provides information explaining how to proceed.
- **Cartridge Protection:** This feature permanently associates toner cartridges with a specific printer, or fleet of printers, so they cannot be used in other printers. Protecting cartridges protects your investment. When this feature is enabled, if someone attempts to transfer a protected cartridge from the original printer into an unauthorized printer, that printer will not print with the protected cartridge. The printer control panel displays a message that the cartridge is protected, and it provides information explaining how to proceed.

 **CAUTION:** After enabling cartridge protection for the printer, all subsequent toner cartridges installed in the printer are automatically and *permanently* protected. To avoid protecting a new cartridge, disable the feature *before* installing the new cartridge.

Turning the feature off does not turn off protection for cartridges that are currently installed.

Both features are off by default. Follow these procedures to enable or disable them.

Enable or disable the Cartridge Policy feature

The Cartridge Policy feature can be enabled or disabled using the embedded web server (EWS).

 **NOTE:** Enabling or disabling this feature might require entering an administrator password.

1. Open the EWS.
2. From the left menu, click **Supplies**, and then select **Supply Settings**.
3. Select the desired option under **Authorized HP Cartridge Policy**.

Replace toner cartridge

Replace cartridges with new Original HP cartridges when toner cartridge levels are too low and no longer yield good print quality.

 **NOTE:** When a toner cartridge approaches the end of its useful life, redistributing the toner in the cartridge might improve print quality and enable you to continue printing. To redistribute the toner in the cartridge, remove the toner cartridge from the printer, gently rock the cartridge back and forth along its horizontal axis, and then replace it in the printer.

1. Open the cartridge access door.

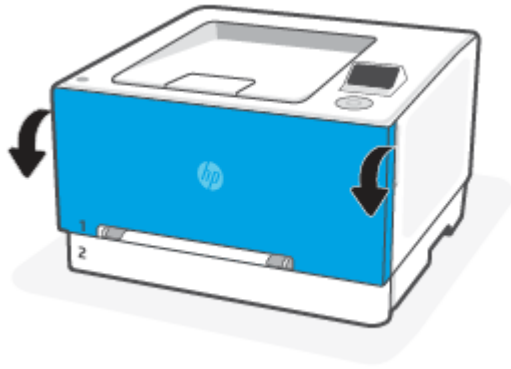

2. Grasp the blue handle on the toner cartridge drawer, and then pull out the drawer.

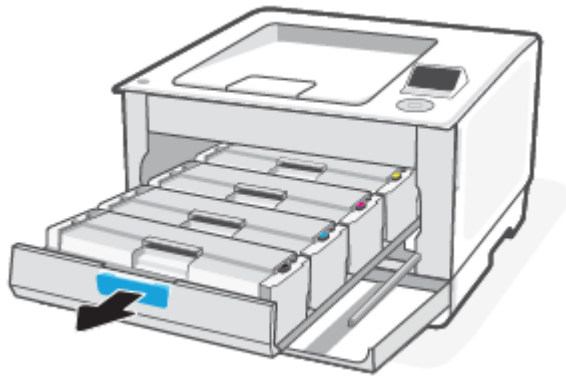

3. Grasp the handle on the toner cartridge, and then pull the toner cartridge straight up to remove it.

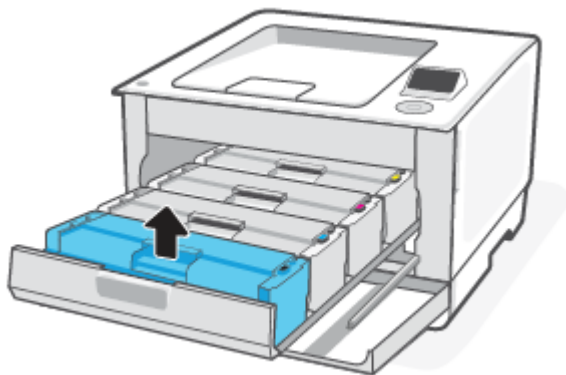

4. Recycle the used toner cartridge. To recycle the used toner cartridge, visit hp.com/recycle.
5. Remove the new cartridge from the package and gently rock it at the sides, up and down to distribute the toner evenly inside the cartridge.

⚠ CAUTION: To prevent damage to the cartridge, hold the cartridge at each end. Do not touch the protective cover or roller surface.

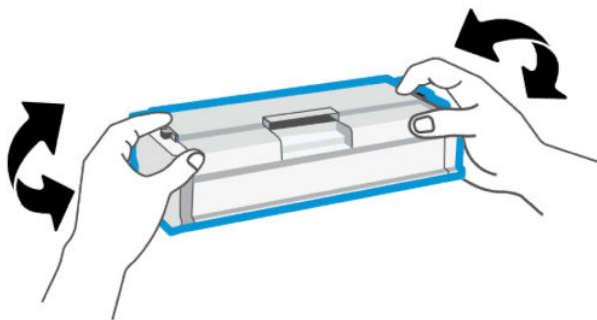

6. Install the new toner cartridge. Make sure that the color chip on the cartridge matches the color chip on the drawer.

⚠ CAUTION:

- When a toner cartridge approaches the end of its useful life, redistributing the toner in the cartridge might improve print quality and enable you to continue printing. To redistribute the toner in the cartridge, remove the toner cartridge from the printer, gently rock the cartridge back and forth along its horizontal axis, and then replace it in the printer.
- If toner gets on your clothing, wipe it off with a dry cloth and wash the clothing in cold water. *Hot water sets toner into the fabric.*

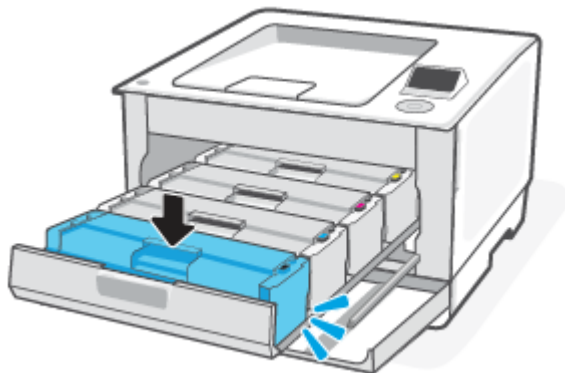

7. Insert the cartridge in the drawer and close the toner cartridge drawer.

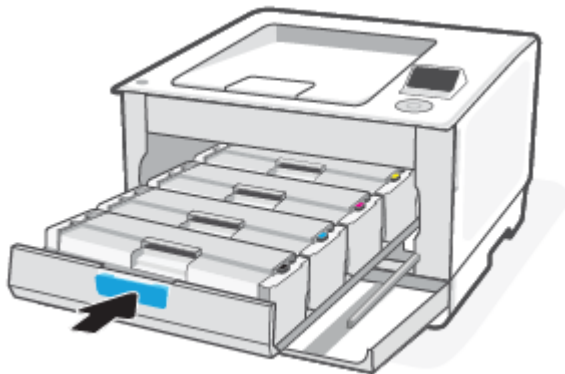

8. Close the cartridge access door.

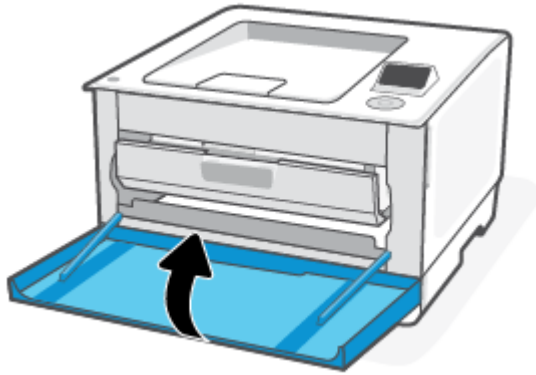

Cartridge low

This topic describes how to manage the cartridges at low and very low settings.

Cartridge is low

Actual cartridge life remaining may vary. Consider having a replacement available to install when print quality is no longer acceptable. The cartridge does not need to be replaced now.

Continue printing with the current cartridge until redistributing the toner no longer yields acceptable print quality. To redistribute the toner, remove the toner cartridge from the printer and gently rock the cartridge back and forth about its horizontal axis. For graphical representation, see cartridge replacement instructions. Reinsert the toner cartridge into the printer and close the cover.

Cartridge is very low

Actual cartridge life remaining may vary. Consider having a replacement available to install when print quality is no longer acceptable. The cartridge does not need to be replaced now unless the print quality is no longer acceptable.

Once an HP toner cartridge has reached Very Low, HP's Premium Protection Warranty on that toner cartridge has ended.

Change the "Very Low" settings

To change printer supplies settings using the embedded web server (EWS).

You can change the way the printer reacts when supplies reach the Very Low state. You do not have to re-establish these settings when you install a new toner cartridge.

1. Open the EWS.
2. Click **Supplies** from the left navigation pane
3. Click **Supply Settings** tab and select the desired options.
4. Click **Apply**.

Order supplies

Table 6-4 Order supplies

| Order | HP Support |
|--|--|
| Order supplies and paper | www.hp.com/go/suresupply |
| Order through service or support providers | Contact an HP-authorized service or support provider. |

7 Solve a problem

Solve common printer problems.

You can get help from the HP software and the printer control panel.

- **HP software:** Provides alerts for printer issues (jams and other problems), links to help content, and options to contact support for additional assistance.

See [Use HP software](#) for more information.

- **Printer control panel:** At the printer control panel, use the control pad and click the right button to select **Help** option,  and press **OK** button to access the Help menu, contextual help, and also animations for some tasks.

If the suggestions do not solve the problems, try getting help using one of the support services, contact HP support.

Visit hp.com/support for more information.

Jams and paper-feed issues

Learn how to troubleshoot jams and paper-feed issues.

Possible jam locations

Paper jams can occur in the following areas of the printer.

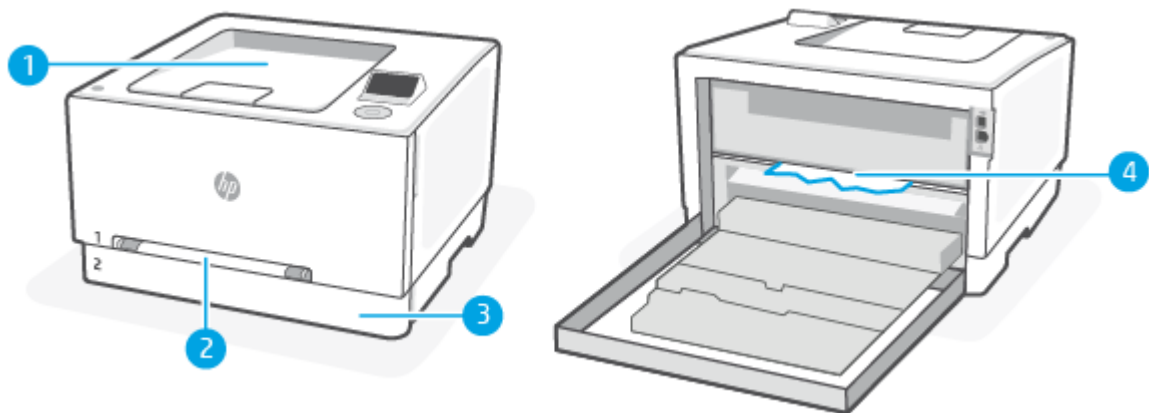

Table 7-1 Possible jam locations

| Feature | Description |
|---------|--|
| 1 | Output tray |
| 2 | Single-sheet priority feed slot tray 1 |
| 3 | Input tray/tray 2 |

Table 7-1 Possible jam locations (continued)

| Feature | Description |
|---------|------------------|
| 4 | Rear access door |

Remove jammed paper

Look in all areas where jams can occur and remove any jammed paper or foreign objects found.

⚠ CAUTION:

- Do not use sharp objects, such as tweezers or needle-nose pliers, to remove jams.
- When removing jammed paper, use both hands to pull the paper straight out from the printer.
- To help avoid additional paper jams, make sure to remove all small pieces of paper and foreign objects found.
- When a jam occurs, the control panel might display a message and an animation that assists in clearing the jam.

Clear a paper jam from single sheet slot tray 1

Clear any jams in the tray area.

1. Make sure the printer is off.
2. Pull tray 2 completely out of the printer.

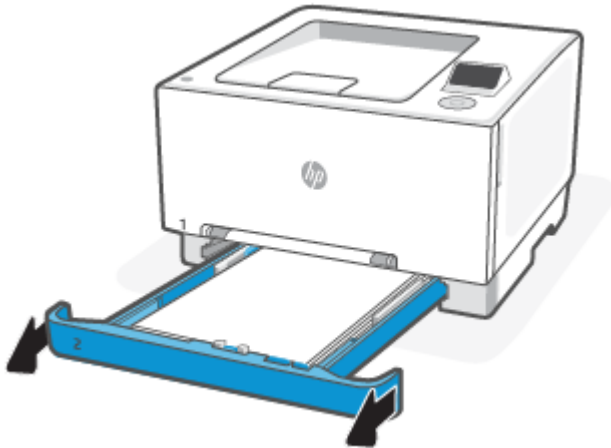

3. Push down on the single-sheet priority feed slot, and then pull out the feed slot tray.

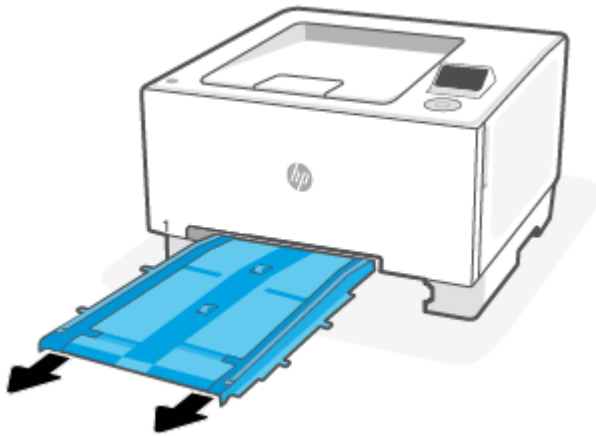

4. Gently pull any jammed paper straight out of the single-sheet priority feed slot.

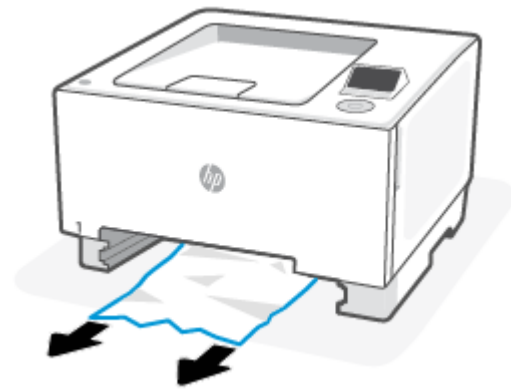

5. Push the single-sheet priority feed slot tray 1 into the printer.

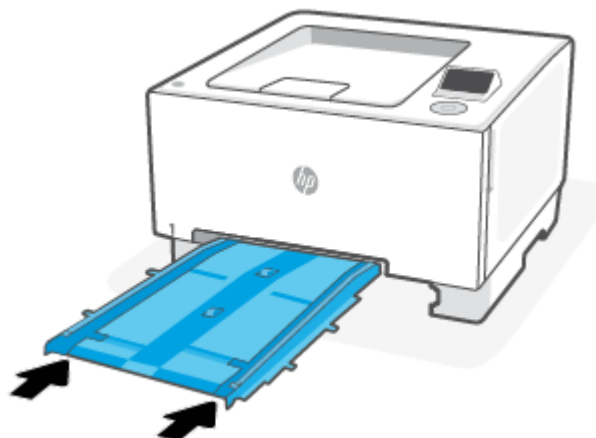

6. Reinsert and close tray 2.

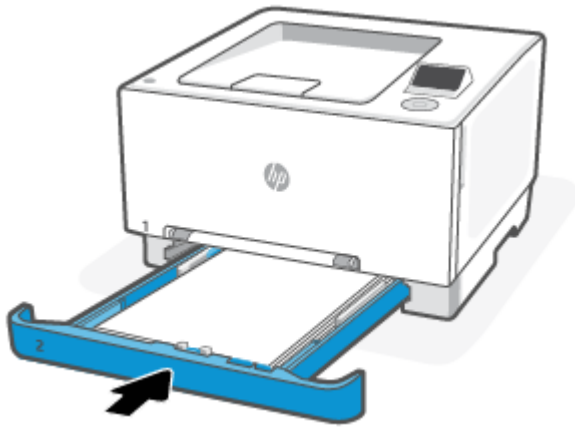

Clear a paper jam from tray 2

Remove the input and output trays and clear any jams found inside the tray area.

1. Make sure the printer is off.
2. Pull tray 2 completely out of the printer.

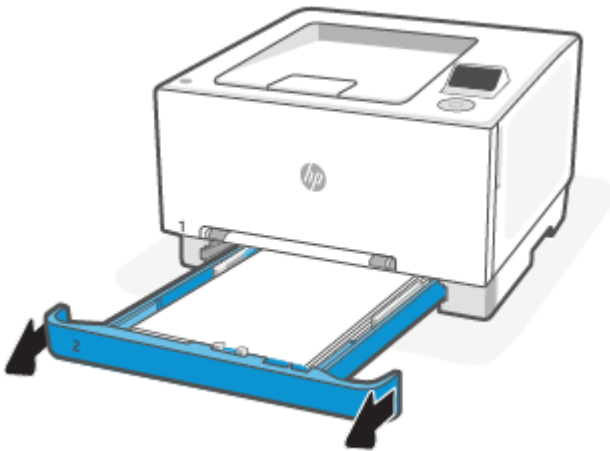

3. Remove any jammed or damaged sheets of paper.

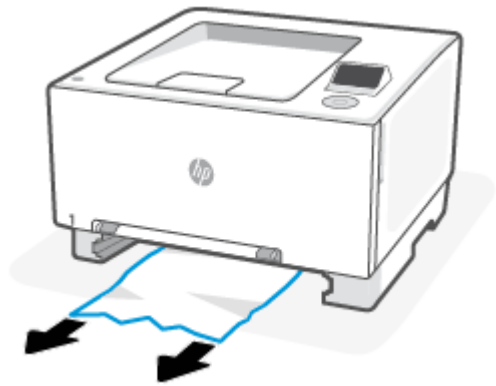

4. If no jammed paper is visible, or if jammed paper is deep enough in the tray 2 feed area that it is difficult to remove, press down on the single-sheet priority feed slot, and then remove the feed slot tray.

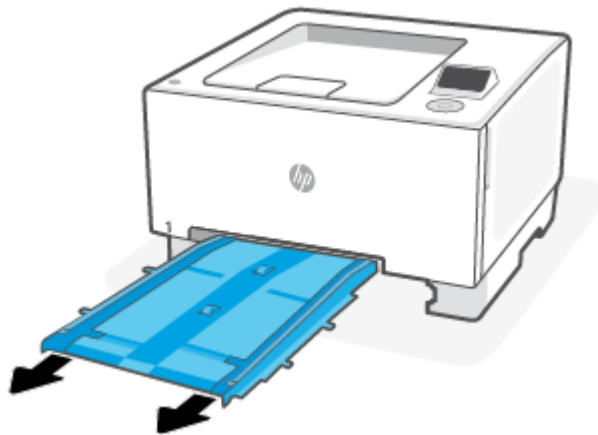

5. Remove any jammed or damaged sheets of paper.

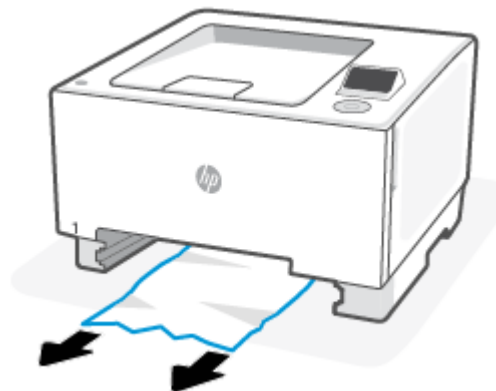

6. If the single-sheet priority tray was removed, replace it by pushing it into the printer.

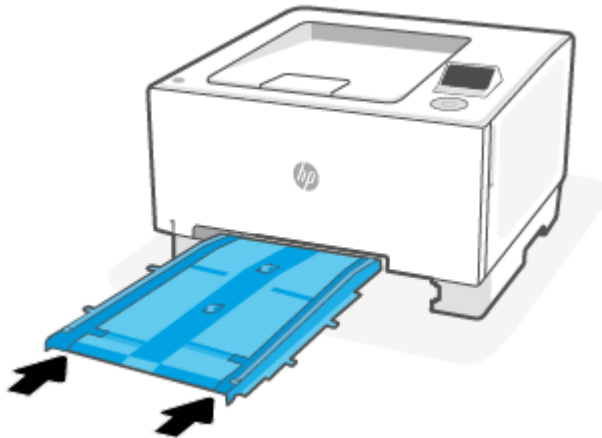

7. Reinsert and close tray 2.

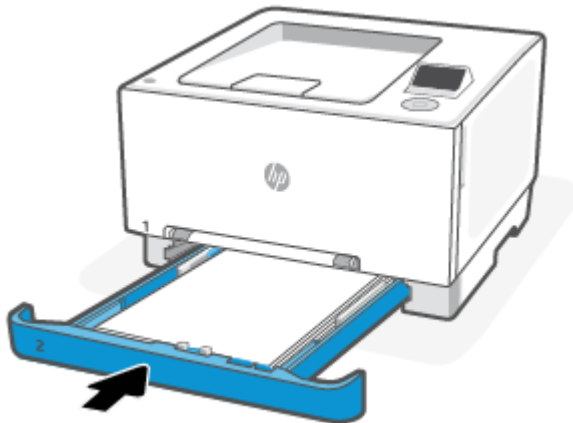

Clear a paper jam from the rear access door

Remove the rear access door and clear any jam found in that area.

1. Make sure the printer is off.
2. At the rear of the printer, open the rear access door.

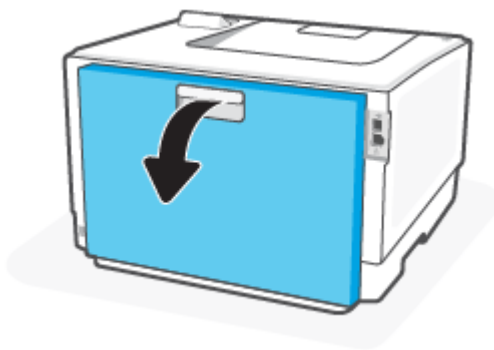

3. Remove any jammed or damaged sheets of paper.

⚠ CAUTION: The fuser can be hot while the printer is in use. Wait for the fuser to cool before handling it.

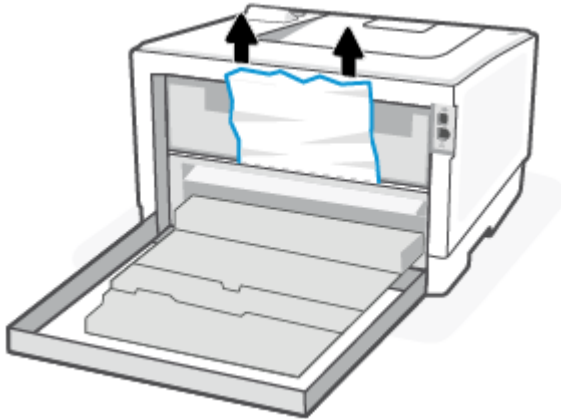

4. Close the rear access door.

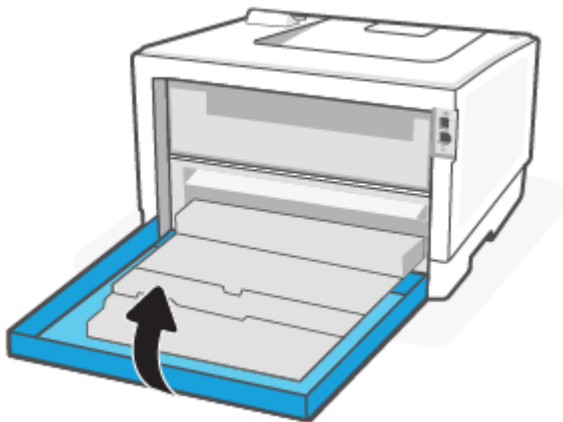

Clear a paper jam in the output bin

Clear a paper jam in all possible jam locations related to the output bin.

1. Make sure the printer is off.

2. At the rear of the printer, open the rear access door.

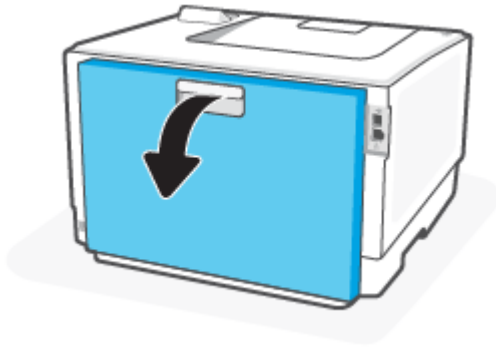

3. If paper is visible in the output bin, grasp the leading edge and remove it. Use both hands to remove jammed paper to avoid tearing the paper.



4. Gently remove any jammed paper from the rollers in the rear access door area.

⚠ CAUTION: The fuser can be hot while the printer is in use. Wait for the fuser to cool before handling it.

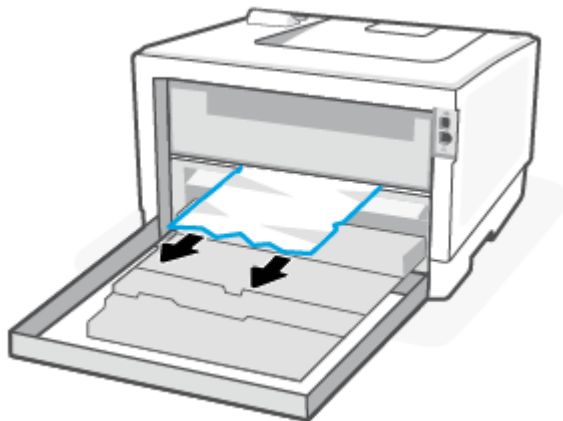

5. Close the rear access door.

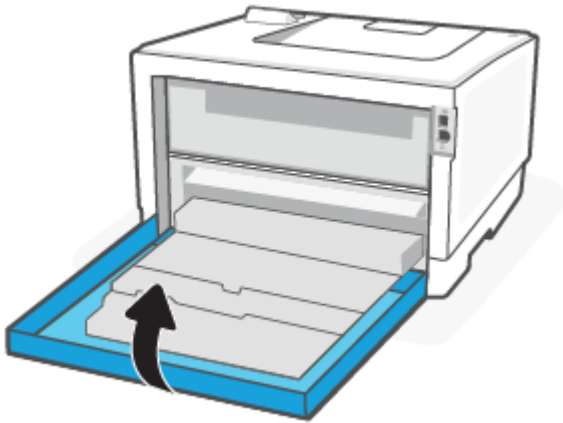

Solve paper-feed problems

What kind of problem are you having?

- **Paper is not picked up from a tray**
 - Make sure paper is loaded in the tray.
See [Load media](#).
 - Make sure the paper-width guides are set to the correct markings in the tray for the paper size you are loading. Also make sure the paper guides are snug, but not tight, against the stack.
 - Make sure that the stack of paper is aligned with the appropriate paper size lines on the bottom of the input tray, and does not exceed the stack height indicated by one or more label on the side or paper-width guide of the input tray.
 - Make sure paper in the tray is not curled. Uncurl paper by bending it in the opposite direction of the curl.
 - Fan paper before loading
- **Pages are skewing**
 - Make sure the paper loaded in the input tray is aligned to the paper-width guides. If needed, pull out the input tray from the printer and reload the paper correctly, making sure that the paper guides are aligned correctly.
 - Load paper into the printer only when it is not printing.
 - Make sure the rear access door is securely shut.
- **Multiple pages are being picked up**
 - Make sure the paper-width guides are set to the correct markings in the tray for the paper size you are loading. Also make sure the paper-width guides are snug, but not tight, against the stack.

- Make sure that the stack of paper is aligned with the appropriate paper size lines on the bottom of the input tray, and does not exceed the stack height indicated by one or more label on the side or paper-width guide of the input tray.
- Make sure the tray is not overloaded with paper.
- Use HP paper for optimum performance and efficiency.

Printing issues

Learn how to troubleshoot printing issues.

Fix print quality issues

Learn how to troubleshoot print quality issues.



NOTE: To avoid print quality problems, always turn the printer off (using the Power button), and wait until (the Power button) light goes out before you pull the plug or turn off a power strip. This allows the printer to move the cartridges to a capped position, where they are protected from drying out.

Print from a different software program

Try printing from a different software program. If the page prints correctly, the problem is with the software program from which you were printing.

If the page does not print correctly, try updating the printer and print again. See [Update printer](#).

Check the paper-type setting for the print job

Check the paper type setting when printing from a software program and the printed pages have smears, fuzzy or dark print, curled paper, scattered dots of toner, loose toner, or small areas of missing toner.

Check the paper type setting on the printer

Verify that the tray is loaded with the correct type of paper.

Check the paper type setting (Windows)

1. From the software program, select the **Print** option.
2. Select the printer, and then click the **Set Preferences** button.
3. Check the paper settings.

Check the paper type setting (OS X)

1. Click the **File** menu, and then click the **Print** option.
2. In the **Printer** menu, select the printer.
3. By default, the print driver displays the **Copies & Pages** menu. Open the menus drop-down list, and then click the **Finishing** menu.
4. Select a type from the **Media Type** drop-down list.

Check toner-cartridge status

Print quality problems can occur when using a toner cartridge that is at its estimated end of life. The configuration report indicates when a supply level is very low.

Once an HP toner cartridge has reached Very Low, HP's Premium Protection Warranty on that toner cartridge has ended.

The toner cartridge does not need to be replaced now unless the print quality is no longer acceptable. Consider having a replacement available to install when print quality is no longer acceptable.

The information page provides information about the printer, its connectivity, supplies status, and replacement cartridge number.

1. Open the EWS.
2. Check to see if you are using a genuine HP cartridge.

A genuine HP toner cartridge has "HP" on it or has the HP logo on it. For more information on identifying HP cartridges go to www.hp.com/go/learnaboutsupplies

Print a cleaning page

During the printing process paper, toner, and dust particles can accumulate inside the printer and can cause print-quality issues such as toner specks or spatter, smears, streaks, lines, or repeating marks.

Use the following procedure to print a cleaning page from EWS.

1. Open the EWS.
2. Click **Print Quality** from the left navigation pane.
3. Click **Tools** from the drop-down menu.



NOTE: If prompted to enter a PIN, open the cartridge access door and enter the PIN displayed on the product label.

4. In the **Fuser Cleaning** area, click **Print** to begin the cleaning process.

Visually inspect the toner cartridge

Follow these steps to inspect the toner cartridge.

1. Remove the toner cartridge from the printer and verify that the sealing tape has been removed.
2. Check the memory chip for damage.
3. If you see any damage on the toner cartridge, replace the toner cartridge.
4. Reinstall the toner cartridge and print a few pages to see if the problem is resolved.

Check paper and the printing environment

This topic describes how to troubleshoot the paper quality issues and the printing environment.

Step one: Use paper that meets HP specifications

Some print-quality problems arise from using paper that does not meet HP specifications.

- Always use a paper type and weight that this printer supports.

- Use paper that is of good quality and free of cuts, nicks, tears, spots, loose particles, dust, wrinkles, voids, staples, and curled or bent edges.
- Use paper that has not been previously printed on.
- Use paper that does not contain metallic material, such as glitter.
- Use paper that is designed for use in laser printers. Do not use paper that is designed only for use in Inkjet printers.
- Use paper that is not too rough. Using smoother paper generally results in better print quality.

Step two: Check the environment

The environment can directly affect print quality and is a common cause for print-quality or paper-feeding issues. Try the following solutions:

- Move the printer away from drafty locations, such as open windows or doors, or air-conditioning vents.
- Make sure the printer is not exposed to temperatures or humidity outside of printer specifications.
- Do not place the printer in a confined space, such as a cabinet.
- Place the printer on a sturdy, level surface.
- Remove anything that is blocking the vents on the printer. The printer requires good air flow on all sides, including the top.
- Protect the printer from airborne debris, dust, steam, grease, or other elements that can leave residue inside the printer.

Try a different print driver

Try a different print driver when printing from a software program and the printed pages have unexpected lines in graphics, missing text, missing graphics, incorrect formatting, or substituted fonts.

Download any of the following drivers from the HP Web site: support.hp.com.

Table 7-2 Print drivers

| Driver | Description |
|------------------|--|
| HP PCL-6 driver | This driver supports Windows 10 and newer operating systems that support version 4 drivers. For a list of supported operating systems, go to www.hp.com/go/support . |
| HP UPD PS driver | <ul style="list-style-type: none"> • Recommended for printing with Adobe® software programs or with other highly graphics-intensive software programs • Provides support for printing from postscript emulation needs, or for postscript flash font support |
| HP PCL 6 | <ul style="list-style-type: none"> • Recommended for printing in all Windows environments • Provides the overall best speed, print quality, and printer feature support for most users • Developed to align with Windows Graphic Device Interface (GDI) for best speed in Windows environments • Might not be fully compatible with third-party and custom software programs that are based on PCL 5 |

Adjust color settings (Windows)

When printing from a software program, follow these steps if colors on the printed page do not match colors on the computer screen, or if the colors on the printed page are not satisfactory.

1. From the software program, select the **Print** option.
2. Select the printer, and then click the **Properties** or **Preferences** button.
3. Click the **Color** tab.
4. Click the **Print in Grayscale** option to print a color document in black and shades of gray. Use this option to print color documents for photocopying or faxing. Also use this option to print draft copies or to save color toner.
5. Click the **OK** button to close the **Document Properties** dialog box. In the **Print** dialog box, click the **OK** button to print the job.

Adjust Print Density

Complete the following steps to adjust the print density.

1. Open the EWS.
2. Click **Print Quality** tab.
3. Click **Adjust Color**.
4. Make the necessary changes and then click **Apply**.

Print and interpret the print quality page

Follow these steps:

1. At the printer control panel, use the control pad to select **Menu** option, and press **OK** button to confirm.
2. Press the down button to select **Tools**, and press **OK** button to continue.
3. Select **Reports** and press **OK**.
4. Select **Status Reports** and press **OK**.
5. Select **Print Quality Troubleshooting Page** and press **OK**.

This page contains five bands of color, which are divided into four groups as indicated in the following illustration. By examining each group, you can isolate the problem to a particular toner cartridge.

Figure 7-1 Print quality page

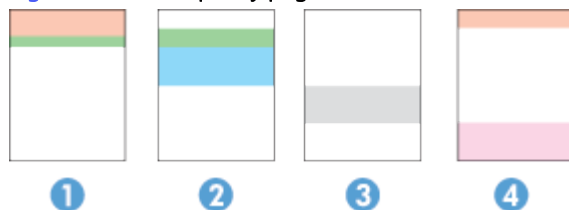

| Section | Toner cartridge |
|---------|-----------------|
| 1 | Yellow |

| Section | Toner cartridge |
|---------|-----------------|
| 2 | Cyan |
| 3 | Black |
| 4 | Magenta |

- If dots or streaks appear in only one of the groups, replace the toner cartridge that correlates with that group.
- If dots appear in more than one group, print a cleaning page. If this does not solve the problem, determine if the dots are always the same color; for example, if magenta dots appear in all five color bands. If the dots are all the same color, replace that toner cartridge.
- If streaks appear in multiple color bands, contact HP. A component other than the toner cartridge is probably causing the problem.

Resolving print quality problems

This topic describes how to troubleshoot the image defect issues, including the following defects:

- Light print
- Gray background or dark print
- Blank pages
- Black pages
- Dark or light bands
- Dark or light streaks
- Missing toner
- Skewed images
- Colors that do not align
- Curled paper

Troubleshoot print quality problems

The information provides common troubleshooting steps for solving image defect issues and examples of specific image defects and steps to resolve these defects.

1. Reprint the document. Print quality defects can be intermittent in nature or can go away completely with continued printing.
2. Check the condition of the cartridge. If a cartridge is in a **Very Low** state (it has passed the rated life), replace the cartridge.
3. Make sure that the driver and tray print mode settings match the media that is loaded in the tray. Try using a different ream of media or a different tray. Try using a different print mode.
4. Make sure that the printer is within the supported operating temperature/humidity range.
5. Make sure that the paper type, size, and weight are supported by the printer. For a list of the supported paper sizes and types for the printer, visit www.support.hp.com and find your printer.



NOTE: The term “fusing” refers to the part of the printing process where toner is affixed to paper.

The following examples depict letter-size paper that has passed through the printer short-edge first.

Table 7-3 Light print

| Description | Sample | Possible solutions |
|---|---|---|
| <p>Light print:</p> <p>The printed content on the entire page is light or faded.</p> |  | <ol style="list-style-type: none">1. Reprint the document.2. Remove the cartridge, and then shake it to redistribute the toner.3. Make sure that the cartridge is installed correctly.4. Check the supplies status from the EWS or the printer control panel.5. Replace toner cartridge.6. Visit www.support.hp.com if the problem persists. |

Table 7-4 Gray background or dark print

| Description | Sample | Possible solutions |
|--|--|---|
| <p>Gray background or dark print:</p> <p>The image or text is darker than expected.</p> |  | <ol style="list-style-type: none">1. Make sure that the paper in the trays has not already been run through the printer.2. Use a different paper type.3. Reprint the document.4. Make sure that the printer is within the supported operating temperature and humidity range.5. Replace toner cartridge.6. Visit www.support.hp.com if the problem persists. |

Table 7-5 Blank page — No print

| Description | Sample | Possible solutions |
|---|---|--|
| <p>Blank page — No print:</p> <p>The page is completely blank and contains no printed content.</p> |  | <ol style="list-style-type: none"> 1. Make sure that the cartridge is genuine HP cartridges. 2. Make sure that the cartridge is installed correctly. 3. Print with a different cartridge. 4. Check the paper type in the paper tray and adjust the printer settings to match. If necessary, select a lighter paper type. 5. Visit www.support.hp.com if the problem persists. |

Table 7-6 Black page

| Description | Sample | Possible solutions |
|--|--|--|
| <p>Black page:</p> <p>The entire printed page is black.</p> |  | <ol style="list-style-type: none"> 1. Visually inspect the toner cartridge to check for damage. 2. Make sure that the cartridge is installed correctly. 3. Replace toner cartridge. 4. Visit www.support.hp.com if the problem persists. |

Table 7-7 Banding defects

| Description | Sample | Possible solutions |
|--|---|---|
| <p>Repetitive wide-pitch banding and Impulse bands:</p> <p>Dark or light lines which repeat down the length of the page. They might be sharp or soft in nature. The defect displays only in areas of fill, not in text or sections with no printed content.</p> |  | <ol style="list-style-type: none"> 1. Reprint the document. 2. Replace toner cartridge. 3. Use a different paper type. 4. Visit www.support.hp.com if the problem persists. |

Table 7-8 Streak defects

| Description | Sample | Possible solutions |
|--|---|--|
| <p>Light vertical streaks:</p> <p>Light streaks that usually span the length of the page. The defect displays only in areas of fill, not in text or sections with no printed content.</p> |  | <ol style="list-style-type: none"> 1. Reprint the document. 2. Remove the cartridge, and then shake it to redistribute the toner. 3. Visit www.support.hp.com if the problem persists. <p>NOTE: Both light and dark vertical streaks can occur when the printing environment is outside the specified range for temperature or humidity. Refer to your printer's environmental specifications for allowable temperature and humidity levels.</p> |
| <p>Dark vertical streaks and ITB cleaning streaks:</p> <p>Dark lines which occur down the length of the page. The defect might occur anywhere on the page, in areas of fill or in sections with no printed content.</p> |  | <ol style="list-style-type: none"> 1. Reprint the document. 2. Remove the cartridge, and then shake it to redistribute the toner. 3. Print a cleaning page. 4. Check the toner level in the cartridge. 5. Visit www.support.hp.com if the problem persists. |

Table 7-9 Fixing/fuser defects

| Description | Fixing/fuser | Possible solutions |
|--|---|--|
| <p>Hot fuser offset (shadow):</p> <p>Slight shadows, or offsets, of the image repeated down the page. The repeated image might fade with each recurrence.</p> |  | <ol style="list-style-type: none"> 1. Reprint the document. 2. Check the paper type in the paper tray and adjust the printer settings to match. If necessary, select a lighter paper type. 3. Visit www.support.hp.com if the problem persists. |

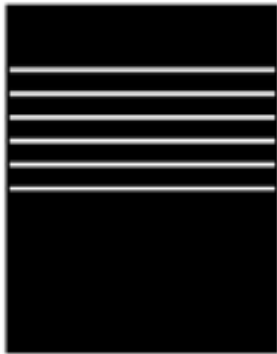
Table 7-9 Fixing/fuser defects (continued)

| Description | Fixing/fuser | Possible solutions |
|--|---|--|
| <p>Poor fusing:</p> <p>Toner rubs off along either edge of page. This defect is more common at the edges of high-coverage jobs and on light media types but can occur anywhere on the page.</p> |  | <ol style="list-style-type: none"> 1. Reprint the document. 2. Check the paper type in the paper tray and adjust the printer settings to match. If necessary, select a heavier paper type. 3. Visit www.support.hp.com if the problem persists. |

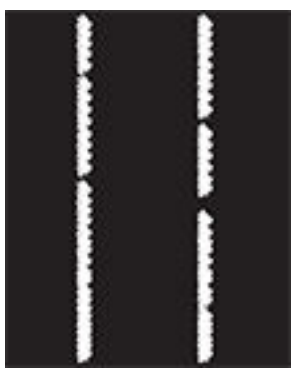
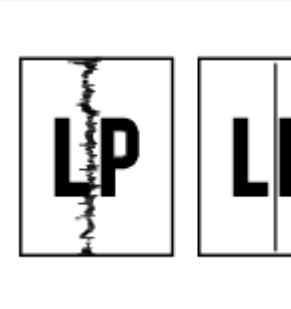
Table 7-10 Image placement defects

| Description | Sample | Possible solutions |
|--|--|--|
| <p>Margins and skew:</p> <p>The image is not centered or is skewed on the page. The defect occurs when the paper is not positioned properly as it is pulled from the tray and moves through the paper path.</p> |  | <ol style="list-style-type: none"> 1. Reprint the document. 2. Remove the paper and then reload the tray. Make sure that all the paper edges are even on all sides. 3. Make sure that the top of the paper stack is below the tray full indicator. Do not overfill the tray. 4. Make sure that the paper guides are adjusted to the correct size for the paper. Do not adjust the paper guides tightly against the paper stack. Adjust them to the indentations or markings in the tray. 5. Visit www.support.hp.com if the problem persists. |

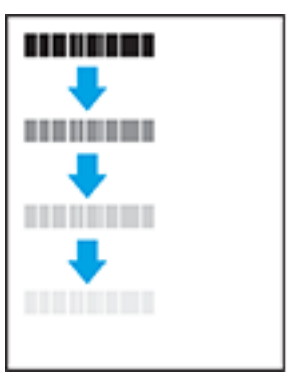
Table 7-11 Output defects

| Description | Sample | Possible solutions |
|--|--|--|
| <p>Output curl:</p> <p>Printed paper has curled edges. The curled edge can be along the short or long side of the paper. Two types of curl are possible:</p> <ul style="list-style-type: none"> • Positive curl: The paper curls toward the printed side. The defect occurs in dry environments or when printing high coverage pages. • Negative curl: The paper curls away from the printed side. The defect occurs in high-humidity environments or when printing low coverage pages. |  | <ol style="list-style-type: none"> 1. Reprint the document. 2. Positive curl: From the printer EWS, select a heavier paper type. The heavier paper type creates a higher temperature for printing. Negative curl: From the printer EWS, select a lighter paper type. The lighter paper type creates a lower temperature for printing. Try storing the paper in a dry environment prior or use freshly opened paper. 3. Print in duplex mode. 4. Visit www.support.hp.com if the problem persists. |
| <p>Output stacking:</p> <p>The paper does not stack well in the output tray. The stack might be uneven, skewed, or the pages might be pushed out of the tray and onto the floor. Any of the following conditions can cause this defect:</p> <ul style="list-style-type: none"> • Extreme paper curl • The paper in the tray is wrinkled or deformed • The paper is a non-standard paper type, such as envelopes • The output tray is too full |  | <ol style="list-style-type: none"> 1. Reprint the document. 2. Extend the output bin extension. 3. If the defect is caused by extreme paper curl, complete the troubleshooting steps for Output curl. 4. Use a different paper type. 5. Use freshly opened paper. 6. Remove the paper from the output tray before the tray gets too full. 7. Visit www.support.hp.com if the problem persists. |

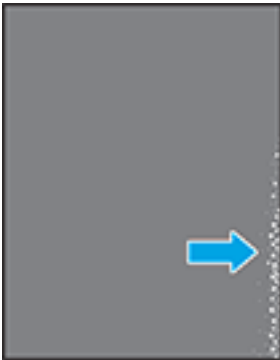
Network and connection issues

Troubleshoot network and connection issues.

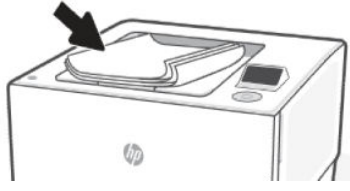
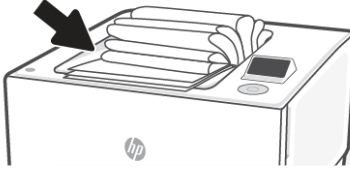
Fix Wi-Fi connection

Select one of the following troubleshooting options:

- Restore network settings and reconnect the printer.

See [Restore settings](#).

- Check the network configuration or print the Wi-Fi test report to assist in diagnosing network connection issues.

1. At the printer control panel, use the control pad to select **Menu** option, and press **OK** button to confirm.
2. Press the down button to select **Tools**, and press **OK** button to continue.
3. Select **Reports** and press **OK**.
4. Select **Status Reports** and press **OK**.

5. Select **Configuration Report**, and press **OK**.
6. Select **Print** and press **OK**.

Check the Wi-Fi Network Test report to see if something failed during the test.

- See the **DIAGNOSTICS RESULTS** section for all tests that were performed, to determine whether or not your printer passed.
 - From the **CURRENT CONFIGURATION** section, find out the Network Name (SSID) to which your printer is currently connected. Make sure that the printer is connected to the same network as your computer or mobile devices.
- Use an HP online troubleshooting tool to solve your printer issues.

Wi-Fi connectivity checklist

- Verify that the printer and the Wi-Fi router are turned on and have power. Also make sure that the wireless radio in the printer is turned on.
- Verify that the service set identifier (SSID) is correct. Print the network configuration page to determine the SSID. See [Understand printer reports](#).
If you are not sure the SSID is correct, run the Wi-Fi setup again.
- With secured networks, verify that the security information is correct. If the security information is incorrect, run the Wi-Fi setup again.
- If the Wi-Fi network is working correctly, try accessing other computers on the Wi-Fi network. If the network has Internet access, try connecting to the Internet over a Wi-Fi connection.
- Verify that the encryption method (AES or TKIP) is the same for the printer as it is for the Wi-Fi access point (on networks using WPA security).
- Verify that the printer is within the range of the Wi-Fi network. For most networks, the printer must be within 30 m (100 ft) of the Wi-Fi access point (Wi-Fi router).
- Verify that obstacles do not block the Wi-Fi signal. Remove any large metal objects between the access point and the printer. Make sure poles, walls, or support columns containing metal or concrete do not separate the printer and Wi-Fi access point.
- Verify that the printer is located away from electronic devices that might interfere with the Wi-Fi signal. Many devices can interfere with the Wi-Fi signal including motors, cordless phones, security system cameras, other Wi-Fi networks, and some Bluetooth devices.
- Verify that the print driver is installed on the computer.
- Verify that you have selected the correct printer port.
- Verify that the computer and printer connect to the same Wi-Fi network.
- For OS X, verify that the Wi-Fi router supports Bonjour.

The printer does not print after the Wi-Fi configuration completes

- Make sure that the printer is turned on and in the ready state.
- Turn off any third-party firewalls on your computer.
- Make sure that the Wi-Fi network is working correctly.

- Make sure that your computer is working correctly. If necessary, restart the computer.
- Verify that you can open the printer EWS from a computer on the network.

The printer does not print, and the computer has a third-party firewall installed

- Update the firewall with the most recent update available from the manufacturer.
- If programs request firewall access when you install the printer or try to print, make sure you allow the programs to run.
- Temporarily turn off the firewall, and then install the Wi-Fi printer on the computer. Enable the firewall when you have completed the Wi-Fi installation.

The Wi-Fi connection does not work after moving the Wi-Fi router or printer

- Make sure that the router or printer connects to the same network that your computer connects to.
- Print a network configuration page.
- Compare the service set identifier (SSID) on the information report to the SSID in the printer configuration for the computer.
- If the numbers are not the same, the devices are not connecting to the same network. Reconfigure the Wi-Fi setup for the printer.

Cannot connect more devices to the Wi-Fi printer (Wi-Fi Direct)

- Make sure that the other computers are within the Wi-Fi range and that no obstacles block the signal. For most networks, the wireless range is within 30 m (100 ft) of the Wi-Fi access point.
- Make sure that the printer is turned on and in the ready state.
- Make sure there are not more than 5 concurrent Wi-Fi Direct users.
- Turn off any third-party firewalls on your computer.
- Make sure that the Wi-Fi network is working correctly.
- Make sure that your computer is working correctly. If necessary, restart the computer.

The printer cannot print when your computer is on a VPN

- The printer might lose connection when your computer switches to a virtual private network (VPN).

The network does not appear in the wireless networks list

- Make sure the wireless router is turned on and has power.
- The network might be hidden.
- Make sure that the printer is within wireless range of the wireless router, and that there are no obstacles blocking the signal.
- The printer operates on the 2.4 GHz and 5 GHz wireless bands.
- Refresh the wireless networks list.

- Try restarting the printer.

The Wi-Fi network is not functioning

- To verify if the network has lost communication, try connecting other devices to the network.
- Test network communication by pinging the network.
 1. Open a command-line prompt on your computer.
 - a. For Windows, click **Start**, click **Run**, type `cmd`, and then press **Enter**.
 - b. For OS X, go to **Applications**, then **Utilities**, and open **Terminal**.
 2. Type `ping` followed by the router IP address.
 3. If the window displays round-trip times, the network is working.
 - a. Print the network configuration page. See [Understand printer reports](#).
 - b. Compare the service set identifier (SSID) on the information report to the SSID in the printer information for the computer.
 - c. If the numbers are not the same, the devices are not connecting to the same network. Reconfigure the Wi-Fi setup for the printer.

Reduce interference on a wireless network

The following tips can reduce interference in a wireless network:

- Keep the wireless devices away from large metal objects, such as filing cabinets, and other electromagnetic devices, such as microwaves and cordless telephones. These objects can disrupt radio signals.
- Keep the wireless devices away from large masonry structures and other building structures. These objects can absorb radio waves and lower signal strength.
- Position the wireless router in a central location in line of sight with the wireless printers on the network.

Fix Wi-Fi Direct connection

Complete the following to resolve Wi-Fi Direct connection issues.

1. Check the printer to confirm that the Wi-Fi Direct is turned on.

See [Print using Wi-Fi Direct](#) to turn on Wi-Fi Direct.
2. From your wireless computer or mobile device, turn on the Wi-Fi connection, and then search for and connect to the Wi-Fi Direct name of your printer.
3. Enter the Wi-Fi Direct password when prompted.

The Wi-Fi Direct name and password are listed on the Network Configuration Report.

See [Print a printer report](#).

If you are using a mobile device, visit the hp.com/mobileprinting website for more information about mobile printing.

Fix Ethernet connection

Check the following:

- The network is operational and the network hub, switch, or router is turned on.
- The Ethernet cable is properly connected between the printer and the router. The Ethernet cable is plugged into the Ethernet port on the printer and the light near the connector lights up when connected.
- Antivirus programs, including spyware protection programs, are not impacting your network connection to the printer. If you know that antivirus or firewall software is preventing your computer from connecting to the printer, use [HP online firewall troubleshooter](#) to help solve the problem.
- HP Print and Scan Doctor: Download and run [HP Print and Scan Doctor](#) to help diagnose and fix issues automatically.



NOTE: This tool is for the Windows operating system, and is only available in some languages.

Poor physical connection

- Verify that the printer is attached to the correct network port using a cable of the correct length.
- Verify that cable connections are secure.
- Look at the network port connection on the back of the printer, and verify that the amber activity light flashes indicating network traffic, and the green link-status light is continuously lit indicating a network link.
- If the problem continues, try a different cable or port on the hub.

The computer is using the incorrect IP address for the printer

- Open the printer properties and click the **Ports** tab. Verify that the current IP address for the printer is selected. The printer IP address is listed on the printer configuration page.
- If you installed the printer using the HP standard TCP/IP port, select the box labeled **Always print to this printer, even if its IP address changes**.
- If you installed the printer using a Microsoft standard TCP/IP port, use the hostname instead of the IP address.
- If the IP address is correct, delete the printer and then add it again.

The computer is unable to communicate with the printer

- Test network communication by pinging the network.
 1. Open a command-line prompt on your computer.
 - a. For Windows, click **Start**, click **Run**, type `cmd`, and then press **Enter**.
 - b. For macOS, go to **Applications**, then **Utilities**, and open **Terminal**.
 2. Type `ping` followed by the IP address for your printer.
 3. If the window displays round-trip times, the network is working.
- If the ping command failed, verify that the network hubs are on, and then verify that the network settings, the printer, and the computer are all configured for the same network (also known as subnet).

- Open the printer properties and click the **Ports** tab. Verify that the current IP address for the printer is selected. The printer IP address is listed on the printer configuration page.
- If you installed the printer using the HP standard TCP/IP port, select the box labeled **Always print to this printer, even if its IP address changes**.
- If you installed the printer using a Microsoft standard TCP/IP port, use the printer's hostname instead of the IP address.
- If the IP address is correct, delete the printer and then add it again.

The printer is using incorrect link and duplex settings for the network

HP recommends leaving these settings in automatic mode (the default setting). If you change these settings, you must also change them for your network.

New software programs might be causing compatibility problems

Verify that any new software programs are correctly installed and that they use the correct print driver.

The computer or workstation might be set up incorrectly

- Check the network drivers, print drivers, and the network redirection settings.
- Verify that the operating system is configured correctly.

The printer is disabled, or other network settings are incorrect

- Review the printer's configuration/networking pages to check the status of the network settings and protocols.
- Reconfigure the network settings if necessary.

Restore original network settings

If you want to restart **Wi-Fi setup mode** or troubleshoot network-related issues, you can restore the printer to its original network settings.

NOTE:

- You must reconnect the printer to the network using the HP software after you restore network settings.
 - For network-related issues, try the following before restoring network settings.
 - Run [HP Print and Scan Doctor](#) to help diagnose and fix issues automatically.
 - Visit hp.com/support for information and utilities that can help you fix many common printer problems.
-

See [Restore settings](#).

Understand printer reports

Learn more about how to print some useful printer reports.

- **Network Configuration Report**

Provides important network settings such as network status and the printer IP address.

- **Wi-Fi Network Test Results**

Provides information about your printer network connection or to troubleshoot connection issues.

- **Web Access Test Report**

Provides information about the printer status, DNS setting, and the IP address. If the printer is connected to a Wi-Fi network, the test report displays details about the network settings. It also indicates any Wi-Fi connectivity issues.

Print a printer report

Follow these steps to print a printer report.

1. At the printer control panel, use the control pad to select **Menu** option, and press **OK** button to confirm.
2. Press the down button to select **Tools**, and press **OK** button to continue.
3. Select **Reports** and press **OK**.
4. Select **Status Reports** and press **OK**.
5. Select a desired report to print then select **Print** and press **OK**.

Print a report from EWS

Follow these steps to print a report from EWS.

1. Open the EWS.
2. Click the **Support Tools** tab.
3. From the left menu, click **Reports and Pages**.
4. Click **Print** to print the desired report.

EWS reports

Learn more about how to print some useful printer EWS reports.

Table 7-12 Printer EWS reports

| Printer report | Description | How to print |
|----------------------------|---------------------------------------|---|
| Adjust Alignment Test Page | The printer prints an alignment page. | <ol style="list-style-type: none">1. Open the EWS.2. Click the Print Quality tab.3. Click Image Registration and make the necessary changes.4. Click Apply. |

Restore settings

If you change some settings or disable some functions and want to change them back, you can restore or reset the settings.

- **Reset user settings**

If you want to discard the changes you have made to the printer user settings, you can reset the printer to the default user settings.

- **Reset user data**

If you want to discard the changes you have made to the printer user data, you can reset the printer to the original default data.

- **Restore all factory defaults**

If you want to discard the changes you have made to the printer settings, you can restore all the printer settings to the original factory default settings.

Complete the following steps to restore settings.

1. At the printer control panel, use the control pad to select **Menu** option, and press **OK** button to confirm.
2. Press the down button to select **Tools**, and press **OK** button to continue.
3. Select **Maintenance** and press **OK**.
4. Select **Restore settings** and press **OK** then change the desired settings.

Restore network settings

If you want to discard the changes you have made to the printer network settings, you can restore them to the original network settings.

1. At the printer control panel, use the control pad to select **Menu** option, and press **OK** button to confirm.
2. Press the down button to select **Settings**, and press **OK** button to continue.
3. Select **Network settings** and press **OK**.
4. Press the down button to select **Restore network reports** and press **OK** then change the desired settings.

HP support

HP online support provides information and utilities that can help you solve common printer problems.

- **View video tutorials**

Learn how to set up printer and perform common tasks.

- **Get troubleshooting assistance**

Find information for resolving paper jams, network connection issues, print quality issues, printer errors, and more.

- **Get software and drivers**

Download software, drivers, and firmware you need for the printer.

- **Ask the community**

Join the community forums to find solutions, ask questions, and share tips.

- **HP diagnostics solutions**

Use HP online tools to detect your printer and find recommended solutions.

Download and run [HP Print and Scan Doctor](#) to help diagnose and fix issues automatically.

Contact HP

If you need help from an HP technical support representative to solve a problem.

Visit hp.com/support for more information.

The following contact options are available at no cost for in-warranty customers (HP agent-assisted support for out-of-warranty customers may require a fee).

- **Chat**

Chat with an HP support agent or the HP Virtual Assistant online.

- **Call**

Call an HP support agent.

When contacting HP support, provide the following information:

- Product name (Located on the printer)
- Product number and serial number (located near the cartridge access area)

Register printer

By taking just a few quick minutes to register, you can enjoy quicker service, more efficient support, and product support alerts.

If you did not register your printer while installing the printer software, you can register anytime on the register.hp.com website.

Additional warranty options

Extended service plans are available for the printer at additional costs.

Visit hp.com/support, select your country/region and language, then explore the service plan options available for your printer.

Additional information

Go to www.support.hp.com. Select your country/region. Enter the product name, and then select **Search**.

Instructions are available for performing various tasks, such as the following:

- Troubleshooting your printer
- Printing from various applications, and from various devices
- Obtaining support

You will find documents, videos, and many other resources to help you get the most from your printer.

8 HP EcoSolutions (HP and the Environment)

HP is committed to helping you optimize your environmental footprint and empowering you to print responsibly—at home or in the office.

For more detailed information about environmental guidelines that HP follows during the manufacturing process, see [Environmental product stewardship program](#).

Power management

Use Sleep, Inactivity Shutdown, and Schedule Printer On/Off to conserve electricity.

- **Sleep**

After initial setup, the printer enters Sleep mode after 5 minutes of inactivity by default.

- **Inactivity Shutdown**

To conserve power, the printer turns off completely after a default period of inactivity. Press (the Power button) to turn on the printer again.

Follow these steps to change the settings:

1. At the printer control panel, use the control pad to select **Menu** option, and press **OK** button to confirm.
2. Press the down button to select **Settings**, and press **OK** button to continue.
3. Select **General**, and press **OK**.
4. Select **Energy** and press **OK**.
5. Select the feature and change the desired settings.

A Printer specifications

The information contained herein is subject to change without notice.

Some statements might not be applicable for your printer or all countries/regions. For current information, visit www.support.hp.com. Select your country/region and language, find your printer, click **Product Information**, and check the product specifications for your printer.

Technical specifications

For more information, visit www.support.hp.com, select your country/region and language, find your printer, click **Product Information**, and then select Product specifications.

System requirements

For information about software and system requirements or future operating system releases and support, visit www.support.hp.com and find your printer.

Supported operating systems

The following information applies to the printer-specific Windows PCL 6 and to the software installer.

Windows: The HP Software Installer installs the “HP PCL.6” version 3 print driver, the “HP PCL 6” version 3 print driver, or the “HP PCL-6” version 4 print driver, depending on the Windows operating system, along with optional software when using the software installer. Download the “HP PCL.6” version 3 print driver, the “HP PCL 6” version 3 print driver, and the “HP PCL-6” version 4 print driver from the printer-support website for this printer: support.hp.com.

macOS: Mac computers are supported with this printer. Download HP Smart either from hpsmart.com/download or from the Printer Support page, and then use HP Smart to install the HP print driver. HP Smart is not included in the HP Software Installer.

1. Go to hpsmart.com/download.
2. Follow the steps provided to download the printer software.

Linux: For information and print drivers for Linux, go to www.hp.com/go/linuxprinting.

UNIX: For information and print drivers for UNIX®, go to www.hp.com/go/unixmodelscripts.

Table A-1 Supported operating systems and print drivers

| Operating system | Print driver installed (from the software on the web) | Notes |
|-------------------------------|--|---|
| Windows 11, 64-bit | The “HP PCL-6” V7 printer-specific print driver is installed for this operating system as part of the software installation. | This operating system is fully supported. |
| Windows 10, 32-bit and 64-bit | The “HP PCL-6” V4 printer-specific print driver is installed for this operating system as part of the software installation. | This operating system is fully supported. |

Table A-1 Supported operating systems and print drivers (continued)

| Operating system | Print driver installed (from the software on the web) | Notes |
|--|---|---|
| Windows 10 server (Server 2016,2019,2022), 32-bit and 64-bit | The "HP PCL-6" printer-specific print driver is installed for this operating system as part of the software installation. | This operating system is fully supported. |
| macOS 11.0 Big Sur, macOS 12.0 Monterey, macOS 13.0 Ventura | To install the print driver, download HP Smart from 123.hp.com . Follow the steps provided to install the printer software and print driver. | This operating system is fully supported. |



NOTE:

- For a current list of supported operating systems, go to support.hp.com for HP's all-inclusive help for the printer.
- For HP UPD driver support for this printer, go to www.hp.com/go/upd. Under **Additional information**, click the links.

Table A-2 Minimum system requirements

| Windows | macOS |
|--|---|
| <ul style="list-style-type: none">• Internet connection• 2 GB available hard disk space | <ul style="list-style-type: none">• Internet connection• 2 GB of available hard-disk space |

Printer hardware setup and software installation

For basic setup instructions, see the Setup Poster and Getting Started Guide that came with the printer. For additional instructions, go to HP support on the Web.

Go to support.hp.com for HP's all-inclusive help for the printer. Find the following support:

- Install and configure
- Learn and use
- Solve problems
- Download software and firmware updates
- Join support forums
- Find warranty and regulatory information

Supported Wi-Fi band

The printer supports dual band Wi-Fi 802.11 ac.

Printer dimensions

This topic describes the printer dimensions.

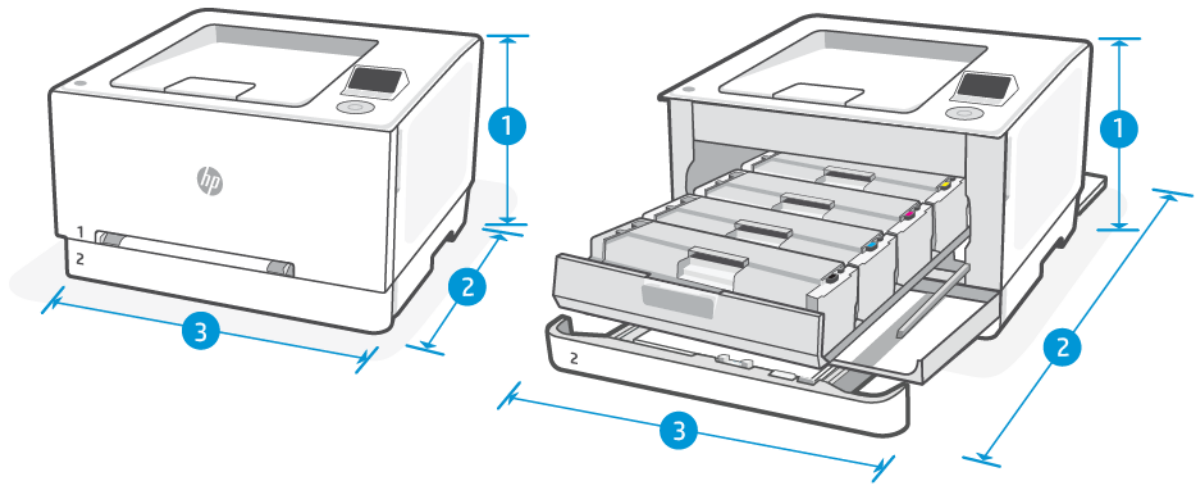

Table A-3 Printer dimensions

| Dimensions | Printer fully closed | Printer fully open |
|--------------------------|----------------------|----------------------|
| 1. Height | 254.19 mm (10.01 in) | 314.19 mm (12.37 in) |
| 2. Depth | 419.12 mm (16.5 in) | 990 mm (38.98 in) |
| 3. Width | 390 mm (15.35 in) | 390 mm (15.35 in) |
| Weight (with cartridges) | 13.08 kg (30.42 lb) | 13.08 kg (30.42 lb) |

Power consumption, electrical specifications, and acoustic emissions

For current information, visit www.support.hp.com and find your printer.

CAUTION: Power requirements are based on the country/region where the printer is sold. Do not convert operating voltages. This will damage the printer and void the printer warranty.

Operating-environment range

Table A-4 Operating-environment range

| Environment | Recommended | Allowed |
|--------------------|---|---------------------------------|
| Temperature | 15° to 27°C (59° to 80.6°F) | 15° to 30°C (59° to 86°F) |
| Operating humidity | 30% to 70% relative humidity (RH), non-condensing | 10% to 80% (RH), non-condensing |

Warning icons

Warning icon definitions: The following warning icons may appear on HP products. Apply appropriate caution where applicable.



Caution: Electric shock



Caution: Hot surface



Caution: Keep body parts away from moving parts



Caution: Sharp edge in close proximity



Warning

Laser Warning



CAUTION - CLASS 3B INVISIBLE LASER RADIATION WHEN OPEN. AVOID EXPOSURE TO THE BEAM.

ATTENTION - RAYONNEMENT LASER INVISIBLE DE CLASSE 3B EN CAS D'OUVERTURE. ÉVITEZ L'EXPOSITION AU FAISCEAU.

VORSICHT - UNSICHTBARE LASERSTRAHLUNG KLASSE 3B, WENN ABDECKUNG GEÖFFNET. NIQUIT DEM STRAHL AUSSETZEN.

PRECAUCIÓN - RADIACIÓN LÁSER INVISIBLE DE CLASE 3B PRESENTE AL ABRIR. EVITE LA EXPOSICIÓN AL HAZ.

WARNING - OSYNLIG LASERSTRÅLNING KLASSE 3B VID ÖPPEN LUCKA UINDVIK EXPONERING FÖR LASERSTRÅLNINGEN.

VAROITUS - LUOKAN 3B NÄKYMÄTTÖMÄLLE LASER-SÄTEILYÄ AVATTUNA. VÄLTÄ ALTISTUMISTA SÄTEELLE.

注意 - 打开时，存在不可见的 3B 类激光辐射，请避免接触该激光束。

주의 - 켜지면 3B 비가시레이저 방사선이 발생할 수 있습니다. 광선에 노출을 피하십시오.

注意 - ここを開くとクラス 3B 不可視レーザー放射が出ます。ビームに身をさらさないこと。

B Service and support

This section describes the service and support information.

HP limited warranty statement

Table B-1 HP limited warranty statement

| HP PRODUCT | DURATION OF LIMITED WARRANTY* |
|---|-------------------------------|
| HP Color LaserJet Pro 3201-3204/3288 series | One-year limited warranty |



NOTE: *Warranty and support options vary by product, country, and local legal requirements. Go to www.support.hp.com to learn about HP award-winning service and support options in your region. For details on the HP limited warranty policy on supplies, go to www.hp.com/go/learnaboutsupplies.

HP warrants to you, the end-user customer, this HP Limited Warranty applies only to HP branded products sold or leased a) from HP Inc., its subsidiaries, affiliates, authorized resellers, authorized distributors, or country distributors; and, b) with this HP Limited Warranty, that HP hardware and accessories will be free from defects in materials and workmanship after the date of purchase, for the period specified above. If HP receives notice of such defects during the warranty period, HP will, at its option, either repair or replace products which prove to be defective. Replacement products may be either new or equivalent in performance to new. HP products presented for repair may be replaced by refurbished goods of the same type rather than being repaired. Refurbished parts may be used to repair the goods. Repair of goods may result in lost user-generated data.

HP warrants to you that HP software will not fail to execute its programming instructions after the date of purchase, for the period specified above, due to defects in material and workmanship when properly installed and used. If HP receives notice of such defects during the warranty period, HP will replace software which does not execute its programming instructions due to such defects.

HP does not warrant that the operation of HP products will be uninterrupted or error free. If HP is unable, within a reasonable time, to repair or replace any product to a condition as warranted, you will be entitled to a refund of the purchase price upon prompt return of the product.

HP products may contain remanufactured parts equivalent to new in performance or may have been subject to incidental use.

Warranty does not apply to defects resulting from (a) improper or inadequate maintenance or calibration, (b) software, interfacing, parts or supplies not supplied by HP, (c) unauthorized modification or misuse, (d) operation outside of the published environmental specifications for the product, or (e) improper site preparation or maintenance.

TO THE EXTENT ALLOWED BY LOCAL LAW, THE ABOVE WARRANTIES ARE EXCLUSIVE AND NO OTHER WARRANTY OR CONDITION, WHETHER WRITTEN OR ORAL, IS EXPRESSED OR IMPLIED AND HP SPECIFICALLY DISCLAIMS ANY IMPLIED WARRANTIES OR CONDITIONS OF MERCHANTABILITY, SATISFACTORY QUALITY, AND FITNESS FOR A PARTICULAR PURPOSE. Some countries/regions, states or provinces do not allow limitations on the duration of an implied warranty, so the above limitation or exclusion might not apply to you. This warranty gives you specific legal rights and you might also have other rights that vary from country/region to country/region, state to state, or province to province. Please refer to the Country Specific statements at the end of this document.

HP's limited warranty is valid in any country/region or locality where HP has a support presence for this product and where HP has marketed this product. The level of warranty service you receive may vary according to local standards. HP will not alter form, fit or function of the product to make it operate in a country/region for which it was never intended to function for legal or regulatory reasons.

TO THE EXTENT ALLOWED BY LOCAL LAW, THE REMEDIES IN THIS WARRANTY STATEMENT ARE YOUR SOLE AND EXCLUSIVE REMEDIES. EXCEPT AS INDICATED ABOVE, IN NO EVENT WILL HP OR ITS SUPPLIERS BE LIABLE FOR LOSS OF DATA OR FOR DIRECT, SPECIAL, INCIDENTAL, CONSEQUENTIAL (INCLUDING LOST PROFIT OR DATA), OR OTHER DAMAGE, WHETHER BASED IN CONTRACT, TORT, OR OTHERWISE. Some countries/regions, states or provinces do not allow the exclusion or limitation of incidental or consequential damages, so the above limitation or exclusion may not apply to you.

THE WARRANTY TERMS CONTAINED IN THIS STATEMENT, EXCEPT TO THE EXTENT LAWFULLY PERMITTED, DO NOT EXCLUDE, RESTRICT OR MODIFY AND ARE IN ADDITION TO THE MANDATORY STATUTORY RIGHTS APPLICABLE TO THE SALE OF THIS PRODUCT TO YOU. PLEASE REFER TO THE COUNTRY SPECIFIC STATEMENTS AT THE END OF THIS DOCUMENT (IF APPLICABLE) FOR FURTHER INFORMATION ON YOUR CONSUMER RIGHTS.

Country Specific Terms

In some jurisdictions, you may have other statutory rights. Please see below.

Australia

Your rights as an Australian consumer are different to those stated in the document above.

You should disregard any limitations or exclusions in the above document and refer to the information below.

1. When you buy a good from HP as a consumer, the goods come with guarantees that cannot be excluded under the Australian Consumer Law. You are entitled to a replacement or refund for a major failure and for compensation for any other reasonably foreseeable loss or damage. You are also entitled to have the goods repaired or replaced if the goods fail to be of acceptable quality and the failure does not amount to a major failure.
2. This means that there is no defined warranty period for HP goods supplied to Australian consumers.
3. Instead, the goods should, for example, be fit for the purposes for which they are commonly supplied for such a period as a reasonable consumer fully acquainted with the state and condition of the goods would expect. This period may vary depending on the product.
4. You should contact HP if you are concerned that one of HP's products fails to satisfy any of the guarantees listed below. HP will discuss with you the specific nature and circumstances of that good and whether the particular fault/issue falls within the scope of the statutory guarantees.

Nothing in HP's Limited Warranty excludes, restricts, or modifies any condition, warranty, guarantee, right or remedy you may have at law (including a consumer guarantee under the Australian Consumer Law) which cannot be lawfully excluded or limited.

The relevant guarantees are as follows:

1. **Quality** — goods supplied by HP must be of acceptable quality. The test for acceptable quality is whether a reasonable consumer, fully aware of the state and condition of the goods, would find them:
 - safe, durable, and free from defects;
 - acceptable in appearance and finish; and
 - fit for all the purposes for which goods of that kind are commonly supplied.

This must take into account the nature and price of the goods, and any statements on packaging or labeling.

2. **Disclosed Purpose** — goods or services supplied by HP that HP represents are reasonably fit for a purpose expressly disclosed by a consumer must be reasonably fit for that purpose.
3. **Description** — goods supplied by HP must match the description provided by HP.
4. **Sample** — goods supplied by HP must match any sample shown to you by HP.
5. **Title** — a consumer who purchases a good from HP must receive clear title to the good.
6. **Due care and skill** — services provided to you by HP must be provided with due care and skill.
7. **Express warranties** — HP will be legally required to comply with the express warranty that is set out in its terms and conditions.
8. **Reasonable time** — repair services provided by HP must be provided within a reasonable time.

If you think that you are entitled to any of the above remedies or any remedy under the HP Worldwide Limited Warranty and Technical Support Document, please contact HP:

HP PPS Australia Pty Ltd

Rhodes Corporate Park, Building F, Level 5

1 Homebush Bay Drive

Rhodes, NSW 2138

Australia

To initiate a support request, please use the numbers below or visit www.hp.com.au and select the “Customer Service” option for the most current list of phone support numbers.

| Product | Phone |
|---|---|
| Support for all HP Products except those listed separately below | 13 10 47 If dialing internationally: +61 2 8278-1039 |
| DeskJet, Office Jet, PSC, All-in-One, Photosmart & Personal LaserJet Series 1000, P1000, M1000 and Colour LaserJet CP1000 Series and model CM1415 | 1300 721 147 If dialing internationally: +61 2 8934 4380 |

For further information on consumer rights, visit www.consumerlaw.gov.au and www.accc.gov.au.

New Zealand

In New Zealand, the hardware and software come with guarantees that cannot be excluded under the New Zealand consumer law. In New Zealand, Consumer Transaction means a transaction involving a person who is purchasing goods for personal, domestic, or household use or consumption and not for the purpose of a business. New Zealand consumers who are purchasing goods for personal, domestic or household use or consumption and not for the purpose of a business (“New Zealand Consumers”) are entitled to repair, replacement or refund for a failure and compensation for other reasonably foreseeable loss or damage. A New Zealand Consumer (as defined above) may recover the costs of returning the product to the place of purchase if there is a breach of the New Zealand consumer law; furthermore, if it will be of significant cost to the New Zealand Consumer to return the goods to HP then HP will collect such goods at its own cost.

Table B-2 Support phone numbers

| Product | Phone |
|---|---|
| Support for all HP Products except those listed separately below | 0800 449 553 If dialing internationally: +61 2 8031-8317 |
| DeskJet, Office Jet, PSC, All-in-One, Photosmart & Personal LaserJet Series 1000, P1000, M1000 and Colour LaserJet CP1000 Series and model CM1415 | 0800 441 147 If dialing internationally: +61 2 8934 4380 |

UK, Ireland, and Malta

The HP Limited Warranty is a commercial guarantee voluntarily provided by HP. The name and address of the HP entity responsible for the performance of the HP Limited Warranty in your country/region is as follows:

UK: HP Inc UK Limited, Cain Road, Amen Corner, Bracknell, Berkshire, RG12 1HN

Ireland: Hewlett-Packard Ireland Limited, Liffey Park Technology Campus, Barnhall Road, Leixlip, Co.Kildare

Malta: Hewlett-Packard Europe B.V., Amsterdam, Meyrin Branch, Route du Nant-d'Avril 150, 1217 Meyrin, Switzerland

United Kingdom: The HP Limited Warranty benefits apply in addition to any legal rights to a guarantee from seller of nonconformity of goods with the contract of sale. These rights expire six years from delivery of goods for products purchased in England or Wales and five years from delivery of goods for products purchased in Scotland. However various factors may impact your eligibility to receive these rights. For further information, please consult the following link: Consumer Legal Guarantee (www.hp.com/go/eu-legal) or you may visit the European Consumer Centers website (commission.europa.eu). Consumers have the right to choose whether to claim service under the HP Limited Warranty or against the seller under the legal guarantee.

Ireland: The HP Limited Warranty benefits apply in addition to any statutory rights from seller in relation to nonconformity of goods with the contract of sale. However various factors may impact your eligibility to receive these rights. Consumer statutory rights are not limited or affected in any manner by HP Care Pack. For further information, please consult the following link: Consumer Legal Guarantee (www.hp.com/go/eu-legal) or you may visit the European Consumer Centers website (commission.europa.eu). Consumers have the right to choose whether to claim service under the HP Limited Warranty or against the seller under the legal guarantee.

Malta: The HP Limited Warranty benefits apply in addition to any legal rights to a two-year guarantee from seller of nonconformity of goods with the contract of sale; however various factors may impact your eligibility to receive these rights. Consumer statutory rights are not limited or affected in any manner by the HP Limited Warranty. For further information, please consult the following link: Consumer Legal Guarantee (www.hp.com/go/eu-legal) or you may visit the European Consumer Centers website (commission.europa.eu). Consumers have the right to choose whether to claim service under the HP Limited Warranty or against the seller under two-year legal guarantee.

Austria, Belgium, Germany, and Luxemburg

Die beschränkte HP Herstellergarantie ist eine von HP auf freiwilliger Basis angebotene kommerzielle Garantie. Der Name und die Adresse der HP Gesellschaft, die in Ihrem Land für die Gewährung der beschränkten HP Herstellergarantie verantwortlich ist, sind wie folgt:

Deutschland: HP Deutschland GmbH, Schickardstr. 32, D-71034 Böblingen

Österreich: HP Austria GmbH., Technologiestrasse 5, A-1120 Wien

Luxemburg: Hewlett-Packard Luxembourg S.C.A., 75, Parc d'Activités Capellen, Rue Pafebruc, L-8308 Capellen

Belgien: HP Belgium BVBA, Hermeslaan 1A, B-1831 Diegem

Die Rechte aus der beschränkten HP Herstellergarantie gelten zusätzlich zu den gesetzlichen Ansprüchen wegen Sachmängeln auf eine zweijährige Gewährleistung ab dem Lieferdatum. Ob Sie Anspruch auf diese Rechte haben, hängt von zahlreichen Faktoren ab. Die Rechte des Kunden sind in keiner Weise durch die beschränkte HP Herstellergarantie eingeschränkt bzw. betroffen. Weitere Hinweise finden Sie auf der folgenden Website: Gewährleistungsansprüche für Verbraucher (www.hp.com/go/eu-legal) oder Sie können die Website des Europäischen Verbraucherzentrums (commission.europa.eu) besuchen. Verbraucher haben das Recht zu wählen, ob sie eine Leistung von HP gemäß der beschränkten HP Herstellergarantie in Anspruch nehmen oder ob sie sich gemäß der gesetzlichen zweijährigen Haftung für Sachmängel (Gewährleistung) sich an den jeweiligen Verkäufer wenden.

Belgium, France, and Luxembourg

La garantie limitée HP est une garantie commerciale fournie volontairement par HP. Voici les coordonnées de l'entité HP responsable de l'exécution de la garantie limitée HP dans votre pays:

France: HP France SAS, société par actions simplifiée identifiée sous le numéro 448 694 133 RCS Evry, 1 Avenue du Canada, 91947, Les Ulis

G.D. Luxembourg: Hewlett-Packard Luxembourg S.C.A., 75, Parc d'Activités Capellen, Rue Pafebruc, L-8308 Capellen

Belgique: HP Belgium BVBA, Hermeslaan 1A, B-1831 Diegem

France: Les avantages de la garantie limitée HP s'appliquent en complément des droits dont vous disposez au titre des garanties légales applicables dont le bénéfice est soumis à des conditions spécifiques. Vos droits en tant que consommateur au titre de la garantie légale de conformité mentionnée aux articles L. 211-4 à L. 211-13 du Code de la Consommation et de celle relatives aux défauts de la chose vendue, dans les conditions prévues aux articles 1641 à 1648 et 2232 du Code de Commerce ne sont en aucune façon limités ou affectés par la garantie limitée HP. Pour de plus amples informations, veuillez consulter le lien suivant : Garanties légales accordées au consommateur (www.hp.com/go/eu-legal). Vous pouvez également consulter le site Web des Centres européens des consommateurs (commission.europa.eu). Les consommateurs ont le droit de choisir d'exercer leurs droits au titre de la garantie limitée HP, ou auprès du vendeur au titre des garanties légales applicables mentionnées ci-dessus.

POUR RAPPEL:

Garantie Légale de Conformité:

« Le vendeur est tenu de livrer un bien conforme au contrat et répond des défauts de conformité existant lors de la délivrance.

Il répond également des défauts de conformité résultant de l'emballage, des instructions de montage ou de l'installation lorsque celle-ci a été mise à sa charge par le contrat ou a été réalisée sous sa responsabilité ».

Article L211-5 du Code de la Consommation:

« Pour être conforme au contrat, le bien doit:

1° Etre propre à l'usage habituellement attendu d'un bien semblable et, le cas échéant:

- correspondre à la description donnée par le vendeur et posséder les qualités que celui-ci a présentées à l'acheteur sous forme d'échantillon ou de modèle;

- présenter les qualités qu'un acheteur peut légitimement attendre eu égard aux déclarations publiques faites par le vendeur, par le producteur ou par son représentant, notamment dans la publicité ou l'étiquetage;

2° Ou présenter les caractéristiques définies d'un commun accord par les parties ou être propre à tout usage spécial recherché par l'acheteur, porté à la connaissance du vendeur et que ce dernier a accepté ».

Article L211-12 du Code de la Consommation:

« L'action résultant du défaut de conformité se prescrit par deux ans à compter de la délivrance du bien ».

Garantie des vices cachés

Article 1641 du Code Civil : « Le vendeur est tenu de la garantie à raison des défauts cachés de la chose vendue qui la rendent impropre à l'usage auquel on la destine, ou qui diminuent tellement cet usage que l'acheteur ne l'aurait pas acquise, ou n'en aurait donné qu'un moindre prix, s'il les avait connus. »

Article 1648 alinéa 1 du Code Civil:

« L'action résultant des vices rédhibitoires doit être intentée par l'acquéreur dans un délai de deux ans à compter de la découverte du vice. »

G.D. Luxembourg et Belgique: Les avantages de la garantie limitée HP s'appliquent en complément des droits dont vous disposez au titre de la garantie de non-conformité des biens avec le contrat de vente. Cependant, de nombreux facteurs peuvent avoir un impact sur le bénéfice de ces droits. Vos droits en tant que consommateur au titre de ces garanties ne sont en aucune façon limités ou affectés par la garantie limitée HP. Pour de plus amples informations, veuillez consulter le lien suivant : Garanties légales accordées au consommateur (www.hp.com/go/eu-legal) ou vous pouvez également consulter le site Web des Centres européens des consommateurs (commission.europa.eu). Les consommateurs ont le droit de choisir de réclamer un service sous la garantie limitée HP ou auprès du vendeur au cours d'une garantie légale de deux ans.

Italy

La Garanzia limitata HP è una garanzia commerciale fornita volontariamente da HP. Di seguito sono indicati nome e indirizzo della società HP responsabile della fornitura dei servizi coperti dalla Garanzia limitata HP nel vostro Paese:

Italia: HP Italy S.r.l., Via G. Di Vittorio 9, 20063 Cernusco S/Naviglio

I vantaggi della Garanzia limitata HP vengono concessi ai consumatori in aggiunta ai diritti derivanti dalla garanzia di due anni fornita dal venditore in caso di non conformità dei beni rispetto al contratto di vendita. Tuttavia, diversi fattori possono avere un impatto sulla possibilità di beneficiare di tali diritti. I diritti spettanti ai consumatori in forza della garanzia legale non sono in alcun modo limitati, né modificati dalla Garanzia limitata HP. Per ulteriori informazioni, si prega di consultare il seguente link: Garanzia legale per i clienti (www.hp.com/go/eu-legal), oppure visitare il sito Web dei Centri europei per i consumatori (commission.europa.eu). I consumatori hanno il diritto di scegliere se richiedere un servizio usufruendo della Garanzia limitata HP oppure rivolgendosi al venditore per far valere la garanzia legale di due anni.

Spain

Su Garantía limitada de HP es una garantía comercial voluntariamente proporcionada por HP. El nombre y dirección de las entidades HP que proporcionan la Garantía limitada de HP (garantía comercial adicional del fabricante) en su país es:

España: Hewlett-Packard Española S.L. Calle Vicente Aleixandre, 1 Parque Empresarial Madrid - Las Rozas, E-28232 Madrid

Los beneficios de la Garantía limitada de HP son adicionales a la garantía legal de 2 años a la que los consumidores tienen derecho a recibir del vendedor en virtud del contrato de compraventa; sin embargo, varios factores pueden afectar su derecho a recibir los beneficios bajo dicha garantía legal. A este respecto, la Garantía limitada de HP no limita o afecta en modo alguno los derechos legales del consumidor (www.hp.com/go/eu-legal). Para más información, consulte el siguiente enlace: Garantía legal del consumidor o puede visitar el sitio

web de los Centros europeos de los consumidores (commission.europa.eu). Los clientes tienen derecho a elegir si reclaman un servicio acogiéndose a la Garantía limitada de HP o al vendedor de conformidad con la garantía legal de dos años.

Denmark

Den begrænsede HP-garanti er en garanti, der ydes frivilligt af HP. Navn og adresse på det HP-selskab, der er ansvarligt for HP's begrænsede garanti i dit land, er som følger:

Danmark: HP Inc Danmark ApS, Engholm Parkvej 8, 3450, Allerød

Den begrænsede HP-garanti gælder i tillæg til eventuelle juridiske rettigheder, for en toårig garanti fra sælgeren af varer, der ikke er i overensstemmelse med salgsaftalen, men forskellige faktorer kan dog påvirke din ret til at opnå disse rettigheder. Forbrugers lovbestemte rettigheder begrænses eller påvirkes ikke på nogen måde af den begrænsede HP-garanti. Se nedenstående link for at få yderligere oplysninger: Forbrugers juridiske garanti (www.hp.com/go/eu-legal) eller du kan besøge De Europæiske Forbrugercentres websted (commission.europa.eu). Forbrugere har ret til at vælge, om de vil gøre krav på service i henhold til HP's begrænsede garanti eller hos sælger i henhold til en toårig juridisk garanti.

Norway

HPs garanti er en begrenset og kommersiell garanti som HP selv har valgt å tilby. Følgende lokale selskap innestår for garantien:

Norge: HP Norge AS, Rolfbuktveien 4b, 1364 Fornebu

HPs garanti kommer i tillegg til det mangelsansvar HP har i henhold til norsk forbrukerkjøpslovgivning, hvor reklamasjonsperioden kan være to eller fem år, avhengig av hvor lenge salgsgjenstanden var ment å vare. Ulike faktorer kan imidlertid ha betydning for om du kvalifiserer til å kreve avhjelp iht slikt mangelsansvar. Forbrukers lovmessige rettigheter begrenses ikke av HPs garanti. Hvis du vil ha mer informasjon, kan du klikke på følgende kobling: Juridisk garanti for forbruker (www.hp.com/go/eu-legal) eller du kan besøke nettstedet til de europeiske forbrukersentrene (commission.europa.eu). Forbrukere har retten til å velge å kreve service under HPs garanti eller iht selgerens lovpålagte mangelsansvar.

Sweden

HP:s begränsade garanti är en kommersiell garanti som tillhandahålls frivilligt av HP. Namn och adress till det HP-företag som ansvarar för HP:s begränsade garanti i ditt land är som följer:

Sverige: HP PPS Sverige AB, SE-169 73 Stockholm

Fördelarna som ingår i HP:s begränsade garanti gäller utöver de lagstadgade rättigheterna till tre års garanti från säljaren angående varans bristande överensstämmelse gentemot köpeavtalet, men olika faktorer kan påverka din rätt att utnyttja dessa rättigheter. Konsumentens lagstadgade rättigheter varken begränsas eller påverkas på något sätt av HP:s begränsade garanti. Mer information får du om du följer denna länk: Lagstadgad garanti för konsumenter (www.hp.com/go/eu-legal) eller så kan du gå till European Consumer Centers webbplats (commission.europa.eu). Konsumenter har rätt att välja om de vill ställa krav enligt HP:s begränsade garanti eller på säljaren enligt den lagstadgade treåriga garantin.

Portugal

A Garantia Limitada HP é uma garantia comercial fornecida voluntariamente pela HP. O nome e a morada da entidade HP responsável pela prestação da Garantia Limitada HP no seu país são os seguintes:

Portugal: HPCP – Computing and Printing Portugal, Unipessoal, Lda., Edifício D. Sancho I, Quinta da Fonte, Porto Salvo, Lisboa, Oeiras, 2740 244

As vantagens da Garantia Limitada HP aplicam-se cumulativamente com quaisquer direitos decorrentes da legislação aplicável à garantia de dois anos do vendedor, relativa a defeitos do produto e constante do contrato de venda. Existem, contudo, vários fatores que poderão afetar a sua elegibilidade para beneficiar de tais direitos. Os direitos legalmente atribuídos aos consumidores não são limitados ou afetados de forma alguma pela Garantia Limitada HP. Para mais informações, consulte a ligação seguinte: Garantia legal do consumidor (www.hp.com/go/eu-legal) ou visite o Web site da Rede dos Centros Europeus do Consumidor (commission.europa.eu). Os consumidores têm o direito de escolher se pretendem reclamar assistência ao abrigo da Garantia Limitada HP ou contra o vendedor ao abrigo de uma garantia jurídica de dois anos.

Greece and Cyprus

Η Περιορισμένη εγγύηση HP είναι μια εμπορική εγγύηση η οποία παρέχεται εθελοντικά από την HP. Η επωνυμία και η διεύθυνση του νομικού προσώπου HP που παρέχει την Περιορισμένη εγγύηση HP στη χώρα σας είναι η εξής:

Ελλάδα /Κύπρος: HP Printing and Personal Systems Hellas EPE, Tzavella 1-3, 15232 Chalandri, Attiki

Ελλάδα /Κύπρος: HP Συστήματα Εκτύπωσης και Προσωπικών Υπολογιστών Ελλάς Εταιρεία Περιορισμένης Ευθύνης, Tzavella 1-3, 15232 Chalandri, Attiki

Τα προνόμια της Περιορισμένης εγγύησης HP ισχύουν επιπλέον των νόμιμων δικαιωμάτων για διετή εγγύηση έναντι του Πωλητή για τη μη συμμόρφωση των προϊόντων με τις συνομολογημένες συμβατικά ιδιότητες, ωστόσο η άσκηση των δικαιωμάτων σας αυτών μπορεί να εξαρτάται από διάφορους παράγοντες. Τα νόμιμα δικαιώματα των καταναλωτών δεν περιορίζονται ούτε επηρεάζονται καθ' οιονδήποτε τρόπο από την Περιορισμένη εγγύηση HP. Για περισσότερες πληροφορίες, συμβουλευτείτε την ακόλουθη τοποθεσία web: Νόμιμη εγγύηση καταναλωτή (www.hp.com/go/eu-legal) ή μπορείτε να επισκεφτείτε την τοποθεσία web των Ευρωπαϊκών Κέντρων Καταναλωτή (commission.europa.eu). Οι καταναλωτές έχουν το δικαίωμα να επιλέξουν αν θα αξιώσουν την υπηρεσία στα πλαίσια της Περιορισμένης εγγύησης HP ή από τον πωλητή στα πλαίσια της νόμιμης εγγύησης δύο ετών.

Hungary

A HP korlátozott jótállás egy olyan kereskedelmi jótállás, amelyet a HP a saját elhatározásából biztosít. Az egyes országokban a HP mint gyártó által vállalt korlátozott jótállást biztosító HP vállalatok neve és címe:

Magyarország: HP Inc Magyarország Kft., H-1117 Budapest, Alíz utca 1.

A HP korlátozott jótállásban biztosított jogok azokon a jogokon felül illetik meg Önt, amelyek a termékeknek az adásvételi szerződés szerinti minőségére vonatkozó kétéves, jogszabályban foglalt eladói szavatosságból, továbbá ha az Ön által vásárolt termékre alkalmazandó, a jogszabályban foglalt kötelező eladói jótállásból erednek, azonban számos körülmény hatással lehet arra, hogy ezek a jogok Önt megilletik-e. További információért kérjük, keresse fel a következő webhelyet: Jogi Tájékoztató Fogyasztóknak (www.hp.com/go/eu-legal) vagy látogassa meg az Európai Fogyasztói Központok webhelyét (commission.europa.eu). A fogyasztóknak jogában áll, hogy megválasszák, hogy a jótállással kapcsolatos igényüket a HP korlátozott jótállás alapján vagy a kétéves, jogszabályban foglalt eladói szavatosság, illetve, ha alkalmazandó, a jogszabályban foglalt kötelező eladói jótállás alapján érvényesítik.

Czech Republic

Omezená záruka HP je obchodní zárukou dobrovolně poskytovanou společností HP. Názy a adresy společnosti skupiny HP, které odpovídají za plnění omezené záruky HP ve vaší zemi, jsou následující:

Česká republika: HP Inc Czech Republic s. r. o., Za Brumlovkou 5/1559, 140 00 Praha 4

Výhody, poskytované omezenou zárukou HP, se uplatňují jako doplněk k jakýmkoli právním nárokům na dvouletou záruku poskytnutou prodejcem v případě nesouladu zboží s kupní smlouvou. Váš nárok na uznání těchto práv však může záviset na mnohých faktorech. Omezená záruka HP žádným způsobem neomezuje ani

neovlivňuje zákonná práva zákazníka. Další informace získáte kliknutím na následující odkaz: Zákonná záruka spotřebitele (www.hp.com/go/eu-legal) případně můžete navštívit webové stránky Evropského spotřebitelského centra (commission.europa.eu). Spotřebitelé mají právo se rozhodnout, zda chtějí službu reklamovat v rámci omezené záruky HP nebo v rámci zákonem stanovené dvouleté záruky u prodejce.

Slovakia

Obmedzená záruka HP je obchodná záruka, ktorú spoločnosť HP poskytuje dobrovoľne. Meno a adresa subjektu HP, ktorý zabezpečuje plnenie vyplývajúce z Obmedzenej záruky HP vo vašej krajine:

Slovenská republika: HP Inc Slovakia, s.r.o., Galvaniho 7, 821 04 Bratislava

Výhody Obmedzenej záruky HP sa uplatnia vedľa prípadných zákazníkových zákonných nárokov voči predávajúcemu z väd, ktoré spočívajú v nesúlade vlastností tovaru s jeho popisom podľa predmetnej zmluvy. Možnosť uplatnenia takých prípadných nárokov však môže závisieť od rôznych faktorov. Služby Obmedzenej záruky HP žiadnym spôsobom neobmedzujú ani neovplyvňujú zákonné práva zákazníka, ktorý je spotrebiteľom. Ďalšie informácie nájdete na nasledujúcom prepojení: Zákonná záruka spotrebiteľa (www.hp.com/go/eu-legal), prípadne môžete navštíviť webovú lokalitu európskych zákazníckych stredísk (commission.europa.eu). Spotrebiteľia majú právo zvoliť si, či chcú uplatniť servis v rámci Obmedzenej záruky HP alebo počas zákonnej dvojročnej záručnej lehoty u predajcu.

Poland

Ograniczona gwarancja HP to komercyjna gwarancja udzielona dobrowolnie przez HP. Nazwa i adres podmiotu HP odpowiedzialnego za realizację Ograniczonej gwarancji HP w Polsce:

Polska: HP Inc Polska sp. z o.o., Szturmowa 2a, 02-678 Warszawa, wpisana do rejestru przedsiębiorców prowadzonego przez Sąd Rejonowy dla m.st. Warszawy w Warszawie, XIII Wydział Gospodarczy Krajowego Rejestru Sądowego, pod numerem KRS 0000546115, NIP 5213690563, REGON 360916326, GIOŚ E0020757WZBW, kapitał zakładowy 480.000 PLN.

Świadczenia wynikające z Ograniczonej gwarancji HP stanowią dodatek do praw przysługujących nabywcy w związku z dwuletnią odpowiedzialnością sprzedawcy z tytułu niezgodności towaru z umową (rekojmia). Niemniej, na możliwość korzystania z tych praw mają wpływ różne czynniki. Ograniczona gwarancja HP w żaden sposób nie ogranicza praw konsumenta ani na nie nie wpływa. Więcej informacji można znaleźć pod następującym łączem: Gwarancja prawna konsumenta (www.hp.com/go/eu-legal), można także odwiedzić stronę internetową Europejskiego Centrum Konsumentckiego (commission.europa.eu). Konsumenti mają prawo wyboru co do możliwości skorzystania albo z usług gwarancyjnych przysługujących w ramach Ograniczonej gwarancji HP albo z uprawnień wynikających z dwuletniej rekojmii w stosunku do sprzedawcy.

Bulgaria

Ограничената гаранция на HP представлява търговска гаранция, доброволно предоставяна от HP. Името и адресът на дружеството на HP за вашата страна, отговорно за предоставянето на гаранционната поддръжка в рамките на Ограничената гаранция на HP, са както следва:

HP Inc Bulgaria EOOD (Ейч Пи Инк България EOOD), гр. София 1766, район р-н Младост, бул. Околовръстен Път No 258, Бизнес Център Камбаните

Предимствата на Ограничената гаранция на HP се прилагат в допълнение към всички законови права за двугодишна гаранция от продавача при несъответствие на стоката с договора за продажба. Въпреки това, различни фактори могат да окажат влияние върху условията за получаване на тези права. Законите права на потребителите не са ограничени или засегнати по никакъв начин от Ограничената гаранция на HP. За допълнителна информация, моля вижте Правната гаранция на потребителя (www.hp.com/go/eu-legal) или посетете уебсайта на Европейския потребителски център (commission.europa.eu). Потребителите имат правото да избират дали да претендират за извършване на услуга в рамките на Ограничената гаранция на HP или да потърсят такава от търговеца в рамките на двугодишната правна гаранция.

Romania

Garanția limitată HP este o garanție comercială furnizată în mod voluntar de către HP. Numele și adresa entității HP răspunzătoare de punerea în aplicare a Garanției limitate HP în țara dumneavoastră sunt următoarele:

România: HP Inc Romania SRL, 5 Fabrica de Glucoza Str., Building F, Ground Floor and Floor 8, 2nd District, București

Beneficiile Garanției limitate HP se aplică suplimentar față de orice drepturi privind garanția de doi ani oferită de vânzător pentru neconformitatea bunurilor cu contractul de vânzare; cu toate acestea, diverși factori pot avea impact asupra eligibilității dvs. de a beneficia de aceste drepturi. Drepturile legale ale consumatorului nu sunt limitate sau afectate în vreun fel de Garanția limitată HP. Pentru informații suplimentare consultați următorul link: garanția acordată consumatorului prin lege (www.hp.com/go/eu-legal) sau puteți accesa site-ul Centrul European al Consumatorilor (commission.europa.eu). Consumatorii au dreptul să aleagă dacă să pretindă despăgubiri în cadrul Garanției limitate HP sau de la vânzător, în cadrul garanției legale de doi ani.

Belgium and the Netherlands

De Beperkte Garantie van HP is een commerciële garantie vrijwillig verstrekt door HP. De naam en het adres van de HP-entiteit die verantwoordelijk is voor het uitvoeren van de Beperkte Garantie van HP in uw land is als volgt:

Nederland: HP Nederland B.V., Startbaan 16, 1187 XR Amstelveen

België: HP Belgium BVBA, Hermeslaan 1A, B-1831 Diegem

De voordelen van de Beperkte Garantie van HP vormen een aanvulling op de wettelijke garantie voor consumenten gedurende twee jaren na de levering te verlenen door de verkoper bij een gebrek aan conformiteit van de goederen met de relevante verkoopovereenkomst. Niettemin kunnen diverse factoren een impact hebben op uw eventuele aanspraak op deze wettelijke rechten. De wettelijke rechten van de consument worden op geen enkele wijze beperkt of beïnvloed door de Beperkte Garantie van HP. Raadpleeg voor meer informatie de volgende webpagina: Wettelijke garantie van de consument (www.hp.com/go/eu-legal) of u kan de website van het Europees Consumenten Centrum bezoeken (commission.europa.eu). Consumenten hebben het recht om te kiezen tussen enerzijds de Beperkte Garantie van HP of anderzijds het aanspreken van de verkoper in toepassing van de wettelijke garantie.

Finland

HP:n rajoitettu takuu on HP:n vapaaehtoisesti antama kaupallinen takuu. HP:n myöntämästä takuusta maassanne vastaavan HP:n edustajan yhteystiedot ovat:

Suomi: HP Finland Oy, Piispankalliontie, FIN - 02200 Espoo

HP:n takuun edut ovat voimassa mahdollisten kuluttajansuojalakiin perustuvien oikeuksien lisäksi sen varalta, että tuote ei vastaa myyntisopimusta. Saat lisätietoja seuraavasta linkistä: Kuluttajansuoja (www.hp.com/go/eu-legal) tai voit käydä Euroopan kuluttajakeskuksen sivustolla (commission.europa.eu). Kuluttajilla on oikeus vaatia virheen korjausta HP:n takuun ja kuluttajansuojan perusteella HP:lta tai myyjältä.

Slovenia

Omejena garancija HP je prostovoljna trgovska garancija, ki jo zagotavlja podjetje HP. Ime in naslov poslovne enote HP, ki je odgovorna za omejeno garancijo HP v vaši državi, sta naslednja:

Slovenija: Hewlett-Packard Europe B.V., Amsterdam, Meyrin Branch, Route du Nant-d'Avril 150, 1217 Meyrin, Switzerland

Ugodnosti omejene garancije HP veljajo poleg zakonskih pravic, ki ob sklenitvi kupoprodajne pogodbe izhajajo iz dveletne garancije prodajalca v primeru neskladnosti blaga, vendar lahko na izpolnjevanje pogojev za uveljavitev

pravic vplivajo različni dejavniki. Omejena garancija HP nikakor ne omejuje strankinih z zakonom predpisanih pravic in ne vpliva nanje. Za dodatne informacije glejte naslednjo povezavo: Strankino pravno jamstvo (www.hp.com/go/eu-legal); ali pa obiščite spletno mesto evropskih središč za potrošnike (commission.europa.eu). Potrošniki imajo pravico izbrati, ali bodo uveljavljali pravice do storitev v skladu z omejeno garancijo HP ali proti prodajalcu v skladu z dvoletno zakonsko garancijo.

Croatia

HP ograničeno jamstvo komercialno je dobrovoljno jamstvo koje pruža HP. Ime i adresa HP subjekta odgovornog za HP ograničeno jamstvo u vašoj državi:

Hrvatska: HP Computing and Printing d.o.o. za računalne i srodne aktivnosti, Radnička cesta 41, 10000 Zagreb

Pogodnosti HP ograničenog jamstva vrijede zajedno uz sva zakonska prava na dvogodišnje jamstvo kod bilo kojeg prodavača s obzirom na nepodudaranje robe s ugovorom o kupnji. Međutim, razni faktori mogu utjecati na vašu mogućnost ostvarivanja tih prava. HP ograničeno jamstvo ni na koji način ne utječe niti ne ograničava zakonska prava potrošača. Dodatne informacije potražite na ovoj adresi: Zakonsko jamstvo za potrošače (www.hp.com/go/eu-legal) ili možete posjetiti web-mjesto Europskih potrošačkih centara (commission.europa.eu). Potrošači imaju pravo odabrati žele li ostvariti svoja potraživanja u sklopu HP ograničenog jamstva ili pravnog jamstva prodavača u trajanju ispod dvije godine.

Latvia

HP ierobežotā garantija ir komercgarantija, kuru brīvprātīgi nodrošina HP. HP uzņēmums, kas sniedz HP ierobežotās garantijas servisa nodrošinājumu jūsu valstī:

Latvija: HP Finland Oy, PO Box 515, 02201 Espoo, Finland

HP ierobežotās garantijas priekšrocības tiek piedāvātas papildus jebkurām likumīgajām tiesībām uz pārdevēja un/vai ražotāju nodrošinātu divu gadu garantiju gadījumā, ja preces neatbilst pirkuma līgumam, tomēr šo tiesību saņemšanu var ietekmēt vairāki faktori. HP ierobežotā garantija nekādā veidā neierobežo un neietekmē patērētāju likumīgās tiesības. Lai iegūtu plašāku informāciju, izmantojiet šo saiti: Patērētāju likumīgā garantija (www.hp.com/go/eu-legal) vai arī Eiropas Patērētāju tiesību aizsardzības centra tīmekļa vietni (commission.europa.eu). Patērētājiem ir tiesības izvēlēties, vai pieprasīt servisa nodrošinājumu saskaņā ar HP ierobežoto garantiju, vai arī pārdevēja sniegto divu gadu garantiju.

Lithuania

HP ribotoji garantija yra HP savanoriškai teikiama komercinė garantija. Toliau pateikiami HP bendrovių, teikiančių HP garantiją (gamintojo garantiją) jūsų šalyje, pavadinimai ir adresai:

Lietuva: HP Finland Oy, PO Box 515, 02201 Espoo, Finland

HP ribotoji garantija papildomai taikoma kartu su bet kokiomis kitomis įstatymais nustatytais teisėmis į pardavėjo suteikiamą dviejų metų laikotarpio garantiją dėl prekių atitikties pardavimo sutarčiai, tačiau tai, ar jums ši teisė bus suteikiama, gali priklausyti nuo įvairių aplinkybių. HP ribotoji garantija niekaip neapriboja ir neįtakoja įstatymais nustatytų vartotojo teisių. Daugiau informacijos rasite paspaudę šią nuorodą: Teisinė vartotojo garantija (www.hp.com/go/eu-legal) arba apsilankę Europos vartotojų centro internetinėje svetainėje (commission.europa.eu). Vartotojai turi teisę prašyti atlikti techninį aptarnavimą pagal HP ribotąją garantiją arba pardavėjo teikiamą dviejų metų įstatymais nustatytą garantiją.

Estonia

HP piiratud garantii on HP poolt vabatahtlikult pakutav kaubanduslik garantii. HP piiratud garantii eest vastutab HP üksus aadressil:

Eesti: HP Finland Oy, PO Box 515, 02201 Espoo, Finland

HP piiratud garantii rakendub lisaks seaduses ettenähtud müüjapoolsele kaheaastasele garantiile, juhul kui toode ei vasta müügilepingu tingimustele. Siiski võib esineda asjaolusid, mille puhul teie jaoks need õigused ei pruugi kehtida. HP piiratud garantii ei piira ega mõjuta mingil moel tarbija seadusjärgseid õigusi. Lisateavet leiate järgmiselt lingilt: tarbija õiguslik garantii (www.hp.com/go/eu-legal) või võite külastada Euroopa tarbijakeskuste veebisaiti (commission.europa.eu). Tarbijal on õigus valida, kas ta soovib kasutada HP piiratud garantiid või seadusega ette nähtud müüjapoolset kaheaastast garantiid.

Russia

Срок службы принтера для России

Срок службы данного принтера HP составляет пять лет в нормальных условиях эксплуатации. Срок службы отсчитывается с момента ввода принтера в эксплуатацию. В конце срока службы HP рекомендует посетить веб-сайт нашей службы поддержки по адресу www.hp.com/support и/или связаться с авторизованным поставщиком услуг HP для получения рекомендаций в отношении дальнейшего безопасного использования принтера.

HP's Premium Protection Warranty: LaserJet toner cartridge limited warranty statement

This HP product is warranted to be free from defects in materials and workmanship.

This warranty does not apply to products that (a) have been refilled, refurbished, remanufactured or tampered with in any way, (b) experience problems resulting from misuse, improper storage, or operation outside of the published environmental specifications for the printer product or (c) exhibit wear from ordinary use.

To obtain warranty service, please return the product to place of purchase (with a written description of the problem and print samples) or contact support. At HP's option, HP will either replace products that prove to be defective or refund your purchase price.

TO THE EXTENT ALLOWED BY LOCAL LAW, THE ABOVE WARRANTY IS EXCLUSIVE AND NO OTHER WARRANTY OR CONDITION, WHETHER WRITTEN OR ORAL, IS EXPRESSED OR IMPLIED AND HP SPECIFICALLY DISCLAIMS ANY IMPLIED WARRANTIES OR CONDITIONS OF MERCHANTABILITY, SATISFACTORY QUALITY, AND FITNESS FOR A PARTICULAR PURPOSE.

TO THE EXTENT ALLOWED BY LOCAL LAW, IN NO EVENT WILL HP OR ITS SUPPLIERS BE LIABLE FOR DIRECT, SPECIAL, INCIDENTAL, CONSEQUENTIAL (INCLUDING LOST PROFIT OR DATA), OR OTHER DAMAGE, WHETHER BASED IN CONTRACT, TORT, OR OTHERWISE.

THE WARRANTY TERMS CONTAINED IN THIS STATEMENT, EXCEPT TO THE EXTENT LAWFULLY PERMITTED, DO NOT EXCLUDE, RESTRICT OR MODIFY AND ARE IN ADDITION TO THE MANDATORY STATUTORY RIGHTS APPLICABLE TO THE SALE OF THIS PRODUCT TO YOU.

HP policy on non-Original HP supplies

HP cannot recommend the use of non-Original HP toner cartridges, either new or remanufactured.

 **NOTE:** For HP printer products, the use of a non-Original HP toner cartridge or a refilled toner cartridge does not affect either the warranty to the customer or any HP support contract with the customer. However, if product failure or damage is attributable to the use of a non-Original HP toner cartridge or refilled toner cartridge, HP will charge its standard time and materials charges to service the product for the particular failure or damage.

HP anticounterfeit Web site

Go to www.hp.com/go/anticounterfeit when you install an HP toner cartridge and the control-panel message indicates the cartridge is non-Original HP supplies. HP will help determine if the cartridge is genuine and take steps to resolve the problem.

Your toner cartridge might not be a genuine HP toner cartridge if you notice the following:

- The supplies status page indicates that a non-Original HP supply is installed.
- You are experiencing a high number of problems with the cartridge.
- The cartridge does not look like it usually does (for example, the packaging differs from HP packaging).

Data stored on the toner cartridge

The HP toner cartridges used with this product contain a memory chip that assists in the operation of the product.

In addition, this memory chip collects a limited set of information about the usage of the product, which might include the following: the date when the toner cartridge was first installed, the date when the toner cartridge was last used, the number of pages printed using the toner cartridge, the page coverage, the printing modes used, any printing errors that might have occurred, and the product model. This information helps HP design future products to meet our customers' printing needs.

The data collected from the toner cartridge memory chip does not contain information that can be used to identify a customer or user of the toner cartridge or their product.

HP collects a sampling of the memory chips from toner cartridges returned to HP's free return and recycling program (HP Planet Partners: www.hp.com/recycle). The memory chips from this sampling are read and studied in order to improve future HP products. HP partners who assist in recycling this toner cartridge might have access to this data, as well.

Any third party possessing the toner cartridge might have access to the anonymous information on the memory chip.

End User License Agreement

READ CAREFULLY BEFORE USING THIS SOFTWARE EQUIPMENT:

This End-User License Agreement ("EULA") is a legal agreement between (a) you (either an individual or a single entity) and (b) HP Inc. ("HP") that governs your use of any Software Product, installed on or made available by HP for use with your HP product ("HP Product"), that is not otherwise subject to a separate license agreement between you and HP or its suppliers. Other software may contain a EULA in its online documentation. The term "Software Product" means computer software and may include associated media, printed materials and "online" or electronic documentation.

An amendment or addendum to this EULA may accompany the HP Product.

RIGHTS IN THE SOFTWARE PRODUCT ARE OFFERED ONLY ON THE CONDITION THAT YOU AGREE TO ALL TERMS AND CONDITIONS OF THIS EULA. BY INSTALLING, COPYING, DOWNLOADING, OR OTHERWISE USING THE SOFTWARE PRODUCT, YOU AGREE TO BE BOUND BY THE TERMS OF THIS EULA. IF YOU DO NOT ACCEPT THESE LICENSE TERMS, YOUR SOLE REMEDY IS TO RETURN THE ENTIRE UNUSED PRODUCT (HARDWARE AND SOFTWARE) WITHIN 14 DAYS FOR A REFUND SUBJECT TO THE REFUND POLICY OF YOUR PLACE OF PURCHASE.

THIS EULA IS A GLOBAL AGREEMENT AND IS NOT SPECIFIC TO ANY PARTICULAR COUNTRY, STATE OR TERRITORY. IF YOU ACQUIRED THE SOFTWARE AS A CONSUMER WITHIN THE MEANING OF RELEVANT CONSUMER LEGISLATION IN YOUR COUNTRY, STATE OR TERRITORY, THEN DESPITE ANYTHING TO THE CONTRARY IN THIS EULA, NOTHING IN THIS EULA AFFECTS ANY NON EXCLUDABLE STATUTORY RIGHTS OR REMEDIES THAT YOU MAY HAVE UNDER SUCH CONSUMER LEGISLATION AND THIS EULA IS SUBJECT TO THOSE RIGHTS AND REMEDIES. REFER TO SECTION 16 FOR FURTHER INFORMATION ON YOUR CONSUMER RIGHTS.

1. **GRANT OF LICENSE.** HP grants you the following rights provided you comply with all terms and conditions of this EULA:
 - a. **Use.** You may use the Software Product on a single computer ("Your Computer"). If the Software Product is provided to you via the internet and was originally licensed for use on more than one computer, you may install and use the Software Product only on those computers. You may not separate component parts of the Software Product for use on more than one computer. You do not have the right to distribute the Software Product, nor do you have the right to modify the Software Product or disable any licensing or control feature of the Software Product. You may load the Software Product into Your Computer's temporary memory (RAM) for purposes of using the Software Product.
 - b. **Storage.** You may copy the Software Product into the local memory or storage device of the HP Product.
 - c. **Copying.** You may make archival or back-up copies of the Software Product, provided the copy contains all of the original Software Product's proprietary notices and that it is used only for back-up purposes.
 - d. **Reservation of Rights.** HP and its suppliers reserve all rights not expressly granted to you in this EULA.
 - e. **Freeware.** Notwithstanding the terms and conditions of this EULA, all or any portion of the Software Product which constitutes non-proprietary HP software or software provided under public license by third parties ("Freeware"), is licensed to you subject to the terms and conditions of the software license agreement accompanying such Freeware whether in the form of a discrete agreement, shrink wrap license or electronic license terms accepted at time of download. Use of the Freeware by you shall be governed entirely by the terms and conditions of such license.
 - f. **Recovery Solution.** Any software recovery solution provided with/for your HP Product, whether in the form of a hard disk drive-based solution, an external media-based recovery solution (e.g. floppy disk, CD or DVD) or an equivalent solution delivered in any other form, may only be used for restoring the hard disk of the HP Product with/for which the recovery solution was originally purchased. The use of any Microsoft operating system software contained in such recovery solution shall be governed by the Microsoft License Agreement.
2. **UPGRADES.** To use a Software Product identified as an upgrade, you must first be licensed for the original Software Product identified by HP as eligible for the upgrade. After upgrading, you may no longer use the original Software Product that formed the basis for your upgrade eligibility. By using the Software Product, you also agree that HP may automatically access your HP Product when connected to the internet to check the version or status of certain Software Products and may automatically download and install upgrades or updates to such Software Products on to your HP Product to provide new versions or updates required to maintain the functionality, performance, or security of the Software Product and your HP Product and facilitate the provision of support or other services provided to you. In certain cases, and depending on the type of upgrade or update, notifications will be provided to you (via pop-up or other means), which may require you to initiate the upgrade or update.
3. **ADDITIONAL SOFTWARE.** This EULA applies to updates or supplements to the original Software Product provided by HP unless HP provides other terms along with the update or supplement. In case of a conflict between such terms, the other terms will prevail.
4. **TRANSFER.**

- a. **Third Party.** The initial user of the Software Product may make a one-time transfer of the Software Product to another end user. Any transfer must include all component parts, media, printed materials, this EULA, and if applicable, the Certificate of Authenticity. The transfer may not be an indirect transfer, such as a consignment. Prior to the transfer, the end user receiving the transferred product must agree to all the EULA terms. Upon transfer of the Software Product, your license is automatically terminated.
 - b. **Restrictions.** You may not rent, lease or lend the Software Product or use the Software Product for commercial timesharing or bureau use. You may not sublicense, assign or transfer the license or Software Product except as expressly provided in this EULA.
5. **PROPRIETARY RIGHTS.** All intellectual property rights in the Software Product and user documentation are owned by HP or its suppliers and are protected by law, including but not limited to United States copyright, trade secret, and trademark law, as well as other applicable laws and international treaty provisions. You shall not remove any product identification, copyright notices or proprietary restrictions from the Software Product.
6. **LIMITATION ON REVERSE ENGINEERING.** You may not reverse engineer, decompile, or disassemble the Software Product, except and only to the extent that the right to do so is mandated under applicable law notwithstanding this limitation or it is expressly provided for in this EULA.
7. **TERM.** This EULA is effective unless terminated or rejected. This EULA will also terminate upon conditions set forth elsewhere in this EULA or if you fail to comply with any term or condition of this EULA.
8. **NOTICE OF DATA COLLECTION.**

CONSENT TO COLLECTION/USE OF DATA.

- a. You agree that HP and its affiliates may collect, combine, and use device and individual user information you provide in relation to support services related to the Software Product. HP agrees not to use this information to market to you without your consent. Learn More about HP data collection practices at www.hp.com/go/privacy
- b. HP will use cookies and other web technology tools to collect anonymous technical information related to HP Software and your HP Product. This data will be used to provide the upgrades and related support or other services described in Section 2. HP will also collect personal information including your Internet Protocol address or other unique identifier information associated with your HP Product and data provided by you on registration of your HP Product. As well as providing the upgrades and related support or other services, this data will be used for sending marketing communications to you (in each case with your express consent where required by applicable law).

To the extent permitted by applicable law, by accepting these terms and conditions you consent to the collection and use of anonymous and personal data by HP, its subsidiaries, and affiliates as described in this EULA and as further described in HP's privacy policy: www.hp.com/go/privacy

- c. **Collection/Use by Third Parties.** Certain software programs included in your HP Product are provided and separately licensed to you by third party providers ("Third Party Software"). Third Party Software may be installed and operational on your HP Product even if you choose not to activate/purchase such software. Third Party Software may collect and transmit technical information about your system (i.e., IP address, unique device identifier, software version installed, etc.) and other system data. This information is used by the third party to identify technical system attributes and ensure that the most current version of the software has been installed on your system. If you do not want the Third Party Software to collect this technical information or automatically send you version updates, you should uninstall the software prior to connecting to the Internet.

9. **DISCLAIMER OF WARRANTIES.** TO THE MAXIMUM EXTENT PERMITTED BY APPLICABLE LAW, HP AND ITS SUPPLIERS PROVIDE THE SOFTWARE PRODUCT “AS IS” AND WITH ALL FAULTS, AND HEREBY DISCLAIM ALL OTHER WARRANTIES, DUTIES, AND CONDITIONS, EITHER EXPRESS, IMPLIED, OR STATUTORY, INCLUDING, BUT NOT LIMITED TO, WARRANTIES: (i) OF TITLE AND NON-INFRINGEMENT; (ii) OF MERCHANTABILITY; (iii) OF FITNESS FOR A PARTICULAR PURPOSE; (iv) THAT THE SOFTWARE PRODUCT WILL FUNCTION WITH NON-HP SUPPLIES OR ACCESSORIES; AND (v), OF LACK OF VIRUSES ALL WITH REGARD TO THE SOFTWARE PRODUCT. Some states/jurisdictions do not allow exclusion of implied warranties or limitations on the duration of implied warranties, so the above disclaimer may not apply to you in its entirety.
10. **LIMITATION OF LIABILITY.** Subject to the laws of the People's Republic of China, notwithstanding any damages that you might incur, the entire liability of HP and any of its suppliers under any provision of this EULA and your exclusive remedy for all of the foregoing shall be limited to the greater of the amount actually paid by you separately for the Software Product or U.S. \$5.00. TO THE MAXIMUM EXTENT PERMITTED BY APPLICABLE LAW, IN NO EVENT SHALL HP OR ITS SUPPLIERS BE LIABLE FOR ANY SPECIAL, INCIDENTAL, INDIRECT, OR CONSEQUENTIAL DAMAGES WHATSOEVER (INCLUDING, BUT NOT LIMITED TO, DAMAGES FOR LOSS OF PROFITS OR CONFIDENTIAL OR OTHER INFORMATION, FOR BUSINESS INTERRUPTION, FOR PERSONAL INJURY, OR FOR LOSS OF PRIVACY) ARISING OUT OF OR IN ANY WAY RELATED TO THE USE OF OR INABILITY TO USE THE SOFTWARE PRODUCT, OR OTHERWISE IN CONNECTION WITH ANY PROVISION OF THIS EULA, EVEN IF HP OR ANY SUPPLIER HAS BEEN ADVISED OF THE POSSIBILITY OF SUCH DAMAGES AND EVEN IF THE REMEDY FAILS OF ITS ESSENTIAL PURPOSE. Some states/jurisdictions do not allow the exclusion or limitation of incidental or consequential damages, so the above limitation or exclusion may not apply to you.
11. **U.S. GOVERNMENT CUSTOMERS.** Consistent with FAR 12.211 and 12.212, Commercial Computer Software, Computer Software Documentation, and Technical Data for Commercial Items are licensed to the U.S. Government under HP's standard commercial license.
12. **COMPLIANCE WITH EXPORT LAWS.** You shall comply with all laws and regulations of the United States and other countries (“Export Laws”) to assure that the Software Product is not (1) exported, directly or indirectly, in violation of Export Laws, or (2) used for any purpose prohibited by Export Laws, including, without limitation, nuclear, chemical, or biological weapons proliferation.
13. **CAPACITY AND AUTHORITY TO CONTRACT.** You represent that you are of the legal age of majority in your state of residence and, if applicable, you are duly authorized by your employer to enter into this contract.
14. **APPLICABLE LAW.** This EULA is governed by the laws of the country in which the equipment was purchased.
15. **ENTIRE AGREEMENT.** This EULA (including any addendum or amendment to this EULA which is included with the HP Product) is the entire agreement between you and HP relating to the Software Product and it supersedes all prior or contemporaneous oral or written communications, proposals and representations with respect to the Software Product or any other subject matter covered by this EULA. To the extent the terms of any HP policies or programs for support services conflict with the terms of this EULA, the terms of this EULA shall control.
16. **CONSUMER RIGHTS.** Consumers in some countries, states or territories may have the benefit of certain statutory rights and remedies under consumer legislation in respect of which HP's liability cannot lawfully be excluded or limited. If you acquired the Software as a consumer within the meaning of relevant consumer legislation in your country, state or territory, the provisions of this EULA (including the disclaimers of warranties, limitations and exclusions of liability) must be read subject to applicable law and apply only to the maximum extent permitted by that applicable law.

Australian Consumers: If you acquired the Software as a consumer within the meaning of the ‘Australian Consumer Law’ under the Australian Competition and Consumer Act 2010 (Cth) then despite any other provision of this EULA:

- a. the Software comes with guarantees that cannot be excluded under the Australian Consumer Law, including that goods will be of acceptable quality and services will be supplied with due care and skill. You are entitled to a replacement or refund for a major failure and compensation for any other reasonably foreseeable loss or damage. You are also entitled to have the Software repaired or replaced if it is not of acceptable quality and the failure does not amount to a major failure.
- b. nothing in this EULA excludes, restricts or modifies any right or remedy, or any guarantee, warranty or other term or condition implied or imposed by the Australian Consumer Law which cannot be lawfully excluded or limited; and
- c. the benefits provided to you by the express warranties in this EULA are in addition to other rights and remedies available to you under the Australian Consumer Law. Your rights under the Australian Consumer Law prevail to the extent that they are inconsistent with any limitations contained in the express warranty.
- d. The Software may be capable of retaining user-generated data. HP hereby provides you with notice that if HP repairs your Software, that repair may result in the loss of that data. To the full extent permitted by law, the limitations and exclusions of HP's liability in this EULA apply in respect of any such loss of data.

If you think that you are entitled to any warranty under this agreement or any of the above remedies, please contact HP:

HP PPS Australia Pty Ltd

Rhodes Corporate Park, Building F, Level 5

1 Homebush Bay Drive

Rhodes, NSW 2138

Australia

To initiate a support request or warranty claim, please call 13 10 47 (within Australia) or +61 2 8278 1039 (if dialing internationally) or visit www8.hp.com/au/en/contact-hp/phone-assist.html for the most current list of phone support numbers.

If you are a consumer within the meaning of the Australia Consumer Law and you are purchasing the Software or warranty and support services for the Software which are not of a kind ordinarily acquired for personal, domestic or household use or consumption, then despite any other provision of this EULA, HP limits its liability for failure to comply with a consumer guarantee as follows:

- a. provision of warranty or support services for the Software: to any one or more of the following: re-supply of the services or payment of the costs of having the services re-supplied;
- b. provision of the Software: to any one or more of the following: replacement of the Software or the supply of equivalent software; repair of the Software; payment of the costs of replacing the Software or of acquiring equivalent software; or payment of the costs of having the Software repaired; and
- c. otherwise, to the maximum extent permitted by law.

New Zealand Consumers: In New Zealand, the Software comes with guarantees that cannot be excluded under the Consumer Guarantees Act 1993. In New Zealand, Consumer Transaction means a transaction involving a person who is purchasing goods for personal, domestic or household use or consumption and not for the purpose of a business. New Zealand consumers who are purchasing goods for personal, domestic or household use or consumption and not for the purpose of a business ("New Zealand Consumers") are entitled to repair, replacement or refund for a failure and compensation for other reasonably foreseeable loss or damage. A New Zealand Consumer (as defined above) may recover the costs of returning the product to the place of purchase if there is a breach of the New Zealand consumer law; furthermore, if it will be of significant cost to the New Zealand Consumer to return the goods to HP then HP will collect such goods at its own cost. Where any supply of products or services is for business purposes, you agree that the Consumer Guarantees Act 1993 does not apply and that given the nature and value of the transaction, this is fair and reasonable.

© Copyright 2022 HP Development Company, L.P.

The information contained herein is subject to change without notice. All other product names mentioned herein may be trademarks of their respective companies. To the extent permitted by applicable law, the only warranties for HP products and services are set forth in the express warranty statements accompanying such products and services. Nothing herein should be construed as constituting an additional warranty. To the extent permitted by applicable law, HP shall not be liable for technical or editorial errors or omissions contained herein.

Customer self-repair warranty service

HP products are designed with many Customer Self Repair (CSR) parts to minimize repair time and allow for greater flexibility in performing defective parts replacement. If during the diagnosis period, HP identifies that the repair can be accomplished by the use of a CSR part, HP will ship that part directly to you for replacement. There are two categories of CSR parts: 1) Parts for which customer self repair is mandatory. If you request HP to replace these parts, you will be charged for the travel and labor costs of this service. 2) Parts for which customer self repair is optional. These parts are also designed for Customer Self Repair. If, however, you require that HP replace them for you, this may be done at no additional charge under the type of warranty service designated for your product.

Based on availability and where geography permits, CSR parts will be shipped for next business day delivery. Same-day or four-hour delivery may be offered at an additional charge where geography permits. If assistance is required, you can call the HP Technical Support Center and a technician will help you over the phone. HP specifies in the materials shipped with a replacement CSR part whether a defective part must be returned to HP. In cases where it is required to return the defective part to HP, you must ship the defective part back to HP within a defined period of time, normally five (5) business days. The defective part must be returned with the associated documentation in the provided shipping material. Failure to return the defective part may result in HP billing you for the replacement. With a customer self repair, HP will pay all shipping and part return costs and determine the courier/carrier to be used.

Customer support

Table B-3 Customer Support

| Support | URL links |
|--|--|
| Get telephone support for your country/region | Country/region phone numbers are on the flyer that was in the box with your product or at www.hp.com/support |
| Have the product name, serial number, date of purchase, and problem description ready. | |
| Get 24-hour Internet support, and download software utilities and drivers | www.hp.com/support |

Table B-3 Customer Support (continued)

| Support | URL links |
|---|--|
| Order additional HP service or maintenance agreements | www.hp.com/go/carepack |
| Register your product | www.register.hp.com |

C Environmental product stewardship program

This section describes the environmental-friendly product stewardship program at HP.

Protecting the environment

HP is committed to providing quality products in an environmentally sound manner. This product has been designed with several attributes to minimize impacts on our environment.

Ozone production

The airborne emissions of ozone for this product have been measured according to a standardized protocol and when these emissions data are applied to an anticipated high-use scenario in an office workspace, HP has determined there is no appreciable amount of ozone generated during printing and the levels are well within current indoor air quality standards and guidelines.

References -

Test method for the determination of emissions from hardcopy devices with respect to awarding the environmental label for office devices with printing function; DE-UZ 205 – BAM; January 2018.

Based on ozone concentration when printing 2 hours per day in 30.6 cubic meter room with a ventilation rate of 0.68 air changes per hour with HP printing supplies.

Power consumption

Power usage drops significantly while in Ready, Sleep, or Off mode, which saves natural resources and saves money without affecting the high performance of this product. HP printing and imaging equipment marked with the ENERGY STAR® logo is qualified to the U.S. Environmental Protection Agency's ENERGY STAR specifications for imaging equipment. The following mark will appear on ENERGY STAR qualified imaging products:



Additional ENERGY STAR qualified imaging product model information is listed at:

www.hp.com/go/energystar

Paper use

This product's duplex feature (manual or automatic) and N-up printing (multiple pages printed on one page) capability can reduce paper usage and the resulting demands on natural resources.

Plastics

Plastic parts over 25 grams are marked according to international standards that enhance the ability to identify plastics for recycling purposes at the end of the product's life.

HP LaserJet print supplies

Original HP Supplies were designed with the environment in mind. HP makes it easy to conserve resources and paper when printing. And when you are done, we make it easy and free to recycle.¹

All HP cartridges returned to HP Planet Partners go through a multiphase recycling process where materials are separated and refined for use as raw material in new Original HP cartridges and everyday products. No Original HP cartridges returned through HP Planet Partners are ever sent to a landfill, and HP never refills or resells Original HP cartridges.

To participate in HP Planet Partners return and recycling program, visit www.hp.com/recycle. Select your country/region for information on how to return HP printing supplies. Multi-lingual program information and instructions are also included in every new HP LaserJet print cartridge package.

¹ Program availability varies. For more information, visit www.hp.com/recycle

Paper

This product is capable of using recycled paper and lightweight paper (EcoFFICIENT™) when the paper meets the guidelines outlined in the *HP Laser Printer Family Print Media Guide*. This product is suitable for the use of recycled paper and lightweight paper (EcoFFICIENT™) according to EN12281:2002.

Material restrictions

This HP product does not contain added mercury.

Disposal of waste equipment by users (EU and India)



This symbol means do not dispose of your product with your other household waste. Instead, you should protect human health and the environment by handing over your waste equipment to a designated collection point for the recycling of waste electrical and electronic equipment. For more information, please contact your household waste disposal service, or go to: www.hp.com/recycle

Electronic hardware recycling

HP encourages customers to recycle used electronic hardware. For more information about recycling programs go to: www.hp.com/recycle

Hardware recycling information (Brazil)



**Não descarte o
produto eletrônico
em lixo comum**

Este produto eletrônico e seus componentes não devem ser descartados no lixo comum, pois embora estejam em conformidade com padrões mundiais de restrição a substâncias nocivas, podem conter, ainda que em quantidades mínimas, substâncias impactantes ao meio ambiente. Ao final da vida útil deste produto, o usuário deverá entregá-lo à HP. A não observância dessa orientação sujeitará o infrator às sanções previstas em lei.

Após o uso, as pilhas e/ou baterias dos produtos HP deverão ser entregues ao estabelecimento comercial ou rede de assistência técnica autorizada pela HP.

Para maiores informações, inclusive sobre os pontos de recebimento, acesse:

www8.hp.com/br/pt/ads/planet-partners/index.html

Chemical substances

HP is committed to providing our customers with information about the chemical substances in our products as needed to comply with legal requirements such as REACH (Regulation EC No 1907/2006 of the European Parliament and the Council). A chemical information report for this product can be found at: www.hp.com/go/reach

Product Power Data per European Union Commission Regulation 1275/2008

For product power data, including the power consumption of the product in networked standby if all wired network ports are connected and all wireless network ports are activated, please refer to section P14 'Additional Information' of the product IT ECO Declaration at www.hp.com/hpinfo/globalcitizenship/environment/productdata/itecodesktop-pc.html

SEPA Ecolabel User Information (China)

中国环境标识认证产品用户说明

噪声大于 63.0 dB(A)的办公设备不宜放置于办公室内，请在独立的隔离区域使用。

如需长时间使用本产品或打印大量文件，请确保在通风良好的房间内使用。

如您需要确认本产品处于零能耗状态，请按下电源关闭按钮，并将插头从电源插座断开。

您可以使用再生纸，以减少资源耗费。

The regulation of the implementation on China energy label for printer, and copier

依据“复印机、打印机和传真机能源效率标识实施规则”，本打印机具有中国能效标签。根据“复印机、打印机和传真机能效限定值及能效等级”（“GB21521”）决定并计算得出该标签上所示的能效等级和 TEC（典型能耗）值。

1. 能效等级

能效等级分为三个等级，等级 1 级能效最高。根据产品类型和打印速度标准决定能效限定值。

2. 能效信息

2.1 激光打印机及一体机和高性能喷墨打印机及一体机

- 典型能耗

典型能耗是正常运行 GB21521 测试方法中指定的时间后的耗电量。此数据表示为每周千瓦时 (kWh)。

标签上所示的能效数字按涵盖根据“复印机、打印机和传真机能源效率标识实施规则”选择的登记装置中所有配置的代表性配置测定而得。因此，本特定产品型号的实际能耗可能与标签上所示的数据不同。

有关规范的详情信息，请参阅 GB21521 标准的当前版本。

Restriction of Hazardous Substances statement (India)

This product, as well as its related consumables and spares, complies with the reduction in hazardous substances provisions of the "India E-waste Rule 2016." It does not contain lead, mercury, hexavalent chromium, polybrominated biphenyls or polybrominated diphenyl ethers in concentrations exceeding 0.1 weight % and 0.01 weight % for cadmium, except where allowed pursuant to the exemptions set in Schedule 2 of the Rule.

WEEE (Turkey)

Türkiye Cumhuriyeti: AEEE Yönetmeliğine Uygundurp

The Table of Hazardous Substances/Elements and their Content (China)

产品中有害物质或元素的名称及含量

The Table of Hazardous Substances/Elements and their Content

根据中国《电器电子产品有害物质限制使用管理办法》

As required by China's Management Methods for Restricted Use of Hazardous Substances in Electrical and Electronic Products



| 部件名称 Part Name | 有害物质 Hazardous Substances | | | | | |
|-------------------|------------------------------|----------------------|----------------------|---|--|--|
| | 铅 Lead (Pb) | 汞 Mercury (Hg) | 镉 Cadmium (Cd) | 六价铬 Hexavalent Chromium (Cr(VI)) | 多溴联苯 Polybrominated biphenyls (PBB) | 多溴二苯醚 Polybrominated diphenyl ethers (PBDE) |
| 打印引擎 | X | ○ | ○ | ○ | ○ | ○ |
| 控制面板 | X | ○ | ○ | ○ | ○ | ○ |
| 塑料外壳 | ○ | ○ | ○ | ○ | ○ | ○ |
| 格式化板组件 | X | ○ | ○ | ○ | ○ | ○ |
| 碳粉盒 | X | ○ | ○ | ○ | ○ | ○ |

CHR-LJ-PK-SF-02

表格依据SJ/T 11364 的规定编制。

This form has been prepared in compliance with the provisions of SJ/T 11364.

○：表示该有害物质在该部件所有均质材料中的含量均在GB/T 26572 规定的限量要求以下。

○: Indicates that the content of said hazardous substance in all of the homogenous materials in the component is within the limits required by GB/T 26572.

X：表示该有害物质至少在该部件的某一均质材料中的含量超出GB/T 26572 规定的限量要求。

X: Indicates that the content of said hazardous substance exceeds the limits required by GB/T 26572 in at least one homogenous material in the component.

此表中所有名称中含“X”的部件均符合中国 RoHS达标管理目录限用物质应用例外清单的豁免。

All parts named in this table with an "X" are in compliance with the China RoHS "List of Exceptions to RoHS Compliance Management Catalog (or China RoHS Exemptions)".

此表中所有名称中含“X”的部件均符合欧盟 RoHS 立法。

All parts named in this table with an "X" are in compliance with the European Union's RoHS Legislation.

注：环保使用期限的参考标识取决于产品正常工作的温度和湿度等条件

Note: The referenced Environmental Protection Use Period Marking was determined according to normal operating use conditions of the product such as temperature and humidity.

Material Safety Data Sheet (MSDS)

Material Safety Data Sheets (MSDS) for supplies containing chemical substances (for example, toner) can be obtained by accessing the HP Web site at www.hp.com/go/msds

EPEAT

Many HP products are designed to meet EPEAT. EPEAT is a comprehensive environmental rating that helps identify greener electronics equipment. For more information on EPEAT go to www.epeat.net. For information on HP's EPEAT registered products go to www8.hp.com/us/en/hp-information/global-citizenship/index.html

Declaration of the Presence Condition of the Restricted Substances Marking (Taiwan)

台灣 限用物質含有情況標示聲明書

Taiwan Declaration of the Presence Condition of the Restricted Substances Marking

| 單元 Unit | 限用物質及其化學符號 Restricted substances and its chemical symbols | | | | | |
|---|--|------------------|------------------|--|--|--|
| | 鉛Lead (Pb) | 汞Mercury (Hg) | 鎘Cadmium (Cd) | 六價鉻 Hexavalent chromium (Cr ⁺⁶) | 多溴聯苯 Polybrominated biphenyls (PBB) | 多溴二苯醚 Polybrominated diphenyl ethers (PBDE) |
| 列印引擎 Print engine | — | ○ | ○ | ○ | ○ | ○ |
| 外殼和紙匣 External Casing and Trays | ○ | ○ | ○ | ○ | ○ | ○ |
| 電源供應器 Power Supply | — | ○ | ○ | ○ | ○ | ○ |
| 電線 Cables | ○ | ○ | ○ | ○ | ○ | ○ |
| 印刷電路板 Print printed circuit board | — | ○ | ○ | ○ | ○ | ○ |
| 控制面板 Control panel | — | ○ | ○ | ○ | ○ | ○ |
| 碳粉匣 Cartridge | ○ | ○ | ○ | ○ | ○ | ○ |
| <p>備考1. “超出0.1 wt %” 及 “超出0.01 wt %” 係指限用物質之百分比含量超出百分比含量基準值。 Note 1 : “Exceeding 0.1 wt %” and “exceeding 0.01 wt %” indicate that the percentage content of the restricted substance exceeds the reference percentage value of presence condition.</p> <p>備考2. “○” 係指該項限用物質之百分比含量未超出百分比含量基準值。 Note 2 : “○” indicates that the percentage content of the restricted substance does not exceed the percentage of reference value of presence.</p> <p>備考3. “—” 係指該項限用物質為排除項目。 Note 3 : The “—” indicates that the restricted substance corresponds to the exemption.</p> | | | | | | |

TWR-LJ-PK-SF-02

若要存取產品的最新使用指南或手冊，請前往 hp.com/support。選取搜尋您的產品，然後依照畫面上的指示繼續執行。

To access the latest user guides or manuals for your product, go to hp.com/support. Select **Find your product**, and then follow the on-screen instructions.

For more information

To obtain information about these environmental topics:

- Product environmental profile sheet for this and many related HP products
- HP's commitment to the environment
- HP's environmental management system
- HP's end-of-life product return and recycling program
- Material Safety Data Sheets

Visit www.hp.com/go/environment

Also, visit www.hp.com/recycle

D Regulatory information

This section describes the regulatory statements.

Regulatory statements

The printer meets product requirements from regulatory agencies in your country/region.

European Union and United Kingdom Regulatory Notice



Products bearing the CE marking and UK marking comply to applicable EU Directives and the equivalent UK Statutory Instruments and can operate in at least one EU Member State and in United Kingdom. The full EU and UK Declaration of Conformity can be found at the following website: hp.eu/certificates (Search with the product model name or its Regulatory Model Number (RMN), which may be found on the regulatory label.)

The point of contact for regulatory matters:

For EU: HP REG 23010, 08028 Barcelona, Spain

For UK: HP Inc UK Ltd, Regulatory Enquiries, Earley West, 300 Thames Valley Park Drive, Reading, RG6 1PT

Email: techregshelp@hp.com

Regulatory model numbers

For regulatory identification purposes, your product is assigned a regulatory model number. Regulatory model numbers should not be confused with marketing names or product numbers.

Table D-1 Regulatory model numbers

| Product model number | Regulatory model number |
|------------------------------|-------------------------|
| HP Color LaserJet Pro 3201dw | SHNGC-2200-01 |
| HP Color LaserJet Pro 3202dw | |
| HP Color LaserJet Pro 3203dw | |
| HP Color LaserJet Pro 3288dw | |
| HP Color LaserJet Pro 3288dn | SHNGC-2200-00 |
| HP Color LaserJet Pro 3202dn | |
| HP Color LaserJet Pro 3203dn | |

FCC regulations

This equipment has been tested and found to comply with the limits for a Class B digital device, pursuant to Part 15 of the FCC rules. These limits are designed to provide reasonable protection against harmful interference in a residential installation. This equipment generates, uses, and can radiate radio frequency energy. If this equipment is not installed and used in accordance with the instructions, it may cause harmful interference to radio communications. However, there is no guarantee that interference will not occur in a particular installation. If this equipment does cause harmful interference to radio or television reception, which can be determined by turning the equipment off and on, the user is encouraged to try to correct the interference by one or more of the following measures:

- Reorient or relocate the receiving antenna.
- Increase separation between equipment and receiver.
- Connect equipment to an outlet on a circuit different from that to which the receiver is located.
- Consult your dealer or an experienced radio/TV technician.

 **NOTE:** Any changes or modifications to the printer that are not expressly approved by HP could void the user's authority to operate this equipment.

Use of a shielded interface cable is required to comply with the Class B limits of Part 15 of FCC rules.

Canada - Industry Canada ICES-003 Compliance Statement

CAN ICES-3(B)/NMB-3(B)

Power cord instructions

Make sure your power source is adequate for the product voltage rating. The voltage rating is on the product label. The product uses either 110-127 Vac or 220-240 Vac and 50/60 Hz.

Connect the power cord between the product and a grounded AC outlet.

 **CAUTION:** To prevent damage to the product, use only the power cord that is provided with the product.

Laser safety

The Center for Devices and Radiological Health (CDRH) of the U.S. Food and Drug Administration has implemented regulations for laser products manufactured since August 1, 1976. Compliance is mandatory for products marketed in the United States. The device is certified as a "Class 1" laser product under the U.S. Department of Health and Human Services (DHHS) Radiation Performance Standard according to the Radiation Control for Health and Safety Act of 1968. Since radiation emitted inside the device is completely confined within protective housings and external covers, the laser beam cannot escape during any phase of normal user operation.

 **WARNING!** Using controls, making adjustments, or performing procedures other than those specified in this user guide may result in exposure to hazardous radiation.

For other US/Canada regulatory matters, please contact:

HP Inc.

HP Inc. 1501 Page Mill Rd, Palo Alto, CA 94304, USA

Email contact: (techregshelp@hp.com) or Telephone contact: +1 (650) 857-1501

Laser safety statement for EMEA

CLASS 1 CONSUMER LASER PRODUCT

EN: 50689:2021

Laser statement for Finland

Luokan 1 laserlaite

HP Color LaserJet Pro 3201-3204/3288, laserkirjoitin on käyttäjän kannalta turvallinen luokan 1 laserlaite. Normaalisissa käytössä kirjoittimen suojakoteloointi estää lasersäteen pääsyn laitteen ulkopuolelle. Laitteen turvallisuusluokka on määritetty standardin EN 60825-1 (2014) mukaisesti.

VAROITUS !

Laitteen käyttäminen muulla kuin käyttöohjeessa mainitulla tavalla saattaa altistaa käyttäjän turvallisuusluokan 1 ylittävälle näkymättömälle lasersäteilylle.

WARNING !

Om apparaten används på annat sätt än i bruksanvisning specificerats, kan användaren utsättas för osynlig laserstrålning, som överskrider gränsen för laserklass 1.

HUOLTO

HP Color LaserJet Pro 3201-3204/3288 - kirjoittimen sisällä ei ole käyttäjän huollettavissa olevia kohteita. Laitteen saa avata ja huoltaa ainoastaan sen huoltamiseen koulutettu henkilö. Tällaiseksi huoltotoimenpiteeksi ei katsota väriainekasetin vaihtamista, paperiradan puhdistusta tai muita käyttäjän käsikirjassa lueteltuja, käyttäjän tehtäväksi tarkoitettuja ylläpitotoimia, jotka voidaan suorittaa ilman erikoistyökaluja.

VARO !

Mikäli kirjoittimen suojakotelo avataan, olet alttiina näkymättömälle lasersäteilylle laitteen ollessa toiminnassa. Älä katso säteeseen.

WARNING !

Om laserprinterns skyddshölje öppnas då apparaten är i funktion, utsättas användaren för osynlig laserstrålning. Betrakta ej strålen.

Tiedot laitteessa käytettävän laserdiodin säteilyominaisuuksista: Aallonpituus 775-795 nm Teho 5 m W Luokan 3B laser.

GS statement (Germany)

Das Gerät ist nicht für die Benutzung im unmittelbaren Gesichtsfeld am Bildschirmarbeitsplatz vorgesehen. Um störende Reflexionen am Bildschirmarbeitsplatz zu vermeiden, darf dieses Produkt nicht im unmittelbaren Gesichtsfeld platziert werden.

Das Gerät ist kein Bildschirmarbeitsplatz gemäß BildscharbV. Bei ungünstigen Lichtverhältnissen (z. B. direkte Sonneneinstrahlung) kann es zu Reflexionen auf dem Display und damit zu Einschränkungen der Lesbarkeit der dargestellten Zeichen kommen.

Die Bildarstellung dieses Gerätes ist nicht für verlängerte Bildschirmtätigkeiten geeignet.

Nordic Statements (Denmark, Finland, Norway, Sweden)

Denmark:

Apparatets stikprop skal tilsattes en stikkontakt med jord, som giver forbindelse til stikproppens jord.

Finland:

Laite on liitettävä suojakoskettimilla varustettuun pistorasiaan.

Norway:

Apparatet må tilkoples jordet stikkontakt.

Sweden:

Apparaten skall anslutas till jordat uttag.

Taiwan BSMI USB Port (Walk-up) Statement

The front USB port (walk-up port) located at the front, top, or side of the product is typically used with thumb drives.

Eurasian Conformity (Armenia, Belarus, Kazakhstan, Kirgizstan, Russia)

Производитель и дата производства



HP Inc.

Адрес: 1501 Page Mill Road, Palo Alto, California 94304, U.S.

Дата производства зашифрована в 10-значном серийном номере, расположенном на наклейке со служебной информацией изделия. 4-я, 5-я и 6-я цифры обозначают год и неделю производства. 4-я цифра обозначает год, например, «3» обозначает, что изделие произведено в «2013» году. 5-я и 6-я цифры обозначают номер недели в году производства, например, «12» обозначает «12-ю» неделю.

Өндіруші және өндіру мерзімі

HP Inc.

Мекенжайы: 1501 Page Mill Road, Palo Alto, California 94304, U.S.

Өнімнің жасалу мерзімін табу үшін өнімнің қызмет көрсету жапсырмасындағы 10 таңбадан тұратын сериялық нөмірін қараңыз. 4-ші, 5-ші және 6-шы сандар өнімнің жасалған жылы мен аптасын көрсетеді. 4-ші сан жылын көрсетеді, мысалы «3» саны «2013» дегенді білдіреді. 5-ші және 6-шы сандары берілген жылдың қай аптасында жасалғанын көрсетеді, мысалы, «12» саны «12-ші» апта дегенді білдіреді.

Местные представители

Россия: 000 "Эйч Пи Инк",

Российская Федерация, 125171, г. Москва, Ленинградское шоссе, 1 6А, стр.3,

Телефон/факс: +7 495 797 35 00 / +7 499 92132 50

Казахстан: Филиал компании "ЭйчПи Глобал Трэйдинг Би.Ви.", Республика Казахстан, 050040, г. Алматы, Бостандыкский район, проспект Аль-Фараби, 77/7,

Телефон/факс: + 7 7 27 355 35 52

Жергілікті өкілдіктері

Ресей: 000 "Эйч Пи Инк",

Ресей Федерациясы, 125171, Мәскеу, Ленинград шоссесі, 16А блок 3,

Телефон/факс: +7 495 797 35 00 / +7 499 92132 50

Қазақстан: "ЭйчПи Глобал Трэйдинг Би.Ви." компаниясының Қазақстандағы филиалы, Қазақстан Республикасы, 050040, Алматы қ., Бостандық ауданы, Әл-Фараби даңғылы, 77/7,

Телефон/факс: +7 727 355 35 52

Wireless statements

The statements in this section apply to wireless-capable printers only.

FCC compliance statement—United States

Exposure to radio frequency radiation

- ⚠ **CAUTION:** The radiated output power of this device is far below the FCC radio frequency exposure limits. Nevertheless, the device shall be used in such a manner that the potential for human contact during normal operation is minimized.

In order to avoid the possibility of exceeding the FCC radio frequency exposure limits, human proximity to the antenna shall not be less than 20 cm (8 in) during normal operation.

This device complies with Part 15 of FCC Rules. Operation is subject to the following two conditions: (1) this device may not cause interference, and (2) this device must accept any interference, including interference that may cause undesired operation of the device.

- ⚠ **CAUTION:** Based on Section 15.21 of the FCC rules, changes of modifications to the operation of this product without the express approval by HP may invalidate its authorized use.

Australia statement

This device incorporates a radio-transmitting (wireless) device. For protection against radio transmission exposure, it is recommended that this device be operated no less than 20 cm from the head, neck, or body.

Belarus statement

В соответствии с Постановлением Совета Министров Республики Беларусь от 24 мая 2017 года № 383 (об описании и порядке применения знака соответствия к техническому регламенту Республики Беларусь) продукция, требующая подтверждения соответствия техническому регламенту Республики Беларусь, размещенная на рынке Республики Беларусь, должна быть маркирована знаком соответствия ТР ВУ.



Brazil ANATEL statement

Este equipamento não tem direito à proteção contra interferência prejudicial e não pode causar interferência em sistemas devidamente autorizados.

Para maiores informações consulte o site da ANATEL – www.anatel.gov.br

Canadian statements

For Indoor Use. This digital apparatus does not exceed the Class B limits for radio noise emissions from digital apparatus as set out in the radio interference regulations of the Canadian Department of Communications. The internal wireless radio complies with RSS 210 of Industry Canada.

Pour l'usage d'intérieur. Le présent appareil numérique n'émet pas de bruits radioélectriques dépassant les limites applicables aux appareils numériques de Classe B prescrites dans le règlement sur le brouillage radioélectrique édicté par le Ministère des Communications du Canada. Le composant RF interne est conforme à la norme CNR-210 d'Industrie Canada.

China CMIIT Wireless statements

中国无线电发射设备通告

型号核准代码显示在产品本体的铭牌上。

Korean statement

무선 전용제품:

해당 무선설비는 전파혼신 가능성이 있음으로 인명안전과 관련된 서비스는 할 수 없음. (무선모듈제품이 설치되어있는 경우)

Taiwan statement (Traditional Chinese)

取得審驗證明之低功率射頻器材，非經核准，公司、商號或使用者均不得擅自變更頻率、加大功率或變更原設計之特性及功能。低功率射頻器材之使用不得影響飛航安全及干擾合法通信；經發現有干擾現象時，應立即停用，並改善至無干擾時方得繼續使用。前述合法通信，指依電信管理法規定作業之無線電通信。低功率射頻器材須忍受合法通信或工業、科學及醫療用電波輻射性電機設備之干擾。

應避免影響附近雷達系統之操作。

高增益指向性天線只得應用於固定式點對點系統。

Products with 5 GHz Operation Industry of Canada

- ⚠ CAUTION:** When using IEEE 802.11a wireless LAN, this product is restricted to indoor use, due to its operation in the 5.15- to 5.25-GHz frequency range. Industry Canada requires this product to be used indoors for the frequency range of 5.15 GHz to 5.25 GHz to reduce the potential for harmful interference to co-channel mobile satellite systems. High-power radar is allocated as the primary user of the 5.25- to 5.35-GHz and 5.65- to 5.85-GHz bands. These radar stations can cause interference with and/or damage to this device.

Lors de l'utilisation d'un réseau local sans fil IEEE 802.11a, ce produit est réservé à une utilisation en intérieur en raison de sa plage de fréquences, comprise entre 5,15 et 5,25 GHz. Industrie Canada recommande l'utilisation en intérieur de ce produit pour la plage de fréquences comprise entre 5,15 et 5,25 GHz afin de réduire les interférences nuisibles potentielles avec les systèmes de satellite portables utilisant le même canal. Le radar à haute puissance est défini comme étant le principal utilisateur des bandes 5,25 à 5,35 GHz et 5,65 à 5,85 GHz. Ces stations radar peuvent provoquer des interférences sur ce périphérique et/ou l'endommager.

Taiwan NCC Statement:(Only for 5GHz)

應避免影響附近雷達系統之操作。

Exposure to Radio Frequency Radiation (Canada)

- ⚠ WARNING!** Exposure to Radio Frequency Radiation. The radiated output power of this device is below the Industry Canada radio frequency exposure limits. Nevertheless, the device should be used in such a manner that the potential for human contact is minimized during normal operation.
- ⚠ WARNING!** Exposition aux émissions de fréquences radio. La puissance de sortie émise par ce périphérique est inférieure aux limites fixées par Industrie Canada en matière d'exposition aux fréquences radio. Néanmoins, les précautions d'utilisation du périphérique doivent être respectées afin de limiter tout risque de contact avec une personne.

To avoid the possibility of exceeding the Industry Canada radio frequency exposure limits, human proximity to the antennas should not be less than 20 cm (8 inches).

Pour éviter tout dépassement des limites fixées par Industrie Canada en matière d'exposition aux fréquences radio, la distance entre les utilisateurs et les antennes ne doit pas être inférieure à 20 cm (8 pouces).

European regulatory notice

The telecommunications functionality of this product may be used in the following European countries/regions:

Austria, Belgium, Bulgaria, Cyprus, Czech Republic, Denmark, Estonia, Finland, France, Germany, Greece, Hungary, Iceland, Ireland, Italy, Latvia, Liechtenstein, Lithuania, Luxembourg, Malta, Netherlands, Norway, Poland, Portugal, Romania, Slovak Republic, Slovenia, Spain, Sweden, Switzerland, and United Kingdom.

Notice for use in Russia

Существуют определенные ограничения по использованию беспроводных сетей (стандарта 802.11 b/g) с рабочей частотой 2,4 ГГц: Данное оборудование может использоваться внутри помещений с использованием диапазона частот 2400-2483,5 МГц (каналы 1-13). При использовании внутри помещений максимальная эффективная изотропно-излучаемая мощность (ЭИИМ) должна составлять не более 100мВт.

Mexico statement

Aviso para los usuarios de México

“La operación de este equipo está sujeta a las siguientes dos condiciones: (1) es posible que este equipo o dispositivo no cause interferencia perjudicial y (2) este equipo o dispositivo debe aceptar cualquier interferencia, incluyendo la que pueda causar su operación no deseada.”

Para saber el modelo de la tarjeta inalámbrica utilizada, revise la etiqueta regulatoria de la impresora.

Thailand statement

เครื่องวิทยุคมนาคมนี้มีระดับการแผ่คลื่นแม่เหล็กไฟฟ้าสอดคล้องตามมาตรฐานความปลอดภัยต่อสุขภาพของมนุษย์จากการใช้เครื่องวิทยุคมนาคมที่คณะกรรมการกิจการโทรคมนาคมแห่งชาติประกาศกำหนด

This radio communication equipment has the electromagnetic field strength in compliance with the Safety Standard for the Use of Radio Communication Equipment on Human Health announced by the National Telecommunications Commission.

Vietnam Telecom



 **NOTE:** Telecom wireless marking for ICTQC Type approved products.

Dynamic Security Enabled Printers

This printer is intended to work only with cartridges that have a new or reused HP chip. A reused HP chip enables the use of reused, remanufactured, and refilled cartridges.

The printer uses dynamic security measures to block cartridges using a non-HP chip. Periodic firmware updates delivered over the internet will maintain the effectiveness of the dynamic security measures and block cartridges that previously worked.

Updates can improve, enhance, or extend the printer's functionality and features, protect against security threats, and serve other purposes, but these updates can also block cartridges using a non-HP chip from working in the printer, including cartridges that work today. Unless you are enrolled in certain HP programs such as Instant Ink or use other services that require automatic online firmware updates, most HP printers can be configured to receive updates either automatically or with a notification that allows you to choose whether to update or not. For more information on dynamic security and how to configure online firmware updates, please go to www.hp.com/learn/ds.