



User Guide

SUMMARY

This guide provides basic information for using and upgrading this product, including topics such as components, features, networks, and HP resources.

Legal information

© Copyright 2023 HP Development Company, L.P.

Microsoft and Windows are either registered trademarks or trademarks of Microsoft Corporation in the United States and/or other countries. USB Type-C and USB-C are registered trademarks of USB Implementers Forum. DisplayPort™, the DisplayPort logo, and VESA are trademarks owned by the Video Electronics Standards Association (VESA) in the United States and other countries.

The information contained herein is subject to change without notice. The only warranties for HP products and services are set forth in the express warranty statements accompanying such products and services. Nothing herein should be construed as constituting an additional warranty. HP shall not be liable for technical or editorial errors or omissions contained herein.

Fourth Edition: May 2023

Document Part Number: N05901-004

Product Notice

This guide describes features that are common to most products. Some features may not be available on your computer.

Not all features are available in all editions or versions of Windows. Systems may require upgraded and/or separately purchased hardware, drivers, software or BIOS update to take full advantage of Windows functionality. Windows is automatically updated, which is always enabled. High-speed internet and Microsoft account required. ISP fees may apply and additional requirements may apply over time for updates. See <http://www.windows.com>.

If your product ships with Windows in S

Mode: Windows in S Mode works exclusively with apps from the Microsoft Store within Windows. Certain default settings, features, and apps cannot be changed. Some accessories and apps that are compatible with Windows may not work (including some antivirus, PDF writers, driver utilities, and accessibility apps), and performance may vary, even if you switch out of S Mode. If you switch to Windows, you cannot switch back to S Mode. Learn more at Windows.com/SmodeFAQ.

To access the latest user guides, go to <http://www.hp.com/support>, and follow the instructions to find your product. Then select **Manuals**.

Software terms

By installing, copying, downloading, or otherwise using any software product preinstalled on this computer, you agree to be bound by the terms of the HP End User License Agreement (EULA). If you do not accept these license terms, your sole remedy is to return the entire unused product (hardware and software) within 14 days for a full refund subject to the refund policy of your seller.

For any further information or to request a full refund of the price of the computer, please contact your seller.

About this guide

This guide provides basic information for using and upgrading this product.

-
-  **WARNING!** Indicates a hazardous situation that, if not avoided, **could** result in serious injury or death.
 -  **CAUTION:** Indicates a hazardous situation that, if not avoided, **could** result in minor or moderate injury.
 -  **IMPORTANT:** Indicates information considered important but not hazard-related (for example, messages related to property damage). Warns the user that failure to follow a procedure exactly as described could result in loss of data or in damage to hardware or software. Also contains essential information to explain a concept or to complete a task.
 -  **NOTE:** Contains additional information to emphasize or supplement important points of the main text.
 -  **TIP:** Provides helpful hints for completing a task.
-

Table of contents

1 Locating HP resources	1
Product information	1
Support	1
Product documentation	2
Product diagnostics	2
Product updates	3
2 Computer features	4
Standard configuration features	4
Front panel components	4
Rear panel components	5
Side panel components	6
Bottom components	7
Serial number location	7
Using an optional security lock	7
Security cable lock	7
3 Setup	8
Overview	8
Attaching and removing a stand	8
Attaching and removing a recline stand	8
Attaching a recline stand	8
Removing a recline stand	9
Attaching and removing an adjustable-height stand	10
Attaching an adjustable-height stand	10
Removing an adjustable-height stand	10
Attaching the computer to a mounting fixture	11
Connecting and disconnecting cables	11
Connecting cables	11
Connecting a monitor	12
Disconnecting cables	12
Connecting and disconnecting power	12
Connecting power	12
Disconnecting power	13
Webcam	13
Using Windows Hello (select products only)	13
Setting up Auto Lock and Awake (select products only)	14
Synchronizing the optional wireless keyboard and mouse	14

Adjusting low blue light mode	15
Turning on the low blue light mode.....	16
Turning on the night light mode	16
4 Backing up, restoring, and recovering	17
Backing up information and creating recovery media.....	17
Using Windows tools for backing up.....	17
Using the HP Cloud Recovery Download Tool to create recovery media (select products only).....	17
Restoring and recovering your system.....	18
Creating a system restore	18
Restoring and recovery methods.....	18
Recovering using HP Recovery media	18
Changing the computer boot order	19
Using HP Sure Recover (select products only).....	19
5 Using HP PC Hardware Diagnostics	20
Using HP PC Hardware Diagnostics Windows (select products only).....	20
Using an HP PC Hardware Diagnostics Windows hardware failure ID code.....	20
Accessing HP PC Hardware Diagnostics Windows	20
Accessing HP PC Hardware Diagnostics Windows from HP Help and Support (select products only)	20
Accessing HP PC Hardware Diagnostics Windows from HP Support Assistant.....	21
Accessing HP PC Hardware Diagnostics Windows from the Start menu (select products only).....	21
Downloading HP PC Hardware Diagnostics Windows.....	21
Downloading the latest HP PC Hardware Diagnostics Windows version from HP.....	21
Downloading the HP PC Hardware Diagnostics Windows from the Microsoft Store.....	21
Downloading HP Hardware Diagnostics Windows by product name or number (select products only)	22
Installing HP PC Hardware Diagnostics Windows.....	22
Using HP PC Hardware Diagnostics UEFI	22
Using an HP PC Hardware Diagnostics UEFI hardware failure ID code.....	22
Starting HP PC Hardware Diagnostics UEFI.....	23
Downloading HP PC Hardware Diagnostics UEFI to a USB flash drive.....	23
Downloading the latest HP PC Hardware Diagnostics UEFI version.....	23
Downloading HP PC Hardware Diagnostics UEFI by product name or number (select products only)	24
Using Remote HP PC Hardware Diagnostics UEFI settings (select products only).....	24
Downloading Remote HP PC Hardware Diagnostics UEFI.....	24
Downloading the latest Remote HP PC Hardware Diagnostics UEFI version.....	24
Downloading Remote HP PC Hardware Diagnostics UEFI by product name or number.....	24
Customizing Remote HP PC Hardware Diagnostics UEFI settings.....	25
6 Computer operating guidelines, routine care, and shipping preparation	26
Operating guidelines and routine care	26
Cleaning your computer	26
Removing dirt and debris from your computer.....	27
Cleaning your computer with a disinfectant.....	27
Shipping preparation	28

7 Electrostatic discharge	29
8 Accessibility	30
HP and accessibility.....	30
Finding the technology tools you need.....	30
The HP commitment.....	30
International Association of Accessibility Professionals (IAAP).....	31
Finding the best assistive technology.....	31
Assessing your needs.....	31
Accessibility for HP products.....	31
Standards and legislation.....	32
Standards.....	32
Mandate 376 – EN 301 549.....	32
Web Content Accessibility Guidelines (WCAG).....	32
Legislation and regulations.....	33
Useful accessibility resources and links.....	33
Organizations.....	33
Educational institutions.....	33
Other disability resources.....	34
HP links.....	34
Contacting support.....	34
Index	35

1 Locating HP resources

Read this chapter to learn about where to find additional HP resources.

Product information

To locate resources that provide product details, how-to information, and more, use this table.

Table 1-1 Where to find product information

Topic	Location
Technical specifications	To find the QuickSpecs for your product, go to http://www.hp.com/go/quickspecs , and then select the link. Select Search all QuickSpecs , type your model name in the search box, and then select Go .
<i>Regulatory, Safety, and Environmental Notices</i>	See the <i>Regulatory, Safety, and Environmental Notices</i> for product regulatory information. You can also see the Agency/Environmental label. To access this guide: <ul style="list-style-type: none">■ Select the Search icon (select products only) in the taskbar, type HP Documentation in the search box, and then select HP Documentation.
System board	A diagram of the system board is located on the inside of the chassis. Additional information is located in the computer <i>Maintenance and Service Guide</i> on the web at http://www.hp.com/support . Follow the instructions to find your product, and then select Manuals .
Serial number, Agency/Environmental, and operating system labels	The serial number, Agency/Environmental, and operating system labels might be on the bottom of the computer, on the rear panel of the computer, or under the service door.

Support

To locate resources that provide support and warranty information, use this table.

Table 1-2 Where to find support information

Topic	Location
Product support	For HP support, go to http://www.hp.com/support . Here you can access the following types of support: <ul style="list-style-type: none">• Online chat with an HP technician• Support telephone numbers• HP service center locations

Table 1-2 Where to find support information (continued)

Topic	Location
Warranty information	<p>To access this document:</p> <ul style="list-style-type: none">■ Select the Search icon (select products only) in the taskbar, type HP Documentation in the search box, and then select HP Documentation. <p>- or -</p> <ul style="list-style-type: none">■ Go to http://www.hp.com/go/orderdocuments. <p>IMPORTANT: You must be connected to the internet to access the latest version of the warranty.</p> <p>You can find your HP Limited Warranty located with the user guides on your product. The warranty might be on a CD or DVD provided in the box. In some countries or regions, HP might provide a printed warranty in the box. For countries or regions where the warranty is not provided in printed format, you can request a copy from http://www.hp.com/go/orderdocuments. For products purchased in Asia Pacific, you can write to HP at POD, PO Box 161, Kitchener Road Post Office, Singapore 912006. Include your name, phone number, address, and product name.</p>

Product documentation

To locate resources that provide product documentation, use this table.

Table 1-3 Where to find product documentation

Topic	Location
HP user documentation, white papers, and third-party documentation	User documentation is located on your hard drive. Select the Search icon (select products only) in the taskbar, type HP Documentation in the search box, and then select HP Documentation . For the latest online documentation, go to http://www.hp.com/support and follow the instructions to find your product. Then select Manuals . The documentation includes this user guide and the <i>Maintenance and Service Guide</i> .
Product notifications	Subscriber's Choice is an HP program that allows you to sign up to receive driver and software alerts, proactive change notifications (PCNs), the HP newsletter, customer advisories, and more. Sign up at https://h41369.www4.hp.com/ .
Technical specifications	The Product Bulletin application contains QuickSpecs for HP computers. QuickSpecs include information about the operating system, power supply, memory, processor, and many other system components. To access the QuickSpecs, go to http://www.hp.com/go/quickspecs/ .
Bulletins and Notices	To find advisories, bulletins, and notices: <ol style="list-style-type: none">1. Go to http://www.hp.com/support.2. Follow the instructions to find your product.3. Select Advisories or Bulletins and Notices.

Product diagnostics

To locate resources that provide product diagnostics tools, use this table.

Table 1-4 Where to find diagnostics tools

Topic	Location
Diagnostics tools	For additional information, see the computer <i>Maintenance and Service Guide</i> at http://www.hp.com/support . Follow the instructions to find your product, and then select Manuals .
Audible beep and light code definitions	See the computer <i>Maintenance and Service Guide</i> at http://www.hp.com/support . Follow the instructions to find your product, and then select Manuals .
POST error codes	See the computer <i>Maintenance and Service Guide</i> at http://www.hp.com/support . Follow the instructions to find your product, and then select Manuals .

Product updates

To locate resources that provide product updates, use this table.

Table 1-5 Where to find product updates

Topic	Location
Driver and BIOS updates	Go to http://www.hp.com/support and select Software and Drivers to verify that you have the latest drivers for the computer.
Operating systems	For information about Windows® operating systems, go to http://www.support.microsoft.com .

2 Computer features

This chapter provides you with an overview of your computer's features.

Standard configuration features

To identify a typical computer configuration, read this section. Features vary depending on the model. For support assistance and to learn more about the hardware and software installed on your computer model, run the HP Support Assistant utility.



Front panel components

To identify the front panel components, use this illustration and table.

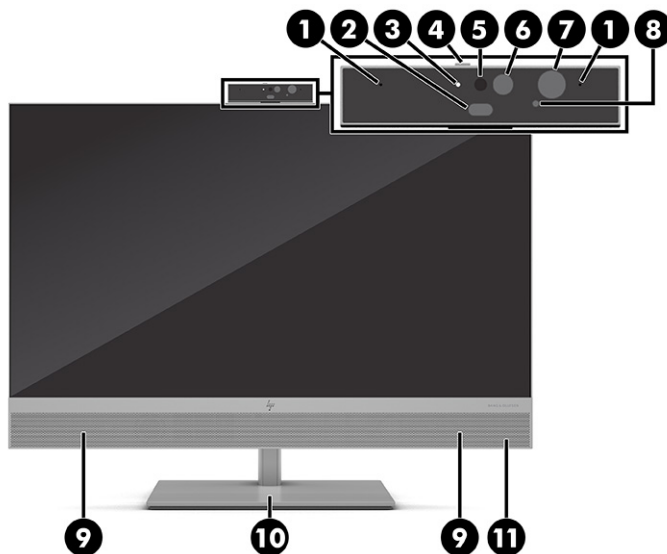

Table 2-1 Identifying the front panel components

Front panel components			
1	Internal microphones (2)	7	Camera IR light
2	User-proximity sensor	8	Color light sensor
3	Camera light	9	Integrated speakers (2)
4	Camera privacy shutter	10	Wireless charging area
5	Camera	11	Power light
6	Camera IR lens		

NOTE: The power light is normally white when the power is on. If the light blinks red, the computer displays a diagnostic code to indicate a problem. See the *Maintenance and Service Guide* to interpret the code.

NOTE: The camera rotation is 180°. The camera tilt is -5° to +40°.

NOTE: The user-proximity sensor monitors your presence in front of the computer to save power and add security. For more information, see [Setting up Auto Lock and Awake \(select products only\) on page 14](#).

Rear panel components

To identify the rear panel components, use this illustration and table.

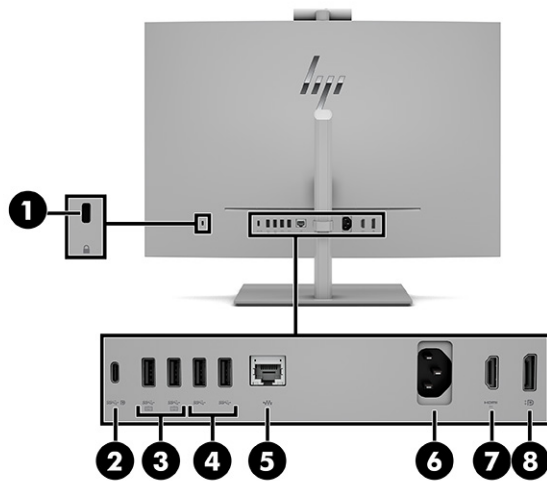

Table 2-2 Identifying the rear panel components





Rear panel components			
1	Security cable slot	5	 RJ-45 (network) jack
2	 USB Type-C SuperSpeed 10 Gbps power connector port, and DisplayPort output	6	Power connector

Table 2-2 Identifying the rear panel components (continued)

Rear panel components				
3		USB SuperSpeed 5 Gbps ports (includes keyboard connection) (2)	7	HDMI-in port
<p>NOTE: Use a standard USB Type-A charging cable or cable adapter (purchased separately) when charging a small external device such as a smartphone.</p>				
4		USB SuperSpeed 10 Gbps ports (2)	8	DisplayPort™ monitor connector
<p>NOTE: Use a standard USB Type-A charging cable or cable adapter (purchased separately) when charging a small external device such as a smartphone.</p>				

Side panel components

To identify the side panel components, use this illustration and table.

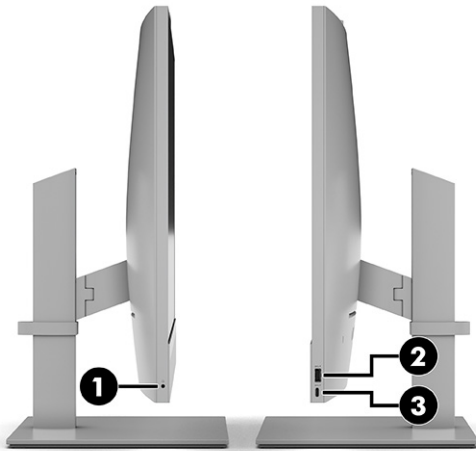



Table 2-3 Identifying the side panel components

Side panel components				
1		Audio-out (headphone)/Audio-in (microphone) combo jack	3	USB Type-C SuperSpeed 20 Gbps port with HP Sleep and Charge
2		USB SuperSpeed 10 Gbps port with HP Sleep and Charge		
<p>NOTE: Use a standard USB Type-A charging cable or cable adapter (purchased separately) when charging a small external device such as a smartphone.</p>				
<p>NOTE: The combo jack supports headphones, line output devices, microphones, line input devices, or CTIA-style headsets.</p>				

Bottom components

To identify the bottom components, use this illustration and table.

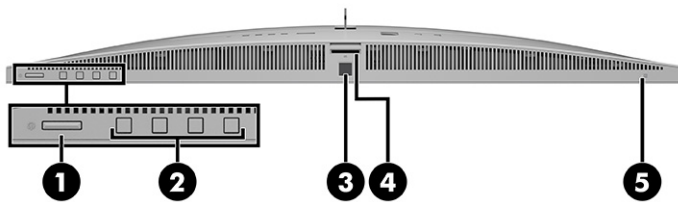
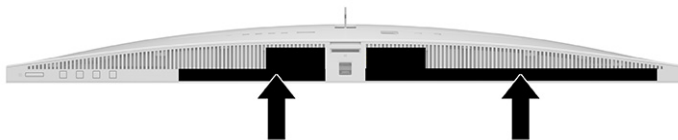

Table 2-4 Identifying the bottom components

Bottom components			
1	Power button	4	SD memory card reader
2	OSD buttons (4)	5	Drive activity light
3	Fingerprint reader		

Serial number location

Each computer has a unique serial number and a product ID number that are located on the exterior of the computer. Keep these numbers available when contacting customer service for assistance.



Using an optional security lock

You can use different types of locks (purchased separately) to secure the computer.

Security cable lock

You can secure the computer with a security cable lock.

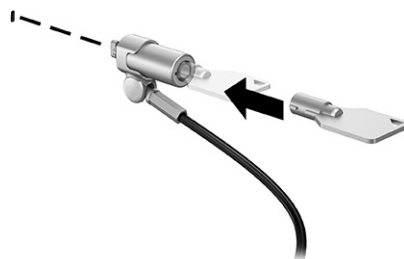

3 Setup

This chapter provides detailed computer setup instructions.

Overview

Read this section for an overview of the setup process.

Perform one of the following tasks:

- Attach a stand. See [Attaching and removing a stand on page 8](#).
- Attach the computer to a mounting fixture. See [Attaching the computer to a mounting fixture on page 11](#).
- Connect the cables for peripherals and power. See [Connecting and disconnecting cables on page 11](#).
- Optionally, connect an additional display. See [Connecting a monitor on page 12](#).
- Install a security cable. See [Security cable lock on page 7](#).
- Turn on the power. See [Connecting power on page 12](#).

The mouse and keyboard are paired at the factory. If you need to synchronize the mouse and keyboard again, see [Synchronizing the optional wireless keyboard and mouse on page 14](#).

Attaching and removing a stand

To attach or remove a stand, follow these instructions.

Three stands are available for the computer:

- Recline stand
- Adjustable-height stand
- Adjustable-height stand with wireless charging



NOTE: The computer must be attached in landscape orientation.

Attaching and removing a recline stand

You can attach or remove a recline stand.

Attaching a recline stand

Attach a recline stand to your computer by following these steps.

1. Place the computer facedown on a soft flat surface. HP recommends that you set down a blanket, towel, or other soft cloth to protect the bezel and screen surface from scratches or other damage.

2. Align the stand with the connector on the back of the computer.
3. Press down on the stand to install into place. Confirm that the stand is firmly attached to the computer by pulling up on the stand arm.

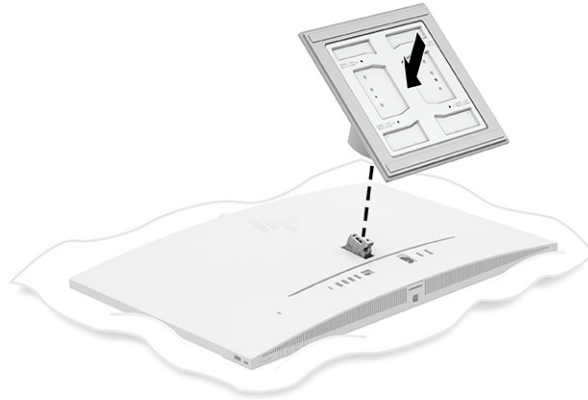

Removing a recline stand

Remove a recline stand from your computer by following these steps.

1. Remove all removable media, such as optical discs or USB flash drives, from the computer.
2. Turn off the computer properly through the operating system. Then turn off any external devices.
3. Disconnect the power cord from the AC outlet, and then disconnect any external devices.
4. Place the computer facedown on a soft flat surface. HP recommends that you set down a blanket, towel, or other soft cloth to protect the bezel and screen surface from scratches or other damage.
5. Press the stand release latch (1).
6. Lift the stand away from the computer (2).

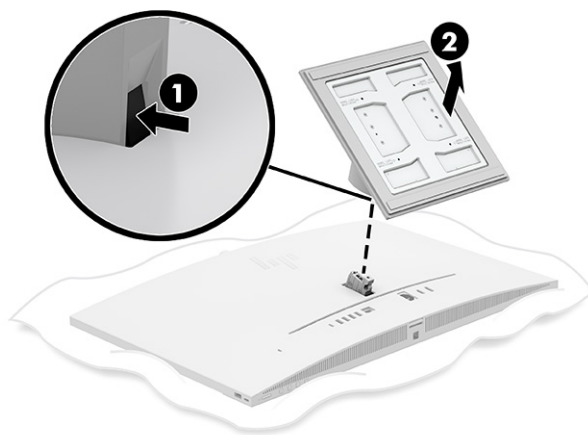

Attaching and removing an adjustable-height stand

You can attach or remove an adjustable-height stand.

Attaching an adjustable-height stand

Attach an adjustable-height stand to your computer by following these steps.

1. Place the computer facedown on a soft flat surface. HP recommends that you set down a blanket, towel, or other soft cloth to protect the bezel and screen surface from scratches or other damage.
2. Align the stand with the connector on the back of the computer (1), and rotate to install (2).
3. Press down on the stand to install into place (3). Confirm that the stand is firmly attached to the computer by pulling up on the stand arm.

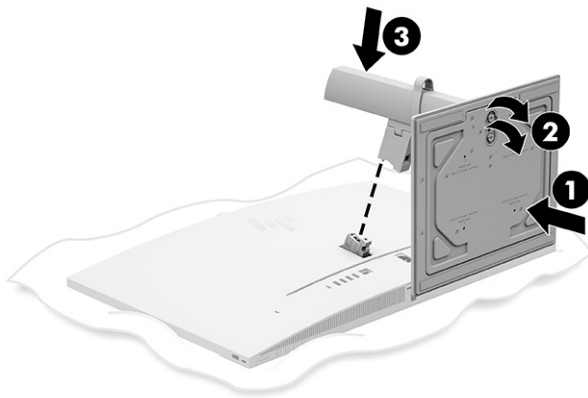

Removing an adjustable-height stand

Remove an adjustable-height stand from your computer by following these steps.

1. Remove all removable media, such as optical discs or USB flash drives, from the computer.
2. Turn off the computer properly through the operating system. Then turn off any external devices.
3. Disconnect the power cord from the AC outlet, and then disconnect any external devices.
4. Place the computer facedown on a soft flat surface. HP recommends that you set down a blanket, towel, or other soft cloth to protect the bezel and screen surface from scratches or other damage.
5. Press the stand release latch (1).

6. Lift the stand (2) away from the computer.

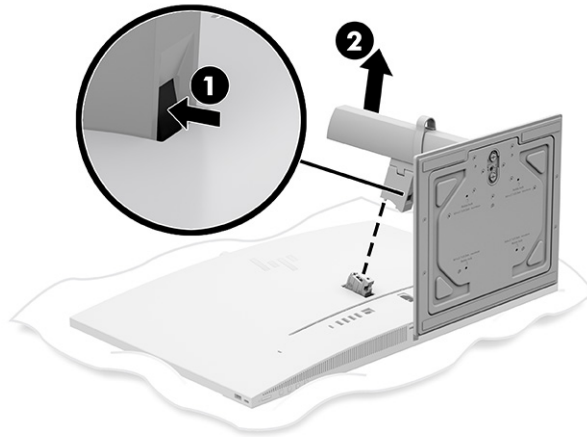

Attaching the computer to a mounting fixture

The computer can be attached to a wall, swing arm, or other mounting fixture.

 **NOTE:** The computer must be attached in landscape orientation.

- To attach the computer to a swing arm or other mounting device, insert four mounting screws through the holes on the mounting device and into the VESA® screw holes on the back of the computer.

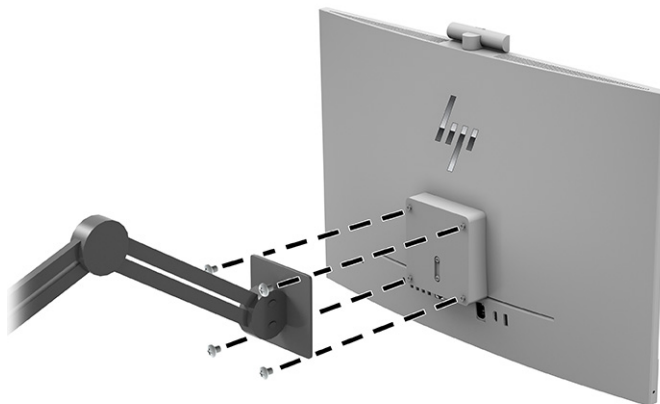

Connecting and disconnecting cables

To connect or disconnect cables, follow these instructions.

Connecting cables

Connect cables to your computer by following these steps.

1. Connect the peripheral cables to the appropriate ports.

2. Connect the power cord to the power connector on the rear of the computer.

Connecting a monitor

The ports on the rear of the computer allow you to connect up to two monitors to the computer.

If you are adding a monitor that has a DisplayPort™ connector, no video adapter is required. If you are adding a monitor that does not have a DisplayPort connector, you can purchase a video adapter from HP for your configuration.

DisplayPort adapters and video cables are purchased separately. HP offers the following adapters:

- DisplayPort-to-VGA adapter
- DisplayPort-to-DVI adapter

To connect a monitor:

1. Turn off power to the computer and to the monitor that you are connecting to the computer.
2. If your monitor has a DisplayPort connector, connect a DisplayPort cable directly between the DisplayPort connector on the rear of the computer and the DisplayPort connector on the monitor.
3. If your monitor does not have a DisplayPort connector, connect a DisplayPort video adapter to the DisplayPort connector on the computer. Then connect a cable (VGA or DVI, depending on your application) between the adapter and the monitor.
4. Turn on power to the computer and the monitor.



NOTE: Use the graphics card software or the Windows Display Settings to configure the monitor as a mirrored image of the computer display or an extension of the computer display.

Disconnecting cables

Disconnect cables from your computer by following these steps.

1. You might need to remove the security cable, if one is installed on the rear of the computer.
2. Disconnect the cables from the ports.

Connecting and disconnecting power

To connect power to or disconnect power from the computer, follow these instructions.

Connecting power

Connect a power cable to your computer by following these steps.

1. Connect one end of the power cord to the AC adapter and the other end to a grounded AC outlet, and then connect the AC adapter to the computer.

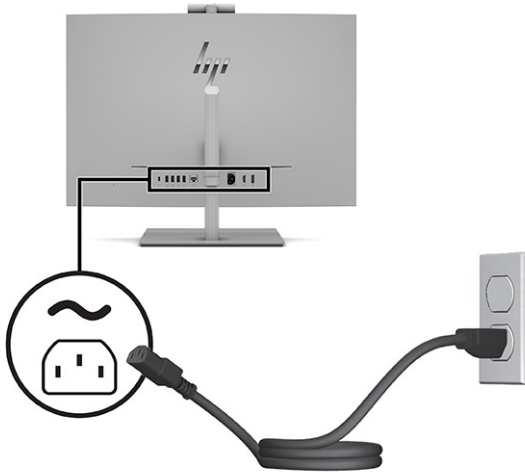

2. Press the power button on the computer to turn it on.

Disconnecting power

Disconnect a power cable from your computer by following these steps.

1. Remove all removable media, such as optical discs or USB flash drives, from the computer.
2. Turn off the computer properly through the operating system, and then turn off any external devices.
3. Disconnect the power cord from the AC outlet, and disconnect any external devices.

Webcam

When logged into a video conferencing platform via web browser or app, you can use the webcam in the following ways.

- Stream online video conferences
- Maintain security over conversations

Using Windows Hello (select products only)

On products equipped with a fingerprint reader or an infrared camera, Windows Hello allows you to enroll your fingerprint, register your facial ID, and set up a PIN. After enrollment, you can use your fingerprint reader, facial ID, or PIN to sign in to Windows.

To set up Windows Hello:

1. Select the **Start** button, select **Settings**, select **Accounts**, and then select **Sign-in options**.
2. If you do not have a password set up, you must add one before you can use other sign-in options. Select **Password**, and then select **Add**.

3. Select **Facial recognition (Windows Hello)** or **Fingerprint recognition (Windows Hello)**, and then select **Set up**.
4. Select **Get started**, and then follow the on-screen instructions to enroll your fingerprint or facial ID and set up a PIN.

 **IMPORTANT:** To prevent fingerprint logon issues, be sure when you register your fingerprint that all sides of your finger are registered by the fingerprint reader.

 **NOTE:** The PIN is not limited in length. The default setting is for numbers only. To include alphabetic or special characters, select the **include letters and symbols** check box.

Setting up Auto Lock and Awake (select products only)

Auto Lock and Awake monitors your presence in front of the computer to save power and add security. When you step away from the computer, the user-proximity sensor puts the computer into the Sleep state. When you return to the computer, your computer recognizes you and wakes the computer automatically. Auto Lock and Awake is turned on by default.

To access Auto Lock and Awake on your monitor:

1. Select the **Start** button, and select **Settings**. Select **System**, and then select **Power & battery**.
2. Under **Power & battery**, select **Screen and sleep**.
3. Select one or both of the following choices:
 - Select **Automatically turn off my screen when I leave** to turn off your screen when you leave the computer.
 - Select **Automatically wake up my device when I approach** to wake your computer when you approach it.
4. For more settings, select **More options** in this screen, and then select from the following choices:
 - Select **Consider me gone when I'm this far away** to set the distance at which the user-proximity sensor considers you gone.
 - Select **Then turn off my screen after this amount of time** to determine how much time to wait before your screen turns off after you leave your computer.
 - Select **Wake my device when I'm this close** to determine how close you need to be for your computer to wake when you approach it.

You can use the IR camera on the computer to log in when using Windows Hello.

 **NOTE:** Some devices might have more than one user-proximity sensor. You can select which one you want to use.

Synchronizing the optional wireless keyboard and mouse

The mouse and keyboard are synchronized at the factory. If they do not work, remove and replace the batteries. If the mouse and keyboard are still not synchronized, follow this procedure to manually resynchronize the pair.

1. Connect the receiver to a USB port on the computer. If your computer has only USB SuperSpeed ports, connect the receiver to a USB SuperSpeed port.

2. To avoid signal interference with a USB SuperSpeed device, distance the receiver at least 3.0 cm (1.18 in) from the USB SuperSpeed device.
3. Press the **Connect** button on the receiver for approximately 5 seconds. The status light on the receiver flashes for approximately 30 seconds after you press the Connect button.
4. While the status light on the receiver is flashing, press the **Connect** button on the underside of the keyboard for 5 to 10 seconds. After you release the **Connect** button, the status light on the receiver stops flashing, indicating that the devices have been synchronized.
5. Press the **Connect** button on the receiver for approximately 5 seconds. The status light on the receiver flashes for approximately 30 seconds after you press the **Connect** button.
6. While the status light on the receiver is flashing, press the **Connect** button on the underside of the mouse for 5 to 10 seconds. After you release the **Connect** button, the status light on the receiver stops flashing, indicating that the devices have been synchronized.



 **NOTE:** If the mouse and keyboard still do not work, remove and replace the batteries. If the mouse and keyboard are still not synchronized, synchronize the keyboard and mouse again.

Adjusting low blue light mode

Decreasing the blue light emitting from the monitor reduces the blue light exposure to your eyes. HP computers provide a setting to reduce blue light output and create a more relaxing and less stimulating image while you read content on the screen.

You can adjust the following settings.

- **Low Blue Light:** Reduces blue light for improved eye comfort.
- **Night:** Adjusts to the lowest blue light and reduces the impact on sleep.

- **Reading:** Optimizes blue light and brightness for indoor viewing.

⚠ WARNING! To reduce the risk of serious injury, read the *Safety & Comfort Guide*. It describes proper workstation setup and proper posture, health, and work habits for computer users. The *Safety & Comfort Guide* also provides important electrical and mechanical safety information. The *Safety & Comfort Guide* is available on the web at <http://www.hp.com/ergo>.

Turning on the low blue light mode

To turn on the low blue light mode, follow these steps.

1. Turn on the computer by pressing the power button located on the bottom of the computer.
2. Press the OSD button located next to the power button.
3. In the OSD menu, select **Low Blue Light** to enable the low blue light function.

Turning on the night light mode

To turn on the night light mode, follow these steps.

1. On the desktop, right-click and select **Display Setting**.
2. Select the **Night Light** check box. The night light setting adjusts to 48%.

4 Backing up, restoring, and recovering

You can use Windows tools or HP software to back up your information, create a restore point, reset your computer, create recovery media, or restore your computer to its factory state. Performing these standard procedures can return your computer to a working state faster.

 **IMPORTANT:** If you are performing recovery procedures on a tablet, the tablet battery must be at least 70% charged before you start the recovery process.

 **IMPORTANT:** For a tablet with a detachable keyboard, connect the tablet to the keyboard base before beginning any recovery process.

Backing up information and creating recovery media

These methods of creating recovery media and backups are available on select products only.

Using Windows tools for backing up

HP recommends that you back up your information immediately after initial setup. You can do this task either using Windows Backup locally with an external USB drive or using online tools.

 **IMPORTANT:** Windows is the only option that allows you to back up your personal information. Schedule regular backups to avoid information loss.

 **NOTE:** If computer storage is 32 GB or less, Microsoft® System Restore is disabled by default.

Using the HP Cloud Recovery Download Tool to create recovery media (select products only)

You can use the HP Cloud Recovery Download Tool to create HP Recovery media on a bootable USB flash drive.

For details:

- Go to <http://www.hp.com>, search for HP Cloud Recovery, and then select the result that matches the type of computer that you have.

 **NOTE:** If you cannot create recovery media yourself, contact support to obtain recovery discs. Go to <http://www.hp.com/support>, select your country or region, and then follow the on-screen instructions.

 **IMPORTANT:** HP recommends that you follow the [Restoring and recovery methods on page 18](#) to restore your computer before you obtain and use the HP recovery discs. Using a recent backup can return your machine to a working state sooner than using the HP recovery discs. After the system is restored, reinstalling all the operating system software released since your initial purchase can be a lengthy process.

Restoring and recovering your system

You have several tools available to recover your system both within and outside of Windows if the desktop cannot load.

HP recommends that you attempt to restore your system using the [Restoring and recovery methods on page 18](#).

Creating a system restore

System Restore is available in Windows. The System Restore software can automatically or manually create restore points, or snapshots, of the system files and settings on the computer at a particular point.

When you use System Restore, it returns your computer to its state at the time you made the restore point. Your personal files and documents should not be affected.

Restoring and recovery methods

After you run the first method, test to see whether the issue still exists before you proceed to the next method, which might now be unnecessary.

1. Run a Microsoft System Restore.
2. Run Reset this PC.



NOTE: The options **Remove everything** and then **Fully clean the drive** can take several hours to complete and leave no information on your computer. It is the safest way to reset your computer before you recycle it.

3. Recover using HP Recovery media. For more information, see [Recovering using HP Recovery media on page 18](#).

For more information about the first two methods, see the Get Help app:

Select the **Start** button, select **All apps** (select products only), select the **Get Help** app, and then enter the task you want to perform.



NOTE: You must be connected to the internet to access the Get Help app.

Recovering using HP Recovery media

You can use HP Recovery media to recover the original operating system and software programs that were installed at the factory. On select products, it can be created on a bootable USB flash drive using the HP Cloud Recovery Download Tool.

For details, see [Using the HP Cloud Recovery Download Tool to create recovery media \(select products only\) on page 17](#).



NOTE: If you cannot create recovery media yourself, contact support to obtain recovery discs. Go to <http://www.hp.com/support>, select your country or region, and then follow the on-screen instructions.

To recover your system:

- Insert the HP Recovery media, and then restart the computer.

 **NOTE:** HP recommends that you follow the [Restoring and recovery methods on page 18](#) to restore your computer before you obtain and use the HP recovery discs. Using a recent backup can return your machine to a working state sooner than using the HP recovery discs. After the system is restored, reinstalling all the operating system software released since your initial purchase can be a lengthy process.

Changing the computer boot order

If your computer does not restart using the HP Recovery media, you can change the computer boot order, which is the order of devices listed in BIOS for startup information. You can select an optical drive or a USB flash drive, depending on the location of your HP Recovery media.

 **IMPORTANT:** For a tablet with a detachable keyboard, connect the tablet to the keyboard base before beginning these steps.

To change the boot order:

1. Insert the HP Recovery media.
2. Access the system **Startup** menu.
 - For computers or tablets with keyboards attached, turn on or restart the computer or tablet, quickly press **esc**, and then press **f9** for boot options.
 - For tablets without keyboards, turn on or restart the tablet, quickly press and hold the volume up button, and then select **f9**.

– or –

Turn on or restart the tablet, quickly press and hold the volume down button, and then select **f9**.
3. Select the optical drive or USB flash drive from which you want to boot, and then follow the on-screen instructions.

Using HP Sure Recover (select products only)

Select computer models are configured with HP Sure Recover, a PC operating system (OS) recovery solution built into the hardware and software. HP Sure Recover can fully restore the HP OS image without installed recovery software.

Using HP Sure Recover, an administrator or user can restore the system and install:

- Latest version of the operating system
- Platform-specific device drivers
- Software applications, in the case of a custom image

To access the latest documentation for HP Sure Recover, go to <http://www.hp.com/support>. Follow the on-screen instructions to find your product and locate your documentation.

5 Using HP PC Hardware Diagnostics

You can use the HP PC Hardware Diagnostics utility to determine whether your computer hardware is running properly. The three versions are HP PC Hardware Diagnostics Windows, HP PC Hardware Diagnostics UEFI (Unified Extensible Firmware Interface), and (for select products only) Remote HP PC Hardware Diagnostics UEFI, a firmware feature.

Using HP PC Hardware Diagnostics Windows (select products only)

HP PC Hardware Diagnostics Windows is a Windows-based utility that allows you to run diagnostic tests to determine whether the computer hardware is functioning properly. The tool runs within the Windows operating system to diagnose hardware failures.

If HP PC Hardware Diagnostics Windows is not installed on your computer, you must download and install it. To download HP PC Hardware Diagnostics Windows, see [Downloading HP PC Hardware Diagnostics Windows on page 21](#).

Using an HP PC Hardware Diagnostics Windows hardware failure ID code

When HP PC Hardware Diagnostics Windows detects a failure that requires hardware replacement, a 24-digit failure ID code is generated for select component tests. For interactive tests, such as keyboard, mouse, or audio and video palette, you must perform troubleshooting steps before you can receive a failure ID.

- You have several options after you receive a failure ID:
 - Select **Next** to open the Event Automation Service (EAS) page, where you can log the case.
 - Scan the QR code with your mobile device, which takes you to the EAS page, where you can log the case.
 - Select the box next to the 24-digit failure ID to copy your failure code and send it to support.

Accessing HP PC Hardware Diagnostics Windows

After HP PC Hardware Diagnostics Windows is installed, you can access it from HP Support Assistant or the Start menu.

Accessing HP PC Hardware Diagnostics Windows from HP Help and Support (select products only)

After HP PC Hardware Diagnostics Windows is installed, follow these steps to access it from HP Help and Support.

1. Select the **Start** button, and then select **HP Help and Support**.
2. Select **HP PC Hardware Diagnostics Windows**.
3. When the tool opens, select the type of diagnostic test that you want to run, and then follow the on-screen instructions.

 **NOTE:** To stop a diagnostic test, select **Cancel**.

Accessing HP PC Hardware Diagnostics Windows from HP Support Assistant

After HP PC Hardware Diagnostics Windows is installed, follow these steps to access it from HP Support Assistant.

1. Select the **Search** icon (select products only) from the taskbar, type `support`, and then select **HP Support Assistant**.

- or -
Select the question mark icon (select products only) in the taskbar.
2. Select **Troubleshooting and fixes** (select products only) or **Fixes & Diagnostics**.
3. Select **Diagnostics**, and then select **HP PC Hardware Diagnostics Windows**.
4. When the tool opens, select the type of diagnostic test that you want to run, and then follow the on-screen instructions.

 **NOTE:** To stop a diagnostic test, select **Cancel**.

Accessing HP PC Hardware Diagnostics Windows from the Start menu (select products only)

After HP PC Hardware Diagnostics Windows is installed, follow these steps to access it from the Start menu.

1. Select the **Start** button, and then select **All apps** (select products only).
2. Select **HP PC Hardware Diagnostics Windows**.
3. When the tool opens, select the type of diagnostic test that you want to run, and then follow the on-screen instructions.

 **NOTE:** To stop a diagnostic test, select **Cancel**.

Downloading HP PC Hardware Diagnostics Windows

The HP PC Hardware Diagnostics Windows downloading instructions are provided in English only. You must use a Windows computer to download this tool because only .exe files are provided.

Downloading the latest HP PC Hardware Diagnostics Windows version from HP

To download HP PC Hardware Diagnostics Windows from HP, follow these steps:

1. Go to <http://www.hp.com/go/techcenter/pcdiags>. The HP PC Diagnostics home page is displayed.
2. Select **Download HP Diagnostics Windows**, and then select the specific Windows diagnostics version to download to your computer or a USB flash drive.

The tool downloads to the selected location.

Downloading the HP PC Hardware Diagnostics Windows from the Microsoft Store

You can download the HP PC Hardware Diagnostics Windows from the Microsoft Store.

1. Select the Microsoft Store app on your desktop.

- or -

Select the **Search** icon (select products only) in the taskbar, and then type `Microsoft Store`.

2. Enter `HP PC Hardware Diagnostics Windows` in the **Microsoft Store** search box.
3. Follow the on-screen directions.

The tool downloads to the selected location.

Downloading HP Hardware Diagnostics Windows by product name or number (select products only)

You can download HP PC Hardware Diagnostics Windows by product name or number.



NOTE: For some products, you might have to download the software to a USB flash drive by using the product name or number.

1. Go to <http://www.hp.com/support>.
2. Select **Software and Drivers**, select your type of product, and then enter the product name or number in the search box that is displayed.
3. In the **Diagnostics** section, select **Download**, and then follow the on-screen instructions to select the specific Windows diagnostics version to be downloaded to your computer or USB flash drive.

The tool downloads to the selected location.

Installing HP PC Hardware Diagnostics Windows

To install HP PC Hardware Diagnostics Windows, navigate to the folder on your computer or the USB flash drive where the .exe file downloaded, double-click the .exe file, and then follow the on-screen instructions.

Using HP PC Hardware Diagnostics UEFI

HP PC Hardware Diagnostics UEFI (Unified Extensible Firmware Interface) allows you to run diagnostic tests to determine whether the computer hardware is functioning properly. The tool runs outside the operating system so that it can isolate hardware failures from issues that are caused by the operating system or other software components.



NOTE: For some products, you must use a Windows computer and a USB flash drive to download and create the HP UEFI support environment because only .exe files are provided. For more information, see [Downloading HP PC Hardware Diagnostics UEFI to a USB flash drive on page 23](#).

If your PC does not start in Windows, you can use HP PC Hardware Diagnostics UEFI to diagnose hardware issues.

Using an HP PC Hardware Diagnostics UEFI hardware failure ID code

When HP PC Hardware Diagnostics UEFI detects a failure that requires hardware replacement, a 24-digit failure ID code is generated.

For assistance in solving the problem:

- Select **Contact HP**, accept the HP privacy disclaimer, and then use a mobile device to scan the failure ID code that appears on the next screen. The HP Customer Support - Service Center page appears with your failure ID and product number automatically filled in. Follow the on-screen instructions.

- or -

Contact support, and provide the failure ID code.

 **NOTE:** To start diagnostics on a convertible computer, your computer must be in notebook mode, and you must use the attached keyboard.

 **NOTE:** If you need to stop a diagnostic test, press **esc**.

Starting HP PC Hardware Diagnostics UEFI

To start HP PC Hardware Diagnostics UEFI, follow this procedure.

1. Turn on or restart the computer, and quickly press **esc**.
2. Press **f2**.

The BIOS searches three places for the diagnostic tools, in the following order:

- a. Connected USB flash drive

 **NOTE:** To download the HP PC Hardware Diagnostics UEFI tool to a USB flash drive, see [Downloading the latest HP PC Hardware Diagnostics UEFI version on page 23](#).

- b. Hard drive

- c. BIOS

3. When the diagnostic tool opens, select a language, select the type of diagnostic test you want to run, and then follow the on-screen instructions.

Downloading HP PC Hardware Diagnostics UEFI to a USB flash drive

Downloading HP PC Hardware Diagnostics UEFI to a USB flash drive can be useful in some situations.

- HP PC Hardware Diagnostics UEFI is not included in the preinstallation image.
- HP PC Hardware Diagnostics UEFI is not included in the HP Tool partition.
- The hard drive is damaged.

 **NOTE:** The HP PC Hardware Diagnostics UEFI downloading instructions are provided in English only, and you must use a Windows computer to download and create the HP UEFI support environment because only .exe files are provided.

Downloading the latest HP PC Hardware Diagnostics UEFI version

To download the latest HP PC Hardware Diagnostics UEFI version to a USB flash drive, follow this procedure:

1. Go to <http://www.hp.com/go/techcenter/pcdiags>. The HP PC Diagnostics home page is displayed.
2. Select **Download HP Diagnostics UEFI**, and then select **Run**.

Downloading HP PC Hardware Diagnostics UEFI by product name or number (select products only)

You can download HP PC Hardware Diagnostics UEFI by product name or number (select products only) to a USB flash drive.

 **NOTE:** For some products, you might have to download the software to a USB flash drive by using the product name or number.

1. Go to <http://www.hp.com/support>.
2. Enter the product name or number, select your computer, and then select your operating system.
3. In the **Diagnostics** section, follow the on-screen instructions to select and download the specific UEFI Diagnostics version for your computer.

Using Remote HP PC Hardware Diagnostics UEFI settings (select products only)

Remote HP PC Hardware Diagnostics UEFI is a firmware (BIOS) feature that downloads HP PC Hardware Diagnostics UEFI to your computer. It can then run the diagnostics on your computer, and it might upload results to a preconfigured server.

For more information about Remote HP PC Hardware Diagnostics UEFI, go to <http://www.hp.com/go/techcenter/pcdiags>, and then select **Find out more**.

Downloading Remote HP PC Hardware Diagnostics UEFI

Remote HP PC Hardware Diagnostics UEFI is also available as a SoftPaq that you can download to a server.

Downloading the latest Remote HP PC Hardware Diagnostics UEFI version

You can download the latest Remote HP PC Hardware Diagnostics UEFI version to a USB flash drive.

1. Go to <http://www.hp.com/go/techcenter/pcdiags>. The HP PC Diagnostics home page is displayed.
2. Select **Download Remote Diagnostics**, and then select **Run**.

Downloading Remote HP PC Hardware Diagnostics UEFI by product name or number

You can download Remote HP PC Hardware Diagnostics UEFI by product name or number.

 **NOTE:** For some products, you might have to download the software by using the product name or number.

1. Go to <http://www.hp.com/support>.
2. Select **Software and Drivers**, select your type of product, enter the product name or number in the search box that is displayed, select your computer, and then select your operating system.
3. In the **Diagnostics** section, follow the on-screen instructions to select and download the **Remote UEFI** version for the product.

Customizing Remote HP PC Hardware Diagnostics UEFI settings

Using the Remote HP PC Hardware Diagnostics setting in Computer Setup (BIOS), you can perform several customizations.

- Set a schedule for running diagnostics unattended. You can also start diagnostics immediately in interactive mode by selecting **Execute Remote HP PC Hardware Diagnostics**.
- Set the location for downloading the diagnostic tools. This feature provides access to the tools from the HP website or from a server that has been preconfigured for use. Your computer does not require the traditional local storage (such as a hard drive or USB flash drive) to run remote diagnostics.
- Set a location for storing the test results. You can also set the user name and password that you use for uploads.
- Display status information about the diagnostics run previously.

To customize Remote HP PC Hardware Diagnostics UEFI settings, follow these steps:

1. Turn on or restart the computer, and when the HP logo appears, press **f10** to enter Computer Setup.
2. Select **Advanced**, and then select **Settings**.
3. Make your customization selections.
4. Select **Main**, and then **Save Changes and Exit** to save your settings.

Your changes take effect when the computer restarts.

6 Computer operating guidelines, routine care, and shipping preparation

Follow these guidelines to ensure the best performance and useful life of your computer.

Operating guidelines and routine care

HP has developed guidelines to help you properly set up and care for the computer and monitor.

- Keep the computer away from excessive moisture, direct sunlight, and extreme heat and cold.
- Operate the computer on a sturdy, level surface. Leave a 10.2 cm (4 inch) clearance on all vented sides of the computer and above the monitor to permit the required airflow.
- Never restrict the airflow into the computer by blocking any vents or air intakes. Do not place the keyboard, with the keyboard feet down, directly against the front of the desktop unit because this also restricts airflow.
- Never operate the computer with the access panel or any of the expansion card slot covers removed.
- Do not stack computers on top of each other or place computers so near each other that they are subject to each other's recirculated or preheated air.
- To operate a computer within a separate enclosure, intake and exhaust ventilation must be provided on the enclosure, and the previous operating guidelines still apply.
- Keep liquids away from the computer and keyboard.
- Never cover the ventilation slots on the monitor with any type of material.
- Install or enable power management functions of the operating system or other software, including sleep states.
- Turn off the computer before you do either of the following tasks:
 - Wipe the exterior of the computer with a soft, damp cloth as needed. Cleaning products might discolor or damage the finish. See [Removing dirt and debris from your computer on page 27](#) for the recommended steps to clean the high-touch, external surfaces on your computer. After you remove the dirt and debris, you can also clean the surfaces with a disinfectant. See [Cleaning your computer with a disinfectant on page 27](#) for guidelines to help prevent the spread of harmful bacteria and viruses.
 - Occasionally clean the air vents on all vented sides of the computer. Lint, dust, and other foreign matter can block the vents and limit the airflow.

Cleaning your computer

Cleaning your computer regularly removes dirt and debris so that your device continues to operate at its best. Use the following information to safely clean the external surfaces of your computer.

Removing dirt and debris from your computer

Here are the recommended steps to clean dirt and debris from your computer.

1. Wear disposable gloves made of latex (or nitrile gloves, if you are latex-sensitive) when cleaning the surfaces.
2. Turn off your device and unplug the power cord and other connected external devices. Remove any installed batteries from items such as wireless keyboards.

 **CAUTION:** To prevent electric shock or damage to components, never clean a product while it is turned on or plugged in.

3. Moisten a microfiber cloth with water. The cloth should be moist, but not dripping wet.

 **IMPORTANT:** To avoid damaging the surface, avoid abrasive cloths, towels, and paper towels.

4. Wipe the exterior of the product gently with the moistened cloth.

 **IMPORTANT:** Keep liquids away from the product. Avoid getting moisture in any openings. If liquid makes its way inside your HP product, it can cause damage to the product. Do not spray liquids directly on the product. Do not use aerosol sprays, solvents, abrasives, or cleaners containing hydrogen peroxide or bleach that might damage the finish.

5. Start with the display (if applicable). Wipe carefully in one direction, and move from the top of the display to the bottom. Finish with any flexible cables, like power cord, keyboard cable, and USB cables.
6. Be sure that surfaces have completely air-dried before turning the device on after cleaning.
7. Discard the gloves after each cleaning. Clean your hands immediately after you remove the gloves.

See [Cleaning your computer with a disinfectant on page 27](#) for recommended steps to clean the high-touch, external surfaces on your computer to help prevent the spread of harmful bacteria and viruses.

Cleaning your computer with a disinfectant

The World Health Organization (WHO) recommends cleaning surfaces, followed by disinfection, as a best practice for preventing the spread of viral respiratory illnesses and harmful bacteria.

After cleaning the external surfaces of your computer using the steps in [Removing dirt and debris from your computer on page 27](#), you might also choose to clean the surfaces with a disinfectant. A disinfectant that is within HP's cleaning guidelines is an alcohol solution consisting of 70% isopropyl alcohol and 30% water. This solution is also known as rubbing alcohol and is sold in most stores.

Follow these steps when disinfecting high-touch, external surfaces on your computer:

1. Wear disposable gloves made of latex (or nitrile gloves, if you are latex-sensitive) when cleaning the surfaces.
2. Turn off your device and unplug the power cord and other connected external devices. Remove any installed batteries from items such as wireless keyboards.

 **CAUTION:** To prevent electric shock or damage to components, never clean a product while it is turned on or plugged in.

3. Moisten a microfiber cloth with a mixture of 70% isopropyl alcohol and 30% water. The cloth should be moist, but not dripping wet.

 **CAUTION:** Do not use any of the following chemicals or any solutions that contain them, including spray-based surface cleaners: bleach, peroxides (including hydrogen peroxide), acetone, ammonia, ethyl alcohol, methylene chloride, or any petroleum-based materials, such as gasoline, paint thinner, benzene, or toluene.

 **IMPORTANT:** To avoid damaging the surface, avoid abrasive cloths, towels, and paper towels.
4. Wipe the exterior of the product gently with the moistened cloth.

 **IMPORTANT:** Keep liquids away from the product. Avoid getting moisture in any openings. If liquid makes its way inside your HP product, it can cause damage to the product. Do not spray liquids directly on the product. Do not use aerosol sprays, solvents, abrasives, or cleaners containing hydrogen peroxide or bleach that might damage the finish.
5. Start with the display (if applicable). Wipe carefully in one direction, and move from the top of the display to the bottom. Finish with any flexible cables, like power cord, keyboard cable, and USB cables.
6. Be sure that surfaces have completely air-dried before turning the device on after cleaning.
7. Discard the gloves after each cleaning. Clean your hands immediately after you remove the gloves.

Shipping preparation

If you have to ship your computer, follow these tips to keep your equipment safe.

1. Back up the hard drive files to an external storage device. Be sure that the backup media is not exposed to electrical or magnetic impulses while stored or in transit.

 **NOTE:** The hard drive locks automatically when the system power is turned off.
2. Remove and store all removable media.
3. Turn off the computer and external devices.
4. Disconnect the power cord from the AC outlet, and then from the computer.
5. Disconnect the system components and external devices from their power sources and then from the computer.

 **NOTE:** Be sure that all boards are seated properly and secured in the board slots before shipping the computer.
6. Pack the system components and external devices in their original packing boxes or similar packaging with sufficient packing material to protect them.

7 Electrostatic discharge

Electrostatic discharge is the release of static electricity when two objects come into contact—for example, the shock you receive when you walk across the carpet and touch a metal door knob.

A discharge of static electricity from fingers or other electrostatic conductors may damage electronic components.

 **IMPORTANT:** To prevent damage to the computer, damage to a drive, or loss of information, observe these precautions:

- If removal or installation instructions direct you to unplug the computer, first be sure that it is properly grounded.
 - Keep components in their electrostatic-safe containers until you are ready to install them.
 - Avoid touching pins, leads, and circuitry. Handle electronic components as little as possible.
 - Use nonmagnetic tools.
 - Before handling components, discharge static electricity by touching an unpainted metal surface.
 - If you remove a component, place it in an electrostatic-safe container.
-

8 Accessibility

HP's goal is to design, produce, and market products, services, and information that everyone everywhere can use, either on a standalone basis or with appropriate third-party assistive technology (AT) devices or applications.

HP and accessibility

Because HP works to weave diversity, inclusion, and work/life into the fabric of the company, it is reflected in everything HP does. HP strives to create an inclusive environment focused on connecting people to the power of technology throughout the world.

Finding the technology tools you need

Technology can unleash your human potential. Assistive technology removes barriers and helps you create independence at home, at work, and in the community. Assistive technology helps increase, maintain, and improve the functional capabilities of electronic and information technology.

For more information, see [Finding the best assistive technology on page 31](#).

The HP commitment

HP is committed to providing products and services that are accessible for people with disabilities. This commitment supports the company's diversity objectives and helps ensure that the benefits of technology are available to all.

The HP accessibility goal is to design, produce, and market products and services that can be effectively used by everyone, including people with disabilities, either on a standalone basis or with appropriate assistive devices.

To achieve that goal, this Accessibility Policy establishes seven key objectives to guide HP actions. All HP managers and employees are expected to support these objectives and their implementation in accordance with their roles and responsibilities:

- Raise the level of awareness of accessibility issues within HP, and provide employees with the training they need to design, produce, market, and deliver accessible products and services.
- Develop accessibility guidelines for products and services, and hold product development groups accountable for implementing these guidelines where competitively, technically, and economically feasible.
- Involve people with disabilities in the development of accessibility guidelines and in the design and testing of products and services.
- Document accessibility features, and make information about HP products and services publicly available in an accessible form.
- Establish relationships with leading assistive technology and solution providers.
- Support internal and external research and development that improves assistive technology relevant to HP products and services.

- Support and contribute to industry standards and guidelines for accessibility.

International Association of Accessibility Professionals (IAAP)

IAAP is a not-for-profit association focused on advancing the accessibility profession through networking, education, and certification. The objective is to help accessibility professionals develop and advance their careers and to better enable organizations to integrate accessibility into their products and infrastructure.

As a founding member, HP joined to participate with other organizations to advance the field of accessibility. This commitment supports HP's accessibility goal of designing, producing, and marketing products and services that people with disabilities can effectively use.

IAAP will make the profession strong by globally connecting individuals, students, and organizations to learn from one another. If you are interested in learning more, go to <http://www.accessibilityassociation.org> to join the online community, sign up for newsletters, and learn about membership options.

Finding the best assistive technology

Everyone, including people with disabilities or age-related limitations, should be able to communicate, express themselves, and connect with the world using technology. HP is committed to increasing accessibility awareness within HP and with our customers and partners.

Whether it's large fonts that are easy on the eyes, voice recognition that lets you give your hands a rest, or any other assistive technology to help with your specific situation—a variety of assistive technologies make HP products easier to use. How do you choose?

Assessing your needs

Technology can unleash your potential. Assistive technology removes barriers and helps you create independence at home, at work, and in the community. Assistive technology (AT) helps increase, maintain, and improve the functional capabilities of electronic and information technology.

You can choose from many AT products. Your AT assessment should allow you to evaluate several products, answer your questions, and facilitate your selection of the best solution for your situation. You will find that professionals qualified to do AT assessments come from many fields, including those licensed or certified in physical therapy, occupational therapy, speech/language pathology, and other areas of expertise. Others, while not certified or licensed, can also provide evaluation information. You will want to ask about the individual's experience, expertise, and fees to determine if they are appropriate for your needs.

Accessibility for HP products

These links provide information about accessibility features and assistive technology, if applicable and available in your country or region, that are included in various HP products. These resources will help you select the specific assistive technology features and products most appropriate for your situation.

- HP Aging & Accessibility: Go to <http://www.hp.com>, type `Accessibility` in the search box. Select **Office of Aging and Accessibility**.
- HP computers: For Windows products, go to <http://www.hp.com/support>, type `Windows Accessibility Options` in the **Search our knowledge** search box. Select the appropriate operating system in the results.
- HP Shopping, peripherals for HP products: Go to <http://store.hp.com>, select **Shop**, and then select **Monitors or Accessories**.

If you need additional support with the accessibility features on your HP product, see [Contacting support on page 34](#).

Additional links to external partners and suppliers that may provide additional assistance:

- [Microsoft Accessibility information \(Windows and Microsoft Office\)](#)
- [Google Products accessibility information \(Android, Chrome, Google Apps\)](#)

Standards and legislation

Countries worldwide are enacting regulations to improve access to products and services for persons with disabilities. These regulations are historically applicable to telecommunications products and services, PCs and printers with certain communications and video playback features, their associated user documentation, and their customer support.

Standards

The US Access Board created Section 508 of the Federal Acquisition Regulation (FAR) standards to address access to information and communication technology (ICT) for people with physical, sensory, or cognitive disabilities.

The standards contain technical criteria specific to various types of technologies, as well as performance-based requirements which focus on functional capabilities of covered products. Specific criteria cover software applications and operating systems, web-based information and applications, computers, telecommunications products, video and multimedia, and self-contained closed products.

Mandate 376 – EN 301 549

The European Union created the EN 301 549 standard within Mandate 376 as an online toolkit for public procurement of ICT products. The standard specifies the accessibility requirements applicable to ICT products and services, with a description of the test procedures and evaluation methodology for each requirement.

Web Content Accessibility Guidelines (WCAG)

Web Content Accessibility Guidelines (WCAG) from the W3C's Web Accessibility Initiative (WAI) helps web designers and developers create sites that better meet the needs of people with disabilities or age-related limitations.

WCAG advances accessibility across the full range of web content (text, images, audio, and video) and web applications. WCAG can be precisely tested, is easy to understand and use, and allows web developers flexibility for innovation. WCAG 2.0 has also been approved as [ISO/IEC 40500:2012](#).

WCAG specifically addresses barriers to accessing the web experienced by people with visual, auditory, physical, cognitive, and neurological disabilities, and by older web users with accessibility needs. WCAG 2.0 provides characteristics of accessible content:

- **Perceivable** (for instance, by addressing text alternatives for images, captions for audio, adaptability of presentation, and color contrast)
- **Operable** (by addressing keyboard access, color contrast, timing of input, seizure avoidance, and navigability)
- **Understandable** (by addressing readability, predictability, and input assistance)
- **Robust** (for instance, by addressing compatibility with assistive technologies)

Legislation and regulations

Accessibility of IT and information has become an area of increasing legislative importance. These links provide information about key legislation, regulations, and standards.

- [United States](#)
- [Canada](#)
- [Europe](#)
- [Australia](#)

Useful accessibility resources and links

These organizations, institutions, and resources might be good sources of information about disabilities and age-related limitations.



NOTE: This is not an exhaustive list. These organizations are provided for informational purposes only. HP assumes no responsibility for information or contacts you encounter on the internet. Listing on this page does not imply endorsement by HP.

Organizations

These organizations are a few of the many that provide information about disabilities and age-related limitations.

- American Association of People with Disabilities (AAPD)
- The Association of Assistive Technology Act Programs (ATAP)
- Hearing Loss Association of America (HLAA)
- Information Technology Technical Assistance and Training Center (ITTATC)
- Lighthouse International
- National Association of the Deaf
- National Federation of the Blind
- Rehabilitation Engineering & Assistive Technology Society of North America (RESNA)
- Telecommunications for the Deaf and Hard of Hearing, Inc. (TDI)
- W3C Web Accessibility Initiative (WAI)

Educational institutions

Many educational institutions, including these examples, provide information about disabilities and age-related limitations.

- California State University, Northridge, Center on Disabilities (CSUN)
- University of Wisconsin - Madison, Trace Center
- University of Minnesota computer accommodations program

Other disability resources

Many resources, including these examples, provide information about disabilities and age-related limitations.

- ADA (Americans with Disabilities Act) Technical Assistance Program
- ILO Global Business and Disability network
- EnableMart
- European Disability Forum
- Job Accommodation Network
- Microsoft Enable

HP links

These HP-specific links provide information that relates to disabilities and age-related limitations.

[HP comfort and safety guide](#)

[HP public sector sales](#)

Contacting support

HP offers technical support and assistance with accessibility options for customers with disabilities.



NOTE: Support is in English only.

- Customers who are deaf or hard of hearing who have questions about technical support or accessibility of HP products:
 - Use TRS/VRS/WebCapTel to call (877) 656-7058 Monday through Friday, 6 a.m. to 9 p.m. Mountain Time.
- Customers with other disabilities or age-related limitations who have questions about technical support or accessibility of HP products:
 - Call (888) 259-5707 Monday through Friday, 6 a.m. to 9 p.m. Mountain Time.

Index

A

- accessibility 30, 31, 33, 34
- accessibility needs
 - assessment 31
- assistive technology (AT)
 - finding 31
 - purpose 30
- AT (assistive technology)
 - finding 31
 - purpose 30

B

- backup, creating 17
- backups 17
- boot order, changing 19
- bottom components 7

C

- cables
 - connecting 11
 - disconnecting 12
- caring for your computer 26
- cleaning your computer 26
 - disinfecting 27
 - removing dirt and debris 27
- computer operating
 - guidelines 26
- customer support,
 - accessibility 34

D

- diagnostics 2
- documentation 2

E

- electrostatic discharge 29

F

- fingerprints, registering 13
- front panel components 4

H

- HP Assistive Policy 30
- HP PC Hardware Diagnostics UEFI
 - downloading 23

- failure ID code 22
 - starting 23
 - using 22
- HP PC Hardware Diagnostics
 - Windows
 - accessing 20, 21
 - downloading 21
 - failure ID code 20
 - installing 22
 - using 20
- HP Recovery media
 - recovery 18
- HP resources 1
- HP Sure Recover 19

I

- International Association of Accessibility Professionals 31

K

- keyboard
 - synchronizing wireless 14

L

- locks
 - cable lock 7
- low blue light mode 15

M

- monitor
 - attaching 12
- mounting fixture 11
- mouse
 - synchronizing wireless 14

N

- night light mode 16

P

- power
 - connecting 12
 - disconnecting 13
- product ID location 7
- product information 1

R

- rear panel components 5
- recovery 17, 18
 - discs 18
 - media 18
 - USB flash drive 18
- recovery media 17
 - creating using HP Cloud Recovery Download Tool 17
 - creating using Windows tools 17
- Remote HP PC Hardware Diagnostics UEFI settings
 - customizing 25
 - using 24
- resources, accessibility 33
- restoring 17
- restoring and recovery methods 18

S

- Section 508 accessibility standards 32
- security
 - cable lock 7
- serial number location 7
- setup 8
- setup, order of 8
- shipping preparation 28
- side panel components 6
- Skype 13
- stand
 - adjustable-height 10
 - attaching 8, 10
 - recline 8, 9
 - removing 8-10
- standards and legislation, accessibility 32
- support
 - general resources 1
 - HP resources 1
- system restore 18
- system restore point, creating 17

U

- updates 3

V

ventilation guidelines 26

W

webcam 13

Windows

 backup 17

 recovery media 17

 system restore point 17

Windows Hello

 using 13

Windows tools, using 17