



Voyager Focus 2 Office

Bluetooth headset system for
computer and desk phone

User Guide

Contents

Hook up system	3	
Desk phone setup details		3
Position Your Base	5	
Overview	6	
Headset	6	
Base overview	7	
Accessories	7	
Pair	9	
Pair headset to base	9	
Pair to mobile device	9	
Pair mode	9	
Fit and charge	10	
Wear on the right or left		10
Charge	10	
Check headset battery status		10
Load software	11	
Update firmware	11	
The basics	12	
Power on/off	12	
Adjust volume	12	
Make, answer, end calls	12	
Launch Microsoft Teams (Teams model only)		13
Use sensors	13	
More Features	15	
Play or pause audio	15	
Voice assistant (smartphone feature)		15
ANC	15	
Change your default line	15	
Online indicator	15	
Corded mode (audio over USB)		15
Troubleshooting	17	
Headset	17	
Desk phone	18	
Softphone	18	
What's in the box	20	
Support	21	

Hook up system

Using the diagram, connect your headset system.

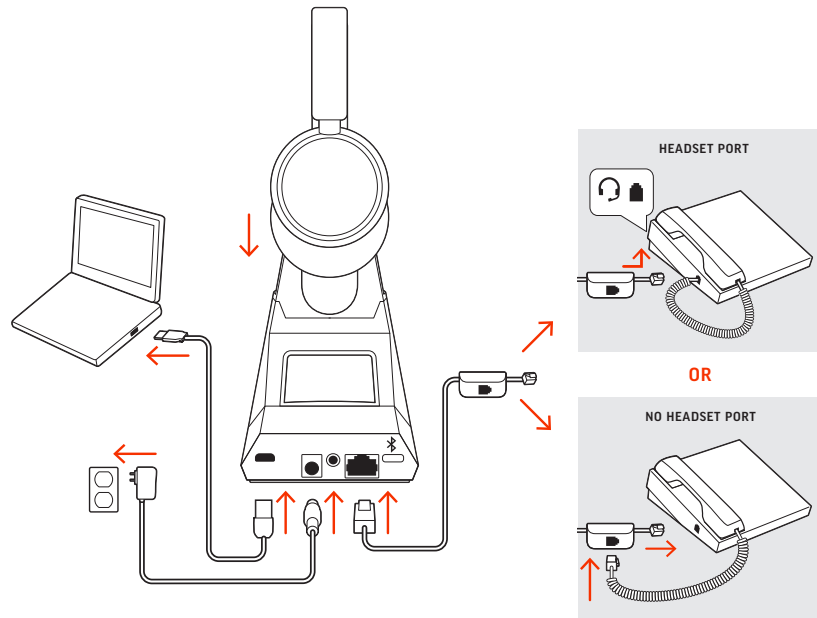

*Headset design/headset cradle may vary but function is the same.

Note: Base configuration settings

Desk phone	Setting (on bottom of base)
Most phones	A
Cisco phones	D
Cisco phones with EHS cable	A

Desk phone setup details

Choose a desk phone setup **A, B, C or D** and connect cables.

A Desk phone with dedicated headset port

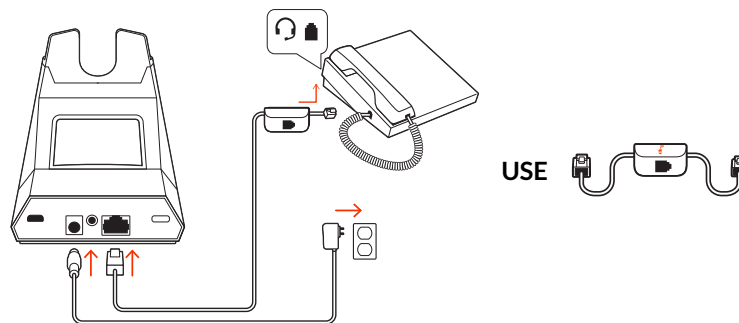

- Connect one end of the telephone interface cable to the back of the base

- Connect the other end of the telephone interface cable into the dedicated headset port on the desk phone

Important: Cisco phones use configuration **D** on the bottom of the base. Most other phones use default configuration **A**.

Note: Use this setup if you are not using the HL10 lifter or EHS cable. In this configuration, press both the headset button on your desk phone and the call control button on the headset to answer or end calls.

B Desk phone (standard)

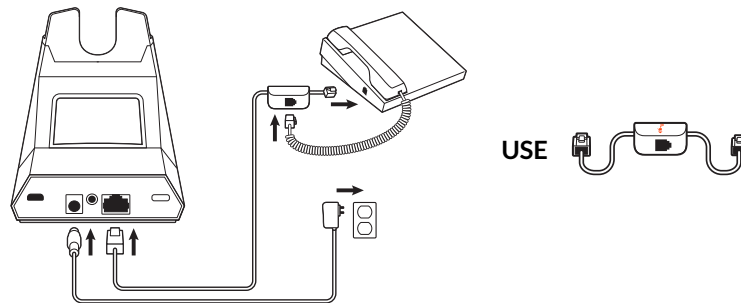

- Connect one end of the telephone interface cable to the back of the base
- Disconnect the handset coil cord from the base of the desk phone and re-connect it to the telephone interface cable junction box
- Finally connect the remaining end of the telephone interface cable into the open handset port on the desk phone

Important: Cisco phones use configuration **D** on the bottom of the base. Most other phones use default configuration **A**.

Note: Use this setup if you are not using the HL10 lifter or EHS cable and your desk phone does not have a dedicated headset port. In this configuration, manually remove the handset on your desk phone and press the call control button on the headset to answer or end calls.

C Desk phone + EHS cable (sold separately)

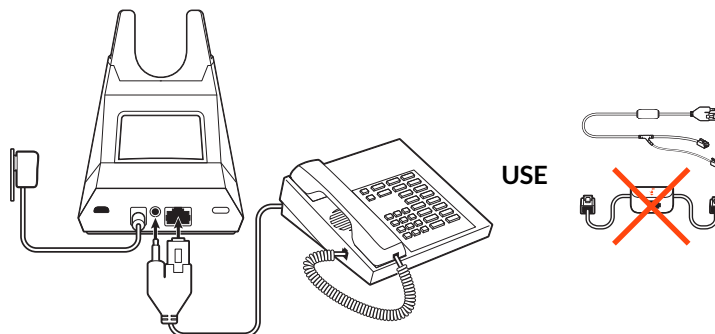

Important: Use configuration **A** on the bottom of the base, which works for most phones including Cisco phones.

D Desk phone + HL10 lifter (sold separately)

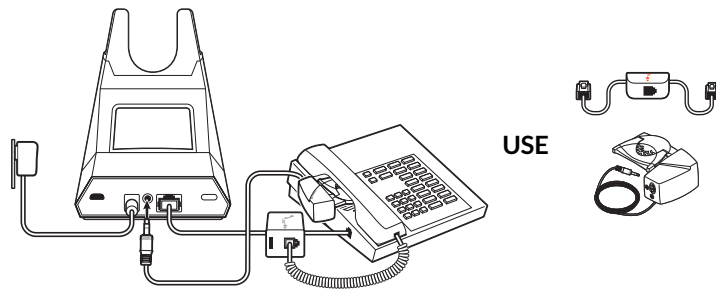

Important: Cisco phones use configuration **D** on the bottom of the base. Most other phones use default configuration **A**.

Position Your Base

The minimum recommended separation between your desk phone and the base is 6 inches.

The minimum recommended separation between the base and computer is 12 inches. Incorrect position can cause noise and interference problems.

Note: Headset cradle may vary, but function is the same.

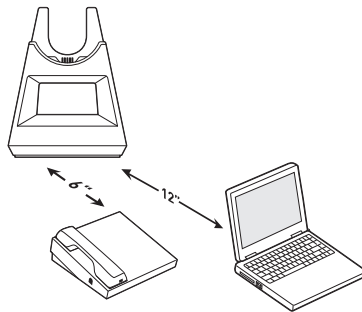

Overview

Headset

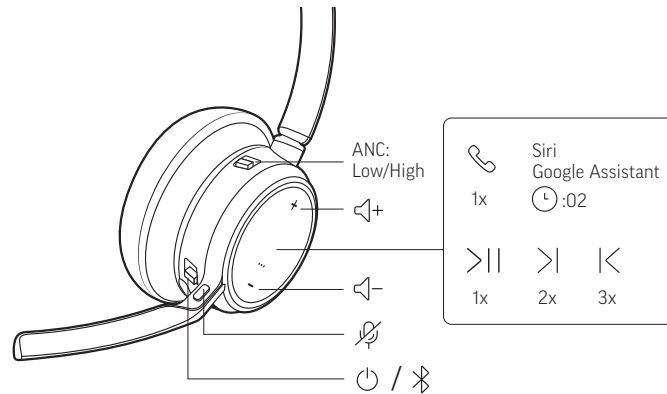

ANC	Active Noise Cancelling (off/low/high)
🔊+	Volume up
📞	Call button/Press to interact with Microsoft Teams (Teams model only, requires Teams app)
Siri/Google Assistant	Default voice assistant
▶	Play/pause**
▶	Next track**
◀	Previous track**
🔊-	Volume down
🔇	Mute/unmute
🔌	Power on/off
📶	Bluetooth pairing

Note: **Functionality varies by application. May not function with web-based apps.

Be safe

Please read the safety guide for important safety, charging, battery and regulatory information before using your new headset.

Base overview

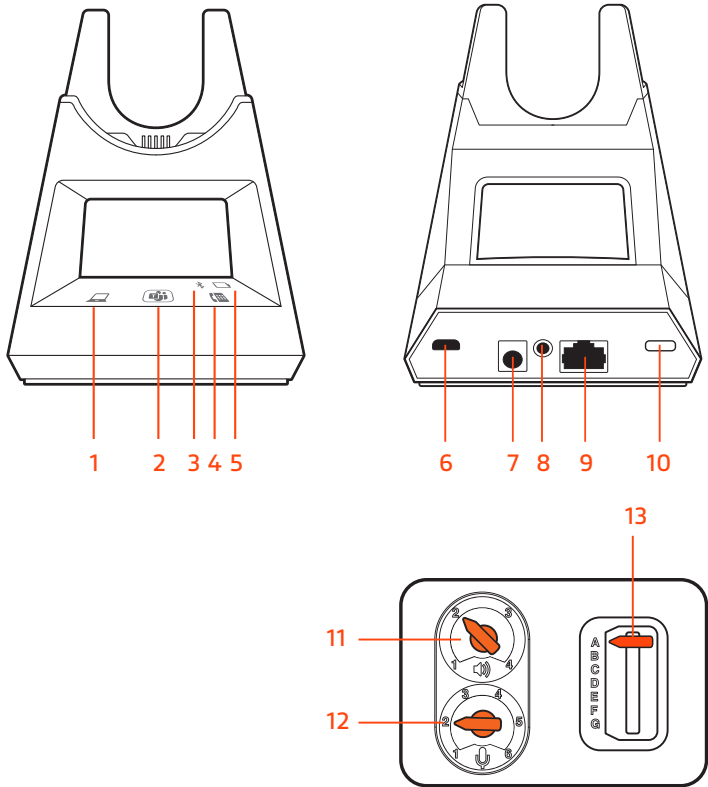

- 1 Computer button
- 2 Microsoft Teams button (Teams model only)
- 3 Bluetooth LED
- 4 Desk phone button
- 5 Charging LED
- 6 USB port
- 7 Power jack
- 8 Handset lifter jack
- 9 Telephone interface cable jack
- 10 Bluetooth pairing button
- 11 Desk phone listening volume
- 12 Desk phone speaking volume
- 13 Desk phone configuration switch

Accessories

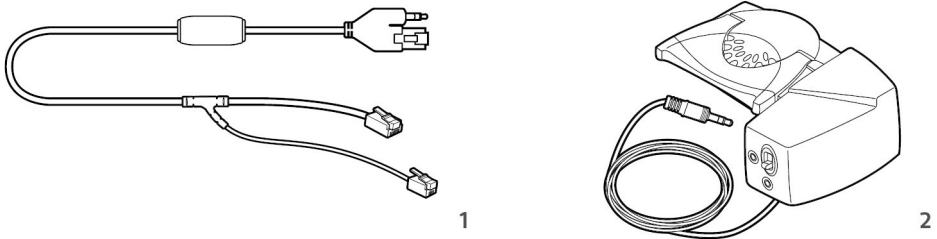

- 1 **Electronic hookswitch cable (EHS cable)** Electronically and automatically answers/ends a desk phone call. Enables remote call control with your headset.
- 2 **HL10 lifter** Automatically lifts handset and returns it to the cradle. Enables remote call control with your headset.

Pair

Pair headset to base

Your system has a base and compatible Bluetooth headset.

Your headset comes pre-paired to the base. To pair again:

- 1 Slide and hold the headset Power ⏻ switch away from the off position until the LEDs flash red and blue.
- 2 Put your base into pair mode by pressing and holding the Bluetooth pairing Ⓜ button on the back of your base for 2 seconds until the display panel's Bluetooth Ⓜ icon flashes blue and red.



Pairing is successful when you hear "pairing successful" and "base connected" and the display panel's Bluetooth Ⓜ icon turns solid blue.

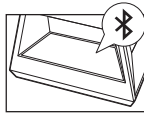

Note: Your headset can pair with up to 8 devices but only maintain 2 connections simultaneously; this includes the base.

Pair to mobile device

- 1 To put your headset in pair mode, slide and hold the Power ⏻ switch away from the off position until you hear "pairing" and the headset LEDs flash red and blue.



- 2 Activate Bluetooth on your phone and set it to search for new devices.

- iPhone Settings > Bluetooth > On*
- Android Settings > Bluetooth On > Scan for devices*

Note: *Menus may vary by device.

- 3 Select "Poly VFOCUS2 Series."
Once successfully paired, you hear "pairing successful" and the headset LEDs stop flashing.

Note: Your headset can pair with up to 8 devices but only maintain 2 connections simultaneously; this includes the base.

Pair mode

Slide and hold the headset Power ⏻ switch away from the off position until the LEDs flash red and blue.

Fit and charge

Wear on the right or left

- To position the microphone on the right or left side, rotate the microphone boom up and over. Bend the boom so it is approximately 2 finger widths from the corner of your mouth.

Note: Your headset senses when you change the microphone boom from one side to the other and syncs the audio specific to each side.

- Gently flex the headband wider if the fit is uncomfortable on your ears.

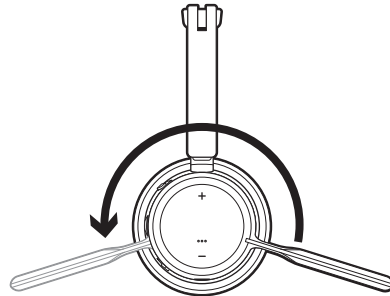

Charge

Charge your headset by placing it in the base's cradle or by using a micro USB cable. The headset LEDs flash when charging. It takes approximately 2 hours to fully charge your headset. The LEDs turn off once charging is complete.

Note: The micro USB cable plugs into a computer or wall charger's USB port.

Headset LEDs	What they mean
Off	Charging complete
●●●	Battery high
●●	Battery medium
●	Battery low
⚡	Battery critical

Check headset battery status

Check your headset battery status:

- With headset inactive, slide and release the Power ⏻ switch away from the off position. Listen to the voice alert or observe the headset LEDs.

Load software

Customize your device behavior through advanced settings and options with Poly Lens App. Some softphones require the installation of Poly software to enable device call control (answer/end and mute) functionality. Download: poly.com/lens.

Note: Device settings are also available in Plantronics Hub App.

Update firmware

Keep your firmware up-to-date to improve performance and add new features to your Poly device.

Update your firmware using your computer with Poly Lens App. Download at poly.com/lens.

While updating firmware:

- Do not use your Poly device until the update is complete.
- Disconnect your Poly device from paired devices such as phones, tablets and computers.
- Do not start a second update from a second device.
- Do not stream media.
- Do not answer or place a call.

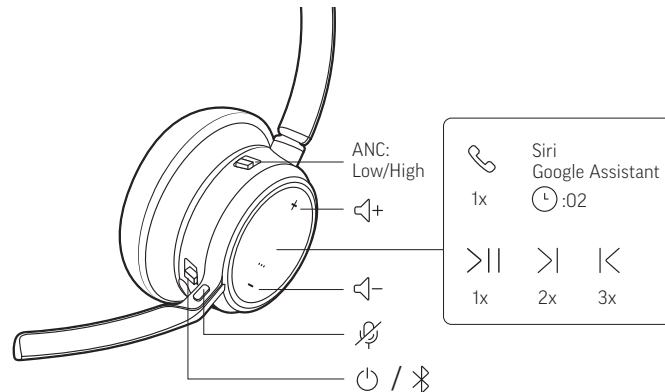

The basics



Power on/off

Slide the switch  to power on or off.

Adjust volume

- **Headset volume** Fine-tune your headset volume by adjusting the headset's volume up (+) and down (-) controls.
- **Desk phone volume** When you are on a desk phone call and your voice is too quiet/loud, adjust the speaking  volume on the bottom of the base. If your caller's voice is too loud/quiet on a desk phone call, adjust the listening  volume.
- **Base ringtone volume** Adjust the base ringtone volume setting in Poly Lens Desktop App. This ringtone alerts you if you are not wearing your headset and a call comes in.

Adjust headset microphone volume (softphone)

Place a test softphone call and adjust softphone volume and PC sound volume accordingly.

Make, answer, end calls

On the front of the base there are 2 Audio /  buttons: computer and desk phone. These buttons allow you to switch to a different phone line/audio channel.

Make a call (computer or desk phone)

1 Tap an Audio button /  on your base display. You hear a dial tone.



: Desk phone only: Press the phone's Headset  button or manually remove the handset if you don't have an HL10 lifter or EHS cable.

Tip: If you do not hear a dial tone, turn over the base and adjust the switch (A--G). "A" works for the majority of desk phones. "D" works for Cisco phones.

2 Dial from your softphone or desk phone.

Answer or end a call

To answer or end a call, choose:

- Tap the headset Call  button.
- **Computer or desk phone:** Tap the corresponding Audio button / 

: Desk phone only: If you don't have an HL10 lifter or EHS cable, Press the phone's Headset  button or manually remove the handset when answering a call or hang up the handset when ending a call.



Mute

Mute your headset on an active call:

- Tap the Mute  button
- Rotate your microphone boom and click it into the up position
- Take off your headset (requires active smart sensors). Put on your headset to unmute.

Hold a call

To hold an active call or resume a held call:



- Standard headset: Press the Call button for 2 seconds.
- Microsoft Teams headset: Press the Mute button for 2 seconds.
- Base: Tap the corresponding Computer or Desk phone Audio / button. The button flashes red when a call is on hold.

Note: Two desk phone calls can be put on hold only from your desk phone. Check your desk phone user guide.

Switch between calls (flash)

Switch between two calls on your headset. This feature is not available for mobile phone calls.

To switch between calls:

- Standard headset: Press the Call button for 2 seconds.
- Microsoft Teams headset: Press the Mute button for 2 seconds.
- Base: Tap the corresponding Computer or Desk phone Audio / button. The button flashes red when a call is on hold.

Note: Switching 2 desk phone calls can be done only from your desk phone. Check your desk phone user guide.

Launch Microsoft Teams (Teams model only)

Your base and headset each have a Teams  button to quickly open and use the Microsoft Teams desktop app. The base Teams button illuminates when you have a meeting or notification.

Tip: Your headset's Call  button is also a Teams button.

- When not on a call, tap the Teams  button to view Microsoft Teams app on your computer.
- When the base's Teams button LED pulses purple, tap to join your meeting.
- When the base's Teams button LED is solid purple, tap to view your Teams notifications.

Note: Teams model and Teams desktop application required. Teams mobile application is not supported.

Use sensors

Smart sensors respond when you put on or take off your headset. Customize in Poly Lens App. Below describes default settings.

With active sensors	putting on the headset will:	taking off the headset will:
Mobile/softphone call	answer the call	keep call in headset
Music/media	resume music/media (if playing previous to taking off)*	pause music/media (if playing)*
Mute (activate in Poly Lens App)	unmute if on an active call	mute if on an active call

Note: *Functionality varies by application. May not function with web-based apps.

Reset sensors



You may need to reset the sensors if they are not working as expected.

There are two ways to reset the headset sensors. Choose:

- With your headset powered on, charge your headset on the charge stand for 10 seconds
- Power on your headset while pressing the Mute  button for more than 4 seconds until the LEDs flash purple 4 times, being careful to not touch the earcup padding or allow it to come in contact with surfaces

Disable sensors

You can disable your headset smart sensors 2 ways:

- Manage sensors in Poly Lens App
- Hold both the Mute  and Call  buttons for more than 4 seconds until the LED flashes purple then red. Repeat to reactivate; the LED flashes purple then blue

Note: Sensors cannot be disabled while streaming audio.



More Features

Play or pause audio

Tap the Call  button to pause or resume streaming audio.



Note: Functionality varies by application. May not function with web-based apps.

Track selection

Double-tap the Call  button to skip to the next track or triple-tap the Call  button to play the previous track.

Note: Functionality varies by application. May not function with web-based apps.

Fast forward/rewind

Double-tap and hold the Call  button to fast-forward. Triple-tap and hold the Call  button to rewind.

Note: Functionality varies by application. May not function with web-based apps.

Voice assistant (smartphone feature)

Siri, Google Assistant™, Cortana Press and hold the Call button for 2 seconds to activate your smartphone's default voice assistant. Wait for the phone prompt to activate voice dialing, search, and other smartphone voice controls.

Attention: Voice assistant is only active when your headset is out of base range and paired to a smartphone.

ANC

Active Noise Canceling (ANC) reduces external noise and enhances your music and sound quality.

Slide the ANC switch to choose:

- Low: recommended for office
- High: recommended for loud environments

Change your default line

Change the default outbound phone line/audio channel.

With the system idle, do one of the following:

- On your base, press the desired audio button for 4 seconds until it flashes 4 times.
- Download and open Poly Lens Desktop App on your computer, go to **Device Name > Settings > General > Default Phone Line** and choose the desired audio line.

Online indicator

Your headset LED illuminates red to inform others that you are on a call. Manage settings in Poly Lens App.

Corded mode (audio over USB)

If your audio is cutting out during softphone calls, you may be experiencing Bluetooth density problems. Improve audio performance by using density-friendly corded mode.

- 1 Disconnect your Bluetooth USB adapter from your computer

- 2 Connect your headset directly to your computer with the provided 1.5 m USB cable
- 3 Power off your headset to use density-friendly corded mode

Note: Your headset battery charges while in corded mode.

Troubleshooting

Headset

I can't hear a dial tone in the headset.

- Make sure your headset is charged.
- Make sure your headset is paired to base. See [Pair headset to base](#).
- Adjust the configuration switch (A--F) on the bottom of the base until a dial tone is heard. The default **A** works for most phones.

Attention: Use configuration **D** for Cisco phones. Cisco phones connected with EHS cable use configuration **A**.

- Make sure your desk phone is connected correctly to your base. See [Desk phone setup details](#).
- If your base is connected to your desk phone's dedicated headset port, press the desk phone's headset button to hear a dial tone.
- If your base is connected to your desk phone's dedicated headset port, press the desk phone's headset button and base's desk phone button to hear a dial tone.
- If your base is connected to your handset port, manually remove the handset to hear a dial tone (if you do not have an EHS cable or HL10 lifter).
- Make sure your HL10 lifter is lifting the handset high enough to operate the hookswitch; set to a higher setting if necessary.
- Adjust the headset's listening volume. See [Adjust volume](#).
- If the volume is still too low, adjust the desk phone listening volume on the base. See [Adjust volume](#).

Can I connect my headset to a mobile phone and the base at the same time?

Yes, your headset remembers up to 8 devices, but connect to up to 2 devices at a time. That includes your base.

I hear static.

- Make sure there is at least 12 inches between your base and your computer, and 6 inches between your base and your telephone. If adjusting the distance doesn't help, your headset is going out of range, move closer to the base. See [Position Your Base](#)

The sound is distorted.

- Lower the desk phone speaking volume and/or desk phone listening volume on the base. For most telephones the correct setting is position 2. See [Adjust volume](#).
 - If your desk phone has a volume control, lower until the distortion disappears.
 - If the distortion is still present, adjust the headset volume control to lower the headset speaker volume. See [Adjust volume](#).
 - Make sure there is 12 inches between your base and your computer, and 6 inches between your base and your telephone. See [Position Your Base](#).
-

I hear echo in the headset.

- Lower the desk phone speaking volume and/or desk phone listening volume on the base. For most telephones the correct setting is position 2. See [Adjust volume](#).
- If the audio level is too low in this position, increase the headset volume. See [Adjust volume](#).
- If your speaking volume is too low for your listener in this position, adjust the position of the headset to make sure the microphone is as close as possible to your mouth.

People I talk to can hear a buzz in the background.

- Move the base further away from your phone. See [Position Your Base](#).
- If the base power supply is plugged into a power strip, plug it into the wall directly.

I can't activate Siri or Google Now on my headset.

Your smartphone's default voice assistant is a mobile-only feature and is not active when your headset is in range of your base.

- Ensure that your headset is out of base range
- Ensure that the headset is paired to your smartphone
- See [Voice assistant](#)

Desk phone

The handset lifter is installed but does not lift the handset.

- Be sure the handset lifter power cord is firmly pushed into the handset lifter jack on the base.

Softphone

When I dial from my softphone application, nothing happens.

- Ensure your headset is charged.
- Ensure your headset is paired to the base. See [Pair headset to base](#).
- Ensure that Poly Lens Desktop App is installed. Download: poly.com/lens.
- If Poly Lens Desktop App is not installed and you do not have a compatible softphone, you must first press the base's Audio button and then use the softphone interface to place/answer/end calls.
- Ensure that the headset is the default sound device by going to your Sound Control Panel (Windows) or your Sound System Preferences (Mac).
- Restart your computer.

Speaking and/or listening volume is too low or too high.

- Adjust headset listening volume with volume button.
 - Adjust listening/speaking volumes in the computer's sound control panel/system preferences.
 - Adjust listening/speaking volumes in the softphone application.
-

The sound is distorted or I hear an echo in the headset.

- Reduce speaking and/or listening volume on the computer using your softphone application.
- Point microphone towards your chin.
- If the distortion is still present, lower the volume on the headset.

I can no longer hear any audio through my PC Speakers.

For Windows 10 and Windows 8 systems

- Go to **Start > Control Panel > Sounds and Audio Devices > Audio > Sound Playback** and change the default setting from your headset to your PC speakers. Click "OK" to confirm your change.



For Windows Vista and Windows 7 systems

- Go to **Start > Control Panel > Sounds > Playback** and change the default setting from your headset to your PC speakers. Click "OK" to confirm your change.

For Mac OS X

- Choose Apple menu > System Preferences and click Sound.
- Click Output, and then select "Internal Speakers" or your speaker choice.

(Teams model only) How do I interact with Microsoft Teams?

- Tap the headset Call  button or your base's Teams  button to quickly open and use Microsoft Teams. See [Launch Microsoft Teams](#).
- Set your target softphone in Poly Lens Desktop App

(Teams model only) Does my Microsoft Teams-enabled headset work with other softphones?

Yes, while your headset is optimized for Microsoft Teams, it can be configured to use with other supported softphones. Set your target phone by going to Poly Lens Desktop App. When you configure another softphone, the Call  button:

- doesn't interact with Teams
- doesn't go to Teams notifications
- will not launch Cortana

My audio is cutting out during softphone calls.

- You may be experiencing Bluetooth density problems. Connect your headset directly to your computer. See [Corded mode \(audio over USB\)](#).

What's in the box

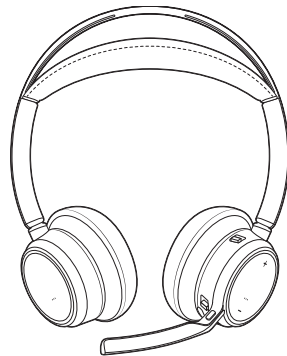

Headset

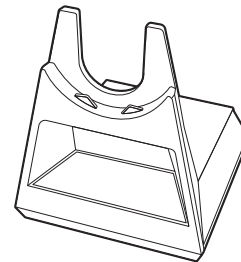

Base

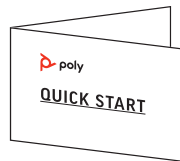

Quick start guide

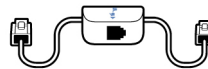

Telephone interface cable

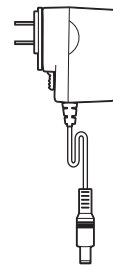

Power supply



USB cable



Carrying case

Support

NEED MORE HELP?

poly.com/support

HP Inc.

1501 Page Mill Road
Palo Alto 94304, U.S.A.
650-857-1501

HP Deutschland GmbH

HP HQ-TRE
71025 Boeblingen, Germany

HP Inc UK Ltd

Regulatory Enquiries, Earley West
300 Thames Valley Park Drive
Reading, RG6 1PT
United Kingdom

© 2023 Poly. Bluetooth is a registered trademark of Bluetooth SIG, Inc. All trademarks are the property of their respective owners.

Model ID: Headset VFOCUS2/VFOCUS2-M, Base VFOCUS2 CD/VFOCUS2-M CD.
System: Poly Voyager Focus 2 Office has a VFOCUS2 headset and VFOCUS2 CD base, or a VFOCUS2-M headset and VFOCUS2-M CD base.

219507-06 07.23