

# LS741HD

## Projector User Guide

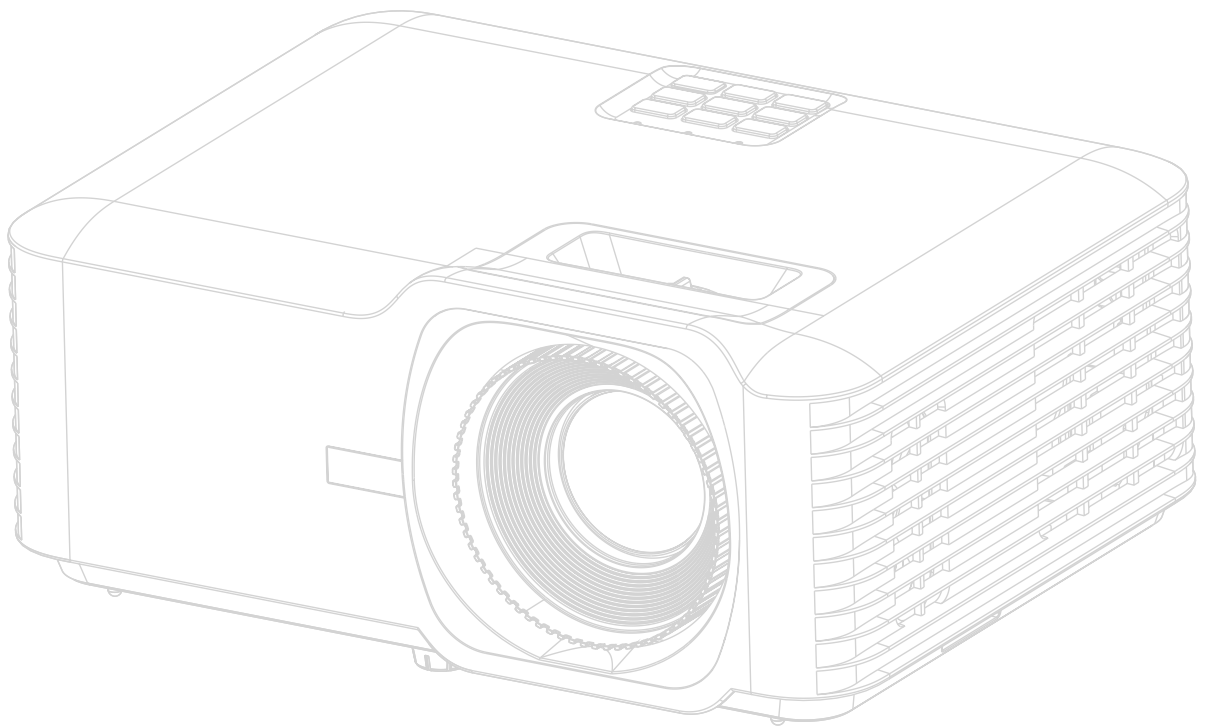

**IMPORTANT:** Please read this User Guide to obtain important information on installing and using your product in a safe manner, as well as registering your product for future service. Warranty information contained in this User Guide will describe your limited coverage from ViewSonic® Corporation, which is also found on our web site at <http://www.viewsonic.com> in English, or in specific languages using the Regional selection box on our website.

Model No. VS19894  
P/N: LS741HD

## **Thank you for choosing ViewSonic®**

As a world-leading provider of visual solutions, ViewSonic® is dedicated to exceeding the world's expectations for technological evolution, innovation, and simplicity. At ViewSonic®, we believe that our products have the potential to make a positive impact in the world, and we are confident that the ViewSonic® product you have chosen will serve you well.

Once again, thank you for choosing ViewSonic®!

# Safety Precautions

Please read the following **Safety Precautions** before you start using the projector.

- Keep this user guide in a safe place for later reference.
- Read all warnings and follow all instructions.
- Allow at least 20" (50 cm) clearance around the projector to ensure proper ventilation.
- Place the projector in a well-ventilated area. Do not place anything on the projector that prevents heat dissipation.
- Do not place the projector on an uneven or unstable surface. The projector may fall over, causing personal injury or projector malfunction.
- Do not look straight at the projector lens during operation. The intense light beam may damage your eyes.
- Always open the lens shutter or remove the lens cap when the projector lamp is on.
- Do not block the projection lens with any objects when the projector is under operation as this could cause objects to become heated and deformed or even cause a fire.
- Do not attempt to disassemble the projector. There are dangerous high voltages inside which may cause death if you should come into contact with live parts.
- When moving the projector, be careful not to drop or bump the projector on anything.
- Do not place any heavy objects on the projector or connection cables.
- Avoid exposing the projector to direct sunlight or other sources of sustained heat. Do not install near any heat sources such as radiators, heat registers, stoves, or other devices (including amplifiers) that may increase the temperature of the projector to dangerous levels.
- Do not place liquids near or on the projector. Liquids spilled into the projector may cause it to fail. If the projector does become wet, disconnect it from the power supply and call your local service center to have the projector serviced.
- When the projector is under operation, you may sense some heated air and odor from its ventilation grill. It is a normal operation and not a defect.
- Do not attempt to circumvent the safety provisions of the polarized or grounding-type plug. A polarized plug has two blades with one wider than the other. A grounding-type plug has two blades and a third grounding prong. The wide and third blade are provided for your safety. If the plug does not fit into your outlet, obtain an adapter and do not attempt to force the plug into the outlet.

- When connecting to a power outlet, DO NOT remove the grounding prong. Please ensure grounding prongs are NEVER REMOVED.
- Protect the power cord from being treaded upon or pinched, particularly at the plug, and at the point where it emerges from the projector.
- In some countries, the voltage is NOT stable. This projector is designed to operate safely within a voltage between 100 to 240 volts DC, but could fail if power cuts or surges of  $\pm 10$  volts occur. In areas where voltage may fluctuate or cut out, it is recommended that you connect your projector through a power stabilizer, surge protector, or uninterruptable power supply (UPS).
- If smoke, an abnormal noise, or a strange odor is present, immediately switch the projector off and call your dealer or ViewSonic®. It is dangerous to continue using the projector.
- Use only attachments/accessories specified by the manufacturer.
- Disconnect the power cord from the DC outlet if the projector is not being used for a long period of time.
- Refer all servicing to qualified service personnel.



**CAUTION:** Possibly hazardous optical radiation is emitted from this product. As with any bright light source, do not stare into the beam, RG2 IEC 62471-5:2015. Additional warning against eye exposure for close exposures less than 1 m.

# Safety Precautions - Ceiling Mounting

Please read the following **Safety Precautions** before you start using the projector.

If you intend to mount the projector on the ceiling, it is strongly recommended that you use a proper fitting projector ceiling mount kit and that you ensure it is securely and safely installed.

If you use an inappropriate projector ceiling mount kit, there is a safety risk that the projector may fall from the ceiling due to an improper attachment through the use of the wrong gauge or length screws.

## Laser Caution

This product belongs to CLASS I laser product and complies with IEC 60825-1:2014, EN 60825-1:2014/A11:2021, EN 50689:2021.

IEC 60825-1:2014, EN 60825-1:2014+A11:2021, EN 50689:2021 CLASS 1 CONSUMER LASER  
PRODUCT RISK GROUP 2, Complies with 21 CFR 1040.10 and 1040.11 except for conformance as  
a Risk Group 2 LIP as defined in IEC 62471-5:Ed.1.0. For more information see Laser Notice No. 57,  
dated May 8, 2019.  
IEC 60825-1:2014 等級1雷射產品RG2危險等級  
IEC 60825-1:2014 1类激光产品RG2危险等级

Above laser cautions are located on the bottom of this apparatus.

- Notice is given to supervise children and to never allow them to stare into the projector beam at any distance from the projector.
- Notice is given to use caution when using the remote control for starting the projector while in front of the projection lens.
- Notice is given to the user to avoid the use of optical aids such as binoculars or telescopes inside the beam.

# Contents

<b>Safety Precautions.....</b>	<b>3</b>
<b>Introduction .....</b>	<b>8</b>
<b>Package Contents .....</b>	<b>8</b>
Product Overview .....	9
Projector.....	9
Keypad.....	10
Indicator Lights.....	10
I/O Ports .....	11
Remote Control .....	12
<b>Initial Setup.....</b>	<b>16</b>
Choosing a Location - Projection Orientation.....	16
Projection Dimensions.....	17
Mounting the Projector .....	19
Using the Security Bar .....	19
<b>Making Connections.....</b>	<b>20</b>
Connecting to Power .....	20
Connecting to External Devices .....	21
HDMI Connection .....	21
Audio Connection.....	22
USB and Network Connection .....	23
RS-232 Connection .....	24
<b>Using the Projector.....</b>	<b>25</b>
Starting Up the Projector.....	25
Selecting an Input Source .....	26
Adjusting the Projected Image .....	27
Adjusting the Projector’s Height and Projection Angle .....	27
Adjusting the Focus, Keystone, and Zoom .....	28
Shutting Down the Projector .....	29

<b>Operating the Projector.....</b>	<b>30</b>
<b>On-Screen Display (OSD) Menu.....</b>	<b>30</b>
Menu Navigation .....	31
On-Screen Display (OSD) Menu Tree.....	32
Menu Operation .....	38
Display Menu.....	38
Audio Menu.....	43
Setup Menu.....	44
Network Menu .....	47
Information Menu.....	48
<b>Appendix.....</b>	<b>49</b>
Specifications.....	49
Projector Dimensions .....	50
Timing Chart .....	51
Video Input.....	51
PC Input.....	52
3D Support .....	52
Troubleshooting .....	53
LED Indicators.....	55
Maintenance.....	56
General Precautions .....	56
Cleaning the Lens .....	56
Cleaning the Case .....	56
Storing the Projector .....	56
<b>Regulatory and Service Information .....</b>	<b>57</b>
Compliance Information.....	57
FCC Compliance Statement.....	57
Industry Canada Statement.....	57
CE Conformity for European Countries .....	58
Declaration of RoHS2 Compliance.....	59
Indian Restriction of Hazardous Substances .....	60
Product Disposal at End of Product Life .....	60
Copyright Information .....	61
Customer Service .....	62
Limited Warranty .....	63
Mexico Limited Warranty.....	66

# Introduction

## Package Contents

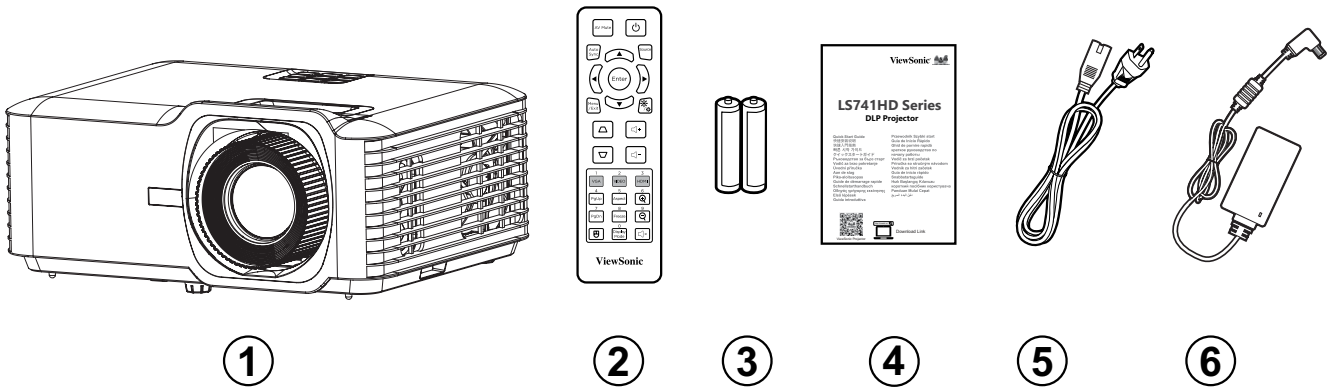

Number	Description
1	Projector
2	Remote Control
3	AAA Batteries
4	Quick Start Guide
5	Power Cord
6	Power Adapter

**NOTE:** The power cord and remote control included in your package may vary depending on your country. Please contact your local dealer for more information.



# Product Overview

## Projector

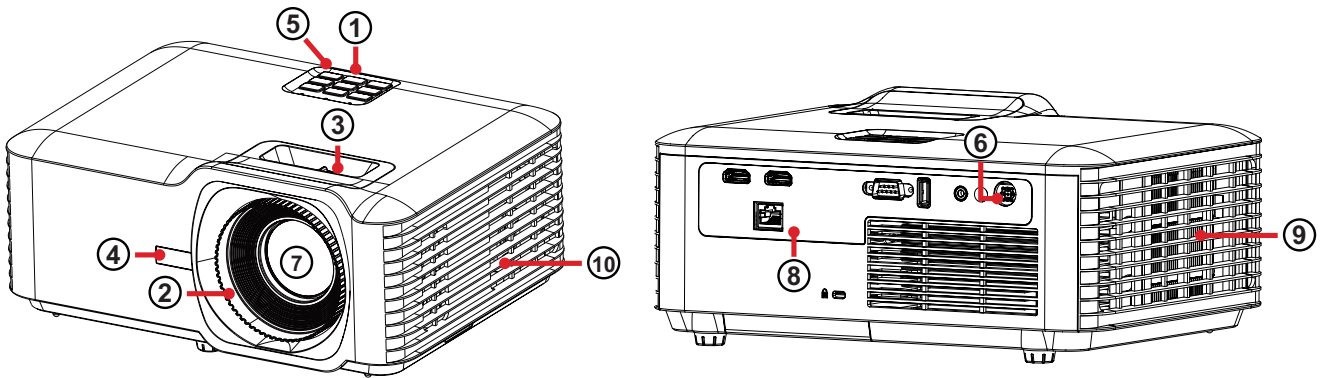

Number	Description
1	Keypad
2	Focus Ring
3	Zoom Ring
4	Front IR Remote Sensor
5	Top IR Remote Sensor
6	DC In
7	Lens
8	I/O Ports
9	Vent (inlet)
10	Vent (outlet)

**NOTE:** Do not block projector intake and exhaust vents.

## Keypad

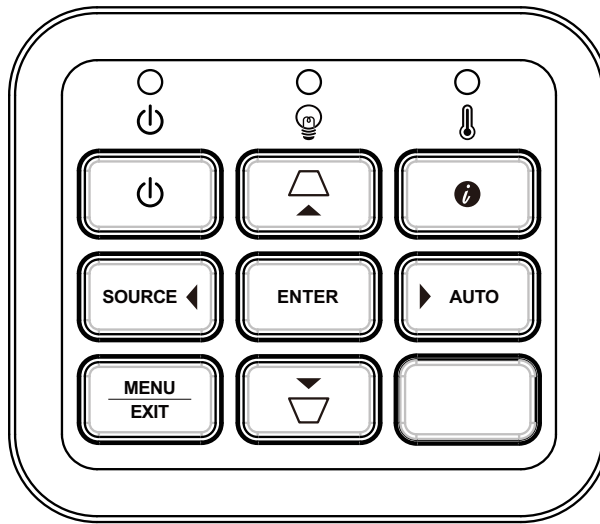

Key		Description
	<b>Power</b>	Toggles the projector between standby mode and Power On.
	<b>Keystone</b>	Manually corrects distorted images resulting from an angled projection.
	<b>Navigation</b>	Selects the desired menu items and makes adjustments when the On-Screen Display (OSD) Menu is activated.
	<b>Menu/Exit</b>	Opens/exits the On-Screen Display (OSD) Menu.
<b>SOURCE</b>	<b>Source</b>	Displays the input source selection bar.
	<b>Information</b>	Displays the INFORMATION menu.
<b>ENTER</b>	<b>Enter</b>	Enacts the selected On-Screen Display (OSD) Menu item when the OSD Menu is activated.
<b>AUTO</b>	<b>Auto</b>	Automatically determines the best picture timings for the displayed image.

## Indicator Lights

Indicator Light	Description
	Power indicator light
	Light source indicator light
	Temperature indicator light

## I/O Ports

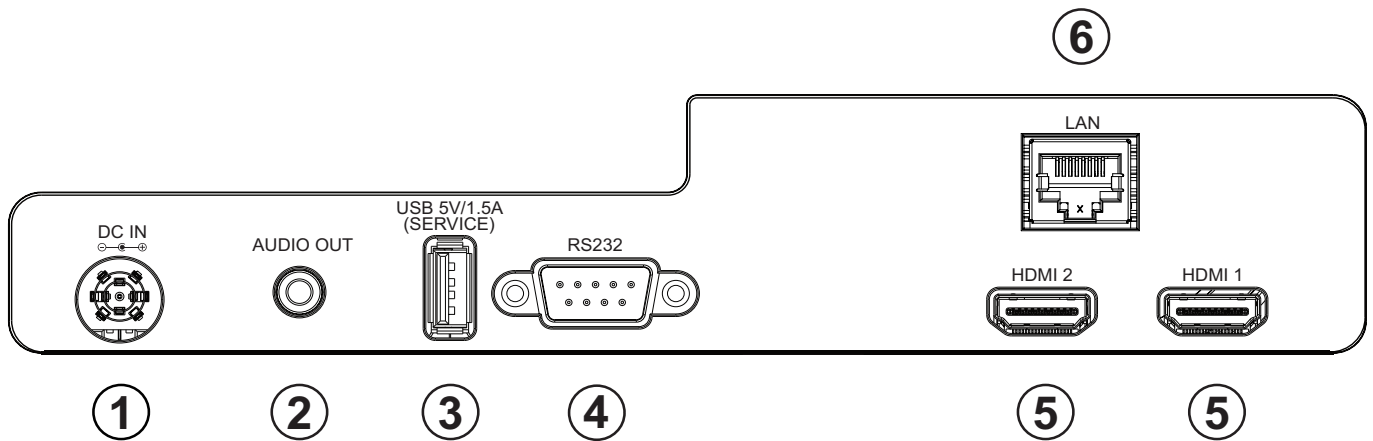

Port	Description
1	DC IN socket.
2	Audio signal output socket.
3	USB Type A port for power and service.
4	RS-232 control port.
5	HDMI port.
6	LAN port.







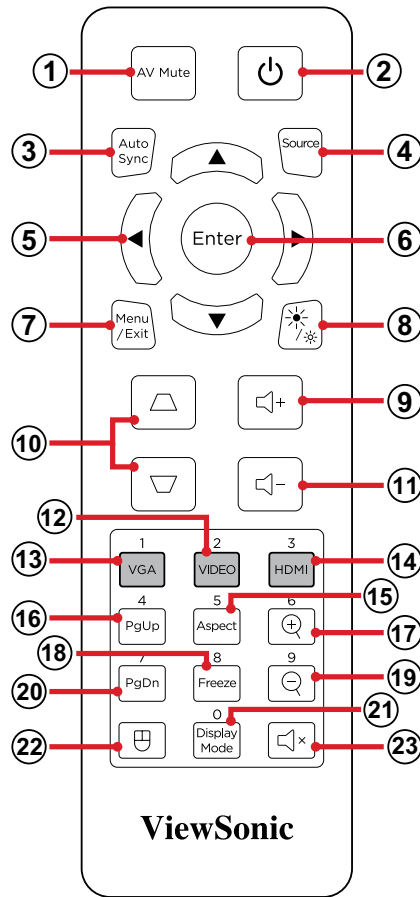







<sup>1</sup> Supports HDCP 2.2.

<sup>2</sup> Supports HDCP 1.4.

# Remote Control



Button		Description	
1	AV Mute		Hides the screen picture and volume mute.
2	Power		Turns the projector on or to standby mode.
3	Auto Sync		Automatically determines the best picture timings for the displayed image.
4	Source		Displays the input source selection bar.
5	Navigation Buttons		Navigates and selects the desired menu items and make adjustments.
6	Enter		Confirms the selection.
7	Menu/Exit		<ul style="list-style-type: none"> <li>• Turns the On-Screen Display (OSD) Menu On or Off.</li> <li>• Go back to a previous OSD Menu.</li> <li>• Exit and Save menu settings.</li> </ul>
8	Brightness		Displays the Light Source Mode selection bar.
9	Volume Up		Increase the volume level.

Button			Description
10	Keystone		Manually correct distorted images.
11	Volume Down		Decrease the volume level.
12	Video		<i>Unsupported Button</i>
13	VGA		<i>Unsupported Button</i>
14	HDMI		Selects the <b>HDMI 1</b> or <b>HDMI 2</b> input source.
15	Aspect		Displays the aspect ratio selection bar.
16	Page Up		<i>Unsupported Button</i>
17	Zoom In		Increases the projected image size.
18	Freeze		Freeze the projected image.
19	Zoom Out		Reduces the projected image size.
20	Page Down		<i>Unsupported Button</i>
21	Display Mode		Displays the color mode selection bar.
22	Mouse Mode		<i>Unsupported Button</i>
23	Mute		Mute/Unmute.

## Remote Control - Receiver Range

To ensure proper function of the remote control follow the steps below:

1. The remote control must be held at an angle within 30° perpendicular to the projector's IR remote control sensor(s).
2. The distance between the remote control and the sensor(s) should not exceed 8 m (26 ft.)

**NOTE:** Refer to the illustration for the location of the infrared (IR) remote control sensor(s).

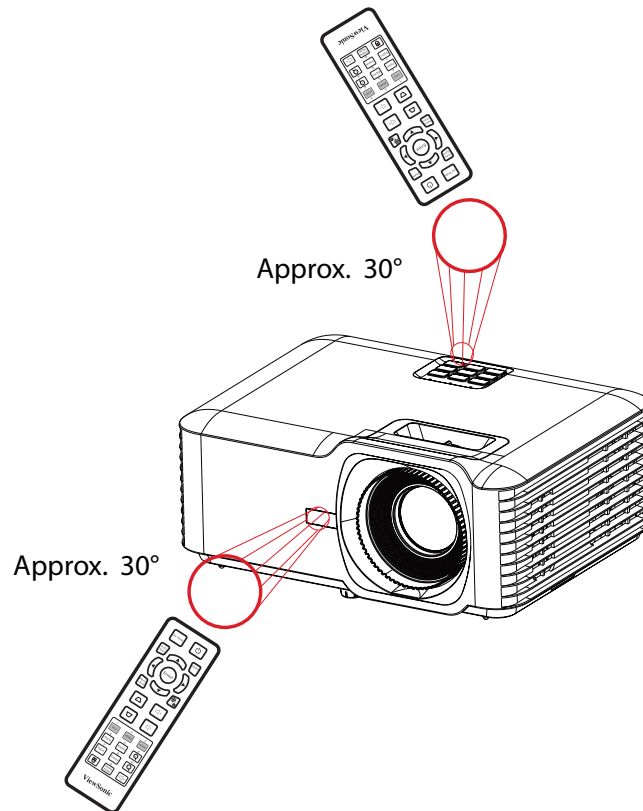

## Remote Control - Replacing the Batteries

1. Remove the battery cover from the bottom of the remote control by pressing the finger grip and sliding it across.
2. Remove any existing batteries (if necessary) and install two AAA batteries.

**NOTE:** Observe the battery's polarities as indicated.

3. Replace the battery cover by aligning it with the base and pushing it back into position.

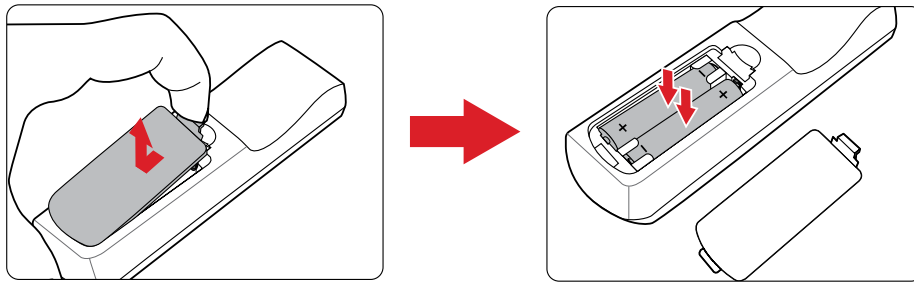

### NOTE:

- Avoid leaving the remote control and batteries in excessive heat or a humid environment.
- Replace only with the same or equivalent type recommended by the battery manufacturer.
- If the batteries are drained or if you will not be using the remote control for an extended period of time, remove the batteries to avoid damage to the remote control.
- Dispose of the used batteries according to the manufacturer's instructions and local environment regulations for your region.

# Initial Setup

This section provides detailed instructions for the initial set up your projector.

## Choosing a Location - Projection Orientation

Personal preference and room layout will decide the installation location. Consider the following:

- Size and position of your screen.
- Location of a suitable power outlet.
- Location and distance between the projector and other equipment.

The projector is designed to be installed in one of the following locations:

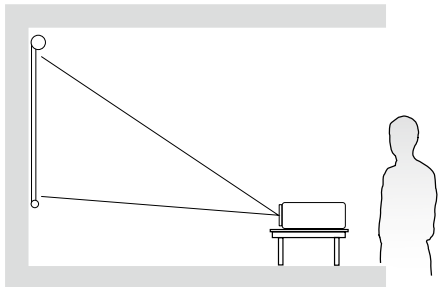
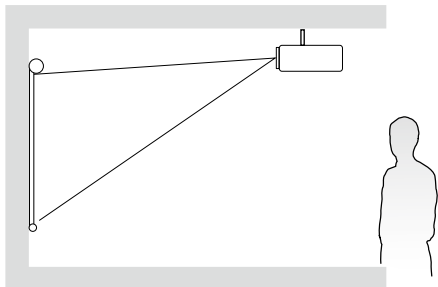
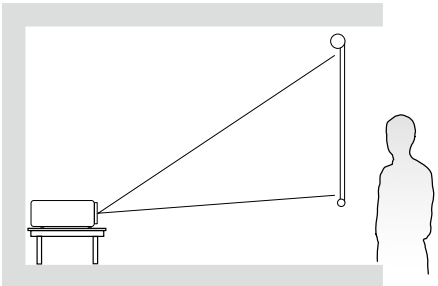
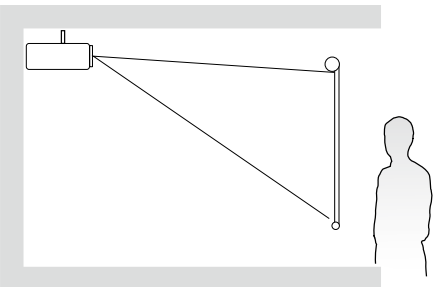
Location	
<p><b>Desk Front</b></p> <p>The projector is placed near the floor in front of the screen.</p>	
<p><b>Ceiling Front</b></p> <p>The projector is suspended upside-down from the ceiling in front of the screen.</p>	
<p><b>Desk Rear<sup>1</sup></b></p> <p>The projector is placed near the floor behind the screen.</p>	
<p><b>Ceiling Rear<sup>1</sup></b></p> <p>The projector is suspended upside-down from the ceiling behind the screen.</p>	

<sup>1</sup> A rear projection screen is required.



# Projection Dimensions

- 16:9 Image on a 16:9 Screen

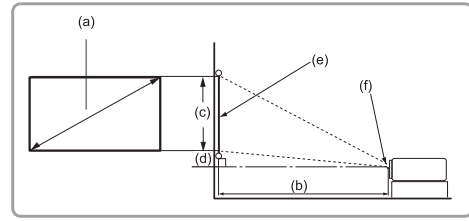
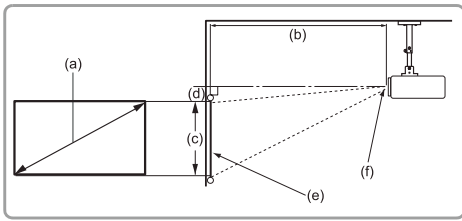

**NOTE:**

- (e) = Screen (f) = Center of Lens

## 16:9 Image on a 16:9 Screen

(a) Screen Size		(b) Projection Distance				(c) Image Height		(d) Vertical Offset	
		Minimum		Maximum					
in.	mm	in.	mm	in.	mm	in.	mm	in.	mm
30	763	36.67	931	58.67	1490	14.73	374	2.35	60
40	1016	48.81	1240	78.09	1984	19.61	498	3.14	80
50	1270	61.01	1550	97.62	2479	24.51	623	3.92	100
60	1524	73.21	1860	117.14	2975	29.42	747	4.71	120
70	1778	85.41	2170	136.66	3471	34.32	872	5.49	139
80	2032	97.62	2479	156.19	3967	39.22	996	6.28	159
90	2286	109.82	2789	175.71	4463	44.12	1121	7.06	179
100	2540	122.02	3099	195.23	4959	49.03	1245	7.84	199
110	2794	134.22	3409	214.76	5455	53.93	1370	8.63	219
120	3048	146.42	3719	234.28	5951	58.83	1494	9.41	239
130	3302	158.63	4029	253.80	6447	63.73	1619	10.20	259
140	3556	170.83	4339	273.33	6942	68.64	1743	10.98	279
150	3810	183.03	4649	292.85	7438	73.54	1868	11.77	299
200	5080	244.04	6199	390.47	9918	98.05	2491	15.69	398
250	6350	305.05	7748	488.08	12397	122.57	3113	19.61	498
300	7622	366.15	9300	585.84	14880	147.11	3737	23.53	598

**NOTE:**

- These figures are for reference purposes only. Please refer to the actual projector for the precise dimensions.
- We recommend that, If you intend to permanently install the projector, you should physically test the projection size and distance using the actual projector before permanently installing it.

- 16:9 Image on a 4:3 Screen

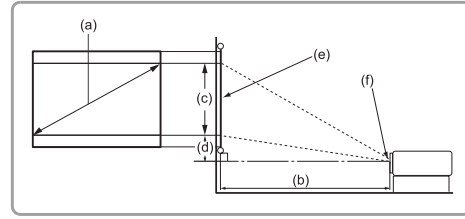
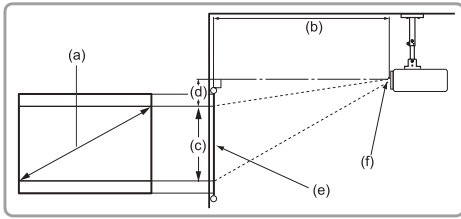

**NOTE:**

- (e) = Screen (f) = Center of Lens

**16:9 Image on a 4:3 Screen**

(a) Screen Size		(b) Projection Distance				(c) Image Height		(d) Vertical Offset	
		Minimum		Maximum					
in.	mm	in.	mm	in.	mm	in.	mm	in.	mm
30	763	34.16	868	54.66	1388	13.52	343	2.16	55
40	1016	44.80	1138	71.68	1821	18.00	457	2.88	73
50	1270	56.00	1422	89.60	2276	22.50	572	3.60	91
60	1524	67.20	1707	107.52	2731	27.00	686	4.32	110
70	1778	78.40	1991	125.44	3186	31.50	800	5.04	128
80	2032	89.60	2276	143.36	3641	36.00	914	5.76	146
90	2286	100.80	2560	161.28	4097	40.50	1029	6.48	165
100	2540	112.00	2845	179.20	4552	45.00	1143	7.20	183
110	2794	123.20	3129	197.12	5007	49.50	1257	7.92	201
120	3048	134.40	3414	215.04	5462	54.00	1372	8.64	219
130	3302	145.60	3698	232.96	5917	58.50	1486	9.36	238
140	3556	156.80	3983	250.88	6372	63.00	1600	10.08	256
150	3810	168.00	4267	268.80	6828	67.50	1715	10.80	274
200	5080	224.00	5690	358.40	9103	90.00	2286	14.40	366
250	6350	280.00	7112	448.00	11379	112.50	2858	18.00	457
300	7622	336.08	8536	537.60	13655	135.03	3430	21.60	549

**NOTE:**

- These figures are for reference purposes only. Please refer to the actual projector for the precise dimensions.
- It is recommended that if you intend to permanently install the projector, you should physically test the projection size and distance using the actual projector before you permanently install it.

# Mounting the Projector

**NOTE:** If you buy a third-party mount, please use the correct screw size. Screw size can vary depending on the thickness of the mounting plate.

1. To ensure the most secure installation, please use a ViewSonic® wall or ceiling mount.
2. Ensure the screws used to attach the mount to the projector meet the following specifications:
  - Screw type: M4 x 8
  - Maximum Screw Length: 8 mm
3. Place the power adapter within the designated area and secure it with a cable strap.

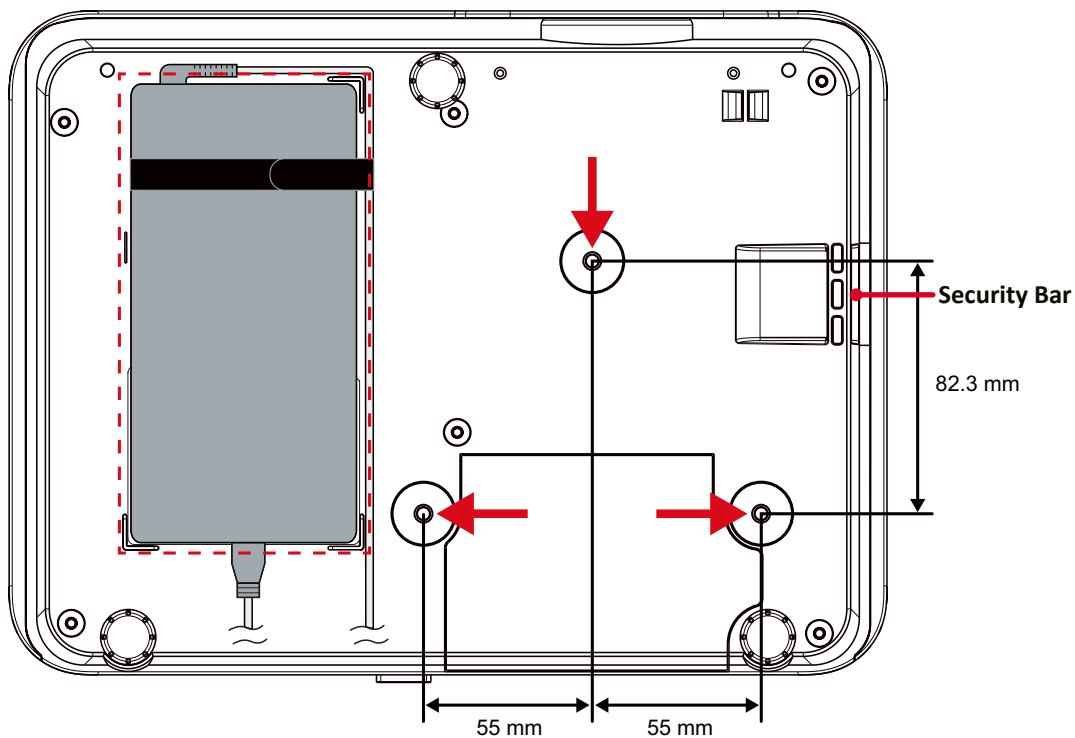

## CAUTION:

- Avoid installing the projector near a heat source or air conditioner.
- Keep at least a 10 cm (3.9 in.) gap between the ceiling and the bottom of the projector.

## Using the Security Bar

To prevent the projector from being stolen, use a security slot locking device to secure the projector to a fixed object. The security slot can also be used as a safety anchor if the projector is mounted to the ceiling.

# Making Connections

## Connecting to Power

1. Connect the power cord to the power adapter.
2. Connect the power adapter to the DC IN jack at the rear of the projector.
3. Plug the power cord into a power outlet.

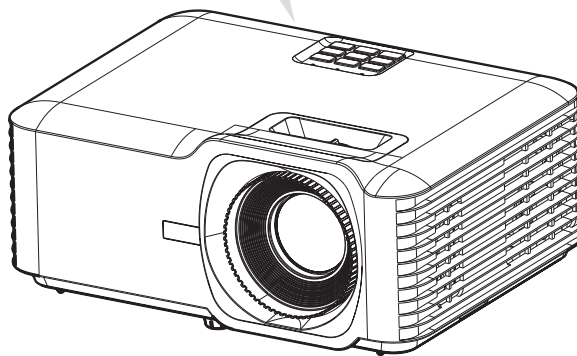
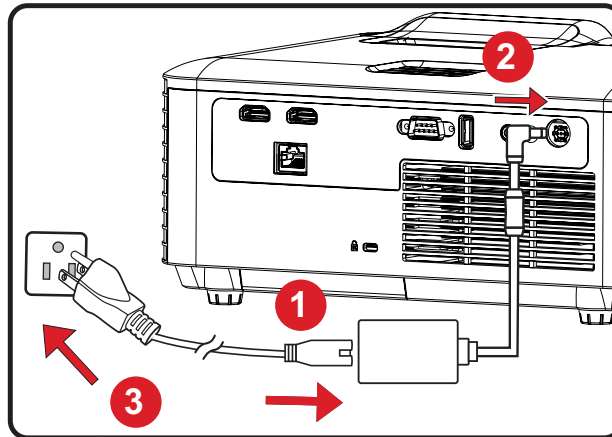

**NOTE:** When installing the projector, incorporate a readily accessible disconnect device in the fixed wiring, or connect the power plug to an easily accessible outlet near the unit. If a fault should occur during operation of the projector, use the disconnect device to switch off the power supply, or disconnect the power plug.

# Connecting to External Devices

## HDMI Connection

Connect one end of an HDMI cable to the HDMI port of your video device. Then connect the other end of the cable to the **HDMI 1/2** port of your projector.

### NOTE:

- The **HDMI 1** port supports HDCP 2.2.
- The **HDMI 2** port supports HDCP 1.4.

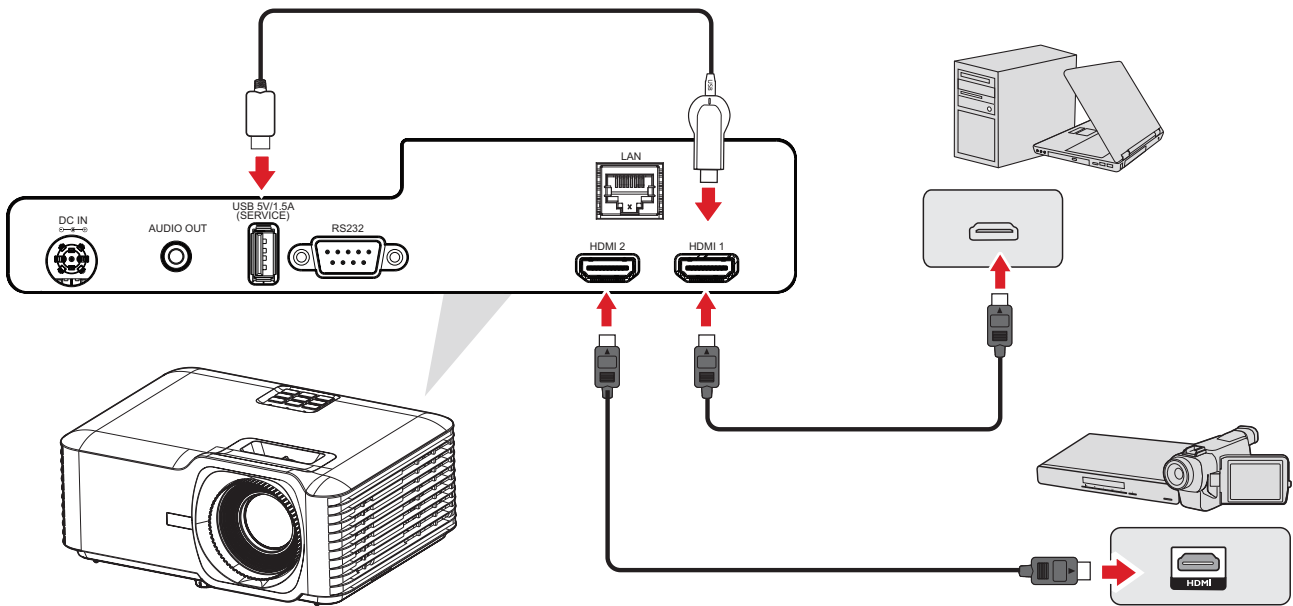

## Audio Connection

To play audio from the projector through an external speaker, connect one end of an audio cable to the external speaker, and the other end to the projector's **Audio Out** port.

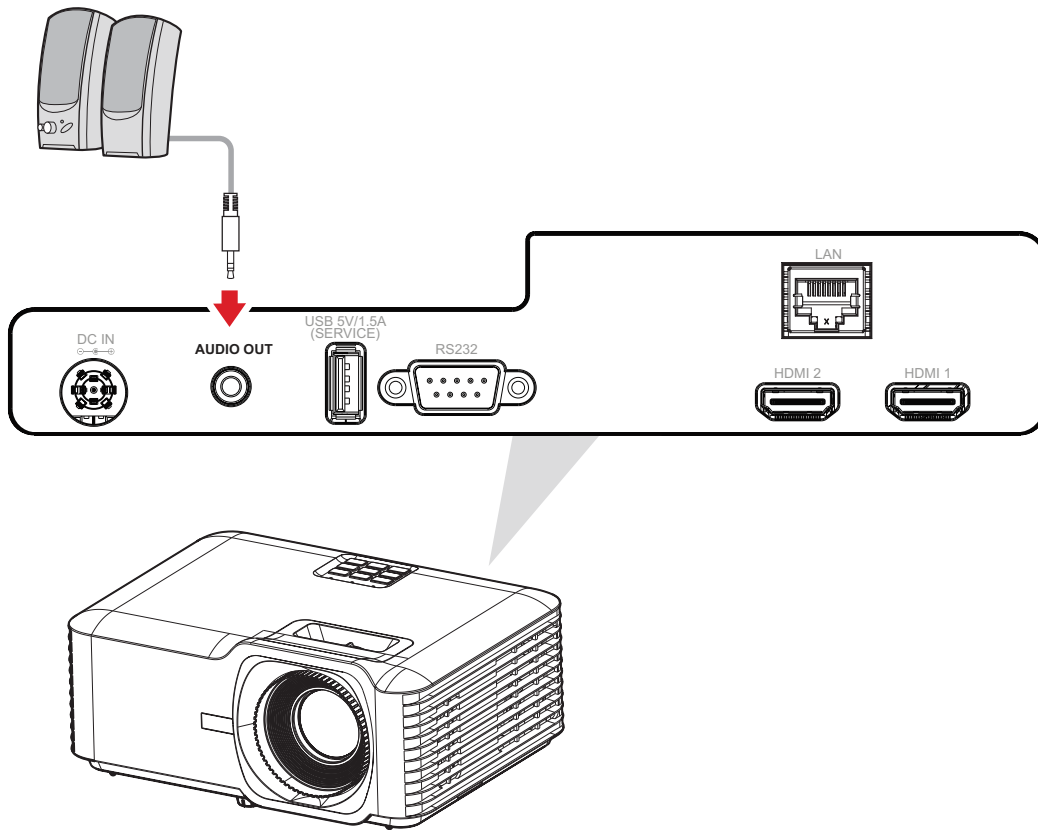

## USB and Network Connection

### USB Type A Connection

The USB port is for supplying power (e.g., dongles) and service needs.

**NOTE:** The USB port does not supply power when the projector is in standby mode.

### Network Connection

Plug the network cable into the **LAN** port.

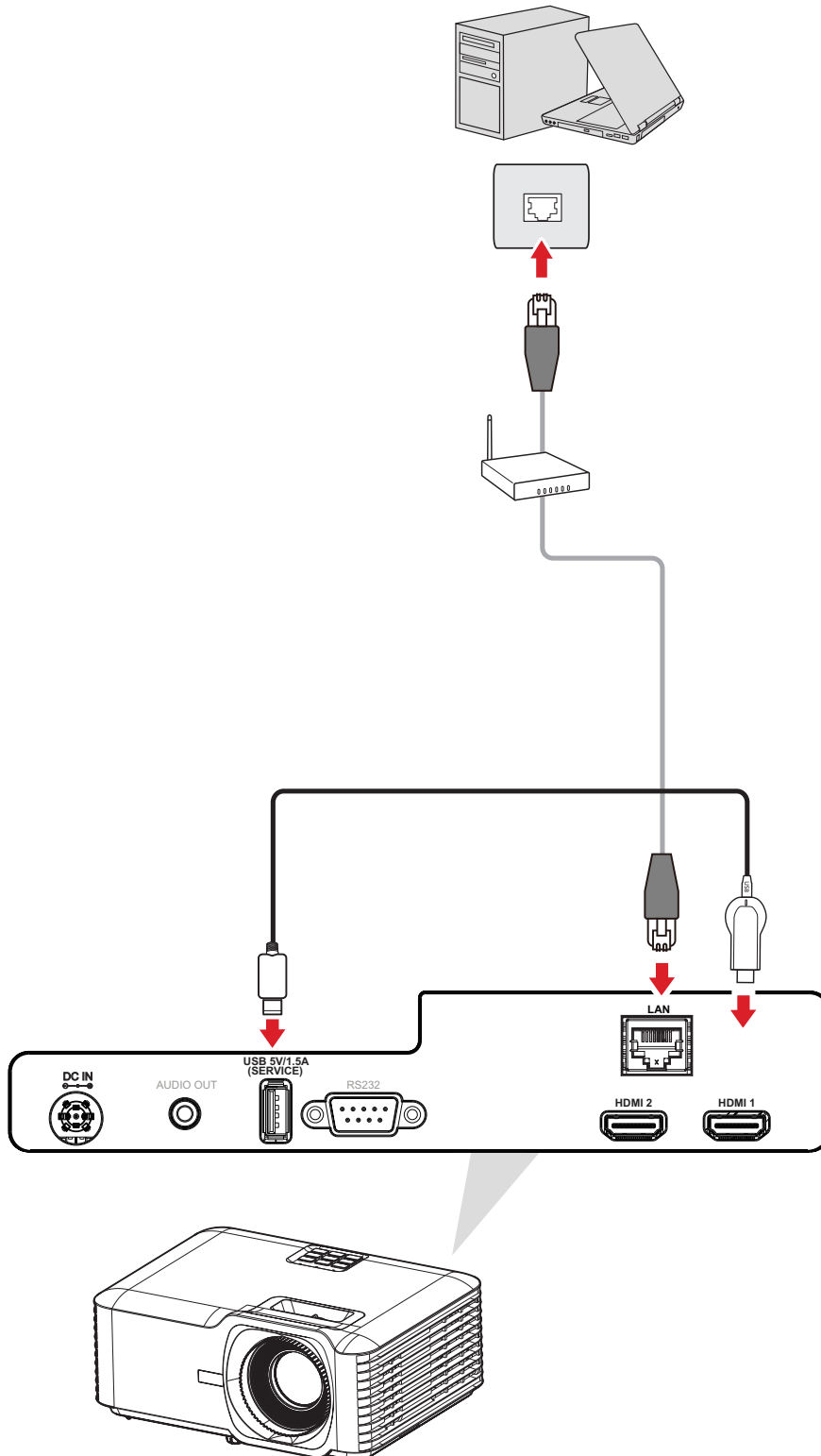

## RS-232 Connection

When you use a RS-232 serial port cable to connect the projector to an external computer certain functions can be controlled remotely by the PC, including Power On/Off, Volume adjustment, Input select, Brightness, and more.

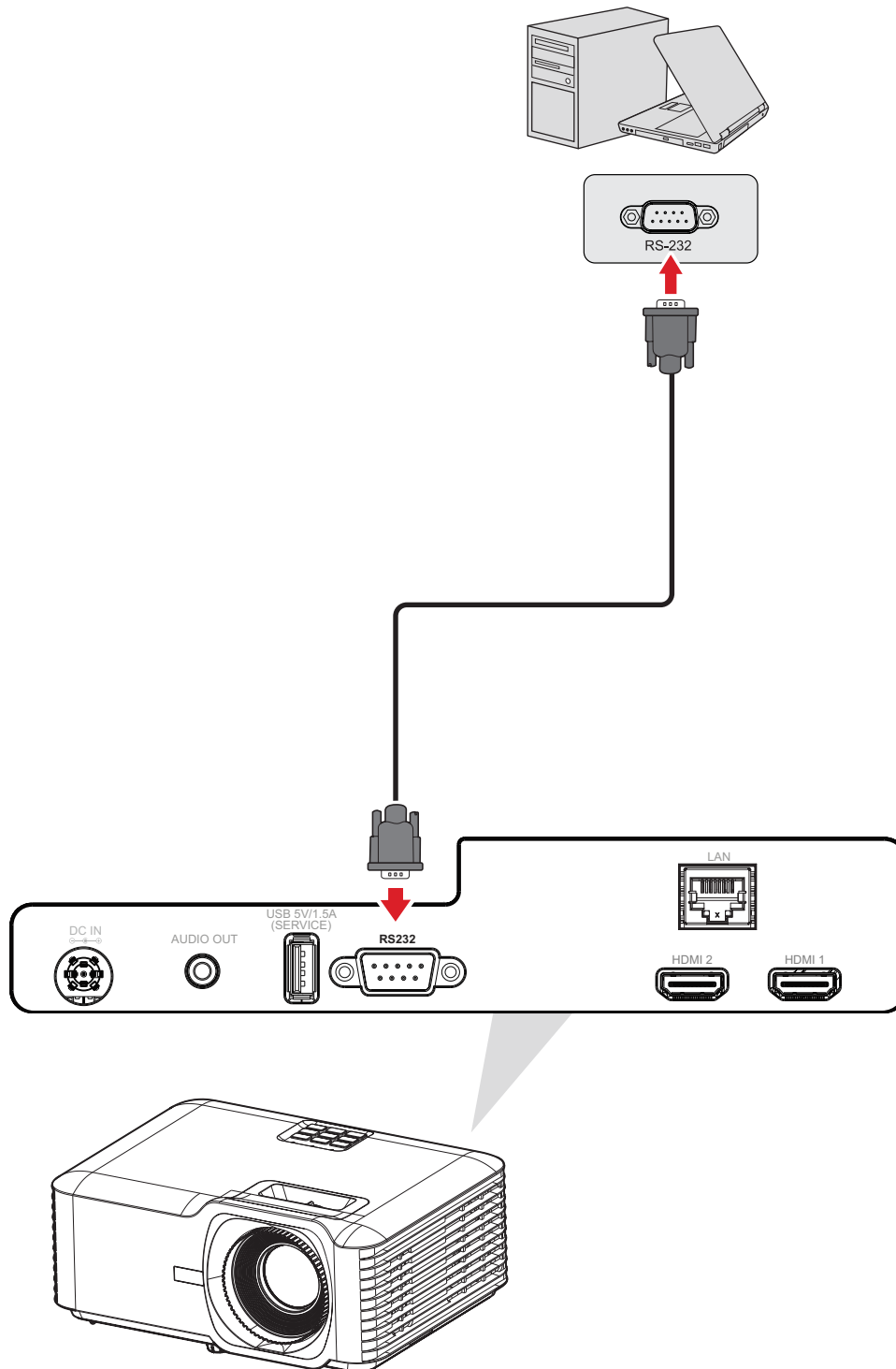



# Using the Projector

## Starting Up the Projector

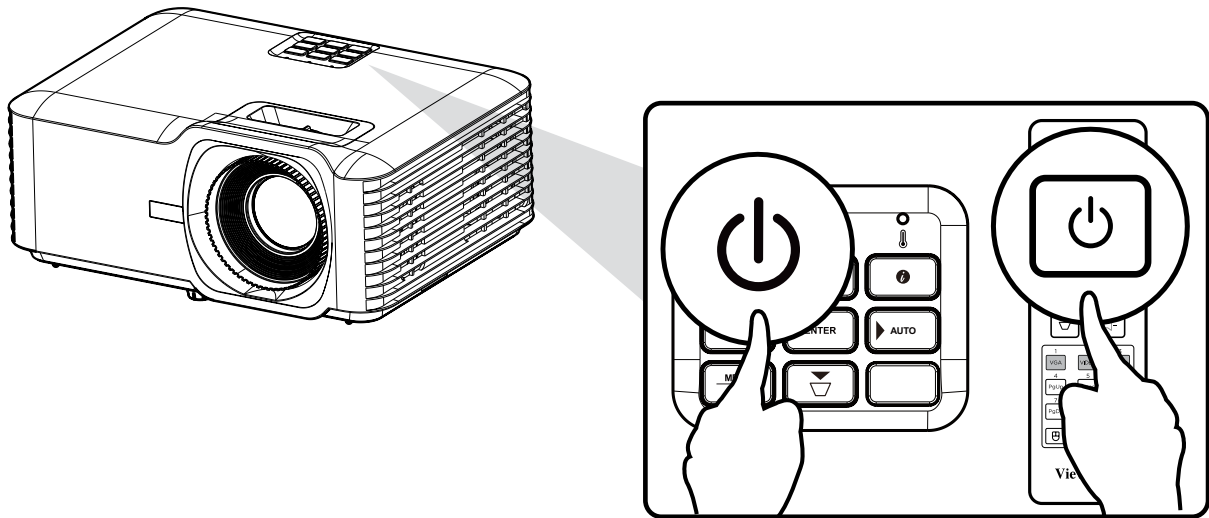

1. Ensure the projector's power cord is properly connected to a power outlet.
2. Press the **Power** button on the projector or remote control to turn on the projector.

### NOTE:

- The Power Indicator Light will be flashing blue during startup.
- The first time the projector is turned on, you will be prompted to select the preferred language, projection orientation, and other settings.

## Selecting an Input Source

The projector can be connected to multiple devices at the same time. However, it can only display one full screen at a time.

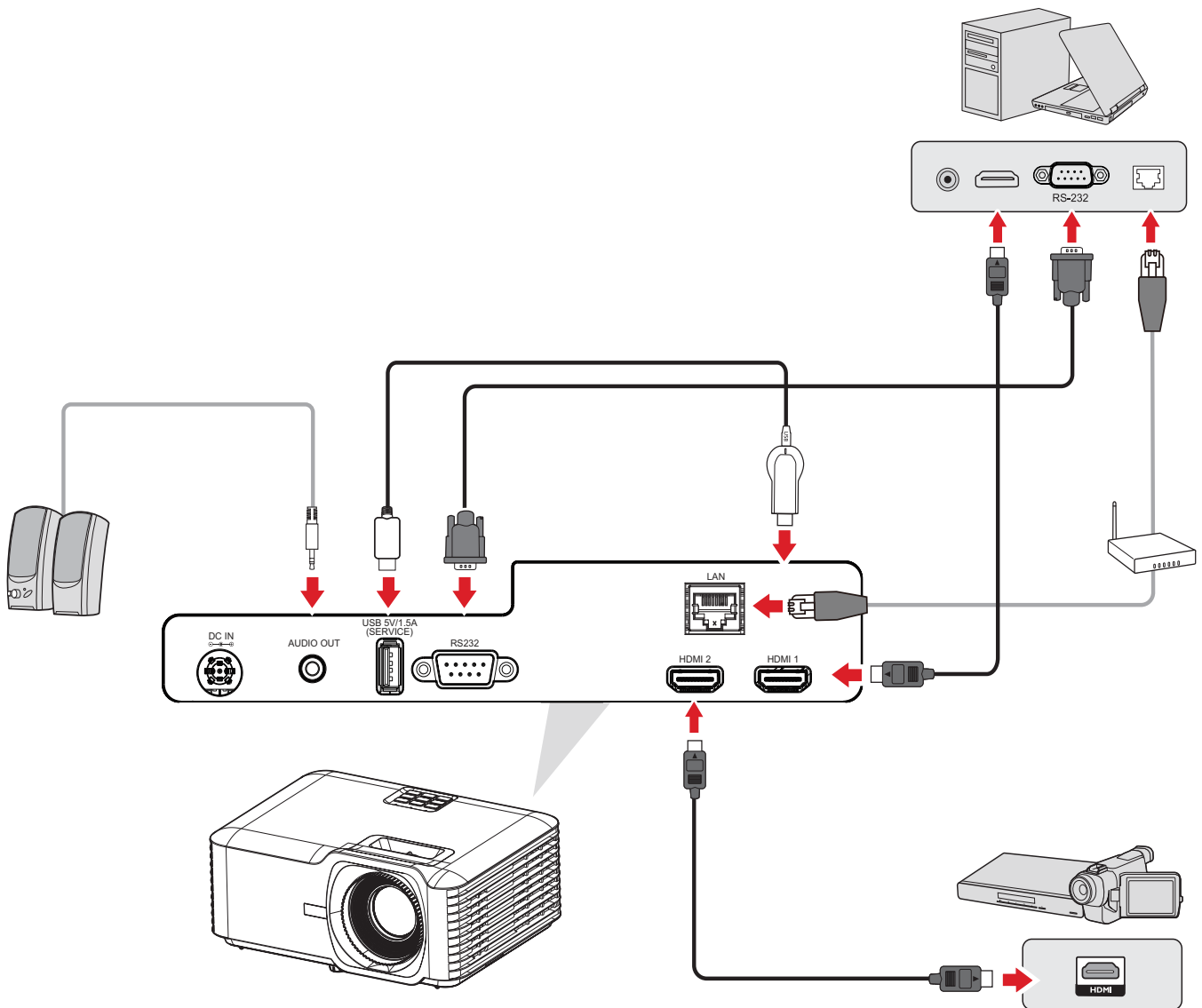

When **Auto Source** is On, the projector will automatically search for input sources. If multiple sources are connected, press the **Source** button on the projector or remote control to select the desired input.

**NOTE:** Ensure the connected sources are also turned on.

# Adjusting the Projected Image

## Adjusting the Projector's Height and Projection Angle

The projector is equipped with three (3) adjustment feet. Adjusting the feet will change the projector's height and the vertical projection angle.

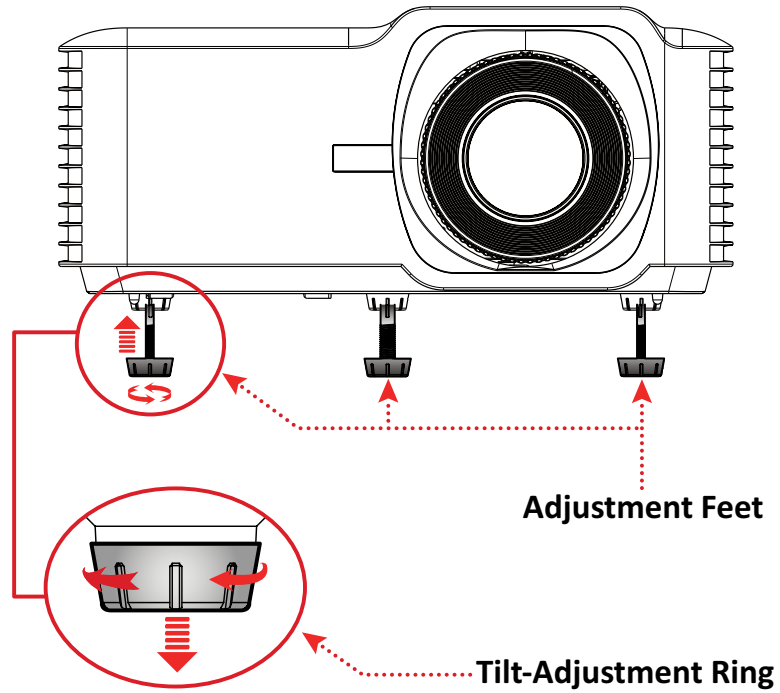

## Adjusting the Focus, Keystone, and Zoom

You can improve and adjust the clarity and position of the image by adjusting the **Focus Ring**, **Keystone Keys**, or **Zoom Ring**.

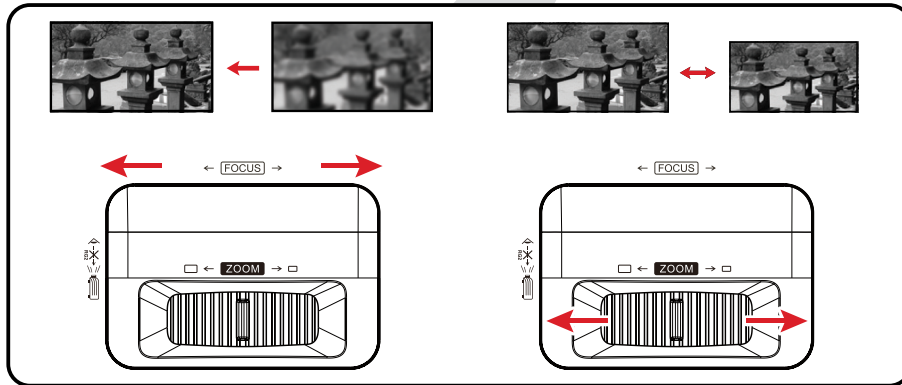
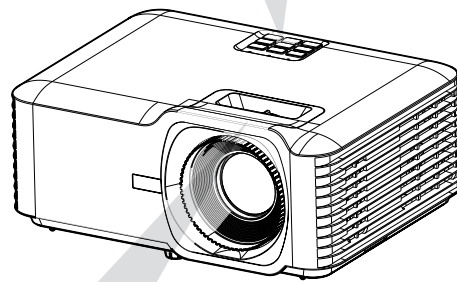
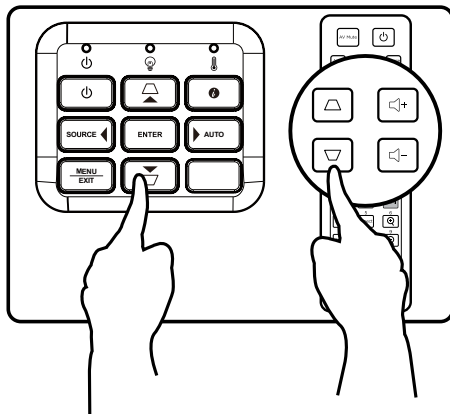

## Shutting Down the Projector

1. Press the **Power** button on the projector or remote control and a “power off message” will appear.
2. Press the **Power** button again to confirm and shut down the projector.
3. The Power Indicator Light will be flashing blue and enter standby mode.



# Operating the Projector

## On-Screen Display (OSD) Menu

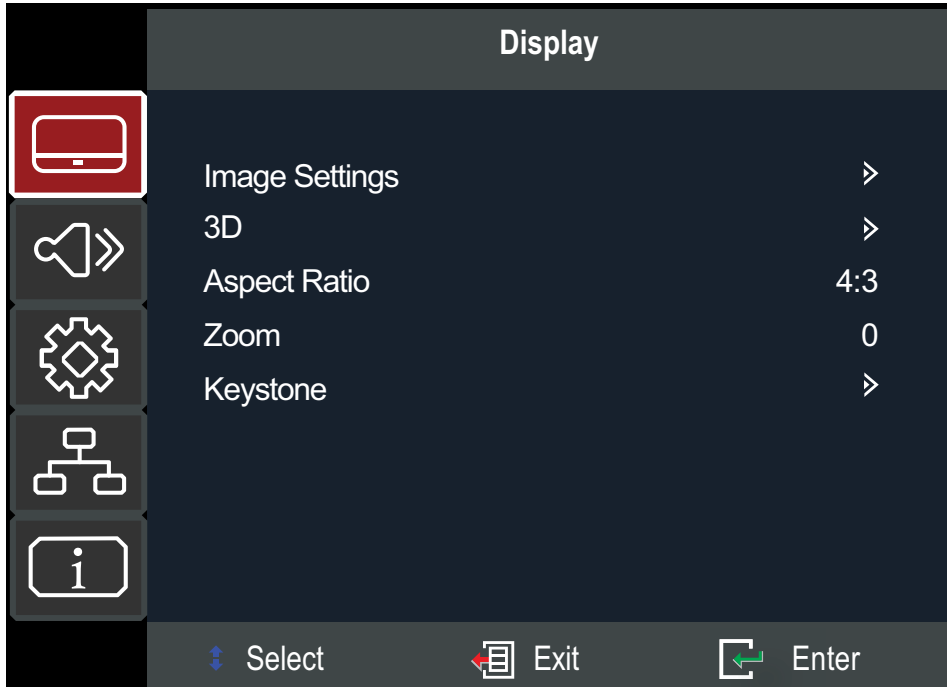
The projector has multilingual on-screen display menus that allow you to make image adjustments and change a variety of settings.

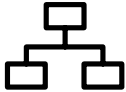
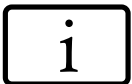

1.

Menu		Description
Display		Adjust Image, 3D, Aspect Ratio, Zoom, and Keystone settings.
Audio		Adjust the volume level or mute.
Setup		Adjust Projection, Power, Security, Language, etc. settings.
Network		Adjust LAN control settings.
Information		View projector information.

## Menu Navigation

The projector has multilingual on-screen display menus that allow for image and settings adjustment.

1. To open the On-Screen Display (OSD) Menu, press the **Menu/Exit** button on the projector or the remote control.
2. When the OSD is displayed, use the **Navigation** buttons (**▲ / ▼**) to select any item in the main menu. While making a selection on a particular page, press the **Enter** button on the projector or the remote control to enter a sub-menu.
3. Use the **Navigation** buttons (**▲ / ▼ / ◀ / ▶**) to select the desired item in the sub-menu and then press **Enter** to view further settings. Adjust the settings by using the **Navigation** buttons (**▲ / ▼ / ◀ / ▶**).
4. Select the next item to be adjusted in the sub-menu and adjust as described above.
5. Press **Enter** to confirm, and the screen will return to the main menu.
6. To exit, press the **Menu/Exit** button again. The OSD menu will close and the projector will automatically save the new settings.

# On-Screen Display (OSD) Menu Tree

Main Menu	Sub-menu	Menu Option				
Display	Image Settings	Color Mode	Presentation			
			Brightest			
			Movie			
			Gaming			
			User			
			3D			
		Brightness	(-/+ , -50~50)			
		Contrast	(-/+ , -50~50)			
		Sharpness	(-/+ , 1~15)			
		Color	(-/+ , -50~50)			
		Tint	(-/+ , -50~50)			
		Gamma	Film			
			Video			
			Graphics			
			Standard (2.2)			
		BrilliantColor™	(-/+ , 1~10)			
			Color Temperature	Warm		
		Standard				
		Cold				
		Color Settings	Color Management	Color	Red	
					Green	
					Blue	
					Cyan	
					Yellow	
					Magenta	
					White	
			Hue / R	(-/+ , -50~50)		
Saturation / G	(-/+ , -50~50)					
Gain / B	(-/+ , -50~50)					
Reset						
Exit						



Main Menu	Sub-menu	Menu Option			
Display	Image Settings	Color Settings	Color Space	Auto	
				RGB (0~255)	
				RGB (16~235)	
				YUV	
		Light Source Mode	Dynamic Black		
			Eco.		
			Power 100%~50%		
	Reset				
	3D	3D Mode	Off		
			On		
		3D Format	Auto		
			SBS		
			Top and Bottom		
			Frame Sequential		
		3D Sync Invert	Off		
			On		
	Aspect Ratio	4:3			
		16:9			
		Full			
		L.BOX			
		Auto			
	Zoom	(-/+, -5~25)			
	Keystone	Four Corners	Top-Left		
			Top-Right		
			Bottom-Left		
			Bottom-Right		
		H. Keystone	(-/+, -30~30)		
		V. Keystone	(-/+, -30~30)		
Reset					
Audio	Mute	Off			
		On			
	Volume	(-/+, 0~10)			

Main Menu	Sub-menu	Menu Option				
Setup	Projection	Desk Front				
		Desk Rear				
		Ceiling Front				
		Ceiling Rear				
	Power Settings	Direct Power On	Off			
			On			
		Signal Power On	Off			
			On			
		Auto Power Off	(-/+ , 0~180) minutes			
		Power Mode (Standby)	Active			
	Eco.					
	Security	Power On Lock	Off			
			On			
		Security Timer	Month	(-/+ , 0~12)		
			Day	(-/+ , 0~30)		
			Hour	(-/+ , 0~24)		
Change Password						

Main Menu	Sub-menu	Menu Option	
Setup	HDMI CEC	HDMI CEC	Off
			On
	Test Pattern	Test Pattern	Off
			Green Grid
			Magenta Grid
			White Grid
			White
			Test Card
	Options	Language	English
			Deutsch
			Français
			Italiano
			Español
			Português
			Polski
			Nederlands
			Svenska
			Norsk
			Suomi
			ελληνικά
			繁體中文
			簡體中文
			日本語
			한국어
			Русский
			Čeština
			يبرع
			ไทย
	Türkçe		
	Tiếng Việt		
	Bahasa Indonesia		

Main Menu	Sub-menu	Menu Option	
Setup	Options	Auto Source	Off
			On
		High Altitude	Off
			On
		Keypad Lock	Off
			On
Splash Screen	Default		
	User		
	Reset	Reset to Default	
LAN	LAN	Network Status	
		MAC Address	
		DHCP	Off
			On
		IP Address	xxx.xxx.xxx
		Subnet Mask	xxx.xxx.xxx
		Gateway	xxx.xxx.xxx
		DNS	xxx.xxx.xxx
	Reset		
	Control	Crestron	Off
			On
		Extron	Off
			On
		PJ Link	Off
			On
AMX Device Discovery		Off	
		On	
Telnet		Off	
	On		
HTTP	Off		
	On		

Main Menu	Sub-menu	Menu Option	
<b>Information</b>	Serial Number		
	Source		
	Resolution		
	Refresh Rate		
	Color Mode		
	Light Source Hours		
	Light Source Mode		
	Firmware Version	System	
	MCU		

# Menu Operation

## Display Menu

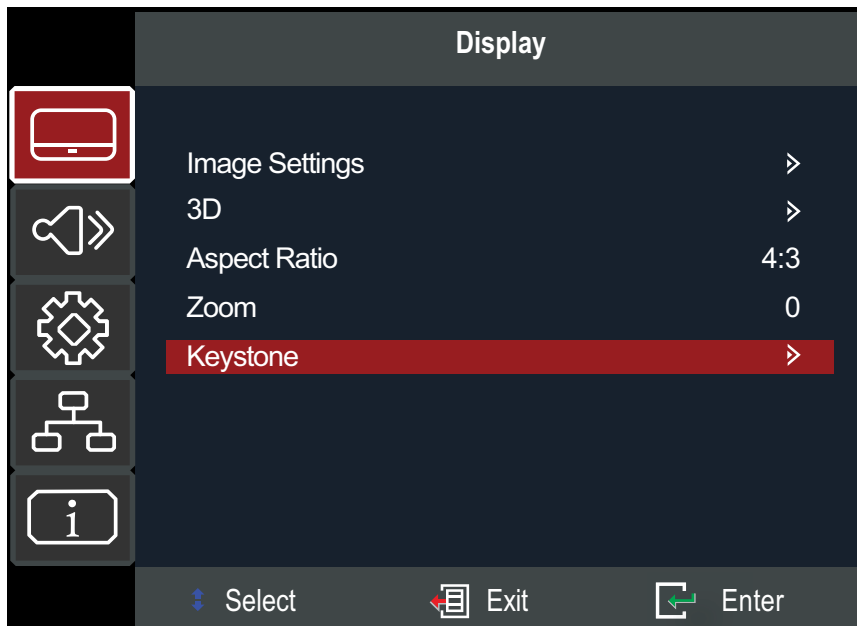

Menu	Description														
<b>Image Settings</b>	<p><u>Color Mode</u> There are several predefined display modes that you can choose from to suit your viewing preference.</p> <table border="1" style="width: 100%; border-collapse: collapse;"> <thead> <tr> <th style="background-color: #ff0000; color: white;">Mode</th> <th style="background-color: #ff0000; color: white;">Description</th> </tr> </thead> <tbody> <tr> <td style="text-align: center;"><b>Presentation</b></td> <td>Is suitable for most presenting needs in business and education environments.</td> </tr> <tr> <td style="text-align: center;"><b>Brightest</b></td> <td>Is suitable for bright, well-lit environments.</td> </tr> <tr> <td style="text-align: center;"><b>Movie</b></td> <td>Provides the best balance of detail and colors for watching movies.</td> </tr> <tr> <td style="text-align: center;"><b>Gaming</b></td> <td>Optimizes your projector for maximum contrast and vivid colors. With this mode, you can see shadow detail when playing games.</td> </tr> <tr> <td style="text-align: center;"><b>User</b></td> <td>User's custom settings.</td> </tr> <tr> <td style="text-align: center;"><b>3D</b></td> <td>Is suitable for 3D content. <b>NOTE:</b> 3D glasses are needed.</td> </tr> </tbody> </table>	Mode	Description	<b>Presentation</b>	Is suitable for most presenting needs in business and education environments.	<b>Brightest</b>	Is suitable for bright, well-lit environments.	<b>Movie</b>	Provides the best balance of detail and colors for watching movies.	<b>Gaming</b>	Optimizes your projector for maximum contrast and vivid colors. With this mode, you can see shadow detail when playing games.	<b>User</b>	User's custom settings.	<b>3D</b>	Is suitable for 3D content. <b>NOTE:</b> 3D glasses are needed.
Mode	Description														
<b>Presentation</b>	Is suitable for most presenting needs in business and education environments.														
<b>Brightest</b>	Is suitable for bright, well-lit environments.														
<b>Movie</b>	Provides the best balance of detail and colors for watching movies.														
<b>Gaming</b>	Optimizes your projector for maximum contrast and vivid colors. With this mode, you can see shadow detail when playing games.														
<b>User</b>	User's custom settings.														
<b>3D</b>	Is suitable for 3D content. <b>NOTE:</b> 3D glasses are needed.														

Menu	Description
<p style="text-align: center;"><b>Image Settings</b></p>	<p><u>Brightness</u> The higher the value, the brighter the image. Lower values will result in a darker image.</p> <p><u>Contrast</u> The higher the value, the greater the contrast. Use this to set the peak white level after you have previously adjusted the <b>Brightness</b> setting to suit your selected input and viewing environment.</p> <p><u>Sharpness</u> A high value results in a sharper picture; a low value softens the picture.</p> <p><u>Color</u> Adjusts an image from black and white to fully saturated color.</p> <p><u>Tint</u> The higher the value, the more greenish the picture becomes. The lower the value, the more reddish the picture becomes.</p> <p><u>Gamma</u> Reflects the relationship between input source and picture brightness.</p>

Menu	Description																		
<b>Image Settings</b>	<p><u>Color Settings</u></p> <table border="1" data-bbox="609 250 1396 1310"> <thead> <tr> <th data-bbox="609 250 884 297">Setting</th> <th data-bbox="884 250 1396 297">Description</th> </tr> </thead> <tbody> <tr> <td data-bbox="609 297 884 459"><b>BrilliantColor™</b></td> <td data-bbox="884 297 1396 459">A color-processing algorithm and enhancements to enable higher brightness while providing true, more vibrant colors in picture.</td> </tr> <tr> <td data-bbox="609 459 884 539"><b>Color Temperature</b></td> <td data-bbox="884 459 1396 539">Select from Warm, Standard, or Cold.</td> </tr> <tr> <td data-bbox="609 539 884 1227"><b>Color Management</b></td> <td data-bbox="884 539 1396 1227"> <p>Only in permanent installations with controlled lighting levels such as: boardrooms, lecture halls, or home theaters should Color Management be considered.</p> <p>Color Management provides fine color control adjustment to allow for more accurate color reproduction, should you require it.</p> <p>If you have purchased a test disc, which contains various color test patterns and can be used to test the color presentation on monitors, TVs, projectors, etc., you can project any image from the disc on the screen and enter the Color Management menu to make adjustments.</p> </td> </tr> <tr> <td data-bbox="609 1227 884 1310"><b>Color Space</b></td> <td data-bbox="884 1227 1396 1310">Select from Auto, RGB (0~255), RGB (16~235), and YUV color space.</td> </tr> </tbody> </table> <p><u>Light Source Mode</u></p> <table border="1" data-bbox="609 1377 1396 1713"> <thead> <tr> <th data-bbox="609 1377 884 1424">Mode</th> <th data-bbox="884 1377 1396 1424">Description</th> </tr> </thead> <tbody> <tr> <td data-bbox="609 1424 884 1547"><b>Dynamic Black</b></td> <td data-bbox="884 1424 1396 1547">Automatically adjusts the picture brightness in order to give optimum contrast performance.</td> </tr> <tr> <td data-bbox="609 1547 884 1628"><b>Eco.</b></td> <td data-bbox="884 1547 1396 1628">Automatically dims the light output, lowering power consumption.</td> </tr> <tr> <td data-bbox="609 1628 884 1713"><b>Power</b></td> <td data-bbox="884 1628 1396 1713">Select the power percentage (50%~100%) for brightness.</td> </tr> </tbody> </table> <p><u>Reset</u> Returns current display mode settings (Brightness, Contrast, Sharpness, Color, Tint, Gamma, Brilliant Color, Color Temperature, Color Management, Color Space, Light Source Mode) to default.</p>	Setting	Description	<b>BrilliantColor™</b>	A color-processing algorithm and enhancements to enable higher brightness while providing true, more vibrant colors in picture.	<b>Color Temperature</b>	Select from Warm, Standard, or Cold.	<b>Color Management</b>	<p>Only in permanent installations with controlled lighting levels such as: boardrooms, lecture halls, or home theaters should Color Management be considered.</p> <p>Color Management provides fine color control adjustment to allow for more accurate color reproduction, should you require it.</p> <p>If you have purchased a test disc, which contains various color test patterns and can be used to test the color presentation on monitors, TVs, projectors, etc., you can project any image from the disc on the screen and enter the Color Management menu to make adjustments.</p>	<b>Color Space</b>	Select from Auto, RGB (0~255), RGB (16~235), and YUV color space.	Mode	Description	<b>Dynamic Black</b>	Automatically adjusts the picture brightness in order to give optimum contrast performance.	<b>Eco.</b>	Automatically dims the light output, lowering power consumption.	<b>Power</b>	Select the power percentage (50%~100%) for brightness.
	Setting	Description																	
	<b>BrilliantColor™</b>	A color-processing algorithm and enhancements to enable higher brightness while providing true, more vibrant colors in picture.																	
	<b>Color Temperature</b>	Select from Warm, Standard, or Cold.																	
	<b>Color Management</b>	<p>Only in permanent installations with controlled lighting levels such as: boardrooms, lecture halls, or home theaters should Color Management be considered.</p> <p>Color Management provides fine color control adjustment to allow for more accurate color reproduction, should you require it.</p> <p>If you have purchased a test disc, which contains various color test patterns and can be used to test the color presentation on monitors, TVs, projectors, etc., you can project any image from the disc on the screen and enter the Color Management menu to make adjustments.</p>																	
	<b>Color Space</b>	Select from Auto, RGB (0~255), RGB (16~235), and YUV color space.																	
	Mode	Description																	
	<b>Dynamic Black</b>	Automatically adjusts the picture brightness in order to give optimum contrast performance.																	
	<b>Eco.</b>	Automatically dims the light output, lowering power consumption.																	
	<b>Power</b>	Select the power percentage (50%~100%) for brightness.																	



Menu	Description										
<b>3D</b>	<p><u>3D Mode</u> Enables or disables the 3D function.</p> <p><u>3D Format</u> Select from Auto, SBS, Top and Bottom, or Frame Sequential format.</p> <p><b>NOTE:</b> A Blu-ray 3D source will be detected automatically, and formats will not be selectable.</p> <table border="1" data-bbox="619 510 1406 853"> <thead> <tr> <th data-bbox="619 510 892 555">Option</th> <th data-bbox="892 510 1406 555">Description</th> </tr> </thead> <tbody> <tr> <td data-bbox="619 555 892 719" style="text-align: center;"><b>Auto</b></td> <td data-bbox="892 555 1406 719">When a 3D identification signal is detected, the projector automatically chooses a suitable 3D format.</td> </tr> <tr> <td data-bbox="619 719 892 763" style="text-align: center;"><b>SBS</b></td> <td data-bbox="892 719 1406 763">Displays in Side-by-Side format.</td> </tr> <tr> <td data-bbox="619 763 892 808" style="text-align: center;"><b>Top and Bottom</b></td> <td data-bbox="892 763 1406 808">Displays in Top and Bottom format.</td> </tr> <tr> <td data-bbox="619 808 892 853" style="text-align: center;"><b>Frame Sequential</b></td> <td data-bbox="892 808 1406 853">Displays in Frame Sequential format.</td> </tr> </tbody> </table> <p><u>3D Sync Invert</u> Enables or disables the 3D Sync Invert function.</p>	Option	Description	<b>Auto</b>	When a 3D identification signal is detected, the projector automatically chooses a suitable 3D format.	<b>SBS</b>	Displays in Side-by-Side format.	<b>Top and Bottom</b>	Displays in Top and Bottom format.	<b>Frame Sequential</b>	Displays in Frame Sequential format.
Option	Description										
<b>Auto</b>	When a 3D identification signal is detected, the projector automatically chooses a suitable 3D format.										
<b>SBS</b>	Displays in Side-by-Side format.										
<b>Top and Bottom</b>	Displays in Top and Bottom format.										
<b>Frame Sequential</b>	Displays in Frame Sequential format.										

**NOTE:** This projector is a 3D ready projector with DLP-Link 3D solution. Please make sure your 3D glasses are for DLP-Link 3D. This projector supports frame sequential (page-flip) 3D via the **HDMI 1/HDMI 2** ports. For the best performance, 1920 x 1080 resolution is recommended. Please note that 4K (3840 x 2160) resolution is not supported in 3D mode.

Menu	Description												
<p style="text-align: center;"><b>Aspect Ratio</b></p>	<p>Select the aspect ratio of the projected image.</p> <table border="1" data-bbox="611 226 1398 1301"> <thead> <tr> <th data-bbox="611 226 884 275">Aspect Ratio</th> <th data-bbox="884 226 1398 275">Description</th> </tr> </thead> <tbody> <tr> <td data-bbox="611 275 884 546" style="text-align: center;"><b>4:3</b></td> <td data-bbox="884 275 1398 546">Scales an image so that it is displayed in the center of the screen with a 4:3 aspect ratio. This is most suitable for 4:3 images like computer monitors, standard definition TV, and 4:3 aspect DVD movies, as it displays them without aspect alteration.</td> </tr> <tr> <td data-bbox="611 546 884 781" style="text-align: center;"><b>16:9</b></td> <td data-bbox="884 546 1398 781">Scales an image so that it is displayed in the center of the screen with a 16:9 aspect ratio. This is most suitable for images which are already in a 16:9 aspect, like high definition TV.</td> </tr> <tr> <td data-bbox="611 781 884 943" style="text-align: center;"><b>L.BOX</b></td> <td data-bbox="884 781 1398 943">For non-16:9 letterbox source and if you use an external 16:9 lens to display 2.35:1 aspect ratio in full resolution.</td> </tr> <tr> <td data-bbox="611 943 884 1025" style="text-align: center;"><b>Full</b></td> <td data-bbox="884 943 1398 1025">Extends the image to fully fill the screen.</td> </tr> <tr> <td data-bbox="611 1025 884 1301" style="text-align: center;"><b>Auto</b></td> <td data-bbox="884 1025 1398 1301">Scales an image proportionally to fit the projector's native resolution in its horizontal width. This is suitable for the incoming image which is neither 4:3 nor 16:9 and you want to make the most use of the screen without altering the image's aspect ratio.</td> </tr> </tbody> </table>	Aspect Ratio	Description	<b>4:3</b>	Scales an image so that it is displayed in the center of the screen with a 4:3 aspect ratio. This is most suitable for 4:3 images like computer monitors, standard definition TV, and 4:3 aspect DVD movies, as it displays them without aspect alteration.	<b>16:9</b>	Scales an image so that it is displayed in the center of the screen with a 16:9 aspect ratio. This is most suitable for images which are already in a 16:9 aspect, like high definition TV.	<b>L.BOX</b>	For non-16:9 letterbox source and if you use an external 16:9 lens to display 2.35:1 aspect ratio in full resolution.	<b>Full</b>	Extends the image to fully fill the screen.	<b>Auto</b>	Scales an image proportionally to fit the projector's native resolution in its horizontal width. This is suitable for the incoming image which is neither 4:3 nor 16:9 and you want to make the most use of the screen without altering the image's aspect ratio.
	Aspect Ratio	Description											
	<b>4:3</b>	Scales an image so that it is displayed in the center of the screen with a 4:3 aspect ratio. This is most suitable for 4:3 images like computer monitors, standard definition TV, and 4:3 aspect DVD movies, as it displays them without aspect alteration.											
	<b>16:9</b>	Scales an image so that it is displayed in the center of the screen with a 16:9 aspect ratio. This is most suitable for images which are already in a 16:9 aspect, like high definition TV.											
	<b>L.BOX</b>	For non-16:9 letterbox source and if you use an external 16:9 lens to display 2.35:1 aspect ratio in full resolution.											
	<b>Full</b>	Extends the image to fully fill the screen.											
<b>Auto</b>	Scales an image proportionally to fit the projector's native resolution in its horizontal width. This is suitable for the incoming image which is neither 4:3 nor 16:9 and you want to make the most use of the screen without altering the image's aspect ratio.												
<b>Zoom</b>	Reduces or magnifies the projected image.												
<p style="text-align: center;"><b>Keystone</b></p>	<table border="1" data-bbox="611 1391 1398 2002"> <thead> <tr> <th data-bbox="611 1391 884 1440">Option</th> <th data-bbox="884 1391 1398 1440">Description</th> </tr> </thead> <tbody> <tr> <td data-bbox="611 1440 884 1832" style="text-align: center;"><b>Four Corners</b></td> <td data-bbox="884 1440 1398 1832">Adjusts each corner to make a square image when the projection surface is not level.  <b>NOTE:</b> While adjusting the Four Corners, the Aspect Ratio, and Zoom menus will be disabled. To enable them, reset the Keystone settings to default.</td> </tr> <tr> <td data-bbox="611 1832 884 1877" style="text-align: center;"><b>H. Keystone</b></td> <td data-bbox="884 1832 1398 1877">Adjusts image distortion horizontally.</td> </tr> <tr> <td data-bbox="611 1877 884 1921" style="text-align: center;"><b>V. Keystone</b></td> <td data-bbox="884 1877 1398 1921">Adjusts image distortion vertically.</td> </tr> <tr> <td data-bbox="611 1921 884 2002" style="text-align: center;"><b>Reset</b></td> <td data-bbox="884 1921 1398 2002">Returns the Keystone settings to default.</td> </tr> </tbody> </table>	Option	Description	<b>Four Corners</b>	Adjusts each corner to make a square image when the projection surface is not level.  <b>NOTE:</b> While adjusting the Four Corners, the Aspect Ratio, and Zoom menus will be disabled. To enable them, reset the Keystone settings to default.	<b>H. Keystone</b>	Adjusts image distortion horizontally.	<b>V. Keystone</b>	Adjusts image distortion vertically.	<b>Reset</b>	Returns the Keystone settings to default.		
	Option	Description											
	<b>Four Corners</b>	Adjusts each corner to make a square image when the projection surface is not level.  <b>NOTE:</b> While adjusting the Four Corners, the Aspect Ratio, and Zoom menus will be disabled. To enable them, reset the Keystone settings to default.											
	<b>H. Keystone</b>	Adjusts image distortion horizontally.											
<b>V. Keystone</b>	Adjusts image distortion vertically.												
<b>Reset</b>	Returns the Keystone settings to default.												

## Audio Menu

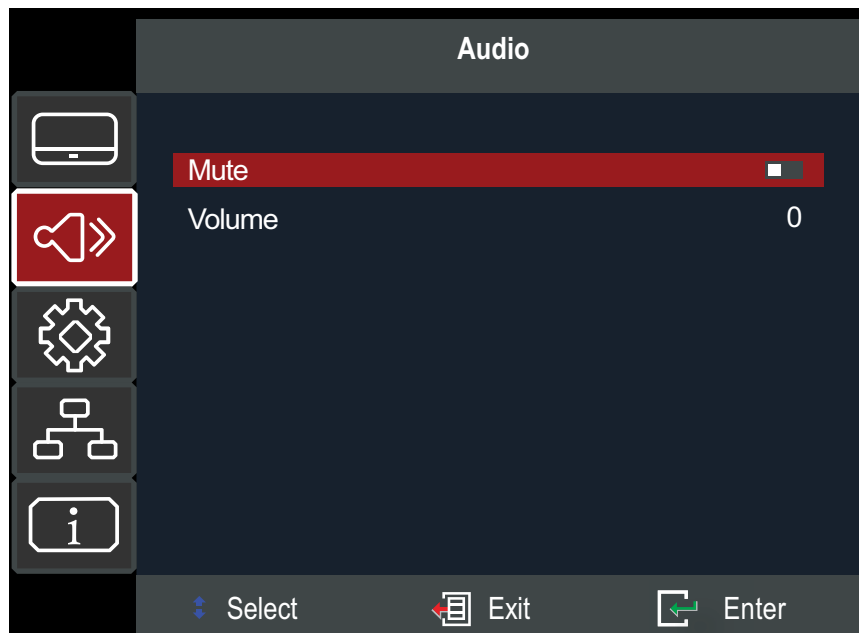

Menu	Description
Mute	Temporarily turns off the sound.
Volume	Adjusts the volume level.

## Setup Menu

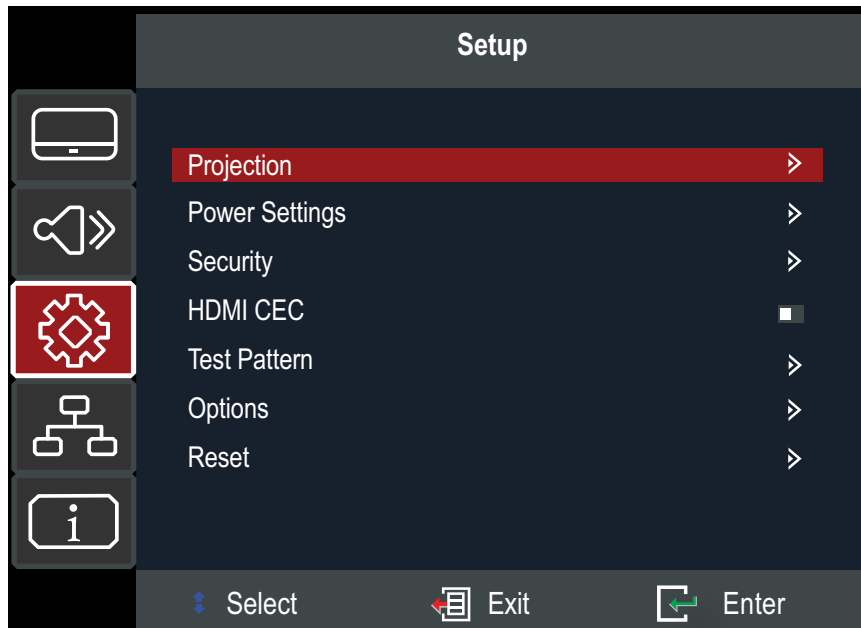

Menu	Description
<b>Projection</b>	Select the preferred projection location: Desk Front, Desk Rear, Ceiling Front, or Ceiling Rear.
<b>Power Settings</b>	<p><u>Direct Power On</u> Automatically powers on the projector when DC power is supplied, without pressing the <b>Power</b> button on the projector or the remote control.</p> <p><u>Signal Power On</u> Automatically powers on the projector when a signal is detected, without pressing the <b>Power</b> button on the projector or the remote control. <b>NOTE:</b> The projector will not automatically power on when it is already connected via HDMI.</p> <p><u>Auto Power Off</u> A countdown timer will start when no signal is being sent to the projector. The projector will automatically power off when the countdown has finished (in minutes).</p> <p><u>Power Mode (Standby)</u> Select the preferred function when the projector is in standby mode: Active or Eco.</p>

Menu	Description
<p style="text-align: center;"><b>Security</b></p>	<p><u>Power On Lock</u> Enables or disables a password prompt before using the projector. <b>NOTE:</b> The default password is: 1234</p> <p><u>Security Timer</u> Sets the amount of time the projector can be used. Once this time has elapsed you will be requested to enter your password again.</p> <p><u>Change Password</u> Sets or modifies the password. <b>NOTE:</b> Please follow the OSD message to input the current password first, then enter a new password (security code). Confirm the new password by entering the new password again.</p>
<p style="text-align: center;"><b>HDMI CEC</b></p>	<p>When you connect HDMI CEC-compatible devices to the projector with HDMI cables, you can control them on the same power on or power off status using the HDMI CEC control feature in the projector's OSD. This lets one device or multiple devices in a group power on or power off via HDMI CEC in a typical configuration.</p> <p><b>NOTE:</b></p> <ul style="list-style-type: none"> <li>• In order for the CEC function to work properly, make sure that the device is correctly connected to the <b>HDMI</b> input of the projector via an HDMI cable, and its CEC function is turned on.</li> <li>• If both <b>HDMI 1</b> and <b>HDMI 2</b> ports are occupied, the CEC function will not be able to detect the correct source.</li> <li>• Depending on the connected device, the CEC function may not work.</li> </ul>
<p style="text-align: center;"><b>Test Pattern</b></p>	<p>Select the test pattern from green grid, magenta grid, white grid, white, test card or disable this function (off).</p>

Menu	Description						
<b>Options</b>	<p><u>Language</u> Select the On-Screen Display (OSD) Menu language.</p> <p><u>Auto Source</u> Automatically finds an available input source.</p> <table border="1" data-bbox="609 365 1398 775"> <thead> <tr> <th data-bbox="609 365 884 412">Option</th> <th data-bbox="884 365 1398 412">Description</th> </tr> </thead> <tbody> <tr> <td data-bbox="609 412 884 533" style="text-align: center;"><b>Off</b></td> <td data-bbox="884 412 1398 533">Only searches the current input selection. Press the <b>Source</b> button to display the list of sources.</td> </tr> <tr> <td data-bbox="609 533 884 775" style="text-align: center;"><b>On</b></td> <td data-bbox="884 533 1398 775">Automatically finds an available input source. Press the <b>Source</b> button to automatically detect the next source. <b>NOTE:</b> The scan order is: <b>HDMI 1 &gt; HDMI 2.</b></td> </tr> </tbody> </table> <p><u>High Altitude</u> When On, the fans will spin faster for better cooling and performance. This is useful for high altitude environments where the air is thin.</p> <p><u>Keypad Lock</u> Locks all keypad buttons, except the <b>Power</b> key. <b>NOTE:</b> To release keypad lock, press and hold the <b>Enter</b> key on the projector for 5 seconds. You can also use the remote control and go to: <b>Setup &gt; Keypad Lock &gt; Off.</b></p> <p><u>Splash Screen</u> Sets the “startup screen”. If changes are made, they will take effect the next time the projector is powered on. <b>NOTE:</b> Use the “splash tool” to change the startup screen image.</p>	Option	Description	<b>Off</b>	Only searches the current input selection. Press the <b>Source</b> button to display the list of sources.	<b>On</b>	Automatically finds an available input source. Press the <b>Source</b> button to automatically detect the next source. <b>NOTE:</b> The scan order is: <b>HDMI 1 &gt; HDMI 2.</b>
Option	Description						
<b>Off</b>	Only searches the current input selection. Press the <b>Source</b> button to display the list of sources.						
<b>On</b>	Automatically finds an available input source. Press the <b>Source</b> button to automatically detect the next source. <b>NOTE:</b> The scan order is: <b>HDMI 1 &gt; HDMI 2.</b>						
<b>Reset</b>	<p>Returns all settings to default. <b>NOTE:</b> When resetting, the following settings will still remain: Language, Projection, High Altitude, Security Settings, Zoom, Keystone Settings.</p>						

## Network Menu

The projector provides diverse networking and remote management features. You can use a LAN cable to connect the projector to an existing network.

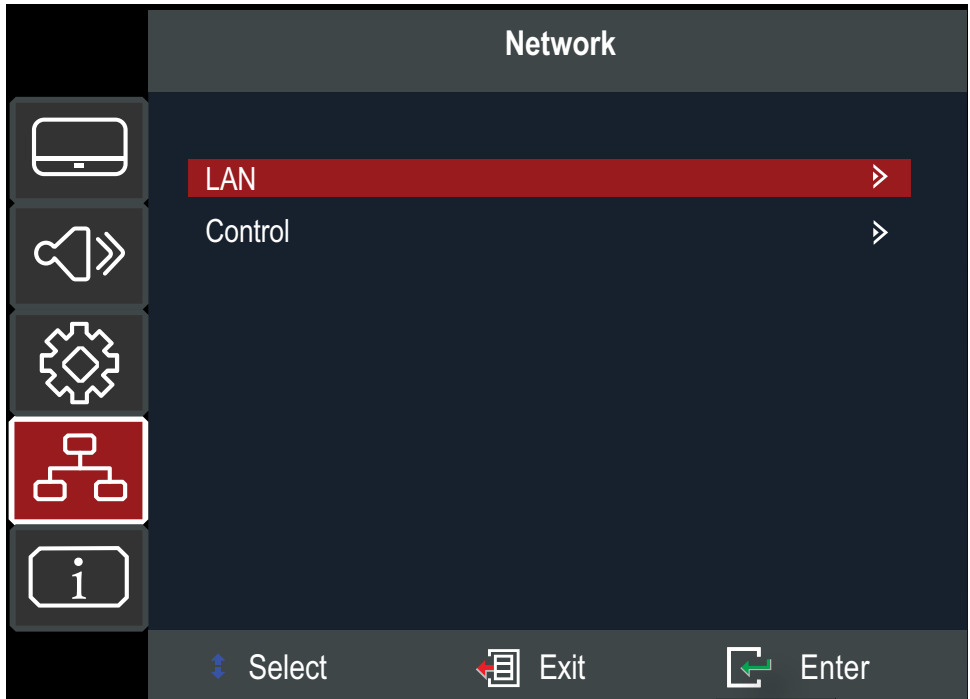

Menu	Description
LAN	View network information and enable/disable DHCP protocol. <b>NOTE:</b> The projector will automatically detect the projector's current IP address, Subnet Mask, Gateway, and DNS addresses when <b>DHCP</b> is enabled.
Control	Enable or disable network control suites.

## Information Menu

Displays Serial Number, Source, Resolution, Refresh Rate, Color Mode, Light Source Hours, Light Source Mode, and Firmware Version information.

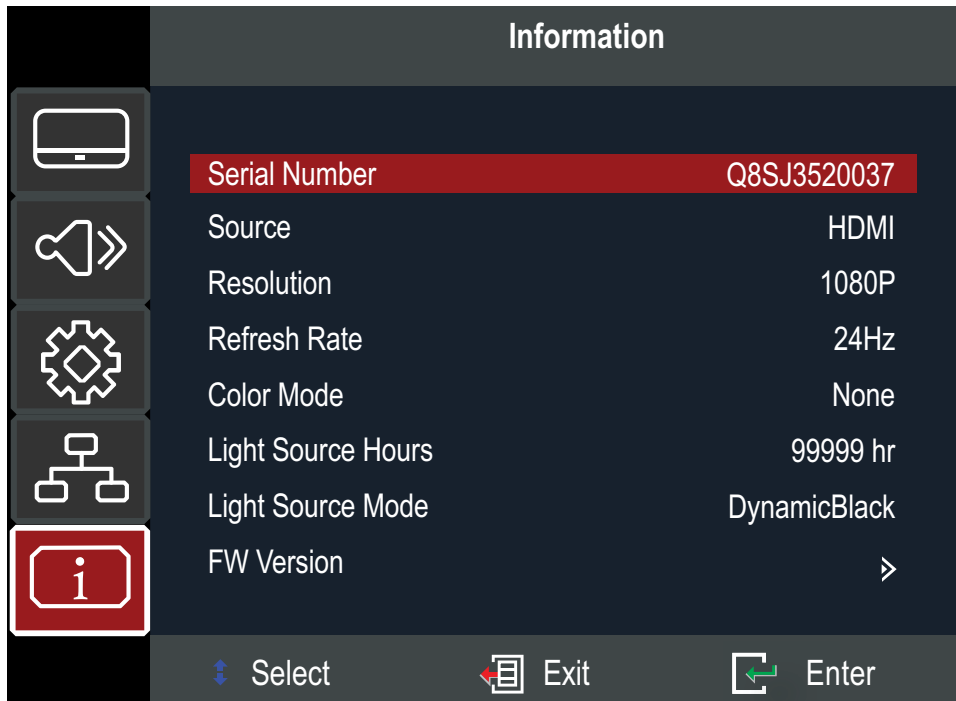



# Appendix

## Specifications

Item	Category	Specifications
Projector	Type	Laser
	Display Size	30"~300"
	Throw Ratio	1.4~2.24 (100"@3.10 m)
	Lens	F=2.5~3.26, f=20.911~32.62 mm
	Display System	1-CHIP DMD
Input Signal	HDMI (v. 1.4)	$f_h$ : 15~102 kHz, $f_v$ : 23~120 Hz, Pixel rate: 165 MHz
Resolution	Native	1920 (H) x 1080 (V)
Power	Input Voltage	DC 100~240V, 50/60 Hz (auto switch)
Operating Conditions	Temperature	0°C to 40°C (32°F to 104°F)
	Humidity	10% to 80% (non-condensing)
	Altitude	0 to 760 m (0 to 2,500 ft.) at 0°C to 40°C (32°F to 104°F) 760 to 1,520 m (2,500 to 5,000 ft.) at 0°C to 35°C (32°F to 95°F) 1,520 to 3,048 m (5,000 to 10,000 ft.) at 0°C to 30°C (32°F to 86°F)
Storage Conditions	Temperature	-20°C to 60°C (-4°F to 140°F)
	Humidity	5% to 90% (non-condensing)
	Altitude	0 to 12,100 m (0 to 40,000 ft.)
Dimensions	Physical (W x H x D)	286 x 216 x 129 mm (11.26" x 8.50" x 5.08")
Weight	Physical	3.00 kg (6.61 lbs)
Power Consumption	On <sup>1</sup>	210W (Typical)
	Off	< 0.5W (Standby)

<sup>1</sup> The test condition follows EEI standards.

# Projector Dimensions

286 mm (W) x 216 mm (H) x 129 mm (D)

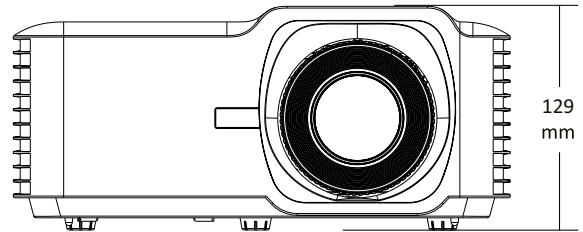
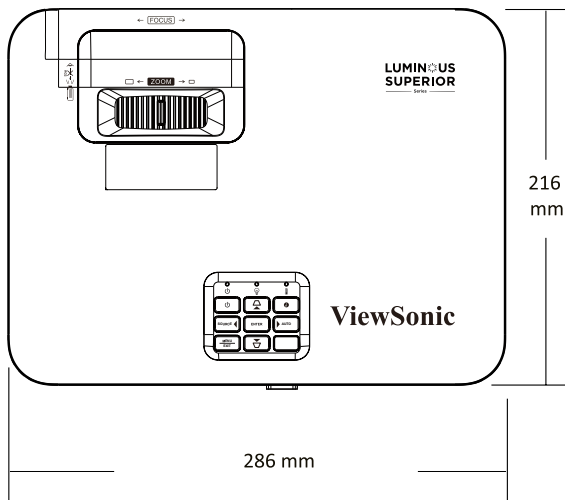

# Timing Chart

## Video Input

<b>Timing</b>	<b>Resolution</b>	<b>H-frequency (kHz)</b>	<b>V-frequency (Hz)</b>	<b>Dot Clock Frequency (MHz)</b>
<b>480i</b>	720(1440) x 480	15.73	59.94	27
<b>480p</b>	720 x 480	31.47	59.94	27
<b>720/50p</b>	1280 x 720	37.50	50	74.25
<b>720/60p</b>		45.00	60	74.25
<b>1080/24P</b>	1920 x 1080	27.00	24	74.25
<b>1080/50i</b>		28.13	50	74.25
<b>1080/60i</b>		33.75	60	74.25
<b>1080/50P</b>		56.25	50	148.50
<b>1080/60P</b>		67.50	60	148.50

## PC Input

Resolution	Mode	Refresh Rate (Hz)	H-frequency (kHz)	Clock (MHz)
<b>720 x 400</b>	720 x 400_70	70.09	31.47	28.32
<b>800 x 600</b>	SVGA_56	56.25	35.16	36.00
	SVGA_60	60.32	37.88	40.00
	SVGA_72	72.19	48.08	50.00
	SVGA_75	75.00	46.88	49.50
<b>1024 x 768</b>	XGA_60	60.00	48.36	65.00
	XGA_70	70.07	56.48	75.00
	XGA_75	75.03	60.02	78.75
<b>1152 x 870</b>	1152 x 870_75	75.00	67.50	108.00
<b>1280 x 1024</b>	SXGA_60	60.02	63.98	108.00
	SXGA_75	75.03	79.98	135.00
<b>1280 x 960</b>	1280 x 960_60	60.00	60.00	108.00
<b>1440 x 900</b>	WXGA+_60	59.89	55.94	106.50
<b>1680 x 1050</b>	1680 x 1050_60	59.95	65.29	146.25
<b>640 x 480 @ 67Hz</b>	MAC13	66.67	35.00	30.24

## 3D Support

<b>HDMI 3D</b>		
<b>Frame Packing Format</b>		
<b>Timing</b>	<b>Resolution</b>	<b>Refresh Rate (Hz)</b>
<b>1080p</b>	1920 x 1080	24
<b>720p</b>	1280 x 720	50 / 60
<b>Side by Side Format</b>		
<b>Timing</b>	<b>Resolution</b>	<b>Refresh Rate (Hz)</b>
<b>1080i</b>	1920 x 1080	50 / 60
<b>Top and Bottom Format</b>		
<b>Timing</b>	<b>Resolution</b>	<b>Refresh Rate (Hz)</b>
<b>1080p</b>	1920 x 1080	24
<b>720p</b>	1280 x 720	50 / 60

## Troubleshooting

This section describes some common problems that you may experience when using the projector.

Problem or Issue	Possible Solutions
The projector does not turn on	<ul style="list-style-type: none"><li>• Ensure the power cord is properly attached to the projector and to the power outlet.</li><li>• If the cooling process has not completed, please wait until it has finished then try to turn on the projector again.</li><li>• If the above does not work, try another power outlet or another electrical device with the same power outlet.</li></ul>
There is no picture	<ul style="list-style-type: none"><li>• Ensure the video source cable is connected properly, and that the video source is turned on.</li><li>• If the input source is not selected automatically, select the correct source with the “Source Input” on either the projector or the remote control.</li></ul>
The image is blurred	<ul style="list-style-type: none"><li>• Adjusting focus with the <b>Focus Switch</b> will help correctly focus the projection lens.</li><li>• Ensure the projector and screen are aligned properly. If necessary, adjust the height of the projector as well as the projection angle and direction.</li></ul>
The image is reversed	<ul style="list-style-type: none"><li>• Open the OSD Menu and go to: <b>Setup &gt; Projection</b> and adjust the projection option.</li></ul>
The image is stretched when projecting a 16:9 DVD	<ul style="list-style-type: none"><li>• When you play an anamorphic DVD or 16:9 DVD, the projector will show the best image in 16:9.</li><li>• If you play a 4:3 format DVD title, please change the format as 4:3 in projector OSD Menu.</li><li>• Please setup the display format as 16:9 (wide) aspect ratio on the DVD player.</li></ul>
The remote control does not work	<ul style="list-style-type: none"><li>• Ensure there are no obstacles between the remote control and projector; and that they are within range, 8m (26 ft).</li><li>• The batteries may be out of power, please check and replace if necessary.</li></ul>

<b>Problem or Issue</b>	<b>Possible Solutions</b>
The projector stops responding to all controls	<ul style="list-style-type: none"><li>• Turn off the projector and unplug the power cord. Wait at least 20 seconds then reconnect and try again.</li></ul>

## LED Indicators

When the warning indicators (see below) light up or flash, the projector will automatically shutdown. Unplug the power cord from the projector, wait for 30 seconds and try again. If the warning indicators light up or flash, please contact your nearest service center for assistance.

Status and Description	Power Indicator Light		Temperature Indicator Light	Light Source Indicator Light
	Red	Blue or Green	Red	Red
<b>Standby State (Power cord input)</b>	Steady Light			
<b>Power On (Warming)</b>		Flashing (0.5 sec off/0.5 sec on)		
<b>Power On and Lamp Lighting</b>		Steady Light		
<b>Power Off (Cooling)</b>		Flashing (0.5 sec off/0.5 sec on) Back to red steady light when the cooling fan turns off.		
<b>Error (Lamp failure)</b>	Flashing			Steady Light
<b>Error (Fan failure)</b>	Flashing		Flashing	
<b>Error (Overheat)</b>	Flashing		Steady Light	

# Maintenance

## General Precautions

- Make sure the projector is turned off and the power cable is unplugged from the power outlet.
- Never remove any parts from the projector. Contact ViewSonic® or a reseller when any part of the projector needs replacing.
- Never spray or pour any liquid directly onto the case.
- Handle the projector with care, as a darker-colored projector, if scuffed, may show marks more clearly than a lighter-colored projector.

## Cleaning the Lens

- Use a canister of compressed air to remove dust.
- If the lens is still not clean, use lens-cleaning paper or moisten a soft cloth with lens cleaner and gently wipe the surface.

**CAUTION:** Never rub the lens with abrasive materials.

## Cleaning the Case

- Use a soft, lint-free, dry cloth to remove dirt or dust.
- If the case is still not clean, apply a small amount of non-ammonia, non-alcohol based, mild non-abrasive detergent onto a clean, soft, lint-free cloth, then wipe the surface.

**CAUTION:** Never use wax, alcohol, benzene, thinner, or other chemical detergents.

## Storing the Projector

If you intend to store the projector for an extended period of time:

- Ensure the temperature and humidity of the storage area are within the recommend range.
- Retract the adjuster foot completely.
- Remove the batteries from the remote control.
- Pack the projector in its original packaging or equivalent.

## Disclaimer

- ViewSonic® does not recommend the use of any ammonia or alcohol-based cleaners on the lens or case. Some chemical cleaners have been reported to damage the lens and/or case of the projector.
- ViewSonic® will not be liable for damage resulting from use of any ammonia or alcohol-based cleaners.



# Regulatory and Service Information

## Compliance Information

This section addresses all connected requirements and statements regarding regulations. Confirmed corresponding applications shall refer to nameplate labels and relevant markings on the unit.

### FCC Compliance Statement

This device complies with part 15 of FCC Rules. Operation is subject to the following two conditions: (1) this device may not cause harmful interference, and (2) this device must accept any interference received, including interference that may cause undesired operation. This equipment has been tested and found to comply with the limits for a Class B digital device, pursuant to part 15 of the FCC Rules.

These limits are designed to provide reasonable protection against harmful interference in a residential installation. This equipment generates, uses, and can radiate radio frequency energy, and if not installed and used in accordance with the instructions, may cause harmful interference to radio communications. However, there is no guarantee that interference will not occur in a particular installation. If this equipment does cause harmful interference to radio or television reception, which can be determined by turning the equipment off and on, the user is encouraged to try to correct the interference by one or more of the following measures:

- Reorient or relocate the receiving antenna.
- Increase the separation between the equipment and receiver.
- Connect the equipment into an outlet on a circuit different from that to which the receiver is connected.
- Consult the dealer or an experienced radio/TV technician for help.

**Warning:** You are cautioned that changes or modifications not expressly approved by the party responsible for compliance could void your authority to operate the equipment.

### Industry Canada Statement

This Class B digital apparatus complies with Canadian ICES-003.

Cet appareil numérique de classe B est conforme à la norme NMB-003 du Canada.

CAN ICES-003(B) / NMB-003(B)

## CE Conformity for European Countries

**CE** The device complies with the EMC Directive 2014/30/EU and Low Voltage Directive 2014/35/EU. Ecodesign Directive 2009/125/EC.

### The following information is only for EU-member states:

The mark shown to the right is in compliance with the Waste Electrical and Electronic Equipment Directive 2012/19/EU (WEEE). The mark indicates the requirement NOT to dispose of the equipment as unsorted municipal waste, but use the return and collection systems according to local law.



## Declaration of RoHS2 Compliance

This product has been designed and manufactured in compliance with Directive 2011/65/EU of the European Parliament and the Council on restriction of the use of certain hazardous substances in electrical and electronic equipment (RoHS2 Directive) and is deemed to comply with the maximum concentration values issued by the European Technical Adaptation Committee (TAC) as shown below:

Substance	Proposed Maximum Concentration	Actual Concentration
Lead (Pb)	0.1%	< 0.1%
Mercury (Hg)	0.1%	< 0.1%
Cadmium (Cd)	0.01%	< 0.01%
Hexavalent Chromium (Cr6 <sup>+</sup> )	0.1%	< 0.1%
Polybrominated biphenyls (PBB)	0.1%	< 0.1%
Polybrominated diphenyl ethers (PBDE)	0.1%	< 0.1%
Bis (2-ethylhexyl) phthalate (DEHP)	0.1%	< 0.1%
Butyl benzyl phthalate (BBP)	0.1%	< 0.1%
Dibutyl phthalate (DBP)	0.1%	< 0.1%
Diisobutyl phthalate (DIBP)	0.1%	< 0.1%

**Certain components of products as stated above are exempted under the Annex III of the RoHS2 Directives as noted below. Examples of exempted components are:**

- Copper alloy containing up to 4% lead by weight.
- Lead in high melting temperature type solders (i.e. lead-based alloys containing 85% by weight or more lead).
- Electrical and electronic components containing lead in a glass or ceramic other than dielectric ceramic in capacitors, e.g. piezoelectronic devices, or in a glass or ceramic matrix compound.
- Lead in dielectric ceramic in capacitors for a rated voltage of 125V AC or 250V DC or higher.

## **Indian Restriction of Hazardous Substances**

Restriction on Hazardous Substances statement (India). This product complies with the “India E-waste Rule 2011” and prohibits use of lead, mercury, hexavalent chromium, polybrominated biphenyls or polybrominated diphenyl ethers in concentrations exceeding 0.1 weight % and 0.01 weight % for cadmium, except for the exemptions set in Schedule 2 of the Rule.

## **Product Disposal at End of Product Life**

ViewSonic® respects the environment and is committed to working and living green. Thank you for being part of Smarter, Greener Computing. Please visit the ViewSonic® website to learn more.

### **USA & Canada:**

<https://www.viewsonic.com/us/go-green-with-viewsonic>

### **Europe:**

<https://www.viewsonic.com/eu/go-green-with-viewsonic>

### **Taiwan:**

<https://recycle.epa.gov.tw/>

## Copyright Information

Copyright© ViewSonic® Corporation, 2024. All rights reserved.

Macintosh and Power Macintosh are registered trademarks of Apple Inc.

Microsoft, Windows, and the Windows logo are registered trademarks of Microsoft Corporation in the United States and other countries.

ViewSonic®, the three birds logo are registered trademarks of ViewSonic® Corporation.

VESA is a registered trademark of the Video Electronics Standards Association. DPMS, DisplayPort, and DDC are trademarks of VESA.

ENERGY STAR® is a registered trademark of the U.S. Environmental Protection Agency (EPA).

As an ENERGY STAR® partner, ViewSonic® Corporation has determined that this product meets the ENERGY STAR® guidelines for energy efficiency.

**Disclaimer:** ViewSonic® Corporation shall not be liable for technical or editorial errors or omissions contained herein; nor for incidental or consequential damages resulting from furnishing this material, or the performance or use of this product.

In the interest of continuing product improvement, ViewSonic® Corporation reserves the right to change product specifications without notice. Information in this document may change without notice.

No part of this document may be copied, reproduced, or transmitted by any means, for any purpose without prior written permission from ViewSonic® Corporation.

## Customer Service

For technical support or product service, see the table below or contact your reseller.

**NOTE:** You will need the product's serial number.

Country/ Region	Website	Country/ Region	Website
<b>Asia Pacific &amp; Africa</b>			
Australia	<a href="http://www.viewsonic.com/au/">www.viewsonic.com/au/</a>	Bangladesh	<a href="http://www.viewsonic.com/bd/">www.viewsonic.com/bd/</a>
中国 (China)	<a href="http://www.viewsonic.com.cn">www.viewsonic.com.cn</a>	香港 (繁體中文)	<a href="http://www.viewsonic.com/hk/">www.viewsonic.com/hk/</a>
Hong Kong (English)	<a href="http://www.viewsonic.com/hk-en/">www.viewsonic.com/hk-en/</a>	India	<a href="http://www.viewsonic.com/in/">www.viewsonic.com/in/</a>
Indonesia	<a href="http://www.viewsonic.com/id/">www.viewsonic.com/id/</a>	Israel	<a href="http://www.viewsonic.com/il/">www.viewsonic.com/il/</a>
日本 (Japan)	<a href="http://www.viewsonic.com/jp/">www.viewsonic.com/jp/</a>	Korea	<a href="http://www.viewsonic.com/kr/">www.viewsonic.com/kr/</a>
Malaysia	<a href="http://www.viewsonic.com/my/">www.viewsonic.com/my/</a>	Middle East	<a href="http://www.viewsonic.com/me/">www.viewsonic.com/me/</a>
Myanmar	<a href="http://www.viewsonic.com/mm/">www.viewsonic.com/mm/</a>	Nepal	<a href="http://www.viewsonic.com/np/">www.viewsonic.com/np/</a>
New Zealand	<a href="http://www.viewsonic.com/nz/">www.viewsonic.com/nz/</a>	Pakistan	<a href="http://www.viewsonic.com/pk/">www.viewsonic.com/pk/</a>
Philippines	<a href="http://www.viewsonic.com/ph/">www.viewsonic.com/ph/</a>	Singapore	<a href="http://www.viewsonic.com/sg/">www.viewsonic.com/sg/</a>
臺灣 (Taiwan)	<a href="http://www.viewsonic.com/tw/">www.viewsonic.com/tw/</a>	ประเทศไทย	<a href="http://www.viewsonic.com/th/">www.viewsonic.com/th/</a>
Việt Nam	<a href="http://www.viewsonic.com/vn/">www.viewsonic.com/vn/</a>	South Africa & Mauritius	<a href="http://www.viewsonic.com/za/">www.viewsonic.com/za/</a>
<b>Americas</b>			
United States	<a href="http://www.viewsonic.com/us">www.viewsonic.com/us</a>	Canada	<a href="http://www.viewsonic.com/us">www.viewsonic.com/us</a>
Latin America	<a href="http://www.viewsonic.com/la">www.viewsonic.com/la</a>		
<b>Europe</b>			
Europe	<a href="http://www.viewsonic.com/eu/">www.viewsonic.com/eu/</a>	France	<a href="http://www.viewsonic.com/fr/">www.viewsonic.com/fr/</a>
Deutschland	<a href="http://www.viewsonic.com/de/">www.viewsonic.com/de/</a>	Қазақстан	<a href="http://www.viewsonic.com/kz/">www.viewsonic.com/kz/</a>
Россия	<a href="http://www.viewsonic.com/ru/">www.viewsonic.com/ru/</a>	España	<a href="http://www.viewsonic.com/es/">www.viewsonic.com/es/</a>
Türkiye	<a href="http://www.viewsonic.com/tr/">www.viewsonic.com/tr/</a>	Україна	<a href="http://www.viewsonic.com/ua/">www.viewsonic.com/ua/</a>
United Kingdom	<a href="http://www.viewsonic.com/uk/">www.viewsonic.com/uk/</a>		

## **Limited Warranty**

### ViewSonic® Projector

#### **What the warranty covers:**

ViewSonic® warrants its products to be free from defects in material and workmanship, under normal use, during the warranty period. If a product proves to be defective in material or workmanship during the warranty period, ViewSonic® will, at its sole option, repair or replace the product with a like product. Replacement product or parts may include remanufactured or refurbished parts or components.

#### **Limited Three (3) year General Warranty:**

Subject to the more limited one (1) year warranty set out below, North and South America: Three (3) years warranty for all parts excluding the lamp, three (3) years for labor, and one (1) year for the original lamp from the date of the first consumer purchase.

Other regions or countries: Please check with your local dealer or local ViewSonic® office for the warranty information.

#### **Limited One (1) year Heavy Usage Warranty:**

Under heavy usage settings, where a projector's use includes more than fourteen (14) hours average daily usage, North and South America: One (1) year warranty for all parts excluding the lamp, one (1) year for labor, and ninety (90) days for the original lamp from the date of the first consumer purchase; Europe: One (1) year warranty for all parts excluding the lamp, one (1) year for labor, and ninety (90) days for the original lamp from the date of the first consumer purchase. Other regions or countries: Please check with your local dealer or local ViewSonic® office for the warranty information. Lamp warranty subject to terms and conditions, verification and approval. Applies to manufacturer's installed lamp only. All accessory lamps purchased separately are warranted for 90 days.

#### **Who the warranty protects:**

This warranty is valid only for the first consumer purchaser.

## **What the warranty does not cover:**

1. Any product on which the serial number has been defaced, modified, or removed.
2. Damage, deterioration, or malfunction resulting from:
  - » Accident, misuse, neglect, fire, water, lightning, or other acts of nature, unauthorized product modification, or failure to follow instructions supplied with the product.
  - » Operation outside of product specifications.
  - » Operation of the product for other than the normal intended use or not under normal conditions.
  - » Repair or attempted repair by anyone not authorized by ViewSonic®.
  - » Any damage of the product due to shipment.
  - » Removal or installation of the product.
  - » Causes external to the product, such as electric power fluctuations or failure.
  - » Use of supplies or parts not meeting Viewsonic's specifications.
  - » Normal wear and tear.
  - » Any other cause which does not relate to a product defect.
3. Removal, installation, and set-up service charges.

## **How to get service:**

1. For information about receiving service under warranty, contact ViewSonic® Customer Support (Please refer to the "Customer Support" page). You will need to provide your product's serial number.
2. To obtain warranted service, you will be required to provide: (a) the original dated sales slip, (b) your name, (c) your address, (d) a description of the problem, and (e) the serial number of the product.
3. Take or ship the product, freight prepaid, in the original container to an authorized ViewSonic® service center or ViewSonic®.
4. For additional information or the name of the nearest ViewSonic® service center, contact ViewSonic®.

## **Limitation of implied warranties:**

There are no warranties, express or implied, which extend beyond the description contained herein including the implied warranty of merchantability and fitness for a particular purpose.



**Exclusion of damages:**

ViewSonic's liability is limited to the cost of repair or replacement of the product. ViewSonic® shall not be liable for:

1. Damage to other property caused by any defects in the product, damages based upon inconvenience, loss of use of the product, loss of time, loss of profits, loss of business opportunity, loss of goodwill, interference with business relationships, or other commercial loss, even if advised of the possibility of such damages.
2. Any other damages, whether incidental, consequential or otherwise.
3. Any claim against the customer by any other party.

**Effect of state law:**

This warranty gives you specific legal rights, and you may also have other rights which vary from local authority. Some local governments do not allow limitations on implied warranties and/or do not allow the exclusion of incidental or consequential damages, so the above limitations and exclusions may not apply to you.

**Sales outside the U.S.A. and Canada:**

For warranty information and service on ViewSonic® products sold outside of the U.S.A. and Canada, contact ViewSonic® or your local ViewSonic® dealer.

The warranty period for this product in mainland China (Hong Kong, Macao, and Taiwan Excluded) is subject to the terms and conditions of the Maintenance Guarantee Card.

For users in Europe and Russia, full details of warranty provided can be found at: <http://www.viewsonic.com/eu/> under "Support/Warranty Information".

# Mexico Limited Warranty

## ViewSonic® Projector

### What the warranty covers:

ViewSonic® warrants its products to be free from defects in material and workmanship, under normal use, during the warranty period. If a product proves to be defective in material or workmanship during the warranty period, ViewSonic® will, at its sole option, repair or replace the product with a like product. Replacement product or parts may include remanufactured or refurbished parts or components & accessories.

### How long the warranty is effective:

3 years for all parts excluding the lamp, 3 years for labor, 1 year for the original lamp from the date of the first consumer purchase.

Lamp warranty subject to terms and conditions, verification and approval. Applies to manufacturer's installed lamp only.

All accessory lamps purchased separately are warranted for 90 days.

### Who the warranty protects:

This warranty is valid only for the first consumer purchaser.

### What the warranty excludes and does not cover:

1. Any product on which the serial number has been defaced, modified or removed.
2. Damage, deterioration, or malfunction resulting from:
  - » Accident, misuse, neglect, fire, water, lightning, or other acts of nature, unauthorized product modification, unauthorized attempted repair, or failure to follow instructions supplied with the product.
  - » Any damage of the product due to shipment.
  - » Causes external to the product, such as electrical power fluctuations or failure.
  - » Use of supplies or parts not meeting ViewSonic®'s specifications.
  - » Normal wear and tear.
  - » Any other cause which does not relate to a product defect.
3. Any product exhibiting a condition commonly known as "image burn-in" which results when a static image is displayed on the product for an extended period of time.
4. Removal, installation, insurance, and set-up service charges.

**How to get service:**

For information about receiving service under warranty, contact ViewSonic® Customer Support (Please refer to the attached “Customer Service” page). You will need to provide your product’s serial number, so please record the product information in the space provided below on your purchase for your future use. Please retain your receipt of proof of purchase to support your warranty claim.

**For Your Records**

Product Name: \_\_\_\_\_ Model Number: \_\_\_\_\_

Document Number: \_\_\_\_\_ Serial Number: \_\_\_\_\_

Purchase Date: \_\_\_\_\_ Extended Warranty Purchase? \_\_\_\_\_ (Y/N)

If so, what date does warranty expire? \_\_\_\_\_

1. To obtain warranty service, you will be required to provide (a) the original dated sales slip, (b) your name, (c) your address, (d) a description of the problem, and (e) the serial number of the product.
2. Take or ship the product, in the original container packaging, to an authorized ViewSonic® service center.
3. Round trip transportation costs for in-warranty products will be paid by ViewSonic®.

**Limitation of implied warranties:**

There are no warranties, express or implied, which extend beyond the description contained herein including the implied warranty of merchantability and fitness for a particular purpose.

**Exclusion of damages:**

ViewSonic®’s liability is limited to the cost of repair or replacement of the product. ViewSonic® shall not be liable for:

1. Damage to other property caused by any defects in the product, damages based upon inconvenience, loss of use of the product, loss of time, loss of profits, loss of business opportunity, loss of goodwill, interference with business relationships, or other commercial loss, even if advised of the possibility of such damages.
2. Any other damages, whether incidental, consequential or otherwise.
3. Any claim against the customer by any other party.
4. Repair or attempted repair by anyone not authorized by ViewSonic®.

Contact Information for Sales & Authorized Service (Centro Autorizado de Servicio) within Mexico:

**Name, address, of manufacturer and importers:**

México, Av. de la Palma #8 Piso 2 Despacho 203, Corporativo Interpalmas,  
Col. San Fernando Huixquilucan, Estado de México  
Tel: (55) 3605-1099 <http://www.viewsonic.com/la/soporte/index.htm>

NÚMERO GRATIS DE ASISTENCIA TÉCNICA PARA TODO MÉXICO: 001.866.823.2004

<p><b>Hermosillo:</b> Distribuciones y Servicios Computacionales SA de CV. Calle Juarez 284 local 2 Col. Bugambilias C.P: 83140 Tel: 01-66-22-14-9005 E-Mail: <a href="mailto:disc2@hmo.megared.net.mx">disc2@hmo.megared.net.mx</a></p>	<p><b>Villahermosa:</b> Compumantenimientos Garantizados, S.A. de C.V. AV. GREGORIO MENDEZ #1504 COL, FLORIDA C.P. 86040 Tel: 01 (993) 3 52 00 47 / 3522074 / 3 52 20 09 E-Mail: <a href="mailto:compumantenimientos@prodigy.net.mx">compumantenimientos@prodigy.net.mx</a></p>
<p><b>Puebla, Pue. (Matriz):</b> RENTA Y DATOS, S.A. DE C.V. Domicilio: 29 SUR 721 COL. LA PAZ 72160 PUEBLA, PUE. Tel: 01(52).222.891.55.77 CON 10 LINEAS E-Mail: <a href="mailto:datos@puebla.megared.net.mx">datos@puebla.megared.net.mx</a></p>	<p><b>Veracruz, Ver.:</b> CONEXION Y DESARROLLO, S.A DE C.V. Av. Americas # 419 ENTRE PINZÓN Y ALVARADO Fracc. Reforma C.P. 91919 Tel: 01-22-91-00-31-67 E-Mail: <a href="mailto:gacosta@qplus.com.mx">gacosta@qplus.com.mx</a></p>
<p><b>Chihuahua:</b> Soluciones Globales en Computación C. Magisterio # 3321 Col. Magisterial Chihuahua, Chih. Tel: 4136954 E-Mail: <a href="mailto:Cefeo@soluglobales.com">Cefeo@soluglobales.com</a></p>	<p><b>Cuernavaca:</b> Compusupport de Cuernavaca SA de CV Francisco Leyva # 178 Col. Miguel Hidalgo C.P. 62040, Cuernavaca Morelos Tel: 01 777 3180579 / 01 777 3124014 E-Mail: <a href="mailto:aquevedo@compusupportcva.com">aquevedo@compusupportcva.com</a></p>
<p><b>Distrito Federal:</b> QPLUS, S.A. de C.V. Av. Coyoacán 931 Col. Del Valle 03100, México, D.F. Tel: 01(52)55-50-00-27-35 E-Mail : <a href="mailto:gacosta@qplus.com.mx">gacosta@qplus.com.mx</a></p>	<p><b>Guadalajara, Jal.:</b> SERVICRECE, S.A. de C.V. Av. Niños Héroes # 2281 Col. Arcos Sur, Sector Juárez 44170, Guadalajara, Jalisco Tel: 01(52)33-36-15-15-43 E-Mail: <a href="mailto:mmiranda@servicrece.com">mmiranda@servicrece.com</a></p>
<p><b>Guerrero Acapulco:</b> GS Computación (Grupo Sesicomp) Progreso #6-A, Colo Centro 39300 Acapulco, Guerrero Tel: 744-48-32627</p>	<p><b>Monterrey:</b> Global Product Services Mar Caribe # 1987, Esquina con Golfo Pérsico Fracc. Bernardo Reyes, CP 64280 Monterrey N.L. México Tel: 8129-5103 E-Mail: <a href="mailto:aydeem@gps1.com.mx">aydeem@gps1.com.mx</a></p>
<p><b>MERIDA:</b> ELECTROSER Av Reforma No. 403Gx39 y 41 Mérida, Yucatán, México CP97000 Tel: (52) 999-925-1916 E-Mail: <a href="mailto:rrrb@sureste.com">rrrb@sureste.com</a></p>	<p><b>Oaxaca, Oax.:</b> CENTRO DE DISTRIBUCION Y SERVICIO, S.A. de C.V. Murguía # 708 P.A., Col. Centro, 68000, Oaxaca Tel: 01(52)95-15-15-22-22 Fax: 01(52)95-15-13-67-00 E-Mail: <a href="mailto:gpotai2001@hotmail.com">gpotai2001@hotmail.com</a></p>
<p><b>Tijuana:</b> STD Av Ferrocarril Sonora #3780 L-C Col 20 de Noviembre Tijuana, Mexico</p>	<p><b>FOR USA SUPPORT:</b> ViewSonic® Corporation 381 Brea Canyon Road, Walnut, CA. 91789 USA Tel: 800-688-6688 E-Mail: <a href="http://www.viewsonic.com">http://www.viewsonic.com</a></p>

