



User Guide

SUMMARY

This guide provides technical specifications and information about monitor features, setting up the monitor, and using the monitor.

Legal information

© Copyright 2023 HP Development Company, L.P.

Thunderbolt and the Thunderbolt logo are trademarks of Intel Corporation or its subsidiaries in the U.S. and/or other countries. Microsoft and Windows are either registered trademarks or trademarks of Microsoft Corporation in the United States and/or other countries. USB Type-C and USB-C are registered trademarks of USB Implementers Forum. VESA, DisplayPort™ and the DisplayPort™ logo are trademarks owned by the Video Electronics Standards Association (VESA) in the United States and other countries.

The information contained herein is subject to change without notice. The only warranties for HP products and services are set forth in the express warranty statements accompanying such products and services. Nothing herein should be construed as constituting an additional warranty. HP shall not be liable for technical or editorial errors or omissions contained herein.

Product notice

This guide describes features that are common to most models. Some features may not be available on your product. To access the latest user guide, go to <http://www.hp.com/support>, and follow the instructions to find your product. Then select **Setup & User Guides**.

To help us improve this document, please send any suggestions, comments, or errors to <mailto:hp.doc.feedback@hp.com>. Include the document part number when submitting your feedback.

First Edition: December 2023

Document part number: N76623-001





Table of contents

1 About this guide	1
2 Getting started	2
Important safety information	2
More HP resources	3
Preparing to call technical support	3
Getting to know your monitor	3
Features	3
Front components	5
Rear components	5
Bottom components	6
Locating the serial number and product number	7
Setting up the monitor	8
Attaching the monitor stand	8
Mounting the monitor head	8
Removing the monitor stand	9
Attaching the monitor head to a mounting device	9
Connecting the cables	10
Connecting USB devices	13
Adjusting the monitor	14
Installing a security cable	16
Turning on the monitor	16
HP watermark and image retention policy	17
3 Connecting a second computer to the monitor using the KVM function	18
KVM connection priorities	18
4 Using the monitor	20
Downloading HP Display Center	20
Downloading software and utilities	20
The Information file	20
The Image Color Matching file	21
Using the OSD menu	21
Using the OSD function buttons	21
Reassigning the function buttons	22
Display mode status	22
Changing the Power Mode setting	22
Using Auto-Sleep Mode	23
Using PiP and PbP	23

DisplayPort multistreaming over USB Type-C Thunderbolt.....	24
Configuring an external monitor.....	25
USB Type-C mode.....	25
Updating the monitor.....	25
Downloading the HP firmware installer.....	25
Updating firmware for the monitor.....	26
5 Support and troubleshooting.....	27
Solving common issues.....	27
Button lockouts.....	28
6 Maintaining the monitor.....	29
Maintenance guidelines.....	29
Cleaning the monitor.....	29
Shipping the monitor.....	30
Appendix A Technical specifications.....	31
80 cm (31.5 in) model specifications.....	31
Preset display resolutions.....	32
80 cm (31.5 in) model.....	32
High-definition video formats.....	32
Energy saver feature.....	33
Appendix B Accessibility.....	34
HP and accessibility.....	34
Finding the technology tools you need.....	34
The HP commitment.....	34
International Association of Accessibility Professionals (IAAP).....	35
Finding the best assistive technology.....	35
Assessing your needs.....	35
Accessibility for HP products.....	35
Monitor accessibility features (select products/regions only).....	36
Built-in accessibility features.....	36
What is Accessibility Mode?.....	36
How do you turn Accessibility Mode on or off?.....	36
Standards and legislation.....	37
Standards.....	37
Mandate 376 - EN 301 549.....	38
Web Content Accessibility Guidelines (WCAG).....	38
Legislation and regulations.....	38
Useful accessibility resources and links.....	38
Organizations.....	39
Educational institutions.....	39
Other disability resources.....	39
HP links.....	39
Contacting support.....	40

1 About this guide

This guide provides technical specifications and information about monitor features, setting up the monitor, and using the software. Depending on the model, your monitor may not have all the features included in this guide.

-
-  **WARNING!** Indicates a hazardous situation that, if not avoided, **could** result in serious injury or death.
 -  **CAUTION:** Indicates a hazardous situation that, if not avoided, **could** result in minor or moderate injury.
 -  **IMPORTANT:** Indicates information considered important but not hazard-related (for example, messages related to property damage). Warns the user that failure to follow a procedure exactly as described could result in loss of data or in damage to hardware or software. Also contains essential information to explain a concept or to complete a task.
 -  **NOTE:** Contains additional information to emphasize or supplement important points of the main text.
 -  **TIP:** Provides helpful hints for completing a task.
-

2 Getting started

Read this chapter to learn about safety information and where to find additional HP resources.

Important safety information

An AC adapter and power cord might be included with the monitor. If you use another cord, use only a power source and connection appropriate for this monitor. For information about the correct power cord set to use with the monitor, see the *Product Notices* provided in your documentation kit.

 **WARNING!** To reduce the risk of electric shock or damage to the equipment:

- Plug the power cord into an AC outlet that is easily accessible at all times.
- If the power cord has a three-pin attachment plug, plug the cord into a grounded (earthed) three-pin outlet.
- Disconnect power from the computer by unplugging the power cord from the AC outlet. When unplugging the power cord from the AC outlet, grasp the cord by the plug.

For your safety, do not place anything on power cords or cables. Take care to route all cords and cables connected to the monitor so that they cannot be stepped on, pulled, grabbed, or tripped over.

To reduce the risk of serious injury, read the *Safety & Comfort Guide* provided with your user guides. It describes proper workstation setup and proper posture, health, and work habits for computer users. The *Safety & Comfort Guide* also provides important electrical and mechanical safety information. The *Safety & Comfort Guide* is also available on the web at <http://www.hp.com/ergo>.

 **IMPORTANT:** For the protection of the monitor and the computer, connect all power cords for the computer and its peripheral devices (such as a monitor, printer, scanner) to a surge protection device such as a power strip or uninterruptible power supply (UPS). Not all power strips provide surge protection; the power strip must be specifically labeled as having this capability. Use a power strip whose manufacturer offers a damage replacement policy so that you can replace the equipment if surge protection fails.

Use the appropriate and correctly sized furniture designed to properly support your monitor.

 **WARNING!** Monitors that are inappropriately situated on dressers, bookcases, shelves, desks, speakers, chests, or carts could fall over and cause personal injury.

 **WARNING! Stability hazard:** The device might fall, causing serious personal injury or death. To prevent injury, securely attach the monitor to the floor or wall in accordance with the installation instructions.

 **WARNING!** This equipment is not suitable for use in locations where children are likely to be present.

 **NOTE:** This product is suitable for entertainment purposes. Consider placing the monitor in a controlled luminous environment to avoid interference from surrounding light and bright surfaces that might cause disturbing reflections from the screen.

More HP resources

Use this table to locate resources that provide product details, how-to information, and more.

Table 2-1 Additional information

Resource	Contents
Setup Instructions	Overview of monitor setup and features
HP support	For HP support or to resolve a hardware or software problem, go to http://www.hp.com/support , and follow the instructions to find your product. - or - Select the Search icon in the taskbar, type <code>support</code> in the search box, and then select HP Support Assistant . - or - Select the question mark icon in the taskbar.

NOTE: Contact customer support to replace the power cord, the AC adapter (select products only), or any other cables that shipped with your monitor.

Preparing to call technical support

Use this information if you have to troubleshoot an issue.

If you cannot solve a problem using [Support and troubleshooting on page 27](#), a call to technical support can provide additional help. Have the following information available when you call:

- Monitor model number
- Monitor serial number
- Purchase date on invoice
- Conditions under which the problem occurred
- Error messages received
- Hardware configuration
- Name and version of the hardware and software that you are using

Getting to know your monitor

Your monitor has top-rated features. This section provides details about your components, where they are located, and how they work.

Features

Depending on the model, your monitor might include the following features:

Display features

- 80 cm (31.5 in) diagonal viewable screen area with 3840 × 2160 resolution, plus full-screen support for lower resolutions; includes custom scaling for maximum image size while preserving original aspect ratio
- Liquid crystal display (LCD) with active matrix and in-plane switching (IPS) Black technology
- Wide color gamut to provide coverage of sRGB color spaces (sRGB 100%, DCI P3 98%)
- Nonglare panel with an LED backlight
- Wide viewing angle to allow viewing from a sitting or standing position, or moving from side to side (horizontal/vertical viewing angles: 178°)
- Single power button on the monitor turns the monitor and HP notebook (if connected to Thunderbolt™ or USB Type-C® cable) on and off
- Tilt, swivel, and height adjustment capabilities
- Pivot capability to rotate the monitor head from landscape to portrait orientation
- Dual Picture in Picture (PiP) and Picture by Picture (PbP) functionality to enable the USB Type-C Thunderbolt, DisplayPort™, and HDMI inputs to be viewed in each half of the screen
- 5-in-1 joystick control and five on-screen display (OSD) buttons

Moving the joystick up, down, left, or right displays the OSD button labels, or hot keys. For select monitors, moving the joystick or Joypad in a defined direction immediately performs a hot-key function without showing the OSD button menu first.

- On-screen display (OSD) adjustments in 11 languages for easy setup and screen optimization
- Energy saver feature to meet requirements for reduced power consumption
- Security cable slot on the rear of the monitor for an optional security cable
- Cable management feature for placement of cables and cords

Connectors

- DisplayPort video input and output
- High-Definition Multimedia Interface (HDMI) video input
- USB Type-C Thunderbolt ports (cable included in select regions)
- USB hub with one USB Type-B port that connects to the computer (upstream), four USB Type-A ports, and one USB Type-C port that connects to USB devices (downstream)
- Plug and Play capability, if supported by your operating system
- RJ-45 (network) jack

Monitor stand

- Removable stand for flexible monitor head mounting solutions
- HP Quick Release 2 device to quickly attach the monitor head to the stand with a simple click, and then remove it with the convenient sliding tab release

- VESA® mounting bracket for attaching the monitor head to a wall-mount device or swing arm
- VESA mounting capability (100 × 100 mm) for attaching the monitor to a swing arm mount
- Support for a mounting bracket to attach the monitor to a Mini Workstation or Mini Desktop

 **NOTE:** For safety and regulatory information, see the *Product Notices* provided in your documentation kit. To access the latest user guide, go to <http://www.hp.com/support>, and follow the instructions to find your product. Then select **Setup & User Guides**.

Front components

To identify the components on the front of the monitor, use this illustration and table.



Table 2-2 Front components and their descriptions

Component	Description
(1) Power button	Turns the monitor on or off. NOTE: Be sure that the master power switch on the monitor is in the On position to turn on the monitor. NOTE: When an HP notebook is connected to the Thunderbolt port, pressing the power button on the display turns off your notebook or puts it to sleep based on your power setting preferences.
(2) Power light	White: The monitor is on. Amber: The monitor is in a reduced power state because of inactivity.

Rear components

To identify the components on the rear of the monitor, use this illustration and table.

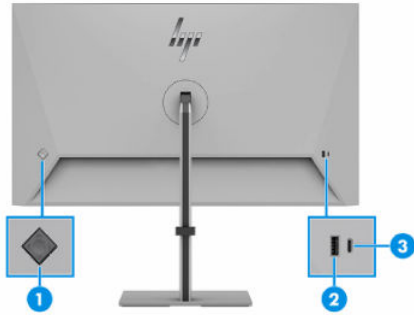

Table 2-3 Rear components and their descriptions

Component		Description
(1)	Joypad	Press to open the OSD settings.
(2)	USB port (downstream)	Connects a USB cable to a peripheral device, such as a keyboard, mouse, or USB hard drive, and supports battery charging.
(3)	USB Type-C port (downstream)	Connects a USB cable to a peripheral device, such as a keyboard, mouse, or USB hard drive, and supports 5V/3A battery charging.

Bottom components

To identify the components on the bottom of the monitor, use this illustration and table.

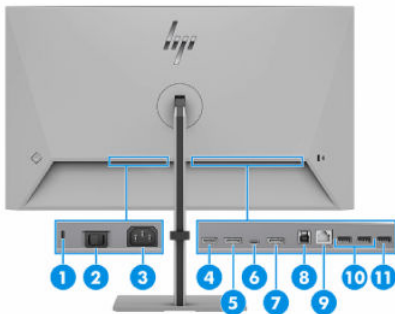

Table 2-4 Bottom components and their descriptions

Component		Description
(1)	Security cable slot	Connects an optional security cable.
(2)	Master power switch	Turns on or off all power to the monitor.
(3)	Power connector	Connects your monitor to a power outlet.
(4)	HDMI port	Connects the HDMI cable to a source device such as a computer or game console.
(5)	DisplayPort connector	Connects the DisplayPort cable to a source device such as a computer or game console.

Table 2-4 Bottom components and their descriptions (continued)

Component	Description
(6) USB Type-C Thunderbolt port (upstream)	<p>Connects a Thunderbolt or USB Type-C cable to a source device such as a computer or game console. This Thunderbolt port can function as a DisplayPort input or as a USB 3.0 connection. It can also be used to deliver up to 100 W of power to a device. Power outputs are 5 V/ 9 V/ 12 V/ 15 V/ 20 V to achieve a 100 W output.</p> <p>This port also enables the USB Type-A ports to perform their functions.</p>
(7) DisplayPort OUT connector	Connects a DisplayPort cable to a secondary monitor for daisy-chaining.
(8) USB Type-B port (upstream)	<p>Connects the USB Type-B cable to a source device such as a computer or game console.</p> <p>NOTE: A USB Type-B cable or a Thunderbolt cable must be connected from the source device to the monitor to enable USB Type-A ports on the monitor.</p>
(9) RJ-45 (network) port	<p>Connects a network cable. The network data rate via Thunderbolt maximum speed is 1000 Mbps.</p> <ul style="list-style-type: none">• Green (left): The network is connected.• Amber (right): Activity is occurring on the network. <p>NOTE: The RJ-45 (network) port supports Wake On Lan (WOL) in-band, Mac Address Passthrough (MAPT) in-band, and PXE boot. Functionality may vary with PC settings. For more information, see USB Type-C mode on page 25.</p>
(10) USB ports (2) (downstream)	Connect a USB cable to a peripheral device, such as a keyboard, mouse, or USB hard drive.
(11) USB port (downstream)	Connects a USB cable to a peripheral device, such as a keyboard, mouse, or USB hard drive and supports battery charging.

Locating the serial number and product number

Depending on the product, the serial number and product number are located on a label on the rear of the monitor or on a label under the front bezel of the monitor head. You might need these numbers when you contact HP for support.

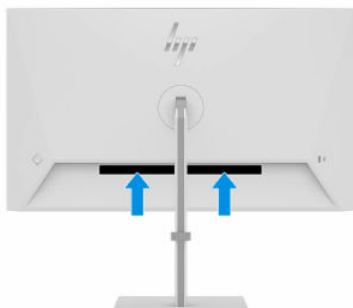

Setting up the monitor

This section describes attaching the monitor stand or wall mount and the options for connecting your monitor to a PC, notebook, gaming console, or similar device.

- ⚠ WARNING!** To reduce the risk of serious injury, read the *Safety & Comfort Guide*. It describes proper workstation setup and proper posture, health, and work habits for computer users. The *Safety & Comfort Guide* also provides important electrical and mechanical safety information. The *Safety & Comfort Guide* is available on the web at <http://www.hp.com/ergo>.
- 📌 IMPORTANT:** To prevent damage to the monitor, do not touch the surface of the LCD panel. Pressure on the panel can cause nonuniformity of color or disorientation of the liquid crystals. If this occurs, the screen will not recover to its normal condition.
- 📌 IMPORTANT:** To prevent the screen from getting scratched, defaced, or broken and to prevent damage to the control buttons, position the monitor facedown on a flat surface covered with protective sheet foam or a nonabrasive cloth.

Attaching the monitor stand

Correctly attaching your monitor stand is critical for safe use. This section describes how to safely attach a stand.

- 💡 TIP:** Consider the placement of the monitor, because surrounding light and bright surfaces might cause interfering reflections.
- 📌 NOTE:** The procedures for attaching a monitor stand might be different on other models.
- 📌 NOTE:** Leave the monitor in the box to protect the screen.

1. Open the box so that the monitor head is facedown in the box.
2. Position the monitor stand on the mounting plate on the rear of the monitor (1), and then snap the monitor stand into place.
3. Attach the base to the monitor stand (2), and then tighten the screws (3).

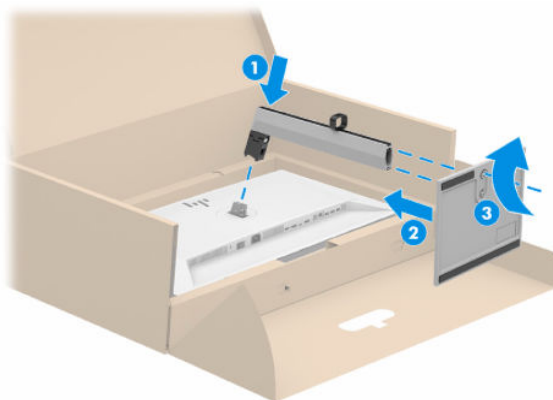

Mounting the monitor head

To attach your monitor to a wall using a swing arm or other mounting fixture, follow the steps in this section to safely and securely connect your monitor.

IMPORTANT: This monitor supports the VESA industry-standard 100 mm mounting holes. To attach a third-party mounting solution to the monitor head, use four 4 mm, 0.7 pitch, and 10 mm long screws (M4× 10L). Longer screws might damage the monitor. Be sure that the manufacturer’s mounting solution is compliant with the VESA standard and is rated to support the weight of the monitor head. For best performance, use the power and video cables provided with the monitor.

NOTE: This apparatus is intended to be supported by a UL-listed, CSA-listed, or GS-listed wall-mount bracket.

Removing the monitor stand

If you decide to use a wall mount instead of the monitor stand that you attached, first remove the stand.

IMPORTANT: Before you disassemble the monitor, be sure that the monitor is turned off and all cables are disconnected.

IMPORTANT: To position and stabilize the monitor, HP recommends that two people perform these procedures.

1. Disconnect and remove all cables from the monitor.
2. Position the monitor facedown in the box.
3. Push down on the monitor stand.
4. Remove the stand from the monitor.

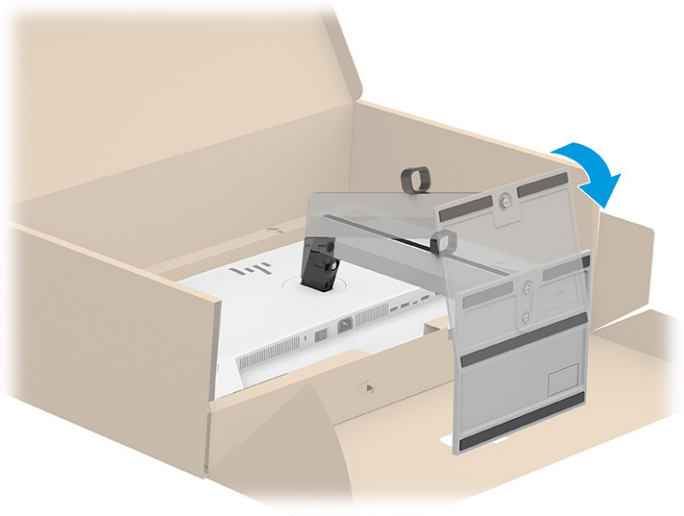

Attaching the monitor head to a mounting device

You might need additional tools such as a screwdriver (purchased separately) when you attach a mounting device. To avoid damage to your monitor, follow these instructions:

1. Remove the two screws from the VESA holes located on the rear of the monitor head **(1)**, and then remove the screw fastener **(2)**.



2. Align the VESA adapter with the screw holes located on the rear of the monitor head **(1)**, and then install the two screws to secure the adapter **(2)**.

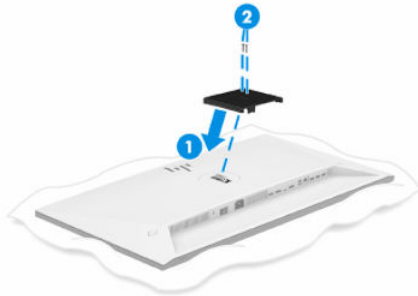

 **NOTE:** The adapter attaches only after you lower the stand mount to the correct position.

3. To attach the monitor head to a swing arm or other mounting device, insert four mounting screws through the holes on the mounting device and into the VESA screw holes on the back of the monitor head.

 **IMPORTANT:** If these instructions do not apply to your device, then follow the mounting device manufacturer's instructions when mounting the monitor to a wall or swing arm.

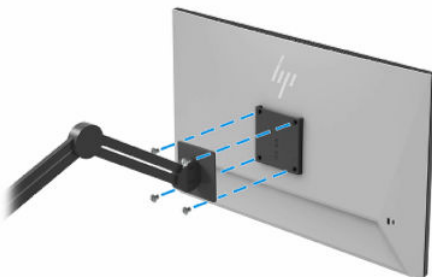

Connecting the cables

In addition to details about how to connect a cable, this section contains information about how your monitor functions when you connect certain cables.

 **NOTE:** Depending on the model, the monitor might be capable of supporting Thunderbolt, USB Type-C, HDMI, or DisplayPort inputs. The video mode is determined by the video cable used. The monitor automatically determines which inputs have valid video signals. You can select the inputs through the OSD menu. The monitor ships with select cables. Not all cables shown in this section are included with the monitor.

1. Place the monitor in a convenient, well-ventilated location near the computer.
2. Connect a video cable.

 **NOTE:** Some USB Type-C ports support display output. To determine if the USB Type-C port on your monitor is capable of supporting DisplayPort output, see [Rear components on page 5](#) and [Bottom components on page 6](#).

- Connect one end of a DisplayPort cable to the DisplayPort connector on the rear of the monitor and the other end to the DisplayPort connector on the source device.

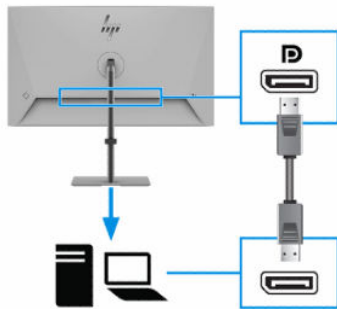

- Connect one end of an HDMI cable to the HDMI port on the rear of the monitor and the other end to the HDMI port on the source device.

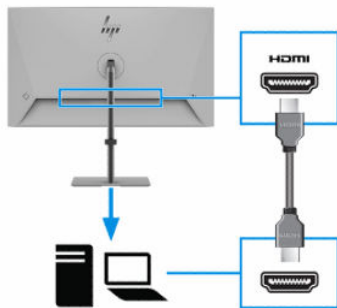

- Connect one end of a Thunderbolt cable to the Thunderbolt port on the rear of the monitor and the other end to the Thunderbolt port on the source device. Use only the HP-approved Thunderbolt cable provided with the monitor.

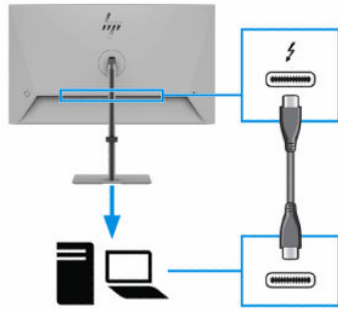

 **NOTE:** The monitor's Thunderbolt port provides network, data, video, and power delivery (up to 100 W).

The host device must be able to support DisplayPort Alt Mode (video, charging, and USB 3.1) over the Thunderbolt connector. The host device must also be compatible with USB Type-C-Thunderbolt-enabled ports.

3. Connect one end of the USB Type-B cable to a USB Type-B port on the monitor and the other end to a USB Type-A port on the source device.

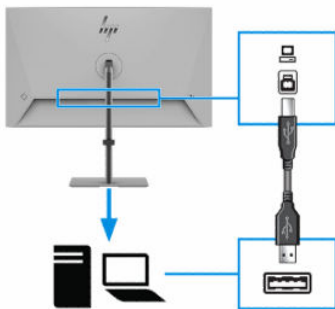

4. Connect one end of a network cable to the network jack on the monitor and the other end to a network wall jack or router.

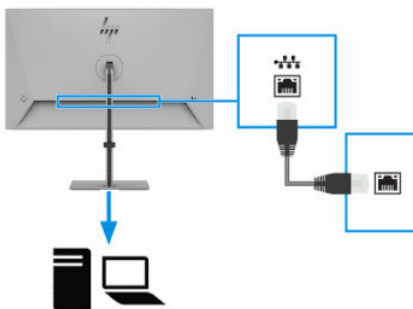

 **NOTE:** To enable the network function, be sure that the Thunderbolt port is connected.

5. Connect one end of the power cord to the power connector on the monitor and the other end to a grounded AC outlet.

 **WARNING!** To reduce the risk of electric shock or damage to the equipment:

- Do not disable the power cord grounding plug. The grounding plug is an important safety feature.
- Plug the power cord into a grounded (earthed) AC outlet that is easily accessible at all times.
- Disconnect power from the equipment by unplugging the power cord from the AC outlet.

For your safety, do not place anything on power cords or cables. Arrange them so that no one can accidentally step on or trip over them. Do not pull on a cord or cable. When unplugging the power cord from the AC outlet, grasp the cord by the plug.

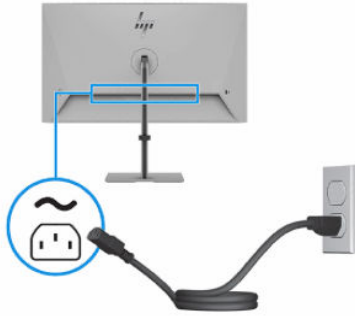

Connecting USB devices

Use USB ports to connect devices such as a digital camera, USB keyboard, or USB mouse. There are four USB ports on the monitor to connect to a device (downstream): three USB Type-A on the rear, and one USB Type-C and one USB Type-A on the side.

NOTE: You must connect the Thunderbolt cable or USB Type-B cable from the source device (computer) to the rear of the monitor to enable the USB Type-A ports to serve as a USB hub for a mouse, keyboards, phones, external hard drives, and practically anything that is USB-connected and can accept 5 V.

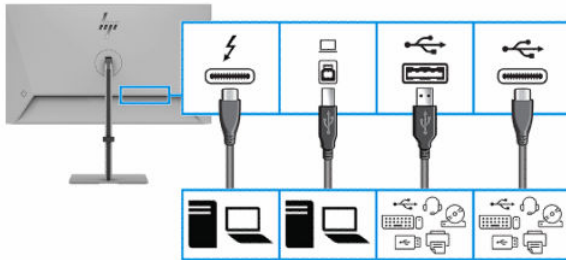

Table 2-5 USB port locations

USB Ports
Thunderbolt port (upstream)
USB Type-B port
USB Type-A ports (4) downstream
USB Type-C port downstream

Adjusting the monitor

To support an ergonomic work space, your monitor offers the adjustment options outlined in this section.

⚠ WARNING! To reduce the risk of serious injury, read the *Safety & Comfort Guide*. It describes proper workstation setup and proper posture, health, and work habits for computer users. The *Safety & Comfort Guide* also provides important electrical and mechanical safety information. The *Safety & Comfort Guide* is available on the web at <http://www.hp.com/ergo>.

1. Tilt the monitor head forward or backward to set it to a comfortable eye level.



2. Adjust the monitor's height to a comfortable position for your individual workstation. The monitor's top bezel edge should not exceed a height that is parallel to your eye height. A monitor that is positioned low and reclined might be more comfortable for users with corrective lenses. Reposition your monitor as you adjust your working posture throughout the work day.

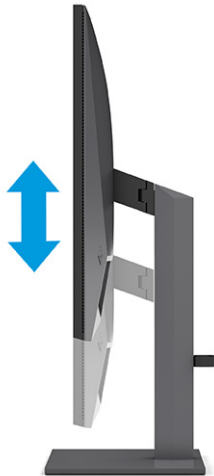

3. Swivel the monitor head to the left or right for the best viewing angle.

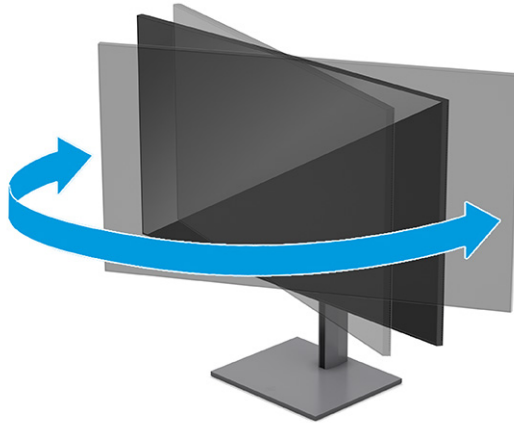

4. You can pivot the monitor head from landscape to portrait orientation viewing to adapt to your application.
 - a. Adjust the monitor to full height position and tilt the monitor back to full tilt position (1).
 - b. Pivot the monitor clockwise or counterclockwise 90° from landscape to portrait orientation (2).

 **IMPORTANT:** If the monitor is not in full height and full tilt position when pivoting, the bottom right corner of the monitor panel will come in contact with the base and potentially cause damage to the monitor.

If you are adding an optional speaker bar to the monitor, install it after pivoting the monitor. The speaker bar will come in contact with the base when the monitor pivots and potentially cause damage to the monitor or speaker bar.

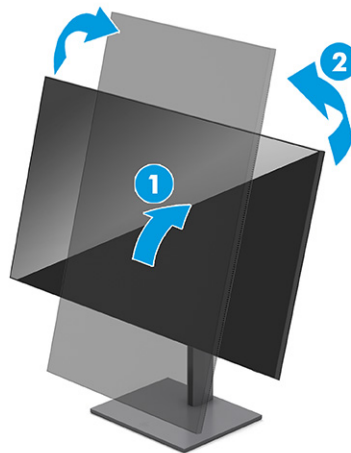

 **NOTE:** Use the operating system's display settings to rotate the image on the screen from portrait to landscape. To rotate the OSD from portrait to landscape, select **OSD menu**, select **Menu Rotation**, and then select **Portrait**.

Installing a security cable

As a security measure, you can secure the monitor to a fixed object with an optional security cable available from HP. Use the key that came with the optional security cable to attach and remove the lock.

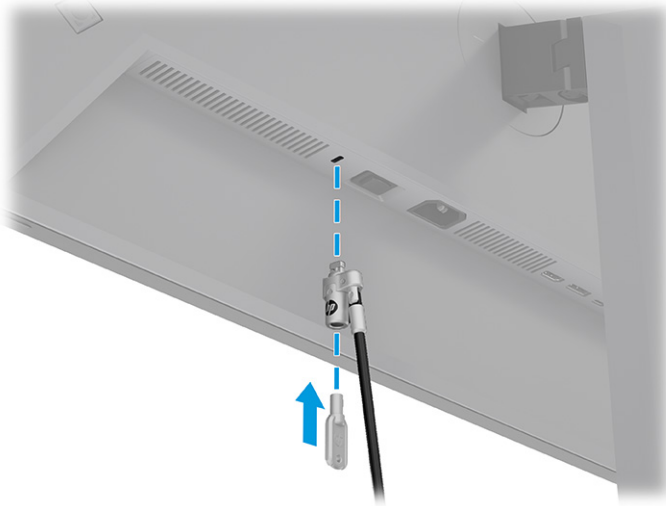

Turning on the monitor

This section provides important information about preventing damage to your monitor, startup indicators, and troubleshooting information.

 **IMPORTANT:** Burn-in image damage might occur on monitors that display the same static image on the screen for 12 or more hours. To avoid burn-in image damage, you should always activate a screen saver application or turn off the monitor when it will not be in use for a prolonged period of time. Image retention is a condition that might occur on all LCD screens. Burn-in damage on the monitor is not covered under the HP warranty.

 **NOTE:** On select HP monitors, you can disable the power light in the OSD menu. Press the **Menu** button to open the OSD, select **Power**, select **Power LED**, and then select **Off**.

- Press the power button on the monitor to turn it on. Be sure that the master power switch is in the **On** position.



 **NOTE:** If pressing the power button has no effect, the Power Button Lockout feature might be enabled. To disable this feature, press and hold the monitor power button for 10 seconds.

When you first turn on your monitor, a monitor status message is displayed for 5 seconds. The message shows which input is the current active signal, the status of the auto-switch source setting (On or Off; default setting is On), the current preset display resolution, and the recommended preset display resolution.

The monitor automatically scans the signal inputs for an active input and uses that input for the display.

 **NOTE:** When an HP notebook is connected to the Thunderbolt port, pressing the power button on the display turns off your notebook or puts it to sleep, based on your power setting preferences.

HP watermark and image retention policy

Some monitors are designed with In-Plane Switching (IPS) display technology, which provides ultrawide viewing angles and advanced image quality. Though suitable for many applications, this panel technology is not suitable for static, stationary, or fixed images for long periods of time, unless you use screen savers.

Applications with static images can include camera surveillance, video games, marketing logos, and templates. Static images can cause image retention damage that could look like stains or watermarks on the monitor's screen.

Image retention damage on monitors that are in use 24 hours per day is not covered under the HP warranty. To avoid image retention damage, always turn off the monitor when it is not in use, or use the power management setting, if supported on your computer, to turn off the monitor when the computer is idle.

3 Connecting a second computer to the monitor using the KVM function

The keyboard, video, mouse (KVM) function in the monitor provides the capability to connect two computers to one monitor with quick monitor access to either computer, and control using one keyboard and one mouse.

For video input from a second computer, connect either a DisplayPort cable or an HDMI cable to the appropriate connector on the rear of the monitor. For example, connect one end of a DisplayPort cable to a DisplayPort connector on the rear of the monitor and the other end to a DisplayPort connector on the second computer. If the second computer has only an HDMI port, connect one end of the HDMI cable to an HDMI port on the rear of the monitor and the other end to an HDMI port on the second computer.

For the USB connection to the second computer, you can use a USB Type-B to Type-A cable connected to the monitor's USB Type-B port.

When the Thunderbolt (bottom side) input is connected, the monitor will automatically switch to the Thunderbolt input for both video and USB data regardless of the computer state. When the Thunderbolt input is disconnected and the second computer is active, the monitor will automatically switch back to the active input (DisplayPort or HDMI).

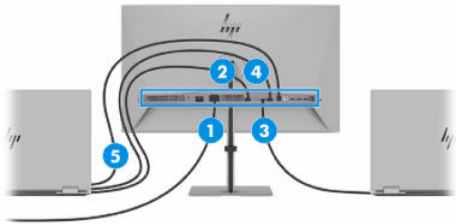

Table 3-1 Connecting a second computer

Component	Description
(1) Power connector	Connects your monitor to a power outlet.
(2) HDMI port	When the second computer is active (PC #2), the monitor switches to the active input (HDMI or DisplayPort).
(3) Thunderbolt port	Multiple function support includes charging, USB, and display functions.
(4) DisplayPort port	
(5) USB Type-B port	USB port connects to PC #2.

KVM connection priorities

The section describes KVM connection priorities.

There are 2 types of KVM connections:

- Thunderbolt uses a Thunderbolt or USB Type-C cable only.
- USB Type-B uses a USB Type-B cable for USB data transfer and to connect with HDMI or DisplayPort for video transfer.

The KVM function uses the current video input port. If the first computer is disconnected, the KVM setting switches to the powered-on second computer.

If two active computers are connected, the KVM function can be quickly switched by pressing the OSD [Next Input](#) button (1).

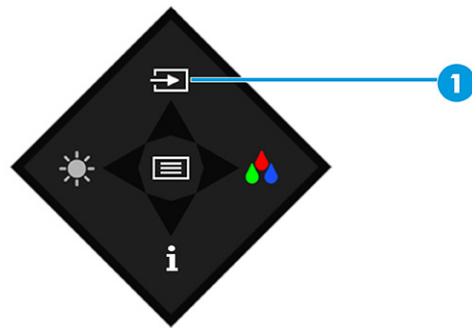

In PbP mode, to activate the KVM function for two active computers, follow the instructions to first enable PbP mode (see [Using PiP and PbP on page 23](#)). Two video inputs will be shown picture by picture at the same time. Next, you can quickly switch hosts by pressing the OSD [USB host swap](#) button (1).

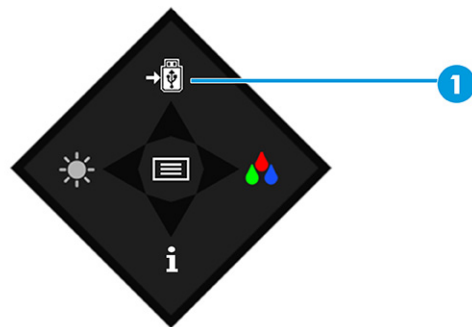

4 Using the monitor

This chapter describes how to use your monitor and its features, including software and utilities, the OSD menu, the function buttons, power modes, and Windows Hello.

Downloading HP Display Center

You can download and install the HP Display Center software from the Microsoft® store.

1. Select the Microsoft Store app on your desktop or type `Microsoft Store` in the taskbar search box.
2. Type `HP Display Center` in the **Microsoft Store** search box.
3. Follow the on-screen instructions.

The tool downloads to the selected location.

Downloading software and utilities

You can download and install these files from HP Support.

- INF (Information) file
- ICM (Image Color Matching) files

To download the files:

1. Go to <http://www.hp.com/support>.
2. Select **Software and Drivers**.
3. Select your product type.
4. Enter your HP monitor model in the search field and follow the on-screen instructions. The .inf and .icm files are included in the SoftPkg.

The Information file

The INF file defines monitor resources used by Windows® operating systems to ensure monitor compatibility with the computer's graphics adapter.

This monitor is Plug and Play compatible, and the monitor will work correctly without installing the INF file. Monitor Plug and Play compatibility requires that the computer's graphics card is VESA DDC2 compliant and that the monitor connects directly to the graphics card. Plug and Play does not work through separate BNC-type connectors or through distribution buffers, boxes, or both.

The Image Color Matching file

The ICM files are data files that are used in conjunction with graphics programs to provide consistent color matching from monitor screen to printer, or from scanner to monitor screen. These files are activated from within graphics programs that support this feature.

 **NOTE:** The ICM color profile is written in accordance with the International Color Consortium (ICC) Profile Format specification.

Using the OSD menu

You can adjust your HP monitor to suit your preferences. Use the OSD menu to customize the viewing features of your monitor.

To access and make adjustments in the OSD, use the Joypad on the monitor's rear panel. See [Rear components on page 5](#).

1. If the monitor is not already on, press the power button to turn on the monitor.
2. Press the center of the Joypad.
3. Press the function buttons up, down, left, or right to navigate menu choices. Press the center of the Joypad to make a selection.

The following table lists possible menu selections in the OSD main menu. It includes descriptions for each setting and its impacts on your monitor's appearance or performance.

Table 4-1 OSD menu options and descriptions for using a button or a controller

Main menu	Description
Brightness +	Adjusts the brightness level of the screen.
Color	Selects and adjusts the screen color.
Image	Adjusts the screen image.
Input	Selects the video input signal (DisplayPort, HDMI, USB-C video).
Power	Adjusts the power settings.
Menu	Adjusts the OSD menu and function button controls, and selects the language used to display the OSD menu (the factory default is English).
Management	Adjusts the DDC/CI settings, and returns all OSD menu settings to the factory default settings.
Information	Opens the Information menu.
Exit	Exits the OSD menu screen.

Using the OSD function buttons

The function buttons offer useful actions, and you can customize all but one of them to make them even more useful.

 **NOTE:** The actions of the function buttons vary among monitor models.

For information about changing the function of the buttons, see [Reassigning the function buttons on page 22](#).

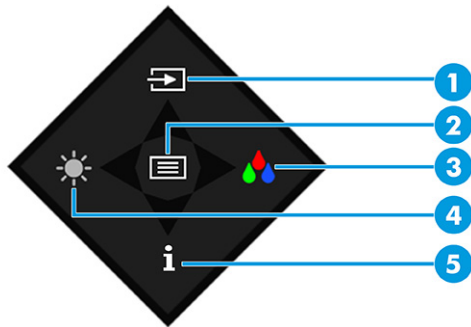

Table 4-2 Button names and descriptions

Button	Description
(1) Next Input button	Switches the monitor's input source to the next active input.
(2) Menu button	Opens the OSD main menu, selects a menu item from the OSD, or closes the OSD menu.
(3) Color button	Opens the Color menu where you can select a preset view mode.
(4) Brightness button	Adjusts the monitor screen brightness.
(5) Information button	Opens the Information menu where you can get information about the monitor and the input signal of the host.

Reassigning the function buttons

Except for the **Menu** button, you can change the action associated with a function button from the default action to another action that helps you quickly access your most commonly used menu items.

To reassign the function buttons:

1. Press the **Menu** button to open the OSD menu.
2. Select **Menu**, select **Assign Buttons**, and then select one of the available options for the button that you want to assign.

Display mode status

When you turn on the monitor, the **Monitor Status** window appears and shows you the status of the inputs, the current selected color preset, and the current and optimal resolutions.

The current display mode shows in the **Information** menu window and at the bottom of the OSD's main menu in the status bar area.

Changing the Power Mode setting

This section describes how to activate Performance mode. Certain features on your monitor might require Performance mode to be active.

When in sleep mode, to comply with international power standards, the monitor default setting is Power Saver mode.

If your monitor supports Performance mode and you need to keep the USB ports enabled when the monitor is in Auto-Sleep Mode, change the Power Mode setting from **Power Saver** to **Performance**.



NOTE: If you are connecting a computer that is not battery powered, you must change the Power Mode setting to Performance mode.

To change the power mode setting:

1. Press the **Menu** button to open the OSD menu.
2. Select **Power**, select **Power Mode**, and then select **Performance**.
3. Select **Back** and close the OSD.

Using Auto-Sleep Mode

Your monitor has an energy-saving feature called Auto-Sleep Mode, which is a reduced power state. This section describes how to activate or adjust Auto-Sleep Mode on your monitor.

When Auto-Sleep Mode is enabled, which it is by default, the monitor enters a reduced power state when the computer signals low-power mode, which it does by the absence of either a horizontal or vertical sync signal.

Upon entering this reduced power state (Auto-Sleep mode), the monitor screen is blanked, the backlight turns off, and the power light turns amber. The monitor draws less than 0.5 W of power when in this reduced power state. The monitor wakes from Auto-Sleep mode when the computer sends an active signal to the monitor (for example, when you activate the mouse or keyboard).

To disable Auto-Sleep Mode in the OSD:

1. Press the **Menu** button to open the OSD, or press the center of the joypad to open the OSD.
2. In the OSD, select **Power**.
3. Select **Auto-Sleep Mode**, and then select **Off**.

Using PiP and PbP

The monitor supports both Picture in Picture (PiP), where one source is overlaid on another, and Picture by Picture (PbP), where one source is positioned adjacent to another either horizontally (for landscape orientation) or vertically (for portrait orientation). Two full HD (FHD) images can be displayed in the PbP mode.

To use PiP or PbP:

1. Connect a secondary input source to the monitor.
2. Press one of the OSD buttons on the rear panel to activate the buttons, and then press the **Menu** button to open the OSD.
3. In the OSD, select **Input**, select **PIP Control** and then select **Enable PIP**.

The monitor scans the secondary inputs for a valid signal input and uses that input for the PiP or PbP picture.

4. To change the PiP or PbP input, select **PIP Control** in the OSD, and then select **Assign Inputs**.
5. To change the size of the PiP, select **PIP Size** in the OSD, and then select the size that you want.
6. To adjust the position of the PiP, select **PIP Position** in the OSD, and then select the position that you want.

DisplayPort multistreaming over USB Type-C Thunderbolt

If you are using USB Type-C Thunderbolt as the primary video input source, you can multistream to other DisplayPort monitors connected in a daisy-chain configuration. You can connect up to two 4K monitors in this configuration if the graphics card in your computer supports this configuration.

The number of monitors you can connect through DisplayPort multistreaming depends on a number of factors, including the resolutions and scan rates used for each monitor and the capabilities of your GPU or embedded graphics system. If you have purchased a new graphics card for your computer, check the manual that came with your graphics card for further information about its capabilities.

To multistream:

1. Be sure that the USB Thunderbolt port is your primary video input.
2. Add a second monitor by connecting a DisplayPort cable between the DisplayPort OUT port on the primary monitor and the DisplayPort IN port on a secondary monitor.

 **NOTE:** The daisy-chained monitors need to have DisplayPort IN and OUT video ports. The last monitor in the chain needs only a DisplayPort IN video port.

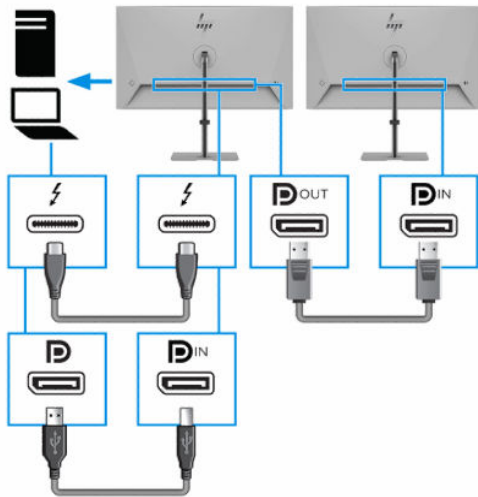

3. Set a connected monitor to display the same image as the primary monitor or a different image.
4. For a non-Thunderbolt host PC with USB Type-C only, to connect an additional monitor, press the **Menu** button to open the OSD menu. Navigate to the USB Type-C configuration and select **USB-C Video+USB2.0**.

 **NOTE:** All but the final monitor in the chain must support DisplayPort multistreaming.

5. Connect the DisplayPort cable from the DisplayPort OUT port of one monitor to the DisplayPort IN port of the next monitor.

Configuring an external monitor

To use Windows to configure the display of a monitor attached to the docking station, follow this procedure.

1. In the taskbar search box, type **Duplicate**, and then select **Open**.
2. Set the external monitor to be used in one of these methods.
 - For use as the primary monitor, select **Second screen only**.
 - For use as an extension of the primary monitor, select **Extend**.
 - For use as a copy of the primary monitor, select **Duplicate**.

USB Type-C mode

When a Thunderbolt or USB Type-C cable is connected to the computer and Alt mode is detected, the monitor switches to the USB Type-C mode and the following features are activated.

- PXE boot
- MAC address pass through: Your computer might support MAC Address Pass Through from the on, off, sleep, or hibernation states, or only when the computer is on or in the sleep state.

The MAC Address Pass Through is supported for UEFI PXE boot.

- Wake on LAN (WOL): Your computer might support WOL from the off, sleep, or hibernation states, or only when the computer is on or in the sleep state.

WLAN-LAN switching is supported only on select computers running the Windows 10 operating system.

Connect one end of the network cable to the RJ-45 (network) jack on the monitor and connect the other end to an RJ-45 wall jack or router.

- Single power on: Pressing the monitor power button can also turn on power to the computer.

Updating the monitor

This section describes how to download and update the firmware for the monitor.

Downloading the HP firmware installer

To download the HP firmware installer, follow this procedure:

1. Go to <http://www.hp.com/support>.
2. Select **Get software and drivers**, and follow the on-screen instructions to find your monitor.
3. Follow the on-screen instructions to select and download the HP firmware installer.
4. Complete the installation wizard.

Updating firmware for the monitor

To update the monitor firmware while connected to your computer:

1. Open Windows Explorer and navigate to where you saved the HP firmware installer.
2. Double-click to execute the installer file.
3. In the firmware update page, enter the display model, and then enter the operating system and build information.
4. Select the correct firmware update to download and follow the on-screen instructions.



NOTE: You must be connected to the internet for new updates to download.

5 Support and troubleshooting

If your monitor is not working as expected, you might be able to resolve the issue by following the instructions in this section.

Solving common issues

The following table lists possible issues, the possible cause of each issue, and the recommended solutions.

Table 5-1 Common issues and solutions

Issues	Possible cause	Solution
Screen is blank or video is blinking.	Power cord is disconnected.	Connect the power cord.
	Monitor is off.	Press the monitor power button. NOTE: If pressing the power button has no effect, press and hold the power button for 10 sec to disable the Power Button Lockout feature.
	Master power switch is set to off.	Set the master power switch on the rear of the monitor to the On position.
	Video cable is improperly connected.	Connect the video cable properly. For more information, see Connecting the cables on page 10 .
	System is in Auto-Sleep Mode.	Press any key on the keyboard or move the mouse to inactivate the screen blanking utility.
Video card is incompatible.		Open the OSD menu and select the Input menu. Set Auto-Switch Input to Off and manually select the input.
		or Replace the video card or connect the video cable to one of the computer's on-board video sources.
Image appears blurred, indistinct, or too dark.	Brightness setting is too low.	Open the OSD menu, and select Brightness to adjust the brightness scale as needed.
"Check Video Cable" is displayed on the screen.	Monitor video cable is disconnected.	Connect the appropriate video signal cable between the computer and monitor. Be sure that the computer power is off while connecting the video cable.
"Input Signal Out of Range" is displayed on screen.	Video resolution and/or refresh rate are set higher than the monitor supports.	Change the settings to a supported setting (see Preset display resolutions on page 32).
The monitor does not enter into a low-power sleep state.	The monitor's power saving control is disabled.	Open the OSD menu and select Power , select Auto-Sleep Mode , and then set auto-sleep to On .
"OSD Lockout" is displayed.	The monitor's OSD Lockout function is enabled.	Press and hold the Menu button for 10 seconds to disable the OSD Lockout function.
"Power Button Lockout" is displayed.	The monitor's Power Button Lockout feature is enabled.	Press and hold the Power button for 10 seconds to unlock the power button function.

Table 5-1 Common issues and solutions (continued)

Issues	Possible cause	Solution
Monitor has trouble waking from Sleep mode		DisplayPort or USB Type-C inputs: Set the DisplayPort hot-plug detection to Always Active . Power mode monitors: Set the hot-plug detection to Always Active to switch the monitor to Performance mode.
Monitor is not displaying the preferred resolution or refresh rate.		Multi-streaming USB Type-C: Set the USB Type-C configuration to USB 2.x.
Slow performance from USB devices connected to the USB Type-A monitor connectors		Set the USB Type-C configuration to 3.x to enable better performance for integrated or connected USB Type-A devices.

Button lockouts

To lock the menu on the Joypad, hold the Joypad to the left for 10 seconds to toggle the lock and unlock feature.

Table 5-2 Button lockouts

Button lockout	Status	Description
OSD lockout (toggle)	On	Press and hold the left button for 10 seconds.
Power button lockout (toggle)	On	Press and hold the power button for 10 seconds.
Accessibility button on and off (toggle)	On	Press and hold the center button for 10 seconds.

6 Maintaining the monitor

Properly maintained, your monitor can run for many years. These instructions provide steps you can perform to keep your monitor in the best condition.

Maintenance guidelines

Follow these instructions to enhance the performance and extend the life of the monitor.

- Do not open the monitor cabinet or attempt to service this product yourself. Adjust only those controls that are covered in the operating instructions. If the monitor is not operating properly or has been dropped or damaged, contact an authorized HP dealer, reseller, or service provider.
- Use only a power source and connection appropriate for this monitor, as indicated on the label or back plate of the monitor.
- Be sure that the total ampere rating of the products connected to the outlet does not exceed the current rating of the AC outlet and that the total ampere rating of the products connected to the cord does not exceed the rating of the cord. Look on the power label to determine the ampere rating (AMPS or A) for each device.
- Install the monitor near an outlet that you can easily reach. Disconnect the monitor by grasping the plug firmly and pulling it from the outlet. Never disconnect the monitor by pulling the cord.
- Turn the monitor off when it is not in use, and use a screen saver program. Doing this can substantially increase the life expectancy of the monitor.



NOTE: A burned-in image on the monitor is not covered under the HP warranty.

- Never block the slots and openings of the cabinet or push objects into them. These openings provide ventilation.
- Do not drop the monitor or place it on an unstable surface.
- Do not allow anything to rest on the power cord. Do not walk on the cord.
- Keep the monitor in a well-ventilated area, away from excessive light, heat, or moisture.

Cleaning the monitor

Use these instructions to clean your monitor when necessary.

1. Turn off the monitor and unplug the power cord from the AC outlet.
2. Disconnect any external devices.
3. Dust the monitor by wiping the screen and the cabinet with a soft, clean antistatic cloth.



IMPORTANT: Do not use cleaners that contain petroleum-based materials such as benzene, thinner, or any volatile substance to clean the monitor screen or cabinet. These chemicals might damage the monitor.

 **IMPORTANT:** Spray the cleaner onto a cloth and use the damp cloth to gently wipe the screen surface. Never spray cleaner directly on the screen surface. It can run behind the bezel and damage the electronics. The cloth should be moist, but not wet. Water dripping into the ventilation openings or other points of entry can cause damage to the monitor. Allow the monitor to air-dry before use.

4. After you remove the dirt and debris, you can also clean the surfaces with a disinfectant. The World Health Organization (WHO) recommends cleaning surfaces, followed by disinfection, as a best practice for preventing the spread of viral respiratory illnesses and harmful bacteria. A disinfectant that is within HP's cleaning guidelines is an alcohol solution consisting of 70% isopropyl alcohol and 30% water. This solution is also known as rubbing alcohol and is sold in most stores.

Shipping the monitor

Keep the original packing box in a storage area. You might need it later if you ship the monitor or move.

A Technical specifications

This section contains technical specifications for the physical aspects of your monitor, such as the weight and viewing dimensions, as well as required environmental operating conditions and power source ranges.

All specifications represent the typical specifications provided by HP component manufacturers; actual performance can vary either higher or lower.



NOTE: For the latest specifications or additional specifications for this product, go to <http://www.hp.com/go/quickspecs/> and search for your specific monitor model to find the model-specific QuickSpecs.

80 cm (31.5 in) model specifications

This section provides specifications for your monitor.

Table A-1 Technical specifications

Specification	Measurement	
Display, wide-screen	80 cm	31.5 in
Type	IPS Black	
Viewable image size	80 cm diagonal	31.5 in diagonal
Maximum weight (unpacked)	8.77 kg	19.33 lbs
Dimensions (include base)		
Height (highest position)	60.49 cm	23.81 in
Height (lowest position)	45.49 cm	17.91 in
Depth	21.70 cm	8.54 in
Width	71.35 cm	28.09 in
Tilt	-5° to 20°	
Swivel	+/- 45°	
Pivot	+/- 90°	
Environmental requirements temperature		
Operating temperature	5°C to 35°C	41°F to 95°F
Storage temperature	-20°C to 60°C	-4°F to 140°F
Storage humidity	5% to 95% (noncondensing)	
Power source	100 V ac to 240 V ac 50/60 Hz	
Input terminal	One HDMI port, one DisplayPort connector, one USB Type-B connector, and one Thunderbolt connector	

Preset display resolutions

The following display resolutions are the most commonly used modes and are set as factory defaults. The monitor automatically recognizes these preset modes, and they will appear properly sized and centered on the screen.

80 cm (31.5 in) model

This section provides preset display resolutions and preset timing resolutions.

Table A-2 Preset display resolutions

Preset	Pixel format	Horz freq (kHz)	Vert freq (Hz)
1	640 × 480	31.469	59.940
2	720 × 400	31.469	70.087
3	800 × 600	37.879	60.317
4	1024 × 768	48.363	60.004
5	1280 × 720	45.000	60.000
6	1280 × 800	49.702	59.810
7	1280 × 1024	63.981	60.020
8	1440 × 900	55.935	59.887
9	1600 × 900	60.000	60.000
10	1680 × 1050	65.290	59.954
11	1920 × 1080	67.500	60.000
12	1920 × 1200	74.038	59.950
13	2560 × 1440	88.787	59.951
14	3840 × 2160	60.000	60.000

High-definition video formats

This section provides high-definition video formats.

Table A-3 High-definition video formats

Preset	Timing name	Pixel format	Horz freq (kHz)	Vert freq (Hz)
1	480p	720 × 480	31.469	59.94
2	576p	720 × 576	31.250	50.00
3	720p50	1280 × 720	37.500	50.00
4	720p60	1280 × 720	45.000	60.00
5	1080p50	1920 × 1080	56.250	50.00
6	1080p60	1920 × 1080	67.500	60.00

Energy saver feature

This monitor supports a reduced power state.

The reduced power state is initiated if the monitor detects the absence of either the horizontal sync signal or the vertical sync signal. Upon detecting the absence of these signals, the monitor screen is blank, the backlight is turned off, and the power light turns amber. In the reduced power state, the monitor uses < 0.5 W of power. There is a brief warm-up period before the monitor returns to its normal operating state.

See the computer manual for instructions on setting the energy saver mode (sometimes called “power management feature”).



NOTE: This power saver feature works only when the monitor is connected to a computer that has energy-saver features.

By selecting the settings in the monitor Sleep Timer utility, you can also program the monitor to initiate the reduced power state at a predetermined time. When the monitor Sleep Timer utility initiates the reduced power state, the power light blinks amber.

B Accessibility

HP's goal is to design, produce, and market products, services, and information that everyone everywhere can use, either on a standalone basis or with appropriate third-party assistive technology (AT) devices or applications.

HP and accessibility

Because HP works to weave diversity, inclusion, and work/life into the fabric of the company, it is reflected in everything HP does. HP strives to create an inclusive environment focused on connecting people to the power of technology throughout the world.

Finding the technology tools you need

Technology can unleash your human potential. Assistive technology removes barriers and helps you create independence at home, at work, and in the community. Assistive technology helps increase, maintain, and improve the functional capabilities of electronic and information technology.

For more information, see [Finding the best assistive technology on page 35](#).

The HP commitment

HP is committed to providing products and services that are accessible for people with disabilities. This commitment supports the company's diversity objectives and helps ensure that the benefits of technology are available to all.

The HP accessibility goal is to design, produce, and market products and services that can be effectively used by everyone, including people with disabilities, either on a standalone basis or with appropriate assistive devices.

To achieve that goal, this Accessibility Policy establishes seven key objectives to guide HP actions. All HP managers and employees are expected to support these objectives and their implementation in accordance with their roles and responsibilities:

- Raise the level of awareness of accessibility issues within HP, and provide employees with the training they need to design, produce, market, and deliver accessible products and services.
- Develop accessibility guidelines for products and services, and hold product development groups accountable for implementing these guidelines where competitively, technically, and economically feasible.
- Involve people with disabilities in the development of accessibility guidelines and in the design and testing of products and services.
- Document accessibility features, and make information about HP products and services publicly available in an accessible form.
- Establish relationships with leading assistive technology and solution providers.
- Support internal and external research and development that improves assistive technology relevant to HP products and services.

- Support and contribute to industry standards and guidelines for accessibility.

International Association of Accessibility Professionals (IAAP)

IAAP is a not-for-profit association focused on advancing the accessibility profession through networking, education, and certification. The objective is to help accessibility professionals develop and advance their careers and to better enable organizations to integrate accessibility into their products and infrastructure.

As a founding member, HP joined to participate with other organizations to advance the field of accessibility. This commitment supports HP's accessibility goal of designing, producing, and marketing products and services that people with disabilities can effectively use.

IAAP will make the profession strong by globally connecting individuals, students, and organizations to learn from one another. If you are interested in learning more, go to <http://www.accessibilityassociation.org> to join the online community, sign up for newsletters, and learn about membership options.

Finding the best assistive technology

Everyone, including people with disabilities or age-related limitations, should be able to communicate, express themselves, and connect with the world using technology. HP is committed to increasing accessibility awareness within HP and with our customers and partners.

Whether it's large fonts that are easy on the eyes, voice recognition that lets you give your hands a rest, or any other assistive technology to help with your specific situation—a variety of assistive technologies make HP products easier to use. How do you choose?

Assessing your needs

Technology can unleash your potential. Assistive technology removes barriers and helps you create independence at home, at work, and in the community. Assistive technology (AT) helps increase, maintain, and improve the functional capabilities of electronic and information technology.

You can choose from many AT products. Your AT assessment should allow you to evaluate several products, answer your questions, and facilitate your selection of the best solution for your situation. You will find that professionals qualified to do AT assessments come from many fields, including those licensed or certified in physical therapy, occupational therapy, speech/language pathology, and other areas of expertise. Others, while not certified or licensed, can also provide evaluation information. You will want to ask about the individual's experience, expertise, and fees to determine if they are appropriate for your needs.

Accessibility for HP products

These links provide information about accessibility features and assistive technology, if applicable and available in your country or region, that are included in various HP products. These resources will help you select the specific assistive technology features and products most appropriate for your situation.

- HP Aging & Accessibility: Go to <http://www.hp.com>, type `Accessibility` in the search box. Select **Office of Aging and Accessibility**.
- HP computers: For Windows products, go to <http://www.hp.com/support>, type `Windows Accessibility Options` in the **Search our knowledge library** search box. Select the appropriate operating system in the results.
- HP Shopping, peripherals for HP products: Go to <http://store.hp.com>, select **Shop**, and then select **Monitors or Accessories**.

If you need additional support with the accessibility features on your HP product, see [Contacting support on page 40](#).

Additional links to external partners and suppliers that may provide additional assistance:

- [Microsoft Accessibility information \(Windows and Microsoft Office\)](#)
- [Google Products accessibility information \(Android, Chrome, Google Apps\)](#)

Monitor accessibility features (select products/regions only)

HP monitors enable you to find and configure display settings directly from your monitor, without needing to use an external device such as a computer, using multiple types of accessibility enhancements.

Built-in accessibility features

The following accessibility features are built into the monitor.

- Physical buttons or a Joypad that are tactilely discoverable.
- Physical button or Joypad labels that are displayed on-screen.
- On-Screen Display (OSD) menu
 - Menu items, text, and elements meet a 4.5:1 (or greater) contrast ratio.
 - Focus indication is provided.

What is Accessibility Mode?

Accessibility Mode enables you to use audio navigation and to enlarge items on the screen.

When you turn on Accessibility Mode, the following adjustments are made:

- Menu timeout setting is set to the maximum duration of 60 seconds (default is 30 seconds).
- Language is set to English, which is the only language currently supported in Accessibility Mode. When Accessibility Mode is turned off, the previous language is used.
- On FHD monitors, the OSD menu is set to a fixed position in the lower-right quadrant of the screen.
- Menu items, text, and other elements meet a 4.5:1 contrast ratio or greater.
- Text is enlarged to a 4.8 mm or larger font size.

How do you turn Accessibility Mode on or off?

Turn Accessibility Mode on or off using either physical monitor controls or an OSD menu.

- On a monitor with a Joypad, press and hold the center of the Joypad for four seconds to turn Accessibility Mode on or off.

When Accessibility Mode is turned on using a physical button, an Accessibility Mode is On message is displayed. When Accessibility Mode is turned off using a physical button, an Accessibility Mode is Off message is displayed.

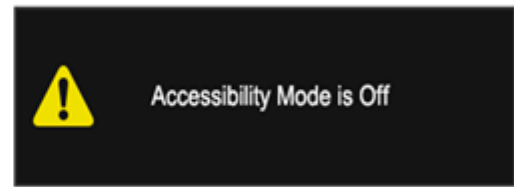
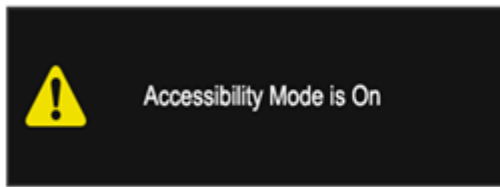

- Using the OSD menu
 - To turn on Accessibility Mode, set the language to English, and then select **Management > Accessibility > On**.
 - To turn off Accessibility Mode, select **Management > Accessibility > Off**.

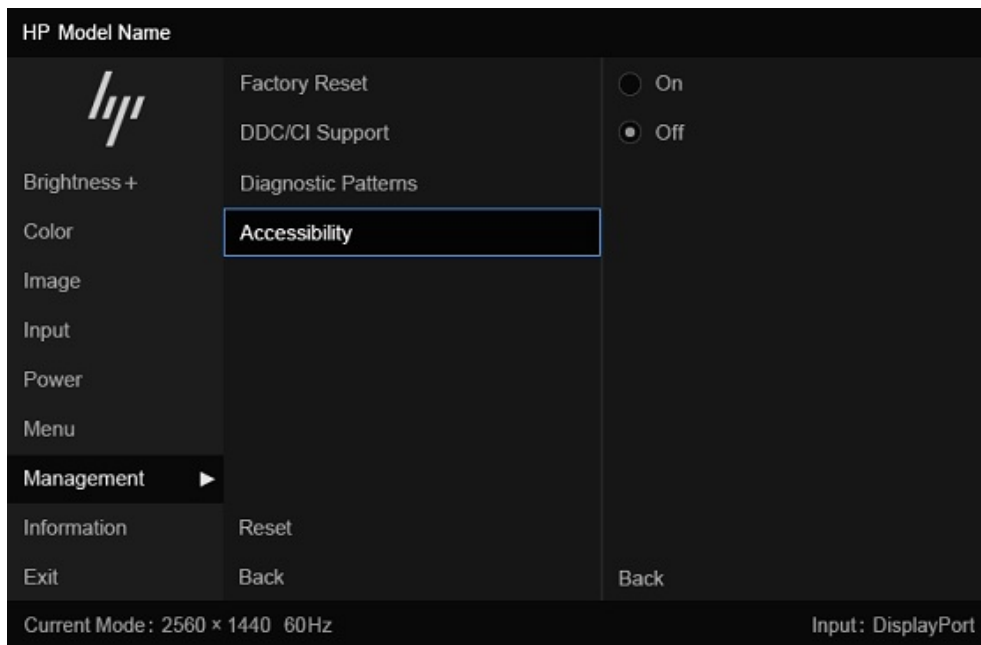

Standards and legislation

Countries worldwide are enacting regulations to improve access to products and services for persons with disabilities. These regulations are historically applicable to telecommunications products and services, PCs and printers with certain communications and video playback features, their associated user documentation, and their customer support.

Standards

The US Access Board created Section 508 of the Federal Acquisition Regulation (FAR) standards to address access to information and communication technology (ICT) for people with physical, sensory, or cognitive disabilities.

The standards contain technical criteria specific to various types of technologies, as well as performance-based requirements which focus on functional capabilities of covered products. Specific criteria cover software applications and operating systems, web-based information and applications, computers, telecommunications products, video and multimedia, and self-contained closed products.

Mandate 376 – EN 301 549

The European Union created the EN 301 549 standard within Mandate 376 as an online toolkit for public procurement of ICT products. The standard specifies the accessibility requirements applicable to ICT products and services, with a description of the test procedures and evaluation methodology for each requirement.

Web Content Accessibility Guidelines (WCAG)

Web Content Accessibility Guidelines (WCAG) from the W3C's Web Accessibility Initiative (WAI) helps web designers and developers create sites that better meet the needs of people with disabilities or age-related limitations.

WCAG advances accessibility across the full range of web content (text, images, audio, and video) and web applications. WCAG can be precisely tested, is easy to understand and use, and allows web developers flexibility for innovation. WCAG 2.0 has also been approved as [ISO/IEC 40500:2012](#).

WCAG specifically addresses barriers to accessing the web experienced by people with visual, auditory, physical, cognitive, and neurological disabilities, and by older web users with accessibility needs. WCAG 2.0 provides characteristics of accessible content:

- **Perceivable** (for instance, by addressing text alternatives for images, captions for audio, adaptability of presentation, and color contrast)
- **Operable** (by addressing keyboard access, color contrast, timing of input, seizure avoidance, and navigability)
- **Understandable** (by addressing readability, predictability, and input assistance)
- **Robust** (for instance, by addressing compatibility with assistive technologies)

Legislation and regulations

Accessibility of IT and information has become an area of increasing legislative importance.

The [HP policy landscape](#) website provides information about key legislation, regulations, and standards in the following locations:

- United States
- Canada
- Europe
- Australia

Useful accessibility resources and links

These organizations, institutions, and resources might be good sources of information about disabilities and age-related limitations.



NOTE: This is not an exhaustive list. These organizations are provided for informational purposes only. HP assumes no responsibility for information or contacts you encounter on the internet. Listing on this page does not imply endorsement by HP.

Organizations

These organizations are a few of the many that provide information about disabilities and age-related limitations.

- American Association of People with Disabilities (AAPD)
- The Association of Assistive Technology Act Programs (ATAP)
- Hearing Loss Association of America (HLAA)
- Information Technology Technical Assistance and Training Center (ITTATC)
- Lighthouse International
- National Association of the Deaf
- National Federation of the Blind
- Rehabilitation Engineering & Assistive Technology Society of North America (RESNA)
- Telecommunications for the Deaf and Hard of Hearing, Inc. (TDI)
- W3C Web Accessibility Initiative (WAI)

Educational institutions

Many educational institutions, including these examples, provide information about disabilities and age-related limitations.

- California State University, Northridge, Center on Disabilities (CSUN)
- University of Wisconsin - Madison, Trace Center
- University of Minnesota computer accommodations program

Other disability resources

Many resources, including these examples, provide information about disabilities and age-related limitations.

- ADA (Americans with Disabilities Act) Technical Assistance Program
- ILO Global Business and Disability network
- EnableMart
- European Disability Forum
- Job Accommodation Network
- Microsoft Enable

HP links

These HP-specific links provide information that relates to disabilities and age-related limitations.

[HP comfort and safety guide](#)

[HP public sector sales](#)

Contacting support

HP offers technical support and assistance with accessibility options for customers with disabilities.



NOTE: Support is in English only.

- Customers who are deaf or hard of hearing who have questions about technical support or accessibility of HP products:
 - Use TRS/VRS/WebCapTel to call (877) 656-7058 Monday through Friday, 6 a.m. to 9 p.m. Mountain Time.
- Customers with other disabilities or age-related limitations who have questions about technical support or accessibility of HP products:
 - Call (888) 259-5707 Monday through Friday, 6 a.m. to 9 p.m. Mountain Time.

Index

A

accessibility 34, 35, 38, 39
accessibility needs
 assessment 35
assistive technology (AT)
 finding 35
 purpose 34
AT (assistive technology)
 finding 35
 purpose 34

B

bottom components 6

C

calling technical support 3
components
 bottom 6
 front 5
 rear 5
connectors
 DisplayPort 6
 power 6
customer support,
 accessibility 40

D

DisplayPort connector 6

F

front components 5

G

getting started 2
getting to know your monitor 3

H

HDMI port 6
HP Assistive Policy 34
HP Display Center 20
HP resources 3
HP support 3

I

International Association of
 Accessibility Professionals 35

J

joypad 5

L

label 7

P

ports
 HDMI 6
 USB 5
 USB Type-C 5, 6
power button 5
power connector 6
power light 5
product label 7
product number 7

R

rear components 5
resources, accessibility 38

S

safety information 2
Section 508 accessibility
 standards 37
serial number 7
standards and legislation,
 accessibility 37
support 3

T

technical support 3
troubleshooting 27

U

USB port 5
USB Type-C port 5, 6

W

warnings 2