

Eaton Tripp Lite SmartOnline Series

Rack / Tower Advanced User's Guide

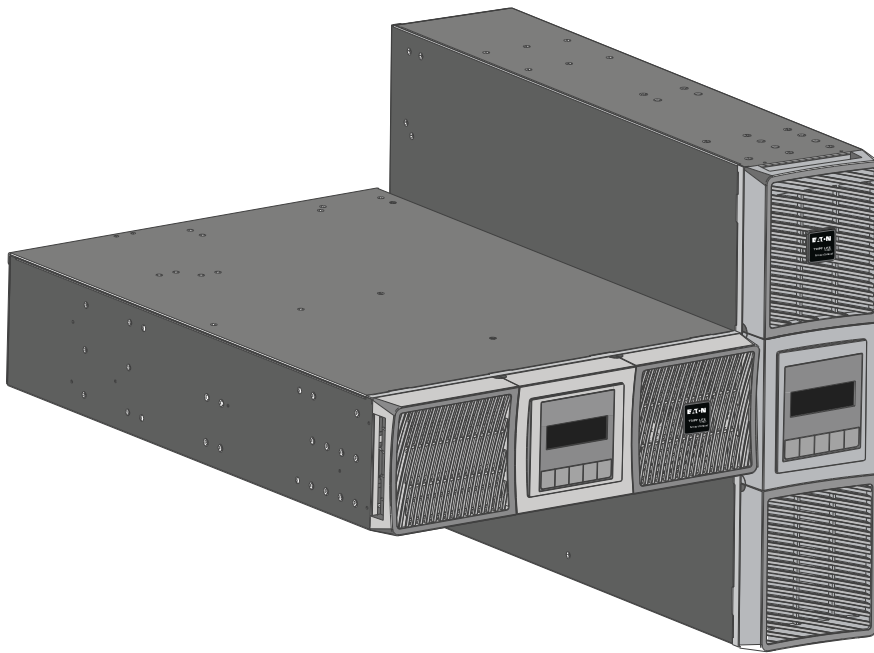

SU5000RT
SU6000RT
BP180RT

Safety Instructions

SAVE THESE INSTRUCTIONS.

This manual contains important instructions **that should be followed during installation and maintenance of the UPS and batteries.**

This equipment has been tested and found to comply with the limits for a Class A digital device, pursuant to Part 15 of the FCC Rules. These limits are designed to provide reasonable protection against harmful interference when the equipment is operated in a commercial environment. This equipment generates, uses, and can radiate radio frequency energy and, if not installed and used in accordance with the instruction manual, may cause harmful interference to radio communications. Operation of this equipment in a residential area is likely to cause harmful interference in which case the user will be required to correct the interference at his own expense.

⚠ WARNING

This is a category C2 UPS product. In a residential environment, this product may cause radio interference, in which case the user may be required to take additional measures.

Suppliers Declaration of Conformity

Unique Identifier: EATON, SU5000RT, SU6000RT, BP180RT

Responsible Party:

EATON
10000 Woodward Ave
Woodridge, IL 60517 USA
773-869-1111
tripplite.eaton.com

Special Symbols

The following are examples of symbols used on the product to alert you to important information:



RISK OF ELECTRIC SHOCK - Observe the warning associated with the risk of electric shock symbol.



CAUTION: REFER TO OPERATOR'S MANUAL - Refer to your operator's manual for additional information, such as important operating and maintenance instructions.



This symbol indicates that you should not discard the UPS or the UPS batteries in the trash. This product contains sealed, lead-acid batteries and must be disposed of properly. For more information, contact your local recycling/reuse or hazardous waste center.



This symbol indicates that you should not discard waste electrical or electronic equipment (WEEE) in the trash. For proper disposal, contact your local recycling/reuse or hazardous waste center.

Battery Warning Instructions

- Risk of electric shock. All repairs and service should be performed by **AUTHORIZED SERVICE PERSONNEL ONLY**. There are **NO USER-SERVICEABLE PARTS** inside the UPS.
- Remove watches, rings, and other metal objects from the hands.
- Wear rubber gloves and boots.
- Use tools with insulated handles.
- The system must be properly grounded at all times.
- The battery supplied with the system contains small amounts of toxic materials. To avoid accidents, observe the following directives:
 - Servicing of batteries should be performed or supervised by personnel knowledgeable about batteries and the required precautions.
 - When replacing batteries, replace with the same type and number of batteries or battery packs.
 - Do not dispose of batteries in a fire. The batteries may explode.
 - Batteries constitute a danger (electrical shock and burning). The short-circuit current may be very high.
- Precautions must be taken for all handling. A battery can present a risk of electric shock and high short circuit current. The following precautions should be observed when working on batteries:
 - Do not lay tools or metal parts on top of batteries.
 - Disconnect the charging source prior to connecting or disconnecting battery terminals.
 - Remove battery grounds during installation and maintenance to reduce the likelihood of shock
 - Determine if the battery is inadvertently grounded. If inadvertently grounded, remove the source from the ground. Contact with any part of a grounded battery can result in electrical shock. The likelihood of such shock can be reduced if such grounds are removed during installation and maintenance (applicable to equipment and remote battery supplies not having a grounded supply circuit).

Product Safety

- To connect the UPS, instructions and operation described in the manual must be followed in the indicated order.
- CAUTION - To reduce the risk of fire, the unit connects only to a circuit provided with 20 or 30 amperes maximum branch circuit over current protection in accordance with the National Electric Code.
- Check that the indications on the rating plate correspond to your AC powered system and to the actual electrical consumption of all the equipment to be connected to the system.
- Ensure that the system is free of any contaminants, the surrounding area is free of debris, and there are no foreign substances within the system.
- For PLUGGABLE EQUIPMENT, the socket-outlet shall be installed near the equipment and shall be easily accessible
- Do not allow any liquids to enter the UPS. Do not place beverages or any other liquid-containing vessels on or near the unit.
- This unit is intended for installation in a controlled environment (temperature-controlled, indoor area free of conductive contaminants). Avoid installing the UPS in locations with standing or running water or excessive humidity.
- Never install the system near liquids or in an excessively damp environment. This equipment should only be used in a dry, indoor environment.
- Never let a foreign body penetrate inside the system.
- Do not plug the UPS input into its own output.
- Never block the ventilation grates of the system.
- Never expose the system to direct sunlight or to a heat source.
- Store the system in a dry place before installing, if storage is required.
- Unplug the UPS prior to cleaning, and do not use liquid or spray detergent.
- The admissible storage temperature range is -25°C to +55°C without batteries, 0°C to 40°C with batteries.
- The system is not for use in a computer room AS DEFINED IN the standard for the Protection of Information Technology Equipment, ANSI/NFPA.
- To reduce the risk of overheating the UPS, do not cover the unit's cooling vents and avoid exposing the UPS to direct sunlight or installing the unit near heat-emitting appliances such as space heaters or furnaces.

Special Precautions

- The unit is heavy: wear safety shoes and use vacuum lifter preferentially for handling operations.
- All handling operations will require at least two people (unpacking, lifting, installation in rack system).
- Before and after the installation, if the UPS remains de-energized for a long period, the UPS must be energized for a period of 24 hours, at least once every 6 months (for a normal storage temperature less than 25°C). This charges the battery, thus avoiding possible irreversible damage.
- For potential safety issue on defective UPS : DISCONNECT INTERNAL BATTERY for storage and transportation.

Table of Contents

1 Introduction	1
1.1 Introduction	1
1.2 Environmental Protection	1
2 Presentation	3
2.1 Standard Installations	3
2.2 Accessories	3
2.3 Rear Panels	4
3 Installation	5
3.1 Inspecting the Equipment	5
3.2 Unpacking the Cabinet	5
3.3 Checking the Accessory Kit	6
3.4 Tower Installation	7
3.5 Rack Installation	8
3.6 Connecting the Internal Battery	9
3.7 Installation Requirements	10
3.8 Connecting the EBM's	11
3.9 Connecting the Power Cables	12
3.10 Detecting Other Accessories	12
4 Interfaces and Communication	13
4.1 Control Panel	13
4.2 LCD Description	14
4.3 UPS Home Menu	15
4.4 User Settings	16
4.5 Display Functions	19
4.6 Communication Ports	21
4.7 UPS Remote Control Functions	22
4.8 Tripp Lite by Eaton PowerAlert Software Suite	24
5 Operation	25
5.1 Startup and Normal Operation	25
5.2 Starting the UPS on Battery	25
5.3 UPS Shutdown	25
6 Modes of Operation	27
6.1 Online Mode	27
6.2 Battery Mode	27
6.3 Low Battery Warning	27
6.4 Bypass Mode	27
6.5 Standby Mode	27

Table of Contents

6.6 Transferring Between Modes.....	28
6.7 Setting High-Efficiency mode.....	28
6.8 Configuring Battery Settings.....	28
6.9 Retrieving the Event Log.....	28
7 UPS Maintenance.....	29
7.1 Equipment Care.....	29
7.2 Storing the Equipment.....	29
7.3 Replacing the Batteries.....	29
7.4 Recycling The Used Equipment.....	31
8 Troubleshooting.....	33
8.1 Typical Alarms and Faults.....	33
8.2 Silencing the Alarm.....	34
8.3 Service and Support.....	35
9 Specifications.....	37
9.1 Model Specifications.....	37

Chapter 1 Introduction

1.1 Introduction

Thank you for selecting an Eaton Tripp Lite Series product to protect your electrical equipment. The Eaton Tripp Lite Series SmartOnline UPS range has been designed with the utmost care. Please take the time to read the safety instructions and the advanced user guide to take full advantage of the many features of your Uninterruptible Power System.

To discover the entire range of products and the options available for the Tripp Lite by Eaton SmartOnline UPS range, visit our website at tripplite.eaton.com or contact your Eaton Tripp Lite Series representative.

1.2 Environmental Protection

Eaton has implemented an environmental-protection policy.

Products are developed according to an eco-design approach.

Substances

This product does not contain CFCs, HCFCs, or asbestos.

Packing

To improve waste treatment and facilitate recycling, separate the various packing components.

- The cardboard we use comprises over 50% of recycled cardboard.
- All bags are made of polyethylene.
- Packing materials are recyclable and bear the appropriate identification symbol



Table 1. Packing Material Symbols

Materials	Abbreviations	Number in the symbols
Polyethylene terephthalate	PET	01
High-density polyethylene	HDPE	02
Polyvinyl chloride	PVC	03
Low-density polyethylene	LDPE	04
Polypropylene	PP	05
Polystyrene	PS	06

Follow all local regulations for the disposal of packing materials.

End of Life

Eaton will process products at the end of their service life in compliance with local regulations. Eaton works with companies in charge of collecting and eliminating our products at the end of their service life.

Product

The product is made up of recyclable materials.

Dismantling and destruction must take place in compliance with all local regulations concerning waste. At the end of its service life, the product must be transported to a processing center for electrical and electronic waste.

Battery

The product contains lead acid (Pb) batteries that must be processed according to applicable local regulations concerning batteries.

The battery may have to be removed to comply with regulations and in view of the correct local disposal requirements.

Benefits

The Eaton Tripp Lite Series UPS protects your sensitive electronic equipment from the most common power problems, including power failures, power sags, power surges, brownouts, line noise, high voltage spikes, frequency variations, switching transients, and harmonic distortion.

Power outages can occur when you least expect it, and power quality can be erratic. These power problems have the potential to corrupt critical data, destroy unsaved work sessions, and damage hardware, causing hours of lost productivity and expensive repairs.

With the Eaton Tripp Lite Series SmartOnline UPS, you can safely eliminate the effects of power disturbances and guard the integrity of your equipment. Providing outstanding performance and reliability and unique benefits that include the following:

- True online double-conversion technology with high power density, utility frequency independence, and generator compatibility.
- Selectable High-Efficiency mode of operation.
- Standard communication options: one RS-232 communication port, USB communication port, and relay output contacts.
- Optional connectivity cards with enhanced communication capabilities.
- Extended runtime with up to four Extended Battery Modules (EBMs) per UPS.
- Remote On/Off control through Remote On/Off (ROO) and Remote Power Off (RPO) ports.
- Backed by worldwide agency certifications.

Chapter 2 Presentation

2.1 Standard Installations

Figure 1. UPS Dimensions

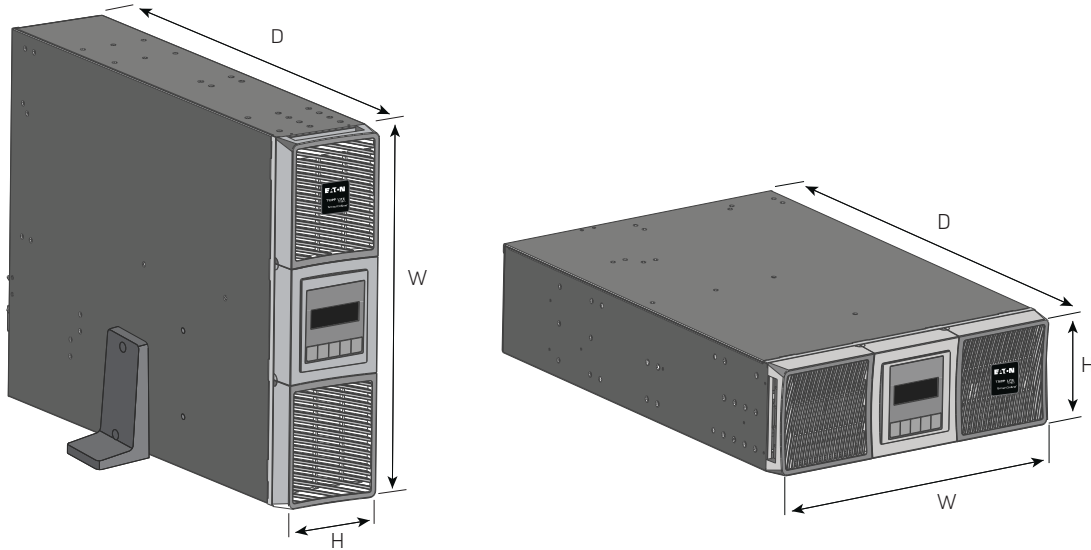

Description	Weights (lb/kg)	Dimensions (inch/mm) D xW xH
SU5000RT	106 / 48	28.4 x 17.3 x 5.1 / 722 x 440 x 130
SU6000RT	106 / 48	28.4 x 17.3 x 5.1 / 722 x 440 x 130
BP180RT	150/68	25.4 x 17.3 x 5.1 / 645 x 440 x 130

2.2 Accessories

Table 2. UPS Accessories

Part number	Description
BP180RT	Extended battery module
SUTFMR	5K transformer module
SUPDMBP6K	SmartOnline maintenance bypass module
RK2PC	Two-post rail kit
LXE communication card	Network card
RELAY-MS	Relay card

2.3 Rear Panels

Figure 2. SU5000RT / SU6000RT

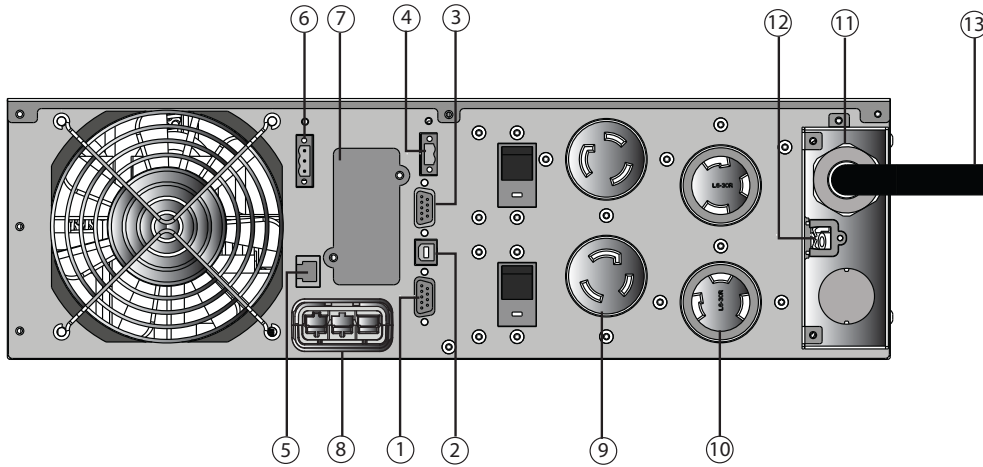

- ① RS232 communication port
- ② USB communication port
- ③ Dry (relay)contacts communication port
- ④ Connector for ROO (Remote On / Off) control
- ⑤ Connector for communicating with an additional battery module
- ⑥ Connector for RPO (Remote Power Off) control
- ⑦ Slot for optional communication card
- ⑧ Connector for additional battery module
- ⑨ (2) L6-20R outlets
- ⑩ (2) L6-30R outlets
- ⑪ Input / Output terminal blocks
- ⑫ Connector for Hotswap / MBP detection
- ⑬ Input power cable with L6-30 plug

Figure 3. BP180RT

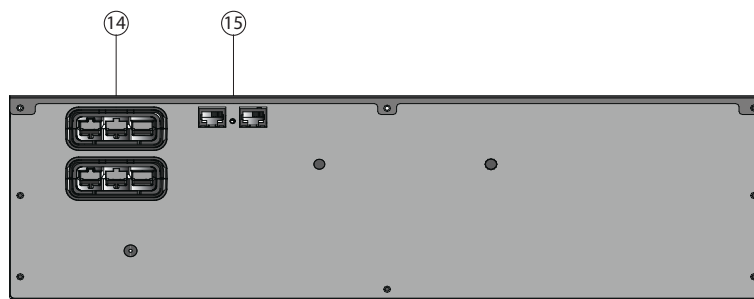

- ⑭ Connectors for battery modules (to the UPS or to the other battery modules)
- ⑮ Connectors for communicating with an additional battery module

Chapter 3 Installation

3.1 Inspecting the Equipment

If your equipment has been damaged during shipment, keep the shipping cartons and packing materials for the carrier or place of purchase and file a claim for shipping damage. If you discover damage after acceptance, file a claim for concealed damage.

To file a claim for shipping damage or concealed damage:

1. File with the carrier within 15 days of receipt of the equipment;
2. Send your Eaton Tripp Lite Series service representative a copy of the damage claim within 15 days.



IMPORTANT

Check the battery recharge date on the shipping carton label. If the date has passed and the batteries were never recharged, do not use the UPS. Contact your service representative.

3.2 Unpacking the Cabinet

Unpacking the UPS in a low-temperature environment may cause condensation in and on the UPS cabinet. Do not install the UPS until the inside and outside of the UPS are dry (hazard of electric shock).

The cabinet is heavy. Follow the special precautions provided and on the carton.

Unpack the equipment and remove all the packing materials and shipping carton.



NOTE

Do not lift the UPS or EBM from the front panel.

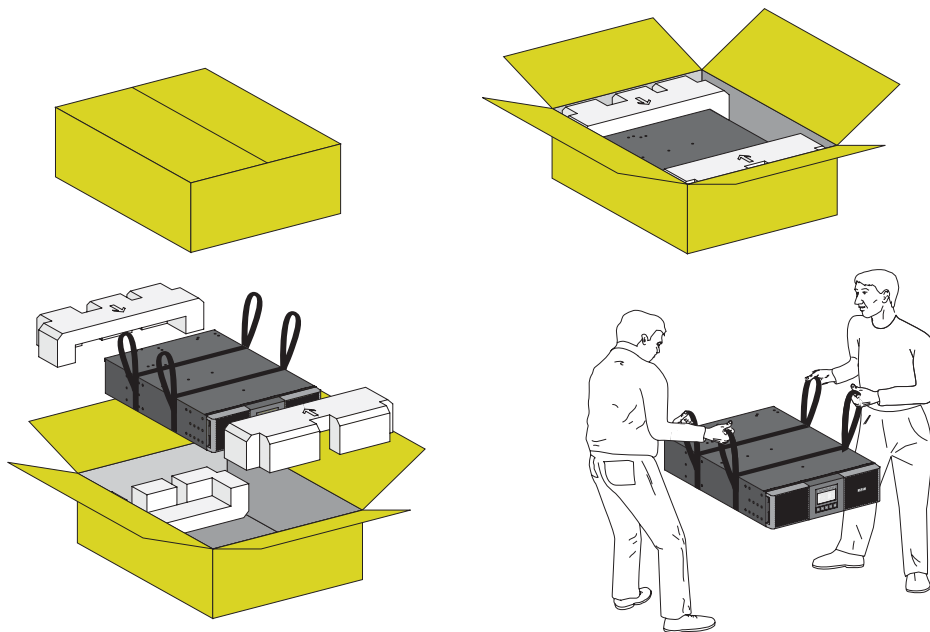

Discard or recycle the packaging responsibly, or store it for future use. Place the cabinet in a protected area with adequate airflow free of humidity, flammable gas, and corrosion.

Checking the Accessory Kit

Packing materials must be disposed of in compliance with all local regulations concerning waste. Recycling symbols are printed on the packing materials to facilitate sorting.

3.3 Checking the Accessory Kit

Verify that the following additional items are included with the UPS:

Figure 4. SU5000RT / SU6000RT

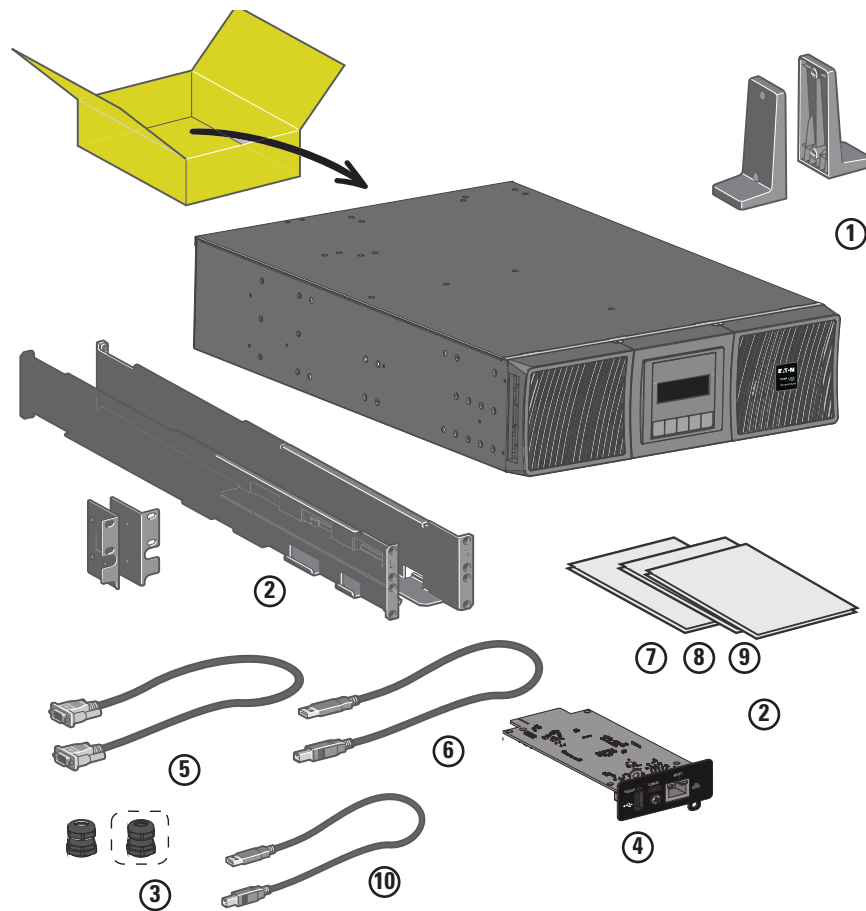

- ① (2) Tower stands
- ② Rack kit for 19-inch enclosures
- ③ Cable gland for output connection
additional cable gland for Input
- ④ LXE communication card (optional)
standard on network bundle models
- ⑤ RS232 communication cable
- ⑥ USB communication cable

- ⑦ Safety instructions
- ⑧ Quick start guide
- ⑨ LXE card user guide
- ⑩ LXE card data cable

Figure 5. BP180RT

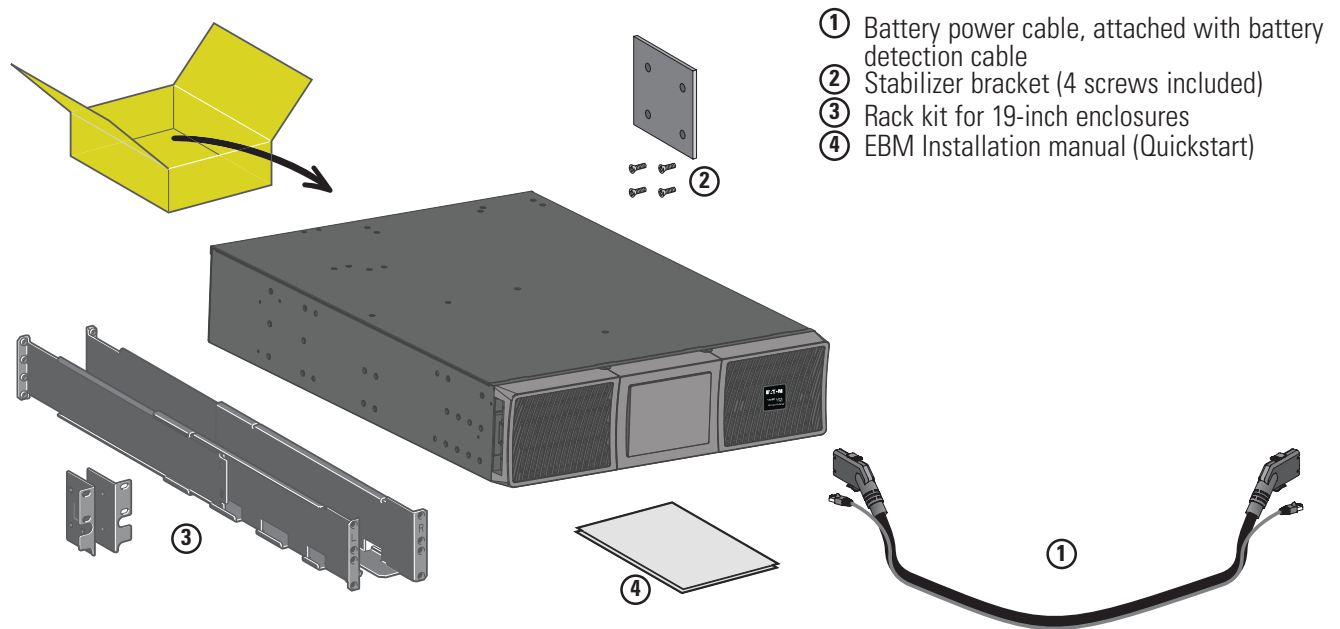

NOTE 1 Discard the EBM user's guide if you are installing the EBM with a new UPS at the same time.

NOTE 2 Use the UPS user's guide to install the UPS and the EBM.

NOTE 3 If you ordered other UPS accessories, refer to specific user manuals to check the packing contents.

3.4 Tower Installation

Tip If you ordered other UPS accessories, refer to specific user manuals to check the tower installation with the UPS. The UPS batteries come from the factory disconnected; see [Figure 6](#) to connect the battery pack.

To install the cabinet:

1. Place the UPS on a flat, stable surface in its final location.
2. Always keep six inches or 150 mm of free space behind the UPS rear panel for ventilation.
3. If installing additional cabinets, place them next to the UPS in their final location.

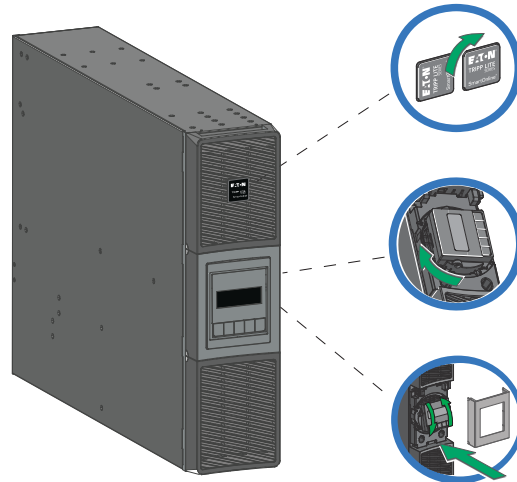
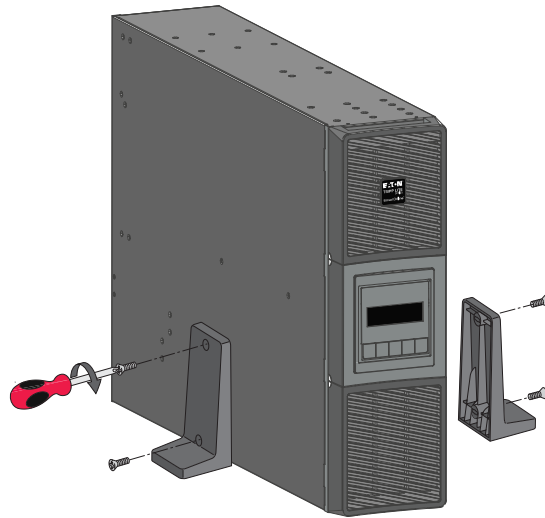

3.5 Rack Installation

i NOTE It is remove the UPS internal battery pack before attempting to install the UPS in a rack. See [Figure 13](#) for instructions on how to remove the battery pack.

Follow steps 1 to 5 to mount the UPS onto the rails.

i NOTE Eaton supplies the rack mounting rails and necessary hardware.

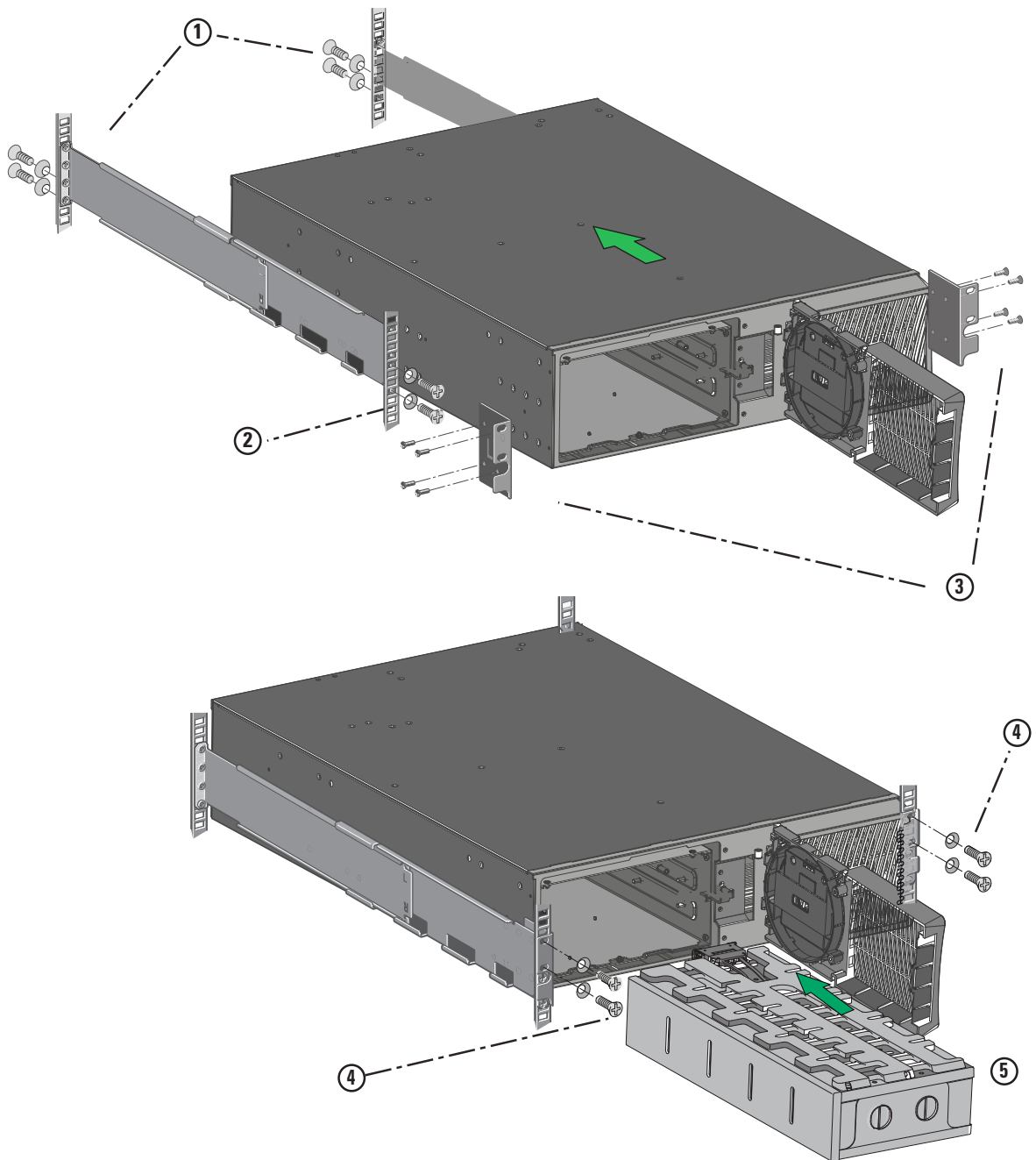

3.6 Connecting the Internal Battery



NOTE

Only connect the UPS to the utility once the installation is complete. Do not make unauthorized changes to the UPS; otherwise, damage may occur to your equipment and void your warranty.

Figure 6. Internal Battery Connection

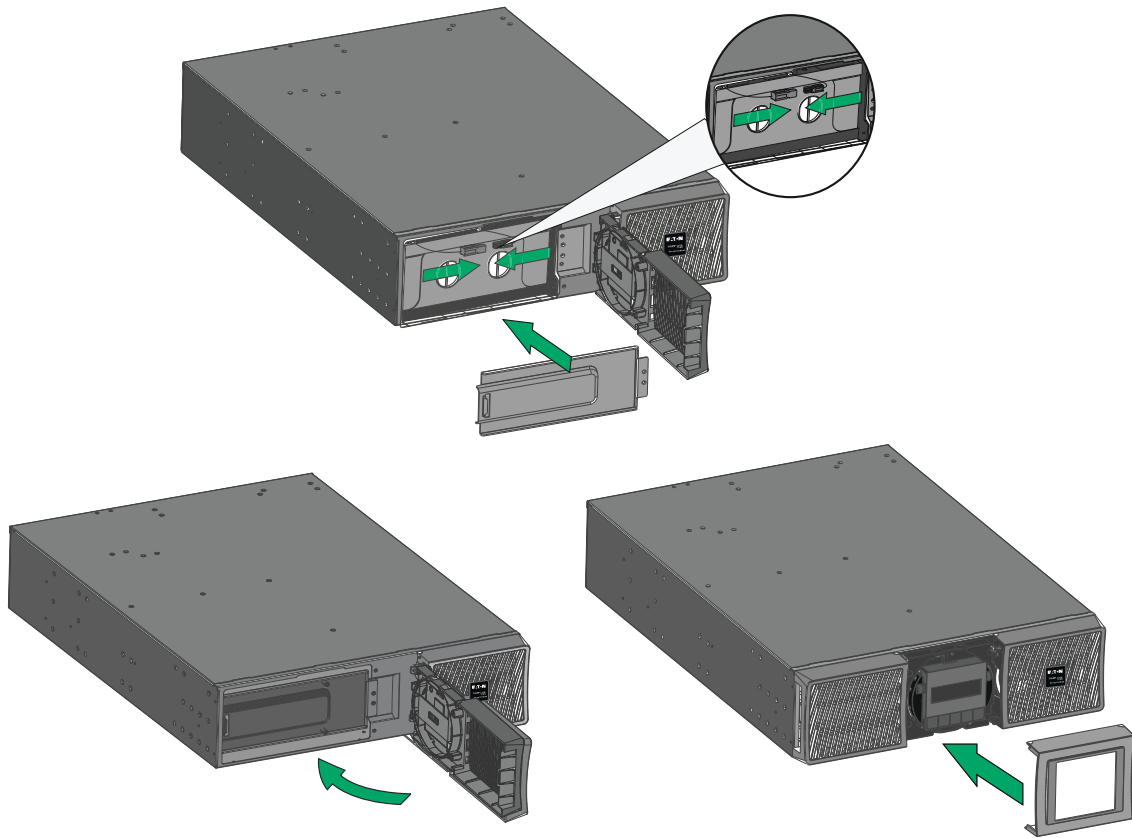

To connect to the UPS internal battery pack:

1. Connect the two battery connectors.
2. Reinstall the battery protection cover and the front panel, then clip the center cover.

3.7 Installation Requirements

Eaton recommends the following protective devices and cable cross-sections.

Table 3. Upstream protection

UPS Power rating	Upstream circuit breaker
5000VA / 6000VA	D curve — 30A

Table 4. Recommended wire size

Terminal Position	Wire Function	Terminal Wire Size Rating	Minimum Input Wire Size	Tightening Torque
L1	Phase	4-16 mm ² (12-6 AWG)	6 mm ² (10 AWG) 105° C 10 mm ² (8 AWG) 75°C	10 lb in / 1.13 Nm

Table 4. Recommended wire size (Continued)

Terminal Position	Wire Function	Terminal Wire Size Rating	Minimum Input Wire Size	Tightening Torque
N (L2)	Neutral (Phase)			
	Ground			

3.8 Connecting the EBM's

⚠ CAUTION

To ensure a proper connection, insert the EBM cable into the battery connector quickly and firmly so that the battery cable will not come loose or pull away.

1. Plug the EBM power cable(s) into the battery connector(s). Up to four EBM's may be connected to the UPS.
2. Verify that the EBM connections are tight and that each cable has adequate bend radius and strain relief.
3. Connect the battery detection cable(s) to the UPS connector and the EBM(s).

Figure 7. SmartOnline Rack / Tower EBM Connections

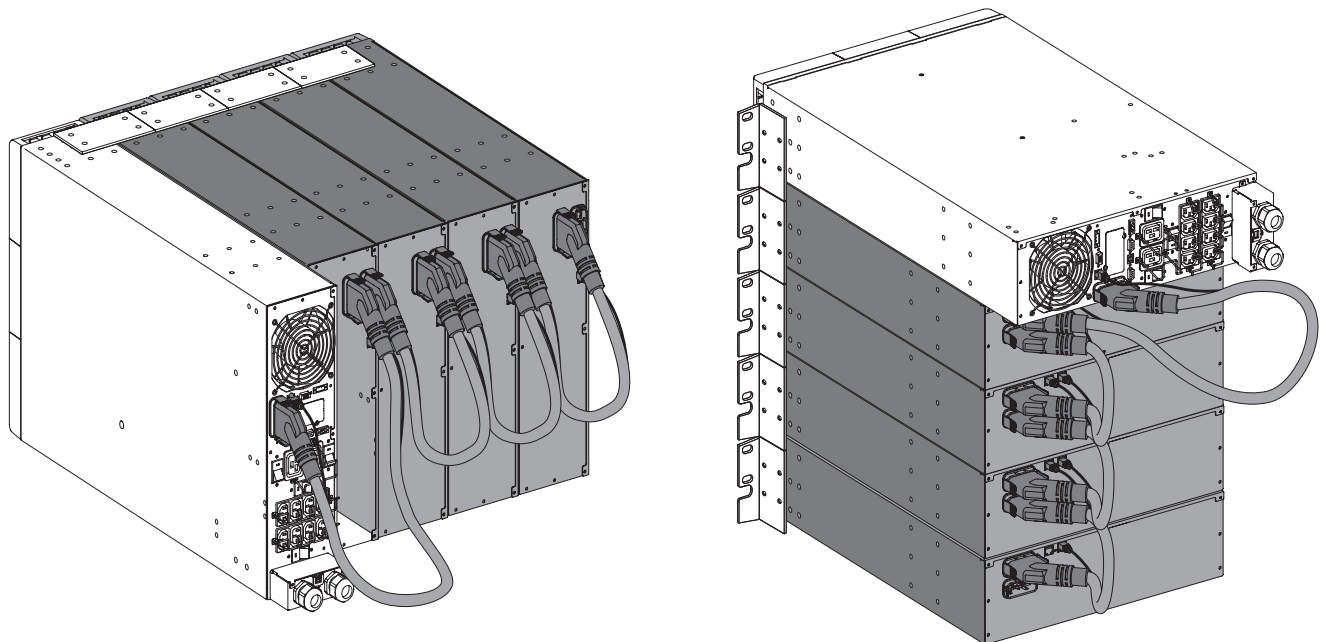

3.9 Connecting the Power Cables

Access to Terminal Blocks

1. Remove the terminal blocks cover (one screw)
2. Punch out the knockouts and insert the cables/conduits inside.

CAUTION

High leakage current. Earth connection essential before connecting supply.

NOTE The L6-30P input power cable is attached by Eaton.

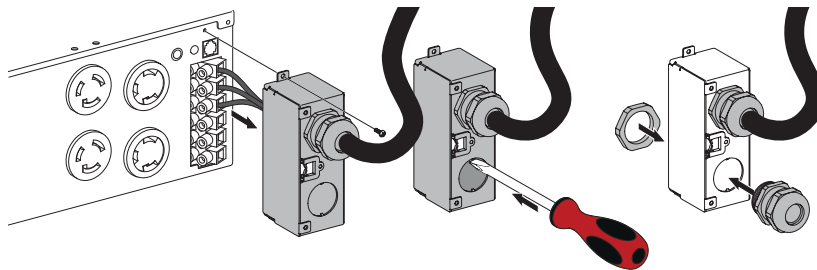

WARNING

This type of connection must be carried out by qualified electrical personnel.

Before carrying out any connection, check that the upstream protection device (Normal AC source) is open "O" (Off). Always connect the ground wire first.

If you ordered additional equipment, refer to the specific user manual to check the terminal blocks connection of the UPS with this accessory.

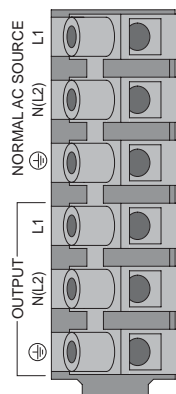

- ① Insert the Normal AC cable through the cable gland.
- ② Connect the three cables to the Normal AC source terminal blocks.
- ③ Insert the Output cable through the cable gland.
- ④ Connect the three cables to the Output terminal blocks.
- ⑤ Put back and secure the terminal blocks cover with the screw.
- ⑥ Tighten the strain relief.

3.10 Detecting Other Accessories





Tip If you ordered other UPS accessories, refer to their specific user manuals to check the connection to the UPS.

Chapter 4 Interfaces and Communication

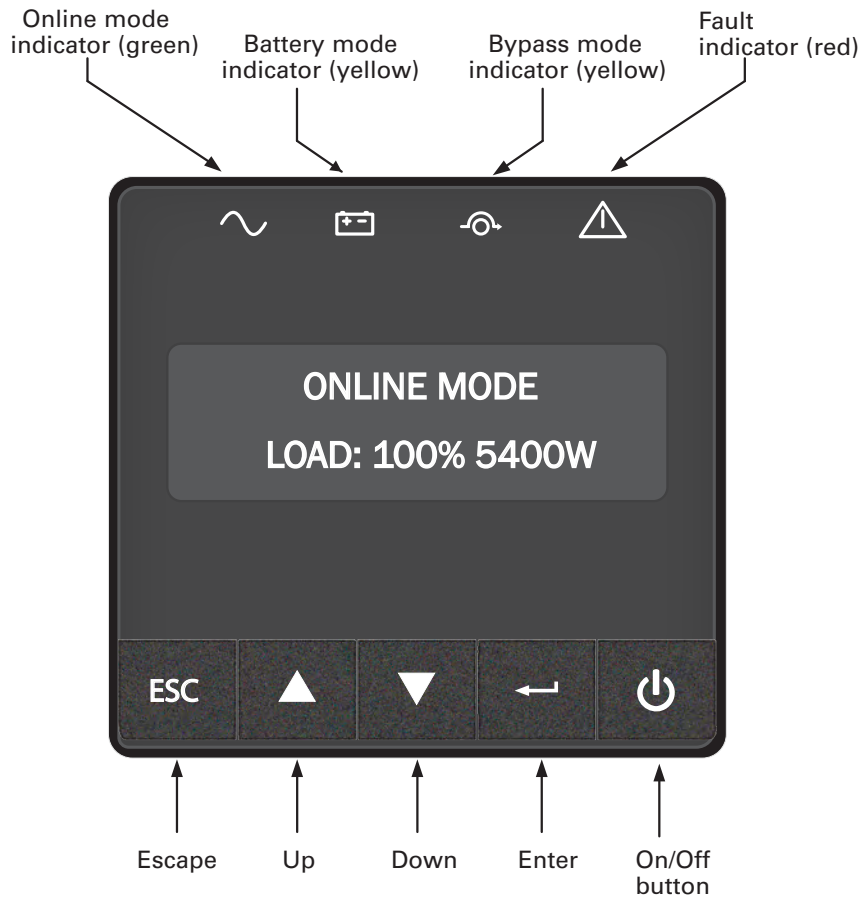
4.1 Control Panel

Figure 8. Control Panel



Indicator	Status	Description
 Green	On	The UPS is operating normally on Online, on High-Efficiency mode or on Battery Mode.
 Orange	On	The UPS is on Battery Mode.
 Orange	On	The UPS is on Bypass Mode.
 Red	On	The UPS has an active alarm or fault.

4.2 LCD Description

The LCD screen has two lines, and each line has 16 characters. The first line shows the UPS status and the second line shows the UPS measurements.

After five minutes of inactivity, the LCD displays the screen saver, and the LCD backlight automatically dims. Press any button to restore the screen.

Note: If a fault or alarm appears, the first line of LCD will cycle between the fault/alarm message and UPS mode. See [8.1 Typical Alarms and Faults](#) for additional information.

Figure 9. LCD Description

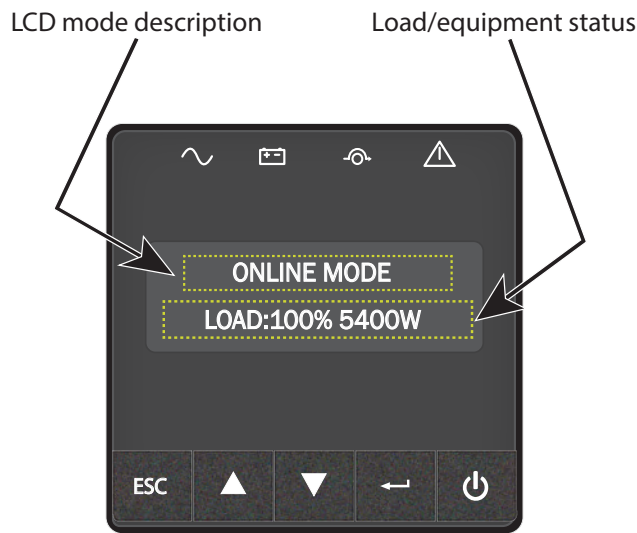

The following table describes the status information provided by the UPS

Note: If any other indicator displays, see [8.1 Typical Alarms and Faults](#) for additional information.

Table 5. LCD Operating Modes

UPS Display	Description
<p>STANDBY MODE IN : 120V 60.0HZ</p>	<p>Equipment is not powered until  button is pressed. The UPS is Off, waiting for the startup command from user.</p>
<p>ONLINE MODE LOAD:100% 5400VA</p>	<p>The UPS is powering and protecting the equipment. The UPS is operating normally.</p>
<p>BATTERY MODE RUNTIME : 104MIN</p>	<p>A utility failure has occurred and the UPS is on Battery Mode. The UPS is powering the equipment with the battery power. Prepare your equipment for shutdown.</p>

Table 5. LCD Operating Modes (Continued)

UPS Display	Description
<p>HIGH EFFIC. MODE IN : 120V 60.0HZ</p>	The UPS is operating on High-Efficiency mode. The UPS is powering and protecting the equipment
<p>BYPASS MODE IN : 120V 60.0HZ</p>	An overload or a fault has occurred, or a command has been received, and the UPS is in Bypass Mode. Equipment is powered but not protected by the UPS.

4.3 UPS Home Menu

The SmartOnline UPS will display the *Home Menu* by default. The *Home Menu* will show the UPS mode and contains nine different types of UPS measurements that can be seen by navigating the menu.

Navigate the *Home Menu* by pressing the ▲ or ▼ buttons on the display.

Press the ESC button to return to the first measurement of the *Home Menu*.

Table 6. UPS Home Menu

Display Information	LCD Display	Bottom Row Values
Displays the UPS mode, load percentage and W.	<p>ONLINE MODE LOAD : 100% 2700W</p>	The LOAD DATA screen specifies the amount of power that connected equipment is currently using in terms of percentage and Watts.
Displays the UPS mode, load percentage and VA.	<p>ONLINE MODE LOAD:100% 5400VA</p>	The OUTPUT LOAD LEVEL screen indicates the load percentage and VA output load level.
Displays the UPS mode and output load power factor.	<p>ONLINE MODE LOAD: PF = 0.99</p>	The OUTPUT LOAD POWER FACTOR screen indicates the power factor of connected equipment.
Displays the UPS mode, input voltage and frequency.	<p>ONLINE MODE IN:120V 60.0HZ</p>	The INPUT VOLTAGE & FREQUENCY screen displays current UPS input data.
Displays the UPS mode and output voltage and frequency.	<p>ONLINE MODE OUT : 120V 60.0HZ</p>	The OUTPUT VOLTAGE & FREQUENCY screen displays current UPS output data.
Displays the UPS mode, battery voltage and battery charge percentage.	<p>ONLINE MODE BATT : 50.2V 100%</p>	The BATTERY VOLTAGE screen tracks the charge level of your connected battery bank in terms of voltage and charge percentage.

Table 6. UPS Home Menu (Continued)

Display Information	LCD Display	Bottom Row Values
Displays the UPS mode, and remaining battery runtime.	ONLINE MODE RUNTIME : 104MIN	The RUNTIME REMAINING screen tracks the approximate minutes of runtime available under the current loading and battery pack configuration. The runtime value will automatically re-calculate as connected equipment power consumption changes.
Displays the UPS mode, and external battery quantity.	ONLINE MODE EBM: X	The EBM screen display external battery quantity.
Displays the UPS mode, and remaining Watts of UPS.	ONLINE MODE REMAIN W: 2.20KWH	The REMAIN WATTS screen tracks the remaining capacity of the UPS in kilowatt.
Displays the UPS mode and cumulative demand energy by the UPS.	ONLINE MODE DEMAND E: 2.20KWH	The DEMAND ENERGY screen offers continuous data on the KWh (kilowatt-hour) that connected equipment has consumed in the last one-hour period.

4.4 User Settings





The following table displays the options that the user can change. From the *UPS Home Menu* press the  button. The *Main Menu Screen* will open. To select a menu option, use the  or  buttons. Press the  button to validate the selected item. Pressing the ESC button will return to the previous menu level / screen.

Table 7. User Settings

Main Menu Screen	Submenu	Submenu	Menu Function
CONTROL	GO TO BYPASS / GO BACK NORMAL	GO TO BYPASS / GO BACK NORMAL?	The go to bypass command is used to force ups to Bypass Mode from Online Mode. The go back to normal command is used to comeback to line mode from Bypass Mode.
	BATTERY TEST	BATTERY TEST?	The battery test command is used to start battery test.
	RESET FAULT ST	RESET FAULT ST?	The reset fault state command is used to reset all faults. But some faults may not be cleared.
	CLEAR EVENT LOG	CLEAR EVENT LOG?	The clear event log command is used to clear the event log.
	RESET KWH USED	RESET KWH USED?	Used to reset the power usage.

Table 7. User Settings (Continued)

Main Menu Screen	Submenu	Submenu	Menu Function
	FACTORY SETT	FACTORY SETT?	The factory sett command is used to restore factory settings.
LOCAL SETTINGS	LANGUAGE	ENGLISH* (Default) [FRANCAIS] [ESPANOL]	Sets displayed language for all menus, status and alarms. The UPS fault, event log data and settings are in all supported languages.
	AUDIBLE ALARM	ENABLED* (Default) [ENABLED] [DISABLED ON BAT] [ALWAYS DISABLED]	Enables or disables the audible alarm.
IN / OUT SETTINGS	OUTPUT VOLTAGE	120V* (LV Default) [100V] [110V] [120V] [125V] 208V* (HV Default) [200V] [208V] [220V] [230V] [240V]	Sets the UPS output voltage. The UPS must be in standby to choose output voltage setting.
	OUTPUT FREQUENCY	AUTOSENSING* (Default) [AUTO SENSING] [FREQ CONV. 50HZ] [FREQ CONV. 60HZ]	Sets the output frequency, the output frequency follows the input frequency.
	HIGH EFFIC. MODE	DISABLED* (Default) [ENABLED] [DISABLED]	Powers the UPS output from bypass for High-Efficiency.
	OVERLOAD PREALARM	102%* (Default) [50%] [55%]...[100%][102%]	Sets the load % when overload alarm occurs.
ON / OFF SETTINGS	COLD START	ENABLED* (Default) [ENABLED] [DISABLED]	Cold start allows the UPS to start on battery power without the presence of input mains power.
	AUTO RESTART	ENABLED* (Default) [ENABLED] [DISABLED]	Auto restart allows the UPS to restart automatically when input mains power recovers after a complete battery discharge.
	AUTO START	ENABLED* (Default) [ENABLED] [DISABLED]	Enables the UPS to start as soon as input mains power is available, provided the input mains power is within the UPS operating specification.
	START ON BYPASS	ENABLED* (Default) [ENABLED] [DISABLED]	Enables the UPS to start in Bypass Mode if the input mains power is available and within specification.
	SLEEP MODE	ENABLED* (Default) [ENABLED] [DISABLED]	If Disabled, LCD and communication will turn off immediately after the UPS is OFF. If Enabled, LCD and

Table 7. User Settings (Continued)

Main Menu Screen	Submenu	Submenu	Menu Function
			communication stays ON 90 minutes after the UPS is OFF.
	SITE WIRING FLT	ENABLED* (Default) [ENABLED] [DISABLED]	Prevents the UPS from starting in case of phase to neutral wire swapping or improper grounding,
BATTERY SETTINGS	AUTO BAT TEST	MONTHLY*(Default) [NO TEST] [DAILY] [WEEKLY] [MONTHLY]	Allows the UPS to perform an automatic battery test.
	RESTART LEVEL	0%* (Default) [0%]...[100%]	Allows the UPS to restart when the set percentage battery charge is reached.
	BATT LOW LEVEL	0%* (Default) [0%]...[100%]	The alarm triggers when the set percentage of battery charge is reached.
	BATT LOW TIME	3 MIN* (Default) [0MIN] [3MIN] .. [60MIN]	The alarm triggers when the set battery time remaining is reached.
COM SETTINGS	REMOTE ON /OFF	NO* (Default) [NO] [ROO] [RPO] [BUILDING ALARM] [FORCED BYPASS] [ON GENERATOR] [SHUTDOWN CMD] Delay time and active cannot set by LCD. delay time: 3s active: open	Sets events or faults that actuate the output signal through the external contact connector or RS232 communications port.
	REMOTE PWR OFF	NO* (Default) [NO] [ROO] [RPO] [BUILDING ALARM] [FORCED BYPASS] [ON GENERATOR] [SHUTDOWN CMD] Delay time and active cannot set by LCD. delay time: 3s active: open	Sets events or faults that actuate the output signal through the external contact connector or RS232 communications port.
	INPUT DB9-4	NO* (Default) [NO] [ROO] [RPO] [BUILDING ALARM] [FORCED BYPASS] [ON GENERATOR] [SHUTDOWN CMD] Delay time and active cannot set by LCD. delay time: 3s active: open	Sets events or faults that actuate the output signal through the external contact connector or RS232 communications port.

Table 7. User Settings (Continued)

Main Menu Screen	Submenu	Submenu	Menu Function
	OUTPUT RELAY	BATTERY FAULT* (Default) [ON BATTERY] [LOW BATTERY] [BATTERY FAULT] [BYPASS] [UPS OK] [LOAD PROTECTED] [LOAD POWERED] [GENERAL ALARM] [BAT CHARGING] [OVLD PREALARM] [BAT DISCONN]	Sets events or faults that actuate the output signal through the external contact connector or RS232 communications port.
	OUTPUT DB9-1	LOW BATTERY* (Default) [ON BATTERY] [LOW BATTERY] [BATTERY FAULT] [BYPASS] [UPS OK] [LOAD PROTECTED] [LOAD POWERED] [GENERAL ALARM] [BAT CHARGING] [OVLD PREALARM] [BAT DISCONN]	Sets events or faults that actuate the output signal through the external contact connector or RS232 communications port.
	OUTPUT DB9-7	UPS OK* (Default) [ON BATTERY] [LOW BATTERY] [BATTERY FAULT] [BYPASS] [UPS OK] [LOAD PROTECTED] [LOAD POWERED] [GENERAL ALARM] [BAT CHARGING] [OVLD PREALARM] [BAT DISCONN]	Sets events or faults that actuate the output signal through the external contact connector or RS232 communications port.
	OUTPUT DB9-8	ON BATTERY* (Default) [ON BATTERY] [LOW BATTERY] [BATTERY FAULT] [BYPASS] [UPS OK] [LOAD PROTECTED] [LOAD POWERED] [GENERAL ALARM] [BAT CHARGING] [OVLD PREALARM] [BAT DISCONN]	Sets events or faults that actuate the output signal through the external contact connector or RS232 communications port.

4.5 Display Functions





Press the  button from the *UPS Home Menu* to activate the additional menu options. Use the two middle buttons  or  to scroll through the menu structure. Press the  button to validate the selected item. Pressing the ESC button will exit the previous menu level/screen.

Table 8. Display Functions

Main Menu	Submenu	Display Information or Menu function
CONTROL	GO TO BYPASS / GO BACK NORMAL	The GO TO BYPASS command is used to force the ups to Bypass Mode from Online Mode. The GO BACK NORMAL command returns the UPS to Online Mode.
	BATTERY TEST	The BATTERY TEST command is used to initiate the UPS battery test.

Table 8. Display Functions (Continued)

Main Menu	Submenu	Display Information or Menu function
	RESET FAULT ST	The RESET FAULT ST command is used to reset all faults. But some faults may not be cleared.
	CLEAR EVENT LOG	The CLEAR EVENT LOG command is used to clear all the event log.
	RESET KWH USED	The RESET KWH USED is used to reset the power used.
	FACTORY SETT	The FACTORY SETT command restores the UPS to original factory settings.
LOCAL SETTINGS	LANGUAGE	Sets the language displayed on the UPS.
	AUDIBLE ALARM	Allows the audible alarm to be enabled or disabled.
IN/OUT SETTINGS	OUTPUT VOLTAGE	Sets the UPS output voltage.
	OUTPUT FREQUENCY	Sets the UPS output frequency.
	HIGH EFFIC. MODE	Enables / Disables High-Efficiency mode.
	OVERLOAD PREALARM	Sets the overload pre-alarm percentage.
ON/OFF SETTINGS	COLD START	Enables / Disables the ability for the UPS to start on battery.
	AUTO RESTART	Enables / Disables the UPS to restart when mains power is available after a on battery shutdown.
	AUTO START	Enables / Disables the UPS to start when mains power is available.
	START ON BYPASS	Enables / Disables the UPS to start in Bypass Mode when mains power is available.
	SLEEP MODE	Enables / Disables the UPS to enter into Sleep Mode 90 minutes after the UPS is commanded to shut down.
	SITE WIRING FLT	Enables / Disables the UPS site wiring fault alarm.
BATTERY SETTINGS	AUTO BAT TEST	Sets the automatic UPS battery test interval.
	RESTART LEVEL	Sets the UPS battery restart level percentage.
	BAT LOW LEVEL	Sets the battery low alarm level percentage.
	BAT LOW TIME	Sets the battery low remaining time in minutes.
COM SETTINGS	REMOTE ON/OFF	Sets the input signal function for REMOTE ON/OFF.
	REMOTE PWR OFF	Sets the input signal function for REMOTE PWR OFF.
	INPUT DB9-4	Sets the input signal function for INPUT DB9-4.
	OUTPUT RELAY	Sets the output signal function for OUTPUT RELAY.
	OUTPUT DB9-1	Sets the output signal function for OUTPUT DB9-1.
	OUTPUT DB9-7	Sets the output signal function for OUTPUT DB9-7.

Table 8. Display Functions (Continued)

Main Menu	Submenu	Display Information or Menu function
	OUTPUT DB9-8	Sets the output signal function for OUTPUT DB9-8.
EVENT LOG		Displays the last 50 logged system events.
IDENTIFICATION		Displays the UPS serial number, model information and firmware information.

4.6 Communication Ports

Figure 10. Communication Port Information

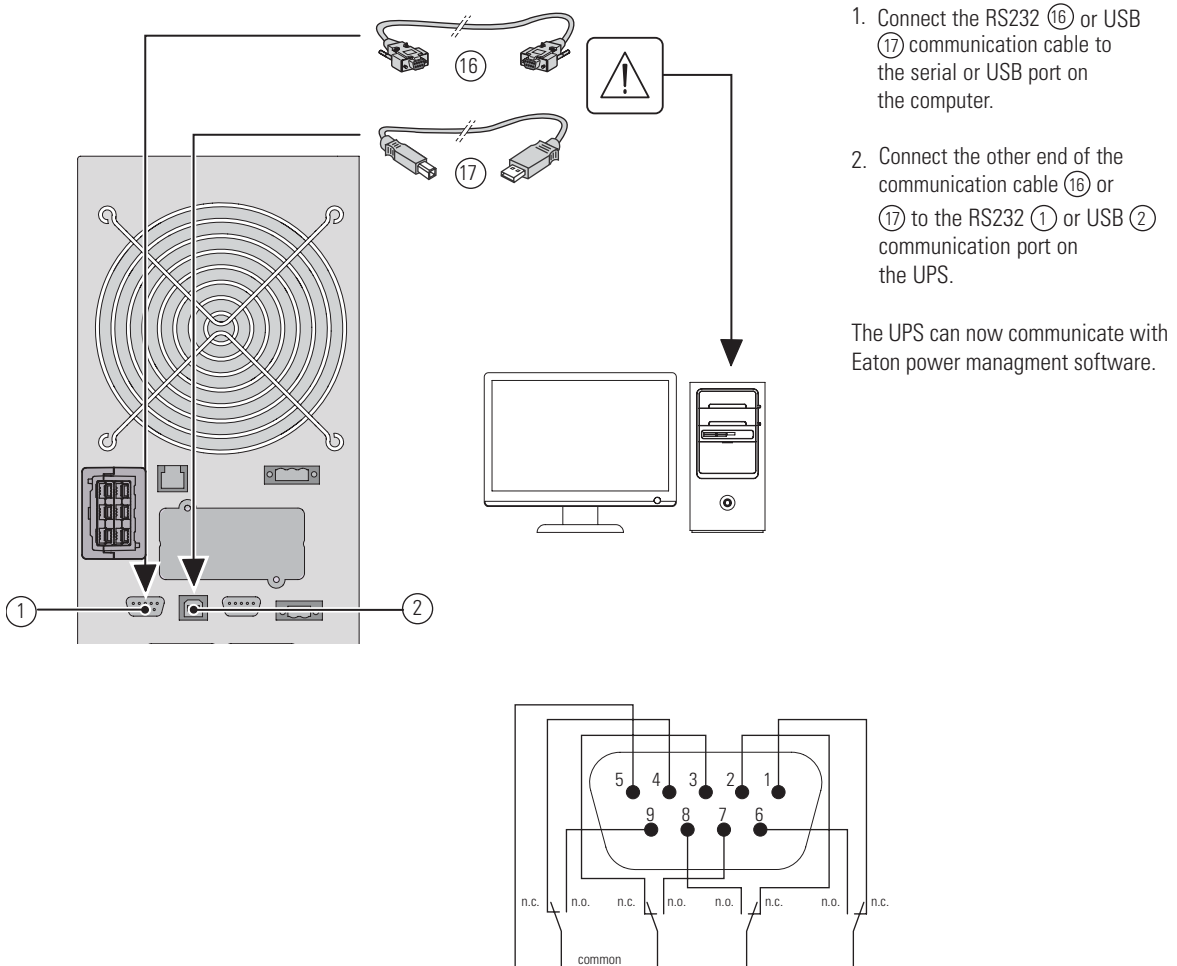

Table 9. Communication Port Pinouts

Pin 1: not on bypass	Pin 6: on bypass
Pin 2: load not protected	Pin 7: low battery
Pin 3: not low battery	Pin 8: load protected

Table 9. Communication Port Pinouts (Continued)

Pin 4: not on battery	Pin 9: on battery
Pin 5: user common	
n.o.: contact normally open n.c.: contact normally closed	

 **IMPORTANT**



The relay output contacts must not be connected to any utility-connected circuits. Reinforced insulation to the utility is required. The relay output contacts have a maximum rating of 250 Vac/5A.

4.7 UPS Remote Control Functions

Remote On/Off

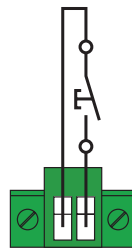
Figure 11. Normally Open ROO



- Remote On/Off allows for remote activation of the  button to switch the UPS On/Off.
- When contact changes from open to closed, the UPS is switched on (or stays on).
- When contact changes from closed to open, the UPS is switched off (or stays off).
- On/off control via the  button has priority over the remote control.

Remote Power Off

RPO is used to shut down the UPS remotely when the contact is open. This feature can be used for shutting down the load and the UPS by thermal relay, for instance, in the event of room over temperature. When RPO is activated, the UPS shuts down the output and all of its power converters immediately. The UPS remains on to alarm the fault. The RPO circuit is an IEC 60950 safety extra low voltage (SELV) . This circuit must be separated from any hazardous voltage circuits by reinforced insulation.

- The RPO must not be connected to any utility-connected circuits. Reinforced insulation to the utility is required. The RPO switch must have a minimum rating of 27 Vdc and 20 mA and be a dedicated latching type switch not tied into any other circuit. For proper operation, the RPO signal must remain active for at least 250 ms.
- To ensure the UPS stops supplying power to the load during any mode of operation, the input power must be disconnected from the UPS when the Remote Power Off function is activated.

Leave the RPO connector installed in the RPO port on the UPS even if the RPO function is not utilized.

RPO Connections:

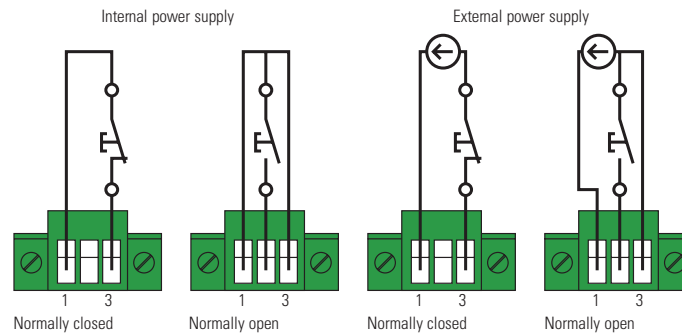

Terminal wire size rating is 0.32-4 mm² (22-12 AWG).
Suggested wire size is 0.82 mm² (18 AWG).

Remote control connection and test

1. Verify that the UPS is shut down and that the mains electrical input is disconnected from the UPS.
2. Remove the RPO connector from the UPS by loosening the screws.
3. Connect a normally closed volt-free contact between the two pins of the connector.

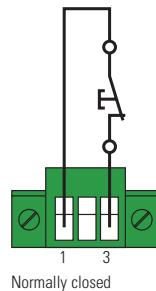

Contact open: shut down of UPS
To return to normal operation, deactivate the external remote shut down contact and restart the UPS from the front panel.

4. Plug the RPO connector into the back of the UPS and tighten the screws.
5. Connect and restart the UPS according to the previously-described procedures.
6. Activate the external remote shutdown contact to test the function. Always test the RPO function before applying your critical load to avoid an accidental load loss.

Connectivity Cards

Connectivity cards allow the UPS to communicate in a variety of networking environments and with different types of devices. The SmartOnline models have one open communication bay for the WEBCARDLXE network card, which provides monitoring and control using an SNMP network management platform, web browser, SSH, or Telnet.

Figure 12. WEBCARDLXE

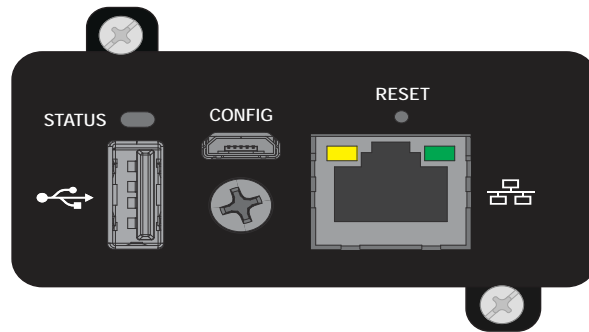

NOTE

Connect a Cat-6 shielded ethernet cable (F/UTP or F/FTP) or higher between the LXE platform device's ethernet port and a network jack.

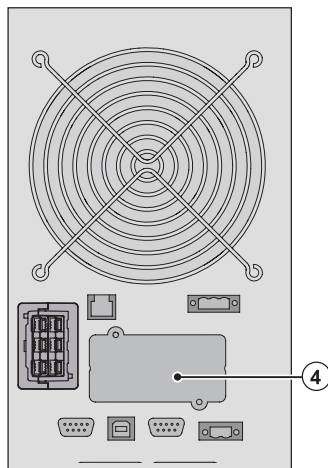

It is not necessary to shutdown the UPS before installing a communication card.

1. Remove the slot cover (4) secured by screws.
2. Insert the communication card in the slot.
3. Secure the card cover with the 2 screws.

4.8 Tripp Lite by Eaton PowerAlert Software Suite

The Tripp Lite by Eaton PowerAlert software suite is available from www.tripplite.eaton.com. The PowerAlert software suite provides up-to-date graphics representing UPS power and system data and power flow. It also gives you a complete record of critical power events and notifies you of important UPS or power information.

In the case of a power outage, or the SmartOnline UPS battery power becomes low, the PowerAlert Software suite can automatically shut down your computer system to protect your data before the UPS shutdown occurs.



Chapter 5 Operation

5.1 Startup and Normal Operation

**NOTE**

If you ordered a transformer module or other accessory, refer to the specific user manual of that accessory to check the startup sequence of the UPS with the accessory.

To start the UPS:

1. Verify that the internal batteries are connected. See [3.6 Connecting the Internal Battery](#).
2. If optional EBMs are installed, verify that the EBMs are connected to the UPS. See section [3.8 Connecting the EBM's](#).
3. Verify that the UPS power cord is plugged in.
4. The UPS front panel display will illuminate.
5. Press the  button on the UPS front panel for at least 3 seconds. The UPS front panel display changes status to "UPS starting...".
6. Check the UPS front panel display for active alarms or notices. Resolve any active alarms before continuing. See section [8.1 Typical Alarms and Faults](#). If the  indicator is on, do not proceed until all alarms are clear. Check the UPS status from the front panel to view the active alarms. Correct the alarms and restart if necessary.
7. Verify that the  indicator illuminates solid green, indicating that the UPS is operating normally and any loads are powered and protected.

5.2 Starting the UPS on Battery

Before using this feature, the UPS must have been powered by utility power with output enabled at least once. Battery start can be disabled. See cold start setting in .

To Start the UPS on the battery:

1. Press the  button on the UPS front panel until the UPS front panel display illuminates and shows a status of "UPS starting...".

The UPS cycles from Standby mode to Battery mode. The  indicator illuminates solid yellow.

The UPS supplies power to your equipment.

2. Check the UPS front panel display for active alarms or notices. Resolve any active alarms before continuing. See [8.1 Typical Alarms and Faults](#).

5.3 UPS Shutdown

To shut down the UPS:

1. Press the  button on the front panel for three seconds. A confirmation message will appear. When confirmed, the UPS starts to beep and shows a status of "UPS shutting OFF". The UPS then transfers to Standby Mode.
2. Set the upstream circuit breaker (not provided) to the "O" position (off) to switch off the utility power.

Chapter 6 Modes of Operation

6.1 Online Mode

During Online mode, the  indicator illuminates solid green and the UPS is powered from the utility. The UPS monitors and charges the batteries as needed and provides filtered power protection to your equipment. Optional High-Efficiency and Energy Saving settings minimize heat contribution to the rack environment.

6.2 Battery Mode

When the UPS is operates during a power outage, the alarm beeps once every ten seconds, and the  indicator illuminates solid yellow. The battery provides the necessary energy. When the utility power returns, the UPS transfers to the Online mode of operation while the battery recharges. If battery capacity becomes low while in Battery Mode, the audible alarm beeps once every three seconds. This warning is approximate, and the actual time to shutdown may vary significantly. Shut down all applications on the connected equipment, because automatic UPS shut down is imminent. The UPS automatically restarts when utility power is restored after the UPS shuts down.

6.3 Low Battery Warning

- The  indicator illuminates solid yellow.
- The audio alarm beeps every three seconds.

The remaining battery power is low. Shut down all applications on the connected equipment because automatic UPS shutdown is imminent.

End of battery backup time

- LCD displays "End of backup time."
- All of the LEDs are OFF.
- The audio alarms will stop.

6.4 Bypass Mode

In the event of a UPS overload or internal failure, the UPS transfers your equipment to utility power. Battery mode is not available, and your equipment is not protected, However, the UPS continues to filter utility power.

The  indicator illuminates. Depending on overload conditions, the UPS remains in Bypass mode for at least five seconds and will stay in this mode if three transfers to Bypass occur within twenty minutes.

The UPS transfers to Bypass mode when:

- the user activates Bypass mode through the front panel.
- the UPS detects an internal failure.
- the UPS has an over-temperature condition.
- the UPS has an overload condition listed in [9.1 Model Specifications](#).

The UPS shuts down after a specified delay for overload conditions listed in [9.1 Model Specifications](#). The UPS remains on to alarm the fault.

6.5 Standby Mode

When the UPS is turned off and remains connected to the AC source, the UPS is in Standby mode.

The output is powered but not protected if the Bypass Standby setting is enabled.

The battery recharges when necessary and the communication ports are powered.

6.6 Transferring Between Modes

From Online (or Battery) to Bypass mode. Press any button to activate the menu options, then select Control and go to Bypass.

From Bypass to Online (or Battery) mode. Press any button to activate the menu options, then select Control and go to back Normal.

See [4.4 User Settings](#) for help with navigation between settings.

6.7 Setting High-Efficiency mode

In High-Efficiency mode, the UPS operates on bypass and transfers to Online (or Battery) mode in less than 10 ms when the utility fails. Transfers to High-Efficiency mode will be active after five minutes of bypass voltage monitoring: if bypass quality is out of tolerance, then the UPS will remain in Online mode.

Eaton recommends using High-Efficiency mode only to protect IT equipment.

To set the High-Efficiency mode:

1. Select settings, In/Out settings, and High-Efficiency mode.
2. Select Enabled and press enter to confirm.
3. The UPS transfers to High-Efficiency mode after five minutes.

6.8 Configuring Battery Settings

Automatic Battery Tests

Automatic battery tests occur once a month in constant charging mode.

The battery test frequency can be modified.

During the test, the UPS transfers to Battery mode and discharges the batteries for ten seconds under load.

Low battery warning

During discharge, the low battery alarm is activated if the remaining runtime goes below three minutes or less than the setting capacity threshold (0% by default). This threshold can be modified.







Restart battery level

This setting is used to define the battery restart level. The battery level must reach this threshold (0% by default) to enable the UPS to start.

See the [4.4 User Settings](#) section to modify these settings.

6.9 Retrieving the Event Log

To retrieve the event log through the display:

1. From the UPS home menu, press the  button to enter User Settings.
2. In the User Settings screen press the  or  button until the Event Log menu is displayed.
3. Press the  button. Use the  or  buttons to display the events.

The log retains 50 events, with the most recent event listed first. Press the esc button twice to return to the UPS home menu.

Chapter 7 UPS Maintenance

7.1 Equipment Care

For the best preventive maintenance, keep the area around the equipment clean and dust free. If the atmosphere is very dusty, clean the outside of the system with a vacuum cleaner. For full battery life, keep the equipment at an ambient temperature of 25° C (77° F).

If the UPS needs to be transported, verify that the battery is disconnected and the UPS is turned off. The batteries are rated for a 3-5 year service life. The length of service life varies, depending on the frequency of use and ambient temperature (product life divided by two for each ten degrees C over 25).

Batteries used beyond expected service life will often have reduced runtimes. Replace batteries at least every four years to keep units running at peak efficiency. Battery runtime will be reduced at low temperatures (below 10° C).

7.2 Storing the Equipment

If you store the equipment for an extended period, recharge the battery every six months by connecting the UPS to utility power. The internal batteries charge to 90% capacity in less than 3 hours. However, Eaton recommends charging the batteries for 48 hours after long-term storage. Check the battery recharge date on the shipping carton label. If the date has passed and the batteries were never recharged, do not use them. Contact your service representative.

7.3 Replacing the Batteries



IMPORTANT

DO NOT DISCONNECT the batteries while the UPS is in Battery Mode.

Batteries can be replaced easily without turning off the UPS or disconnecting the load. If you prefer to remove input power to change the batteries, see [5.3 UPS Shutdown](#).

Consider all warnings, cautions, and notes before replacing batteries.

- Servicing should be performed by qualified service personnel knowledgeable of batteries and required precautions. Keep unauthorized personnel away from batteries.
- Batteries can present a risk of electrical shock or burn from a high short circuit current. Observe the following precautions:
 1. Remove watches, rings, or other metal objects
 2. Use tools with insulated handles
 3. Do not lay tools or metal parts on top of batteries
 4. Wear rubber gloves and boots
- When replacing batteries, use the same type and number of batteries or battery packs. Contact your service representative to order new batteries.
- Proper disposal of batteries is required. Refer to your local regulations for proper disposal requirements.
- Never dispose of batteries in a fire. Batteries may explode when exposed to flame.
- Do not open or mutilate the batteries. Released electrolyte is highly toxic and will harm your eyes and skin.
- Determine whether the battery is inadvertently grounded. If it is inadvertently grounded, remove the source from the ground. Contact with any part of a grounded battery can result in electrical shock. The likelihood of such shock can be reduced if such grounds are removed during installation and maintenance (applicable to equipment and remote battery supplies not having a grounded supply circuit).

- Disconnect the charging source prior to connecting or disconnecting battery terminals.



ELECTRIC ENERGY HAZARD. Do not attempt to alter any battery wiring or connectors. Attempting to alter wiring can cause injury.

Replacing the internal battery

The internal battery is heavy. Use caution when handling heavy batteries.

Figure 13. Internal Battery Pack Replacement

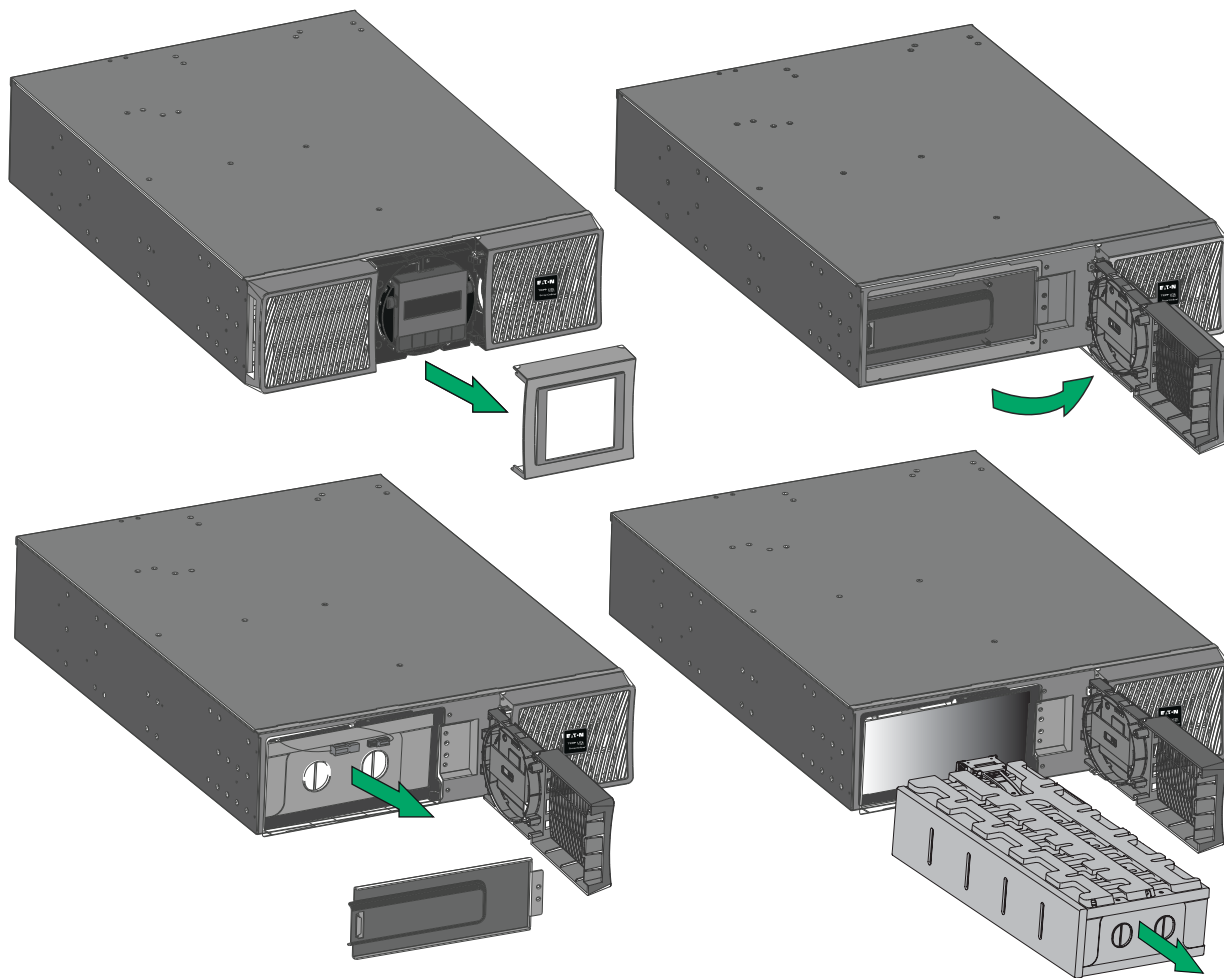

To replace the battery pack:

1. Remove the center cover of the front panel.
2. Remove the two screws to open the left front panel.
3. Disconnect the battery connectors.

A ribbon cable connects the LCD control panel to the UPS. Do not pull or disconnect the cable.

4. Remove the two screws to pull out the metal battery protection cover.
5. Pull out the handle of the battery pack, and slide the pack out slowly onto a flat and stable surface. Use two hands to support the battery pack. See [7.4 Recycling The Used Equipment](#) for proper disposal.
6. Verify that the replacement batteries have the same rating as those being replaced.
7. Put the new battery pack into the UPS. Seat the battery pack firmly into the UPS,
8. Verify that all of the alarms have cleared on the display.
9. Screw back the metal battery protection cover and the front panel, then clip the center cover back into place.
10. If the UPS was shut down during the battery replacement process, see [5.1 Startup and Normal Operation](#) to power the UPS back on.

Replacing the EBM(s)

The EBM is heavy. Lifting the cabinet into a rack requires a minimum of two people.

To replace the EBM(s):

1. Unplug the UPS's EBM power and battery detection cables. If additional EBM(s) are installed, unplug the EBM power cable and battery detection cable from each EBM.
2. Replace the EBM(s). See [7.4 Recycling The Used Equipment](#) for proper disposal.
A small amount of arcing may occur when connecting an EBM to the UPS which is normal and will not harm personnel. Insert the EBM cable into the UPS battery connector quickly and firmly.
3. Plug the EBM cable(s) into the battery connector(s). Up to four EBMs may be connected to the UPS.
4. Verify that the EBM connections are tight and that each cable has adequate bend radius and strain relief.
5. Connect the battery detection cable(s) to the UPS connector and the EBM(s).
6. If the UPS was shut down during the battery replacement process follow the start procedure in the Start-up and Normal Operation section.

7.4 Recycling The Used Equipment

Contact your local recycling or hazardous waste center for information on proper disposal of the used equipment.



RISK OF ELECTRIC SHOCK - Observe the warning associated with the risk of electric shock symbol.



This symbol indicates that you should not discard the UPS or the UPS batteries in the trash. This product contains sealed, lead-acid batteries and must be disposed of properly. For more information, contact your local recycling/reuse or hazardous waste center.



This symbol indicates that you should not discard waste electrical or electronic equipment (WEEE) in the trash. For proper disposal, contact your local recycling/reuse or hazardous waste center.

Recycling The Used Equipment

Chapter 8 Troubleshooting

8.1 Typical Alarms and Faults

The Eaton Tripp Lite Series UPS alerts you to whenever potential operating problems occur. The alarms shown by the control panel do not mean that the output power is affected. Instead, they are preventive alarms intended to alert the user.

- Events are silent status information that is recorded in the Event log. For example = "AC freq in range."
- Alarms are recorded in the Event log and display on the LCD status screen. Some alarms may be announced by a beep every three seconds. For example = "Battery low."
- Faults are announced by a continuous beep and a red LED, recorded into the fault log, and display on the LCD with a specific message box. For example = Output short circuit.





Use the following troubleshooting chart to determine the UPS alarm condition.

Checking the Alarms and Faults





To check the Event log or Fault log :

1. Press any button on the front panel display to activate the menu options.
2. Press the ▼ button to select Event log or Fault log.
3. Scroll through the list of events or faults.

The following table describes typical conditions.

Conditions	Possible cause	Action
Battery mode  LED is on One beep every One0 seconds	A utility failure has occurred, and the UPS is in Battery mode.	The UPS is powering the equipment with battery power. Prepare your equipment for a shutdown.
Battery mode  LED is on One beep every three seconds	The UPS is in Battery mode, and the battery is running low.	This warning is approximate, and the actual time to shut down can vary significantly. Depending on the UPS load and number of Extended Battery Modules (EBMs), the Battery Low warning may occur before the batteries reach 20% capacity.
No battery  LED is on Beep continuous	The batteries are disconnected.	Verify that all batteries are properly connected. To clear a battery disconnected alarm initiate a battery test. If the condition persists, contact your service representative.
Battery fault  LED is on Beep continuous	The battery test failed due to discharged or disconnected batteries.	Verify that all batteries are properly connected. To clear a battery disconnected alarm initiate a battery test. If the condition persists, contact your service representative.
The UPS does not provide the expected backup time	The batteries need charging or service.	Apply utility power for 48 hours to charge the batteries. If the condition persists, contact your service representative.

Silencing the Alarm

Conditions	Possible cause	Action
Bypass mode  LED is on	An overload or a fault has occurred, or a command has been received, and the UPS is in Bypass mode.	Equipment is powered but not protected by the UPS. Check for one of the following alarms: over-temperature or overload alarms, or that the red LED on the UPS is on.
Power overload  LED is on	Power requirements exceed the UPS capacity (greater than 100% of nominal).	Remove some of the equipment from the UPS. The UPS continues to operate, but may switch to Bypass mode or shut down if the load increases. The alarm resets when the condition becomes inactive.
UPS over temperature  LED is on. One beep every three seconds	The UPS internal temperature is too high or a fan has failed. At the warning level, the UPS generates the alarm but remains in the current operating state. If the temperature rises another One0° C, the UPS transfers to Bypass mode or shuts down if Bypass is unusable.	If the UPS transferred to Bypass mode, the UPS will return to normal operation when the temperature drops 5° C below the warning level. If the condition persists, shut down the UPS. Clear vents and remove any heat sources. Allow the UPS to cool. Ensure the airflow around the UPS is not restricted. Restart the UPS. If the condition persists, contact your service representative.
The UPS does not start	The input source is not connected correctly.	Check the input connections.
	The Remote Power Off (RPO) switch is active or the RPO connector is missing.	If the UPS Status menu displays "Remote Power Off", deactivate the RPO input.
Input bad wiring / Output bad wiring  LED is on Beep is continuous	Input/Output cables are not connected to the correct terminal blocks.	Correctly connect the Input/Output cables.

8.2 Silencing the Alarm

Press the ESC button on the front panel display to silence the alarm. Check the alarm condition and perform the appropriate action to resolve the situation. If the alarm status changes, the alarm will beep again, overriding the previous alarm silencing.

8.3 Service and Support

If you have any questions or problems with the UPS, call your **Local Distributor** or **Eaton Support** at one of the following telephone numbers and ask for a UPS technical representative.

United States:	1-800-356-5737
Canada:	1-800-461-9166 ext 260
All other countries:	Call your local service representative

Please have the following information ready when you call Eaton Support:

- Model number
- Serial number
- Version number (if available)
- Date of failure or problem
- Symptoms of failure or problem
- Customer return address and contact information

If repair is required, you will be given a Returned Material Authorization (RMA) number. This number must appear on the outside of the package and on the Bill Of Lading (if applicable). Use the original packaging or request packaging from Eaton Support or your local distributor. Units damaged in shipment as a result of improper packaging are not covered under warranty. A replacement or repair unit will be shipped, and freight prepaid for all units within the warranty period.

**NOTE**

For critical applications, immediate replacement may be available. Call **Eaton Support** for the dealer or distributor nearest you.

Chapter 9 Specifications

9.1 Model Specifications

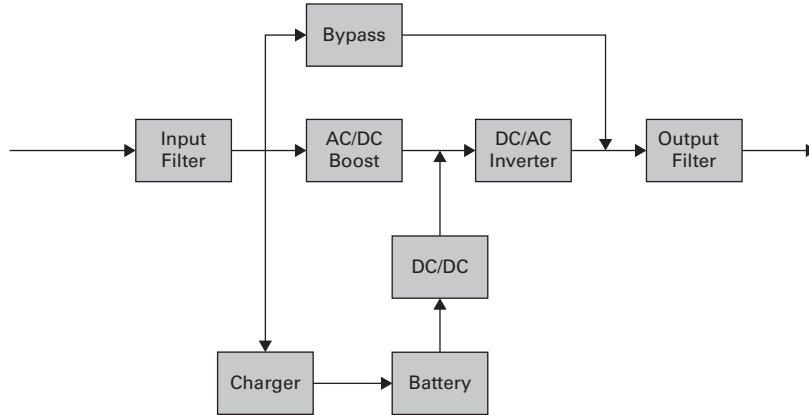

Table 10. Power Module List

Model	Power ratings
SU5000RT	5000VA / 4500W
SU6000RT	5200VA / 4600W at 200V output
	5400VA / 4800W at 208V output
	5700VA / 5100W at 220V output
	6000VA / 5300W at 230V output
	6000VA / 5400W at 240V output

Table 11. Extended Battery Module List

Model	Configuration	Battery voltage	For power module
BP180RT	Rack / Tower	180Vdc	SU5000RT / SU6000RT

Table 12. Weights and Dimensions

Description	Weights (lb/kg)	Dimensions (inch/mm) D x W x H
SU5000RT	106 / 48	28.4 x 17.3 x 5.1 / 722 x 440 x 130
SU6000RT	106 / 48	28.4 x 17.3 x 5.1 / 722 x 440 x 130
BP180RT	150/68	25.4 x 17.3 x 5.1 / 645 x 440 x 130

Table 13. Electrical Input

Model	Default input (Voltage/Max Current)	Input nominal voltages	Input voltage window at rated load
SU5000RT	208V / 23.3A	200V, 208V, 220V, 230V, 240V	176-276V
SU6000RT	208V / 24.8A		
Nominal frequency		50/60Hz auto-sensing	
Frequency range		50Hz : 40-60Hz before transfer to battery 60Hz : 50-70Hz before transfer to battery	
Bypass voltage range		-20% / +15% of nominal value (default)	
Noise filtering		MOV for normal and common mode noise	

Table 14. Electrical Input Connections

Model	Input connection
SU5000RT	L6-30P cord or hardwired
SU6000RT	L6-30P cord or hardwired

Table 15. Electrical Output

All models	Normal mode	Battery mode
Voltage regulation	±1%	±1%
Efficiency	> 98% (High-Efficiency mode) >93%	> 91%
Frequency regulation	Sync with line ±5% of nominal line frequency (outside this range: ±0.5% of auto-selected nominal frequency)	±0.5% of auto-selected nominal frequency
Nominal output	200*/208*/220*/230*/240V (voltage configurable) 5000 / 6000VA* 4500/5400W*	
Frequency	50 or 60 Hz, auto-sensing or configurable as a frequency converter	
Output overload	100-102% : no alarm 102-110% : load transfers to Bypass mode after 2 minutes 110-125% : load transfers to Bypass mode after 1 minute 125-150% : load transfers to Bypass mode after 10 seconds > 150% : load transfers to Bypass mode after 500 ms	
Output overload (Bypass mode)	100-125% : no alarm 125-150% : UPS shuts down after one minute > 150% : UPS shuts down after one second	
Voltage waveform	Sine wave	
Harmonic distortion	< 2% THDV on linear load < 5% THDV on non-linear load	
Transfer time	Online mode: 0 ms (no break) High-Efficiency mode: 10 ms maximum (due to loss of utility)	

Table 15. Electrical Output (Continued)

All models	Normal mode	Battery mode
Power factor	Up to 0.9	
Load crest ratio	Up to 3:1	
* 200/208/220/230V are derated at 4600/4800/5100/5300W.		

Table 16. Electrical Output Connections

Model	Output connection	Output cable
SU5000RT / SU6000RT	Hardwired (2) L6-30R (2) L6-20R	No

Table 17. Environmental and Safety

Certifications	IEC/EN 62040-1 IEC/EN 62040-2 :Cat. C2 IEC/EN 62040-3 UL1778 5th edition CSA 22.2
EMC (Emissions)*	CISPR32 (EN55032) Class A AS/NZS CISPR32 Class A IEC 61000 (-3-11) IEC 61000 (-3-12) FCC part 15 Class A
EMC (Immunity)	IEC 61000-2-2 IEC 61000-4-2, Level 3 IEC 61000-4-3, Level 3 IEC 61000-4-4, Level 4 (also on signal ports) IEC 61000-4-5, Level 4, Criteria B IEC 61000-4-6, Level 3 IEC 61000-4-8, Level 4 IEC 61000-4-11 IEC 61000-4-12
* for output cable < 10m.	
Agency markings*	cTUVus/NOM(TUV NOM)/CE
Operating temperatures	0 to 40°C (32 to 104°F) in Online mode, with linear de rating for altitude Note: thermal protection switches load to bypass in case of overheating.
Storage temperatures	0 to 40°C (32 to 104°F) with batteries -25 to 55°C (-13 to 130°F) without batteries
Transit temperature	-25 to 55°C (-13 to 130°F)
Relative humidity	0 to 96% no condensing

Table 17. Environmental and Safety (Continued)

Operating altitude	Up to 3,000 meters (9,843 ft) above sea level with 10% derating per 1000m
Transit altitude	Up to 10,000 meters (32,808 ft) above sea level
Audible noise	< 45 dBA at 1 meter typical

Table 18. Battery

	Internal batteries	EBM
Rack / Tower configuration	SU5000RT: 180Vdc SU6000RT: 180Vdc	BP180RT: 180Vdc
Type	Sealed, maintenance-free, valve-regulated, lead-acid, with minimum 3-year float service life at 25 °C (77 °F). Lifetime is reduced above 25° C (77° F)	
Monitoring	Advanced monitoring for earlier failure detection and warning	
Battery port	External three-pole SBS75G black connector on UPS for connection to EBM	
EBM battery cable length	40 cm (15.7 in)	

Table 19. Communications Options

Communication bay	Available independent communication bay for connectivity card
Compatible connectivity cards	WEBCARDLXE
Communication ports	RS-232 (DB9): 1200-19200 bps USB: 19200 bps
Relay output contacts	Four relay outputs (normally open or normally closed)
Remote On/Off	Two pins jumper (normally open)
Remote power off	Three pins jumper (normally open or normally closed)



614-40204 01