

The top half of the page features a complex, abstract background of overlapping blue triangles and polygons in various shades, creating a textured, crystalline effect. A white diagonal line separates this pattern from the plain white background below.

User Guide

020-001779-03

Secure Series II LCD Panels

CHRISTIE

NOTICES

COPYRIGHT AND TRADEMARKS

Copyright © 2023 Christie Digital Systems USA, Inc. All rights reserved.

All brand names and product names are trademarks, registered trademarks or trade names of their respective holders.

GENERAL

Every effort has been made to ensure accuracy, however in some cases changes in the products or availability could occur which may not be reflected in this document. Christie reserves the right to make changes to specifications at any time without notice. Performance specifications are typical, but may vary depending on conditions beyond Christie's control such as maintenance of the product in proper working conditions. Performance specifications are based on information available at the time of printing. Christie makes no warranty of any kind with regard to this material, including, but not limited to, implied warranties of fitness for a particular purpose. Christie will not be liable for errors contained herein or for incidental or consequential damages in connection with the performance or use of this material. Canadian manufacturing facility is ISO 9001 and 14001 certified.

For the most current technical documentation and office contact information, visit www.christiedigital.com.

WARRANTY

Products are warranted under Christie's standard limited warranty, the details of which are available at <https://www.christiedigital.com/help-center/warranties/> or by contacting your Christie dealer or Christie.

PREVENTATIVE MAINTENANCE

Preventative maintenance is an important part of the continued and proper operation of your product. Failure to perform maintenance as required, and in accordance with the maintenance schedule specified by Christie, will void the warranty.

REGULATORY (if applicable)

The product has been tested and found to comply with the limits for a Class A digital device, pursuant to Part 15 of the FCC Rules. These limits are designed to provide reasonable protection against harmful interference when the product is operated in a commercial environment. The product generates, uses, and can radiate radio frequency energy and, if not installed and used in accordance with the instruction manual, may cause harmful interference to radio communications. Operation of the product in a residential area is likely to cause harmful interference in which case the user will be required to correct the interference at the user's own expense. Changes or modifications not expressly approved by the party responsible for compliance could void the user's authority to operate the equipment.

CAN ICES-3 (A) / NMB-3 (A)

이 기기는 업무용(A급)으로 전자파적합등록을 한 기기이오니 판매자 또는 사용자는 이점을 주의하시기 바라며, 가정 외의 지역에서 사용하는 것을 목적으로 합니다.

ENVIRONMENTAL



The product is designed and manufactured with high-quality materials and components that can be recycled and reused. This symbol  means that electrical and electronic equipment, at their end-of-life, should be disposed of separately from regular waste. Please dispose of the product appropriately and according to local regulations. In the European Union, there are separate collection systems for used electrical and electronic products.

If printing this document, consider printing only the pages you need and select the double-sided option.

Please help us to conserve the environment we live in!

Content

- Unpacking and handling the display6**
 - Unpacking the panel 6
 - Handling and mounting guidelines for extreme narrow bezel series panels 7
 - Cleaning the panel 7
 - Product documentation 7
 - Related documentation 8
 - Important safeguards 8
 - General Safety precautions 8
 - Electrical specifications 9
 - Environmental specifications 9
 - Symbols 10

- Introduction 11**
 - Product overview 11
 - Key features 11
 - Parts List 12
 - Technical support 12

- Controls and functions 13**
 - Display-at-a-glance 13
 - In/Output panel 15
 - Remote control unit 20

- Installing the display 22**
 - Remote control 22
 - Notes on batteries 22
 - Notes on remote control operation 22
 - Quick setup: workflow 23
 - Installation considerations 23
 - Ambient light 23
 - Ambient heat 23
 - Ventilation considerations 23
 - Mounting the display 24
 - Connections to the display 24
 - Connecting a control system or PC 25

RS232 connection	25
IR Receiver kit connection	25
Connecting source components to the display	26
DisplayPort source connection	26
HDMI source connections	27
Turning on the power	28
Avoiding image retention.....	28
Avoid static content	29
Changing the on-screen display language	29
Operation	30
Using the on-screen menus.....	30
Picture settings	34
Determining the image input	34
Setting panel backlight	34
Selecting.....	34
Picture Mode	34
Setting image contrast.....	34
Setting image brightness	35
Setting image color	36
Setting image sharpness.....	36
Setting image color temperature.....	37
Enabling or disabling HDR10.....	37
Resetting the picture values	37
Sound settings.....	38
Setting the audio input	38
Adjusting the volume.....	38
Adjusting the sound balance.....	38
OSD settings.....	39
Specifying the language.....	39
Turning off the on-screen display menus.....	39
Determining the on-screen display position	39
Setup settings.....	40
Enabling Power Save	40
Determining how the display goes into Power Off Mode.....	40
Selecting the interface	40
Powering the display on or off using a.....	41

CEC command	41
Setting the OPS/HDMI4 EDID	41
Determining the gamma curve.....	41
Enabling or disabling the active source	41
Enabling or disabling Low Latency Mode.....	41
Performing a factory reset.....	42
Presets.....	42
Applying presets	42
Editing presets.....	42
Storing multiple window presets	42
Resetting presets	43
Preset Edit.....	43
Selecting an input mode	44
Viewing status information.....	45
Open Plugable Specification (OPS).....	45
Supported timings	47
Updating the Scaler firmware using USB	49
Network guide	51
Setting the connection	51
PC Setting	52
Completing a ping test.....	52
Connecting a web server	52
Upgrading the Ethernet or Scaler firmware.....	53
Connecting to the Crestron–X-panel program.....	53
Connecting to the Crestron–Roomview program	54
Controlling monitor settings.....	54
Maintenance and troubleshooting.....	55
Maintenance	55
Troubleshooting.....	55

Unpacking and handling the display

Learn how to remove the display panel from the packaging and how to handle the display panel.

Unpacking the panel

Learn how to remove the panel from the packaging. Each LCD panel is packed inside a box carton. To protect the panel during transportation, additional packing material has been placed within the carton.

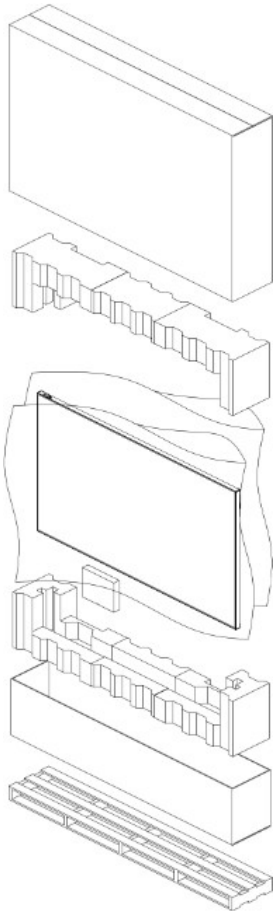

Before unpacking, prepare a stable, level and clean surface near a wall outlet.

1. Set the box in an upright position and pull out the white carton locks.
2. Lift up the top cover carton.
3. Remove the polybag before removing the display from the bottom tray carton.
4. Remove any additional packaging, such as protective stickers, from the display panel.

Handling and mounting guidelines for extreme narrow bezel series panels

Follow these best practices when handling and mounting extreme narrow bezel panels:



Notice. If not avoided, the following could result in property damage.

- When moving the panel, always use the handles. Do not carry the frame.
- Do not twist, bend, or tilt the panel.
- Do not apply excessive force to the sides of the bezel when mounting the panel or pushing into its locked position.
- Always handle the display panel from the sides or handles.

Follow the following guidelines before removing the panel from the packaging:

- To verify normal operation before handling, power on the panel in the packaging.
- Always use the handles to pick up and carry the panel.
- Leave the panel in the box until the mount is on the wall and you are ready to install the panel.
- To avoid putting undue stress on the panel when mounted, make sure the mount is square, flat, and level.
- Do not rest panels on top of a lower panel.
- When inserting the panel into the wall, pay close attention to adjacent panels.
- Make sure there is a minimum of 0.5 mm between mounted panels to allow for thermal expansion.

Cleaning the panel

Learn how to clean the display panel.

1. After disconnecting the power cable, wipe contaminated parts and each part of the product screen lightly with a dry and soft cloth.
 - Do not use a liquid, spray cleaners, or any abrasive cleaners to clean the LCD panel.
 - Washing with various cleaning agents, brighteners, abrasives, waxes, benzene, alcohol, solvent, surface active agent, may damage the surface of the product.

Product documentation

For installation, setup, and user information, see the product documentation available on the Christie website. Read all instructions before using or servicing this product. To access the documentation from the Christie website:

- Go to this URL: <https://bit.ly/2VccFTr>
- Scan the QR code using a QR code reader app on a smartphone or tablet



2. On the product page, select the model and switch to the **Downloads** tab.

Related documentation

Additional information on the LCD panels is available in the following documents.

- SUHD863-L, SUHD753-L, SUHD653-L, SUHD553-L LCD Panels Product Safety Guide (P/N: 020-001778-XX)
- SUHD863-L, SUHD753-L, SUHD653-L, SUHD553-L LCD Display Panels External Commands (P/N: 020-001915-XX)
- SUHD553-L LCD Panels Service Guide (P/N: 020-001850-XX)
- SUHD653-L LCD Panels Service Guide (P/N: 020-001851-XX)
- SUHD753-L LCD Panels Service Guide (P/N: 020-001876-XX)
- SUHD863-L LCD Panels Service Guide (P/N: 020-001887-XX)

Important safeguards

To prevent personal injury and to protect the device from damage, read and follow these safety precautions.

General Safety precautions

Observe these important safety rules to avoid personal injury or damage to the product.



Warning! If not avoided, the following could result in death or serious injury.

- Christie products must be installed and serviced by Christie qualified technicians.
- Two people or adequately rated lifting equipment are required to safely lift, install, or move the product.
- FIRE HAZARD! Do not install near any devices that produce heat such as amplifiers, radiators, heat registers, or stoves.
- SHOCK HAZARD! Only use the AC power cord provided with the product or recommended by Christie.
- SHOCK HAZARD! Disconnect the product from AC before servicing, cleaning, removing components, or opening any enclosure.
- FIRE HAZARD! Do not use a power cord that appears damaged.
- SHOCK HAZARD! Do not attempt operation if the AC supply is not within the specified voltage and power range, as specified on the license label.
- SHOCK HAZARD! The AC power cord must be inserted into an outlet with grounding.
- Always connect the ground first to reduce shock hazard.

- TRIP OR FIRE HAZARD! Position all cables where they cannot contact hot surfaces, be pulled, be tripped over, or damaged by persons walking on or objects rolling over the cables.
- Do not drop the panel (even a short distance), or apply pressure to the sides of the bezel. The small size of the bezel, means there is reduced protection of the LCD glass and components. Dropping the panel or applying unnecessary force to the sides of the bezel will result in permanent damage.
- To avoid serious injury and/ or serious damage to the LCD panel, moving the panel requires at least four people.
- Extreme care must be taken when pushing the mounted display into its locked position. Always handle the display on the opposing corners of the frame to avoid direct contact with the LCD glass.



Caution! If not avoided, the following could result in minor or moderate injury.

- Do not tilt the product more than ± 15 degrees.
- Use the handles when moving the shipping package.
- Do not twist, bend, or tilt the panel.



Notice. If not avoided, the following could result in property damage.

- Install the product at least 10 cm from the wall.
- Do not install in locations where has vibration or in an unstable position as the product may fall and cause damage.
- Do not install in places where dirt, moisture, smoke, much water or rain water can reach the product.
- Avoid exposure to direct sunlight and do not place near hot objects such as a fire or heater heat. This may cause a fire or shortening the product life.
- Do not place heavy objects on the product.
- Always provide proper ventilation for the product to prevent overheating.
- Do not place the screen on a hard surface.

Electrical specifications

Rate input voltage:

- SUHD553L: 100 to 240 V, 50/60 Hz, 3.1 to 1.3 A
- SUHD653L: 100 to 240 V, 50/60 Hz, 2.6 to 1.1 A
- SUHD753L: 100 to 240 V, 50/60 Hz, 2.9 to 1.2 A
- SUHD863L: 100 to 240 V, 50/60 Hz, 4.1 to 1.7 A

Environmental specifications

Learn about the environmental specifications:

- Operating temperature:
 - 0 to 40°C (32 to 104°F)
 - 20 to 80% RH
- Storage temperature:

- -20 to 60°C (-4 to 140°F)
- 5 to 90% RH

Symbols

The following symbols are used on the panels:

- I/O: On or off
- ~: Alternating current

Introduction

This guide describes how to install, set up and operate the Secure Series II LCD Panels. Throughout this guide, the Secure Series II LCD Panels are referred to collectively as the display.

Christie prepared this manual to help end users get the most out of the display.

Christie has made every effort to ensure that this guide is accurate as of the date it was printed. However, because of ongoing product improvements and customer feedback, it may require updating without notice from time to time.

Product overview

The Secure Series II LCD Panels are 86", 75", 65", 55" high performance UHD display featuring 450(55": 500) nits brightness, advanced input connectivity and multi-source viewing.

Key features

The display offers these key features and benefits:

- Ultra-HD native resolution: 3840x2160 (16:9 native aspect ratio)
- High Brightness: Up to approximately 450 (55": 500) nits
- Ultra-wide 178-degree viewing angle
- Modern connectivity with DisplayPort 1.2, HDMI2.0 inputs with high-bandwidth digital content protection (HDCP2.2)
- Supported OPS (Open Pluggable Specification) slot:
 - HDMI2.0
 - DisplayPort 1.2
 - RS232
- Display Area:
 - 86": 1895.04 mm X 1065.96 mm (horizontal X vertical)
 - 75": 1649.664 mm X 927.936 mm (horizontal X vertical)
 - 65": 1428.664 mm X 844.4 mm (horizontal X vertical)
 - 55": 1209.60 mm X 680.40 mm (horizontal X vertical)
- Bezel Width for 86", 75", 65", 55": 18.8mm
- Pixel Arrangement: RGB Stripe
- Pixel Pitch: 86":
 - 0.4935 mm X 0.4935 mm75": 0.429 mm X 0.429 mm

- 65": 0.372 mm X 0.372 mm
- 55": 0.105 mm X 0.105 mm
- Display orientation: Landscape
- Surface treatment:
 - 86", 75": AGLR (anti-glare low reflection), hard coating(2H), haze 28%
 - 65": AGLR (anti-glare low reflection), hard coating(2H), haze 3%
 - 55": AGLR (anti-glare low reflection), hard coating(3H), haze 25%
- Latency: 8ms

Parts List

Your display is shipped with the following items. If any items are missing or damaged, contact your dealer or Customer Service.

- SUHD863-L/SUHD753-L/SUHD653-L/SUHD553-L LCD panel
- IR remote controller unit and battery (AAA Size x 2 each)
- RS232 cable (length 1800 mm)
- HDMI cable (length 3000 mm)
- External IR Receiver kit
- Screw (M3x6)—2 each

Technical support

- North and South America: +1-800-221-8025 or Support.Americas@christiedigital.com
- Europe, Middle East, and Africa: +44 (0) 1189 778111 or Support.EMEA@christiedigital.com
- Asia Pacific (support.apac@christiedigital.com):
 - Australia: +61 (0)7 3624 4888
 - China: +86 10 6561 0240
 - India: +91 (80) 6708 9999
 - Japan: 81-3-3599-7481
 - Singapore: +65 6877-8737
 - South Korea: +82 2 702 1601
- Christie Professional Services: +1-800-550-3061 or NOC@christiedigital.com

Controls and functions

The appearance of actual components may differ from the image shown.

Display-at-a-glance

The illustration below shows the key display components, and the paragraphs that follow describe them.

- SUHD863-L

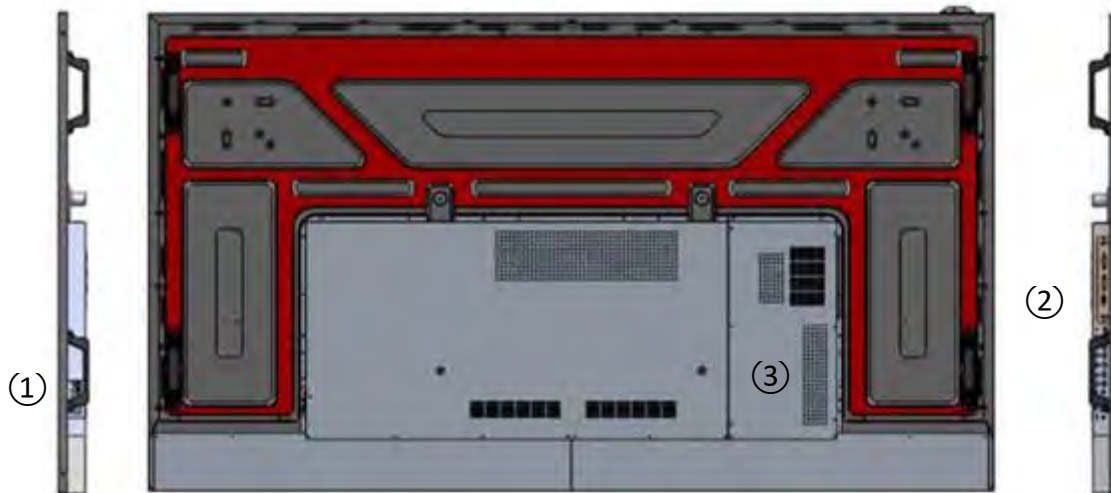

- SUHD753-L



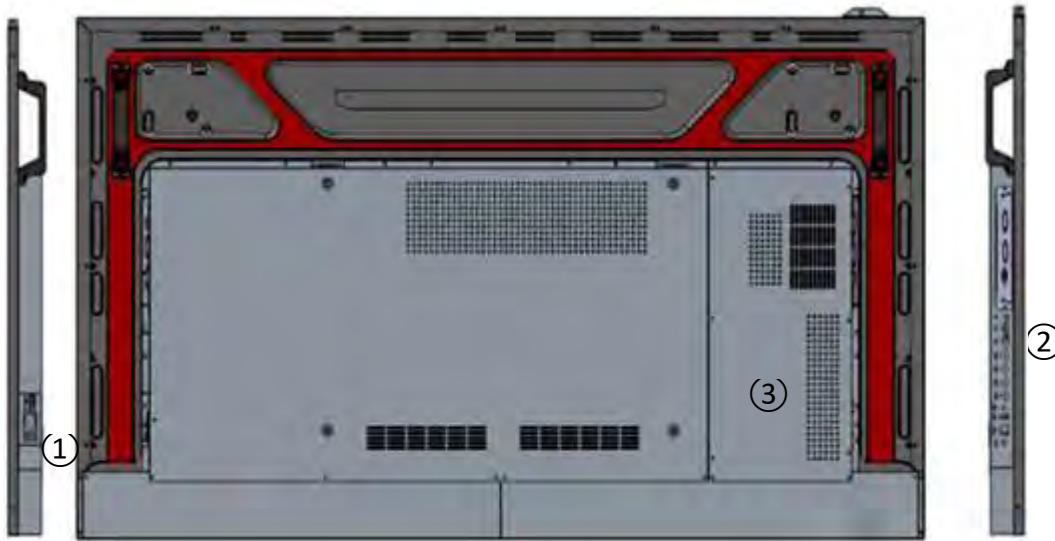

- SUHD653-L

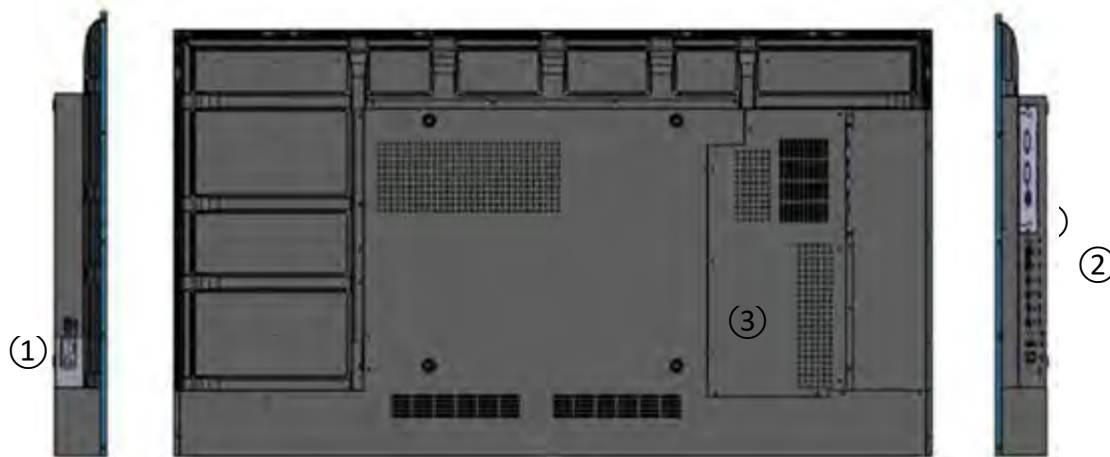

- SUHD553-L

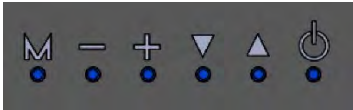

Component	Description		
① Main power	Connects or disconnects the display panel from the AC power source. 100 to 240 VAC, 50/60Hz		
② Input port and IR receiver/power status LED	Power status LED	On	No color
		Standby	Red
		Power Save	Red blinking
③ Keypad	Use the keypad instead of the remote control unit to operate the on-screen display (OSD) controls.		
	 <p>The keypad operates as follows</p>		

		<p>On/Standby ()</p>	<p>Use the keypad instead of the remote control unit to operate the on-screen display (OSD) controls.</p> <p>The keypad operates as follows:</p> <ul style="list-style-type: none"> • Select once to toggle from standby mode to on mode. • Select it again to return to standby mode.
		<p>▲ (SOURCE)</p>	<p>To choose a source, select the ▲(SOURCE) button repeatedly (with no menus visible on-screen).</p> <p>When a menu is visible on-screen, this button operates identically to the up-arrow.</p>
		<p>▼</p>	<p>When a menu is visible on-screen, this button operates identically to the down-arrow button on the display remote control unit.</p>
		<p>+</p>	<p>Select to increase the volume.</p> <p>When a menu is visible on-screen, this button operates identically to the right-arrow (or SEL) button on the display remote control unit.</p>
		<p>-</p>	<p>Select to decrease the volume.</p> <p>When a menu is visible on-screen, this button operates identically to the left-arrow button on the display remote control unit.</p>
		<p>M (MENU)</p>	<p>Select to display the on-screen display (OSD) or to exit the on-screen display and return to the previous one.</p>

In/Output panel

The illustration below shows the display input panel.

- SUHD 863-L

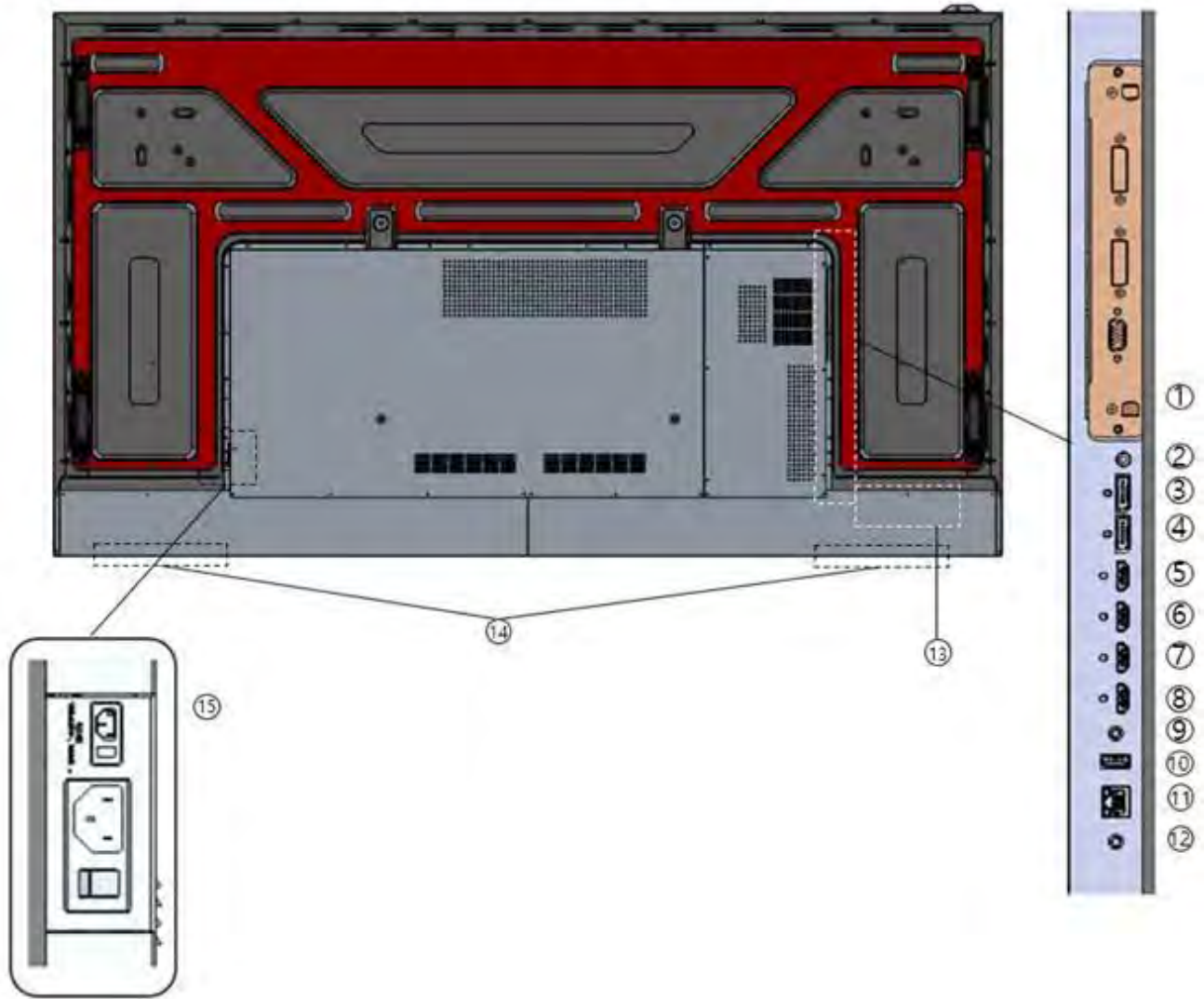

- SUHD 753-L

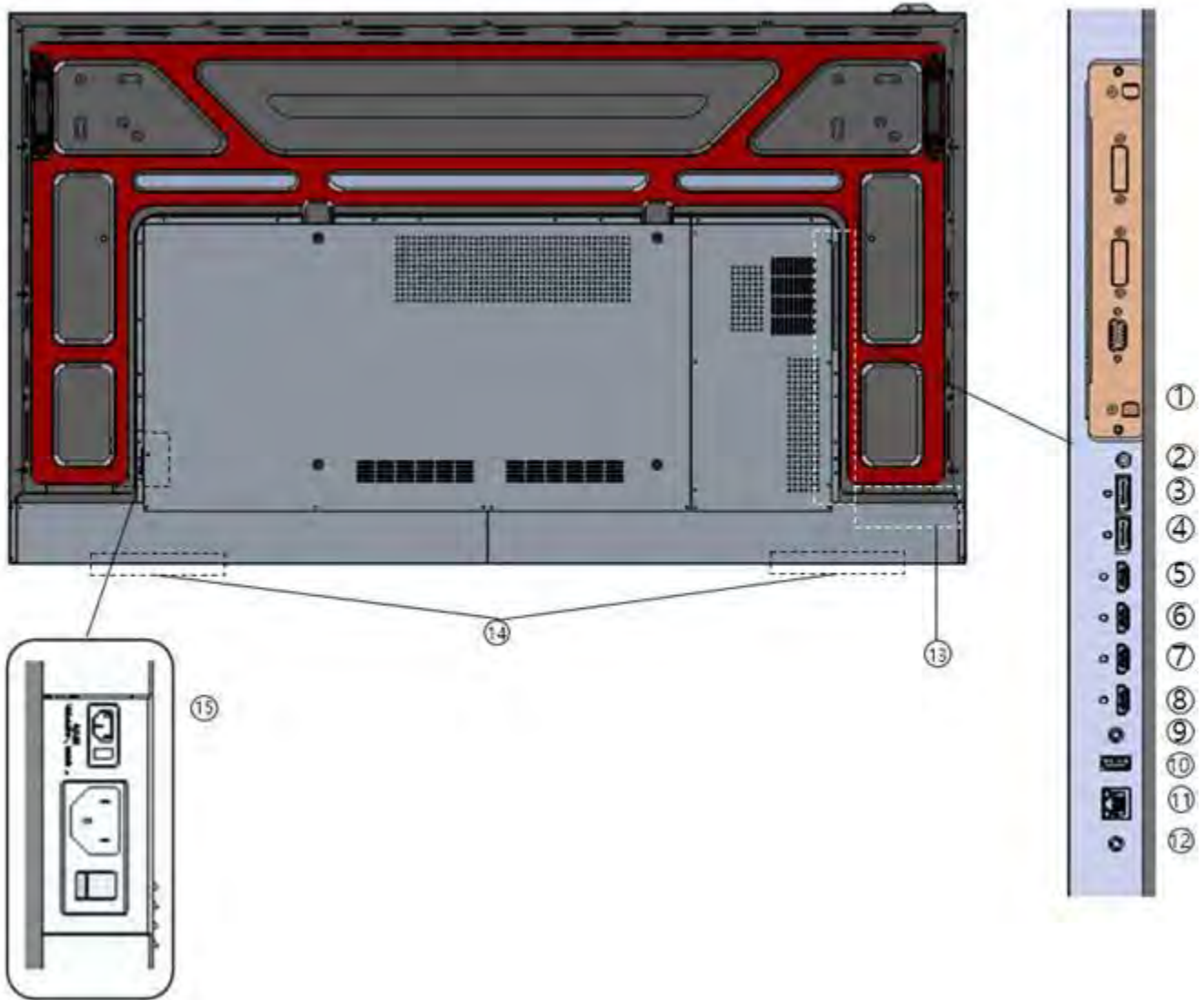

- SUHD 653-L

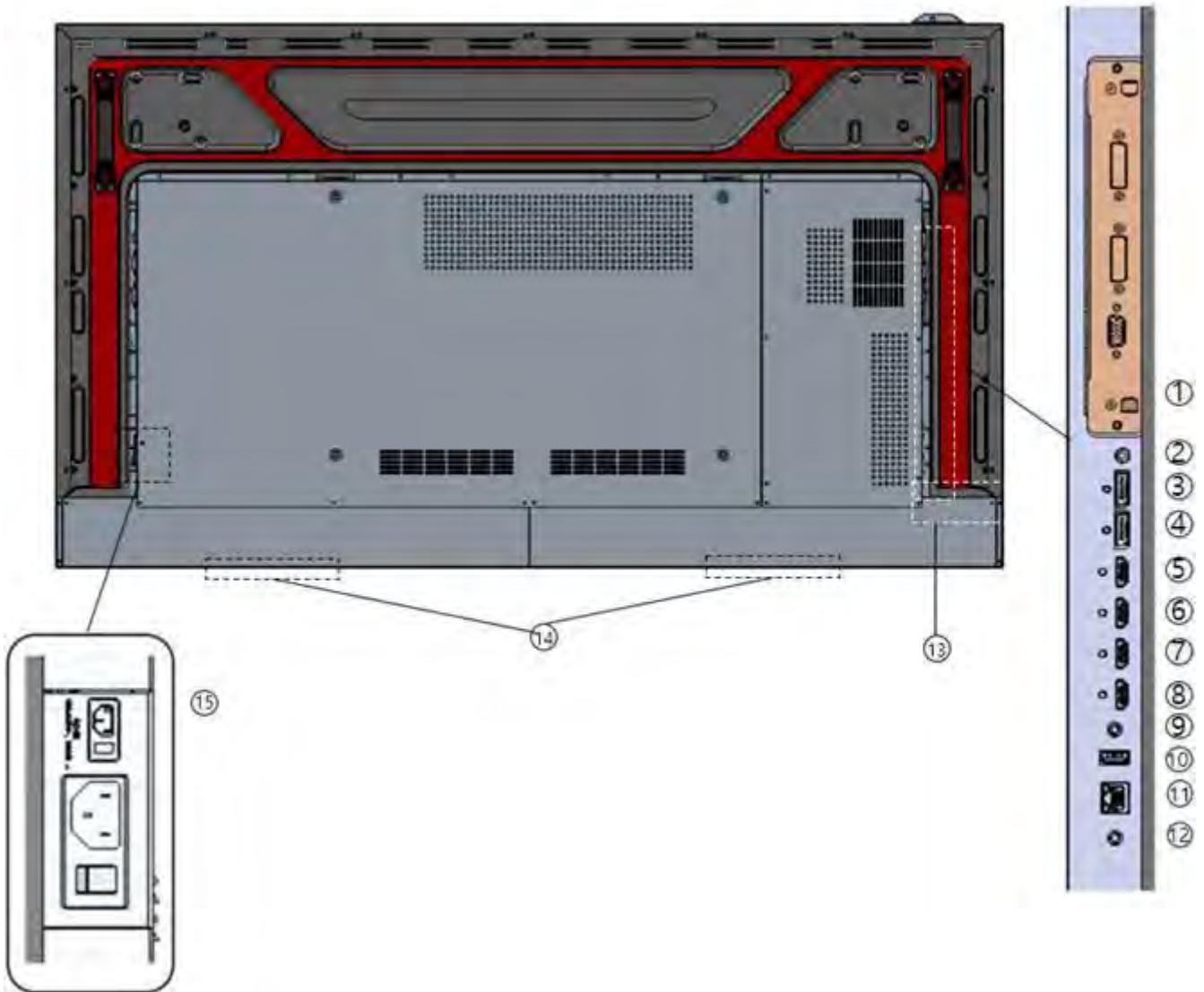

- SUHD 553-L

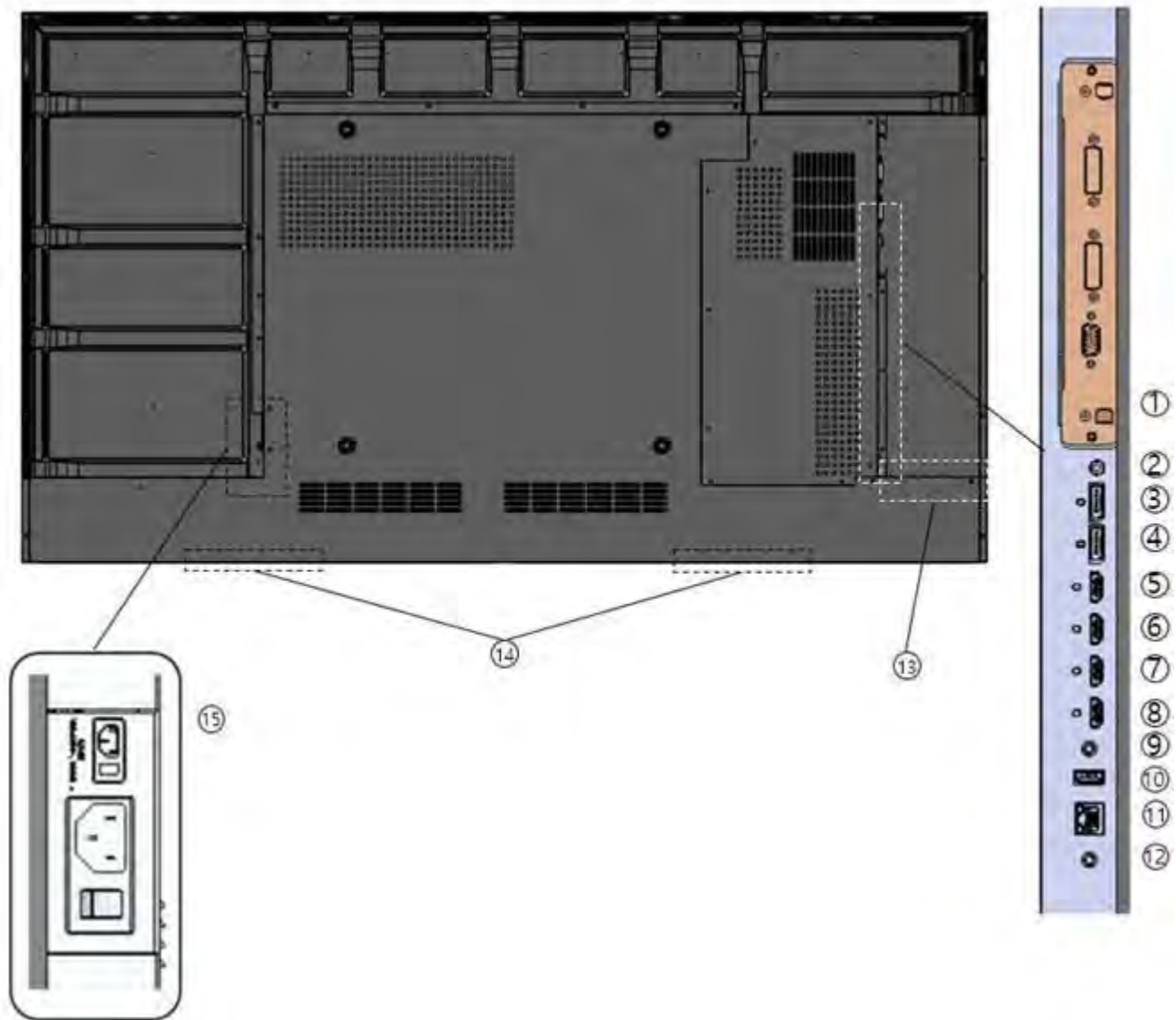

Component	Description
① OPS Slot (optional)	Connect the Open Pluggable Specification (OPS) PC
② IR In (3.5phi 4pole)	Connect the external IR receiver kit.
③④ DP1~2 In	Connect the DisplayPort 1.2 video and audio input.
⑤⑥⑦⑧ HDMI 1 to 4 In	Connect the HDMI 2.0 video & audio input.
⑨ RS232C In (3.5phi 3pole)	Connect the RS232 input cable with control device.
⑩ Service In (USB A type)	Connect with USB device for software update.
⑪ Ethernet In	Connect the Ethernet input cable with control device.
⑫ Audio Out (3.5phi 3pole)	Connect the Audio Out to your Audio In on the audio system.
⑬ OSD Key	Connect the Open Pluggable Specification (OPS) PC

⑭ Internal Speaker (15W x 2ea)	Connect an internal speaker.
⑮ AC Power	Connect to AC power.

Remote control unit

The illustration below shows the display remote control and the table that follows describes its functionality.



Label	Description
	Turns on or off the product
SOURCE	Selects a connected source device
	Moves to the up menu
	Moves to the down menu
SEL	Confirms a menu selection
or -	Decreases the sound volume or move to the left menu
or +	Increases the sound volume or move to the right menu
MENU	Opens the product on-screen menu system. When the menu system is already open, selecting this button chooses the previous submenu.
INFO	Provides source and resolution information
MUTE	Turns off the sound
1	Direct Key Preset 1

2	Direct Key Preset 2
3	Direct Key Preset 3
4	Direct Key Preset 4
5	Direct Key Preset 5
6	Direct Key Preset 6
7	Direct Key Preset 7
8	Direct Key Preset 8
9	Direct Key Preset 9
0	Direct Key Preset 10

Installing the display

Installation of the display must be performed by a qualified installation specialist.

Remote control

The appearance of actual components may differ from the image shown. To install batteries in the remote control:

1. Press the tab on the battery case and open it.
2. Insert the battery (1.5V AAA) into the battery case.
3. Insert the battery case until clack sounds.



Notes on batteries

- Make sure the battery polarities are correct when installing the batteries.
- If you not using the remote control for a long time, remove the batteries to avoid damage from battery leakage.
- Do not expose batteries to excessive heat such as sunshine, fire, or so on.

Notes on remote control operation

- Make sure nothing obstructs the infrared beam between the remote control and the IR receiver on the display.
- If the effective range of the remote control decreases, or it stops working, replace the batteries with new ones.
- The remote control may fail to operate if the infrared remote sensor is exposed to bright sunlight or fluorescent lighting.

Quick setup: workflow

The following provides a quick overview of the display installation process. Subsequent sections provide detailed instructions.

Step	Procedure	Additional details
1	Mount the display(s) on a wall (optional).	<i>Mounting the display on page 24</i>
2	Connect other external equipment to the display: <ul style="list-style-type: none"> Automation/control system (RS232) 	<i>Connecting a control system or PC on page 25</i>
3	Connect signal sources to the display.	<i>Connecting source components to the display on page 26</i>
4	Apply power to the display.	<i>Turning on the power on page 28</i>
5	Change the on-screen display language.	<i>Changing the on-screen display language on page 29</i>
6	Display calibration and adjust the following for each input: <ul style="list-style-type: none"> Backlight Contrast Brightness Color Sharpness Color temperature 	<i>Picture settings on page</i>

Installation considerations

Proper installation of your display ensures a satisfying viewing experience. Whether installing a temporary or permanent display, take the following into account to ensure your display performs optimally.

Ambient light

In general, minimize or eliminate light sources directed at the screen. Images may appear washed out and less vibrant if light, such as sunlight through a window or floodlight, directly strikes the screen.

Ambient heat

The display performs best and achieves longer life if operated in normal office environment conditions. The ambient temperature should be kept below 40°C (95°F). Keep the display away from heating and/or air conditioning vents.

Ventilation considerations

The appearance of components may differ from the image shown.

If mounting the display in an enclosure, leave sufficient space on all sides between it and surrounding objects, as shown below. This allows heat to disperse, maintaining the proper operating temperature.

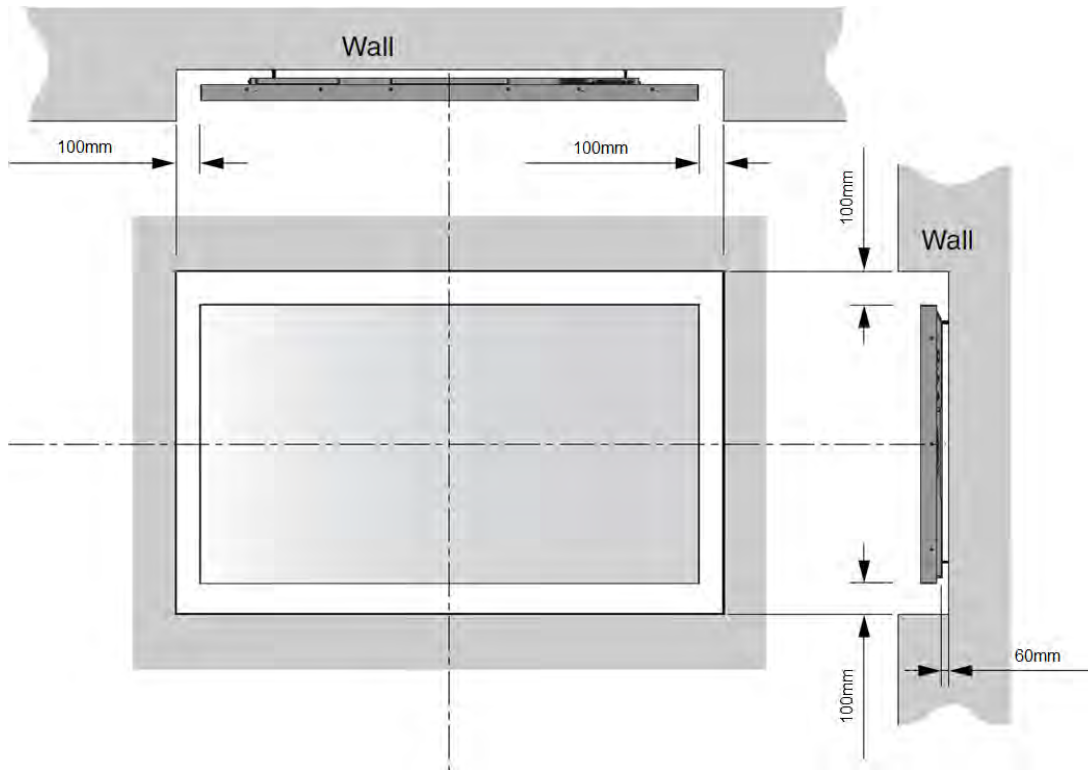

Mounting the display

If you decide to wall-mount the display, make sure the wall-mount bracket is installed according to the instructions included with it. The wall must be capable of supporting a multiple weight factor of three times the weight of the display or be reinforced. Christie recommends a custom installation specialist doing this.



Use only the approved wall-mount kit designed for your display.

Connections to the display

The appearance of components may differ from the image shown. Connect the display to your video sources, external controller(s), if present, and AC power as follows.

When connecting your equipment:

- Turn off all equipment before making any connections.
- Use the correct signal cables for each source.
- For best performance and to minimize cable clutter, use high-quality cables, only as long as necessary to connect two devices. Do not use a 20-foot cable when a 6-foot cable suffices.
- Ensure the cables are securely connected. Tighten the thumbscrews on connectors that have them.

Connecting a control system or PC

Learn how to connect a control system or PC.

RS232 connection

Use a straight-through RS232 cable with a 3.5mm stereo connector to connect a PC or control/automation system, if present, to the RS232 port on the display. For more information about using this connection, refer to API control manual document.

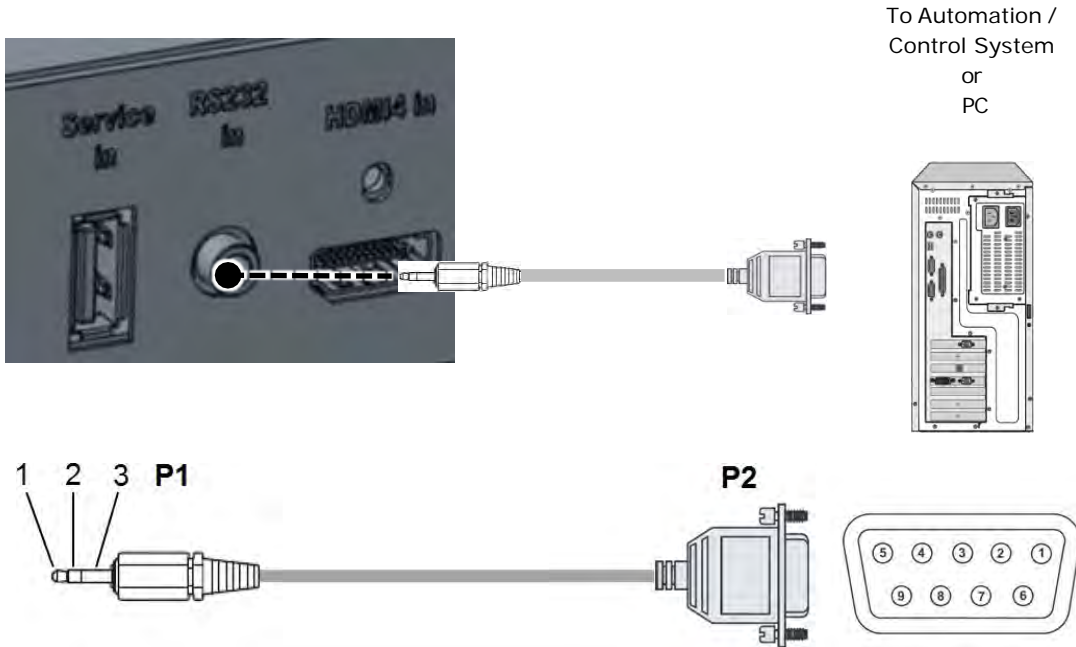

P1				P2		
Stereo	Tx	1	←	2	Rx	DSUB9P
3.5mm	Rx	2	→	3	Tx	(Female)
	Gnd	3	—	5	Gnd	

IR Receiver kit connection

Connect the provided External IR Receiver kit to the IR input as shown below.



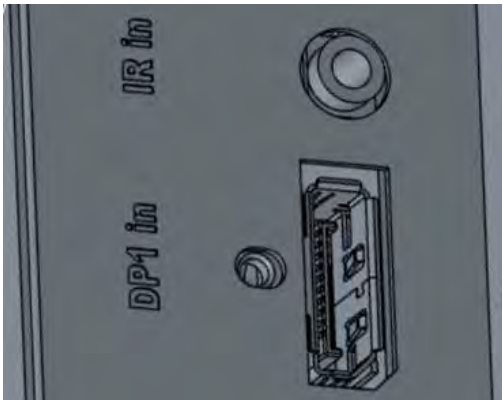

Fix the included external remote sensor to external remote sensor on the product by removing two screws on the top/bottom of the left/middle/right of the front, and re-using the screw.

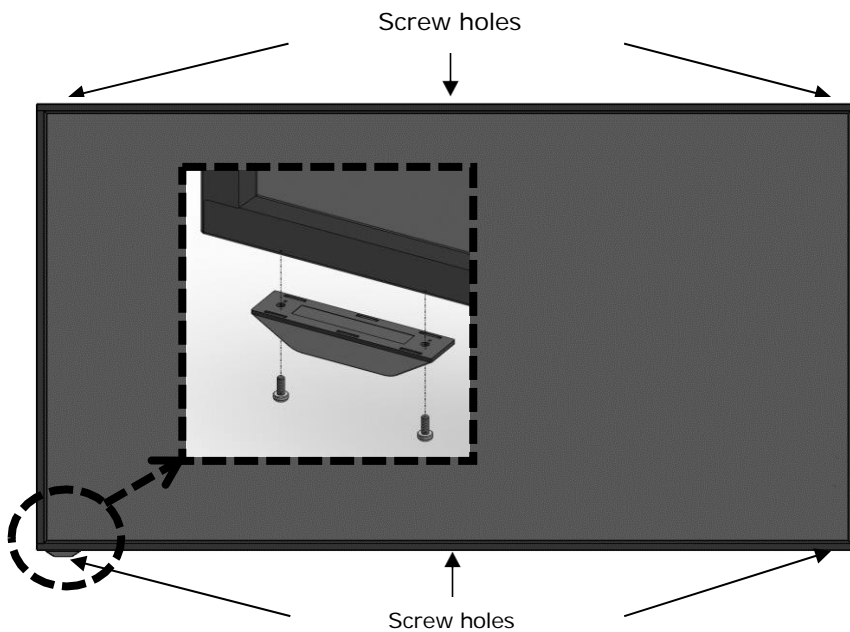

Connecting source components to the display

Connect your video sources to the display as shown and described in the following sections.

DisplayPort source connection

Refer to *Supported timings* on page 47 for a list of compatible input signals. This display supports the VESA Display Data Channel (DDC) standard. This standard provides plug-and-play capability; the display and a VESA DDC-compatible computer communicate their setting requirements, allowing for quick and easy setup.

For plug-and-play to work correctly, turn on the display before you turn on the connected computer

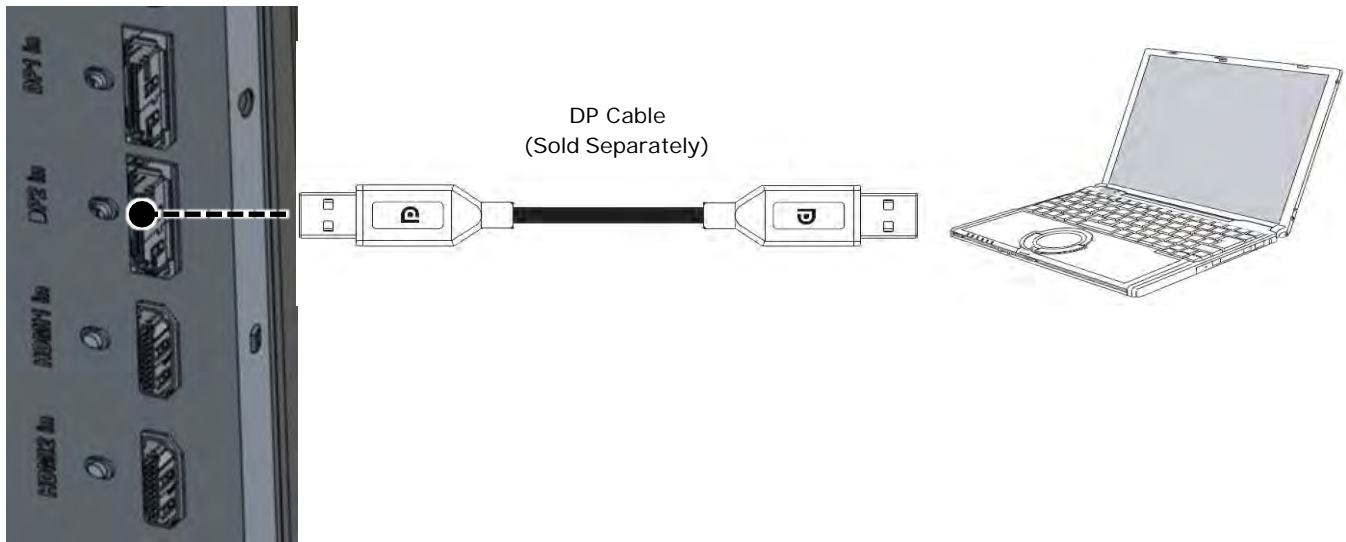

Purchase a certified Display Port cable. Otherwise, the picture may not display or a connection error may occur.

HDMI source connections

Use the HDMI inputs whenever possible. This ensures the highest video quality because the signal is carried in the digital domain throughout the entire signal path, from source component output into the display.

Refer to *Supported timings* on page 47 for a list of compatible input signals. This display supports the VESA Display Data Channel (DDC) standard. This standard provides plug-and-play capability; the display and a VESA DDC-compatible computer communicate their setting requirements, allowing for quick and easy setup.

For plug-and-play to work correctly, turn on the display before you turn on the connected computer.

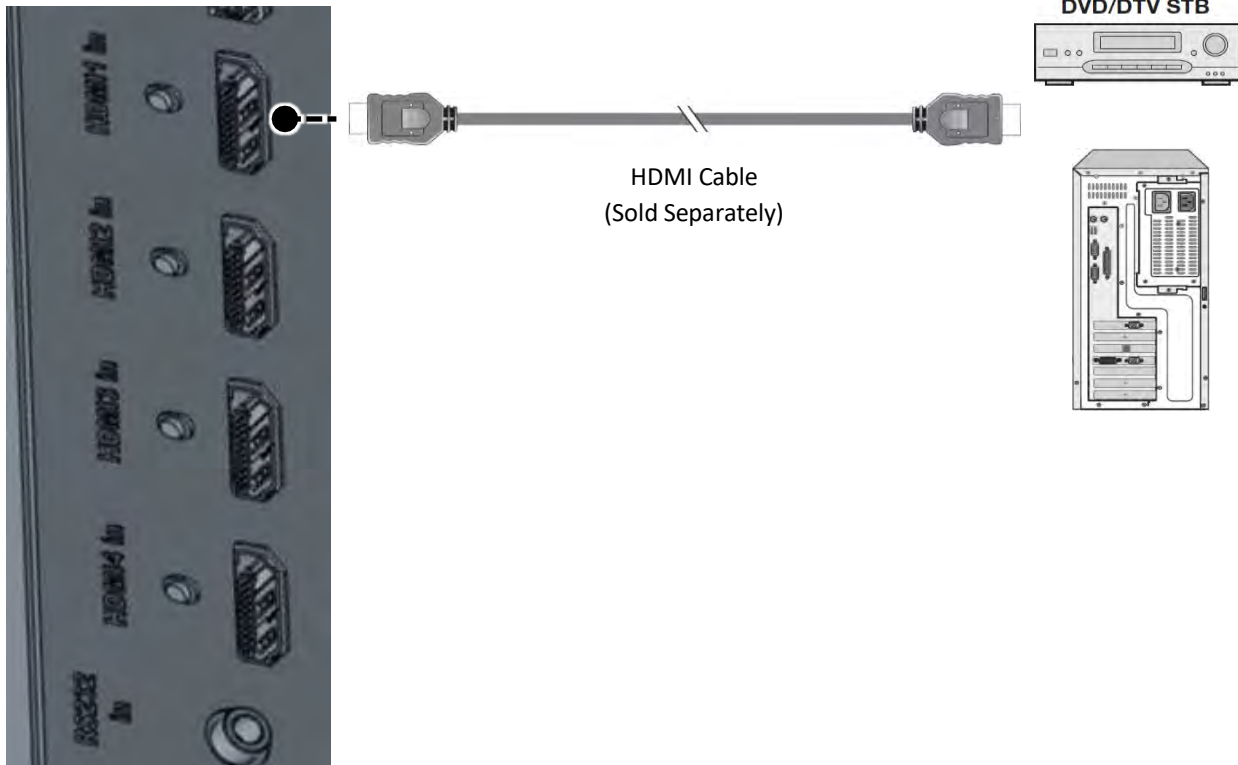

Purchase a certified HDMI cable. Otherwise, the picture may not display or a connection error may occur.

Turning on the power

Follow these steps to turn on the power.

1. Connect the power cable of the display into an outlet with AC 100-240V 50/60Hz.
2. Turn on the main AC power switch.
3. If the power indicator is green, the screen turns on automatically.
4. If the power indicator is red not green, select **Power** on the remote control or on the keypad to turn on the power.

Avoiding image retention

Christie recommends the following to prolong the life of the display:

- Operate the display within its rated ambient environment
- Operating temperature: 0 to 40°C (32 to 104°F)
- Relative humidity: 80%, maximum.



Notice. If not avoided, the following could result in property damage.

- Do not display static (non-moving) content on the display for long periods of time. This may cause image burn-in or image retention, which is not covered under warranty.

Avoid static content

To avoid static content, do the following:

- Display dynamic (moving) images whenever possible. Consider using a screen saver to avoid displaying continuous static (fixed) video content.
- Turn off the display when not in use.

Changing the on-screen display language

Select the language used for the menus and on screen display.

1. To go to the menu, select **Menu**.
2. From the main menu, select **OSD**.
3. Select **Language**
4. Select the preferred language.
5. Exit the menu.

Operation

Learn how to operate the panel.

Using the on-screen menus

Complete the following steps to use the on-screen menus.

1. To display the on-screen menus, select **MENU** on the remote control or built-in keypad.
2. To select a submenu, use the **▲** and **▼** buttons to highlight it.
3. To enter a submenu, select **SEL**.
4. To select a menu item, use the **▲** and **▼** and buttons to highlight it.
5. Select **▲** or **▼** to adjust the setting.
6. To exit the menu, Select **Menu**.

The on-screen display menus are arranged hierarchically, as shown below. Depending on the selected input source and signal characteristics, some menu options may not be available.

Level 1	Level 2	Level 3	Values	Default
Picture	Input	HDMI1	DP1 DP2 HDMI1 HDMI2 HDMI3 HDMI4 OPS-HDMI OPS-DP	HDMI1
	Backlight	70	0 to 100	70
	Picture Mode	Standard	Standard Dynamic User	Standard
	Contrast	100	0 to 100	100
	Brightness	50	0 to 100	50
	Color	50	0 to 100	50
	Sharpness	50	0 to 100	50
	Color Temperature	Normal	Normal Warm Cool Studio1 Studio2 User	Normal

	Red	—	0 to 100	Depends on model
	Green	—	0 to 100	Depends on model
	Blue	—	0 to 100	Depends on model
	HDR10	Off	Off/On	Off
	Picture Reset	—	—	Reset Picture menu
Sound	Audio Select	—	DP1 DP2 HDMI1 HDMI2 HDMI3 HDMI4 OPS-HDMI OPS-DP	Depends on current input
	Volume	50	0 to 100	50
	Balance	0	-50 to +50	0
OSD	Language	English	English Spanish French Russian German Italian Korean	English
	OSD Turn Off	Off	Off seconds 5 seconds 10 seconds 20 seconds	20 seconds
	OSD Position	C	TL TR C BL BR	C
Setup	Power Save	On	Off On	On
	Power off Mode	Standby	Standby Sleep Deep Sleep	Standby
	Interface Select	Off	Off RS232 OPS-RS232t	RS232
	FRC Mode	Free run	Lock Free run	Free run
	CEC Control	Off	Off On	Off

	OPS/HDMI4 EDID	UHD	UHD FHD	UHD
	Gamma	2.2	2.2 Standard	2.2
	Auto Source Switch	Off	Off On	Off
	Low Latency Mode	Off	Off On	Off
	Factory Reset	—	—	Reset all menus
Preset	Apply/ Edit	Preset1	—	Single/HDMI1
		Preset2	—	Dual1/HDMI1/HDMI2
		Preset3	—	Dual2/HDMI1/HDMI2
		Preset4	—	Dual3/HDMI1/HDMI2
		Preset5	—	Dual4/HDMI1/HDMI2
		Preset6	—	Triple1/HDMI1/HDMI2/HDMI3
		Preset7	—	Triple2/HDMI1/HDMI2/HDMI3
		Preset8	—	Triple3/HDMI1/HDMI2/HDMI3
		Preset9	—	Triple4/HDMI1/HDMI2/HDMI3
		Preset10	—	Quad/HDMI1/HDMI2/ HDMI3/HDMI4
		Preset11	—	Single /DP1
		Preset12	—	Dual1 /DP1/DP2
		Preset13	—	Dual2 /DP1/DP2
		Preset14	—	Dual3 /DP1/DP2
		Preset15	—	Dual4 /DP1/DP2
		Preset16	—	Triple1/DP1/DP2/HDMI1
		Preset17	—	Triple2/DP1/DP2/HDMI1
		Preset18	—	Triple3/DP1/DP2/HDMI1
		Preset19	—	Triple4/DP1/DP2/HDMI1
		Preset20	—	Quad/DP1/DP2/ HDMI1/HDMI2
		Preset Reset	—	
Preset-Edit	Mode	—	Single Dual1 Dual2 Dual3 Dual4 Triple1 Triple2 Triple3 Triple4 Quad	Single

	Window1	—	DP1 DP2 HDMI1 HDMI2 HDM3	—
	Window2	—	HDMI4	—
	Window3	—	OPS-HDMI	—
	Window4	—	OPS-DP	—
LAN Setting	DHCP	Off	Off On	Off
	IP Address	—	192.168.10.10	192.168.10.10
	Subnet Mask	—	255.255.255.0	255.255.255.0
	Gate Way	—	192.168.10.1	192.168.10.1
	DNS	—	168.126.63.1	168.126.63.1
	LAN Setting Reset	—	—	Reset the all Lan Setting
ABOUT	Model	—	The read-only System menu provides status information about the display	—
	Version	—		—
	MAC	—		—
	S/N	—		—
	Window1	—		—
	Resolution	—		—
	Window2	—		—
	Resolution	—		—
	Window3	—		—
	Resolution	—		—
	Window4	—		—
	Resolution	—		—

Specifications are subject to change without notice to improve quality.

Picture settings

Picture	Input	HDMI
Sound	Backlight	70
OSD	Picture Mode	Standard
Setup	Contrast	100
Presets	Brightness	50
LAN Setting	Color	50
About	Sharpness	50
	Color Temperature	Normal
	Picture Reset	

Determining the image input

Set the type of input for the image.

1. From the Picture Settings menu, select **Input**.
2. Set the current input:

[DP1],[DP2],[HDMI 1],[HDMI 2],[HDMI 3],[HDMI 4],[OPS-HDMI],[OPS-DP]

Setting panel backlight

The Backlight control changes the back light unit intensity of the panel.

1. From the Picture Settings menu, select **Backlight**.
2. Indicate the intensity of the backlight.

Selecting Picture Mode

Determine what mode you want to view the image.

3. From the Picture Settings menu, select **Picture Mode**.
4. Select ▲ or ▼ to choose one of two image quality presets (Standard or Dynamic) depending on the type of program material you are viewing.

These presets automatically adjust the other image settings for optimal image quality. You can adjust Brightness, Contrast, and other settings manually.

Setting image contrast

Contrast adjusts the white levels of the image.

1. On your external test pattern source, select a stepped, gray-bar pattern like the one shown below.



2. Select **Contrast**.
3. Select ▲ or ▼ to adjust the contrast to a point just below which the white rectangle starts to increase in size.

Setting image brightness

Determine the brightness of the image.

1. On your external test pattern source, select a PLUGE pattern.

PLUGE is an acronym for Picture Line-up Generation Equipment.

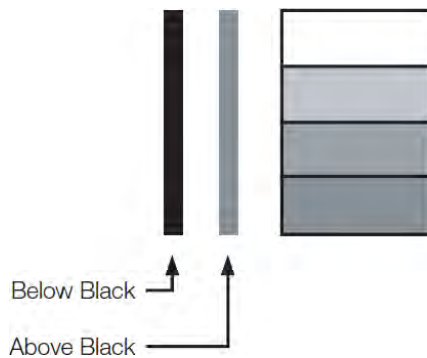

PLUGE patterns vary but generally consist of some combination of black, white, and gray areas against a black background. The example above includes two vertical bars and four shaded boxes.

2. From the Picture Settings menu, select **Brightness**.
3. Select ▲ or ▼ to adjust the black level so the following happens:
 - The darkest black bars disappear into the background.
 - The dark gray areas are barely visible.
 - The lighter gray areas are clearly visible.
 - The white areas are a comfortable level of true white.
 - The image contains only black, gray and white (no color).

Contrast and Black Level controls are interactive. A change to one may require a subtle change to the other to achieve the optimum setting.

Setting image color

Color (hue or tint) is the ratio of red to green in the color portion of the image. When Color is decreased, the image appears redder; when it is increased the image appears greener. To adjust the color, use a blue filter when viewing the color bar pattern, as you would for adjusting color saturation.

1. From the Pictures Settings menu, select **Color**.
2. Select ▲ or ▼ to adjust the color until the cyan and magenta color bars (on either side of the green bar) appear to be a single shade of blue.

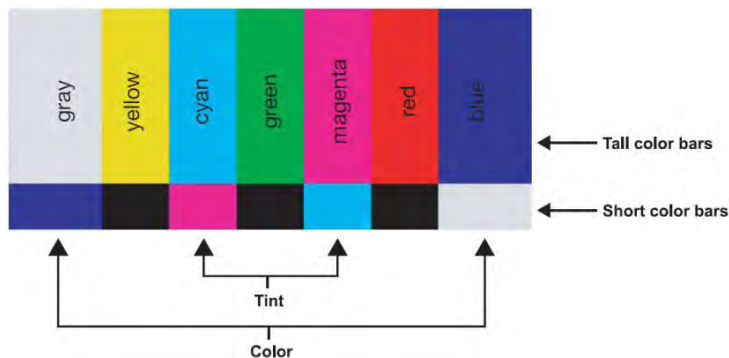

Like the brightness and contrast controls, the color and tint controls are interactive. A change to one may require a subtle change to the other to achieve the optimum setting.

Setting image sharpness

Sharpness is the amount of high-frequency detail in the image.

1. From the Pictures Settings menu, select **Sharpness**.
2. On your external test pattern source.

Select a pattern like the one shown below.

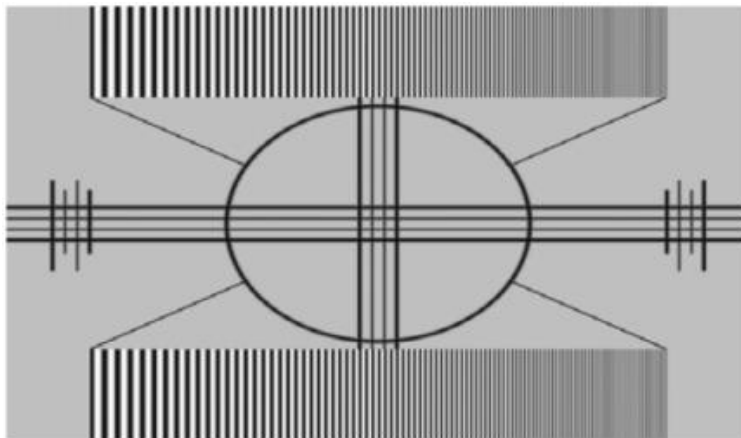

3. Adjust as needed, looking for white edges around the transitions from black to gray and differently-sized lines in the sweep patterns at the top and bottom. Lower the sharpness setting to eliminate them.

Setting image color temperature

A Color Temperature is an x/y coordinate pair that defines a color's location on the standard CIE chromaticity shown in the graph. CIE stands for Commission Internationale de l'Éclairage International Commission on Illumination, the organization responsible for color measurement and management.

1. From the Pictures Settings menu, select **Color Temperature** to adjust the color temperature.
 - Studio1 = 3200K
 - Studio2 = 5600K
 - Warm = 6500K
 - Normal = 10000K
 - Cool = 12000K
2. Select a value of from 3200K (Studio1) to 12000K (Cool).
Higher settings produce a bluer picture; lower ones produce a reddish hue to the image.
3. To select a custom color temperature, select **User**.
4. Set the Gain and Offset as described below.

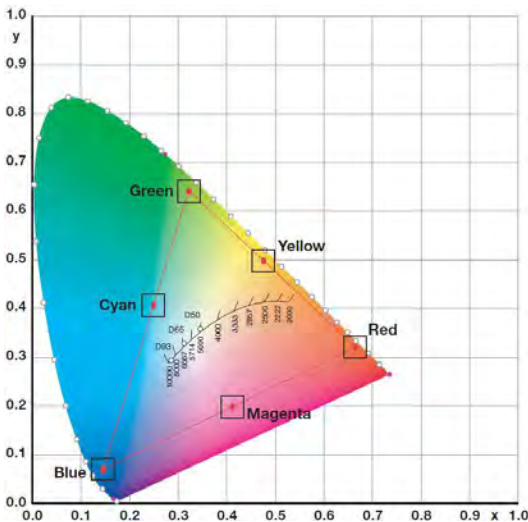

Enabling or disabling HDR10

HDR10 controls the display's HDR mode enable/disable.

1. From the Pictures Settings menu, select **HDR10**.
2. Enable or disable the control.



Caution! If not avoided, the following could result in minor or moderate injury.

- HDR10 support only YCbCr444 format.

Resetting the picture values

Reset all values in the Picture menu.

1. From the Pictures Settings menu, select **Reset**.

All values in the Picture menu are reset.

Sound settings

Picture	Audio Select	HDMI1
Sound	Volume	50
OSD	Balance	0
Setup		
Presets		
LAN Setting		
About		

Setting the audio input

1. From the Sound menu, select **Audio Input**.
2. Select audio input source:
 [DP1],[DP2],[HDMI 1],[HDMI 2],[HDMI 3],[HDMI 4],[OPS-HDMI],[OPS-DP]

Adjusting the volume

The volume can be changed or the sound can be muted only for displays are on.

1. From the Sound menu, select **Volume**.
2. Adjust the Volume using the slider bar in the range of 0 to 100.

Adjusting the sound balance

Adjust the volume of the left and right speakers of the selected display device.

1. From the Sound menu, select **Balance**.
2. Adjust the Balance using the slider bar in the range of -50 to +50.

OSD settings

Picture	Language	English
Sound	OSD Turn Off	20sec
OSD	OSD Position	C
Setup		
Presets		
LAN Setting		
About		

Specifying the language

Specify the language for the on-screen display.

1. From the OSD Settings menu, select **OSD Language**.
2. Select ▲ or ▼ to choose the on-screen display language.

Valid values: English, French, German, Italian, Russian, Spanish, and Korean

Turning off the on-screen display menus

Specify how long the menus remain on-screen after selecting them.

1. From the Basic Settings menu, select **OSD Timeout**.

Valid values: 5 seconds, 10 seconds, 20 seconds, Off

Determining the on-screen display position

Specify the position displayed on the screen after selecting the menu.

1. From the Basic Settings menu, select **OSD Position**.

Valid values:

- TL: Top Left
- TR: Top Right
- C: Center
- BL: Bottom Left
- BR: Bottom Right

Setup settings

Picture	Power Save	On
Sound	Power Off Mode	Standby
OSD	Interface Select	RS232
Setup	FRC Mode	Free run
Presets	CEC Control	Off
LAN Setting	OPS/HDMI4 EDID	UHD
About	Gamma	2.2
	Auto Source Switch	Off
	Low Latency Mode	Off
	Factory Reset	

Enabling Power Save

1. From the Setup menu, select **Power Save > On**.

After 40 seconds of no signal, the display enters the power-saving mode.

Determining how the display goes into Power Off Mode

1. From the Setup menu, select **Power Off Mode**.
2. Determine how you want the display to go into Power Save Mode.

Power Off Mode	IR	RS232 control	Ethernet control	Crestron control	Power consumption
Standby	Yes	Yes	Yes	Yes	Under 5W
Sleep	Yes	Yes	No	No	Under 2W
Deep Sleep	Yes	No	No	No	Under 0.5W

When the Power Off Mode is set to sleep, do not enter sleep mode before the Mac address appears in the About menu of the on-screen display. The Mac address display indicates all booting is complete.

Selecting the interface

Determine what type of interface is required.

1. From the Setup menu, select the **Interface Select**.
2. Select the control interface.

Valid values: RS232, OPS-RS232, and Off

Setting FRC Mode

Adjusts the amount FRC frequency

1. From the Setup menu, select **FRC Mode**.
2. Select the FRC Mode value.

When the input vertical frequency 50Hz is applied, the screen is correctly displayed on the high-speed motion screen. Valid values:

- Free Run: Only 60Hz
- Lock: 50Hz/60Hz

Powering the display on or off using a CEC command

Use the CEC Control to power the display on or off using a CEC command.

1. From the Setup menu, select **CEC Control**.
2. Enable (On) or disable (Off) the CEC Control.

Setting the OPS/HDMI4 EDID

Set the OPS/HDMI4 EDID.

1. From the Setup menu, select **OPS/HDMI4**.
2. Select the EDID for the OPS/HDMI4.

Valid values: UHD or FHD.

Determining the gamma curve

1. From the Setup menu, select **Gamma**.
2. Set the gamma curve.

Valid values: 2.2 standard or DICOM.

Enabling or disabling the active source

When Auto Source Switch is enabled, the display switches to the currently active source automatically. When the source is removed, the display switches to other active source.

1. From the Setup menu, select **Auto Source Switch**.
2. Enable (On) or disable (Off) switching to the current active source automatically.

Enabling or disabling Low Latency Mode

When Low Latency Mode is enabled, the video delay is reduced.

1. From the Setup menu, select **Low Latency Mode**.

2. Enable (On) or disable (Off) if the video delay is reduced.

Performing a factory reset

Reset all display settings to their factory defaults.

1. From the Setup menu, select **Factory Reset**.

All settings, including image settings are restored to their factory defaults.

Presets

Use the Presets menu to display multiple inputs simultaneously and save them to a preset, which can be quickly recalled.

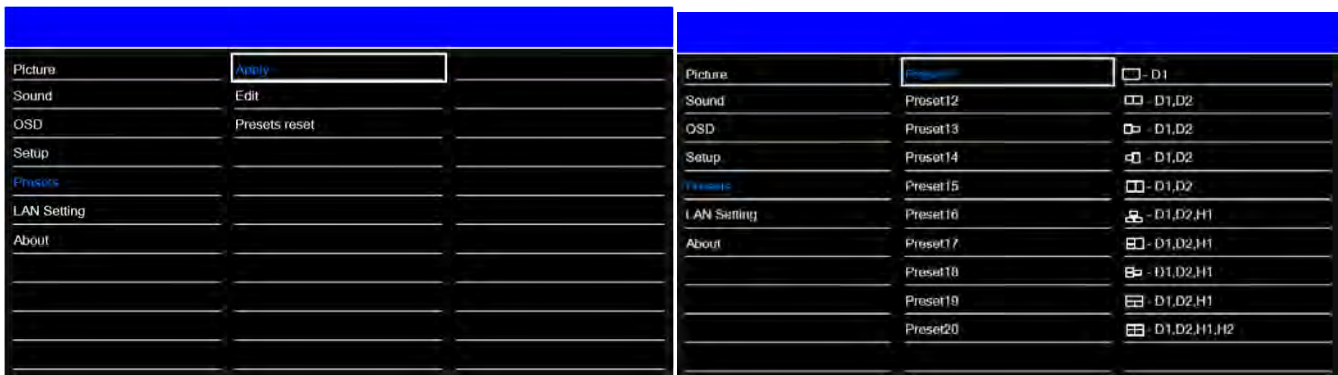

Applying presets

Recall a previously configured preset.

1. From the Presets menu, select **Apply**.

Editing presets

Change the configuration or the source for the preset.

1. From the Presets menu, select **Edit**.

Storing multiple window presets

Store up to 20 different configured multi-window presets

Number	Window count and input
Preset1	One /HDMI1
Preset2	Dual1 /HDMI1/HDMI2
Preset3	Dual2 /HDMI1/HDMI2
Preset4	Dual3 /HDMI1/HDMI2

Preset5	Dual4 /HDMI1/HDMI2
Preset6	Triple1/HDMI1/HDMI2/HDMI3
Preset7	Triple2/HDMI1/HDMI2/HDMI3
Preset8	Triple3/HDMI1/HDMI2/HDMI3
Preset9	Triple4/HDMI1/HDMI2/HDMI3
Preset10	Quad/HDMI1/HDMI2/HDMI3/HDMI4
Preset11	One /DP1
Preset12	Dual1 /DP1/DP2
Preset13	Dual2 /DP1/DP2
Preset14	Dual3 /DP1/DP2
Preset15	Dual4 /DP1/DP2
Preset16	Triple1/DP1/DP2/HDMI1
Preset17	Triple2/DP1/DP2/HDMI1
Preset18	Triple3/DP1/DP2/HDMI1
Preset19	Triple4/DP1/DP2/HDMI1
Preset20	Quad/DP1/DP2/HDMI1/HDMI2

Resetting presets

Reset the 20 preset settings.

1. From the Presets menu, select **Presets reset**.

Preset Edit

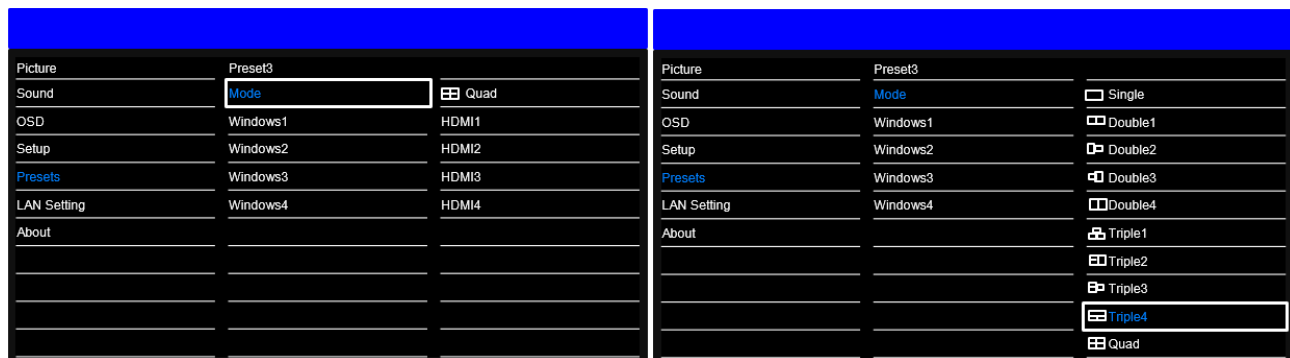

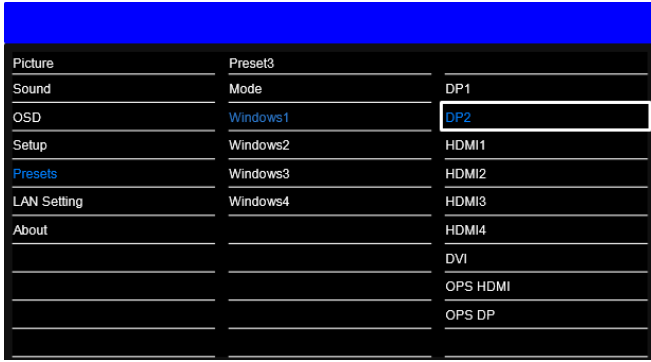

Selecting an input mode

You can select and save several modes to a preset.

1. From the Preset menu, select **Modes**.
2. Select an input source.
3. Valid values: Single, Dual1, Dual2, Dual3, Dual4, Triple1, Triple2, Triple3, Triple4, and Quad

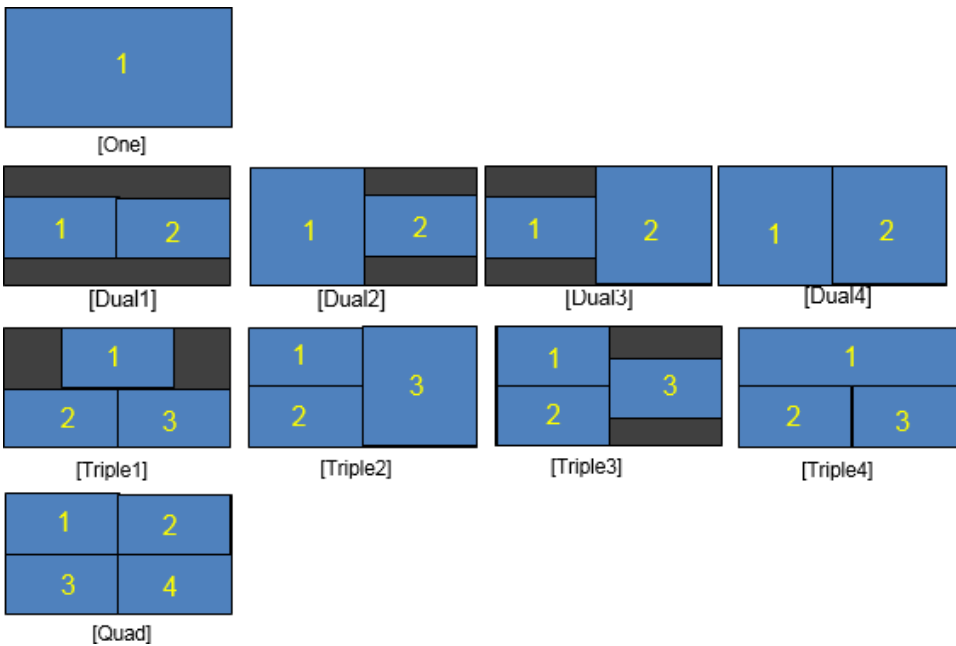

Window1-Window4

To configure which source is in the respective window, select a Source in Window 1-4. Some limitations exist to which sources can be applied in some modes, see below.

Dual/Quad		Sub screen							
		DP1	DP2	HDMI 1	HDMI 2	HDMI 3	HDMI 4	OPS HDMI	OPS DP
Main Screen	DP1	Yes	Yes	Yes	Yes	Yes	Yes	Yes	Yes
	DP2	Yes	Yes	Yes	Yes	Yes	Yes	Yes	Yes

	HDMI1	Yes	Yes	Yes	Yes	Yes	Yes	Yes	Yes
	HDMI2	Yes	Yes	Yes	Yes	Yes	Yes	Yes	Yes
	HDMI3	Yes	Yes	Yes	Yes	Yes	Yes	Yes	Yes
	HDMI4	Yes	Yes	Yes	Yes	Yes	Yes	No	No
	OPS-HDMI	Yes	Yes	Yes	Yes	Yes	No	Yes	No
	OPS-DP	Yes	Yes	Yes	Yes	Yes	No	No	Yes

Viewing status information

Picture	Model: SUHD863-L	MAC : 2D:3F:45:1C:5A:98
Sound	Version : 1.0.0.0 - 1	S/N : SUHD86U330001
OSD	Window1	HDMI1
Setup	Resolution	1920x1080@60Hz
Presets	Window2	HDMI2
LAN Setting	Resolution	1920x1080@60Hz
About	Window3	HDMI3
	Resolution	1920x1080@60Hz
	Window4	HDMI4
	Resolution	1920x1080@60Hz

The read-only About menu provides the following status information about the display:

- Resolution and refresh rate of the active source
- Currently-installed firmware version

Open Pluggable Specification (OPS)

This section describes the electrical and mechanical specifications of the Open Pluggable Specification (OPS), which enables a standard and easier integration of a pluggable module into the display panel.

Throughout this section the 80pin JAE TX24A/TX25A series connector is referred to as the JAE connector. Dimensions shown in all figures are in unit mm.

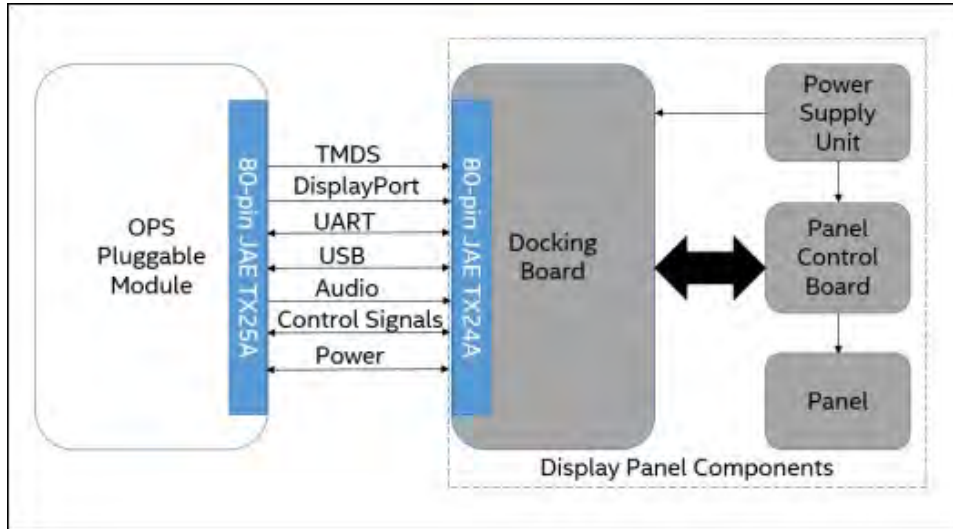

The OPS involves the integration concept of a pluggable module into the display panel through a single and standard interfacing based on the 80 pin JAE plug and receptacle connectors.

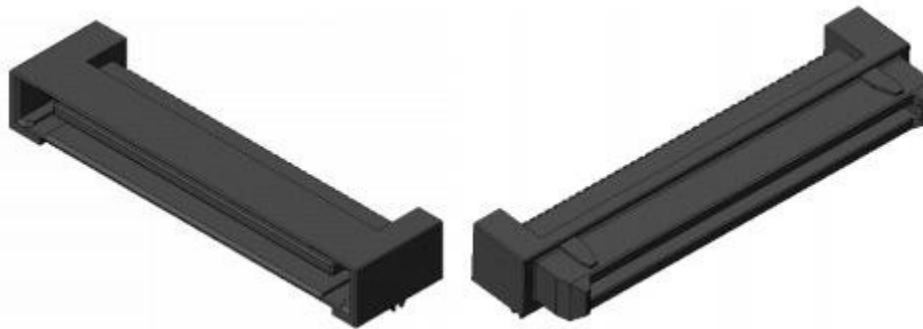

The connector used for the Pluggable Module and the docking board interconnect is based on the JAE TX24A/TX25A family of plug and receptacle connectors. The JAE connector pins are capable of supporting up to a maximum current of 1A. The 80-pin right angle blind mate plug connector (P/N: TX25A-80P-LT-H1E) and its receptacle (P/N: TX24A-80R-LT-H1E) provide interfacing for the following features.

- Power: DC IN +12V~+19V @ 8A maximum
- Display Interface: DVI-D/TMDSt and DisplayPort
- Audio: Left and Right Channel
- USB: 3xUSB 2.0 (when USB3.0 is not used) or 2xUSB 2.0 and 1xUSB 3.0
- UART: Serial communication (Tx and Rx only)
- Control Signals: Pluggable Module Power Status, Power ON using display panel, Pluggable Board Detect, Consumer Electronics Control (CEC), and System Fan Control.
- The connector series image is for reference only.

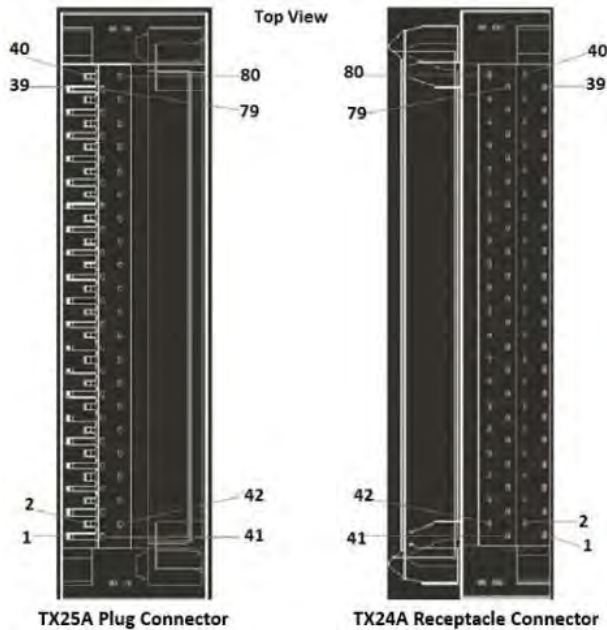

Left: Plug connector (P/N: TX25A-80P-LT-H1E).

Right: Receptacle connector (P/N: TX24A-80R-LT-H1E).



Caution! If not avoided, the following could result in minor or moderate injury.

- Always use screws to install OPS.
- Do not swap OPS modules while the display is powered on.
- This display supports OPS power consumption up to 60W.

Supported timings

Signal Type	Format	Hres	Vres	Frame rate (Hz)	Sampling	Bit-Depth
HDMI	640x480	640	480	60	RGB/4: 4: 4/4: 2: 2	8/10/12bpc
	800x600	800	600	50,60	RGB/4: 4: 4/4: 2: 2	8/10/12bpc
	1024x768	1024	768	50,60	RGB/4: 4: 4/4: 2: 2	8/10/12bpc
	1280x720	1280	720	50,60	RGB/4: 4: 4/4: 2: 2	8/10/12bpc
	1280x800	1280	800	50,60	RGB/4: 4: 4/4: 2: 2	8/10/12bpc
	1280x1024	1280	1024	50,60	RGB/4: 4: 4/4: 2: 2	8/10/12bpc
	1600x900	1600	900	50,60	RGB/4: 4: 4/4: 2: 2	8/10/12bpc
	1920x1080	1920	1080	50,60	RGB/4: 4: 4/4: 2: 2	8/10/12bpc
	3840x2160	3840	2160	30,50,60	RGB/4: 4: 4/4: 2: 2	8/10/12bpc
DP	640x480	640	480	60	RGB/4: 4: 4	8/10/12bpc
	800x600	800	600	50,60	RGB/4: 4: 4	8/10/12bpc

	1024x768	1024	768	50,60	RGB/4:4:4	8/10/12bpc
	1280x720	1280	720	50,60	RGB/4:4:4	8/10/12bpc
	1280x800	1280	800	50,60	RGB/4:4:4	8/10/12bpc
	1280x1024	1280	1024	50,60	RGB/4:4:4	8/10/12bpc
	1600x900	1600	900	50,60	RGB/4:4:4	8/10/12bpc
	1920x1080	1920	1080	50,60	RGB/4:4:4	8/10/12bpc
	3840x2160	3840	2160	30,50,60	RGB/4:4:4	8/10/12bpc
OPS HDMI, OPS DP	640x480	640	480	60	RGB/4:4:4/4:2:2	8/10/12bpc
	800x600	800	600	50,60	RGB/4:4:4/4:2:2	8/10/12bpc
	1024x768	1024	768	50,60	RGB/4:4:4/4:2:2	8/10/12bpc
	1280x720	1280	720	50,60	RGB/4:4:4/4:2:2	8/10/12bpc
	1280x800	1280	800	50,60	RGB/4:4:4/4:2:2	8/10/12bpc
	1280x1024	1280	1024	50,60	RGB/4:4:4/4:2:2	8/10/12bpc
	1600x900	1600	900	50,60	RGB/4:4:4/4:2:2	8/10/12bpc
	1920x1080	1920	1080	50,60	RGB/4:4:4/4:2:2	8/10/12bpc
	3840x2160	3840	2160	30,50,60	RGB/4:4:4/4:2:2	8/10/12bpc

Updating the Scaler firmware using USB

Follow these steps to update the Scaler firmware using a USB.



Regardless of the software version, the filename must always be `Secure_Series_II.bin` to upload correctly.

1. Plug in a USB memory to the service terminal.

The firmware is stored on the USB and the filename of firmware must be `Secure_Series_II.bin`.



2. Enter the **Factory** menu.

To enter the Factory menu using the remote control:



3. Select **Software Update (USB)** and select **SEL** on the remote control

To enter the Factory menu. disable **Multi-Window mode**.

4. Select **USB Update**.

- If the *Connected* message appears, select **USB Update**.

The firmware is automatically updated. The panel goes into Standby mode after a successful firmware update (approximately 30 seconds).

- a. Reset the main power switch to turn the panel on.
 - b. When the firmware update is complete, perform an **Initial Setting** in the Factory menu.
 - c. When the Initial Setting is complete, power off the panel using the rocker-switch.
 - d. Wait at least 10 seconds and power the panel on.
- In case the USB storage device is not compatible, a *Can't Detect USB message* appears.

Network guide

Connecting the monitor and the computer using the network, remote control, and status monitoring of the monitor can be performed by web browser.

Setting the connection

1. To use a static IP address, select **Disable under DHCP**.

Picture	DHCP	Disable
Sound	IP Address	192.168.10.10
OSD	Subnet Mask	255.255.255.0
Setup	Gate Way	192.168.10.1
Presets	DNS	168.126.63.1
LAN Setting	LAN Setting Reset	
About		

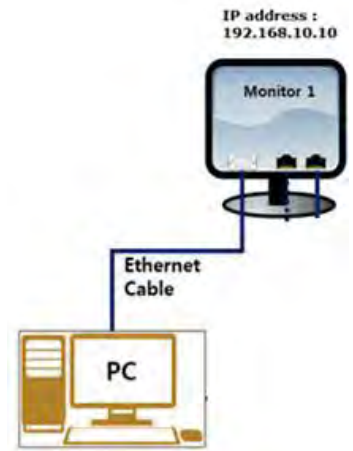

The default static IP address is 192.168.10.10

2. Select DHCP Enable to use a dynamic IP address
 - If there is router, the IP address starts with 192.168.
 - If there is no router, the IP address starts with 169.254.

Picture	DHCP	Enable
Sound	IP Address	192.168.1.3
OSD	Subnet Mask	255.255.255.0
Setup	Gate Way	192.168.10.1
Presets	DNS	168.126.63.1
LAN Setting	LAN Setting Reset	
About		

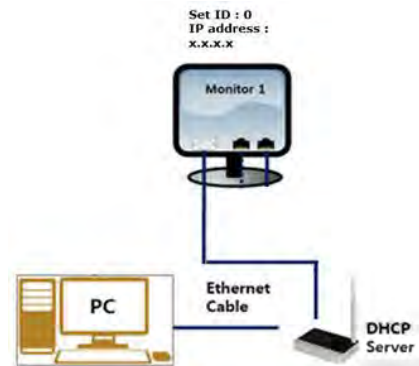

PC Setting

1. Go to **Local Network Setting – Internet protocol version 4(TCP/IPv4)**.
2. If DHCP disable on the on-screen display, From the General tab set the following:
 - IP address: 192.168.10.50
The IP address must be a different address than the display.
 - Subnet Mask: 255.255.255.0
3. If DHCP is enabled, select **Obtain an IP address automatically**.
4. Select **OK**.

Completing a ping test

The ping test checks the Ethernet connection.

1. Select **Windows + R**.
2. Enter cmd.
3. Select **OK**
4. Enter ping -t 192.168.10.10.

Replace the IP address with the address of display panel.

A response similar to below indicates success:

```

C:\Windows\system32\cmd.exe - ping -t 192.168.10.10
Microsoft Windows [Version 6.2.9200]
(c) 2012 Microsoft Corporation. All rights reserved.

C:\Users\Wcseo>ping -t 192.168.10.10

Pinging 192.168.10.10 with 32 bytes of data:
Reply from 192.168.10.10: bytes=32 time<1ms TTL=64
Reply from 192.168.10.10: bytes=32 time<1ms TTL=64
Reply from 192.168.10.10: bytes=32 time<1ms TTL=64
Reply from 192.168.10.10: bytes=32 time<1ms TTL=64
    
```

A response similar to below indicates a failure

```

C:\Windows\system32\cmd.exe - ping -t 192.168.10.10
Microsoft Windows [Version 6.2.9200]
(c) 2012 Microsoft Corporation. All rights reserved.

C:\Users\Wcseo>
C:\Users\Wcseo>ping -t 192.168.10.10

Pinging 192.168.10.10 with 32 bytes of data:
Reply from 192.168.1.96: Destination host unreachable.
Reply from 192.168.1.96: Destination host unreachable.
Reply from 192.168.1.96: Destination host unreachable.
    
```

Connecting a web server

To connect to the built-in web server open a web browser (for example, Internet Explorer or Chrome) and follow the instructions below.

1. In a web browser, go to the address of the display panel.

The web page provides all the menu controls on the on-screen display.

2. To set a value, select **Apply**.
3. To display the current value, select **Read**.

Upgrading the Ethernet or Scaler firmware

1. To upgrade the Ethernet or Scaler firmware, go to the General settings page.
 - Ethernet firmware update time: approximately 5 minutes
 - Scaler firmware update time: approximately 8 minutes



Caution! If not avoided, the following could result in minor or moderate injury.

- Do not disconnect LAN cable or power off during F/W update
- Wait until upgrade complete message show

Connecting to the Crestron-X-panel program

To connect to Crestron by X-Panel program, use the X-Panel program. Follow the instructions below.

1. Execute the **X-Panel** program.
2. Select **options > Settings**.
3. In the Gateway Settings dialog, set the IP address 192.168.10.10 (Monitor IP) and Port 41794.
4. Control the monitor settings, for example, the Picture setting and remote control.



Connecting to the Crestron-Roomview program

To connect to Crestron by Roomview program, Use the Roomview program. Follow the instructions below.

1. Execute the **Roomview** program.
2. Add **New Room** to control the monitor or load Roomview database file.
3. Select **Edit > Rooms > New Room**.
4. Set the following:
 - Set Name
 - Location
 - IP address 192.168.10.10 (Monitor IP)
 - IP ID/Port 41794
5. Select **Browser > Open** and select the Load Roomview database file.

Controlling monitor settings

You can control monitor settings, such as adding various attributes.

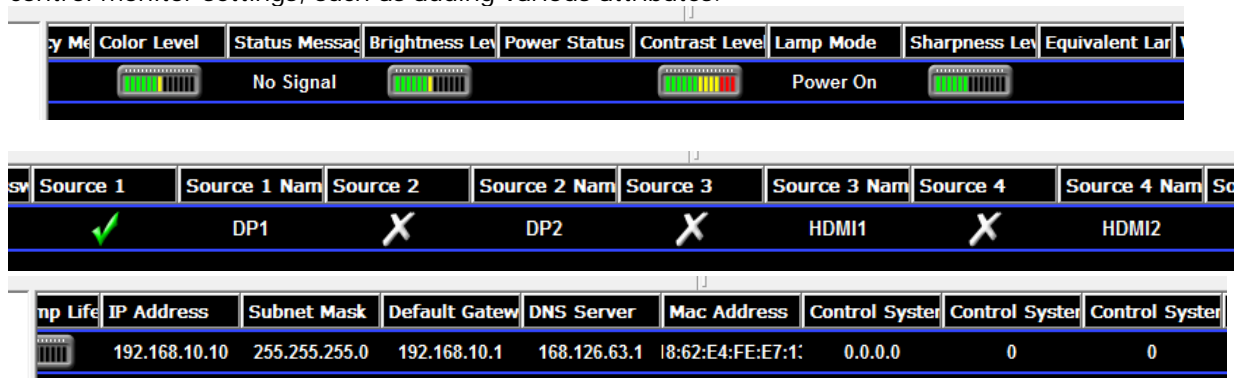

Maintenance and troubleshooting

Maintenance

Under normal operating conditions, routine maintenance is not required. No user-serviceable or replaceable parts exist. Unless you are a qualified, factory-trained technician, do not attempt to repair or replace any system component or the product warranty maybe voided.

Troubleshooting

The table below provides some general guidelines for troubleshooting problems you may encounter with your display. If the suggested solutions fail to resolve the problem or if you encounter an issue not described here, contact your dealer.

Symptom	Possible causes	Solution
The display does not turn on.	<ul style="list-style-type: none"> The display is not plugged in or the AC outlet is not active. The main power switch is off. The remote control batteries have run out. 	<ul style="list-style-type: none"> Ensure the display is plugged in and the AC outlet is active. Set the main power switch (see <i>Display-at-a-glance</i> on page 13) to the on position. Replace the batteries.
The display is on and menus appear but there is no picture.	<ul style="list-style-type: none"> Incorrect source selection. Source component is not turned on. Source component is connected incorrectly or not at all. 	<ul style="list-style-type: none"> Select the correct source. Turn on the source component. Check connections from the source component to the display. Reboot or restart the source.
The remote control does not work.	<ul style="list-style-type: none"> The remote control batteries have run out. 	<ul style="list-style-type: none"> Replace the batteries.
The display is jittery or unstable.	<ul style="list-style-type: none"> Poor-quality or improperly connected source. The horizontal or vertical scan frequency of the input signal may be out of range for the display. 	<ul style="list-style-type: none"> Make sure the source is properly connected and of adequate quality for detection. Correct at the source. Use a different certified cable.
Image is too bright and/or lacks definition in the bright areas of the image.	<ul style="list-style-type: none"> Contrast is set too high. 	<ul style="list-style-type: none"> Decrease the contrast setting.
Image appears washed out and/or dark areas appear too bright.	<ul style="list-style-type: none"> Black level is set too high. 	<ul style="list-style-type: none"> Decrease the black level setting.
Image is too dark.	<ul style="list-style-type: none"> Black level and/or brightness are set too low. 	<ul style="list-style-type: none"> Increase the black level and/or brightness settings.

<p>Images from an HDMI source do not display.</p>	<ul style="list-style-type: none"> • The resolution and frequency of the video card in the computer are not compatible with the display. • HDMI cable from source to display is either defective or too long. 	<ul style="list-style-type: none"> • Select a compatible resolution and vertical frequency (see <i>Supported timings</i> on page 47). • Try a known good and/or shorter HDMI cable.
<p>Computer images do not display correctly.</p>	<ul style="list-style-type: none"> • The resolution and frequency of the video card in the computer are not compatible with the display. • The Clock and Phase settings need adjustment. 	<ul style="list-style-type: none"> • Select a compatible resolution and vertical frequency (see <i>Supported timings</i> on page 47).

