

IFP52-2 Series

Commercial Touch Display

User Guide

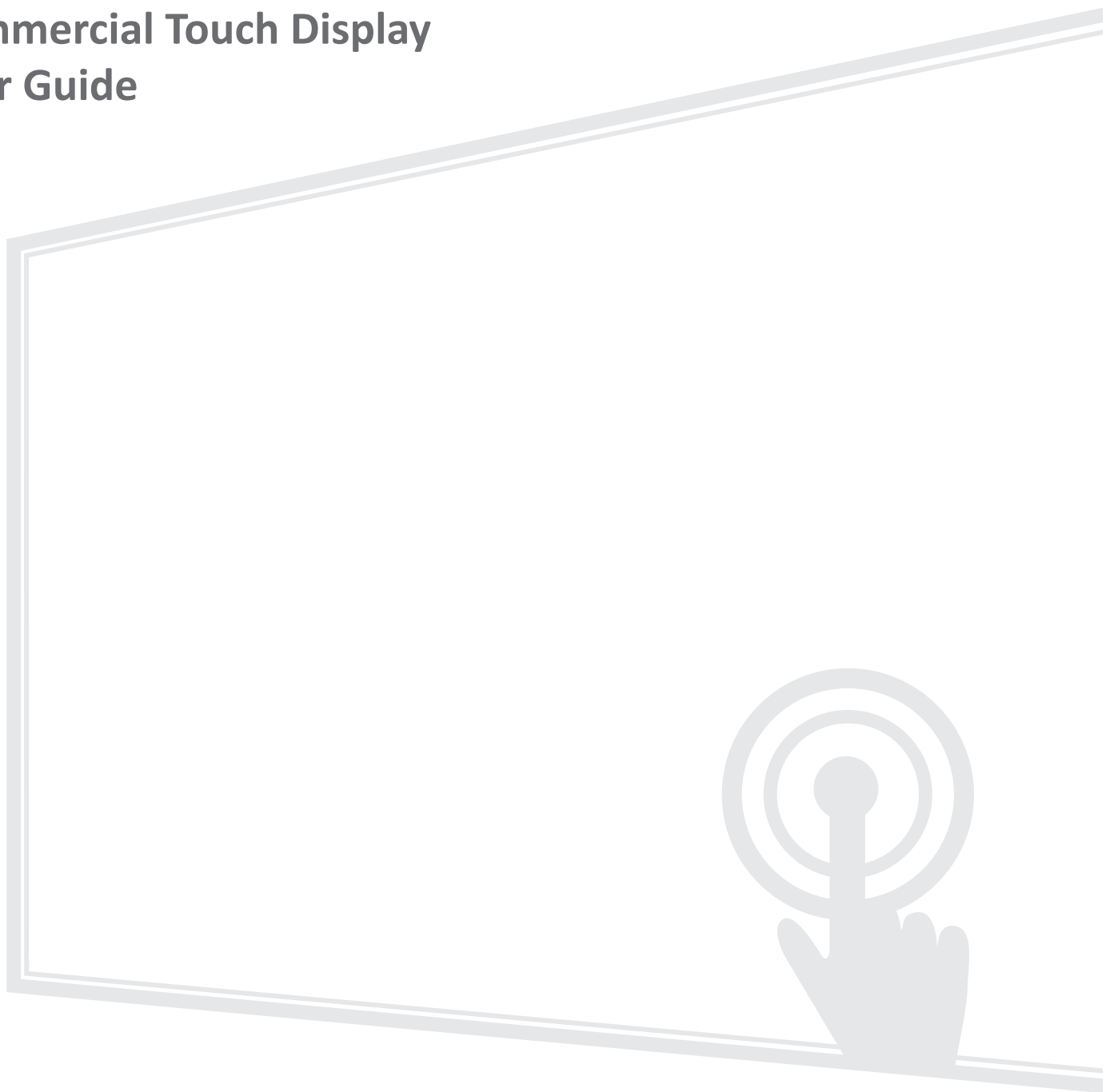

IMPORTANT: Please read this User Guide to obtain important information on installing and using your product in a safe manner, as well as registering your product for future service. Warranty information contained in this User Guide will describe your limited coverage from ViewSonic® Corporation, which is also found on our web site at <http://www.viewsonic.com> in English, or in specific languages using the Regional selection box of our website.

Model No. VS19364 | VS19365 | VS19366

P/N: IFP6552-2/IFP6552-2F/IFP6552-2ED | IFP7552-2/IFP7552-2F/IFP7552-2ED | IFP8652-2/IFP8652-2F/IFP8652-2ED

Thank you for choosing ViewSonic®

As a world-leading provider of visual solutions, ViewSonic® is dedicated to exceeding the world's expectations for technological evolution, innovation, and simplicity. At ViewSonic®, we believe that our products have the potential to make a positive impact in the world, and we are confident that the ViewSonic® product you have chosen will serve you well.

Once again, thank you for choosing ViewSonic®!

Safety Precautions

Please read the following **Safety Precautions** before you start using the device.

- Keep this user guide in a safe place for later reference.
- Read all warnings and follow all instructions.
- Do not use the device near water. To reduce the risk of fire or electric shock, do not expose the device to moisture.
- Never remove the rear cover. This display contains high-voltage parts. You may be seriously injured if you touch them.
- Avoid exposing the device to direct sunlight or other sources of sustained heat.
- Do not install near any heat sources such as radiators, heat registers, stoves, or other devices (including amplifiers) that may increase the temperature of the device to dangerous levels.
- Use a soft, dry cloth to clean the external housing. For more information, refer to the "Maintenance" section.
- When moving the device, be careful not to drop or bump the device on anything.
- Do not place the device on an uneven or unstable surface. The device may fall over resulting in an injury or a malfunction.
- Do not place any heavy objects on the device or connection cables.
- If smoke, an abnormal noise, or a strange odor is present, immediately turn the device off and call your dealer or ViewSonic®. It is dangerous to continue using the device.
- The device is a monitor with an LED backlight intended for general office use.
- Do not attempt to circumvent the safety provisions of the polarized or grounding-type plug. A polarized plug has two blades with one wider than the other. A grounding-type plug has two blades and a third grounding prong. The wide blade and the third prong are provided for your safety. If the plug does not fit into your outlet, obtain an adapter and do not attempt to force the plug into the outlet.
- When connecting to a power outlet, DO NOT remove the grounding prong. Please ensure grounding prongs are NEVER REMOVED.
- Protect the power cord from being treaded upon or pinched, particularly at the plug, and at the point where it emerges from the equipment. Ensure that the power outlet is located near the equipment so that it is easily accessible.

- Only use attachments/accessories specified by the manufacturer.
- When a cart is used, use with caution when moving the cart/equipment combination to avoid injury from tipping over.
- Disconnect the power plug from the AC outlet if the device is not being used for a long period of time.
- Place the device in a well-ventilated area. Do not place anything on the device that prevents heat dissipation.

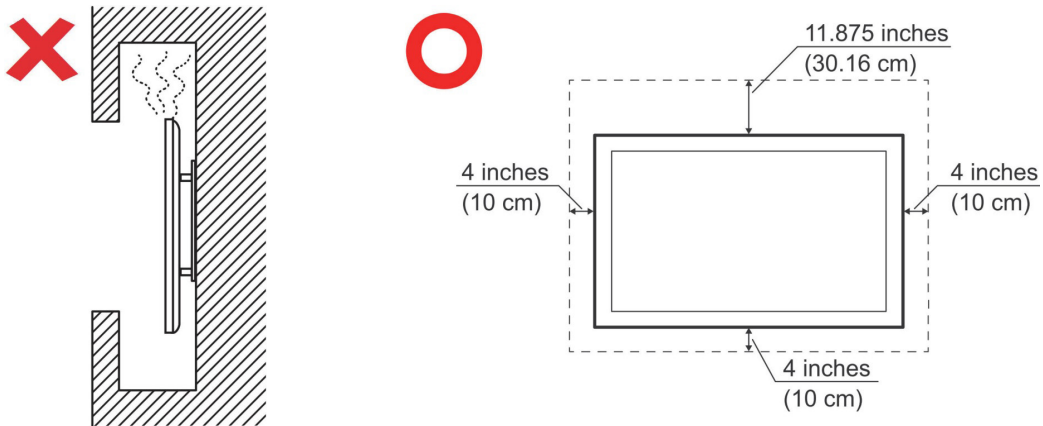

- Refer all servicing to qualified service personnel. Service will be required when the unit has been damaged in any way, such as:
 - » if the power supply cord or plug is damaged
 - » if liquid is spilled onto or objects fall in the unit
 - » if the unit is exposed to moisture
 - » if the unit does not operate normally or has been dropped

Contents

Safety Precautions.....	3
Introduction	9
Package Contents	9
Wall Mount Kit Specifications (VESA)	10
IFP6552-2	10
IFP7552-2	11
IFP8652-2	12
Product Overview	13
IFP6552-2	13
IFP7552-2	14
IFP8652-2	15
Control Panel.....	16
I/O Panels	17
Front I/O	18
Rear I/O	19
Side I/O.....	20
Remote Control	21
Using Gestures	24

Making Connections	26
Connecting to Power	26
Connecting External Devices and Touch Connection	27
USB Type C Connection	28
HDMI Connection	28
DisplayPort Connection	28
VGA Connection	28
RS-232 Connection	29
USB and Networking Connections	30
USB Peripherals	30
Networking and Modem cables	30
Media Player Connection	31
Audio Connection	32
Audio In	32
Audio Out	32
SPDIF Connection	33
Video Output Connection	34
Optional Connections	35
Slot-in PC (OPS Slot) Installation	35
Wi-Fi Card (Wi-Fi Slot) Installation	36
Using Your ViewBoard	37
Powering ON/OFF your ViewBoard	37
Initial Launch Setup	38
Home Screen (Launcher Scheme)	42
Toolbar	43
Toolbar Icons	44
Control and Notification Panel	45
On-Screen Display (OSD) Menu - General Settings	46
Input Settings	47
Display Settings	49
Audio Settings	51
Low Blue Light Filter and Eye Health	53
Applications	55

ViewBoard Settings	56
Network & Internet	56
Connected Devices	58
Apps	59
Notifications	60
Storage	62
Sound.....	63
Display	64
Wallpaper & Style.....	65
Accessibility	66
Security.....	68
Privacy	69
Location	71
Passwords & Accounts.....	72
Digital Wellbeing	73
Google	74
System	75
About Device	76
Tips & Support.....	77
ViewBoard Settings Menu Tree	78
Pre-installed Applications and Settings.....	106
myViewBoard Display.....	106
myViewBoard Manager	107
myViewBoard Whiteboard	108
vCast	111
Display Group Settings	113
Synchronized Group Screen All the Time	115
Share a Screen to the Display Group (One to Many Casting).....	115
Moderator Mode	116
Broadcast	117
Multiple Screen Sharing	117
Preview Screen.....	117
Touch.....	117
Casting from Windows, MacBook, and Chrome Devices	118
Casting from Android Devices	120
Casting from Apple iOS Devices	123
Connecting to a ViewBoard from a Mobile Device	126

RS-232 Protocol	127
Description	127
RS-232 Hardware Specification	127
LAN Hardware Specification.....	128
RS232 Communication Setting.....	128
LAN Communication Setting	128
Command Message Reference.....	128
Protocol	129
Set-Function Listing.....	129
Get-Function Listing	137
Remote Control Pass-through Mode	145
Appendix	148
Specifications.....	148
Display Modes	150
DisplayPort	150
HDMI	150
USB Type C	151
VGA	151
HDMI Out	152
Troubleshooting	153
Maintenance.....	155
General Precautions	155
Cleaning the Screen.....	155
Cleaning the Case	155
Regulatory and Service Information	156
Compliance Information.....	156
FCC Compliance Statement.....	156
Industry Canada Statement.....	156
CE Conformity for European Countries.....	156
Declaration of RoHS2 Compliance.....	157
ENERGY STAR Statement.....	158
Indian Restriction of Hazardous Substances	158
Product Disposal at End of Product Life	158
Copyright Information	159
Customer Service	160
Limited Warranty	161
Mexico Limited Warranty.....	164

Introduction

Package Contents

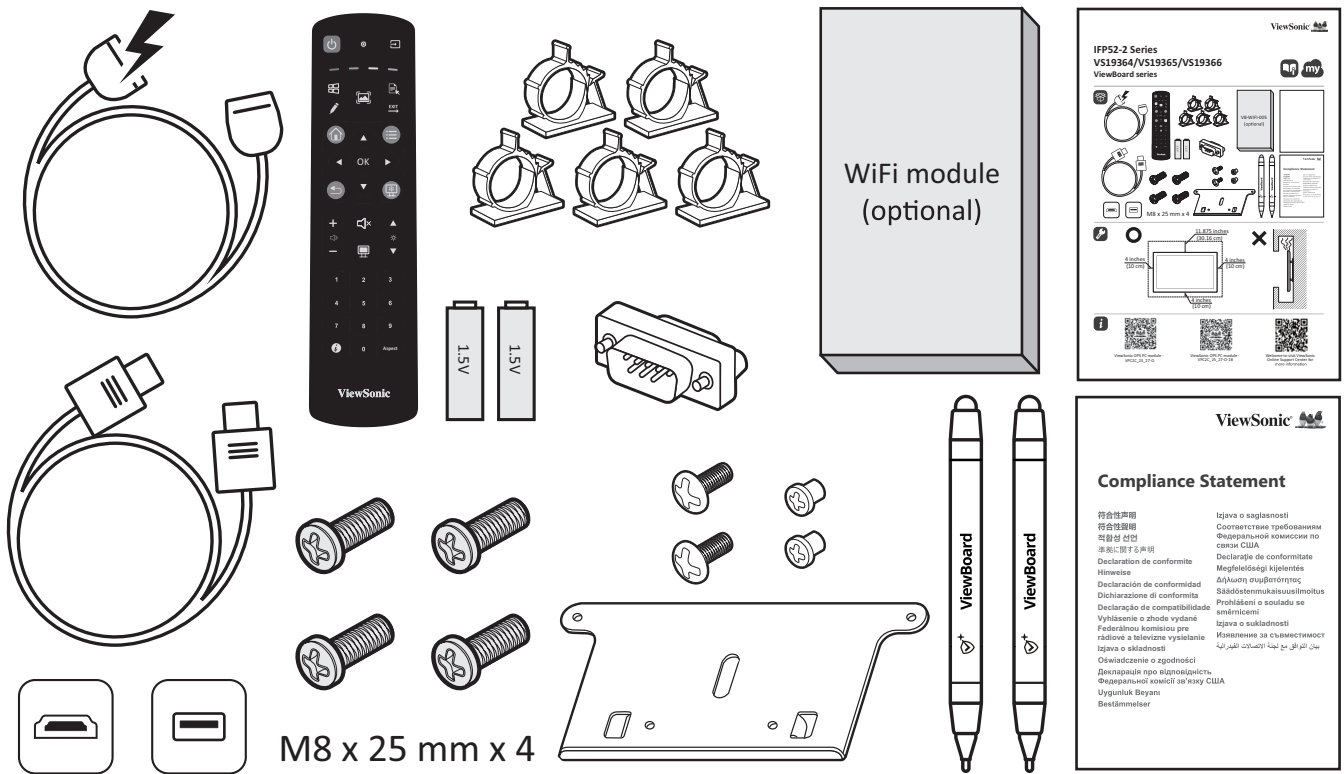

- AAA Battery
- Camera Plate
- Clamp x 5
- Compliance Statement
- HDMI Cable (3 m)
- Power Cord (3 m)
- Quick Start Guide
- Remote Control
- RS-232 Adapter
- Screw x 8
- Touch Pen x 2
- USB Touch Cable (3 m)

NOTE: The power cord and video cables included in your package may vary depending on your country. Please contact your local reseller for more information.

Wall Mount Kit Specifications (VESA)

NOTE: Please follow the instructions in the wall mount installation guide to install your wall mount or mobile mount bracket. If attaching to other building materials, please contact your nearest dealer.

IFP6552-2

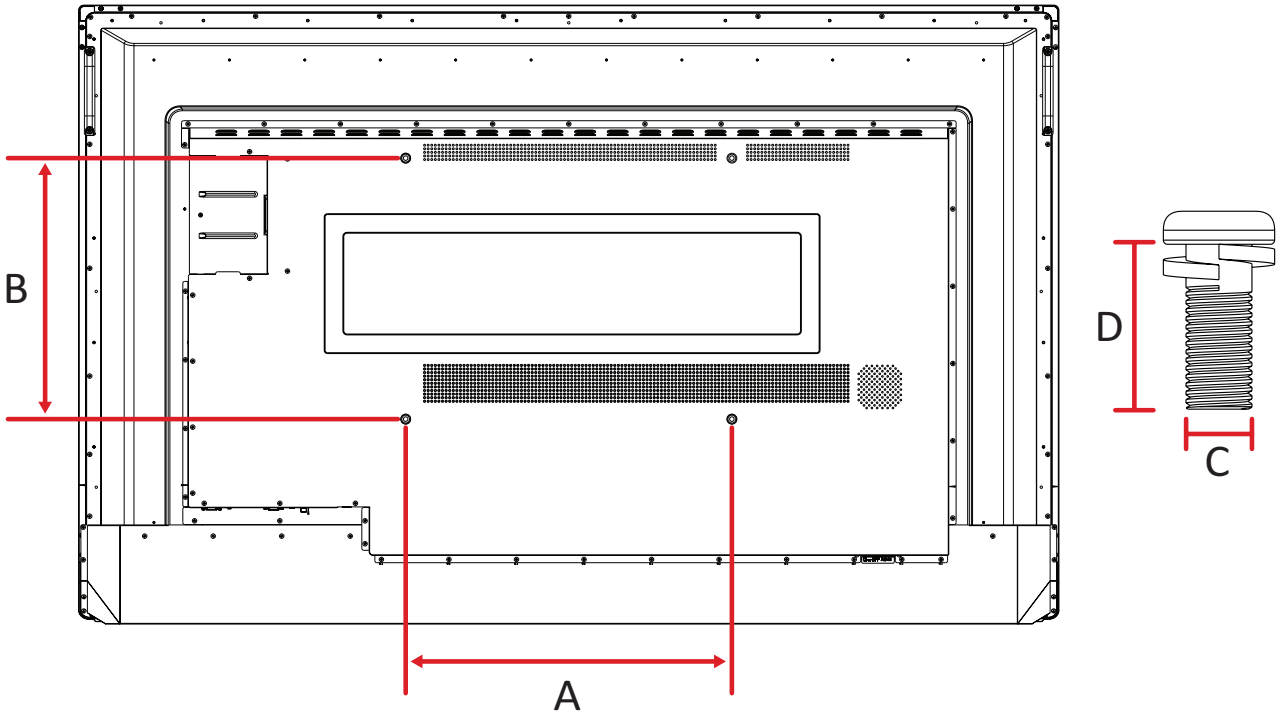

Model	VESA Spec. (A x B)	Standard Screw (C x D)	Quantity
IFP6552-2	500 x 400 mm	M8 x 25 mm	4

NOTE: Do not use screws that are longer than the standard dimension, as they may cause damage to the inside of the display.

IFP7552-2

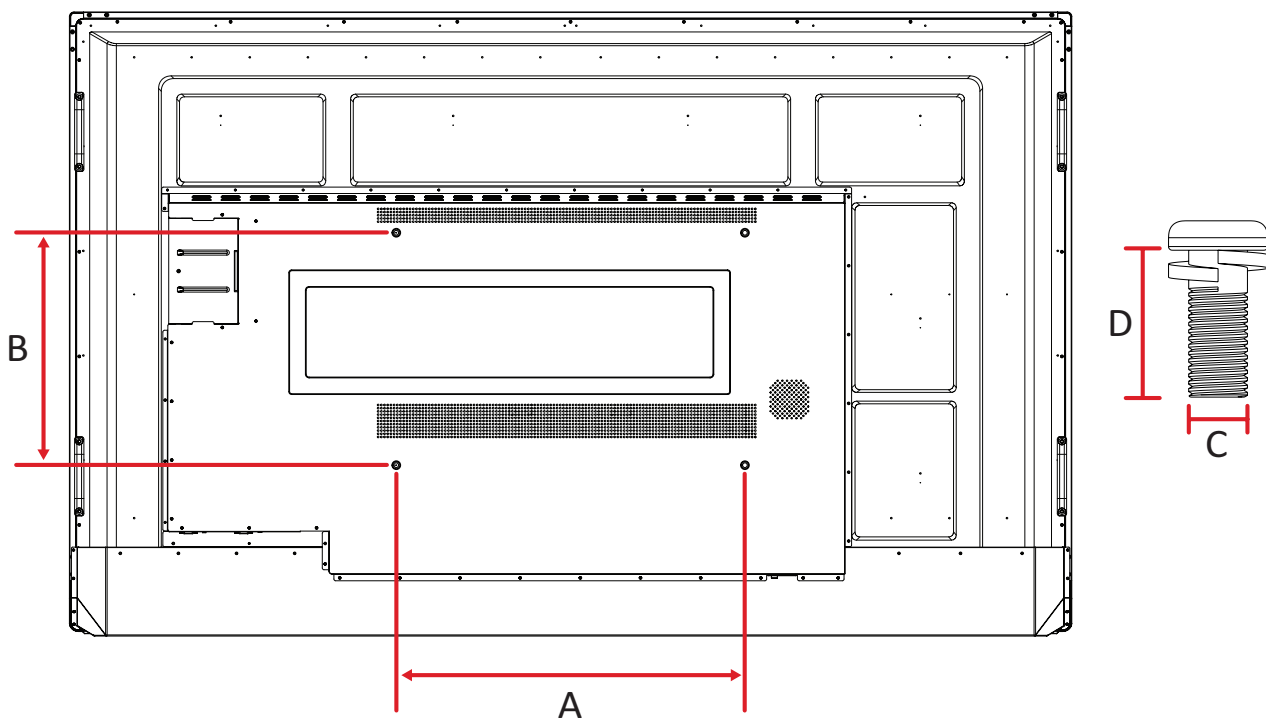

Model	VESA Spec. (A x B)	Standard Screw (C x D)	Quantity
IFP7552-2	600 x 400 mm	M8 x 25 mm	4

NOTE: Do not use screws that are longer than the standard dimension, as they may cause damage to the inside of the display.

IFP8652-2

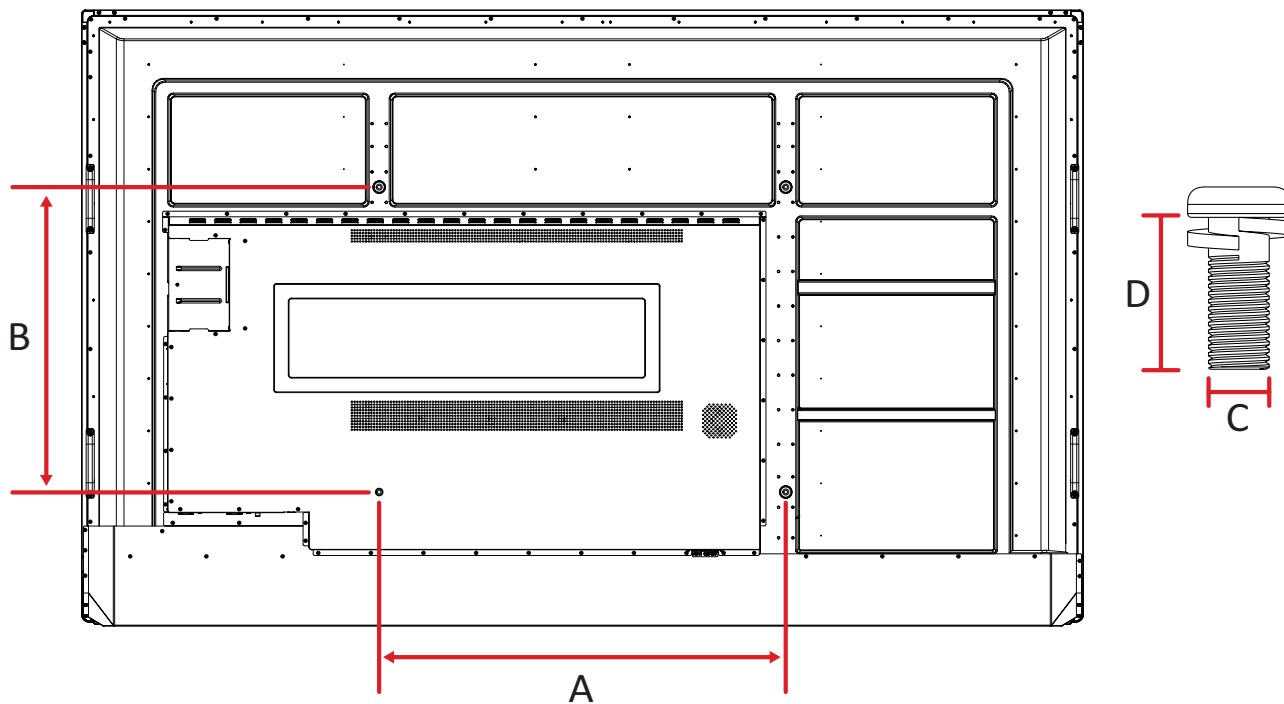

Model	VESA Spec. (A x B)	Standard Screw (C x D)	Quantity
IFP8633	800 x 600 mm	M8 x 25 mm	4

NOTE: Do not use screws that are longer than the standard dimension, as they may cause damage to the inside of the display.

Product Overview

IFP6552-2

Front Panel



Rear Panel

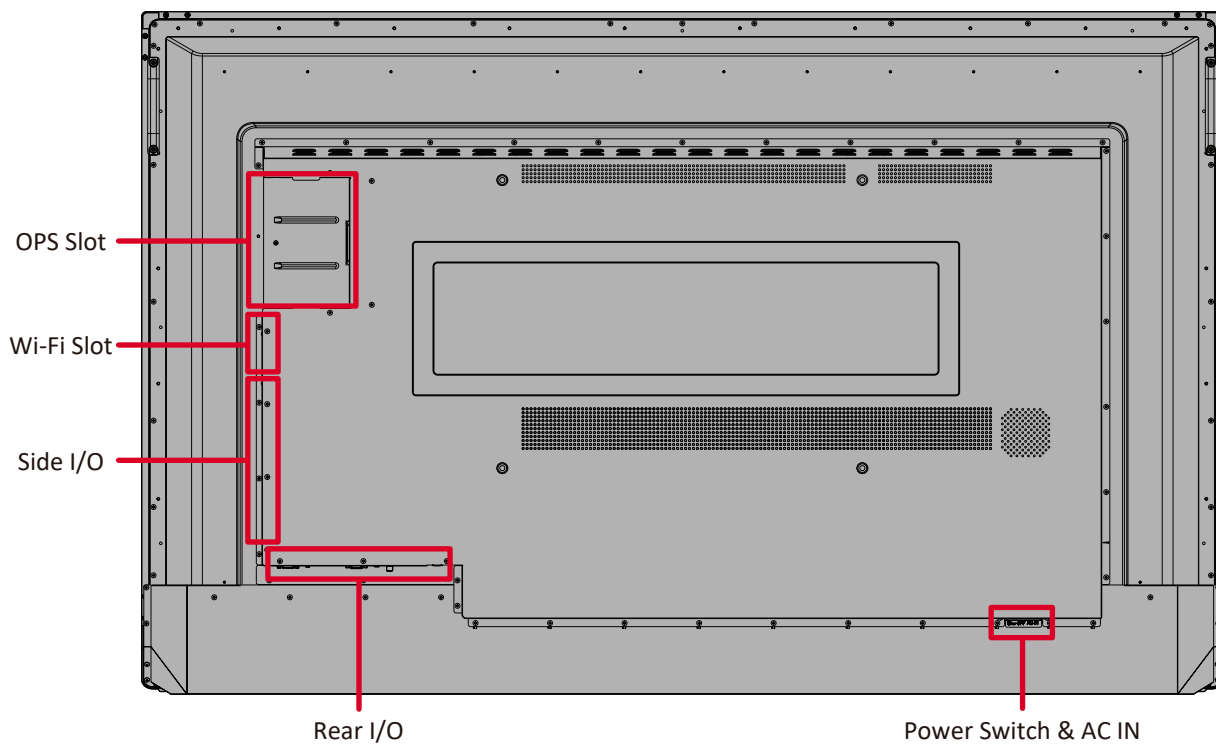

IFP7552-2

Front Panel



Rear Panel

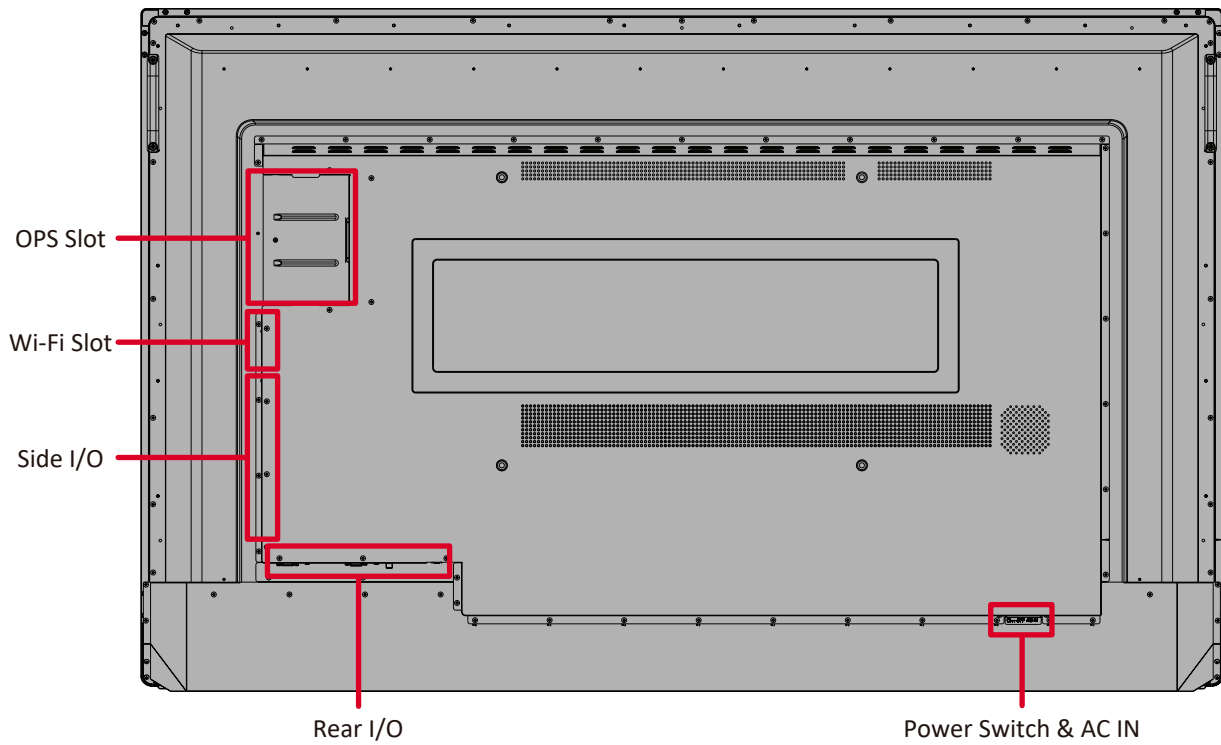

IFP8652-2

Front Panel





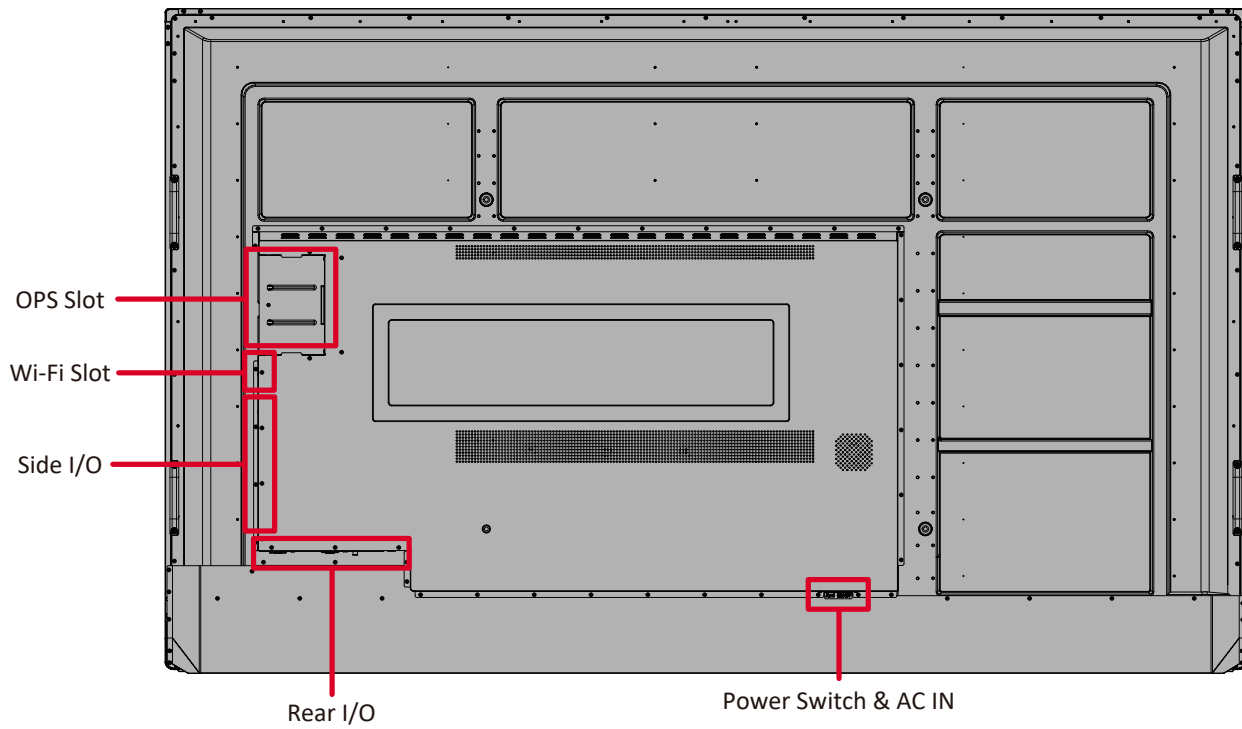



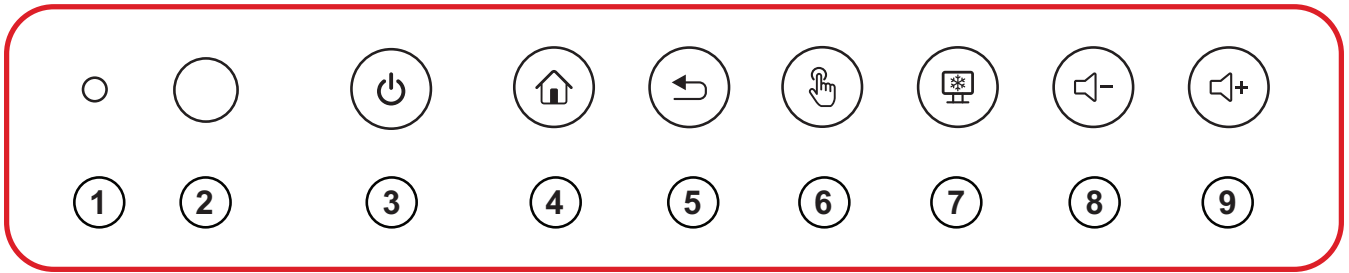

Rear Panel



Control Panel



Number	Item	Description
1		Ambient light sensor
2		Remote control receiver
3		<ul style="list-style-type: none"> • Power indicator light • Press to turn ON the device • Press to turn OFF/ON the display backlight only • Press and hold to turn OFF the device
4		Return to the ViewBoard's main interface
5		Return to the ViewBoard's previous level
6		Disable/Enable the touch screen
7		Freeze the current image on the screen
8		Decrease the volume
9		Increase the volume

I/O Panels





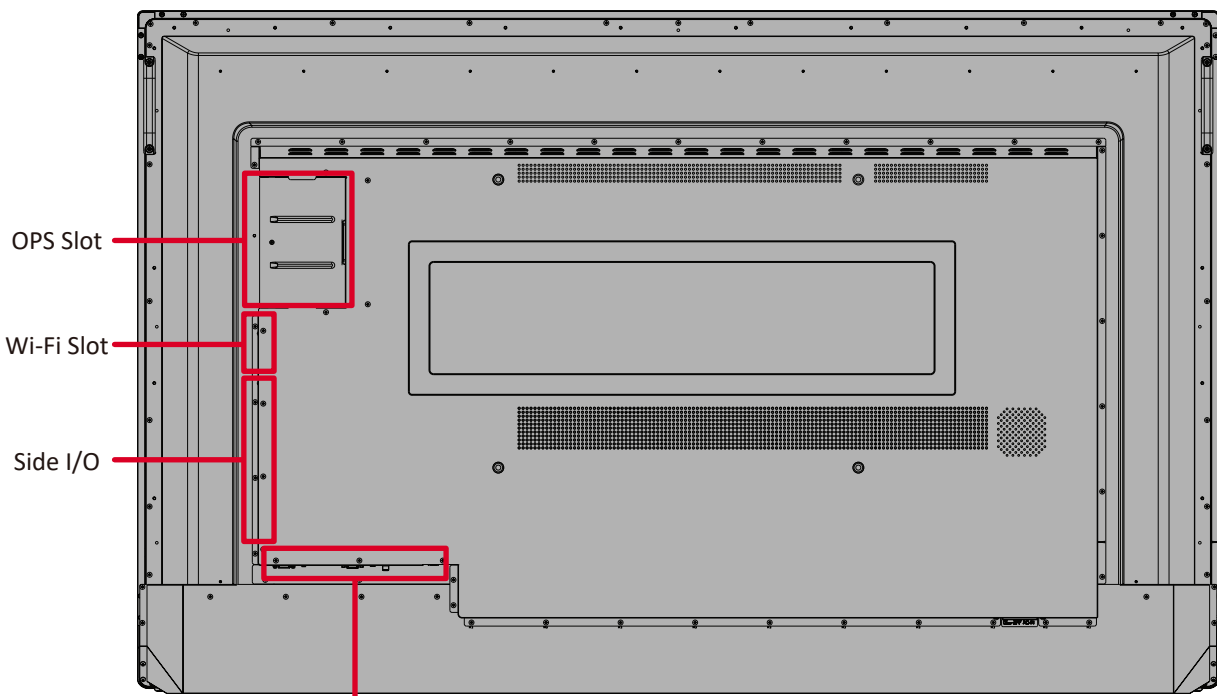

Front I/O

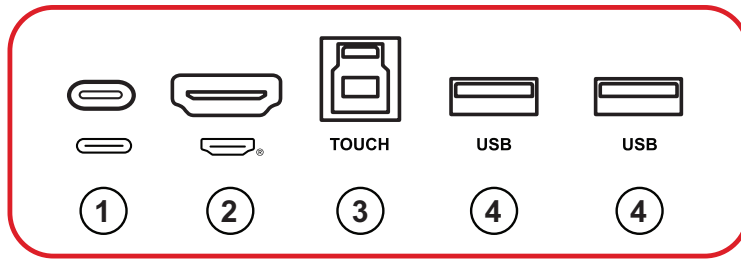

Rear I/O

Front I/O



Number	Item	Description
1	 (Type C 2)	<ul style="list-style-type: none"> • USB Type C input • USB 3.0 standard • Supports DP v. 1.2 with audio, video, and touch • Supports LAN by 10M/100M • Supports power charge up to 65W. Power charge supported: 5V/3A, 9V/3A, 15V/3A, 20V/3.25A
2	 (HDMI 3)	<ul style="list-style-type: none"> • HDMI input • Connect to a computer with HDMI output, set-top box, or other video device • Supports 4K display; HDMI v. 2.0; CEC
3	TOUCH (TOUCH 3)	<ul style="list-style-type: none"> • USB Type B • Touch signal output to external computer • After connection (with an external computer), the device connected to the USB port can directly be used by the external computer <p>NOTE: Pairs with the HDMI 3 port () next to it.</p>
4	USB	<ul style="list-style-type: none"> • USB Type A input • USB 3.0 standard • Connect USB devices such as hard disks, keyboard, mouse, etc. • Automatically switches between the external computer and ViewBoard

Rear I/O

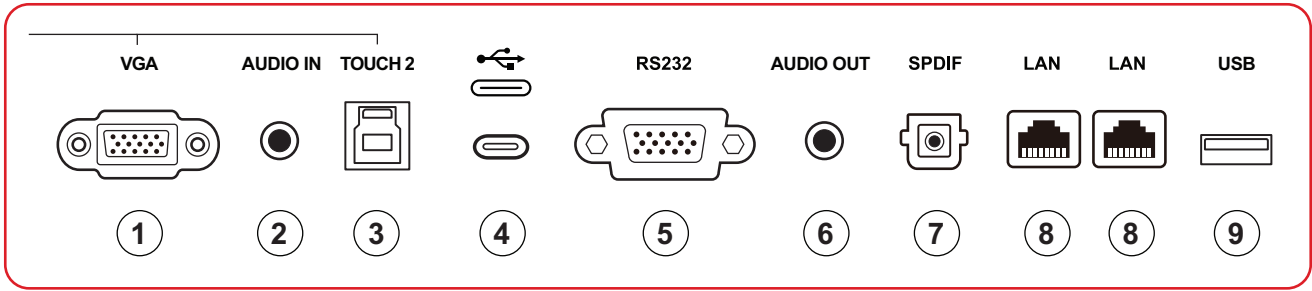

Number	Item	Description
1	VGA	External computer video input
2	AUDIO IN	External computer audio input
3	TOUCH 2	<ul style="list-style-type: none"> • USB Type B • Touch signal output to external computer • After connection (with an external computer), the device connected to the USB port can directly be used by the external computer <p>NOTE: Pairs with the VGA and HDMI 2 port.</p>
4	 (Type C 3)	<ul style="list-style-type: none"> • USB Type C • For data read/write only • USB 3.0 standard
5	RS232	Serial interface; used for mutual transfer of data between devices
6	AUDIO OUT	Audio output to an external speaker/headset
7	SPDIF	Multichannel sound via optical signals.
8	LAN	Standard RJ45 (10M/100M/1000M) Internet connection interface. Features hub support for network sharing.
9	USB	<ul style="list-style-type: none"> • USB Type A input • USB 2.0 standard • Microphone for external device use

Side I/O

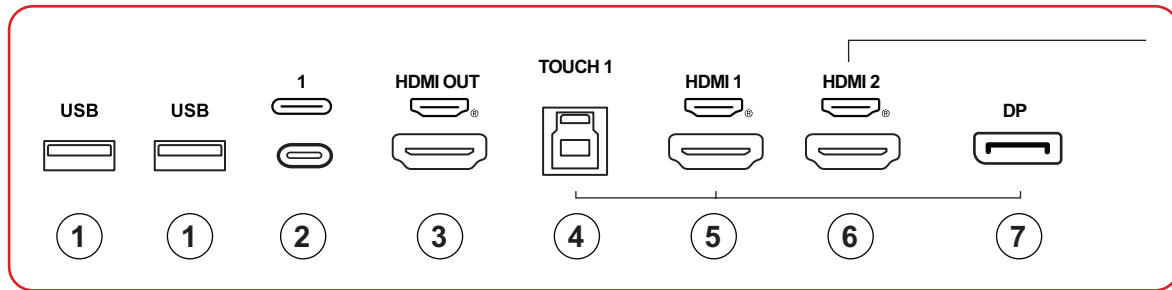

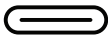
Number	Item	Description
1	USB	<ul style="list-style-type: none"> • USB Type A input • USB 3.0 standard • Connect USB devices such as hard disks, keyboard, mouse, etc. • Automatically switches between the external computer and ViewBoard
2	 (Type C 1)	<ul style="list-style-type: none"> • USB Type C input • USB 3.0 standard • Supports DP v. 1.2 with audio, video, and touch • Supports power charge up to 100W. Power charge supported: 5V/3A, 9V/3A, 15V/3A, 20V/3.25A, 20V/5A
3	HDMI OUT	<p>Connect to devices with HDMI input function. Supports 1080p and 4K@60Hz.</p> <p>NOTE: Supported by select models</p>
4	TOUCH 1	<ul style="list-style-type: none"> • USB Type B • Touch signal output to external computer • After connection (with an external computer), the device connected to the USB port can directly be used by the external computer <p>NOTE: Pairs with the DP and HDMI 1 port.</p>
5	HDMI 1	<ul style="list-style-type: none"> • HDMI input • Connect to a computer with HDMI output, set-top box, or other video device • Supports 4K display; HDMI v. 2.1; CEC; ARC
6	HDMI 2	<ul style="list-style-type: none"> • HDMI input • Connect to a computer with HDMI output, set-top box, or other video device • Supports 4K display; HDMI v. 2.0; CEC
7	DP	<ul style="list-style-type: none"> • DisplayPort input, v. 1.2 • Supports 4K display

Remote Control

Number	Description
1	Power on/off
2	Screen capture
3	Startup writing
4	Back to the ViewBoard player Home Screen
5	Back/Return to the previous page
6	Increase/Decrease the Volume
7	Number Keypad
8	Information
9	Input source selection
10	Media control buttons: <ul style="list-style-type: none"> • Red: Play/Pause • Green: Stop • Yellow: Forwards • Blue: Backwards
11	Settings menu
12	Up/Down/Right/Left/OK
13	Freeze screen
14	Mute/Unmute
15	Increase/Decrease Brightness
16	Blank Screen
17	Adjust Aspect Ratio

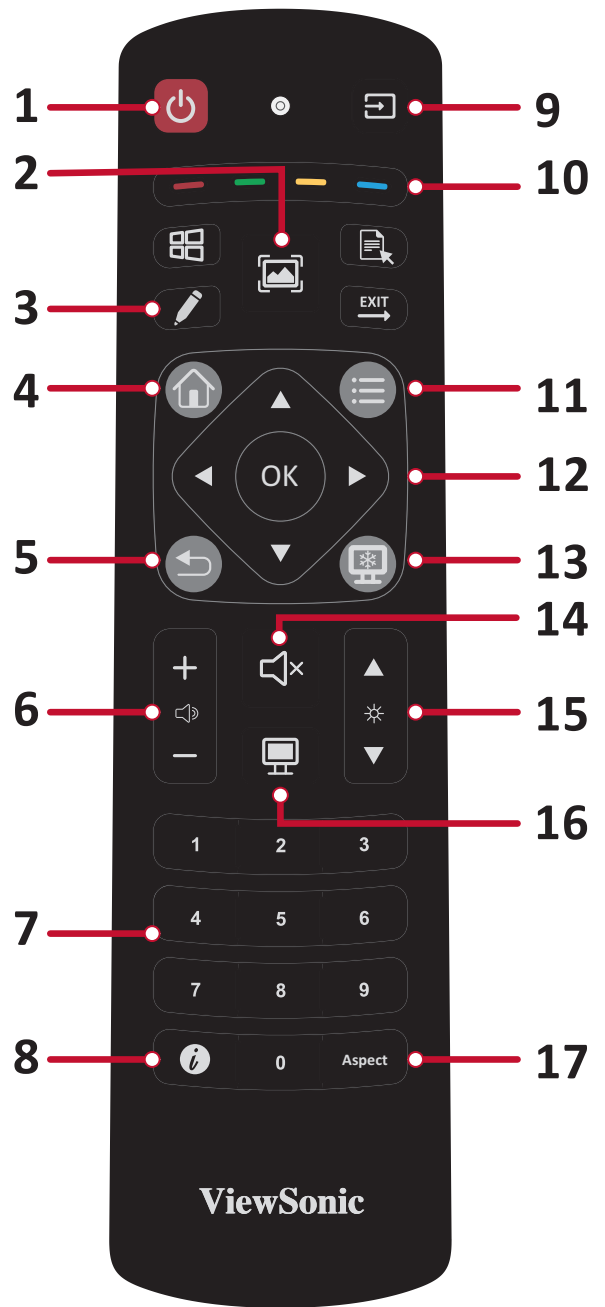

Inserting Remote Control Batteries

To insert batteries into the remote control:

1. Remove the cover on the rear of the remote control.
2. Insert two “AAA” batteries, ensuring the “+” symbol on the battery matches the “+” on the battery post.
3. Replace the cover by aligning it with the slot on the remote control and snapping the latch shut.

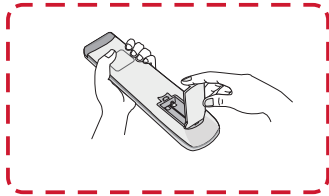

(1)

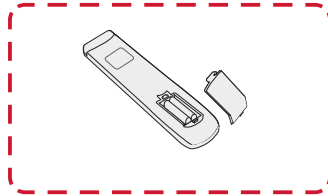

(2)



(3)

WARNING: There is a risk of explosion if batteries are replaced with the incorrect type.

NOTE:

- It is recommended that you do not mix battery types.
- Always dispose of old batteries in an environmentally friendly way. Contact your local government for more information on how to dispose of batteries safely.

Remote Control Receiver Range

The working range of the remote control is shown here. It has an effective range of 8 meters, 30° degrees left and right. Ensure there is nothing obstructing the remote control's signal to the receiver.

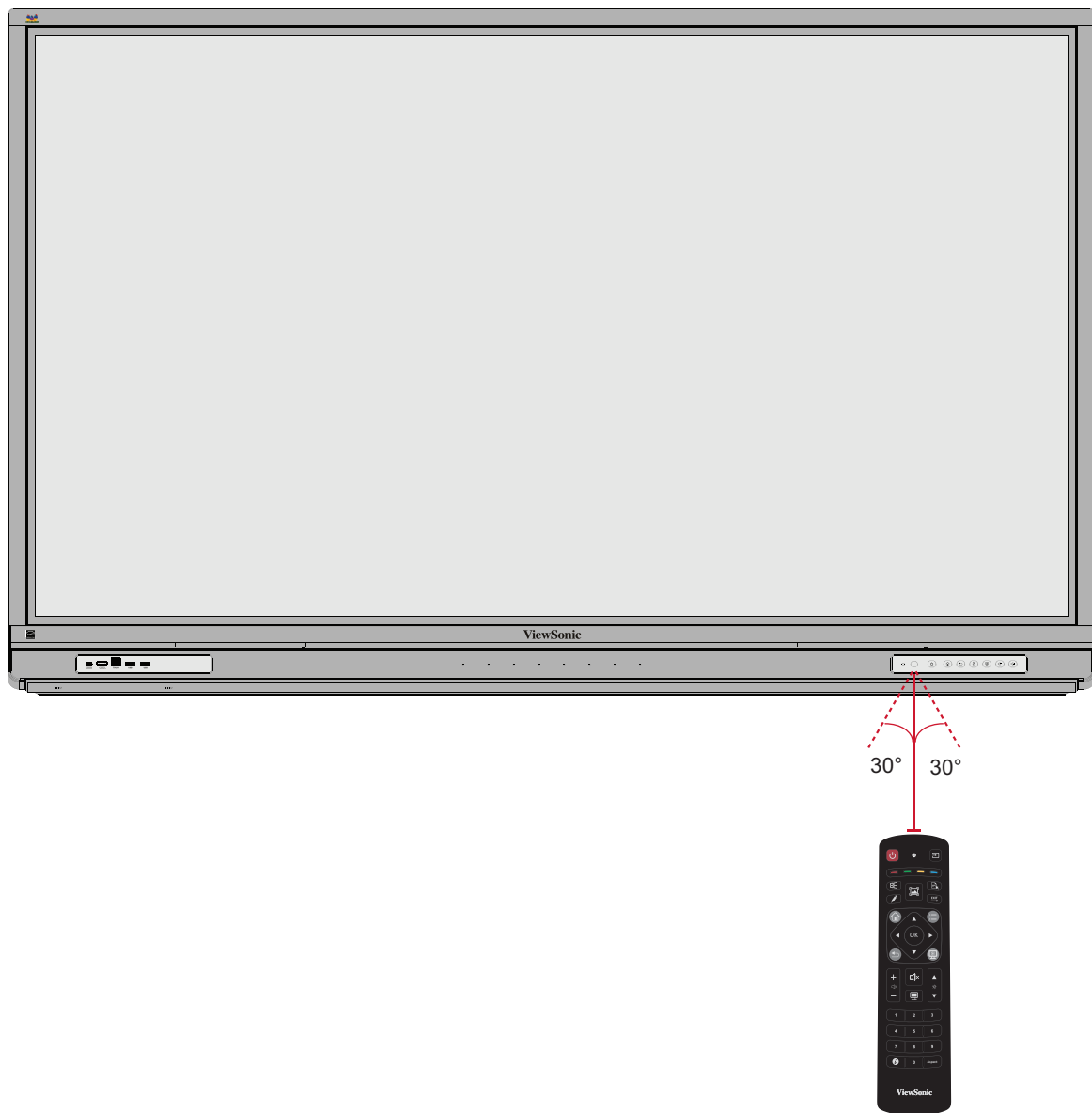

Using Gestures

Touch gestures allow the user to use pre-determined commands without using a keyboard or mouse. Using gestures on the ViewBoard, the user can select/deselect objects, change the location of an object, access settings, erase digital ink, and much more.

Select and Deselect an Object (Clicking)

Press and release the ViewBoard to select/deselect options or objects. This is like a single, standard left mouse click.

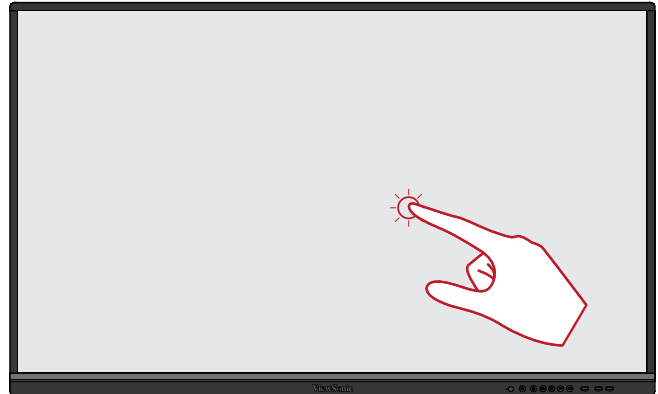

Display Menu Options (Right-Clicking)

Press and hold the ViewBoard with your finger. This is like a single, standard right mouse click.

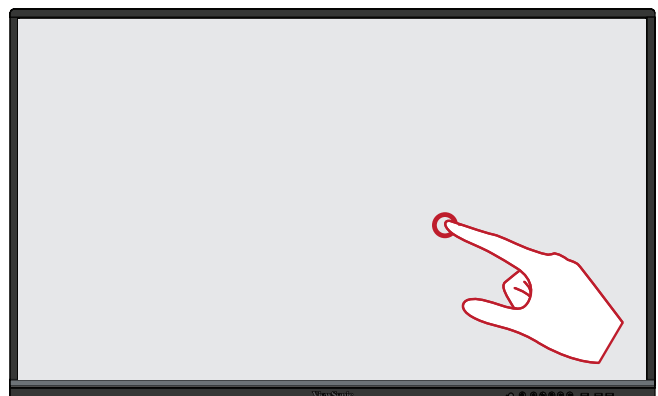

Double-Clicking

Quickly press and release twice in the same location on the ViewBoard. This is like a double, standard left mouse click.

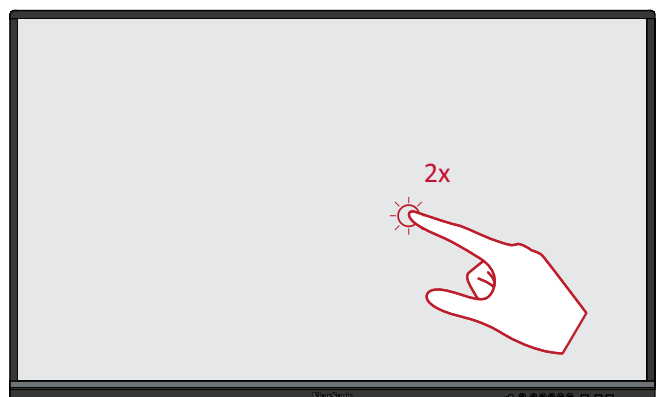

Moving an Object

Press and hold the object on the ViewBoard and slowly drag it with your finger to your desired location.



Erasing Digital Ink

Use your flattened hand, palm, or fist on the ViewBoard and move your hand across the area which you wish to erase.

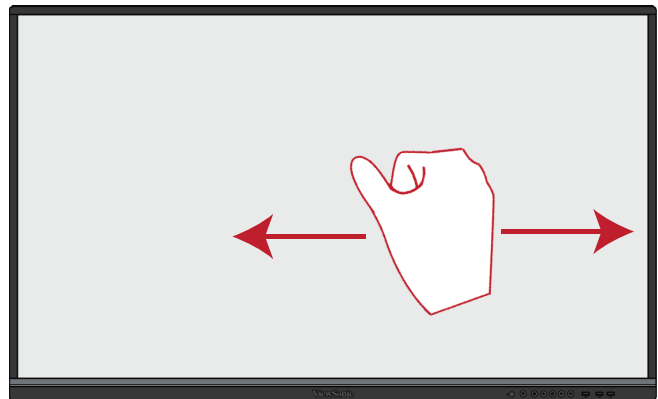

Swipe Up for General Settings

Swipe up from the bottom of the ViewBoard to launch the General Settings.

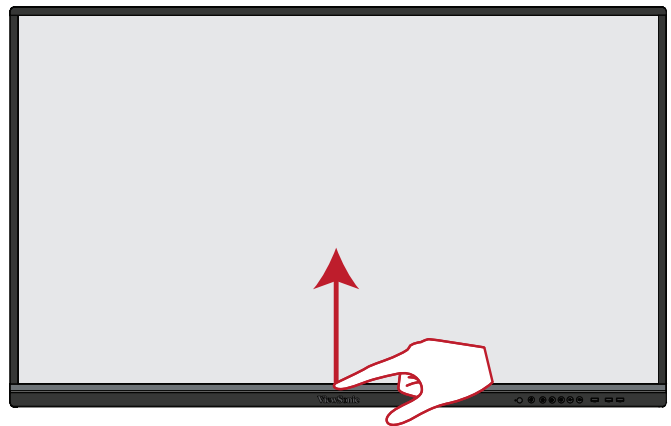

Making Connections

Connecting to Power

1. Connect the power cord to the AC IN jack at the rear of the device.
2. Plug the power cord plug into a power outlet.

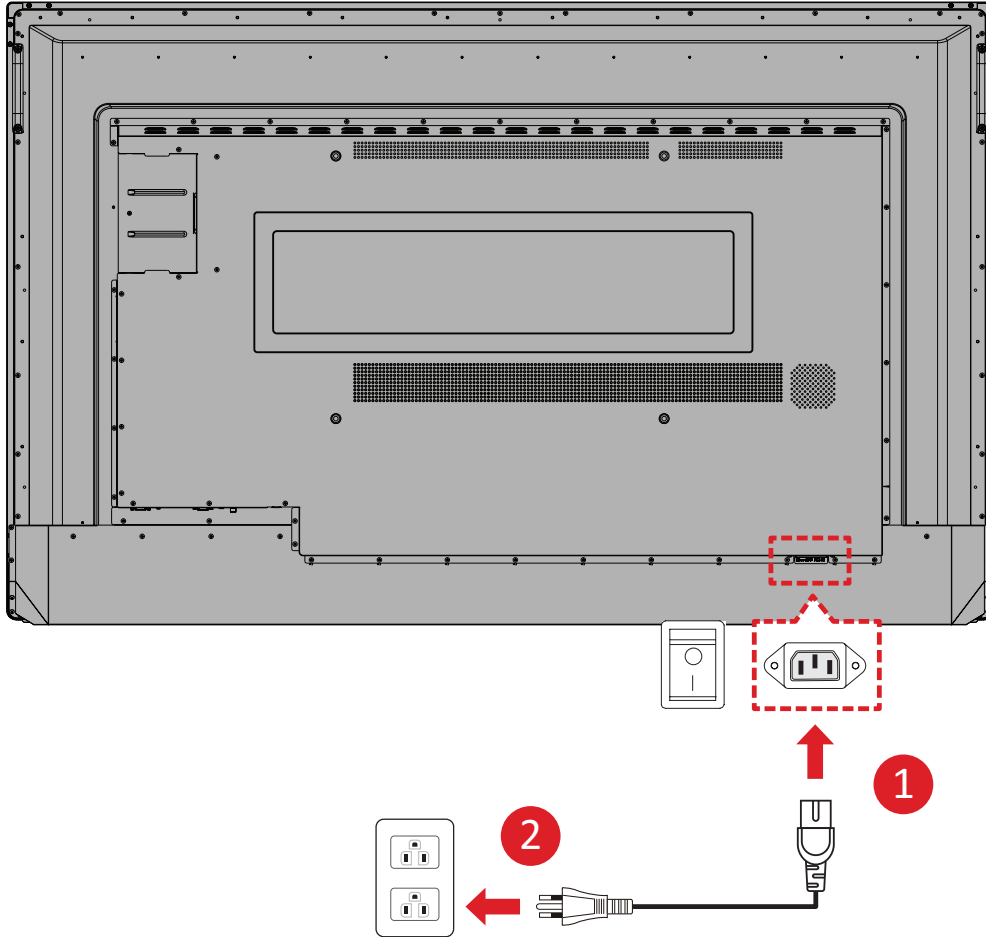

Connecting External Devices and Touch Connection

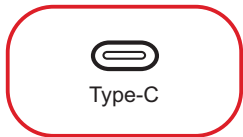

or

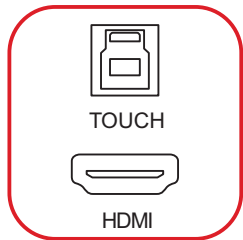

or

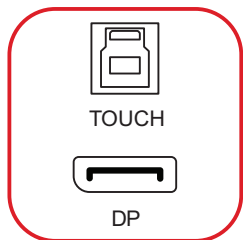

or

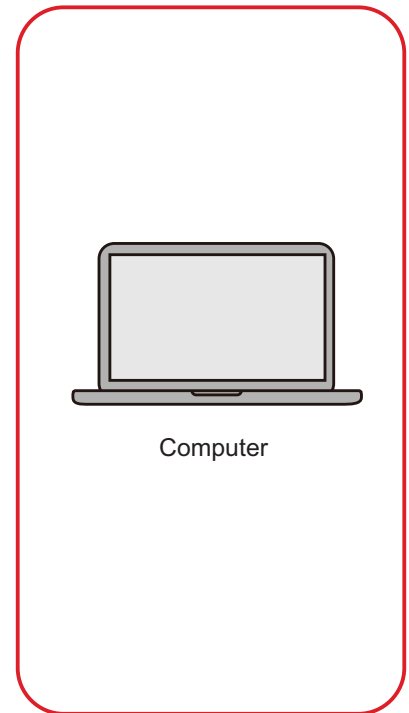
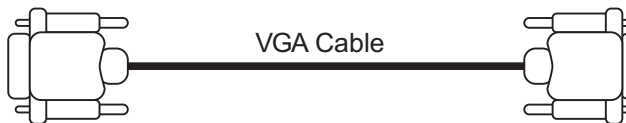

Your external device(s) can be connected in any of the following configurations:

USB Type C Connection

To connect via Type C:

Connect a Type C cable from your external device to a **Type C** port on the ViewBoard.

HDMI Connection

To connect via HDMI:

1. Connect an HDMI cable from your external device to the **HDMI 1/2/3** port on the ViewBoard.
2. Connect a USB Type B to A to the external device from the appropriate **TOUCH** port of the ViewBoard.

NOTE: The **TOUCH 1** port is for the **HDMI 1** and **DP** ports. The **TOUCH 2** port is for the **HDMI 2** and **VGA** ports. The **TOUCH 3** port is for the **HDMI 3** port.

DisplayPort Connection

To connect via DisplayPort:

1. Connect a DisplayPort cable from your external device to the **DP** port on the ViewBoard.
2. Connect a USB Type B to A cable to the external device from the **TOUCH 1** port of the ViewBoard.

NOTE: The **TOUCH 1** port is for the **HDMI 1** and **DP** ports. The **TOUCH 2** port is for the **HDMI 2** and **VGA** ports. The **TOUCH 3** port is for the **HDMI 3** port.

VGA Connection

To connect via VGA:

1. Connect a VGA cable from your external device to the **VGA** port on the ViewBoard.
2. Connect a USB Type B to A to the external device from the **TOUCH 2** port of the ViewBoard.

NOTE: The **TOUCH 1** port is for the **HDMI 1** and **DP** ports. The **TOUCH 2** port is for the **HDMI 2** and **VGA** ports. The **TOUCH 3** port is for the **HDMI 3** port.

RS-232 Connection

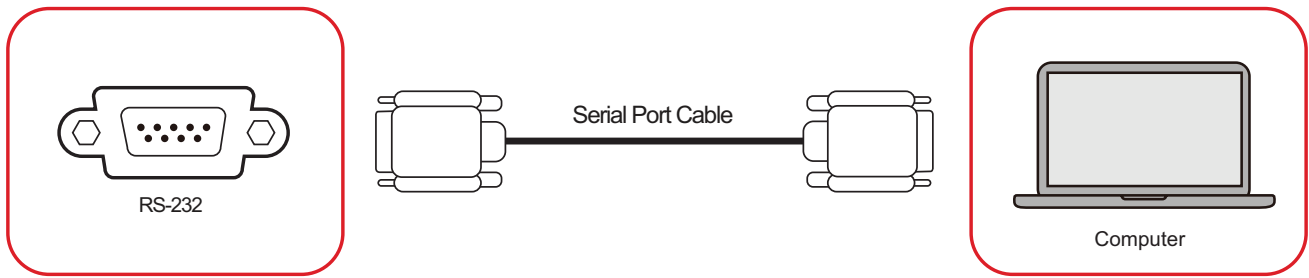

When you use a RS-232 serial port cable to connect your display to an external computer certain functions can be controlled remotely by the PC, including Power ON/OFF, Volume adjustment, Input select, Brightness, and more.

USB and Networking Connections

Just like any PC, it is easy to connect various USB devices and other peripherals to your ViewBoard.

USB Peripherals

Plug the USB device into a **USB** port.

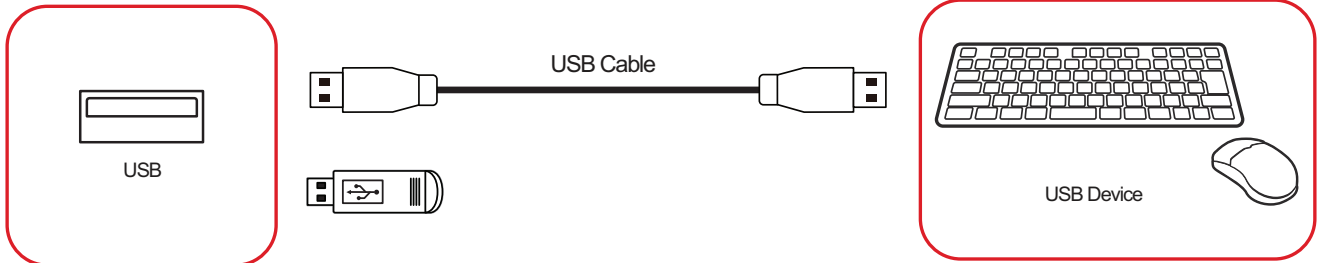

Networking and Modem cables

Plug the network cable into a **LAN** port.

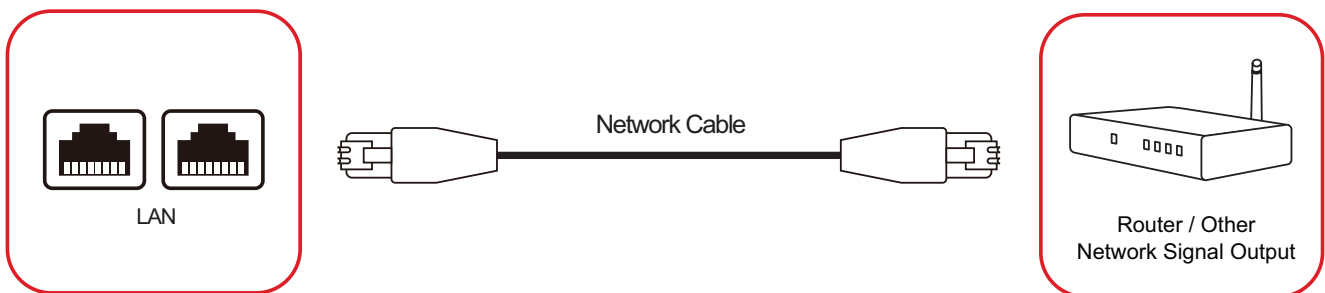

Media Player Connection

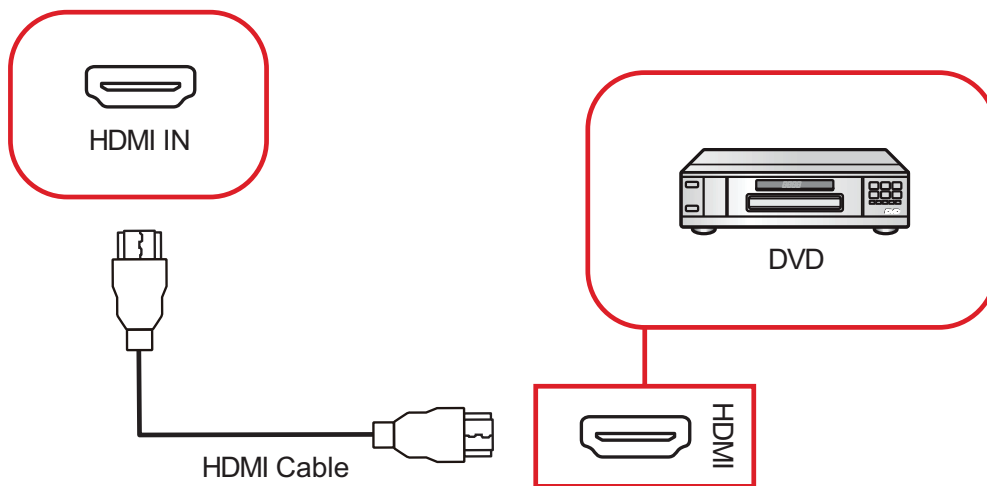

To connect to a media player:

1. Connect the HDMI cable to a **HDMI** port on your ViewBoard and peripheral device.
2. Plug in the power cord of your ViewBoard, and turn on the power supply switch.
3. Press the **Power** button on the ViewBoard to turn the screen on.
4. Press the **INPUT** button on the remote control and switch to the "HDMI" input source.

Audio Connection

The ViewBoard supports **Audio In**, **Audio Out**, and **SPDIF**.

Audio In

To play audio from your external device through the ViewBoard's speakers, connect one end of an audio cable to your external device, and the other end to the ViewBoard's **AUDIO IN** port.

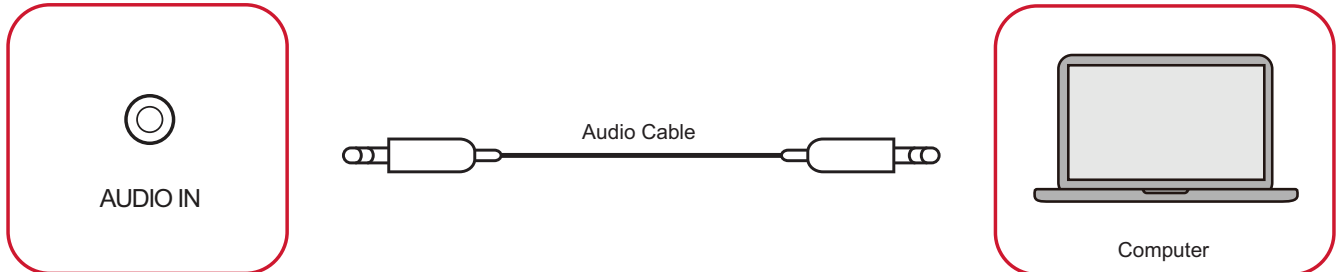

Audio Out

To play audio from the ViewBoard through an external speaker, connect one end of an audio cable to the external speaker, and the other end to the ViewBoard's **AUDIO OUT** port.

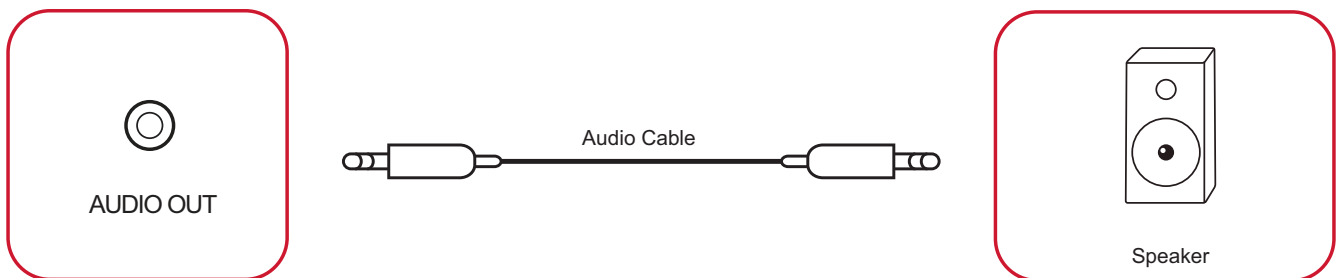

SPDIF Connection

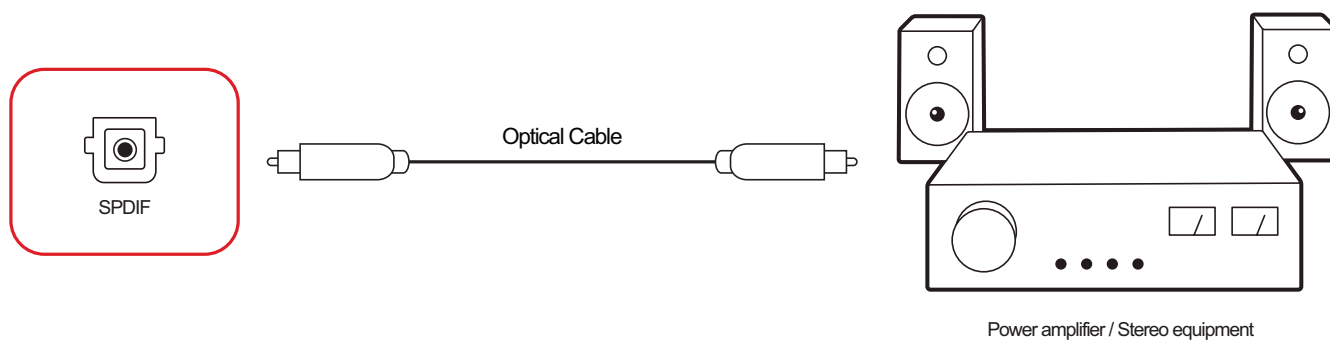

To connect to an external sound system:

1. Connect an optical cable from the **SPDIF** port to your sound system's optical connector.
2. Plug in the power cord of your ViewBoard, and turn on the power supply switch.
3. Press the **Power** button on the ViewBoard to turn the screen on.

Video Output Connection

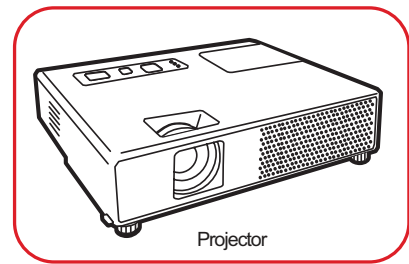
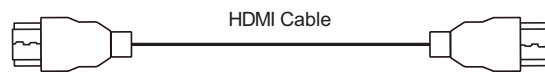
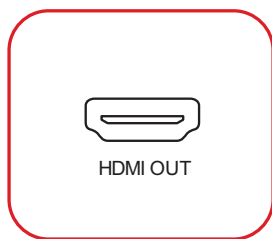

To output video via a display device:

1. Connect an HDMI cable to the **HDMI IN** port of your display device, and the other end to the **HDMI OUT** port of your ViewBoard.
2. Plug in the power cord of your ViewBoard, and turn on the power supply switch.
3. Press the **Power** button on the ViewBoard to turn the screen on.
4. Press the **INPUT** button on the remote control and switch to the "HDMI IN" input source.

Optional Connections

The ViewBoard comes with an **OPS Slot** as well as a **Wi-Fi Slot** for optional add-ons such as a slot-in PC (e.g., VPC-25-O) or Wi-Fi card (e.g., VB-WIFI-001).

Slot-in PC (OPS Slot) Installation

1. Remove the **OPS Slot** cover of the display.

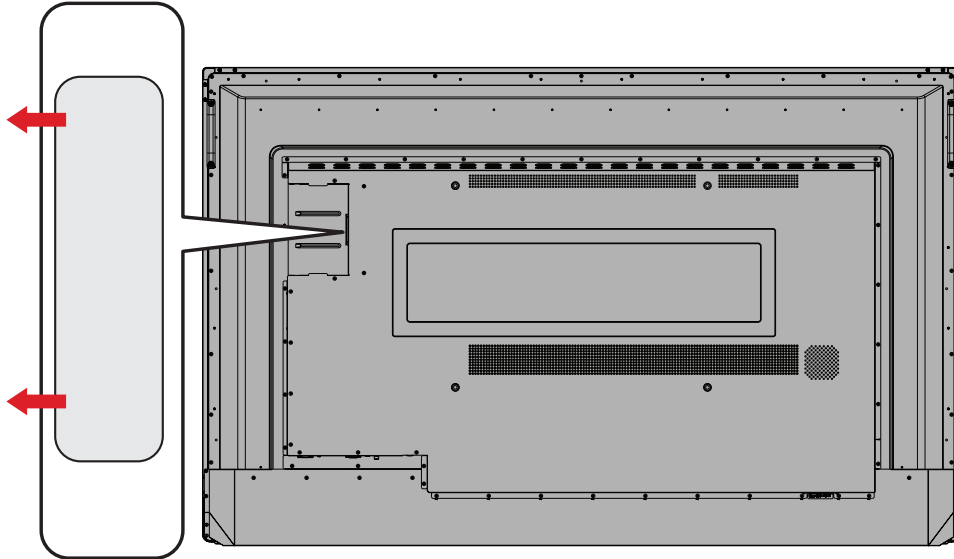

2. Carefully insert the slot-in PC into the **OPS Slot** of the display.

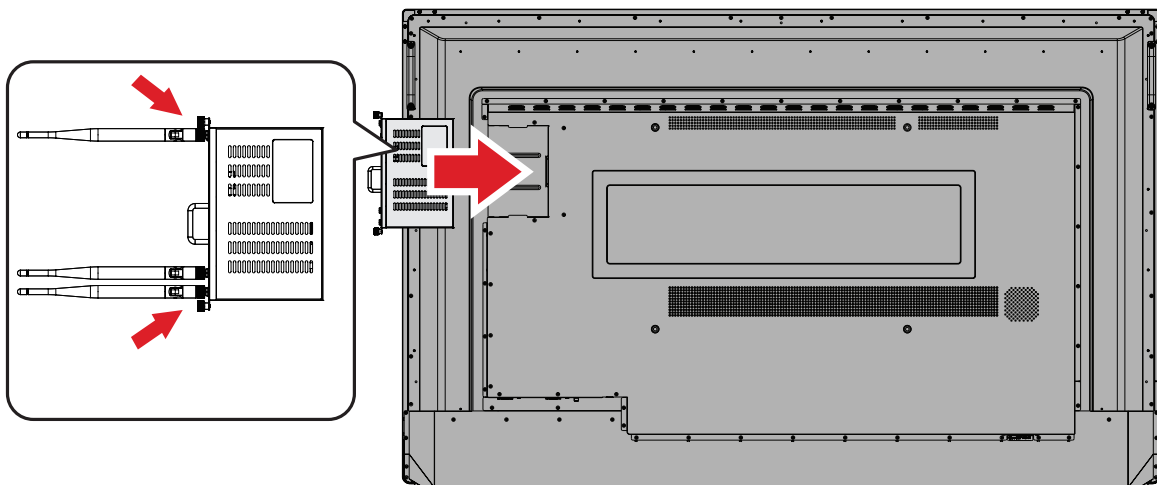

3. Secure the slot-in PC to the display.

Wi-Fi Card (Wi-Fi Slot) Installation

1. Remove the **Wi-Fi Slot** cover of the display.

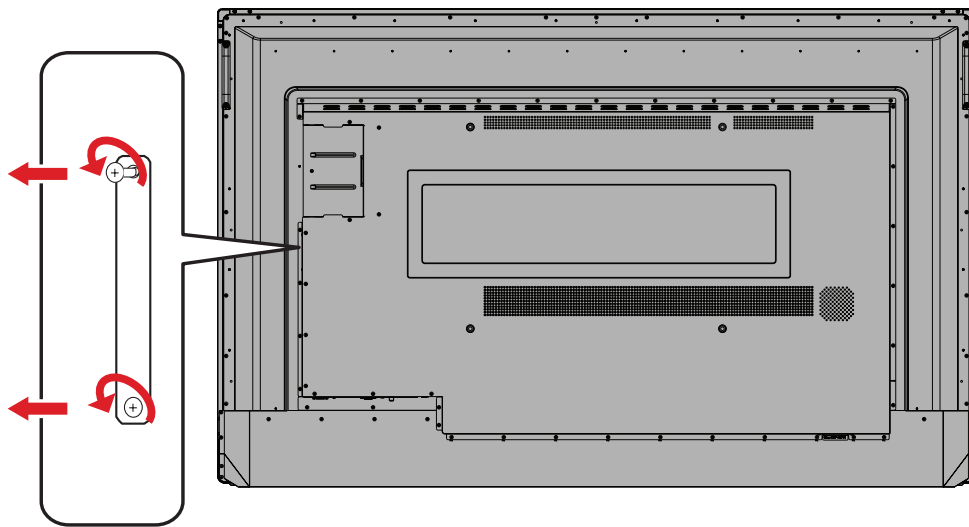

2. Carefully insert the slot-in Wi-Fi card into the **Wi-Fi Slot** of the display.

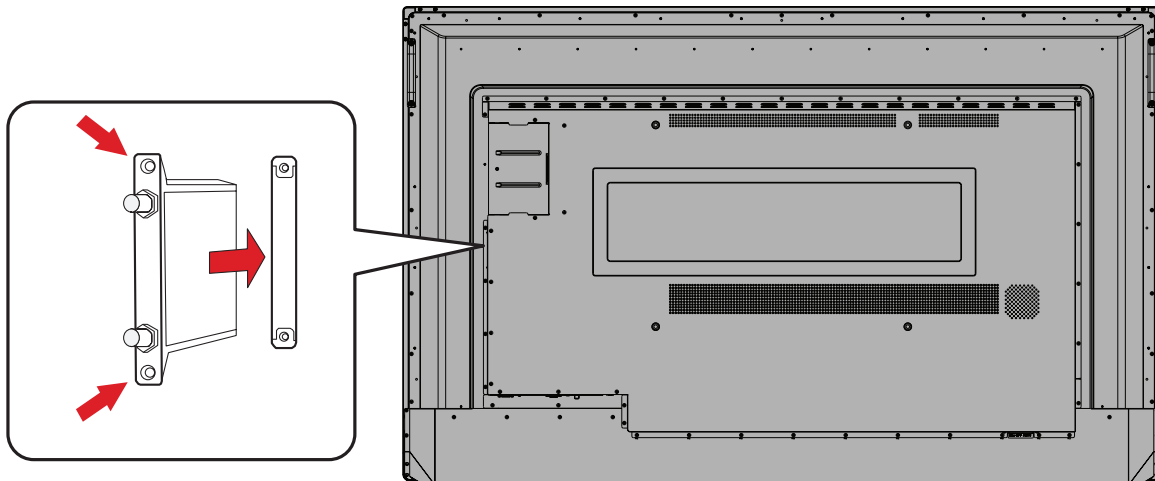

3. Secure the slot-in Wi-Fi card to the display.

Using Your ViewBoard

Powering ON/OFF your ViewBoard

1. Ensure the power cord is connected, plugged into a power outlet, and the power switch is in the "ON" position.

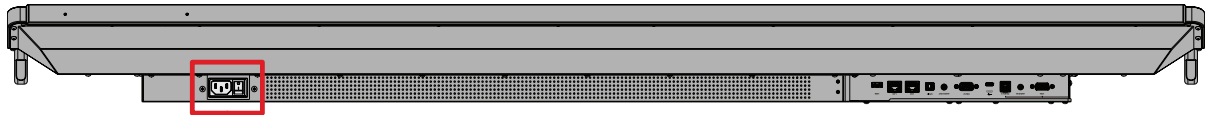

The AC Power input and switch are located at the bottom of the unit.

2. Press the **Power** button to turn ON the ViewBoard.
3. To turn the ViewBoard OFF, press and hold the **Power** button.

Initial Launch Setup

When you first turn ON your ViewBoard, an initial setup wizard will launch.

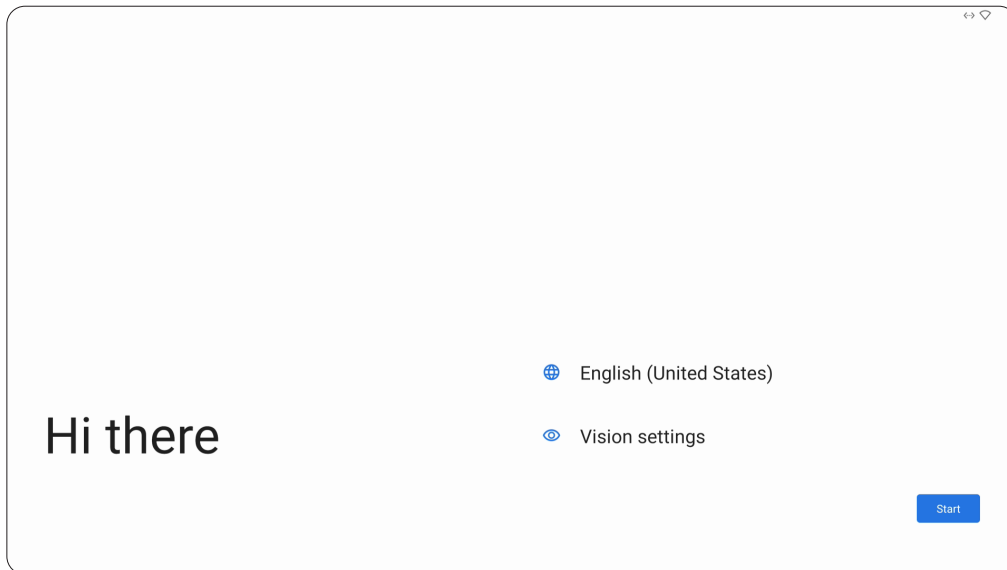

1. Choose your preferred Language.

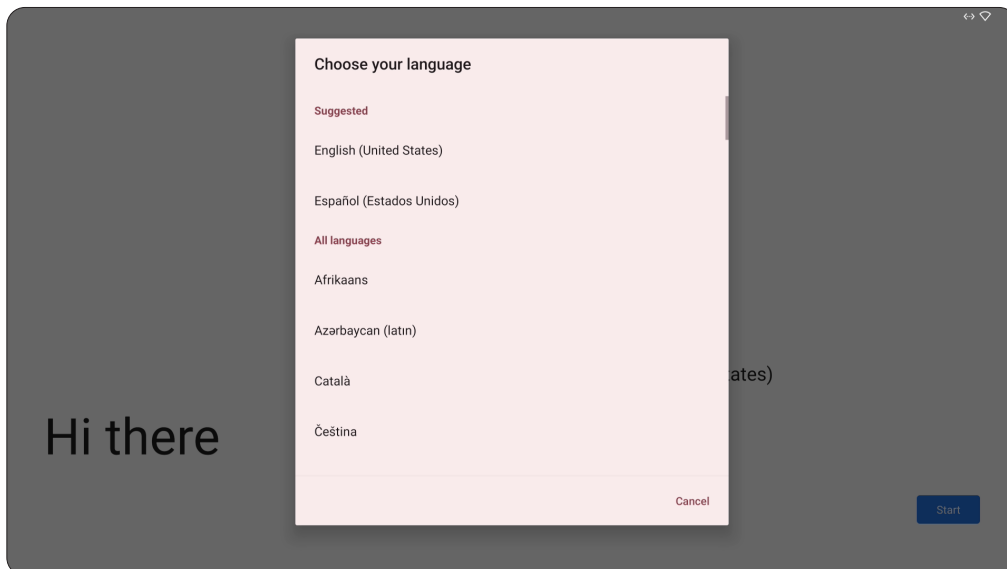

2. Adjust accessibility features as needed.

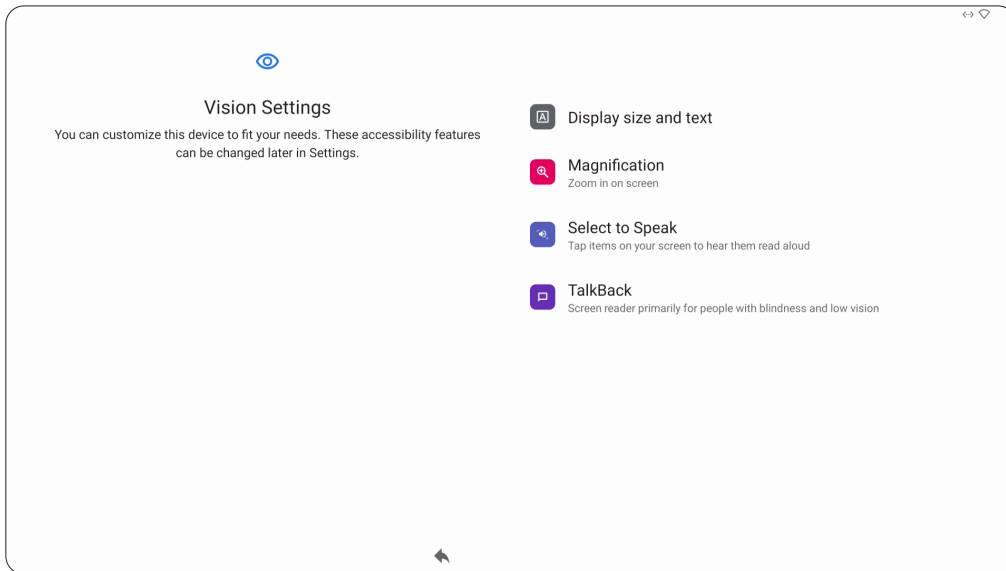

3. Setup and connect to a network.

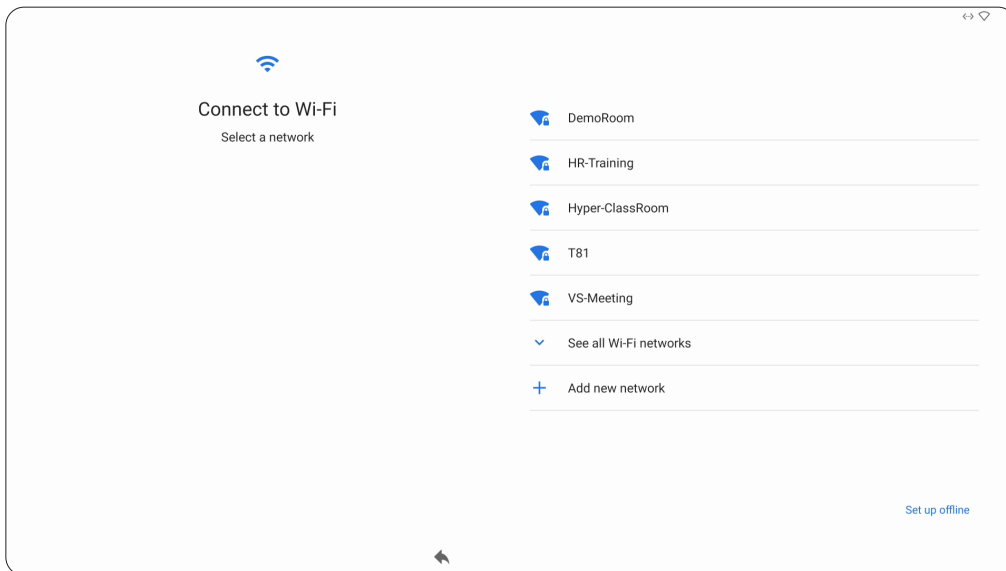

4. Set and adjust the Date and Time as needed.

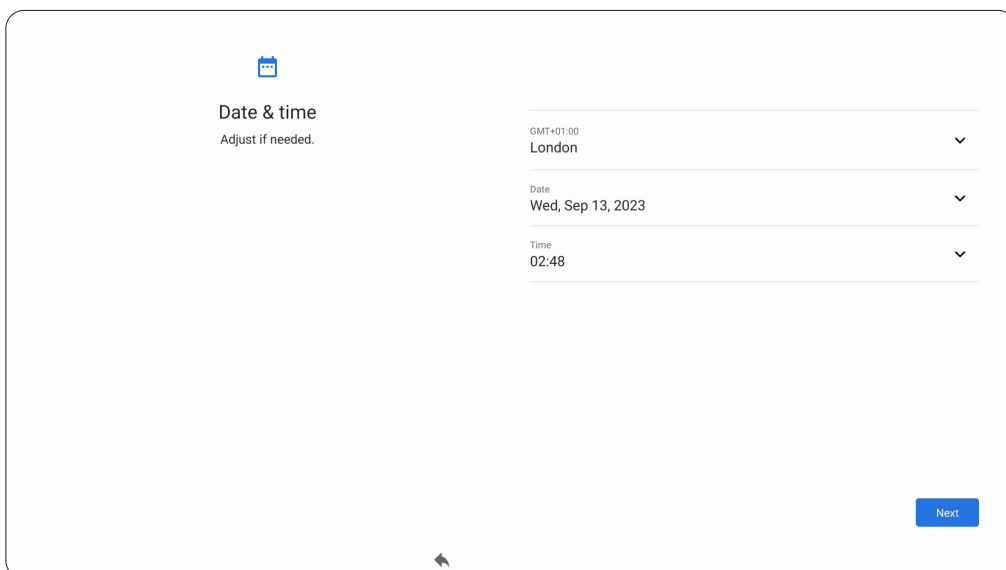

5. Copy your apps and data from another device to the ViewBoard or tap **Don't copy** to continue without copying anything.

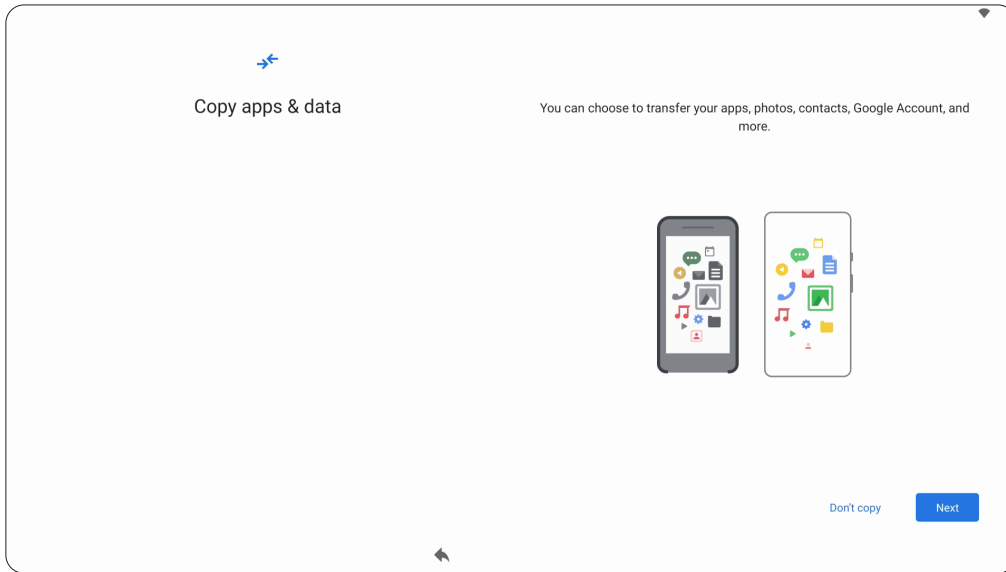

6. Sign in with a Google account, or tap **Skip** to continue without signing in.

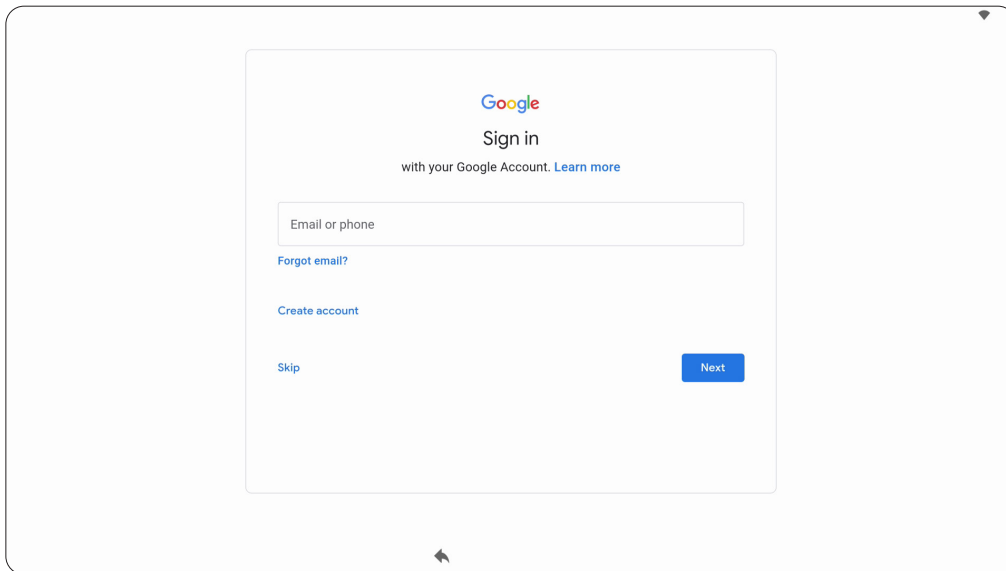

7. Accept or decline the Google services.

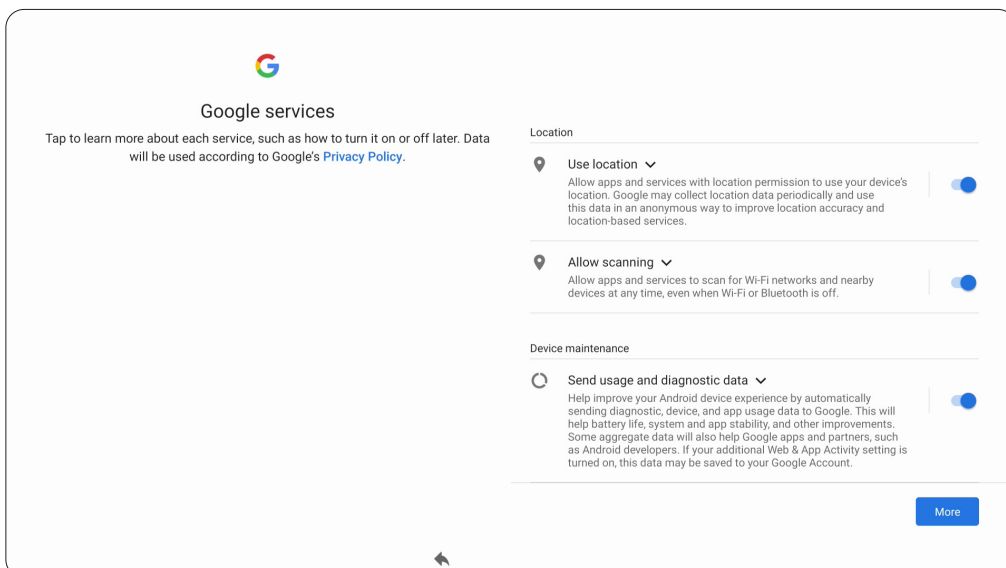

8. Set a PIN to setup a Screen lock, or tap **Skip** to continue without setting one.

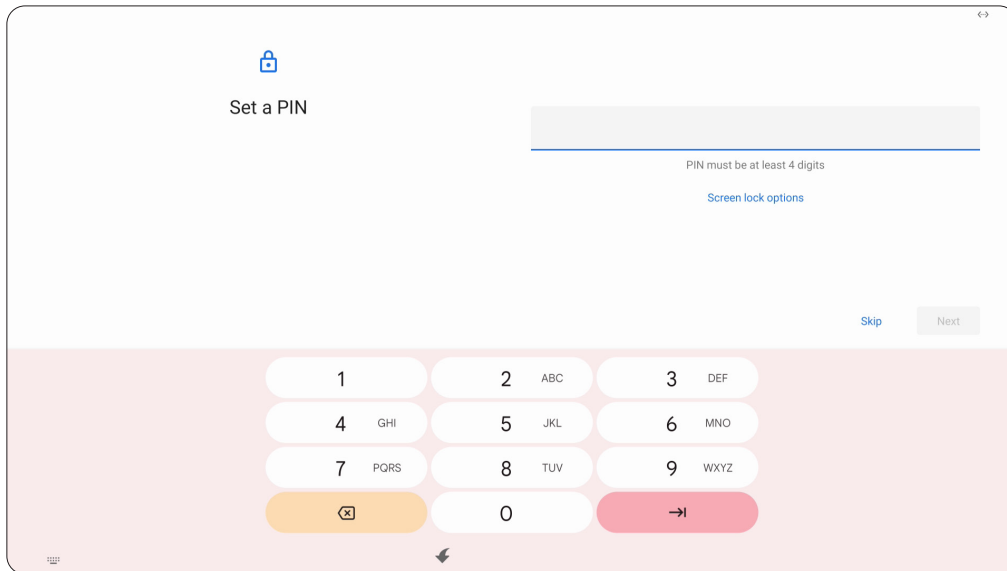

Home Screen (Launcher Scheme)

The IFP52-2 series' Home Screen layout can be customized by selecting from **Scheme A** and **Scheme B**.

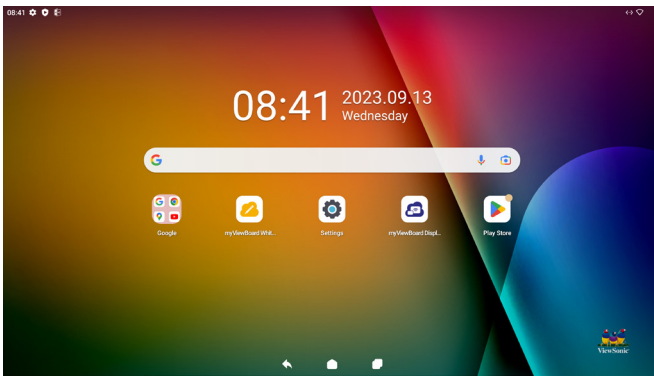

Scheme A

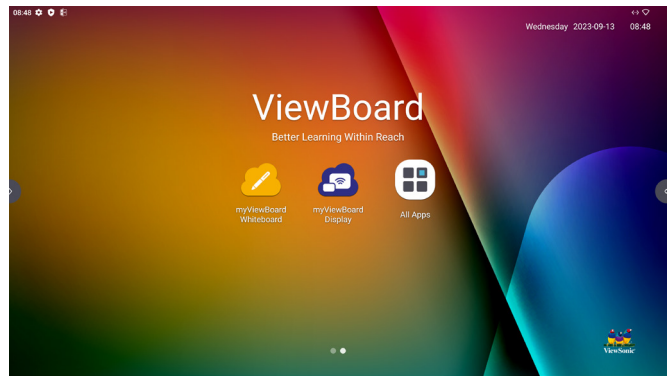

Scheme B

To change the scheme:

1. Go to: **Settings > System > Launcher Scheme**
2. Select either **Scheme A** or **Scheme B**.

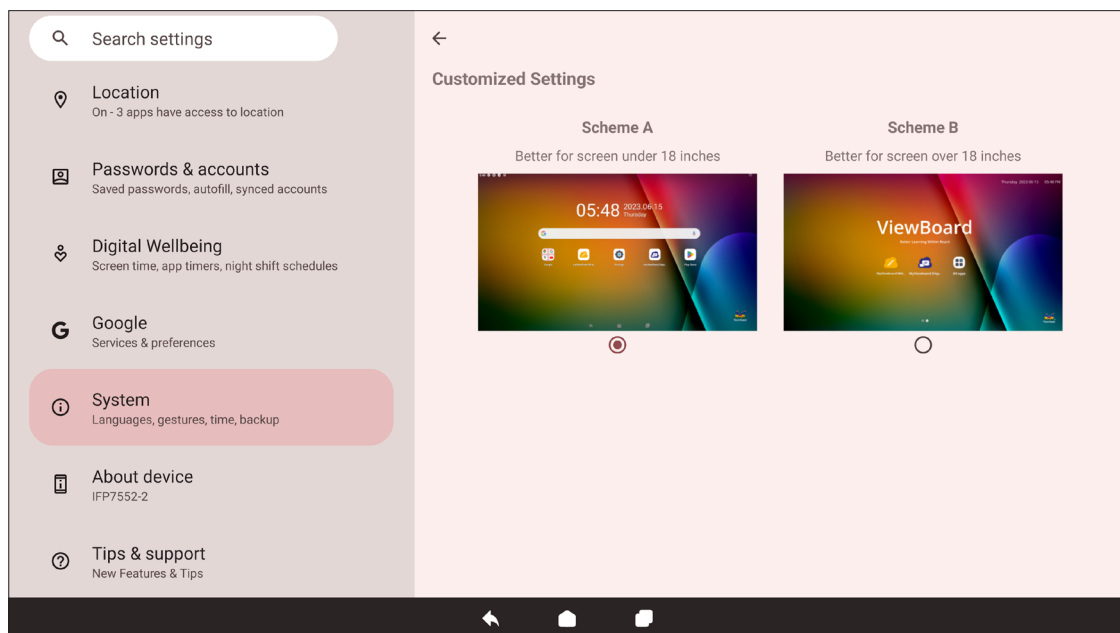

Toolbar

The Toolbar is where applications and tools can be found. Trigger icons are on the edge of the screen for quick access.

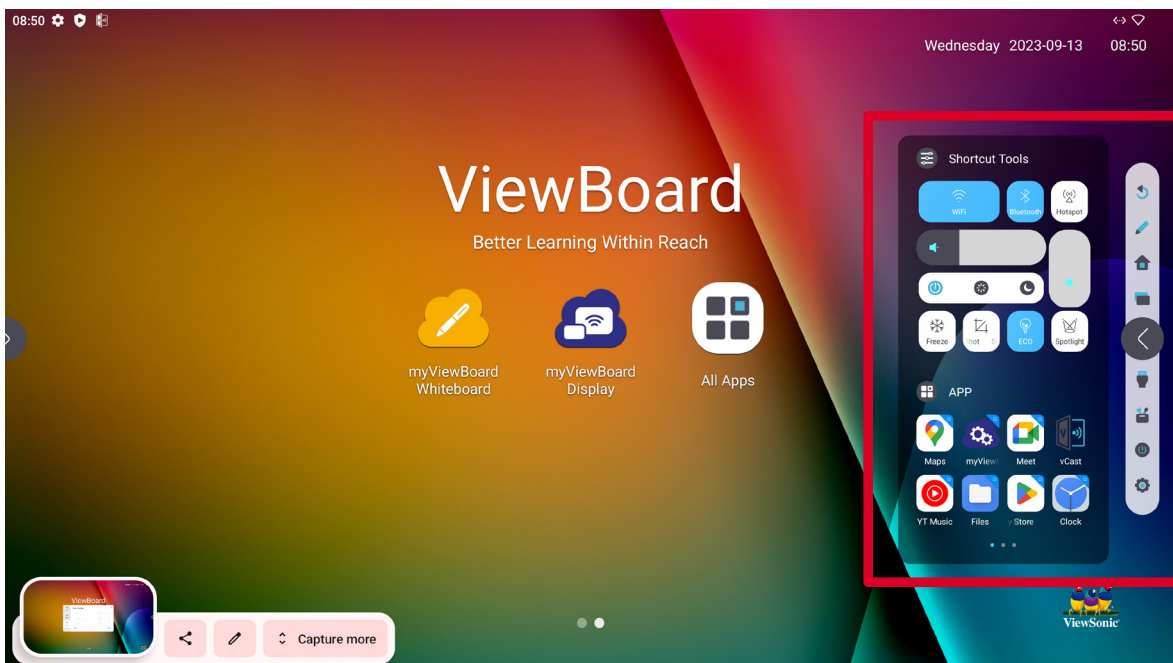
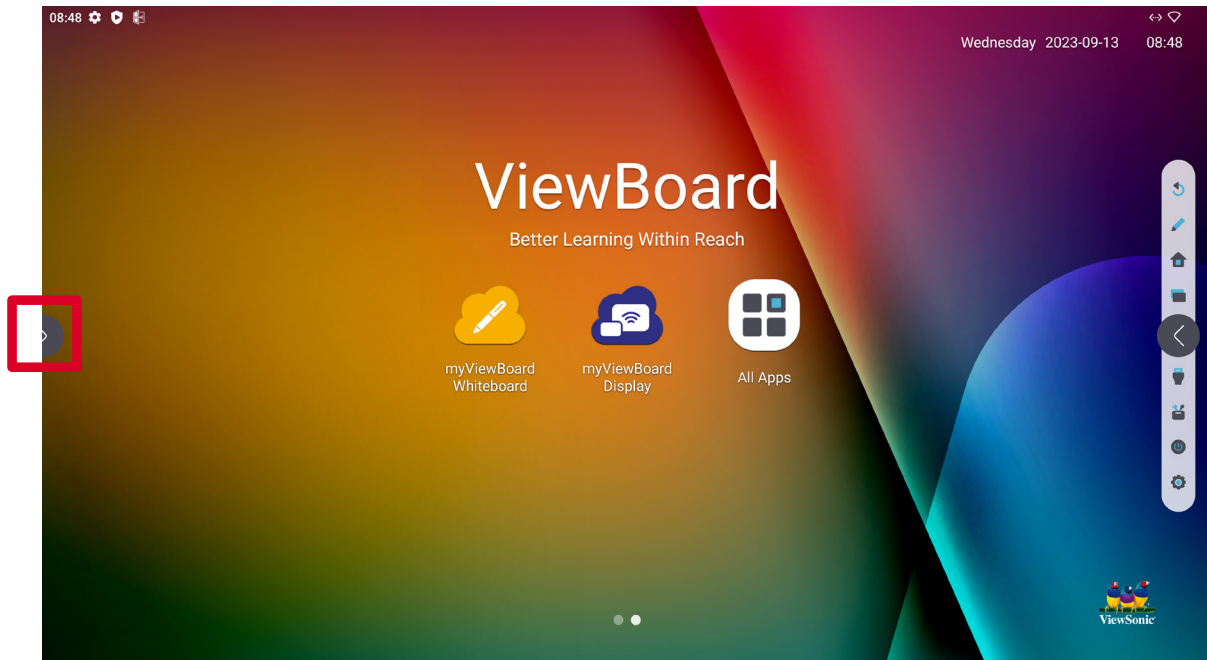









To launch an application or tool:

1. Tap a Toolbar trigger icon.
2. Tap on your desired application or tool.

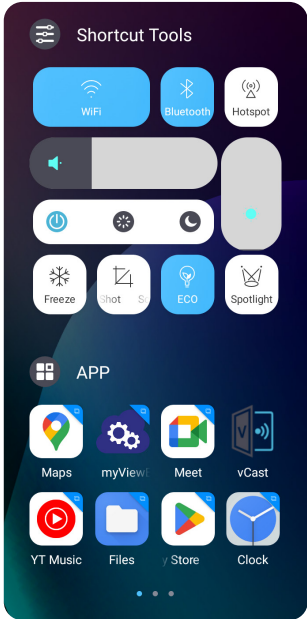

Toolbar Icons

Icon	Description
 Return	Return to the previous operation screen. NOTE: Only for the ViewBoard OS source.
 Pen	Annotate the overlay of any input source with a pen or brush.
 Home	Return to the Home Screen of the ViewBoard OS source.
 Recent	Display all embedded applications that are currently open.
 Input Source	Select and change the input source.
 Shortcut Tools	Quickly view and adjust various frequently used tools, settings, and applications. 
 Power	Access power options and settings.
 Settings	Access the System Settings.

Control and Notification Panel

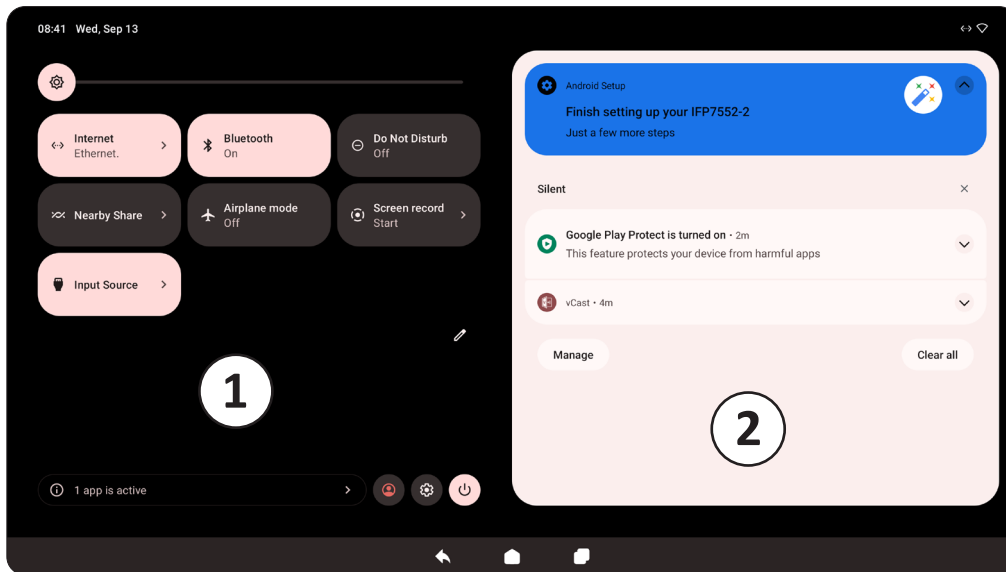

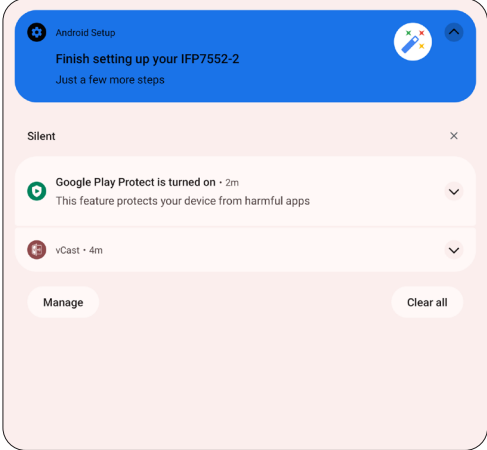
Item	Description
<p>1</p> <p>Control Panel</p>	<p>Access frequently used settings and tools.</p> <div style="display: flex; flex-wrap: wrap; justify-content: space-around;"> <div style="border: 1px solid #ccc; border-radius: 15px; padding: 10px; width: 30%; text-align: center;"> <p>Internet Ethernet.</p> <p>Internet</p> </div> <div style="border: 1px solid #ccc; border-radius: 15px; padding: 10px; width: 30%; text-align: center;"> <p>Bluetooth On</p> <p>Bluetooth</p> </div> <div style="border: 1px solid #ccc; border-radius: 15px; padding: 10px; width: 30%; text-align: center;"> <p>Do Not Disturb Off</p> <p>Do Not Disturb</p> </div> <div style="border: 1px solid #ccc; border-radius: 15px; padding: 10px; width: 30%; text-align: center;"> <p>Nearby Share</p> <p>Nearby Share</p> </div> <div style="border: 1px solid #ccc; border-radius: 15px; padding: 10px; width: 30%; text-align: center;"> <p>Airplane mode Off</p> <p>Airplane Mode</p> </div> <div style="border: 1px solid #ccc; border-radius: 15px; padding: 10px; width: 30%; text-align: center;"> <p>Screen record Start</p> <p>Screen Record</p> </div> <div style="border: 1px solid #ccc; border-radius: 15px; padding: 10px; width: 30%; text-align: center;"> <p>Input Source</p> <p>Input Source</p> </div> </div>
<p>2</p> <p>Notification Panel</p>	<p>Receive and manage system and application notifications.</p> 

On-Screen Display (OSD) Menu - General Settings

Access **Input**, **Display**, **Audio** and other general settings through the OSD Menu.

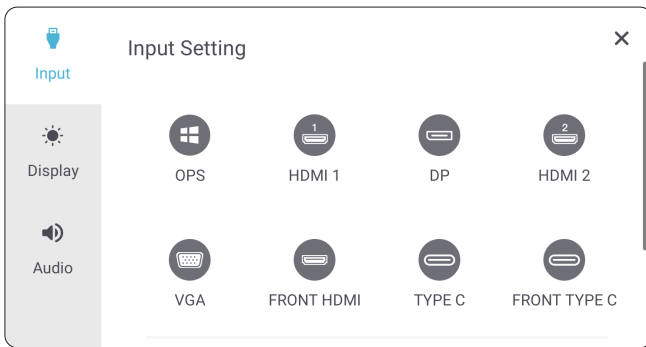

Input Settings

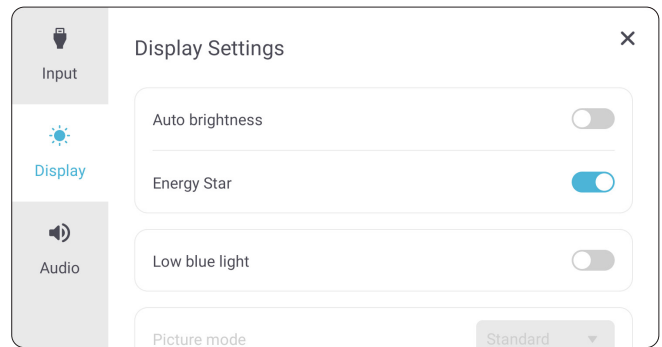

Display Settings

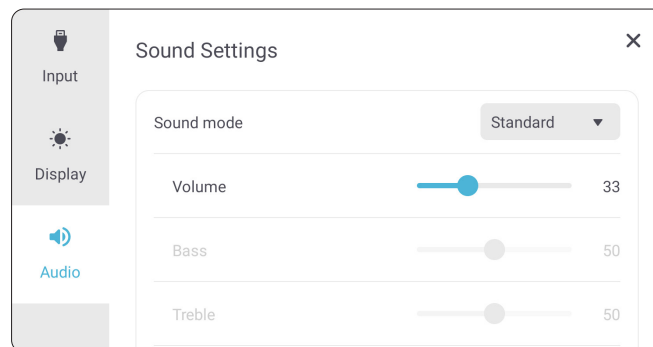

Audio Settings

Open the OSD Menu by pressing **INPUT** on the remote control or touching the **Input Source** icon (📺) of the Toolbar.

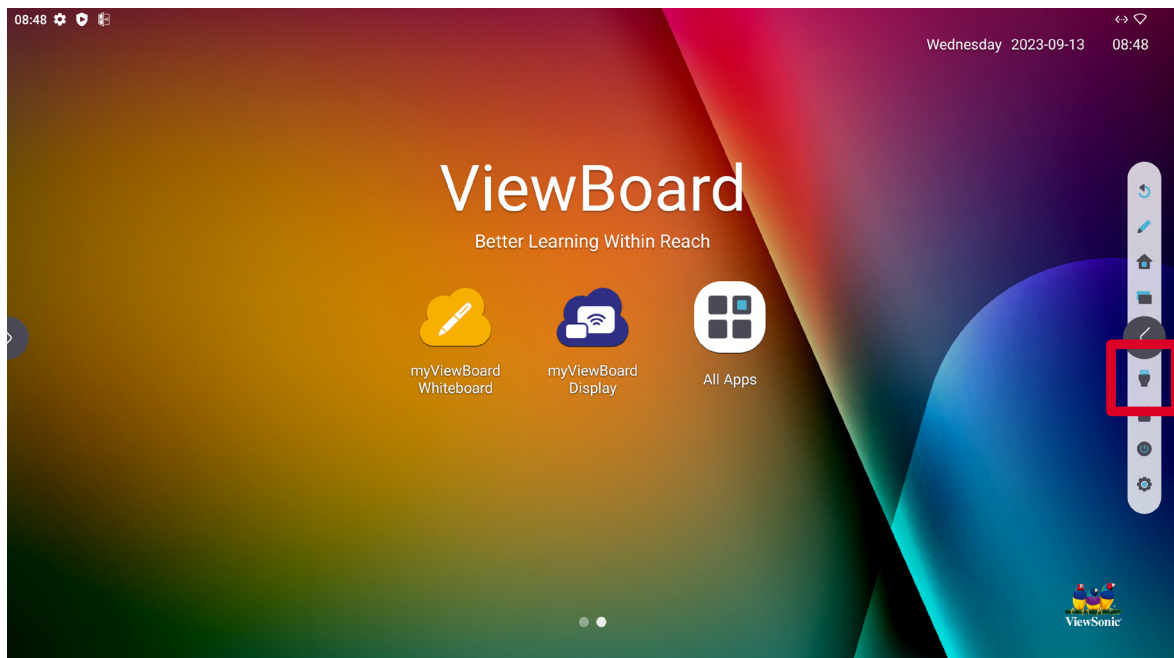

Input Settings

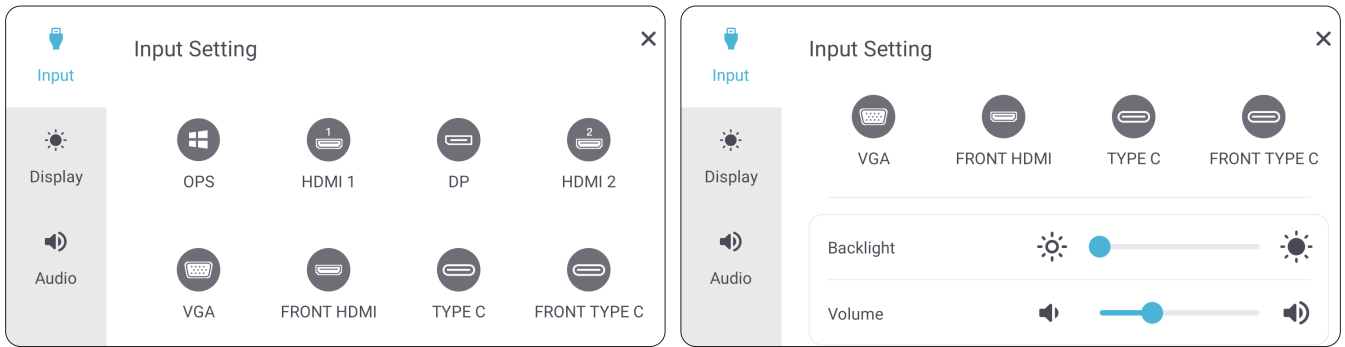

To select an input source:

1. Press **INPUT** on the remote control or touch the **Input Source** icon (🔌) of the Toolbar to display the **Input Settings** menu.
2. Press **▼/▲/◀/▶** on the remote control to select the input source you want.
NOTE: The PC source will only be visible when a slot-in computer is installed.
3. Press **ENTER** on the remote control, or touch the input source.
4. Press **BACK** (⏪) on the remote control, or touch a blank area outside of the menu to exit.



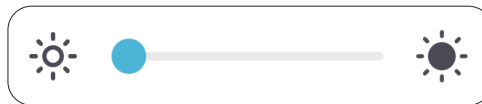

To adjust the brightness:

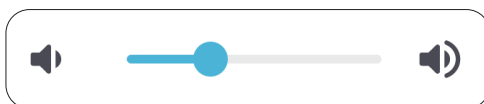

1. Press **INPUT** on the remote control or touch the **Input Source** icon (🔌) of the Toolbar to display the **Input Settings** menu.
2. Touch and drag the brightness slider directly to adjust the backlight value.
3. Press **BACK** (⏪) on the remote control, or touch a blank area outside of the menu to exit.

To adjust the volume:



1. Press **INPUT** on the remote control or touch the **Input Source** icon () of the Toolbar to display the **Input Settings** menu.
2. Touch and drag the volume slider directly to adjust the value, or press  +/- on the remote control to adjust. Additionally, pressing **Mute** () on the remote control will mute/unmute the volume.
3. Press **BACK** () on the remote control, or touch a blank area outside of the menu to exit.

Display Settings

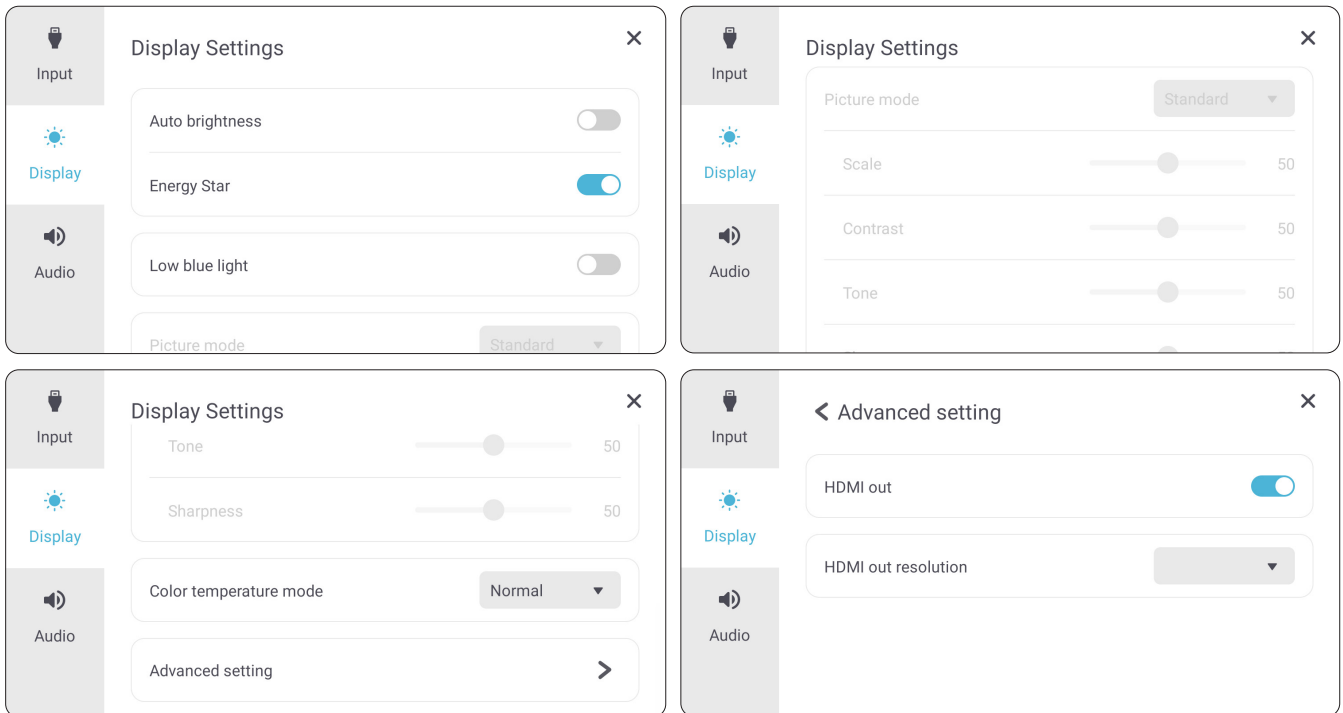

To adjust the display settings:

1. Press **INPUT** on the remote control or touch the **Input Source** icon (📺) of the Toolbar to display the **Input Settings** menu. Then select the **Display** tab.
2. Press **▼/▲/◀/▶** on the remote control to select the menu option you want.
3. Press **ENTER** on the remote control to confirm or press **◀/▶** to adjust the menu option. Additionally, touch/adjust the menu option directly.
4. Press **BACK** (⏪) on the remote control, or touch a blank area outside of the menu to exit.

Display Settings - Menu Options

Item	Description										
Auto Brightness	Automatic brightness adjustment. Adjusts maximum brightness according to ambient light levels.										
Energy Star	Enable to reduce power consumption.										
Low Blue Light	Adjusts the filter that blocks high-energy blue light for a more comfortable viewing experience.										
Picture Mode	Select a predefined picture setting.										
	<table border="1"> <thead> <tr> <th>Mode</th> <th>Description</th> </tr> </thead> <tbody> <tr> <td>Standard</td> <td>Default picture mode.</td> </tr> <tr> <td>Bright</td> <td>Maximizes the brightness of the display. This mode is suitable for environments where extra-high brightness is required (e.g., well-lit rooms).</td> </tr> <tr> <td>Brilliant</td> <td>A high brightness level with lower contrast level.</td> </tr> <tr> <td>Custom</td> <td>Customize the picture settings.</td> </tr> </tbody> </table>	Mode	Description	Standard	Default picture mode.	Bright	Maximizes the brightness of the display. This mode is suitable for environments where extra-high brightness is required (e.g., well-lit rooms).	Brilliant	A high brightness level with lower contrast level.	Custom	Customize the picture settings.
	Mode	Description									
	Standard	Default picture mode.									
	Bright	Maximizes the brightness of the display. This mode is suitable for environments where extra-high brightness is required (e.g., well-lit rooms).									
Brilliant	A high brightness level with lower contrast level.										
Custom	Customize the picture settings.										
Scale	Adjust the size of text, applications, and other items.										
Contrast	Adjusts the difference between the image background (black level) and the foreground (white level). Use this to set the peak white level after you have previously adjusted the Brightness setting to suit your selected input and viewing environment.										
Tone	Adjust the color tone value.										
Sharpness	A high value results in a sharper picture; a low value softens the picture.										
Color Temperature Mode	Adjust the color temperature value.										
VGA Setting (for VGA input only)	Adjust the analog picture settings when connected via the VGA port.										
Advanced Setting	<u>HDMI Out</u> Toggle HDMI Out support ON or OFF.										
	<u>HDMI Out Resolution</u> Set the display resolution for HDMI Out connections.										

Audio Settings

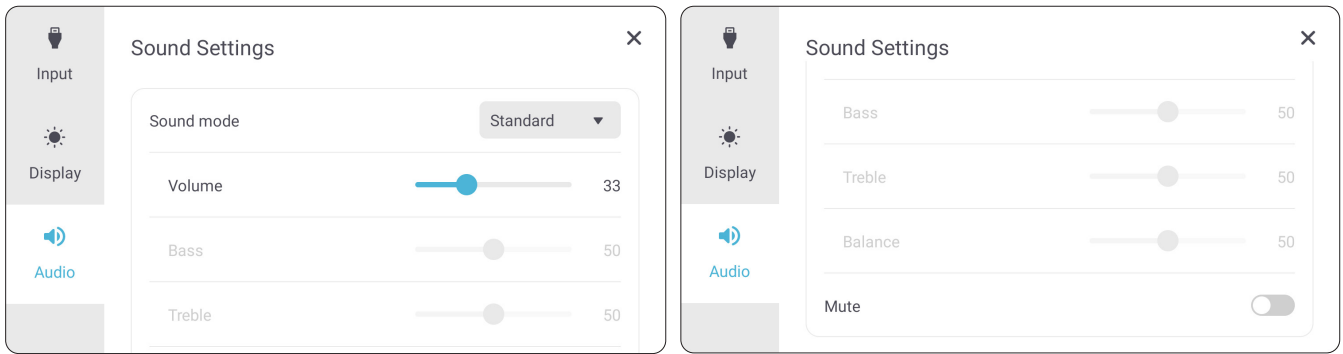

To adjust the display settings:

1. Press **INPUT** on the remote control or touch the **Input Source** icon (📺) of the Toolbar to display the **Input Settings** menu. Then select the **Audio** tab.
2. Press **▼/▲/◀/▶** on the remote control to select the menu option you want.
3. Press **ENTER** on the remote control to confirm or press **◀/▶** to adjust the menu option. Additionally, touch/adjust the menu option directly.
4. Press **BACK** (⏪) on the remote control, or touch a blank area outside of the menu to exit.

Audio Settings - Menu Options

Item	Description													
Sound Mode	Select a predefined audio setting.													
	<table border="1"> <thead> <tr> <th data-bbox="480 309 703 360">Mode</th> <th data-bbox="703 309 1401 360">Description</th> </tr> </thead> <tbody> <tr> <td data-bbox="480 360 703 412"> Standard </td> <td data-bbox="703 360 1401 412"> Default audio mode. </td> </tr> <tr> <td data-bbox="480 412 703 463"> Meeting Room </td> <td data-bbox="703 412 1401 463"> Ideal for meetings. Higher bass, lower treble levels. </td> </tr> <tr> <td data-bbox="480 463 703 515"> Classroom </td> <td data-bbox="703 463 1401 515"> Ideal for the classroom. Low bass and treble levels. </td> </tr> <tr> <td data-bbox="480 515 703 566"> Cinema </td> <td data-bbox="703 515 1401 566"> Ideal for movies. </td> </tr> <tr> <td data-bbox="480 566 703 618"> Custom </td> <td data-bbox="703 566 1401 618"> Customize the audio settings. </td> </tr> </tbody> </table>	Mode	Description	Standard	Default audio mode.	Meeting Room	Ideal for meetings. Higher bass, lower treble levels.	Classroom	Ideal for the classroom. Low bass and treble levels.	Cinema	Ideal for movies.	Custom	Customize the audio settings.	
	Mode	Description												
	Standard	Default audio mode.												
	Meeting Room	Ideal for meetings. Higher bass, lower treble levels.												
	Classroom	Ideal for the classroom. Low bass and treble levels.												
Cinema	Ideal for movies.													
Custom	Customize the audio settings.													
Standard	Default audio mode.													
Meeting Room	Ideal for meetings. Higher bass, lower treble levels.													
Classroom	Ideal for the classroom. Low bass and treble levels.													
Cinema	Ideal for movies.													
Custom	Customize the audio settings.													
Volume	Increase or decrease the display's volume level.													
Bass	Increase or decrease the bass level (lower-pitched sounds).													
Treble	Increase or decrease the treble level (higher-pitched sounds).													
Balance	Adjust the left/right speaker balance.													
Mute	Toggle mute ON or OFF.													

Low Blue Light Filter and Eye Health

The low blue light filter blocks high-energy blue light for a more comfortable viewing experience.

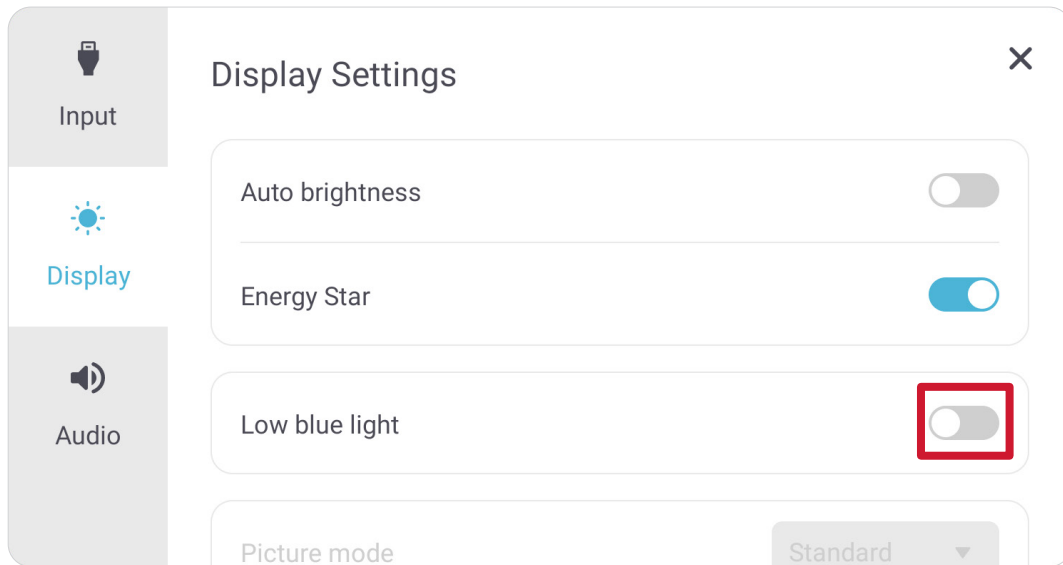

Calculating Breaks

When viewing screens for extended periods, it is recommended to take periodic breaks from viewing. Short breaks of at least 10 minutes are recommended after one (1) hour of continuous viewing.

Taking shorter, more frequent breaks are generally more beneficial than longer, less frequent breaks.

Focus Fatigue (20-20-20 Rule)

To reduce the risk of eye fatigue by constantly looking at the screen, look away from the screen at least every 20 minutes and gaze at a distant object (at least 20 feet away) for at least 20 seconds.

Looking at Distant Objects

While taking breaks, users can further reduce eye strain and dryness by focusing on objects that are further away from them for 10-15 seconds, then gaze at something up close for 10-15 seconds. Repeat this up to 10 times. This exercise reduces the risk of your eyes' focusing ability to "lock up" after prolonged computer work.

Eye and Neck Exercises

Eye Exercises

Eye exercises can help minimize eye strain. Slowly roll your eyes to the left, right, up, and down. Repeat as many times as needed.

Exercises for the eyes

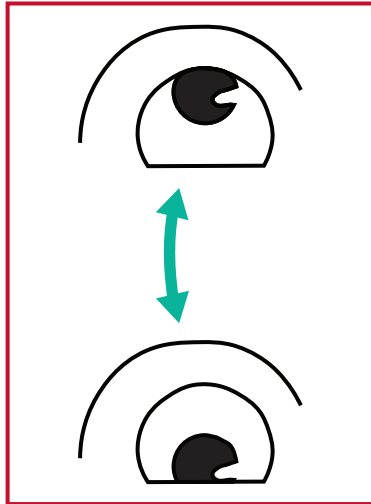

(1) Keep the body and the head upright. Move the eyes up to look at the ceiling, then turn down to look at the floor.

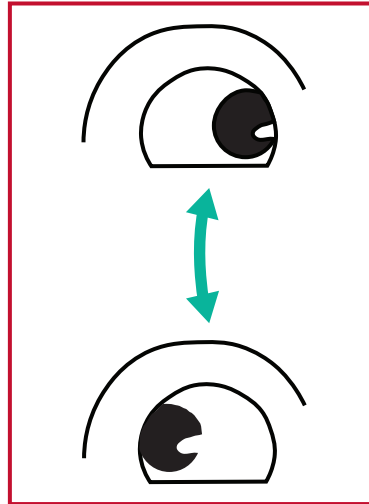

(2) Move the eyes left and right slowly to look at objects on the two sides.

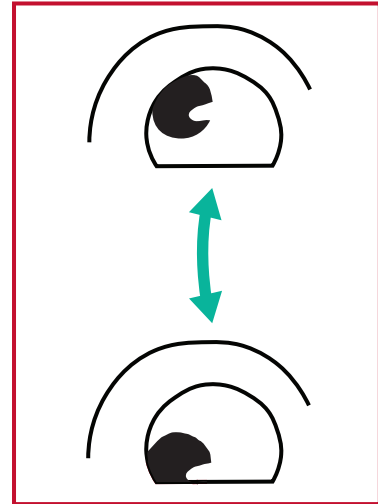

(3) Move the eyes to look at objects at the right upper direction and then right lower direction. Repeat for the left upper and left lower directions.

Neck Exercises

Neck exercises can also help minimize eye strain. Relax your arms and let them hang at your sides, bend forward slightly to stretch the neck, turn your head to the right and to the left. Repeat as many times as needed.



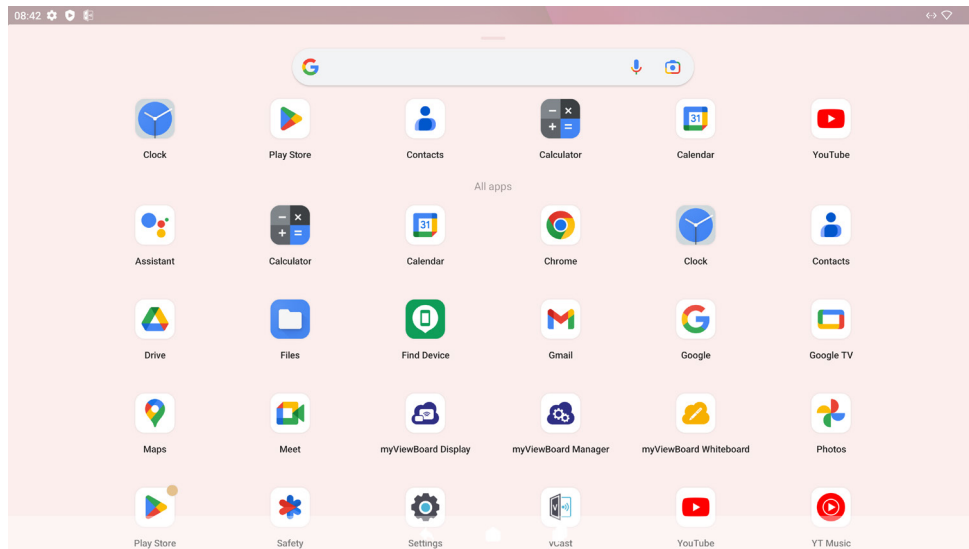

Applications

Much like any smart phone or tablet you can install several different applications from the installed Google Play Store.



Applications can be accessed from the Toolbar, directly from the Home Screen via shortcuts, or by selecting the **All Apps** icon (☰).

NOTE: The following included application descriptions are not a comprehensive list and will vary by the user.

Icon	Description
	<u>myViewBoard Display</u> Wirelessly mirror screens to a larger display.
	<u>myViewBoard Manager</u> Remotely manage multiple installations of ViewSonic devices.
	<u>myViewBoard Whiteboard</u> A digital whiteboarding application.
	<u>Settings</u> Access the System Settings.
	<u>vCast</u> Working with ViewBoard Cast software, receive vCastSender laptop screens (Windows/Mac/Chrome) and mobile (iOS/Android) users' screens, photos, videos, annotations, and camera(s).

ViewBoard Settings

The ViewBoard input source is the default source that is active when turning on the ViewBoard. Press **MENU** on the remote control or tap the setting icon (⚙️) next to the input source in the On-Screen Display (OSD) Menu's Input Settings to enter the **Settings** menu.

Network & Internet

Check current connection status, set up and manage Wi-Fi, Ethernet, VPN, and wireless Hotspot.

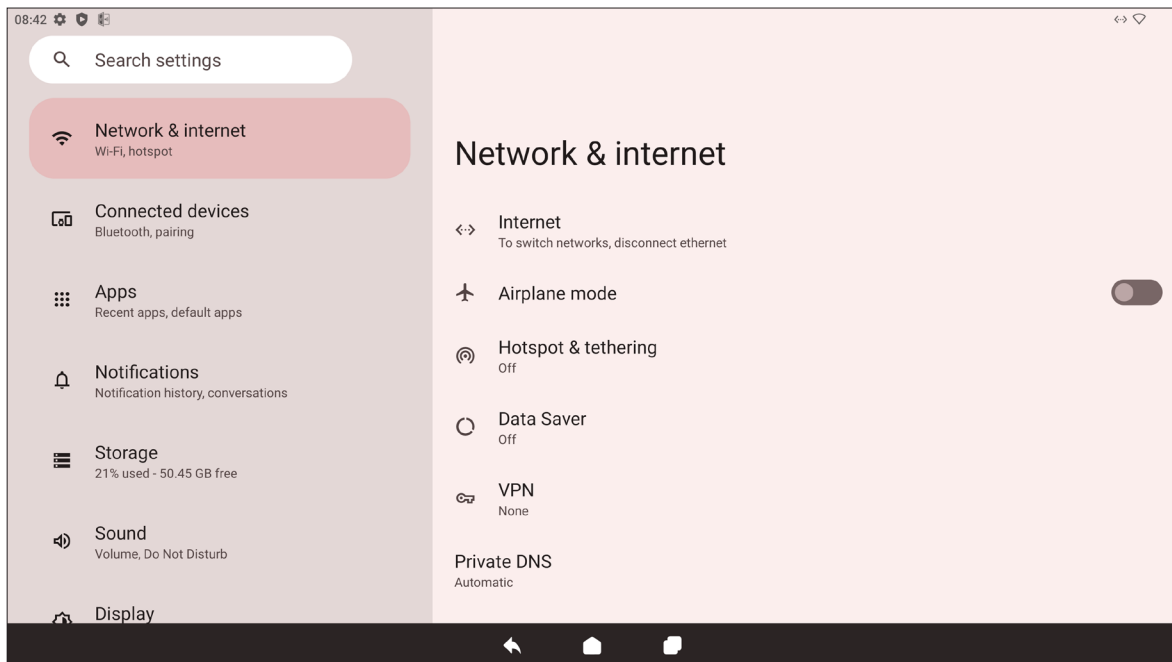

Item	Description
Internet	Set up and manage Ethernet and Wi-Fi connection, as well as Network preferences.
Airplane Mode	When enabled, all wireless communication will be turned off.
Hotspot & Tethering	Set and share your internet connection with other devices.
Data Saver	When enabled, most apps and services will get background data via an internet connection. Active apps will not be affected.
VPN	Set up and manage Virtual Private Networks.
Private DNS	Maintain an Automatic Private DNS or set one up manually for security and privacy.

NOTE:

- Wi-Fi, Hotspot, and Bluetooth settings will appear when an optional Wi-Fi card (e.g., VB-WIFI-001) has been installed in the Wi-Fi Slot.
- Ethernet will take priority when both Ethernet and Wi-Fi are enabled.
- The device can connect to the Internet when Hotspot is enabled.

Connected Devices

Set up and manage Bluetooth connections, saved devices, and connection preferences for Bluetooth, Casting, and Print Services.

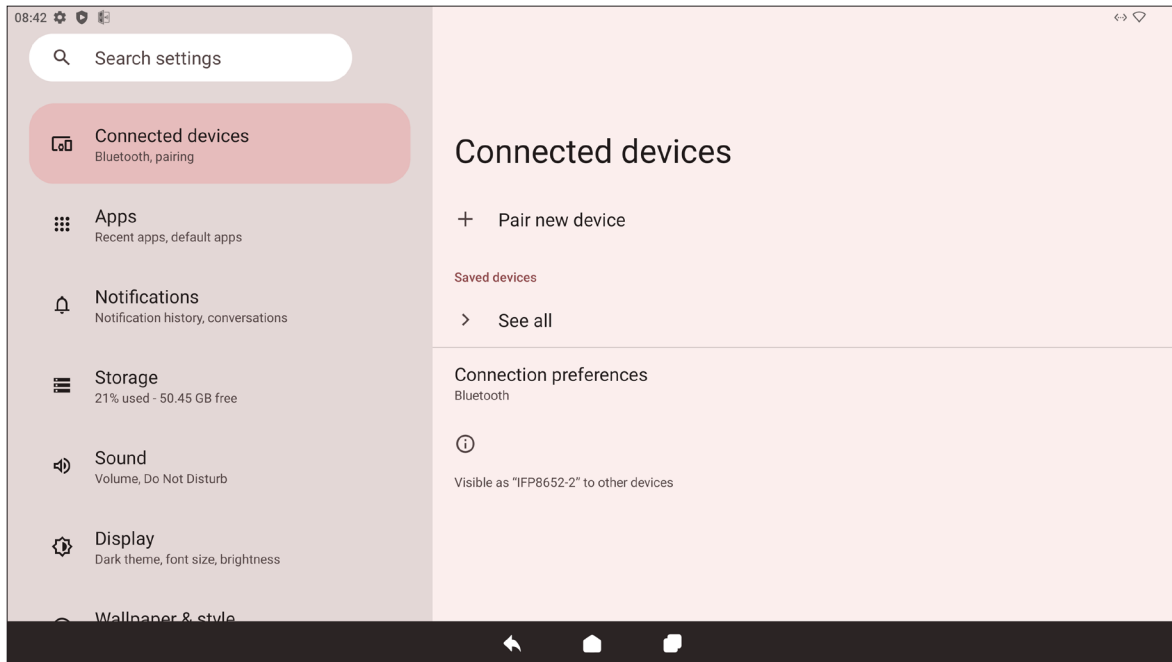

Item	Description
Pair New Device	Enable Bluetooth to search for and connect to a Bluetooth device.
Saved Devices	View all previously connected Bluetooth devices. NOTE: Bluetooth will turn on.
Connection Preferences	View Bluetooth, Cast, and Print Service preferences and share files with nearby devices.

Apps

View any running or installed applications. Tap on them for more detailed information and options.

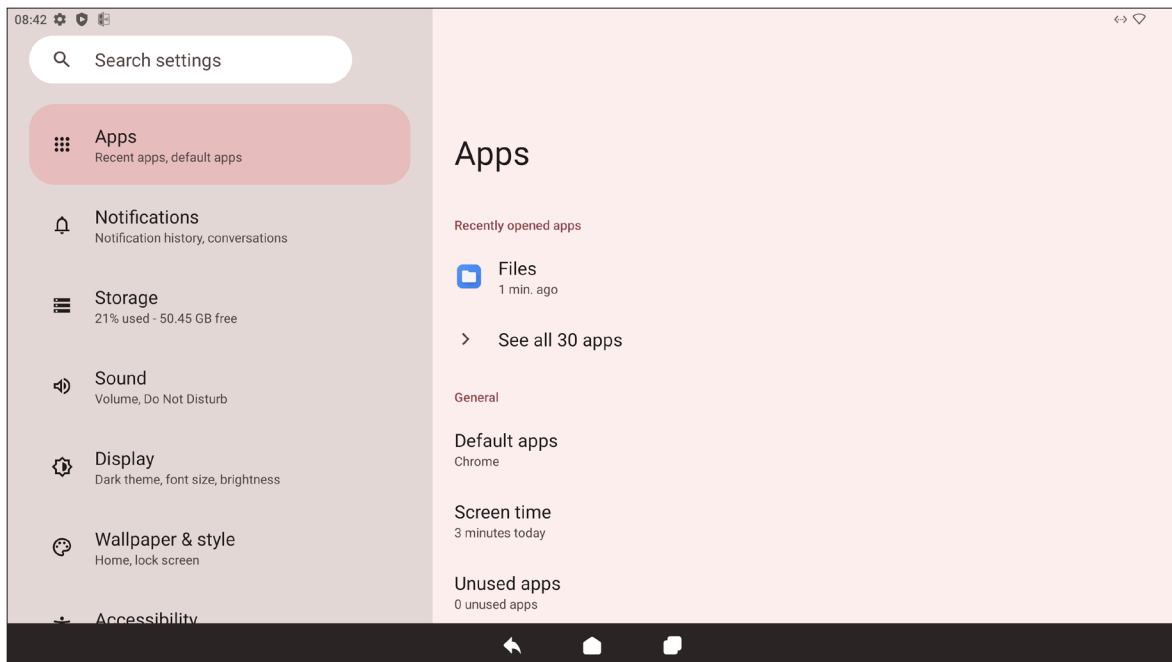

Item	Description
Recently Opened Apps	Any recently used applications will be listed here.
Default Apps	Set default applications for certain uses (e.g., default browser application).
Screen Time	Displays the total amount of time the ViewBoard has been in use by the day.
Unused Apps	Applications that have not been used for a certain period of time will be listed here.
Special App Access	Set several access permissions for applications.

Notifications

Manage notification and conversation settings and preferences.

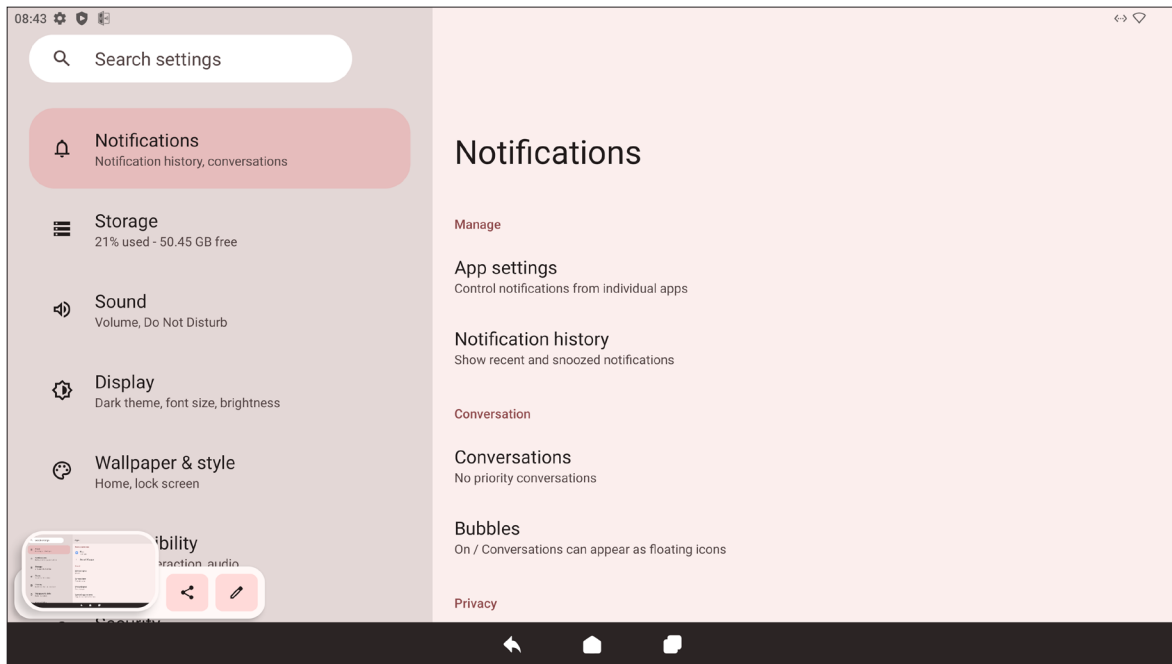

Item	Description
App Settings	Set up notification settings for individual applications.
Notification History	View recent notifications.
Conversations	Set previously received notifications or messages as priority.
Bubbles	When enabled, conversations can appear as a floating icon on screen.
Device & App Notifications	Control which applications and devices can read notifications.
Notifications on Lock Screen	Choose to show all, some, or no conversations or notifications on the lock screen.
Do Not Disturb	Set notification preferences for when “Do Not Disturb” mode is turned on.
Wireless Emergency Alerts	Choose to receive or not receive Emergency Alerts.
Hide Silent Notifications in Status Bar	When enabled, notifications that have been “silenced” will no longer appear in the status bar area.
Allow Notification Snoozing	When enabled, notifications can be “snoozed” for a short period of time for applications.

Item	Description
Notification Dot on App Icon	When enabled, a small dot will appear on the application icon when there is a new notification available.
Enhanced Notifications	When enabled, receive suggestions for actions, replies, etc.

Storage

Check the storage status of the ViewBoard.

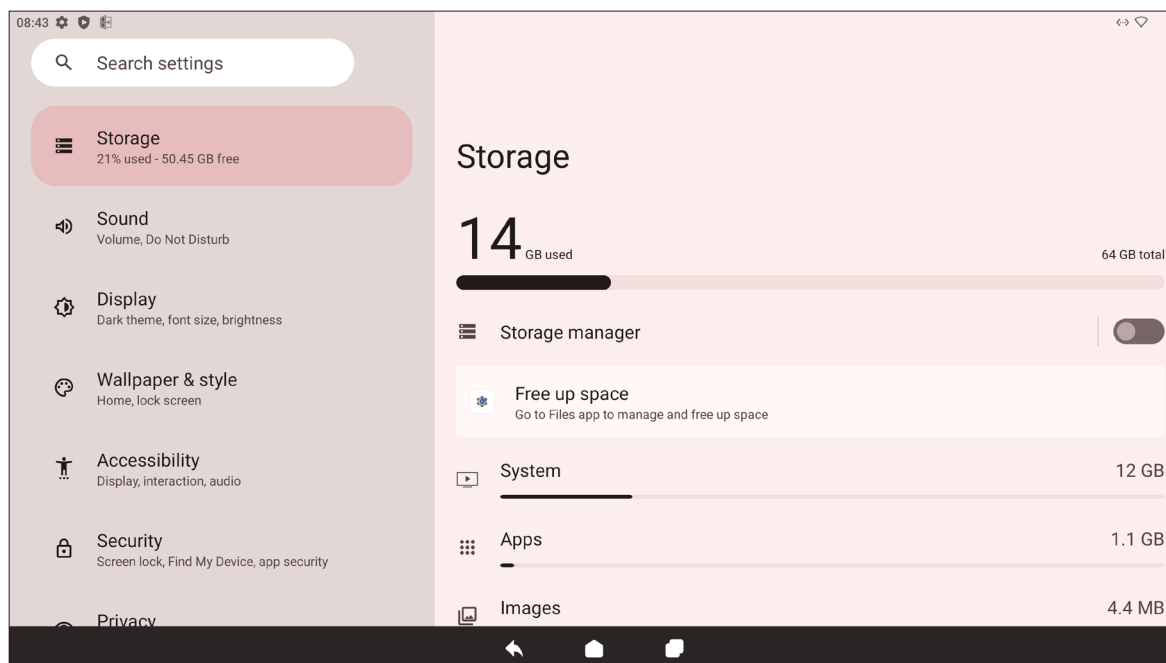

Item	Description
Storage Manager	When enabled, the storage manager will remove backed up photos and videos.
System	View the total storage space of system files.
Apps	View and manage the storage space used by applications.
Documents & Other	View and manage the Documents folder.
Images	View and manage the Images folder.
Trash	View and manage files that have been moved to the Trash.
Games	View and manage the storage space used by gaming applications.
Audio	View and manage the Audio folder.
Videos	View and manage the Video folder.

Sound

Adjust the volume level and set up various sound preferences.

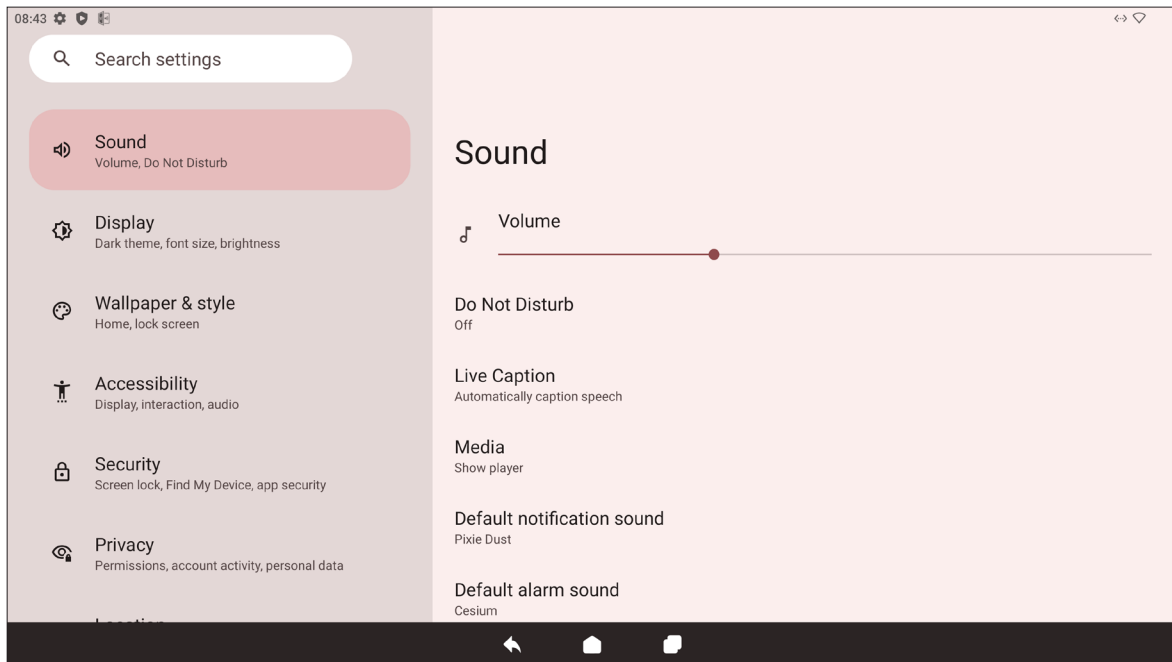

Item	Description
Volume	Adjust the volume level.
Do Not Disturb	Set sound preferences for when “Do Not Disturb” mode is turned on.
Live Caption	When enabled, automatically caption
Media	Set the media player preferences.
Default Notification Sound	Choose the default sound effect for notifications.
Default Alarm Sound	Choose the default sound for alarms.
Screen Locking Sound	When enabled, a sound effect will play when the ViewBoard’s screen is locked.
Touch Sounds	When enabled, a sound effect will play every time a touch input is received.

Display

Adjust Brightness, Timeout, Theme, HDMI CEC, and other display related settings.

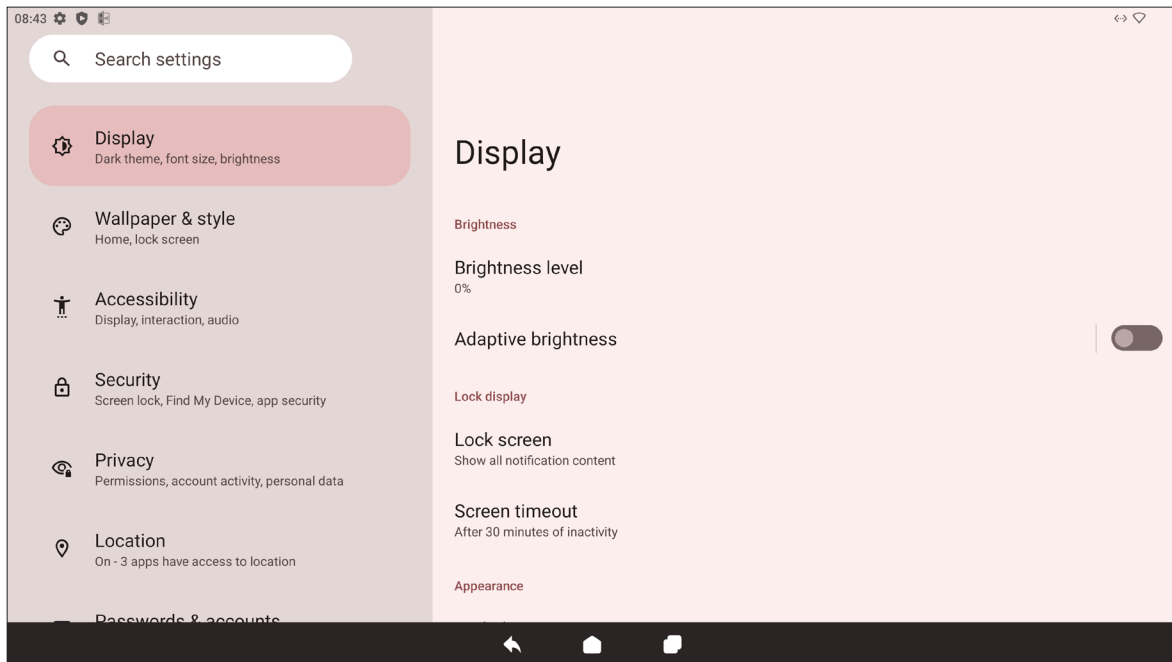

Item	Description
Brightness Level	Adjust the brightness level.
Adaptive Brightness	When enabled, the brightness level will dynamically adjust automatically based on the ambient light level of the surrounding area.
Lock Screen	Set lock screen preferences.
Screen Timeout	Set when the screen will lock after a period of inactivity.
Dark Theme	When enabled, the brighter default background color will be changed to a darker one.
Display Size and Text	Adjust the overall display size or only the text size.
Screen Saver	When enabled, a screen saver will play when the ViewBoard is not in use.
HDMI CEC	When enabled, HDMI CEC allows devices connected to the ViewBoard via HDMI to turn on automatically when the ViewBoard is turned on.
Wake Up by Active HDMI Input	When enabled, and if the ViewBoard is in standby mode, the ViewBoard display will “wake up” and turn on when connecting to an external device via HDMI.

Wallpaper & Style

Adjust and personalize the Wallpaper, Colors and theme of the ViewBoard.

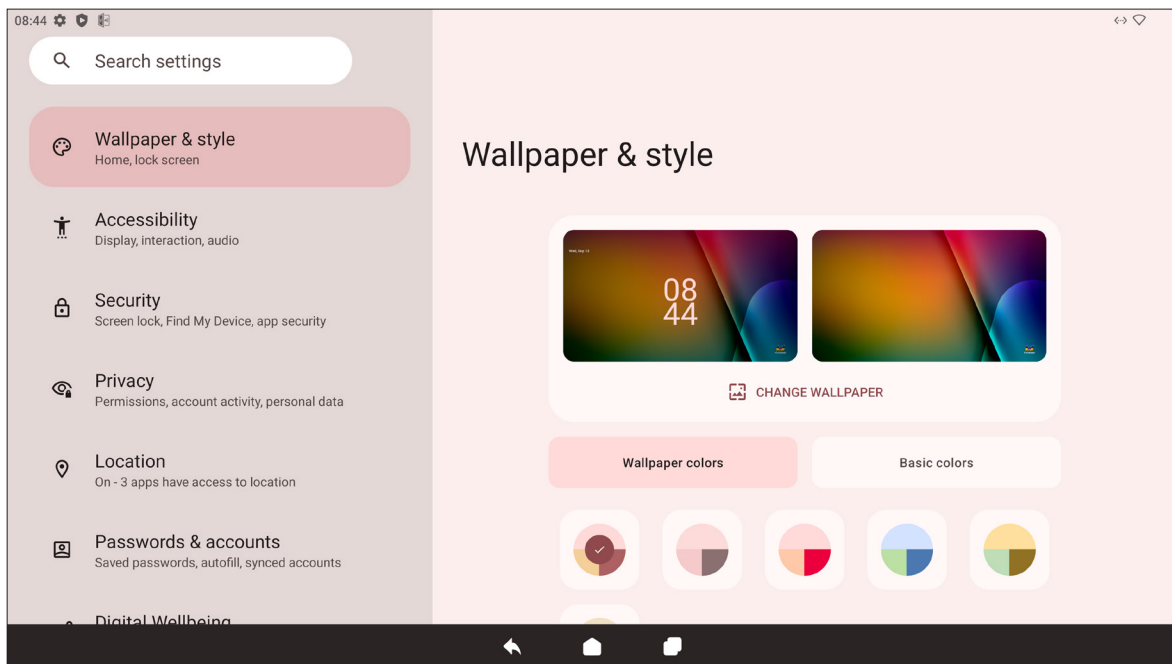

Item	Description
Change Wallpaper	Select a wallpaper for the background.
Wallpaper Colors	Choose a color scheme based on the selected wallpaper.
Basic Colors	Choose a color scheme from a select amount of options.
Dark Theme	When enabled, the brighter default background color will be changed to a darker one.

Accessibility

View and adjust various tools that can help people with visual, auditory, speech, or physical disabilities use the ViewBoard.

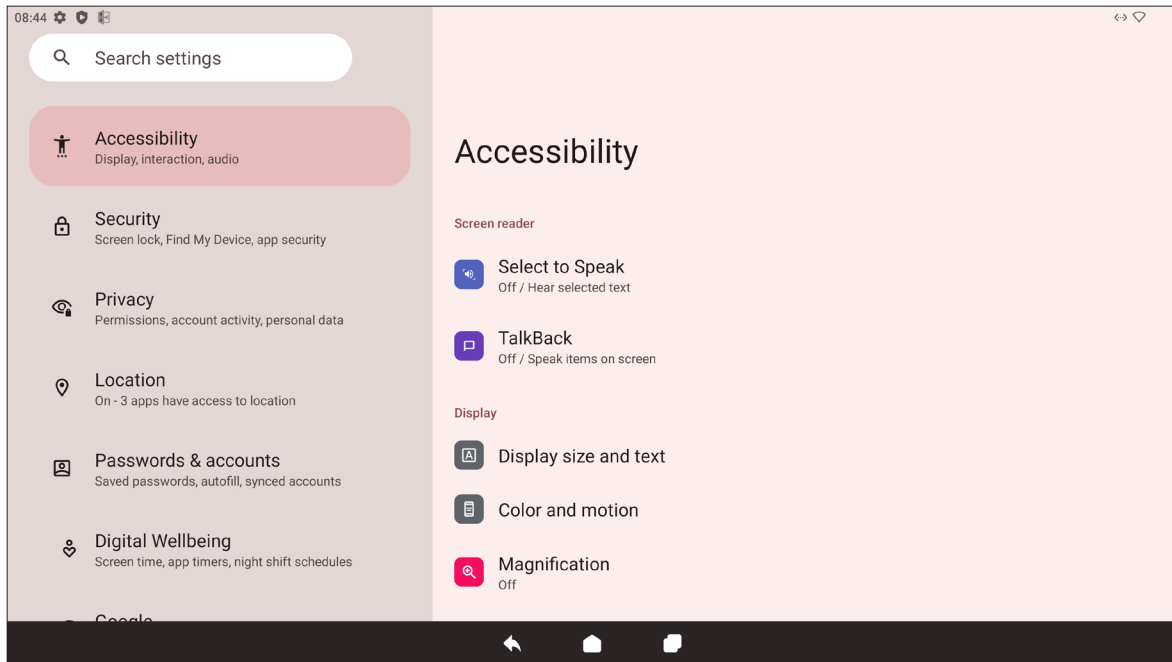

Item	Description
Select to Speak	When enabled, certain on-screen items will be read or described aloud when tapped (e.g., text or image).
TalkBack	When enabled, device actions will be described by audio so it can be used without looking at the screen.
Display Size and Text	Adjust the overall display size or only the text size.
Color and Motion	Apply color correction and inversion and enlarge the mouse pointer.
Magnification	Zoom in on the screen to enlarge the content.
Accessibility Menu	Add a shortcut for an enlarged on-screen menu to control the device.
Switch Access	Allows the use of one or more switch, keyboard, controller, etc. to control the device.
Timing Controls	Adjust how long temporary messages that ask for an action are on screen, enable Autoclick, and adjust the touch and hold delay time.
System Controls	Adjust the way to navigate the system.
Live Caption	Set the live caption preferences.
Caption Preferences	Enable captions and adjust the size and style.

Item	Description
Audio Description	When enabled, an audio description of what is happening on screen in supported movies and shows will be given.
Hearing Aids	Connect a hearing aid to the ViewBoard.
Audio Adjustment	Combine audio channels into a single mono channel.
Accessibility Shortcuts	Adjust the shortcut settings and availability on the lock screen.
Text-to-Speech Output	When set up, text can be read out loud.

Security

Review and adjust device security settings.

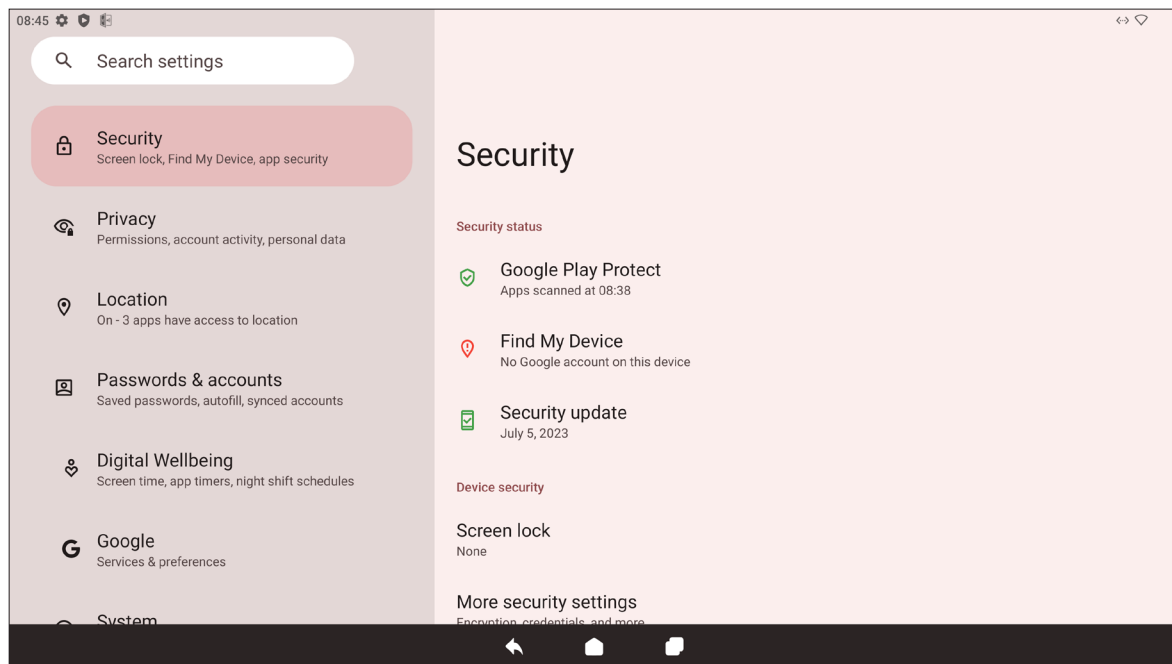

Item	Description
Google Play Protect	Regularly check the installed applications and device for any harmful behavior.
Find My Device	Locate the ViewBoard remotely.
Security Update	Check for security updates.
Google Play System Update	Check for system updates.
More Security Settings	View and adjust various security related settings.

Privacy

Check and manage current privacy settings.

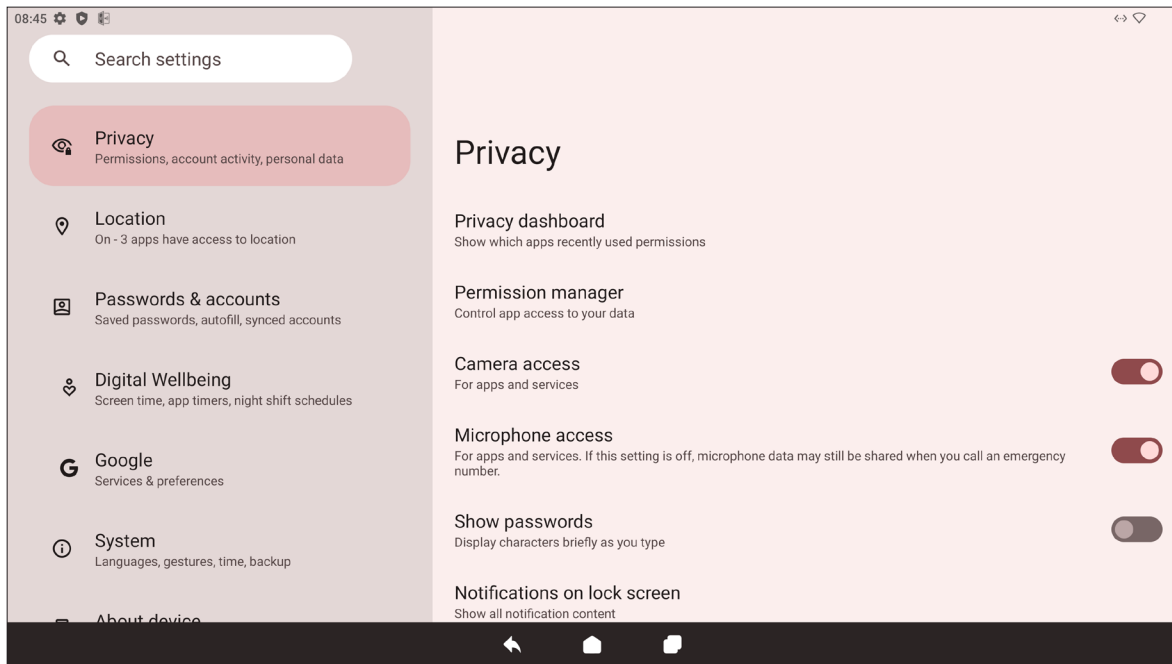

Item	Description
Privacy Dashboard	View which applications recently used permissions.
Permission Manager	Control application access to your data.
Camera Access	Allow or disallow camera access for applications or services.
Microphone Access	Allow or disallow microphone access for applications or services.
Show Passwords	When enabled, characters will be displayed briefly as a password is being inputted.
Notifications on Lock Screen	Choose to show all, some, or no conversations or notifications on the lock screen.
Show Media on Lock Screen	Choose to show media on the lock screen.
Android System Intelligence	Get suggestions based on the people, applications, and content used.
App Content	When enabled, applications can send content to the system.
Show Clipboard Access	When enabled, a message will appear when applications access something (e.g., text, image, etc.) that has been copied.
Autofill Service from Google	With a Google account, passwords and other information can be filled in automatically.

Item	Description
Activity Controls	Select which activities and information Google is allowed to save.
Ads	Manage advertisement personalization.
Usage & Diagnostics	Choose to share usage and diagnostic data to Google.

Location

View and manage location settings.

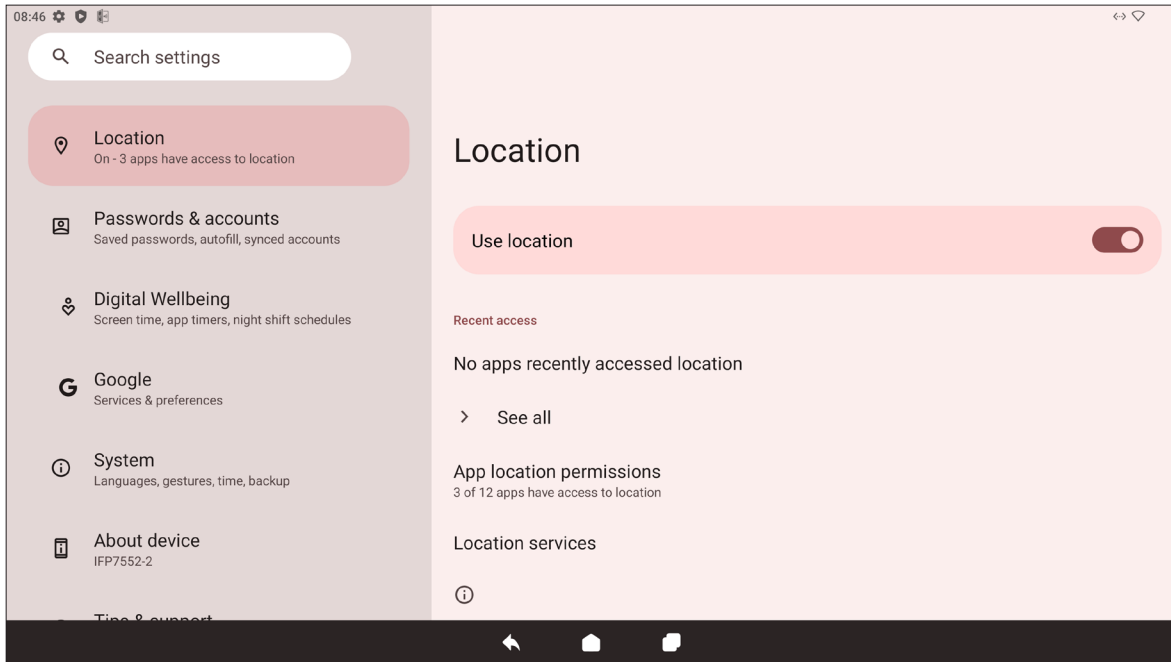

Item	Description
Use Location	When enabled, the location of the device will be accessible to applications.
Recent Access	Review which applications recently accessed the device's location.
App Location Permissions	Review which applications have permission to access the device's location.
Location Services	Turn ON/OFF various alerts, services, and scanning related to location and location accuracy.

Passwords & Accounts

Review saved passwords, select autofill services, and add accounts.

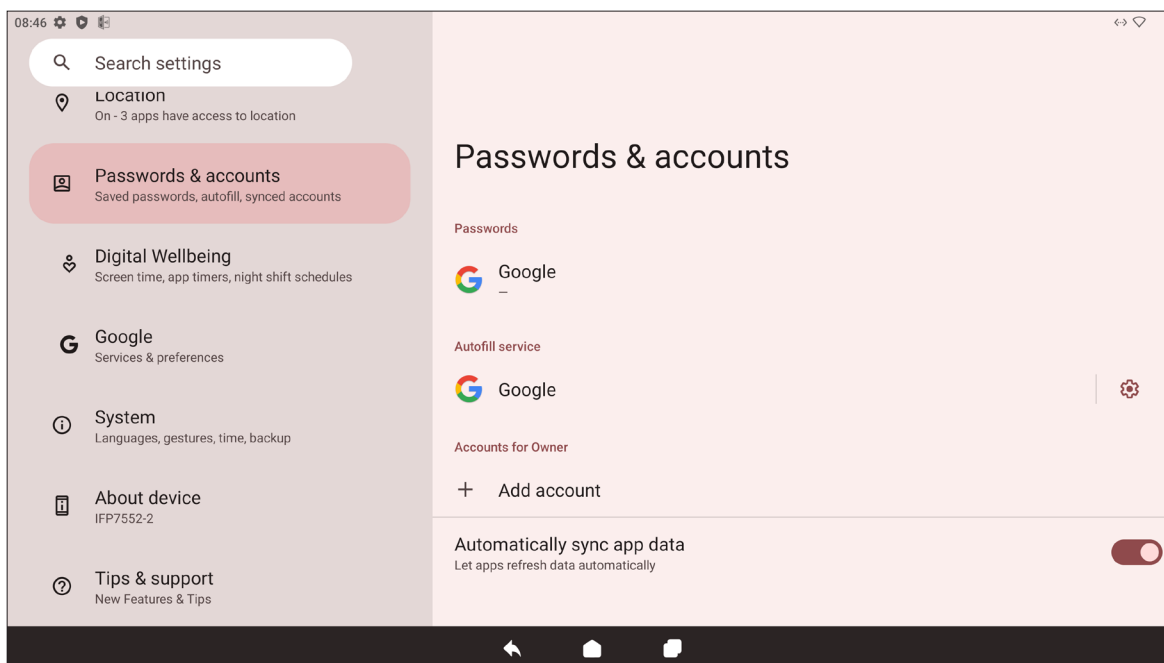

Item	Description
Passwords	Review saved passwords.
Autofill Service	Select which autofill service to use, if any.
Accounts for Owner	Add or remove accounts.
Automatically Sync App Data	When enabled, applications can refresh data automatically.

Digital Wellbeing

Review the ViewBoard’s usage time, and set up various tools to promote a better balance with the device.

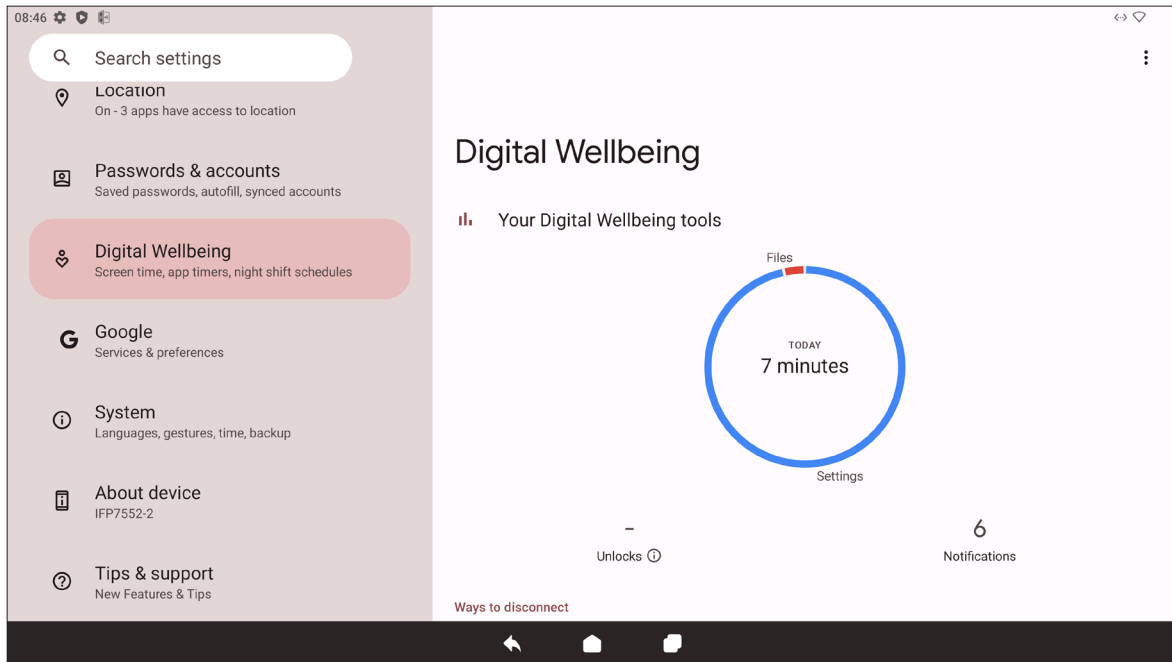

Item	Description
Your Digital Wellbeing Tools	A brief overview of device usage, unlocks, and notifications.
Dashboard	Review screen time, number of notifications, and number of device unlocks.
Night Shift	Reduce the amount of blue light emitted by the ViewBoard’s screen.
Focus Mode	When set up, distracting applications can be paused and their notifications hidden.
Manage Notifications	Review which applications can send notifications.
Do Not Disturb	Set notification preferences for when “Do Not Disturb” mode is turned on.

Google

Review all of Google's services and set up preferences.

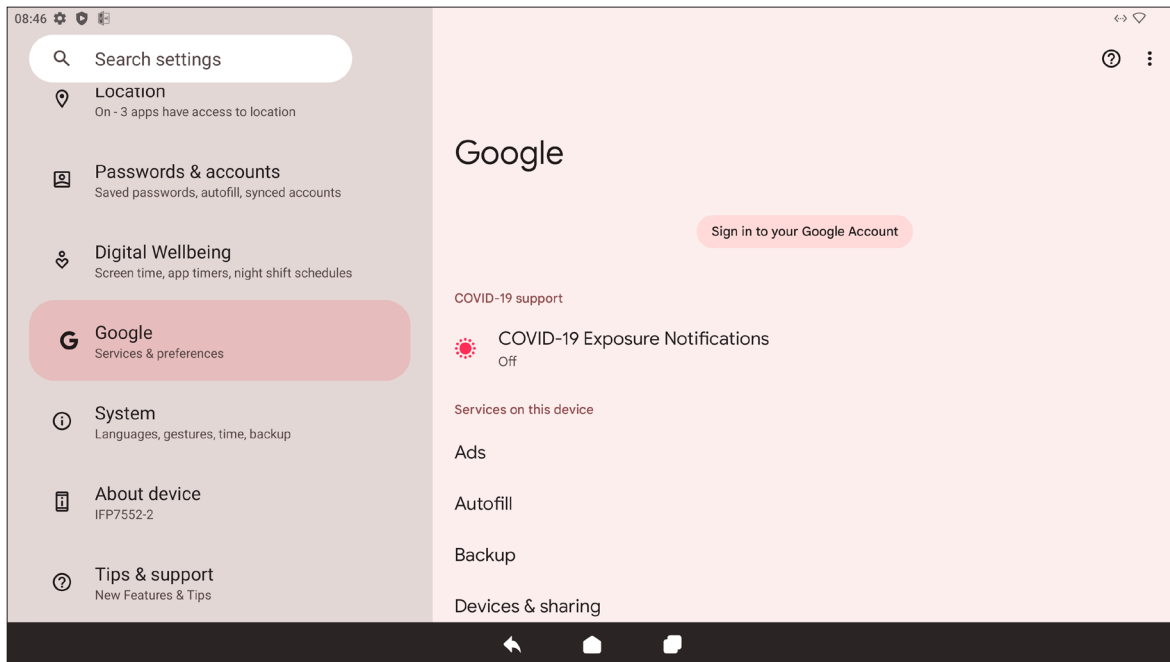

Item	Description
Ads	Manage advertisement personalization.
Autofill	With a Google account, passwords and other information can be filled in automatically.
Backup	With a Google account, back up the device's data.
Devices & Sharing	Set Cast and device sharing options.
Find My Device	Locate the ViewBoard remotely.
Parental Controls	Set up parental controls with Google's Family Link application.
Personalize Using Shared Data	Allow or disallow Google to use the installed applications' data for diagnostics and recommendations.
Set Up & Restore	Set up a nearby device or a work profile.
Settings for Google Apps	Review settings for Google-specific applications.

System

View and adjust various system settings.

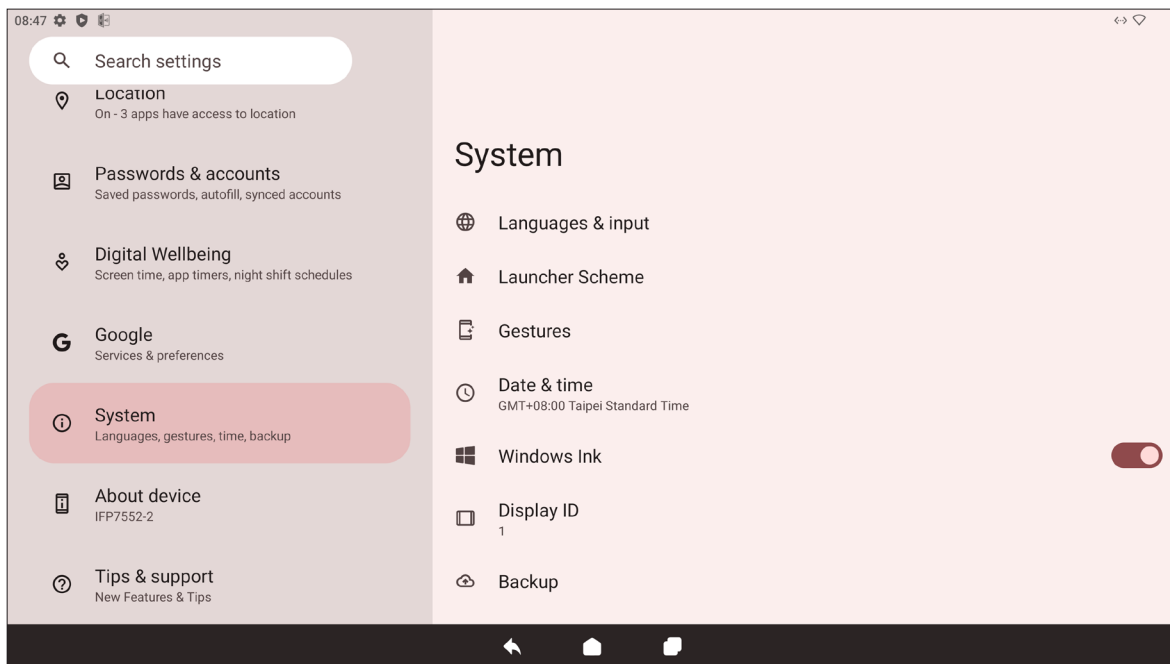

Item	Description
Languages & Input	Choose the preferred language and input method.
Launcher Scheme	Choose between Scheme A and Scheme B to set the Home Screen layout.
Sidebar	Adjust the side toolbar settings.
Date & Time	Set the date and time.
Windows Ink	Enable and set up Windows Ink support.
Display ID	Assign a number to remote control the display by RS-232/LAN.
Backup	With a Google account, back up the device's data.
ViewSonic System Update	Check for system updates.
Multiple Users	Review who is signed in and the available user logins.
Reset Options	Reset the ViewBoard to factory default settings.

About Device

Review device information.

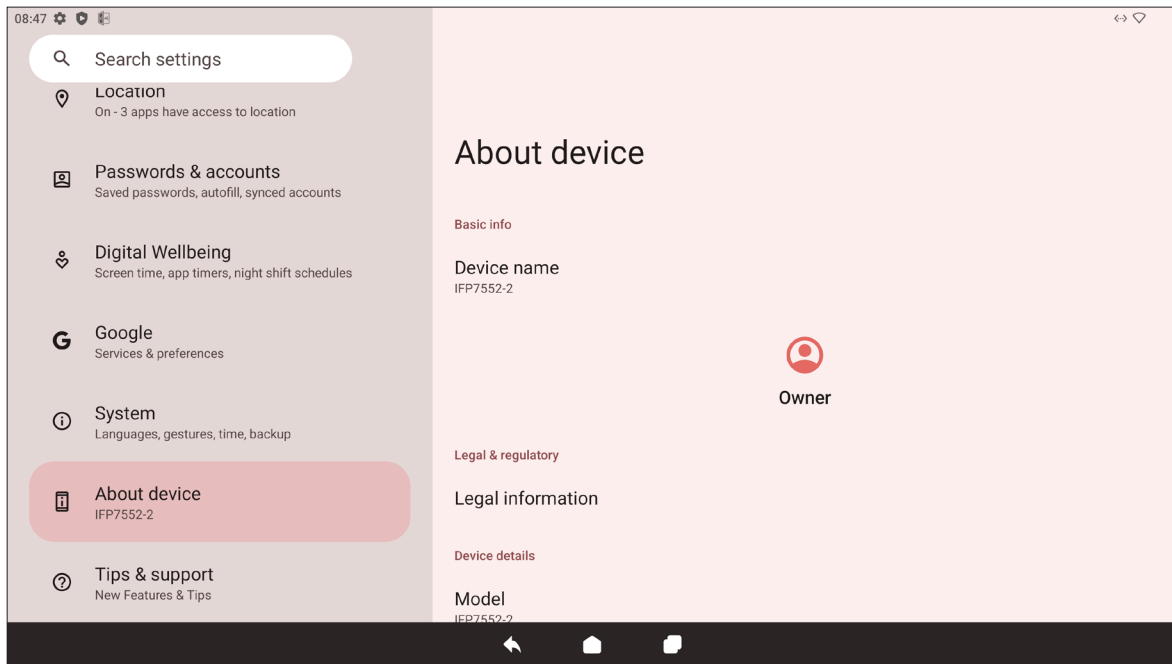

Item	Description
Device Name	View the name of the device.
Legal Information	View the relevant legal information.
Model	View the model of the ViewBoard.
Android Version	View the installed version of Android.
IP Address	View the IP Address.
Ethernet Address	View the Ethernet Address.
Wi-Fi MAC Address	View the Wi-Fi MAC Address.
Device Wi-Fi MAC Address	View the Device Wi-Fi MAC Address.
Bluetooth Address	View the Bluetooth Address.
Up Time	View how long the device has been in operation.
Build Number	View the build number.
Custom Build Number	View the custom build number.

Tips & Support

View new features, tips, and get support for the myViewBoard Whiteboard, myViewBoard Display, myViewBoard manager, and vCast applications.

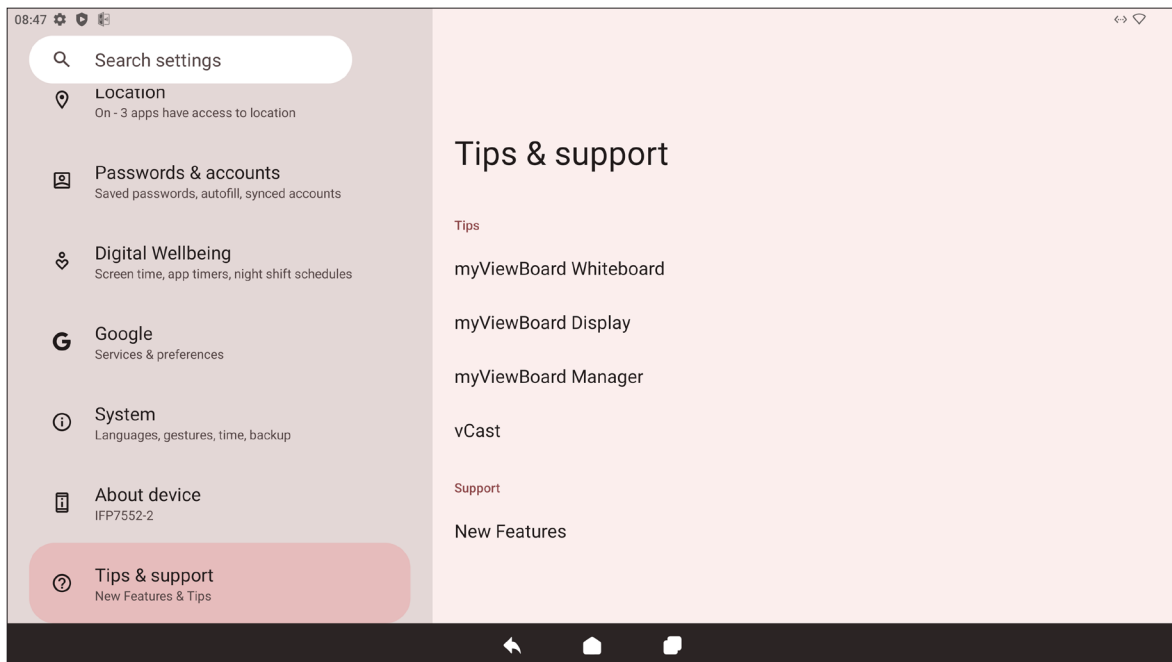

ViewBoard Settings Menu Tree

Menu	Sub-menu	Menu Option			
Network & Internet	Internet	Ethernet			
		Wi-Fi			
		Network Preferences	Turn on Wi-Fi automatically		
			Notify for public networks		
			Install certificates		
			Wi-Fi Direct		
	Saved Networks				
	Non-carrier data usage				
	Airplane Mode				
	Hotspot & tethering	Wi-Fi hotspot	Use Wi-Fi hotspot		
			Hotspot name		
			Security	WPA2-Personal	
				None	
			Turn off hotspot automatically		
		Extend compatibility			
USB tethering					
Bluetooth tethering					
Ethernet tethering					

Menu	Sub-menu	Menu Option			
Network & Internet	Data Saver	Use Data Saver			
		Unrestricted data			
	VPN	Name			
		Type	IKEv2		
			IPSec RSA		
		Server address			
		IPSec identifier			
		IPSec server certificate			
		Proxy	None		
			Manual	Proxy hostname	
				Proxy port	
		Username			
		Password			
		Always-on VPN			
	Private DNS	Off			
		Automatically			
		Private DNS provider hostname	Enter hostname of DNS provider		

Menu	Sub-menu	Menu Option		
Connected Devices	Pair new device	Device name		
		Available devices		
	Saved devices	See all		
	Connection preferences	Bluetooth	Use Bluetooth	
			Pair new device	Available devices
		Cast		
		Printing	Default Print Service	Use print service
				Add service
		Nearby Share	Account & device	
			Device visibility	
			Data	Wi-Fi only
				Without internet
			Show notification	

Menu	Sub-menu	Menu Option		
Apps	Recently opened apps			
	Default apps			
	Screen time			
	Unused apps			
	Special app access	All files access		
		Device admin apps		
		Display over other apps		
		Do No Disturb access		
		Media management apps		
		Modify system settings		
		Device & app notifications		
		Picture-in-picture		
		Premium SMS access		
		Unrestricted data		
		Install unknown apps		
		Alarms & reminders		
		Usage access		
		VR helper services		
		Wi-Fi control		
Turn screen on				

Menu	Sub-menu	Menu Option		
Notifications	App settings			
	Notification history	Use notification history		
	Conversations			
	Bubbles	Allow apps to show bubbles		
	Device & app notifications	Allowed		
		Not allowed		
	Notifications on lock screen	Show conversations, default, and silent		
		Hide silent conversations and notifications		
		Don't show any notifications		
	Do Not Disturb	People	Message	Favorite contacts
				Contacts
				Priority conversations
				Anyone
				None
			Calls	Favorite contacts
Contacts				
Anyone				
None				
Allow repeat callers				

Menu	Sub-menu	Menu Option	
Notifications	Do Not Disturb	Apps	Add apps
		Alarms & other interruptions	Alarms
			Media sounds
			Touch sounds
			Reminders
			Calendar events
		Schedules	Sleeping
			Event
			Add more
		Duration for Quick Settings	Until you turn off
			For 1 hour
			Ask every time
		Display options for hidden notifications	No sound from notifications
			No visuals or sound from notifications
			Custom
	Wireless emergency alerts		
	Hide silent notifications in status bar		
	Hide silent notifications in Always-on Panel		
	Allow notification snoozing		
	Notification dot on app icon		
	Enhanced notifications		

Menu	Sub-menu	Menu Option		
Storage	Storage manager			
	System			
	Apps			
	Documents & other			
	Images			
	Trash			
	Games			
	Audio			
	Videos			
Sound	Volume			
	Do Not Disturb			
	Live Caption			
	Media	Pin media player		
		Show media on lock screen		
		Show media recommendations		
	Default notification sound	None		
		Alya		
		Argon		
		Canopus		
		Deneb		
		Highwire		
		Iridium		
		Pixie Dust		
Talitha				
Add notification				

Menu	Sub-menu	Menu Option		
Sound	Default alarm sound	None		
		Argon		
		Beep-Beep-Beep		
		Cesium		
		Helium		
		Oxygen		
		Piezo		
		Platinum		
		Add alarm		
	Screen locking sound			
Touch sounds				
Display	Brightness level			
	Adaptive brightness			
	Lock screen	Privacy	Show all notifications content	
			Don't show notifications at all	
		Add users from lock screen		
		Add text on lock screen		
		Show wallet		
		Show device controls		
		Control from locked device		
	Double-line clock			

Menu	Sub-menu	Menu Option	
Display	Screen timeout	15 seconds	
		30 seconds	
		1 minute	
		2 minutes	
		5 minutes	
		10 minutes	
		30 minutes	
	Dark theme		
	Display size and text	Font size	
		Display size	
		Bold text	
		High contrast text	
		Reset Settings	
	Screen saver		
HDMI CEC			
Wake up by active HDIM input			
Wallpaper	Change Wallpaper		
	Wallpaper colors		
	Basic colors		
	Dark theme		

Menu	Sub-menu	Menu Option				
Accessibility	Select to Speak	Select to Speak shortcut				
		Settings	Text to speech settings	Preferred engine		
				Language		
				Speech rate		
				Pitch		
			Read in background			
			Read text on images			
			Help & feedback			
		TalkBack	Use TalkBack			
			TalkBack shortcut			
	Settings		New features in TalkBack			
			Text-to-speech settings	Preferred engine		
				Language		
				Speech rate		
				Pitch		
			Verbosity	Choose a preset		
				Speak usage hints		
	Speak list and grid info					
	Always speak number of list items					
	Speak element type					
Speak window names						
Speak notifications when screen is off						
Use pitch changes						

Menu	Sub-menu	Menu Option		
Accessibility	TalkBack	Settings	Verbosity	Speak letters with examples
				Keyboard echo: On-screen keyboard
				Keyboard echo: Physical keyboard
				Capital letters
				Speak all progress updates
				Speak element IDs
				Speak punctuation and symbols
			Sound	Audio ducking
				Sound feedback
				Sound feedback volume
			Customize Focus Indicator	Default
				Red
				Orange
				Yellow
				Green
				Blue
			Customize Gestures	Customize TalkBack menu
				Customize reading controls
			Automatically describe icons	

Menu	Sub-menu	Menu Option		
Accessibility	TalkBack	Settings	Braille keyboard	Set up braille keyboard
				Typing languages
				Preferred language
				Review all gestures
				Include all pressed dots
				Reverse dots
			Braille display	Languages
				Preferred reading language
				Preferred typing language
				Braille commands
				Auto-connect
				Show braille output on screen
			Tutorial and help	Tutorial
				Practice gestures
				Help & feedback

Menu	Sub-menu	Menu Option		
Accessibility	TalkBack	Settings	Advanced settings	Speak passwords
				Custom labels
				Single-tap to activate
				Element description order
				Reduce window announcement delay
				Typing preference
				Touch and hold delay when typing
				Keyboard shortcuts
				Developer settings
				Privacy Policy
			Terms of service	
	Open TalkBack at the Play Store			
	Display size and text	Font size		
		Display size		
		Bold text		
		High contrast text		
		Reset Settings		

Menu	Sub-menu	Menu Option		
Accessibility	Color and motion	Color inversion		
		Dark theme		
		Color correction	Red-green (deuteranomaly)	
			Red-green (protanomaly)	
			Blue-yellow	
			Grayscale	
			Color correction shortcut	
	Remove animations			
	Large mouse pointer			
	Magnification	Magnification shortcut		
		Magnification type	Magnify full screen	
			Magnify part of screen	
			Switch between full and partial screen	
	Magnify typing			
	Accessibility Menu	Accessibility Menu		
Settings		Large buttons		
		Help & feedback		

Menu	Sub-menu	Menu Option					
Accessibility	Switch Access	Use Switch Access					
		Switch Access shortcut					
		Settings	Help & feedback				
			Open setup guide	USB switch	Bluetooth switch		
				Camera switch	Use Camera Switches		
				Open Mouth	Smile		
			Camera Switch settings	Raise Eyebrows	Look Left	Look Right	
				Look Up	Enhanced visual feedback	Enhanced audio feedback	
				Keep screen on	Ignore repeated Camera Switch triggers		

Menu	Sub-menu	Menu Option		
Accessibility	Switch Access	Settings	Assign switches for scanning	Pause
				Camera Switch
				Auto-scan
				Reverse auto-scan
				Select
				Next
				Previous
				Touch & hold
				Scroll forward
				Scroll backward
			Assign switches to global actions	Pause Camera Switch
				Back
				Home
				Notifications
				Quick Settings
			Assign switches to shortcuts	
			Enable Menu Customization	
			Revert to Default Menu	
			Auto-scan	Auto-scan time
				Delay on first item
				Number of scans
			Scanning method	Linear scanning
				Row-column scanning
				Group selection

Menu	Sub-menu	Menu Option		
Accessibility	Switch Access	Settings	Point scan	Line speed
				Delay on first item
				Number of scans
				Vertical scans
				Horizontal scans
			Automatically start scanning	
			Auto-select	
			Scanning highlight style	Highlight color
				Highlight line style
			Speech, sound & vibration	Speak descriptive text
				Verbosity
				TTS settings
				Finish speech before moving
				Maximum spoken time per item
				Vibration feedback
				Sound feedback
				Sound volume
				Audio ducking
			Ignore repeated presses	
			Release to perform action	
			Privacy policy	
			Developer settings	Version
				Display speech output
				Delete all shortcuts
Log output level				

Menu	Sub-menu	Menu Option			
Accessibility	Timing controls	Touch & hold delay	Short		
			Medium		
			Long		
		Time to talk action	Default		
			10 seconds		
			30 seconds		
			1 minute		
			2 minutes		
		Auto click	Off		
			Short		
			Medium		
			Long		
			Custom		
		System controls	System navigation		Gesture navigation
					3-button navigation
	Live Caption	Languages			
		Hide profanity			
		Show sound labels			
		Live Caption in volume control			
		Help			

Menu	Sub-menu	Menu Option			
Accessibility	Caption preferences	Show captions			
		Caption size and style	Text size	Very Small	
				Small	
				Medium	
				Large	
				Very Large	
		Caption size and style	Caption style	Set by app	
				White on black	
				Black on white	
				Yellow on black	
	Yellow on blue				
	Custom				
	More options	Language			
	Audio description				
	Hearing aids				
	Audio adjustment	Mono audio			
		Audio balance			
	Accessibility shortcuts	Accessibility button	Location	Floating over other apps	
				Navigation bar	
			Size	Small	
				Large	
			Fade when not in use		
			Transparency when not in use		
Shortcut from lock screen					

Menu	Sub-menu	Menu Option			
Accessibility	Text-to-speech output	Preferred engine	Speech Services by Google		
		Language			
		Speech rate			
		Pitch			
Security	Google Play Protect				
	Find My Device	Find My Device			
		Find My Device app			
		Find My Device web			
	Security update				
	Google Play system update				
	Screen lock	None			
		Swipe Pattern			
		PIN			
		Password			
	More security settings	Smart Lock			
		Device admin apps			
		Encryption & credentials	Encrypt tablet		
			Trusted credentials		
			User credentials		
			Install a certificate		
			Clear credentials		
Certificate management app					
Trust agents					
App pinning					

Menu	Sub-menu	Menu Option	
Privacy	Privacy dashboard	Location	
		Camera	
		Microphone	
		Body sensors	
		Calendar	
		Call logs	
		Contacts	
		Files	
		Music and audio	
		Nearby devices	
		Phone	
		Photos and videos	
		Physical activity	
		SMS	
		Privacy	
Calendar			
Call logs			
Camera			
Contacts			
Files			
Location			
Microphone			
Music and audio			
Nearby devices			
Notifications			
Phone			
Photos and videos			
Physical activity			
SMS			
	Additional permissions		

Menu	Sub-menu	Menu Option		
Privacy	Camera access			
	Microphone access			
	Show passwords			
	Notifications on lock screen	Show all notification content		
		Don't show notifications at all		
	Show media on lock screen			
	Android System Intelligence	Device learning		
		Keyboard	Show smart text suggestions in the keyboard suggestion strip including smart reply and paste	
		Clear data	Last hour	
			Last 24 hours	
	All time			
	App content			
	Show clipboard access			
	Autofill service from Google			
	Activity controls			
	Ads			
Usage & diagnostics				

Menu	Sub-menu	Menu Option												
Location	Use location													
	Recent access													
	App location permissions													
	Location services	Earthquake alerts												
		Emergency Location Service												
		Google Location Accuracy												
		Google Location History												
		Google Location Sharing												
		Wi-Fi scanning												
		Bluetooth scanning												
Passwords & Accounts	Passwords													
	Autofill service													
	Accounts for Owner													
	Automatically sync app data													

Menu	Sub-menu	Menu Option				
Digital Wellbeing	Your Digital Wellbeing tools					
	Dashboard					
	Night Shift	Do Not Disturb for Night Shift mode				
	Focus Mode					
	Manage notifications					
	Do Not Disturb	People	Messages	Favorite contacts		
				Contacts		
				Priority conversations		
				Anyone		
				None		
			Calls	Favorite contacts		
		Contacts				
		Anyone				
		None				
		Apps	Alarms & other interruptions	Schedule	Allow repeat callers	
		Alarms				
		Media sound				
		Touch sounds				
		Reminders				
		Calendar events				
		Sleeping				
		Event				

Menu	Sub-menu	Menu Option		
Digital Wellbeing	Do Not Disturb	Duration for Quick Settings	Until you turn off	
			For 1 hour	
			Ask every time	
		Display options for hidden notifications	No sound from notifications	
			No visuals or sound from notifications	
			Custom	
Google	COVID-19 Exposure Notifications			
	Ads			
	Autofill			
	Backup			
	Devices & sharing			
	Find My Device			
	Parental controls			
	Personalize using shared data			
	Set up & restore			
	Settings for Google apps			

Menu	Sub-menu	Menu Option		
System	Languages & input	Languages		
		App Languages		
		On-screen keyboard		
		Physical keyboard	Use on-screen keyboard	
			Keyboard shortcuts	
		Voice input		
		Text-to-speech output	Preferred engine	
			Language	
			Speech rate	
			Pitch	
		Spell checker	Languages	
			Default spell checker	
	Personal dictionary			
	Pointer speed			
	Launcher Scheme	Scheme A		
		Scheme B		
Sidebar				

Menu	Sub-menu	Menu Option			
System	Date & time	Set time automatically			
		Date			
		Time			
		Set time zone automatically			
		Use location to set time zone			
		Time zone			
		Use locale default			
		Use 24-hour format			
	Windows Ink				
	Display ID				
	Backup				
	ViewSonic System Update				
		Multiple Users		User	
				Guest	
Delete guest activity					
Add users from lock screen					
	Reset options	Reset Wi-Fi, mobile & Bluetooth			
		Reset all settings			
		Erase all data (factory rest)			

Menu	Sub-menu	Menu Option
About Device	Device name	
	Legal information	
	Model	
	Android version	
	IP address	
	Ethernet address	
	Wi-Fi MAC address	
	Device Wi-Fi MAC address	
	Bluetooth address	
	Up time	
	Build number	
	Custom build version	
Tips & Support	myViewBoard Whiteboard	
	myViewBoard Display	
	myViewBoard Manager	
	vCast	
	New Features	

Pre-installed Applications and Settings

myViewBoard Display

Wirelessly mirror screens to a larger display.

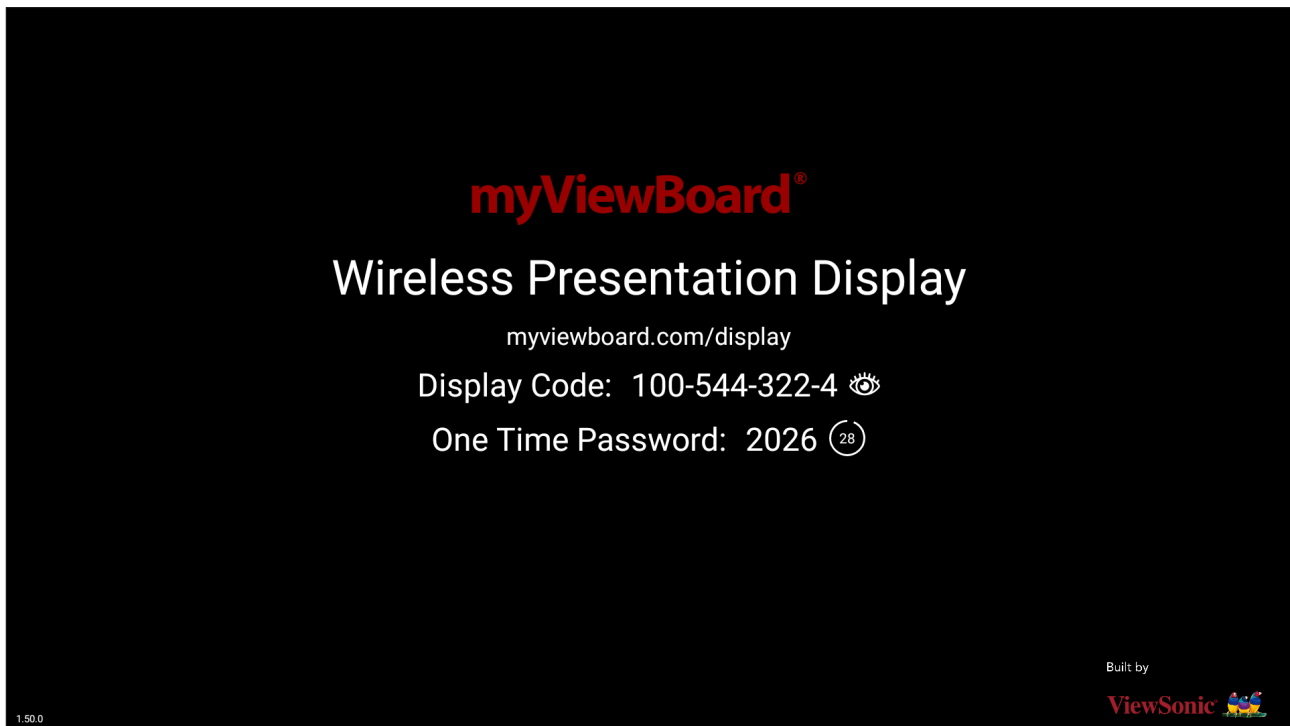

To share a screen to a ViewBoard with myViewBoard Display:

1. Open myViewBoard Display on the ViewBoard you want to share your screen to.
2. On the device you want to share the screen from, go to: <https://myviewboard.com/display>.
3. Enter the **Display Code** and **One Time Password** for the ViewBoard you wish to share to.

NOTE: Note that the password refreshes every 30 seconds.

myViewBoard Manager

Remotely manage multiple installations of ViewSonic devices.

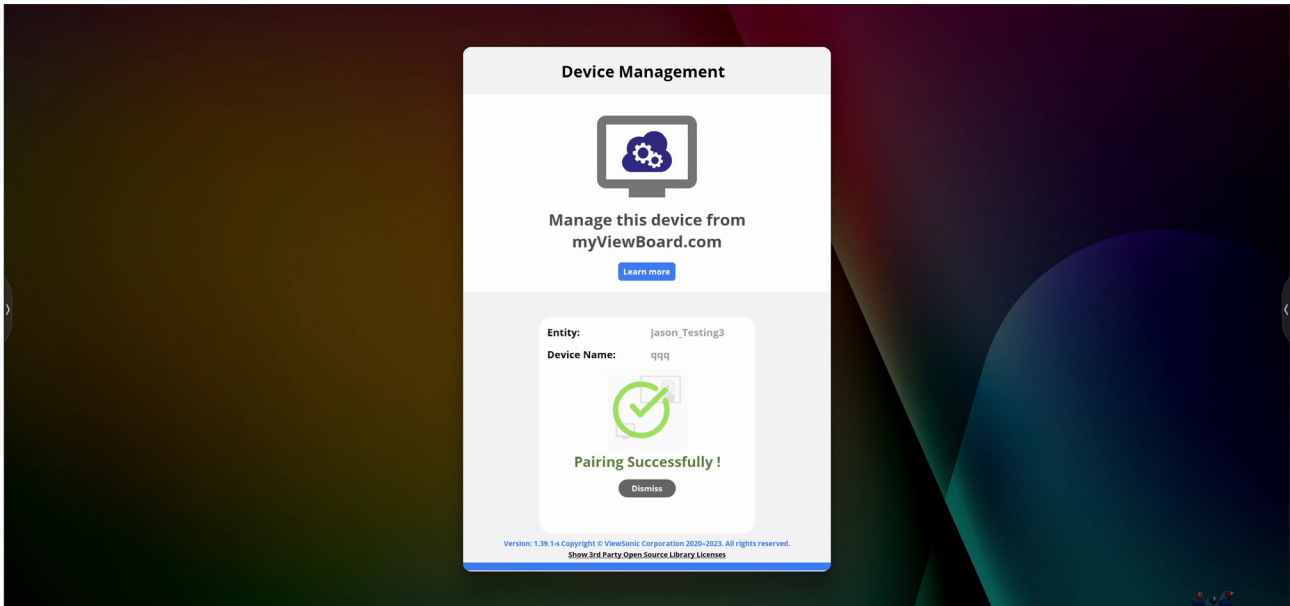

Once devices are set up and have myViewBoard Manager installed, they can be added to the entity and managed remotely from the Manager web application.

NOTE: Only available to Entity Admins from myviewboard.com after signing in.

Add a Device

On the device to manage:

1. Download and install myViewBoard Manager.
2. Open myViewBoard Manager and note the 6-digit PIN displayed.

In the myViewBoard Manager web application on myviewboard.com:

1. Click **Add Device**.
2. Input the 6-digit PIN obtained earlier.
3. Name the device (if applicable).
4. Click **Add**.

NOTE: To learn more about myViewBoard Manager, visit: https://wiki.myviewboard.com/MyViewBoard_Manager.

myViewBoard Whiteboard

A digital whiteboarding application.



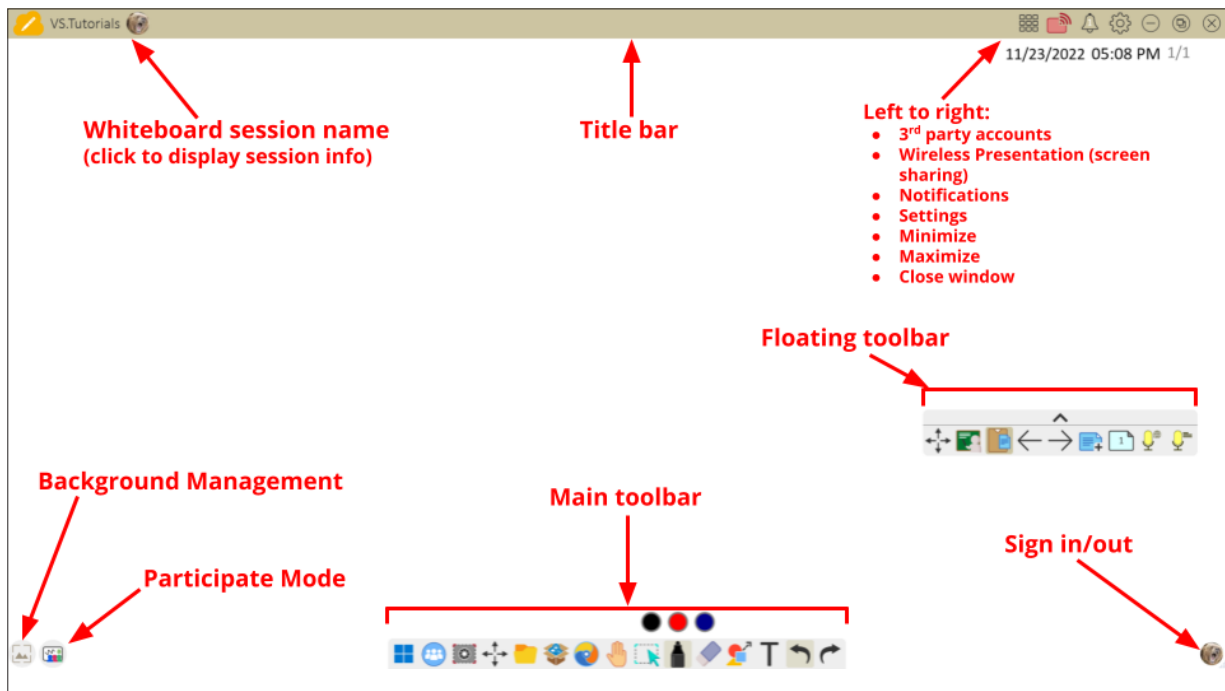









NOTE: To learn more about myViewBoard Whiteboard, visit: https://wiki.myviewboard.com/Whiteboard_for_Android.









Floating Toolbar

Item	Description
	Move Move the Floating Toolbar.
	Present Mode Switch between presentation and preparation modes.
	Paste from Clipboard Insert the current clipboard content onto the canvas.
	Previous Page Go to the previous page (if the canvas has multiple pages).
	Next Page Go to the next page (if the canvas has multiple pages).
	New Page Add a new canvas.
	Pages in Whiteboard Create, select, rearrange, copy and delete pages.

Main Toolbar

	Item	Description
	Screen Capture	Screenshot, video, and audio recording.
	Move	Select and hold to move the toolbar to the left side, right side, or bottom of the screen.
	File	Open, save, export, and print whiteboard files.
	Magic Box	Import resources (image, video, audio, etc.) to the whiteboard.
	Embedded Browser	Open the built-in browser to access internet resources, which can be dragged onto the canvas.
	Infinite Canvas	Drag to move the canvas. Use two hands to zoom in/zoom out. Select again for an overview.
	Selection	Select objects, text, and other elements on the canvas.
	Pen	Writing tools and customization options.
	Eraser	Erase objects or clear the page.
	Shapes and Lines	Draw shapes, arrows, and add tables.
	Text and Handwriting	Add a text box.
	Undo	Undo the previous action.
	Redo	Redo the previous action.

Background Management

Item		Description
	Sign In	Sign in to a myViewBoard account.
	Background Management	Change the canvas background.
	FollowMe Setting	Display custom images uploaded to a cloud storage account.
	Color Palette	Choose from solid or gradient colors as the background.
	Pre-installed	Choose backgrounds that come pre-installed with Whiteboard.
	myViewBoard Originals	Display original content created by myViewBoard.
	Local Hard Drive	Use images from the local hard drive.

vCast

Working with ViewBoard® Cast software (vCast, vCast Pro, and vCastSender), the vCast application will allow the ViewBoard to receive laptop screens (Windows/Mac/Chrome) and mobile (iOS/Android) users' screens, photos, videos, annotations, and camera(s) that are using the vCastSender application.

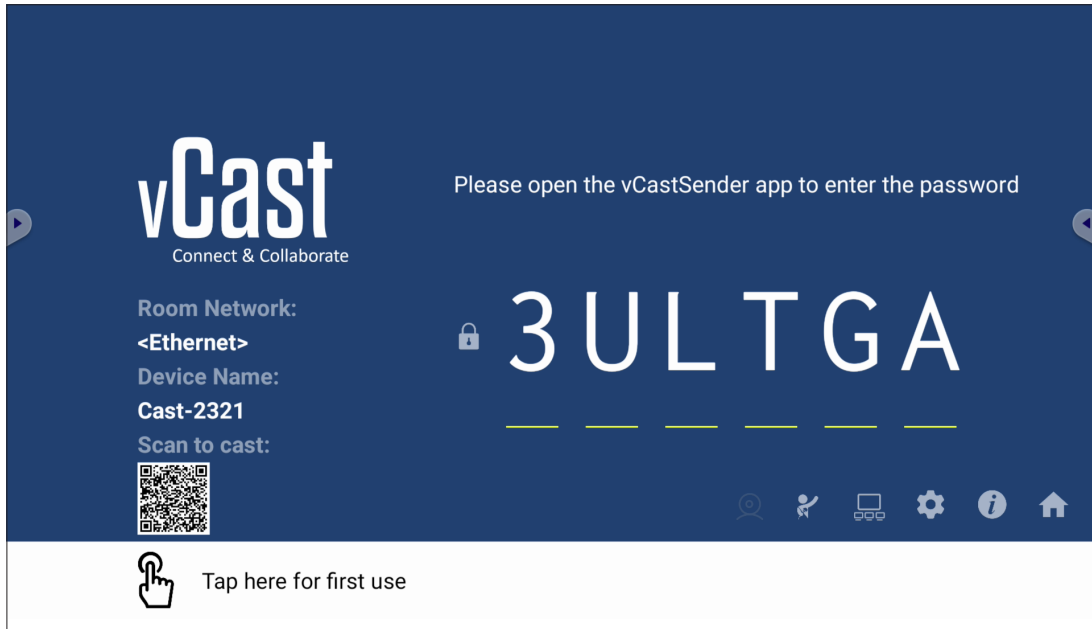

Network Information

- ViewBoard® Cast software, laptops, and mobile devices can connect to both the same subnet and cross subnet by entering the on-screen PIN code.
- Connected devices will show up under **Device List** on the same subnet connection.
- If the device does not show up under **Device List**, users will need to key-in the on-screen PIN code.
- **Ports:**
 - » TCP 56789, 25123, 8121 & 8000 (Controlling message port & client device audio transfer)
 - » TCP 8600 (BYOM)
 - » TCP 53000 (Request share screen)
 - » TCP 52020 (Reverse control)
 - » TCP 52025 (Reverse control for ViewBoard Cast Button)
 - » TCP 52030 (Status sync)
 - » UDP 48689, 25123 (Device searching and broadcast & client device audio transfer)
 - » UDP 5353 (Multicast search device protocol)
- **Port and DNS for Activation:**
 - » Port: 443
 - » DNS: <https://vcastactivate.viewsonic.com>
- **OTA Service**
 - » Server Port: TCP 443
 - » Server FQDN Name: <https://vcastupdate.viewsonic.com>

Display Group Settings

To adjust the Display Group Settings, select the Display Group icon () located in the lower-right corner of the screen.

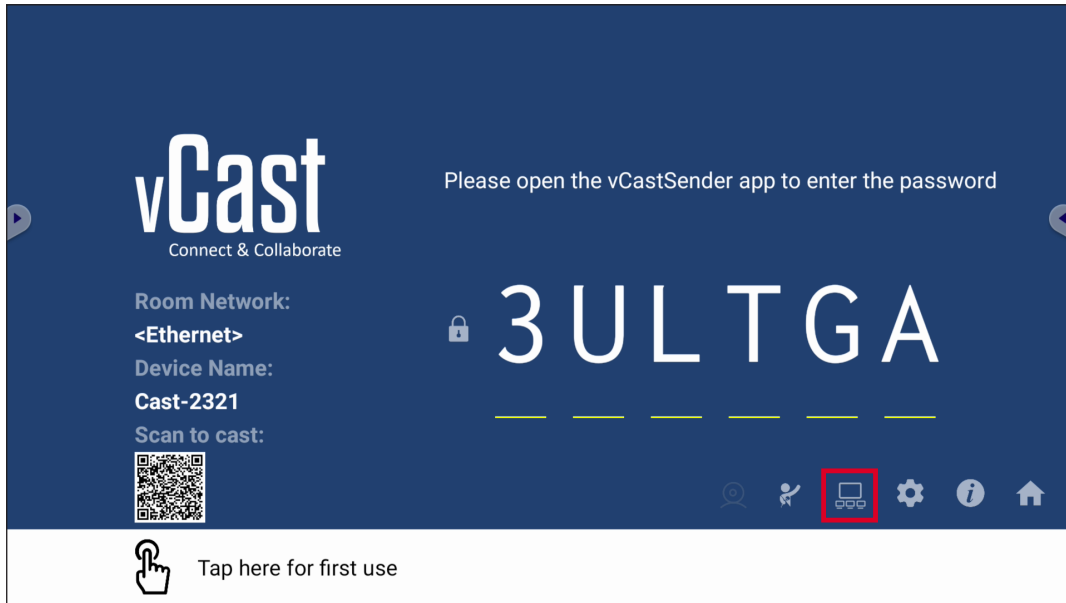

1. Toggle the “Turn On/Off Display Group” ON to enable the Display Group feature.

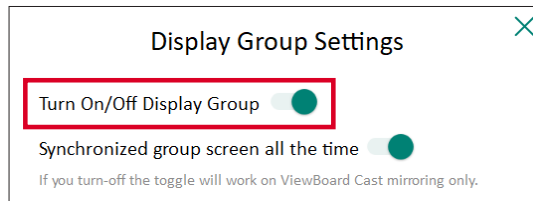

NOTE: Other preinstalled ViewBoard Cast devices in the same network will be listed.

2. Select the devices you want to join the display group and select **OK** to save the settings.

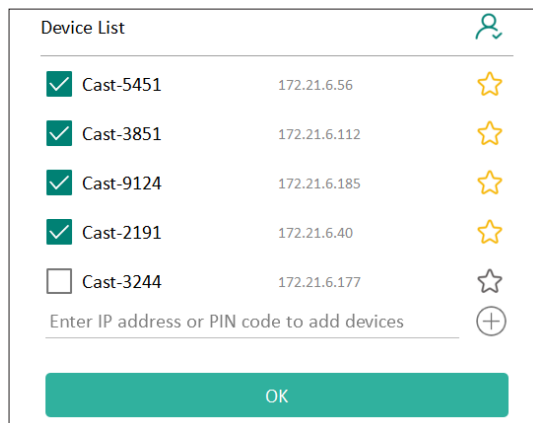

NOTE:

- If the devices you want to group are not listed, you can enter their respective IP address or connecting PIN code.
- The Display Group maximum device limit is six devices.

3. If you frequently connect to the same device, you can select the Star icon (★) next to the device to add it to your frequently connected devices list, “My List of Devices in Group”, for easier Display Group setup and management.

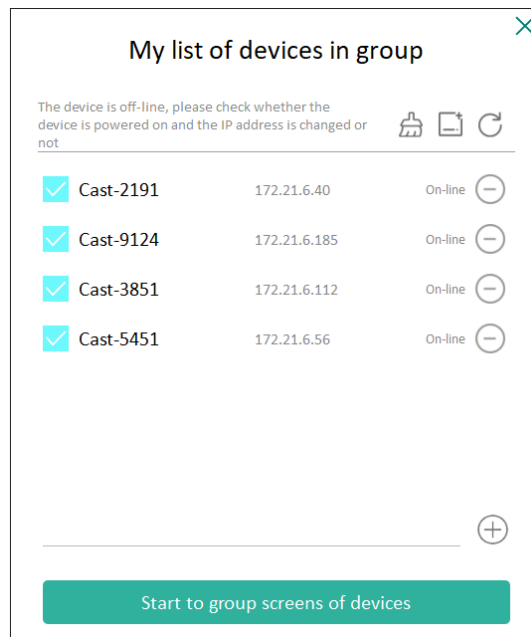

Synchronized Group Screen All the Time

When the “Synchronized group screen all the time” function is toggled ON, it will display a synchronized group screen continuously. If it is toggled OFF, it will work on vCast mirroring only.

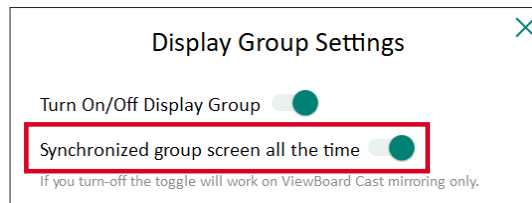

NOTE: Select the devices to group first, then toggle the “Synchronized group screen all the time” function ON to avoid interruption.

Share a Screen to the Display Group (One to Many Casting)

After confirming the above settings, you can share your screen to the main display, then the grouped client devices will be synced up to your screen.



Moderator Mode

Moderator Mode allows the moderator to take control of the devices connected to the ViewBoard or display. To enter Moderator Mode, select the Moderator Mode icon (👤) located in the lower-right corner of the screen.

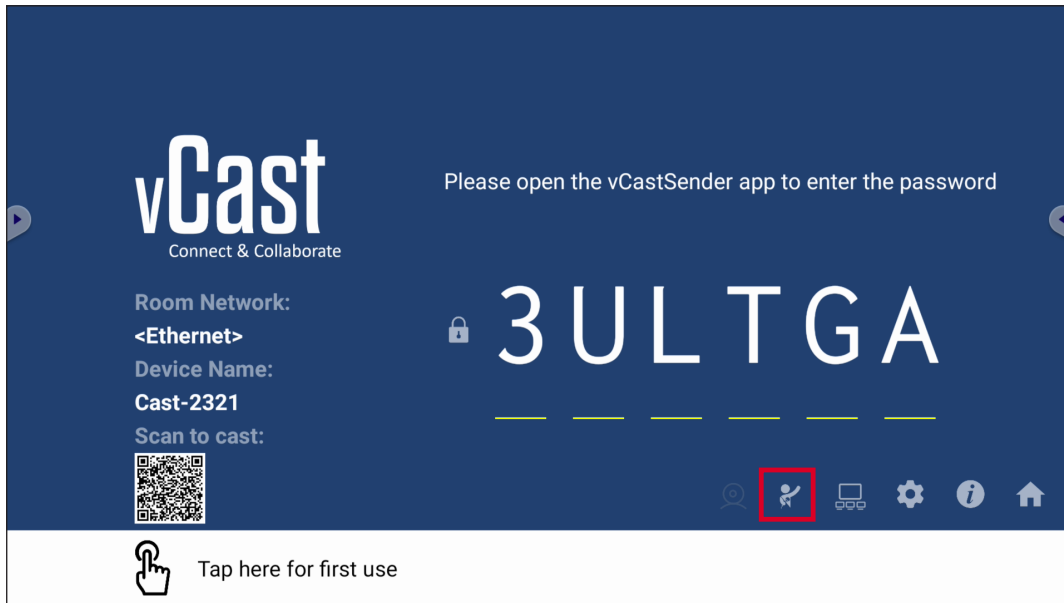

When enabled, the moderator can view a list of all connected screens in the left floating window and can preview each participant's screen and then select any of participant's screen and cast to the ViewBoard's or display's main screen for presentation. The moderator can also control each participant's screen, annotate on the ViewBoard or display, and remove unwanted participants by selecting the close icon (X).

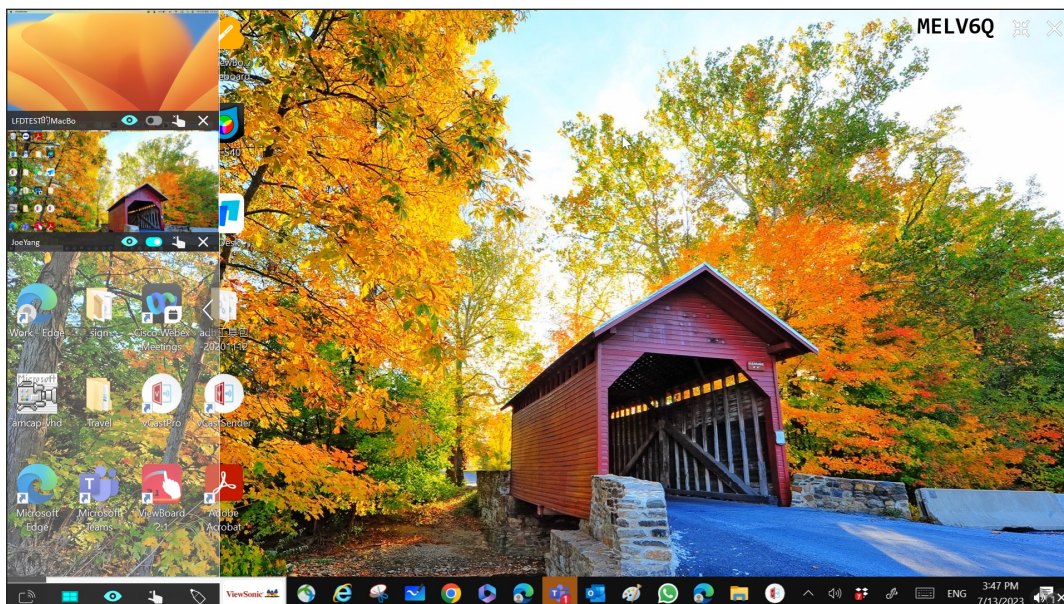

Broadcast

When enabled, the ViewBoard's screen will be broadcasted to all of the participant's connected screens simultaneously. The participants can only view the presentation contents until the moderator disables the Broadcast function.

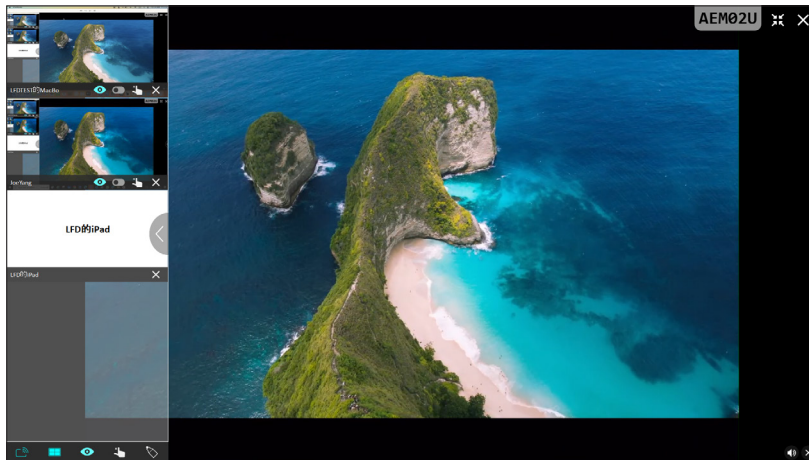

Multiple Screen Sharing

By default, vCast is set to allow multiple screen sharing, but can also be set to single screen sharing. To do this, the moderator can select the Multiple Screen Sharing icon to switch to single screen sharing.

Preview Screen

By default, vCast is set to let the moderator preview the participant's screen contents prior to sharing to the ViewBoard. Selecting the Preview Screen icon, the Moderator can switch to see the participant's name only.

Touch

By default, participants can use touch for collaboration after connecting. The moderator can enable/disable the touch function of a participant by selecting the Touch icon in their window.

NOTE:

- Moderator Mode is supported on all vCastSender and AirPlay devices, but mobile devices are limited to a “preview” function. Additionally, mobile Android devices cannot cast sound out.
- When you cast your Windows/Mac/Chrome screen to a ViewBoard or display, the selected full screen unit will not be broadcasted back to your device to avoid repetitive screen casting.
- The active presenter can touch each of the participant's screens to remotely control casting devices.
- The number of multi-screen presenters on-screen depends on your Windows CPU processor performance and router specifications.

Casting from Windows, MacBook, and Chrome Devices

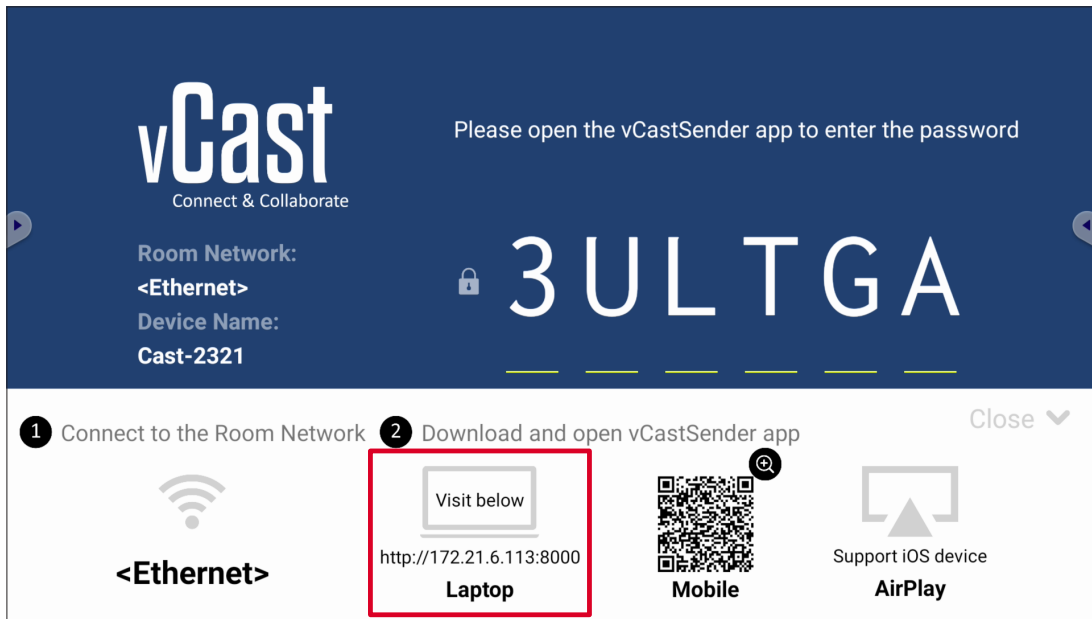

1. Ensure the client device (e.g., laptop) is connected to the same network as the ViewBoard.

NOTE: The network name can be found under **Room Network**.

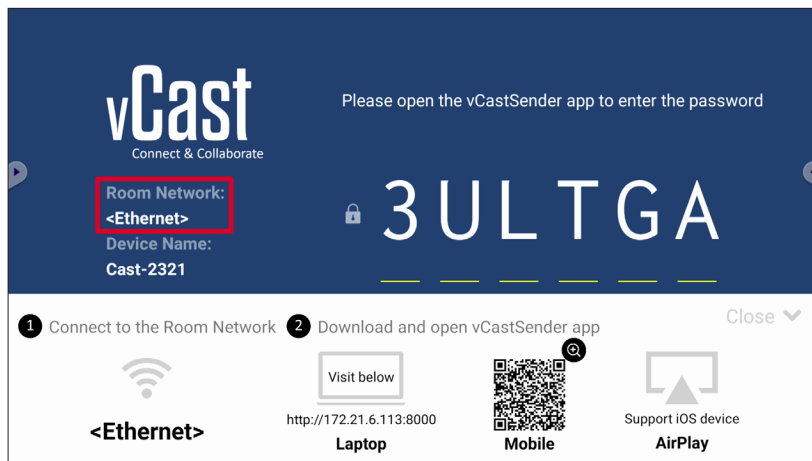

2. On the client device, visit the address that is shown on the ViewBoard to download and install the vCastSender application.

3. After installing, launch the vCastSender application.

4. To connect to the ViewBoard, input the PIN code and click OK.

NOTE: The PIN code can be found as highlighted below:

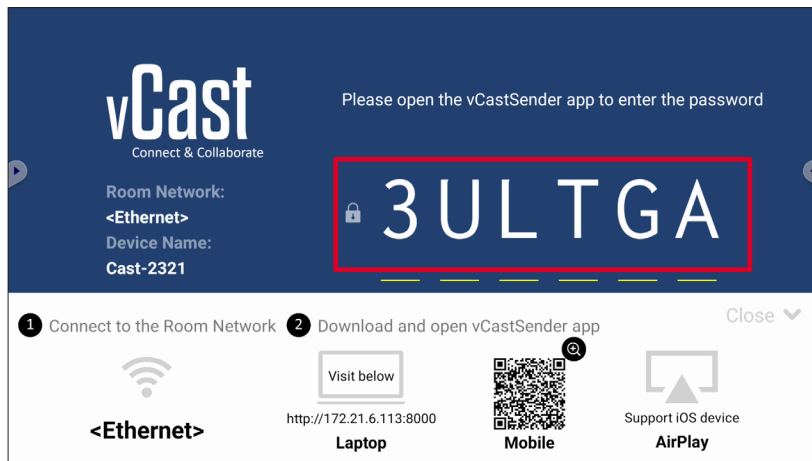

5. Additionally, you can connect to the ViewBoard by clicking **Device List** then the **Device Name** listed.

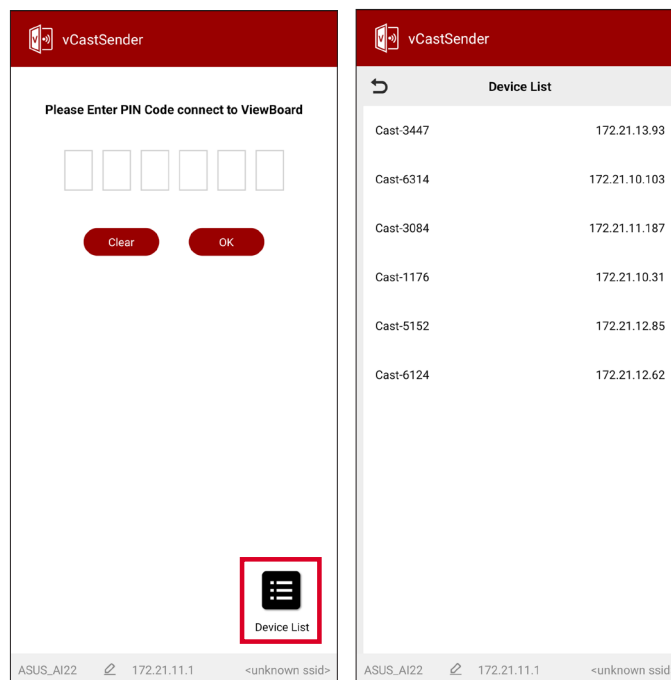

NOTE: The Device Name can be found as highlighted below:

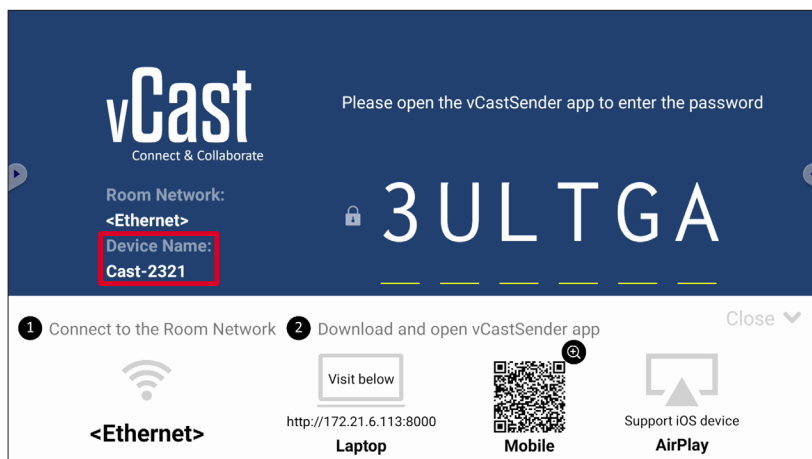

Casting from Android Devices

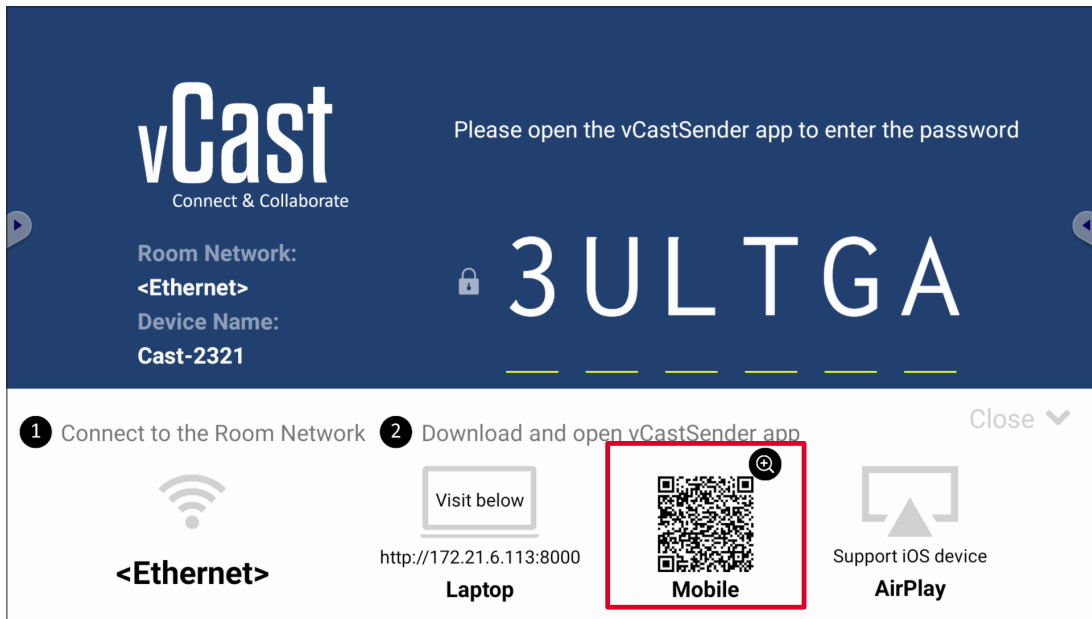

1. Ensure the client device (e.g., Android phone or tablet) is connected to the same network as the ViewBoard.

NOTE: The network name can be found under **Room Network**.

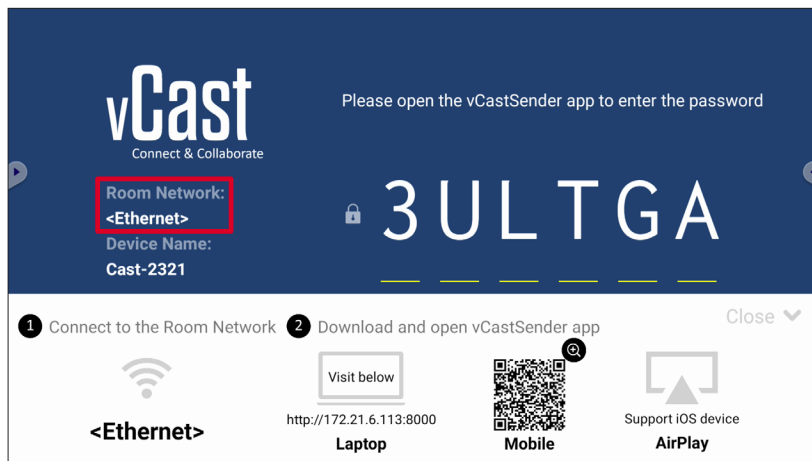

2. On the Android client device, scan the QR code shown on the ViewBoard to directly download the vCastSender application, or download the application from the Google Play Store.

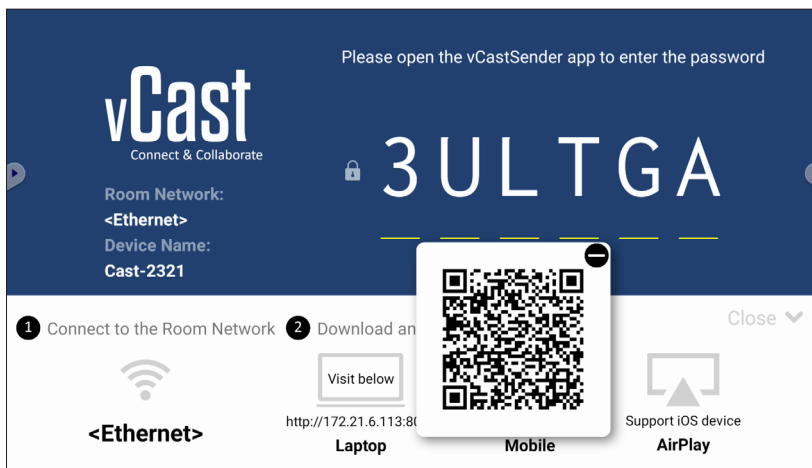

3. After installing, launch the vCastSender application.

4. To connect to the ViewBoard, input the PIN code and select **OK**.

NOTE: The **PIN code** can be found as highlighted below:

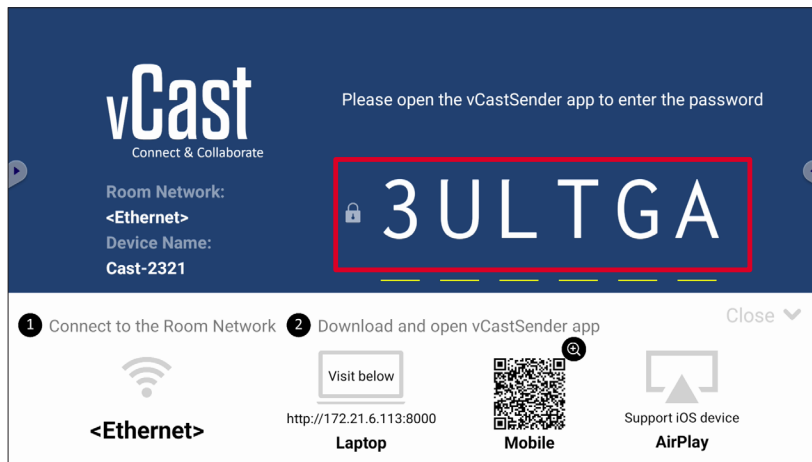

5. You can also connect to the ViewBoard by selecting **Device List** then the **Device Name** listed.

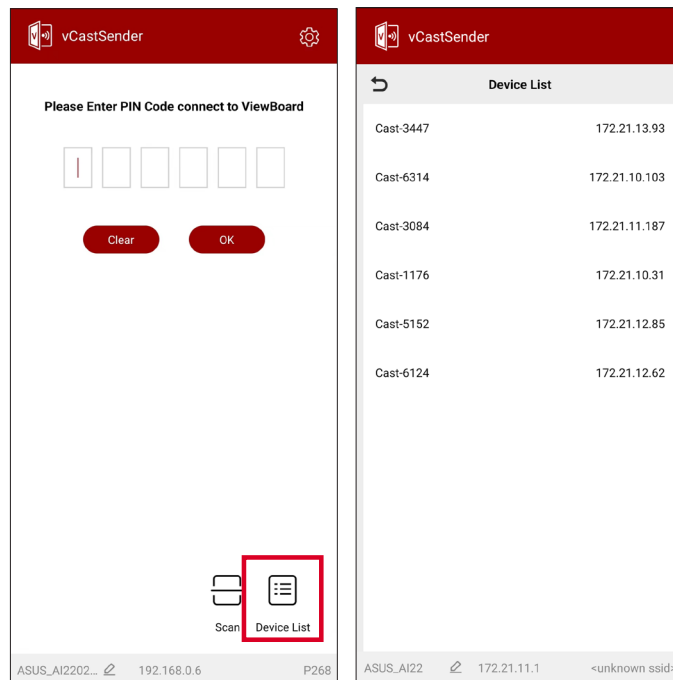

NOTE: The **Device Name** can be found as highlighted below:

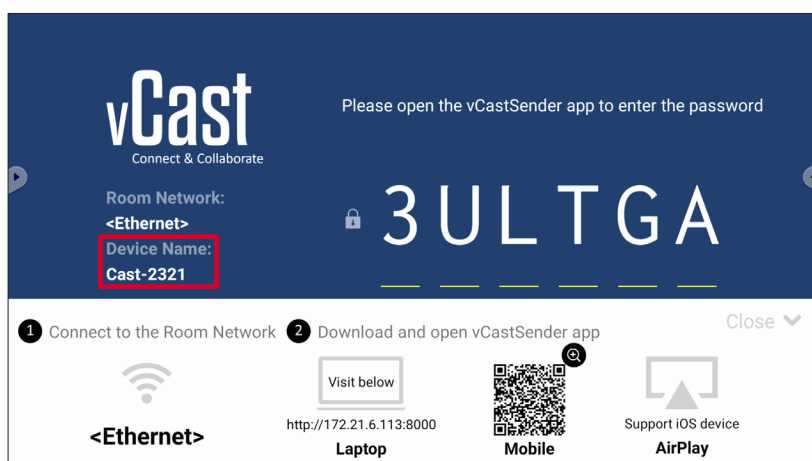

6. Additionally, you can connect to the ViewBoard or by selecting **Scan** then placing the on-screen QR code into the box to automatically connect.

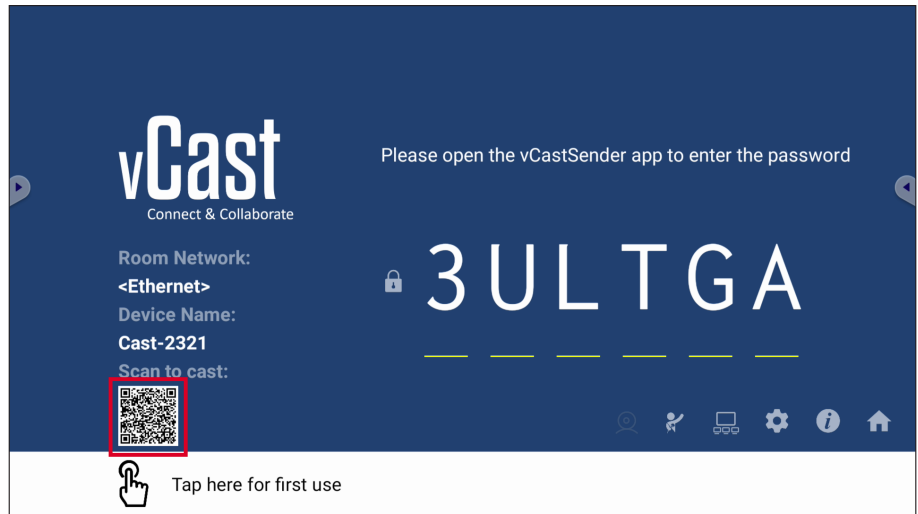
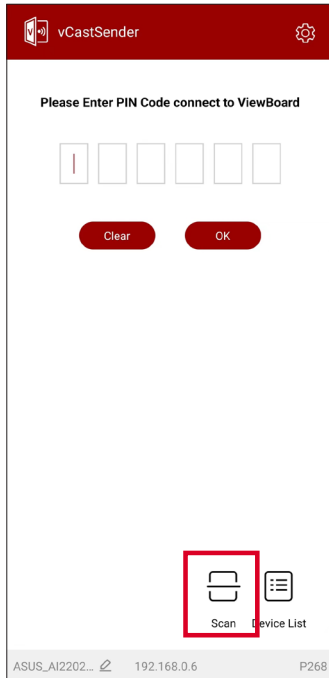

Casting from Apple iOS Devices

Apple AirPlay® is compatible with vCast for screen mirroring and content streaming under the same subnet environment only. An “AirPlay Password” will be generated on-screen for connection when using AirPlay to cast to a ViewBoard.

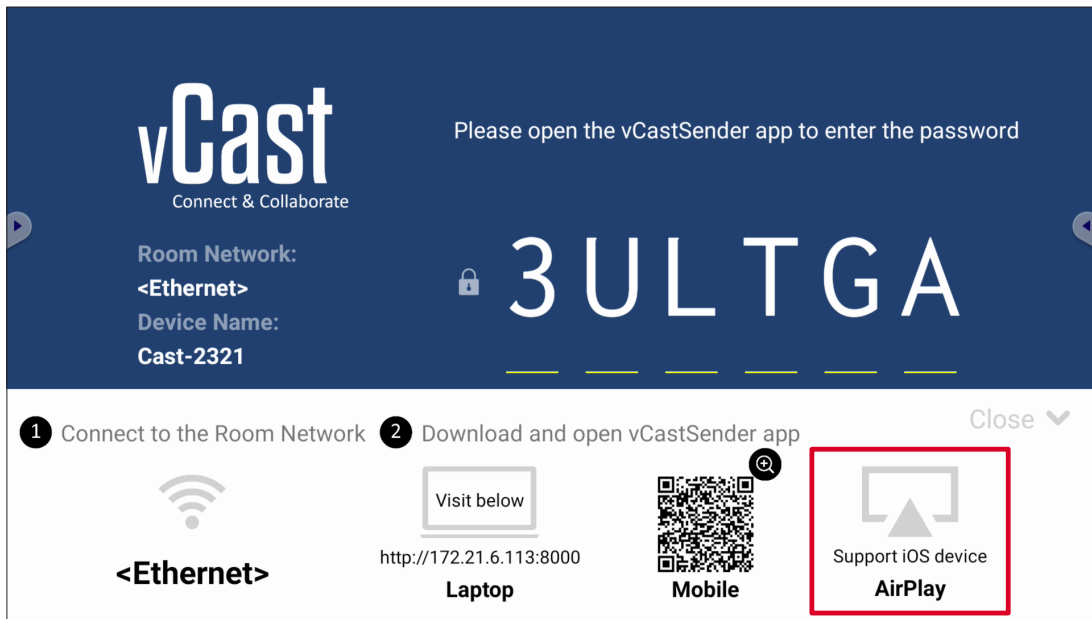

1. Ensure the client device (e.g., iPhone or iPad) is connected to the same network as the ViewBoard.

NOTE: The network name can be found under **Room Network**.

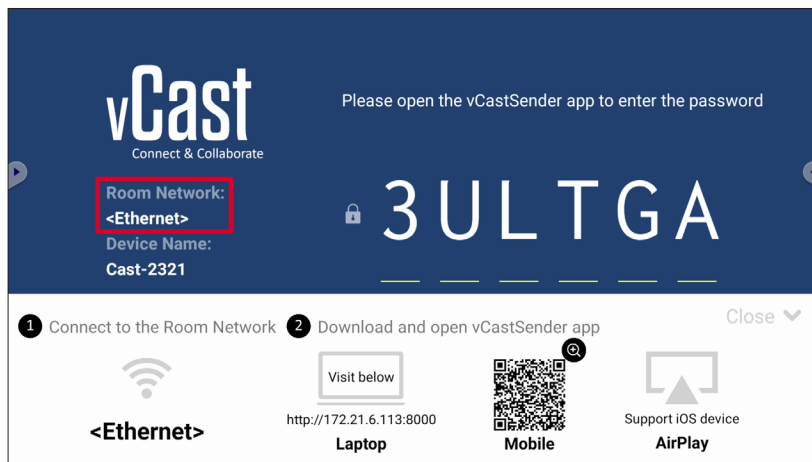

2. On the iOS client device, directly open AirPlay and select the **Device Name** of the ViewBoard to connect.

NOTE: The **Device Name** can be found as highlighted below:

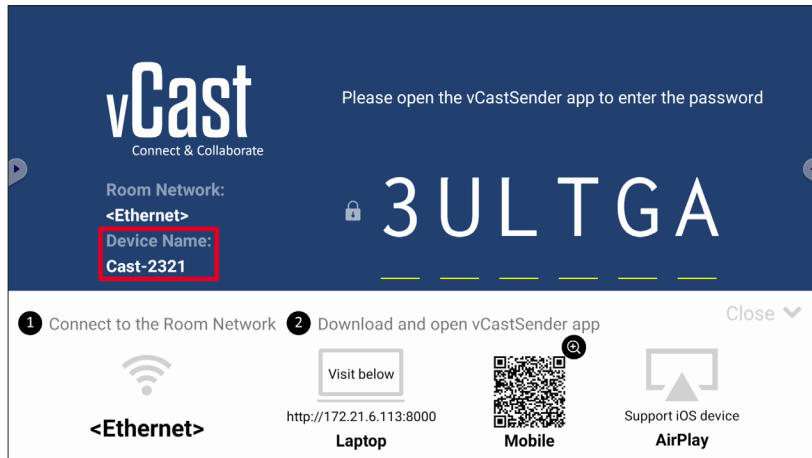

3. Input the generated on-screen **AirPlay Password** on the client device to connect.

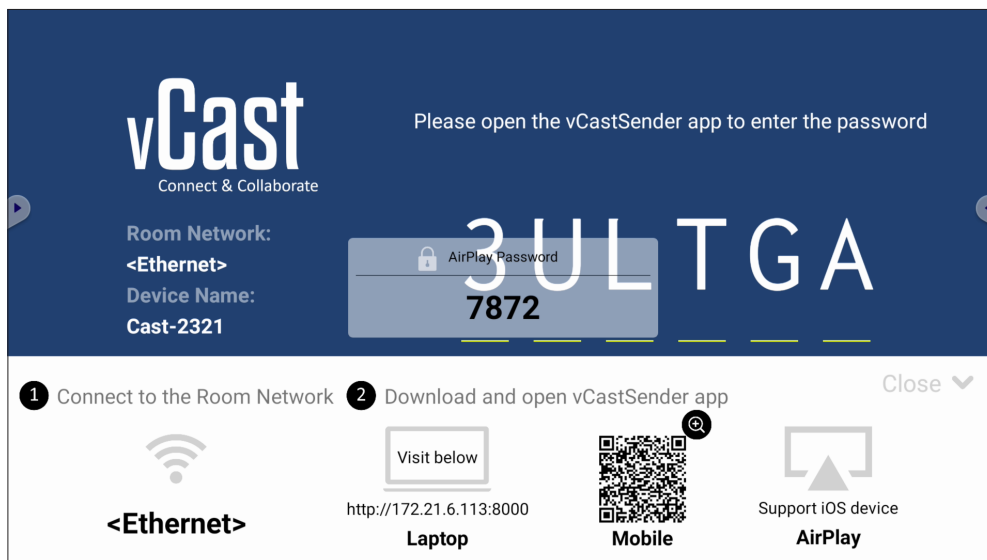

NOTE: In a cross subnet environment, please download and connect with the vCastSender iOS application from the Apple App Store.



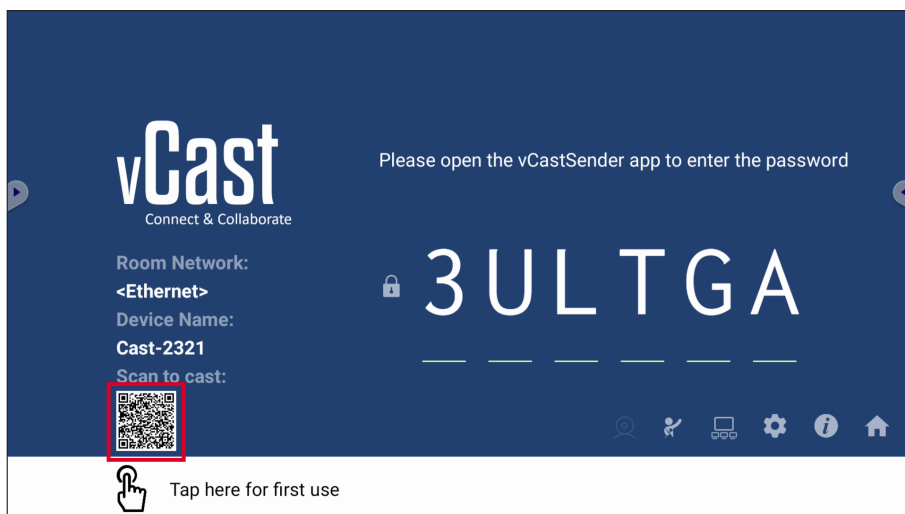
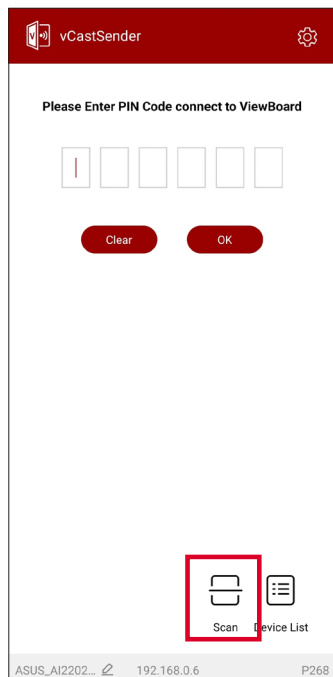



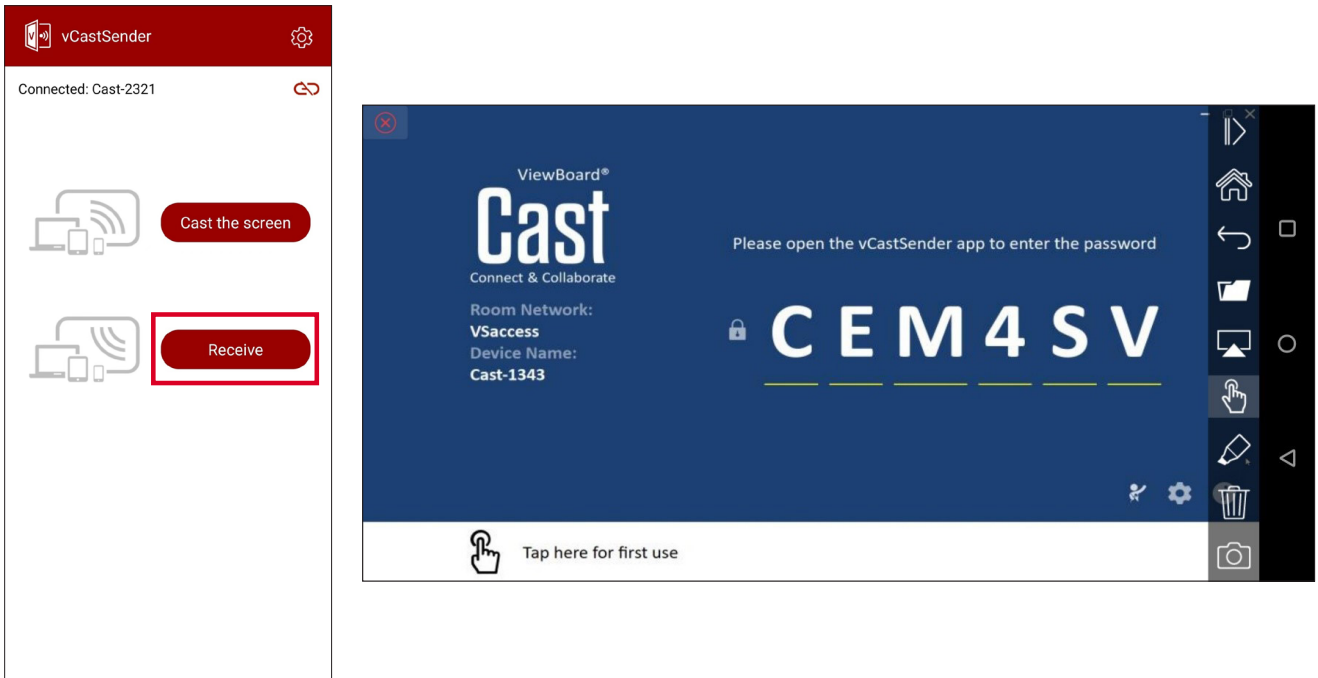

4. You can also connect to the ViewBoard by selecting **Scan** then placing the on-screen QR code into the box to automatically connect.



Connecting to a ViewBoard from a Mobile Device

Once connected, select **Receive**. The ViewBoard will appear on the mobile device with an on-screen toolbar. Users can interact with the ViewBoard with annotations, file sharing, etc.



Item	Description
	Toggle Hide or display the toolbar.
	Home Return to the Home interface.
	Return Return to the previous operation.
	Folder View or open the mobile device's files.
	Share Cast the mobile device's screen to the connected ViewBoard or display.
	Touch Remotely control the connected ViewBoard or display.
	Annotate Make annotations, and adjust the pen color.
	Clear Clear everything on screen.
	Camera Send camera images to the connected ViewBoard or display.

RS-232 Protocol

This document describes the hardware interface spec and software protocols of RS-232 interface communication between ViewSonic LFD and PC or other control units with RS-232 protocol.

The protocol contains three command sections:

- Set-Function
- Get-Function
- Remote control pass-through mode

NOTE: Below, “PC” represents all the control units that can send or receive the RS-232 protocol command.

Description

RS-232 Hardware Specification

ViewSonic LFD communication port on the rear side:

1. Connector type: DSUB 9-Pin Male (or 3.5 mm barrel connector)
2. Use of crossover (null modem) cable for connection
3. Pin Assignment:

Female DSUB 9-Pin

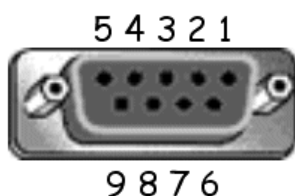

Male DSUB 9-Pin

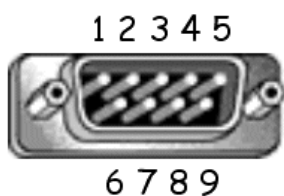

3.5 mm barrel connector (alternative for limited space)



Pin #	Signal	Remark
1	NC	
2	RXD	Input to Display
3	TXD	Output from Display
4	NC	
5	GND	
6	NC	
7	NC	
8	NC	
9	NC	Provide +5V/2A power for external specific dongle *3.0
frame	GND	

Item	Signal	Remark
Tip	TXD	Output from Display
Ring	RXD	Input to Display
Sleeve	GND	

LAN Hardware Specification

ViewSonic LFD communication port on the rear side:

1. Connector type: 8P8C RJ45
2. Pin Assignment:

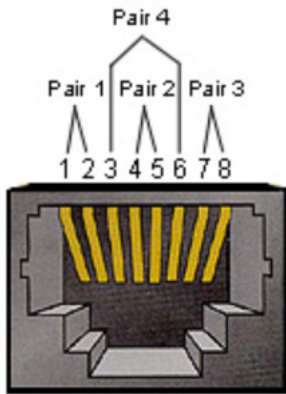

Pin #	Signal	Remark
1	TX+	Output from Display
2	TX-	Output from Display
3	RX+	Input to Display
4	BI_D3+	For 1G case
5	BI_D3-	For 1G case
6	RX-	Input to Display
7	BI_D4+	For 1G case
8	BI_D4-	For 1G case
frame	GND	

RS232 Communication Setting

- Baud Rate Select: 9600bps (fixed)
- Data bits: 8 bits (fixed)
- Parity: None (fixed)
- Stop Bits: 1(fixed)

LAN Communication Setting

- Type: Ethernet
- Protocol: TCP/IP
- Port: 5000 (fixed)
- Cross subnet: No
- Logon Credentials: No

Command Message Reference

PC sends to LFD command packet followed by “CR”. Every time PC sends control command to Display, the Display shall respond as follows:

1. If the message is received correctly it will send “+” (02Bh) followed by “CR” (00Dh)
2. If the message is received incorrectly it will send “-” (02Dh) followed by “CR” (00Dh)

Protocol

Set-Function Listing

The PC can control the Display for specific actions. The Set-Function command allows you to control the Display behavior at a remote site through the RS-232 port. The Set-Function packet format consists of 9 bytes.

Set-Function Description:

- Length:** Total Byte of Message excluding "CR"
- LFD ID** Identification for each of Display (01~98; default is 01)
ID "99" means to apply the set command for all connected displays. Under such circumstances, only ID#1 display has to reply.
The LFD ID can be set via the OSD menu for each Display.
- Command Type** Identify command type,
"s" (0x73h): Set Command
"+" (0x2Bh): Valid command Reply
"- " (0x2Dh): Invalid command Reply
- Command:** Function command code: One byte ASCII code.
- Value[1~3]:** Three bytes ASCII that defines the value.
- CR** 0x0D

Set-Function Format

Send: (Command Type="s")

Name	Length	ID	Command Type	Command	Value1	Value2	Value3	CR
Byte Count	1 Byte	2 Byte	1 Byte	1 Byte	1 Byte	1 Byte	1 Byte	1 Byte
Bytes order	1	2~3	4	5	6	7	8	9

Reply: (Command Type="+" or "-")

Name	Length	ID	Command Type	CR
Byte Count	1 Byte	2 Byte	1 Byte	1 Byte
Bytes order	1	2~3	4	5

NOTE: When PC applies command to all displays (ID=99), only the #1 set needs to reply by the name of ID=1.

Example 1: Set Brightness as 76 for Display (#02) and this command is valid

Send (Hex Format)

Name	Length	ID	Command Type	Command	Value1	Value2	Value3	CR
Hex	0x38	0x30 0x32	0x73	0x24	0x30	0x37	0x36	0x0D

Reply (Hex Format)

Name	Length	ID	Command Type	CR
Hex	0x34	0x30 0x32	0x2B	0x0D

Example 2: Set Brightness as 75 for Display (#02) and this command is NOT valid

Send (Hex Format)

Name	Length	ID	Command Type	Command	Value1	Value2	Value3	CR
Hex	0x38	0x30 0x32	0x73	0x24	0x30	0x37	0x35	0x0D

Reply (Hex Format)

Name	Length	ID	Command Type	CR
Hex	0x34	0x30 0x32	0x2D	0x0D

Set-Function Table

A. Basic Function

Set Function	Length	ID	Command		Value Range	Comments	
			Type (ASCII)	Code (ASCII) Code (Hex)			
Power on/ off (standby)	8		s	!	21	000: STBY 001: ON	1. The Power-on via LAN control may work only under specific mode. To see display UG for details. *3.1.1 2. "WOL by MAC address" may available as alternative.*3.2.1
Input Select	8		s	"	22	000: TV 001: AV 002: S-Video 003: YPbPr 004: HDMI1 014: HDMI2 024: HDMI3 034: HDMI4 005: DVI 006: VGA1 016: VGA2 026: VGA3 007: Slot-in PC (OPS/SDM)/HDBT 008: Internal memory 009: DP 00A: Embedded/ Main (Android)	1. No need for USB 2. For the case of two more same sources, the 2nd digital is used to indicate the extension. 3. The HEX of 00A is 30 30 41.
Brightness	8		s	\$	24	000 ~ 100 900: Bright down (-1) 901: Bright up (+1) *3.1.1	
Backlight*3.2.0	8		A	B	42	000 ~ 100	1. For Android platform whose main mode is controlled by backlight and the other sources are controlled by brightness. 2. Derived from Color calibration. *3.2.0
Power lock	8		s	4	34	000: Unlock 001: Lock	*See note in details
Volume	8		s	5	35	000 ~ 100 900: Volume down(-1) 901:Volume up(+1)	
Mute	8		s	6	36	000: OFF 001: ON (mute)	

Set Function	Length	ID	Command	Command	Value Range	Comments
Button lock	8		s	8	38	000: Unlock 001: Lock *See note in details
Menu lock	8		s	>	3E	000: Unlock 001: Lock *See note in details
Number *3.1.1	8		s	@	40	000~009
Key Pad *3.1.1	8		s	A	41	000: UP 001: DOWN 002: LEFT 003: RIGHT 004: ENTER 005: INPUT 006: MENU/(EXIT) 007: EXIT
Remote Control	8		s	B	42	000: Disable 001: Enable 002: Pass through Disable: RCU will be no function Enabled: RCU controls normally Pass through: Display will bypass the RC code to connected device via the RS232 port, but not react itself.
Restore default	8		s	~	7E	000 Recover to factory setting

NOTE:

1. Behavior at Lock Modes

Lock Mode	Behavior
Button Lock	<ol style="list-style-type: none">1. Lock all buttons on the front panel and RCU, except for "Power"2. All the SET functions should be workable via RS-232, even the ones with according hot key in RCU like Mute,...etc.
MENU Lock	<ol style="list-style-type: none">1. Lock "MENU" key of front panel and RCU2. The Factory and Hospitality modes should not be blocked for the model using MENU-combined key to enter these two modes. Alternative approach will be indicated separately if any limitation by model.
POWER Lock	<ol style="list-style-type: none">1. Lock "POWER" key on the front and RCU.2. The SET_POWER on/off should be workable via RS-232, but does not mean the POWER lock will be released under this case.3. Can not be unlocked by reset in OSD setting4. Will auto AC power-on in power-lock5. Under power-lock, the set will not enter power saving when no PC signal and neither not turn off when no other video signals after 15 minutes.
Remote control disable	Lock the RCU keys, but keep the front panel buttons workable.

2. Wake-on-LAN by MAC address as alternative for SET Power on

(Length=126 Bytes)

6 Bytes	6 Bytes (#1)	6 Bytes (#2)	...	6 Bytes (#16)	24 Bytes
0xFF FF ... FF	MAC address	MAC address	...	MAC address	0x00 00 ... 00

B. Optional Function

Set Function	Length	ID	Command		Value Range (Three ASCII bytes)	Comments
			Type (ASCII)	Code (ASCII) Code (Hex)		
Contrast	8		s	# 23	000 ~ 100	
Sharpness	8		s	% 25	000 ~ 100	
Color	8		s	& 26	000 ~ 100	
Tint	8		s	' 27	000 ~ 100	
Backlight On_Off	8		s	(29	000: Off 001: On	
Color mode	8		s) 29	000: Normal 001: Warm 002: Cold 003: Personal	
Surround sound	8		s	- 2D	000: OFF 001: ON	
Bass	8		s	. 2E	000 ~ 100	
Treble	8		s	/ 2F	000 ~ 100	
Balance	8		s	0 30	000 ~ 100	050 is central
Picture Size	8		s	1 31	000: FULL (16:9) 001: NORMAL (4:3) 002: REAL (1:1) *3.1.0	
OSD language	8		s	2 32	000: English 001: French 002: Spanish	Could be extended for more supported languages by model
PIP-Mode	8		s	9 39	000: OFF 001: PIP(POP) 002: PBP	
PIP-Sound select	8		s	: 3A	000: Main 001: Sub	
PIP-Position	8		s	; 3B	000: Up 001: Down 002: Left 003: Right	
PIP-Input	8		s	7 37 *2.9	000: TV 001: AV 002: S-Video 003: YPbPr 004: HDMI1 014: HDMI2 024: HDMI3 034: HDMI4 005: DVI 006: VGA1 016: VGA2 026: VGA3 007: Slot-in PC (OPS/SDM)/HDBT 008: Internal memory 009: DP 00A: Embedded/Main (Android)	Value range is same as SET-Input select

Set Function	Length	ID	Command	Command	Value Range	Comments
Tiling-Mode	8		s	P	50	000: OFF 001: ON (for video wall)
Tiling-Compensation	8		s	Q	51	000: OFF 001: ON (for video wall) Bezel width compensation
Tiling-H by V Monitors	8		s	R	52	01x~09x: H 0x1~0x9: V (for video wall) 1. 2nd digital for H monitors 2. 3rd digital for V monitors
Tiling-Position	8		s	S	53	001~025 (for Video wall) Copy the screen of Position# to identified display
Date: Year	8		s	V	56	Y17~Y99 Last 2 digits (20)17~(20)99
Date: Month	8		s	V	56	M01~M12 2 digits
Date: Day	8		s	V	56	D01~D31 2 digits
Time: Hour	8		s	W	57	H00~H23 24-hr format. 2 digits.
Time: Min	8		s	W	57	M00~M59 2 digits
Time: Sec	8		s	W	57	S00~S59 2 digits

NOTE:

1. Tiling definition of H Monitors, V Monitors, and Position

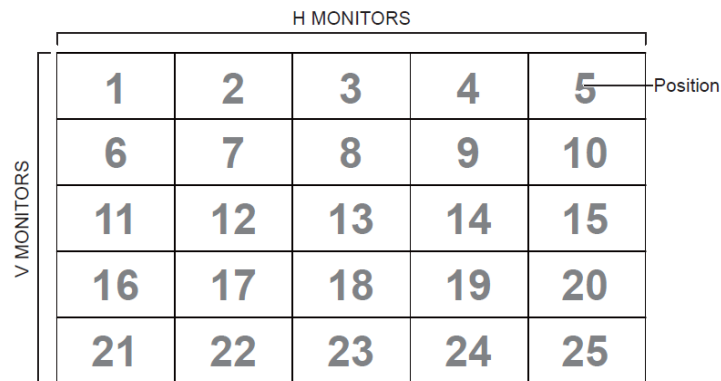

2. Set Date example

Date: 2017-3/15

Send: 0x 38 30 31 73 56 59 31 37 0D ("Y17")

Send: 0x 38 30 31 73 56 4D 30 33 0D ("M03")

Send: 0x 38 30 31 73 56 44 31 35 0D ("D15")

3. Set Time example

Time: 16:27:59

Send: 0x 38 30 31 73 57 48 31 36 0D ("H16")

Send: 0x 38 30 31 73 57 4D 32 37 0D ("M27")

Send: 0x 38 30 31 73 57 53 35 39 0D ("S59")

Get-Function Listing

The PC can interrogate the LFD for specific information. The Get-Function packet format consists of 9 bytes which is similar to the Set-Function packet structure. Note that the “Value” byte is always = 000.

Get-Function Description:

- Length:** Total Byte of Message excluding “CR”.
- TV/DS ID** Identification for each of TV/DS (01~98; default is 01).
- Command Type** Identify command type,
 “g” (0x67h) : Get Command
 “r” (0x72h) : Valid command Reply
 “-” (0x2Dh) : Invalid command Reply
- Command:** Function command code: One byte ASCII code.
- Value[1~3]:** Three bytes ASCII that defines the value.
- CR** 0x0D

Get-Function Format

Send: (Command Type=“g”)

Name	Length	ID	Command Type	Command	Value1	Value2	Value3	CR
Byte Count	1 Byte	2 Byte	1 Byte	1 Byte	1 Byte	1 Byte	1 Byte	1 Byte
Bytes order	1	2~3	4	5	6	7	8	9

Reply: (Command Type=“r” or “-”)

If the Command is valid, Command Type = “r”

Name	Length	ID	Command Type	Command	Value1	Value2	Value3	CR
Byte Count	1 Byte	2 Byte	1 Byte	1 Byte	1 Byte	1 Byte	1 Byte	1 Byte
Bytes order	1	2~3	4	5	6	7	8	9

If the Command is NOT valid, Command Type = “-”

Name	Length	ID	Command Type	CR
Byte Count	1 Byte	2 Byte	1 Byte	1 Byte
Bytes order	1	2~3	4	5

Example 1: Get Brightness from TV-05 and this command is valid. The Brightness value is 67.

Send (Hex Format)

Name	Length	ID	Command Type	Command	Value1	Value2	Value3	CR
Hex	0x38	0x30 0x35	0x67	0x62	0x30	0x30	0x30	0x0D

Reply (Hex Format)

Name	Length	ID	Command Type	Command	Value1	Value2	Value3	CR
Hex	0x38	0x30 0x35	0x72	0x62	0x30	0x36	0x37	0x0D

Example 2: Get Color from Display (#05), but the Color command is not supported by this model.

Send (Hex Format)

Name	Length	ID	Command Type	Command	Value1	Value2	Value3	CR
Hex	0x38	0x30 0x35	0x67	0x26	0x30	0x30	0x30	0x0D

Reply (Hex Format)

Name	Length	ID	Command Type	CR
Hex	0x34	0x30 0x35	0x2D	0x0D

Get-Function Table

A. Basic Function

Get Function	Length	ID	Command		Response Range (Three ASCII bytes)	Comments
			Type (ASCII)	Code (ASCII) Code (Hex)		
Get-Brightness	8		g	b 62	000 ~ 100	
Get-Backlight ^{*3.2.0}	8		a	B 42	000 ~ 100	1. For Android platform whose main mode is controlled by backlight and the other sources are controlled by brightness. 2. Derived from Color calibration. ^{*3.2.0}
Get-Volume	8		g	f 66	000 ~ 100	
Get-Mute	8		g	g 67	000: Off 001: On (muted)	
Get-Input select	8		g	j 6A	000~ 100~	1. 1st digit for signal detection: 0 means "no signal"; 1 means "signal detected" 2. 2nd & 3rd digit: See Set-function table
Get-Power status: ON/ STBY	8		g	l 6C	001: ON 000: STBY	
Get-Remote control	S		g	n 6E	000: Disable 001: Enable 002: Pass through	Get RCU mode status
Get-Power lock	8		g	o 6F	000: Unlock 001: Lock	
Get-Button lock	8		g	p 70	000: Unlock 001: Lock	
Get-Menu lock	8		g	l 6C	000: Unlock 001: Lock	
Get-ACK	8		g	z 7A	000	This command is used to test the communication link
Get-Thermal	8		g	0 30	000~100: 0~+100 deg C -01~-99: -1~-99 deg C	
Get-Operation time ^{*3.2.0}	8		g	1 31	000	1. Accumulated hours in 6-digit integer (000,001~999,999) ^{*3.2.0} 2. Can not be reset when FW update and Factory initiation ^{*3.2.2} 3. Reply in new 32-byte format ^{*3.2.0}
Get-Device name	8		g	4 34	000	Reply in new 32-byte format ^{*3.2.0}

Get Function	Length	ID	Command	Command		Response Range	Comments
Get-MAC address	8		g	5	35	000	(for the model with LAN) Reply in new 32-byte format*3.2.0
Get-IP address *3.2.0	8		g	6	36	000	(for the model with LAN) Reply in new 32-byte format*3.2.0
Get-Serial number *3.2.0	8		g	7	37	000	Reply in new 32-byte format *3.2.0
Get-FW version *3.2.0	8		g	8	38	000	Reply in new 32-byte format *3.2.0

NOTE:

1. Get Operation Hour example

Assumed the accumulated operation hour is 123,456 hrs

Send: 0x 38 30 31 67 31 30 30 30 0D (Get Operation hour)

Reply: 0x 32 30 31 72 31 31 32 33 34 35 36 00 00 ... 00 00 0D

2. Get Device Name example

Assumed the device name is CDE-5500

Send: 0x 38 30 31 67 34 30 30 30 0D (Get Device Name)

Reply: 0x 32 30 31 72 34 43 44 45 2D 35 35 30 30 00 00 ... 00 00 0D

Assumed the device name is "NMP-302#1"

Send: 0x 38 30 31 67 34 30 30 30 0D (Get Device Name)

Reply: 0x 32 30 31 72 34 4E 4D 50 2D 33 30 32 23 31 00 00 ...00 00 0D

3. Get MAC address example

Assumed the MAC address is 00:11:22:aa:bb:cc

Send: 0x 38 30 31 67 35 30 30 30 0D (Get MAC add)

Reply: 0x 32 30 31 72 35 30 30 31 31 32 32 61 61 62 62 63 63 00 00...00 00 0D

4. Get IP address example

Assumed the IP address is 192.168.100.2

Send: 0x 38 30 31 67 36 30 30 30 0D (Get IP address)

Reply: 0x 32 30 31 72 36 31 39 32 2E 31 36 38 2E 31 30 30 2E 32 00 00...00 00 0D

5. Get Serial number example

Assumed the Serial number is ABC180212345

Send: 0x 38 30 31 67 37 30 30 30 0D (Get Serial number)

Reply: 0x 32 30 31 72 37 41 42 43 31 38 30 32 31 32 33 34 35 00 00...00 00 0D

6. Get FW version example

Assumed the FW version is 3.02.001

Send: 0x 38 30 31 67 38 30 30 30 0D (Get FW version)

Reply: 0x 32 30 31 72 38 33 2E 30 32 2E 30 30 31 00 00...00 00 0D

B. Optional Function

Get Function	Length	ID	Command		Response Range (Three ASCII bytes)	Comments
			Type (ASCII)	Code (ASCII) Code (Hex)		
Get-Contrast	8		g	a 61	000 ~ 100	
Get-Sharpness	8		g	c 63	000 ~ 100	
Get-Color	8		g	d 64	000 ~ 100	
Get-Tint	8		g	e 65	000 ~ 100	
Get-Backlight On_Off	8		g	h 68	000: Off 001: On	
Get-PIP mode	8		g	t 74	000: OFF 001: PIP (POP) 002: PBP	
Get-PIP input	8		g	u 75	000 ~	See Set-input select
Get-Tiling Mode	8		g	v 76	000: OFF 001: ON	(for Video wall)
Get-Tiling Compens- ation	8		g	w 77	000: OFF 001: ON	(for Video wall) Bezel width com- pensation
Get-Tiling H by V monitors	8		g	x 78	01x~09x: H monitors 0x1~0x9: V monitors	(for Video wall) 1. 2nd digital for H monitors 2. 3rd digital for V monitors
Get-Tiling position	8		g	y 79	000: OFF 001~025	(for Video wall) Copy the screen of Position# to identi- fied display
Get-Date: Year	8		g	2 32	Y00~Y00	Last 2 digits (20)17~(20)99
Get-Date: Month	8		g	2 32	M00~M00	2 digits
Get-Date: Day	8		g	2 32	D00~M00	2 digits
Get-Time: Hour	8		g	3 33	H00~H00	24-hr format. 2 digits
Get-Time: Min	8		g	3 33	M00~M00	2 digits
Get-Time: Sec	8		g	3 33	S00~S00	2 digits

NOTE:

1. Get Date example

Assumed the current date of display#01 as below:

Date: 2017-3/15

Send: 0x 38 30 31 67 32 59 30 30 0D (Get Date:Year)

Reply: 0x 38 30 31 72 32 59 31 37 0D ("Y17")

Send: 0x 38 30 31 67 32 4D 30 30 0D (Get Date:Month)

Reply: 0x 38 30 31 72 32 4D 30 33 0D ("M03")

Send: 0x 38 30 31 67 32 44 30 30 0D (Get Date:Day)

Reply: 0x 38 30 31 72 32 44 31 35 0D ("D15")

2. Get Time example

Assumed the current time of display#01 as below:

Time: 16:27:59

Send: 0x 38 30 31 67 33 48 30 30 0D (Get Time:Hour)

Reply: 0x 38 30 31 72 33 48 31 36 0D ("H16")

Send: 0x 38 30 31 67 33 4D 30 30 0D (Get Time:Min)

Reply: 0x 38 30 31 72 33 4D 32 37 0D ("M27")

Send: 0x 38 30 31 67 33 53 30 30 0D (Get Time:Sec)

Reply: 0x 38 30 31 72 33 53 35 39 0D ("S59")

3. Get RS232 Version example

Assumed the version is 3.0.1

Send: 0x 38 30 31 67 36 30 30 30 0D (Get RS232 version)

Reply: 0x 38 30 31 72 36 33 30 31 0D ("301")

C. Auto Reply *3.2.1

The display will send out the updated data/status automatically without getting a query from the host whenever the following data/status is changed by the user through any of the available ways like: remote control unit, front keys, or touch screen.

- Power On/Off
- Input Select
- Brightness
- Backlight
- Volume
- Mute On/Off

Remote Control Pass-through Mode

When the PC sets the Display to Remote Control Pass through mode, the Display will send a 7-byte packet (followed by “CR”) in response to remote control unit (RCU) button activation. In this mode the remote control shall have no effect on the Display function. For example: “Volume+” will not change the volume of the Display, but instead only sends the “Volume+” code to the PC over the RS-232 port.

IR Pass Through-Function format

Reply: (Command Type=“p”)

Name	Length	ID	Command Type	RCU Code1 (MSB)	RCU Code2 (LSB)	CR
Byte Count	1 Byte	2 Byte	1 Byte	1 Byte	1 Byte	1 Byte
Bytes order	1	2~3	4	5	6	7

Example 1: Remote Control Pass-through when “VOL+” key is pressed for Display (#5)

Send (Hex Format)

Name	Length	ID	Command Type	RCU Code1 (MSB)	RCU Code2 (LSB)	CR
Hex	0x36	0x30 0x35	0x70	0x31	0x30	0x0D

Key	Code (HEX)	Basic *3.1.1	Optional *3.1.1
1	01	V	
2	02	V	
3	03	V	
4	04	V	
5	05	V	
6	06	V	
7	07	V	
8	08	V	
9	09	V	
0	0A	V	
-	0B		V
RECALL (LAST)	0C		V
INFO (DISPLAY)	0D		V
	0E		
ASPECT (ZOOM, SIZE)	0F		V
VOLUME UP (+)	10	V	

Key	Code (HEX)	Basic *3.1.1	Optional *3.1.1
VOLUME DOWN (-)	11	V	
MUTE	12	V	
CHANNEL/PAGE UP (+)/ BRIGHTNESS+	13		V
CHANNEL/PAGE DOWN (-)/ BRIGHTNESS-	14		V
POWER	15	V	
SOURCES (INPUTS)	16	V	
	17		
	18		
SLEEP	19		V
MENU	1A	V	
UP	1B	V	
DOWN	1C	V	
LEFT (-)	1D	V	
RIGHT (+)	1E	V	
OK (ENTER, SET)	1F	V	
EXIT	20	V	
	21		
	22		
	23		
	24		
	25		
	26		
	27		
	28		
	29		
	2A		
	2B		
RED ■ (F1)	2C		
GREEN ■ (F2)	2D		
YELLOW ■ (F3)	2E		
BLUE ■ (F4)	2F		

NOTE:

1. This IR-pass-through code is different from the RCU key code.
2. Special control sequence for POWER key under IR-pass through mode.
 - 2-1. When Display is OFF and receives the IR POWER code: Display will turn itself on, then forward the POWER code to the host via RS-232.
 - 2-2. When Display is ON and receives the IR POWER code: Display will forward the POWER code to the host via RS-232, then turn off itself.
 - 2-3. When SET-POWER LOCK is enabled, the Display will not respond to POWER key pressing.
3. The VOLUME UP and VOLUME DOWN code will repeatedly output when you press and hold the keys.

Appendix

Specifications

Item	Category	Specifications		
Model	P/N	IFP6552-2/2F/2ED	IFP7552-2/2F/2ED	IFP8652-2/2F/2ED
	No.	VS19364	VS19365	VS19366
Screen	Size	64.5"	74.6"	85.6"
	Display Area (mm)	1428.48(H) x 803.52(V)	1650.24(H) x 928.94(V)	1895.04(H) x 1065.96(V)
	Surface Treatment	Anti-Glare (Haze 25%), Hard Coating (3H)		
	Brightness	350 nits (Typical)		
	Native Resolution	3840 x 2160 (UHD)		
Input Signal		3 x HDMI (HDMI 1: v. 2.1, CEC, ARC; HDMI 2 & 3: v. 2.0, CEC)		
		1 x DP (v. 1.2)		
		1 x VGA		
		1 x Audio In (3.5 mm)		
		1 x RS-232		
		3 x USB Type C (Type C 1: DP v. 1.2, PD 100W, Touch; Type C 2: DP v.1.2, 65W PD, Touch, 100M Ethernet; Type C 3: USB 3.0)		
		1 x USB Type A (2.0) (Microphone for external device use)		
		4 x USB Type A (3.0)		
		3 x USB Type B (3.0)		
		2 x RJ45		
Output Signal		1 x HDMI (v. 2.1)		
		1 x Audio Out (3.5 mm)		
		1 x SPDIF		
Network	LAN	10M/100M/1000M (for ViewBoard) 10M/100M/1000M (for Slot-in PC)		
	Wi-Fi	1 x Wi-Fi Slot (VB-WIFI-001, VB-WIFI-005)		
PC Slot		1 x 80-pin OPS		
Speaker Output		15W x 2, 15W Subwoofer x 1		
RS-232		RS-232 Communication		
Power	Voltage	100V-240V AC 50/60Hz		
Operating Conditions	Temperature	32° F to 104° F (0° C to 40° C)		
	Humidity	20%~80% non-condensing		
	Altitude	≤ 5,000 m		

Item	Category	Specifications		
Storage Conditions	Temperature	14° F to 140° F (-10° C to 60° C)		
	Humidity	10%~80% non-condensing		
	Altitude	≤ 5,000 m		
Dimensions	Physical (mm)	1502.7 x 948.7 x 122.2	1725 x 1074 x 121.4	1971.2 x 1212.5 x 121.3
	Physical (in)	59.2" x 37.3" x 4.8"	67.9" x 42.3" x 4.8"	77.6" x 47.7" x 4.8"
Weight	Physical (kg)	43 kg	55 kg	70 kg
	Physical (lbs)	94.8 lbs	121.3 lbs	154.3 lbs
Power Consumption	On (Typical)	91.41W	124.06W	148.12W
	Off	< 0.5W	< 0.5W	< 0.5W

NOTE: Product specifications are subject to change without notice.

Display Modes

DisplayPort

Resolution	Refresh Rate (@)
640 x 480	60, 67, 72 Hz
800 x 600	56, 60, 72, 75 Hz
832 x 624	75 Hz
1024 x 768	60, 70, 75 Hz
1152 x 864	75 Hz
1152 x 870	75 Hz
1280 x 720	60 Hz
1280 x 960	60 Hz
1280 x 1024	60, 75 Hz
1360 x 768	60, 85 Hz
1366 x 768	60 Hz
1440 x 900	60 Hz
1600 x 1200	60 Hz
1680 x 1050	60 Hz
1920 x 1080	60 Hz
1920 x 1200	60 Hz
3840 x 2160	25, 30, 50, 60 Hz

HDMI

Resolution	Refresh Rate (@)
640 x 480	60, 67, 72, 75 Hz
800 x 600	56, 60, 72, 75 Hz
832 x 624	75 Hz
1024 x 768	60, 70, 75 Hz
1152 x 864	75 Hz
1152 x 870	75 Hz
1280 x 720	60 Hz
1280 x 960	60 Hz
1280 x 1024	60, 75 Hz
1360 x 768	60, 85 Hz
1366 x 768	60 Hz
1440 x 900	60 Hz
1600 x 1200	60 Hz
1680 x 1050	60 Hz
1920 x 1080	60 Hz
1920 x 1200	60 Hz
3840 x 2160	25, 30, 50, 60 Hz

USB Type C

Resolution	Refresh Rate (@)
640 x 480	60, 67, 72 Hz
800 x 600	56, 60, 72, 75 Hz
832 x 624	75 Hz
1024 x 768	60, 70, 75 Hz
1152 x 864	75 Hz
1152 x 870	75 Hz
1280 x 720	60 Hz
1280 x 960	60 Hz
1280 x 1024	60, 75 Hz
1360 x 768	60, 85 Hz
1366 x 768	60 Hz
1440 x 900	60 Hz
1600 x 1200	60 Hz
1680 x 1050	60 Hz
1920 x 1080	60 Hz
1920 x 1200	60 Hz
3840 x 2160	25, 30, 50, 60 Hz

VGA

Resolution	Refresh Rate (@)
640 x 480	60, 67, 72 Hz
800 x 600	56, 60, 72, 75 Hz
832 x 624	75 Hz
1024 x 768	60, 70, 75 Hz
1152 x 864	75 Hz
1152 x 870	75 Hz
1280 x 720	60 Hz
1280 x 960	60 Hz
1280 x 1024	60, 75 Hz
1360 x 768	60, 85 Hz
1366 x 768	60 Hz
1440 x 900	60 Hz
1600 x 1200	60 Hz
1680 x 1050	60 Hz
1920 x 1080	60 Hz
1920 x 1200	60 Hz

HDMI Out

Resolution	Refresh Rate (@)
720 x 480	60 Hz
1920 x 1080	60 Hz
3840 x 2160	60 Hz

Troubleshooting

This section describes some common problems that you may experience when using the ViewBoard.

Problem or Issue	Possible Solutions
Remote Control is not working	<ol style="list-style-type: none">1. Check whether something is obstructing the display's remote control receiver.2. Check whether the batteries in the remote control are installed correctly.3. Check whether the batteries need to be replaced.
The unit turns off unexpectedly	<ol style="list-style-type: none">1. Check whether Sleep mode is enabled.2. Check if there is a power outage in your area.3. Turn on the display and see if the problem is with the signal and control system.

PC Mode

Problem or Issue	Possible Solutions
No PC signal	<ol style="list-style-type: none">1. Check the display settings.2. Check the display resolution.3. Adjust the Hs & Vs (synchronization) settings using the OSD menu.
Background streaking	<ol style="list-style-type: none">1. Choose auto adjust.2. Adjust clock and phase.
Unsupported format	<ol style="list-style-type: none">1. Choose auto adjust.2. Adjust clock and phase settings.

Touch Function

Problem or Issue	Possible Solutions
Touch function does not work	<ol style="list-style-type: none">1. Check that drivers are installed correctly.2. Reinstall driver(s).3. Check setup and align it.4. Check whether the touch pen is working properly.

Video Not Working Properly

Problem or Issue	Possible Solutions
No picture/ No sound	<ol style="list-style-type: none">1. Check the Power status.2. Check the signal cable.3. Check that the internal PC is installed correctly.
Picture is unclear or cuts in and out	<ol style="list-style-type: none">1. Check the signal cable.2. Check if other electronics are interrupting the signal.
Poor picture	<ol style="list-style-type: none">1. Adjust chroma, brightness, and contrast settings in the menu.2. Check the signal cable.

Audio Not Working Properly

Problem or Issue	Possible Solutions
No sound	<ol style="list-style-type: none">1. Press the Mute/Unmute button.2. Adjust the volume.3. Check the audio cable.
One speaker only	<ol style="list-style-type: none">1. Adjust the sound balance in the menu.2. Check the sound control panel settings of the computer.3. Check the audio cable.

Maintenance

General Precautions

- Make sure the device is turned off and the power cable is unplugged from the power outlet.
- Never spray or pour any liquid directly onto the screen or case.
- Handle the device with care, as a darker-colored device, if scuffed, may show marks more clearly than a lighter-colored device.
- Do not use the system continuously for long periods of time.

Cleaning the Screen

- Wipe the screen with a clean, soft, lint-free cloth. This removes dust and other particles.
- If the screen is still not clean, apply a small amount of non-ammonia, non-alcohol based glass cleaner onto a clean, soft, lint-free cloth; then wipe the screen.

Cleaning the Case

- Use a soft, dry cloth.
- If the case is still not clean, apply a small amount of non-ammonia, non-alcohol based, mild non-abrasive detergent onto a clean, soft, lint-free cloth, then wipe the surface.

Disclaimer

- ViewSonic® does not recommend the use of any ammonia or alcohol-based cleaners on the display screen or case. Some chemical cleaners have been reported to damage the screen and/or case of the device.
- ViewSonic® will not be liable for damage resulting from use of any ammonia or alcohol-based cleaners.

NOTE: If condensation appears between the glass and the panel, keep the display turned on until the moisture disappears.

Regulatory and Service Information

Compliance Information

This section addresses all connected requirements and statements regarding regulations. Confirmed corresponding applications shall refer to nameplate labels and relevant markings on the unit.

FCC Compliance Statement

This device complies with part 15 of FCC Rules. Operation is subject to the following two conditions: (1) this device may not cause harmful interference, and (2) this device must accept any interference received, including interference that may cause undesired operation. This equipment has been tested and found to comply with the limits for a Class B digital device, pursuant to part 15 of the FCC Rules.

These limits are designed to provide reasonable protection against harmful interference in a residential installation. This equipment generates, uses, and can radiate radio frequency energy, and if not installed and used in accordance with the instructions, may cause harmful interference to radio communications. However, there is no guarantee that interference will not occur in a particular installation. If this equipment does cause harmful interference to radio or television reception, which can be determined by turning the equipment off and on, the user is encouraged to try to correct the interference by one or more of the following measures:

- Reorient or relocate the receiving antenna.
- Increase the separation between the equipment and receiver.
- Connect the equipment into an outlet on a circuit different from that to which the receiver is connected.
- Consult the dealer or an experienced radio/TV technician for help.

Warning: You are cautioned that changes or modifications not expressly approved by the party responsible for compliance could void your authority to operate the equipment.

Industry Canada Statement

CAN ICES-003(B) / NMB-003(B)

CE Conformity for European Countries



The device complies with the EMC Directive 2014/30/EU and Low Voltage Directive 2014/35/EU.

The following information is only for EU-member states:

The mark shown to the right is in compliance with the Waste Electrical and Electronic Equipment Directive 2012/19/EU (WEEE). The mark indicates the requirement NOT to dispose of the equipment as unsorted municipal waste, but use the return and collection systems according to local law.



Declaration of RoHS2 Compliance

This product has been designed and manufactured in compliance with Directive 2011/65/EU of the European Parliament and the Council on restriction of the use of certain hazardous substances in electrical and electronic equipment (RoHS2 Directive) and is deemed to comply with the maximum concentration values issued by the European Technical Adaptation Committee (TAC) as shown below:

Substance	Proposed Maximum Concentration	Actual Concentration
Lead (Pb)	0.1%	< 0.1%
Mercury (Hg)	0.1%	< 0.1%
Cadmium (Cd)	0.01%	< 0.01%
Hexavalent Chromium (Cr6 ⁺)	0.1%	< 0.1%
Polybrominated biphenyls (PBB)	0.1%	< 0.1%
Polybrominated diphenyl ethers (PBDE)	0.1%	< 0.1%
Bis (2-ethylhexyl) phthalate (DEHP)	0.1%	< 0.1%
Butyl benzyl phthalate (BBP)	0.1%	< 0.1%
Dibutyl phthalate (DBP)	0.1%	< 0.1%
Diisobutyl phthalate (DIBP)	0.1%	< 0.1%

Certain components of products as stated above are exempted under the Annex III of the RoHS2 Directives as noted below:

- Copper alloy containing up to 4% lead by weight.
- Lead in high melting temperature type solders (i.e. lead-based alloys containing 85% by weight or more lead).
- Electrical and electronic components containing lead in a glass or ceramic other than dielectric ceramic in capacitors, e.g. piezoelectronic devices, or in a glass or ceramic matrix compound.
- Lead in dielectric ceramic in capacitors for a rated voltage of 125V AC or 250V DC or higher.

ENERGY STAR Statement

ENERGY STAR is a U.S. Environmental Protection Agency voluntary program that helps businesses and individuals save money and protect our climate through superior energy efficiency. Products that earn the ENERGY STAR prevent greenhouse gas emissions by meeting strict energy efficiency criteria or requirements set by the U.S. Environmental Protection Agency.

As an ENERGY STAR Partner, ViewSonic is determined to meet the Energy star Guidelines and mark all certified models with the ENERGY STAR logo.

The following logo appears on all ENERGY STAR-certified models:



NOTE: The power management features significantly reduce energy consumption when the product is not in use. Power management allows the device to automatically enter a low power “sleep” mode after a defined period of inactivity. And the power management features also enter Sleep Mode or Off Mode within 5 minutes of being disconnected from a host computer. Please note any change in energy settings will increase energy consumption.

Indian Restriction of Hazardous Substances

Restriction on Hazardous Substances statement (India). This product complies with the “India E-waste Rule 2011” and prohibits use of lead, mercury, hexavalent chromium, polybrominated biphenyls or polybrominated diphenyl ethers in concentrations exceeding 0.1 weight % and 0.01 weight % for cadmium, except for the exemptions set in Schedule 2 of the Rule.

Product Disposal at End of Product Life

ViewSonic® respects the environment and is committed to working and living green. Thank you for being part of Smarter, Greener Computing. Please visit the ViewSonic® website to learn more.

USA & Canada:

<https://www.viewsonic.com/us/go-green-with-viewsonic>

Europe:

<https://www.viewsonic.com/eu/go-green-with-viewsonic>

Taiwan:

<https://recycle.epa.gov.tw/>

Copyright Information

Copyright© ViewSonic® Corporation, 2023. All rights reserved.

Macintosh and Power Macintosh are registered trademarks of Apple Inc.

Microsoft, Windows, and the Windows logo are registered trademarks of Microsoft Corporation in the United States and other countries.

ViewSonic® and the three birds logo are registered trademarks of ViewSonic® Corporation.

VESA is a registered trademark of the Video Electronics Standards Association. DPMS, DisplayPort, and DDC are trademarks of VESA.

ENERGY STAR® is a registered trademark of the U.S. Environmental Protection Agency (EPA).

As an ENERGY STAR® partner, ViewSonic® Corporation has determined that this product meets the ENERGY STAR® guidelines for energy efficiency.

Disclaimer: ViewSonic® Corporation shall not be liable for technical or editorial errors or omissions contained herein; nor for incidental or consequential damages resulting from furnishing this material, or the performance or use of this product.

In the interest of continuing product improvement, ViewSonic® Corporation reserves the right to change product specifications without notice. Information in this document may change without notice.

No part of this document may be copied, reproduced, or transmitted by any means, for any purpose without prior written permission from ViewSonic® Corporation.

Customer Service

For technical support or product service, see the table below or contact your reseller.

NOTE: You will need the product's serial number.

Country/ Region	Website	Country/ Region	Website
Asia Pacific & Africa			
Australia	www.viewsonic.com/au/	Bangladesh	www.viewsonic.com/bd/
中国 (China)	www.viewsonic.com.cn	香港 (繁體中文)	www.viewsonic.com/hk/
Hong Kong (English)	www.viewsonic.com/hk-en/	India	www.viewsonic.com/in/
Indonesia	www.viewsonic.com/id/	Israel	www.viewsonic.com/il/
日本 (Japan)	www.viewsonic.com/jp/	Korea	www.viewsonic.com/kr/
Malaysia	www.viewsonic.com/my/	Middle East	www.viewsonic.com/me/
Myanmar	www.viewsonic.com/mm/	Nepal	www.viewsonic.com/np/
New Zealand	www.viewsonic.com/nz/	Pakistan	www.viewsonic.com/pk/
Philippines	www.viewsonic.com/ph/	Singapore	www.viewsonic.com/sg/
臺灣 (Taiwan)	www.viewsonic.com/tw/	ประเทศไทย	www.viewsonic.com/th/
Việt Nam	www.viewsonic.com/vn/	South Africa & Mauritius	www.viewsonic.com/za/
Americas			
United States	www.viewsonic.com/us	Canada	www.viewsonic.com/us
Latin America	www.viewsonic.com/la		
Europe			
Europe	www.viewsonic.com/eu/	France	www.viewsonic.com/fr/
Deutschland	www.viewsonic.com/de/	Қазақстан	www.viewsonic.com/kz/
Россия	www.viewsonic.com/ru/	España	www.viewsonic.com/es/
Türkiye	www.viewsonic.com/tr/	Україна	www.viewsonic.com/ua/
United Kingdom	www.viewsonic.com/uk/		

Limited Warranty

ViewSonic® Smart White Board

What the warranty covers:

ViewSonic® warrants its products to be free from defects in material and workmanship during the warranty period. If a product proves to be defective in material or workmanship during the warranty period, ViewSonic® will, at its sole option, and as your sole remedy, repair or replace the product with a similar product. Replacement Product or parts may include remanufactured or refurbished parts or components. The repair or replacement unit or parts or components will be covered by the balance of the time remaining on the customer's original limited warranty and the warranty period will not be extended. ViewSonic® provides no warranty for any third-party software whether included with the product or installed by the customer, installation of any unauthorized hardware parts or components (e.g. Projector Lamps). (Please refer to: "What the warranty excludes and does not cover" section).

Who the warranty protects:

This warranty is valid only for the first consumer purchaser.

What the warranty excludes and does not cover:

- Any product on which the serial number has been defaced, modified, or removed.
- Damage, deterioration, or malfunction resulting from:
 - » Accident, misuse, neglect, fire, water, lightning, or other acts of nature, unauthorized product modification, or failure to follow instructions supplied with the product.
 - » Repair or attempted repair by anyone not authorized by ViewSonic®.
 - » Damage to or loss of any programs, data, or removable storage media.
 - » Normal wear and tear.
 - » Removal or installation of the product.
- Software or data loss occurring during repair or replacement.
- Any damage of the product due to shipment.
- Causes external to the product, such as electric power fluctuations or failure.
- Use of supplies or parts not meeting ViewSonic's specifications.
- Failure of owner to perform periodic product maintenance as stated in the User Guide.

- Any other cause which does not relate to a product defect.
- Damage caused by static (non-moving) images displayed for lengthy periods of time (also referred to as image burn-in).
- Software - Any third-party software included with the product or installed by the customer.
- Hardware/Accessories/Parts/Components – Installation of any unauthorized hardware, accessories, consumable parts or components (e.g. Projector Lamps).
- Damage to, or abuse of, the coating on the surface of the display through inappropriate cleaning as described in the product User Guide.
- Removal, installation, and set-up service charges, including wall-mounting of the product.

How to get service:

- For information about receiving service under warranty, contact ViewSonic® Customer Support (Please refer to the “Customer Service” page). You will need to provide your product’s serial number.
- To obtain warranty service, you will be required to provide: (a) the original dated sales slip, (b) your name, (c) your address, (d) a description of the problem, and (e) the serial number of the product.
- Take or ship the product, freight prepaid, in the original container to an authorized ViewSonic® service center or ViewSonic®.
- For additional information or the name of the nearest ViewSonic® service center, contact ViewSonic®.

Limitation of implied warranties:

There are no warranties, express or implied, which extend beyond the description contained herein including the implied warranty of merchantability and fitness for a particular purpose.

Exclusion of damages:

ViewSonic's liability is limited to the cost of repair or replacement of the product. ViewSonic® shall not be liable for:

- Damage to other property caused by any defects in the product, damages based upon inconvenience, loss of use of the product, loss of time, loss of profits, loss of business opportunity, loss of goodwill, interference with business relationships, or other commercial loss, even if advised of the possibility of such damages.
- Any other damages, whether incidental, consequential or otherwise.
- Any claim against the customer by any other party.
- Repair or attempted repair by anyone not authorized by ViewSonic®.

Effect of state law:

This warranty gives you specific legal rights, and you may also have other rights which vary from state to state. Some states do not allow limitations on implied warranties and/or do not allow the exclusion of incidental or consequential damages, so the above limitations and exclusions may not apply to you.

Sales outside the U.S.A. and Canada:

For warranty information and service on ViewSonic® products sold outside of the U.S.A. and Canada, contact ViewSonic® or your local ViewSonic® dealer.

The warranty period for this product in mainland China (Hong Kong, Macao, and Taiwan Excluded) is subject to the terms and conditions of the Maintenance Guarantee Card.

For users in Europe and Russia, full details of warranty provided can be found at: <http://www.viewsonic.com/eu/> under "Support/Warranty Information".

Mexico Limited Warranty

ViewSonic® Smart White Board

What the warranty covers:

ViewSonic® warrants its products to be free from defects in material and workmanship, under normal use, during the warranty period. If a product proves to be defective in material or workmanship during the warranty period, ViewSonic® will, at its sole option, repair or replace the product with a like product. Replacement product or parts may include remanufactured or refurbished parts or components & accessories.

Who the warranty protects:

This warranty is valid only for the first consumer purchaser.

What the warranty excludes and does not cover:

- Any product on which the serial number has been defaced, modified or removed.
- Damage, deterioration, or malfunction resulting from:
 - » Accident, misuse, neglect, fire, water, lightning, or other acts of nature, unauthorized product modification, unauthorized attempted repair, or failure to follow instructions supplied with the product.
 - » Causes external to the product, such as electrical power fluctuations or failure.
 - » Use of supplies or parts not meeting ViewSonic®'s specifications.
 - » Normal wear and tear.
 - » Any other cause which does not relate to a product defect.
- Any product exhibiting a condition commonly known as “image burn-in” which results when a static image is displayed on the product for an extended period of time.
- Removal, installation, insurance, and set-up service charges.

How to get service:

For information about receiving service under warranty, contact ViewSonic® Customer Support (Please refer to the attached “Customer Service” page). You will need to provide your product’s serial number, so please record the product information in the space provided below on your purchase for your future use. Please retain your receipt of proof of purchase to support your warranty claim.

For Your Records

Product Name: _____ Model Number: _____
Document Number: _____ Serial Number: _____
Purchase Date: _____ Extended Warranty Purchase? _____(Y/N)
If so, what date does warranty expire? _____

- To obtain warranty service, you will be required to provide (a) the original dated sales slip, (b) your name, (c) your address, (d) a description of the problem, and (e) the serial number of the product.
- Take or ship the product, in the original container packaging, to an authorized ViewSonic® service center.
- Round trip transportation costs for in-warranty products will be paid by ViewSonic®.

Limitation of implied warranties:

There are no warranties, express or implied, which extend beyond the description contained herein including the implied warranty of merchantability and fitness for a particular purpose.

Exclusion of damages:

ViewSonic®’s liability is limited to the cost of repair or replacement of the product. ViewSonic® shall not be liable for:

- Damage to other property caused by any defects in the product, damages based upon inconvenience, loss of use of the product, loss of time, loss of profits, loss of business opportunity, loss of goodwill, interference with business relationships, or other commercial loss, even if advised of the possibility of such damages.
- Any other damages, whether incidental, consequential or otherwise.
- Any claim against the customer by any other party.
- Repair or attempted repair by anyone not authorized by ViewSonic®.

Contact Information for Sales & Authorized Service (Centro Autorizado de Servicio) within Mexico:	
Name, address, of manufacturer and importers: México, Av. de la Palma #8 Piso 2 Despacho 203, Corporativo Interpalmas, Col. San Fernando Huixquilucan, Estado de México Tel: (55) 3605-1099 http://www.viewsonic.com/la/soporte/index.htm	
NÚMERO GRATIS DE ASISTENCIA TÉCNICA PARA TODO MÉXICO: 001.866.823.2004	
Hermosillo: Distribuciones y Servicios Computacionales SA de CV. Calle Juarez 284 local 2 Col. Bugambilias C.P: 83140 Tel: 01-66-22-14-9005 E-Mail: disc2@hmo.megared.net.mx	Villahermosa: Compumantenimientos Garantizados, S.A. de C.V. AV. GREGORIO MENDEZ #1504 COL, FLORIDA C.P. 86040 Tel: 01 (993) 3 52 00 47 / 3522074 / 3 52 20 09 E-Mail: compumantenimientos@prodigy.net.mx
Puebla, Pue. (Matriz): RENTA Y DATOS, S.A. DE C.V. Domicilio: 29 SUR 721 COL. LA PAZ 72160 PUEBLA, PUE. Tel: 01(52).222.891.55.77 CON 10 LINEAS E-Mail: datos@puebla.megared.net.mx	Veracruz, Ver.: CONEXION Y DESARROLLO, S.A DE C.V. Av. Americas # 419 ENTRE PINZÓN Y ALVARADO Fracc. Reforma C.P. 91919 Tel: 01-22-91-00-31-67 E-Mail: gacosta@qplus.com.mx
Chihuahua: Soluciones Globales en Computación C. Magisterio # 3321 Col. Magisterial Chihuahua, Chih. Tel: 4136954 E-Mail: Cefeo@soluglobales.com	Cuernavaca: Compusupport de Cuernavaca SA de CV Francisco Leyva # 178 Col. Miguel Hidalgo C.P. 62040, Cuernavaca Morelos Tel: 01 777 3180579 / 01 777 3124014 E-Mail: aquevedo@compusupportcva.com
Distrito Federal: QPLUS, S.A. de C.V. Av. Coyoacán 931 Col. Del Valle 03100, México, D.F. Tel: 01(52)55-50-00-27-35 E-Mail : gacosta@qplus.com.mx	Guadalajara, Jal.: SERVICRECE, S.A. de C.V. Av. Niños Héroes # 2281 Col. Arcos Sur, Sector Juárez 44170, Guadalajara, Jalisco Tel: 01(52)33-36-15-15-43 E-Mail: mmiranda@servicrece.com
Guerrero Acapulco: GS Computación (Grupo Sesicomp) Progreso #6-A, Colo Centro 39300 Acapulco, Guerrero Tel: 744-48-32627	Monterrey: Global Product Services Mar Caribe # 1987, Esquina con Golfo Pérsico Fracc. Bernardo Reyes, CP 64280 Monterrey N.L. México Tel: 8129-5103 E-Mail: aydeem@gps1.com.mx
MERIDA: ELECTROSER Av Reforma No. 403Gx39 y 41 Mérida, Yucatán, México CP97000 Tel: (52) 999-925-1916 E-Mail: rrrb@sureste.com	Oaxaca, Oax.: CENTRO DE DISTRIBUCION Y SERVICIO, S.A. de C.V. Murguía # 708 P.A., Col. Centro, 68000, Oaxaca Tel: 01(52)95-15-15-22-22 Fax: 01(52)95-15-13-67-00 E-Mail: gpotai2001@hotmail.com
Tijuana: STD Av Ferrocarril Sonora #3780 L-C Col 20 de Noviembr Tijuana, Mexico	FOR USA SUPPORT: ViewSonic® Corporation 381 Brea Canyon Road, Walnut, CA. 91789 USA Tel: 800-688-6688 E-Mail: http://www.viewsonic.com



ViewSonic®