

CAM520 Pro3

User Manual



Federal Communications Commission Statement

NOTE: This equipment has been tested and found to comply with the limits for a Class A digital device, pursuant to part 15 of the FCC Rules. These limits are designed to provide reasonable protection against harmful interference when the equipment is operated in a commercial environment. This equipment generates, uses, and can radiate radiofrequency energy and, if not installed and used in accordance with the instruction manual, may cause harmful interference to radio communications. Operation of this equipment in a residential area is likely to cause harmful interference in which case the user will be required to correct the interference at his own expense.

FCC Caution: Any changes or modifications not expressly approved by the party responsible for compliance could void the user's authority to operate this equipment.

This device complies with part 15 of the FCC Rules.

Operation is subject to the following two conditions:

- (1) This device may not cause harmful interference, and
- (2) this device must accept any interference received, including interference that may cause undesired operation.

This Class A digital apparatus complies with Canadian ICES-003. Cet appareil numérique de la classe A est conforme à la norme NMB-003 du Canada.

Warning

This is a class A product. In a domestic environment this product may cause radio interference in which case the user may be required to take adequate measures.

この装置は、クラス A 機器です。この装置を住宅環境で使用すると電波妨害を引き起こすことがあります。この場合には使用者が適切な対策を講ずるよう要求されることがあります。 VCCI-A

사 용 자 안 내 문

이 기기는 업무용 환경에서 사용할 목적으로 적합성평가를 받은 기기로서 가정용 환경에서 사용하는 경우 전자파간섭의 우려가 있습니다.

※ 사용자 안내문은 "업무용 방송통신기자재"에만 적용됩니다.

기종별	사용자안내문
A 급 기기 (업무용 방송통신기자재)	이 기기는 업무용(A 급) 전자파적합기기로서 판매자 또는 사용자는 이 점을 주의하시기 바라며, 가정외의 지역에서 사용하는 것을 목적으로 합니다.

Remote Control Battery Safety Information

- Store batteries in a cool and dry place.
- Do not throw away used batteries in the trash. Properly dispose of used batteries through specially approved disposal methods.
- Remove the batteries if they are not in use for long periods of time. Battery leakage and corrosion can damage the remote control. Dispose of batteries safely and through approved disposal methods.
- Do not use old batteries with new batteries.
- Do not mix and use different types of batteries: alkaline, standard (carbon-zinc) or rechargeable (nickel-cadmium).
- Do not dispose of batteries in a fire.
- Do not attempt to short-circuit the battery terminals.

遙控器電池安全資訊

- 請將電池存放在涼爽與乾燥的位置。
- 不要將電量用盡的電池棄置在家庭廢棄物中。請將電池棄置在特定回收處，或送回原購買的商店。
- 如果長時間不使用電池，請將其取出。電池漏液與腐蝕可能會損壞遙控器，請以安全方式棄置電池。
- 不可混用新舊電池。
- 不可混用不同類型的電池：鹼性、標準（碳鋅）或可充電（鎳鎘）電池。
- 不可將電池棄置於火源中。
- 請勿嘗試讓電池端子短路。

遙控器電池安全信息

- 请将电池存放在凉爽与干燥的位置。
- 不要将电量用尽的电池弃置在家庭废弃物中。请将电池弃置在特定回收处，或送回原购买的商店。
- 如果长时间不使用电池，请将其取出。电池漏液与腐蚀可能会损坏遥控器，请以安全方式弃置电池。
- 不可混用新旧电池。
- 不可混用不同类型的电池：碱性、标准（碳锌）或可充电（镍镉）电池。
- 不可将电池弃置于火源中。
- 请勿尝试让电池端子短路。

WARNING

- To reduce risk of fire or electric shock, do not expose this appliance to rain or moisture. Warranty will be void if any unauthorized modifications are done to the product.
- Do not drop the camera or subject it to physical shock.
- Use correct power supply voltage to avoid damaging camera.
- Do not place the camera where the cord can be stepped on as this may result in fraying or damage to the lead or the plug.
- Hold the bottom of the camera with both hands to move the camera. Do not grab the lens or lens holder to move the camera.

DISCLAIMER

No warranty or representation, either expressed or implied, is made with respect to the contents of this documentation, its quality, performance, merchantability, or fitness for a particular purpose.

Information presented in this documentation has been carefully checked for reliability; however, no responsibility is assumed for inaccuracies. The information contained in this documentation is subject to change without notice.

In no event will AVer Information Inc. be liable for direct, indirect, special, incidental, or consequential damages arising out of the use or inability to use this product or documentation, even if advised of the possibility of such damages.

TRADEMARKS

“AVer” is a trademark owned by AVer Information Inc. Other trademarks used herein for description purpose only belong to each of their companies.

COPYRIGHT

©2023 AVer Information Inc. All rights reserved. | May x, 2023

All rights of this object belong to AVer Information Inc. Reproduced or transmitted in any form or by any means without the prior written permission of AVer Information Inc. is prohibited. All information or specifications are subject to change without prior notice.

More Help

For FAQs, technical support, software and user manual download, please visit:

Headquarters

Download Center: <https://www.aver.com/download-center>

Technical Support: <https://www.aver.com/technical-support>

USA Branch Office

Download Center: <https://www.averusa.com/business/support>

Technical Support: <https://averusa.force.com/support/s/contactsupport>

Europe Branch Office

Download Center: <https://www.avereurope.com/download-center>

Technical Support: <https://www.avereurope.com/technical-support>

Contact Information

Headquarters

AVer Information Inc.

<https://www.aver.com>

8F, No.157, Da-An Rd., Tucheng Dist., New Taipei City 23673, Taiwan

Tel: +886 (2) 2269 8535

USA Branch Office

AVer Information Inc., Americas

<https://www.averusa.com>

668 Mission Ct., Fremont, CA 94539, USA

Tel: +1 (408) 263 3828

Toll-free: +1 (877) 528 7824

Technical support: support.usa@aver.com

Europe Branch Office

AVer Information Europe B.V.

<https://www.avereurope.com>

Westblaak 134, 3012 KM, Rotterdam, The Netherlands

Tel: +31 (0) 10 7600 550

Technical support: eu.rma@aver.com

Japan Branch Office

アパー・インフォメーション株式会社

<https://jp.aver.com>

〒160-0023 日本東京都新宿区西新宿 3-2-26 立花新宿ビル 7 階

Tel: +81 (0) 3 5989 0290

テクニカル・サポート: <https://jp.aver.com/technical-support>

Vietnam Branch Office

Công ty TNHH AVer Information (Việt Nam)

Tầng 5, 596 Nguyễn Đình Chiểu, P.3, Quận 3,

Thành phố Hồ Chí Minh 700000, Việt Nam

Tel: +84 (0)28 22 539 211



Contents

Package Contents	1
Product Introduction	2
Overview	2
LED Indicator	2
Remote Control.....	3
Pan and Tilt Angle.....	6
Installation	7
Device Connection.....	7
Power Connection	8
HDMI Connection	9
RS-232 Connection	10
Wall Mount Installation.....	16
Ceiling Mount Installation.....	19
Secure the Cables	21
Operating the Camera	22
Make a Video Call.....	22
Make a Connection through the Browser.....	22
Web Settings	25
First Time Login	25
Live Screen Operation	26
PTZ Control.....	27
Camera Settings	29
Tracking Mode.....	30
Camera Moving Speed	31
Framing Speed.....	32
Framing Size	32

SmartFrame Preset Point.....	32
Auto Focus	33
Camera Focus.....	33
Home Position.....	33
Sleep Position	33
Sleep Timer	34
On Screen Menu	34
Camera Binding	34
Save Preset.....	34
Image Settings	35
Image Flip	35
Image Mirror.....	35
WDR	35
Flicker Decrease on IFP/Monitor.....	36
Frequency	36
White Balance	36
Noise Reduction.....	36
Brightness	37
Sharpness.....	37
Saturation.....	37
Low Light Compensation.....	37
Low Resolution under 720p.....	37
Enlarge Total Zoom Up To 36x.....	38
Video Frame Rate	38
RS-232 Settings.....	38
Video Format Settings	39
H.264 Profile	39
IP Stream Resolution only.....	39
Frame Rate	39

Bit Rate	39
RTSP.....	40
RTMP	41
Network Settings.....	42
Hostname.....	42
DHCP	42
Static IP.....	43
System Settings	44
Language	44
Firmware Update.....	44
Factory Default.....	45
Camera Reboot.....	45
Change Password.....	46
SSL Certificate	47
Date Format	47
Time Format.....	47
Time Correction Mode.....	48
Allow Providing of anonymous usage data	49
Information	49
PTZApp 2.....	50
Install PTZApp 2	50
Use PTZApp 2 with USB Devices.....	51
Use PTZApp 2 with a Virtual Stream	59
EZLive.....	60
Use AVer EZLive.....	60

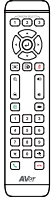
Package Contents

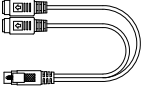
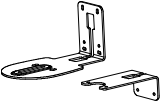
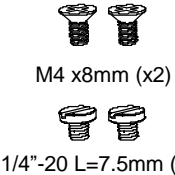
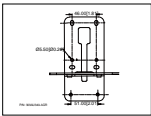



Camera Unit	Remote Control	Power Adapter & Power Plug*	USB 2.0 Type-B to Type-A Cable (5m)
			
Mini DIN 9 to Mini DIN 8 RS-232 Adapter Cable	L-Mount Brackets	Screws for Mount	Drilling Paper
		 <p>M4 x8mm (x2)</p> <p>1/4"-20 L=7.5mm (x2)</p>	

QR Code Card

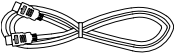

*The power plug will vary depending on the standard power outlet of the country where it is sold.

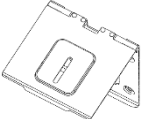
Optional Accessories*

HDMI Cable (3m)	Mini DIN 8 to D-Sub 9 Cable	Foldable TV Mount	Ceiling Mount (Upside Down Installation)
			

*Optional Accessories will vary depending on the country where it is sold.

**To mount on ceiling, please purchase ceiling mount kit from AVer.

Product Introduction

Overview

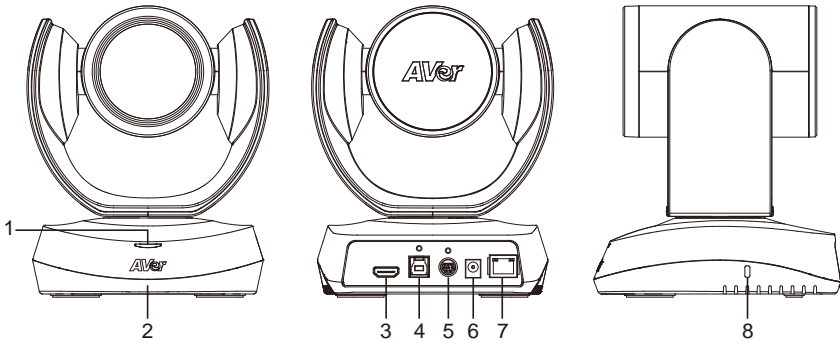

- 1 Status LED
- 2 IR Sensor
- 3 HDMI Port

- 4 USB 3.1 Type B Port
- 5 RS-232 In/Out Port
- 6 12V DC Power Jack

- 7 PoE Port*
- 8 Kensington Lock

*Power over Ethernet (PoE), compatible with IEEE 802.3AT. Please use CAT 5e FTP cable (not included).

LED Indicator

Blink blue once: Power on
Solid red: Start-up
Solid orange: Standby
Solid blue: Video on

Remote Control

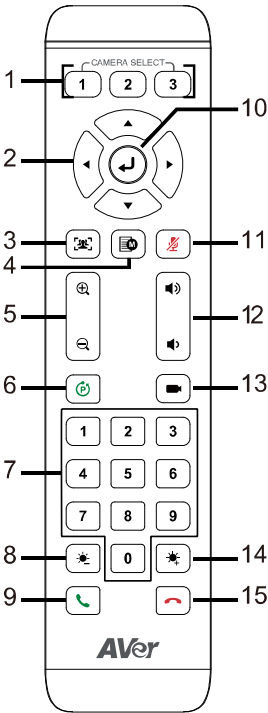

Name	Function
<p>1. Camera Select</p>	<p>One remote control can control up to 3 AVer USB series cameras. You can use AVer PTZApp 2 or IP web page to set numbers associated with each camera, and then select which camera you would like to control using the remote.</p> <p>[Note] The default is Off. If you don't do any binding, no matter you press camera 1 or 2, 3 button on the remote control, you can control all the AVer USB cameras around you.</p>
<p>2. Camera Directional Control</p>	<p>Use the directional buttons on the remote to control the direction of the camera. Press the directional button to move the camera or press and hold to continuously pan or tilt.</p>
<p>3. SmartFrame</p>	<p>One-click automatic field of view adjustment to fit all participants. Press for 1~2 seconds to switch the SmartFrame function among Manual Frame / Auto Frame / Preset Framing / Smart Composition. A message will appear on the screen to indicate the mode.</p> <p>While in Auto Framing mode, or doing one-click manual frame, an icon message (as figure shown) will display on the upper left screen to indicate that the framing action is triggered. The icon will appear 2~3 seconds on the screen. Once the framing process is done, it will disappear. If you don't want to see the icon display, please go to PTZApp 2, find "On Screen Menu"</p>

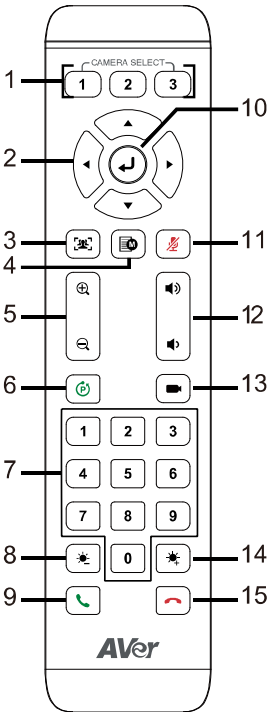

function and select “Off”.



[Notes]

- Default is Manual Framing. SmartFrame deploys face and body detection technology. People wearing masks and side facial profiles can still be detected. The maximum detection distance is 7~10 meters away from the camera.
- Camera will track people while moving. It will start to focus and zoom in once people stop moving for 1~5 seconds, depending on the framing speed you choose. The default framing speed is “Middle” speed. “High” speed is more suitable for one person tracking.
- Preset Framing: Set up preset points in advance (Only for Preset points 1~9. Preset 0 is for home position). Camera tracks one presenter and shoots the preset areas instead of focusing and zooming into presenter.

4. OSD Menu	Short press the button to open OSD menu during HDMI output.
5. Zoom In/Out	Increase / Decrease the camera zoom.
6. Preset	The Preset button on the remote serves 2 functions. To Save a Preset – Move camera to desired position. Press and hold the preset button until you receive the save message on the screen. Select preset position button 0-9 to store the current camera position. Repeat steps if needed. To Load a Preset - Press the preset

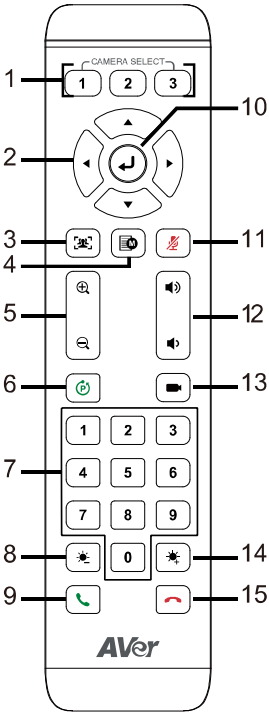

7. Preset Position/Number Buttons

button and preset position button 0-9 to load a saved camera position. Repeat steps if needed.

Preset position buttons are used in conjunction with the Preset button to save positions. There are a total of 10 presets.

Press the preset button first and then press 0-9 for the camera to move to the saved position.

Shortcuts

Press and Hold	To
1 for 2 sec	Turn on/off WDR
5 for 2 sec	Turn on/off SmartFrame
8 for 2 sec	Turn on/off RTMP streaming (when RTSP and RTMP is on)
9 for 2 sec	Enter sleep mode
[Red Phone] for 6 sec	Reboot

8. Brightness -	Decrease the brightness.
9. Call/Answer	Answer a call or start a call.
10. Enter	Not supported.
11. Mute/Un-mute Speakerphone	Not supported.
12. Volume Up/Down	Not supported.
13. Preset Hot Key	Press to move the camera to the preset position the user has set.
14. Brightness +	Increase the brightness.
15. Hang Up	End the call.

Pan and Tilt Angle

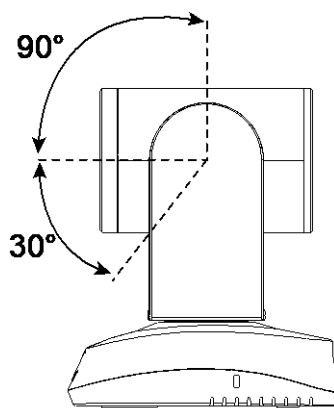
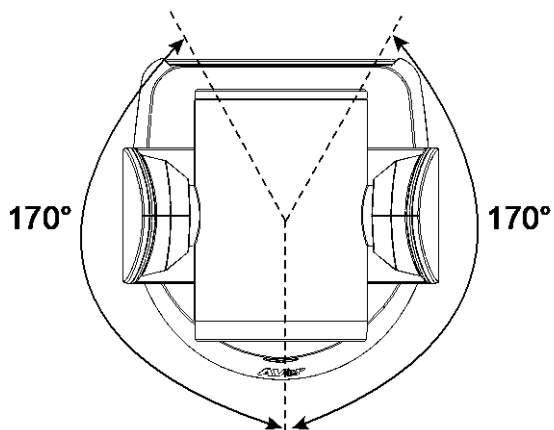

Installation

Device Connection

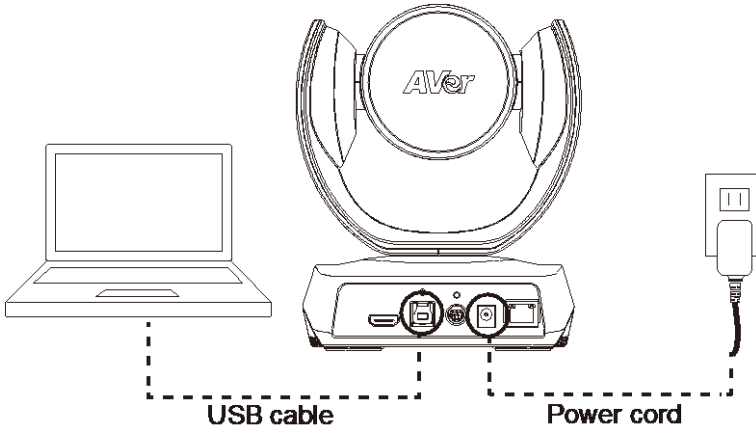

1. Use USB cable to connect the CAM520 Pro3 to your PC/laptop (refer to diagram above).
2. Connect the power to the CAM520 Pro3; power indicator will light up and camera head will rotate.
3. Install PTZApp 2 on laptop or PC that is connected with CAM520 Pro3. The app can be used to adjust and setup the parameters of the camera (refer to the section of PTZApp 2).
4. To make a call, run your video application (Zoom, Microsoft® Teams, Skype for Business, Skype, Google Meet, Intel® Unite™, RingCentral, BlueJeans, V-Cube, LiveOn, CyberLink U Meeting®, TrueConf, Adobe Connect, Cisco WebEx®, Fuze, GoToMeeting™, Microsoft® Lync™, Vidyo, vMix, WebRTC, Wirecast, XSplit, etc.). Select CAM520 Pro3 as your video device.

[Notes]

- Use the USB 2.0 cable included in the package.
- CAM520 Pro3 has the USB 3.1 port which is USB 2.0 compatible.

Maximum resolution/fps for USB 2.0 and USB 3.1 port are shown below.

USB 2.0		USB 3.1		HDMI
YUV	M-JPEG	YUV	M-JPEG	
- 640x480 or less resolution, up to 30fps - 720p, up to 10fps	- 1080p/60fps	- Up to 1080p/30fps - 720p/60fps	- 1080p/60fps	- 1080p/60fps - 1080p/30fps

Power Connection

The power supply can be plugged into the wall outlet or drawn from PoE switch (Ethernet).

Wall outlet

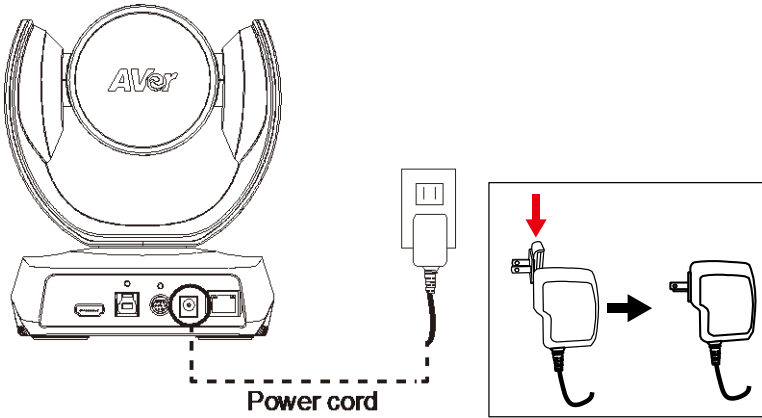

PoE

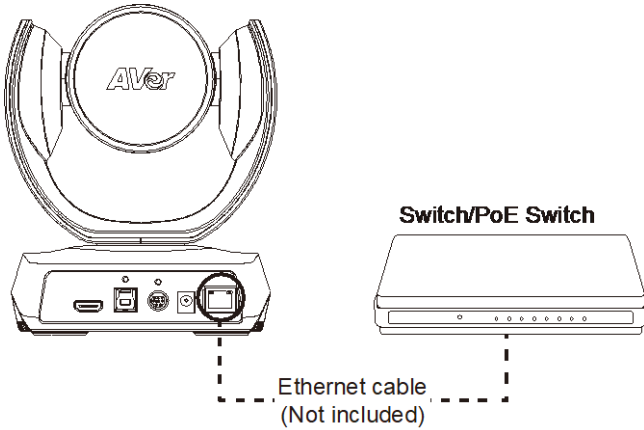

[Note] To ensure stability of IP video streaming, please use CAT 5e FTP cable (not included).

HDMI Connection

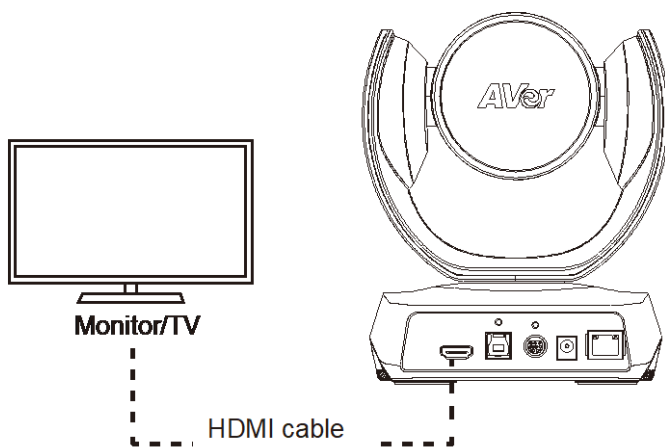

Connect with TV or monitor through the HDMI port to display camera video on the screen.

RS-232 Connection

■ Camera RS-232 Port Pin Definition

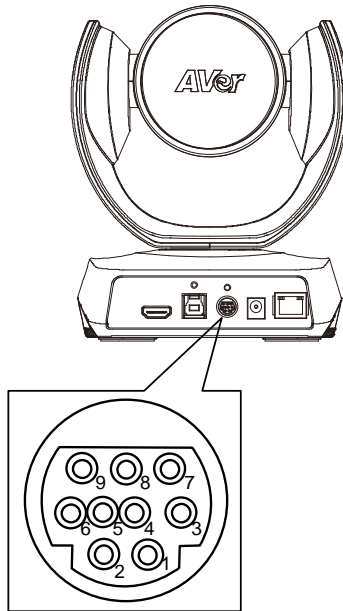

Function	Mini DIN9 PIN #	I/O Type	Signal	Description
VISCA IN	1	Output	DTR	Data Terminal Ready
	2	Input	DSR	Data Set Ready
	3	Output	TXD	Transmit Data
	6	Input	RXD	Receiver Data
VISCA OUT	7	Output	DTR	Data Terminal Ready
	4	Input	DSR	Data Set Ready
	8	Output	TXD	Transmit Data
	9	Input	RXD	Receiver Data
	5	---	---	Not connect

■ Computer/Keyboard Controller and Camera Connection

Direct Connection

If users do not use AVer RS-232 adapter cable, please refer to the pin connection shown below.

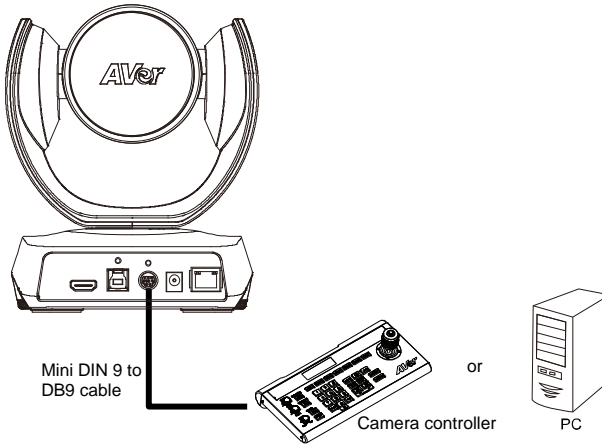

Camera (Mini DIN 9)	Camera controller or PC (DB9)
1. DTR (IN)	1. DCD
2. DSR (IN)	2. RXD
3. TXD (IN)	3. TXD
6. RXD (IN)	4. DTR
7. DTR (OUT)	5. GND
4. DSR (OUT)	6. DSR
8. TXD (OUT)	7. RTS
9. RXD (OUT)	8. CTX
	9. RI

Use the supplied RS-232 mini DIN 9 to mini DIN 8 cable

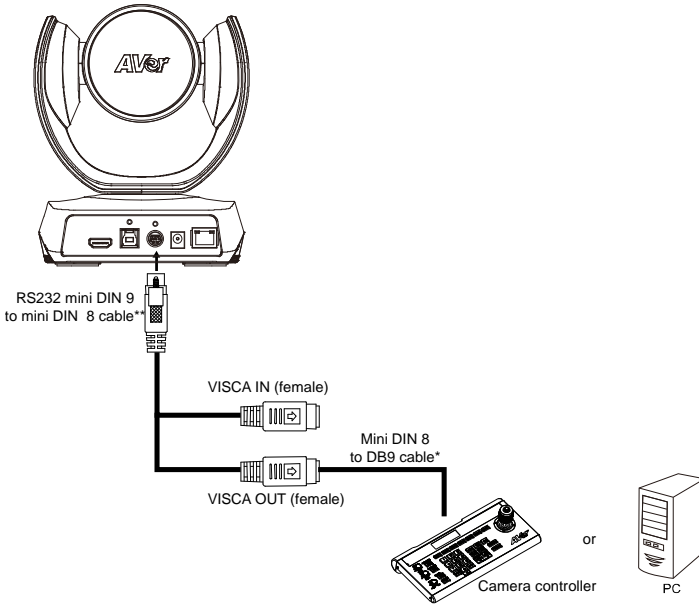

Camera controller or PC
(DB9)

1. DCD
2. RXD
3. TXD
4. DTR
5. GND
6. DSR
7. RTS
8. CTX
9. RI

Camera
(Mini DIN 8)

1. DTR (IN)
2. DSR (IN)
3. TXD (IN)
4. GND (IN)
5. RXD (IN)
6. GND (IN)
1. DTR (OUT)
2. DSR (OUT)
3. TXD (OUT)
4. GND (OUT)
5. RXD (OUT)
6. GND (OUT)

* Mini DIN 8 to D-Sub 9 (DB9) cable 064AOTHERCGN is an optional item.

**** RS-232 mini DIN 9 to mini DIN 8 Cable Pin Definition**

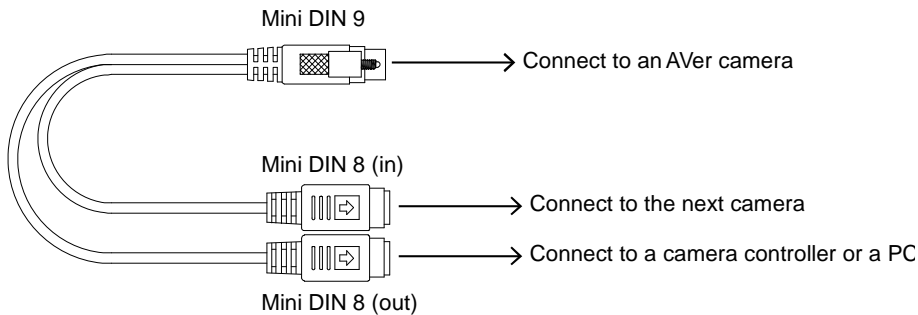

Mini DIN 8 Pin Definition

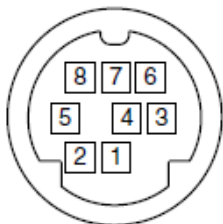

No.	Pin
1	DTR
2	DSR
3	TXD
4	GND
5	RXD
6	GND
7	NC
8	NC

■ Camera Cascade Connection

Direct Connection

If users do not use AVer RS-232 adapter cable, please refer to the pin connection shown below for cascading cameras.

Total can connect up to 7 cameras.

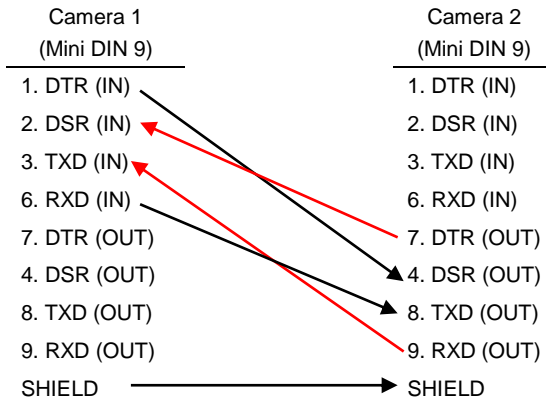
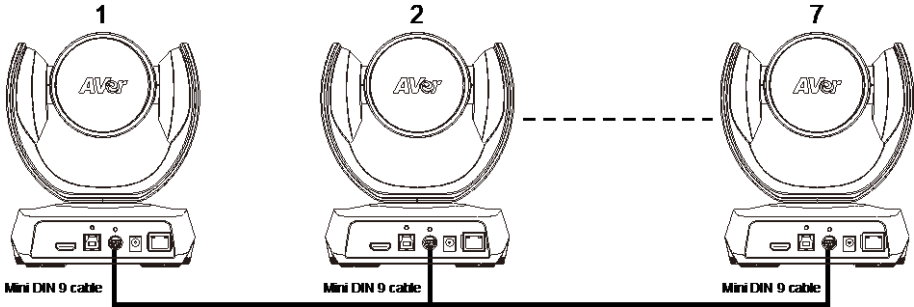

Use the RS-232 mini DIN 9 to mini DIN 8 cable

Total can connect up to 7 cameras.

To facilitate the camera cascade, users can use AVer RS-232 adapter cable.

Connect camera with AVer mini DIN 9 to mini DIN 8 adapter cable. Connect the mini DIN 8 female side to male mini DIN 8 Visca cable (Users have to buy it in the market) and then connect AVer mini DIN 9 to mini DIN 8 adapter cable again to connect to next camera.

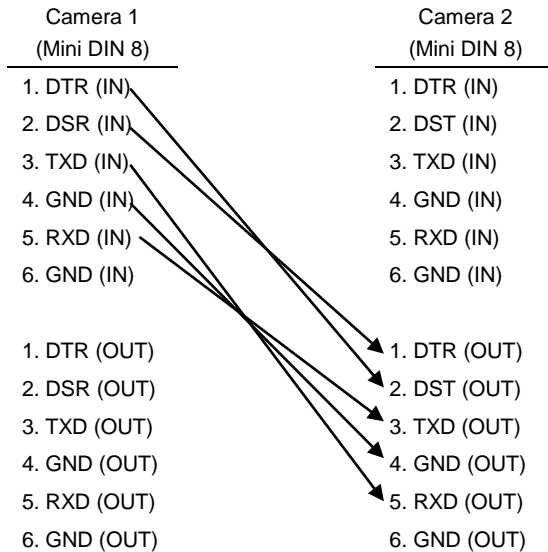
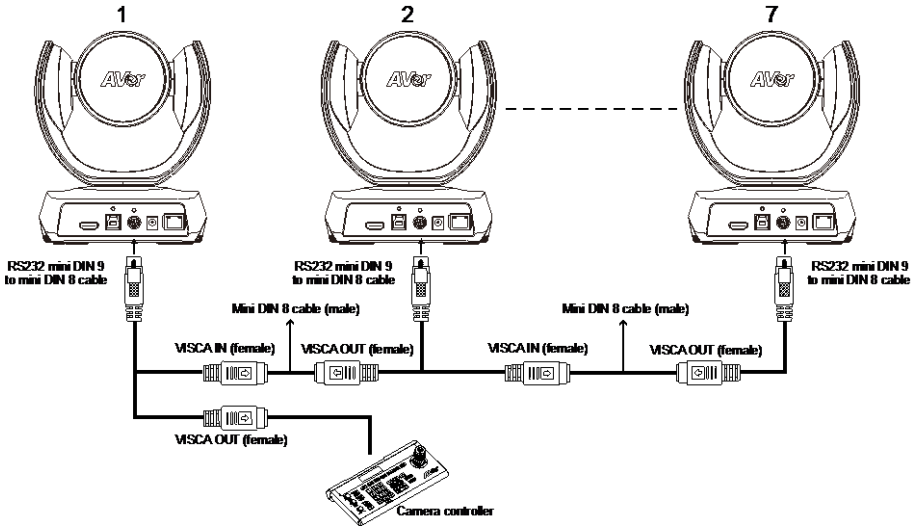

Wall Mount Installation

1. Use the drilling paper included in the package to drill the holes in the wall where the user wants to mount the camera.

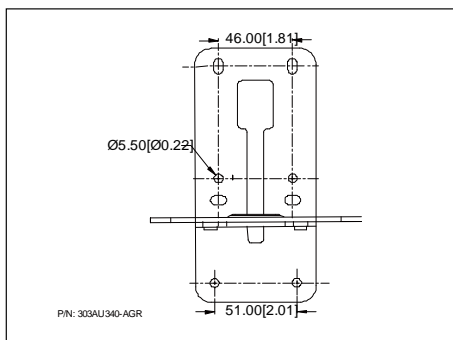

2. Use the screws (not included) to secure the L-mount bracket **A** on the wall.

Screw

For Cement wall: M4 x20mm self-tapping screws (x4) + Plastic conical anchor

For Wooden wall: M4 x20mm self-tapping screws (x4)

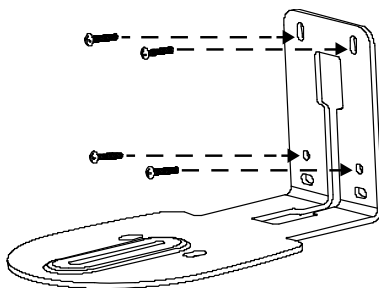

3. Then, assemble the L-mount brackets **A** + **B** with screws (included in package).

Screw size:  M4 x8mm (x2)

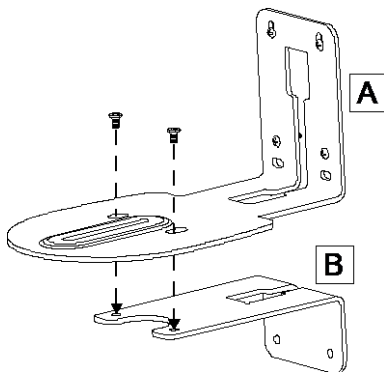

4. After assembling the L-mount brackets, use the screws (not included) to secure the lower part of L-mount brackets on the wall.

Screw

For Cement wall: M4 x20mm self-tapping screws (x2) + Plastic conical anchor

For Wooden wall: M4 x20mm self-tapping screws (x2)

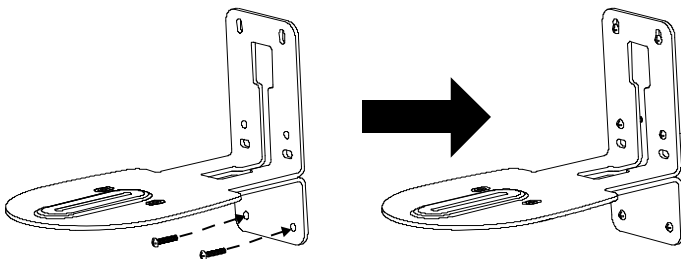

5. Pass the cables through the hole on the L-mount bracket and connect the cables to corresponding connection ports.

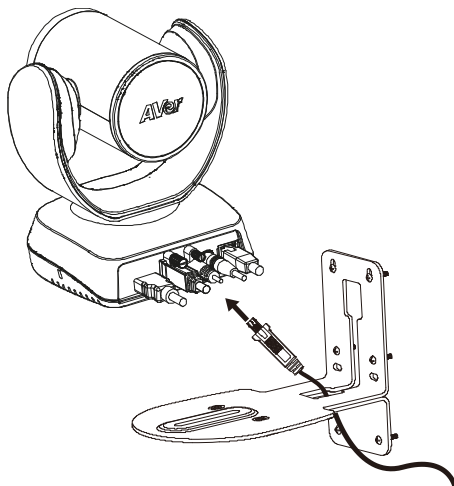

6. Use the remaining screws (included in package) to secure the camera on the L-mount bracket.

Screw:  1/4"-20 L=7.5mm (x2)

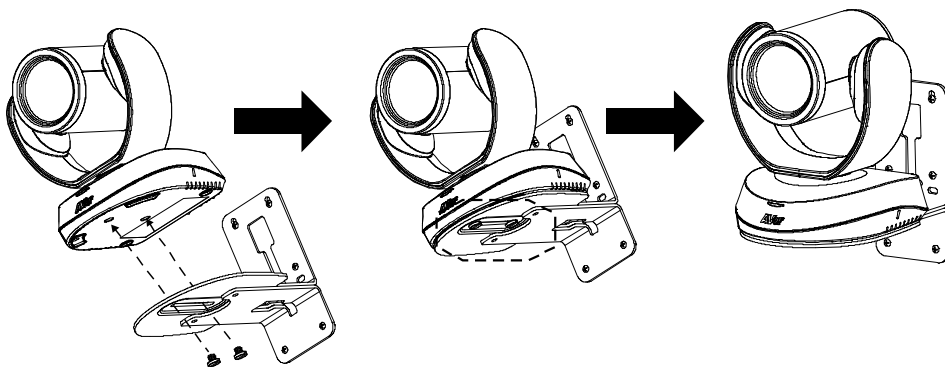

Ceiling Mount Installation

1. Install the provided screw underneath the camera but do not tighten.

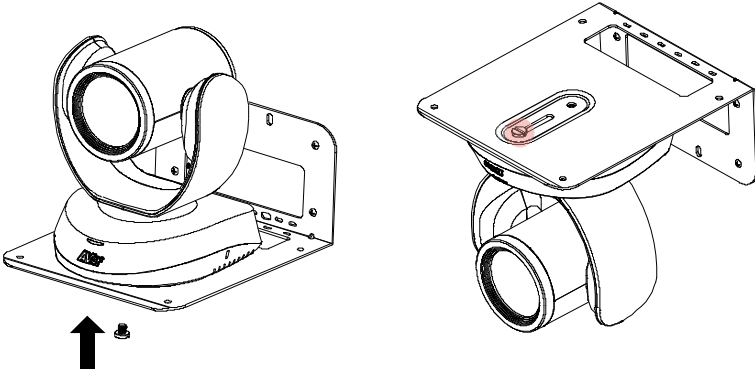

2. Turn the camera to right side.

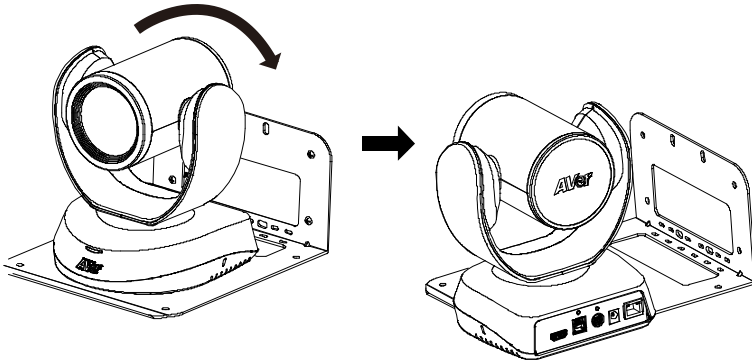

3. Pass cables through A or B hole first. Connect cables with camera.

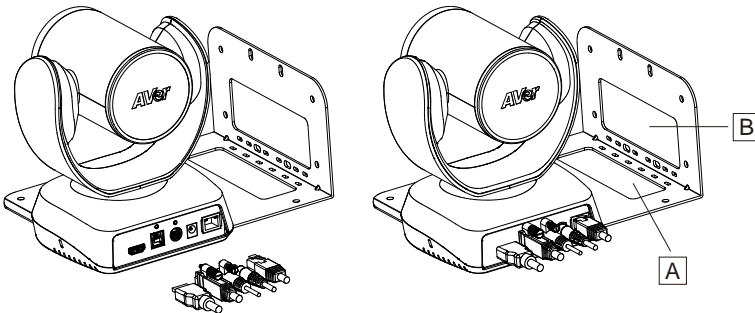

4. Turn the camera to face the front side. Install the second screw and tighten both screws.

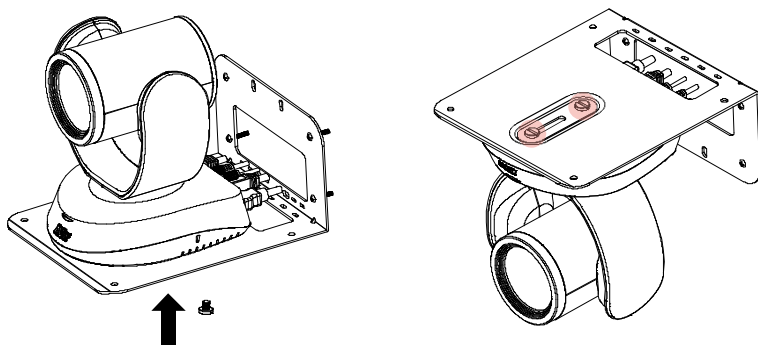

5. Find suitable screws to fix the camera mount to the ceiling.

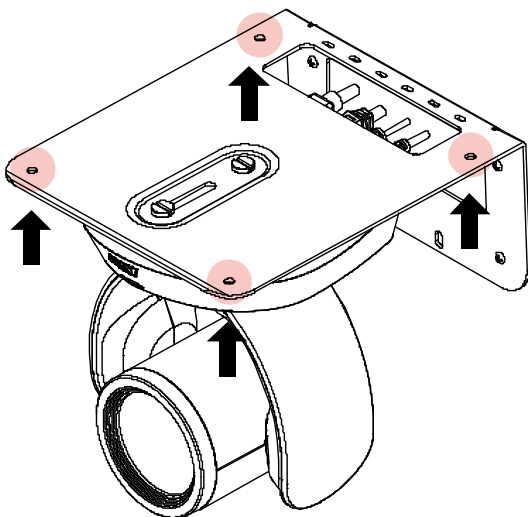

Secure the Cables

The USB and RS-232 cables have a screw on the cable for securing cable on the camera.

Install the cable first and tighten the screw to secure the cable.

[Note] Make sure the cable is well connected to the connector on the camera before securing the cable.

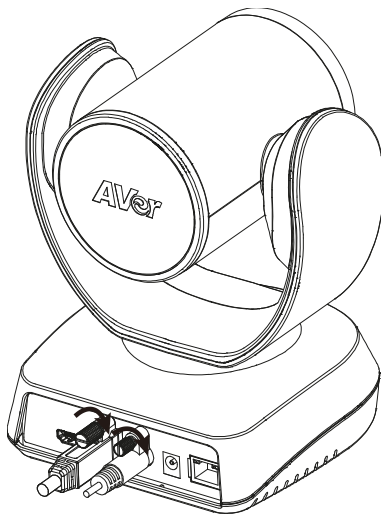

Operating the Camera

Make a Video Call

1. Make sure all devices (CAM520 Pro3, laptop/PC, TV/monitor) are well connected and powered on.
2. Run your video application (Zoom, Microsoft® Teams, Skype for Business, Skype, Google Meet, Intel® Unite™, RingCentral, BlueJeans, V-Cube, LiveOn, CyberLink U Meeting®, TrueConf, Adobe Connect, Cisco WebEx®, Fuze, GoToMeeting™, Microsoft® Lync™, Vidyo, vMix, WebRTC, Wirecast, XSplit, etc.) on your PC or laptop.
3. Set the CAM520 Pro3 camera as the primary camera for your video application (refer to your video application user guide). You can now make your call.

[Note] The CAM520 Pro3 is a plug-and-play conference camera. The system requires no special drivers, but we do recommend installing the PTZApp 2 for a better user experience. For information on how to install and use the PTZApp 2, refer to the PTZApp 2 section in this user manual.

Make a Connection through the Browser

CAM520 Pro3 has an Ethernet port for IP streaming and allows administrators to remotely control and set up the camera via an internet access. Moreover, CAM520 Pro3 also supports RTSP and RTMP functions. For more details, please contact our technical support.

1. Make sure the CAM520 Pro3 has an internet access connection.
2. Launch PTZApp 2* () and connect CAM520 Pro3 to PC with USB cable. The camera default IP address is **192.168.1.168**.



[Note] The browser supports:

- Chrome: version 76.x or above
- Firefox: version 69 or above
- IE: Doesn't support

3. Click pencil icon (✎) to edit IP address**.

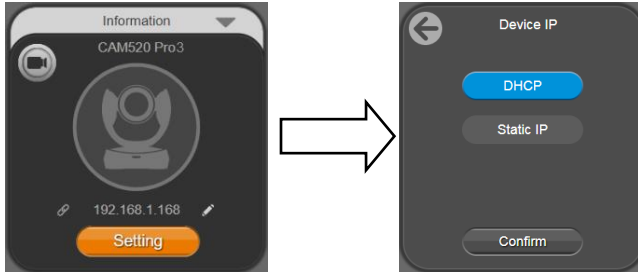

4. Click weblink icon (🔗) to launch Chrome page. Please enter the password (default password is **aver4321**). User will be asked to set a new account and password. (Please enter PTZApp2 to reset password back to default while password is forgotten.)

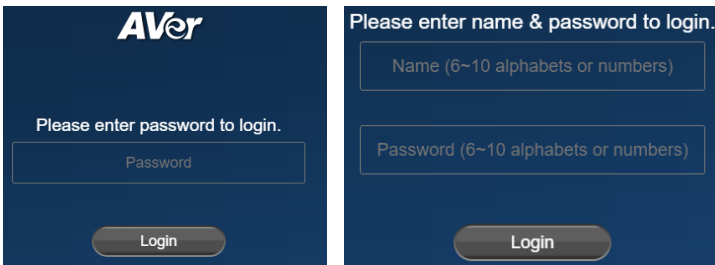

5. Input the new account, password and click **Login**, you will be prompted with a setting for sharing the non-personal data with AVer, such as the functions used and firmware versions of the AVer devices. Click to enable sharing the usage data with AVer and then click **Done**. You can optionally disable this setting afterward (**System > Allow providing of anonymous usage data**).

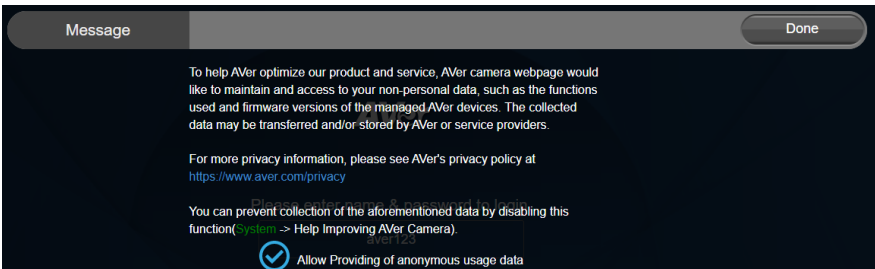

6. Now you can access web settings of the camera with only Ethernet cable connection. Unplug the USB cable.

7. The main web screen is displayed as below.

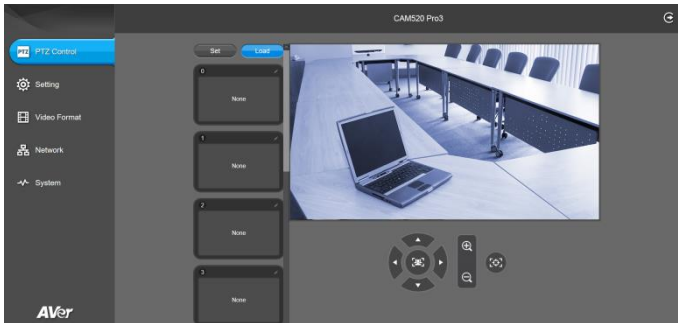

* For information on how to install and use the PTZApp 2, refer to the PTZApp 2 section in this user manual.

** To support IP address changes in groups, user can download AVer IP Finder app.

1. Download the IP Finder from <https://www.aver.com/download-center> (Headquarters & Europe) or <https://www.averusa.com/business/support/> (USA).

2. Run the IP Finder.

3. Click **“Search”**, and all available devices will be listed on the screen.

4. Select a camera from the list. The corresponding fields of IP address will display.

5. To change the IP address of camera, user can select **“DHCP”** or **“Static IP”**.

The DHCP should get the IP address from local dynamic IP sever. The static IP, user can enter the specific IP address. Click **“Apply”** to apply the setting to the camera. The password is required (default password is **aver4321**).

6. Click **“Search”** button to re-scan the camera.

7. Double-click on the IP address of camera from the list can connect to camera through the browser.

8. Enter the default password (**aver4321**) to login to Web setup screen.

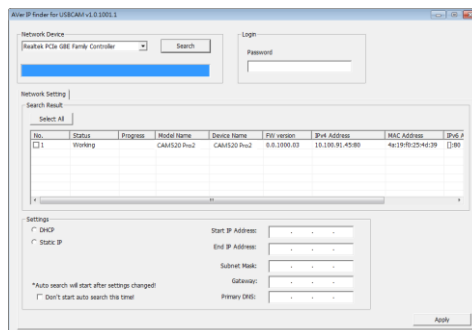

Web Settings

CAM520 Pro3 supports Ethernet connection; users can enter the IP address into the web browser to connect to the camera for detail settings.

First Time Login

To find the IP address of the camera, please refer to “**Make a connection through the Browser**” section.

1. Open the browser on your laptop/PC and enter the IP address of the camera.
2. Enter the password at login screen. The default password is “**aver4321**”.
3. The main web screen is displayed.

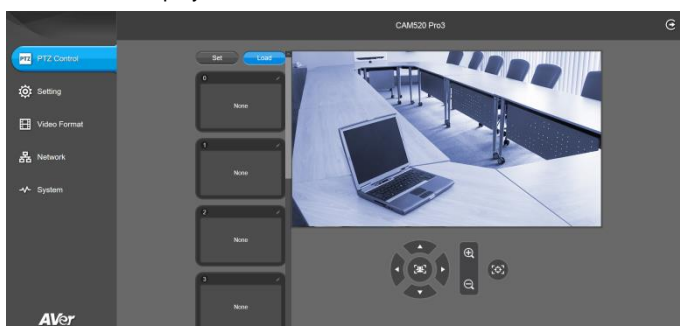

Live Screen Operation

User can control the camera direction, zoom in/out, and preset selection.

[Notes]

- The system will force the previous login to log out, when there is a second login.
If the web page is idle without any request for more than 4 hours, user will be logged out.
- The resolution of live screen is 1280x720/30fps.

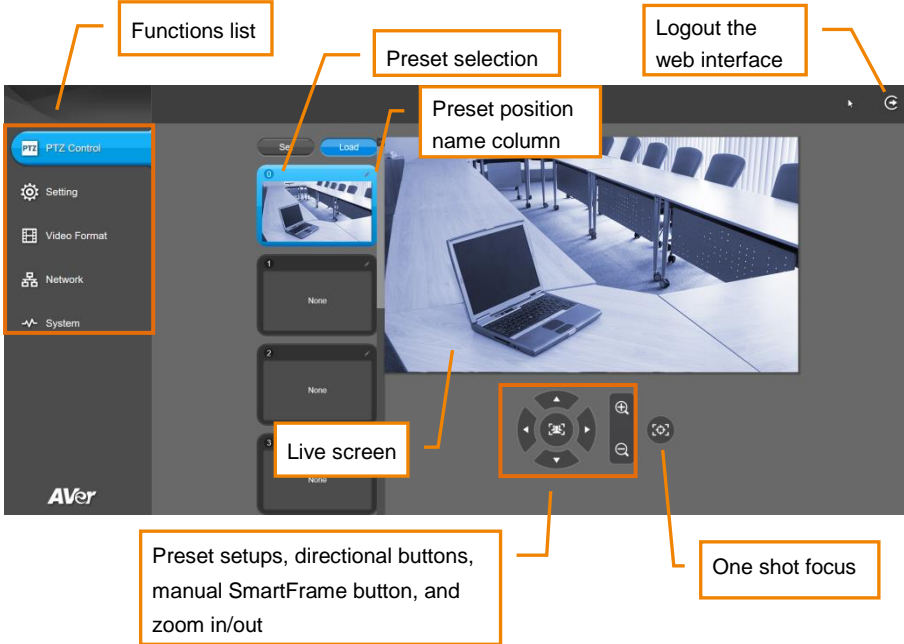

PTZ Control

You can use the PTZ Control page to configure up to 10 preset positions.

1. In live screen, use ▲, ▼, ◀, ▶ and zoom in/out buttons to adjust the camera screen view to desired position.
2. Select “Set” button and click on the preset number to save the preset. The system will capture the preset screen view and display in preset number frame.

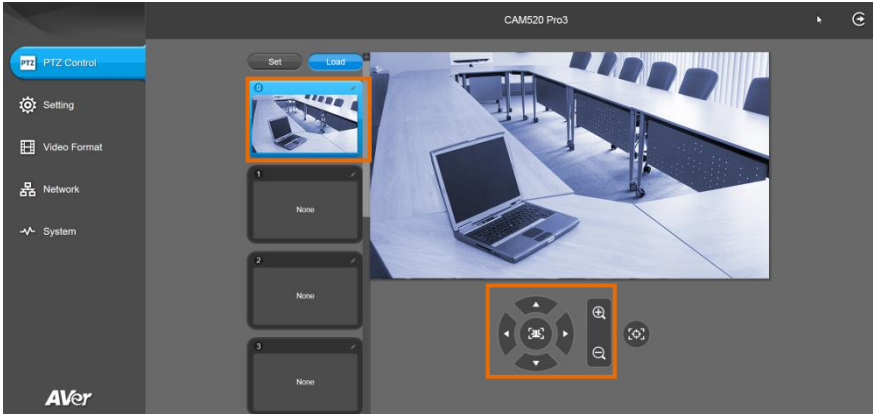

3. Select  icon to edit name of preset frame. Click other Web interface to save the name edited.

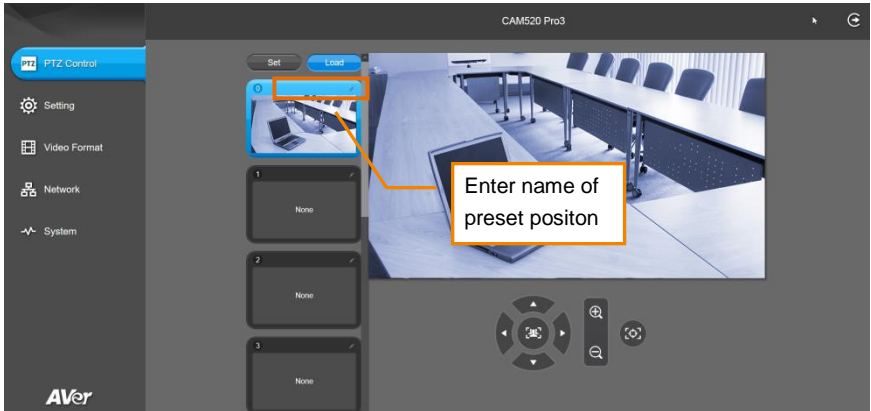

4. To set another preset, repeat the above steps.

5. After setting up the preset positions, you can start performing the function. Select the “**Load**” button and then click on the preset numbers, the live screen will move to the preset screen view.

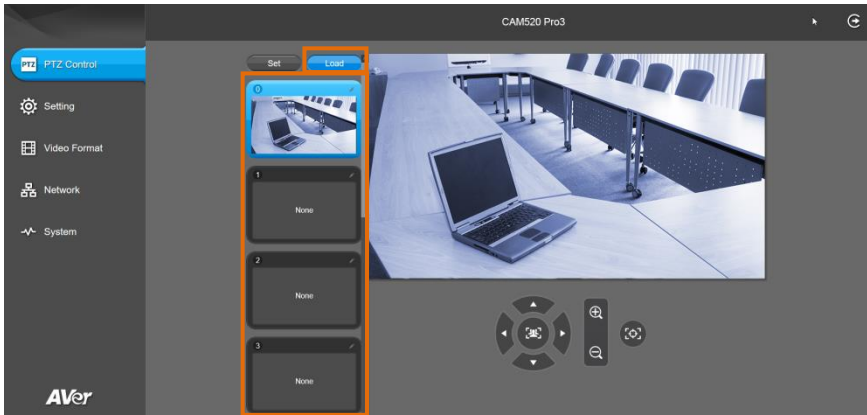

Camera Settings

The video  icon is to turn on camera live view while adjusting any settings.

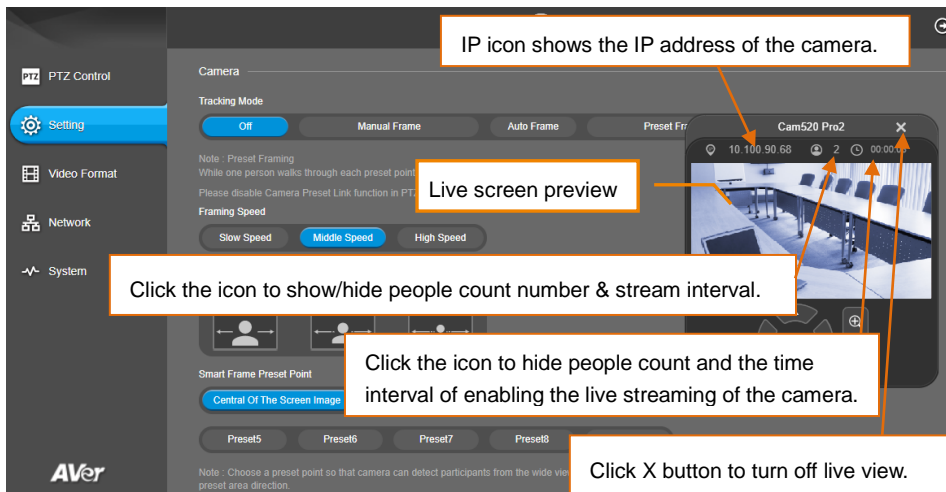

The screenshot shows the PTZ Control interface for a camera. The interface includes a sidebar with navigation options: PTZ Control, Setting (selected), Video Format, Network, and System. The main area displays camera settings for 'Cam520 Pro2'. The Tracking Mode is set to 'Off', and the Framing Speed is set to 'Middle Speed'. A live screen preview is shown in the top right corner, displaying a meeting room. The preview includes an IP address '10.100.90.68', a person count '2', and a stream interval '00:00:00'. The preview also has an 'X' button to turn off live view. Callouts explain the following features:

- IP icon shows the IP address of the camera.
- Live screen preview
- Click the icon to show/hide people count number & stream interval.
- Click the icon to hide people count and the time interval of enabling the live streaming of the camera.
- Click X button to turn off live view.

Tracking Mode

Select **Setting > Camera > Tracking Mode > Off, Manual Frame, Auto Frame, Preset Framing or Smart Composition.**

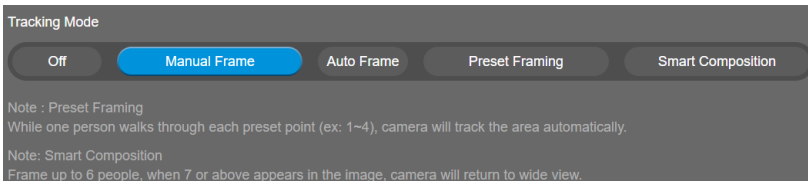

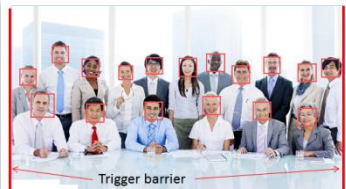
- **Off:** Tracking mode is disabled.
- **Manual Frame:** User one-click SmartFrame button and camera will adjust view angle to fit all participants in screen.
- **Auto Frame:** Camera automatically adjusts view angle to frame all participants on screen every time when it detects participants' faces or bodies. This action will be activated once people in the room sit or stand still for 1~5 seconds, depending on the framing speed you select. Once all the participants are in frame, the camera will keep the image stable by not completing any action until subjects move in or out of the screen. When a participant touches the sides of the screen, it will trigger the camera and automatically track, detect, and frame all the participants again.

*The default framing speed is "Middle" speed. "High" speed is more suitable for one person tracking.

- **Preset Framing:** Set up preset points in advance. (Only for Preset points 1~9. Preset 0 is for home position). This is designed for requiring a specific zooming area with preferred image proportion. Camera tracks and frames all the participants in the screen if none of them touch any preset area. When any of them touch a preset area, the camera will immediately shoot the preset zones instead of focusing and zooming into presenter. To keep the screen stable, whenever there is a person in the area, the camera won't move any more until no one shows up. However, the camera can detect the direction where the last person goes. If the person goes to the next preset area with overlap section, the camera will directly move to the next preset area. Thus, to ensure smooth transition, please set up zones with overlapping presets.
If the preset zones do not overlap and when the last person leave the preset area, camera will zoom out to wide to find people and frame them again.
If more than 2 presets areas are touched by 2 persons, camera will go to preset 1. The priority is preset 1>preset2> preset 3....>preset 9

Overlap beginning & end of each zone



[Note] CAM520 Pro3 frames people in masks or any facial profile up to 7~10 meters away!



- **Smart Composition:** Frame up to 6 people, when 7 or above appear in the image, camera will return to wide view.

Camera Moving Speed

Select **Setting > Camera > Camera Moving Speed > Slow Speed, Middle Speed** (default), or **High Speed**. *Note: available in later PTZApp2/firmware release

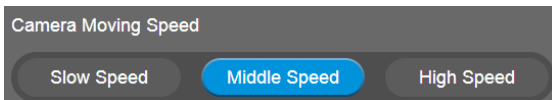

Framing Speed

Select **Setting > Camera > Framing Speed > Slow Speed, Middle Speed** (default), or **High Speed**.

When in auto framing or preset framing mode, camera will automatically frame people if they stand still without moving for 1~5 seconds.

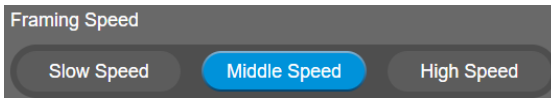

- **Slow Speed:** camera starts to frame people if they don't move for 5 seconds.
- **Middle Speed:** camera starts to frame people if they don't move for 3 seconds.
- **High Speed:** camera starts to frame people if they don't move for 1 second.

[Note] The default framing speed is “Middle” speed. “High” speed is more suitable for one person tracking.

Framing Size

Select **Setting > Camera > Framing Size > Tight, Medium** (default), or **Wide**.

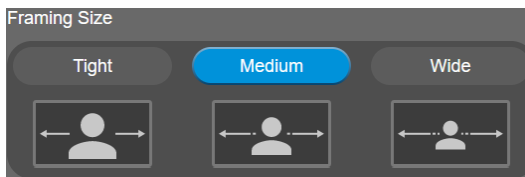

- **Tight:** It provides a close-up view of meeting participants.
- **Medium:** It provides a medium view of meeting participants.
- **Wide:** It provides a wide view of meeting participants.

SmartFrame Preset Point

Select **Setting > Camera > SmartFrame Preset Point > Default (Center of the screen)** or **Preset 0 ~ Preset9**.

The default is the central of the image screen. Choose a preset point so that camera can detect participants from the wide view of the assigned preset area direction.

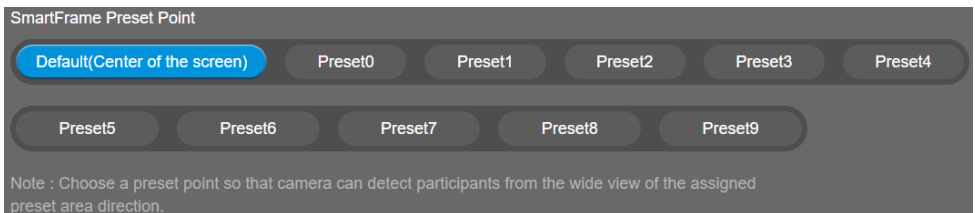

Auto Focus

Set auto focus mode.

First select **Setting > Camera > Camera Focus > Auto**.

Select **Setting > Camera > Auto Focus > PTZ** or **Continuous**.



- **PTZ:** Click the button (such as pan, tilt, or zoom in/out) to adjust focus once.
- **Continuous:** The camera will adjust the focus when the objects have moved.

Camera Focus

Set auto/manual focus mode.

Select **Setting > Camera > Camera Focus > Auto** or **Manual**.

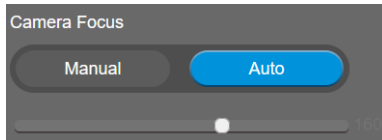

- **Auto:** Camera adjusts focus automatically.
- **Manual:** You can adjust the camera focus by moving the control bar below.

Home Position

Every time when powering on the camera, it will turn to this position.

Select **Setting > Camera > Home Position > Last Operation Position, Factory Center Position, or Preset 0**.

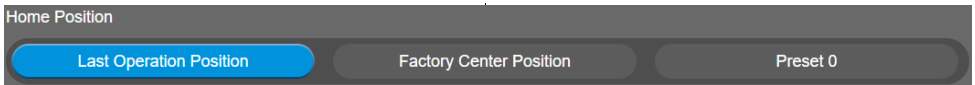

Sleep Position

When the camera idles for certain period, it will enter sleep mode and go to the sleep position. Please set up sleep timer to enable sleep mode.

Select **Setting > Camera > Sleep Position > Factory Downside Position** or **Preset 9**.



Sleep Timer

Set the camera idle time to enter sleep mode. When entering sleep mode, the camera will turn to sleep position.

Select **Setting > Camera > Sleep Timer > Off, 10 sec, 5 min, 10 min, or 20 min.**

Please notice that whenever there is USB streaming or RTSP/RTMP streaming, the camera won't enter sleep mode.

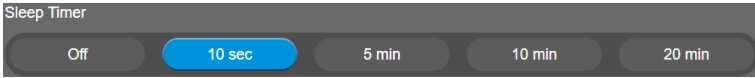

On Screen Menu

Enable/disable on screen display status information. For instance, when it is at auto frame mode, it will appear "AVC" on the upper left side of the screen. If you don't want to see the icon, please select Off.

Select **Setting > Camera > On Screen Menu > Off, On, or Load Preset Off.**



Camera Binding

With multiple cameras connection, users can set each camera to buttons 1 to 3 on the remote control.

Select **Setting > Camera > Camera Binding > Camera1, Camera2, or Camera3.**

[Note] When camera binding is off, press camera 1, 2, or 3 button on the remote control can control all the AVer USB camera nearby you.



Save Preset

Enable/disable "save preset" function. When applicable, IT personnel can limit end-user access to change preset points by locking "save preset" function and switching this function off.

When off, user can't save preset points via IR remote, Hot key, VISCA, and webpage.

Select **Setting > Camera > Save Preset > Off or On.**

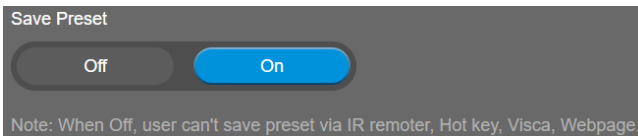

Image Settings

Image Flip

Flip the image vertically for upside down installation.

Select **Setting** > **Image** > **Image Flip** > **Off** or **On**.



Image Mirror

Flip the image horizontally.

Select **Setting** > **Image** > **Image Mirror** > **Off** or **On**.



WDR

In back light environment, enable WDR to improve the brightness of image.

Select **Setting** > **Image** > **WDR** > **Off** or **On**.

If users enable this function in a normal light condition, the image will become over exposure and encounter image blur.

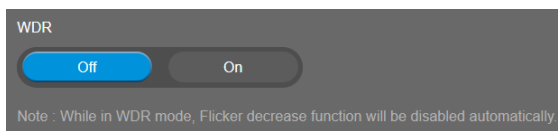

Flicker Decrease on IFP/Monitor

This is to ensure fluid content capture on IFP monitor

Select **Setting > Image > Flicker Decrease on IFP / Monitor > Off or On.**

[Note] While in WDR mode, flicker decrease function will be disabled.

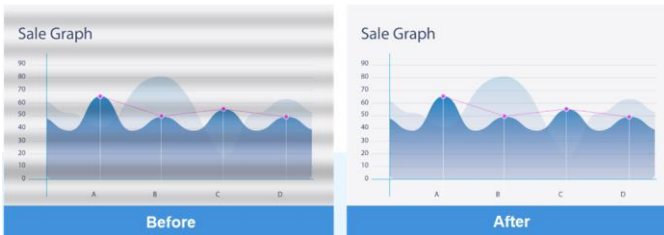
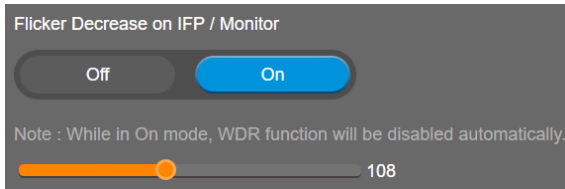

Frequency

Select the frequency of the camera.

Select **Setting > Image > Frequency > 50 HZ or 60 HZ.**



White Balance

Select the white balance setting for various light conditions or color temperature.

Select **Setting > Image > White Balance > Auto or Manual.**

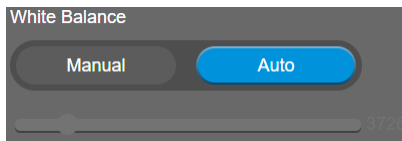

Noise Reduction

To reduce the noise from the signal.

Select **Setting > Image > Noise Reduction > Off, Low, Middle, or High.**



Brightness

Adjust the value of brightness.

Select **Setting > Image > Brightness > 1 ~ 9**.

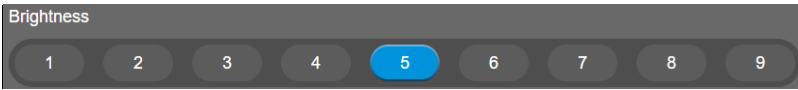

Sharpness

Adjust the value of sharpness.

Select **Setting > Image > Sharpness > Off, Low, Middle, or High**.



Saturation

Adjust the value of saturation.

Select **Setting > Image > Saturation > 1 ~ 9**.

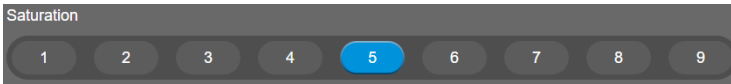

Low Light Compensation

Select **Setting > Image > Low Light Compensation > Off or On**.

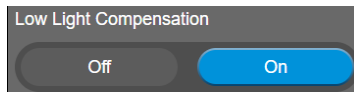

Low Resolution under 720p

Select **Setting > Image > Low resolution under 720p > Disable or Enable**.

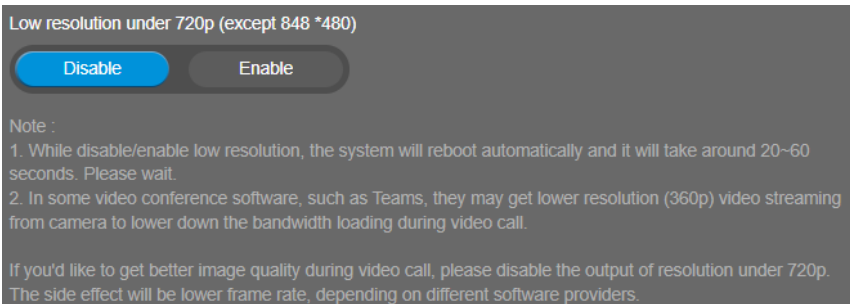

Enlarge Total Zoom Up To 36x

Enable/Disable enlarge zoom up to 36x. The default is 24x.

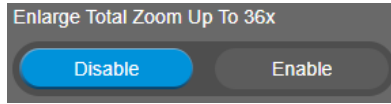

Video Frame Rate

Set up the frame rate value.

Select **Setting > Image > Video Frame Rate > 30Fps** or **60Fps**.

30fps is with much better image quality than 60fps. Unless you want to shoot fast moving objects, please use 30fps.

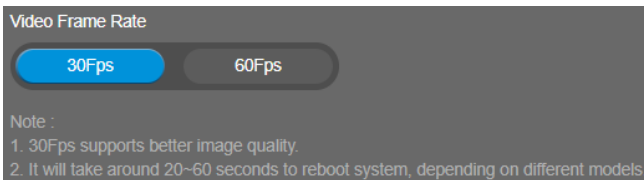

RS-232 Settings

When CAM520 Pro3 connects with PTZ camera controller through the RS-232 port, please setup **ADDR**, **Baud Rate**, **Protocol**, and **Visca Over IP** settings.

Select **Setting > RS-232**.

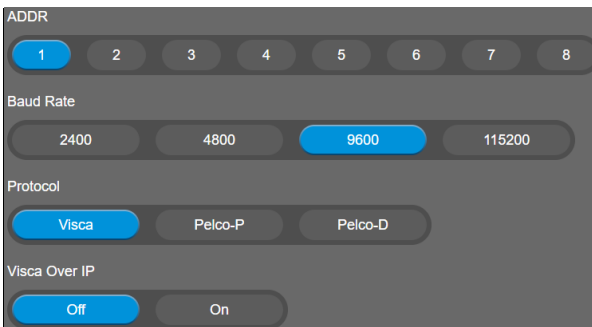

Video Format Settings

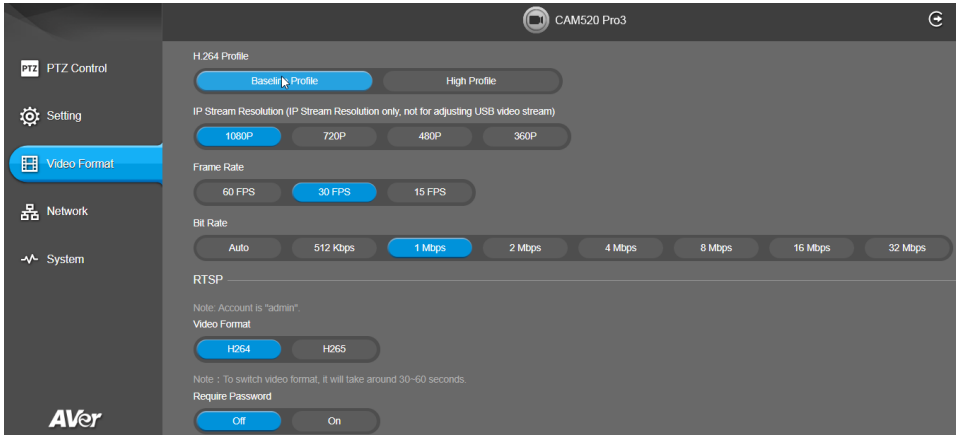

H.264 Profile

While in live broadcasting, user can choose preferable profile to get best streaming quality.

Select **Video Format > H.264 Profile > Baseline Profile or High Profile.**



IP Stream Resolution only

Set up the resolution for IP stream. Not supported for USB video stream.

Select **Video Format > IP Stream Resolution only (not for adjusting USB video stream) > 1080P, 720P, 480P, or 360P.**

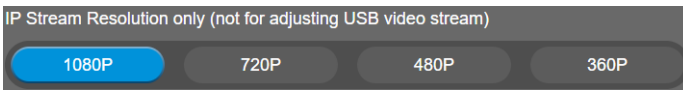

Frame Rate

Set up the frame rate value.

Select **Video Format > Frame Rate > 60 FPS, 30 FPS, or 15 FPS.**

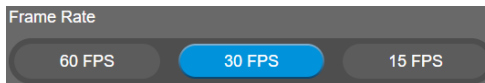

Bit Rate

Set up the bit rate value.

Select **Video Format > Bit Rate > Auto, 512 Kbps, 1 Mbps, 2 Mbps, 4 Mbps, 8 Mbps, 16 Mbps, or 32 Mbps.**

For Facebook live broadcasting, it's suggested to choose less than 4Mbps to ensure smooth streaming.



RTSP

To use RTSP player connecting to the camera, please enter the RTSP URL which displays on the web in your application such as VLC, PotPlayer, or Quick Time.

Select **On/Off** to enable/disable password requirement while opening RTSP.

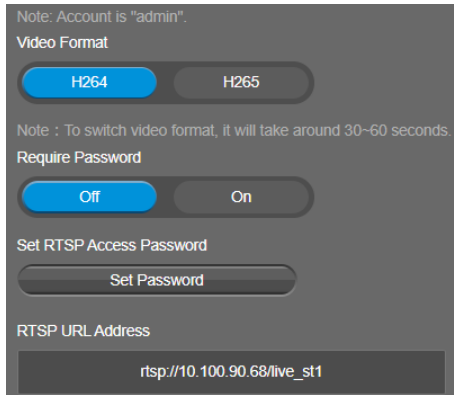

Change RTSP Password

1. Select **Video Format > RTSP > Set RTSP Access Password**.
2. Enter the new password.
3. Select **Change** to save the new password.

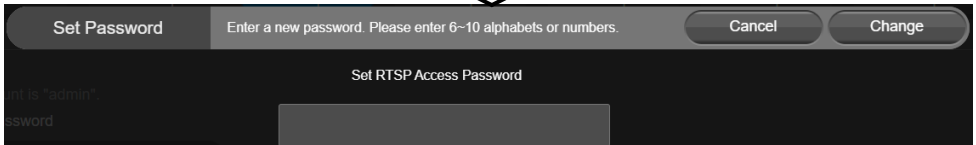
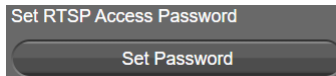

RTMP

Set up for uploading the camera's live view to the broadcasting platform (e.g. YouTube).

Select **Video Format > RTMP**.

1. Locate the RTMP server URL and stream key from the broadcasting platform and enter in **Server URL** and **Stream Key** fields.
2. Select **Start** to begin uploading the live video of the camera to the broadcasting platform.
3. Select **Stop** to stop uploading the video.

Note: Due to Facebook limitation, to ensure video quality, please set maximum Bitrate at 4Mbps.

Server URL

Stream Key

Start Using RTMP

Start

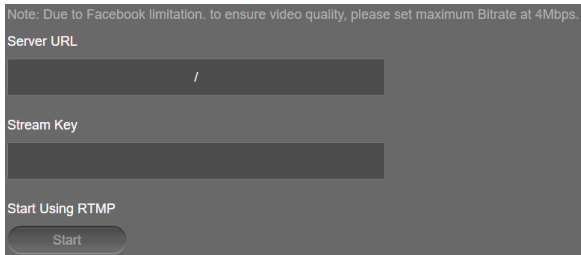
A screenshot of a user interface for configuring RTMP streaming. At the top, there is a note: "Note: Due to Facebook limitation, to ensure video quality, please set maximum Bitrate at 4Mbps." Below the note are two input fields: "Server URL" and "Stream Key". The "Server URL" field contains a single forward slash character "/". Below these fields is a section titled "Start Using RTMP" which contains a button labeled "Start".

Network Settings

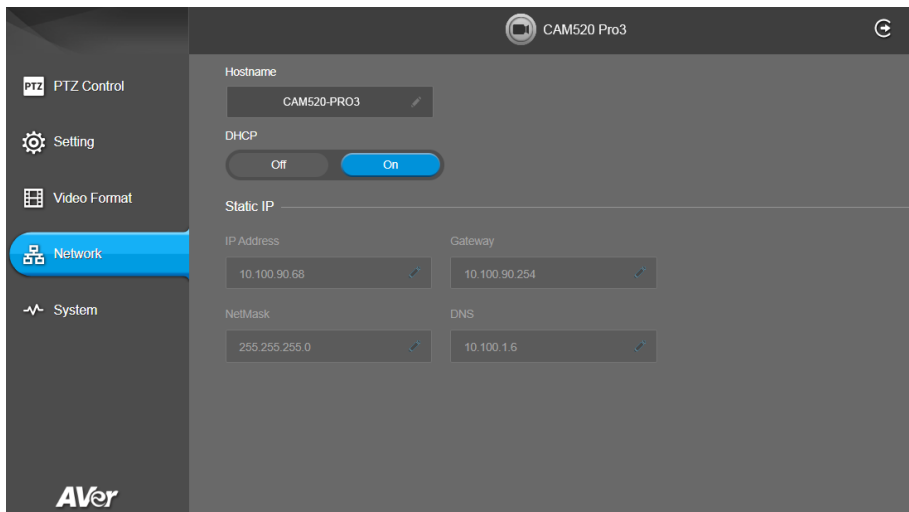

Hostname

User can set a hostname. The hostname only allows numeric and alphabetic characters.

Select **Network > Hostname**. Click the pencil icon to enter hostname.

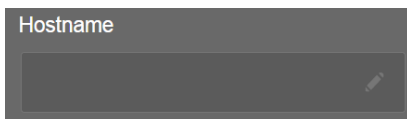

DHCP

Enable/disable DHCP function.

Select **Network > DHCP > Off** or **On**.



Static IP

Assign a fixed IP address to the camera. Please turn off the DHCP function.

1. Select **Network > DHCP > Off**.
2. Click pencil icon and enter the **IP Address**, **Gateway**, **NetMask**, and **DNS** in the corresponding fields.
3. Select **Confirm** to complete the setting.

IP Address	Gateway	NetMask	DNS
10.100.90.85	10.100.90.254	255.255.255.0	10.100.1.6



IP Address				Gateway				NetMask				DNS			
10	100	90	85	10	100	90	254	255	255	255	0	10	100	1	6
<input type="button" value="Confirm"/>															

System Settings

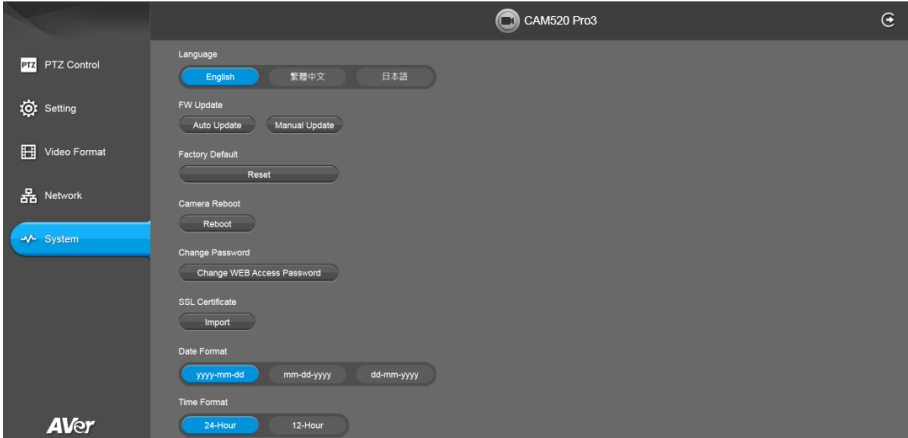

Language

Select the language of the system.

Select **System** > **Language** > **English**, **Traditional Chinese**, or **Japanese**.

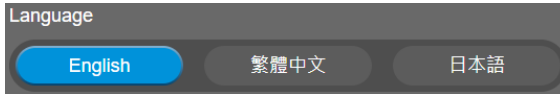

Firmware Update

Update the camera's firmware.

Select **System** > **FW Update** > **Auto Update** or **Manual Update**.



- **Auto Update:** The system will check firmware version from AVer server and request to update.
 - **Manual Update:** To update the firmware from specific location.
- After updating, the camera will **reboot** and the connection will be lost. Please wait for few minutes and always keep the power cable connected. If unplugging the power during this process, it will cause damage of the device.

Factory Default

Reset the camera back to factory default setting.

1. Select **System** > **Factory Default** > **Reset**.
2. User can choose to keep current IP address or back to default.
3. Select **Continue** to reset back to factory default.

[Note] When factory default is activated, the password of Webpage login will not be set to default. For security concerns, to reset password of webpage access, please download PTZApp 2 to reset it.

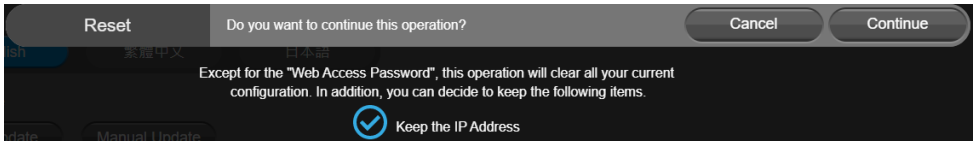
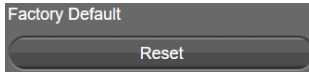

Camera Reboot

Restart the camera manually.

1. Select **System** > **Camera Reboot** > **Reboot**.
2. Select **Continue** to reboot the camera.

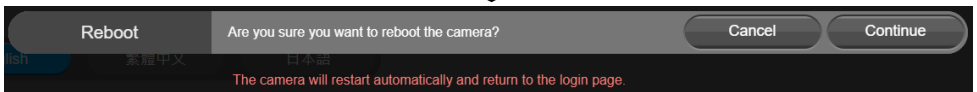
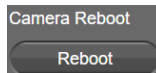

Change Password

Change the web login password. The default password is "aver4321".

1. Select **System** > **Change Password** > **Change WEB Access Password**.
2. Enter the old account and password. Select **Continue**.
3. Enter the new account and password. Select **Continue** to save the new setting.
4. If users forget the password and want to revert back to the default password, please use PTZApp 2 to reset it.

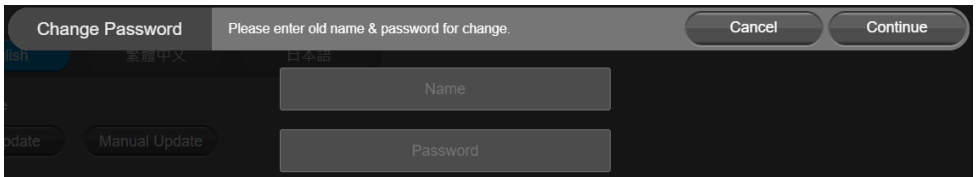
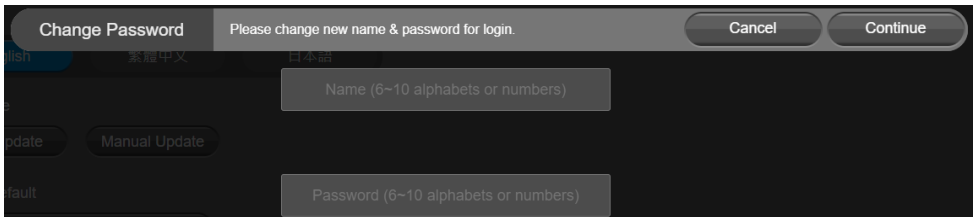
A screenshot of the "Change Password" screen. The title bar says "Change Password" and the subtitle is "Please enter old name & password for change." There are two input fields: "Name" and "Password". At the top right, there are "Cancel" and "Continue" buttons. On the left side, there are language options: "English", "繁體中文", and "日本語". There are also "Manual Update" and "Update" buttons visible.A screenshot of the "Change Password" screen. The title bar says "Change Password" and the subtitle is "Please change new name & password for login." There are two input fields: "Name (6~10 alphabets or numbers)" and "Password (6~10 alphabets or numbers)". At the top right, there are "Cancel" and "Continue" buttons. On the left side, there are language options: "English", "繁體中文", and "日本語". There are also "Manual Update" and "Update" buttons visible.

SSL Certificate

Import the SSL certificate from specific location.

1. Select **System** > **SSL Certificate** > **Import**.
2. Select the type by clicking "+".
3. Direct the file location.
4. Select **Import**.

[Note] If you want to disable SSL certificate function, please use PTZApp 2 to switch off this function.

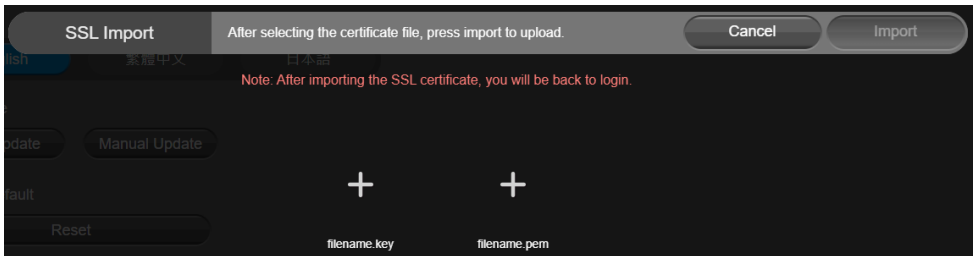
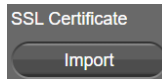

Date Format

Select the date format.

Select **System** > **Date Format** > **yyyy-mm-dd**, **mm-dd-yyyy**, or **dd-mm-yyyy**.

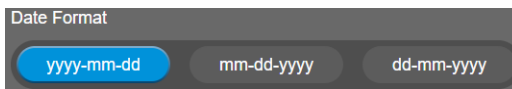

Time Format

Set up the time format.

Select **System** > **Time Format** > **24-Hour** or **12-Hour**.



Time Correction Mode

Adjust time automatically or manually.

Select **System > Time Correction Mode > Auto** or **Manual**.

- **Auto:** The system time will be set by NTP server on the network. Click the pencil icon of NTP Server and enter the URL of NTP server. Select the **Time Zone**. Select **NTP Update** to save setting. Select **Confirm** to start auto time adjustment.

[Note] Our default NTP server is located in the USA. If this does not work in your country, please manually key in the desired NTP server.

The screenshot shows the 'Time Correction Mode' interface. At the top, there are two buttons: 'Auto' (highlighted in blue) and 'Manual'. Below this, there are three main sections: 'NTP Server' with the value 'pool.ntp.org' and a pencil icon; 'Time Zone' with a dropdown menu showing 'UTC-12:00'; and 'NTP Update' with a button labeled 'Update Completed'. At the bottom, there is a 'Time' section showing '2021/4/29 17:42'.



This screenshot is similar to the previous one, but the 'NTP Update' button is now labeled 'Disconnect'. A 'Confirm' button is now visible at the bottom left of the interface.

- **Manual:** User can set up time manually. Click the pencil icon and enter the **Year, Month, Day, Hour, and Minute**. Select **Confirm** to save the settings.

The screenshot shows the 'Time Correction Mode' interface with 'Manual' selected. The 'Time' section shows '2021/4/29 19:01' with a pencil icon. Below this, there is a detailed time input form with labels 'Year / Month / Day' and 'Hour : Minute'. The input fields contain '2021', '04', '29' for the date and '19', '01' for the time. A 'Confirm' button is at the bottom.

Allow Providing of anonymous usage data

You can enable this function to help AVer continuously improve our products and services. Please visit AVer's privacy policy for more information. <https://www.aver.com/privacy>

Select **System** > **Allow Providing of anonymous usage data** > **Off** or **On**.

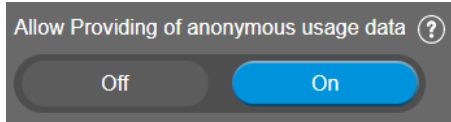

Information

Display the information of **Model Name**, **Firmware Version**, **Serial Number**, **IP Address**, and **MAC Address**.

Select **System** > **Information**.

Model Name	Firmware Version	Serial Number
CAM520 Pro3	0.0.7200.32	1234567890123
IP Address	MAC Address	
10.100.91.93	7e:67:58:f7:1a:6d	

PTZApp 2

In PTZApp 2, user can change the IP address setting of CAM520 Pro3, configure the parameters of the camera, set up AI tracking functions and some advanced image settings, pan, tilt, and zoom the camera.

Install PTZApp 2

Please go to <https://www.aver.com/download-center> (Headquarters and Europe) or <https://www.averusa.com/business/support/> (USA) to download the PTZApp 2. After downloading, double-click on the file and follow the on-screen instructions to complete the installation. After installing the PTZApp 2, double-click on the PTZApp 2 icon to run the application.

[Notes]

While installing PTZApp 2, if you refuse to install IP virtual streaming, Keystone Correction and Smart Gallery plug-in in your PC (illustrated as below), you will not be able to use these functions. To enable these functions, please reinstall PTZApp 2 for the necessary plug-in. Note: Keystone Correction and Smart Gallery plug-in are not available now and would be updated in later release.

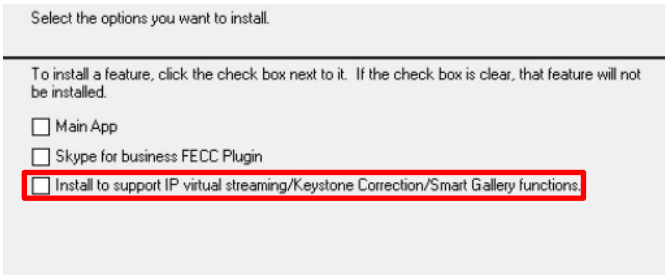

(Windows PC)

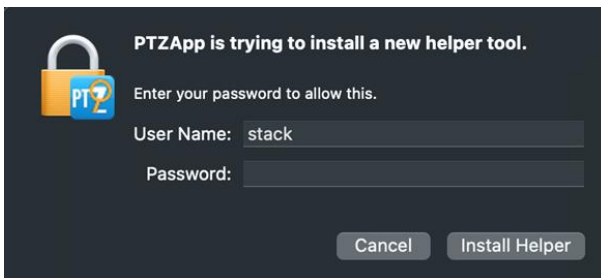

(MAC PC)

Use PTZApp 2 with USB Devices

1. Run your video application and make a video call.
2. During your video call, you can use the PTZApp 2 to pan, tilt and zoom the camera in/out and enable/disable the true WDR, brightness, and sharpness feature.
3. Launch PTZApp 2 () and it will open in Chrome browser automatically.

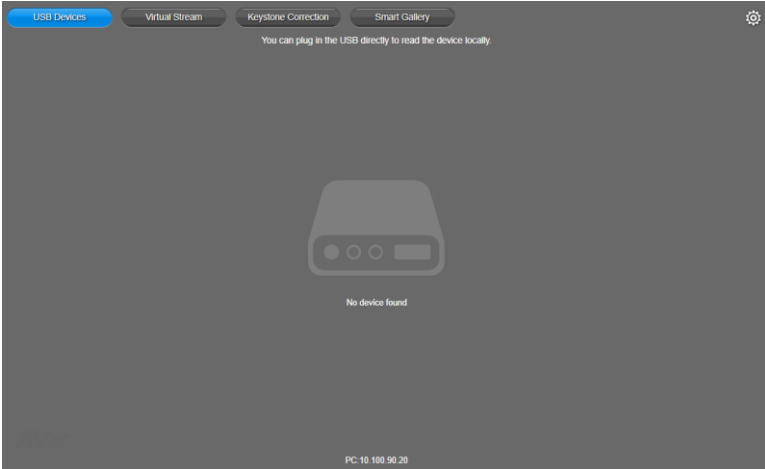

4. Choose “USB device” and connect CAM520 Pro3 to PC/laptop with USB cable. When the camera is detected, the product card will show up.



5. Set up IP address. The camera default IP address is **192.168.1.168**. Click pencil icon (✎) to edit IP address.

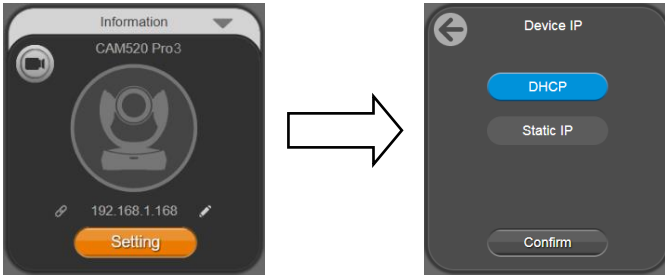

6. Click the setting icon to change Language, Hotkey Control, and PTZApp 2 Version.

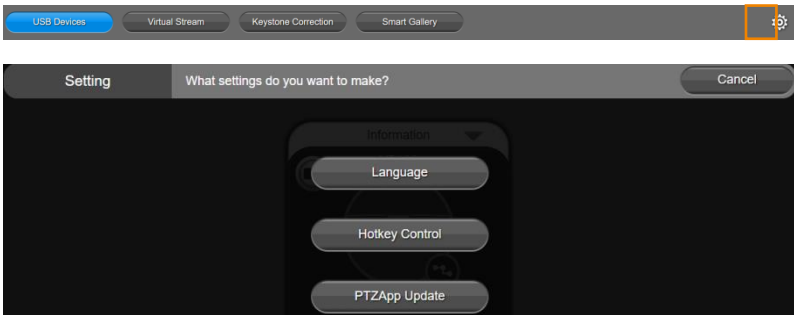

- **Language:** Select desired language and click the check icon to confirm the selection.



- **Hotkey Control:** User can control the camera by using keyboard. This is a general list for all AVer USB Cameras. Backlight control equals to WDR function in CAM520 Pro3.

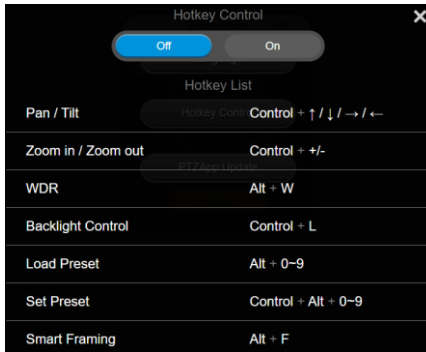

- **PTZApp Update:** Get current PTZApp 2's version number and do auto update here.



7. **Information:** Click the drop-down triangle icon to review the information of camera. To minimize the information, click the triangle again or the model name.







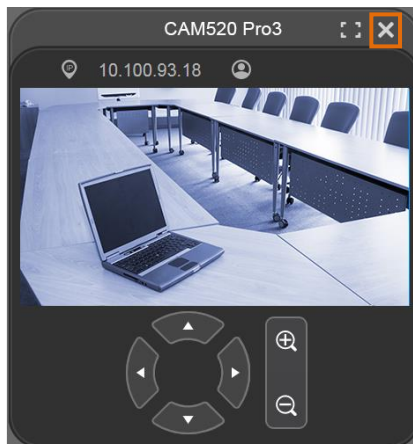

8. **Camera:** Click the camera icon to view the camera live view.



Click the X icon to close the camera live view. If the live video did not appear, please check the camera and the laptop/PC connection to make sure all are correct and well connected. The resolution of this small live view is 640x480 resolutions.



- **Full Screen:** PTZApp 2 can switch to full screen mode. Click   icon and video screen will switch to full screen mode. In full screen mode, user can use direction panel to control camera direction.   camera direction. Click   icon to go back to normal screen view. The resolution of full screen mode is 1080p/ 30fps.

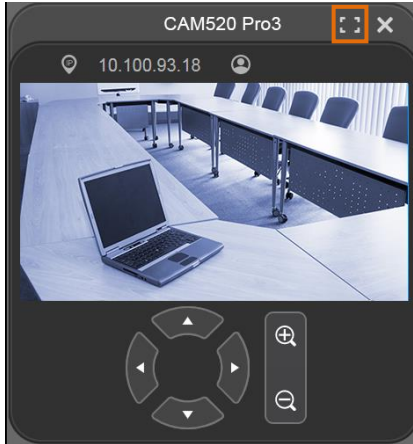

- **People Count and Stream Interval:** Click the  icon to show people count number and stream interval. Click the  or  icon to hide the stream interval.



- **Control Panel:** To control the camera direction, zoom in and out during your video call.

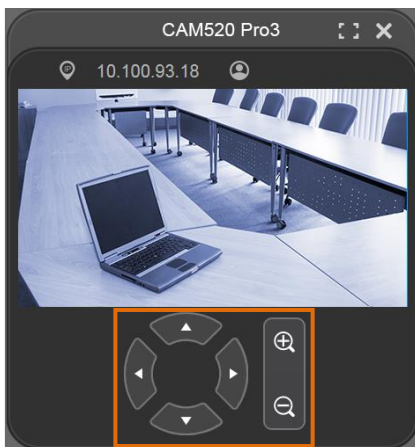

9. **Setting:** Click “**Setting**” button to set up parameters of the camera and speakerphone. Click arrow icon to leave the Setting page.

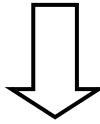

- **PTZ Control:** Use control panel to set up preset positions. Since most of operations are the same as web page, refer to [<PTZ Control>](#) for detailed setup.
- **Setting:** To set up parameters of the camera. Since most of operations are the same as web page, refer to [<Camera Settings>](#) , [<Image Settings>](#), and [<RS-232 Settings>](#) for detailed setup.
- **System:** To set up system. Since most of operations are the same as web page, refer to [<System Settings>](#) for detailed setup.

10. **PTZApp 2 Quit & Restore:** To quit the application, right-click the icon on the system tray and select **Quit**. If you can't launch PTZApp 2 right after installation, please right -click the icon and choose **Restore**.

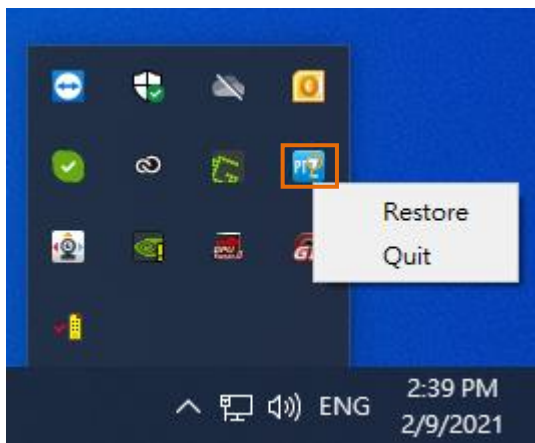

Use PTZApp 2 with a Virtual Stream

With this function, you can have a virtual meeting with only Ethernet connection and get rid of USB cable connection. Make sure the camera is connected with Ethernet and under the same subnetwork as the meeting room PC (e.g. NUC) and the RTSP function is enabled.

1. Launch PTZApp2 () on a PC and click **Virtual Stream**.
2. When the camera card appears, click **Start** to enable the Virtual Stream function.

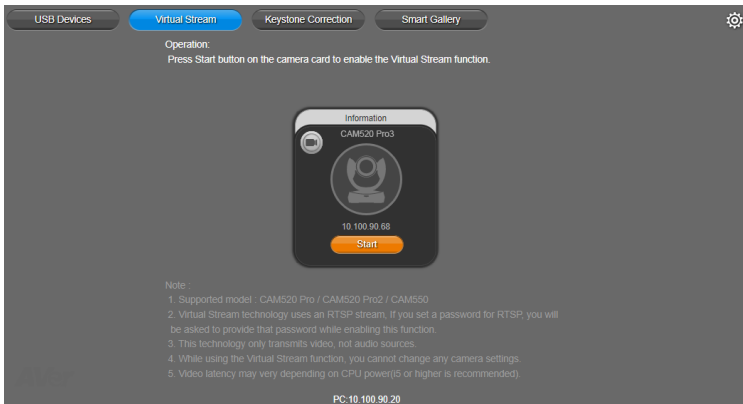

3. Virtual Stream technology uses an RTSP stream. If you set a password for RTSP, you will be asked to provide that password while enabling this function.

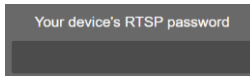

4. Launch VC software (e.g. Zoom, Teams, Skype) and choose AVer USB VCam as the video source to start collaborating.
5. While using the Virtual Stream function, you cannot change any camera settings. To pan/tilt or zoom in/out the camera, use a remote control or VISCA control.
6. Click **Stop** and **Home** to stop using this function.

[Notes]

- This technology only transmits video, not audio sources.
- Video latency may vary depending on CPU power (i5 or higher is recommended).

EZLive

Please go to <http://www.aver.com/download-center> to download the AVer EZLive software. After downloading, double-click on the file and follow the on-screen instructions to complete the installation.

Use AVer EZLive

During a video call, EZLive can help user to do:

- (1) Camera ePTZ
- (2) Volume control for the speaker connected
- (3) Capture camera's still images
- (4) Record video
- (5) Live stream to Youtube, Livehouse.in, USTREAM...etc.
- (6) Camera Zoom in/out
- (7) Capture PC screen shot
- (8) Record PC screen video
- (9) Set up livestream
- (10) Open file management to retrieve photos and video files
- (11) Livestream setting
- (12) Drawing tool

