

PRO 22X Series

All-in-One (AIO) PC

MS-ACD3 System

Contents

Copyright and Trademarks Notice	iii
Revision	iii
Upgrade and Warranty	iv
Acquisition of Replaceable Parts	iv
Technical Support	iv
Chemical Substances Information	iv
Battery Information	v
Safety Instructions.....	vi
CE Conformity.....	viii
FCC-B Radio Frequency Interference Statement	viii
WEEE Statement	ix
RoHS Statement	ix

Overview.....1-1

Packing Contents	1-2
System Overview	1-3
Component Replacement & Upgrade	1-8

Getting Started.....2-1

Safety & Comfort Tips	2-2
Hardware Setup	2-3

System Operations.....3-1

Power Management.....	3-2
Network Connection (Windows 10).....	3-3
System Recovery (Windows 10)	3-6
System Recovery (F3 Hotkey Recovery) (Optional)	3-10

OSD Setup.....4-1

Navi Key	4-2
OSD Setup via Navi Key	4-5

Troubleshooting.....A-1

Copyright and Trademarks Notice

Copyright © Micro-Star Int'l Co., Ltd. All rights reserved. The MSI logo used is a registered trademark of Micro-Star Int'l Co., Ltd. All other marks and names mentioned may be trademarks of their respective owners. No warranty as to accuracy or completeness is expressed or implied. MSI reserves the right to make changes to this document without prior notice.

Revision

Revision	Date
V1.0	2020/07

Upgrade and Warranty

Please note that certain components preinstalled in the product may be upgradable or replaceable by user's request. For any further information about the product users purchased, please contact the local dealer. Do not attempt to upgrade or replace any component of the product if you are not an authorized dealer or service center, since it may cause the warranty void. It is strongly recommended that you contact the authorized dealer or service center for any upgrade or replace service.

Acquisition of Replaceable Parts

Please be noticed that the acquisition of replaceable parts (or compatible ones) of the product users purchased in certain countries or territories may be fulfilled by the manufacturer within 5 years at most since the product has been discontinued, depending on the official regulations declared at the time. Please contact the manufacturer via <https://www.msi.com/support/> for the detailed information about the acquisition of spare parts.

Technical Support

If a problem arises with your system and no solution can be obtained from the user's manual, please contact your place of purchase or local distributor. Alternatively, please try the following help resources for further guidance. Visit the MSI website for technical guide, BIOS updates, driver updates and other information via <https://www.msi.com/support/>

Chemical Substances Information

In compliance with chemical substances regulations, such as the EU REACH Regulation (Regulation EC No. 1907/2006 of the European Parliament and the Council), MSI provides the information of chemical substances in products at: https://www.msi.com/html/popup/csr/evmtprrt_pcm.html

Battery Information



European Union:

Batteries, battery packs, and accumulators should not be disposed of as unsorted household waste. Please use the public collection system to return, recycle, or treat them in compliance with the local regulations.



Taiwan:

For better environmental protection, waste batteries should be collected separately for recycling or special disposal.

廢電池請回收

California, USA:

The button cell battery may contain perchlorate material and requires special handling when recycled or disposed of in California.

For further information please visit: <https://dtsc.ca.gov/perchlorate/>

Safety Instructions



- ☐ Read the safety instructions carefully and thoroughly.
- ☐ All cautions and warnings on the computer or user's manual should be noted.



- ☐ Make sure that the power voltage is within its safety range and has been adjusted properly to the value of 100~240V before connecting the computer to the power outlet.
- ☐ If the power cord comes with a 3-pin plug, do not disable the protective earth pin from the plug. The computer must be connected to an earthed mains socket-outlet.
- ☐ Always unplug the AC power cord before installing any add-on card or module to the computer.
- ☐ Always disconnect the AC power cord or switch the wall socket off if the computer would be left unused for a certain time to achieve zero energy consumption.
- ☐ Place the power cord in a way that people are unlikely to step on it. Do not place anything on the power cord.
- ☐ If this computer comes with an adapter, use only the MSI provided AC adapter approved for use with this computer.
- ☐ Power Rating: 120W: 19.5V  6.15A



- Please take special precautions if this computer comes with a battery.
- ☐ Danger of explosion if battery is incorrectly replaced. Replace only with the same or equivalent type recommended by the manufacturer.
 - ☐ Avoid disposal of a battery into fire or a hot oven, or mechanically crushing or cutting of a battery, which can result in an explosion.
 - ☐ Avoid leaving a battery in an extremely high temperature or extremely low air pressure environment that can result in an explosion or the leakage of flammable liquid or gas.
 - ☐ Do not ingest battery. If the coin/button cell battery is swallowed, it can cause severe internal burns and can lead to death. Keep new and used batteries away from children.



- ☐ To reduce the possibility of heat-related injuries or of overheating the computer, do not place the computer on a soft, unsteady surface or obstruct the computer air ventilators.
- ☐ Use this computer only on a hard, flat and steady surface.



- ☐ Keep this computer away from humidity and high temperature.
- ☐ Do not leave the computer in an unconditioned environment with a storage temperature above 60°C or below 0°C, which may damage the computer.
- ☐ The maximum operating temperature is around 35°C.



Never pour any liquid into the opening that could damage or cause electrical shock.



Always keep the strong magnetic or electrical objects away from the computer.



If any of the following situations arises, get the computer checked by service personnel:

- The power cord or plug is damaged.
- Liquid has penetrated into the computer.
- The computer has been exposed to moisture.
- The computer does not work well or you can not get it work according to user's manual.
- The computer has dropped and damaged.
- The computer has obvious sign of breakage.

Green Product Features

- Reduced energy consumption during use and stand-by
- Limited use of substances harmful to the environment and health
- Easily dismantled and recycled
- Reduced use of natural resources by encouraging recycling
- Extended product lifetime through easy upgrades
- Reduced solid waste production through take-back policy



Environmental Policy

- The product has been designed to enable proper reuse of parts and recycling and should not be thrown away at its end of life.
- Users should contact the local authorized point of collection for recycling and disposing of their end-of-life products.
- Visit the MSI website and locate a nearby distributor for further recycling information.
- Users may also reach us at gpcntdev@msi.com for information regarding proper disposal, take-back, recycling, and disassembly of MSI products.

★ Warning! Overuse of screens is likely to affect eyesight.

★ Recommendations:

1. Take a 10-minute break for every 30 minutes of screen time.
2. Children under 2 years of age should have no screen time. For children aged 2 years and over, screen time should be limited to less than one hour per day.

CE Conformity

Hereby, Micro-Star International CO., LTD declares that this device is in compliance with the essential safety requirements and other relevant provisions set out in the European Directive.



FCC-B Radio Frequency Interference Statement



This equipment has been tested and found to comply with the limits for a Class B digital device, pursuant to Part 15 of the FCC Rules. These limits are designed to provide reasonable protection against harmful interference in a residential installation. This equipment generates, uses and can radiate radio frequency energy and, if not installed and used in accordance with the instruction manual, may cause harmful interference to radio communications. However, there is no guarantee that interference will not occur in a particular installation. If this equipment does cause harmful interference to radio or television reception, which can be determined by turning the equipment off and on, the user is encouraged to try to correct the interference by one or more of the measures listed below:

- Reorient or relocate the receiving antenna.
- Increase the separation between the equipment and receiver.
- Connect the equipment into an outlet on a circuit different from that to which the receiver is connected.
- Consult the dealer or an experienced radio/television technician for help.

viii

Notice 1

The changes or modifications not expressly approved by the party responsible for compliance could void the user's authority to operate the equipment.

Notice 2

Shielded interface cables and AC power cord, if any, must be used in order to comply with the emission limits.

This device complies with Part 15 of the FCC Rules. Operation is subject to the following two conditions:

1. this device may not cause harmful interference, and
2. this device must accept any interference received, including interference that may cause undesired operation.

MSI Computer Corp.

901 Canada Court, City of Industry, CA 91748, USA

(626)913-0828

www.msi.com

WEEE Statement

Under the European Union (“EU”) Directive on Waste Electrical and Electronic Equipment, Directive 2002/96/EC, which takes effect on August 13, 2005, products of “electrical and electronic equipment” cannot be discarded as municipal waste anymore and manufacturers of covered electronic equipment will be obligated to take back such products at the end of their useful life.



RoHS Statement

Japan JIS C 0950 Material Declaration

A Japanese regulatory requirement, defined by specification JIS C 0950, mandates that manufacturers provide material declarations for certain categories of electronic products offered for sale after July 1, 2006.

https://storage-asset.msi.com/html/popup/csr/cemm_jp.html

India RoHS

This product complies with the “India E-waste (Management and Handling) Rule 2011” and prohibits use of lead, mercury, hexavalent chromium, polybrominated biphenyls or polybrominated diphenyl ethers in concentrations exceeding 0.1 weight % and 0.01 weight % for cadmium, except for the exemptions set in Schedule 2 of the Rule.

Turkey EEE regulation

Conforms to the EEE Regulations of the Republic Of Turkey.

Ukraine restriction of hazardous substances

The equipment complies with requirements of the Technical Regulation, approved by the Resolution of Cabinet of Ministry of Ukraine as of December 3, 2008 № 1057, in terms of restrictions for the use of certain dangerous substances in electrical and electronic equipment.

Vietnam RoHS

As from December 1, 2012, all products manufactured by MSI comply with Circular 30/2011/TT-BCT temporarily regulating the permitted limits for a number of hazardous substances in electronic and electric products.

1

Overview

This system is integrated in design, selecting a stylish appearance with a mirror screen, which displays the simplicity of modern individualism and the comfort of home. With a touchscreen display, flawless audio/video capabilities and intuitive user interface, it blends technology with life, making computers easier and more fun to use — suitable for the whole family.

Packing Contents

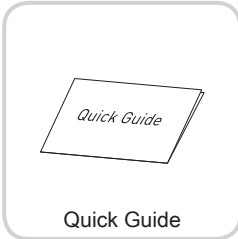
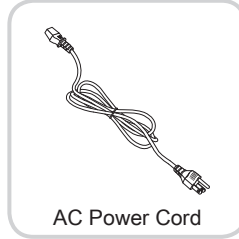
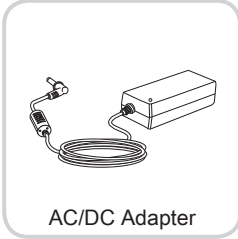
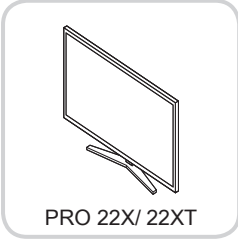

1-2

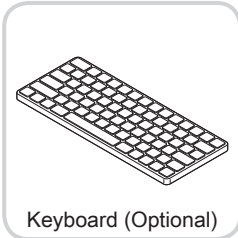
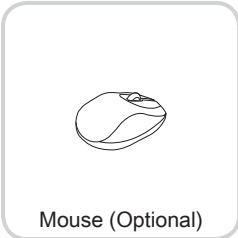

- * Please contact us immediately if any of the items is damaged or missing.
- * The illustrations are for reference only and your packing contents may slightly vary depending on the model you purchased.

System Overview

► Front View

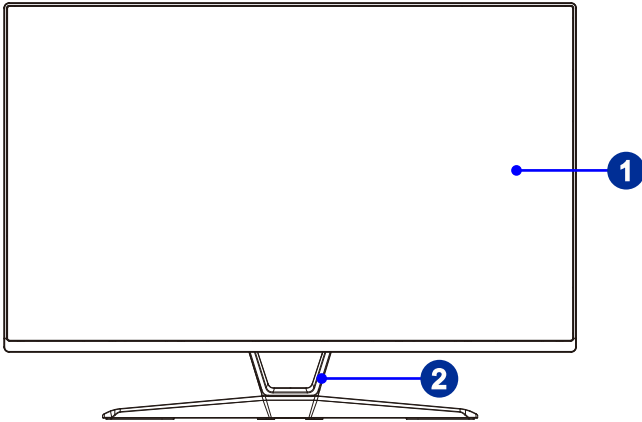
**1****Display**

The 21.5-inch LED-backlit display provides 1920 x 1080 FHD resolution in a 16:9 widescreen format.

2**Stand**

Use this stand to position your system on a flat and stable surface.

► Side View

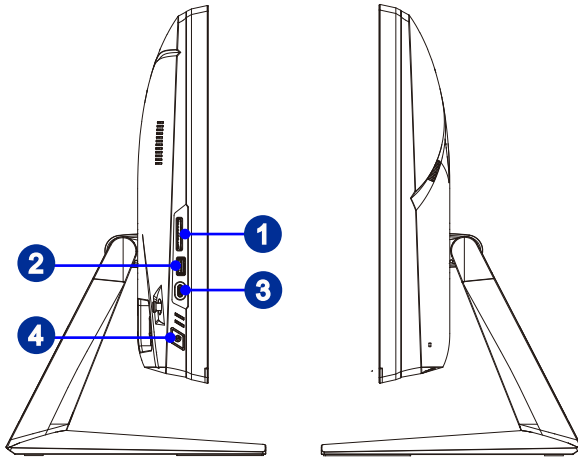

1-4

1

Card Reader Drive

The built-in card reader may support various types of memory cards.

2

USB 3.2 Gen 1 Port

USB 3.2 Gen 1, the SuperSpeed USB, delivers up to 5Gbps high-speed data transfer for various devices, such as storage devices, hard drives, video cameras, etc.

3

USB 3.2 Gen 1 Port (Type-C)

USB 3.2 Gen 1, the SuperSpeed USB, delivers up to 5Gbps high-speed data transfer for various devices, such as storage devices, hard drives, video cameras, etc. The slim and sleek USB Type-C connector features reversible plug orientation and up to 5V/3A power supply for external devices.

4

Power Button

Press the power button to turn the system on and off.

► Rear View

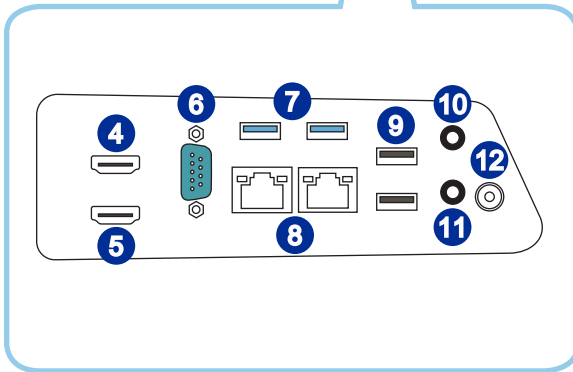
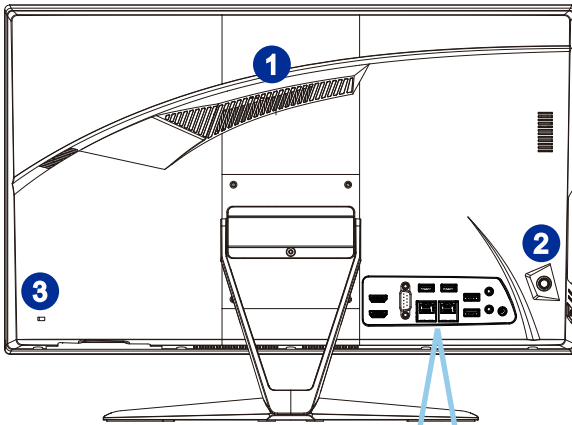

Important

We suggest that you connect the AC/DC adapter to your AIO PC first and then connect the AC power cord to the socket-outlet for safety concerns.

1 Ventilator

The ventilator on the enclosure is used for air convection and to prevent the equipment from overheating. Do not cover the ventilator.

2 Navi Key

The AIO PC comes with a Navi Key, a multi-directional control that helps navigate the On-Screen Display (OSD) menu.

3 Kensington Lock Port

This AIO PC provides a Kensington lock port, which allows users to secure the AIO PC in place with a key or some mechanical PIN device and attached through a rubberised metal cable. The end of the cable has a small loop which allows the whole cable to be looped around a permanent object, such as a heavy table or other similar equipment, thus securing the AIO PC in place.

4 HDMI-Out Port 

The High-Definition Multimedia Interface (HDMI) is an all-digital audio/video interface capable of transmitting uncompressed streams. HDMI supports all TV format, including standard, enhanced, or high-definition video, plus multi-channel digital audio on a single cable.

5 HDMI-In Port (with MSI Instant Display Technology) 

The High-Definition Multimedia Interface (HDMI) is an all-digital audio/video interface capable of transmitting uncompressed streams. HDMI supports all TV format, including standard, enhanced, or high-definition video, plus multi-channel digital audio on a single cable.

With MSI Instant Display Technology, when you connect power to the AIO PC successfully, the monitor will automatically enter “standby” mode without pressing the power button. When devices are connected to the HDMI-in port, the monitor will be turned on immediately. You can also switch the modes through the Monitor Power/ Mode Button on the side panel if you have already turned on your AIO PC. This technology helps to save more energy for your system.

6 Serial Port

The serial port supports barcode scanners, barcode printers, bill printers, credit card machine, etc.

7 USB 3.2 Gen 1 Port

USB 3.2 Gen 1, the SuperSpeed USB, delivers up to 5Gbps high-speed data transfer for various devices, such as storage devices, hard drives, video cameras, etc.

8 RJ-45 LAN Jack

The standard RJ-45 LAN jack is provided for connection to the Local Area Network (LAN). You can connect a network cable to it.

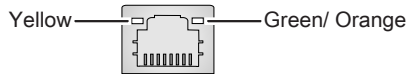

LED	Color	LED State	Condition
Left	Yellow	Off	LAN link is not established.
		On (steady state)	LAN link is established.
		On (blinking)	The computer is communicating with another computer on the LAN.
Right	Green	Off	10 Mbit/sec data rate is selected.
		On	100 Mbit/sec data rate is selected.
	Orange	On	1000 Mbit/sec data rate is selected.

9 USB 2.0 Port

The USB (Universal Serial Bus) port is for attaching USB devices such as keyboard, mouse, or other USB-compatible devices. It supports up to 480Mbit/s (Hi-Speed) data transfer rate.

10 Headphone Jack

This connector is provided for headphones or speakers.

11 Microphone Jack

This connector is provided for microphones.

12 Power Jack

The AC/DC adapter converts AC power to DC power for this jack. Power supplied through this jack supplies power to the PC. To prevent damage to the PC, always use the supplied power adapter.

Important

High-speed devices are recommended for USB 3.2 ports whereas low-speed devices, such as mouse or keyboard, are suggested to be plugged into the USB 2.0 ports.

Component Replacement & Upgrade

Please note that certain components preinstalled in the product may be upgradable or replaceable by user's request depending on the models users purchased.

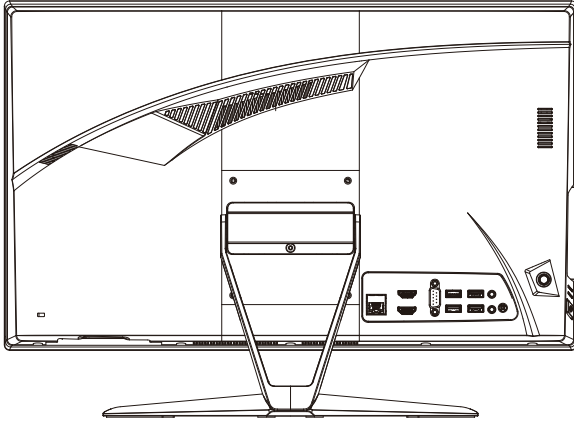

1-8

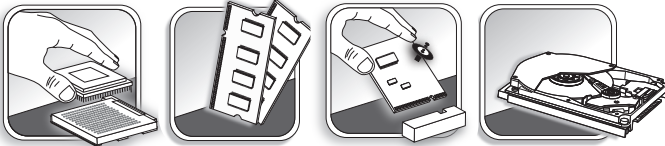

For any further information on the product users purchased, please contact the local dealer. Do not attempt to upgrade or replace any component of the product if you are not an authorized dealer or service center, since it may cause the warranty void. It is strongly recommended that you contact the authorized dealer or service center for any upgrade or replace service.

2

Getting Started

This chapter provides you with the information on hardware setup procedures. While connecting peripheral devices, be careful in holding the devices and use a grounded wrist strap to avoid static electricity.

Safety & Comfort Tips

The AIO PC is a portable platform that allows you to work anywhere. However, choosing a good workspace is important if you have to work with your PC for a long period of time.

1. Your work area should have enough illumination.
2. Choose the proper desk and chair and adjust their height to fit your posture when operating.
3. When sitting on the chair, sit straight and keep a good posture. Adjust the chair's back (if available) to support your back comfortably.
4. Place you feet flat and naturally on the floor, so that your knees and elbows have the proper position (about 90-degree) when operating.
5. Put your hands on the desk naturally to support your wrists.
6. Adjust the angle/ position of the AIO PC to have an optimal view.
7. Avoid using your PC in a place where discomfort may occur (such as on the bed).
8. The AIO PC is an electrical device. Please treat it with great care to avoid personal injury.

Hardware Setup

Important

- The illustrations are for reference only. Your system may vary in appearance.
 - Please make sure the system has been grounded to earth through the AC power cord and the electrical outlet before powering on the system.
 - Do not use any sharp objects on the display.
1. Adjust the stand to an appropriate angle until the system is securely positioned.



2. Connect the adapter to the system and plug in the power cord.

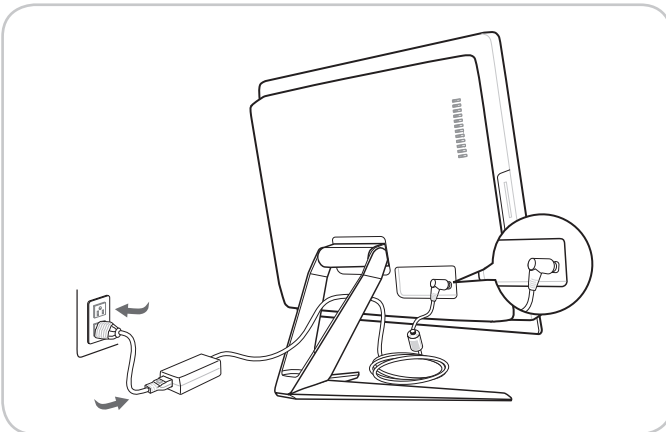

3. Press the power button to power on the system.

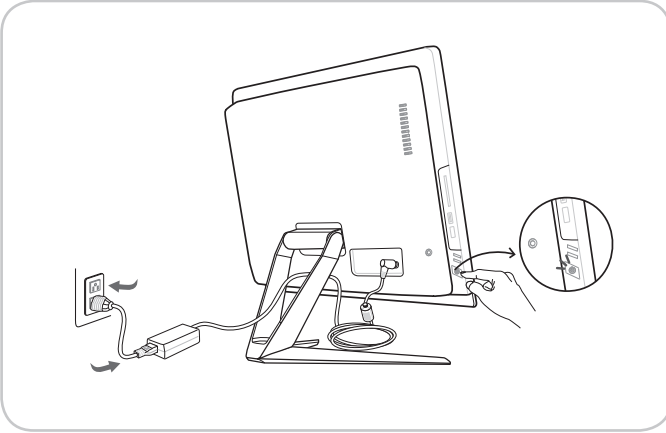

3

System Operations

This chapter provides you with essential information on system operations.

Important

All information is subject to change without prior notice.

Power Management

Power management of personal computers (PCs) and monitors has the potential to save significant amounts of electricity as well as deliver environmental benefits. To be energy efficient, turn off your display or set your PC to sleep mode after a period of user inactivity.

► Power Management in Windows 10

- [Power Options] in Windows OS allow you to control the power management features of your display, hard drive, and battery. Right-click [Start] , select [Control Panel] from the list and then click [System and Security].



Select [Power Options] and choose a power plan that suits your personal needs. You may also fine-tune the settings by clicking [Change plan settings].

- The Shut Down Computer menu presents the options of Sleep (S3/S4) & Shut Down (S5) for rapid and easy management of your system power.

3-2

► Waking the System Up

The computer shall be able to wake up from power saving mode in response to a command from any of the following:

- the power button,
- the network (Wake On LAN),
- the mouse,
- the keyboard.



Energy Saving Tips:

- Turn off the monitor by pressing the monitor power button after a period of user inactivity.
- Tune the settings in Power Options under Windows OS to optimize your PC's power management.
- Install power saving software to manage your PC's energy consumption.
- Always disconnect the AC power cord or switch the wall socket off if your PC would be left unused for a certain time to achieve zero energy consumption.

Network Connection (Windows 10)

► Wired Network

1. Right-click [Start]  and select [Network Connections] from the list.
2. Select [Ethernet] and then [Network and Sharing Center].

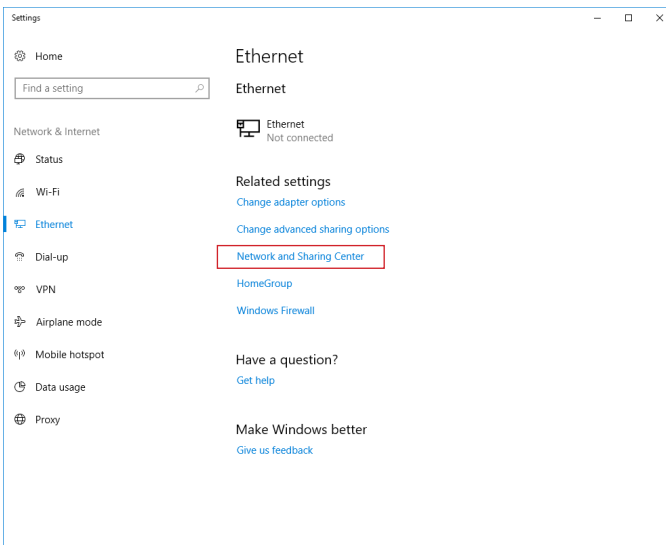

3. Select [Set up a new connection or network].

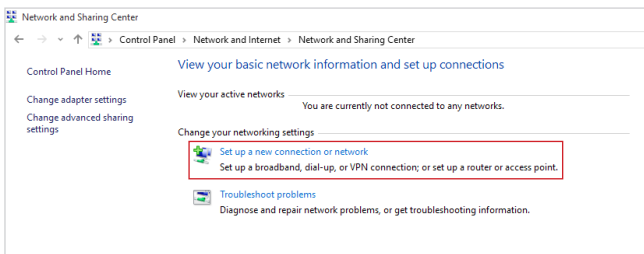

4. Choose [Connect to the Internet] and click [Next].
5. Select [Broadband (PPPoE)] to connect using DSL or cable that requires a user name and password.

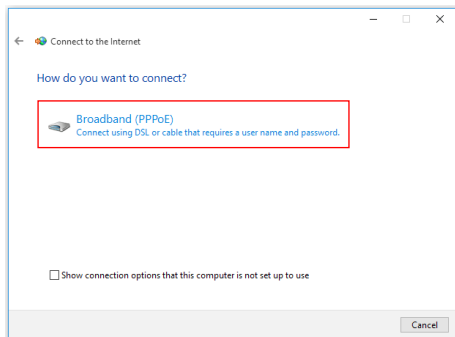

6. Type the information from your Internet Service Provider (ISP) and click [Connect] to establish your LAN connection.

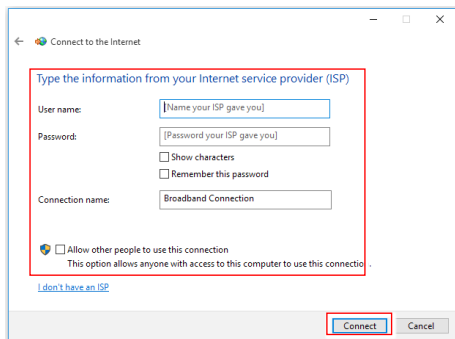

► Wireless Network

1. Go to [Start] , click [Settings] and select [Network and Internet].
2. A list of available WLAN connections pops up. Choose a connection from the list.
3. To establish a new connection, select [Network and Sharing Center].

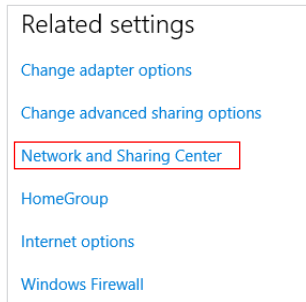

4. Select [Set up a new connection or network].
5. Followingly, choose [Manually connect to a wireless network] and click [Next] to continue.
6. Enter information for the wireless network you intend to add and click [Next] to proceed.

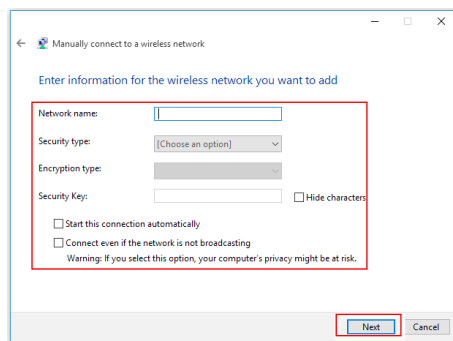

7. A new WLAN connection has been made.

System Recovery (Windows 10)

The purposes for using the System Recovery Function may include:

- Restore the system back to the initial status of original manufacturer's default settings.
- When some errors have occurred to the operating system in use.
- When the operating system is affected by virus and is not able to work normally.
- When you want to install the OS with other built-in languages.

Before using the System Recovery Function, please back up the important data saved on your system drive to other storage devices.

If the following solution fails to recover your system, please contact the authorized local distributor or service center for further assistance.

Reset this PC

1. Go to [Start] , click [Settings] and select [Update and security].
2. Select [Recovery] and click [Get started] under [Reset this PC] to start the system recovery.

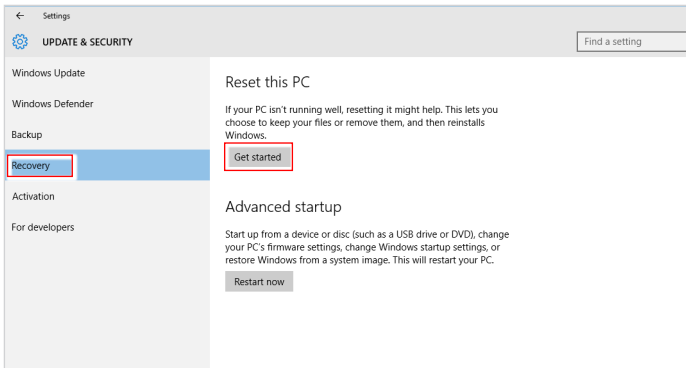

3. The [Choose an option] screen pops up. Choose between [Keep my files] and [Remove everything].

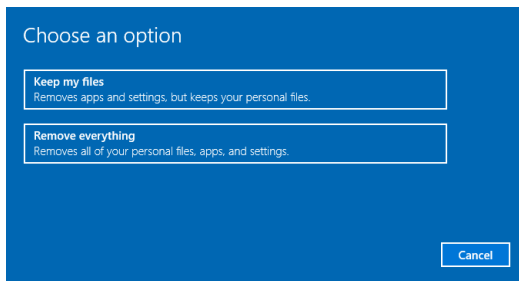

Reset this PC	Keep my files		
	Remove everything	Only the drive where Windows is installed	Just remove my files
			Remove files and clean the drive
	All drives		Just remove my files
		Remove files and clean the drive	

► Keep my files

1. Select [Keep my files].

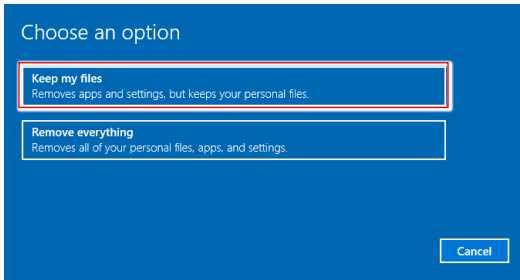

2. The [Your apps will be removed] screen shows a list of apps that will need to be reinstalled from the web or installation discs. Click [Next] to continue.

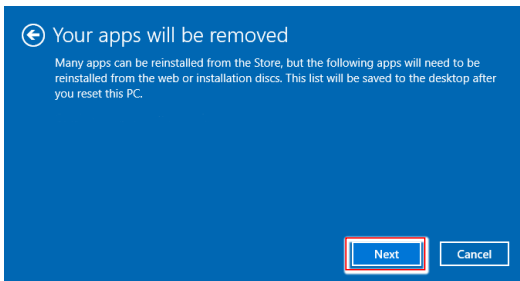

3. The next screen will show the changes to be made during the process. Click [Reset] to start the system reset.

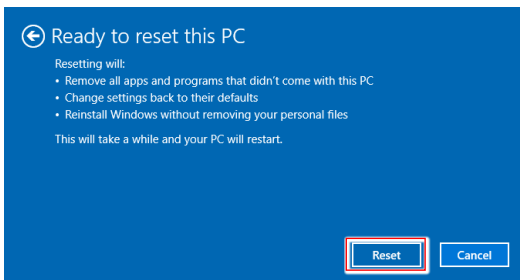

► Remove everything

1. Select [Remove everything].

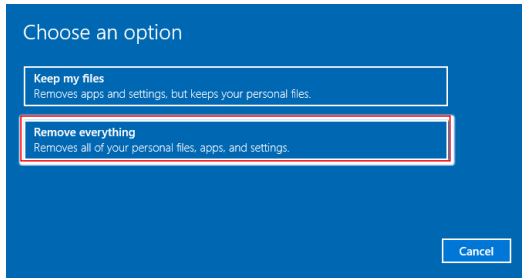

2. If you have multiple hard drives, a screen will pop up, asking you to choose between [Only the drive where Windows is installed] and [All drives].
3. Then select between [Just remove my files] and [Remove files and clean the drive].

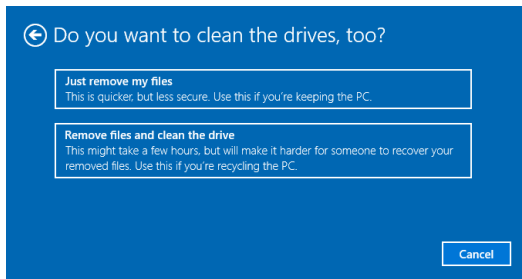

4. The next screen will show the changes to be made during the process. Click [Reset] to start the system reset.

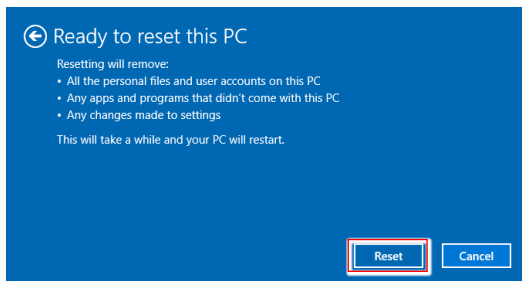

System Recovery (F3 Hotkey Recovery) (Optional)

► Precautions for Using the System Recovery Function

1. If your hard drive and system encountered non-recoverable problems, please use the F3 Hotkey recovery from the Hard Drive first to perform the System Recover Function.
2. Before using the System Recovery Function, please backup the important data saved on your system drive to other storage devices.

► Recovering the system with the F3 Hotkey

Follow the instructions below to continue:

1. Restart the PC.
2. Press the F3 hotkey on the keyboard promptly when the MSI greeting appears on the display.
3. On the “Choose an Option” screen, tap “Troubleshoot”.
4. On the “Troubleshoot” screen, tap “Restore MSI factory” to reset the system to the default settings.
5. On the “RECOVERY SYSTEM” screen, tap “System Partition Recovery”.
6. Follow the on-screen instructions to continue and complete the Recovery Function.

4

OSD Setup

This chapter provides you with essential information on OSD Setup.

IMPORTANT





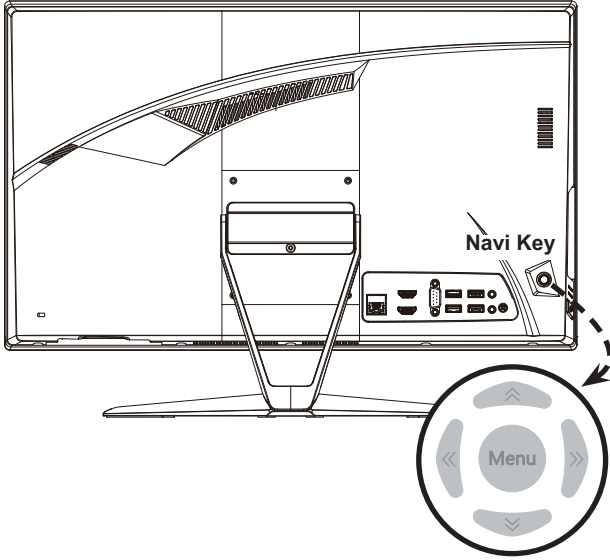

All information is subject to change without prior notice.



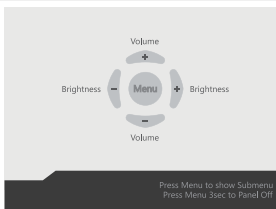

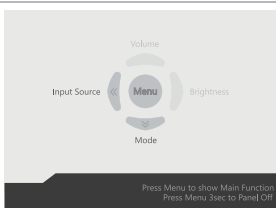

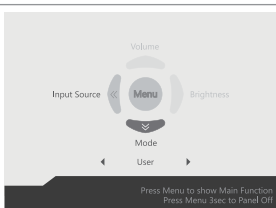

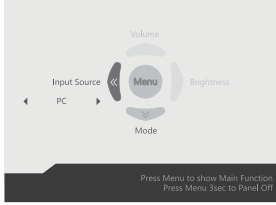
Navi Key

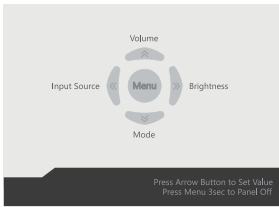
The AIO comes with a Navi Key, a multi-directional control that helps navigate the On-Screen Display (OSD) menu.

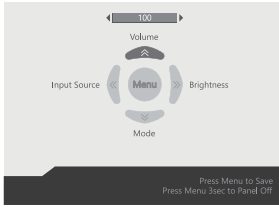

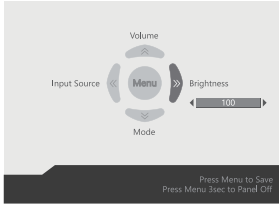
The Navi Key default settings are as follows.

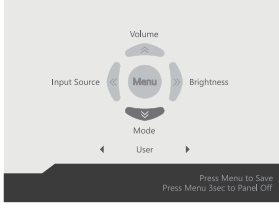
Input Source: PC Mode		Operations
Menu 	 <p>Press Menu to show Submenu Press Menu 3sec to Panel Off</p>	<ul style="list-style-type: none"> ■ Use the Up, Down, Left, Right buttons to adjust Brightness and Volume of your system. ■ Press Menu to enter sub-menus. ■ Press Menu again to show main menu.
Sub-menus 	 <p>Press Menu to show Main Function Press Menu 3sec to Panel Off</p>	<ul style="list-style-type: none"> ■ Press Menu to show sub-menus. ■ Only Input Source and Mode are available in PC Mode.
Mode 	 <p>Press Menu to show Main Function Press Menu 3sec to Panel Off</p>	<ul style="list-style-type: none"> ■ Press Menu to show sub-menus. ■ Press the Down button to enter Mode function, and Left and Right buttons to adjust the setting. ■ Press Menu to confirm selection and exit.
Input Source 	 <p>Press Menu to show Main Function Press Menu 3sec to Panel Off</p>	<ul style="list-style-type: none"> ■ Press the Left button to enter Input Source function, and Left and Right buttons to adjust the settings. ■ Press Menu to confirm selection and exit.

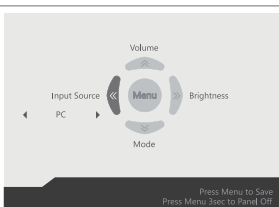
Input Source: Monitor Mode		Operations
Menu 		<ul style="list-style-type: none"> ■ Press Menu to enter sub-menus. ■ Press Menu again to enter Main Menu.
Volume 		<ul style="list-style-type: none"> ■ Press the Up button to enter Volume function, and Left and Right buttons to adjust the value. ■ Press Menu to save and exit. ■ Monitor Mode only.
Brightness 		<ul style="list-style-type: none"> ■ Press the Right button to enter Brightness function, and Left and Right buttons to adjust the value. ■ Press Menu to save and exit. ■ Monitor Mode only.
Mode 		<ul style="list-style-type: none"> ■ Press the Down button to enter Mode function, and Left and Right buttons to adjust the setting. ■ Press Menu to save and exit.
Input Source 		<ul style="list-style-type: none"> ■ Press the Left button to enter Input Source function, and Left and Right buttons to adjust the setting. ■ Press Menu to save and exit.

OSD Setup via Navi Key

Press the Middle button of Navi Key to launch the On-Screen Display (OSD) main menu. Use the Up, Down, Left, Right buttons to tune the desired function menus to suit your personal preferences. Press Menu 3 seconds to shut the panel off. Press Menu again to wake it up.



4-5

➤ Image

1st Level Menu	2nd/ 3rd Level Menu	Description
Mode	User	<ul style="list-style-type: none"> Default is User.
	Reader	<ul style="list-style-type: none"> While sRGB mode is selected, the color space will be changed to standard sRGB from original panel gamut.
	Cinema	
	Designer	
	sRGB	
Brightness	0-100	<ul style="list-style-type: none"> Default is 80. Brightness has to be gray out in PC Mode.
Contrast	0-100	<ul style="list-style-type: none"> Default is 80.
Sharpness	0-5	<ul style="list-style-type: none"> Default is 0.
Eye Saver	<input type="checkbox"/> OFF	<ul style="list-style-type: none"> Default is OFF. Eye Saver has to be enabled in Reader Mode.
	<input checked="" type="checkbox"/> ON	

Color Temperature	Cool	<ul style="list-style-type: none"> Default is Normal. Cool Mode is 9300K; Normal Mode is 6500K; Warm Mode is 5000K. 	
	Normal		
	Warm	<ul style="list-style-type: none"> Customization Mode default R/G/B are 50/50/50. Color Temperature has to gray out while sRGB mode is selected. 	
	Customization		
G (0-100)			
B (0-100)			
Screen Size	4:3	<ul style="list-style-type: none"> Default is 16:9. 	
	16:9		

➤ Input Source

1st Level Menu	Description
PC	User can use Navi Key, and OSD Menu to adjust the Input Source in any Mode.
HDMI	

➤ Setting

1st Level Menu	2nd Level Menu	Description
Language	English	<ul style="list-style-type: none"> Default is English. Language is an independent setting. User's own language setting will override the factory default. When user sets Reset to Yes, Language will not be changed.
	繁體中文	
	简体中文	
	Italiano	
	Español	
	Français	
	Portugués	
	Deutsch	
	日本語	
Русский		
Transparency	0-5	<ul style="list-style-type: none"> Default is 0.
OSD Time Out	5-30	<ul style="list-style-type: none"> Default is 20s.
Audio Volume	0-100	<ul style="list-style-type: none"> Default is 50.
Reset	YES	<ul style="list-style-type: none"> User can Reset the settings to original OSD default in any Mode.
	NO	

A

Troubleshooting

My system does not start.

1. Check if the system is connected to an electrical outlet and it is turned on.
2. Check if the power cord and all cables are connected firmly.

When I turn on my computer, the message “Operating System not found” appears or Windows does not start.

1. Check if there is a non-bootable CD/ DVD inside the optical disk drive. If so, remove the CD/ DVD then restart the computer.
2. Check Boot Device Priority settings in the BIOS Setup.

The system can not be shut down.

It is best to shut down your computer using the Shut Down icon in the operating system. Using other methods, including those listed below, may result in data failure. If the Shut Down procedure does not work, choose one of the following steps:

1. Press Ctrl+Alt+Del keys, then choose Shut Down.
2. Press and hold the power button till the system is off.
3. Unplug the power cable from the system.

My microphone does not work.

1. For built-in microphone, please go to Start > Control Panel > Sounds and Audio Devices > Audio to check if it is muted.
2. If you are using an external microphone, check that the microphone is plugged into the Microphone jack.

The Internet connection has problems.

1. If you are having a problem connecting to your Internet Service Provider (ISP), check if the ISP is experiencing technical problems.
2. Check the Network settings and connection and make sure the system is properly configured to Internet access.
3. The wireless LAN data transfer speed is affected by distance and obstructions between devices and access points. To maximize the data transfer speed, choose the access point closest to your system.

System speakers do not work.

1. Check the master volume setting in the Audio Mixer.
2. If you are using an application that has its own volume control, check if the volume is muted.
3. If you have connected an audio cable to the Headphone jack, disconnect it.
4. If the system has OSD function, please adjust the volume of OSD.

System monitor does not display anything.

1. Check if the system is connected to an electrical outlet and it is turned on.
2. The system may be in Standby mode. Press any key to activate the Display.