



Digital Projector User Manual

Warranty and Copyright information

Limited warranty

BenQ warrants this product against any defects in material and workmanship, under normal usage and storage.

Proof of purchase date will be required with any warranty claim. In the event this product is found to be defective within the warranty period, BenQ's only obligation and your exclusive remedy shall be replacement of any defective parts (labor included). To obtain warranty service, immediately notify the dealer from which you purchased the product of any defects.

Important: The above warranty shall be void if the customer fails to operate the product in accordance with BenQ's written instructions, especially the ambient humidity must be in-between 10% and 90%, temperature in-between 0°C and 35°C, altitude lower than 4920 feet, and avoiding to operate the projector in a dusty environment. This warranty gives you specific legal rights, and you may have other rights which vary from country to country.

For other information, please visit www.BenQ.com.

Copyright

Copyright © 2023 by BenQ Corporation. All rights reserved. No part of this publication may be reproduced, transmitted, transcribed, stored in a retrieval system or translated into any language or computer language, in any form or by any means, electronic, mechanical, magnetic, optical, chemical, manual or otherwise, without the prior written permission of BenQ Corporation.

Disclaimer

BenQ Corporation makes no representations or warranties, either expressed or implied, with respect to the contents hereof and specifically disclaims any warranties, merchantability or fitness for any particular purpose. Further, BenQ Corporation reserves the right to revise this publication and to make changes from time to time in the contents hereof without obligation to notify any person of such revision or changes.

*DLP, Digital Micromirror Device and DMD are trademarks of Texas Instruments. Others are copyrights of their respective companies or organizations.

The terms HDMI, HDMI High-Definition Multimedia Interface, HDMI Trade dress and the HDMI Logos are trademarks or registered trademarks of HDMI Licensing Administrator, Inc.

Table of Contents

Warranty and Copyright information	2
Important safety instructions	4
Introduction	6
Shipping contents	6
Projector exterior view	7
Controls and functions	8
Positioning your projector	10
Choosing a location	10
Obtaining a preferred projected image size	12
Mounting the projector	13
Adjusting the projected image	16
Connection	18
Operation	20
Starting up the projector	20
Using the menus	21
Securing the projector	22
Switching input signal	24
Controlling the projector through a Wired LAN environment	24
Shutting down the projector	27
Menu operation	28
Basic Menu	28
Advanced Menu	29
Maintenance	51
Care of the projector	51
Light source information	52
Troubleshooting	55
Specifications	56
Projector specifications	56
Dimensions	57
Timing chart	58
RS232 command	63

Important safety instructions

Your projector is designed and tested to meet the latest standards for safety of information technology equipment. However, to ensure safe use of this product, it is important that you follow the instructions mentioned in the user manual / installation guide and marked on the product.

1. **Please read the user manual / installation guide before you operate your projector.** Save it for future reference.
2. **Do not look straight at the projector lens during operation.** The intense light beam may damage your eyes.
3. **Refer servicing to qualified service personnel.**
4. **Always open the lens shutter (if any) or remove the lens cap (if any) when the projector light source is on.**
5. The light source becomes extremely hot during operation.
6. In some countries, the line voltage is NOT stable. This projector is designed to operate safely within a mains voltage between 100 to 240 volts AC, but could fail if power cuts or surges of ± 10 volts occur. **In areas where the mains voltage may fluctuate or cut out, it is recommended that you connect your projector through a power stabilizer, surge protector or uninterruptible power supply (UPS).**
7. Do not block the projection lens with any objects when the projector is under operation as this could cause the objects to become heated and deformed or even cause a fire. To temporarily turn off the light source, use the blank function.
8. Do not operate light sources beyond the rated light source life.
9. Do not place this product on an unstable cart, stand, or table. The product may fall, sustaining serious damage.
10. Do not attempt to disassemble this projector. There are dangerous high voltages inside which may cause death if you should come into contact with live parts.

Under no circumstances should you ever undo or remove any other covers. Refer servicing only to suitably qualified professional service personnel.
11. Do not block the ventilation holes.
 - Do not place this projector on a blanket, bedding or any other soft surface.
 - Do not cover this projector with a cloth or any other item.
 - Do not place inflammables near the projector.If the ventilation holes are seriously obstructed, overheating inside the projector may result in a fire.
12. Do not stand the projector on end vertically. Doing so may cause the projector to fall over, causing injury or resulting in damage to the projector.
13. Do not step on the projector or place any objects upon it. Besides probable physical damage to the projector, doing so may result in accidents and possible injury.
14. When the projector is under operation, you may sense some heated air and odor from its ventilation grill. It is a normal phenomenon and not a product defect.
15. Do not place liquids near or on the projector. Liquids spilled into the projector may cause it to fail. If the projector does become wet, disconnect it from the power supply's power outlet and call BenQ to have the projector serviced.
16. This apparatus must be earthed.

17. Do not place this projector in any of the following environments.

- Space that is poorly ventilated or confined. Allow at least 50 cm clearance from walls and free flow of air around the projector.
- Locations where temperatures may become excessively high, such as the inside of a car with all windows rolled up.
- Locations where excessive humidity, dust, or cigarette smoke may contaminate optical components, shorten the projector's life span and darken the image.
- Locations near fire alarms
- Locations with an ambient temperature above 40°C / 104°F
- Locations where the altitudes are higher than 3000 m (10000 feet).

18. To avoid damaging the DLP chips, do not direct a high-power laser beam onto the projection lens.

Risk Group 2

1. According to the classification of photobiological safety of light sources and light source systems, this product is Risk Group 2, IEC 62471-5:2015.
2. Possibly hazardous optical radiation emitted from this product.
3. Do not stare at operating light source. May be harmful to the eyes.
4. As with any bright source, do not stare into the direct beam.



The projector's light source unit uses a laser.

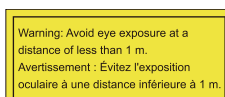

- Notice is given to supervise children and to never allow them to stare into the projector beam at any distance from the projector.
- Notice is given to use caution when using the remote control for starting the projector while in front of the projection lens.
- Notice is given to the user to avoid the use of optical aids such as binoculars or telescopes inside the beam.

Laser Caution

This product belongs to CLASS 1 consumer laser product and complies with IEC 60825-1:2014, EN 60825-1:2014/A11:2021 and EN 50689:2021.



Above laser caution are located on the bottom of this apparatus.

Caution – Use of controls or adjustments or performance of procedures other than those specified herein may result in hazardous radiation exposure.

Introduction

Shipping contents

Carefully unpack and verify that you have all of the items shown below. If any of these items are missing, please contact your place of purchase.

Standard accessories

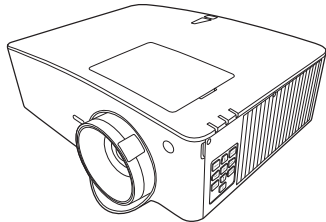

Projector

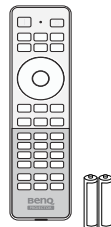

Remote control with batteries



Installation guide



Regulatory statements



Warranty card*

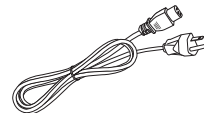

Power cord



- The supplied accessories will be suitable for your region, and may differ from those illustrated.
- *The warranty card is only supplied in some specific regions. Please consult your dealer for detailed information.

Optional accessories

1. InstaShow™ (WDC10/WDC20)

Replacing the remote control batteries

1. Press and slide off the battery cover, as illustrated.
2. Remove the old batteries (if applicable) and install two AAA batteries. Make sure that the positive and negative ends are positioned correctly, as illustrated.
3. Slide the battery cover in until it clicks into place.

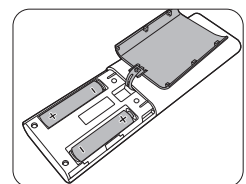
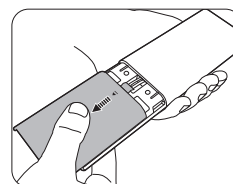

- Avoid leaving the remote control and batteries in an excessive heat or humid environment like the kitchen, bathroom, sauna, sunroom or in a closed car.
- Replace only with the same or equivalent type recommended by the battery manufacturer.
- Dispose of the used batteries according to the manufacturer's instructions and local environment regulations for your region.
- Never throw the batteries into a fire. There may be danger of an explosion.
- If the batteries are dead or if you will not be using the remote control for an extended period of time, remove the batteries to avoid damage to the remote control from possible battery leakage.

Projector exterior view

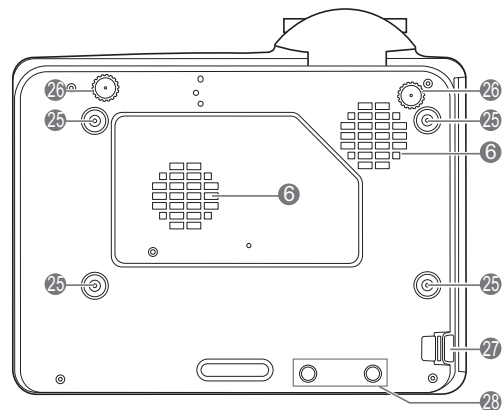
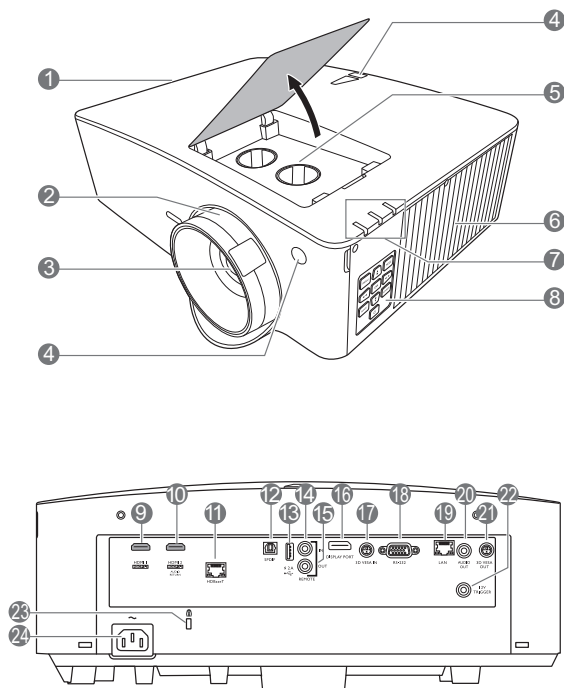

1. Vent (air exhaust)
2. Focus and zoom ring
3. Projection lens
4. IR remote sensor
5. Lens shift adjustment knobs (LEFT/RIGHT, UP/DOWN)
6. Vent (air inlet)
7. **POWER indicator light/TEMPerature warning light/LIGHT indicator light**
(See [Indicators](#) on page 54.)
8. External control panel
(See [Controls and functions](#) on page 8.)
9. HDMI 1 input port
10. HDMI 2 input port
11. HDBaseT port
For connection to a HDBaseT transmitter via an Ethernet cable (Cat5e/Cat6) to input up to 1080/60p timing, RS232 control signal and IR control signal. The HDBaseT port does not support LAN control.
12. S/PDIF port
13. USB Type A port (5V/2A power supply)
14. Wired remote input
15. Wired remote output
16. DisplayPort
17. 3D VESA input
18. RS-232 control port
19. RJ-45 LAN input jack
20. Audio output jack
21. 3D VESA output
22. 12V trigger
23. Kensington anti-theft lock slot
24. AC power jack
25. Wall mount holes
26. Adjuster feet
27. Security bar
28. InstaShow holes



*Power for WDC20 should come from external power supply.

Controls and functions

Projector & Remote control



All the key presses described in this document are available on the remote control or projector.

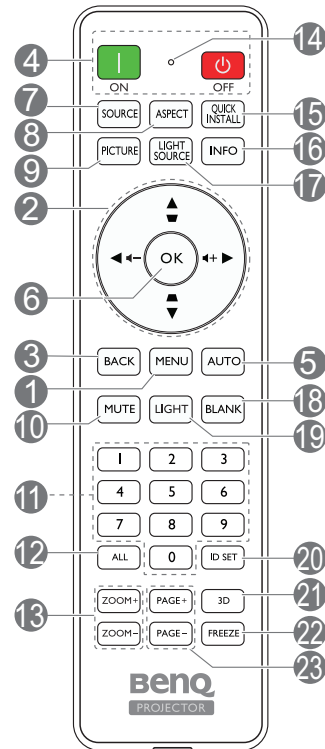
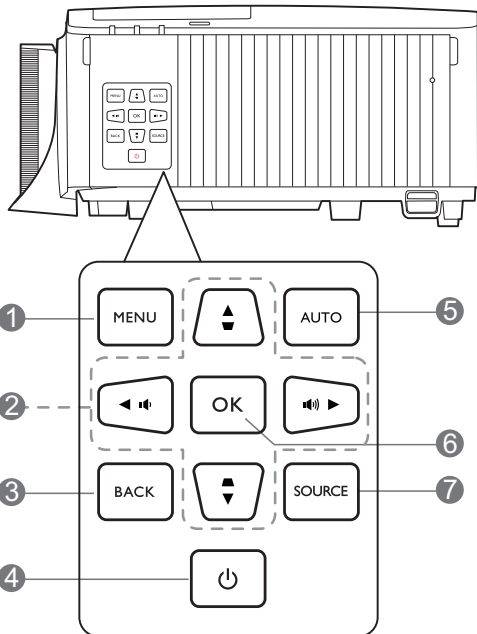

1. MENU

Turns on the On-Screen Display (OSD) menu.

2. Arrow keys (▲, ▼, ◀, ▶)

When the On-Screen Display (OSD) menu is activated, these keys are used as directional arrows to select the desired menu items and to make adjustments.

Keystone keys (△, ▽)

Displays the keystone correction page.

Volume keys (◀/▶), (◀-/▶+)

Decreases or increases the projector volume.

3. BACK

Goes back to previous OSD menu, exits and saves menu settings.

4. POWER

Toggles the projector between standby mode and on.

 ON/  Off

Toggles the projector between standby mode and on.

5. AUTO

No function.

6. OK

Confirms the selected On-Screen Display (OSD) menu item.

7. SOURCE

Displays the source selection bar.

8. ASPECT

Selects the display aspect ratio.

9. PICTURE

Selects an available picture setup mode.

10. MUTE

Toggles projector audio between on and off.

11. Numeric buttons

Enters numbers in network settings or when setting the remote control ID. Numeric buttons 1, 2, 3, 4 cannot be pressed when asked to enter password.

12. ALL

Press and hold **ID SET** until the ID setting indicator lights up. Press **ALL** to clear current ID setting of the remote control. The ID is cleared successfully when you see the ID setting indicator starts flickering and then blackout.

13. ZOOM+/ZOOM-

Magnifies or reduces the projected picture size.

14. ID setting indicator

15. QUICK INSTALL

Quickly selects several functions to adjust the projected image and displays the test pattern.

16. INFO

Displays the projector information.

17. LIGHT SOURCE

Selects an available light mode.

18. BLANK

Used to hide the screen picture.



Do not block the projection lens from projecting as this could cause the blocking object to become heated and deformed or even cause a fire.

Remote control effective range

The remote control must be held at an angle within 30 degrees perpendicular to the projector's IR remote control sensor(s) to function correctly. The distance between the remote control and the sensor(s) should not exceed 8 meters (~ 26 feet).

Make sure that there are no obstacles between the remote control and the IR sensor(s) on the projector that might obstruct the infra-red beam.

• Operating the projector from the front

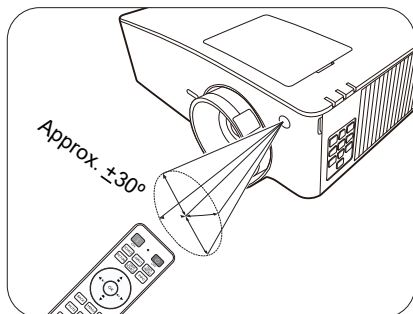

• Operating the projector from the top

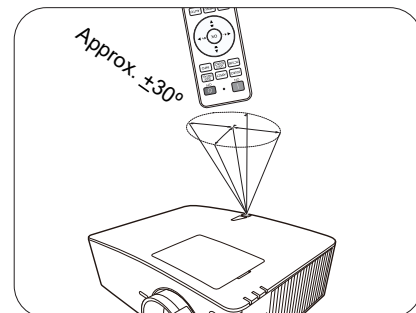

19. LIGHT

Turns on the remote control backlight for a few seconds. To keep the backlight on, press any other key while the backlight is on. Press the key again to turn the backlight off.

20. ID SET

Sets the code for this remote control. Press and hold **ID SET** until the ID setting indicator lights up. Enter the ID for the remote control (between 01~99). The remote control ID should be the same as the corresponding projector ID. The ID is saved successfully when you see the ID setting indicator starts flickering and then blackout.

21. 3D

Displays the **3D** menu.

22. FREEZE

Freezes the projected image.

23. PAGE+/PAGE-

No function.

Positioning your projector

Choosing a location

Before choosing an installation location for your projector, take the following factors into consideration:

- Size and position of your screen
- Electrical outlet location
- Location and distance between the projector and the rest of your equipment

You can install your projector in the following ways.

1. Front

Select this location with the projector placed on the table in front of the screen. This is the most common way to position the projector for quick setup and portability.

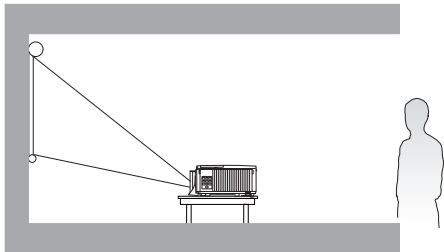

2. Rear

Select this location with the projector placed on the table behind the screen. Note that a special rear projection screen is required.

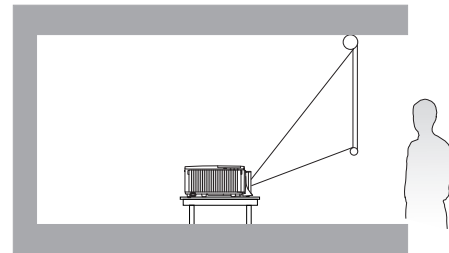

3. Front Ceiling

Select this location with the projector suspended upside-down from the ceiling in front of the screen. Purchase the BenQ Projector Ceiling Mount Kit from your dealer to mount your projector on the ceiling.

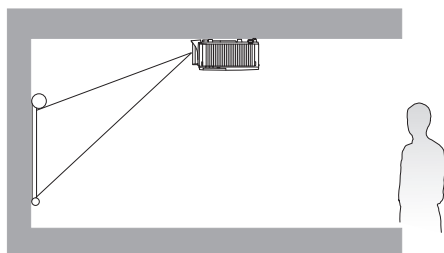

4. Rear Ceiling

Select this location with the projector suspended upside-down from the ceiling behind the screen. Note that a special rear projection screen and the BenQ Projector Ceiling Mount Kit are required for this installation location.

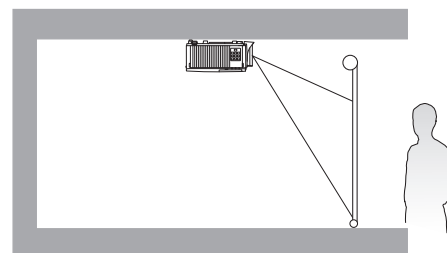

After turning on the projector, go to **Advanced** menu - **Installation** > **Projector Position**, press **OK** and press ◀/▶ to select a setting.

You can also use **QUICK INSTALL** on the remote control to access this menu.

The projector can also be installed at following angles:

360-degree projection

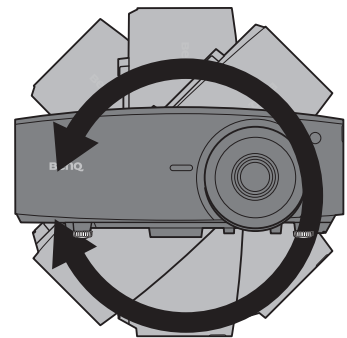
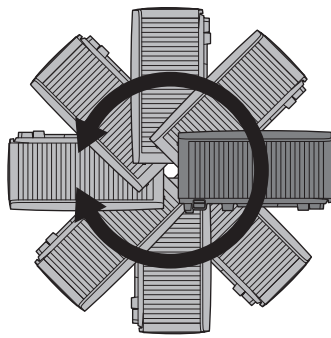
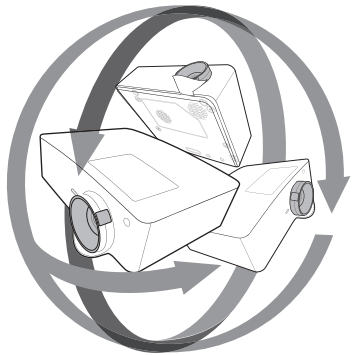

Installation of the projector should be performed carefully. Incomplete or improper installation may cause the projector to fall, resulting in personal injury or property damage.

Obtaining a preferred projected image size

The distance from the projector lens to the screen, the zoom setting (if available), and the video format each factors in the projected image size.

Projection dimensions

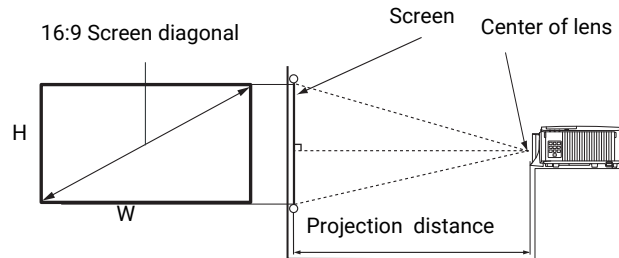

- The screen aspect ratio is 16:9 and the projected picture is in a 16:9 aspect ratio

Screen size			Projection distance (mm)			
Diagonal		H (mm)	W (mm)	Min distance (with max zoom)	Average	Max distance (with min zoom)
Inch	mm					
30	762	374	664	903	1176	1448
40	1016	498	886	1204	1567	1930
50	1270	623	1107	1505	1959	2413
60	1524	747	1328	1806	2351	2896
70	1778	872	1550	2108	2743	3378
80	2032	996	1771	2409	3135	3861
90	2286	1121	1992	2710	3527	4343
100	2540	1245	2214	3011	3918	4826
110	2794	1370	2435	3312	4310	5309
120	3048	1494	2657	3613	4702	5791
130	3302	1619	2878	3914	5094	6274
140	3556	1743	3099	4215	5486	6757
150	3810	1868	3321	4516	5878	7239
160	4064	1992	3542	4817	6269	7722
170	4318	2117	3763	5118	6661	8204
180	4572	2241	3985	5419	7053	8687
190	4826	2366	4206	5720	7445	9170
200	5080	2491	4428	6022	7837	9652
210	5334	2615	4649	6323	8229	10135
220	5588	2740	4870	6624	8621	10617
230	5842	2864	5092	6925	9012	11100
240	6096	2989	5313	7226	9404	11583
250	6350	3113	5535	7527	9796	12065
260	6604	3238	5756	7828	10188	12548
270	6858	3362	5977	8129	10580	13030
280	7112	3487	6199	8430	10972	13513
290	7366	3611	6420	8731	11363	13996
300	7620	3736	6641	9032	11755	14478

For example, if you are using a 120-inch screen, the recommended projection distance in the "Average" column is 4702 mm.

If your measured projection distance is 7000 mm, the closest match in the "Average" column is 7053 mm. Looking across this row shows that a 180" (about 4.6 m) screen is required.



To optimize your projection quality, we suggest doing the projection by referring to the values listed in the non-gray rows.



All measurements are approximate and may vary from the actual sizes.

BenQ recommends that if you intend to permanently install the projector, you should physically test the projection size and distance using the actual projector in situ before you permanently install it, so as to make allowance for this projector's optical characteristics. This will help you determine the exact mounting position so that it best suits your installation location.

Mounting the projector

If you intend to mount your projector, we strongly recommend that you use a proper fitting BenQ projector mounting kit and that you ensure it is securely and safely installed.

If you use a non-BenQ brand projector mounting kit, there is a safety risk that the projector may fall down due to an improper attachment through the use of the wrong gauge or length screws.

Before mounting the projector

- Purchase a BenQ projector mounting kit from the place you purchased your BenQ projector.
- Ask your dealer to install the projector for you. Installing the projector on your own may cause it to fall and result in injury.
- Take necessary procedures to prevent the projector from falling off such as during an earthquake.
- The warranty doesn't cover any product damage caused by mounting the projector with a non-BenQ brand projector mounting kit.
- Consider the surrounding temperature where the projector is ceiling/wall mounted. If a heater is used, the temperature around the ceiling may be higher than expected.
- Read the user manual for the mounting kit about the range of torque. Tightening with torque exceeding the recommended range may cause damage to the projector and subsequently falling off.
- Make sure the power outlet is at an accessible height so that you can easily shut down the projector.

Ceiling/Wall mount installation diagram

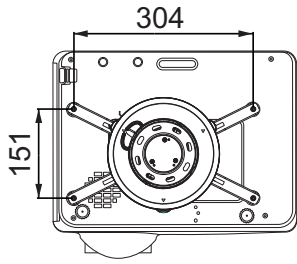

BenQ ceiling mount CMG3
(5J.JAM10.001)
Ceiling mount screw: M4
(Max. L = 25 mm; Min. L = 20 mm)

Unit: mm

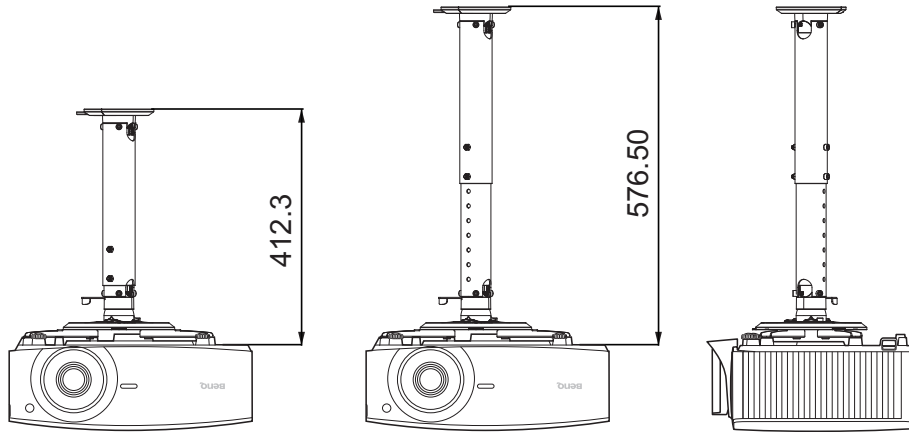



Shifting the projection lens

The lens shift control provides flexibility for installing your projector. It allows the projector to be positioned off the center of the screen.

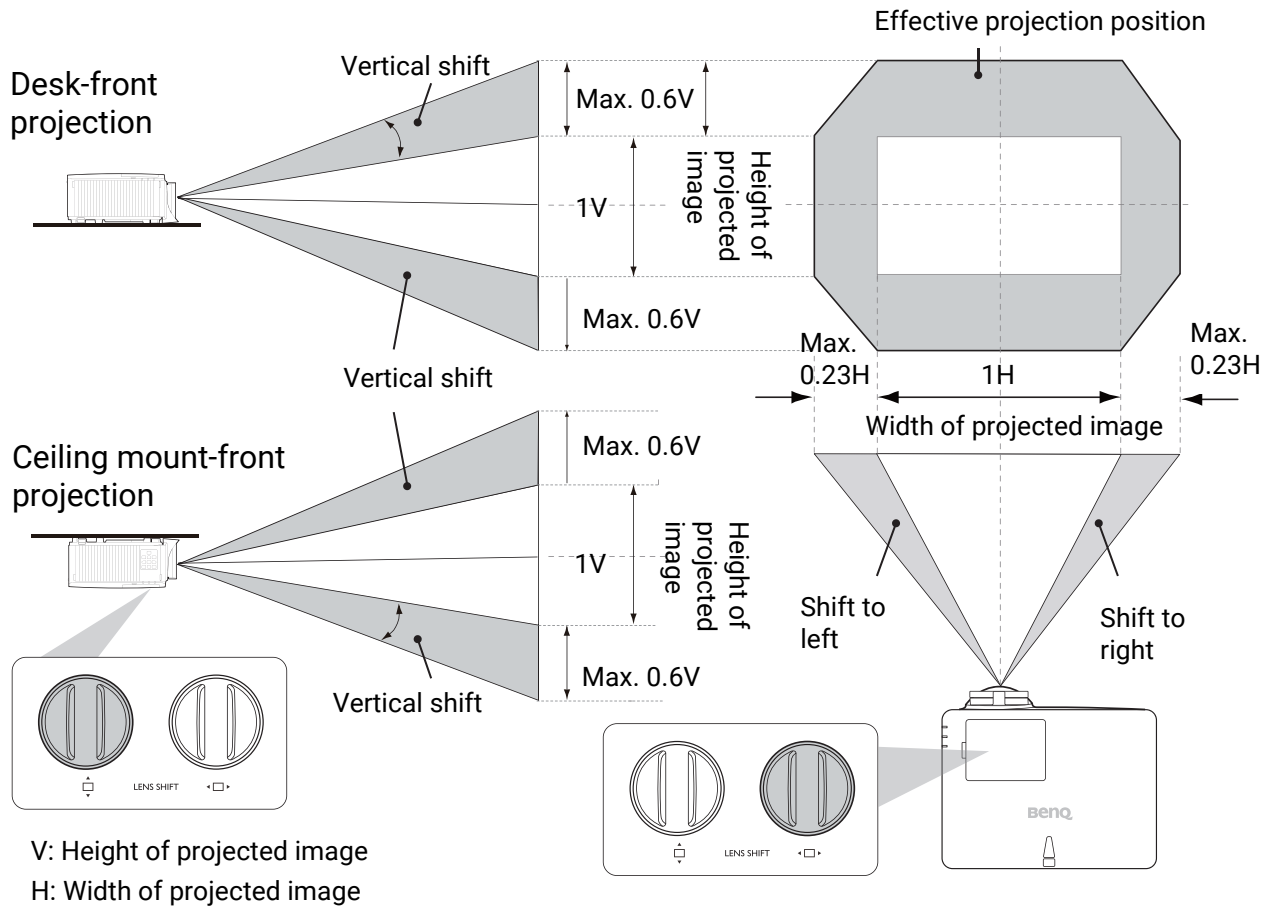
The lens shift is expressed as a percentage of the projected image height or width. You can turn the knobs on the projector to shift the projection lens in any direction within the allowable range depending on your desired image position.



To reach the highest or lowest projection position:

1. Turn  (Up/Down).
2. When you feel it is reaching the limit, turn  (Left/Right) to the left or right and turn  again.
3. Repeat the step above until finding the suitable position you need.

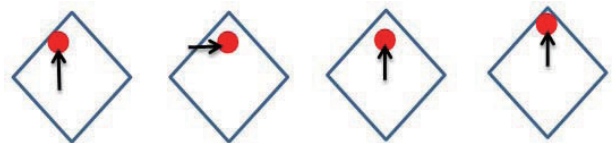

- If you hear a "clicking sound" during the adjustment, it means that the knob is past its adjustment limit. Please stop adjusting it, in order to avoid any unexpected damage, and turn the knob in the opposite direction, at least to one step before the click.
- If you can't turn it back, please press and turn the knob back at same time.

Adjusting the projected image

Adjusting the projection angle

If the projector is not placed on a flat surface or the screen and the projector are not perpendicular to each other, the projected image becomes trapezoidal. You can adjust the adjuster feet to fine-tune the horizontal angle.

To retract the feet, screw the adjuster feet in a reverse direction.

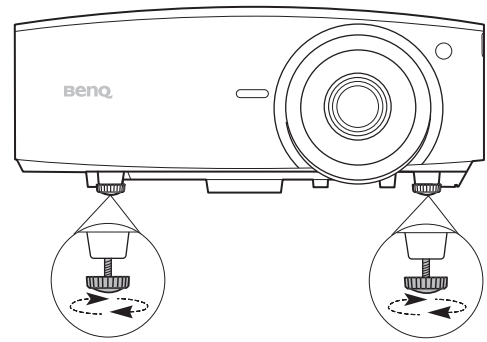

! Do not look into the lens while the light source is on. The strong light from the light source may cause damage to your eyes.

Fine-tuning the image size and clarity

- Adjust the projected image to the size that you need using the zoom ring.
- Sharpen the image by rotating the focus ring.

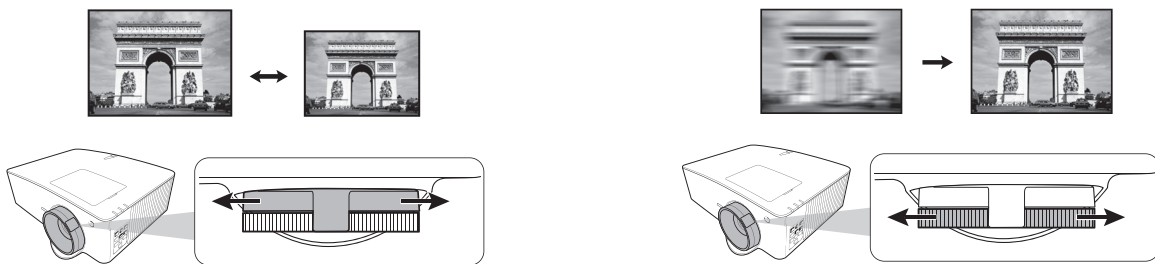

Correcting keystone

Keystoning refers to the situation where the projected image becomes a trapezoid due to angled projection.

To correct the distorted image:

1. Display the **3D Keystone** correction from the following menus.
 - The **Installation** menu of the **Advanced** menu system
2. After the **3D Keystone** correction page appears:
 - Press **◀/▶** to select V, H, or R.
Selecting V corrects the vertical sides keystone.
Selecting H corrects the horizontal sides keystone.
Selecting R rotates the projected image clockwise or counterclockwise.
 - Press **▲/▼** to adjust its value.
 - To automatically correct the vertical sides of the distorted image, press **OK** for 2 seconds, or enable **Auto Vertical Keystone** on the **Installation** menu.
3. Please be noticed that the projected image might be distorted when the keystone value is set to over 30. And when the keystone adjustment reaches its limit, the machine will not respond to your request. You have to set the keystone value of the axis you are adjusting to 0 and lower another axis with the maximum value. Thus, it is recommended to set your keystone value under 30 for each axis.

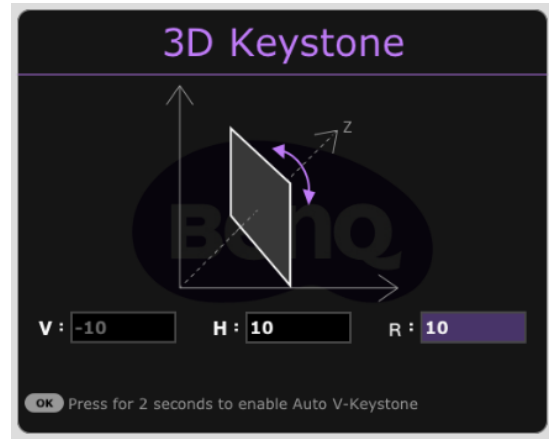
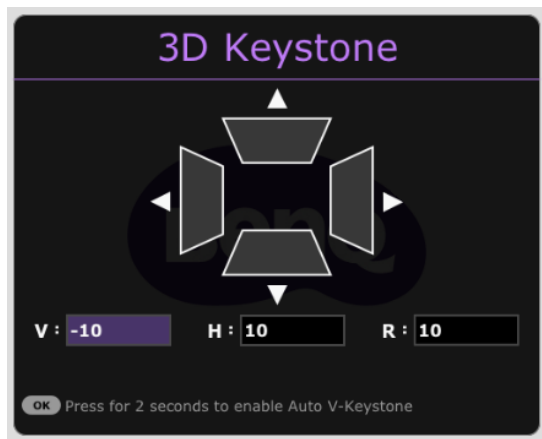

4. When done, press **BACK** to save your changes and exit.

 This function is not available when the **Warping** is enabled.

Adjusting Corner Fit

You can manually adjust four corners of the image by setting the horizontal and vertical values.

1. To display the corner fit correction page, go to **Advanced** menu - **Installation** > **Corner Fit** and press **OK**.
2. Press **▲/▼/◀/▶** to select one corner and press **OK**.
3. Press **▲/▼** to adjust vertical values.
4. Press **◀/▶** to adjust horizontal values.

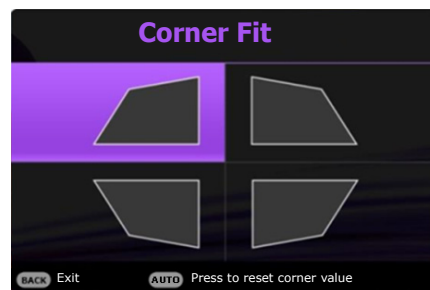

Connecting audio

The projector has built-in mono speaker(s) which are designed to provide basic audio functionality accompanying data presentations for business purposes only. They are not designed for, nor intended for stereo audio reproduction use as might be expected in home theater or home cinema applications. Any stereo audio input (if provided), is mixed into a common mono audio output through the projector speaker(s).

The built-in speaker(s) will be muted when the **AUDIO OUT** jack is connected.



- The projector is only capable of playing mixed mono audio, even if a stereo audio input is connected.

Operation

Starting up the projector

1. Plug the power cord. Turn on the power outlet switch (where fitted). The power indicator on the projector lights orange after power has been applied.
2. Press  to start the projector. The power indicator flashes green and stays green when the projector is on.

The start up procedure takes about 30 seconds. In the later stage of start up, a startup logo is projected.

(If necessary) Rotate the focus ring to adjust the image clearness.

3. If the projector is activated for the first time, select your OSD language following the on-screen instructions.
4. If you are prompted for a password, press the arrow keys to enter a 6-digit password. See [Utilizing the password function on page 22](#).
5. Switch all of the connected equipment on.

The projector will search for input signals. The current input signal being scanned appears. If the projector does not detect a valid signal, the message “No Signal” will continue displaying until an input signal is found.

You can also press **SOURCE** to select your desired input signal. See [Switching input signal on page 24](#).

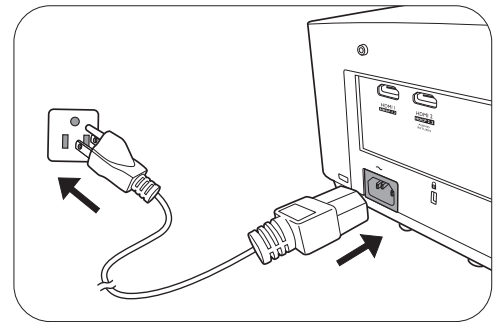

- Please use the original accessories (e.g. power cord) to avoid possible dangers such as electric shock and fire.
- If the projector is still hot from previous activity, it will run the cooling fan for approximately 90 seconds before energizing the lamp.



- The Setup Wizard screenshots are for reference only and may differ from the actual design.
- If the frequency/resolution of the input signal exceeds the projector's operating range, you will see the message “Out of Range” displayed on the background screen. Please change to an input signal which is compatible with the projector's resolution or set the input signal to a lower setting. See [Timing chart on page 58](#).
- If no signal is detected for 3 minutes, the projector automatically enters saving mode.

Using the menus

The projector is equipped with 2 types of On-Screen Display (OSD) menus for making various adjustments and settings.

- **Basic** OSD menu: provides primary menu functions. (See [Basic Menu on page 28](#))
- **Advanced** OSD menu: provides full menu functions. (See [Advanced Menu on page 29](#))

To access the OSD menu, press **MENU** on the projector or remote control.

- Use the arrow keys (▲/▼/◀/▶) on the projector or remote control to move through the menu items.
- Use **OK** on the projector or remote control to confirm the selected menu item.

The first time you use the projector (after finishing the initial setup), press **MENU**, and the **Advanced** OSD menu will be displayed.



The OSD screenshots below are for reference only, and may differ from the actual design.

Below is the overview of the **Basic** OSD menu.

The screenshot shows the Basic OSD menu with the following items: Picture Mode (Presentation), Volume (10), Aspect Ratio (Auto), Brightness (50), Light Source Mode (Normal), Information, 3D Keystone, and Menu Type. At the bottom, there are buttons for HDMI, OK Exit, and MENU Exit. Numbered callouts point to: 1. Menu type (Basic menu), 2. Sub-menu and status (Picture Mode, Volume, etc.), 3. Current input signal (HDMI), and 4. Function keys (OK Exit, MENU Exit).

If you intend to switch from the **Basic** OSD menu to the **Advanced** OSD menu, follow the instructions below:

1. Go to **Menu Type** and press **OK**.
2. Press **▲ / ▼** to select **Advanced** and press **OK**. Your projector will switch to **Advanced** OSD menu.

Below is the overview of the **Advanced** OSD menu.

The screenshot shows the Advanced OSD menu with the following items: Picture (selected), Audio, Display, Installation, System, and Information. The Picture sub-menu is open, showing: Picture Mode (Presentation), User Management, Brightness (50), Contrast (0), Sharpness (0), Advanced Color Settings, and a Reset Current Picture Mode button. At the bottom, there are buttons for HDMI, OK Enter, BACK Return, and MENU Exit. Numbered callouts point to: 1. Main menu (Picture), 2. Current input signal (HDMI), 3. Sub-menu and status (Picture Mode, Brightness, etc.), and 4. Function keys (OK Enter, BACK Return, MENU Exit).

Likewise, when you wish to switch from the **Advanced** OSD menu to the **Basic** OSD menu, follow the instructions below:

1. Go to **System > Menu Settings > Menu Type** and press **OK**.
2. Press **▲ / ▼** to select **Basic**. Your projector will switch to the **Basic** OSD menu.

Securing the projector

Utilizing the password function

Setting a password

1. Go to **Advanced** menu - **System > Security Settings > Password**. Press **OK**. The **Password** page appears.
2. Highlight **Change Password** and press **OK**.
3. The four arrow keys (**▲**, **▶**, **▼**, **◀**) respectively represent 4 digits (1, 2, 3, 4). According to the password you desire to set, press the arrow keys to enter six digits for the password.
4. Confirm the new password by re-entering the new password.
5. To activate the **Power On Lock** function, go to **System > Security Settings > Password > Power On Lock**, press **OK** and **◀/▶** to select **On**. Input the password again.

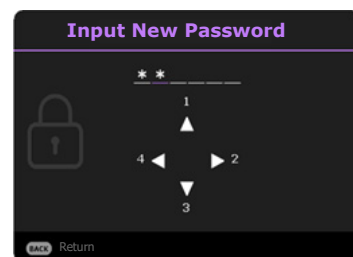

- The digits being input will display as asterisks on-screen. Make a note of your selected password and keep it in a safe place in advance or right after the password is entered so that it is available to you should you ever forget it.
- Once a password has been set and the **Power On Lock** is activated, the projector cannot be used unless the correct password is entered every time the projector is started.

If you forget the password

If you enter the wrong password, the password error message will appear, and the **Input Password** message follows. If you absolutely do not remember the password, you can use the password recall procedure. See [Entering the password recall procedure on page 23](#).

If you enter an incorrect password 5 times in succession, the projector will automatically shut down in a short time.

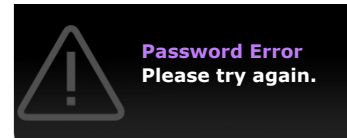

Entering the password recall procedure

1. Press and hold **OK** for 3 seconds. The projector will display a coded number on the screen.
2. Write down the number and turn off your projector.
3. Seek help from the local BenQ service center to decode the number. You may be required to provide proof of purchase documentation to verify that you are an authorized user of the projector.

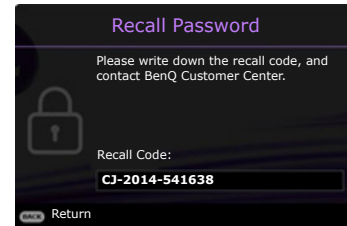

Changing the password

1. Go to **Advanced** menu - **System** > **Security Settings** > **Password**. Press **OK**. The **Password** page appears.
2. Highlight **Change Password** and press **OK**.
3. Enter the old password.
 - If the password is correct, another message **Input New Password** appears.
 - If the password is incorrect, the password error message will appear, and the message **Input Current Password** appears for your retry. You can press **BACK** to cancel the change or try another password.
4. Enter a new password.
5. Confirm the new password by re-entering the new password.

Disabling the password function

To disable password protection, go to **Advanced** menu - **System** > **Security Settings** > **Password** > **Power On Lock** and press **OK** and **◀/▶** to select **Off**. The message **Input Password** appears. Enter the current password.

- If the password is correct, the OSD menu returns to the **Security Settings** page. You will not have to enter the password next time turning on the projector.
- If the password is incorrect, the password error message will appear, and the message **Input Current Password** appears for your retry. You can press **BACK** to cancel the change or try another password.



Though the password function is disabled, you need to keep the old password in hand should you ever need to re-activate the password function by entering the old password.

Switching input signal

The projector can be connected to multiple devices at the same time. However, it can only display one full screen at a time. When starting up, the projector automatically searches for the available signals.

Be sure the **Advanced** menu - **Display > Auto Source Search** menu is **On** if you want the projector to automatically search for the signals.

To manually select the source:

1. Press **SOURCE**. A source selection bar appears.
2. Press **▲/▼** until your desired signal is selected and press **OK**.

Once detected, the selected source information will appear at the corner of the screen for seconds. If there is multiple equipment connected to the projector, repeat steps 1-2 to search for another signal.

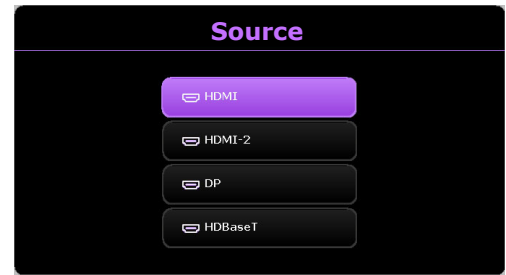

- The brightness level of the projected image will change accordingly when you switch between different input signals.
- For best display picture results, you should select and use an input signal which outputs at the projector's native resolution. Any other resolutions will be scaled by the projector depending upon the "aspect ratio" setting, which may cause some image distortion or loss of picture clarity. See [Aspect Ratio on page 37](#).

Controlling the projector through a Wired LAN environment

Wired LAN allows you to manage the projector from a computer using a web browser when the computer and the projector are properly connected to the same local area network.

Configuring the Wired LAN

If you are in a DHCP environment:

1. Take a RJ45 cable and connect one end to the RJ45 LAN input jack of the projector and the other end to the RJ45 port.



When connecting the RJ45 cable, avoid coiling and intertwining the cable as it may cause signal noise or interruption.

2. Make sure the menu type is **Advanced**. See [Using the menus on page 21](#) for how to switch to the **Advanced** OSD menu.
3. Go to the **Advanced** menu - **System > Network Settings** menu.
4. Highlight **Wired LAN** and then press **OK**. The **Wired LAN** page is displayed.
5. Press **▲/▼** to highlight **DHCP** and press **◀/▶** to select **On**.
6. Press **▲/▼** to highlight **Apply** and press **OK**.
7. Go back to the **Network** page.
8. Press **▲/▼** to highlight **AMX Device Discovery** and press **◀/▶** to select **On** or **Off**. When **AMX Device Discovery** is **On**, the projector can be detected by AMX controller.
9. Please wait for around 15 - 20 seconds, and then re-enter the **Wired LAN** page.

- The **IP Address**, **Subnet Mask**, **Default Gateway**, and **DNS Server** settings will be displayed. Note down the IP address displayed in the **IP Address** row.

 If the **IP Address** still does not display, contact your ITS administrator.

If you are in a non-DHCP environment:

- Repeat steps 1-4 above.
- Press **▲/▼** to highlight **DHCP** and press **◀/▶** to select **Off**.
- Contact your ITS administrator for information on the **IP Address**, **Subnet Mask**, **Default Gateway**, and **DNS Server** settings.
- Press **▲/▼** to select the item you want to modify and press **OK**.
- Press **◀/▶** to move the cursor and then press **▲/▼** to enter the value.
- To save the setting, press **OK**. If you do not want to save the setting, press **BACK**.
- Press **▲/▼** to highlight **Apply** and press **OK**.
- Press **BACK** to return to **Wired LAN** page, press **▲/▼** to highlight **AMX Device Discovery** and press **◀/▶** to select **On** or **Off**.
- Press **BACK** to exit the menu.

Controlling the projector remotely through a web browser

Once you have the correct IP address for the projector and the projector is on or in standby mode, you can use any computer that is on the same local area network to control the projector.

- Enter the address of the projector in the address bar of your browser and click Go.

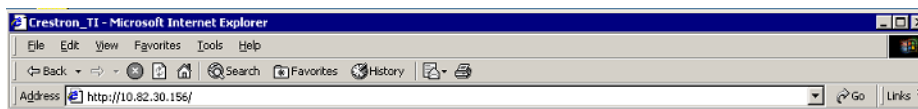

- The remote network operation page opens. This page allows you to operate the projector as if you were using the remote control or control panel on the projector.



<p>i</p>	<ul style="list-style-type: none"> • Menu (MENU) • OK • ▲ (▽) • ◀ • Blank (BLANK) 	<ul style="list-style-type: none"> • Back (BACK) • ▼ (△) • ▶ • Input (SOURCE) 	<p>See Projector & Remote control on page 8 for details.</p>
-----------------	---	---	--

i To switch input source, click on your desired signal.

ii The source list varies according to the connectors available on the projector. "Video" stands for the Video signal.

The tools page allows you to manage the projector, configure the **Network** settings and secure access of remote network operation on this projector.



- i. You can name the projector, keep track of its location and the person in charge of it.
- ii. You can adjust the **Network** settings.
- iii. Once set, access to the remote network operation on this projector has been password-protected.
- iv. Once set, access to the tools page has been password-protected.

ii After making the adjustments, press the Send button and the data will be saved in the projector.

v. Press **Exit** to go back to the remote network operation page.

Please pay attention to the limitation of input length (including space and other punctuation keys) in the list below:

Category Item	Input Length	Maximum Number of Characters
Crestron Control	IP Address	15
	IP ID	4
	Port	5
Projector	Projector Name	22
	Comment	22
	Assigned To	22
Network Configuration	DHCP (Enabled)	(N/A)
	IP Address	15
	Subnet Mask	15
	Default Gateway	15
	DNS Server	15
User Password	Enabled	(N/A)
	New Password	15
	Confirm	15
Admin Password	Enabled	(N/A)
	New Password	15
	Confirm	15

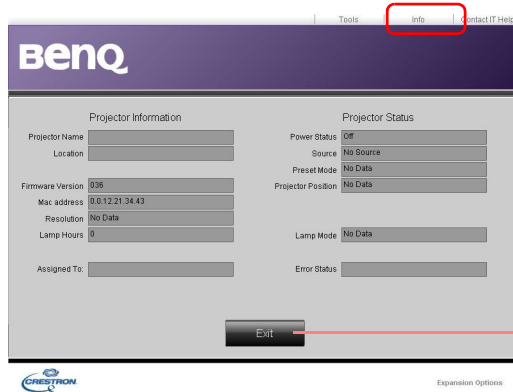

The info page displays the information and status of this projector.



Press **Exit** to go back to the remote network operation page.

For more information, visit <http://www.crestron.com> & www.crestron.com/getroomview.

Shutting down the projector

1. Press  and a confirmation message will appear prompting you. If you don't respond in a few seconds, the message will disappear.
2. Press  a second time. The power indicator flashes orange, the projection light source shuts down, and the fans will continue to run for approximately 90 seconds to cool down the projector.
3. Once the cooling process finishes, the power indicator becomes a steady orange and fans stop. Disconnect the power cord from the power outlet.

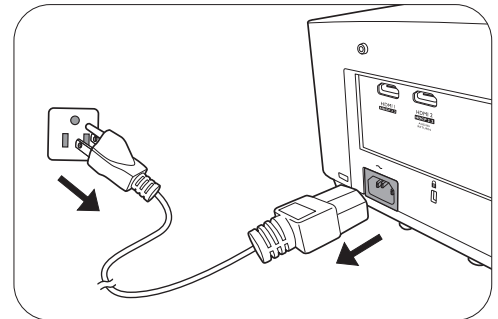

- To protect the light source, the projector will not respond to any commands during the cooling process.
- Avoid turning on the projector immediately after turning it off as excessive heat may shorten lamp life.
- Lamp life results will vary depending on environmental conditions and usage.

Menu operation

Please note that the on-screen display (OSD) menus vary according to the signal type selected and the projector model you are using.

The menu items are available when the projector detects at least one valid signal. If there is no equipment connected to the projector or no signal detected, limited menu items are accessible.

Basic Menu

Menu (Ref. Page)	Options
Picture Mode (30)	Bright/Presentation/sRGB/Infographic/DICOM-SIM/Video/Video Conference/(3D)/(HDR10)/(HLG)/User 1/User 2
Aspect Ratio (37)	Auto/4:3/16:9/16:10/2.4:1/21:9
Light Source Mode (52)	Normal Mode
	ECO Mode
	Dimming Mode
	Custom Mode
3D Keystone (16)	H: -40~0~40
	V: -40~0~40
	R: -40~0~40
Volume (35)	0 – 20
Brightness (31)	0–100
Information (50)	Native Resolution
	Detected Resolution
	Source
	Picture Mode
	Light Source Mode
	3D Format
	Color System
	Light Source Usage Time
	Projector ID
	Firmware Version
Service Code	
Menu Type (46)	Basic/Advanced

Advanced Menu

1. Main menu: **Picture**

Structure

Menu		Options	
Picture Mode		Bright/Presentation/sRGB/Infographic/DICOM-SIM/Video/Video Conference/(3D)/(HDR10)/(HLG)/User 1/User 2	
User Management	Load Settings From	Bright/Presentation/sRGB/Infographic/DICOM-SIM/Video/Video Conference	
	Rename User Mode		
Brightness		0-100	
Contrast		0-100	
Sharpness		0~7~15	
Gamma Selection		1.8/2.0/2.1/2.2/2.3/2.4/2.6/BenQ/DICOM	
Color Temperature		Normal/Cool/Native/Warm	
Advanced Color Settings	Color Temperature Tuning	R Gain/G Gain/B Gain	0-200
		R Offset/G Offset/B Offset	0-511
	Color Management	R/G/B/C/M/Y W	Hue/Saturation/Gain R Gain/G Gain/B Gain
Brilliant Color		0-10	
Light Source Mode		Normal/ECO/Dimming/Custom	
Custom Brightness		20%-100%	
Wall Color		Off/Light Yellow/Pink/Light Green/Blue/Blackboard	
HDR Brightness		-2/-1/0/1/2	
Noise Reduction		0 - 15	
Reset Current Picture Mode		Reset/Cancel	

Function descriptions

Menu	Descriptions
Picture Mode	<p>The projector is preset with several predefined picture modes so that you can choose one to suit your operating environment and input signal picture type.</p> <ul style="list-style-type: none">• Bright: Maximizes the brightness of the projected image. This mode is suitable for environments where extra-high brightness is required, such as using the projector in well lit rooms.• Presentation: Is designed for presentations. The brightness is emphasized in this mode to match PC and notebook coloring.• sRGB: Maximizes the purity of RGB colors to provide true-to-life images regardless of brightness setting. It is most suitable for viewing photos taken with an sRGB compatible and properly calibrated camera, and for viewing PC graphic and drawing applications such as AutoCAD.• Infographic: Is perfect for presentations with the mixture of text and graphics due to its high color brightness and better color gradation to see the details clearly.• DICOM-SIM: Follows the standard of DICOM to get the gray level parameter.• Video: Is suitable for playing videos in an environment where there is ambient light. Dynamic color details are preserved by BenQ enhancement technology.• Video Conference: Design for video conference scenarios which showcases detail skin color of remote meeting attendees.• 3D: Is appropriate for playing 3D images and 3D video clips. This mode is only available when 3D function is enabled and 3D content is detected.• HDR10: Delivers High Dynamic Range effects with higher contrasts of brightness and colors for HDR Blu-ray movies. Picture Mode will be switched to HDR10 automatically while detecting metadata or EOTF info from HDR contents.• HLG: Delivers High Dynamic Range effects with higher contrasts of brightness and colors. Picture Mode will be switched to HLG automatically while detecting metadata or EOTF info from HLG streaming contents.• User 1/User 2: Recalls the settings customized based on the current available picture modes. See User Management on page 31.

There is one user-definable mode if the current available picture modes are not suitable for your need. You can use one of the picture modes (except the **User**) as a starting point and customize the settings.

• **Load Settings From**

1. Go to **Picture > Picture Mode**.
2. Press ◀/▶ to select **User 1** or **User 2**.
3. Press ▼ to highlight **User Management**, and press **OK**. The **User Management** page is displayed.
4. Select **Load Settings From** and press **OK**.
5. Press ▼/▲ to select a picture mode that is closest to your need.
6. Press **OK** and **BACK** to return to the **Picture** menu.
7. Press ▼ to select the sub-menu items you want to change and adjust the values with ◀/▶. The adjustments define the selected user mode.

• **Rename User Mode**

Select to rename the customized picture mode (**User 1/User 2**). The new name can be up to 9 characters including English letters (A-Z, a-z), digits (0-9), and space (_).

1. Go to **Picture > Picture Mode**.
2. Press ◀/▶ to select **User 1** or **User 2**.
3. Press ▼ to highlight **User Management**, and press **OK**. The **User Management** page is displayed.
4. Press ▼ to highlight **Rename User Mode** and press **OK**. The **Rename User Mode** page is displayed.
5. Use ▲/▶ /▼/◀, and **OK** to set desired characters.
6. When done, press **BACK** to save the changes and exit.

User Management

Brightness

The higher the value, the brighter the image. Adjust this control so the black areas of the image appear just as black and that detail in the dark areas is visible.

Contrast

The higher the value, the greater the contrast. Use this to set the peak white level after you have previously adjusted the Brightness setting to suit your selected input and viewing environment.

Sharpness

The higher the value, the sharper the picture becomes.

• Gamma Selection

Gamma refers to the relationship between input source and picture brightness.

- **1.8/2.0/2.1/BenQ/DICOM:** Select these values according to your preference.
- **2.2/2.3:** Increases the average brightness of the picture. Best for a lit environment, meeting room or family room.
- **2.4:** Best for viewing movies in a dark environment.
- **2.6:** Best for viewing movies which are mostly composed of dark scenes.

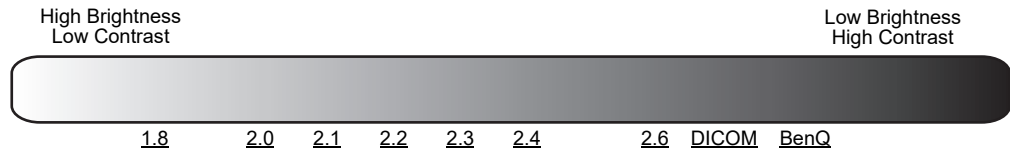

Advanced Color Settings

• Color Temperature Tuning

There are several preset color temperature settings available. The available settings may vary according to the signal type selected.

- **Normal:** Maintains normal colorings for white.
- **Cool:** Makes images appear bluish white.
- **Native:** With the light source's original color temperature and higher brightness. This setting is suitable for environments where high brightness is required, such as projecting pictures in well lit rooms.
- **Warm:** Makes images appear reddish white.

You can also set a preferred color temperature by adjusting the following options.

- **R Gain/G Gain/B Gain:** Adjusts the contrast levels of Red, Green, and Blue.
 - **R Offset/G Offset/B Offset:** Adjusts the brightness levels of Red, Green, and Blue.
-

• Color Management

The Color Management provides six sets (RGBCMY) of colors to be adjusted. When you select each color, you can independently adjust its range and saturation according to your preference.

To make adjustments, press the ▲/▼ arrows to highlight an independent color from among Red (R), Green (G), Blue (B), Cyan (C), Magenta (M), or Yellow (Y), and press **OK**. The following menu items are displayed for your choice.

- **Hue:** Increase in the range will include colors consisted of more proportions of its two adjacent colors. Please refer to the illustration for how the colors relate to each other.
For example, if you select Red and set its range at 0, only pure red in the projected picture will be selected. Increasing its range will include red close to yellow and red close to magenta.

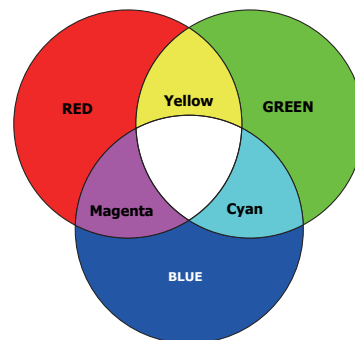

- **Saturation:** Adjusts the values to your preference. Every adjustment made will reflect to the image immediately. For example, if you select Red and set its value at 0, only the saturation of pure red will be affected.
- **Gain:** Adjusts the values to your preference. The contrast level of the primary color you select will be affected. Every adjustment made will reflect to the image immediately.

If you selected **W**, you can adjust the contrast levels of Red, Green, and Blue by selecting **R Gain**, **G Gain**, and **B Gain**.

To return all the settings to the factory default values, highlight **Reset**, and press **OK**.



Saturation is the amount of that color in a video picture. Lower settings produce less saturated colors; a setting of "0" removes that color from the image entirely. If the saturation is too high, that color will be overpowering and unrealistic.

• Brilliant Color

This function utilizes a new color-processing algorithm and system level enhancements to enable higher brightness while providing truer, more vibrant colors in picture. It enables a greater than 50% brightness increase in mid-tone images, which are common in video and natural scenes, so the projector reproduces images in realistic and true colors.

• Light Source Mode

Selects a suitable light source power from among the provided modes. See [Extending light source life on page 52](#).

• Custom Brightness

You can adjust the light source brightness. This function is only available when **Light Source Mode** is **Custom**.

Advanced Color Settings (Continued)

**Advanced Color
Settings
(Continued)**

• **Wall Color**

Corrects the projected picture's color when the projection surface such as a painted wall which may not be white, the Wall Color feature can help correct the projected picture's colors to prevent possible color difference between the source and projected pictures. There are several precalibrated colors to choose from: **Light Yellow, Pink, Light Green, Blue,** and **Blackboard.**

• **HDR Brightness**

The projector can automatically adjust the brightness levels of your image according to the input source. You can also manually select a brightness level to display better picture quality. When the value is higher, the image becomes brighter; when the value is lower, the image becomes darker.

• **Noise Reduction**

Reduces electrical image noise caused by different media players.

**Reset Current
Picture Mode**

Returns all of the adjustments you've made for the selected **Picture Mode** (including the preset mode, **User 1** and **User 2**) to the factory preset values.

1. Press **OK**. The confirmation message is displayed.
2. Use **◀/▶** to select **Reset** and press **OK**. The current picture mode returns to the factory preset settings.



The following settings will still remain: **Picture Mode.**

2. Main menu: **Audio**

Structure

Menu	Options
Mute	Off/On
Volume	0 – 20
Audio Output	Internal Speaker/S/PDIF/Audio Return/3.5mm Jack
Audio Output Format	LPCM/RAW/RAW+
Power On/Off Ring Tone	Off/On
Reset Audio	Reset/Cancel

Function descriptions

Menu	Descriptions
Mute	Select On to temporarily turn off the projector's internal speaker or the volume being output from the audio output jack. To restore the audio, select Off .
Volume	Adjusts the volume level of the projector's internal speaker or the volume being output from the audio output jack. If the Mute function is activated, adjusting Volume will turn off the Mute function.
Audio Output	Selects an audio output source from built-in speakers (Internal Speaker), the S/PDIF port (S/PDIF), the HDMI 2 port (Audio Return), or the audio output jack (3.5mm Jack).
Audio Output Format	Audio Output Format supports multi-audio outputs including 2.0, 5.1, 7.1 and Dolby Atmos to external audio system like soundbar. The following audio output formats are provided to achieve the audio performance you desire: LPCM outputs 2 channel audio output, RAW supports 5.1 channel audio output, and RAW+ supports Dolby Atmos audio output.
Power On/Off Ring Tone	Sets the ring tone for the projector On or Off . The Power On/Off Ring Tone can only be adjusted here. Setting the sound mute or adjusting the sound level do not affect the Power On/Off Ring Tone .
Reset Audio	Returns all of the adjustments you've done under the Audio menu to the factory preset values.



3. Main menu: **Display**

Structure

Menu		Options
Aspect Ratio		Auto/4:3/16:9/16:10/2.4:1/21:9
Auto Source Search		Off/On
Source Rename		HDMI-1/HDMI-2/DP*/HDBaseT
3D	3D Sync Mode	DLP Link/VESA 3D
	3D Mode	Auto/Frame Sequential/Off
	3D Sync Invert	Disable/Invert
	3D Sync Out Delay	0~359
	3D Sync Out Reference	3D VESA/Bypass
	Save 3D Settings	3D Settings 1/3D Settings 2/ 3D Settings 3
	Apply 3D Settings	3D Settings 1/3D Settings 2/ 3D Settings 3
HDMI Settings	HDMI Format	Auto/Limited/Full
	HDMI Equalizer	HDMI-1/HDMI-2 Auto/1/2/3/4/5
	HDMI EDID	HDMI-1/HDMI-2/ HDBaseT/ DisplayPort Enhanced/Standard
	Electronics Control	Off/On
	Audio Return (HDMI-2)	Off/On
	Power On Link	Off/From Device
	Power Off Link	Off/From Projector
Dynamic Dimming		Off/On
4K Upscaling		Off/On
Fast Mode		Off/On
Reset Display		Reset/Cancel

* DisplayPort (hereinafter also referred to as DP).

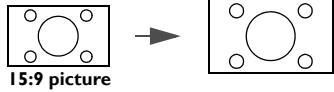
Function descriptions

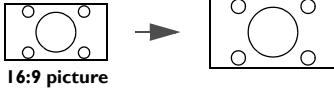
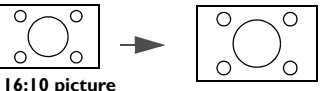
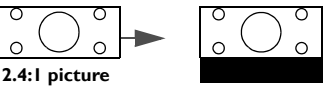
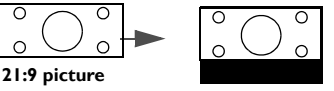
Menu	Descriptions
<p>Aspect Ratio</p>	<p>There are several options to set the image's aspect ratio depending on your input signal source.</p> <ul style="list-style-type: none"> • Auto: Scales an image proportionally to fit the projector's native resolution in its horizontal or vertical width. • 4:3: Scales an image so that it is displayed in the center of the screen with a 4:3 aspect ratio. • 16:9: Scales an image so that it is displayed in the center of the screen with a 16:9 aspect ratio. • 16:10: Scales an image so that it is displayed in the center of the screen with a 16:10 aspect ratio. • 2.4:1: Scales an image so that it is displayed aligned with the upper edge of the display region with a 2.4:1 aspect ratio. • 21:9: Scales an image so that it is displayed aligned with the upper edge of the display region with a 21:9 aspect ratio.      
<p>Auto Source Search</p>	<p>Allows the projector to automatically search for a signal.</p>
<p>Source Rename</p>	<p>Renames the current input source to your desired name.</p> <p>On the Source Rename page:</p> <ol style="list-style-type: none"> 1. Press OK to display the on-screen keyboard. 2. Press ▲/▼/◀/▶ to select each desired digit/letter, and press OK to confirm each input. 3. Repeat the step above and when done, press BACK and ▼ to highlight Commit. 4. Press OK and the source name changes.
<p>3D</p>	<p>This projector supports playing three-dimensional (3D) content transferred through your 3D-compatible video devices and contents, such as PlayStation consoles (with 3D game discs), 3D Blu-ray players (with 3D Blu-ray discs), and so on. After you have connected the 3D video devices to the projector, wear the BenQ 3D glasses and make sure the power is on to view 3D contents.</p>

When watching 3D contents:

- The image may seem misplaced; however, this is not a product malfunction.
- Take appropriate breaks when watching 3D contents.
- Stop watching 3D contents if you feel fatigue or discomfort.
- Keep a distance from the screen of about three times the effective height of the screen.
- Children and people with a history of oversensitivity to light, heart problems, or any other existing medical conditions should be refrained from watching 3D contents.
- The image may seem reddish, greenish, or bluish without wearing 3D glasses. However, you will not notice any color bias when watching 3D contents with 3D glasses.
- The 4K source will not be displayed.

- **3D Sync Mode**

Select a proper 3D sync mode.

- **3D Mode**

The projector can automatically enable 3D mode via the contents when the source type is HDMI and supports 1.4a. Or you can choose **Frame Sequential** format when detecting 3D contents.

When **3D Mode** is enabled:

- The brightness level of the projected image decreases.
- The **Picture Mode** cannot be adjusted.
- The **3D Keystone** can only be adjusted within limited degrees.

- **3D Sync Invert**

When your 3D image is distorted, enable this function to switch between the image for the left eye and the right eye for more comfortable 3D viewing experience.

- **3D Sync Out Delay**

You can adjust the 3D sync out signal delay time.

- **3D Sync Out Reference**

You can decide the 3D sync out signal goes to a 3D VESA emitter or is bypassed to another projector.

- **Save 3D Settings**

When you have successfully displayed the 3D contents after making the appropriate adjustments, you can enable this function and choose a set of 3D settings to memorize current 3D settings.

3D

• Apply 3D Settings

After the 3D settings are saved, you can decide if you would like to apply them by choosing a set of 3D settings that you have saved. Once applied, the projector will automatically play the incoming 3D contents if it matches the 3D settings saved.



Only the set(s) of 3D settings with memorized data is available.

• HDMI Format

Selects a suitable RGB color range to correct the color accuracy.

- **Auto:** Automatically selects a suitable color range for the incoming HDMI signal.
- **Limited:** Utilizes the Limited range RGB 16-235.
- **Full:** Utilizes the Full range RGB 0-255.

• HDMI Equalizer

Sets a suitable value to maintain the HDMI picture quality in long distance data transmission.

• HDMI EDID

Switches between **Enhanced** for HDMI 2.0 EDID and **Standard** for HDMI 1.4 EDID. Selecting **Standard** which supports up to 1080p 60Hz may solve abnormal display issues with some old players.



When the **Aspect Ratio** is **21:9**, the **HDMI EDID** is fixed at **Standard**. To change the settings switch to a different aspect ratio.

• Electronics Control

When you enable this function and connect an HDMI CEC-compatible device to your projector with an HDMI cable, turning on the HDMI CEC compatible device automatically turns on the projector, while turning off the projector automatically turns off the HDMI CEC compatible device.

• Audio Return (HDMI-2)

When connecting to ARC compatible speaker to the projector with HDMI cables, the audio can be returned to these speakers from the projector HDMI 2 port.

HDMI-1 audio can via ARC function (**HDMI-2**) to output audio to external speakers.

• Power On Link/Power Off Link

When you connect an HDMI CEC-compatible device to your projector with an HDMI cable, you can set the behavior of powering on/off between the device and the projector.

Power On Link > From Device	When the connected device is turned on, the projector will be activated, too.
Power Off Link > From Projector	When the projector is turned off, the connected device will be shut down, too.

HDMI Settings

Dynamic Dimming	Allows the projector to automatically detect the video content and enhance contrast during dark scenes.
4K Upscaling	Allows the projector to automatically upscale all input timings to 4K resolution.
Fast Mode	<p>Minimizes the response time between the input source and the displayed image. For the optimized latency, when Fast Mode is activated, 3D Keystone/Aspect Ratio will return to the default settings.</p> <p>*Fast Mode can only be enabled for below input timing adopted by most of popular games:</p> <ul style="list-style-type: none"> - 1080p 60Hz/120Hz/240Hz - 4K 60Hz
Reset Display	Returns all the settings on the Display main menu to the factory default values.

4. Main menu: **Installation**

Structure

Menu		Options
Projector Position		Front/Front Ceiling/Rear/Rear Ceiling
		H: -40 – +40
3D Keystone		V: -40 – +40
		R: -40 – +40
Auto Vertical Keystone		Off/On
12V Trigger		Off/On
Test Pattern		On/Off
High Altitude Mode		On/Off
Serial Port Setting	Port Selection	RS232/HDBaseT
	Baud Rate	9600/14400/19200/38400/57600/ 115200
Corner Fit		0~60
Image Resizing	Digital Zoom	1.0X – 1.8X/2.0X
	Digital Shrink & Shift	0.75X~1.0X
	Modes of Adjustment	
	Top	
	Bottom	
	Blanking	
		Left
		Right
Warping	Enable	On/Off
	Warping Pattern	5x3/10x5/15x9/24x15
	Warping Background	
	Warping Correction	
	Reset	Reset/Cancel
Image Memory	Save Image Memory	Memory-1/Memory-2/Memory-3/
	Apply Image Memory	Memory-4/Memory-5
	Rename	

Function descriptions

Menu	Descriptions
Projector Position	The projector can be installed on a ceiling or behind a screen, or with one or more mirrors. See Choosing a location on page 10 for details.
3D Keystone	See Correcting keystone on page 16 for details.
Auto Vertical Keystone	Automatically corrects the keystone at the left/right side of the projected image.
12V Trigger	<p>There is one 12V trigger that works independently according to your needs for installation scenarios.</p> <ul style="list-style-type: none"> • Off: If this is selected, the projector will not send electronic signal out when it is turned on. • On: The projector will send a low to high electronic signal out when it is turned on, a high to low signal out when it is turned off.

Test Pattern

Adjusts the image size and focus and check that the projected image is free from distortion.

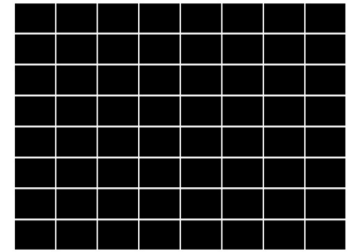

High Altitude Mode

We recommend you use the **High Altitude Mode** when your environment is between 1500 m–3000 m above sea level, and ambient temperature is between 0°C–30°C.

Operation under "**High Altitude Mode**" may cause a higher decibel operating noise level because of increased fan speed necessary to improve overall system cooling and performance.

If you use this projector under other extreme conditions excluding the above, it may display auto shut-down symptoms, which is designed to protect your projector from over-heating. In cases like this, you should switch to High Altitude mode to solve these symptoms. However, this is not to state that this projector can operate under any and all harsh or extreme conditions.



Do not use the **High Altitude Mode** if your altitude is between 0 m and 1500 m and ambient temperature is between 0°C and 35°C. The projector will be over cooled, if you turn the mode on under such a condition.

Serial Port Setting

- **Port Selection:** Allows you to select a preferred control port: through the RS-232C port (**RS232** port on the projector) or the HDBaseT port (**HDBaseT** input port on the projector).
- **Baud Rate:** Selects a baud rate that is identical with your computer's so that you can connect the projector using a suitable RS-232 cable. This function is intended for qualified service personnel.

Corner Fit

See [Adjusting Corner Fit on page 17](#) for details.

• Digital Zoom

Magnifies or reduces the projected image size.

1. After the adjustment bar displays, press ▲/▼ on the projector or **ZOOM+/ZOOM-** on the remote control repeatedly to reduce or magnify the image to a desired size.
2. Press **OK** to enter panning mode.
3. Press the directional arrows (▲, ▼, ◀, ▶) on the projector or remote control to navigate the picture.



The picture can only be navigated after it is magnified. You can further magnify the picture while searching for details.

• Digital Shrink & Shift

Shrinks and/or shifts the projected image.

1. After the adjustment bar displays, press ◀/▶ repeatedly to shrink or magnify the picture to a desired size.
2. Press **OK** to activate digital shift function.
3. After digital shift function is activated, press the directional arrows (▲, ▼, ◀, ▶) to shift the image.
4. Press **AUTO** to restore the picture to its original size.



The picture can only be shifted after it shrank.

• Blanking

Blanks some parts of the projected image.

1. Select the **Modes of Adjustment** first by pressing ◀/▶.
2. Press ▲/▼ to highlight the area you want to adjust and press ◀/▶ to adjust its range.

This function aims at correcting the geometric distortion of the projector's images when they are projected onto an uneven surface such as a cylinder, a spherical shape, etc.

• Enable

When this function is enabled, the following functions will not be available: **3D Keystone, Corner Fit, Digital Shrink & Shift, Blanking.**

• Warping Pattern

After the warping function is enabled, select a pattern.

Image Resizing

Warping

- **Warping Background**

Choose **Yes** if you want to set the warping data with your projected image. If not, a black screen will be displayed.

- **Warping Correction**

If you have never set the warping data under the selected warping pattern, a grid pattern is displayed.

1. Press **▲/▼/◀/▶** to move the cursor to an adjustment point.
2. Press **OK**.
3. Press **▲/▼/◀/▶** to move the adjustment point up/down/left/right. Short press on the directional arrow moves 1 pixel, while long press moves 30 pixel.

Warping

The adjustment data will be saved and can be loaded the next time you select the same warping pattern.

- **Reset**

If you want to set a new warping data for the selected pattern, reset its data first by choosing **Reset**.

- **Save Image Memory:** Allows you to save and apply several sets of image settings for regularly used circumstances, including the following settings: **Projector Installation, Aspect Ratio, Picture Mode, Source, Resolution, Light Source Mode, Digital Shrink & Shift, Blanking**. You can choose one set of memory to save the current settings.

Image Memory

- **Apply Image Memory:** After the image memories are saved, you can decide if you would like to apply it by choosing a set of memory that you have saved.

- **Rename:** Renames the image memories.

5. Main menu: **System**

Structure

Menu		Options		
Language		English / Français / Deutsch / Italiano / Español / Русский / 繁體中文 / 简体中文 / 日本語 / 한국어 / Svenska / Nederlands / Türkçe / Čeština / Português / ไทย / Polski / Magyar / Hrvatski / Română / Norsk / Dansk / Български / Suomi / Indonesian / Ελληνικά / العربية / हिन्दी / Fârsi / Tiếng Việt		
Background Settings	Background Color	Black/Blue/Purple		
	Splash Screen	BenQ/Black/Blue		
Menu Settings	Menu Type	Basic/Advanced		
	Menu Display Time	5 sec/10 sec/20 sec/30 sec/Always		
	Menu Position	Center/Top-Left/Top-Right/ Bottom-Right/Bottom-Left		
Light Source Information	Light Source Usage Time			
	Normal Mode			
	ECO Mode			
	Dimming Mode			
Standby Settings	Standby Mode	Eco/Network/Normal		
	Auto Disable Network Standby Mode	Never/20 min/1 hr/3 hr/6 hr		
	Audio Pass Through	Off/HDMI-1/HDMI-2/DisplayPort		
Operation Settings	Reminder Message	Off/On		
	LED Indicator	Off/On		
	Power On/Off Settings	Auto Power Off	Disable/3 min/10 min/15 min/ 20 min/25 min/30 min	
		Direct Power On	Off/On	
		Signal Power On	Off/HDMI-1/HDMI-2	
Security Settings	Panel Key Lock	Off/On	Yes/No	
	Password	Change Password Power On Lock		
Network Settings		Status		
		DHCP	Off/On	
	Wired LAN	IP Address		
		Subnet Mask		
		Default Gateway		
		DNS Server		
		Apply		
	AMX Device Discovery	Off/On		
	MAC Address (Wired)			
Projector ID Setting		Off/01/02/.../99		

Menu		Options	
Simulator Settings	Simulator Mode	Off/On	
	IR Receiver	IR Front	Off/On
		IR Rear	Off/On
Factory Default		Reset/Cancel	
Reset System		Reset/Cancel	

Function descriptions

Menu	Descriptions
Language	Sets the language for the On-Screen Display (OSD) menus.
Background Settings	<ul style="list-style-type: none"> • Background Color Sets the background color for the projector.
	<ul style="list-style-type: none"> • Splash Screen Allows you to select which logo screen will be displayed during projector start-up.
Menu Settings	<ul style="list-style-type: none"> • Menu Type Sets the OSD menu type according to your needs.
	<ul style="list-style-type: none"> • Menu Display Time Sets the length of time the OSD will remain active after your last key press.
	<ul style="list-style-type: none"> • Menu Position Sets the On-Screen Display (OSD) menu position.
Light Source Information	This menu page displays the following information:
	<ul style="list-style-type: none"> • Light Source Usage Time • Light hours used under Normal Mode, ECO Mode, Dimming Mode, Custom Mode.

- **Standby Mode**

- **Eco:** The projector maintains at normal standby mode with less than 0.5W power consumption.
- **Network:** The projector maintains at network standby mode with less than 2W power consumption.
- **Normal:** Allows the projector to provide network, monitor out and audio pass through functions in standby mode.

- **Auto Disable Network Standby Mode**

Standby Settings

Allows the projector to disable the network function after a set period of time after it enters standby mode. For instance, if 20 min is selected, the projector is able to provide the network function for 20 minutes after it enters standby mode. When 20 minutes is up, the projector enters normal standby mode.

- **Audio Pass Through**

The projector can play sound when it is in standby mode and the corresponding jacks are correctly connected to devices. Press ◀/▶ to choose the source that you wish to use. See [Connection on page 18](#) for how to make the connection.



- **Reminder Message**

Sets the reminder messages on or off.

- **LED Indicator**

You can turn off the LED warning lights. This is to avoid any light disturbance when viewing images in a dark room.

- **Power On/Off Settings**

- **Auto Power Off:** Allows the projector to turn off automatically if no input signal is detected after a set period of time to prevent unnecessary waste of light source life.
- **Direct Power On:** Allows the projector to turn on automatically once the power is fed through the power cord.
- **Signal Power On:** Sets whether to turn the projector directly on without pressing  **POWER** or  **ON** when the projector is in standby mode and detects a HDMI signal.

Operation Settings

- **Panel Key Lock**

With the control keys on the projector and remote control locked, you can prevent your projector settings from being changed accidentally (by children, for example). When the **Panel Key Lock** is on, no control keys on the projector and remote control will operate except **POWER**.

Security Settings

To release panel key lock, press and hold **▶** (the right key) on the projector or remote control for 3 seconds.



If you turn off the projector without disabling panel key lock, the projector will still be in locked status the next time it is turned on.

- **Password/Power On Lock**

See [Utilizing the password function on page 22](#).

- **Wired LAN**

See [Controlling the projector through a Wired LAN environment on page 24](#).

Network Settings

- **AMX Device Discovery**

When this function is **On**, the projector can be detected by AMX controller.

- **MAC Address (Wired)**

Displays the mac address for this projector.

Sets the projector ID for this projector (between 01~99). When multiple adjacent projectors are in operation at the same time, switching the projector ID codes can prevent interference from other remote controls. After the Projector ID is set, switch to the same ID for the remote control to control this projector. See [Projector & Remote control on page 8](#).

Set the ID

1. Press and hold **ID SET** until the ID setting indicator lights up.
2. Enter the ID for the remote control (between 01~99). The remote control ID should be the same as the corresponding projector ID.
3. The ID is saved successfully when you see the ID setting indicator starts flickering and then blackout.

Projector ID Setting

Clear the ID

1. Press and hold **ID SET** until the ID setting indicator lights up.
 2. Press **ALL** to clear current ID setting of the remote control.
- The ID is cleared successfully when you see the ID setting indicator starts flickering and then blackout.
-

Simulator Settings

- **Simulator Mode**

When this function is activated, the following settings will apply:

- **Picture Mode** will be set as **sRGB**.
- **Direct Power On** will be set as **On**.
- **Fast Mode** will be activated.
- **Standby Mode** will be set as **Normal**.

- **IR Receiver**

You can enable or disable selected remote receiver.

Factory Default

Returns all settings to the factory preset values.



The following settings will still remain: **Projector Position, 3D Keystone, Auto Vertical Keystone, 12V Trigger, High Altitude Mode, Baud Rate, Corner Fit, Digital Shrink & Shift, Blanking, Warping, Light Source Information, Security Settings, Network Settings, Projector ID Setting.**

Reset System

Returns all the settings on the **System** main menu to the factory default values.



The following settings will still remain: **Light Source Information, Security Settings, Network Settings, Projector ID Setting.**

6. Main menu: **Information**

Structure

Menu	Options
Native Resolution	
Detected Resolution	
Source	
Picture Mode	
Light Source Mode	
3D Format	
Color System	
Light Source Usage Time	
Projector ID	
Firmware Version	
Service Code	

Function descriptions

Menu	Descriptions
Native Resolution	Shows the native resolution of the projector.
Detected Resolution	Shows the native resolution of the input signal.
Source	Shows the current signal source.
Picture Mode	Shows the selected mode on the Picture menu.
Light Source Mode	Shows the used light source mode.
	Displays the current 3D mode.
3D Format	 3D Format is only available when 3D is enabled.
Color System	Shows the input system format.
Light Source Usage Time	Shows the number of hours the light has been used.
Projector ID	Shows projector ID of the projector.
Firmware Version	Shows the firmware version of your projector.
Service Code	Shows the projector's serial number.

Maintenance

Care of the projector

Cleaning the lens

Clean the lens whenever you notice dirt or dust on the surface. Please be sure to turn off the projector and let it cool down completely before cleaning the lens.

- Use a canister of compressed air to remove dust.
- If there is dirt or smears, use lens-cleaning paper or moisten a soft cloth with lens cleaner and gently wipe the lens surface.
- Never use any type of abrasive pad, alkaline/acid cleaner, scouring powder, or volatile solvent, such as alcohol, benzene, thinner or insecticide. Using such materials or maintaining prolonged contact with rubber or vinyl materials may result in damage to the projector surface and cabinet material.

Cleaning the projector case

Before you clean the case, turn the projector off using the proper shutdown procedure as described in [Shutting down the projector on page 27](#) and unplug the power cord.

- To remove dirt or dust, wipe the case with a soft, lint-free cloth.
- To remove stubborn dirt or stains, moisten a soft cloth with water and a neutral pH detergent. Then wipe the case.



Never use wax, alcohol, benzene, thinner or other chemical detergents. These can damage the case.

Storing the projector

If you need to store the projector for an extended time, please follow the instructions below:

- Make sure the temperature and humidity of the storage area are within the recommended range for the projector. Please refer to [Specifications on page 56](#) or consult your dealer about the range.
- Retract the adjuster feet.
- Remove the battery from the remote control.
- Pack the projector in its original packing or equivalent.

Transporting the projector

It is recommended that you ship the projector with its original packing or equivalent.

Light source information

Getting to know the light hour

When the projector is in operation, the duration (in hours) of light source usage is automatically calculated by the built-in timer. The method of calculating the equivalent light hour is as follows:

1. Light Usage Time = (x+y+z+a) hours, if:
Time used in **Normal** mode = x hours
Time used in **ECO** mode = y hours
Time used in **Dimming** mode = z hours
Time used in **Custom** mode = a hours
2. Equivalent Light Hour = α hours

$$\alpha = \frac{A'}{X} \times x + \frac{A'}{Y} \times y + \frac{A'}{Z} \times z + \frac{A'}{A} \times a, \text{ if}$$

X= light source life spec of **Normal** mode
Y= light source life spec of **ECO** mode
Z= light source life spec of **Dimming** mode
A= light source life spec of **Custom** mode

A' is the longest light life spec among X, Y, Z, A



For time used in each light mode shown in OSD menu:

- Time used is accumulated and rounded down to an integer in **hours**.
- When time used is less than 1 hour, it shows 0 hours.



When you calculate **Equivalent Light Hours** manually, it will probably have deviation from the value shown in OSD menu since projector system calculates time used for each light mode in "Minutes" then rounds down to an integer in hours shown in OSD.

To obtain the light hour information:

Go to **Advanced** menu - **System** > **Light Source Information** and press **OK**. The **Light Source Information** page appears.

You can also get the light hour information on the **Information** menu.

Extending light source life

- Setting the **Light Source Mode**

Go to **Advanced** menu - **Picture** > **Advanced Color Settings** > **Light Source Mode**, press **OK**. The **Light Source Mode** page appears.

Setting the projector in **ECO**, **Dimming** or **Custom** mode extends lamp life.





























































Light Mode	Description
Normal	Provides full light brightness
ECO	Lowers brightness to extend the light life and decreases the fan noise
Dimming	Lowers brightness to offer a longer light source life
Custom	Enables the light source brightness adjustment bar so that you can adjust the setting to your liking









- Setting **Auto Power Off**

This function allows the projector to turn off automatically if no input signal is detected after a set period of time to prevent unnecessary waste of light source life.

To set **Auto Power Off**, go to **Advanced** menu - **System > Operation Settings > Power On/Off Settings > Auto Power Off** and press ◀/▶ to set a period of time.

Indicators

Light			Status & Description
POWER	TEMP	LIGHT	
Power events			
			Stand-by mode
			Powering up
			Normal operation
			Normal power-down cooling
			Download
			CW start fail
			Phosphor wheel start fail
Burn-in events			
			Burn-in ON
			Burn-in OFF
Light source events			
			Light source life exhausted
			Light source error in normal operation
			Light source is not lit up
Thermal events			
			Fan 1 error (the actual fan speed is outside the desired speed)
			Fan 2 error (the actual fan speed is outside the desired speed)
			Fan 3 error (the actual fan speed is outside the desired speed)
			Fan 4 error (the actual fan speed is outside the desired speed)
			Fan 5 error (the actual fan speed is outside the desired speed)
			Fan 6 error (the actual fan speed is outside the desired speed)
			Temperature 1 error (over limited temperature)
			Thermal IC #1 I2C connection error

	 : Off	 : Orange On	 : Green On	 : Red On
		 : Orange Flashing	 : Green Flashing	 : Red Flashing

Troubleshooting

? The projector does not turn on.

Cause	Remedy
There is no power from the power cord.	Plug the power cord into the AC power jack on the projector, and plug the power cord into the power outlet. If the power outlet has a switch, make sure that it is switched on.
Attempting to turn the projector on again during the cooling process.	Wait until the cooling down process has completed.

? No picture

Cause	Remedy
The video source is not turned on or connected correctly.	Turn the video source on and check that the signal cable is connected correctly.
The projector is not correctly connected to the input signal device.	Check the connection.
The input signal has not been correctly selected.	Select the correct input signal with the SOURCE key.

? Blurred image

Cause	Remedy
The projection lens is not correctly focused.	Adjust the focus of the lens using the focus ring.
The projector and the screen are not aligned properly.	Adjust the projection angle and direction as well as the height of the projector if necessary.

? Remote control does not work.

Cause	Remedy
The batteries are out of power.	Replace both of the batteries with new ones.
There is an obstacle between the remote control and the projector.	Remove the obstacle.
You are too far away from the projector.	Stand within 8 meters (26 feet) of the projector.

? The password is incorrect.

Cause	Remedy
You do not remember the password.	See Entering the password recall procedure on page 23 .

Specifications

Projector specifications



All specifications are subject to change without notice.

Optical

Resolution
3840 (H) x 2160 (V)
Display system
1-CHIP DMD
Lens
F = 1.809 ~ 2.1, f = 14.3 ~ 22.9 mm
Clear focus range
1.8 – 6 m@Wide, 2.88 – 9.60 m@Tele
Light source
Laser

Electrical

Power supply
AC100–240V, 6 A, 50–60 Hz (Automatic)
Power consumption
520 W (Max); < 0.5 W (Standby)

Mechanical

Weight
7.0 Kg ± 200 g

Output terminals

Speaker
10 watt x 1
Audio signal output
S/PDIF x 1
PC audio jack x 1
3D VESA
3D VESA OUT x 1
Wired remote out
3.5 mm Mini jack x 1

Control

USB
Type-A power supply 5V / 2 A x 1
RS-232 serial control
9 pin x 1
LAN control
RJ45 x 1
12V trigger x 1
IR receiver x 2

Input terminals

Video signal input
SD/HDTV signal input
Digital - HDMI 2.0 x 2
Digital - DisplayPort x 1
HDBaseT x 1
3D VESA
3D VESA IN x 1
Wired remote in
3.5 mm Mini jack x 1

Environmental Requirements

Operating temperature
0°C–40°C at sea level
Operating relative humidity
10%–90% (without condensation)
Operating altitude
0–1499 m at 0°C–35°C
1500–3000 m at 0°C–30°C (with
High Altitude Mode on)
Storage temperature
-20°C–60°C at sea level
Storage humidity
10%–90% RH (without condensation)
Storage altitude
30°C@ 0~12,200m above sea level

Transporting

Original packing or equivalent is recommended

Repairing

Please visit below website and choose your country to find your service contact window.
<http://www.benq.com/welcome>

Dimensions

416 mm (W) x 166 mm (D) x 351 mm (H)

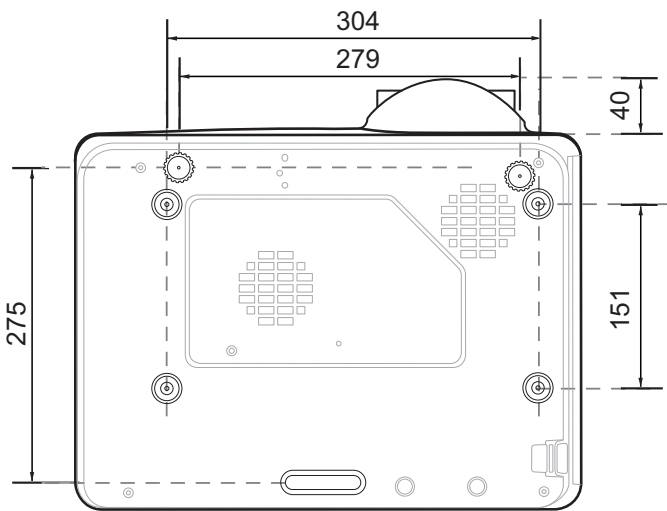
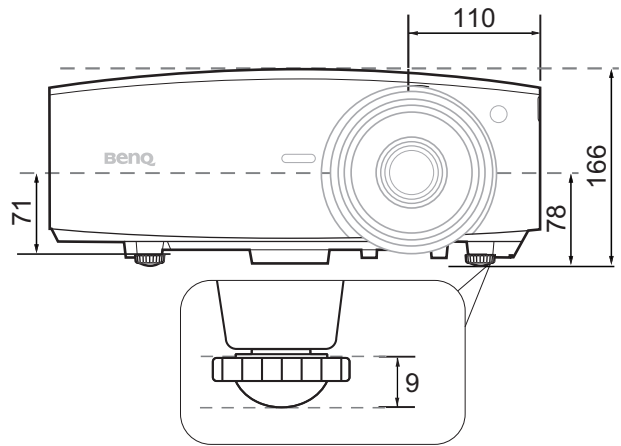
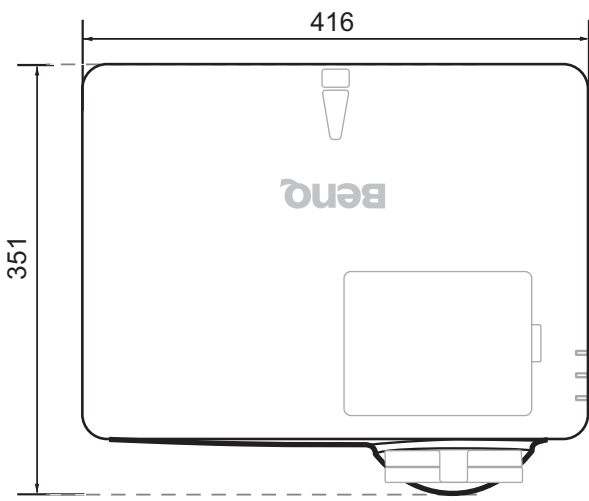

Unit: mm

Timing chart

Supported timing for HDMI (HDCP) input

• PC timings

Resolution	Mode	Vertical Frequency (Hz)	Horizontal Frequency (kHz)	Pixel Frequency (MHz)	Supported 3D format
					Frame Sequential
640 x 480	VGA_60	59.940	31.469	25.175	Supported
	VGA_72	72.809	37.861	31.500	
	VGA_75	75.000	37.500	31.500	
	VGA_85	85.008	43.269	36.000	
	VGA_120	119.518	61.910	52.500	
720 x 400	720 x 400_70	70.087	31.469	28.3221	
800 x 600	SVGA_60	60.317	37.879	40.000	Supported
	SVGA_72	72.188	48.077	50.000	
	SVGA_75	75.000	46.875	49.500	
	SVGA_85	85.061	53.674	56.250	
	SVGA_120 (Reduce Blanking)	119.854	77.425	83.000	Supported
1024 x 768	XGA_60	60.004	48.363	65.000	Supported
	XGA_70	70.069	56.476	75.000	
	XGA_75	75.029	60.023	78.750	
	XGA_85	84.997	68.667	94.500	
	XGA_120 (Reduce Blanking)	119.989	97.551	115.5	Supported
1152 x 864	1152 x 864_75	75	67.5	108	
1024 x 576	BenQ Notebook Timing	60.00	35.820	46.996	
1024 x 600	BenQ Notebook Timing	64.995	41.467	51.419	
1280 x 720	1280 x 720_60	60	45.000	74.250	Supported
1280 x 768	1280 x 768_60	59.870	47.776	79.5	Supported
1280 x 800	WXGA_60	59.810	49.702	83.500	Supported
	WXGA_75	74.934	62.795	106.500	
	WXGA_85	84.880	71.554	122.500	
	WXGA_120 (Reduce Blanking)	119.909	101.563	146.25	Supported
	1280 x 1024	SXGA_60	60.020	63.981	108.000
SXGA_75		75.025	79.976	135.000	
SXGA_85		85.024	91.146	157.500	
1280 x 960	1280 x 960_60	60.000	60.000	108	
	1280 x 960_85	85.002	85.938	148.500	
1360 x 768	1360 x 768_60	60.015	47.712	85.500	
1440 x 900	WXGA+_60	59.887	55.935	106.500	
1400 x 1050	SXGA+_60	59.978	65.317	121.750	
1600 x 1200	UXGA	60.000	75.000	162.000	
1680 x 1050	1680 x 1050_60	59.954	65.290	146.250	
640 x 480@67Hz	MAC13	66.667	35.000	30.240	
832 x 624@75Hz	MAC16	74.546	49.722	57.280	
1024 x 768@75Hz	MAC19	75.020	60.241	80.000	
1152 x 870@75Hz	MAC21	75.06	68.68	100.00	
1920 x 1080@60Hz	1920 x 1080_60	60	67.5	148.5	Supported
1920 x 1200@60Hz	1920 x 1200_60 (Reduce Blanking)	59.950	74.038	154.0000	Supported
1920 x 1080@120Hz	1920 x 1080_120	120.000	135.000	297	Supported
1920 x 1080@240Hz	1920 x 1080_240	239.76	291.309	582.617	
1920 x 1200@120Hz	1920 x 1200_120 (Reduce Blanking)	119.909	152.404	317.00	Supported
2560 x 1600	2560X1600_60 (Reduce Blanking) For 4K2K model	59.972	98.713	268.5	
3840 x 2160	3840 x 2160_30 For 4K2K model	30	67.5	297	
3840 x 2160	3840 x 2160_60 For 4K2K model	60	135	594	



The timings showing above may not be supported due to EDID file and VGA graphic card limitations. It is possible that some timings cannot be chosen.

• Video timings

Timing	Resolution	Vertical Frequency (Hz)	Horizontal Frequency (kHz)	Pixel Frequency (MHz)	Supported 3D format
					Frame Sequential
480i	720 x 480	59.94	15.73	27	Supported
480p	720 x 480	59.94	31.47	27	Supported
576i	720 x 576	50	15.63	27	
576p	720 x 576	50	31.25	27	
720/50p	1280 x 720	50	37.5	74.25	
720/60p	1280 x 720	60	45.00	74.25	Supported
1080/24P	1920 x 1080	24	27	74.25	
1080/25P	1920 x 1080	25	28.13	74.25	
1080/30P	1920 x 1080	30	33.75	74.25	
1080/50i	1920 x 1080	50	28.13	74.25	
1080/60i	1920 x 1080	60	33.75	74.25	
1080/50P	1920 x 1080	50	56.25	148.5	
1080/60P	1920 x 1080	60	67.5	148.5	Supported
1080/120P	1920 x 1080	120	135	297	Supported
1080/240P	1920 x 1080	240	135	594	
2160/24P	3840 x 2160	24	54	297	
2160/25P	3840 x 2160	25	56.25	297	
2160/30P	3840 x 2160	30	67.5	297	
2160/50P	3840 x 2160	50	112.5	594	
2160/60P	3840 x 2160	60	135	594	
2160/24P	4096 x 2160	24	54	297	
2160/25P	4096 x 2160	25	56.25	297	
2160/30P	4096 x 2160	30	67.5	297	
2160/50P	4096 x 2160	50	112.5	594	
2160/60P	4096 x 2160	60	135	594	

Supported timing for HDBaseT input

• Video timings

Cable type	Cable range	Pixel rate	HDMI format support	
CAT 5E/CAT 6A	100m	<=225MHz	640x480p/60Hz 4:3	24bit 30bit 36 bit
			720x480p/60Hz 4:3	24bit 30bit 36 bit
			720x480p/60Hz 16:9	24bit 30bit 36 bit
			1280x720p/60Hz 16:9	24bit 30bit 36 bit
			1920x1080i/60Hz 16:9	24bit 30bit 36 bit
			1440x480i/60Hz 4:3	24bit 30bit 36 bit
			1920x1080p/60Hz 16:9	24bit 30bit 36 bit
			720x576p/50Hz 4:3	24bit 30bit 36 bit
			1280x720p/50Hz 16:9	24bit 30bit 36 bit
			1920x1080i/50Hz 16:9	24bit 30bit 36 bit
			1440x576i/50Hz 4:3	24bit 30bit 36 bit
			1920x1080p/50Hz 16:9	24bit 30bit 36 bit
			1920x1200p/60Hz 16:10	24bit 30bit 36 bit
			CAT 5E/CAT 6A	50m
2160p @25Hz 16:9				
2160p @30Hz 16:9				
2160p @50Hz 16:9 / 4:2:0				
2160p @60Hz 16:9 / 4:2:0				

• PC timings

Resolution	Mode	Vertical Frequency (Hz)	Horizontal Frequency (kHz)	Pixel Frequency (MHz)	Supported 3D format
					Frame Sequential
640 x 480	VGA_60	59.940	31.469	25.175	Supported
	VGA_72	72.809	37.861	31.500	
	VGA_75	75.000	37.500	31.500	
	VGA_85	85.008	43.269	36.000	
720 x 400	720 x 400_70	70.087	31.469	28.3221	
800 x 600	SVGA_60	60.317	37.879	40.000	Supported
	SVGA_72	72.188	48.077	50.000	
	SVGA_75	75.000	46.875	49.500	
	SVGA_85	85.061	53.674	56.250	
	SVGA_120 (Reduce Blanking)	119.854	77.425	83.000	Supported
1024 x 768	XGA_60	60.004	48.363	65.000	Supported
	XGA_70	70.069	56.476	75.000	
	XGA_75	75.029	60.023	78.750	
	XGA_85	84.997	68.667	94.500	
	XGA_120 (Reduce Blanking)	119.989	97.551	115.5	Supported
1152 x 864	1152 x 864_75	75	67.5	108	
1024 x 576	BenQ Notebook Timing	60.00	35.820	46.996	
1024 x 600	BenQ Notebook Timing	64.995	41.467	51.419	
1280 x 720	1280 x 720_60	60	45.000	74.250	Supported
1280 x 768	1280 x 768_60	59.870	47.776	79.5	Supported
1280 x 800	WXGA_60	59.810	49.702	83.500	Supported
	WXGA_75	74.934	62.795	106.500	
	WXGA_85	84.880	71.554	122.500	
	WXGA_120 (Reduce Blanking)	119.909	101.563	146.25	Supported
1280 x 1024	SXGA_60	60.020	63.981	108.000	
	SXGA_75	75.025	79.976	135.000	
	SXGA_85	85.024	91.146	157.500	
1280 x 960	1280 x 960_60	60.000	60.000	108	
	1280 x 960_85	85.002	85.938	148.500	
1360 x 768	1360 x 768_60	60.015	47.712	85.500	
1440 x 900	WXGA+_60	59.887	55.935	106.500	
1400 x 1050	SXGA+_60	59.978	65.317	121.750	
1600 x 1200	UXGA	60.000	75.000	162.000	
1680 x 1050	1680 x 1050_60	59.954	65.290	146.250	
640 x 480@67Hz	MAC13	66.667	35.000	30.240	
832 x 624@75Hz	MAC16	74.546	49.722	57.280	
1024 x 768@75Hz	MAC19	75.020	60.241	80.000	
1152 x 870@75Hz	MAC21	75.06	68.68	100.00	
1920 x 1080@60Hz	1920 x 1080_60	60	67.5	148.5	Supported
1920 x 1200@60Hz	1920 x 1200_60 (Reduce Blanking)	59.950	74.038	154.0000	Supported



The timings showing above may not be supported due to EDID file and VGA graphic card limitations. It is possible that some timings cannot be chosen.

Supported timing for DisplayPort input

- PC timings

Resolution	Mode	Vertical Frequency (Hz)	Horizontal Frequency (kHz)	Pixel Frequency (MHz)	Supported 3D format
					Frame Sequential
640 x 480	VGA_60	59.940	31.469	25.175	Supported
	VGA_72	72.809	37.861	31.500	
	VGA_75	75.000	37.500	31.500	
	VGA_85	85.008	43.269	36.000	
720 x 400	720 x 400_70	70.087	31.469	28.3221	
800 x 600	SVGA_60	60.317	37.879	40.000	Supported
	SVGA_72	72.188	48.077	50.000	
	SVGA_75	75.000	46.875	49.500	
	SVGA_85	85.061	53.674	56.250	
	SVGA_120 (Reduce Blanking)	119.854	77.425	83.000	Supported
1024 x 768	XGA_60	60.004	48.363	65.000	Supported
	XGA_70	70.069	56.476	75.000	
	XGA_75	75.029	60.023	78.750	
	XGA_85	84.997	68.667	94.500	
	XGA_120 (Reduce Blanking)	119.989	97.551	115.5	Supported
1152 x 864	1152 x 864_75	75	67.5	108	
1024 x 576	BenQ Notebook Timing	60.00	35.820	46.996	
1024 x 600	BenQ Notebook Timing	64.995	41.467	51.419	
1280 x 720	1280 x 720_60	60	45.000	74.250	Supported
1280 x 768	1280 x 768_60	59.870	47.776	79.5	Supported
1280 x 800	WXGA_60	59.810	49.702	83.500	Supported
	WXGA_75	74.934	62.795	106.500	
	WXGA_85	84.880	71.554	122.500	
	WXGA_120 (Reduce Blanking)	119.909	101.563	146.25	Supported
1280 x 1024	SXGA_60	60.020	63.981	108.000	
	SXGA_75	75.025	79.976	135.000	
	SXGA_85	85.024	91.146	157.500	
1280 x 960	1280 x 960_60	60.000	60.000	108	
	1280 x 960_85	85.002	85.938	148.500	
1360 x 768	1360 x 768_60	60.015	47.712	85.500	
1440 x 900	WXGA+_60	59.887	55.935	106.500	
1400 x 1050	SXGA+_60	59.978	65.317	121.750	
1600 x 1200	UXGA	60.000	75.000	162.000	
1680 x 1050	1680 x 1050_60	59.954	65.290	146.250	
640 x 480@67Hz	MAC13	66.667	35.000	30.240	
832 x 624@75Hz	MAC16	74.546	49.722	57.280	
1024 x 768@75Hz	MAC19	75.020	60.241	80.000	
1152 x 870@75Hz	MAC21	75.06	68.68	100.00	
1920 x 1080@60Hz	1920 x 1080_60	60	67.5	148.5	Supported
1920 x 1200@60Hz	1920 x 1200_60 (Reduce Blanking)	59.950	74.038	154.000	Supported
1920 x 1080@120Hz	1920 x 1080_120	120.000	135.000	297	Supported
1920 x 1080@240Hz	1920 x 1080_240	239.76	291.309	582.617	
1920 x 1200@120Hz	1920 x 1200_120 (Reduce Blanking)	119.909	152.404	317.00	Supported



The timings showing above may not be supported due to EDID file and VGA graphic card limitations. It is possible that some timings cannot be chosen.

• Video timings

Timing	Resolution	Vertical Frequency (Hz)	Horizontal Frequency (kHz)	Pixel Frequency (MHz)	Supported 3D format
					Frame Sequential
480p	720 x 480	59.94	31.47	27	Supported
576p	720 x 576	50	31.25	27	
720/50p	1280 x 720	50	37.5	74.25	
720/60p	1280 x 720	60	45.00	74.25	Supported
1080/24P	1920 x 1080	24	27	74.25	
1080/25P	1920 x 1080	25	28.13	74.25	
1080/30P	1920 x 1080	30	33.75	74.25	
1080/50i	1920 x 1080	50	28.13	74.25	
1080/60i	1920 x 1080	60	33.75	74.25	
1080/50P	1920 x 1080	50	56.25	148.5	
1080/60P	1920 x 1080	60	67.5	148.5	Supported
1080/120P	1920 x 1080	120	135	297	Supported
1080/240P	1920 x 1080	240	135	594	
2160/24P	3840 x 2160	24	54	297	
2160/25P	3840 x 2160	25	56.25	297	
2160/30P	3840 x 2160	30	67.5	297	
2160/50P	3840 x 2160	50	112.5	594	
2160/60P	3840 x 2160	60	135	594	
2160/24P	4096 x 2160	24	54	297	
2160/25P	4096 x 2160	25	56.25	297	
2160/30P	4096 x 2160	30	67.5	297	
2160/50P	4096 x 2160	50	112.5	594	
2160/60P	4096 x 2160	60	135	594	

RS232 command

RS232 pin assignment

No.	Serial
1	NC
2	RX
3	TX
4	NC
5	GND

No.	Serial
6	NC
7	RTSZ
8	CTSZ
9	NC

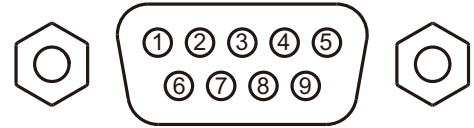

Function	Type	Operation	ASCII
Power	Write	Power On	<CR>*pow=on#<CR>
	Write	Power Off	<CR>*pow=off#<CR>
	Read	Power Status	<CR>*pow=?#<CR>
Source Selection	Write	COMPUTER/YPbPr	<CR>*sour=RGB#<CR>
	Write	HDMI (MHL)	<CR>*sour=hdmi#<CR>
	Write	HDMI 2 (MHL2)	<CR>*sour=hdmi2#<CR>
	Write	HDbaseT	<CR>*sour=hdbaset#<CR>
	Write	DisplayPort	<CR>*sour=dp#<CR>
	Read	Current source	<CR>*sour=?#<CR>
Audio Control	Write	Mute On	<CR>*mute=on#<CR>
	Write	Mute Off	<CR>*mute=off#<CR>
	Read	Mute Status	<CR>*mute=?#<CR>
	Write	Volume +	<CR>*vol=+#<CR>
	Write	Volume -	<CR>*vol=-#<CR>
	Write	Volume level for customer	<CR>*vol=value#<CR>
Audio source select	Read	Volume Status	<CR>*vol=?#<CR>
	Write	Audio pass Through off	<CR>*audiosour=off#<CR>
	Write	Audio-HDMI	<CR>*audiosour=hdmi#<CR>
	Write	Audio-HDMI2	<CR>*audiosour=hdmi2#<CR>
	Read	Audio pass Status	<CR>*audiosour=?#<CR>
	Picture Mode	Write	Presentation
Write		sRGB	<CR>*appmod=srgb#<CR>
Write		Bright	<CR>*appmod=bright#<CR>
Write		Video	<CR>*appmod=video#<CR>
Write		DICOM-SIM	<CR>*appmod=dicom-sim#<CR>
Write		Infographic	<CR>*appmod=infographic#<CR>
Write		Video Conference	<CR>*appmod=videoconference#<CR>
Write		User1	<CR>*appmod=user1#<CR>
Write		User2	<CR>*appmod=user2#<CR>
Write		3D	<CR>*appmod=threed#<CR>
Write		HDR10	<CR>*appmod=hdr10#<CR>
Write		HLG	<CR>*appmod=hlg#<CR>
Write		Golf	<CR>*appmod=golf#<CR>
Read		Picture Mode	<CR>*appmod=?#<CR>
Picture Setting	Write	Contrast +	<CR>*con=+#<CR>
	Write	Contrast -	<CR>*con=-#<CR>
	Write	Set Contrast value	<CR>*con=value#<CR>
	Read	Contrast value	<CR>*con=?#<CR>
	Write	Brightness +	<CR>*bri=+#<CR>
	Write	Brightness -	<CR>*bri=-#<CR>
	Write	Set Brightness value	<CR>*bri=value#<CR>
	Read	Brightness value	<CR>*bri=?#<CR>
	Write	Color +	<CR>*color=+#<CR>
Write	Color -	<CR>*color=-#<CR>	

Picture Setting	Write	Set Color value	<CR>*color=value#<CR>
	Read	Color value	<CR>*color=?#<CR>
	Write	Sharpness +	<CR>*sharp=+#<CR>
	Write	Sharpness -	<CR>*sharp=-#<CR>
	Write	Set Sharpness value	<CR>*sharp=value#<CR>
	Read	Sharpness value	<CR>*sharp=?#<CR>
	Write	Color Temperature-Warm	<CR>*ct=warm#<CR>
	Write	Color Temperature-Normal	<CR>*ct=normal#<CR>
	Write	Color Temperature-Cool	<CR>*ct=cool#<CR>
	Write	Color Temperature-lamp native	<CR>*ct=native#<CR>
	Read	Color Temperature Status	<CR>*ct=?#<CR>
	Write	Aspect 4:3	<CR>*asp=4:3#<CR>
	Write	Aspect 16:9	<CR>*asp=16:9#<CR>
	Write	Aspect 16:10	<CR>*asp=16:10#<CR>
	Write	Aspect 2.4:1	<CR>*asp=2.4:1#<CR>
	Write	Aspect 21:9	<CR>*asp=21:9#<CR>
	Write	Aspect Auto	<CR>*asp=AUTO#<CR>
	Read	Aspect Status	<CR>*asp=?#<CR>
	Write	Vertical Keystone +	<CR>*vkeystone=+#<CR>
	Write	Vertical Keystone -	<CR>*vkeystone=-#<CR>
	Read	Vertical Keystone value	<CR>*vkeystone=?#<CR>
	Write	Horizontal Keystone +	<CR>*hkeystone=+#<CR>
	Write	Horizontal Keystone -	<CR>*hkeystone=-#<CR>
	Read	Horizontal Keystone value	<CR>*hkeystone=?#<CR>
	Write	Overscan Adjustment +	<CR>*overscan=+#<CR>
	Write	Overscan Adjustment -	<CR>*overscan=-#<CR>
	Read	Overscan Adjustment value	<CR>*overscan=?#<CR>
	Write	4 Corners Top-Left-X Decrease	<CR>*cornerfittlx=-#<CR>
	Write	4 Corners Top-Left-X Increase	<CR>*cornerfittlx=+#<CR>
	Read	4 Corners Top-Left-X Status	<CR>*cornerfittlx=?#<CR>
	Write	4 Corners Top-Left-Y Decrease	<CR>*cornerfittly=-#<CR>
	Write	4 Corners Top-Left-Y Increase	<CR>*cornerfittly=+#<CR>
	Read	4 Corners Top-Left-Y Status	<CR>*cornerfittly=?#<CR>
	Write	4 Corners Top-Right-X Decrease	<CR>*cornerfittrx=-#<CR>
	Write	4 Corners Top-Right-X Increase	<CR>*cornerfittrx=+#<CR>
	Read	4 Corners Top-Right-X Status	<CR>*cornerfittrx=?#<CR>
	Write	4 Corners Top-Right-Y Decrease	<CR>*cornerfittry=-#<CR>
	Write	4 Corners Top-Right-Y Increase	<CR>*cornerfittry=+#<CR>
	Read	4 Corners Top-Right-Y Status	<CR>*cornerfittry=?#<CR>
	Write	4 Corners Bottom-Left-X Decrease	<CR>*cornerfitblx=-#<CR>
	Write	4 Corners Bottom-Left-X Increase	<CR>*cornerfitblx=+#<CR>
	Read	4 Corners Bottom-Left-X Status	<CR>*cornerfitblx=?#<CR>
	Write	4 Corners Bottom-Left-Y Decrease	<CR>*cornerfitbly=-#<CR>
	Write	4 Corners Bottom-Left-Y Increase	<CR>*cornerfitbly=+#<CR>
	Read	4 Corners Bottom-Left-Y Status	<CR>*cornerfitbly=?#<CR>
	Write	4 Corners Bottom-Right-X Decrease	<CR>*cornerfitbrx=-#<CR>
	Write	4 Corners Bottom-Right-X Increase	<CR>*cornerfitbrx=+#<CR>
Read	4 Corners Bottom-Right-X Status	<CR>*cornerfitbrx=?#<CR>	
Write	4 Corners Bottom-Right-Y Decrease	<CR>*cornerfitbry=-#<CR>	
Write	4 Corners Bottom-Right-Y Increase	<CR>*cornerfitbry=+#<CR>	
Read	4 Corners Bottom-Right-Y Status	<CR>*cornerfitbry=?#<CR>	
Write	Digital Zoom In	<CR>*zoomI#<CR>	
Write	Digital Zoom out	<CR>*zoomO#<CR>	
Write	Auto	<CR>*auto#<CR>	
Write	Brilliant color on	<CR>*BC=on#<CR>	
Write	Brilliant color off	<CR>*BC=off#<CR>	
Read	Brilliant color status	<CR>*BC=?#<CR>	
Write	Auto(HDR)	<CR>*hdr=auto#<CR>	

Picture Setting	Write	SDR	<CR>*hdr=sdr#<CR>
	Write	HDR10	<CR>*hdr=hdr#<CR>
	Write	HLG	<CR>*hdr=hlg#<CR>
	Read	HDR status	<CR>*hdr=?#<CR>
Operation Settings	Write	Projector Position-Front Table	<CR>*pp=FT#<CR>
	Write	Projector Position-Rear Table	<CR>*pp=RE#<CR>
	Write	Projector Position-Rear Ceiling	<CR>*pp=RC#<CR>
	Write	Projector Position-Front Ceiling	<CR>*pp=FC#<CR>
	Read	Projector Position Status	<CR>*pp=?#<CR>
	Write	Quick auto search	<CR>*QAS=on#<CR>
	Write	Quick auto search	<CR>*QAS=off#<CR>
	Read	Quick auto search status	<CR>*QAS=?#<CR>
	Write	Direct Power On-on	<CR>*directpower=on#<CR>
	Write	Direct Power On-off	<CR>*directpower=off#<CR>
	Read	Direct Power On-Status	<CR>*directpower=?#<CR>
	Read	Signal Power On-Status	<CR>*autopower=?#<CR>
Baud Rate	Write	9600	<CR>*baud=9600#<CR>
	Write	14400	<CR>*baud=14400#<CR>
	Write	19200	<CR>*baud=19200#<CR>
	Write	38400	<CR>*baud=38400#<CR>
	Write	57600	<CR>*baud=57600#<CR>
	Write	115200	<CR>*baud=115200#<CR>
	Read	Current Baud Rate	<CR>*baud=?#<CR>
Lamp Control	Read	Lamp	<CR>*ltim=?#<CR>
	Write	Normal mode	<CR>*lampm=lnor#<CR>
	Write	Eco mode	<CR>*lampm=eco#<CR>
	Write	Dimming mode	<CR>*lampm=dimming#<CR>
	Write	Custom mode	<CR>*lampm=custom#<CR>
	Write	Light level for custom mode	<CR>*lampcustom=value#<CR>
	Read	Light level status for custom mode	<CR>*lampcustom=?#<CR>
	Read	Lamp Mode Status	<CR>*lampm=?#<CR>
Miscellaneous	Read	Model Name	<CR>*modelname=?#<CR>
	Read	System F/W Version	<CR>*sysfwversion=?#<CR>
	Read	Lan F/W Version	<CR>*lanfwversion=?#<CR>
	Read	MCU F/W Version	<CR>*mconfwversion=?#<CR>
	Write	Blank On	<CR>*blank=on#<CR>
	Write	Blank Off	<CR>*blank=off#<CR>
	Read	Blank Status	<CR>*blank=?#<CR>
	Write	Freeze On	<CR>*freeze=on#<CR>
	Write	Freeze Off	<CR>*freeze=off#<CR>
	Read	Freeze Status	<CR>*freeze=?#<CR>
	Write	Menu On	<CR>*menu=on#<CR>
	Write	Menu Off	<CR>*menu=off#<CR>
	Read	Menu Status	<CR>*menu=?#<CR>
	Write	Up	<CR>*up#<CR>
	Write	Down	<CR>*down#<CR>
	Write	Right	<CR>*right#<CR>
	Write	Left	<CR>*left#<CR>
	Write	Enter	<CR>*enter#<CR>
	Write	Back	<CR>*back#<CR>
	Write	Source Menu On	<CR>*sourmenu=on#<CR>
	Write	Source Menu Off	<CR>*sourmenu=off#<CR>
	Read	Source Menu Status	<CR>*sourmenu=?#<CR>
	Write	3D Sync Off	<CR>*3d=off#<CR>
	Write	3D Auto	<CR>*3d=auto#<CR>
	Write	3D Sync Top Bottom	<CR>*3d=tb#<CR>

Miscellaneous	Write	3D Sync Frame Sequential	<CR>*3d=fs#<CR>
	Write	3D Frame packing	<CR>*3d=fp#<CR>
	Write	3D Side by side	<CR>*3d=sbs#<CR>
	Write	3D inverter disable	<CR>*3d=da#<CR>
	Write	3D inverter	<CR>*3d=iv#<CR>
	Read	3D Sync Status	<CR>*3d=?#<CR>
	Write	Remote Receiver-front	<CR>*rr=f#<CR>
	Write	Remote Receiver-top	<CR>*rr=t#<CR>
	Write	Remote Receiver-top+front	<CR>*rr=tf#<CR>
	Read	Remote Receiver Status	<CR>*rr=?#<CR>
	Write	AMX Device Discovery-on	<CR>*amxdd=on#<CR>
	Write	AMX Device Discovery-off	<CR>*amxdd=off#<CR>
	Read	AMX Device Discovery Status	<CR>*amxdd=?#<CR>
	Read	Mac Address	<CR>*macaddr=?#<CR>
	Write	High Altitude mode on	<CR>*Highaltitude=on#<CR>
	Write	High Altitude mode off	<CR>*Highaltitude=off#<CR>
	Read	High Altitude mode status	<CR>*Highaltitude=?#<CR>
Color Calibration (only for service)	Write	Tint +	<CR>*tint=+#<CR>
	Write	Tint -	<CR>*tint=-#<CR>
	Write	Set Tint value	<CR>*tint=value#<CR>
	Read	Get Tint value	<CR>*tint=?#<CR>
	Write	Set BenQ gamma value	<CR>*gamma=value#<CR>
	Read	Gamma value status	<CR>*gamma=?#<CR>
	Write	Set HDR Brightness value	<CR>*hdrbri=value#<CR>
	Read	Get HDR Brightness value	<CR>*hdrbri=?#<CR>
	Write	Red Gain +	<CR>*RGain=+#<CR>
	Write	Red Gain -	<CR>*RGain=-#<CR>
	Write	Set Red Gain value	<CR>*RGain=value#<CR>
	Read	Get Red Gain value	<CR>*RGain=?#<CR>
	Write	Green Gain +	<CR>*GGain=+#<CR>
	Write	Green Gain -	<CR>*GGain=-#<CR>
	Write	Set Green Gain value	<CR>*GGain=value#<CR>
	Read	Get Green Gain value	<CR>*GGain=?#<CR>
	Write	Blue Gain +	<CR>*BGain=+#<CR>
	Write	Blue Gain -	<CR>*BGain=-#<CR>
	Write	Set Blue Gain value	<CR>*BGain=value#<CR>
	Read	Get Blue Gain value	<CR>*BGain=?#<CR>
	Write	Red Offset +	<CR>*ROffset=+#<CR>
	Write	Red Offset -	<CR>*ROffset=-#<CR>
	Write	Set Red Offset value	<CR>*ROffset=value#<CR>
	Read	Get Red Offset value	<CR>*ROffset=?#<CR>
	Write	Green Offset +	<CR>*GOffset=+#<CR>
	Write	Green Offset -	<CR>*GOffset=-#<CR>
	Write	Set Green Offset value	<CR>*GOffset=value#<CR>
	Read	Get Green Offset value	<CR>*GOffset=?#<CR>
	Write	Blue Offset +	<CR>*BOffset=+#<CR>
	Write	Blue Offset -	<CR>*BOffset=-#<CR>
	Write	Set Blue Offset value	<CR>*BOffset=value#<CR>
	Read	Get Blue Offset value	<CR>*BOffset=?#<CR>
	Write	Primary Color	<CR>*primcr=value#<CR>
	Read	Primary Color Status	<CR>*primcr=?#<CR>
	Write	Hue +	<CR>*hue=+#<CR>
	Write	Hue -	<CR>*hue=-#<CR>
	Write	Set Hue value	<CR>*hue=value#<CR>
	Read	Get Hue value	<CR>*hue=?#<CR>
	Write	Saturation +	<CR>*saturation =+#<CR>
	Write	Saturation -	<CR>*saturation =-#<CR>

Color Calibration (only for service)	Write	Set Saturation value	<CR>*saturation =value#<CR>
	Read	Get Saturation value	<CR>*saturation =?#<CR>
	Write	Gain +	<CR>*gain=+#<CR>
	Write	Gain -	<CR>*gain=-#<CR>
	Write	Set Gain value	<CR>*gain=value#<CR>
	Read	Get Gain value	<CR>*gain=?#<CR>
Service (Only for service)	Write	Service mode enable for error report	<CR>*error=enable#<CR>
	Read	Error code report	<CR>*error=report#<CR>
	Read	FAN 1 speed	<CR>*fan1=?#<CR>
	Read	FAN 2 speed	<CR>*fan2=?#<CR>
	Read	FAN 3 speed	<CR>*fan3=?#<CR>
	Read	FAN 4 speed	<CR>*fan4=?#<CR>
	Read	FAN 5 speed	<CR>*fan5=?#<CR>
	Read	FAN 6 speed	<CR>*fan6=?#<CR>
	Read	Temperature 1	<CR>*tmp1=?#<CR>
	Read	LED indicator	<CR>*led=?#<CR>