

KODAK PIXPRO WPZ2

DIGITAL CAMERA

User Manual



BEFORE YOU START

Declaration of Conformity

Responsible Party: JK Imaging Ltd.

Address: JK Imaging Ltd., 17239 So. Main Street, Gardena, CA 90248 USA

Company website: kodakpixpro.com

INDUSTRY CANADA

This device complies with Canadian RSS-247.

This device complies with Industry Canada license-exempt RSS standard (s). Operation is subject to the following two conditions: (1) this device may not cause interference, and (2) this device must accept any interference, including interference that may cause undesired operation of the device.

Radiation Exposure Statement:

This product complies with the Canadian portable RF exposure limit set forth for an uncontrolled environment and is safe for intended operation as described in this manual. Additional RF exposure reduction can be achieved if the product can be kept as far as possible from the user body or set the device to lower output power if such function is available.

For Customers in Europe



This symbol [crossed-out wheel bin WEEE Annex IV] indicates separate collection of electrical waste and electronic equipment in the European countries. Please do not throw the equipment into domestic refuse. Please use the return and collection systems available in your country for proper, safe disposal of this product.



“CE” mark indicates that this product complies with the European requirements for safety, health, environment and customer protection. “CE” marked cameras are intended for sales in Europe.

Europe – EU Declaration of Conformity

This device complies with the essential requirements of the RED Directive 2014/53/EU. The following test methods have been applied in order to prove presumption of conformity with the essential requirements of the RED Directive 2014/53/EU:

- EN 62368-1:2014

Safety of Information Technology Equipment

- EN 55032:2015/AC:2016 Class B

- EN 61000-3-2:2014

- EN 61000-3-3:2013

- EN 55024:2010/A1:2015

- EN 50360:2017

Assessment of electronic and electrical equipment related to human exposure restrictions for electromagnetic fields (0 Hz-300 GHz)

- EN 300 328 V2.1.1 (2016-11)

Wideband transmission systems; Data transmission equipment operating in the 2.4 GHz ISM band and using wide band modulation techniques

- EN 301 489-1 V2.1.1 (2017-02)

Electromagnetic compatibility and Radio spectrum Matters (ERM); ElectroMagnetic Compatibility (EMC) standard for radio equipment and services; Part 1: Common technical requirements

- EN 301 489-17 V3.1.1 (2017-02)

Electromagnetic compatibility and Radio spectrum Matters (ERM); ElectroMagnetic Compatibility (EMC) standard for radio equipment; Part 17: Specific conditions for Broadband Data Transmission Systems

For SAR statement

A minimum separation distance of XX cm must be maintained between the user's body and the device, including the antenna during body-worn operation to comply with the RF exposure requirements in Europe.

To compliance with RF Exposure requirements in Europe, third-party belt-clips, holsters or similar accessories used by this device should not contain any metallic components. The use of accessories that do not satisfy these requirements may not comply with RF exposure requirements, and should be avoided.

Hereby, Sintai Optical (Shenzhen) Co., Ltd, declares that this KODAK PIXPRO WP22 is in compliance with the essential requirements and other relevant provisions of Directive 2014/53/EU.

Manufacturer: Sintai Optical (Shenzhen) Co., Ltd

Address: Qiwei Ind Sec, 1st, 2nd, & 3RD Bldg, Lisonglang Village, Gongming Town, Bao'an District, Shenzhen, Guangdong, China



Batteries: Please dispose of used batteries at designated collection centers.



Packaging: Please follow local regulations for the recycling of packaging.

For Customers in the U.S.A.

Federal Communication Commission Interference Statement

This device complies with Part 15 of the FCC Rules. Operation is subject to the following two conditions: (1) This device may not cause harmful interference, and (2) this device must accept any interference received, including interference that may cause undesired operation.

This equipment has been tested and found to comply with the limits for a Class B digital device, pursuant to Part 15 of the FCC Rules. These limits are designed to provide reasonable protection against harmful interference in a residential installation. This equipment generates, uses and can radiate radio frequency energy and, if not installed and used in accordance with the instructions, may cause harmful interference to radio communications. However, there is no guarantee that interference will not occur in a particular installation. If this equipment does cause harmful interference to radio or television reception, which can be determined by turning the equipment off and on, the user is encouraged to try to correct the interference by one of the following measures:

- Reorient or relocate the receiving antenna.
- Increase the separation between the equipment and receiver.
- Connect the equipment into an outlet on a circuit different from that to which the receiver is connected.
- Consult the dealer or an experienced radio/TV technician for help.

FCC Caution: Any changes or modifications not expressly approved by the party responsible for compliance could void the user's authority to operate this equipment.

This transmitter must not be co-located or operating in conjunction with any other antenna or transmitter.

Radiation Exposure Statement:

This product complies with the FCC portable RF exposure limit set forth for an uncontrolled environment and is safe for intended operation as described in this manual. Additional RF exposure reduction can be achieved if the product can be kept as far as possible from the user body or set the device to lower output power if such function is available.

About this Manual

Thank you for purchasing this KODAK PIXPRO Digital Camera. Please read this manual carefully and keep it in a safe place for future reference.

- JK Imaging Ltd. reserves all rights of this document. No part of this published manual may be reproduced, transmitted, transcribed, stored in a retrieval system or translated into any language or computer language, in any form, by any means, without the prior written permission of JK Imaging Ltd.
- All trademarks mentioned in this manual are used for identification purposes only and are properties of their respective owners.
- This manual provides you with instructions on how to use your new KODAK PIXPRO Digital Camera. Every effort has been made to ensure that the contents of this manual are accurate; however JK Imaging Ltd. reserves the right to make changes without notice.
- Throughout this manual, the following symbols are used to help you locate information quickly and easily:



Indicates useful information.

- The following symbols may be used throughout this manual to facilitate your understanding of how to operate the camera:

[Item properties]: The optional properties in the camera interface are indicated by the [] symbol.

SAFETY NOTES

Waterproof / Dustproof / Shockproof

- JIS / IEC waterproof grade 8 (IPX8).
- JIS / IEC dustproof grade 6 (IP6X).
- Height for shockproof rating is 2m (6.6 feet).

Waterproofing Notes:

- Do not use the product below 15 meters (49.2 feet) underwater. The product can remain waterproof for one hour at the depth of 15m (49.2 feet).
- Do not use this product in a geothermal spring or in water at a temperature greater than 40 °C (104°F).
- Please do not open the battery cover underwater.
- If water accidentally comes in contact with the product, please do not open the battery cover. Turn the product off, and dry it with a clean, dry and lint free cloth. Then open the battery cover, and remove the battery and the memory card.
- When opening the battery cover, if there are water drops on the contact surface between the inside of the battery cover and the body, please dry the water drops.
- After using the product in water or near sand, mud or other foreign materials, please rinse it with clean water (close the battery cover before cleaning). After cleaning, dry the product with a clean, dry and lint free cloth.

- If there is dust, sand or other foreign materials on the waterproof rubber of the battery cover and its contact surface, please wipe it with a clean, dry and lint free cloth as soon as possible.
- Before using the product underwater, make sure that there is no damage to or foreign debris on the waterproof rubber gasket. Then close the battery cover tightly to ensure the waterproof capability of the product.



Waterproof rubber with scratches and cracks will allow water to penetrate into the product. Contact customer service immediately for maintenance with replacement of new waterproof rubber.

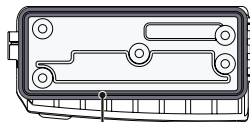
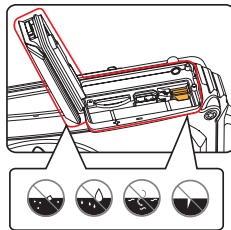

Waterproof Rubber

Safety Notes for this Camera

- Do not drop the camera or allow it to hit solid objects.
- Do not attempt to disassemble or repair the camera.
- Do not use or store the camera in dusty places to help prevent dust from entering the camera, causing possible damage.
- Do not use or store the camera in a hot environment or in direct sunlight.
- Do not use or store the camera near powerful magnetic fields, for example near a magnet or transformer.
- Avoid touching the lens of the camera.
- Do not expose the camera to direct sunlight for a long period of time.
- If water accidentally comes in contact with the interior of the camera, turn the camera off immediately, remove the battery and the memory card and dry it completely within 24 hours.
- When you take the camera from a cold environment to a warmer environment, condensation may occur. Please wait for a reasonable period of time before you turn the camera on.
- Make sure the camera is turned off before you remove the battery and memory card.
- When you clean the body of the camera, do not use abrasive, alcohol-based or organic cleansers or solvents.
- Use a professional lens cleaning cloth and appropriate cleaner to wipe and clean the lens.
- Download your photos and remove the memory card when you are going to store the camera for long periods of time.
- If this camera is not in use for a long period of time, please keep it in a dry and clean storage location.
- Our company will not pay compensation for any failure of playback of pictures or videos caused by improper operation.

Safety Notes for Battery

- Please use a battery that is the same type as the one included.
- Please use the included USB cable and AC adapter to charge the battery inside the camera.
- If battery fluid leaks inside the camera, contact our customer service department immediately. If battery fluid leaks onto your skin, rinse your skin with clean water and seek immediate medical attention.
- Disposal of used batteries should be carried out in accordance with your local (national or regional) regulations.
- To prevent the battery from being damaged, do not drop the battery or allow it to hit solid objects or to be scratched by foreign objects.
- Do not let the battery come in contact with metal objects (including coins) to avoid short circuiting, discharging, excessive heat or possible leakage.
- Do not attempt to disassemble the battery.
- Do not expose the battery to water. Always keep the battery contacts dry.
- Do not heat the battery or throw it into a fire to avoid a possible explosion.
- Do not store the battery in a hot environment or in direct sunlight.
- If the battery overheats during charging or use, stop charging or stop use immediately. Turn off the product, remove the battery carefully and wait until it cools down.
- When the camera is stored for a long period of time, remove the battery and keep it in a safe, dry place that is not accessible to infants and children.
- In colder environments, the performance of the battery could be noticeably reduced.
- When you install the battery, align the battery markings according to the positive and negative markings inside the camera battery compartment. Never force the battery into the battery compartment.

Safety Notes for Memory Cards

- The memory card referred to in this user manual is a microSD card/microSDHC card that is Class 4 or higher and no larger than 32GB.
- We highly suggest buying only well-known, name brand memory cards to ensure peak performance and reliability.
- Format the microSD/microSDHC memory card using the camera before you use it to store photo or video files or when you insert a new microSD/microSDHC memory card.
- Do not drop the microSD/microSDHC memory card or allow it to hit solid objects to avoid damaging it.
- Do not attempt to disassemble or repair the microSD/microSDHC memory card.
- Do not expose the microSD/microSDHC memory card to water. Always keep it dry.
- Do not remove the microSD/microSDHC memory card when the camera is turned on. Otherwise, the memory card and photo/video files could be permanently damaged.
- Do not directly edit the data on the microSD/microSDHC memory card. Copy the data to your computer before you edit files.
- When the camera is stored for long periods of time, be sure to download your photos and remove the microSD/microSDHC memory card. Store the microSD/microSDHC memory card in a dry environment.
- Do not modify the name of the files or folders of the microSD/microSDHC memory card using your computer. Modifying the file names may cause the files to not be recognized on the camera or a possible permanent error may occur.
- A photo taken with the camera will be stored in the folder that is automatically generated on the microSD/microSDHC memory card. Do not store photos that are not taken using this camera in these folders as the pictures cannot be recognized during playback.
- When you insert the microSD/microSDHC memory card, make sure the notch of the card matches the markings on the top of the camera card slot.

Other Safety Notes



- Do not disconnect the power or turn the camera off during the updating process. Doing so may cause incorrect data to be written and the camera may not power on later.
- When using your camera on an airplane, observe the relevant rules specified by the airline and FAA regulations.
- Due to the limitations of manufacturing technology, the LCD may have a few dead or bright pixels. These pixels do no effect the quality or performance of the camera, photos or video.
- If the LCD screen is damaged, pay particular attention to the liquid crystal in the screen. If any of the following situations arise, take the recommended immediate action indicated below:
 1. If liquid crystal comes in contact with your skin, please wipe with a dry cloth, wash thoroughly with soap, and rinse with plenty of clean water.
 2. If liquid crystal gets into your eye, flush the eye immediately with plenty of clean water for at least 15 minutes and then seek for medical assistance.

3. If liquid crystal is swallowed, immediately flush your mouth thoroughly with clean water and induce vomiting. Seek for medical assistance.

WARNING

- Altering, tampering or modifying the any parts of WPZ2 camera are unauthorized and will void the manufacturer's warranty and "could" void Federal and/or State Compliance.

CONTENTS

BEFORE YOU START	1	Resetting Date/Time	23
SAFETY NOTES	6	MODE OVERVIEW	24
CONTENTS.....	11	Display Setting	24
GETTING STARTED.....	15	LCD Screen Display.....	25
Accessories Included.....	15	Overview of the Screen Icons in Photo Shooting Mode	25
Part Names	16	Overview of the Screen Icons in Movie Mode.....	26
Installing Battery and microSD/microSDHC Memory Card.....	18	Using the Mode Button	27
Charging the Battery.....	20	Auto Mode	28
Turning Camera On and Off.....	21	Program AE.....	30
How to Take Pictures.....	21	Manual Mode.....	30
Set your Language, Date/Time	22	Movie Mode	31
Set your Language, Date/Time after the First Power-On.....	22	Scene Mode (SCN).....	32
Resetting your Language.....	22	Panorama Mode 	35
		Anti-Shake 	36
		Underwater Mode	37

Wi-Fi® Mode	38	Overview of the Screen Icons in Playback Mode	52
AP Mode	39	Viewing Photos and Videos	53
Station	40	Thumbnail View	54
Setting	43	Using Zoom Playback (for Still Pictures Only)	55
BASIC OPERATION.....	45	Continuous Capture Group Playback.....	56
Using the Zoom Function.....	45	Animation Panorama Play	57
Macro Mode.....	46	Slideshow	58
Self-Timer Setting.....	47	Deleting Photos and Videos.....	59
Flash Mode	48	USING THE MENUS.....	60
EV Setting	49	Photo Setup Menu.....	60
Exposure Compensation	49	Expo Metering (Exposure Metering)	60
ISO	50	Image Size.....	61
Shutter Adjustment.....	50	Continuous Auto Focus (AF).....	61
Using Quick Recording	51	Continuous Shot	62
PLAYBACK	52	Focus Setting	63

White Balance Setting	63	Display Mode.....	75
Color Effect	64	HDR.....	76
Select Scene	65	Red-Eye Reduction.....	76
Photo Shooting Setting Menu	67	Rotate	77
Quality	67	Resize	77
Auto Focus (AF) Assist Beam.....	68	Color	78
Digital Zoom.....	68	Playback Setting Menu	79
Date Imprint	69	Protect.....	80
Quick Review.....	69	Delete	81
Face Detection	70	DPOF (Digital Print Order Format).....	82
Movie Menu	71	Trim.....	82
Expo Metering (Exposure Metering)	71	Setup Menu	83
Video Quality.....	72	Power Saver.....	84
Color Effect	73	Sound Settings.....	84
Movie Setting Menu	74	Language.....	85
Digital Zoom.....	74	World Time	85
Playback Menu	75	Date & Time.....	85

LCD Brightness.....	85	Print (with Date)	94
SD Card /Firmware.....	86	Print (without Date).....	95
Format	87	Print Index	96
Copy to Card.....	87	Print DPOF Images.....	97
File Numbering.....	88	Exit.....	97
Reset.....	88		
Firmware (FW) Version.....	89		
CONNECTIONS.....	90	APPENDICES	98
Connecting to a Computer.....	90	Specifications.....	98
Setting the USB Mode	90	Prompts and Warning Messages	102
Transferring Files to Your Computer	91	Troubleshooting	106
Connecting to PICTBRIDGE™ Compatible Printers.....	92	MicroSD Memory Card Compatibility ...	108
Setting the USB Mode	92		
Connecting to your Printer.....	93		
Using the PICTBRIDGE™ Menu.....	94		

GETTING STARTED

Accessories Included

Your camera box should contain the camera model you purchased along with the following accessories. If anything is missing or appears to be damaged, please contact your retailer first or our customer service center. (The AC Adapters may be a little different in shape due to the difference of countries or regions this type of cameras are sold to, and are subject to matching the physical product).

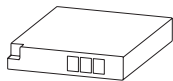

Rechargeable
Li-ion Battery

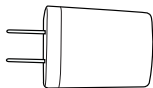

AC Adapter

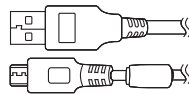

Micro USB Cable



Wrist Strap



Quick Start Guide



Warranty Card



Service Card

Part Names

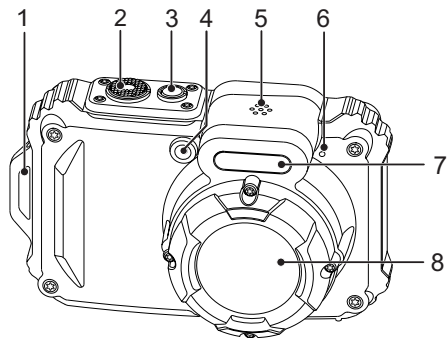

1. Strap Eyelet
2. Shutter Button
3. Power Button
4. Auto Focus (AF) Assist Beam/
Self-Timer Lamp
5. Speaker
6. Microphone
7. Flash Lamp
8. Lens

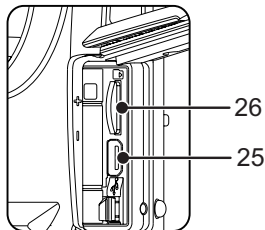
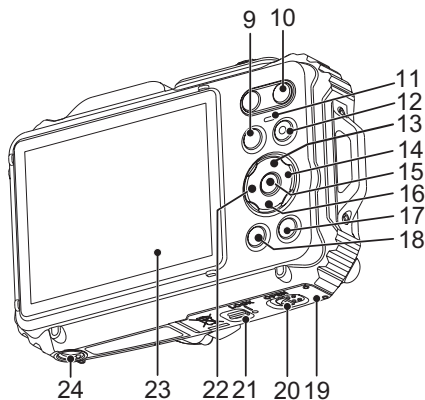

- 9. Mode Button
- 10. Zoom Button
- 11. Indicator Lamp
- 12. Quick Video Recording Button
- 13. Display Button/Arrow Button (Up)
- 14. Flash Button/Arrow Button (Right)
- 15. SET Button
- 16. Delete Button/Self-Timer Button/
Arrow Button (Down)
- 17. Playback Button
- 18. Menu Button
- 19. Battery Cover Door
- 20. Battery Cover Door (Open) Toggle
Switch
- 21. Battery Cover Door Lock
- 22. Macro Button/Arrow Button (Left)
- 23. LCD
- 24. Tripod Socket (1/4" Standard)
- 25. Micro USB Port
- 26. microSD/microSDHC Card Slot
(32GB max)

Installing Battery and microSD/microSDHC Memory Card

1. Unlock the battery cover door lock as shown in step ①, push the battery cover door open switch to open the battery cover door as shown in step ②.

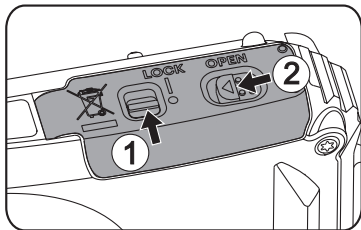

2. Insert the battery into the battery compartment as shown in step ③ being sure to line up metal contacts on bottom of battery with the contacts in slot. Push the battery down until it locks in place.

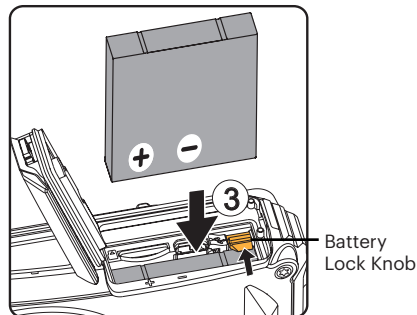

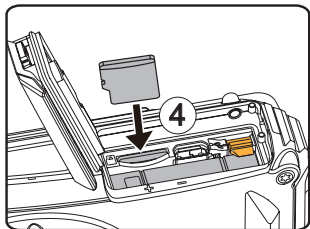

3. Insert the microSD/microSDHC memory card (not to exceed 32GB) into the memory card slot as shown in step ④, push exposed edge of the microSD/microSDHC memory card fully into the slot with your fingertip.

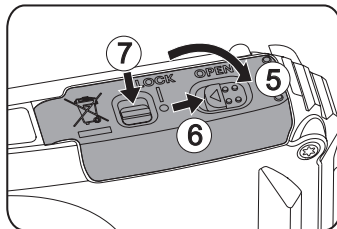

4. Close the battery cover door as shown in step ⑤, push the battery cover door switch to close the battery cover door as shown in step ⑥ and be sure to lock the battery cover door latch as shown in step ⑦.



 A microSD/microSDHC memory card is NOT included with this camera packaging and needs to be purchased separately. This camera takes a microSD/microSDHC memory card. We recommend using a name brand memory card that is Class 4 or higher and has a capacity of 4GB to 32GB. This camera is not compatible with standard SD cards.



 To remove your microSD/microSDHC memory card, open the battery cover door, gently press the memory card to eject it and remove it carefully.

Charging the Battery

Before you charge your battery, make sure the camera is off and the battery is inserted correctly.

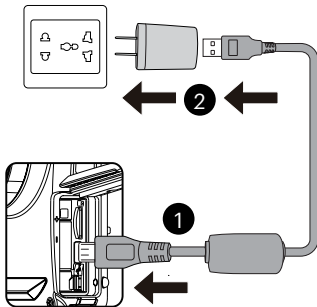
1. Connect the camera to the power charger using the supplied USB cable.
2. Insert the plug of the power charger into the wall outlet to charge the battery.



-  The charger is for indoor use only.
-  After the battery is stored for long periods of time, use the supplied power charger to fully charge the battery prior to use.

-  **Charging Indicator:**
Steady orange : Charging
The indicator lamp will go out once charging is finished and the camera will power off automatically. To maximize battery life, charge the battery for at least 4 - (4-hours) hours the first time.

-  When the camera is turned off, you can also connect the camera to your PC using a USB cable to charge the battery.

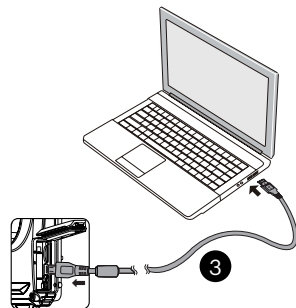

-  Please charge the battery indoors between 0°C and 40°C (32°F and 104°F).

Turning Camera On and Off

Press the Power button to turn the camera on. To turn the camera off, press the Power button again.

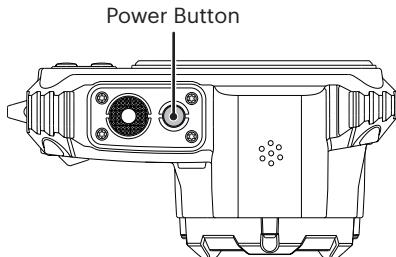

When the power is off, press and hold the play  button to power on and enter Playback mode.

How to Take Pictures

1. Hold the camera with both hands, being careful to not block the flash and lens with fingers.
2. Point the lens toward the object you want to take a picture of, then frame it with the LCD.
3. Use the zoom button to select Tele or Wide position to zoom in or out on your subject(s).
4. Gently press the shutter button half-way down to focus on your subject(s). When the focus frame turns green, press the shutter button completely down to take your photo.

Set your Language, Date/Time

Set your Language, Date/Time after the First Power-On

1. When you turn the camera on for the first time, the language selection screen appears.
2. Press the arrow buttons to select your desired language.
3. After you press the **SET** button to confirm your language selection, the Date/Time settings screen will appear.
4. Press the left/right arrow buttons to select the Date/Time to be adjusted: Time is displayed in YYYY.MM.DD/HH:MM.
5. Press the up/down arrow buttons to adjust the value for the desired Date/Time.
6. Press the **SET** button to confirm the time settings and the snapshot screen will appear.

Resetting your Language

After you set your language for the first time, follow the instructions below to reset your desired language.

1. Press the **⏏** button and press the up/down arrow buttons to select **⏏**. Press the **SET** button to enter the menu.

2. Press the up/down arrow buttons to select **⏏**, and press the **SET** button or right arrow button to enter the menu.
3. Press the up/down arrow buttons to select [Language] and press the **SET** button or right arrow button to enter the menu.
4. Press the arrow buttons to select your desired language and press the **SET** button to confirm.
5. Press the **⏏** button and the snapshot screen will appear.





Resetting Date/Time

After you set your Date/Time for the first time, follow the instructions below to reset date and time.

1. Press the button and press the up/down arrow buttons to select . Press the to enter the menu.
2. Press the up/down arrow buttons to select and press the or right arrow button to enter the menu.
3. Press the up/down arrow buttons to select [Date & Time] and press the or right arrow button to enter the menu.
4. Press the left/right arrow buttons to select the Date/Time to be adjusted: Time is displayed in YYYY.MM.DD/HH:MM.

5. Press the up/down arrow buttons to press the value for your selected entry. After you finish your settings, press the to confirm.
6. Press the button and the following snapshot screen will appear.



MODE OVERVIEW

Display Setting

Press the **DISP.** button to display the settings:
Classic, Full, Off.

Classic: Displays the camera parameters on screen

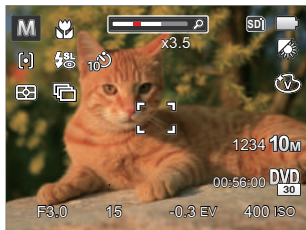

Off: Does not display any additional icons on screen



Full: Camera parameters with Grid and Histogram

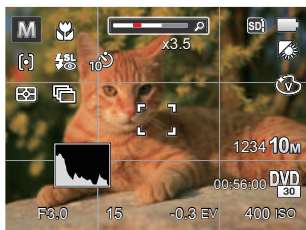

LCD Screen Display

Overview of the Screen Icons in Photo Shooting Mode

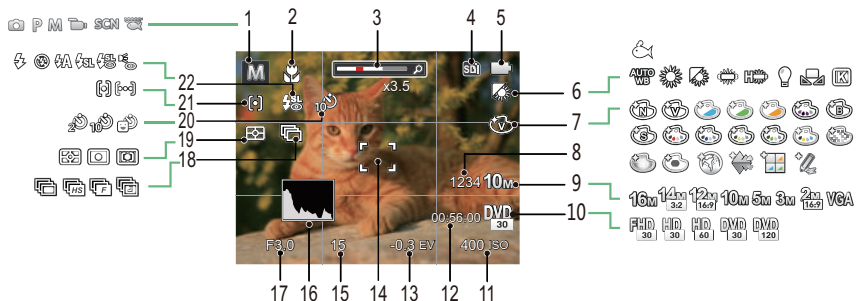

1	Shooting Mode	7	Color Effect	13	Exposure Compensation	19	Expo Metering
2	Macro Mode	8	Number of Remaining Shots	14	Focus Frame	20	Self-Timer
3	Zoom Display	9	Image Size	15	Shutter Speed	21	Auto Focus (AF) Mode
4	Memory Card/ Built-In Memory	10	Video Quality	16	Histogram	22	Flash Mode
5	Battery Status	11	ISO Value	17	Aperture Value		
6	White Balance	12	Remaining Recording Time	18	Continuous Shot		



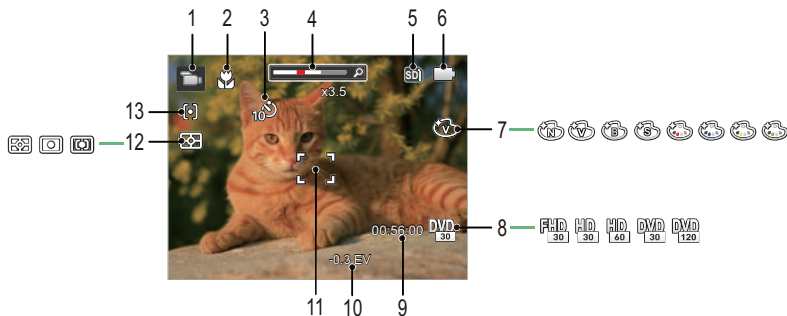



Overview of the Screen Icons in Movie Mode



1	Movie Mode	6	Battery Status	11	Focus Frame
2	Macro Mode	7	Color Effect	12	Expo Metering
3	Self-Timer	8	Video Quality	13	Auto Focus (AF) Mode
4	Zoom Display	9	Remaining Recording Time		
5	Memory Card/Built-In Memory	10	Exposure Compensation		

Using the Mode Button

This camera provides a convenient Mode button that allows you to switch easily between different modes. After pressing the Mode button to enter the Mode Selection Menu, press the left/right button to choose the selected mode. Press the  button to confirm your selection. All the available modes are listed below:

Mode Name	Icon	Description
Auto Mode		In this mode, the optimal conditions for taking pictures will be set based on the subject and environment. It is the most commonly used mode for taking pictures.
Program AE		Under different scenes, the user can switch the ISO and EV value according to personal preference, the camera can automatically set the shutter speed and aperture value.
Manual Mode		Shutter Speed and ISO can be configured manually in this mode.
Movie Mode		Record videos.
Scene Mode		Choose from 18 different pre-set scene types and effects for your photos.
Underwater Mode		Switch to take still pictures underwater.
Wi-Fi® Mode		Enable image transmission and remote control by connecting smart device with Wi-Fi®.

Auto Mode







Auto mode is the most common and easiest mode to take photos. While operating in this mode, the camera automatically optimizes numerous camera settings to take photos and videos with the best possible results.

Follow these steps:

1. Press the **MODE** button () and then press **SET** button to confirm.
2. Hold the camera steadily and aim at the subject. The optimum scene mode will be selected automatically.
3. Compose your picture in the LCD and press the shutter button halfway down to focus on your subject(s).
4. The LCD will show a green focus frame when the subject is in focus.
5. Fully press down the shutter button to take your photo.



The camera will automatically detect the most suitable scene to capture the best pictures.

Mode Name	Description
 Landscape Mode	For landscapes, automatically adjusts the exposure and reproduces vivid green and blue colors.
 Portrait Mode	Most suitable for capturing people with focus on their faces.
 Night Portrait	When you take portraits at night, or in low light conditions, automatically adjusts the exposure for people and night scenes.
 Backlit Portrait	When the sun or any other light source is behind you, automatically adjusts the foreground exposure to produce the best pictures possible.
 Night Landscape Mode	For night scenes, automatically increases the ISO value to compensate for low light.
 Macro Mode	The macro setting is ideal for shooting small objects or close-up photos.
 Auto Mode	The camera automatically adjusts the exposure and focus to ensure the best possible pictures.

Program AE P

When selecting **P** (Program AE) mode is selected, you can adjust the EV value and ISO value.

1. Press the **MODE** button to select Program AE (**P**), press **SET** button to confirm.

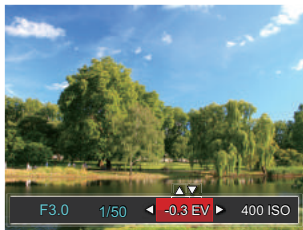

2. Press the left/right arrow buttons to select an adjustment setting.
3. Press the up/down buttons to adjust the parameters.
4. Press the **SET** button to confirm the settings and enter the shooting screen.

Manual Mode M

When selecting **M** (Manual Mode), you can adjust shutter speed manually and ISO value.

1. Press the **MODE** button to select Manual Mode (**M**), press **SET** button to confirm.

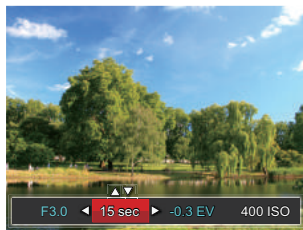

2. Press the left/right arrow buttons to select an adjustment setting.
3. Press the up/down buttons to adjust the parameters.
4. Press the **SET** button to confirm the settings and enter the shooting screen.



Please refer to the table below for unavailable options in P M modes: (O:Available X: Not Available)

Options Mode	Aperture	Shutter	EV	ISO
P	X	X	O	O
M	X	O	X	O
	X	X	O	X

 Please note that even if an option is not able to be adjusted in a particular mode, its value will still be displayed on the shooting screen.

Movie Mode

Switch to this mode to record videos.

1. Press the  button to select Movie Mode () and then press  button to confirm.
2. Press down the Shutter Button to start recording.

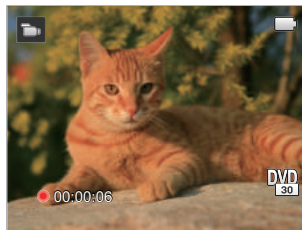

3. Once you are finished, press the Quick Video Recording Button or the Shutter Button to stop recording and return to the shooting screen.

 In the recording process, you can push the zoom buttons to Zoom in or out on the subject.







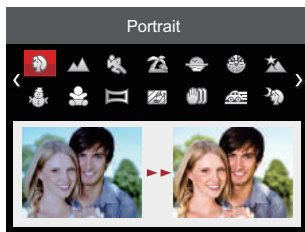



Scene Mode (SCN)









You can select an appropriate mode from the 18 scene modes according to the type of environment you are shooting in. The camera then automatically configures the most appropriate settings for the best possible photos.

1. Press the **MODE** button to select Scene Mode and then press **SET** button to enter the Scene Mode menu.



2. Press the arrow buttons to select a scene and press the **SET** button to confirm.
3. To change to a different scene, press the **MODE** button and then the **SET** button and finally the arrow buttons to to reselect the scene.



Scene	Description
 Portrait	Most suitable for capturing people, focusing on their face.
 Landscape	For landscapes and outdoor shots. Vivid reproduction of greens and blues.
 Sport	For fast-moving subjects. Captures sharp, action shots with minimal blur. This mode is not recommended for shooting indoors.
 Beach	For taking pictures in areas with strong sunlight.
 Sunset	For sunsets. Captures subjects in strong sunlight.
 Fireworks	For fireworks at night. Use of a tripod is recommended with this setting.
 Night Landscape	For night scenes. Use of a tripod is recommended with this setting.
 Snow	For snowy conditions. Reproduces natural, clear, white scenes.
 Children	Turns flash off automatically. Avoids disturbing the subject and is suitable for taking photos of children and pets.
 Panorama Mode	For shooting up to 360-degrees of landscape.

Scene	Description
 Glass	For objects behind transparent glass.
 Anti-Shake	Digital image stabilization to take clear pictures in the handheld state.
 Panning Shot	Suitable for capturing fast moving objects to have a clear subject with a blurred background.
 Night Portrait	For portraits against night scenery.
 Party	Suitable for taking indoor party pictures, even under complicated lighting conditions.
 Indoor	For indoor settings. Reduces blur and improves color accuracy.
 Leaf	For plants. Captures brilliant shots of greenery and blossoms.
 Museum	For museums or flash-free areas. Retains color and reduces blur.





Panorama Mode

This feature allows you to capture a panoramic view that will have significantly more content than a single photograph. Follow the arrow while keeping the camera steady to seamlessly shoot an ultra-wide scene of up to 360 degrees.

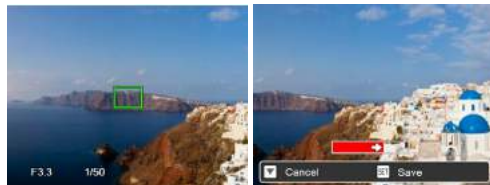
Follow the steps below:

1. Select the Panorama Mode () and then press the  button to confirm.
2. Press the arrow buttons to select a desired shooting direction. Should you not select a direction, the default shooting direction is "right." 2 seconds later, the camera will be ready to take pictures. You can also press the  button or press the shutter button halfway down to get ready to take panoramic pictures.
3. Compose your shot on the LCD and half press the shutter button to focus on the subject. After focusing, fully press the shutter button down to take the first picture. At this time, the process dialog of panorama mode stitching appears on the screen.



4. Pan the camera according to the set direction. When the range of motion does not exceed the range that the camera can detect, the progress bar behind the arrow partially turns red. When it completely turns red, panorama mode shooting is finished.
-  In Panorama Mode, the Flash, Self-Timer, Macro Modes and Exposure Compensation are not available. Focus Adjustment is also not available at this time.
 -  During Panorama Mode shooting, press the  button to interrupt shooting and save the current pictures. Press the down button () to cancel shooting and delete previously taken pictures.



During panorama mode shooting, when the moving direction of the camera is wrong or the angle deviates from the internal settings, the LCD shows a warning message [Improper alignment. Please try again.] and the current pictures taken are saved.



Panoramic image can be played back by the method of flash playing. Please see the animation panoramic playback on page 57.

Anti-Shake

This mode can help reduce photo blur caused by shakiness of hands, low light and/or slow shutter speed.



Use Anti-Shake mode in dark environments or when using a slower shutter speed.



Shooting in a windy or unstable environment (such as a moving vehicle) may cause blurry images.

Underwater Mode

When you are in the water, you can select Underwater Mode in the Mode Selection menu to take pictures under water.

Press the  button to enter Underwater Mode () and then press  button to confirm.

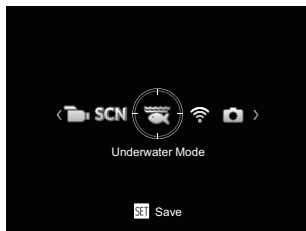

Wi-Fi® Mode



Enable image transmission and remote control by connecting smart device with Wi-Fi®.

Before utilizing Wi-Fi® Mode, please review the following:

- Your smart device operating system version needs to be iOS 10 or higher, or ANDROID 5.0 or higher. If not, please upgrade your smart device before using the APP.
- Please do not use in places that have a high intensity magnetic field, electrostatic and electric wave interference (for example near a microwave oven), which may cause failure in receiving signals.
- To maintain a connection, please keep the camera within 10 meters (32.8 feet) without signal shielding interference.
- Please do not use Wi-Fi® connection functionality on a plane.
- The camera and the smart device can only be connected one to one.



Downloading the APP package:

Download a dedicated installation package from the application store (APP name: PIXPRO Remote Viewer ) and then install it.

- ANDROID™ devices : Search and download the APP “PIXPRO Remote Viewer”  in Google play, and install it following the instructions on the interface.
- iOS™ devices : Search and download the APP “PIXPRO Remote Viewer”  in APP store, and install it following the instructions on the interface.

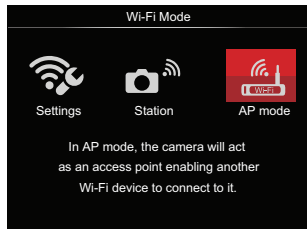
1. Press the **MODE** button to select  and then press **SET** button to enter the Wi-Fi® selection interface.



2. Press the left/right arrow buttons to select and set options.
 -  [Settings] :
Customize the Wi-Fi® settings for the camera system.
 -  [Station] :
Use the Station Mode to connect to a “Personal Hotspot” created by your mobile device.
 -  [AP Mode] :
In AP mode, the camera will act as an access point enabling another Wi-Fi® device to connect to it.



Press the mode button to disconnect.

AP Mode

This camera may connect with your smart device through Wi-Fi®.

Settings of Camera:

1. Select  and press the **SET** button to enter the setting interface.
2. Press the up/down buttons to select options to be adjusted, and press the **SET** button to enter the option setting interface.

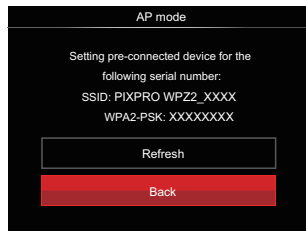

- Refresh: Create a new WPA2 PSK password.
- Back: Back to previous page.

Settings of Smart Device:

1. Enable the Wi-Fi® of smart device and then search surrounding wireless devices.
2. Select the name of camera SSID to be connected and then input the eight-digit number password after WPA2-PSK on the camera.
3. Click the icon of the PIXPRO Remote Viewer APP  to enable the APP.

Set up completion:



Once the APP is connected to the camera, functional operation can be enabled on the connected smart device.



Every WPZ2 camera is shipped with a default factory Wi-Fi® password that is randomized and unique to that camera and will not change unless you wish to reset the password with a new randomly generated password. If you wish to change the Wi-Fi® password in your WPZ2 from the assigned, unique factory password, you can do so by selecting and using the refresh setting. If “refresh” is selected, a new random password will be generated and saved in the camera until changed or if you use the “Reset” function. If you reset your WPZ2 to the factory settings, then the initial, randomly factory assigned and unique Wi-Fi® password will be restored to your camera. (Please refer to Reset instructions on page 88).

Station

Enable image transmission and remote control by connecting the camera with a Wi-Fi® access point created by your smart device.

1. Enable the Wi-Fi® access point of smart device.
2. Select the  on camera and then press the  button to confirm connection with smart device.
3. Press the up/down buttons to select the name of smart device to be connected and then press the  button to confirm. Then, the camera enters the password input interface.







Press the left/right arrow buttons to select:

- Scan: Search again surrounding wireless devices.
 - ► : Select the name of device to be connected.
 - Back: Back to Wi-Fi® mode select screen.
4. Press the arrow buttons to select and then press the **SET** button to confirm your selection. You will enter the completion of WPA2- PSK after the password is saved.



Meanings of Interface Icons:

Icon	Description
	Delete the last letter
	Switch the display of letters in capital and lowercase
	Move the Cursor
	Switch the symbol input
	Input Space

5. Connect to network after saving the password.

- If connected, the LCD will display as shown below:

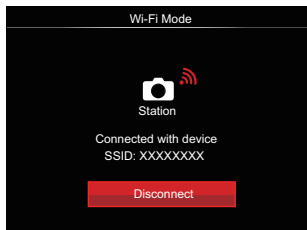

- If connection failed, please check Wi-Fi® device and try again.

6. After connecting, click the icon of the APP  on the smart device.

Display of Wi-Fi® Connection Status:

The Wi-Fi® has successfully connected but APP is not enabled.

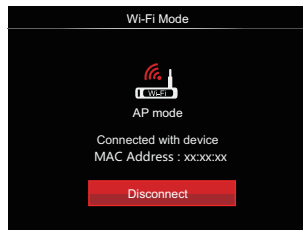

The Wi-Fi® has successfully connected and APP is enabled.

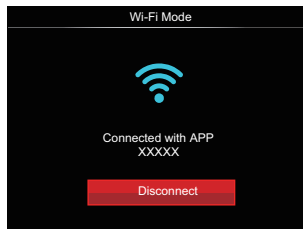

To disconnect from Wi-Fi®:



- No: Keep Wi-Fi® connected and back to previous page.
- Yes: Disconnect and back to Wi-Fi® connection screen.

Disconnected from smart device Wi-Fi®:

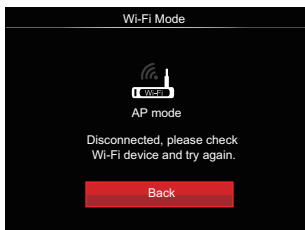

- Back: Back to the SSID interface.

Setting

The name of this camera can be changed under Wi-Fi® settings.

1. Select the and then press the button to enter the setting interface.
2. Press the up/down buttons to select options to be adjusted and then press the button to enter the menu.

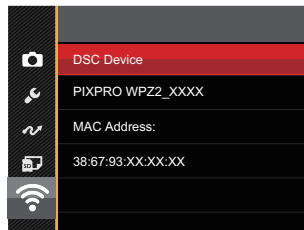

3. Press the button to confirm settings and then skip the menu.

DSC Device

The default name of DSC device is [PIXPRO WPZ2_XXXX]. Change the name of DSC device through typing.



For the method of input, please refer to the introduction on password input on page 41.

MAC Address

Check the wireless MAC address of this camera.

APP Operating Instructions

Refer to the "PIXPRO Remote Viewer User Manual" located on the web:

Americas



<http://kodakpixpro.com/Americas/support/downloads.php>

Europe



<https://kodakpixpro.com/Europe/support/multilang-downloads.php>

BASIC OPERATION

Using the Zoom Function

Your camera is equipped with two types of Zoom Functions: Optical Zoom and Digital Zoom. Press the Zoom button of the camera to zoom in or out on the subject while taking pictures.

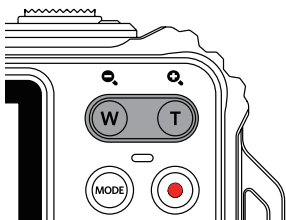

When the Optical Zoom reaches the threshold as Digital Zoom, release and turn the Zoom Button to T to switch between the Optical Zoom and Digital Zoom.



Macro Mode

The Macro Setting is ideal for shooting small objects or close-up photos. This mode allows you to focus on subjects very close to the camera.

1. Press the left arrow button () to enter the Macro Menu.



2. Press the left/right arrow buttons to select the following 2 modes:

-  Macro Off
Select this option to disable Macro.
-  Macro On
Select this to focus on subjects 5cm from the lens.

3. Press the  button to confirm the settings and exit the menu.



Self-Timer Setting



Use this function to take pictures at pre-set intervals. The camera shutter speed can be set to 2 seconds, 10 seconds or when a smile is detected.

1. Press the down arrow button () to enter the Self-Timer Menu.





2. Press the left/right arrow buttons to select one of the following 4 modes:

-  Self-Timer Off
Disables the Self-Timer.
-  Self-Timer 2 sec
A single picture is shot 2 seconds after the Shutter Button is pressed.

-  Self-Timer 10 sec
A single picture is shot 10 seconds after the Shutter Button is pressed.
-  Self-Timer Smile
Press the Shutter Button and a picture will be taken immediately after a smile is detected.

3. Press the **SET** button to confirm the settings and exit the menu.

 When enabling the Self-Timer, pressing the Shutter Button or the () button will select the highlighted Self-Timer option and return to the shooting screen, and keep the Self-Timer setting.



 When enabling the smile detection, pressing the Shutter Button or the **SET** button will select the Self-Timer smile option (if highlighted) and return to the shooting screen, and keeping the Self-Timer smile setting.





Flash Mode

The flash provides supplemental light for scenes. The flash is usually used when shooting against the light to highlight the object; it is also suitable for metering and shooting in darker scenes to improve the exposure.

1. Press the right arrow button () to enter the Flash Settings Menu.



2. Press the left/right arrow buttons to select one of the following 6 modes:
 -  Force Off
Flash is turned off.
 -  Flash Auto
Camera flash goes off automatically based on lighting conditions.

-  Fill Flash
The flash will engage with each shot even, supplementing the existing light in a scene and helping to eliminate shadows.
 -  Slow Sync
This allows you to take pictures of people at night that clearly show both your subjects and the night time backdrop. The use of a tripod is recommended when shooting with this setting.
 -  Slow Sync + Red-Eye
Use this mode for slow synchrony shots with red-eye reduction.
 -  Red-Eye Reduction
The camera emits a brief pre-flash before the picture is taken to reduce red-eye effects.
3. Press the  button to confirm the settings and exit this option.

EV Setting

The EV function menu of the camera includes functions, such as EV (Exposure Value) Adjustment, ISO, Shutter Adjustment, Aperture Adjustment, etc. Using the appropriate function settings can improve your pictures.

To select the best setting for optimum photos, follow these steps:

1. Press the **(SET)** button to display the Settings screen.
2. Press the left/right arrow buttons to select the Setting options.



3. Press the up/down arrow buttons to adjust the option values.
4. Press the **(SET)** button to complete the setting and enter Shooting Mode.

Exposure Compensation

Set up to adjust the picture brightness. In the case of a very high contrast between the photographed object and the background, the brightness of the picture can be appropriately adjusted.

(This can be adjusted in P Mode)



The adjustable range of exposure value is from EV -3.0 to EV +3.0.

ISO

ISO allows you to set the sensitivity of the camera sensor. Please use a higher ISO value in darker places and a lower value in brighter conditions.

(This can be adjusted in P M Mode)



The camera's ISO settings include: Auto, 100, 200, 400, 800, 1600 and 3200.

Shutter Adjustment

For shutter speed, the camera may automatically set the aperture value corresponding to the manually set shutter speed to obtain the most suitable exposure value. The movement of objects may be shown by adjusting the shutter speed. High shutter value can help you more clearly capture fast moving objects, while low shutter value can better show the movement of objects. (This can be adjusted in M Mode)



Using Quick Recording

While in the Photo Shooting Mode, press the Quick Video Recording Button  to begin recording a video.

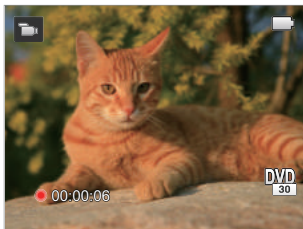

Once you are finished, press the Quick Video Recording Button  or the Shutter Button to stop and store the video. The camera's microSD Memory Card (max 32GB) will store the video and return to the shooting screen.

PLAYBACK

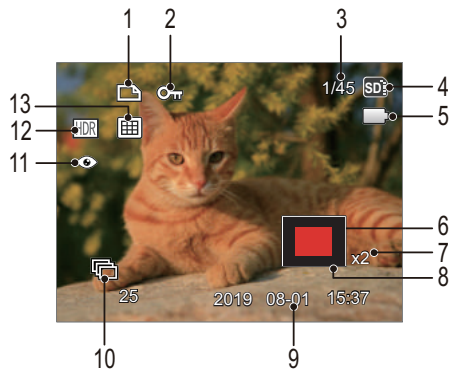

Overview of the Screen Icons in Playback Mode



- 1 DPOF File
- 2 File Protection
- 3 Memory space (indicating the current number of photos and total number of photos)
- 4 Memory Card/Built-in Memory
- 5 Battery Status
- 6 Zoom Magnification Area
- 7 Image Zoom Ratios
- 8 Image Zone
- 9 Shooting Date
10. Continuous Capture Group Playback
- 11 Red-Eye Reduction
- 12 HDR
- 13 Date Folder

Viewing Photos and Videos

To view captured photos and video clips on the LCD:

1. After pressing the  button, the last photo or video clip taken will be displayed on the LCD.
2. Use the left/right navigation buttons to scroll through the photos or video clips stored on the built-in memory or on the Memory Card in the camera.
3. To play a selected video clip, press the  button to enter the Movie Playback Mode.

An operation guide appears on the screen when playing back a video. Press the appropriate buttons to enable the corresponding functions.

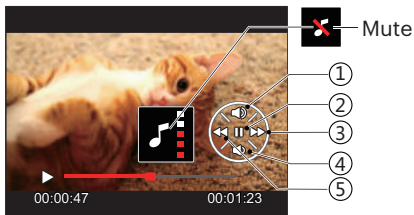

1	Increase Volume
2	Pause
3	Fast Forward
4	Decrease Volume
5	Rewind

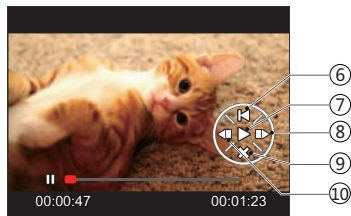

6	Return back to the beginning of the video
7	Play
8	Frame Forward
9	Cancel Playback
10	Frame Backward

Thumbnail View

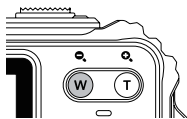

When in Playback Mode, press the **W** on the Zoom button to display thumbnail images of photos and videos on the screen.

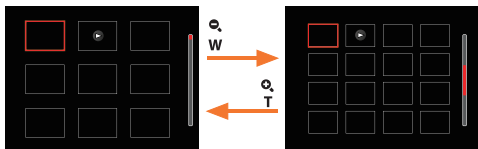

1. Slide the Zoom button to switch between 3 x 3 and 4 x 4 thumbnails.
2. When a 3 x 3 or 4 x 4 thumbnail is displayed, press the arrow buttons to select the picture or video clip to view.



3. Press the arrow buttons to select a picture or video clip to view and press the **SET** button to restore it to the original size.

 If the  indicator appears on the LCD, then a movie file is currently being displayed.

Using Zoom Playback (for Still Pictures Only)

When playing back photos, you can also use the Zoom Button to zoom in on the photos, 2 to 8 times their original magnification.

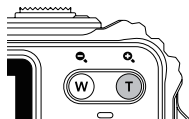

1. Press the left/right buttons to select the picture on which to use the zoom feature.
2. Press the **T** on the Zoom Button to zoom in.
3. The bottom right corner of the screen will display the amount zoomed in as well as the area of the photo shown.

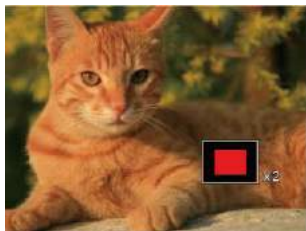



4. Press the arrow buttons to navigate and select the desired portion of the photo to be zoomed in on.
5. Press the **SET** button to return the image to its original scale.



Movie images cannot be magnified.

Continuous Capture Group Playback



Cont.Shot-High Speed (VGA) and Cont.Shot-Fast (4M) can make continuous capture for group image playback.

1. Press the  button to enter playback screen.
2. Press the left/right buttons to select Cont. Group.
3. Press the  to start playback.



Animation Panorama Play

Panoramic Animation Playing is when full size images are played in accordance with the shooting direction. After playing, it will automatically return to the initial panorama screen.

1. Press the  button to enter Playback Screen.
2. Press the left/right arrow buttons to select animated panoramic photos.
3. Press the  button to play in selected shooting direction.



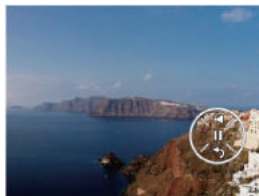

Video Panorama





Playing



Pause



	Pause
	Cancel Play





In the process of panoramic animation playback, press the down button ( ) to stop playing and return to the playback screen.

Slideshow

This setting allows you to view all the stored pictures as a slideshow.

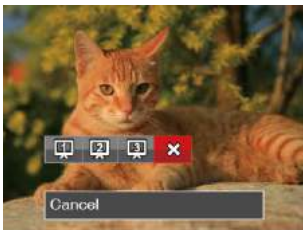
1. Press the  button to enter playback screen.
2. Press the  button to enter slide option.
3. Press the left/right buttons to select slideshow playing or [Cancel] to return to the playback screen.



4. Press the  button to confirm the setting.

Deleting Photos and Videos

In Playback Mode, press the down arrow button (⏮) to select your desired photos and videos.

To delete photos or videos:

1. Press the (▶) button to switch to Playback Mode.
2. Press the left/right arrow buttons to select the photos and videos to be deleted.
3. Press the down arrow button (⏮) and the deletion screen is displayed.



4. Press the up/down arrow buttons to select [Delete One] or [Exit] and press the (SET) button to confirm.



Erased photos/video clips cannot be recovered.



Please refer to page 81 for instructions on deleting more than one image at a time.

USING THE MENUS

Photo Setup Menu

Mode: P M SCN

1. In Photo Shooting Mode, press the button to enter the Photo Shooting Menu.
2. Press the up/down arrow buttons to select the Photo Shooting Menu and settings.
3. Press the left/right arrow buttons to select the Photo Shooting Menu to be set and press the button to confirm.



Functions that can be enabled are different under each mode.

Expo Metering (Exposure Metering)

Use this setting to select the "target" size of the camera's field of view to be metered.



There are 3 options:

- AiAE (Artificial Intelligence AE): Evaluates the light intensity at multiple points in the frame and automatically determines the best value for the light meter.
- Spot metering targets a small area in the center of the camera's field of view.
- Center metering targets a slightly larger area in the center of the camera's field of view.

Image Size

The size setting refers to the image resolution in pixels. A higher image resolution allows you to print that image in larger sizes without degrading the photo image quality.



 The bigger the number of recorded pixels is, the better the image quality becomes. As the number of recorded pixels lessens, you will be able to record more images on a memory card.

Continuous Auto Focus (AF)

Use the Continuous AF setting to be able to continuously focus automatically when taking pictures.



There are 2 options:



- Off
- On





Continuous Shot

Use this setting to perform continuous shooting. After entering this mode, you can shoot multiple images by continuously holding the shutter button down.



There are 8 options:

-  Single
Capture a single shot only.
-  Continuous Shot
Take several pictures at a time.
-  Cont. Shot-High Speed (VGA)
For continuous shot with VGA pixel.

-  Cont. Shot-Fast (4M)
For continuous shot with 4M pixels.
-  Time-Lapse 30sec
-  Time-Lapse 1min
-  Time-Lapse 5min
-  Time-Lapse 10min



 In Continuous Shot mode, the flash is automatically set to Force Off in order to achieve quick succession of shots.

Focus Setting

This setting allows you to select different modes for optimum focus.



There are 2 options:

-  Single-AF: The focus frame appears on the center of the LCD to help you focus on the subject.
-  Multi-AF: The camera automatically focuses the subject in a wider area to find the focal point.



White Balance Setting



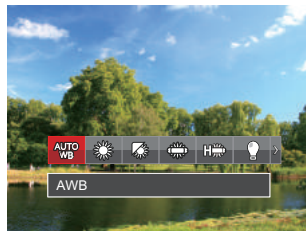

The white balance setting allows you to adjust the color temperature for different lighting conditions to ensure the most accurate color reproduction.

1. Press the  button to enter the white balance setting menu.
2. Press the left/right arrow buttons to select the White Balance Setting options.







There are 9 options in **P M** mode:

-  AWB
-  Daylight
-  Cloudy
-  Fluorescent

-  Fluorescent CWF
-  Incandescent
-  Manual WB (Fully press the Shutter Button to detect the white balance value)
-  Color Temp. (1900K-10000K)
Press the direction buttons up/down to "Adjust the K value"; Press the direction button left to exit the K value.
-  Underwater

There are 4 options in  mode:

-  AWB
-  Manual WB (Fully press the Shutter Button to detect the white balance value)
-  Color Temp. (1900K-10000K)
Press the direction buttons up/down to "Adjust the K value"; Press the direction button left to exit the K value.
-  Underwater

3. Press the  button to confirm the settings and exit the menu.







Color Effect

The Image Color Setting allows you to select different color effects.

1. Press the  button to select the Image Color Setting Menu.
2. Press the left/right arrow buttons to select the Image Color Setting options.



There are 20 options:

-  Normal
-  Vivid
-  Japanese Style
-  Italian Style
-  French Style
-  Punk

-  Black and White
-  Sepia
-  Partial Color-Red
-  Partial Color-Blue
-  Partial Color-Yellow
-  Partial Color-Green
-  Negative
-  Dreamy
-  Vignetting
-  Salon
-  Fish Eye
-  Reflection
-  4 Grids -Stylish(2M)
-  Sketch

Select Scene

Select a scene mode under SCN Mode.

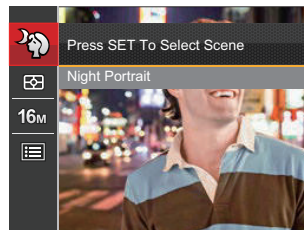

Please refer to P32 for more detailed instructions.

- Options in the shooting mode (O: Available X: Unavailable)









Options	Shooting Modes				
		P	M		
	O	O	O	O	O
16M	O	O	O	X	O
FHD	X	X	X	O	X
	X	O	O	X	O
	X	O	O	X	O
	O	O	O	X	X
AUTO WB	X	O	O	X	O
	X	O	O	O	X

Photo Shooting Setting Menu

Mode: **P** **M** **SCN**

1. Press the button in Photo Shooting Mode and press the up/down buttons to select .



2. Press the button to enter the menu.
3. Press the up/down arrow buttons to select and press the button or right arrow button to enter the menu.
4. Press the up/down arrow buttons to pick the item to be selected and press the button or right arrow button to enter the menu.
5. Press the up/down arrow buttons to select an option and press the button to confirm.

Quality

The quality setting can be used to adjust the image compression ratio.

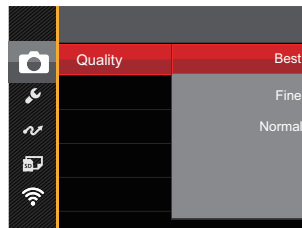

There are three options for picture quality:

- Best (16M Average File Size: 4.0MB)
- Fine (16M Average File Size: 2.5MB)
- Normal (16M Average File Size: 2.0MB)

Auto Focus (AF) Assist Beam

In a darker environment, the AF assist beam setting can be turned on for better focus.

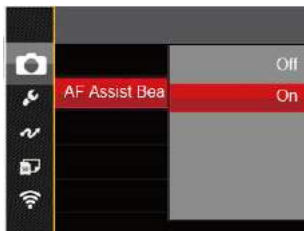

Digital Zoom

This setting is for adjusting digital zoom. If this function is disabled, only optical zoom can be used.



Date Imprint

Include a Date/Time stamp on the photo image.



- Off
- Date
- Date/Time

Quick Review

This option allows quick review of the photos immediately after they are taken. Each photo is displayed on the LCD screen based on the selected time.

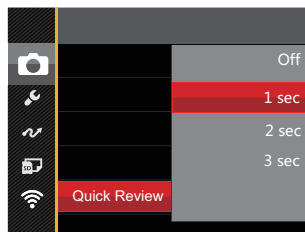

There are 4 options:

- Off
- 1 sec
- 2 sec
- 3 sec

Face Detection

Detects and focuses on faces to make all faces as clear as possible in Photo Mode.

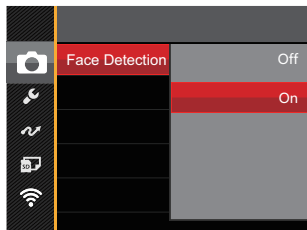

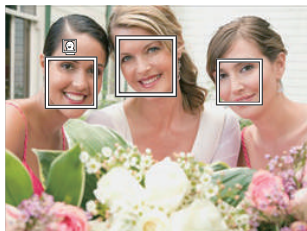

1. Hold the camera steadily and then focus on the object to detect its face. A focus frame will appear at the face on the screen when a face is detected.

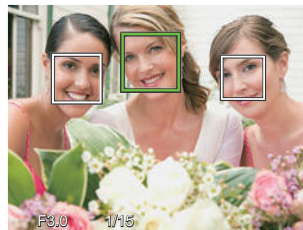

2. Press the shutter button half-way down to focus. The LCD will show a green focus frame when the subject is in focus.





3. Press the shutter button all the way down to take pictures.

 The closed eyes detection is usually on. If the camera detects in the course of quick review there is a face with eyes closed, a prompt of closed eyes will appear .

Movie Menu

Mode: 

1. Press the  button, select the  mode and press the  button to enter the Movie Menu.



2. Press the up/down arrow buttons to select the Movie Menu to be set.
3. Press the left/right arrow buttons to select the Movie Menu to be set and press the  button to confirm.

Expo Metering (Exposure Metering)

Use this setting to select the "target" size of the camera's field of view to be metered.



There are 3 options:

- AiAE (Artificial Intelligence AE): Evaluates the light intensity at multiple points in the frame and automatically determines the best value for the light meter.
- Spot metering targets a small area in the center of the camera's field of view.
- Center metering targets a slightly larger area in the center of the camera's field of view.

Video Quality

Set the image resolution used during video recording.

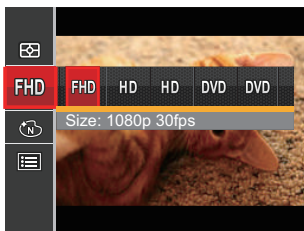



- **FHD** Size: 1080p 30fps
- **HD** Size: 720p 60fps
- **HD** Size: 720p 30fps
- **DVD** Size: 640x480 30fps
- **DVD** Size: High Speed Movie

The speed requirements for reading and writing high resolution image pixel images to an SD card are as follows:

No.	Image Pixels	Frames	Recommendation	Recording Time (4GB) About
1	1920 x 1080 *	30	Class 6	30 Minutes
2	1280 x 720 *	60	Class 6	32 Minutes
3	1280 x 720 *	30	Class 4	58 Minutes
4	640 x 480	30	Class 4	105 Minutes
5	640 x 480	120	Class 6	53 Minutes

 * The recording limit is 29 minutes at one time.

 When recording in higher pixel resolutions for extended periods of time, this can cause the camera to generate heat. This is not a camera malfunction.

 When the video format is set as 640x480 (120fps), shooting time is 30 seconds, playback time is 2 minutes.

 Sound recording is disabled when 640x480 120fps is chosen.

Color Effect

The Image Color Setting allows you to select different color effects.

1. Press the **SET** button to select the Image Color Setting Menu.
2. Press the left/right arrow buttons to select the image Color Setting options.

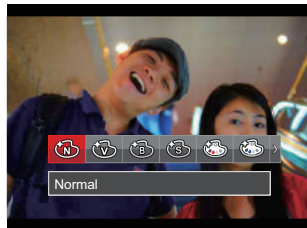





There are 8 options:





-  Normal
-  Vivid
-  Black and White
-  Sepia
-  Partial Color-Red
-  Partial Color-Blue
-  Partial Color-Yellow
-  Partial Color-Green

Movie Setting Menu

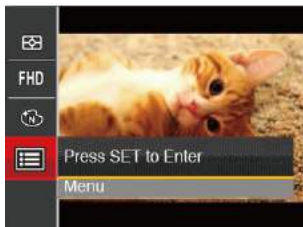
Mode: 

1. Press the  button, and select  to enter the video recording screen.
2. Press the  button and press the up/down arrow buttons to select . Press the  button to enter the menu.



3. Press the up/down arrow buttons to select  and press the  button or right arrow button to enter the menu.
4. Select the items to be set and press the  button or the right arrow button to enter the menu.
5. Press the up/down arrow buttons to select an option and press the  button to confirm.





Digital Zoom

This setting is for adjusting digital zoom. If this function is disabled, only optical zoom can be used.



Playback Menu

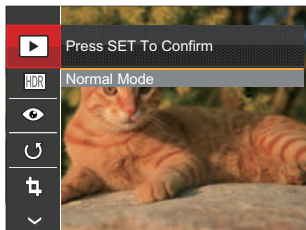

Mode: 

1. Press the  button to display the playback screen and press the  button to enter the menu.
2. Press the up/down arrow buttons to select the playback desired and press  button to enter.
3. Press the left/right arrow buttons to select an option and press the  button to confirm.





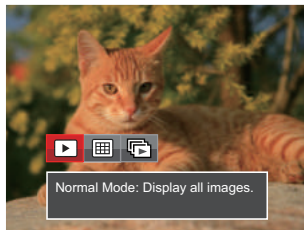

Refer to the following pages 75 to 78 for more details about each setting.

Display Mode

Select the  settings and press the  button to display the settings screen.



-  Normal Mode: Display all images.
-  Date Mode: Arranged by date.
-  Cont. Photo Mode: Arranged by Cont. Photo Group.
-  The Date Folder is displayed in date order based on camera's Date/Time Settings.
-  If there is no Continuous Shot image file in memory, Continuous Shot Playback mode cannot be enabled.

HDR

With the HDR function, pictures that are overexposed may be corrected to optimize the highlights and lowlights captured to more accurately represent the actual scene.

Select the **HDR** settings, and press the **SET** button to display the settings screen.

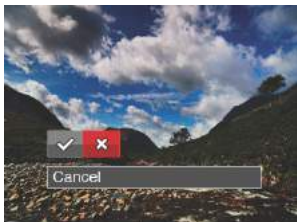

- ✓ : HDR
- ✗ : Cancel

 After using the HDR function, the image will be saved as a new file and the original file is still stored in the memory.

Red-Eye Reduction

You can use this setting to reduce the red-eye of the picture.



Select the  settings, and press the **SET** button to display the settings screen.



- ✓ : Red-Eye Reduction
- ✗ : Cancel

Rotate

You can use this setting to change the orientation of the picture.

Select the  settings, and press the  button to display the settings screen.

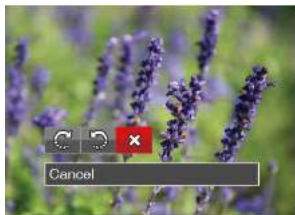

 : Turn Right



 : Turn Left

 : Cancel

 Videos and panoramic pictures cannot be rotated.

 The rotated picture file will replace the original photo.

Resize

This setting allows you to resize a picture to a particular resolution and saves it as a new picture. Select the  settings and press the  button to display the settings screen.



 : Resize to 1024x768
Resize to 1024x680
Resize to 1024x576

 : Resize to 640x480
Resize to 640x428
Resize to 640x360

 : Cancel

 This function can only be used to downsize photos to a lower resolution.

 Sizes of photos taken in panorama mode and sizes of rotated photos cannot be adjusted.







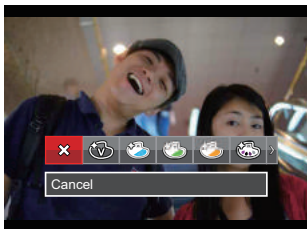











Color

This setting allows you to change the picture color effect. The file is saved as a new photo and stored in memory together with the original photo.

Select the  settings, and press the  button to display the settings screen.











There are 19 options available:

 Cancel	 Sepia	 Vignetting
 Vivid	 Partial Color-Red	 Salon
 Japanese Style (8M)	 Partial Color-Blue	 Fish Eye
 Italian Style (8M)	 Partial Color-Yellow	 Reflection
 French Style (8M)	 Partial Color-Green	 4 Grids - Stylish(2M)
 Punk (4M)	 Negative (8M)	
 Black and White	 Dreamy	

Playback Setting Menu

Mode: 

1. Press the  button to show the playback screen, press the  button, and press the up/down arrow buttons to select .
2. Press the  button to enter the menu.
3. Press the up/down arrow buttons to select  and press the  button or right arrow button to enter the menu.
4. Press the up/down arrow buttons to select the item to be set and press the  button or right arrow button to enter the menu.
5. Press the up/down arrow buttons to select an option and press the  button to confirm.

Refer to the following pages 80 to 82 for more details about each setting.

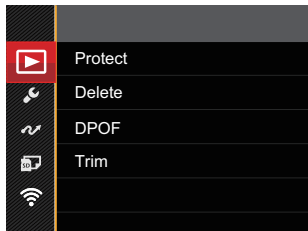

Protect

To prevent any pictures or videos from being accidentally erased, use this setting to lock one or all of the files.

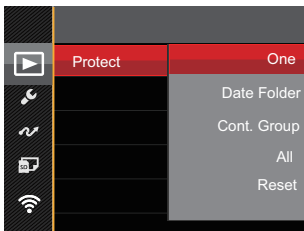

There are 5 sub menus available:

- One: Lock the selected photo or video if they are unprotected; unlock the selected photo or video if they are protected.
- Date Folder: Protect all photos in the Date Folder.
- Cont. Group: Protect all photos in the Cont. Photo Folder.
- All: Lock all photos or videos.
- Reset: Cancel all locked photos or videos.

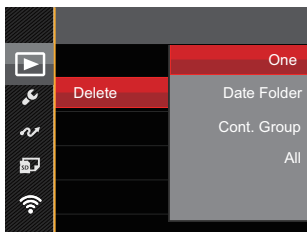

Delete

You can delete one or all photo/video files.





There are 4 sub menus available:

- One: Delete one photo or video.
- Date Folder: Delete all photos in the Date Folder.
- Cont. Group: Delete all photos in the Cont. Photo Folder
- All: Delete all photos or videos.

 The “” indicator means a file is protected. File protection must be removed before a file can be deleted.

 Deleting files will cause DPOF settings to be reset.

 Deleted files will be permanently deleted and will not be able to be recovered or restored.

 When one photo in the Cont. Photo and Date Folders is protected, it will be kept but any other photos will be deleted.

DPOF (Digital Print Order Format)

The DPOF feature allows you to compile and select a group of pictures that you would like to print and will save your selection on the memory card so that you can use the memory card to print without having to individually specify the photos you want to print.

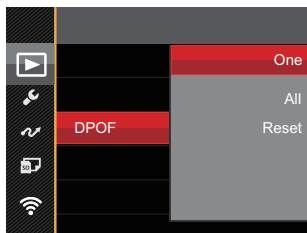

A printer that supports DPOF is needed for photo printing.

Trim

The Trim setting allows you to crop photos and save them as new pictures.

1. Select [Yes] to confirm trim. Select a section of the photo to be trimmed using the zoom button and arrow buttons to trim a photo.



2. Press the **SET** button and the [Save change?] prompt appears. Select [✓] to change and save the picture. Select [✕] to cancel changes and return to the trim prompt screen.







The image cannot be clipped/trimmed again once it has been clipped to 640 X 480.





A trimmed picture cannot be trimmed again.

Setup Menu

Mode :       

1. Press the  button in any mode and press the up/down buttons to select .
2. Press the  button to enter the menu.
3. Press the up/down arrow buttons to select  and press the  button or right arrow button to enter the menu.



4. Press the up/down arrow buttons to select the item to be set and press the  button or right arrow button to enter the menu.
5. Press the up/down arrow buttons to select an option and press the  button to confirm.

Refer to the following pages 84 to 85 for more details about each setting.

Sound Settings

With this setting you may adjust the sound volume.

Press the left/right arrow buttons to adjust the volume and press the **SET** button to confirm.

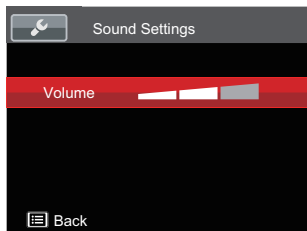

Power Saver

This setting allows you to save power and get the maximum possible running time for your camera's battery. Follow the steps below to turn the LCD and camera off automatically after a consecutive period of inactivity.

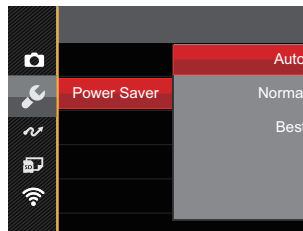

- Auto
- Normal
- Best



Power Saver	LCD power off time	Turn off time
Auto	3 min	5 min
Normal	1 min	3 min
Best	30 sec	1 min

Language

Refer to the “Resetting your Language” section on page 22.

World Time

The World Time setting is a useful function for your overseas trips. This feature enables you to display the local time on the LCD while you are abroad.

1. Press the up/down arrow buttons to select the departure place () and destination () fields.
2. Press the left/right arrow buttons to select a city located in the same time zone as that of the field. Press the  button to confirm settings.



Date & Time

Refer to the “Resetting Date/Time” section on page 23.

LCD Brightness





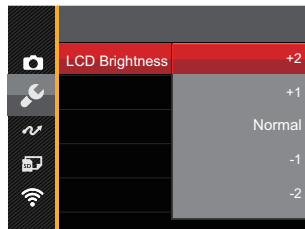

Use this setting to adjust the brightness of your LCD.

Press the up/down arrow buttons to select an option and press the  button to confirm .



SD Card /Firmware

Mode :  **P** **M** **SCN**  

1. Press the  button, press the up/down arrow buttons to select  and press the  button to enter the menu.
2. Press the up/down arrow buttons to select  and press the  button or right arrow button to enter the menu.
3. Press the up/down arrow buttons to select the item to be set and press the  button or right arrow button to enter the menu.

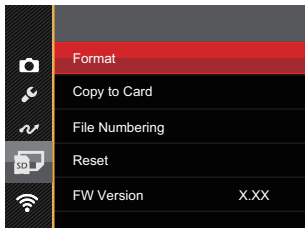



4. Press the up/down arrow buttons to to select an option and press the  button to confirm.

Refer to the following pages 87 to 89 for more details about each setting.

Format

Please Note: formatting enables you to delete all contents on the memory card and camera's built-in memory, including protected photo and movie files.



-  If you select [Yes] the camera will format its memory.
-  If there is no memory card in the camera, the built-in memory will be formatted; if there is a memory card, only the memory card will be formatted.

Copy to Card

Use this setting to copy the files stored in the camera's built-in memory to a memory card.



-  If there is no card available in the camera, this function will not be displayed.

File Numbering

After you take a picture or video clip, the camera will automatically save it with a sequential number. You can use this to reset the file numbering to 1.



Reset

Use this setting to restore the camera to its original factory default settings.



Firmware (FW) Version

Use this setting to view the current camera firmware version.

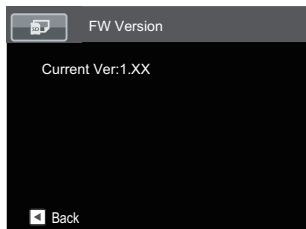

When there is a new firmware version saved on the SD card, select [Yes] to update.

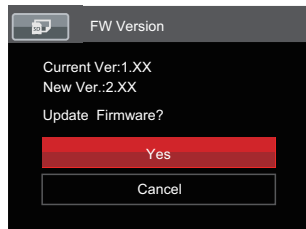







Connecting to a Computer

You can use a USB cable to connect the camera and copy (transmit) photos to a computer, printer or other device.

Setting the USB Mode

The camera's USB port can be used to connect to either a computer or a printer. The following steps will allow you to ensure that the camera is correctly configured to connect with a PC.

1. Press the  button, press the up/down arrow buttons to select  and press the  button to enter the menu.
2. Press the up/down arrow buttons to select  and press the  button or right arrow button to enter the menu.
3. Press the up/down arrow buttons to select [USB] and press the  button or right arrow button to enter the menu.
4. Press the up/down arrow buttons to select [PC] and press the  button to confirm.

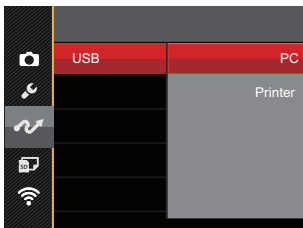

Transferring Files to Your Computer

The computer will automatically detect the camera as a removable drive. Double-click the “My Computer” icon on the desktop to locate the removable drive and to copy folders and files in the drive to a directory on your PC as you would copy any typical folder or file.

Follow the steps below to connect the camera to a computer:

1. Make sure both the camera and computer are turned on.
2. Connect one end of the supplied USB cable to the USB port on your camera.
3. Connect the other end of the cable to an available USB port on your computer.
4. After the transmission is complete, disconnect the USB cable according to your computer manufacturer's instructions specifying how to safely remove USB devices.

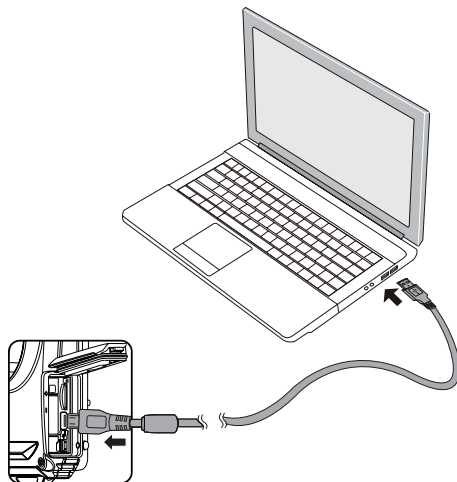







Connecting to PICTBRIDGE™ Compatible Printers

PICTBRIDGE™ technology allows printing of the photos saved on the memory card by a printer.



To find out if a printer is PICTBRIDGE™ compatible, simply look for the PICTBRIDGE™ logo on the packaging or check the owner's manual for specifications. With the PICTBRIDGE™ function on your camera, you can print the captured photos directly to a PICTBRIDGE™ compatible printer using the supplied USB cable, without the need for a PC.

Setting the USB Mode

The camera's USB port can be set to connect with either a PC or a printer. The following steps will ensure that the camera is correctly configured to connect with a compatible printer.

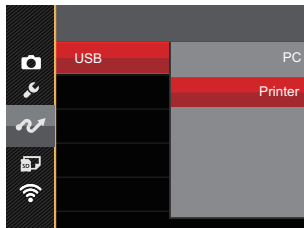
1. Press the  button, press the up/down arrow buttons to select  and press the  button to enter the menu.
2. Press the up/down arrow buttons to select  and press the  button or right arrow button to enter the menu.
3. Press the up/down arrow buttons to select [USB] and press the  button or right arrow button to enter the menu.
4. Press the up/down arrow buttons to select [Printer] and press the  button to confirm.



-  After the camera is reset, it will switch to PC mode automatically from USB Mode.
-  See “Using the PICTBRIDGE™ Menu” section on page 94.

Connecting to your Printer

1. Make sure both the camera and printer are turned on.
2. Connect one end of the supplied USB cable to the USB port on your camera.
3. Connect the other end of the cable to the USB port on the printer.

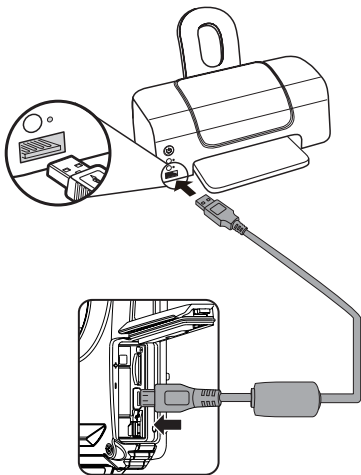

If the camera is not connected to a PICTBRIDGE™ compatible printer, the following error message will appear on the LCD.

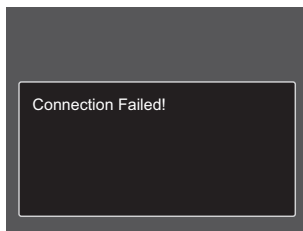

-  The error message above will also appear if the USB Mode is set incorrectly, in which case you should disconnect the USB cable, check the USB Mode settings, ensure that the printer is turned on, and then try connecting the USB cable again.

Using the PICTBRIDGE™ Menu

After setting the USB mode to Printer, the PICTBRIDGE™ menu will appear.

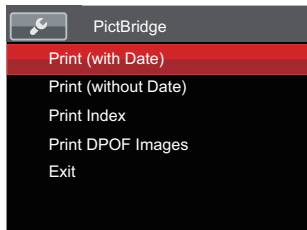

Press the up/down arrow buttons to select a menu item and press the **SET** button or right arrow button to enter the item.

Refer to the following sections for more detailed information on each setting.

Print (with Date)

If you have set the date and time on your camera, the date and time will be recorded and saved with each photo you take.

1. In the PICTBRIDGE™ menu, select [Print (with Date)] and the screen as shown below appears.

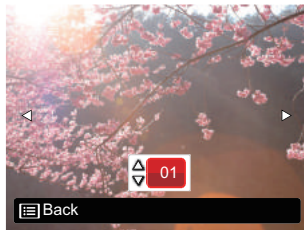

2. Press the left/right arrow buttons to select a photo to be printed.

3. Press the up/down arrow buttons to select the number of copies for the currently displayed photo.
4. Press the **SET** button and the following screen will appear.

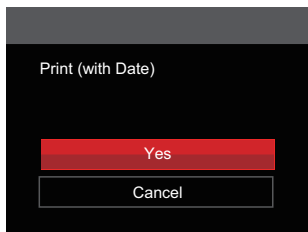

5. Select [Yes] and press the **SET** button to confirm; select [Cancel] to cancel printing.

Print (without Date)

Use this setting to print the photos without dates on them.

1. In the PICTBRIDGE™ menu, select [Print (without Date)] and the screen as shown below appears.

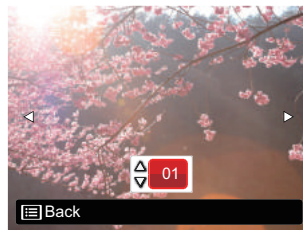

2. Press the left/right arrow button to select the photo to be printed.
3. Press the up/down arrow buttons to select the number of copies for the currently displayed photo.
4. Press the **SET** button and the following screen will appear.

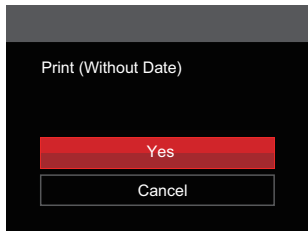

5. Select [Yes] and press the **(SET)** button to confirm; select [Cancel] to cancel printing.

Print Index

You can print all photos in the camera via this function.

1. In the PICTBRIDGE™ menu, select [Print Index] and the screen as shown below appears.

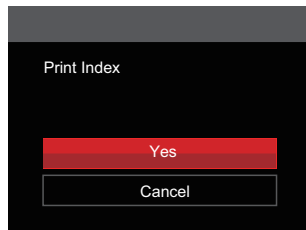

2. Select [Yes] and press the **(SET)** button to confirm; select [Cancel] to cancel printing.

Print DPOF Images

To use DPOF printing, you must select your photos for printing using the DPOF settings before hand. See “**DPOF**” section on page 82.

1. In the PICTBRIDGE™ menu, select [Print DPOF Images] and the screen as shown below appears.

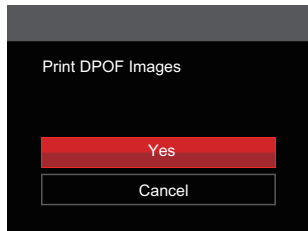

2. Select [Yes] and press the **SET** button to confirm; select [Cancel] to cancel printing.

Exit

Select [Exit] to exit the PICTBRIDGE™ menu. At this time, the message [Remove USB Cable!] will appear on the screen.

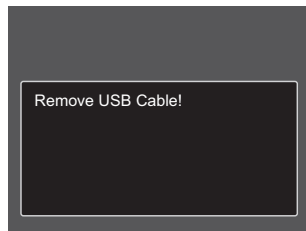

Disconnect the USB cable from the camera and printer.

APPENDICES

Specifications



Design and specifications are subject to change without notice.

Image Sensor	Type	1/2.3" BSI CMOS
	Effective Pixels	16.35 Megapixels
	Total Pixels	16.76 Megapixels
Lens	Focal Length	4.9mm (Wide) — 19.6mm (Tele)
	35mm Film Equivalent	27mm (Wide) — 108mm (Tele)
	F Number	F3.0 (Wide) — F6.6 (Tele)
	Lens Construction	7 groups 7 elements
	Optical Zoom	4x
	Focusing Range	Normal: (Wide) 60cm ~ ∞ (Tele) 100cm ~ ∞ Macro: 5cm ~ ∞ (Wide Only)
Autofocus System		TTL Autofocus
Anti-Handshake		Digital Image Stabilization
Digital Zoom		6x Digital Zoom (Combined Zoom: 24x)

Number of Recording Pixels	Still Image	(4:3) 16MP: 4608 × 3456 10MP: 3648 × 2736 5MP: 2592 × 1944 3MP: 2048 × 1536 0.3MP: 640 × 480	(3:2) 14MP: 4608 × 3072	(16:9) 12MP: 4608 × 2592 2MP: 1920 × 1080
	Movie	1920 × 1080 (30fps), 1280 × 720 (60/30fps), 640 × 480 (30fps), High-Speed Movie: 640 × 480 (120fps)		
Image Compression		Best, Fine, Normal		
DCF, DPOF (Ver1.1) Support		Yes		
File Format	Still Image	Exif 2.3 (JPEG)		
	Movie	MOV [Image: H.264; Audio: Linear PCM (Monaural)]		
Shooting Modes		Auto Mode, Program AE, Manual Mode, Movie Mode, Scene Mode, Underwater Mode, Wi-Fi® Mode		
Scene Mode		Portrait, Landscape, Sport, Beach, Sunset, Fireworks, Night Landscape, Snow, Children, Panorama Mode, Glass, Anti-Shake, Panning Shot, Night Portrait, Party, Indoor, Leaf, Museum		
Detection Features		Face, Smile, Blink		
Waterproof		Up to 15m		
Shockproof		Up to 2m		
Dustproof		Equivalent to JIS/IEC (IP6X)		

Red-Eye Removal	Yes
HDR	Yes (Post-Processing)
Panorama	Up to 360°
LCD Display	2.7 inch (230k Pixels)
ISO Sensitivity	Auto, ISO100/200/400/800/1600/3200
AF Method	Single AF, Multi-AF (TTL 25-point), Face-Detection
Exposure Metering Method	Artificial Intelligence AE (AiAE), Center-Weighted Average, Spot (Fixed to Center of Frame), Face AE
Exposure Control Method	Program AE (AE-Lock Available)
Exposure Compensation	±3 EV in 1/3 Step Increments
Shutter Speed	1/2000 ~ 4 Seconds (Manual: 30 Seconds)
Burst Mode	Up to 6 fps at Full Resolution
Playback Modes	Single, Index (9/16 Thumbnails), Slide Show, Date, Burst Shooting
	Zoom (Approx. x2 ~ x8)
White Balance Control	Auto (AWB), Daylight, Cloudy, Fluorescent, Fluorescent CWF, Incandescent, Manual WB, Color Temp.(1900k-10000k), Underwater

Flash	Flash Method	Internal
	Flash Modes	Flash Off, Flash Auto, Fill Flash, Slow Synchro, Slow Synchro + Red-Eye Reduction, Red-Eye Reduction
Recording Media		Internal Memory: Approx. 8MB
		microSD/microSDHC Card (Up to 32GB Support) [MMC Card not supported]
Multi-Language Support		26 Languages
Jacks		USB 2.0 (Micro 5 pin USB)
Wi-Fi®		Yes (802.11 b/g/n)
Remote Control		Yes (via smart device)
Power		Rechargeable Li-ion Battery LB-015, 3.7V 700mAh, In-Camera Charging
Shooting Capability (Battery Performance)		Approx. 200 Shots (Based on CIPA Standards) Approx. 70 Min for Video (@1080p/30fps)
Operation Environment		Temperature: 0 ~ 40°C, Humidity: 0 ~ 90%
Dimensions (W×H×D)		Approx. 95 × 63 × 25 mm (Based on CIPA Standards)
Weight		Approx. 176g (Body Only)

Prompts and Warning Messages

Message	Description	Action
Warning! Battery exhausted.	The camera battery is depleted. It is a warning indicating that the camera is going to shut off.	Charge battery or replace with a charged battery. The camera will shut down in 2 seconds.
Lens obstruction, Re-start Camera.	The lens is jammed or some foreign object is preventing the lens from functioning properly.	Turn the camera off and restart it to reset the lens.
Suggest using tripod.	When continuous exposure is enabled, this prompt message is displayed when the photo shooting screen is displayed for the first time.	The message will disappear after 2 seconds.
Built-in memory error!	An error has occurred in the internal memory.	Try shutting off the camera and turning it on again. This message will disappear after 2 seconds.
Improper alignment. Please try again.	The offset is too big for panorama shooting.	Keep the camera steady while shooting to maintain alignment.

Message	Description	Action
Warning! Do not turn off your camera during update!	The message appears during the firmware update process.	The message disappears after the camera update and restart.
Connection Failed!	Failure to connect to your PC, printer, TV.	Remove USB cable, reinsert cable, and retry connection.
Please update firmware after the battery is fully charged!	The firmware cannot be updated when power is insufficient.	Charge the battery fully before reattempting to update firmware.
Card Full !	Indicates that the memory card is full.	Replace memory card with another that has available memory or delete photos or videos to create more room on the card. This message will disappear after 2 seconds.
Memory Full !	Indicates that the camera memory is full.	Erase files or insert a memory card that has available memory. It will disappear after 2 seconds.

Message	Description	Action
Card Error !	During power-on, the memory card cannot be recognized or a read/write error has occurred.	Format the memory card. WARNING: Formatting the memory card will erase all data on the card. Copy the data from the memory card to another storage, such as a computer. Otherwise, all data will be erased during formatting. This message will disappear after 2 seconds.
Card is not formatted.	When an error occurs in the memory card, the message "Not Formatted" will appear.	Format the memory card. WARNING: Formatting the memory card will erase all data on the card. Copy the data from the memory card to another storage, such as a computer. Otherwise, all data will be erased after the format.
Slow access	When a memory card lower than Class 4 is used to record a HD movie, the writing speed will be slower and recording will not continue.	Replace the memory card with a card that is Class 4 or higher. This message will disappear after 2 seconds.
Cannot write to SD card.	The photo shooting or video recording has been interrupted, so recording cannot continue.	Turn the camera off. Then remove and reinsert the memory card and turn on the camera to restart.
No Red-Eye Detected!	Red eyes have not been detected in the image.	The message will disappear after 2 seconds.

Message	Description	Action
This image cannot be edited.	The file format does not support editing or the edited file cannot be edited again.	The message will disappear after 2 seconds.
Exceeded maximum folder number.	This indicates that the memory card exceeded the maximum number of folders (999). This could cause a long read time during the camera's power up.	Copy the data to your PC and format the memory card using the camera.
Too many pictures for fast processing.	During the playback by date, the images exceed specifications so that it is not possible to play by date.	The message disappears after 2 seconds and the camera returns to normal playback mode.
Unable to recognize files.	The format of the file to be viewed is not supported or the file is corrupted so it cannot be properly read.	The message disappears only after the file is deleted.
No Picture!	When you press the play button, no image files exist in the camera or on memory card.	The message disappears after 2 seconds and returns to the photo shooting screen.
Protected! Undeletable!	The file is protected. The message appears when you go into delete mode.	If you want to delete a protected file, first unlock the selected photo or video (see page 80). This message will disappear after 2 seconds.

Troubleshooting

Problem	Possible causes	Solution
Camera does not turn on	<ul style="list-style-type: none">■ The battery has been depleted.■ The battery is not inserted correctly.	<ul style="list-style-type: none">■ Replace the battery.■ Correctly reinstall the battery.
Camera turns off suddenly during operation	<ul style="list-style-type: none">■ The battery has been depleted.	<ul style="list-style-type: none">■ Replace the battery.■ Charge the battery.■ Make sure the camera is actually shutting off and not entering Power Save Mode, where the LCD will turn off after the camera has been idle for a period of time.
The picture is blurred	<ul style="list-style-type: none">■ Camera movement while taking a picture.	<ul style="list-style-type: none">■ Turn on Anti-Shake mode.
Images and video files cannot be saved	<ul style="list-style-type: none">■ The memory card is full.	<ul style="list-style-type: none">■ Use another memory card or delete unnecessary files.

Problem	Possible Causes	Solution
Images will not print from the connected printer	<ul style="list-style-type: none"> ■ The camera is not connected to the printer correctly. ■ The printer is not PICTBRIDGE™ compatible. ■ The printer is out of paper or ink. ■ The printer paper is jammed. 	<ul style="list-style-type: none"> ■ Check the connection between the camera and printer. ■ Use a PICTBRIDGE™ compatible printer. ■ Load paper into the printer or replace the ink cartridge in the printer. ■ Remove the jammed paper.
Saving data to memory card is slow	<ul style="list-style-type: none"> ■ Using a memory card below Class 4 may result in slower recording times. 	<ul style="list-style-type: none"> ■ Use a memory card with Class 4 or higher to improve performance.
Too many movies to process	<ul style="list-style-type: none"> ■ The number of pictures or folders in the memory card exceed the specifications, so the playback can not be displayed. 	<ul style="list-style-type: none"> ■ Delete unwanted files.
The flash  flashes on the LCD screen.	<ul style="list-style-type: none"> ■ Current shooting environment requires flash. 	<ul style="list-style-type: none"> ■ Turn on flash.



If you choose to change the factory assigned, random Wi-Fi® password on your WPZ2 camera, please be sure to update and enter the new randomly assigned password on your smart device. Some smart devices will automatically remember and save any previously entered Wi-Fi® password. Be sure to clear the old password on your smart device manually before attempting to connect the WPZ2's Wi-Fi® to your device. (Depending upon your smart device make and model, operation may vary, so please refer to your smart device user manual and instructions.

iOS™ Example

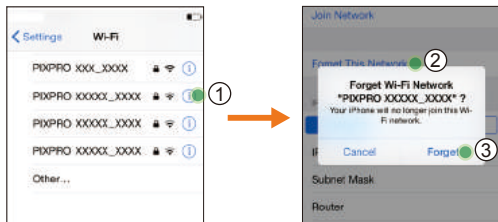

Android™ Example

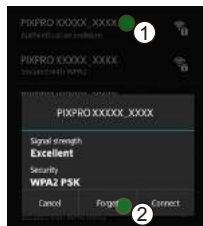

MicroSD Memory Card Compatibility

This camera does not take standard SD cards and uses MicroSD Cards. Refer to the chart below for compatible types of MicroSD cards (√: Compatible X: Not Compatible)

	micro SD	micro SDHC	micro SDXC	Conversion adapter to SD card	SD	SDHC	SDXC
Format	FAT12, 16	FAT32	exFAT	-	FAT12, 16	FAT32	exFAT
Capacity	Up to 2GB	4-32GB	64GB-2TB	-	Up to 2GB	4-32GB	64GB-2TB
Compatibility	√	√	X	X	X	X	X

It indicates that the writing speed class will be displayed on the memory card.

Use a memory card with the appropriate writing speed for the video recording mode to be recorded.
(O: Recommended X: Not recommended)

	Speed Class	UHS Speed Class	Video Speed Class	Video Recording			
				4K	FHD	HD	VGA
90MB/sec			V90	O	O	O	O
60MB/sec		UHS-III	V60	O	O	O	O
30MB/sec		UHS-I	V30	O	O	O	O
10MB/sec	Class 10		V10	O	O	O	O
6MB/sec	Class 6		V6	X	O	O	O
4MB/sec	Class 4			X	X	X	O
2MB/sec	Class 2			X	X	X	O

© 2020 JK Imaging Ltd. All Rights Reserved.

The Kodak trademark, logo and trade dress are used under license from Eastman Kodak Company.

All other logos, products or company names that are referred to in this document are trade names, trademarks or registered trademarks of their holders. The holders are not affiliated with JK Imaging Ltd., our products or our website.

JK Imaging Ltd., 17239 So. Main Street, Gardena, CA 90248 USA

kodakpixpro.com

Made in Myanmar (Burma)

