

acer



Acer Chromebook Spin 714

Acer Chromebook Enterprise Spin 714

USER'S MANUAL

© 2022. All Rights Reserved.

Acer Chromebook Spin 714 / Acer Chromebook Enterprise Spin 714

Covers: CP714-1WN

This revision: April 2022



Important

This manual contains proprietary information that is protected by copyright laws. The information contained in this manual is subject to change without notice. Images provided herein are for reference only and may contain information or features that do not apply to your computer. Acer Group shall not be liable for technical or editorial errors or omissions contained in this manual.

Register your Acer product

Go to www.acer.com/register-product, and sign in or sign up your Acer ID to register your product.

Once it is done, you can review it under “My Products” page.

Model number: _____

Serial number: _____

Date of purchase: _____

Place of purchase: _____

Google and Google Play are trademarks of Google LLC.



The terms HDMI and HDMI High-Definition Multimedia Interface, and the HDMI Logo are trademarks or registered trademarks of HDMI Licensing Administrator, Inc. in the United States and other countries.

TABLE OF CONTENTS

Getting started	4	Rechargeable Active Stylus	12
Turn on your Chromebook.....	4	Remove or insert the stylus	12
Select your language settings	4	Usage Modes	13
Connect to a network.....	4	Frequently asked questions	14
Accept the Terms of Service.....	4	Get help or more information	15
First-time sign-in	4	Information for your safety and comfort	16
Create a new Google Account	4	Basic care and tips for using your	
Browse as a guest	4	computer	16
Your Acer Chromebook tour	5	Turning your computer on and off.....	16
Front view	5	Taking care of your computer	16
Keyboard view	6	Taking care of your AC adapter	17
Function keys	7	Cleaning and servicing.....	17
Common keyboard shortcuts	7	Guidelines for safe battery usage	18
Touchpad	8	Internal battery	20
Left view	9	Finding your comfort zone	21
Right view	10	Taking care of your vision	21
USB 3.2 Gen 2 information	10		
USB Type-C information	10		
Bottom view	11		

GETTING STARTED

Turn on your Chromebook

On the Chromebook, press the power button. A "Welcome" screen will appear when the Chromebook first boots up.

Select your language settings

Use the "Language" drop-down list to choose your default language setting. If there is more than one way to type in your language, you may be prompted to select a keyboard input method as well.

Connect to a network

Select a network from the "Connect to network" list to connect to the Internet. If network access is protected, you will need an access password to connect to it.

Accept the Terms of Service

Once connected to a network, accept the Terms of Service. Your Chromebook will then download any available system updates, so you automatically get the latest Chrome OS features.

First-time sign-in

Create a new Google Account

You can create a new Google Account if you don't already have one. Select **Create a Google Account** to set up a new account. A Google Account gives you access to useful web services developed by Google, such as Gmail, Google Drive, and Google Calendar.

Browse as a guest

You can also use the Chromebook without a Google Account by selecting **Browse as a Guest**.

YOUR ACER CHROMEBOOK TOUR

Front view

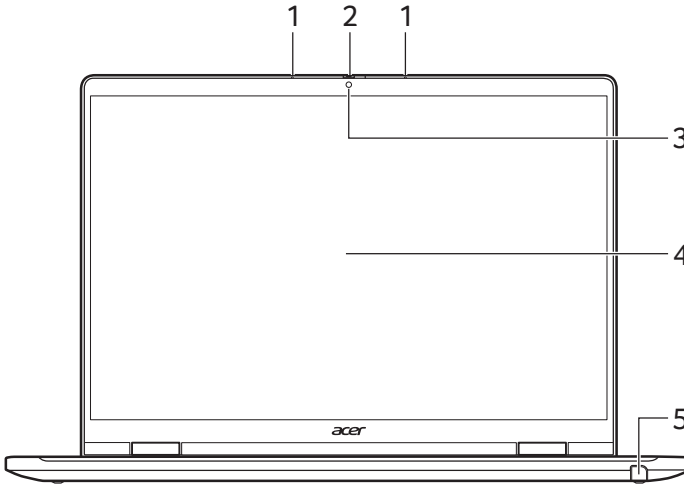

#	Icon	Item	Description
1		Microphones	Internal microphones for sound recording.
2		Webcam shutter	Slide the shutter to the left to cover the webcam. Slide right to open it.
3		Webcam	Web camera for video communication. <i>A light next to the webcam indicates that the webcam is active.</i>
4		Touchscreen	Displays Chromebook output, supports multi-touch input.
5		Stylus	Remove the pen from the slot and perform touch actions on the screen.



Note

This monitor uses low blue light panel. When the monitor is in default setting (Preset mode: Standard), it works in compliance with TÜV Rheinland. The Low Blue Light feature on the display is designed to minimize blue light emitted from the display for better eye comfort.



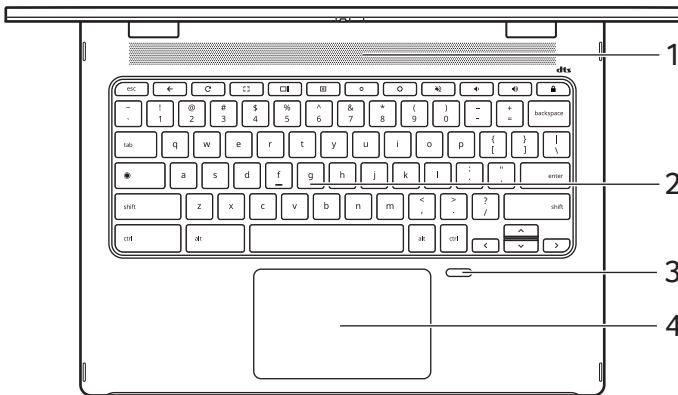







Keyboard view



#	Icon	Item	Description
1		Speakers	Deliver stereo audio output.
2		Keyboard	For entering data into your Chromebook.
3		Fingerprint reader (optional)	Fingerprint reader for unlocking your Chromebook.
4		Touchpad / click button	<p>Touch-sensitive pointing device which functions like a Chromebook mouse.</p> <p><i>Pressing down anywhere on the pad functions like the left button of a mouse.</i></p> <p><i>Pressing down anywhere with two fingers functions like the right button of a mouse.</i></p>



Function keys

The Chromebook uses function keys or key combinations to access some hardware and software controls, such as screen brightness and volume. The dedicated function keys each have a specific function.

Icon	Function	Description
	Previous	Go to the previous page.
	Reload	Reload the current page.
	Full-screen	Open the page in full-screen mode.
	Next window	Switch to the next window.
	Screenshot	Takes screenshot.
	Brightness down	Decreases the screen brightness.
	Brightness up	Increases the screen brightness.
	Mute	Turns off audio output.
	Volume down	Decreases the volume.
	Volume up	Increases the volume.
	Launcher	Launch the Apps panel.

Common keyboard shortcuts

You can use shortcuts to complete some tasks more quickly.

Keyboard shortcuts	Description
Ctrl + 	Takes screenshot.
Alt + 	Toggles caps lock.
Alt + 	Projects your screen.

Note: For a complete list of keyboard shortcuts, press **Ctrl + Alt + /**





Touchpad

The built-in touchpad is a pointing device that senses movement on its surface. This means the cursor responds as you move your fingers across the surface of the touchpad.

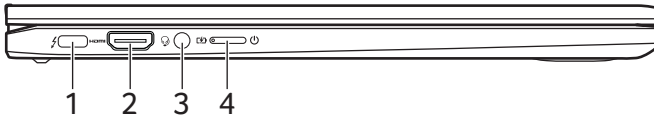
Action	Gesture
Click	Press down on any part of the touchpad.
Two-finger tap (or alt-click)	Tapping the touchpad with two fingers or pressing (and holding) Alt on the keyboard and tapping the touchpad with one finger both equal a "right-click" on a Chromebook mouse.
Two-finger swipe	Place two fingers on the touchpad and move them up and down to scroll vertically, left and right to scroll horizontally.
Drag and drop	Select the item you want to move with one finger. With a second finger, move the item. Release both fingers to drop the item. (This gesture works for files, not windows or icons.)



Left view



#	Icon	Item	Description
1		USB Type-C port with DC-in/Thunderbolt™ 4 port	Connects to the provided USB Type-C power adapter and to USB devices with a USB Type-C connector. Supports Thunderbolt™ 4 and displays.
2		HDMI port	Supports high-definition digital video connections.
3		Headset/speaker jack	Connects to audio devices (e.g., speakers, headphones), or a headset with microphone.
		Power button	Turns the Chromebook on and off.
4		Battery indicator	Indicates the Chromebook's battery status. Charging: The light shows amber when the battery is charging. Fully charged: The light shows blue when in AC mode.

Right view



#	Icon	Item	Description
1	+ / -	Volume control key	Adjusts the system volume.
2		USB port	Connects to USB devices.
3		USB Type-C port with DC-in/Thunderbolt™ 4 port	Connects to the provided USB Type-C power adapter and to USB devices with a USB Type-C connector. Supports Thunderbolt™ 4 and displays.

USB 3.2 Gen 2 information

- USB 3.2 Gen 2 compatible ports are blue.
- Compatible with USB 3.2 Gen 2 and earlier devices.
- For optimal performance, use USB 3.2 Gen 2-certified devices.
- Defined by the USB 3.2 Gen 2 specification (SuperSpeed USB).

USB Type-C information

- Supports DisplayPort™ audio/video output.
- Compatible with Thunderbolt™ 4.
- Delivers up to 3 A at 5 V DC for USB charging.
- DC-in: requires power adapter or power source providing 65 W at 5~20 V.
For optimal performance, please use a certified Acer power adapter or USB Power Delivery device.

Bottom view

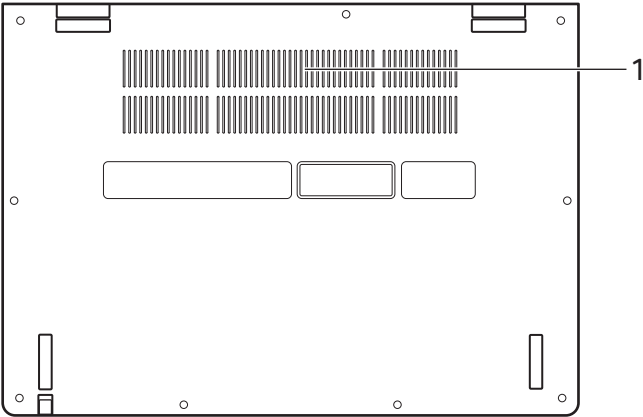

#	Icon	Item	Description
1		Ventilation and cooling fan	Allows the Chromebook to stay cool. <i>Do not cover or obstruct the openings.</i>

RECHARGEABLE ACTIVE STYLUS

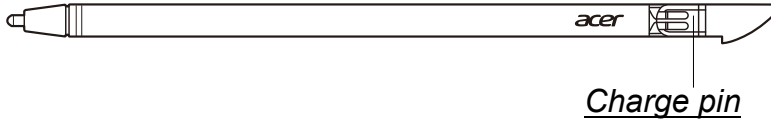

Charge pin

Insert the stylus into the slot completely to start charging.
15 minutes charging: provide 4 hours of usage.

- If you feel that the function is unstable, please insert the stylus into the slot to charge it.
- The pen will enter power-saving mode.
Idle: After 2 minutes, move the tip over the touchscreen to wake the pen.



Note

Function may differ depending on apps

Remove or insert the stylus

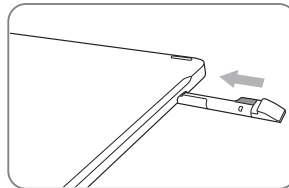
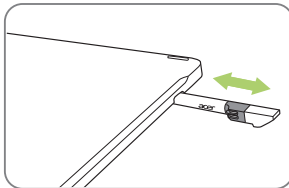

USAGE MODES

Your Chromebook features the following modes. You can choose a mode to fit your needs.

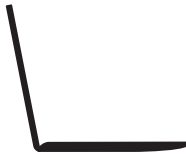

Laptop



Display





Tent



Tablet

FREQUENTLY ASKED QUESTIONS

Question	Answer
What software works on a Chromebook?	Chromebooks use apps from the Google Play Store and on the web. There are apps to be productive, get creative, enjoy movies and shows, play games and more.
How do I get more apps?	You can get more apps from the Google Play Store  or the web.
Can I use Microsoft Office software?	Chromebooks work with Microsoft [®] Office. Whether it's Word, Excel [®] or PowerPoint [®] , you can easily find the apps on the web.
Where can I find my files?	All your files are stored in the Files app  . Find the app by clicking the Launcher icon  and searching "Files".
How do I transfer my local files?	Transfer your local files using a compatible storage device. Your Chromebook works with most external storage devices (e.g.: USB thumb drives, removable hard drives). You can also upload your files, photos, and videos to Google Drive. After setting up your Chromebook with your Google Account, you'll be able to access your files on Drive.
Why does my Chromebook need my Google Account information?	You'll use your Google Account to sign in to your Chromebook. It is the same account you use for Google services such as Gmail and Drive. Your Chromebook uses your account information to automatically sign you into apps and services.

Question	Answer
How do I set this up for my child?	If you want to set up parental controls for your child, it's important that you sign in using your child's personal Google Account. If they don't already have one, you can create one during the sign-in process on your Chromebook. You will be able to add your child's school account after you complete device onboarding.

Get help or more information

For information on:	Refer to:
Chromebook Help	Open the Explore app  on your Chromebook.
Chrome OS	google.com/support/chromebook/

INFORMATION FOR YOUR SAFETY AND COMFORT

Basic care and tips for using your computer

Turning your computer on and off

To turn on the computer, simply press and release the power button. Please refer to the setup poster for the location of the power button.



Note

If you cannot power off the computer normally, press and hold the power button for up to ten seconds to shut down the computer. If you turn off the computer and want to turn it on again, wait at least two seconds before powering up.

Taking care of your computer

Your computer will serve you well if you take care of it.

- Only use the adapter provided with your device, or an Acer-approved adapter to power your device.
- Do not expose the computer to direct sunlight. Do not place it near sources of heat, such as a radiator.
- Do not expose the computer to temperatures below 0° C (32° F) or above 50° C (122° F).
- Do not subject the computer to magnetic fields.
- Do not expose the computer to rain or moisture.
- Do not spill water or any liquid on the computer.
- Do not subject the computer to heavy shock or vibration.
- Do not expose the computer to dust or dirt.
- Never place objects on top of the computer.
- Do not slam the computer display when you close it.
- Never place the computer on uneven surfaces.

Taking care of your AC adapter

Here are some ways to take care of your AC adapter:

- Do not connect the adapter to any other device.
- Do not step on the power cord or place heavy objects on top of it. Route the power cord and any cables away from where people walk.
- When unplugging the power cord, do not pull on the cord itself but pull on the plug.
- The total ampere ratings of the equipment plugged in should not exceed the ampere rating of the cord if you are using an extension cord. Also, the total current rating of all equipment plugged into a single wall outlet should not exceed the fuse rating.

Cleaning and servicing

When cleaning the computer, follow these steps:

1. Turn off the computer.
2. Disconnect the AC adapter.
3. Use a soft, moist cloth. Do not use liquid or aerosol cleaners.

If your computer is dropped or visibly damaged, or does not work normally, please contact your nearest authorized Acer service center.

Guidelines for safe battery usage



Warning

When using a charging cart or a small space to simultaneously charge or operate multiple devices, the area must be well-ventilated and the temperature kept between 0 °C (32 °F) to 35 °C (95 °F) and battery charging must be stopped when 100% capacity is reached. Continuous charging can cause deformation or damage to the battery/device.

Precautions when charging batteries

The useful lifespan of a battery is adversely affected by the following behavior:

- Constantly charging the battery/device when already at full capacity.
- Charging the battery/device at temperatures above 35 °C (95 °F) or below 0 °C (32 °F).

To prevent damage, follow these precautions:

- Stop charging the battery once it reaches 100% capacity; regularly or frequently charging a fully charged battery for an extended period of time may cause battery deformation or damage. We recommend that you recharge the device when the battery level drops below 70% capacity.
- Do not charge battery in temperatures above 35 °C (95 °F) or below 0 °C (32 °F). Charging in abnormally high or abnormally low temperatures can cause battery deformation or damage.
- The charging port must be clean and free from debris and should only be used with Acer charging equipment. Use of a non-Acer battery or charging equipment can cause damage to the product and will void the warranty.
- If you plan to store the device for a long period of time, turn-off the device, remove AC power and store the product at room temperature (0 °C - 35 °C) in a dry (humidity: 45% - 80%), well-ventilated area. Avoid direct sunlight, high temperatures and high humidity. Do not leave your device's battery completely discharged for a long period of time; this may cause battery deformation or damage. We recommend that the battery is checked and charged to approximately 50% capacity every 6 months.

- ONLY CHARGE THE BATTERY IN A CLEAN, WELL VENTILATED AREA.



Warning

Batteries may explode if not handled properly.

Do not disassemble or dispose of batteries in fire.

Do not short external contacts, crush, puncture or otherwise tamper with batteries. Keep batteries away from children.

Follow local regulations when disposing of used batteries.

Precautions when replacing the battery

Improper replacement or mishandling could damage the battery, cause overheating, result in injury, and risk fire or explosion.

- Device with built-in battery: A built-in battery must be replaced by an authorized service center. Do not attempt to replace or remove the battery by yourself.
- Device with removable battery: The battery should only be replaced with parts approved by Acer. Do not replace the battery with any parts other than approved ones.

This notebook uses a Lithium-based battery. Do not use it in a humid, wet or corrosive environment. Do not put, store or leave your product in or near a heat source, in a high temperature location, in strong direct sunlight, in a microwave oven or in a pressurized container, and do not expose it to temperatures over 50 °C (122 °F).

Failure to follow these guidelines may cause the battery to leak acid, become hot, explode or ignite and cause injury and/or damage. Do not pierce, open or disassemble the battery. If the battery leaks and you come into contact with the leaked fluids, rinse thoroughly with water and seek medical attention immediately. For safety reasons, and to prolong the lifetime of the battery, charging will must not occur at temperatures below 0 °C (32 °F) or above 35 °C (95 °F).

The full performance of a new battery is achieved only after two or three complete charge and discharge cycles. The battery can be charged and discharged hundreds of times, but it will eventually wear out. When the operation time becomes noticeably shorter than normal, check an authorized reseller to purchase a new battery.

Use the battery only for its intended purpose. Never use any charger or battery that is damaged. Do not short-circuit the battery. Accidental short-circuiting can occur when a metallic object such as a coin, clip or pen causes direct connection of the positive (+) and negative (-) terminals of the battery. (These look like metal strips on the battery.) This might happen, for example, when you carry a spare battery in your pocket or purse. Short-circuiting the terminals may damage the battery or the connecting object.

The capacity and lifetime of the battery will be reduced if the battery is left in hot or cold places, such as in a closed car in summer or winter. Always try to keep the battery between 15° C and 25° C (59° F and 77° F). A device with a hot or cold battery may not work temporarily, even when the battery is fully charged. Battery performance is especially limited in temperatures well below freezing.

Do not dispose of batteries in a fire as they may explode. Batteries may also explode if damaged. Dispose of batteries according to local regulations. Please recycle when possible. Do not dispose as household waste.

Wireless devices may be susceptible to interference from the battery, which could affect performance.



Note

Please refer to www.acer.com for battery shipping documents.

Internal battery

- Do not attempt to replace a built-in rechargeable battery, battery replacement must be done by an Acer- authorized repair facility.
- Recharge the battery by following the instruction included in the product documentation.

Taking care of your vision

Long viewing hours, wearing incorrect glasses or contact lenses, glare, excessive room lighting, poorly focused screens, very small typefaces and low-contrast displays could stress your eyes. The following sections provide suggestions on how to reduce eyestrain.

Eyes

- Rest your eyes every 5-10 minutes for every 1 hour of viewing.
- Give your eyes regular breaks by looking away from the monitor and focusing on a distant point.
- Blink frequently to keep your eyes from drying out.

Display

- Keep your display clean.
- Keep your head at a higher level than the top edge of the display so your eyes point downward when looking at the middle of the display.
- Adjust the display brightness and/or contrast to a comfortable level for enhanced text readability and graphics clarity.
- Eliminate glare and reflections by:
 - placing your display in such a way that the side faces the window or any light source
 - minimizing room light by using drapes, shades or blinds
 - using a task light
 - changing the display's viewing angle
 - using a glare-reduction filter
 - using a display visor, such as a piece of cardboard extended from the display's top front edge
- Avoid adjusting your display to an awkward viewing angle.
- Avoid looking at bright light sources for extended periods of time.