

**Adjustable TV Wall Mount up to 55 in and 66 lb - VESA Compatible**

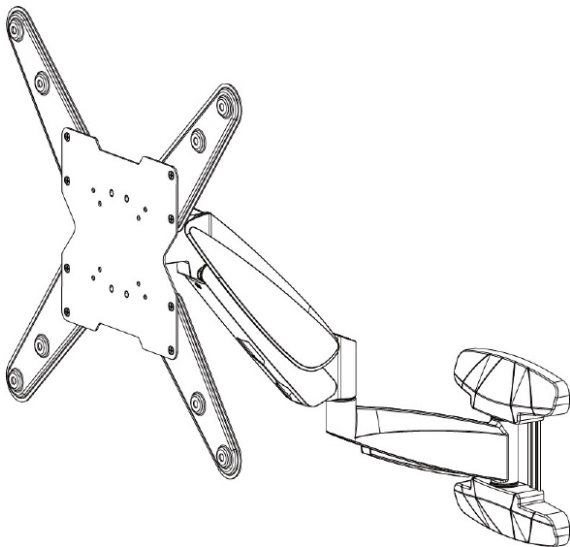

*\*Actual product may vary from photos*

**User Manual**  
**SKU: FHA-TV-WALL-MOUNT**

## Compliance Statements

### **Use of Trademarks, Registered Trademarks, and other Protected Names and Symbols**

This manual may make reference to trademarks, registered trademarks, and other protected names and/or symbols of third-party companies not related in any way to StarTech.com. Where they occur these references are for illustrative purposes only and do not represent an endorsement of a product or service by StarTech.com, or an endorsement of the product(s) to which this manual applies by the third-party company in question. Regardless of any direct acknowledgement elsewhere in the body of this document, StarTech.com hereby acknowledges that all trademarks, registered trademarks, service marks, and other protected names and/or symbols contained in this manual and related documents are the property of their respective holders.

PHILLIPS® is a registered trademark of Phillips Screw Company in the United States or other countries.

# Safety Statements

## Safety Measures

- Product installation and/or mounting should be completed by a certified professional as per the local safety and building code guidelines.

## Mesures de sécurité

- L'installation et/ou le montage du produit doit être réalisé par un professionnel certifié et dans le respect des normes locales et du code de construction local.

## 安全対策

- 製品の設置やマウントは、使用地域の安全ガイドラインおよび建築基準に従い、有資格の専門業者が行うようにしてください。

## Misure di sicurezza

- L'installazione e/o il montaggio dei prodotti devono essere eseguiti da un tecnico professionale certificato che conosca le linee guida locali sulle norme edilizie e sulla sicurezza.

## Säkerhetsåtgärder

- Installation och/eller montering får endast göras av behöriga yrkespersoner och enligt gällande lokala förordningar för säkerhet och byggnormer.

## Warning Statements

- Assemble this product according to the instructions.
- Read the entire manual and ensure the instructions are fully understood before assembling and/or using this product.
- Do not exceed the weight capacity of this product. Overloading this product might result in injury or property damage.
- Weight capacity of the mount: 17.6 to 66 lb. (8 to 30 kg).
- Do not allow children to climb on this product, or use this product without proper supervision.
- This product is intended for indoor use only and should not be used outdoors.
- Do not over-tighten the screws. If any resistance is encountered, stop tightening.
- Assembling this product is a two-person task. Do not attempt to assemble this product and install equipment without assistance.
- Before adding equipment to this product, ensure the product has been properly assembled, and that the product can support the weight of the added equipment.
- Make sure all of the equipment has been properly secured before adjusting this product.
- Stored Energy Hazard! This product contains a spring mechanism which can cause the assembly and/or mounted equipment to move forcibly, and quickly, upwards. Always exercise caution when handling, or in close proximity to, the spring arm(s). Do not remove the mounted equipment unless the spring arm is moved to the highest position or (if possible) the spring force is adequately lowered to remove any danger posed. Failure to do so may result in property damage and/or serious personal injury.
- Pinch hazard! Keep your fingers clear from moving components.

## Varningsmeddelanden

- Se till att du monterar produkten i enlighet med instruktionerna.
- Läs hela manualen och se till att du förstår instruktionerna innan du börjar montera och använda produkten.
- Överskrid inte produktens viktkapacitet. Överbelastning av produkten kan orsaka skada på person eller egendom.
- Fästets viktkapacitet: 8 till 30 kg (17.6 till 66 lb.).
- Låt inte barn klättra på produkten eller använda produkten utan uppsikt.
- Produkten är endast avsedd för användning inomhus och ska inte användas utomhus.

- Dra inte åt skruvarna för hårt när du monterar produkten. Om du måste ta i när du skruvar åt kan du sluta skruva åt.
- Det krävs Monitorå personer för att montera produkten. Försök inte montera produkten och installera utrustning utan hjälp.
- Innan du lägger till utrustning på produkten, se till att produkten är korrekt monterad, installerad och att produkten klarar av vikten på utrustningen som du lägger till.
- Se till att all utrustning är korrekt installerad innan du börjar justera produkten.
- Innan du börjar flytta på vagnen, se till att hjulen är upplåsta.
- Risk för lagrad energi! Denna produkt innehåller en fjädermekanism som kan leda till att monteringskomponenterna och/eller displayen rör sig kraftigt och snabbt uppåt när den aktiveras. Följ de medföljande instruktionerna och var alltid försiktig när du aktiverar handtaget. Använd inte handtaget före steg 4 i installationsförfarandet. När du justerar displayens höjd ska du alltid stödja eller hantera displayen med båda händerna (som på bilden) för att på ett säkert sätt kontrollera höjningen eller sänkningen av displayen. Underlåtenhet att göra detta kan leda till egendomsskador och/eller allvarliga personskador.
- Klämrisk! Håll fingrarna borta från rörliga komponenter.

## Waarschuwingen

- Zorg dat u dit product volgens de instructies in elkaar zet.
- Lees de gehele handleiding en zorg dat u de instructies begrijpt voordat u dit product in elkaar zet en gebruikt.
- Overschrijd de maximale capaciteit van dit product niet. Overbelasting van dit product kan letsel of materiële schade veroorzaken.
- Draagvermogen van de steun: 8 tot 30 kg (17.6 tot 66 lb.).
- Geef kinderen geen toestemming om op dit apparaat te klimmen of dit product zonder goed toezicht te gebruiken.
- Dit product is alleen bedoeld voor binnengebruik en mag niet buiten worden gebruikt.
- Draai de schroeven niet te strak vast wanneer u dit product in elkaar zet. Als u weerstand voelt tijdens het vastdraaien van de schroeven, stop dan.
- Dit product moet met twee personen in elkaar worden gezet. Probeer dit product niet zonder hulp in elkaar te zetten en apparatuur te installeren.
- Voordat u apparatuur aan dit product toevoegt, moet u ervoor zorgen dat u het op de juiste manier in elkaar hebt gezet en geïnstalleerd, en dat het product het gewicht van de toe te voegen apparatuur kan ondersteunen.
- Voordat u de wagen gaat verplaatsen, moet u de zwenkwielen ontgrendelen.

- Gevaar door opgeslagen energie! Dit product bevat een veermechanisme dat ertoe kan leiden dat de montageonderdelen en/of het display bij bediening met kracht en snel omhoog bewegen. Volg de bijgeleverde instructies en wees altijd voorzichtig bij het bedienen van de hendel. Bedien de hendel niet vóór stap 4 van de installatieprocedure. Wanneer u het scherm in hoogte verstelt, moet u het scherm altijd met beide handen ondersteunen of vastpakken (zoals afgebeeld) om het scherm veilig omhoog of omlaag te kunnen bewegen. Doet u dit niet, dan kan dit leiden tot materiële schade en/of ernstig persoonlijk letsel.
- Gevaar voor beknelling! Houd uw vingers weg van de bewegende onderdelen als u.

## 注意

- 必ず取扱説明書に従って本製品の組み立てを行って下さい。
- 最初に取扱説明書を最後まで読み、本製品の組み立て方をすべて理解してから組み立て作業を始めて下さい。
- 本製品で定められた最大積載重量を超えないようにして下さい。最大積載重量をオーバーした場合、怪我をする恐れや器物破損の恐れがあります。
- マウントの耐荷重: 8 から 30 kg (17.6 から 66 lb.).
- 本製品に小さなお子様が乗って遊ばないようにして下さい。お子様が使用する際には、適切な監視を怠らないようにして下さい。
- 本製品は、室内での使用を想定しています。戸外では使用しないで下さい。
- 本製品を組み立てる際、ネジを締めすぎないようにして下さい。ネジを締めているうちに手応えを感じたら、締めるのを止めてください。
- 本製品は、二人がかりでの組み立てを想定しています。手助けなしに単独で組み立てと設置を行わないで下さい。
- コードやケーブルの上、または凹凸のある床面でカートを移動させないで下さい。
- 反動注意! 本製品にはスプリング機構が搭載されており、作動させるとアセンブリ部品やディスプレイが反動で上方方向に大きく動く場合があります。付属の説明書に従い、ハンドルを操作する際には常に注意を払ってください。設置手順のステップ4より前にハンドルを操作しないでください。ディスプレイの高さを調整するときは、必ず両手でディスプレイを支え、ハンドルを握って安全にディスプレイの昇降をコントロールしてください(図参照)。誤った操作をすると、破損や怪我につながる可能性があります。
- 危険! 可動部品に近づかないでください。

## Dichiarazioni di avvertenza

- Assicurarsi di Assemblare il prodotto secondo le istruzioni.
- Leggere l'intero manuale e assicurarsi di aver compreso tutte le istruzioni prima di iniziare ad assemblare e a utilizzare questo prodotto.
- Non superare la capacità di carico del prodotto. Il sovraccarico del prodotto potrebbe causare danni o lesioni.
- Capacità di peso della montatura: 8 a 30 kg (17.6 a 66 lb.).
- Non consentire ai bambini di arrampicarsi sul prodotto o di utilizzarlo senza un'adeguata supervisione.
- Il prodotto è destinato all'uso in ambienti interni. Se ne sconsiglia l'impiego in ambienti esterni.
- Durante l'assemblaggio del prodotto, non stringere troppo le viti. Se si incontra resistenza mentre si stringono le viti, interrompere l'operazione.
- L'assemblaggio di questo prodotto richiede la presenza di due persone. Non tentare di assemblare il prodotto e installare le apparecchiature senza assistenza.
- Prima di aggiungere altre apparecchiature al prodotto, assicurarsi di averlo assemblato e installato correttamente e che sia in grado di sostenere il peso dell'apparecchiatura in questione.
- Prima di procedere allo spostamento del carrello, verificare di aver sbloccato le rotelle.
- Pericolo di energia immagazzinata! Questo prodotto contiene un meccanismo a molla che può far sì che i componenti del dispositivo e/o il display si muovano forzatamente e rapidamente verso l'alto quando vengono azionati. Seguire le istruzioni fornite e prestare sempre attenzione quando si aziona la maniglia. Non azionare la maniglia prima del passo 4 della procedura di installazione. Quando si regola l'altezza del display, reggere o maneggiare sempre il display con entrambe le mani (come mostrato) per controllare in sicurezza il sollevamento o l'abbassamento del display. In caso contrario, si potrebbero verificare danni alla proprietà e/o gravi lesioni personali.
- Pericolo di Schiacciamento! Tenere lontane le dita da parti in movimento.

## Avvertissements

- Assemblez ce produit conformément aux instructions.
- Lisez tout le manuel et assurez-vous que vous comprenez les instructions avant de commencer à assembler et utiliser ce produit.
- Ne dépassez pas la capacité pondérale du produit. Une surcharge du produit peut entraîner des blessures ou des dommages matériels.

- Capacité de poids de la monture: 8 à 30 kg (17.6 à 66 lb.)
- N'autorisez pas les enfants à grimper sur ce produit ni à l'utiliser sans surveillance.
- Ce produit est uniquement destiné à une utilisation en intérieur et ne doit pas être utilisé à l'extérieur.
- Ne serrez pas trop les vis lors de l'assemblage de ce produit. Si vous rencontrez une résistance lors du serrage des vis, cessez de serrer.
- L'assemblage de ce produit nécessite deux personnes. Ne tentez pas d'assembler le produit et d'installer les équipements sans aide.
- Avant d'ajouter des équipements au produit, vérifiez que vous l'avez correctement assemblé et installé, et que le produit peut supporter le poids des équipements que vous y ajoutez.
- Avant de déplacer le meuble, veillez à débloquer les roulettes.
- Danger lié à l'énergie stockée ! Ce produit contient un mécanisme à ressort qui peut entraîner le déplacement forcé et rapide des composants de l'assemblage et/ou de l'écran vers le haut lorsqu'il est actionné. Suivez les instructions fournies et faites toujours preuve de prudence lorsque vous actionnez la poignée. N'actionnez pas la poignée avant l'étape 4 de la procédure d'installation. Lorsque vous réglez la hauteur de l'écran, soutenez ou manipulez toujours l'écran avec les deux mains (comme indiqué) pour contrôler en toute sécurité la montée ou la descente de l'écran. Le non-respect de cette consigne peut entraîner des dommages matériels et/ou des blessures corporelles graves.
- Risque de pincement ! Ne pas approcher les doigts des composants mobiles.

## Mensagens de aviso

- Certifique-se de que monta este produto de acordo com as instruções.
- Leia todo o manual e certifique-se de que entende as instruções antes de começar a montar e a utilizar este produto.
- Não exceda a capacidade de peso deste produto. Sobrecarregar este produto pode resultar em ferimentos ou danos de propriedade.
- Capacidade de peso da montagem: 8 a 30 kg (17.6 a 66 lb.)
- Não deixar as crianças trepar neste produto ou utilizar este produto sem a devida supervisão.
- Este produto destina-se apenas a uma utilização no interior e não deve ser utilizado no exterior.
- Quando montar este produto, não aperte demasiado os parafusos. Se encontrar resistência enquanto aperta os parafusos, pare de apertar.
- Montar este produto é uma tarefa para duas pessoas. Não tentar montar este produto e instalar o equipamento sem assistência.



- Antes de adicionar o equipamento a este produto, certifique-se de que o montou e instalou devidamente e de que o produto pode suportar o peso do equipamento que está a adicionar ao mesmo.
- Antes de começar a mover o carro, certifique-se de que desbloqueia os rodízios.
- Perigo de Energia Armazenada! Este produto contém um mecanismo de mola que pode resultar na movimentação forçada e rápida dos componentes de montagem e/ou visor para cima quando accionado. Siga as instruções fornecidas e tenha sempre cuidado ao accionar o manípulo. Não accionar a pega antes do passo 4 do procedimento de instalação. Ao ajustar a altura do visor, apoi sempre o visor com ambas as mãos (como ilustrado) para controlar com segurança a subida ou descida do visor. Não o fazer pode resultar em danos materiais e/ou ferimentos pessoais graves.
- Risco de dedos trilhados! Mantenha os dedos afastados dos componentes em movimento.

## Advertencias de uso

- Asegúrese de ensamblar este producto según las instrucciones.
- Lea todo el manual y asegúrese de haber comprendido bien las instrucciones antes de proceder con el ensamblaje y el uso de este producto.
- Asegúrese de no exceder la capacidad de peso de este producto. La sobrecarga de este producto puede causar lesiones personales o daños en la propiedad.
- Capacidad de peso del soporte: 8 a 30 kg (17.6 a 66 lb.)
- No permita que los niños se suban a este producto o que lo utilicen sin la debida supervisión de un adulto.
- El uso de este producto es solo para interiores y no debe utilizarse en exteriores.
- Cuando ensamble este producto, no apriete los tornillos más de lo debido. Si al apretar los tornillos siente resistencia, no los apriete más.
- Se requieren dos personas para el ensamblaje de este producto. No intente ensamblar este producto e instalar otros equipos sin la debida asistencia de otra persona.
- Antes de instalar equipos en este producto, asegúrese de haberlo ensamblado correctamente, a fin de que pueda soportar el peso del equipo que vaya a instalar.
- Antes de empezar a mover el carrito, asegúrese de haber desbloqueado las ruedas. Antes de empezar a mover el carrito, asegúrese de haber desbloqueado las ruedas.

- ¡Peligro de Energía Almacenada! Este producto contiene un mecanismo de resorte que puede hacer que los componentes del conjunto y/o la pantalla se muevan rápidamente con fuerza hacia arriba al ser accionados. Siga las instrucciones proporcionadas y tenga siempre precaución al accionar la manija. No la accione antes del paso 4 del procedimiento de instalación. Cuando ajuste la altura de la pantalla, sujete o sosténgala siempre con ambas manos (como se muestra) para controlar con seguridad la subida o bajada de la misma. Si no lo hace, puede provocar daños materiales y/o lesiones personales graves.
- ¡Peligro de Aplastamiento! Mantenga sus dedos alejados de las partes móviles.

## Warnhinweise

- Beachten Sie bei der Montage dieses Produkts die Montageanweisungen.
- Bevor Sie dieses Produkt montieren und verwenden, lesen Sie das gesamte Handbuch und vergewissern Sie sich, dass Sie die Anweisungen verstanden haben.
- Überschreiten Sie nicht die Tragkraft dieses Produkts. Ein Überladen dieses Produkts kann zu Verletzungen oder zur Beschädigung des Produkts führen.
- Gewichtskapazität der Halterung: 8 bis 30 kg (17.6 bis 66 lb.)
- Gestatten Sie Kindern nicht, auf das Produkt zu klettern oder das Produkt ohne Aufsicht zu benutzen.
- Dieses Produkt ist nur zum Gebrauch in Innenräumen vorgesehen und sollte nicht im Freien verwendet werden.
- Achten Sie bei der Montage des Produkts darauf, die Schrauben nicht zu fest anzuziehen. Sobald Sie beim Anziehen der Schrauben auf Widerstand stoßen, stellen Sie das Anziehen ein.
- Die Montage dieses Produkts ist auf die Ausführung von zwei Personen ausgelegt. Versuchen Sie nicht ohne Hilfe, dieses Produkt zu montieren und Geräte zu installieren.
- Bevor Sie Geräte zu diesem Produkt hinzufügen, vergewissern Sie sich, dass Sie es ordnungsgemäß montiert und installiert haben und dass das Produkt das Gewicht der Geräte, die Sie hinzufügen möchten, tragen kann.
- Stellen Sie sicher, dass die Rollen entriegelt sind, bevor Sie den Wagen in Bewegung setzen.
- Gefahr durch gespeicherte Energie! Dieses Produkt enthält einen Federmechanismus, der dazu führen kann, dass sich die Montagekomponenten und/oder das Display bei Betätigung gewaltsam und schnell nach oben bewegen. Befolgen Sie die mitgelieferten Anweisungen

und lassen Sie bei der Betätigung des Griffs stets Vorsicht walten. Betätigen Sie den Griff nicht vor Schritt 4 des Installationsvorgangs. Stützen oder fassen Sie das Display beim Verstellen der Höhe immer mit beiden Händen an (wie abgebildet), um das Anheben oder Absenken des Displays sicher zu steuern. Andernfalls kann es zu Sachschäden und/oder schweren Personenschäden kommen.

- Einklemmgefahr! Halten Sie Ihre Finger fern von beweglichen Teilen.

# Table of Contents

<b>Compliance Statements</b> .....	<b>i</b>
<b>Safety Statements</b> .....	<b>ii</b>
<b>Warning Statements</b> .....	<b>iii</b>
<b>Product Diagram</b> .....	<b>1</b>
<b>Product Dimensions</b> .....	<b>2</b>
Side View .....	2
<b>Product Information</b> .....	<b>3</b>
Requirements .....	3
Package Contents .....	4
<b>Installation</b> .....	<b>6</b>
Remove the VESA Plate from the Arm Assembly.....	6
Mounting the Wall Mount.....	7
Install the Decorative Covers .....	7
Configure the VESA Plate to the TV Mounting Pattern.....	7
Mount a TV with a Flush Mounting Surface .....	8
Mount a TV with a Recessed Mounting Surface .....	10
Attach a TV to the Arm Assembly.....	13
<b>Operation</b> .....	<b>14</b>
Height Adjustment Tension of the Arm Assembly.....	14
Cable Management .....	15
Adjust the Tilt Tension of the TV .....	15
<b>Warranty Information</b> .....	<b>16</b>
<b>Limitation of Liability</b> .....	<b>16</b>

## Product Diagram

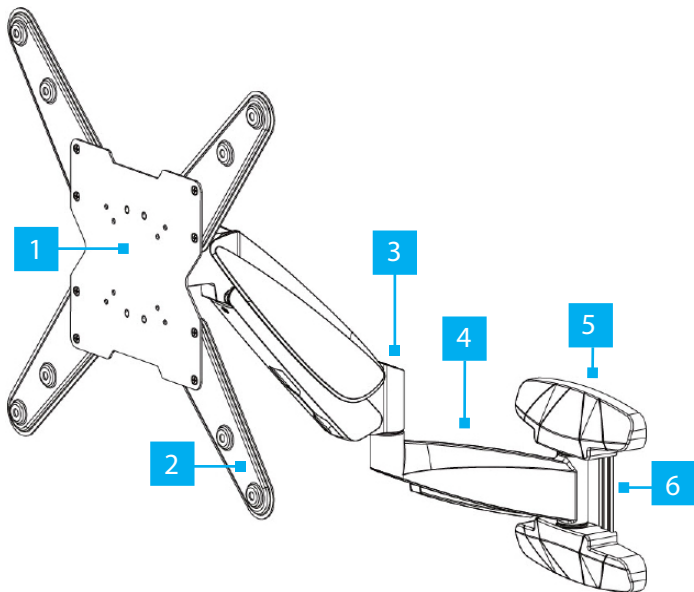

1	VESA Plate	4	Arm Assembly
2	VESA Extension Plates	5	Decorative Covers
3	Height Adjustment Tension Screw	6	Wall Mount

# Product Dimensions

## Side View

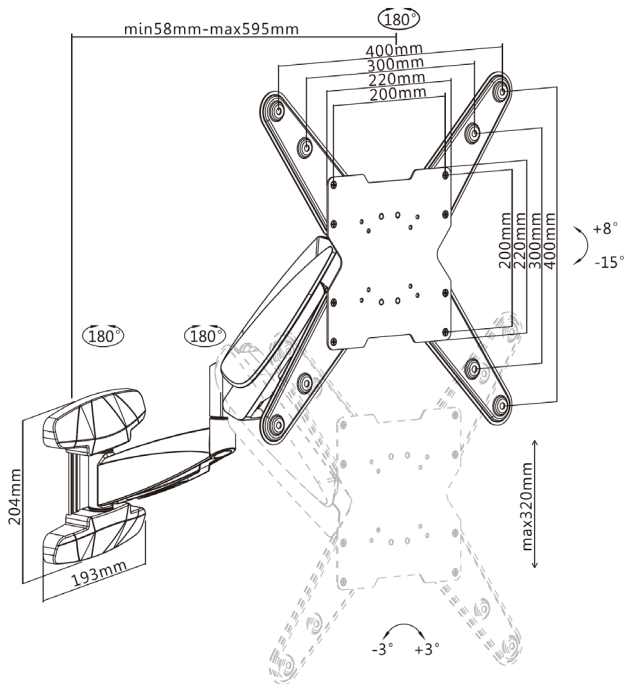

## Product Information

### Requirements

For the latest product information, technical specifications, manuals, and Declarations of Conformance, please visit:

[www.StarTech.com/FHA-TV-WALL-MOUNT](http://www.StarTech.com/FHA-TV-WALL-MOUNT)







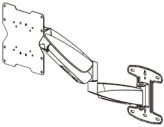
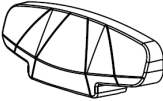
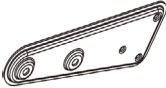
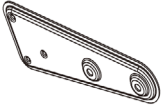

### TV

- Compatible VESA Mounting Hole Pattern
  - VESA Plate: 75 x 75, 100 x 100, 200 x 100, and 200 x 200
  - VESA Plate with VESA Extension Plates: 300 x 300, 400 x 200, and 400 x 400.

### Tools

- Phillips Head Screwdriver

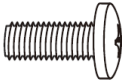
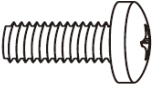
## Package Contents

 <p>Arm Assembly Qty: 1</p>	 <p>Decorative Covers Qty: 2</p>	 <p>VESA Extension Plates, Left Qty: 2</p>	 <p>VESA Extension Plates, Right Qty: 2</p>
 <p>VESA Extension Plates Screws Qty: 8</p>	 <p>Wrench Qty: 1</p>	 <p>4 mm Hex Key Qty: 1</p>	 <p>6 mm Hex Key Qty: 1</p>
 <p>Bubble Level Qty: 1</p>	 <p>M5 x 14 Screws Qty: 4</p>	 <p>M6 x 14 Screws Qty: 4</p>	 <p>M6 x 30 Screws Qty: 4</p>



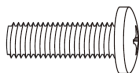

M8 x 30 Screws  
Qty: 4

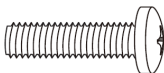

M8 x 50 Screws  
Qty: 4



Display Washers,  
Small  
Qty: 4



Display Washers,  
Large  
Qty: 4



Short Spacers  
Qty: 8



Tall Spacers  
Qty: 8



Wall Mounting  
Screws  
Qty: 5



Concrete  
Anchors  
Qty: 5

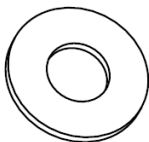

Wall Mounting  
Washers  
Qty: 5

StarTech.com

Full Motion TV Ball Mount - 35" - Up to 50" and 60"



User Manual  
880778-1 (Rev. 05/07)

User Manual  
Qty: 1

## Installation

### Remove the VESA Plate from the Arm Assembly

1. Partially loosen the **Top Nuts**, located on the back of the **VESA Plate**, using the **Wrench**. The **Top Nuts** indicate the **Up** position of the **VESA Plate**.
2. Remove the **Bottom Nuts**, located on the back of the **VESA Plate**, using the **Wrench**. Set aside the **Bottom Nuts** as they will be used in a later step.
3. Slide out the bottom and lift upwards to remove the **VESA Plate** from the **Arm Assembly**. (Figure 1)

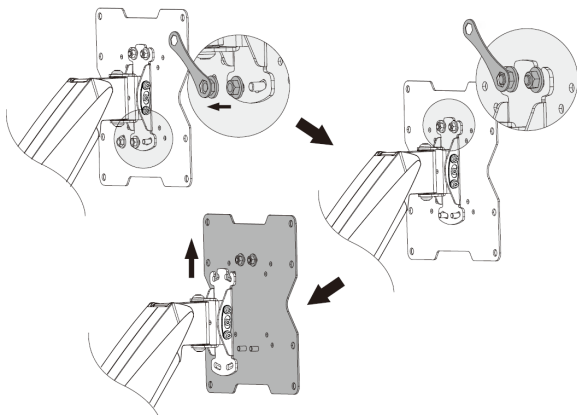

Figure 1

## Mounting the Wall Mount

### Fasten the Wall Mount to a Wood Stud or Concrete Wall

**Warning!** The TV wall mount is designed to be installed on a wood stud, solid concrete, or cinder block wall. The wall structure should be capable of supporting at least four times the weight of the mounted equipment.

The mounting hardware included with this product may not be adequate for installation on certain wall structures.

Contact a construction professional to install the wall mount. Failure to do so may result in personal injury and/or equipment damage.

### Install the Decorative Covers

1. Gently **Push-in** the **Decorative Covers** onto the **Wall Mount**. (Figure 2)

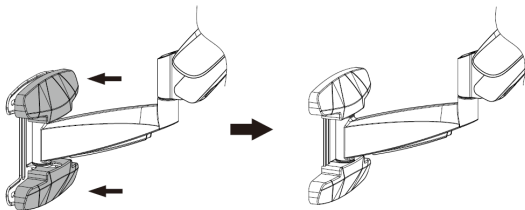

Figure 2

### Configure the VESA Plate to the TV Mounting Pattern

If the two mounting holes on the **VESA Plate** are not compatible with the mounting holes on the TV or display, use the **VESA Extension Plates** to create a compatible mounting hole configuration.

- Fasten the **VESA Extension Plates, Left and Right**, to the **VESA Plate** with the **VESA Extension Plates Screws** (x 8), using a **Phillips Head Screwdriver**. (Figure 3)

*The VESA Extension Plates can be configured to various TV VESA mounting patterns, such as 300x300, 400x400, etc.*

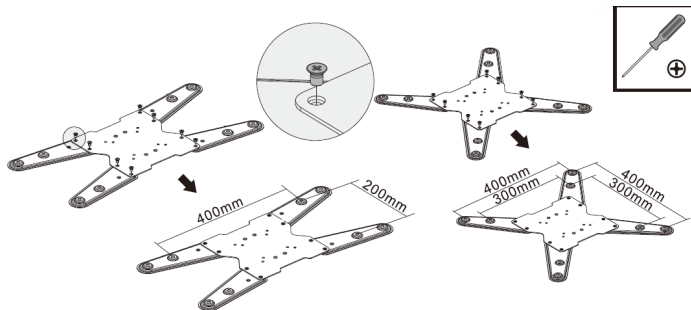

Figure 3

## Mount a TV with a Flush Mounting Surface

To accommodate different TV designs, **FHA-TV-WALL-MOUNT** comes with five sets of screws of various lengths and diameters, two sizes of washers, and two sizes of spacers.

1. To select the combination of mounting hardware needed to use to attach the **VESA Plate** or **VESA Extension Plates** to the TV, complete the following:
  - Determine the depth of the mounting holes on the TV.
  - Determine the diameter of the mounting holes on the TV.

**Note:** *If using a TV with a flush mounting surface, you don't*

*need to use any of the provided spacers.*

2. Align the **VESA Plate** or the **VESA Extension Plates** with the mounting holes on the back of the TV.
3. Place the appropriately sized **Display Washers** (x 4) over the **VESA Plate** or the **VESA Extension Plates**.
4. Insert the appropriately sized **M-Type Screws** (x 4) through the **Display Washers**, the **VESA Plate** or **VESA Extension Plates**, and into the **VESA Mounting Holes**, located in the back of the TV. (Figure 4)
5. Tighten the appropriately sized **M-Type Screws**, using a **Phillips Head Screwdriver**.

**Warning!** Do not overtighten the screws. If you encounter resistance while tightening the screws, stop tightening.

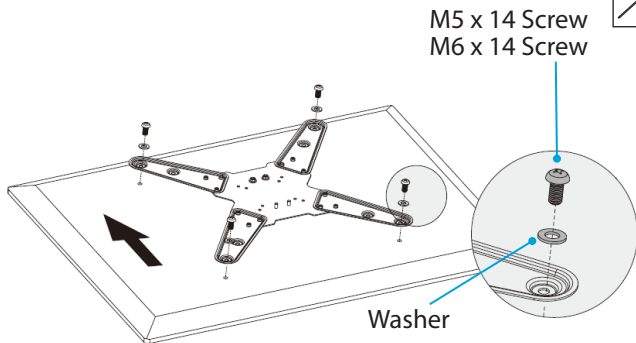

Figure 4

## Mount a TV with a Recessed Mounting Surface

To accommodate different TV designs, the **FHA-TV-WALL-MOUNT** includes five sets of screws of various lengths and diameters, two sizes of washers, and two sizes of spacers.

1. Bridge the gap between the **VESA Plate** or **VESA Extension Plates** and the **VESA Mounting Holes**, located on the back of the TV. Select appropriately sized **M-Type Screws** (x 4) and pair them with an adequate combination of Spacers. Refer to the bullets and Figures 5 and 6.
  - Determine the **Depth** of the mounting holes on the TV.
  - Determine the **Diameter** of the mounting holes on the TV.
  - Refer to the images below to see the possible hardware combinations of **Screws** and **Spacers**.

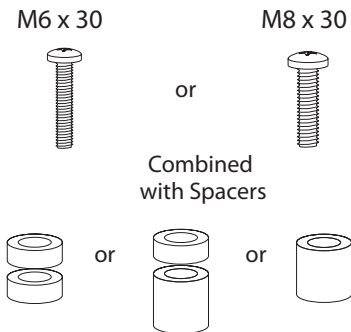
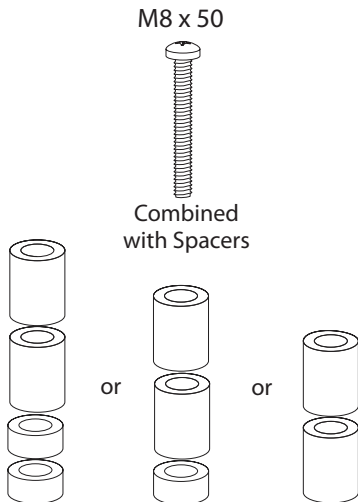

Figure 5



2. Align the **VESA Plate** or the **VESA Extension Plates** with the mounting holes on the back of the **TV**.
3. Place the **Display Washers, Large** over the **VESA Plate** or the **VESA Plate Extensions**.
4. Insert the **M6 x 30 Screws** (x 4), **M8 x 30 Screws** (x4), or **M8 x 50 Screws** (x 4) through the **Washers, Large the VESA Plate** or **VESA Extension Plates**, the **Spacers**, and into the **VESA Mounting Holes**, located in the back of the **TV**. (Figure 7)
5. Tighten the appropriately sized **M-Type Screws**, using a **Phillips Head Screwdriver**.

**Warning!** Do not overtighten the screws. If you encounter resistance while you're tightening the screws, stop tightening. Failure to do so could result in damage to the TV.

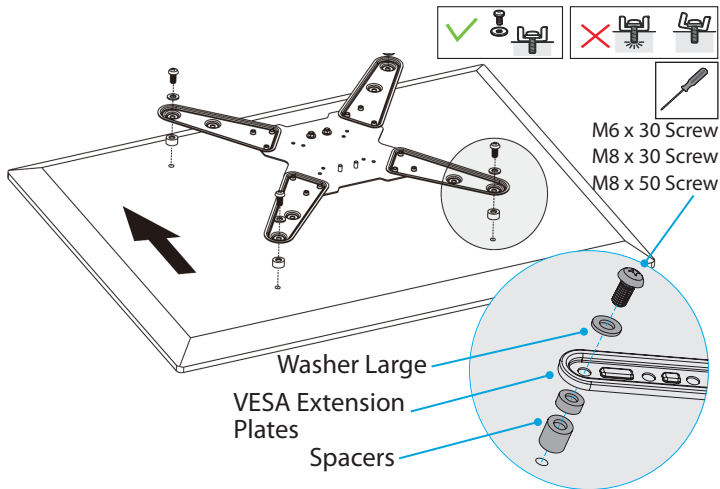

Figure 7



## Attach a TV to the Arm Assembly

**Warning!** Ensure that the weight of the TV does not exceed the weight capacity of this product. Exceeding the weight capacity may result in personal injury and/or damage to the product, the attached equipment, and/or the mounting surface. This product can support the following weight: Up to 66 lbs (30 kg).

Attaching the TV is a two-person job. Do not attempt to complete this task by yourself.

Continue to support the weight of the TV until the nuts (x 4) have been installed and adequately tightened.

1. Locate the **Top Threaded Studs** at the back of the **VESA Plate**.
2. Slide the partially loosened **Top Nuts**, located on the back of the **VESA Plate Assembly**, down into the **Slots**, located on the end of the **Arm Assembly**. (Figure 8)

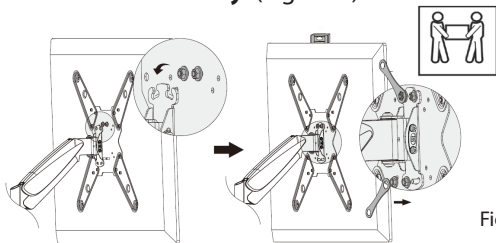

Figure 8

3. Insert the **Two Nuts**, from **Step 1** of **Installation - Release the VESA Plate from the Arm Assembly**, located on the back of the **VESA Plate Assembly**.
4. Use the provided **Wrench** to tighten all the **Nuts** (x 4).

## Operation

### Height Adjustment Tension of the Arm Assembly

1. Position the **Arm Assembly Horizontally** before adjusting. Locate the **Height Tension Adjustment Screw**, located on the **Arm Assembly**.
2. Using the **6 mm Hex Key** rotate the **Height Tension Screw Clockwise** to **Increase the Tension** for **Heavier/Larger TVs**, and rotate **Counterclockwise** to **Decrease the Tension** for **Smaller/Lighter TVs**. (Figure 9)

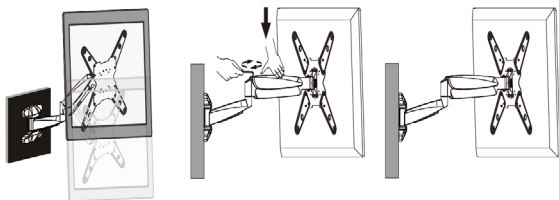

Figure 9

## Cable management

1. Route the **TV Cables** through the **Cable Management Attachments**, located under the **Arm Assembly**, and to the **Power/AV Sources**. (Figure 10)

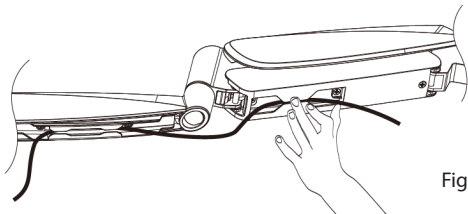

Figure 10

## Adjust the Tilt Tension

1. Locate the adjustment **Bolts**, on the back of the **VESA Plate**. (Figure 11)

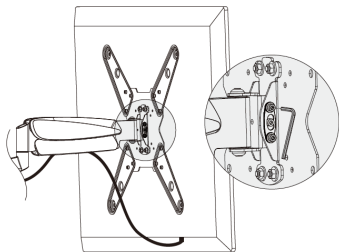

Figure 11

2. Use the provided **4 mm Hex Key**. Rotate **Clockwise** to **Increase the Tension**, and rotate **Counterclockwise** to **Decrease the Tension**.

*To set the TV at a fixed angle, tilt the **TV** to the desired angle and fully tighten the **Tilt Tension Adjustment Screws**, using the **4 mm Hex Key**.*

## Warranty Information

This product is backed by a two-year warranty.

For further information on product warranty terms and conditions, please refer to [www.startech.com/warranty](http://www.startech.com/warranty).

## Limitation of Liability

In no event shall the liability of StarTech.com Ltd. and StarTech.com USA LLP (or their officers, directors, employees or agents) for any damages (whether direct or indirect, special, punitive, incidental, consequential, or otherwise), loss of profits, loss of business, or any pecuniary loss, arising out of or related to the use of the product exceed the actual price paid for the product.

Some states do not allow the exclusion or limitation of incidental or consequential damages. If such laws apply, the limitations or exclusions contained in this statement may not apply to you.

## Hard-to-find made easy. At StarTech.com, that isn't a slogan. It's a promise.

StarTech.com is your one-stop source for every connectivity part you need. From the latest technology to legacy products — and all the parts that bridge the old and new — we can help you find the parts that connect your solutions.

We make it easy to locate the parts, and we quickly deliver them wherever they need to go. Just talk to one of our tech advisors or visit our website. You'll be connected to the products you need in no time.

Visit [www.startech.com](http://www.startech.com) for complete information on all StarTech.com products and to access exclusive resources and time-saving tools.

StarTech.com is an ISO 9001 Registered manufacturer of connectivity and technology parts. StarTech.com was founded in 1985 and has operations in the United States, Canada, the United Kingdom and Taiwan servicing a worldwide market.

### Reviews

Share your experiences using StarTech.com products, including product applications and setup, what you love about the products, and areas for improvement.

#### StarTech.com Ltd.

45 Artisans  
Crescent  
London, Ontario  
N5V 5E9  
Canada

#### StarTech.com LLP

4490 South  
Hamilton Road  
Groveport, Ohio  
43125  
U.S.A.

#### StarTech.com Ltd.

Unit B, Pinnacle 15  
Gowerton Road  
Brackmills,  
Northampton  
NN4 7BW  
United Kingdom

#### StarTech.com Ltd.

Siriusdreef 17-27  
2132 WT  
Hoofddorp  
The Netherlands

FR: [fr.startech.com](http://fr.startech.com)

DE: [de.startech.com](http://de.startech.com)

ES: [es.startech.com](http://es.startech.com)

NL: [nl.startech.com](http://nl.startech.com)

IT: [it.startech.com](http://it.startech.com)

JP: [jp.startech.com](http://jp.startech.com)