

DLP® Projector

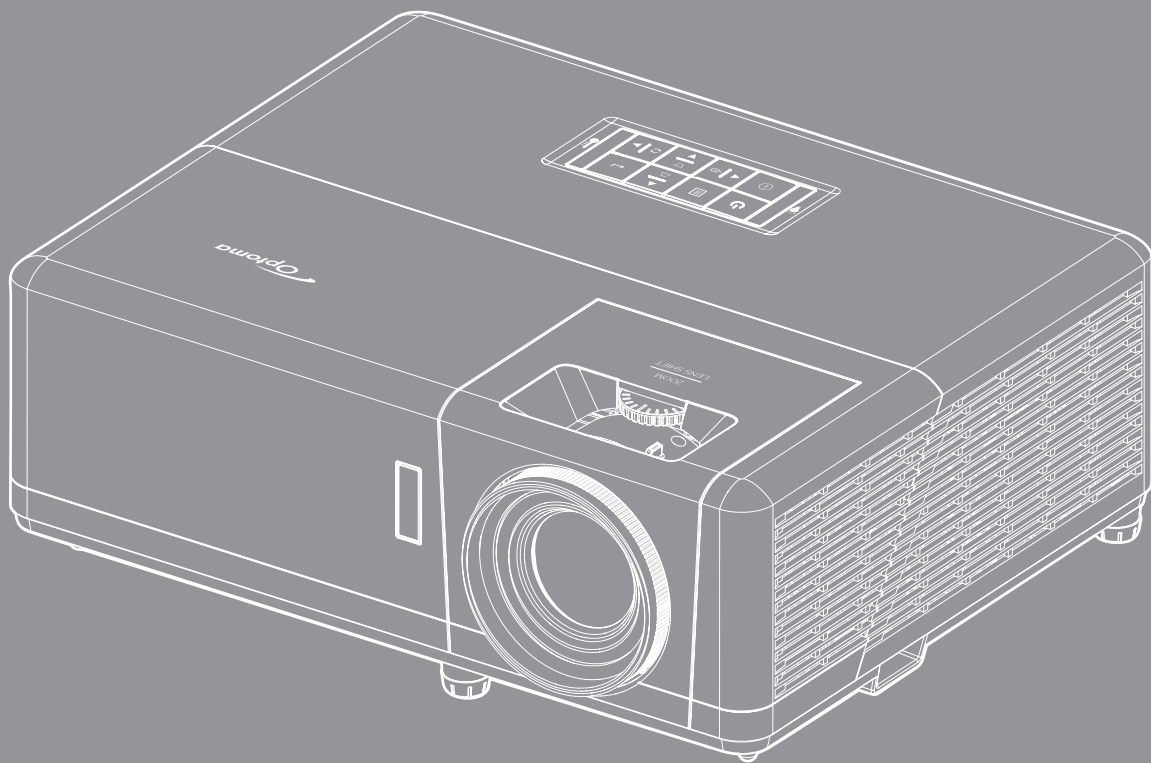

TABLE OF CONTENTS

SAFETY	4
<i>Important Safety Instruction</i>	4
<i>Laser Radiation Safety Information</i>	5
<i>Copyright</i>	7
<i>Disclaimer</i>	7
<i>Trademark Recognition</i>	7
<i>FCC</i>	7
<i>Declaration of Conformity for EU countries</i>	8
<i>WEEE</i>	8
<i>Cleaning the Lens</i>	8
INTRODUCTION	9
<i>Package Overview</i>	9
<i>Standard accessories</i>	9
<i>Product Overview</i>	10
<i>Connections</i>	11
<i>Keypad</i>	12
<i>Remote control 1</i>	13
<i>Remote control 2</i>	14
SETUP AND INSTALLATION	15
<i>Installing the projector</i>	15
<i>Connecting sources to the projector</i>	17
<i>Adjusting the projector image</i>	18
<i>Remote setup</i>	19
USING THE PROJECTOR	21
<i>Powering on / off the projector</i>	21
<i>Selecting an input source</i>	22
<i>Menu navigation and features</i>	23
<i>OSD Menu tree</i>	24
<i>Display image settings menu</i>	32
<i>Display enhanced gaming menu</i>	35
<i>Display 3D menu</i>	36
<i>Display aspect ratio menu</i>	37
<i>Display digital zoom menu</i>	38
<i>Display image shift menu</i>	38
<i>Display geometric correction menu</i>	38
<i>Audio mute menu</i>	39
<i>Audio volume menu</i>	39
<i>Audio audio input menu</i>	39
<i>Setup projection menu</i>	40
<i>Setup power settings menu</i>	40

Setup security menu.....	41
Setup HDMI link settings menu	41
Setup test pattern menu	42
Setup remote settings menu.....	42
Setup projector ID menu.....	42
Setup 12V trigger menu.....	42
Setup options menu.....	43
Setup reset OSD menu	44
Setup auto upgrade FW menu	44
Network LAN menu	45
Network control menu.....	46
Setup network control settings menu	47
Info menu.....	53



MAINTENANCE..... 54

<i>Installing and cleaning the dust filter</i>	<i>54</i>
--	-----------

ADDITIONAL INFORMATION..... 55

<i>Compatible resolutions</i>	<i>55</i>
<i>Image size and projection distance</i>	<i>58</i>
<i>Projector dimensions and ceiling mount installation.....</i>	<i>59</i>
<i>IR remote control 1 codes</i>	<i>60</i>
<i>IR remote control 2 codes</i>	<i>62</i>
<i>Troubleshooting.....</i>	<i>64</i>
<i>Warning indicators.....</i>	<i>66</i>
<i>Specifications</i>	<i>67</i>
<i>Optoma global offices.....</i>	<i>68</i>

SAFETY

	The lightning flash with arrow head within an equilateral triangle is intended to alert the user to the presence of uninsulated "dangerous voltage" within the product's enclosure that may be of sufficient magnitude to constitute a risk of electric shock to persons.
	The exclamation point within an equilateral triangle is intended to alert the user to the presence of important operating and maintenance (servicing) instructions in the literature accompanying the appliance.

Please follow all warnings, precautions and maintenance as recommended in this user's guide.

Important Safety Instruction

- Do not block any ventilation openings. To ensure reliable operation of the projector and to protect from over heating, it is recommended to install the projector in a location that does not block ventilation. As an example, do not place the projector on a crowded coffee table, sofa, bed, etc. Do not put the projector in an enclosure such as a book case or a cabinet that restricts air flow.
- To reduce the risk of fire and/or electric shock, do not expose the projector to rain or moisture. Do not install near heat sources such as radiators, heaters, stoves or any other apparatus such as amplifiers that emits heat.
- Do not let objects or liquids enter the projector. They may touch dangerous voltage points and short out parts that could result in fire or electric shock.
- Do not use under the following conditions:
 - In extremely hot, cold or humid environments.
 - (i) Ensure that the ambient room temperature is within 5°C ~ 40°C
 - (ii) Relative humidity is 10% ~ 85%
 - In areas susceptible to excessive dust and dirt.
 - Near any appliance generating a strong magnetic field.
 - In direct sunlight.
- Do not use the unit if it has been physically damaged or abused. Physical damage/abuse would be (but not limited to):
 - Unit has been dropped.
 - Power supply cord or plug has been damaged.
 - Liquid has been spilled on to the projector.
 - Projector has been exposed to rain or moisture.
 - Something has fallen in the projector or something is loose inside.
- Do not place the projector on an unstable surface. The projector may fall over resulting in injury or the projector may become damaged.
- Do not block the light coming out of the projector lens when in operation. The light will heat the object and may melt, cause burns or start a fire.
- Please do not open or disassemble the projector as this may cause electric shock.
- Do not attempt to service the unit yourself. Opening or removing covers may expose you to dangerous voltages or other hazards. Please call Optoma before you send the unit for repair.
- See projector enclosure for safety related markings.
- The unit should only be repaired by authorized service personnel.
- Only use attachments/accessories specified by the manufacturer.
- Do not look into straight into the projector lens during operation. The bright light may harm your eyes.
- This projector will detect the life of the light source itself.

- When switching the projector off, please ensure the cooling cycle has been completed before disconnecting power. Allow 90 seconds for the projector to cool down.
- Turn off and unplug the power plug from the AC outlet before cleaning the product.
- Use a soft dry cloth with mild detergent to clean the display housing. Do not use abrasive cleaners, waxes or solvents to clean the unit.
- Disconnect the power plug from AC outlet if the product is not being used for a long period of time.
- Do not setup the projector in places where it might be subjected to vibration or shock.
- Do not touch the lens with bare hands.
- Remove battery/batteries from remote control before storage. If the battery/batteries are left in the remote for long periods, they may leak.
- Do not use or store the projector in places where smoke from oil or cigarettes may be present, as it can adversely affect the quality of the projector performance.
- Please follow the correct projector orientation installation as non standard installation may affect the projector performance.
- Use a power strip and or surge protector. As power outages and brown-outs can KILL devices.

Laser Radiation Safety Information

- This product is classified as CLASS 1 LASER PRODUCT - RISK GROUP 2 of IEC60825-1 : 2014 and also complies with 21 CFR 1040.10 and 1040.11 as a Risk Group 2, LIP (Laser Illuminated Projector) as defined in IEC 62471-5:Ed. 1.0. For more information see Laser Notice No. 57, dated May 8, 2019.

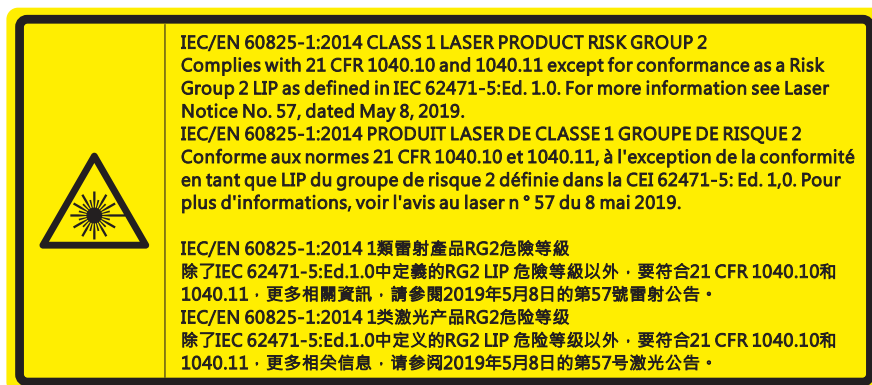

- As with any bright source, do not stare into the direct beam, RG2 IEC 62471-5:2015.
- This projector is class 1 laser product of IEC/EN 60825-1:2014 and risk group 2 with the requirements of IEC 62471-5:2015.
- Additional instructions to supervise children, no staring, and not use optical aids.
- Notice is given to supervise children and to never allow them to stare into the projector beam at any distance from the projector.
- Notice is given to use caution when using the remote control for starting the projector while in front of the projection lens.
- Notice is given to the user to avoid the use of optical aids such as binoculars or telescopes inside the beam.

- When turning on the projector, make sure no one within projection range is looking at the lens.
- Keep any items (magnifying glass etc.) out of the light path of the projector. The light path being projected from the lens is extensive, therefore any kind of abnormal objects that can redirect light coming out of the lens, can cause an unpredictable outcome such as a fire or injury to the eyes.
- Any operation or adjustment not specifically instructed by the user's guide creates the risk of hazardous laser radiation exposure.
- Do not open or disassemble the projector as this may cause damage by the exposure of laser radiation.
- Do not stare into beam when the projector is on. The bright light may result in permanent eye damage.

Without following the control, adjustment or operation procedure may cause damage by the exposure of laser radiation

Copyright

This publication, including all photographs, illustrations and software, is protected under international copyright laws, with all rights reserved. Neither this manual, nor any of the material contained herein, may be reproduced without written consent of the author.

© Copyright 2021

Disclaimer

The information in this document is subject to change without notice. The manufacturer makes no representations or warranties with respect to the contents hereof and specifically disclaims any implied warranties of merchantability or fitness for any particular purpose. The manufacturer reserves the right to revise this publication and to make changes from time to time in the content hereof without obligation of the manufacturer to notify any person of such revision or changes.

Trademark Recognition

Kensington is a U.S. registered trademark of ACCO Brand Corporation with issued registrations and pending applications in other countries throughout the world.

HDMI, the HDMI Logo, and High-Definition Multimedia Interface are trademarks or registered trademarks of HDMI Licensing LLC in the United States and other countries.

DLP®, DLP Link and the DLP logo are registered trademarks of Texas Instruments and BrilliantColor™ is a trademark of Texas Instruments.

All other product names used in this manual are the properties of their respective owners and are Acknowledged.

FCC

This device has been tested and found to comply with the limits for a Class B digital device pursuant to Part 15 of the FCC rules. These limits are designed to provide reasonable protection against harmful interference in a residential installation. This device generates, uses and can radiate radio frequency energy and, if not installed and used in accordance with the instructions, may cause harmful interference to radio communications.

However, there is no guarantee that interference will not occur in a particular installation. If this device does cause harmful interference to radio or television reception, which can be determined by turning the device off and on is encouraged to try to correct the interference by one or more of the following measures:

- Reorient or relocate the receiving antenna.
- Increase the separation between the device and receiver.
- Connect the device into an outlet on a circuit different from that to which the receiver is connected.
- Consult the dealer or an experienced radio/television technician for help.

Notice: Shielded cables

All connections to other computing devices must be made using shielded cables to maintain compliance with FCC regulations.

Caution

Changes or modifications not expressly approved by the manufacturer could void the user's authority, which is granted by the Federal Communications Commission, to operate this projector.

Operation Conditions

This device complies with Part 15 of the FCC Rules. Operation is subject to the following two conditions:

1. This device may not cause harmful interference and
2. This device must accept any interference received, including interference that may cause undesired operation.

Notice: Canadian users

This Class B digital apparatus complies with Canadian ICES-003.

Remarque à l'intention des utilisateurs canadiens

Cet appareil numérique de la classe B est conforme à la norme NMB-003 du Canada.

Declaration of Conformity for EU countries

- EMC Directive 2014/30/EU (including amendments)
- Low Voltage Directive 2014/35/EU
- RED 2014/53/EU (if product has RF function)

WEEE



Disposal instructions

Do not throw this electronic device into the trash when discarding. To minimize pollution and ensure utmost protection of the global environment, please recycle it.

Cleaning the Lens

- Before cleaning the lens, be sure to turn off the projector and unplug the power cord to allow it to completely cool down.
- Use a compressed air tank to remove the dust.

Use a special cloth for cleaning lens and gently wipe the lens. Do not touch the lens with your fingers.

- Do not use alkaline/acid detergents or volatile solvents such as alcohol for cleaning lens. If the lens is damaged due to the cleaning process, it is not covered by the warranty.



Warning: Do not use a spray containing flammable gases to remove dust or dirt from the lens. This may cause a fire due to excessive heat inside the projector.



Warning: Do not clean the lens if the projector is warming up as this may cause the lens' surface film to peel off.



Warning: Do not wipe or tap the lens with a hard object.

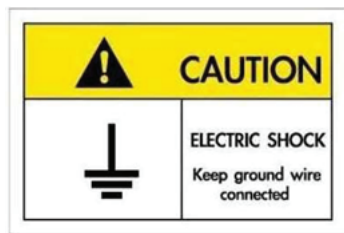

To avoid electric shock, the unit and its peripherals must be properly grounded (earthed).

INTRODUCTION

Thank you for purchasing an Optoma laser projector. For full list of features please visit the product page on our website, where you will also find additional information and documentation such as FAQs.

Package Overview

Carefully unpack and verify that you have the items listed below under standard accessories. Some of the items under optional accessories may not be available depending on the model, specification and your region of purchase. Please check with your place of purchase. Some accessories may vary from region to region.

The warranty card is only supplied in some specific regions. Please consult your dealer for detailed information.

Standard accessories

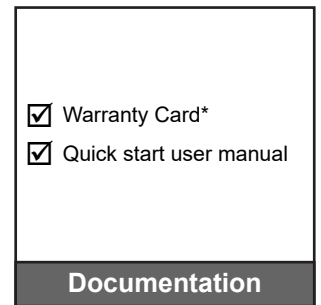
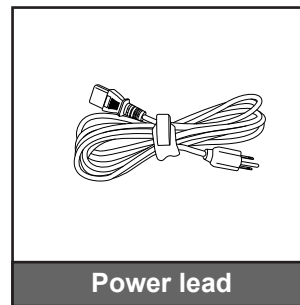
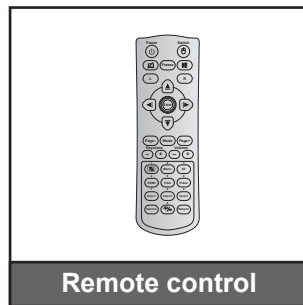
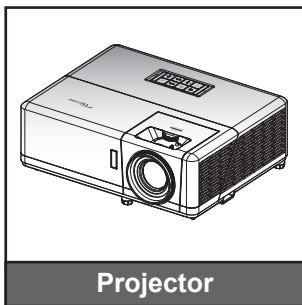

Note:

- *The remote control is shipped with batteries.*
- ** For warranty Information, please visit www.optoma.com.*
- *Accessories vary depending on model, specification and region. Some optional accessories may be available to purchase in select regions. Please visit our website to see more details regarding the accessories included.*

INTRODUCTION

Product Overview

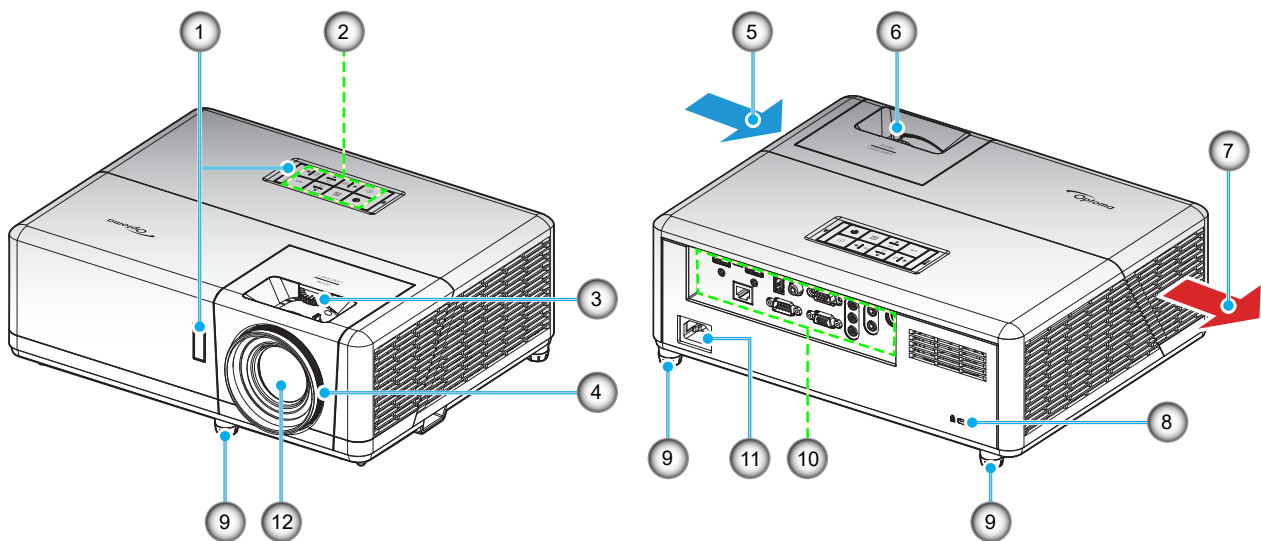

Note:

- Do not block projector intake and exhaust vents.
- When operating the projector in an enclosed space, allow at least 30 cm clearance around the intake and exhaust vents.

No	Item	No	Item
1.	IR Receivers	7.	Ventilation (outlet)
2.	Keypad	8.	Kensington™ Lock Port
3.	Lens Shift Dial	9.	Tilt-Adjustment Feet
4.	Focus Ring	10.	Input / Output
5.	Ventilation (inlet)	11.	Power Socket
6.	Zoom Lever	12.	Lens

INTRODUCTION

Connections

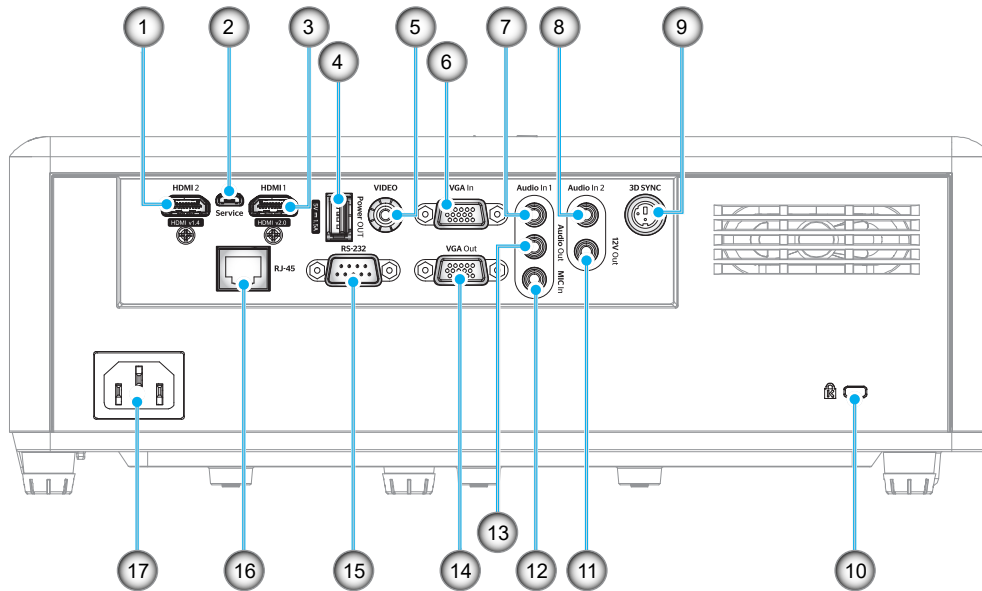

No	Item	No	Item
1.	HDMI 2 Connector	10.	Kensington™ Lock Port
2.	Micro USB Connector	11.	12V Out Connector
3.	HDMI 1 Connector	12.	MIC In Connector
4.	USB Power Out (5V---1.5A) Connector	13.	Audio Out Connector
5.	Video Connector	14.	VGA Out Connector
6.	VGA In Connector	15.	RS-232 Connector
7.	Audio In 1 Connector	16.	RJ-45 Connector
8.	Audio In 2 Connector	17.	Power Socket
9.	3D Sync Connector		

INTRODUCTION

Keypad

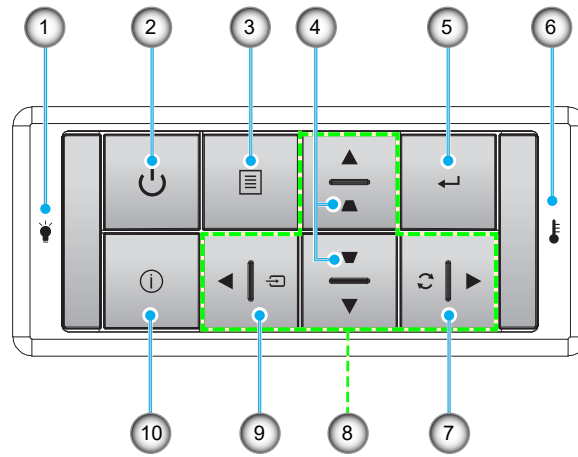

No	Item	No	Item
1.	Lamp LED	6.	Temp LED
2.	Power and Power LED	7.	Re-Sync
3.	Menu	8.	Four Directional Select Keys
4.	Keystone Correction	9.	Source
5.	Enter	10.	Information

INTRODUCTION

Remote control 1

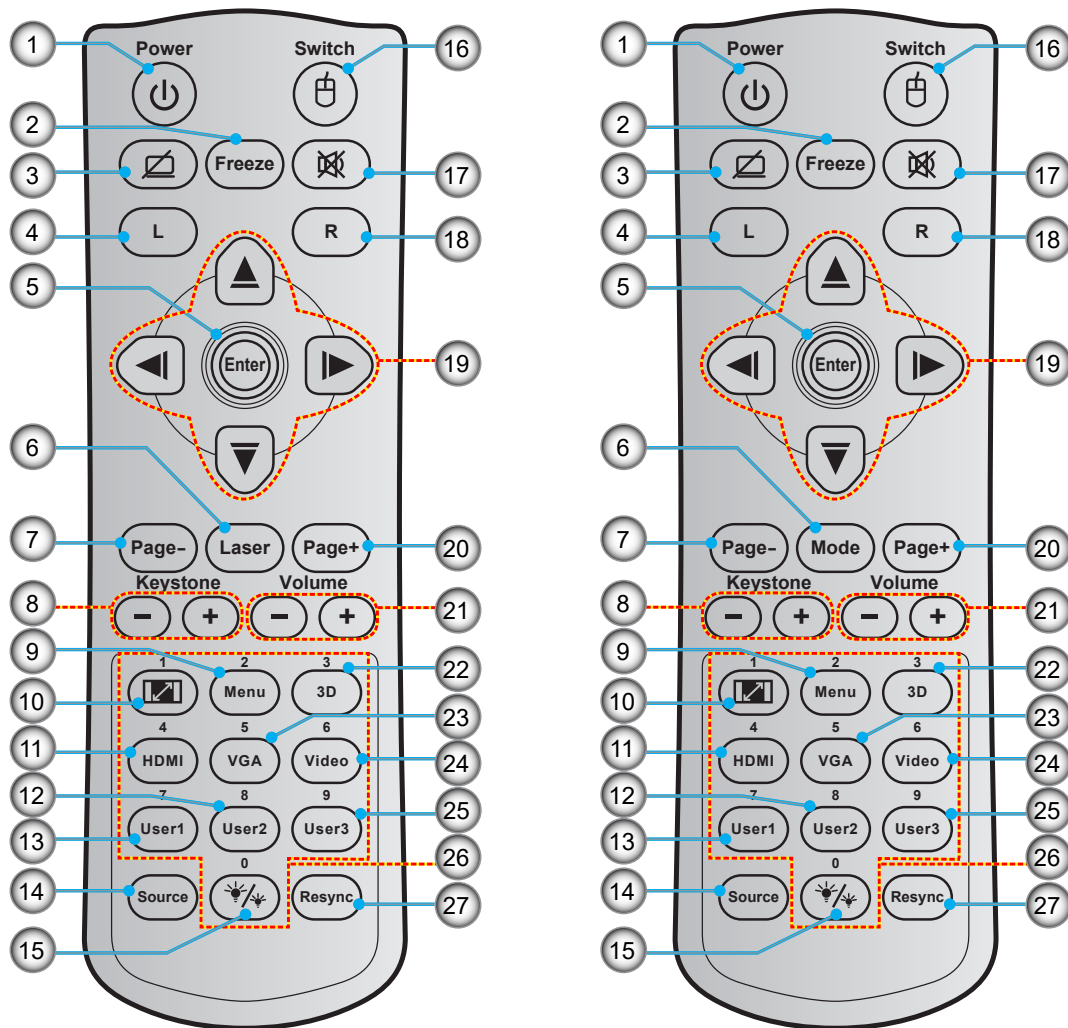

No	Item	No	Item
1.	Power On / Off	14.	Source
2.	Freeze	15.	Brightness Mode
3.	Display Blank / Audio Mute	16.	Mouse On / Off
4.	Mouse Left Click	17.	Mute
5.	Enter	18.	Mouse Right Click
6.	Laser	19.	Four Directional Select Keys
	Mode	20.	Page +
7.	Page -	21.	Volume - / +
8.	Keystone - / +	22.	3D Menu On / Off
9.	Menu	23.	VGA
10.	Aspect Ratio	24.	Video (not supported)
11.	HDMI	25.	User 3 (Assignable)
12.	User 2 (Assignable)	26.	Numeric Keypad (0-9)
13.	User 1 (Assignable)	27.	Resync

Note:

- The actual remote control may vary depending on the region.
- Some keys may have no function for models that do not support these features.

INTRODUCTION

Remote control 2

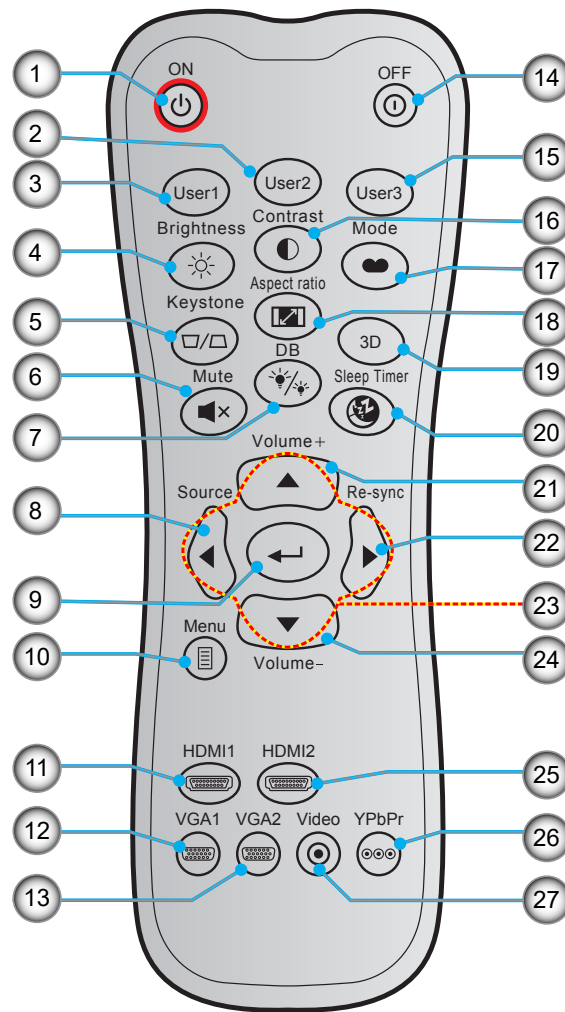

No	Item	No	Item
1.	Power On	15.	User 3 (Assignable)
2.	User 2 (Assignable)	16.	Contrast
3.	User 1 (Assignable)	17.	Display Mode
4.	Brightness	18.	Aspect Ratio
5.	Keystone	19.	3D Menu On / Off
6.	Mute	20.	Sleep Timer
7.	DB (Dynamic Black)	21.	Volume +
8.	Source	22.	Re-Sync
9.	Enter	23.	Four Directional Select Keys
10.	Menu	24.	Volume -
11.	HDMI1	25.	HDMI2
12.	VGA1	26.	YPbPr (not supported)
13.	VGA2 (not supported)	27.	Video (not supported)
14.	Power Off		

Note:

- The actual remote control may vary depending on the region.
- Some keys may have no function for models that do not support these features.

SETUP AND INSTALLATION

Installing the projector

Your projector is designed to be installed in one of four possible positions.

Your room layout or personal preference will dictate which installation location you select. Take into consideration the size and position of your screen, the location of a suitable power outlet, as well as the location and distance between the projector and the rest of your equipment.

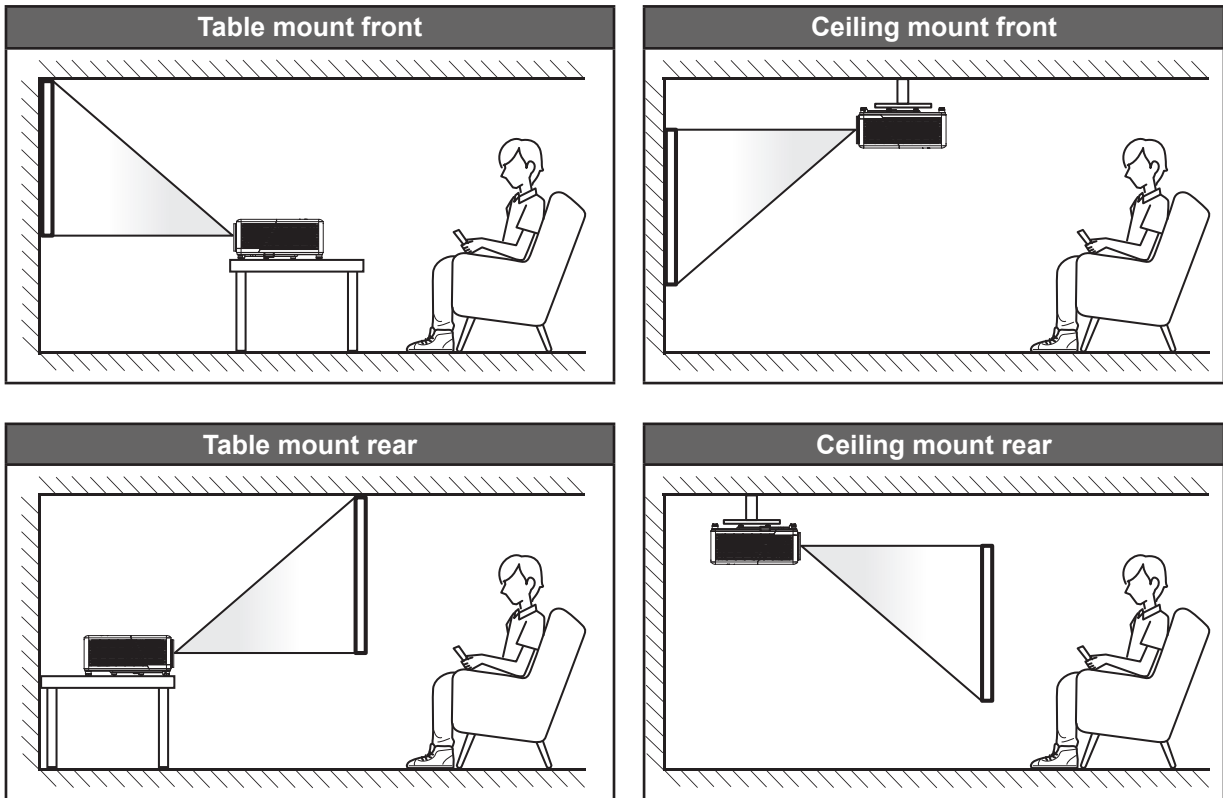

Projector should be placed flat on a surface and 90 degrees / perpendicular to the screen.

- How to determine projector location for a given screen size, please refer to distance table on page 58.
- How to determine screen size for a given distance, please refer to distance table on page 58.

Note: *The further away the projector is placed from the screen the projected image size increases and vertical offset also increases proportionally.*

SETUP AND INSTALLATION

Projector installation notice

- 360° free orientation operation

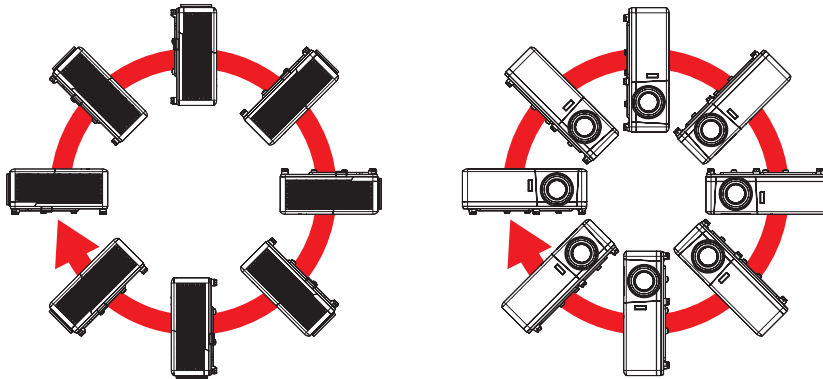

- Allow at least 30 cm clearance around the exhaust vent.

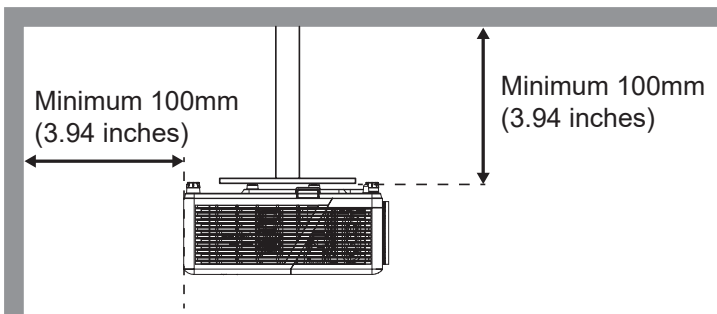
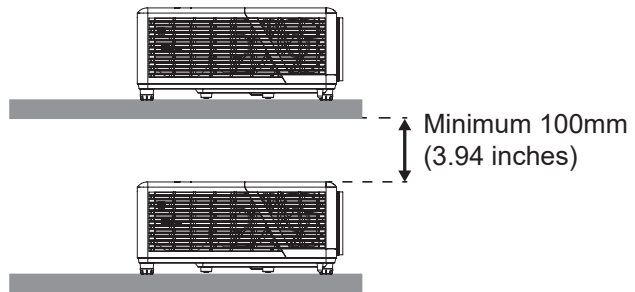
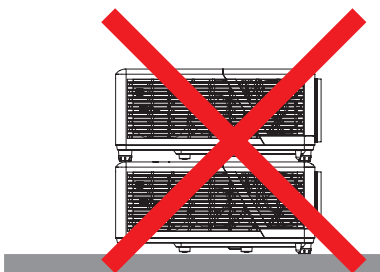
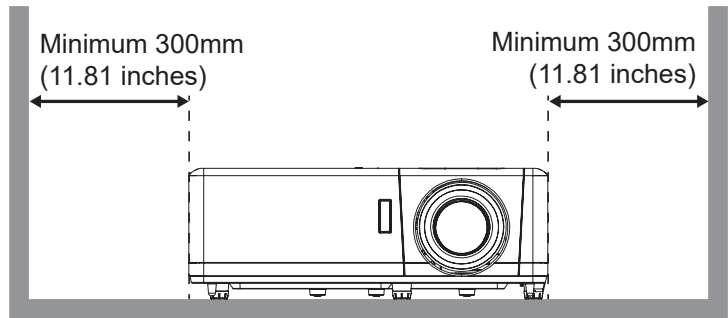
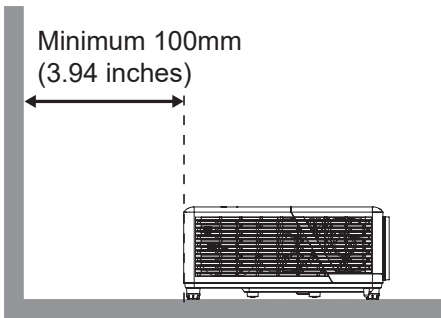

- Ensure that the intake vents do not recycle hot air from the exhaust vent.
- When operating the projector in an enclosed space, ensure that the surrounding air temperature within the enclosure does not exceed operation temperature while the projector is running, and the air intake and exhaust vents are unobstructed.
- All enclosures should pass a certified thermal evaluation to ensure that the projector does not recycle exhaust air, as this may cause the device to shutdown even if the enclosure temperature is within the acceptable operation temperature range.

SETUP AND INSTALLATION

Connecting sources to the projector

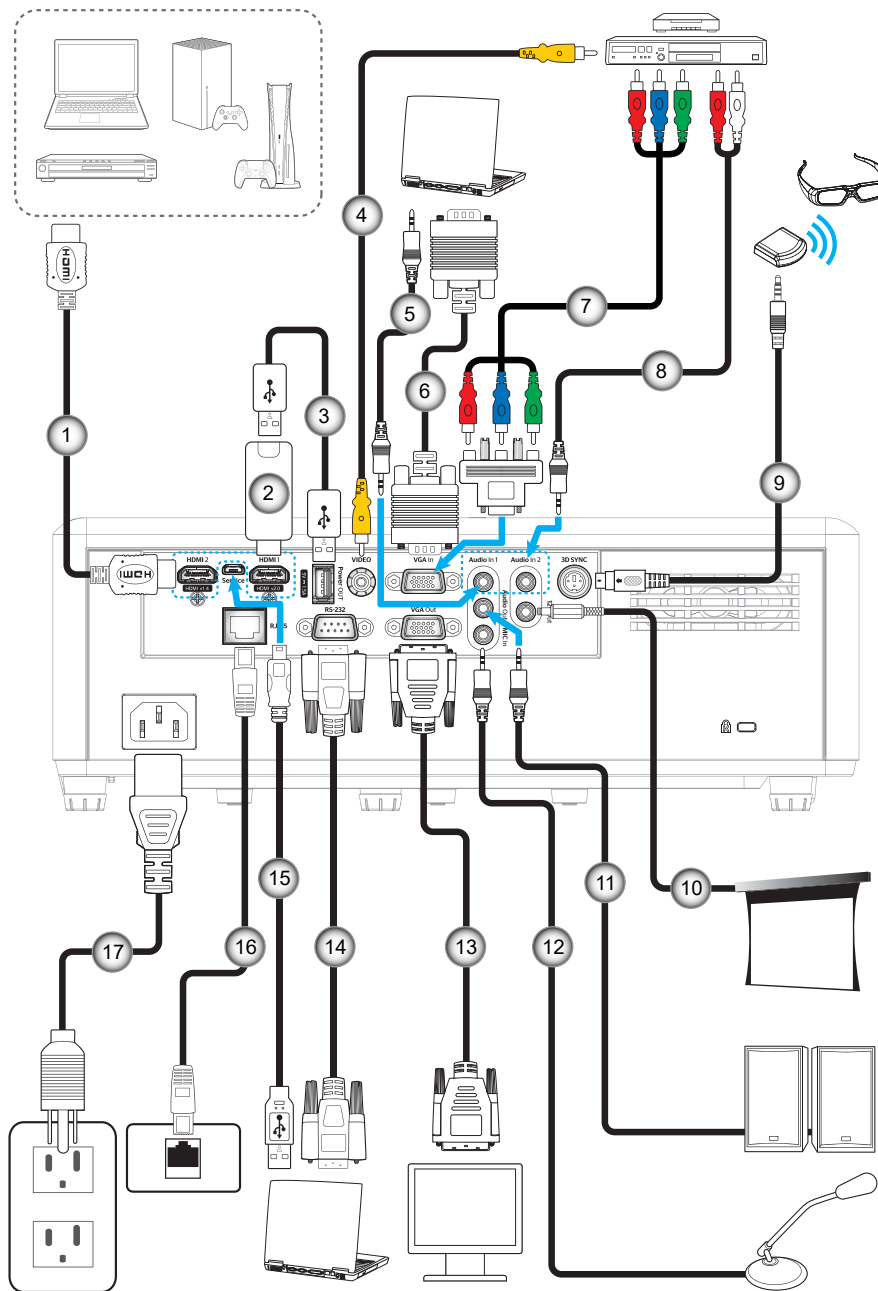

No	Item	No	Item
1.	HDMI Cable	10.	12V DC Jack
2.	HDMI Dongle	11.	Audio Out Cable
3.	USB Power Cable	12.	Microphone Cable
4.	Video Cable	13.	VGA Out Cable
5.	Audio In Cable	14.	RS232 Cable
6.	VGA In Cable	15.	USB Cable
7.	RCA Component Cable	16.	RJ-45 Cable
8.	Audio In Cable	17.	Power Cord
9.	3D Emitter Cable		

Note: To ensure the best image quality and avoid connection errors, we recommend the use of High Speed or Premium Certified HDMI cables up to 5 meters.

SETUP AND INSTALLATION

Adjusting the projector image

Image height

The projector is equipped with elevator feet for adjusting the image height.

1. Locate the adjustable foot you wish to adjust on the underside of the projector.
2. Rotate the adjustable foot clockwise or counterclockwise to raise or lower the projector.

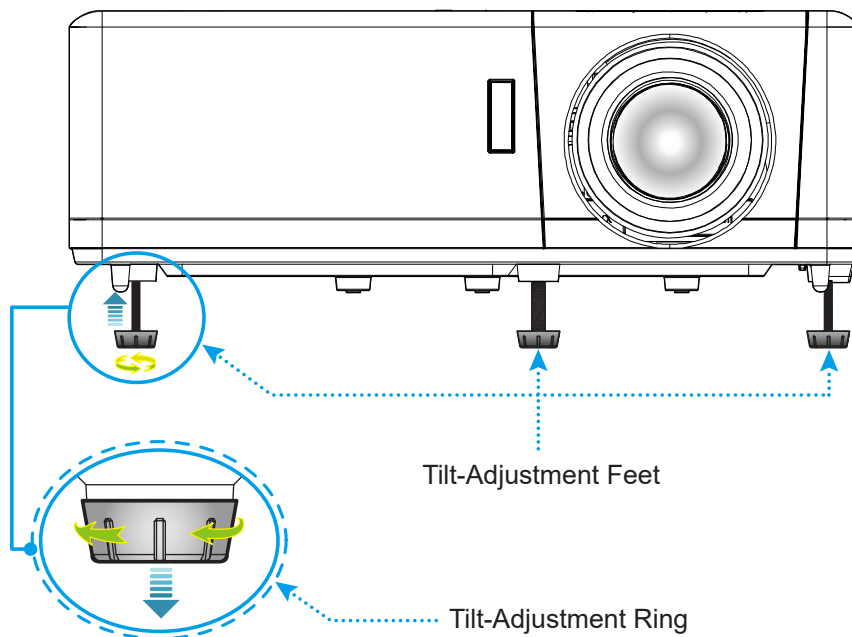

Zoom, lens shift, and focus

- To adjust the image size, turn the zoom lever clockwise or counterclockwise to increase or decrease the projected image size.
- To adjust the image position, turn the lens shift dial clockwise or counterclockwise to adjust the position of the projected image vertically.
- To adjust the focus, turn the focus ring clockwise or counterclockwise until the image is sharp and legible.

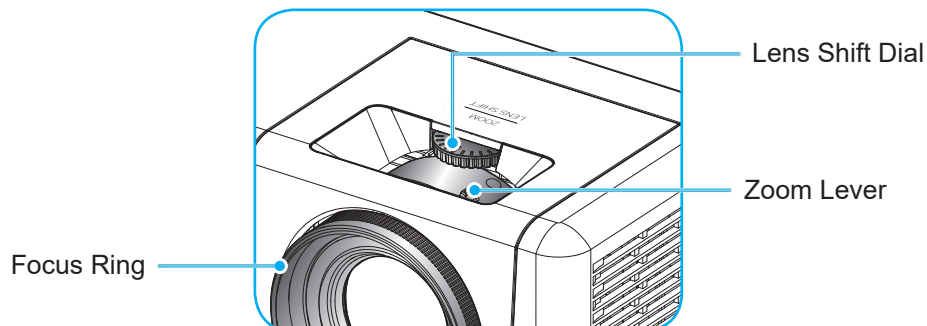

SETUP AND INSTALLATION

Remote setup

Installing / replacing the batteries

Two AAA size batteries are supplied for the remote control.

1. Remove the battery cover on the back of the remote control.
2. Insert AAA batteries in the battery compartment as illustrated.
3. Replace back cover on remote control.

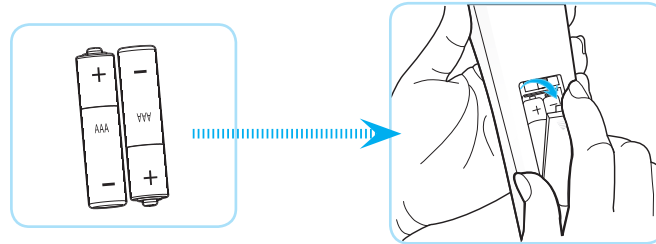

Note: Replace only with the same or equivalent type batteries.

CAUTION

Improper use of batteries can result in chemical leakage or explosion. Be sure to follow the instructions below.

- Do not mix batteries of different types. Different types of batteries have different characteristics.
- Do not mix old and new batteries. Mixing old and new batteries can shorten the life of new batteries or cause chemical leakage in old batteries.
- Remove batteries as soon as they are depleted. Chemicals that leak from batteries that come in contact with skin can cause a rash. If you find any chemical leakage, wipe thoroughly with a cloth.
- The batteries supplied with this product may have a shorter life expectancy due to storage conditions.
- If you will not be using the remote control for an extended period of time, remove the batteries.
- When you dispose of the batteries, you must obey the law in the relative area or country.

SETUP AND INSTALLATION

Effective range

Infra-Red (IR) remote control sensor is located on the top and front sides of the projector. Ensure to hold the remote control at an angle within 60 degrees perpendicular to the projector's IR remote control sensor to function correctly. The distance between the remote control and the sensor should not be longer than 12 meters (39.4 feet).

- Make sure that there are no obstacles between the remote control and the IR sensor on the projector that might obstruct the infra-red beam.
- Make sure the IR transmitter of the remote control is not being shined by sunlight or fluorescent lamps directly.
- Please keep the remote controller away from fluorescent lamps for over 2 m or the remote controller might become malfunction.
- If the remote control is close to Inverter-Type fluorescent lamps, it might become ineffective from time to time.
- If the remote control and the projector are within a very short distance, the remote control might become ineffective.
- When you aim at the screen, the effective distance is less than 5 m from the remote control to the screen and reflecting the IR beams back to the projector. However, the effective range might change according to screens.

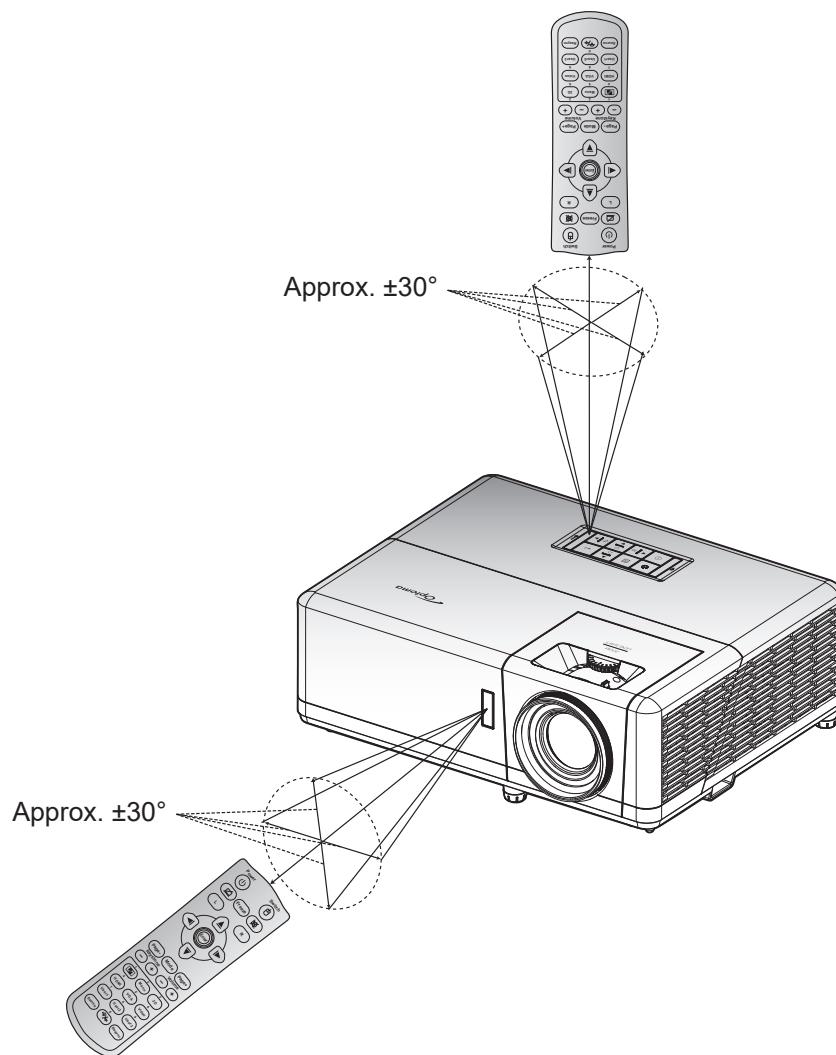

USING THE PROJECTOR

Powering on / off the projector

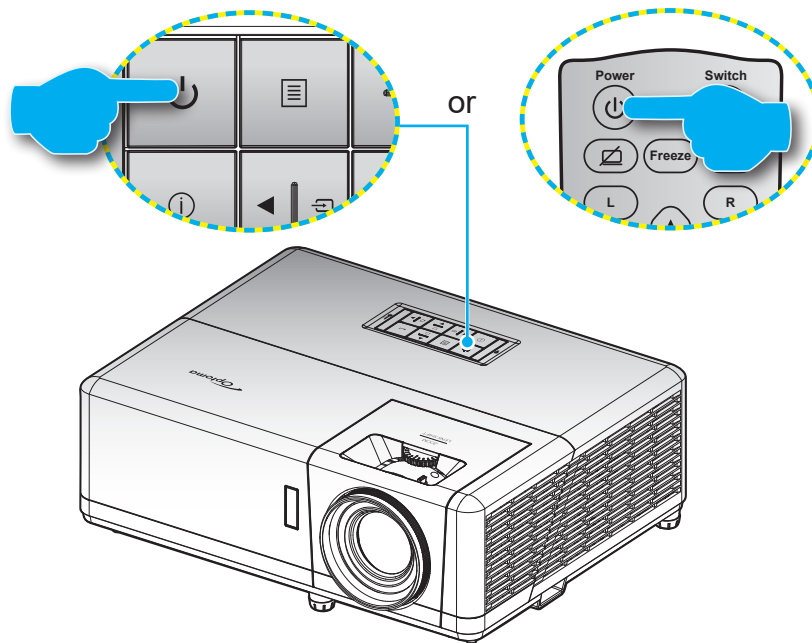

Powering on



1. Securely connect the power lead and signal/source cable. When connected, the Power LED will turn red.
2. Turn on the projector by pressing the  button on the projector keypad or remote control.
3. A start up screen will display in approximately 10 seconds and the Power LED will be flashing blue.

Note: The first time the projector is turned on, you will be prompted to select the preferred language, projection orientation, and other settings.

Powering off

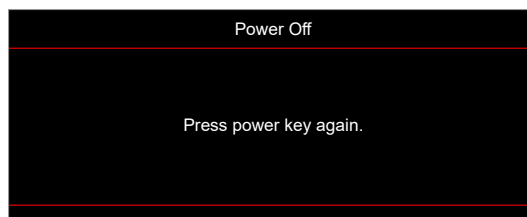
1. Turn off the projector by pressing the  button on the projector keypad or remote control.
2. The following message will be displayed:



3. Press the  button again to confirm, otherwise the message will disappear after 15 seconds. When you press the  button for the second time, the projector will shut down.
4. The cooling fans will continue to operate for about 10 seconds for the cooling cycle and the Power LED will flash blue. When the Power LED turns solid red, this indicates the projector has entered standby mode. If you wish to turn the projector back on, you must wait until the cooling cycle has finished and the projector has entered standby mode. When the projector is in standby mode, simply press the  button again to turn on the projector.
5. Disconnect the power lead from the electrical outlet and the projector.

Note: It is not recommended that the projector is turned on immediately, right after a power off procedure.

USING THE PROJECTOR

Selecting an input source

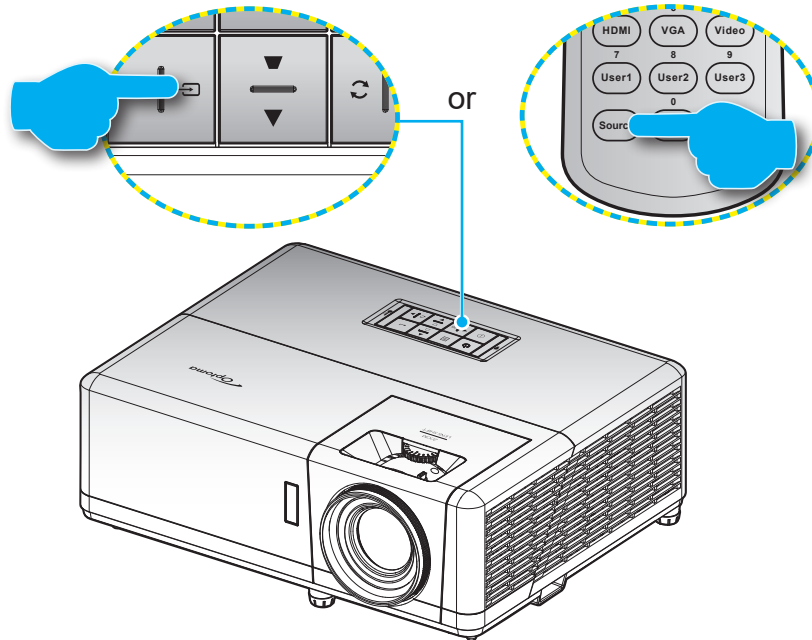

Turn on the connected source that you want to display on the screen, such as computer, notebook, video player, etc. The projector will automatically detect the source. If multiple sources are connected, press the  button on the projector keypad or the **Source** button on the remote control to select the desired input.



USING THE PROJECTOR

Menu navigation and features

The projector has multilingual on-screen display menus that allow you to make image adjustments and change a variety of settings. The projector will automatically detect the source.

1. To open the OSD menu, press the  button on the projector keypad or the **Menu** button on the remote control.
2. When OSD is displayed, use **▲▼** keys to select any item in the main menu. While making a selection on a particular page, press the **←** button on the projector keypad or the **Enter** button on the remote control to enter sub menu.
3. Use **◀▶** keys to select the desired item in the sub menu and then press the **←** or **Enter** button to view further settings. Adjust the settings by using **◀▶** keys.
4. Select the next item to be adjusted in the sub menu and adjust as described above.
5. Press press the **←** or **Enter** button to confirm, and the screen will return to the main menu.
6. To exit, press the  or **Menu** button again. The OSD menu will close and the projector will automatically save the new settings.

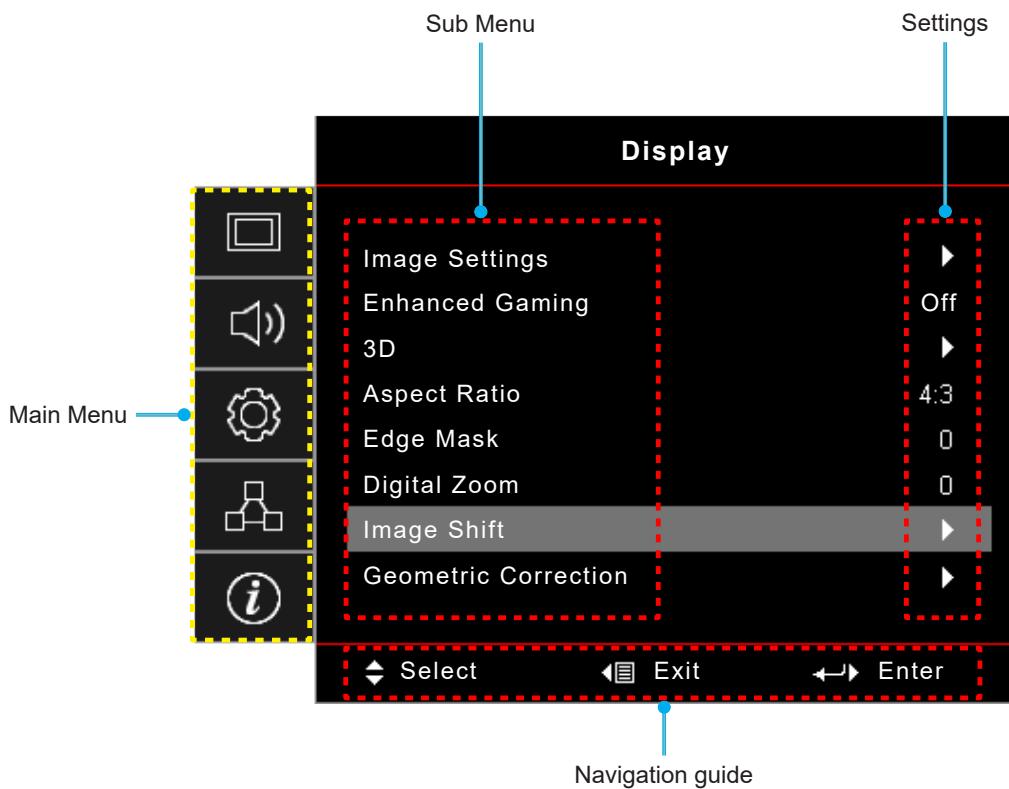

USING THE PROJECTOR

OSD Menu tree



Note: The OSD menu tree items and features are subject to models and region. Optoma reserve the right to add or remove items to improve product performance without notice.

Main Menu	Sub Menu	Sub Menu 2	Sub Menu 3	Sub Menu 4	Values	
Display	Image Settings	Display Mode			Presentation	
					Bright	
					HDR	
					HLG	
					Cinema	
					Game	
					Reference	
					DICOM SIM.	
					User	
					3D	
		Wall Color				Off [Default]
						Blackboard
						Light Yellow
						Light Green
						Light Blue
						Pink
						Gray
		Dynamic Range	HDR / HLG			Off
						Auto [Default]
			HDR Picture Mode			Bright
						Standard [Default]
						Film
					Detail	
		Brightness				-50 ~ 50
		Contrast				-50 ~ 50
		Sharpness				1 ~ 15
		Color				-50 ~ 50
		Tint				-50 ~ 50
		Gamma		Film		
				Video		
				Graphics		
				Standard(2.2)		
				1.8		
	2.0					
	2.4					
	2.6					
	HDR					
	3D					
	Blackboard					
	DICOM SIM.					

USING THE PROJECTOR

Main Menu	Sub Menu	Sub Menu 2	Sub Menu 3	Sub Menu 4	Values	
Display	Image Settings	Color Settings	BrilliantColor™		1 ~ 10	
			Color Temperature		Warm	
					Standard	
					Cool	
					Cold	
			Color Matching	Color		Red [Default]
						Green
						Blue
						Cyan
						Yellow
						Magenta
						White(*)
					Hue / R(*)	-50 ~ 50 [Default: 0]
					Saturation / G(*)	-50 ~ 50 [Default: 0]
					Gain / B(*)	-50 ~ 50 [Default: 0]
					Reset	Cancel [Default] Yes
				Exit		
			RGB Gain/Bias	Red Gain	-50 ~ 50	
				Green Gain	-50 ~ 50	
				Blue Gain	-50 ~ 50	
				Red Bias	-50 ~ 50	
				Green Bias	-50 ~ 50	
				Blue Bias	-50 ~ 50	
				Reset	Cancel [Default] Yes	
				Exit		
			Color Space [Not HDMI Input]		Auto [Default]	
					RGB	
					YUV	
			Color Space [HDMI Input]		Auto [Default]	
					RGB(0~255)	
					RGB(16~235)	
					YUV	
			White Level		0 ~ 31	
			Black Level		-5 ~ 5	
			IRE		0	
					7.5	
			Signal	Automatic		Off
						On [Default]
				Frequency		-10 ~ 10 (depends on signal) [Default: 0]
			Phase		0~31 (depends on signal) [Default: 0]	

USING THE PROJECTOR

Main Menu	Sub Menu	Sub Menu 2	Sub Menu 3	Sub Menu 4	Values	
Display	Image Settings	Signal	H. Position		-5 ~ 5 (depends on signal) [Default: 0]	
			V. Position		-5 ~ 5 (depends on signal) [Default: 0]	
		Brightness Mode			DynamicBlack	
					Eco.	
					Constant Power (Power = 100%/ 95%/ 90%/ 85%/ 80%/ 75%/ 70%/ 65%/ 60%/ 55%/ 50%)	
		Reset			Constant Luminance (Power =85%/80%/75%/70%)	
	Enhanced Gaming				Off [Default]	
					On	
	3D	3D Mode			Off	
					On [Default]	
		3D Tech			DLP-Link [Default]	
					3D Sync	
		3D → 2D			3D [Default]	
					L	
				R		
		3D Format			Auto [Default]	
					SBS	
					Top and Bottom	
					Frame Sequential	
		3D Sync Invert			Frame Packing	
					On	
		Reset			Off [Default]	
				Cancel		
	Aspect Ratio				Yes	
					4:3	
					16:9	
					LBX	
					Native	
	Edge Mask				Auto	
	Digital Zoom				0 ~ 10 [Default: 0]	
	Image Shift	H 				-100 ~ 100 [Default: 0]
		V 				-100 ~ 100 [Default: 0]
	Geometric Correction	Four Corners				
		H Keystone				LT:-30 ~ 30 ST:-15~15 [Default: 0]
		V Keystone				LT:-30 ~ 30 ST:-15~15 [Default: 0]
		Auto Keystone				Off
						On [Default]





USING THE PROJECTOR

Main Menu	Sub Menu	Sub Menu 2	Sub Menu 3	Sub Menu 4	Values		
Audio	Mute				Off [Default]		
					On		
	Volume					0 ~ 10 [Default: 5]	
		Audio Input	HDMI1			Default [Default]	
					Audio 1		
					Audio 2		
					Mic		
	HDMI2				Default [Default]		
					Audio 1		
					Audio 2		
	VGA				Mic		
					Audio 1 [Default]		
					Audio 2		
	Video				Mic		
					Audio 1		
				Audio 2 [Default]			
Setup	Projection				Front  [Default]		
					Rear 		
					Ceiling-top 		
					Rear-top 		
	Power Settings	Direct Power On				Off [Default]	
						On	
		Signal Power On				Off [Default]	
						On	
		Auto Power Off (min.)				0 ~ 180 (5 min increments) [Default: 20]	
		Sleep Timer (min.)				0 ~ 990 (30 min increments) [Default: 0]	
			Always On				No [Default]
						Yes	
	Power Mode (Standby)					Active	
						Eco [Default]	
	USB Power (Standby)					Off [Default]	
						On	
	Security	Security				Off	
						On	
		Security Timer	Month				
			Day				
Hour							
Change Password					[Default: 1234]		

USING THE PROJECTOR

Main Menu	Sub Menu	Sub Menu 2	Sub Menu 3	Sub Menu 4	Values	
Setup	HDMI Link Settings	HDMI Link			Off [Default]	
					On	
		Inclusive of TV			No [Default]	
					Yes	
		Power On Link			Mutual [Default]	
					PJ → Device	
		Power Off Link			Device → PJ	
					Off [Default]	
		Test Pattern				Green Grid
						Magenta Grid
						White Grid
						White
					Off	
	Remote Settings [depends on remote]	IR Function				On [Default]
						Off
		F1				Test Pattern
						Brightness
						Contrast
						Sleep Timer
						Color Matching
						Color Temp
						Gamma
		F2				Projection
						Test Pattern
						Brightness
						Contrast
						Sleep Timer
						Color Matching
						Color Temp
		F3				Gamma
						Projection
						Test Pattern [Default]
						Brightness
						Contrast
						Sleep Timer
						Color Matching
		12V Trigger				Color Temp
						Gamma
						Projection
						Off
					On	

USING THE PROJECTOR

Main Menu	Sub Menu	Sub Menu 2	Sub Menu 3	Sub Menu 4	Values			
Setup	Options	Language			English [Default]			
					Deutsch			
					Français			
					Italiano			
					Español			
					Português			
					Polski			
					Nederlands			
					Svenska			
					Norsk/Dansk			
					Suomi			
					ελληνικά			
					繁體中文			
					簡體中文			
					日本語			
					한국어			
					Русский			
					Magyar			
					Čeština			
					عربي			
				ไทย				
				Türkçe				
				فارسی				
				Tiếng Việt				
				Bahasa Indonesia				
				Română				
				Slovenčina				
				Closed Captioning			CC1	
								CC2
				Menu Settings	Menu Location		Off [Default]	
								Top left 
								Top right 
						Center  [Default]		
						Bottom left 		
					Bottom right 			
			Menu Timer		Off			
						5sec		
						10sec [Default]		
		Auto Source			Off [Default]			
						On		

USING THE PROJECTOR

Main Menu	Sub Menu	Sub Menu 2	Sub Menu 3	Sub Menu 4	Values	
Setup	Options	Input Source			HDMI1	
					HDMI2	
					VGA	
					Video	
		Input Name	HDMI1			Default [Default]
						Custom
			HDMI2			Default [Default]
						Custom
			VGA			Default [Default]
						Custom
			Video			Default [Default]
						Custom
		High Altitude			Off [Default]	
					On	
		Display Mode Lock			Off [Default]	
					On	
		Keypad Lock			Off [Default]	
					On	
		Information Hide			Off [Default]	
					On	
		Logo			Default [Default]	
					Neutral	
					User	
		Background Color			None	
					Blue [Default]	
					Red	
					Green	
					Gray	
	Reset	Reset OSD			Cancel [Default]	
					Yes	
		Reset to Default			Cancel [Default]	
					Yes	
Auto upgrade FW				Off [Default]		
				On		

USING THE PROJECTOR

Main Menu	Sub Menu	Sub Menu 2	Sub Menu 3	Sub Menu 4	Values
Network	LAN	Network Status			(read only)
		MAC Address			(read only)
		DHCP			Off [Default]
					On
		IP Address			192.168.0.100 [Default]
		Subnet Mask			255.255.255.0 [Default]
		Gateway			192.168.0.254 [Default]
		DNS			192.168.0.51 [Default]
	Reset				
	Control	Crestron			Off
					On [Default] Note: Port 41794
		Extron			Off
					On [Default] Note: Port 2023
		PJ Link			Off
				On [Default] Note: Port 4352	
AMX Device Discovery				Off	
				On [Default] Note: Port 9131	
Telnet			Off		
			On [Default] Note: Port 23		
HTTP			Off		
			On [Default] Note: Port 80		
Info	Regulatory				
	Serial Number				
	Source				
	Resolution			00x00	
	Refresh Rate			0.00Hz	
	Display Mode				
	Power Mode (Standby)				
	Light Source Hours			0 hr	
	Network Status				
	IP Address				
	Projector ID			00~99	
	Brightness Mode				
	FW Version	System			
		LAN			
MCU					

USING THE PROJECTOR

Display menu

Display image settings menu

Display Mode

There are several predefined display modes that you can choose from to suit your viewing preference. Each mode has been fine-tuned by our expert colour team to ensure superior colour performance for wide range of content.

- **Presentation:** This mode is suitable for most presenting needs for business and education environments.
- **Bright:** This mode is suitable for environments where extra-high brightness is required, such as using the projector in well-lit rooms.
- **HDR / HLG:** Decodes and displays High Dynamic Range (HDR) / Hybrid Log Gamma (HLG) content for the deepest blacks, brightest whites, and vivid cinematic color using REC.2020 color gamut. This mode will be automatically enabled if HDR/HLG is set to Auto (and HDR/HLG Content is sent to projector – 4K UHD Blu-ray, 1080p/4K UHD HDR/HLG Games, 4K UHD Streaming Video). While HDR/HLG mode is active, other display modes (Cinema, Reference, etc.) cannot be selected as HDR/HLG delivers color that is highly accurate, exceeding the color performance of the other display modes.
- **Cinema:** Provides the best balance of detail and colors for watching movies.
- **Game:** Optimises your projector for maximum contrast and vivid colours allowing you to see shadow detail when playing video games.
- **Reference:** This mode reproduces colours as close as possible the image the way the movie director intended. Color, color temperature, brightness, contrast and gamma settings are all configured to Rec.709 color gamut. Select this mode for the most accurate colour reproduction when watching movies.
- **DICOM SIM.:** This mode has been created for viewing greyscale images, perfect for viewing X-rays and scans during medical training*.
Note: **This projector is not suitable for use in medical diagnosis.*
- **User:** Memorizes user defined setting, tailor your own display mode settings.
- **3D:** Optimized settings for watching 3D content.
Note: *To experience the 3D effect, you will need to have compatible DLP Link 3D glasses. See 3D section for more information.*

Wall Color

Designed to adjust the colors of the projected image when projecting on to a wall without a screen. Each mode has been fine-tuned by our expert colour team to ensure superior color performance.

There are several predefined modes that you can choose from to suit the colour of your wall. Select between off, blackboard, light yellow, light green, light blue, pink, and gray.

Note: *For accurate color reproduction, we recommend using a screen.*

USING THE PROJECTOR

Dynamic Range

Configure the High Dynamic Range (HDR) / Hybrid Log Gamma(HLG) setting and its effect when displaying video from 4K Blu-ray players and streaming devices.

Note: Only HDMI supports the Dynamic Range function.

➤ HDR / HLG

- **Off:** Turn off HDR/HLG Processing. When set to Off, the projector will NOT decode HDR/HLG content.
- **Auto:** Auto detect HDR/HLG signal.

➤ HDR Picture Mode

- **Bright:** Choose this mode for brighter more saturated colors.
- **Standard:** Choose this mode for natural looking colors with a balance of warm and cool tones.
- **Film:** Choose this mode for improved detail and image sharpness.
- **Detail:** The signal comes from OETF conversion to achieve the best color matching.

Brightness

Adjust the brightness of the image.

Contrast

The contrast controls the degree of difference between the lightest and darkest parts of the picture.

Sharpness

Adjust the sharpness of the image.

Color

Adjust a video image from black and white to fully saturated color.

Tint

Adjust the color balance of red and green.

Gamma

Set up gamma curve type. After the initial setup and fine tuning is completed, utilize the Gamma Adjustment steps to optimize your image output.

- **Film:** For home theater.
- **Video:** For video or TV source.
- **Graphics:** For PC / Photo source.
- **Standard(2.2):** For standardized setting.
- **1.8 / 2.0 / 2.4 / 2.6:** For specific PC / Photo source.

Note:

- *These options are only available if the 3D mode function is disabled, the **Wall Color** setting is not set to **Blackboard**, and the **Display Mode** setting is not set to **DICOM SIM.** or **HDR.***
- *In 3D mode, user can only select **3D** for **Gamma** setting.*
- *If the **Wall Color** setting is set to **Blackboard**, user can only select **Blackboard** for **Gamma** setting.*
- *If the **Display Mode** setting is set to **HDR**, user can only select **HDR** for **Gamma** setting.*
- *If the **Display Mode** setting is set to **DICOM SIM.**, user can only select **DICOM SIM.** for **Gamma** setting.*

USING THE PROJECTOR

Color Settings

Configure the color settings.

- **BrilliantColor™**: This adjustable item utilizes a new color-processing algorithm and enhancements to enable higher brightness while providing true, more vibrant colors in picture.
- **Color Temperature**: Select a color temperature from Warm, Standard, Cool, or Cold.
- **Color Matching**: Select the following options:
 - Color: Adjust the red, green, black, cyan, yellow, magenta, and white level of the image.
 - Hue / R(red)*: Adjust the color balance of red and green.
Note: **If the **Color** setting is set to **White**, you can adjust the red color setting.*
 - Saturation / G(green)*: Adjust a video image from black and white to fully saturated color.
Note: **If the **Color** setting is set to **White**, you can adjust the green color setting.*
 - Gain / B(blue)*: Adjust the image brightness.
Note: **If the **Color** setting is set to **White**, you can adjust the blue color setting.*
 - Reset: Return the factory default settings for color matching.
 - Exit: Exit the “Color Matching” menu.
- **RGB Gain/Bias**: This settings allows to configure the brightness (gain) and contrast (bias) of an image.
 - Reset: Return the factory default settings for RGB gain/bias.
 - Exit: Exit the “RGB Gain/Bias” menu.
- **Color Space (non-HDMI input only)**: Select an appropriate color matrix type from the following: Auto, RGB, or YUV.
- **Color Space (HDMI input only)**: select an appropriate color matrix type from the following: Auto, RGB(0-255), RGB(16-235), and YUV.
- **White Level**: Allow user to adjust White Level when inputting Video signals.
Note: *White level can only be adjusted for Video/S-Video input sources.*
- **Black Level**: Allow user to adjust Black Level when inputting Video signals.
Note: *Black level can only be adjusted for Video/S-Video input sources.*
- **IRE**: Allow user to adjust IRE value when inputting Video signals.
Note:
 - *IRE is only available with NTSC video format.*
 - *IRE can only be adjusted for Video/S-Video input sources.*

Signal

Adjust the signal options.

- **Automatic**: Configure automatically the signal (the frequency and phase items are grayed out). If automatic is disabled, the frequency and phase items will appear for tuning and saving the settings.
- **Frequency**: Change the display data frequency to match the frequency of your computer’s graphic card. Use this function only if the image appears to flicker vertically.
- **Phase**: Synchronize the signal timing of the display with the graphic card. If the image appears to be unstable or flickers, use this function to correct it.
- **H. Position**: Adjust the horizontal positioning of the image.
- **V. Position**: Adjust the vertical positioning of the image.

Note: *This menu is only available if the input source is RGB/Component.*

USING THE PROJECTOR

Brightness Mode

Adjust the brightness mode settings.

- **DynamicBlack:** Use to automatically adjust the picture brightness in order to give optimum contrast performance.
- **Eco.:** Choose “Eco.” to dim the projector laser diode which will lower power consumption and extend the laser diode life.
- **Constant Power:** Choose the power percentage for brightness mode.
- **Constant Luminance:** Constant Luminance varies the strength of LD luminance such that the brightness maintains consistent with time.

Reset

Return the factory default settings for color settings.

Display enhanced gaming menu

Enhanced Gaming

Enable this feature to reduce response times (input latency) during gaming to 8.2ms (1080p@120Hz). All geometry settings (example: Keystone, Four Corners) will be disabled when Enhanced Gaming Mode is enabled. For more information is below.

Note:

- *The input lag by signals is described in the following table:*
- *The values in the table can vary slightly.*

Source Timing (HDMI1)	Enhanced Gaming	Output	Output Resolution	Input Lag
1080p60	On	1080p60Hz	1080p	16.2ms
1080p120	On	1080p120Hz	1080p	8.2ms
4K60	On	1080p60Hz	1080p	16.8ms
1080p60	Off	1080p60Hz	1080p	49.5ms
1080p120	Off	1080p120Hz	1080p	24.8ms
4K60	Off	1080p60Hz	1080p	49.9ms

Source Timing (HDMI2)	Enhanced Gaming	Output	Output Resolution	Input Lag
1080p60	On	1080p60Hz	1080p	16.2ms
1080p120	On	1080p120Hz	1080p	8.2ms
1080p60	Off	1080p60Hz	1080p	49.5ms
1080p120	Off	1080p120Hz	1080p	24.8ms

- *Please note that if “Enhanced Gaming” mode is enabled, the 3D, Aspect Ratio, Edge Mask, Digital Zoom, Image Shift, and Geometric Correction functions are disabled automatically. These functions and settings will be restored when “Enhanced Gaming Mode” is disabled.*

USING THE PROJECTOR

Display 3D menu

Note:

- *This projector is a 3D ready projector with DLP-Link 3D solution.*
- *Please make sure your 3D glasses are use for DLP-Link 3D before enjoy your video.*
- *This projector supports frame sequential (page-flip) 3D via HDMI1/HDMI2/VGA ports.*
- *To enable 3D mode, the input frame rate should be set to 60Hz only, lower or higher frame rate is not supported.*
- *To reach the best performance, resolution 1920x1080 is recommended, please be noted that 4K (3840x2160) resolution is not supported in 3D mode.*

3D Mode

Use this option to disable or enable the 3D function.

- **Off:** Select “Off” to turn off 3D mode.
- **On:** Select “On” to turn on 3D mode.

3D Tech

Use this option to select 3D technology.

- **DLP-Link:** Select to use optimized settings for DLP 3D Glasses.
- **3D Sync:** Select to use optimized settings for IR, RF or polarized 3D Glasses.

3D → 2D

Use this option to specify how the 3D content should appear on the screen.

- **3D:** Display 3D signal.
- **L (Left):** Display the left frame of 3D content.
- **R (Right):** Display the right frame of 3D content.

3D Format

Use this option to select the appropriate 3D format content.

- **Auto:** When a 3D identification signal is detected, the 3D format is selected automatically.
- **SBS:** Display 3D signal in “Side-by-Side” format.
- **Top and Bottom:** Display 3D signal in “Top and Bottom” format.
- **Frame Sequential:** Display 3D signal in “Frame Sequential” format.
- **Frame Packing:** Display 3D signal in “Frame Packing” format.

3D Sync Invert

Use this option to enable/disable the 3D sync invert function.

Reset

Return the factory default setting for 3D settings.

- **Cancel:** Select to cancel Reset.
- **Yes:** Select to return the factory default settings for 3D.

USING THE PROJECTOR

Display aspect ratio menu

Aspect Ratio

Select the aspect ratio of the displayed image between the following options:

- **4:3:** This format is for 4:3 input sources.
- **16:9:** This format is for 16:9 input sources, like HDTV and DVD enhanced for Wide screen TV.
- **LBX:** This format is for non-16x9, letterbox source and if you use external 16x9 lens to display 2.35:1 aspect ratio in full resolution.
- **Native:** This format displays the original image without any scaling.
- **Auto:** Automatically selects the appropriate display format.

Note: Detailed informations about LBX mode:

- Some Letter-Box Format DVDs are not enhanced for 16x9 TVs. In this situation, the image will not look right when displaying image in 16:9 mode. In this situation, please try to use the 4:3 mode to view the DVD. If the content is not 4:3, there will be black bars around the image in 16:9 display. For this type of content, you can use LBX mode to fill the image on the 16:9 display.
- If you use an external anamorphic lens, this LBX mode also allows you to watch a 2.35:1 content (include Anamorphic DVD and HDTV film source) that supports anamorphic wide is enhanced for 16x9 Display in a wide 2.35:1 image. In this case, there are no black bars. Light source power and vertical resolution are fully utilized.

1080p scaling table:

16:9 screen	480i/p	576i/p	1080i/p	720p	PC
4x3	Scale to 1440x1080.				
16x9	Scale to 1920x1080.				
Native mode	- 1:1 mapping centered. - No scaling will be made; the image is displayed with the resolution based on input source.				

1080p auto mapping rule:

Auto	Input resolution		Auto/Scale	
	H-resolution	V-resolution	1920	1080
4:3	640	480	1440	1080
	800	600	1440	1080
	1024	768	1440	1080
	1280	1024	1440	1080
	1400	1050	1440	1080
	1600	1200	1440	1080
Wide Laptop	1280	720	1920	1080
	1280	768	1800	1080
	1280	800	1728	1080
SDTV	720	576	1350	1080
	720	480	1620	1080
HDTV	1280	720	1920	1080
	1920	1080	1920	1080

USING THE PROJECTOR

Display edge mask menu

Edge Mask

Use this function to remove the video encoding noise on the edge of video source.

Display digital zoom menu

Digital Zoom

Use to reduce or magnify an image on the projection screen. Digital Zoom is not the same as optical zoom and an result in degradation of image quality.

Note: *Zoom settings are retained on power cycle of the projector.*

Display image shift menu

Image Shift

Adjust the projected image position horizontally (H) or vertically (V).

Display geometric correction menu

Four Corners

This setting allows the projected image to be adjusted from each corner to make a square image when the projection surface is not level.

Note: *While adjusting the Four Corners, the Digital Zoom, Aspect Ratio, and Image Shift menus are disabled. To enable Digital Zoom, Aspect Ratio, and Image Shift, reset the Four Corners settings to the factory defaults.*

H Keystone

Adjust image distortion horizontally and make a squarer image. Horizontal keystone is used to correct a keystone image shape in which the left and right borders of the image are unequal in length. This is intended for use with horizontally on-axis applications.

V Keystone

Adjust image distortion vertically and make a squarer image. Vertical keystone is used to correct a keystone image shape in which the top and bottom are slanted to one of the sides. This is intended when for use with vertically on-axis applications.

Auto Keystone

Correct keystone digitally to fit the projected image on the area on which you are projecting.

Note:

- *The image size will reduce slightly when adjusting the horizontal and vertical keystone.*
- *When the Auto Keystone is used, the Four Corner Adjustment function will be disabled.*

USING THE PROJECTOR

Audio menu

Audio mute menu

Mute

Use this option to temporarily turn off the sound.

- **On:** Choose “On” to turn mute on.
- **Off:** Choose “Off” to turn mute off.

Note: “Mute” function affects both internal and external speaker volume.

Audio volume menu

Volume

Adjust the volume level.

Audio audio input menu

Audio Input

Select the audio input port for the video sources as follows:

- **HDMI1:** Default, Audio 1, Audio 2, or Mic.
- **HDMI2:** Default, Audio 1, Audio 2, or Mic.
- **VGA:** Audio 1, Audio 2, or Mic.
- **Video:** Audio 1, Audio 2, or Mic.

USING THE PROJECTOR

Setup menu

Setup projection menu

Projection

Select the preferred projection between front, rear, ceiling-top, and rear-top.

Setup power settings menu

Direct Power On

Choose “On” to activate Direct Power mode. The projector will automatically power on when AC power is supplied, without pressing the “Power” key on the projector keypad or on the remote control.

Signal Power On

Choose “On” to activate Signal Power mode. The projector will automatically power on when a signal is detected, without pressing the “Power” key on the projector Keypad or on the remote control.

Note:

- *If the “Signal Power On” option is turned “On”, the power consumption of the projector in standby mode will be over 3W.*
- *This function is applicable with VGA and HDMI sources.*

Auto Power Off (min.)

Sets the countdown timer interval. The countdown timer will start, when there is no signal being sent to the projector. The projector will automatically power off when the countdown has finished (in minutes).

Sleep Timer (min.)

Configure the sleep timer.

- **Sleep Timer (min.):** Sets the countdown timer interval. The countdown timer will start, with or without a signal being sent to the projector. The projector will automatically power off when the countdown has finished (in minutes).
Note: *The Sleep Timer is reset every time when the projector is powered off.*
- **Always On:** Check to set the sleep timer always on.

Power Mode (Standby)

Set the power mode setting.

- **Active:** Choose “Active” to return to normal standby.
- **Eco:** Choose “Eco.” to save power dissipation further < 0.5W.

USB Power (Standby)

Enable or disable the USB power function when the projector is in standby mode.

USING THE PROJECTOR

Setup security menu

Security

Enable this function to prompt for a password before using the projector.

- **On:** Choose “On” to use security verification when the turning on the projector.
- **Off:** Choose “Off” to be able to switch on the projector without password verification.

Note: The default password is 1234.

Security Timer

Can be select the time (Month/Day/Hour) function to set the number of hours the projector can be used. Once this time has elapsed you will be requested to enter your password again.

Change Password

Use to set or modify the password that is prompted when turning the projector on.

Setup HDMI link settings menu

Note: When you connect HDMI CEC-compatible devices to the projector with HDMI cables, you can control them on the same power on or power off status using the HDMI Link control feature in the projector's OSD. This lets one device or multiple devices in a group power on or power off via HDMI Link Feature in a typical configuration, your DVD player may be connected to the projector through an amplifier or home theater system.

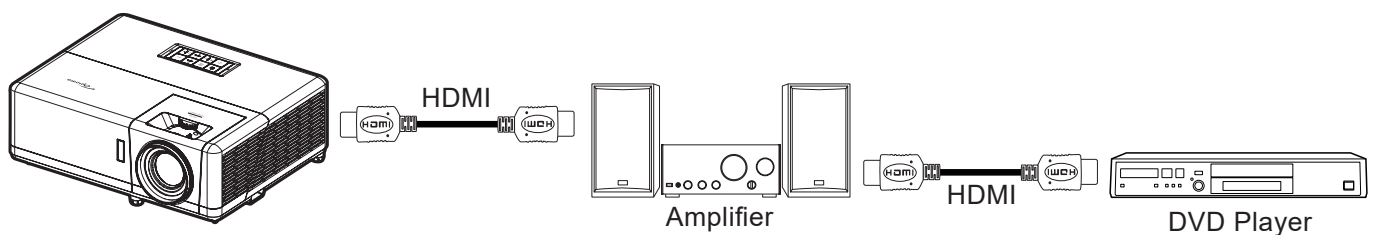

HDMI Link

Enable/disable the HDMI Link function.

Inclusive of TV

If the settings is set to “Yes” then the power on and power off link options are available.

Power On Link

CEC power on command.

- **Mutual:** Both projector and CEC device will be turned on simultaneously.
- **PJ → Device:** The CEC device will be turned on only after the projector is switched on.
- **Device → PJ:** The projector will be switched on only after the CEC device is turned on.

Power Off Link

Enable this function to let both HDMI Link and projector to be automatically turned off at the same time.

USING THE PROJECTOR

Setup test pattern menu

Test Pattern

Select the test pattern from green grid, magenta grid, white grid, white, or disable this function (off).

Setup remote settings menu

IR Function

Set the IR function setting.

- **On:** Choose “On”, the projector can be operated by the remote control from the top and front IR receivers.
- **Off:** Choose “Off”, the projector can't be operated by the remote control. By selecting “Off”, you will be able to use the Keypad keys.

F1/F2/F3

Assign the default function for F1, F2, or F3 between Test Pattern, Brightness, Contrast, Sleep Timer, Color Matching, Color Temp, Gamma, or Projection.

Setup projector ID menu

Projector ID

ID definition can be set up by menu (range 0-99), and allow user control an individual projector by using RS232 command.

Note: For a full list of RS232 commands, please refer to the RS232 user manual on our website.

Setup 12V trigger menu

12V Trigger

Use this function to enable or disable the trigger.

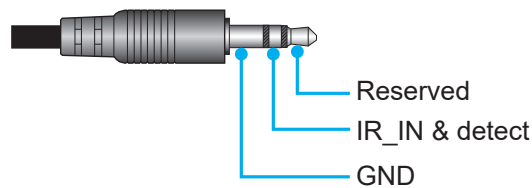

- **Off:** Choose “Off” to disable the trigger.
- **On:** Choose “On” to enable the trigger.

USING THE PROJECTOR

Setup options menu

Language

Select the multilingual OSD menu between English, German, French, Italian, Spanish, Portuguese, Polish, Dutch, Swedish, Norwegian, Danish, Finnish, Greek, Traditional Chinese, Simplified Chinese, Japanese, Korean, Russian, Hungarian, Czechoslovak, Arabic, Thai, Turkish, Farsi, Vietnamese, Indonesian, Romanian, and Slovakian.

Closed Captioning

Closed Captioning is a text version of the program sound or other information displayed on the screen. If the input signal contains closed captions, you can turn on the feature and watch the channels. The available options include “Off”, “CC1”, and “CC2”.

Menu Settings

Set the menu location on the screen and configure menu timer settings.

- **Menu Location:** Select the menu location on the display screen.
- **Menu Timer:** Set the duration where the OSD menu stays visible on the screen.

Auto Source

Choose this option to let the projector automatically find an available input source.

Input Source

Select the input source between HDMI1, HDMI2, VGA, and Video.

Input Name

Use to rename the input function for easier identification. The available options include HDMI1, HDMI2, VGA, and Video.

High Altitude

When “On” is selected, the fans will spin faster. This feature is useful in high altitude areas where the air is thin.

Display Mode Lock

Choose “On” or “Off” to lock or unlock adjusting display mode settings.

Keypad Lock

When the keypad lock function is “On”, the Keypad will be locked. However, the projector can be operated by the remote control. By selecting “Off”, you will be able to reuse the Keypad.

Information Hide

Enable this function to hide the information message.

- **Off:** Choose “Off” to show the “searching” message.
- **On:** Choose “On” to hide the info message.

Logo

Use this function to set the desired startup screen. If changes are made, they will take effect the next time the projector is powered on.

- **Default:** The default startup screen.
- **Neutral:** Logo is not displayed on startup screen.
- **User:** Logo capture tool required.
Note: Please visit the website to download the logo capture tool.
The supported file format: png/bmp/jpg.

USING THE PROJECTOR

Background Color

Use this function to display a blue, red, green, gray color, none, or logo screen when no signal is available.

Note: *If the background color is set to “None”, then the background color is black.*

Setup reset OSD menu

Reset OSD

Return the factory default settings for OSD menu settings.

Reset to Default

Return the factory default settings for all settings.

Setup auto upgrade FW menu

Auto upgrade FW

Automatically upgrade the projector firmware.

USING THE PROJECTOR

Network menu

Network LAN menu

Network Status

Display the network connection status (read-only).

MAC Address

Display the MAC address (read-only).

DHCP

Use this option to enable or disable the DHCP function.

- **Off:** To assign IP, subnet mask, gateway, and DNS configuration manually.
- **On:** Projector will obtain an IP address automatically from your network.

Note: *Exiting OSD will automatically apply the entered values.*

IP Address

Display the IP address.

Subnet Mask

Display subnet mask number.

Gateway

Display the default gateway of the network connected to the projector.

DNS

Display the DNS number.

How to use web browser to control your projector

1. Turn "On" the DHCP option on projector to allow a DHCP server to automatically assign an IP address.
2. Open the web browser in your PC and type in the projector's IP address ("Network > LAN > IP Address").
3. Enter the user name and password, and click "Login".
The projector's configuration web interface opens.

Note:

- *The default user name and password is "admin".*
- *The steps in this section is based on Windows 7 operating system.*
- *Upon first accessing the admin webpage, you MUST change the default admin password.*

USING THE PROJECTOR

Making a direct connection from your computer to the projector*

1. Turn “Off” the DHCP option on the projector.
2. Configure the IP address, Subnet Mask, Gateway, and DNS on projector (“Network > LAN”).
3. Open **Network and Sharing Center** page on your PC, and assign the identical network parameters to your PC as set on projector. Click “OK” to save the parameters.

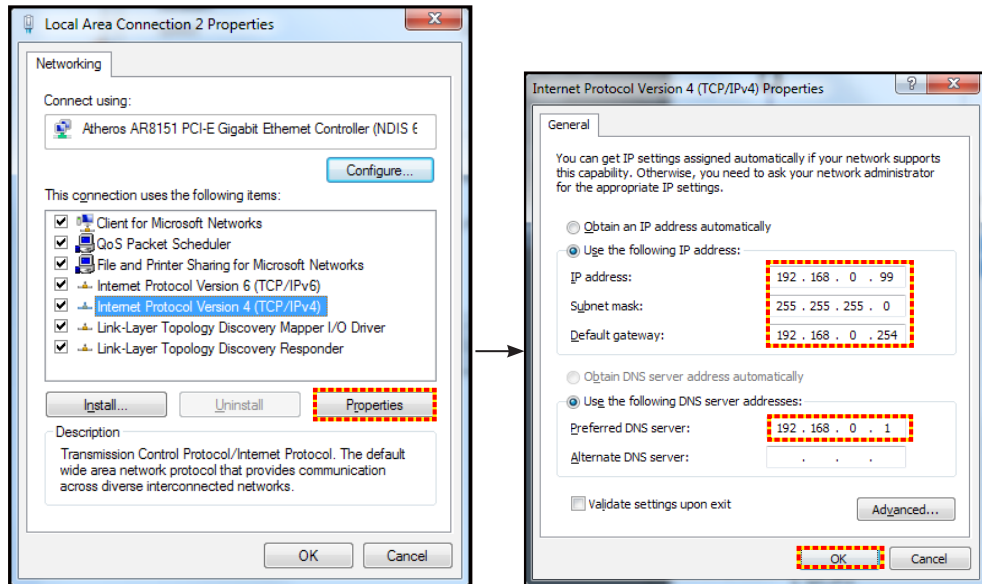

4. Open the web browser on your PC and type in to the URL field the IP address, assigned in step 3. Then press “Enter” key.

Reset

Reset all values for LAN parameters.

Network control menu

Crestron

Use this function to select the network function (port: 41794).

For more information, please visit <http://www.crestron.com> and www.crestron.com/getroomview.

Extron

Use this function to select the network function (port: 2023).

PJ Link

Use this function to select the network function (port: 4352).

AMX Device Discovery

Use this function to select the network function (port: 9131).

Telnet

Use this function to select the network function (port: 23).

HTTP

Use this function to select the network function (port: 80).

USING THE PROJECTOR

Setup network control settings menu

LAN_RJ45 function

For simplicity and ease of operation, the projector provides diverse networking and remote management features. The LAN / RJ45 function of the projector through a network, such as remotely manage: Power On / Off, brightness, and contrast settings. Also, you can view the projector status information, such as: Video- Source, Sound-Mute, etc.

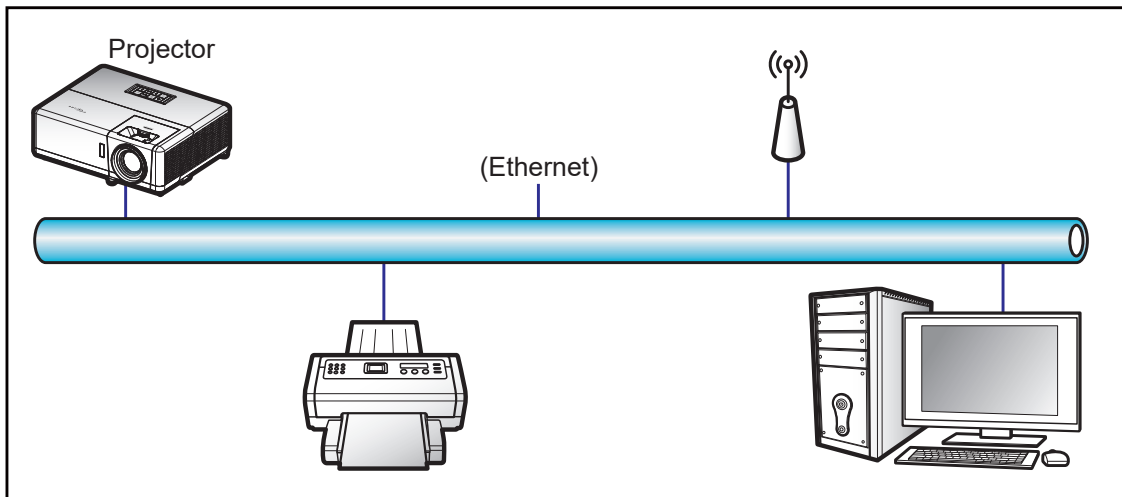

Wired LAN terminal functionalities

This projector can be controlled by using a PC (laptop) or other external device via LAN / RJ45 port and compatible with Crestron / Extron / AMX (Device -Discovery) / PJLink.

- Crestron is a registered trademark of Crestron Electronics, Inc. of the United States.
- Extron is a registered trademark of Extron Electronics, Inc. of the United States.
- AMX is a registered trademark of AMX LLC of the United States.
- PJLink applied for trademark and logo registration in Japan, the United States of America, and other countries by JBMIA.

The projector is supported by the specified commands of the Crestron Electronics controller and related software, for example RoomView®.

<http://www.crestron.com/>

This projector is compliant to support Extron device(s) for reference.

<http://www.extron.com/>

This projector is supported by AMX (Device Discovery).

<http://www.amx.com/>

This projector supports all commands of PJLink Class1 (Version 1.00).

<http://pjlink.jbmia.or.jp/english/>

For more detailed information about the various types of external devices which can be connected to the LAN / RJ45 port and remote control the projector, as well as the supported commands for these external devices, please contact the Support-Service directly.

USING THE PROJECTOR

LAN RJ45

1. Connect an RJ45 cable to RJ45 ports on the projector and the PC (laptop).

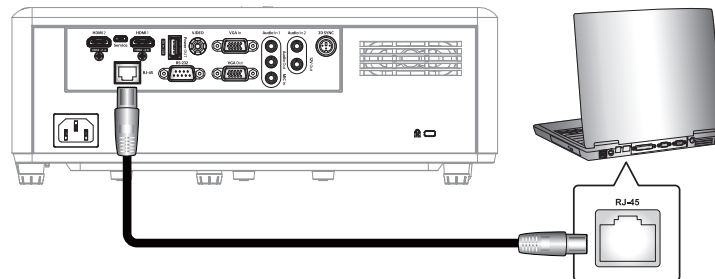

2. On the PC (Laptop), select **Start > Control Panel > Network Connections**.

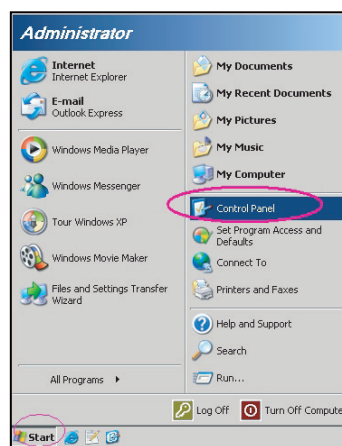

3. Right-click on the **Local Area Connection**, and select **Property**.

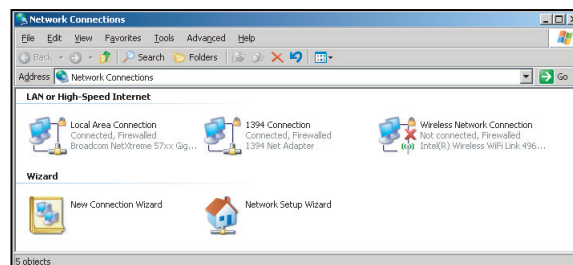

4. In the **Properties** window, select the **General tab**, and select **Internet Protocol (TCP / IP)**.

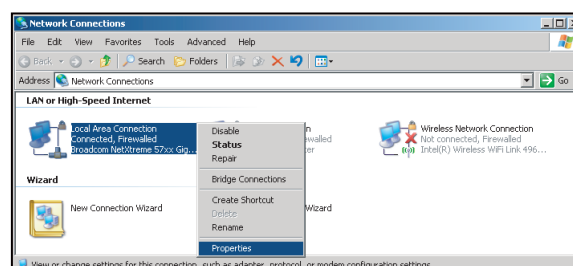

USING THE PROJECTOR

5. Click "Properties".

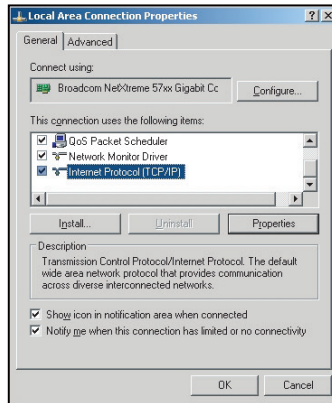

6. Type in the IP address and Subnet mask, then press "OK".

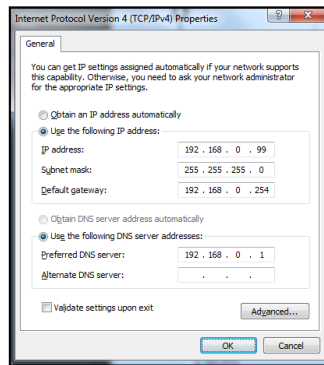

7. Press the "Menu" button on the projector.
8. Open on projector **Network > LAN**.
9. Enter the following connection parameters:
 - DHCP: Off
 - IP Address: 192.168.0.100
 - Subnet Mask: 255.255.255.0
 - Gateway: 192.168.0.254
 - DNS: 192.168.0.51
10. Press "Enter" to confirm settings.
11. Open a web browser, for example Microsoft Internet Explorer or Google Chrome.
12. In the Address bar, input the projector's IP address: 192.168.0.100.



13. Press "Enter".

USING THE PROJECTOR

The projector is setup for remote management. The LAN / RJ45 function displays as follows:

General Setup

Network Setup

Projector Control

USING THE PROJECTOR

System Status

Optoma Logout

Admin > System Status

System Status	Model Name	Optoma
General Setup	Projector Name	
Projector Control	Version	
Network Setup	Firmware Version	B04
Alert Setup	LAN Version	L05
Crestron	LAN Status	
Reset to Default	IP Address	192.168.0.100
Reboot System	Subnet Mask	255.255.255.0
	Default Gateway	192.168.0.254
	MAC Address	00:00:33:32:30:18

Contents Copyright 2018 by Optoma, Inc.

USING THE PROJECTOR

RS232 by Telnet Function

There is alternative RS232 command control way, in projector so called “RS232 by TELNET” for LAN / RJ45 interface.

Note: For a full list of RS232 commands, please refer to the RS232 user manual on our website.

Quick Start-Guide for “RS232 by Telnet”

- Check and get the IP address on OSD of the projector.
- Make sure that the PC / laptop can access the web-page of the projector.
- Make sure that “Windows Firewall” setting is set disabled in case of “TELNET” function filtering out by PC / laptop.

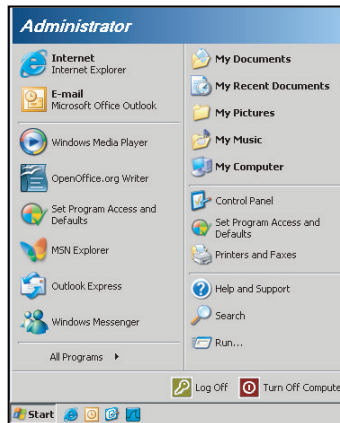

1. Select **Start > All Programs > Accessories > Command Prompt.**

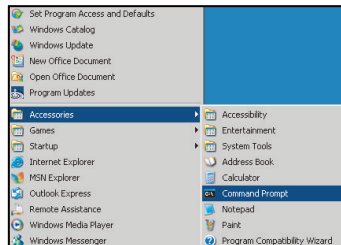

2. Input the command format as follows:
 - telnet ttt.xxx.yyy.zzz 23 (“Enter” key pressed)
 - (ttt.xxx.yyy.zzz: IP-Address of the projector)
3. If Telnet-Connection ready, and user can have RS232 command input, then “Enter” key pressed, the RS232 command will be workable.

Specification for “RS232 by TELNET”:

1. Telnet: TCP.
2. Telnet port: 23 (for more detail, kindly please get contact with the service agent or team).
3. Telnet utility: Windows “TELNET.exe” (console mode).
4. Disconnection for RS232-by-Telnet control normally: Close
5. Windows Telnet utility directly after TELNET connection ready.
 - Limitation 1 for Telnet-Control: there is less than 50 bytes for successive network payload for Telnet-Control application.
 - Limitation 2 for Telnet-Control: there is less than 26 bytes for one complete RS232 command for Telnet-Control.
 - Limitation 3 for Telnet-Control: Minimum delay for next RS232 command must be more than 200 (ms).

USING THE PROJECTOR

Info menu

Info menu

View the projector information as listed below:

- Regulatory
- Serial Number
- Source
- Resolution
- Refresh Rate
- Display Mode
- Power Mode (Standby)
- Light Source Hours
- Network Status
- IP Address
- Projector ID
- Brightness Mode
- FW Version

MAINTENANCE

Installing and cleaning the dust filter

Installing the dust filter

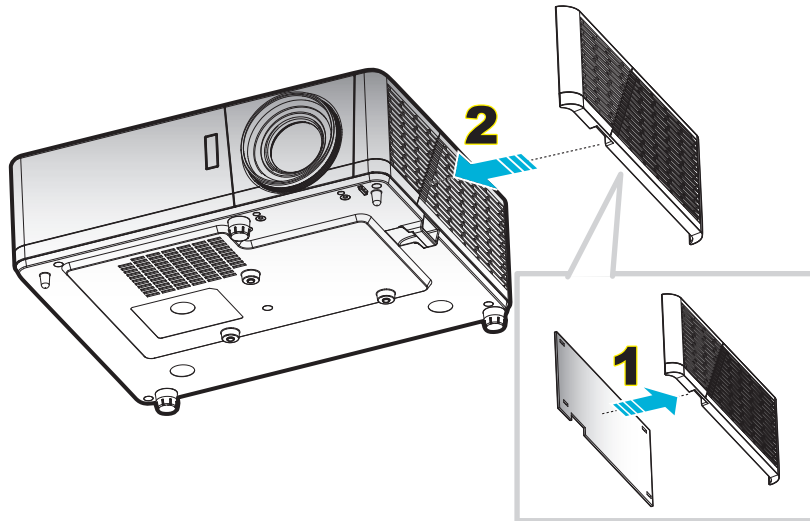

Note:

- *Dust filters are only supplied with some models in select region with excessive dust.*
- *Not available in North America or Europe.*
- *You may be available to purchase this in select regions. Please visit our website to see more details regarding the accessories included.*

Cleaning the dust filter

We recommend you to clean the dust filter every three months. Clean it more often if the projector is used in a dusty environment.

Procedure:

1. Switch off the power to the projector by pressing the  button on the projector keypad or remote control.
2. Disconnect the power cord.
3. Pull the dust filter compartment downwards to remove it out from the bottom of the projector. **1**
4. Carefully remove the air filter. Then clean or replace the dust filter. **2**
5. To install the dust filter, reverse the previous steps.

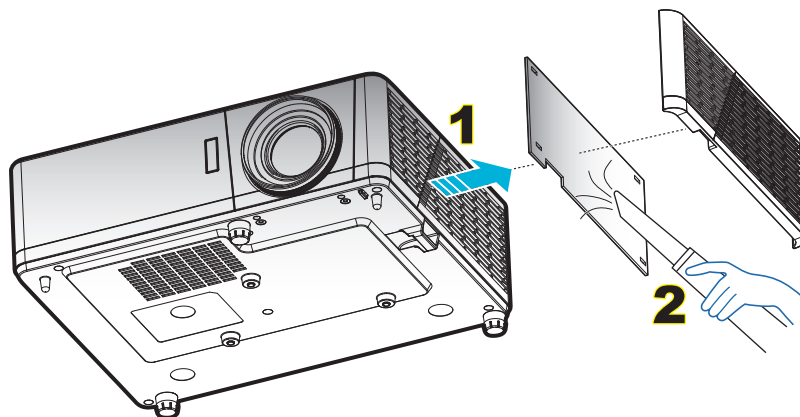

ADDITIONAL INFORMATION

Compatible resolutions

Analog

B0 / Established Timing	B0 / Standard Timing	B0 / Detail Timing	B1 / Detail Timing
720 x 400 @ 70Hz	800 x 600 @ 120Hz	1920 x 1080 @ 60Hz	1366 x 768 @ 60Hz
640 x 480 @ 60Hz	1024 x 768 @ 120Hz		1280 x 800 @ 120Hz
640 x 480 @ 66.6(67)Hz	1280 x 800 @ 60Hz		1920 x 1200 @ 60Hz
640 x 480 @ 72Hz	1280 x 1024 @ 60Hz		
640 x 480 @ 75Hz	1280 x 720 @ 60Hz		
800 x 600 @ 56Hz	640 x 480 @ 120Hz		
800 x 600 @ 60Hz			
800 x 600 @ 72Hz			
800 x 600 @ 75Hz			
832 x 624 @ 75Hz			
1024 x 768 @ 60Hz			
1024 x 768 @ 70Hz			
1024 x 768 @ 75Hz			
1280 x 1024 @ 75Hz			
1152 x 870 @ 75Hz			

HDMI 1.4

B0 / Established Timing	B0 / Standard Timing	B0 / Detail Timing	B1 / Video Mode	B1 / Detail Timing
720 x 400 @ 70Hz	1280 x 720 @ 60Hz	1920 x 1080 @ 60Hz	640 x 480p 4:3 @ 60Hz	1920 x 1080 @ 60Hz
640 x 480 @ 60Hz	1280 x 800 @ 60Hz		720 x 480p 4:3 @ 60Hz	1366 x 768 @ 60Hz
640 x 480 @ 66.6(67)Hz	1280 x 1024 @ 60Hz		720 x 480p 16:9 @ 60Hz	1920 x 1200 @ 60Hz
640 x 480 @ 72Hz	640 x 480 @ 120Hz		1280 x 720p 16:9 @ 60Hz	
640 x 480 @ 75Hz	800 x 600 @ 120Hz		1920 x 1080i 16:9 @ 60Hz	
800 x 600 @ 56Hz	1024 x 768 @ 120Hz		720(1440) x 480i 4:3 @ 60Hz	
800 x 600 @ 60Hz	1280 x 800 @ 120Hz		720(1440) x 480i 16:9 @ 60Hz	
800 x 600 @ 72Hz	1920 x 1200 @ 60Hz		1920 x 1080p 16:9 @ 60Hz	
800 x 600 @ 75Hz			720 x 576p 4:3 @ 50Hz	
832 x 624 @ 75Hz			720 x 576p 16:9 @ 50Hz	
1024 x 768 @ 60Hz			1280 x 720p 16:9 @ 50Hz	
1024 x 768 @ 70Hz			1920 x 1080i 16:9 @ 50Hz	
1024 x 768 @ 75Hz			720(1440) x 576i 4:3 @ 50Hz	
1280 x 1024 @ 75Hz			720(1440) x 576i 16:9 @ 50Hz	
1152 x 870 @ 75Hz			1920 x 1080p 16:9 @ 50Hz	
			1920 x 1080p 16:9 @ 24Hz	
			1920 x 1080p 16:9 @ 30Hz	
			3840 x 2160p 16:9 @ 24Hz	
			3840 x 2160p 16:9 @ 25Hz	
			3840 x 2160p 16:9 @ 30Hz	
			4096 x 2160p 256:135 @ 24Hz	
			4096 x 2160p 256:135 @ 25Hz	
			4096 x 2160p 256:135 @ 30Hz	

ADDITIONAL INFORMATION

HDMI 2.0

B0 / Established Timing	B0 / Standard Timing	B0 / Detail Timing	B1 / Video Mode	B1 / Detail Timing
720 x 400 @ 70Hz	1280 x 720 @ 60Hz	1920 x 1080 @ 60Hz	640 x 480p 4:3 @ 60Hz	1920 x 1080 @ 60Hz
640 x 480 @ 60Hz	1280 x 800 @ 60Hz		720 x 480p 4:3 @ 60Hz	1366 x 768 @ 60Hz
640 x 480 @ 66.6(67)Hz	1280 x 1024 @ 60Hz		720 x 480p 16:9 @ 60Hz	
640 x 480 @ 72Hz	640 x 480 @ 120Hz		1280 x 720p 16:9 @ 60Hz	
640 x 480 @ 75Hz	800 x 600 @ 120Hz		1920 x 1080i 16:9 @ 60Hz	
800 x 600 @ 56Hz	1024 x 768 @ 120Hz		720(1440) x 480i 4:3 @ 60Hz	
800 x 600 @ 60Hz	1280 x 800 @ 120Hz		720(1440) x 480i 16:9 @ 60Hz	
800 x 600 @ 72Hz	1920 x 1200 @ 60Hz		1920 x 1080p 16:9 @ 60Hz	
800 x 600 @ 75Hz			720 x 576p 4:3 @ 50Hz	
832 x 624 @ 75Hz			720 x 576p 16:9 @ 50Hz	
1024 x 768 @ 60Hz			1280 x 720p 16:9 @ 50Hz	
1024 x 768 @ 70Hz			1920 x 1080i 16:9 @ 50Hz	
1024 x 768 @ 75Hz			720(1440) x 576i 4:3 @ 50Hz	
1280 x 1024 @ 75Hz			720(1440) x 576i 16:9 @ 50Hz	
1152 x 870 @ 75Hz			1920 x 1080p 16:9 @ 50Hz	
			1920 x 1080p 16:9 @ 24Hz	
			1920 x 1080p 16:9 @ 30Hz	
			3840 x 2160p 16:9 @ 24Hz	
			3840 x 2160p 16:9 @ 25Hz	
			3840 x 2160p 16:9 @ 30Hz	
			3840 x 2160p 16:9 @ 50Hz	
			3840 x 2160p 16:9 @ 60Hz	
			4096 x 2160p 256:135 @ 24Hz	
			4096 x 2160p 256:135 @ 25Hz	
			4096 x 2160p 256:135 @ 30Hz	
			4096 x 2160p 256:135 @ 50Hz	
			4096 x 2160p 256:135 @ 60Hz	

Note: 4K Input and HDMI 2.0 Port – 4K Input feature allows the projector to “accept” 4K and 4K HDR signals, then output as 1080p HDR, the native resolution of the projector. During a signal sync, 3840x2160 will be displayed when viewing 4K or 4K HDR content. While the maximum resolution of the projector is 3840x2160, the **NATIVE resolution is 1920x1080 (1080p)**.

ADDITIONAL INFORMATION

True 3D video compatibility

		Input timing			
		Input resolutions	HDMI 1.4a 3D Input	1280 x 720P @ 50Hz	Top-and-Bottom
1280 x 720P @ 60Hz	Top-and-Bottom				
1280 x 720P @ 50Hz	Frame packing				
1280 x 720P @ 60Hz	Frame packing				
1920 x 1080i @ 50Hz	Side-by-Side(Half)				
1920 x 1080i @ 60Hz	Side-by-Side(Half)				
1920 x 1080P @ 24Hz	Top-and-Bottom				
1920 x 1080P @ 24Hz	Frame packing				
HDMI 1.3	1920 x 1080i @ 50Hz			Side-by-Side(Half)	SBS mode is on
	1920 x 1080i @ 60Hz				
	1280 x 720P @ 50Hz				
	1280 x 720P @ 60Hz				
	800 x 600 @ 60Hz				
	1024 x 768 @ 60Hz				
	1280 x 800 @ 60Hz		Top-and-Bottom	TAB mode is on	
	1920 x 1080i @ 50Hz				
	1920 x 1080i @ 60Hz				
	1280 x 720P @ 50Hz				
1280 x 720P @ 60Hz					
800 x 600 @ 60Hz					
1024 x 768 @ 60Hz					
1280 x 800 @ 60Hz					
480i	HQFS	3D format is Frame sequential			

Note:

- If 3D input is 1080p@24Hz, the DMD should replay with integral multiple with 3D mode.
- Support NVIDIA 3DTV Play if there is no patent fee from Optoma.
- 1080i@25Hz and 720p@50Hz will run in 100Hz; 1080p@24Hz will run in 144Hz; other 3D timing will run in 120Hz.

ADDITIONAL INFORMATION

Image size and projection distance

Diagonal Length Size of (16:9) Screen	Screen Size (W x H)				Projection Distance (D)				Offset (Hd)		Offset (Hd)	
	(m)		(inch)		(m)		(feet)		(m) max.	(inch) max.	(m) min.	(inch) min.
	Width	Height	Width	Height	Wide	Tele	Wide	Tele				
20.2	0.45	0.25	17.61	9.9	NA	1.0	NA	3.28	0.04	1.57	0.00	0.00
40	0.89	0.5	34.86	19.6	1.2	2.0	3.94	6.56	0.08	3.15	0.00	0.00
50	1.11	0.62	43.58	24.5	1.6	2.5	5.25	8.20	0.10	3.94	0.00	0.00
60	1.33	0.75	52.29	29.4	1.9	3.0	6.23	9.84	0.12	4.72	0.00	0.00
70	1.55	0.87	61.01	34.3	2.2	3.5	7.22	11.48	0.14	5.51	0.00	0.00
80	1.77	1	69.73	39.2	2.5	4.0	8.20	13.12	0.16	6.30	0.00	0.00
90	1.99	1.12	78.44	44.1	2.8	4.5	9.19	14.76	0.18	7.09	0.00	0.00
100	2.21	1.25	87.16	49	3.1	5.0	10.17	16.40	0.19	7.48	0.00	0.00
120	2.66	1.49	104.59	58.8	3.7	6.0	12.14	19.69	0.24	9.45	0.00	0.00
150	3.32	1.87	130.74	73.5	4.7	7.4	15.42	24.28	0.30	11.81	0.00	0.00
180	3.98	2.24	156.88	88.2	5.6	8.9	18.37	29.20	0.36	14.17	0.00	0.00
200	4.43	2.49	174.32	98.1	6.2	9.9	20.34	32.48	0.40	15.75	0.00	0.00
250	5.53	3.11	217.89	122.6	7.8	NA	25.59	NA	0.50	19.69	0.00	0.00
320.4	7.09	3.99	279.25	157.1	10.0	NA	32.81	NA	0.64	25.20	0.00	0.00

Note: Zoom Ratio: 1.6x

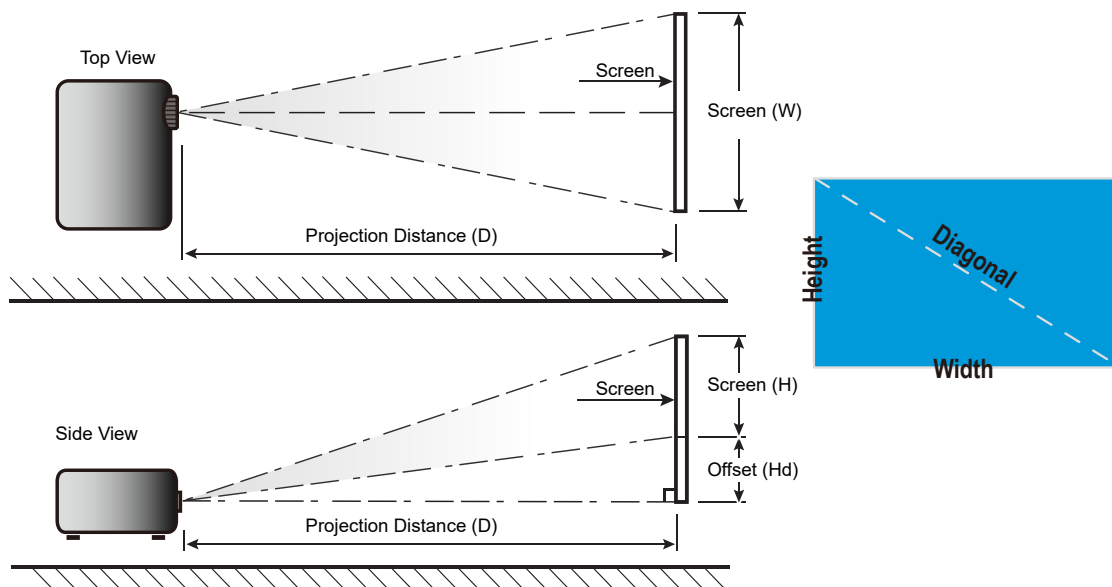

ADDITIONAL INFORMATION

Projector dimensions and ceiling mount installation

1. To prevent damage to your projector, please use the Optoma ceiling mount.
2. If you wish to use a third party ceiling mount kit, please ensure the screws used to attach a mount to the projector meet the following specifications:
 - Screw type: M4*0.7P*10mm
 - Minimum screw length: 10mm

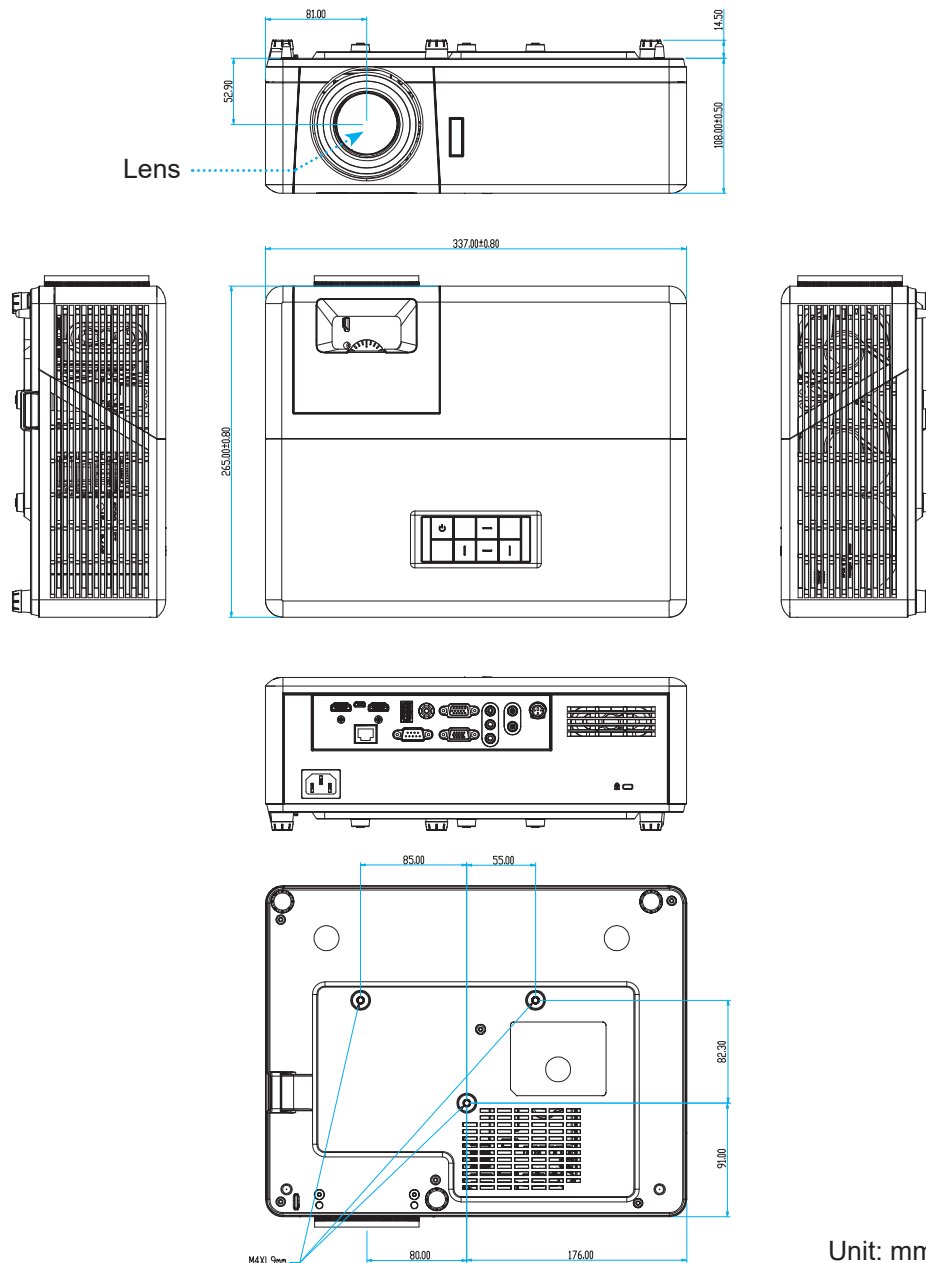

Note: Please note that damage resulting from incorrect installation will void the warranty.



Warning:

- If you buy a ceiling mount from another company, please be sure to use the correct screw size. Screw size will vary depending on the thickness of the mounting plate.
- Be sure to keep at least 10 cm gap between the ceiling and the bottom of the projector.
- Avoid installing the projector near a heat source.

ADDITIONAL INFORMATION

IR remote control 1 codes

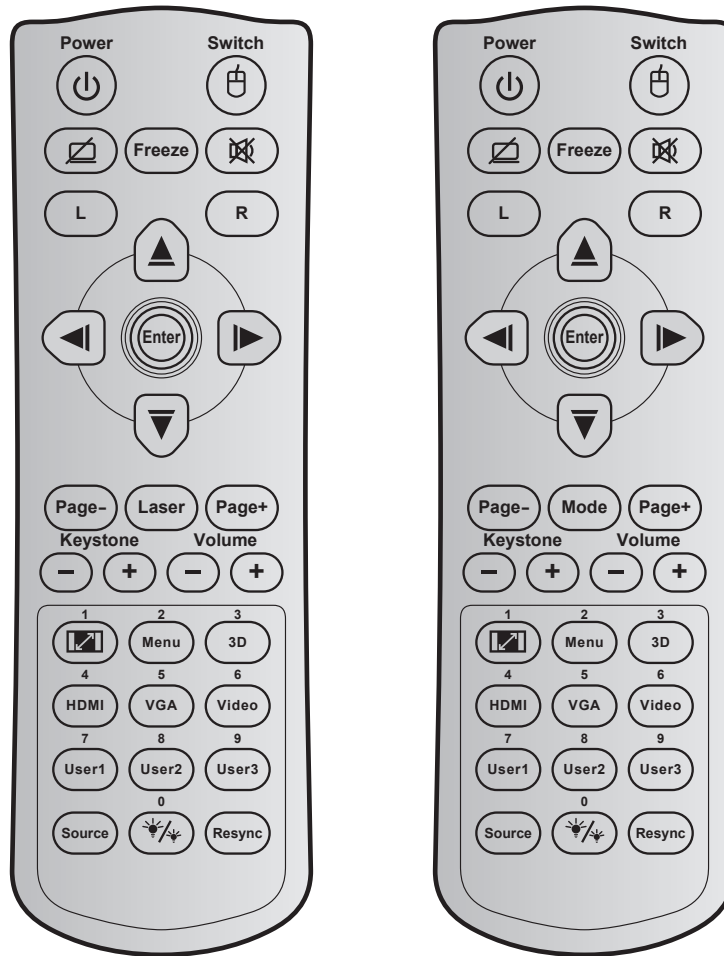

Key	Key code	Printing-key definition	Description
Power	81	Power on/off	Press to turn on / off the projector.
Switch	3E	Switch	Press to switch the USB mouse on / off.
Display blank / audio mute	8A		Press to hide / unhide the screen picture and turn off / on audio.
Freeze	8B	Freeze	Press to freeze the projector image.
Mute	92		Press to momentarily turn off / on the audio.
Mouse left click	CB	L	Use as mouse left click.
Mouse right click	CC	R	Use as mouse right click.
Four directional select keys	C6	Up arrow	Use ▲ ▼ ◀ ▶ to select items or make adjustments to your selection.
	C8	Left arrow	
	C9	Right arrow	
	C7	Down arrow	
Enter	C5	Enter	Confirm your item selection.
	CA	Enter	
Page -	C2	Page-	Press to page down.

ADDITIONAL INFORMATION

Key		Key code	Printing-key definition	Description
Laser		N/A	Laser	Use as laser pointer.
Mode		95	Mode	Press to switch Display mode on or off.
Page +		C1	Page+	Press to page up.
Keystone		85	Keystone+	Press to adjust image distortion caused by tilting the projector.
		84	Keystone-	
Volume		8C	Volume +	Press to adjust to increase / decrease the volume.
		8F	Volume -	
Aspect ratio / 1		98	/ 1	<ul style="list-style-type: none"> Press to change aspect ratio of a displayed image. Use as numeric keypad number "1".
Menu / 2		88	Menu/2	<ul style="list-style-type: none"> Press to display or exit the on-screen display menus for projector. Use as numeric keypad number "2".
3D / 3		93	3D/3	<ul style="list-style-type: none"> Press to manually select a 3D mode that matches your 3D content. Use as numeric keypad number "3".
HDMI / 4		86	HDMI/4	<ul style="list-style-type: none"> Press to choose HDMI source. Use as numeric keypad number "4".
VGA / 5		D0	VGA/5	<ul style="list-style-type: none"> Press to choose VGA source. Use as numeric keypad number "5".
Video / 6		D1	Video/6	Use as numeric keypad number "6".
User1 / 7; User2 / 8; User3 / 9		D2	User 1/7	<ul style="list-style-type: none"> User defined keys. Please see page 42 to setup. Use as numeric keypad numbers "7", "8", and "9" accordingly.
		D3	User 2/8	
		D4	User 3/9	
Source		C3	Source	Press to select an input signal.
Brightness mode / 0		96	/ 0	<ul style="list-style-type: none"> Press to automatically adjust the picture brightness to give an optimum contrast performance. Use as numeric keypad number "0".
Re-sync		C4	Re-Sync	Press to automatically synchronize the projector to the input source.





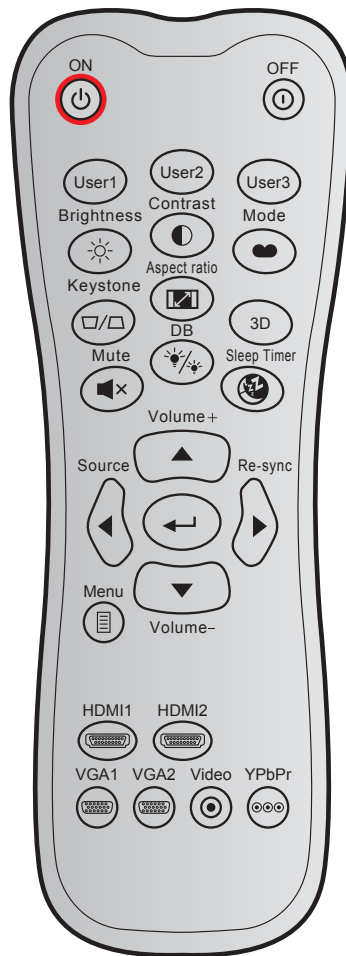









ADDITIONAL INFORMATION

IR remote control 2 codes



Key		Custom code		Data code	Printing-key definition	Description
		Byte 1	Byte 2	Byte 3		
Power on		32	CD	02	ON	Press to turn on the projector.
Power off		32	CD	2E	OFF	Press to turn off the projector.
User 1		32	CD	36	User1	User defined keys. Please see page 42 to setup.
User 2		32	CD	65	User2	
User 3		32	CD	66	User3	
Brightness		32	CD	41	Brightness	Adjust the brightness of the image.
Contrast		32	CD	42	Contrast	Control the degree of difference between the lightest and darkest parts of the picture.
Display mode		32	CD	05	Mode	Select a display mode for optimized settings for different applications. Please see page 32.
Keystone		32	CD	07	Keystone	Adjust image distortion caused by tilting the projector.

ADDITIONAL INFORMATION







Key		Custom code		Data code	Printing-key definition	Description
		Byte 1	Byte 2	Byte 3		
Aspect ratio		32	CD	64	Aspect ratio	Press to change aspect ratio of a displayed image.
3D		32	CD	89	3D	Manually select a 3D mode that matches your 3D content.
Volume +		32	CD	09	Volume +	Adjust to increase volume.
Four direction keys		32	CD	11	▲	Use ▲, ◀, ▶, or ▼ to select items or make adjustments to your selection.
		32	CD	10	◀	
		32	CD	12	▶	
		32	CD	14	▼	
Source		32	CD	18	Source	Press "Source" to select an input signal.
Enter key		32	CD	0F		Confirm your item selection.
Re-sync		32	CD	04	Re-sync	Automatically synchronizes the projector to the input source.
Volume -		32	CD	0C	Volume -	Adjust to decrease volume.
Menu		32	CD	0E	Menu	Display or exit the on-screen display menus for projector.
HDMI 1		32	CD	16	HDMI1	Press "HDMI1" to choose source from HDMI 1 connector.
HDMI 2		32	CD	30	HDMI2	Press "HDMI2" to choose source from HDMI 2 connector.
VGA 1		32	CD	1B	VGA1	Press "VGA1" to choose source from VGA In connector.
VGA 2		32	CD	1E	VGA2	No function
Video		32	CD	1C	Video	No function
YPbPr		32	CD	17	YPbPr	No function

ADDITIONAL INFORMATION

Troubleshooting

If you experience a problem with your projector, please refer to the following information. If a problem persists, please contact your local reseller or service center.

Image problems

-  *No image appears on-screen*
- Ensure all the cables and power connections are correctly and securely connected as described in the "Installation" section.
 - Ensure the pins of connectors are not crooked or broken.
 - Ensure that the "Mute" feature is not turned on.
-  *Image is out of focus*
- Turn the focus ring clockwise or counterclockwise until the image is sharp and legible. (Please see page 18).
 - Make sure the projection screen is between the required distance from the projector. (Please refer to page 58).
-  *The image is stretched when displaying 16:9 DVD title*
- When you play anamorphic DVD or 16:9 DVD, the projector will show the best image in 16: 9 format on projector side.
 - If you play the V-Stretch format DVD title, please change the format as V-Stretch in projector OSD.
 - If you play 4:3 format DVD title, please change the format as 4:3 in projector OSD.
 - Please setup the display format as 16:9 (wide) aspect ratio type on your DVD player.
-  *Image is too small or too large*
- Turn the zoom lever clockwise or counterclockwise to increase or decrease the projected image size. (Please see page 18).
 - Move the projector closer to or further from the screen.
 - Press "Menu" on the projector panel, go to "Display → Aspect Ratio". Try the different settings.
-  *Image has slanted sides:*
- If possible, reposition the projector so that it is centered on the screen and below the bottom of the screen.
-  *Image is reversed*
- Select "Setup → Projection" from the OSD and adjust the projection direction.

ADDITIONAL INFORMATION

Other problems



The projector stops responding to all controls

- If possible, turn off the projector, then unplug the power cord and wait at least 20 seconds before reconnecting power.

Remote control problems



If the remote control does not work

- Check the operating angle of the remote control is pointed within $\pm 30^\circ$ to the IR receiver on the projector.
- Make sure there are not any obstructions between the remote control and the projector. Move to within 12 m (39.4 ft) of the projector.
- Make sure batteries are inserted correctly.
- Replace batteries if they are exhausted.

ADDITIONAL INFORMATION

Warning indicators

When the warning indicators (see below) light up or flash, the projector will automatically shutdown:

- “Lamp” LED indicator is lit red and if “Power” indicator flashes red.
- “Temp” LED indicator is lit red and if “Power” indicator flashes red. This indicates the projector has overheated. Under normal conditions, the project can be switched back on.
- “Temp” LED indicator flashes red and if “Power” indicator flashes red.

Unplug the power cord from the projector, wait for 30 seconds and try again. If the warning indicator light up or flash, please contact your nearest service center for assistance.

LED lightning messages

Message	Power LED		Temp LED	Lamp LED
	(Red)	(Blue)	(Red)	(Red)
Standby state (Input power cord)	Steady light			
Power on (Warming)		Flashing (0.5 sec off / 0.5 sec on)		
Power on and Lamp lighting		Steady light		
Power off (Cooling)		Flashing (0.5 sec off / 0.5 sec on). Back to red steady light when cooling fan turns off.		
Quick Resume(100 secs)		Flashing (0.25 sec off / 0.25 sec on)		
Error (Lamp failure)	Flashing			Steady light
Error (Fan failure)	Flashing		Flashing	
Error (Over temp.)	Flashing		Steady light	

- Power off:

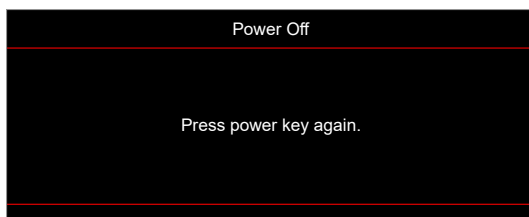

- Temperature warning:

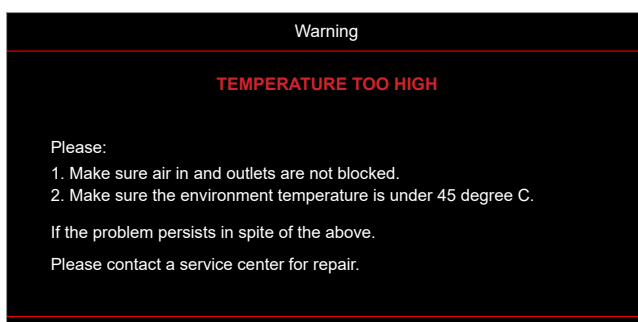

ADDITIONAL INFORMATION

Specifications

Item	Description
Technology	Texas Instrument DMD, 0.65"/1080p DMD X1
Native Resolution	1920x1080
Lens	<ul style="list-style-type: none"> • Throw ratio: 1.4~2.24 • F-stop: 2.5~3.26 • Focal length: 20.911~32.62 mm • Zoom range: 1.6x
Offset	100%~116% ±5%
Image size	20.2"~320.4" (optimized@60")
Projection distance	1m to 10m (optimized@1.87m)
I/Os	<ul style="list-style-type: none"> • HDMI-1 V2.0 (HDCP2.2) • HDMI-2 V1.4 (HDCP1.4) • VGA In • VGA Out • Video • USB Type-A for Power USB 5V/1.5A • Micro USB (for service) • Audio In 3.5mm (x2) • Audio Out 3.5mm • MIC In • 12V Out • 3D SYNC • RS232 • RJ-45 (support web control)
Colour	1073.4 Million color
Scan rate	<ul style="list-style-type: none"> • Horizontal scan rate: 15.375~91.146 KHz • Vertical scan rate: 50~85 Hz (120Hz for 3D feature projector)
Speaker	10W x2
Power consumption	<ul style="list-style-type: none"> • Minimum (ECO mode): <ul style="list-style-type: none"> • 220W (typical), 235W(max)@110VAC • 197W (typical), 227W(max)@220VAC • Maximum (Bright mode): <ul style="list-style-type: none"> • 230W (typical), 292W(max)@110VAC • 245W (typical), 282W(max)@220VAC
Input current	3.2A
Installation orientations	Front, Rear, Ceiling, Rear-top
Dimensions (W x D x H)	<ul style="list-style-type: none"> • Without feet: 337 x 265 x 108 mm (13.27 x 10.43 x 4.25 inches) • With feet: 337 x 265 x 122.5 mm (13.27 x 10.43 x 4.82 inches)
Weight	< 5.0 kg (11.02 lbs)
Environmental	Operating in 5~40°C, 10% to 85% humidity (non-condensing)

Note: All specifications are subject to change without notice.



ADDITIONAL INFORMATION

Optoma global offices

For service or support, please contact your local office.



USA

47697 Westinghouse Drive,
Fremont, CA 94539, USA
www.optomausa.com

 888-289-6786
 510-897-8601
 services@optoma.com



Canada

47697 Westinghouse Drive,
Fremont, CA 94539, USA
www.optomausa.com

 888-289-6786
 510-897-8601
 services@optoma.com

Latin America

47697 Westinghouse Drive,
Fremont, CA 94539, USA
www.optomausa.com

 888-289-6786
 510-897-8601
 services@optoma.com



Europe

Unit 1, Network 41, Bourne End Mills
Hemel Hempstead, Herts,
HP1 2UJ, United Kingdom
www.optoma.eu
Service Tel : +44 (0)1923 691865

 +44 (0) 1923 691 800
 +44 (0) 1923 691 888
 service@tsc-europe.com



Benelux BV

Randstad 22-123
1316 BW Almere
The Netherlands
www.optoma.nl

 +31 (0) 36 820 0252
 +31 (0) 36 548 9052



France

Bâtiment E
81-83 avenue Edouard Vaillant
92100 Boulogne Billancourt, France

 +33 1 41 46 12 20
 +33 1 41 46 94 35
 savoptoma@optoma.fr



Spain

C/ José Hierro,36 Of. 1C
28522 Rivas VaciaMadrid,
Spain

 +34 91 499 06 06
 +34 91 670 08 32



Deutschland

Am Nordpark 3
41069 Mönchengladbach
Germany

 +49 (0) 2161 68643 0
 +49 (0) 2161 68643 99
 info@optoma.de

Scandinavia



Lerpeveien 25
3040 Drammen
Norway

 +47 32 98 89 90
 +47 32 98 89 99
 info@optoma.no

PO.BOX 9515
3038 Drammen
Norway

Korea

WOOMI TECH.CO.,LTD.
4F, Minu Bldg.33-14, Kangnam-Ku,
Seoul,135-815, KOREA
korea.optoma.com

 +82+2+34430004
 +82+2+34430005



Japan

東京都足立区綾瀬3-25-18
株式会社オーエス
コンタクトセンター:0120-380-495

 info@os-worldwide.com
www.os-worldwide.com



Taiwan

12F., No.213, Sec. 3, Beixin Rd.,
Xindian Dist., New Taipei City 231,
Taiwan, R.O.C.
www.optoma.com.tw

 +886-2-8911-8600
 +886-2-8911-6550
 services@optoma.com.tw
asia.optoma.com



Hong Kong

Unit A, 27/F Dragon Centre,
79 Wing Hong Street,
Cheung Sha Wan,
Kowloon, Hong Kong

 +852-2396-8968
 +852-2370-1222
www.optoma.com.hk

China

Room 2001, 20F, Building 4,
No.1398 Kaixuan Road,
Changning District,
Shanghai, 200052, China

 +86-21-62947376
 +86-21-62947375
www.optoma.com.cn

