

# Panasonic®

## Operating Instructions Functional Manual

UHD LCD Display For business use

Model No.	TH-86EQ2W	<span style="border: 1px solid black; border-radius: 5px; padding: 2px;">86-inch model</span>
	TH-75EQ2W	<span style="border: 1px solid black; border-radius: 5px; padding: 2px;">75-inch model</span>
	TH-65EQ2W	<span style="border: 1px solid black; border-radius: 5px; padding: 2px;">65-inch model</span>
	TH-55EQ2W	<span style="border: 1px solid black; border-radius: 5px; padding: 2px;">55-inch model</span>
	TH-50EQ2W	<span style="border: 1px solid black; border-radius: 5px; padding: 2px;">50-inch model</span>
	TH-43EQ2W	<span style="border: 1px solid black; border-radius: 5px; padding: 2px;">43-inch model</span>

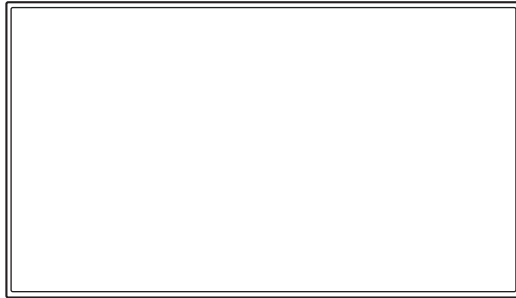

**4K**  
PROFESSIONAL  
\*Actual resolution:  
3840 × 2160p

English

Please read these instructions before operating your set and retain them for future reference.

**HDMI™**



**HEVC Advance™**  
Covered by patents at [patentlist.accessadvance.com](http://patentlist.accessadvance.com)

# Dear Panasonic Customer

Welcome to the Panasonic family of customers. We hope that you will have many years of enjoyment from your new LCD Display.

To obtain maximum benefit from your set, please read these Instructions before making any adjustments, and retain them for future reference.

Retain your purchase receipt also, and note down the model number and serial number of your set in the space provided on the rear cover of these instructions.

Visit our Panasonic Web Site

<https://panasonic.net/cns/prodisplays/>

## Table of Contents

### Before use

- Illustrations and screens in this Operating Instructions are images for illustration purposes, and may be different from the actual ones.
- Descriptive illustrations in this Operating Instructions are created mainly based on the 55-inch model.

<b>Important Safety Instructions</b> .....	<b>4</b>
<b>FCC STATEMENT</b> .....	<b>5</b>
<b>Important Safety Notice</b> .....	<b>6</b>
<b>Safety Precautions</b> .....	<b>8</b>
<b>Precautions for use</b> .....	<b>11</b>
<b>Accessories</b> .....	<b>13</b>
Accessories Supply .....	13
Remote Control Batteries .....	14
Attaching the Function Board .....	14
<b>Cautions when moving</b> .....	<b>16</b>
<b>Kensington security</b> .....	<b>17</b>
<b>Eyebolt</b> .....	<b>17</b>
<b>Connections</b> .....	<b>19</b>
AC cord connection and fixing / Cable fixing .....	19
Video equipment connection .....	21
Before connecting .....	22
HDMI IN 1, HDMI IN 2 and HDMI IN 3 terminals connection ..	22
PC IN terminal connection .....	23
SERIAL IN terminal connection .....	24
IR IN / IR OUT terminal connection .....	26
AUDIO OUT terminal connection .....	26
USB / USB DEVICE terminal connection .....	27
USB-C / USB DEVICE terminal connection .....	28

<b>Identifying Controls</b> .....	<b>30</b>
Display .....	30
Remote Control Transmitter .....	32
<b>Basic Controls</b> .....	<b>33</b>
Selecting the input signal .....	35
RECALL .....	36
Volume Adjustment .....	37
Sound mute On / Off .....	37
OFF TIMER .....	37
<b>ASPECT Controls</b> .....	<b>38</b>
<b>Digital ZOOM</b> .....	<b>40</b>
<b>On-Screen Menu Displays</b> .....	<b>41</b>
<b>Adjusting Position</b> .....	<b>43</b>
Auto setup .....	43
<b>Sound Adjustment</b> .....	<b>45</b>
<b>Picture Adjustments</b> .....	<b>46</b>
<b>Picture Profiles</b> .....	<b>49</b>
Saving profiles .....	50
Loading profiles .....	50
Editing profiles .....	51
<b>Setup menu</b> .....	<b>52</b>
Signal .....	52
Power on settings .....	55
Input search .....	56
Failover/Failback .....	57
Screensaver .....	59
Input label .....	60
Input skip settings .....	61
Power management settings .....	61
Audio input select .....	63
External device link settings .....	64
HDMI-CEC settings .....	65
Image settings .....	66
Input lock .....	67
Off-timer function .....	67
No activity power off .....	67
OSD language .....	68
Multi display settings .....	68
Portrait settings .....	69
Whiteboard settings .....	71
Video conference mode settings .....	71
Set up timer .....	72
Date and time .....	73
Network settings .....	74
USB media player settings .....	82
Memory viewer settings .....	83
Screen Transfer settings .....	84
Wireless presentation settings .....	84
Function button settings .....	85

Colour design settings .....	86	<b>Using the simple drawing function.....</b>	<b>147</b>
OSD settings .....	86	<b>Using Comparison mode .....</b>	<b>148</b>
Options .....	87	Capturing a video .....	148
Control settings .....	88	Displaying a captured image .....	149
Information timing .....	89	Changing screen mode .....	149
Mode settings .....	89	Selecting an image file for comparison .....	150
Restriction settings .....	91	Expanding / Shrinking the screen .....	151
SLOT settings .....	92	Drawing on screen .....	152
<b>Using Network Function .....</b>	<b>93</b>	<b>Performing a capture operation .....</b>	<b>153</b>
Necessary environment for computers to be connected .....	93	<b>Using the video mask function .....</b>	<b>154</b>
Example of network connection .....	93	<b>Use various application functions .....</b>	<b>155</b>
Command control .....	93	<b>Using the WhiteBoard function (Mouse</b>	
Control Command via LAN .....	94	<b>Annotation) .....</b>	<b>156</b>
PJLink protocol .....	96	Mouse menu .....	156
Multi Monitoring & Control Software .....	97	Screen zoom .....	156
Video Wall Manager .....	97	Annotation .....	157
Content Management Software .....	97	Multi-mouse support .....	157
Screen Transfer .....	97	<b>Using HDMI-CEC function .....</b>	<b>158</b>
<b>Connecting with LAN .....</b>	<b>98</b>	Connection example .....	158
Computer operation .....	98	Setting .....	158
<b>Using Web Browser Control .....</b>	<b>98</b>	Interlocking devices .....	158
Before Using Web Browser Control .....	98	Operating a device (using the remote control of this unit) .....	159
Access from Web Browser .....	99	<b>Using ARC function .....</b>	<b>160</b>
Operating with Web Browser .....	100	Connection example .....	160
<b>Using “USB media player” .....</b>	<b>119</b>	Setting .....	160
Function description .....	119	Switching audio output destination .....	160
Preparation .....	120	<b>Using data cloning .....</b>	<b>161</b>
Playing back the files .....	122	Copying the display data to the USB memory .....	162
Network environment (Multi Media Player only) .....	125	Copying (cloning) the USB memory data to the display .....	162
Starting / ending Media Player .....	125	Copying data to other display via LAN .....	163
Resume Play function .....	126	Changing the cloning password .....	165
Playlist edit function .....	126	<b>USB memory network settings .....</b>	<b>166</b>
Schedule playback function using “Content		Saving the LAN setting file to the USB memory device .....	166
Management Software” .....	127	Copying the USB memory data to the display .....	167
<b>Using “Memory viewer” .....</b>	<b>131</b>	<b>ID Remote Control Function .....</b>	<b>168</b>
Preparation .....	131	Setting the remote control's ID number .....	168
Displaying the “Memory viewer” screen .....	133	Cancelling the setting of remote control's ID number	
Playing the pictures .....	134	(ID “0”) .....	168
Playing the video / music .....	134	<b>Entering characters .....</b>	<b>169</b>
<b>Using the WhiteBoard function .....</b>	<b>136</b>	<b>Preset Signals .....</b>	<b>170</b>
Control menu .....	136	<b>Shipping condition .....</b>	<b>173</b>
<b>Using Built-in WhiteBoard .....</b>	<b>138</b>	<b>Initialization .....</b>	<b>174</b>
WhiteBoard mode .....	138	<b>Initializing the [Controller user level] .....</b>	<b>174</b>
Transparent mode (Drawing on video and still image) .....	139	<b>Software on this unit .....</b>	<b>174</b>
Main menu .....	140	<b>Troubleshooting .....</b>	<b>175</b>
How to perform pen drawing .....	142	<b>Specifications .....</b>	<b>178</b>
Selecting the mode .....	144	<b>Software License .....</b>	<b>181</b>
Saving pen drawings (File menu) .....	144		
Switching the drawing page (Page menu) .....	146		

# Important Safety Instructions



**WARNING**  
RISK OF ELECTRIC SHOCK  
DO NOT OPEN



**WARNING:** To reduce the risk of electric shock, do not remove cover or back.

**No user-serviceable parts inside. Refer servicing to qualified service personnel.**



The lightning flash with arrow-head within a triangle is intended to tell the user that parts inside the product are a risk of electric shock to persons.



The exclamation point within a triangle is intended to tell the user that important operating and servicing instructions are in the papers with the appliance.

## **WARNING:**

**To prevent damage which may result in fire or shock hazard, do not expose this apparatus to rain or moisture.**

**Do not place containers with water (flower vase, cups, cosmetics, etc.) above the set. (including on shelves above, etc.)**

## **WARNING:**

- 1) To prevent electric shock, do not remove cover. No user serviceable parts inside. Refer servicing to qualified service personnel.
- 2) Do not remove the grounding pin on the power plug. This apparatus is equipped with a three pin grounding-type power plug. This plug will only fit a grounding-type power outlet. This is a safety feature. If you are unable to insert the plug into the outlet, contact an electrician.  
Do not defeat the purpose of the grounding plug.

- 1) Read these instructions.
- 2) Keep these instructions.
- 3) Heed all warnings.
- 4) Follow all instructions.
- 5) Do not use this apparatus near water.
- 6) Clean only with dry cloth.
- 7) Do not block any ventilation openings. Install in accordance with the manufacturer's instructions.
- 8) Do not install near any heat sources such as radiators, heat registers, stoves, or other apparatus (including amplifiers) that produce heat.
- 9) Do not defeat the safety purpose of the polarized or grounding-type plug. A polarized plug has two blades with one wider than the other. A grounding type plug has two blades and a third grounding prong. The wide blade or the third prong are provided for your safety. If the provided plug does not fit into your outlet, consult an electrician for replacement of the obsolete outlet.
- 10) Protect the power cord from being walked on or pinched particularly at plugs, convenience receptacles, and the point where they exit from the apparatus.
- 11) Only use attachments / accessories specified by the manufacturer.
- 12) Use only with the cart, stand, tripod, bracket, or table specified by the manufacturer, or sold with the apparatus. When a cart is used, use caution when moving the cart / apparatus combination to avoid injury from tip-over. 
- 13) Unplug this apparatus during lightning storms or when unused for long periods of time.
- 14) Refer all servicing to qualified service personnel. Servicing is required when the apparatus has been damaged in any way, such as power-supply cord or plug is damaged, liquid has been spilled or objects have fallen into the apparatus, the apparatus has been exposed to rain or moisture, does not operate normally, or has been dropped.
- 15) To prevent electric shock, ensure the grounding pin on the AC cord power plug is securely connected.



# FCC STATEMENT

This equipment has been tested and found to comply with the limits for a class A digital device, pursuant to Part 15 of the FCC Rules. These limits are designed to provide reasonable protection against harmful interference when the equipment is operated in a commercial environment. This equipment generates, uses and can radiate radio frequency energy and, if not installed and used in accordance with the instructions manual, may cause harmful interference to radio communications. Operation of this equipment in a residential area is likely to cause harmful interference in which case the user will be required to correct the interference at his own expense.

## FCC CAUTION:

**To assure continued compliance, follow the attached installation instructions and use only the provided power supply cord. Any changes or modifications not expressly approved by Panasonic Corp. of North America could void the user's authority to operate this device.**

Supplier's Declaration of Conformity

Model No.

TH-86EQ2W, TH-75EQ2W, TH-65EQ2W,  
TH-55EQ2W, TH-50EQ2W, TH-43EQ2W

Responsible Party:

Panasonic Corporation of North America  
Two Riverfront Plaza, Newark, New Jersey  
07102-5490

Contact Source:

Panasonic Connect North America  
1-877-655-2357

General Contact:

<http://shop.panasonic.com/support>

This device complies with Part 15 of the FCC Rules and all applicable IC RSS standards. Operation is subject to the following two conditions: (1) This device may not cause harmful interference, and (2) this device must accept any interference received, including interference that may cause undesired operation.

## CANADIAN NOTICE:

This Class A digital apparatus complies with Canadian ICES-003.

## WARNING:

- Not for use in a computer room as defined in the Standard for the Protection of Electronic Computer/ Data Processing Equipment, ANSI/NFPA 75.
- For permanently connected equipment, a readily accessible disconnect device shall be incorporated in the building installation wiring.
- For pluggable equipment, the socket-outlet shall be installed near the equipment and shall be easily accessible.

## Note:

Image retention may occur. If you display a still picture for an extended period, the image might remain on the screen. However, it will disappear when a general moving picture is displayed for a while.

## Trademark Credits

- Microsoft, Windows, Internet Explorer and Microsoft Edge are the registered trademarks or trademarks of Microsoft Corporation in the United States and/or other countries.
- Mac, macOS and Safari are the trademarks of Apple Inc. registered in the United States and other countries.
- PJLink is a registered or pending trademark in Japan, the United States, and other countries and regions.
- HDMI, High-Definition Multimedia Interface and the HDMI Logo are trademarks or registered trademarks of HDMI Licensing Administrator, Inc. in the United States and other countries.
- JavaScript is a registered trademark or a trademark of Oracle Corporation and its subsidiary and associated companies in the United States and/or other countries.
- Crestron Connected, Crestron Connected logo and Crestron Fusion are trademarks or registered trademarks of Crestron Electronics, Inc. in the United States and/or other countries.
- Webex is a registered trademark of Cisco Systems, Inc. in the United States and other countries.

Even if no special notation has been made of company or product trademarks, these trademarks have been fully respected.

# Important Safety Notice

## WARNING

- 1) To prevent damage which may result in fire or shock hazard, do not expose this appliance to dripping or splashing.  
Do not place containers with water (flower vase, cups, cosmetics, etc.) above the set. (including on shelves above, etc.)  
No naked flame sources, such as lighted candles, should be placed on / above the set.
- 2) To prevent electric shock, do not remove cover. No user serviceable parts inside. Refer servicing to qualified service personnel.
- 3) Do not remove the earthing pin on the power plug. This apparatus is equipped with a three pin earthing-type power plug. This plug will only fit an earthing-type power outlet. This is a safety feature. If you are unable to insert the plug into the outlet, contact an electrician.  
Do not defeat the purpose of the earthing plug.
- 4) To prevent electric shock, ensure the earthing pin on the AC cord power plug is securely connected.

## CAUTION

This appliance is intended for use in environments which are relatively free of electromagnetic fields.

Using this appliance near sources of strong electromagnetic fields or where electrical noise may overlap with the input signals could cause the picture and sound to wobble or cause interference such as noise to appear.

Using this appliance near sources of strong electromagnetic fields or where electrical noise may overlap with the input signals could cause the sensor function not to work correctly.

To avoid the possibility of harm to this appliance, keep it away from sources of strong electromagnetic fields.

## WARNING:

This equipment is compliant with Class A of CISPR32. In a residential environment this equipment may cause radio interference.

## IMPORTANT INFORMATION: Stability Hazard

Never place a display in an unstable location. A display may fall, causing serious personal injury or death. Many injuries, particularly to children, can be avoided by taking simple precautions such as:

- Using cabinets or stands recommended by the manufacturer of the display.
- Only using furniture that can safely support the display.
- Ensuring the display is not overhanging the edge of the supporting furniture.
- Not placing the display on tall furniture (for example, cupboards or bookcases) without anchoring both the furniture and the display to a suitable support.
- Not placing the display on cloth or other materials that may be located between the display and supporting furniture.
- Educating children about the dangers of climbing on furniture to reach the display or its controls.

If the existing display is going to be retained and relocated, the same considerations as above should be applied.

**IMPORTANT: THE MOULDED PLUG  
FOR YOUR SAFETY, PLEASE READ THE  
FOLLOWING TEXT CAREFULLY.**

This display is supplied with a moulded three pin mains plug for your safety and convenience. A 10 amp fuse is fitted in this plug. Shall the fuse need to be replaced, please ensure that the replacement fuse has a rating of 10 amps and that it is approved by ASTA or BSI to BS1362.

Check for the ASTA mark  or the BSI mark  on the body of the fuse.

If the plug contains a removable fuse cover, you must ensure that it is refitted when the fuse is replaced.

If you lose the fuse cover the plug must not be used until a replacement cover is obtained.

A replacement fuse cover can be purchased from your local Panasonic dealer.

Do not cut off the mains plug.

Do not use any other type of mains lead except the one supplied with this display.

The supplied mains lead and moulded plug are designed to be used with this display to avoid interference and for your safety.

If the socket outlet in your home is not suitable, get it changed by a qualified electrician.

If the plug or mains lead becomes damaged, purchase a replacement from an authorized dealer.

**WARNING : — THIS DISPLAY MUST BE EARTHED**

**How to replace the fuse.**

Open the fuse compartment with a screwdriver and replace the fuse.

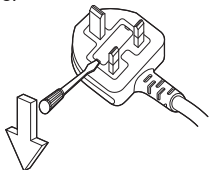

# Safety Precautions

## WARNING

### ■ Setup

**This LCD Display is for use only with the following optional accessories.**

**Use with any other type of optional accessories may cause instability which could result in the possibility of injury.**

**Securely install the wall hanging bracket of the optional accessories. Ask an authorized dealer for installation.**

The following number of people are required for installation.

86-inch model 75-inch model :

4 or more

65-inch model 55-inch model 50-inch model

43-inch model :

2 or more

#### • Pedestal

75-inch model 65-inch model : TY-ST75PE9

55-inch model : TY-ST55PE9

50-inch model 43-inch model : TY-ST43PE9

#### • Wall hanging bracket\*1

86-inch model 75-inch model 65-inch model :

TY-WK98PV1

#### • 3G-SDI Terminal Board

TY-SB01SS

#### • 12G-SDI Terminal Board

TY-SB01QS

#### • DIGITAL LINK Switcher\*2

ET-YFB200G

#### • Early Warning Software

(Basic license/3-year license):

ET-SWA100 series\*3

\*1 : This product can be purchased in the U.S. and Japan.

\*2 : The Digital Interface Box (model number: ET-YFB100G) can also be used.

\*3 : Suffix of the part number may differ depending on the license type.

### Note

- The part number of the optional accessories are subject to change without notice.

When installing the wall hanging bracket, read the operating instructions supplied with it carefully and install properly. Also, always use the overturn prevention accessories.

We are not responsible for any product damage, etc. caused by failures in the installation environment for the pedestal or wall hanging bracket even during the warranty period.

Small parts can present choking hazard if accidentally swallowed. Keep small parts away from young children. Discard unneeded small parts and other objects, including packaging materials and plastic bags/sheets to prevent them from being played with by young children, creating the potential risk of suffocation.

**Do not place the Display on sloped or unstable surfaces, and ensure that the Display does not hang over the edge of the base.**

- The Display may fall off or tip over.

**Install this unit at a location with minimal vibration and which can support the weight of the unit.**

- Dropping or falling of the unit may cause injury or malfunction.

**Caution - For use only with UL Listed Wall Mount Bracket with minimum weight/load 50.7 kg (111.8 lbs).**

**When installing the display vertically, be sure that the power indicator comes to the upper side.**

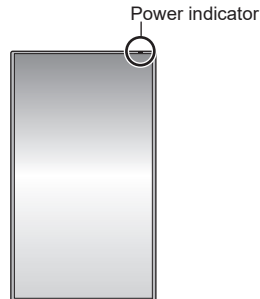

- If installed in different directions, heat is generated and it may cause fire or damage to the Display.

**When using this unit, be sure to take safety measures to prevent falling or dropping of the unit.**

- If an earthquake occurs or a child climbs the unit, the unit may fall or drop, resulting in an injury.

**Do not position the unit with its liquid crystal panel facing upright.**

- There are conditions of mounting method, environmental temperature, connections and settings. If installed in different conditions, heat is generated and it may cause fire or damage to the Display.

### Cautions for Wall or Pedestal Installation

- The installation should be performed by an installation professional. Installing the Display incorrectly may lead to an accident that results in death or serious injury. Use the optional Pedestal. (see page 8)
- When installing the pedestal, the pedestal that conforms to VESA standards must be used.
- When installing on a wall, the specified wall hanging bracket (optional accessory) or a wall hanging bracket that conforms to VESA standards must be used.

86-inch model 75-inch model : VESA 600 × 400

65-inch model 55-inch model 50-inch model :

VESA 400 × 400

43-inch model : VESA 200 × 200

(see page 11)

- Before installation, be sure to check if the mounting location has enough strength to support the weight of the display and the wall hanging bracket for anti drop.
- If you terminate the use of the product, ask a professional to remove it promptly.
- When mounting the Display on the wall, prevent the mounting screws and power cable from contacting metal objects inside the wall. An electric shock may occur if they contact metal objects inside the wall.

### ■ When using the LCD Display

**The Display is designed to operate on 110 – 240 V AC, 50/60 Hz.**

**If problems or malfunction occur, stop using immediately.**

**If problems occur, unplug the power supply plug.**

- Smoke or an abnormal odour come out from the unit.
- No picture appears or no sound is heard, occasionally.
- Liquid such as water or foreign objects got inside the unit.
- The unit has deformed or broken parts.

**If you continue to use the unit in this condition, it could result in fire or electric shock.**

- Unplug the power supply plug from the wall outlet, and then contact the dealer for repairs.
- To cut off the power supply to this Display completely, you need to unplug the power supply plug from the wall outlet.
- Repairing the unit yourself is dangerous, and shall never be done.
- To enable to unplug the power supply plug immediately, use the wall outlet which you can reach easily.

**Do not touch the unit directly by hand when it is damaged.**

- Electric shock could occur.

**Do not stick any foreign objects into the Display.**

- Do not insert any metal or flammable objects into the ventilations holes or drop them onto the Display, as doing so can cause fire or electric shock.

**Do not remove the cover (cabinet) or modify it.**

- High voltages which can cause fire or electric shocks are present inside the Display. For any inspection, adjustment and repair work, please contact your local Panasonic dealer.

**Ensure that the mains plug is easily accessible.**

**The mains plug shall be connected to a mains socket outlet with a protective earthing connection.**

**Do not use any power supply cord other than that provided with this unit.**

- Doing so may cause short-circuit, generates heat, etc., which could cause electric shock or fire.

**Do not use the supplied power supply cord with any other devices.**

- Doing so may cause short-circuit, generates heat, etc., which could cause electric shock or fire.

**Clean the power supply plug regularly to prevent it becoming dusty.**

- If there is a build up of dust on the plug, the resultant humidity may cause short-circuit, which could cause electric shock or fire. Unplug the power supply plug from the wall outlet and wipe it with a dry cloth.

**Do not handle the power supply plug with wet hands.**

- Doing so may cause electric shocks.

**Securely insert the power supply plug (socket outlet side) and the power supply connector (main unit side) as far as it will go.**

- If the plug is not fully inserted, heat may be generated which could cause fire. If the plug is damaged or the wall socket is loose, they shall not be used.

- **86-inch model**:

Make sure that the connector is locked on both the left and right sides.

**Do not do anything that may damage the power supply cord or the power supply plug.**

- Do not damage the cable, make any modifications to it, place heavy objects on top of it, heat it, place it near any hot objects, twist it, bend it excessively or pull it. To do so may cause fire and electric shock. If the power cable is damaged, have it repaired at your local Panasonic dealer.

**Do not touch the power supply cord or the plug directly by hand when they are damaged.**

- Doing so may cause electric shock or fire due to short-circuit.

**Keep the supplied AAA/R03/LR03 batteries, M3 screw and washer out of reach of children. If accidentally swallowed, it will be harmful to the body.**

- Please contact a doctor immediately in case you doubt that the child may have swallowed it.

**To prevent the spread of fire, keep candles or other open flames away from this product at all times.**



## CAUTION

**Do not place any objects on top of the Display.**

**Ventilation should not be impeded by covering the ventilation openings with items such as newspapers, table cloths and curtains.**

- Doing so may cause the Display to overheat, which can cause fire or damage to the Display.

For sufficient ventilation, see page 11.

**Do not place the display where it may be affected by salt or corrosive gas.**

- Doing so may cause the display to fall due to corrosion, and it may result in injury. Also, the unit may malfunction.

**The following number of people are required to carry or unpack this unit.**

:

4 or more

:

2 or more

:

**Be sure to hold the handle, when carrying or moving the Display.**

- If this is not observed, the unit may drop, resulting in injury.

**When disconnecting the power supply cord, always pull on the plug (socket outlet side) / the connector (main unit side).**

- Pulling the cord may damage the cord, and it may cause electric shock or fire due to short-circuit.

**Be sure to disconnect all cables and overturn prevention accessories before moving the Display.**

- If the Display is moved while some of the cables are still connected, the cables may become damaged, and fire or electric shock could result.

**Disconnect the power supply plug from the wall socket as a safety precaution before carrying out any cleaning.**

- Electric shocks can result if this is not done.

**Do not step on, or hang from the display.**

- They might tip over, or might be broken and it may result in injury. Pay special attention to the children.

**Do not reverse the polarity (+ and -) of the battery when inserting.**

- Mishandling the battery may cause its explosion or leakage, resulting in fire, injury or damage to surrounding properties.
- Insert the battery correctly as instructed. (see page 14)

**Do not use batteries with the outer cover peeling away or removed.**

- Mishandling the batteries may cause the batteries to short circuit, resulting in fire, injury or damage to surrounding properties.

**Remove the batteries from the remote control transmitter when not using for a long period of time.**

- The battery may leak, heat, ignite or burst, resulting in fire or damage to surrounding properties.

**Remove exhausted batteries from the remote control immediately.**

- Leaving the batteries unattended in it may cause battery leakage, heat or burst.

**Do not burn or breakup batteries.**

- Batteries must not be exposed to excessive heat such as sunshine, fire or the like.

**Do not turn the Display upside down.**

# Precautions for use

## Cautions when installing

### Do not set up the Display outdoors.

- The Display is designed for indoor use.

### Install this unit at a location which can support the weight of the unit.

- Dropping or falling of the unit may cause injury.

### Do not install the unit near a high-voltage line or a power source.

- Installing the unit near a high-voltage line or a power source may receive interference.

### Install the unit away from heat appliances.

- Failure to do so may cause deformation of the cabinet or malfunction.

### Do not install the unit where it is 2 800 m (9 186 ft) and higher above sea level.

- Failure to do so may shorten the life of the internal parts and result in malfunctions.

### Environmental temperature to use this unit

- When using the unit where it is below 1 400 m (4 593 ft) above sea level: 0 °C to 40 °C (32 °F to 104 °F)
- When using the unit at high altitudes (1 400 m (4 593 ft) and higher and below 2 800 m (9 186 ft) above sea level): 0 °C to 35 °C (32 °F to 95 °F)

### We are not responsible for any product damage, etc. caused by failures in the installation environment even during the warranty period.

### Transport only in upright position!

- Transporting the unit with its liquid crystal panel facing upright or downward may cause damage to the internal circuitry.

### Do not grab the liquid crystal panel.

- Do not forcibly press the liquid crystal panel, or push it with a pointed object. Applying a strong force to the liquid crystal panel will cause unevenness of the screen display, resulting in malfunction.

### Do not install the product to a place where the product is exposed to direct sunlight.

- If the unit is exposed to direct sunlight even indoors, the temperature rise of the liquid crystal panel may cause malfunction.

### In the case of storage, store the unit in a dry room.

### Required space for ventilation

- When installing the unit in a case or chassis, provide a cooling fan or ventilation hole to ensure appropriate ventilation so that the temperatures surrounding the unit including the front surface of the liquid crystal panel (temperature of inside the case or chassis) can be maintained within the range of the operating temperature of the unit.

## About the screws used when using a wall hanging bracket that conforms to VESA standards

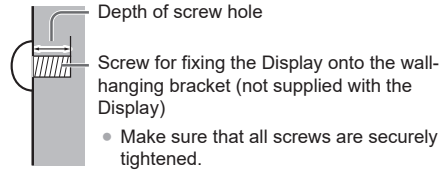

(View from the side)

Inch model	Screw pitch for installation	Depth of screw hole	Screw (quantity)
86	600 mm × 400 mm	20 mm	M8 (4)
75	600 mm × 400 mm	20 mm	M8 (4)
65	400 mm × 400 mm	20 mm	M8 (4)
55	400 mm × 400 mm	18 mm	M6 (4)
50	400 mm × 400 mm	20 mm	M6 (4)
43	200 mm × 200 mm	16 mm	M6 (4)

## Note for connection

### Removing and inserting the power cord and connection cables

- When the unit has been installed on the wall, if the power cord and connection cables are difficult to remove and insert, make connections first before installation. Be careful not to allow the cables to be entangled. After installation is completed, insert the power plug to the outlet.

## When using

### Image retention may occur.

- If you display a still picture for an extended period, the image might remain on the screen. However, it will disappear when a general moving picture is displayed for a while.

### When polarization sunglasses are worn, the screen display may be invisible.

- This phenomenon occurs due to deflection characteristics of the liquid crystal panel. This is not a malfunction.

### Red, blue or green dots on the screen are a liquid crystal panel-specific phenomenon. This is not a malfunction.

- Although the liquid crystal display is manufactured with high-precision technology, always-lighting dots or non-lighting dots may appear on the screen. This is not a malfunction.

Inch model	Dot omission ratio*
86	0.00009% or less
75	0.00007% or less
65	0.00005% or less
55	0.00005% or less
50	0.00005% or less
43	0.00005% or less

\*: Calculated in sub-pixel units according to the ISO9241-307 standard.

**Depending on the temperature or humidity conditions, uneven brightness may be observed. This is not a malfunction.**

- This unevenness will disappear while applying current continuously. If not, consult the distributor.

**If the Display is not going to be used for any prolonged length of time, unplug the power supply plug from the wall outlet.**

- When storing the product for long periods with no power supplied, do not store it in a location exposed to direct sunlight.

**If the power is instantaneously interrupted or stopped, or if the power voltage is instantaneously lowered, the Display may not operate normally.**

- In this case, turn off the power of the Display and the connected devices once, and then turn on the power again.

**Picture noise may occur if you connect / disconnect the cables connected to the input terminals you are currently not watching, or if you turn the power of the video equipment on / off, but it is not a malfunction.**

## Notes on Using Wired LAN

**When setting up the Display at a place, where electric static occurs often, take a sufficient antistatic measure before start using.**

- When the Display is used at a location, where static electricity occurs often, such as on a carpet, a wired LAN communication is disconnected more often. In that case, remove static electricity and the noise source that may cause problems with an antistatic mat, and re-connect the wired LAN.
- In rare cases, the LAN connection is disabled due to static electricity or noise. In that case, turn off the power of the Display and the connected devices once and then re-turn on the power.

**The Display may not work properly due to strong radio wave from the broadcast station or the radio.**

- If there is any facility or equipment, which outputs strong radio wave, near the installation location, set up the Display at a location sufficiently far from the source of the radio wave. Or, wrap the LAN cable connected to the LAN terminal by using a piece of metal foil or a metal pipe, of which is grounded at both ends.

## Request Regarding Security

**When using this unit, take safety measures against the following incidents.**

- Personal information being leaked via this unit
- Unauthorized operation of this unit by a malicious third party
- Interfering or stopping of this unit by a malicious third party

**Take sufficient security measures. (see page 99, 105)**

- Set a password for the LAN control and restrict the users who can log in.

- Make your password difficult to guess as much as possible.
- Change your password periodically.
- Panasonic Connect Co., Ltd. or its affiliate companies will never ask for your password directly. Do not divulge your password in case you receive such inquiries.
- The connecting network must be secured by a firewall, etc.
- When disposing the product, initialize the data before disposing. ([Shipping] (see page 173))

## Cleaning and maintenance

**First, remove the mains plug from the mains socket.**

**Gently wipe the surface of the liquid crystal panel or cabinet by using a soft cloth to remove dirt.**

- To remove stubborn dirt or fingerprints on the surface of the liquid crystal panel, dampen a cloth with diluted neutral detergent (1 part detergent to 100 parts water), wring out the cloth firmly, and then wipe away the dirt. Finally, wipe away all the moisture with a dry cloth.
- If water droplets get inside the unit, operating problems may result.

### Note

- The surface of the liquid crystal panel is specially treated. Do not use a hard cloth or rub the surface too hard, otherwise this may cause scratches on the surface.

**Usage of a chemical cloth**

- Do not use a chemical cloth for the liquid crystal panel surface.
- Follow the instructions for the chemical cloth to use it for the cabinet.

**Avoid contact with volatile substances such as insect sprays, solvents and thinner.**

- This may cause damage to the cabinet or cause peeling of the paint. Furthermore, do not leave it in contact with a rubber or PVC substance for a long time.

**Remove dust and dirt from the ventilation holes**

- Dust may adhere to the vicinity of the ventilation holes depending on the usage environment. As a result, if the internal cooling of this unit or circulation of exhaust heat deteriorates, it may result in a decrease in brightness or a malfunction. Clean and remove dust from the ventilation holes.
- The amount of dust and dirt that adheres depends on the installation location and usage time.

## Disposal

**When disposing the product, ask your local authority or dealer about the correct methods of disposal.**



# Accessories

## Accessories Supply

Check that you have the accessories and items shown.

### Remote Control Transmitter × 1

- DPVF1615ZA



### Batteries for the Remote Control Transmitter × 2

(AAA/R03/LR03 type)

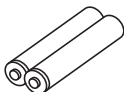

### Clamper × 2

- DPVF1654ZA



### SLOT adapter × 1

- DPVF2722YA/X1

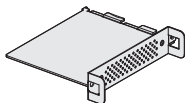

### Power supply cord

TH-86EQ2W

(Approx. 2 m)

- 1JP155AF1U

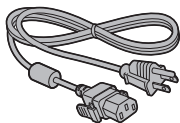

- 1JP155AF1W

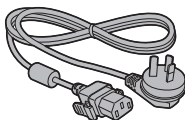

- 2JP155AF1W

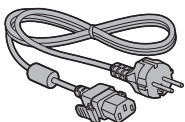

- 3JP155AF1W

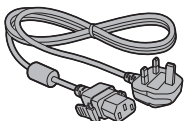

TH-75EQ2W

TH-65EQ2W

TH-55EQ2W

TH-50EQ2W

TH-43EQ2W

(Approx. 2 m)

- 1JP143CQ2U

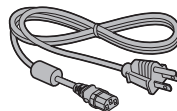

- 1JP143EQ2W

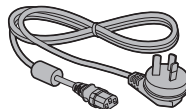

- 2JP143EQ2W

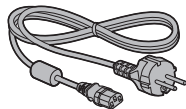

- 3JP143EQ2W

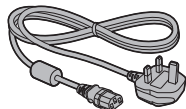

### Attention

- Store small parts in an appropriate manner, and keep them away from young children.
- The part numbers of accessories are subject to change without notice. (The actual part number may differ from the ones shown above.)
- In case you lost accessories, please purchase them from your dealer. (Available from the customer service)
- Dispose the packaging materials appropriately after taking out the items.

## Remote Control Batteries

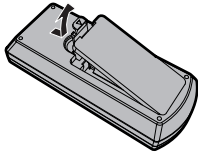

Open the battery cover.

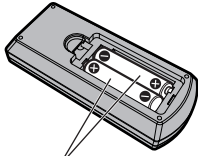

Insert batteries and close the battery cover.

(Insert starting from the  side.)

AAA/R03/LR03 type

### Note

- Incorrect installation of the batteries can cause battery leakage and corrosion that will damage the remote control.
- Disposal of batteries should be done in an environment-friendly manner.

### Take the following precautions.

1. Batteries shall always be replaced as a pair.
2. Do not combine a used battery with a new one.
3. Do not mix battery types (example; manganese dioxide battery and alkaline battery etc.).
4. Do not attempt to charge, disassemble or burn used batteries.
5. Do not burn or breakup batteries.  
Moreover, batteries must not be exposed to excessive heat such as sunshine, fire or the like.

## Attaching the Function Board

When using a narrow-width function board, attach the supplied SLOT adaptor, and insert it to the expansion slot.

### Note

- Be sure to turn off the display unit and connected devices, remove the power plug from the socket, and disconnect the cables from the display.
- When attaching/removing the function board, do not allow the metal to damage the back cover or display label.

When attaching a full-size function board, proceed to step 4.

### 1 Remove one screw from the side with the guide on the SLOT adaptor.

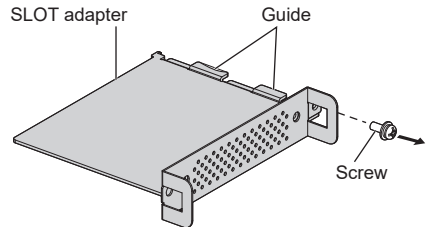

### 2 Fit the circuit board of the function board in the guides of the SLOT adaptor, and bring the circuit board into contact with the hook (one location) and the end faces (two locations) securely.

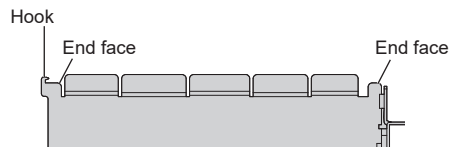
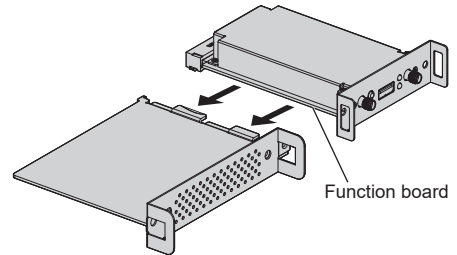

**3 Using the screw removed in step 1, fix the function board to the SLOT adaptor.**

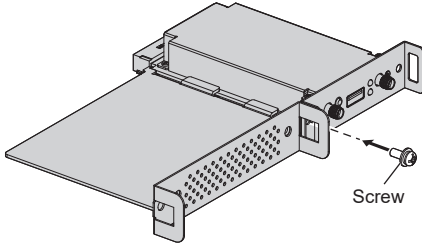

- Tightening torque guideline: 0.5 N·m or less

**Note**

- Firmly tighten the screw, and check that the hook of the SLOT adaptor fixes the circuit board.
- Check that the surface of the SLOT adaptor and the surface of the circuit board match with each other when the function board with the SLOT adaptor attached is viewed from the opposite side of the cover.

Make sure that this side is aligned.

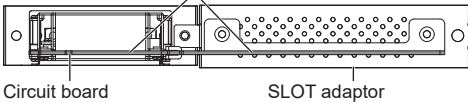

Circuit board

SLOT adaptor

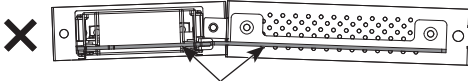

It cannot be attached unless this side is horizontally aligned.



- If there is a lead wire within approx. 3 mm from the end face of the circuit board, the function board cannot be attached due to interference with the guide rail. Ensure that there is no lead wire in this range.

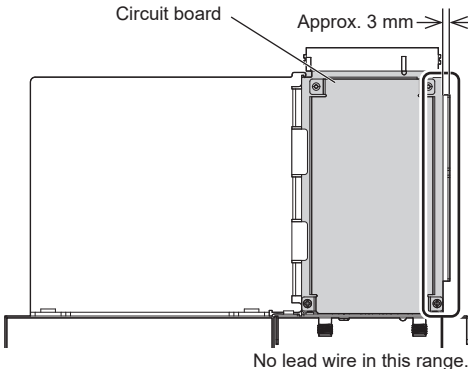

No lead wire in this range.

**4 Remove the 2 screws, and then remove the expansion slot cover or function board from the display unit.**

To remove the function board, hold the handle of the function board and pull it out slowly in the arrow direction.

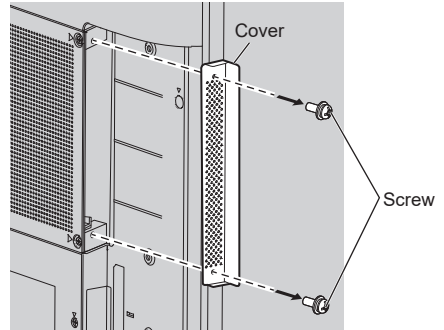

**Note**

- The customer shall keep the removed function board or cover. They are necessary for future repair or servicing.

**5 Insert the function board to the expansion slot, and tighten the 2 screws.**

Fix the function board with the 2 screws removed in step 4.

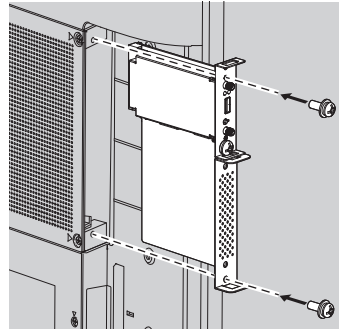

- Tightening torque guideline: 0.5 N·m or less

### Note

- When inserting the function board, be careful not to allow it to come into contact with the edge of the opening of the expansion slot.

The display unit and the function board may be damaged.

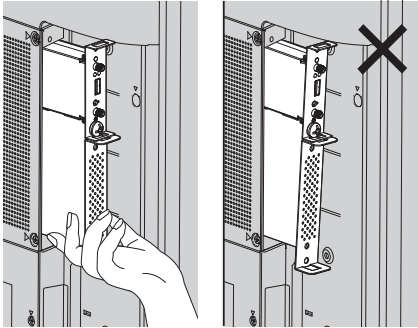

## Cautions when moving

86-inch model 75-inch model  
65-inch model

The display has handles for carrying. Hold them when moving.

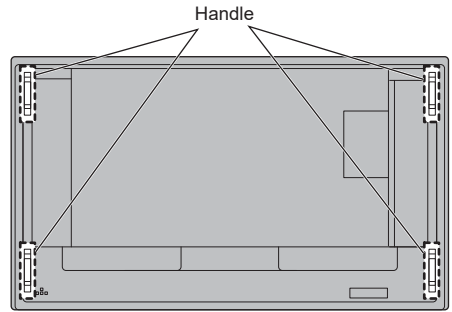

### Note

- 86-inch model 75-inch model 65-inch model :  
Do not hold parts other than the handles.
- The following number of people are required to carry this unit.

86-inch model 75-inch model : 4 or more

65-inch model 55-inch model 50-inch model

43-inch model : 2 or more

If this is not observed, the unit may drop, resulting in injury.

- When carrying the unit, keep the liquid crystal panel upright.  
Carrying the unit with the surface of the liquid crystal panel facing up or down may cause deformation of the panel, or internal damage.
- Do not hold the upper, lower, right and left frames or the corners of the unit. Do not hold the front surface of the liquid crystal panel. Also, do not hit such parts.  
Doing so may damage the liquid crystal panel.  
Also, the panel may crack, resulting in injury.

# Kensington security

The security slot of this unit is compatible with the Kensington security slot.

86-inch model 75-inch model 65-inch model

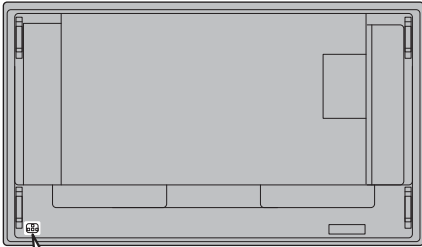

55-inch model 50-inch model 43-inch model

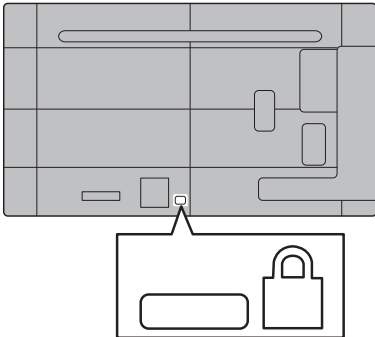

# Eyebolt 86-inch model 75-inch model

The display has holes for attaching eyebolts (M10). When installing, use them to suspend the display.

Use the eyebolt only for temporary suspension or movement for installation. This cannot be used for permanent hanging installation.

### Note

- The 86/75-inch models have the holes for attaching eyebolts. 65/55/50/43-inch models don't.

Eyebolt (commercially available) mounting positions

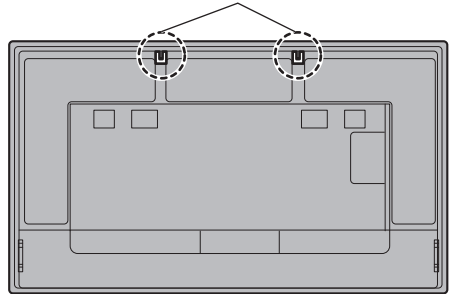

**Attach the eyebolt on the eyebolt mounting position (two locations).**

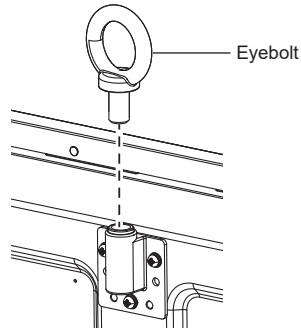

### Note

- Installation should be performed by an installation professional.
- Do not suspend using only 1 eyebolt.
- Use commercially sold M10 eyebolts with a shank length of 12 mm to 40 mm that satisfies the load condition of product quality.
- Use ISO 3266 standard eyebolts. Also use ISO standard members (wire, etc.) for hanging.
- The hanging angle should be 60° or more.

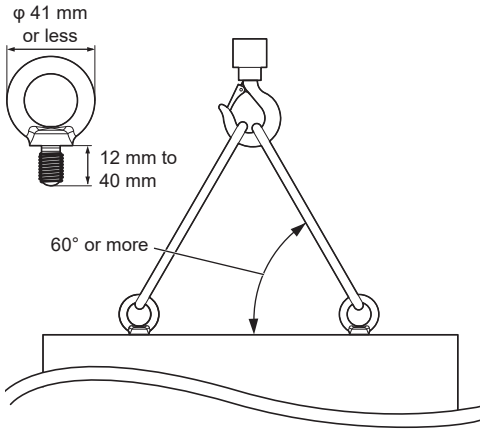

# Connections

## AC cord connection and fixing / Cable fixing

86-inch model

Back of the unit

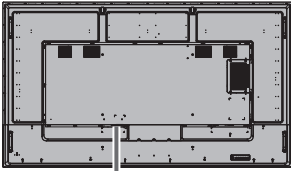

### AC cord fixing

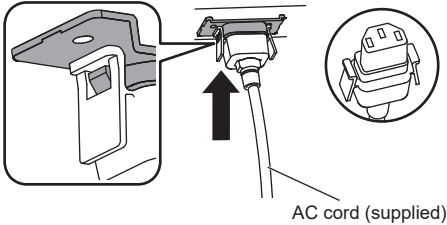

#### Plug the connector into the display unit.

Plug the connector until it clicks.

#### Note

- Make sure that the connector is locked on both the left and right sides.

#### Unplug the AC cord

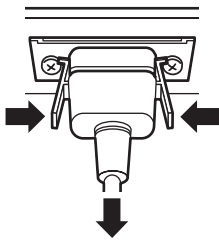

Unplug the connector pressing the two knobs.

#### Note

- Do not use an AC cord of which the knobs are damaged. If it is used with the knobs damaged, a bad connection may result between the AC cord connector and the AC IN terminal. For the repair of the AC cord, consult the dealer where you purchased the product.
- When disconnecting the AC cord, be absolutely sure to disconnect the AC cord plug at the socket outlet first.
- The supplied AC cord is for this unit exclusive use. Do not use this for other purposes.

75-inch model

65-inch model

55-inch model

50-inch model

43-inch model

Back of the unit

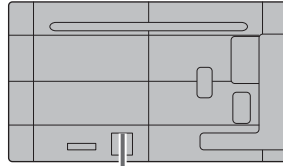

Insert the AC cord securely all the way seated on the back side of the unit.

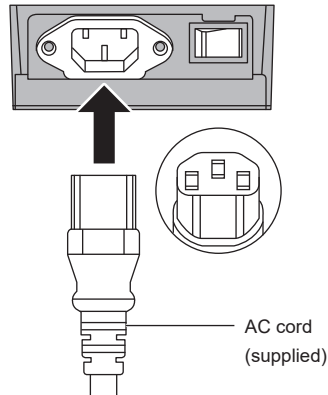

#### Note

- When disconnecting the AC cord, be absolutely sure to disconnect the AC cord plug at the socket outlet first.
- The supplied AC cord is for this unit exclusive use. Do not use this for other purposes.

## Cable fixing

### Note

- 2 clampers are supplied with this unit. Fix the cables at location as shown below.

If you need more clampers, purchase them from your dealer. (Available from the customer service)

86-inch model    75-inch model    65-inch model

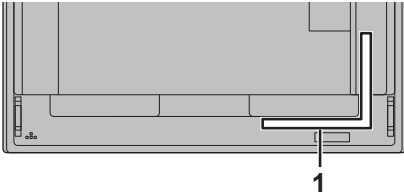

55-inch model    50-inch model    43-inch model

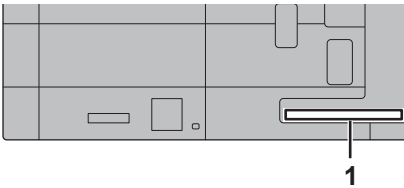

1 For signal cable: clamper

## 1. Attach the clamper

### Note

- Wipe off dirt, such as dust, water and oil on the attachment surface, and affix the clamper on the attachment surface by pushing it firmly.
- Once the clamper is affixed, it cannot be reused. Be sure to confirm the attaching position before affixing it.

Remove the tape at the back, and affix the clamper on the flat surface.

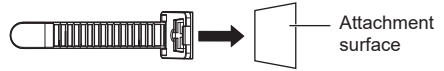

## 2. Bundle the cables

Pass the tip of the band to the hooks. Then pull and hook it on the knob.

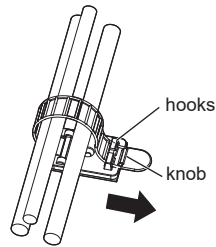

### To loosen:

Remove the band from the knob, and pull out the band tip.



## Video equipment connection

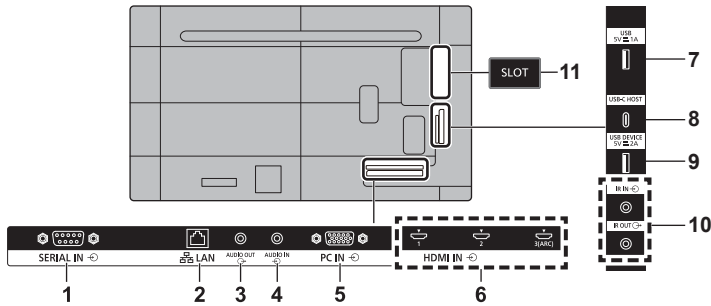

**1 SERIAL IN:** **SERIAL Input Terminal**  
Control the Display by connecting to PC.  
(see page 24)

**2 LAN:** **LAN Terminal**  
Control the Display by connecting to Network.  
(see page 93)

**3 AUDIO OUT:** **Analogue Audio Output Terminal**  
Connect to audio equipment with analogue audio input terminal.  
(see page 26)

**4 AUDIO IN:** **Analogue Audio Input Terminal**  
(see page 23)

**5 PC IN:** **PC Input Terminal**  
Connect to video terminal of PC, video equipment with "YPbPr / YCbCr" or "RGB" output.  
(see page 23)

**6 HDMI IN 1, HDMI IN 2, HDMI IN 3:** **HDMI Input Terminal (2 systems)**  
Connect to video equipment with HDMI output. Also, the HDMI IN 3 terminal outputs audio by connecting it to an ARC-compatible device.  
(see page 22)

**7 USB:** **USB Terminal**  
Connect the USB memory to use "USB media player" or "Memory viewer". Also, this can be used to supply power of up to 5 V/max 1 A to an external device when the picture is displayed.  
(see page 27)

**8 USB-C HOST:** **USB-C terminal**  
Connect a PC or video equipment that has a USB-C terminal. Also, this can be used to supply power of up to 60 W to an external device when the picture is displayed.  
(see page 28)

**9 USB DEVICE:** **USB terminal**  
USB communication with devices connected to the USB-C HOST terminal is possible. Also, when the USB memory is connected, the "USB media player" or "Memory viewer" function can be used. Also, this can be used to supply power of up to 5 V/max 2 A to an external device when the picture is displayed.  
(see page 28)

**10 IR IN, IR OUT:** **Infrared Signal Input / Output Terminal**  
Use this when operating more than one display with one remote control.  
(see page 26)

**11 SLOT:** **Expansion slot**  
(see page 14)

### Note

- For the compatible function board, consult the dealer where you purchased the product.

## Before connecting

- Before connecting cables, carefully read the operating instructions for the external device to be connected.
- Turn off the power of all devices before connecting cables.
- Take note of the following points before connecting the cables. Failure to do so may result in malfunctions.
  - When connecting a cable to the unit or a device connected to the unit itself, touch any nearby metallic objects to eliminate static electricity from your body before performing work.
  - Do not use unnecessarily long cables to connect a device to the unit or to the unit body. The longer the cable, the more susceptible to noise it becomes. Since using a cable while it is wound makes it act like an antenna, it is more susceptible to noise.
  - When connecting cables, insert them straight into the connecting terminal of the connecting device so that the ground is connected first.
- Acquire any cable necessary to connect the external device to the system that is neither supplied with the device nor available as an option.
- If the outer shape of the plug of a connection cable is large, it may come in contact with the periphery such as a back cover or the plug of an adjacent connection cable. Use a connection cable with the suitable plug size for the terminal alignment.
- When connecting the LAN cable with plug cover, be aware that the cover may come in contact with the back cover and it may be difficult to disconnect.
- If video signals from video equipment contain too much jitter, the images on the screen may wobble. In this case, a time base corrector (TBC) must be connected.
- When the sync signals output from PC or video equipment are disturbed, for example, when changing settings of video output, the colour of the video may be disturbed temporarily.
- The unit accepts, YPbPr/YCbCr signals (PC IN), analogue RGB signals (PC IN) and digital signals.
- Some PC models are not compatible with the unit.
- Use cable compensator when you connect devices to the unit using long cables. Otherwise the image may not be displayed properly.
- Refer to "Preset Signals" (see page 170) for the types of video signals that can be displayed with the unit.

## HDMI IN 1, HDMI IN 2 and HDMI IN 3 terminals connection

### Note

- Video equipment and HDMI cable shown are not supplied with this unit.
- Connect the equipment complying with the HDMI standard.
- Some HDMI equipment may not be able to display picture.
- This Display does not support VIERA LINK.
- For audio, it is also possible to use the AUDIO IN terminal. (For [Audio input select] function, see page 63.)
- Use an HDMI High Speed cable complying with the HDMI standards.

Note when inputting 4K video signals exceeding the transmission speed supported by an HDMI High Speed cable, use an HDMI cable supporting 18 Gbps high-speed transmission such as the one certified as a Premium HDMI cable.

When inputting video signals exceeding the transmission speed supported by the HDMI cable you are using, malfunction may occur such as interrupted pictures and no display on the screen.

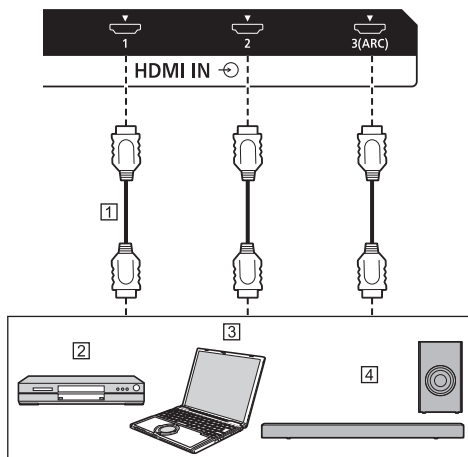

- 1 HDMI cable (commercially available)
- 2 Blu-ray disc player
- 3 PC
- 4 ARC audio device

### Note

- Be sure to connect the ARC audio device to the HDMI IN 3 terminal.

## Pin assignments and signal names for HDMI Terminal

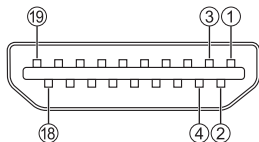

Pin No.	Signal name
①	T.M.D.S Data2 +
②	T.M.D.S Data2 Shield
③	T.M.D.S Data2 -
④	T.M.D.S Data1 +
⑤	T.M.D.S Data1 Shield
⑥	T.M.D.S Data1 -
⑦	T.M.D.S Data0 +
⑧	T.M.D.S Data0 Shield
⑨	T.M.D.S Data0 -
⑩	T.M.D.S Clock +
⑪	T.M.D.S Clock Shield
⑫	T.M.D.S Clock -
⑬	CEC
⑭	NC (not connected)*
⑮	SCL
⑯	SDA
⑰	DDC/CEC Ground
⑱	+5V DC
⑲	Hot Plug Detect

\* Only the HDMI IN 3 terminal supports ARC.

## PC IN terminal connection

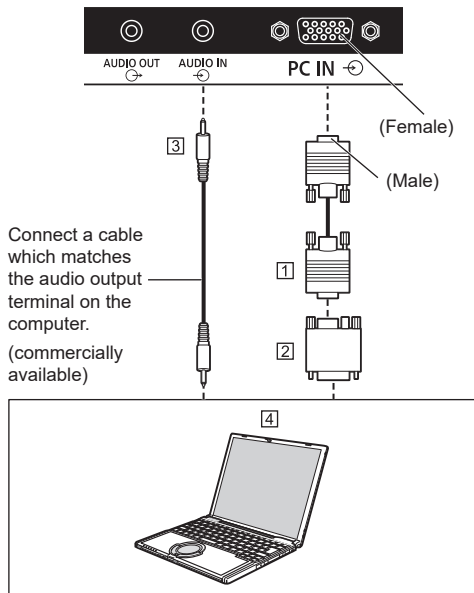

Connect a cable which matches the audio output terminal on the computer.

(commercially available)

- ① Mini D-sub 15p cable (commercially available)
- ② Conversion adapter (if necessary) (commercially available)
- ③ Stereo mini plug (M3) cable (commercially available)
- ④ PC

### The type of computer signal that can be connected

- With regard to the typical PC input signals that are described in "Preset Signals" (see page 170), adjustment values such as for the standard picture positions and sizes have already been stored in this unit.

(Computer signals which can be input are those with a horizontal scanning frequency of 30 to 110 kHz and vertical scanning frequency of 48 to 120 Hz.)

- The display resolution is a maximum of 1 440 x 1 080 dots when the aspect mode is set to [Normal], and 1 920 x 1 080 dots when the aspect mode is set to [Full]. If the display resolution exceeds these maximums, it may not be possible to show fine detail with sufficient clarity.
- If signals outside the range of supported frequencies are input, normal images cannot be displayed. Note that some images may not be correctly displayed even if signals are within the range.
- If the PC screen is not displayed, check if the image signal of the PC meets "Preset Signals" (see page 170), and then change the settings. For power-saving purpose, image output may be OFF on a notebook computer. In this case, it may be set to ON with function key operation etc. of the computer. (Refer to the manual of the computer.)

**Note**

- Component video signal is supported with this terminal (Mini D-sub 15P).  
Select an input signal mode with [Setup] - [PC input mode] according to the input signal. (see page 90)
- According to the [PC input mode] setting, the synchronized signal supports the following inputs only. (see page 90)  
[PC]: HD/VD signal input only  
[PC[YPbPr]]: Only the synchronized signal superimposed on Y signal input
- Additional computer, cables and conversion adapter shown are not supplied with this set.
- If the computer being connected is not DDC2B-compatible, you will need to make setting changes to the computer at the time of connection.
- When connecting a computer equipped with a D-sub15 pin terminal or a Mac, use a commercially sold conversion adapter as necessary.  
\* There is no need to use an adapter for computers with DOS/V compatible Mini D-sub 15P terminal.
- Do not set the horizontal and vertical scanning frequencies for PC signals which are above or below the specified frequency range.

**Pin assignments and signal names for PC Input Terminal (Mini D-sub 15P)**

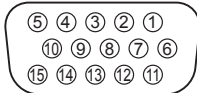

Pin No.	Signal Name
①	R (P <sub>R</sub> /C <sub>R</sub> )
②	G (Y)
③	B (P <sub>B</sub> /C <sub>B</sub> )
④	NC (not connected)
⑤	GND (Ground)
⑥	GND (Ground)
⑦	GND (Ground)
⑧	GND (Ground)
⑨	+5 V DC
⑩	GND (Ground)
⑪	NC (not connected)
⑫	SDA
⑬	HD
⑭	VD
⑮	SCL

**SERIAL IN terminal connection**

The SERIAL terminal conforms to the RS-232C interface specification, so that the Display can be controlled by a computer which is connected to this terminal.

**Note**

- Additional computer and cables shown are not supplied with this set.

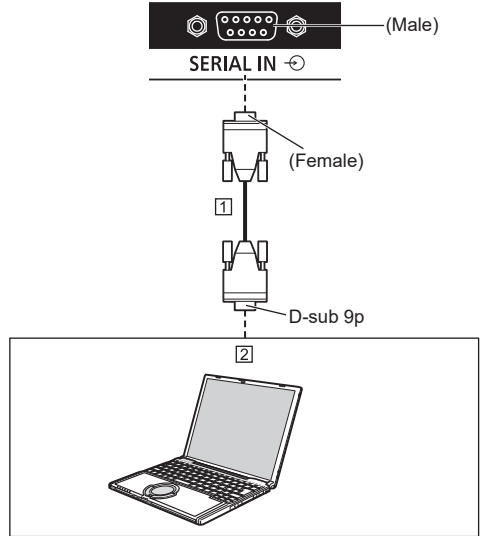

① RS-232C Straight cable (commercially available)

② PC

**Note**

- Select the RS-232C straight cable for communication used for connecting SERIAL terminal and computer according to the computer you are using.

## Pin assignments and signal names for SERIAL Terminal

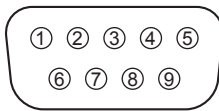

Pin No.	Signal Name	
①	NC (not connected)	
②	RXD	
③	TXD	
④	Non use	
⑤	GND (Ground)	
⑥	Non use	
⑦	RTS	
⑧	CTS	] Shorted in this set
⑨	NC (not connected)	

These signal names are those of computer specifications.

### Communication parameters

Signal level: RS-232C compliant

Synchronization method: Asynchronous

Baud rate: 9 600 bps

Parity: None

Character length: 8 bits

Stop bit: 1 bit

Flow control: None

### Basic format for control data

The transmission of control data from the computer starts with a STX signal, followed by the command, the parameters, and lastly an ETX signal in that order. Add parameters as required according to control details.

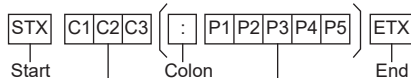

3-character command  
(3 bytes)

Parameter(s)

## Command

Command	Parameter	Control details
PON	None	Power ON
POF	None	Power OFF
AVL	***	Volume 000 – 100
AMT	0	Audio MUTE OFF
	1	Audio MUTE ON
IMS	None	Input select (toggle)
	HM1	HDMI IN 1 input (HDMI1)
	HM2	HDMI IN 2 input (HDMI2)
	HM3	HDMI IN 3 input (HDMI3)
	UC1	USB-C HOST input (USB-C)
	SL1	SLOT input (SLOT)
	PC1	PC IN input (PC)
	NW1	Screen Transfer input (Screen Transfer)
	UD1	USB / Internal Memory input (USB / Internal memory)
	MV1	“Memory viewer” input (MEMORY VIEWER)
WB1	WhiteBoard input (WHITEBOARD)	
DAM	None	Screen mode select (toggle)
	FULL	Full
	NORM	Normal
	NATV	Native
	HFIT	H fit
	VFIT	V fit
	ZOOM	Zoom1
ZOM2	Zoom2	

### Note

- If multiple commands are transmitted, be sure to wait for the response for the first command to come from this unit before sending the next command.
- If an incorrect command is sent by mistake, this unit will send an “ER401” command back to the computer.
- When sending a command which does not require parameter, a colon (:) is not needed.
- Consult your local Panasonic dealer for detail instructions on command usage.

For more details, visit the following web site.

<https://panasonic.net/cns/prodisplays/>

## IR IN / IR OUT terminal connection

Connect the stereo mini plug (M3) cable from the IR OUT terminal of the first display to the IR IN terminal of the second display.

The infrared signal of the first display is sent to the second display.

In this case, the IR (infrared ray reception on the remote control sensor) on the second display does not operate.

Repeating the above connections enables the daisy chain connection.

### Note

- Connection cables are not supplied with this unit.
- Daisy chain connection is possible only between the displays of the same series.

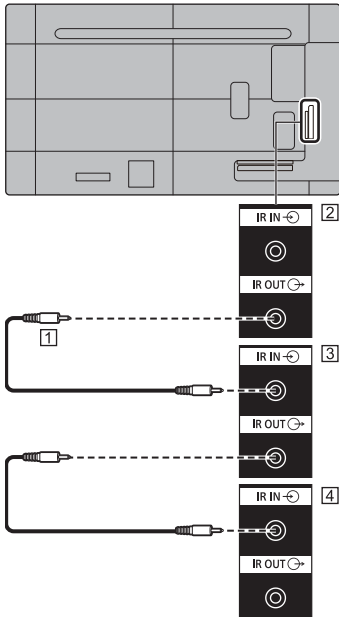

- ① Stereo mini plug (M3) cable (commercially available)
- ② First display
- ③ Second display
- ④ Third display

## AUDIO OUT terminal connection

### Note

- Audio equipment and the cable shown are not supplied with this set.

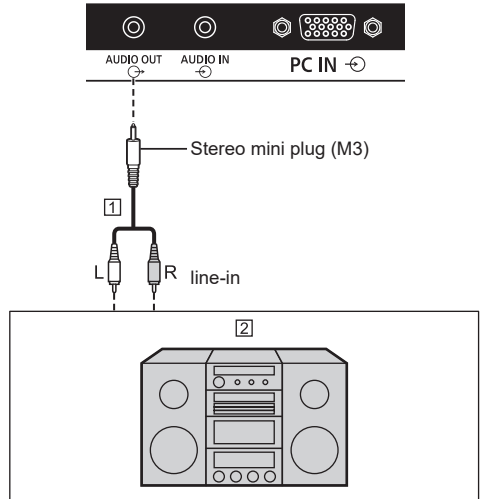

- ① Stereo audio cable (commercially available)
- ② Audio equipment

### Note

- To output sound from AUDIO OUT terminal of the unit, be sure to set [Output select] in the [Sound] menu to [AUDIO OUT]. (see page 45)

## USB / USB DEVICE terminal connection

Connect the USB memory (commercially available) to use "USB media player" or "Memory viewer". (see page 119, 131)

Connect a USB mouse to use the mouse annotation function (see page 156).

Also, power is supplied when a separately sold stick PC, etc. are connected.

### Note

- The connection example of the USB DEVICE terminal shows the case where connection to the internal system of the main unit is made as described in [USB (DEVICE) connect setting] (see page 90).
- A USB device or USB memory can be connected to the USB terminal and USB DEVICE terminal respectively.
- This unit has USB terminal and USB DEVICE terminal. To the terminals, a USB device or USB memory is connectible.
- When more than one USB memory is connected, only the first connected one is enabled.
- When more than one USB memory is connected, those connected second and later are disabled.
- When more than one USB memory is connected, and if all but one are disconnected, the last one remaining connected is enabled.
- When more than one USB memory is connected when the unit is powered on, only one of them is enabled depending on the specifications of the USB memories. To enable a target USB memory when the unit is powered on, connect only the target USB memory when the unit is powered on.
- A stick PC and connection cables are not supplied with this unit.
- If the power is turned off or the USB memory device is removed while accessing data in the USB memory device, the stored data may be destroyed. The access indicator of the USB memory device blinks during data access.
- The USB memory device can be connected or disconnected whether or not the display is on.

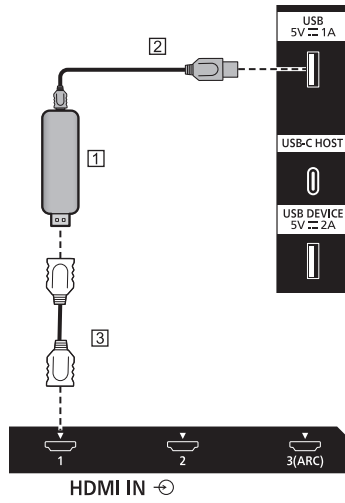

- 1 Stick PC (commercially available)
- 2 USB cable (commercially available)
- 3 HDMI extension cable (commercially available)

When the picture is displayed, depending on the USB terminal, power of up to 5V/1A (USB) or 5V/2A (USB DEVICE) can be supplied to an external device.

- If the electric current exceeding the power supplying capability is applied, the output is blocked, and the following message is displayed.

[USB overload. Please remove cable or equipment, then turn the display off/on.]

If an electric current exceeding the power supplying capability is applied in standby state, the output is blocked, and the power indicator blinks in purple.

In this case, remove the equipment and then turn the power off/on using the remote control, etc.

When [Power on settings] - [Quick start] is set to [On] in standby state, disconnect and connect the power plug from/to the outlet, or turn off and on the <Main Power On / Off button>.

### Note

- If the direct connection to this unit is not possible due to the size of a stick PC, etc. use a commercially sold extension cable.
- Depending on the type of a USB memory device, it may come in contact with the periphery such as a back cover, and cannot be attached. Use a USB memory device connectable to this unit.
- When connecting the USB memory device, confirm the orientation of the plug to prevent damage to the terminal.
- When removing the USB memory device, note the following.
  - When the access indicator of the connected USB memory device is blinking, it shows the display is loading the data. Do not remove the USB memory device while blinking.

- Depending on the USB memory device, the access indicator may remain blinking even when it is not being accessed, or the device is not equipped with an access indicator function, etc. In this case, remove the USB memory device after confirming the following ① or ②.
  - Switch the input to an input other than [USB], [MEMORY VIEWER] and [WHITEBOARD], and confirm that the functions that access USB memory device are finished. The functions are, read user image function (see page 67), playlist edit function (see page 126), data cloning function (see page 161), etc.
  - Turn the unit off.
- Do not frequently repeat connecting/disconnecting the USB memory device. Wait at least 5 seconds after connection, and then remove the USB memory device. Before reconnection, wait at least 5 seconds. A certain length of time is required so that the display can recognise that the USB memory device is switched for connection or disconnection.
- If the power of this unit is turned off or the USB memory device is removed accidentally while accessing data, the data may not be accessed next time the USB memory device is used.  
In such a case, turn the power of the main unit off and on.
- When the power is supplied from the USB DEVICE (5V, max 2A), use a cable supporting a current of 2A or more.

## USB-C / USB DEVICE terminal connection

The USB-C terminal of this unit supports multiple protocols and a maximum power supply of 60 W.

The terminal is compatible with devices that meet the USB-Type-C specification.

Connection is possible with source devices that support the DisplayPort Alternative Mode (DP Alt Mode). The USB DEVICE terminal enables USB communication with a connection destination set in [USB (DEVICE) connect setting] (see page 90), and is able to supply power of up to 5 V/max 2 A to external devices.

In addition, when a USB-C terminal-compatible PC is connected to the USB-C terminal, and a USB peripheral device is connected to the USB DEVICE terminal, USB data communication is possible via pass-through between the PC and the USB peripheral device.

### Note

- PC and connection cables are not supplied with this unit.
- The "USB media player" and "Memory viewer" function cannot be used from the USB-C terminal.
- When streaming video through Type-C connection, use a USB-C cable electronically authenticated as USB-C.
- The connection example of the USB DEVICE terminal shows the case where connection to the 6106 terminal is made as described in [USB (DEVICE) connect setting] (see page 90).
- When [USB (DEVICE) connect setting] (see page 90) is set to [Auto], and if a USB device connected to the USB DEVICE terminal is recognized by the PC connected to the USB-C terminal, switching the display input may not recognize the USB device depending on the type of USB device. In this case, set [USB (DEVICE) connect setting] to [USB-C] or connect the USB device to the USB terminal for use.
- If the electric current exceeding the power supplying capability is applied, the output is blocked, and the following message is displayed.

[USB overload. Please remove cable or equipment, then turn the display off/on.]

If an electric current exceeding the power supplying capability is applied in standby state, the output is blocked, and the power indicator blinks in purple.

In this case, remove the equipment and then turn the power off/on using the remote control, etc.

When [Power on settings] - [Quick start] is set to [On] in standby state, disconnect and connect the power plug from/to the outlet, or turn off and on the <Main Power On / Off button>.



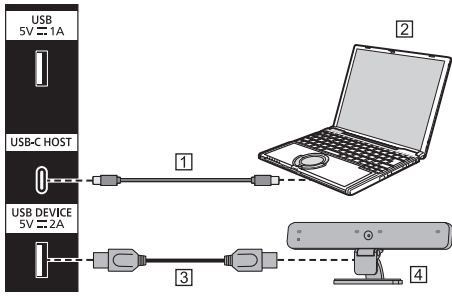

- 1 USB-C cable (commercially available)
- 2 PC
- 3 USB cable (commercially available)
- 4 USB peripheral device

# Identifying Controls

## Display

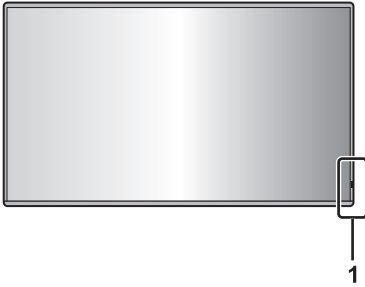

### 1 Power Indicator / Remote control sensor

The Power Indicator will light.

#### **When the power of the unit is ON (Main Power On / Off button (⏻/⏻): ON)**

- Picture is displayed: blue
- When the unit enters the standby mode using the following functions: purple
  - Standby state with the “Quick start” function  
About “Quick start” function, see page 56.
  - Standby state with the “Power management” function  
About “Power management” function, see page 61.
  - Standby state with [HDMI-CEC control] set to [Enable] and at least one [Link function] set to other than [Disable]  
About [HDMI-CEC control] setting and [Link function], see page 65.
  - Standby state with [Network control] set to [On]  
About “Network control” settings, see page 75.
  - Standby state with the “SLOT standby” function  
About “SLOT standby” function, see page 92.
  - Standby state during schedule play mode  
About “Schedule play mode”, see page 128.
- Standby state in conditions other than the above: orange

#### **When the power of the unit is OFF (Main Power On / Off button: OFF): No light**

##### **Note**

- Even if the unit is turned off with the power indicator off, some of the circuits are in power-on status.
- When the power indicator is purple, power consumption during standby is generally larger than that of when the power indicator is orange.
- When [Power LED light-up setting] is set to [Off], the power indicator does not light up. (see page 90 [Power LED light-up setting])

- For the power button, the operation with [POWER button control setting] set to [Off] is described unless otherwise mentioned. (see page 90 [POWER button control setting])

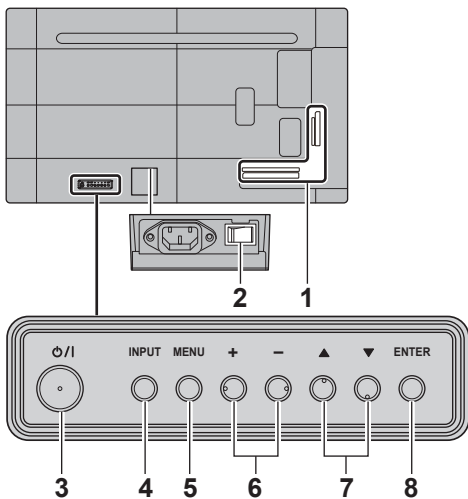

86-inch model    75-inch model    65-inch model

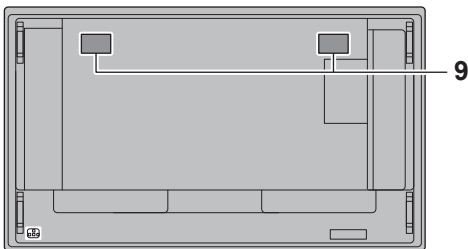

55-inch model    50-inch model    43-inch model

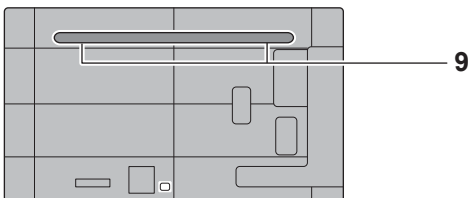

### 5 <MENU (Unit)>

Displays the menu screen. (see page 41)

### 6 <+ (Unit)> / <- (Unit)>

Adjusts the volume. (see page 37)

On the menu screen, switches settings or adjusts settings level. (see page 41)

### 7 <▲ (Unit)> / <▼ (Unit)>

Selects the setting item on menu screen. (see page 41)

### 8 <ENTER (Unit)>

Configures the item on menu screen. (see page 41)

Switches aspect mode. (see page 38)

### 9 Built-in speakers

Sound is output backward.

#### Note

- To output sound from the built-in speakers of the unit, be sure to set [Sound] - [Output select] to [SPEAKERS]. (see page 45)

### 1 External input / output terminal

Connects to video equipment, PC, etc. (see page 21)

### 2 Main power switch ( O/I ) (Unit)

Turns OFF ( O ) or ON ( I ) the main power.

Turning ON and OFF the <Main power switch> is the same as plugging and unplugging the power plug.

Turn ON ( I ) the main power first, and then turn OFF or ON the power using the Power button of the remote control or the unit.

### 3 <Main Power On / Off button> (power symbol)

Turns the power On / Off.

### 4 <INPUT (Unit)>

Selects the connected device. (see page 35)

## Remote Control Transmitter

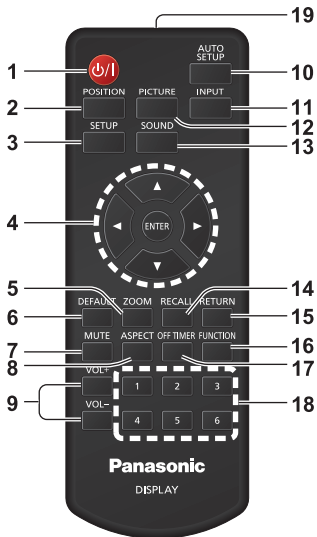

### 1 Standby (ON/OFF) button (⏻/⏻)

- Turns the power on or off when the unit is turned on at the <Main Power On / Off button>. (see page 34)

### 2 POSITION

(see page 43)

### 3 SETUP

(see page 52)

### 4 ENTER / Cursor buttons (▲▼◀▶)

- Used to operate the menu screens. (see page 41)

### 5 ZOOM

- Enters the digital zoom mode. (see page 40)

### 6 DEFAULT

- Resets the settings of picture, sound, etc., to defaults. (see page 43, 45, 46)

### 7 MUTE

- Sound mute on / off. (see page 37)

### 8 ASPECT

- Adjusts the aspect. (see page 38)

### 9 VOL + / VOL -

- Adjusts sound volume level. (see page 37)

### 10 AUTO SETUP

- Automatically adjusts the position/size of the screen. (see page 43)

### 11 INPUT

- Switches input to display on the screen. (see page 35)

### 12 PICTURE

(see page 46)

### 13 SOUND

(see page 45)

### 14 RECALL

- Displays the current setting status of Input mode, Aspect mode, etc. (see page 36)

### 15 RETURN

- Used to return to the previous menu. (see page 41)

### 16 FUNCTION

- Displays [Function button guide]. (see page 86)

### 17 OFF TIMER

- Switches to stand-by after a fixed period. (see page 37)

### 18 Numeric buttons (1 - 6)

- Used as shortcut buttons by assigning frequently used operations. (see page 85)

### 19 Signal emission

#### Note

- In this manual, buttons of the remote control and the unit are indicated as <>.

(Example: <INPUT>.)

The operation is mainly explained indicating the remote control buttons but you can also operate with the buttons on the unit when there are the same buttons.

# Basic Controls

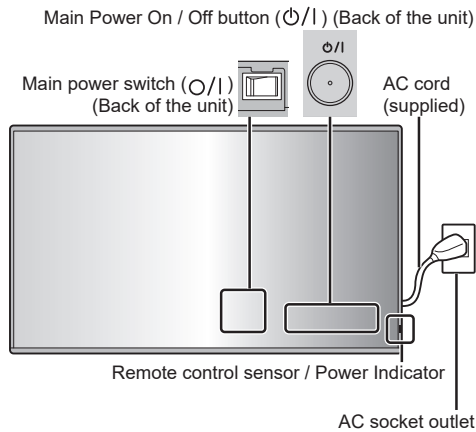

Operate pointing the remote control directly at the unit's Remote Control Sensor.

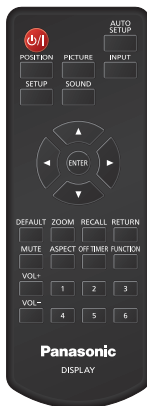

## Note

- Do not put an obstacle between the remote control sensor of the main unit and the remote control.
- Operate the remote control in front of the remote control sensor or from the area where the sensor can be seen.
- When directly aiming the remote control at the remote control sensor of the main unit, the distance from the front of remote control sensor should be approx. 7 m or less. Depending on the angle, the operation distance may be shorter.
- Do not subject the remote control sensor of the main unit to the direct sunlight or strong fluorescent light.

## 1 Connect the AC cord plug to the Display.

(see page 19)

## 2 Connect the plug to the socket outlet.

### Note

- Main plug types vary between countries. The power plug shown at left may, therefore, not be the type fitted to your set.
- When disconnecting the AC cord, be absolutely sure to disconnect the AC cord plug at the socket outlet first.
- The settings may not be saved if the power plug is disconnected immediately after changing settings with on-screen menu. Disconnect the power plug after a enough period of time. Or, disconnect the power plug after turning the power off with the remote control, RS-232C control or LAN control.

## 3 Turn ON (I) the <Main power switch (O/I)> on the unit.

## 4 Press the <Main Power On / Off button> (O/I) on the unit to turn the power of the unit on.

- Power Indicator: Blue (Picture is displayed.)
- When the power of the unit is on, the power indicator lights up and remote control operation is possible.
- When the power indicator is lit, it is not necessary to press the <Main Power On / Off button> (O/I) on the unit. Operate the remote control so that the power indicator turns blue (picture is displayed).

## ■ To turn the power ON/OFF with the remote control

### To turn the power on

- When the <Main power switch> is ON (I) (Power Indicator - orange or purple), press <Standby (ON/OFF) button> then the picture will be displayed.
- Power Indicator: Blue (Picture is displayed.)

### To turn the power off

- When the <Main power switch> is ON (I) (Power Indicator - blue), press <Standby (ON/OFF) button>, then the power will be turned off.
- Power Indicator: Orange or purple (standby)

#### Note

- During operation of the "Power management" function (see page 61), the power indicator turns purple in the power off state.
- After the power plug is disconnected, the power indicator may remain lit for a while. This is not a malfunction.
- The display turns off if the <Main power switch> is turned OFF (O) or press the <Main Power On / Off button> (D/I) on the unit while the unit is ON (picture is displayed) or OFF (standby state).
- When [Power LED light-up setting] is set to [Off], the power indicator does not light up. (see page 90 [Power LED light-up setting])

## ■ When the Unit is turned on for the first time

Following screen will be displayed.

### 1 Select the language with ▲ ▼ and press <ENTER>.



### 2 For vertical installation, select [Portrait] with ▲ ▼ and press <ENTER>.

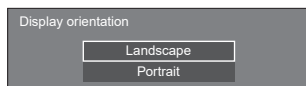

#### Note

- Once the items are set, the screens won't be displayed when switching on the unit next time. Each item can be reset in the following menus. [OSD language] (see page 68) [Display orientation] (see page 89)

## 3 Configure the network account setting as necessary.

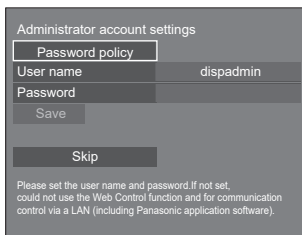

### Password policy

Cautions regarding the password setting in this item are displayed on another window.

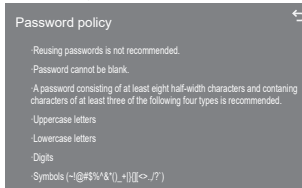

### User name

A keyboard for user name setting is displayed. Enter the user name.

- Entering characters (see page 169)

### Password

A keyboard for password setting is displayed. After the password is entered, select [Ok] to display a confirmation screen. Enter the password again and select [Ok] to determine the password.

### Save

The user name and password set above are saved in the display unit.

### Skip

Exits this screen without configuring this setting.

#### Note

- Once set or skipped, this screen won't be displayed when switching on the unit next time. Use the following menu to configure the setting again.

[Network settings] (see page 74)

## ■ Power ON message

The following message may be displayed when turning the unit power ON:

### No activity power off Precautions

'No activity power off' is enabled.

When [No activity power off] in the [Setup] menu is set to [Enable], a warning message is displayed every time the power is turned ON. (see page 67)

### "Power management" information

Last turn off due to 'Power management'.

When "Power management" is functioned, an information message is displayed every time the power is turned ON. (see page 61)

### COLOUR DESIGN Information

Colour design settings are universal.

The information is displayed when [Setup] - [Colour design settings] - [Colour design] is set to [Universal].

These message displays can be set with the following menu:

- [Power on settings] menu  
Information(No activity power off)  
(see page 55)  
Information(Power management)  
(see page 55)  
Information(Colour design)  
(see page 56)

## Selecting the input signal

Select the signals input to the unit.

Press <INPUT> or <INPUT (Unit)>.

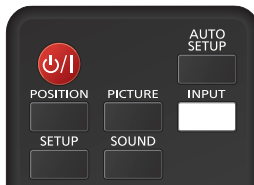

Unit

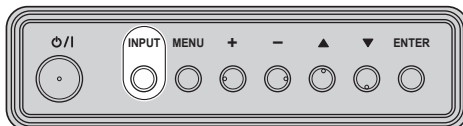

Switches input every time the buttons are pressed.

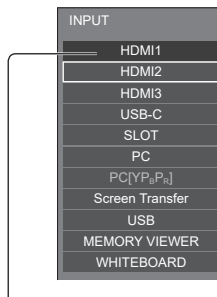

[HDMI1] → [HDMI2] → [HDMI3] → [USB-C] → [SLOT] → [PC] → [Screen Transfer] → [USB] or [Internal Memory] → [MEMORY VIEWER] → [WHITEBOARD]

[HDMI1]: HDMI IN 1 terminal, HDMI input

[HDMI2]: HDMI IN 2 terminal, HDMI input

[HDMI3]: HDMI IN 3 terminal, HDMI input

[USB-C]: USB-C HOST terminal, USB-C input

[SLOT]: Input signal of the function board

[PC]\*1: PC IN terminal, PC input

[Screen Transfer]:

Input that displays images transmitted via network using "Screen Transfer", a dedicated application by Panasonic

[USB]\*2: USB terminal, USB input

[Internal Memory]\*2: Image input from the internal memory

[MEMORY VIEWER]: USB terminal, "Memory viewer" input

[WHITEBOARD]: The screen switches "WHITEBOARD" input.

\*1: [PC] may be displayed as [PC [YPrPr]] depending on the settings of [PC input mode]. (see page 90)

\*2: For [USB] and [Internal Memory] input, either one selected for the [Use memory select] setting is displayed. (see page 90)

## Note

- Inputs set for [Input skip settings] or inputs when each function is disabled cannot be selected. (see page 61)
- Displays the signal name as set in [Input label]. (see page 60)
- Input will not be switched unless [Input lock] is set to [Off]. (see page 67)
- To switch between the component (color difference) video and RGB for the PC IN terminal, make the setting with [Setup] - [PC input mode]. (see page 90)
- Image retention may occur on the LCD liquid crystal panel when a still picture is kept on the panel for an extended period. To prevent such a problem, using the screensaver and the [Wobbling] function is recommended. (see page 59, 60)
- Switching to another input while the unit is connected to Screen Transfer with Screen Transfer input will break the connection. Check the connection again after switching the input.
- When [Whiteboard settings] - [Whiteboard] is set to [On], the WHITEBOARD input is enabled. (see page 71)

## RECALL

It is possible to check the setting status of input label, picture mode, etc.

Press <RECALL>.

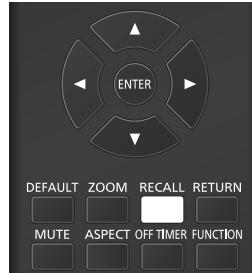

Current setting status will be displayed.

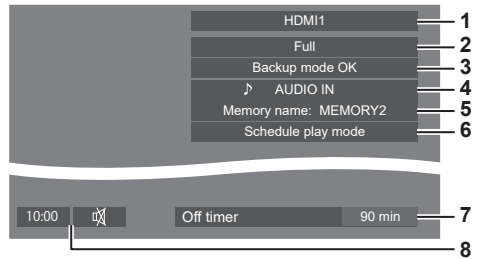

- 1 Input label
- 2 Aspect mode (see page 38)
- 3 Backup input change (see page 58)
- 4 Audio input (see page 63)
- 5 Profile name (see page 50)
- 6 [Schedule play mode] (see page 128)
- 7 Off timer remaining time (see page 37)
- 8 Clock / Mute (see page 37, 73)

- When there is no video signal to the selected input, [No signal] is displayed for about 30 seconds at the end.
- When a USB memory is not connected to the USB terminal at the time of switching to the USB input, [No external media] is displayed for about 30 seconds. Even when a USB memory is connected, if it does not contain any playable file, [No play file] is displayed at all times.
- When [No signal image settings] - [Display setting] is set to [On] (see page 66), the message [No signal] / [No external media] / [No play file] are not displayed. Instead, the image set in [No signal image settings] will be displayed.
- To display the clock, set [Date and time] and then set [Clock display] to [On]. (see page 73)



## Volume Adjustment

Press <VOL +> <VOL -> or <+ (Unit)> <- (Unit)> to adjust volume.

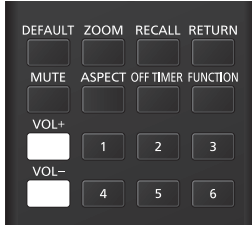

Unit

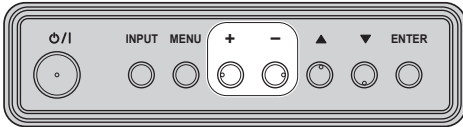

- The current sound volume level is memorised even if the power is turned off.
- When [Maximum VOL function] is set to [On], the volume can only be adjusted to the maximum point you set, and the displayed value turns red when it reached its maximum. (see page 91)
- When [Initial VOL function] is set to [On], the volume will be at the set level when the display is turned on. (see page 55)

## Sound mute On / Off

It is useful when you want to mute the sound temporarily, for example, when answering the phone or door.

Press <MUTE>.

- appears on the screen and the sound is muted. Press again to reactivate the sound.

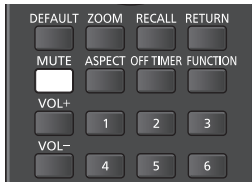

- It is also reactivated when the power is turned on / off or the volume level is changed.
- While MUTE is active, is displayed as a reminder after operation.
- When the image set in [No signal image settings] (see page 66) is displayed, is not displayed after operation.
- In [ENGLISH(US)] OSD language, is displayed as [MUTE].

## OFF TIMER

The Display can be preset to switch to stand-by after a fixed period. (30 min, 60 min, 90 min)

The setting switches each time <OFF TIMER> is pressed.

- [0 min] → [30 min] → [60 min] → [90 min] → [0 min] (Cancel)

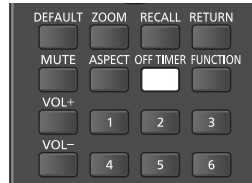

- When 3 minutes remain, the remaining time will flash (Red). After that, it switches to stand-by.
- To see the Off timer remaining time, press <RECALL>.
- The Off timer is cancelled if a power interruption occurs. When the power is turned on later on, it will be in stand-by condition.
- When the image set in [No signal image settings] (see page 66) is displayed, remaining time is not displayed even when the timer expires in 3 minutes. Instead, the image is displayed until the power is turned off. Press <RECALL> to check the remaining time.

# ASPECT Controls

Press <ASPECT> or <ENTER (Unit)> repeatedly to move through the aspect options:

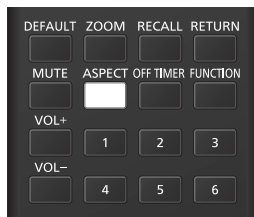

Unit

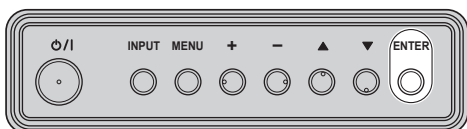

[Normal] → [Native] → [H fit] → [V fit] → [Zoom1] → [Zoom2] → [Full]

### Note

- When using Screen Transfer input, the aspect mode cannot be changed.
- The aspect mode is memorised separately for each input terminal.
- Aspect modes [H fit] and [V fit]:  
Even if the display is installed vertically, the enlargement directions for the [H fit] and [V fit] aspect modes are the same as those in horizontal installation.  
The enlargement directions do not change in the following cases as well.
  - When the unit is installed in the portrait setting by setting [Display orientation] to [Portrait]. (see page 89)
  - When [USB media player settings] - [Still picture rotation] is set to [Portrait]. (see page 82)

## ■ List of Aspect Modes

Aspect mode	Description
Full	<p><b>Picture</b> → <b>Enlarged screen</b></p> <p>Pictures are displayed filling the screen.</p>
Normal	<p>Pictures are displayed with the aspect ratio of input signals.</p>
Native	<p>Pictures are displayed with the resolution of input signals.</p>
H fit	<p>Pictures are enlarged to the maximum horizontal dimension of the screen. Pictures of signals with the aspect ratio vertically longer than the aspect ratio of the screen are displayed with the top and bottom of the pictures cut.</p>
V fit	<p>Pictures are enlarged to the maximum vertical dimension of the screen. Pictures of signals with the aspect ratio horizontally longer than the aspect ratio of the screen are displayed with the right and left of the pictures cut.</p>
Zoom1	<p>Letterbox pictures with a 16:9 aspect ratio are enlarged vertically to fill the screen. The top and bottom edges of the pictures are cut off.</p>
Zoom2	<p>Letterbox pictures with a 16:9 aspect ratio are enlarged vertically and horizontally to fill the screen. The top and bottom edges as well as the left and right edges of the pictures are cut off.</p>

**Note**

- This display incorporates several types of aspect mode select functions. If a mode whose aspect ratio is different from that of TV program content is selected, the on-screen appearance will differ from that of the original images. Note this point when selecting an aspect mode.
- Be aware that if you put the display in a public place for commercial purposes or a public showing and then use the aspect mode select function to shrink or expand the picture, you may be violating the copyright under copyright law. It is prohibited to show or alter the copyrighted materials of other people for commercial purposes without the prior permission of the copyright holder.
- When viewing a non-wide picture with a 4:3 aspect ratio by displaying in full screen using a zoom mode or the 16:9 mode, the circumference image will be partially invisible or deformed. Original images can be viewed in the [Normal] mode with respect for creators' intentions.

# Digital ZOOM

Select the screen areas (25 areas) to zoom in, and zoom in the selected image areas  $\times 2$ ,  $\times 3$  or  $\times 4$ .

(Operate using the remote control. The buttons on the unit cannot be used for some operations.)

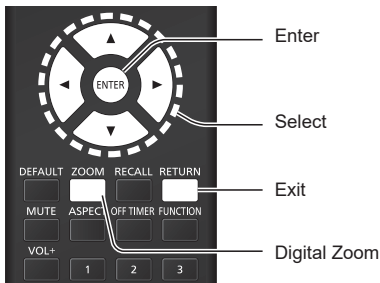

## 1 Set the digital zoom mode.

Press **<ZOOM>**.

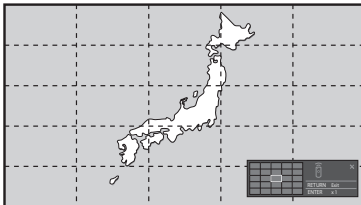

The screen aspect is set to [Full], and the digital zoom operation guide is displayed.

## 2 Select the image areas to zoom in.

Select pressing **▼▲◀▶**.



Digital Zoom operation guide

## 3 Switch the zoom ratio for the screen areas.

Switches every time **<ENTER>** is pressed.

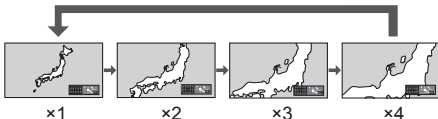

- If no operation is performed for the period set for [Menu display duration] (see page 86) (5 – 180 seconds) **when the zoom ratio for the screen is “ $\times 1$ ”**, the unit exits the zoom mode.
- If no operation is performed for approx. 3 seconds **when the zoom ratio for the screen is “ $\times 2$ ”, “ $\times 3$ ” or “ $\times 4$ ”**, the digital zoom operation guide display disappears. Pressing any of the **▼▲◀▶** buttons displays the guide again.

## 4 Exit the digital zoom mode.

Press **<RETURN>** to exit the mode.

The screen returns to the previous state just before entering the digital zoom mode, and the digital zoom operation guide display disappears.

- Press any of the following buttons to exit the mode. Then, the operation of the pressed button is performed.

Remote Control:

<AUTO SETUP> <POSITION> <PICTURE>  
<INPUT> <SETUP> <SOUND> <DEFAULT>  
<RECALL> <MUTE> <ASPECT>  
<OFF TIMER> <FUNCTION> <VOL +>  
<VOL -> <1> - <6>

Unit:

<INPUT (Unit)> <MENU (Unit)> <+ (Unit)>  
<- (Unit)> **▲▼** <ENTER (Unit)>

- When the screen saver timer starts up, the digital zoom mode finishes.
- When the power is turned OFF, a force-quit is performed.
  - When the power is turned OFF by pressing the **<Standby (ON/OFF) button>**.
  - When the display is turned OFF at the **<Main Power On / Off button>**
  - When the power is turned OFF by the off-timer
  - When the power is turned OFF by [No signal power off] or “Power management”.

### Note

- In the following cases, the digital zoom mode is not available.
  - When [Multi display settings] - [Multi screen display] is set to [On]
  - When [Portrait settings] - [Portrait display] is set to [On]
  - When the screen saver is in operation
  - When Screen Transfer / USB / MEMORY VIEWER / WHITEBOARD input is selected.
- The zoomed image is rougher than the original image.
- For multi display use, use the functions in [Multi display settings]. (see page 71)

# On-Screen Menu Displays

## 1 Display the menu screen.

Remote Control

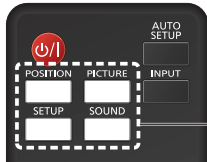

Press to select.

Unit

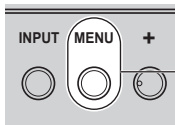

Press for several times.

Each time the button is pressed, the menu screen will switch.

Normal Viewing → [Picture] → [Setup] → [Position] → [Sound]

## 2 Select the item.

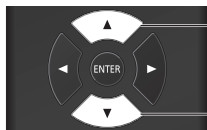

Press to select.

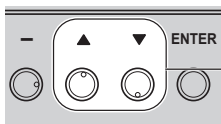

Press to select.

(Example: [Picture] menu)

Picture	
Default	Default
Picture mode	< Standard >
Backlight	< 50 >
Contrast	< 50 >
Brightness	< 50 >
Colour	< 50 >
Hue	< 50 >
Sharpness	< 50 >
Enhance level	< High >
Gamma	< 2.2 >
Colour temperature	< 6500K >
Colour management	< Off >
Dynamic contrast	< 5 >
Colour enhancement	< Off >
Blue light reduction	< Off >
Refine enhancer	< Off >
Gradation smoother	< Off >
Memory save	
Memory load	
Memory edit	

To display the submenu, press <ENTER>.

## 3 Set.

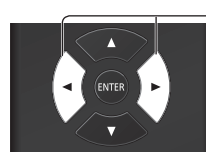

Press to set.

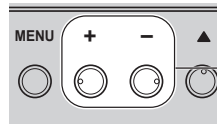

Press to set.

## 4 Exit from the menu.

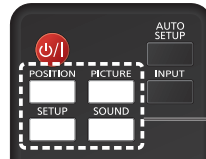

Press.

Press <RETURN> to return to the previous screen.

Alternatively, press the button selected in step 1 to exit from the menu.

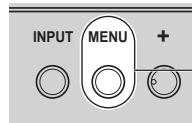

Press for several times.

### Note

- When changing the settings of the display, picture or sound disturbance may occur temporarily. This is not a malfunction.

## Menu display list

- Menu that cannot be adjusted is greyed out.  
Adjustable menu changes depending on signal, input and menu setting.

### [Position] menu

(see page 43)

Position	
Default	Default
Auto setup	
H-position	< 0 <input type="text"/> >
H-size	< 0 <input type="text"/> >
V-position	< 0 <input type="text"/> >
V-size	< 0 <input type="text"/> >
Clock phase	< 15 <input type="text"/> >
Dot clock	< 0 <input type="text"/> >
Over scan	< Off >
PC auto setting < Off >	

### [Sound] menu

(see page 45)

Sound	
Default	Default
Output select	< SPEAKERS >
Balance	< 0 <input type="text"/> >
Sound mode	< Normal >
Bass	< 0 <input type="text"/> >
Treble	< 0 <input type="text"/> >
Surround	< Off >
Auto volume	
Installation	< Wall mounted >

### [Picture] menu

(see page 46 – 51)

Picture	
Default	Default
Picture mode	< Standard >
Backlight	< 50 <input type="text"/> >
Contrast	< 50 <input type="text"/> >
Brightness	< 50 <input type="text"/> >
Colour	< 50 <input type="text"/> >
Hue	< 50 <input type="text"/> >
Sharpness	< 50 <input type="text"/> >
Enhance level	< High >
Gamma	< 2.2 >
Colour temperature	< 6500K >
Colour management	< Off >
Dynamic contrast	< 5 <input type="text"/> >
Colour enhancement	< Off >
Blue light reduction	< Off >
Refine enhancer	< Off >
Gradation smoother	< Off >
Memory save	
Memory load	
Memory edit	

### [Setup] menu

(see page 52 – 92)

Setup		1/3
Signal		
Power on settings		
Input search		
Failover/Fallback		
Screensaver		
Input label		
Input skip settings		
Power management settings		
Audio input select		
External device link settings		
HDMI-CEC settings		
Image settings		
Input lock	< Off >	>
Off-timer function	< Enable >	>
No activity power off	< Disable >	>
OSD language	< English(UK) >	>

Setup		2/3
Multi display settings		
Portrait settings		
Whiteboard settings		
Video conference mode settings		
Set up timer		
Date and time		
Network settings		
USB media player settings		
Memory viewer settings		
Screen Transfer settings		
Wireless presentation settings		
Function button settings		
Colour design settings		
OSD settings		

Setup		3/3
Options		
Control settings		
Information timing		
Mode settings		
Restriction settings		
SLOT settings		

# Adjusting Position

## 1 Press <POSITION> to display the [Position] menu.

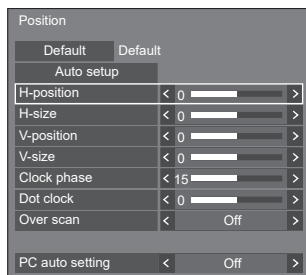

## 2 Select the item to adjust with ▲ ▼.

- Unadjustable items are greyed out.  
Adjustable items differ depending on the signal, input and the display mode.

## 3 Adjust with ◀ ▶.

## 4 Press <POSITION> to exit from adjust mode.

### ■ To return to the previous screen

Press <RETURN>.

### ■ To reset to defaults

When [Default] is selected, pressing <ENTER> resets the adjustment values of all the displayed menus to default.

When adjusting each item, pressing <DEFAULT> resets the adjustment value of the item to default.

#### Note

- When using Screen Transfer or WHITEBOARD input, [Position] cannot be set.
- Settings for [Position] are memorised separately for each input signal.

#### About [Position] setting

Even if the display is installed vertically, the adjustment direction of the position and size does not change.

When [Image rotation] is set to [180 degrees], the adjustment direction becomes opposite of that in [Off] state. (see page 89)

Note these points for adjustment.

## Auto setup

When inputting a PC signal, [H-position] / [V-position], [H-size] / [V-size], [Clock phase] and [Dot clock] are automatically corrected.

### This setting is enabled under the following condition:

- This setting is enabled when an analogue signal (PC) is input, [PC input mode] is set to [PC] and the aspect mode is set to [Full]. (see page 90)

While displaying the picture of the corresponding signal, select [Auto setup] and press <ENTER>.

### Using Remote Control

#### Press <AUTO SETUP>.

When Auto Setup does not work, [Invalid] is displayed.

#### Note

- When the dot clock frequency of a PC signal is 162 MHz or higher, [Clock phase] and [Dot clock] cannot be automatically corrected.
- Auto Setup may not work when a cropped or dark image is input. In such case, switch to a bright image with borders and other objects are clearly shown, and then try auto setup again.
- Depending on the signal, out of alignment may occur after Auto Setup. Carry out fine tuning for the position/size as required.
- If Auto Setup cannot set properly for XGA signal (1024 x 768, 1280 x 768, 1366 x 768), pre-selecting the individual signal in [XGA mode] (see page 53) may result in correct Auto Setup.
- Accurate auto setup is not possible when a signal such as additional information is superimposed out of valid image period or when intervals between synchronizing signal and image signal are short. Also, accurate auto setup is not possible when image signals with tri level synchronizing signal added are input.
- When [PC auto setting] is set to [On], automatic position adjustment starts under the following conditions:
  - When the display power is turned ON.
  - When the input signal is switched.
- If Auto Setup does not work well, select [Default], press <ENTER>, and then adjust the position/size manually.

**[H-position]** Adjust the horizontal position with ◀▶.

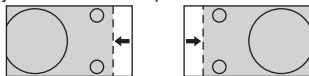

**[H-size]** Adjust the horizontal size with ◀▶.

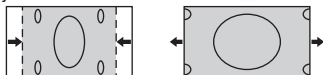

**[V-position]** Adjust the vertical position with ▲▼.

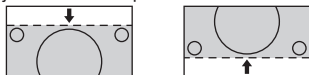

**[V-size]** Adjust the vertical size with ▲▼.

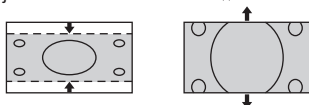

**[Clock phase]** (For PC IN input)

In some cases, frame of the screen appears blurred or smudged, when PC signal is input.

**[Dot clock]** (For PC IN input)

Periodic striped pattern interference (noise) may occur when a striped pattern is displayed. If this happens, adjust so that any such noise is minimized.

**[Over scan]** Turn image over scan On/Off.

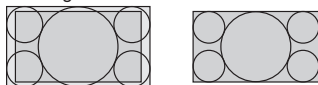

[On]

[Off]

**Note**

- This is enabled when the screen mode is set to [Full], [Zoom1] or [Zoom2].

Note this setting is disabled when using USB / MEMORY VIEWER input, multi screen display of the multi display or digital zoom.

**[PC auto setting]** Sets the operational mode of the automatic position adjustment in the [Position] menu.

**[Off]:**

Automatic position adjustment starts when <AUTO SETUP> is pressed on the remote control or automatic position adjustment is executed from the [Position] menu.

**[On]:**

Other than remote control or menu operation, automatic position adjustment starts:

- When the display power is turned ON.
- When the input signal is switched.

**Note**

- In some cases, noise appears outside the area picture is displayed, but it is not a malfunction.
- [Clock phase] and [Dot clock] are enabled only when [PC input mode] is set to [PC] in PC IN input.



# Sound Adjustment

## 1 Press <SOUND> to display the [Sound] menu.

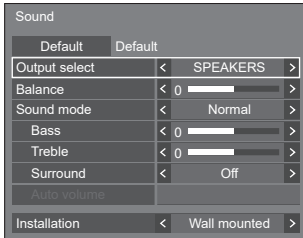

## 2 Select the item to adjust with ▲ ▼.

- Menu that cannot be adjusted is greyed out.

## 3 Adjust with ◀ ▶.

## 4 Press <SOUND> to exit from adjust mode.

### ■ To return to the previous screen

Press <RETURN>.

### ■ To reset to defaults

Press <DEFAULT> while the menu is displayed, or press <ENTER> when [Default] is selected, then the adjustment values of all the displayed menus are reset to default.

**[Output select]** Select the audio output.

#### **[SPEAKERS]:**

Internal speakers output

#### **[AUDIO OUT]:**

AUDIO OUT terminal output

- When [AUDIO OUT] is selected, the other menus are greyed out and cannot be selected.
- Audio volume setting is memorized separately for each output.

**[Balance]** Adjusts left and right volumes.

**[Sound mode]** Select for best audio.

#### **[Normal]:**

Emits the original sound.

#### **[Dynamic]:**

Accentuates sharp sound.

#### **[Clear]:**

Attenuates human voice.

- In [ENGLISH(US)] OSD language, [Sound mode] and [Normal] are displayed as [AUDIO MENU] and [STANDARD].

**[Bass]** Adjusts low pitch sounds.

**[Treble]** Adjusts high pitch sounds.

**[Surround]**

**[Off]:**

Normal sound

**[On]:**

Surround sound

### Note

- [Bass], [Treble] and [Surround] settings are memorised separately for [Normal], [Dynamic] and [Clear] in [Sound mode].

**[Auto volume]**

Adjusts the volume level automatically. Select from among [Min], [Mid] and [Max] according to the degree of imbalance of sound level.

**[Off], [Min], [Mid], [Max]**  
(Small effect - Large effect)

### Note

- This menu is available when [Clear] is selected in [Sound mode].
- When [Auto volume] is activated ([Max] / [Mid] / [Min]), [Surround] will be [Off].
- Use this function when the sound level is variable during TV conference, etc.
- When listening to music, the sound volume may become off-balance between vocals and instruments, which may create a feeling of strangeness or make it difficult to hear audio due to emphasized noise. In this case, lower the adjustment level (e.g., [Max] → [Min]), or set the function to [Off].

**[Installation]**

Switch the audio to audio suitable to the installation environment.

#### **[Stand]:**

Audio suitable to pedestal installation

#### **[Wall mounted]:**

Audio with slightly reduced sound reflection suitable to wall-hanging installation

### Note

- This menu is available when [SPEAKERS] is selected in [Output select].
- When outputting audio to an ARC-compatible device, refer to "Using ARC function" (see page 160).

# Picture Adjustments

## 1 Press <PICTURE> to display the [Picture] menu.



## 2 Select the item to adjust with ▲ ▼.

- Menu that cannot be adjusted is greyed out.

## 3 Adjust with ◀ ▶.

## 4 Press <PICTURE> to exit from adjust mode.

### ■ To return to the previous screen

Press <RETURN>.

### ■ To reset to defaults

When [Default] is selected, pressing <ENTER> resets the adjustment values of all the displayed menus to default.

When adjusting each item, pressing <DEFAULT> resets the adjustment value of the item to default.

#### Note

- When displaying still pictures with the USB/Internal Memory input (USB media player), using WHITEBOARD input (see page 138) or displaying the thumbnail screen or file list screen of the MEMORY VIEWER input (Memory viewer) (see page 133), only the following settings have an effect on the picture.

[Backlight], [Gamma], [Colour temperature], [Blue light reduction]

### [Picture mode]

This menu switches to easy-to-see pictures suitable to the picture source or environment where this unit is used.

#### [Vivid signage]:

Suitable for signage applications featuring more vivid and sharper images in bright environments such as a shop.

#### [Natural signage]:

Suitable for signage applications such as merchandise exhibition, featuring natural tone images with colour reproduction emphasized under light.

#### [Standard]:

Faithfully reproduces original picture.

#### [Surveillance]:

Tone-focused pictures with brightness reduced suitable for input from a monitoring camera.

#### [Graphic]:

Suitable for PC input.

#### [DICOM]:

Pictures close to the grayscale standard DICOM Part14.

- The settings are memorised separately for each input terminal.

#### Note

- DICOM is the abbreviation for "Digital Imaging and Communications in Medicine", which is a standard for communications between medical imaging devices. Although "DICOM" is used as a picture mode name, this unit is not a medical device. Do not use displayed images for such purposes as diagnosis.
- In [ENGLISH(US)] OSD language, [Picture mode] is displayed as [PICTURE MENU].

### [Backlight]

Adjusts luminance of the back light.

**Darker ↔ Brighter**

### [Contrast]

Selects the proper brightness and density for the room.

**Less ↔ More**

- In [ENGLISH(US)] OSD language, [Contrast] is displayed as [PICTURE].

### [Brightness]

Adjusts for easier viewing of dark pictures.

**Darker ↔ Brighter**

### [Colour]

Adjusts colour saturation.

**Less ↔ More**

### [Hue]

Adjusts hue of skin colour.

**Reddish ↔ Greenish**

- In [ENGLISH(US)] OSD language, [Hue] is displayed as [TINT].

**[Sharpness]** Adjusts picture sharpness.

**Less ↔ More**

**[Enhance level]** Switches the effect range for sharpness.

**[High]: Large effect**

**[Low]: Small effect**

**[Gamma]** Adjusts gamma.

**[2.0], [2.2], [2.4], [2.6], [DICOM]:**

**Small tilt - Large tilt**

**Note**

- When [DICOM] is selected in [Picture mode], [Gamma] is fixed to [DICOM].

When the items other than [DICOM] are selected in [Picture mode], [DICOM] cannot be set for [Gamma].

**[Colour temperature]** Adjusts colour tone.

**[3200K], [4000K], [5000K], [6500K], [7500K], [9300K], [10700K], [Native], [User1], [User2]**

**Note**

- Emphasizes red when the numerical value of [Colour temperature] is small, and emphasizes blue when it is big.
- [Native] is a colour tone of the panel element. When this is selected, [Gamma] is fixed to 2.2 or equivalent and it cannot be adjusted.
- When [DICOM] is selected in [Picture mode], only [6500K] and [9300K] can be selected.

**User setting of [Colour temperature]**

2 kinds of detailed [Colour temperature] settings ([User1] and [User2]) can be stored.

- 1 Press <ENTER> while setting [Colour temperature].

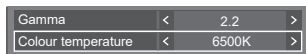

Example:

When [Colour temperature] is [6500K], it is possible to reflect the set point, [6500K], to the set point of [User1] and [User2].

- 2 Select the user to memorize settings with ▲ ▼ and press <ENTER>.

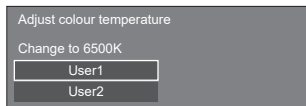

- 3 Select [Yes] with ◀ ▶ and press <ENTER>.

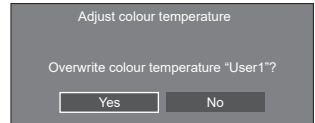

- 4 Set each item on detail settings screen.

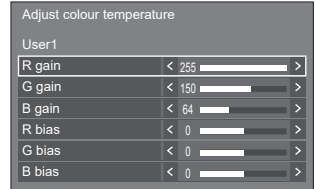

**[R gain]**

Adjusts the white balance for light red areas.

**0 to 255**

**[G gain]**

Adjusts the white balance for light green areas.

**0 to 255**

**[B gain]**

Adjusts the white balance for light blue areas.

**0 to 255**

**[R bias]**

Adjusts the white balance for dark red areas.

**-127 to 128**

**[G bias]**

Adjusts the white balance for dark green areas.

**-127 to 128**

**[B bias]**

Adjusts the white balance for dark blue areas.

**-127 to 128**

The settings are saved for the user.

When you return to [Picture] menu, the user you have set is selected for [Colour temperature].

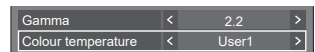

## [Colour management]

Adjusts the colour tone of R (red), G (green), B (blue), complementary colours (cyan, magenta and yellow) and the intermediate colours on the screen individually.

**[Off]:** Disables colour management function.

**[6-segment]:** Enables 6-segment colour management function.

**[12-segment]:** Enables 12-segment colour management function.

- 1 Set [Colour management] to [6-segment] or [12-segment], and then press <ENTER>.

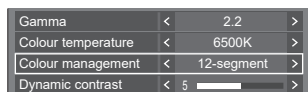

- 2 Set each item on detail settings screen.



### [Select colour]

Select the colour to adjust with ◀▶.

### [Hue]

Adjusts colour balance.

- 127 to + 127

### [Saturation]

Adjusts gradations of colour.

- 127 to + 127

### [Value]

Adjusts brightness of colour.

- 127 to + 127

### [Reset]

Resets to defaults. Select [Yes] with ◀▶ and press <ENTER>.

- In [ENGLISH(US)] OSD language, [Hue] is displayed as [TINT].

### Note

- When [6-segment] is selected, R (red), G (green), B (blue) and complementary colours (cyan, magenta and yellow) are adjusted respectively. When [12-segment] is selected, [6-segment] items and the intermediate colours can be adjusted.

## [Dynamic contrast]

Automatically adjusts the contrast by determining the changes in the use of colours for images that constantly change, such as motion pictures.

**No effect ↔ Large effect**

## [Colour enhancement]

Displays images by emphasizing colours.

**[Off], [Low], [Mid], [High]**  
**(Small effect to Large effect)**

## [Blue light reduction]

Reduces blue light on the picture.

**[Off], [Low], [Mid], [High]** (effect: low to high)

### Note

- When it is set to a setting other than [Off], pictures look yellowish.

## [Refine enhancer]

Enhances the sense of resolution by correcting fuzzy outlines of pictures resulted from resizing, etc.

**[Off], [Low], [Mid], [High]**  
**(Small effect to Large effect)**

## [Gradation smoother]

Extracts and eliminates noise components from the input video signals, and then displays noiseless pictures.

**[Off], [On]**

# Picture Profiles

Up to 6 combinations of picture adjustment values (in the [Picture] menu) can be stored in the display memory as profiles and applied as needed, for a convenient way to enjoy your preferred picture settings.

Picture

Default	Default
Picture mode	< Standard >
Backlight	< 50 [Progress Bar] >
Contrast	< 50 [Progress Bar] >
Brightness	< 50 [Progress Bar] >
Colour	< 50 [Progress Bar] >
Hue	< 50 [Progress Bar] >
Sharpness	< 50 [Progress Bar] >
Enhance level	< High >
Gamma	< 2.2 >
Colour temperature	< 6500K >
Colour management	< Off >
Dynamic contrast	< 5 [Progress Bar] >
Colour enhancement	< Off >
Blue light reduction	< Off >
Refine enhancer	< Off >
Gradation smoother	< Off >

Memory save

Memory load

Memory edit

## [Memory save]

(see page 50)

## [Memory load]

(see page 50)

## [Memory edit]

(see page 51)

1. [ ]	MEMORY1
2. [*]	MEMORY2
3. [*]	MEMORY3
4. [ ]	MEMORY4
5. [ ]	MEMORY5
6. [ ]	MEMORY6

## Overview of Picture Profiles

### Original picture



Adjust picture.  
(see page 46 – 48)



### Custom picture



Example:  
Save the picture adjustment values in the [MEMORY 1] profile.  
**[Memory save]**

### Original picture



Example:  
Load [MEMORY1].  
**[Memory load]**



### Custom picture



### [Memory edit] screen

1. [*]	MEMORY1
2. [*]	MEMORY2
3. [*]	MEMORY3

Example:  
Change the memory name to [MY PICTURE].  
**[Memory edit]**



1. [*]	MY PICTURE
2. [*]	MEMORY2
3. [*]	MEMORY3

## Saving profiles

Follow these steps to save picture adjustment values as profiles.

### 1 Specify the picture quality in the [Picture] menu.

(see page 46 – 48)

### 2 In the [Picture] menu, select [Memory save] with ▲▼ and press <ENTER>.

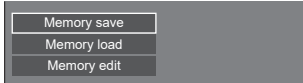

### 3 Select a profile name for saving the picture adjustment values with ▲▼ and press <ENTER>.

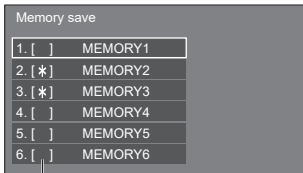

- [\*] appears for a profile in which the picture adjustments have already been saved.

### 4 Select [Ok] with ◀▶ and press <ENTER>.

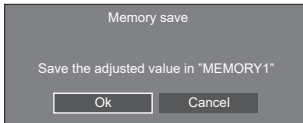

### 5 Enter a profile name with ▲▼◀▶.

- Entering characters (see page 169)



### 6 When you finished entering the profile name, select [Ok] with ▲▼◀▶ and press <ENTER>.

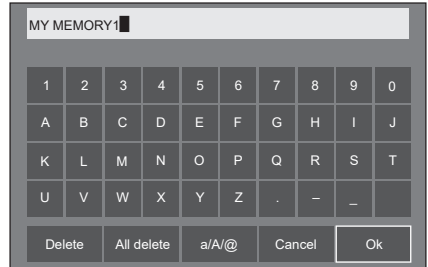

- To cancel saving the profile, select [Cancel].

## Loading profiles

Load profiles and apply the picture adjustment values to the display as follows.

### 1 In the [Picture] menu, select [Memory load] with ▲▼ and press <ENTER>.

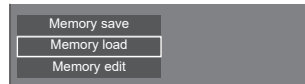

### 2 Select the profile to load with ▲▼ and press <ENTER>.

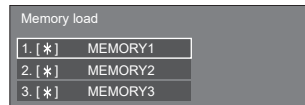

Loading profiles using numeric buttons on the remote control.

Each numeric button <1> – <6> is allocated for loading [MEMORY1] to [MEMORY6].

[Function button settings] (see page 85)

### 1 Press any of <1> – <6>.

### 2 Select [Ok] with ◀▶ and press <ENTER>.

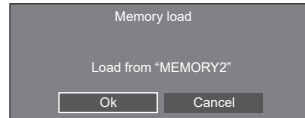

When profile is being loaded, profile name is displayed.

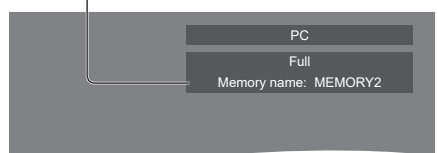

### Note

- Loaded profiles are stored in memory according to the selected input terminal.

## Editing profiles

Delete or rename profiles as follows.

### ■ Deleting profiles

- 1 In the [Picture] menu, select [Memory edit] with ▲ ▼ and press <ENTER>.

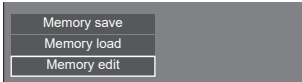

- 2 Select [Memory delete] with ▲ ▼ and press <ENTER>.

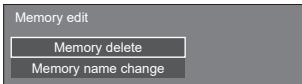

- 3 Select the profile to delete with ▲ ▼ and press <ENTER>.

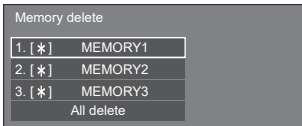

- To delete all profiles, select [All delete].

- 4 Select [Ok] with ◀▶ and press <ENTER>.

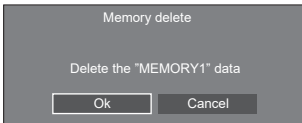

### ■ Renaming profiles

- 1 In the [Picture] menu, select [Memory edit] with ▲ ▼ and press <ENTER>.

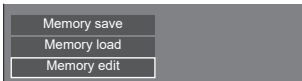

- 2 Select [Memory name change] with ▲ ▼ and press <ENTER>.

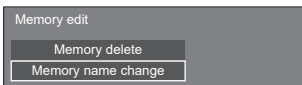

- 3 Select the profile to rename with ▲ ▼ and press <ENTER>.

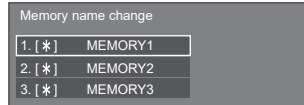

- 4 Enter a name for the profile with ▲ ▼ ◀▶.

- Entering characters (see page 169)

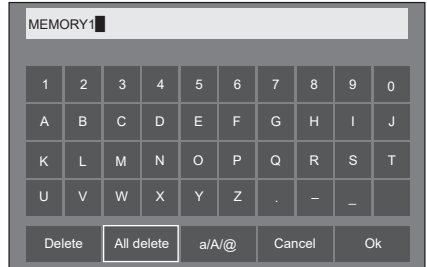

- 5 When you finished entering the profile name, select [OK] with ▲ ▼ ◀▶ and press <ENTER>.



- To cancel renaming the profile, select [Cancel].

# Setup menu

## 1 Press <SETUP> to display the [Setup] menu.

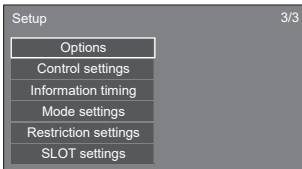
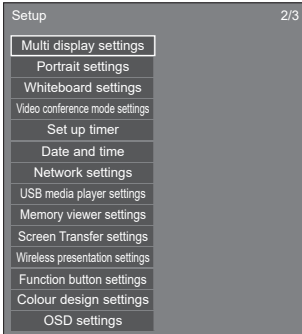
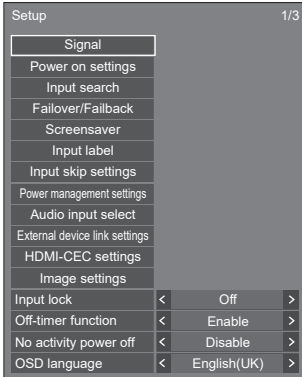

## 2 Select the item to set with ▲ ▼.

- Menu that cannot be adjusted is greyed out. Adjustable menu changes depending on signal input and menu setting.

## 3 Set with ◀ ▶.

## 4 Press <SETUP> to exit from adjust mode.

### ■ To return to the previous screen

Press <RETURN>.

## Signal

Examples of [Signal] submenu screen

When HDMI is selected

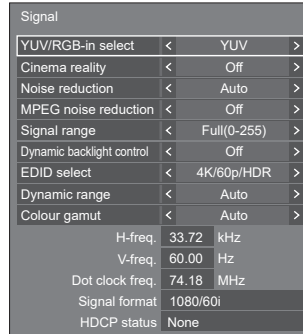

When USB-C is selected

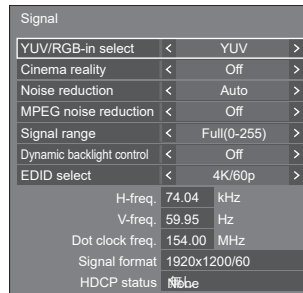

When SLOT is selected

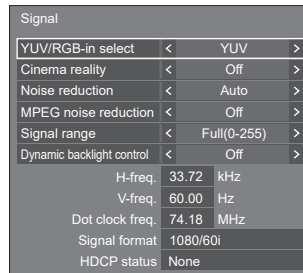

When PC is selected

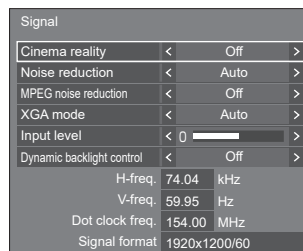



When PC[YPbPr] is selected

Signal		
Cinema reality	< Off >	>
Noise reduction	< Auto >	>
MPEG noise reduction	< Off >	>
Input level	< 0 >	>
Dynamic backlight control	< Off >	>
H-freq.	33.72	kHz
V-freq.	60.00	Hz
Dot clock freq.	74.18	MHz
Signal format	1080/60i	

When Screen Transfer / USB/Internal Memory / MEMORY VIEWER / WHITEBOARD is selected

Signal		
Noise reduction	< Auto >	>
MPEG noise reduction	< Off >	>

#### Note

- [Signal] setup menu displays a different setting condition for each input signal.
- Menu that cannot be adjusted is greyed out.

### ■ [YUV/RGB-in select]

This menu is displayed at HDMI IN 1, HDMI IN 2, HDMI IN 3, USB-C and SLOT inputs.

Select to match the signals from the source connected to each terminal.

#### [YUV]:

YUV signals

#### [RGB]:

RGB signals

#### Note

- Set for each input terminal.

### ■ [Cinema reality]

Faithfully reproduces videos shot with cinema films. Set this to [Off] normally.

#### Note

- In [ENGLISH(US)] OSD language, [Cinema reality] is displayed as [3:2 PULLDOWN].
- If [Cinema reality] is set to [On], videos including movies shot at 24 frames per second are reproduced more naturally.
- If the video is unnatural with [On] set, set it to [Off].

### ■ [Noise reduction]

Reduces picture noise.

#### [Off]:

Disables [Noise reduction].

#### [Min], [Mid], [Max]:

Sets strength of [Noise reduction].

#### [Auto]:

[Noise reduction] will be automatically selected from [Min], [Mid] or [Max].

### ■ [MPEG noise reduction]

Reduces block noise and mosquito noise on MPEG videos.

#### [Off]:

Disables [MPEG noise reduction].

#### [Min], [Mid], [Max]:

Sets strength of [MPEG noise reduction].

### ■ [XGA mode]

This menu is displayed with PC IN input and when [PC input mode] is set to [PC].

This unit supports XGA signals (1024 x 768, 1280 x 768, 1366 x 768) having different aspect ratios and sampling rates.

#### [Auto]:

Automatically detects the signal.

Switch the setting to suit the input signal for better display depends on the angle of view or display resolution condition.

#### Note

- After making this setting, be sure to make each adjustment (such as [Auto setup]) on the [Position] menu as necessary. (see page 43)

### ■ [Signal range]

This menu is displayed at HDMI IN 1, HDMI IN 2, HDMI IN 3, USB-C and SLOT inputs. Switches the dynamic range to match the signals from the source connected to each terminal.

#### [Video(16-235)]:

If the input signal is the video range

Example: HDMI terminal output for Blu-ray disc player

#### [Full(0-255)]:

If the input signal is full range

Example: HDMI terminal output for personal computer

#### [Auto]:

Switches the dynamic range automatically between [Video(16-235)] and [Full(0-255)] according to the input signal.

### ■ [Input level]

This menu is displayed at PC IN input.

Adjustment of parts which are extremely bright and hard to see.

#### -16 to +16:

(Level low) – (Level high)

### ■ [Dynamic backlight control]

Improves picture contrast and alleviates whiteness by controlling the back light when signals with the low average brightness level (APL) are input.

#### [On]:

Enables [Dynamic backlight control].

#### [Off]:

Disables [Dynamic backlight control].

### Note

- The screen may become dark if menu operation or input signal switching is performed while the on-screen menu is being displayed with this function set to [On]. Hiding the on-screen menu will restore the screen to the appropriate brightness.
- If the [Dynamic backlight control] setting is different for each input, the screen brightness may change by switching input.
- Depending on the displayed image, the screen may flicker. If this annoys you, set [Dynamic backlight control] to [Off].

### ■ [EDID select]

This menu is displayed in HDMI IN 1, HDMI IN 2, HDMI IN 3 and USB-C inputs. EDID data of each terminal is switched.

#### [4K/60p/SDR]:

Sets EDID compatible with 4K video signals (Max. 4 096 x 2 160 dots, Max. vertical operation frequency 60 Hz).

This EDID supports SDR (Standard Dynamic Range). HDR (High Dynamic Range) is not supported.

#### [4K/60p/HDR]:

Sets EDID compatible with 4K video signals (Max. 4 096 x 2 160 dots, Max. vertical operation frequency 60 Hz).

This EDID supports HDR (High Dynamic Range).

#### [4K/60p]:

Sets EDID compatible with 4K video signals (Max. 4 096 x 2 160 dots, Max. vertical operation frequency 60 Hz).

#### [4K/30p]:

Sets EDID compatible with 4K video signals (Max. 4 096 x 2 160 dots, Max. vertical operation frequency 30 Hz).

#### [2K]:

Sets EDID compatible with 2K video signals (Max. 1 920 x 1 200 dots).

### Note

- For HDMI IN input, [4K/60p/SDR], [4K/60p/HDR], [4K/30p] and [2K] are selectable.  
For USB-C input, [4K/60p], [4K/30p] and [2K] are selectable.
- If [4K/60p/SDR] or [4K/60p/HDR] is selected and pictures are not displayed correctly during 4K video signal input, switch the setting to [4K/30p].
- If [4K/60p/SDR], [4K/60p/HDR] or [4K/30p] is selected and pictures are not displayed correctly during 2K or lower video signal input, switch the setting to [2K].
- For details of signals written in EDID of [4K/60p/SDR], [4K/60p/HDR], [4K/30p] and [2K], see "Preset Signals" (see page 170).

### ■ [Dynamic range]

This menu is displayed in HDMI IN 1, HDMI IN 2 and HDMI IN 3 inputs.

Switches the dynamic range.

#### [Auto]:

Sets automatically according to the AVInfoFrame information.

#### [HDR(PQ)]:

Sets the dynamic range in compatible with HDR (PQ (Perceptual Quantization)).

#### [HDR(HLG)]:

Sets the dynamic range in compatible with HDR (HLG (Hybrid Log Gamma)).

#### [SDR]:

Sets the dynamic range in compatible with SDR.

### ■ [Colour gamut]

This menu is displayed in HDMI IN 1, HDMI IN 2 and HDMI IN 3 inputs.

Switches the colour gamut.

#### [Auto]:

Sets the colour gamut automatically according to the ITU-2020 emu. information of AVInfoFrame.

#### [Native]:

Displays with the colour space unique to this unit.

#### [ITU-2020 emu.]:

Displays with the colour space close to the ITU-R BT2020 standard.

### ■ Input signal display

Displays the frequency and the type of the current input signal.

H-freq.	33.72	kHz
V-freq.	60.00	Hz
Dot clock freq.	74.18	MHz
Signal format	1080/60i	
HDCP status	None	

#### Display range:

Horizontal (15 kHz – 135 kHz)

Vertical (24 Hz – 120 Hz)

The dot clock frequency is displayed when Digital and PC signal are input.

The HDCP status information is displayed when digital signals are input.

## Power on settings

Makes various settings at power-on.

[Power on settings] - submenu screen

Power on settings		
Initial input	< Off >	>
Initial startup	< Last memory >	>
Initial VOL function	< Off >	>
Initial VOL level	< 0 >	>
Power ON screen delay	< Off >	>
Information(No activity power off)	< Off >	>
Information(Power management)	< Off >	>
Information(Colour design)	< Off >	>
Quick start	< Off >	>

### ■ [Initial input]

Sets the input at power-on.

[Off] / [HDMI1] / [HDMI2] / [HDMI3] / [USB-C] / [SLOT] / [PC] / [PC [YPbPr]] / [Screen Transfer] / [USB/Internal Memory] / [MEMORY VIEWER] / [WHITEBOARD]

#### Note

- When [Input lock] is set to the item other than [Off], this menu will be greyed out and cannot be set. (see page 67)

### ■ [Initial startup]

Sets the power status of the main unit when the power plug is inserted/extracted, or when the power is restored from instantaneous interruption due to blackout, etc.

#### [Last memory]:

Restored to the state before the power is turned off.

#### [On]:

Restored to the power-on state. (power indicator: blue)

#### [Standby]:

Restored to the standby state. (power indicator: orange / purple)

#### Note

- When multiple units are installed, it is recommended to select [Standby] to reduce the load when the power is restored.

### ■ [Initial VOL function]

Enables/Disables the volume setting function at power-on.

#### [Off]:

Volume before power-off

#### [On]:

Volume set for [Initial VOL level]

### ■ [Initial VOL level]

Sets the sound volume when [Initial VOL function] is enabled.

#### Note

- The sound is output with the set volume when [Initial VOL function] on the menu is in [On] state.

- When [Maximum VOL function] is set to [On], the volume cannot be set to the level higher than the level set for [Maximum VOL level].

### ■ [Power ON screen delay]

When multiple displays are installed and are turned on simultaneously, this function distributes the load of power by delaying the power supply timing of each display. Setting is required for each display.

#### [Off]:

The powers are supplied at the same time as power-on.

#### [Auto]:

The delay time is automatically set according to the numbers set for display IDs.

The delay time is determined by multiplying a display ID by 0.3 seconds.

Example: If the display ID is 3, the delay time is 0.9 seconds.

#### 1 - 30:

Sets the delay time (sec.). The powers are supplied to the display with the set time of delay after power-on.

#### Note

- The power indicators blink blue from start to end of the delay operation process.
- This function also works when the power plug is inserted/extracted, or when the power is restored from instantaneous interruption due to blackout, etc.

### ■ [Information(No activity power off)]

Sets the display/non-display of the no-activity-auto-power-off warning message when the power is turned on.

#### [On]:

The warning message is displayed when the power is turned on.

#### [Off]:

The warning message is not displayed when the power is turned on.

#### Note

- This setting is enabled when [No activity power off] is [Enable]. (see page 67)

### ■ [Information(Power management)]

Sets the display/non-display of a message that tells the power has been turned off by the power management function when the power is turned on.

#### [On]:

The message is displayed when the power is turned on.

#### [Off]:

The message is not displayed when the power is turned on.

#### Note

- This setting is enabled when "Power management" function is [On]. (see page 61)

## ■ [Information(Colour design)]

Sets the display/non-display of the message notifying [Colour design settings] is set to [Universal] when the power is turned on.

### [On]:

The message is displayed when the power is turned on.

### [Off]:

The message is not displayed when the power is turned on.

### Note

- This setting is enabled when [Colour design] is set to [Universal]. (see page 86)

## ■ [Quick start]

This function quickly turns the power on at power-on.

### [On]:

Quickly turns the power on at power-on.

### [Off]:

Turns the power on in a usual manner at power-on.

### Note

- When this function is set to [On], power consumption is increased in standby mode.

## Input search

When a signal is not detected, another input with a signal is automatically selected.

### Note

- MEMORY VIEWER / Screen Transfer / WHITEBOARD input is excluded from this function.
- When set to the USB input, the unit determines no signal is present if the USB memory is not connected to the USB terminal.

In addition, even when a USB memory is connected, if there is no playable file, the unit determines no signal is present.

- This menu will be greyed out and cannot be set under the following conditions.
  - [Failover/Failback] is set to the item other than [Off]. (see page 57)
  - [Power management mode] is set to [Input detection]. (see page 61)
  - [Input lock] is not set to [Off]. (see page 67)
  - When [Setup] - [Image settings] - [No signal image settings] - [Display setting] is set to [On]. (see page 66)
  - [SLOT power link] is set to [On]. (see page 92)
- If the input is changed by this function, the last input is selected when the power is turned on next time.

If you wish to retain the original input when the power is turned on, set [Initial input] to the original input. (see page 55)

## [Input search] - submenu screen

Input search		
Input search	<	Custom >
1st search input	<	(None) >
2nd search input	<	(None) >

## ■ [Input search]

**[Off]:** When there is no signal, the input is not switched automatically.

**[All inputs]:** Searches all inputs and switches to an input with a signal.

Input search is executed in the following order.

Example: When the current input is HDMI1

[HDMI2] → [HDMI3] → [USB-C] → [SLOT] → [PC] → [USB] (or [Internal Memory]) → [HDMI1] →

### Note

- The inputs set to [On] in [Input skip settings] (see page 61) are skipped when searching.

**[Custom]:** Repeatedly searches [Current input], [1st search input] and [2nd search input] in order, and switches to an input with a signal.

**[Input detection]:** Monitors the inputs set to [On], detect the status change from no signal to signal present, and switches to the input.

HDMI1
Searching...

[Searching...] is displayed during the input search.

## ■ [Input search]: [Custom]

### [1st search input], [2nd search input]

Set the input to search when [Custom] is selected.

[HDMI1] / [HDMI2] / [HDMI3] / [USB-C] / [SLOT] / [PC] / [PC|YPbPr] / [USB/Internal Memory] / [(None)]

## ■ [Input search]: [Input detection]

Input search		
Input search	<	Input detection >
HDMI1	<	Off >
HDMI2	<	Off >
HDMI3	<	Off >
USB-C	<	Off >
SLOT	<	Off >
PC	<	Off >
Changing delay	<	Off >

Sets the input to monitor during [Input detection].

[HDMI1] / [HDMI2] / [HDMI3] / [USB-C] / [SLOT] / [PC]

**[Off]:** The input is not monitored.

**[On]:** The input is monitored.

## ■ [Changing delay]

Sets the delay time until the input is switched during [Input detection].

**[Off]:** Switches the input if a signal is interrupted even for a very short period.

**1 – 10:** Sets the delay time (sec.).

Switches the input when the set time has elapsed after detecting no signal is present. However, if the detection period during which no signal is present is shorter than the set delay time, the input is not switched.

### Note

- [Input detection] is the function that automatically switches the input as below by monitoring the presence of signal for the set input.
  - If a video signal is input to the set input that is not displayed (When the status has changed from signal absent to signal present.), the input is selected and switched.
  - If no signal is detected for the displayed input, the setting switches to the set input to which a signal is input. Also, if no signal is present for the displayed input when the power is turned on or when the input is switched, the setting switches to the set input to which a signal is input. When signals are input to multiple set inputs, the priority order as default (immediately after power-on) is as follows: HDMI1, HDMI2, HDMI3, USB-C, PC.

In the other case (When the input is switched after power-on), the input displayed last takes priority.

- [Changing delay] is the function to prevent the accidental input switch during a short period, such as when the signal is interrupted due to the frequency change for the input signal while [Input detection] is operating.

If a signal is detected again within the set period (sec.), the input is not switched.

- [Input detection] may not operate correctly depending on the image playback device.
- [PC] operates only when [PC input mode] is set to [PC]. (see page 90)
- [USB-C] and [SLOT] do not operate even if they are selected simultaneously.

## Failover/Failback

Automatically switches to the backup input if an interruption of video occurs.

### Note

- [PC] operates only when [PC input mode] is set to [PC]. (see page 90)
- [SLOT] is enabled when the DIGITAL LINK Terminal Board is attached.
- MEMORY VIEWER / Screen Transfer / WHITEBOARD input is excluded from this function.
- Depending on the image playback device or image signal, a noise may occur on the screen, or this function may not operate.

## 1. Setting the input change mode

### ■ [Input change mode]

#### [Off]:

Disables the Backup Input function.

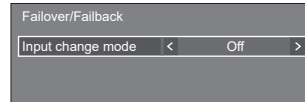

#### [On]:

Switches to the backup input if an interruption of video occurs.

The backup video signal does not need to be in the same format as the (main) input in use for viewing.

Upon switching to the backup input, the video and audio adjustment values for the backup input will be used.

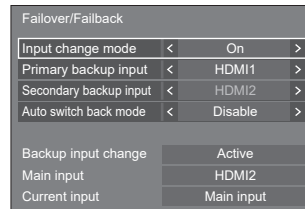

## [Input change mode]: [On] detailed settings

Switches to the backup input if an interruption of video occurs.

### Note

- This function will start operating once a video signal is detected by both the input in use for viewing and the backup input and the [Backup input change] item is displayed as [Active].

### ■ [Primary backup input]

Sets the first priority backup input.

(None) / [HDMI1] / [HDMI2] / [HDMI3] / [USB-C] / [SLOT] / [PC] / [USB/Internal Memory]

The input that is of the same type as the one in use for viewing will be greyed out.

### ■ [Secondary backup input]

Sets the second priority backup input.

(None) / [HDMI1] / [HDMI2] / [HDMI3] / [USB-C] / [SLOT] / [PC] / [USB/Internal Memory]

The input that is of the same type as the one in use for viewing will be greyed out.

### ■ [Auto switch back mode]

Sets whether or not to automatically return to the former (main) input when the former input video initially viewed is restored while viewing the video of the backup input enabled by the operation of the Backup Input function.

#### [Disable]:

Unreturned

#### [Enable]:

Returned

### ■ [Backup input change]

Displays whether or not operating conditions for the Backup Input function are met.

#### [Inactive]:

Indicates that the conditions are not met, and inactivates the Backup Input function.

#### [Active]:

Indicates that the conditions are met, and activates the Backup Input function.

### ■ [Main input]

Displays the (main) input set by switching input.

### ■ [Current input]

Displays whether the input currently in use for viewing is the (main) input set by switching input or the backup one.

## Setting conditions

The following table describes restrictions (available combinations) on each setting item.

		Main		
		HDMI1 HDMI2 HDMI3 USB-C SLOT	PC	USB/ Internal Memory
Backup	HDMI1 HDMI2 HDMI3 USB-C SLOT	○*	○	○
	PC	△	×	△
	USB/Internal Memory	○	○	×

○: Can be selected for both primary and secondary backup

△: Selectable for either Primary or Secondary.

×: Cannot be selected for either primary or secondary backup

\*: [USB-C] and [SLOT] do not operate even if they are selected simultaneously.

### Note

- If the same input is selected for primary and secondary, the secondary backup input is disabled. If the same input as the main input is selected for primary and secondary, those inputs are disabled.

## Recall display

Pressing <RECALL> displays any of the followings.

- When the main input is being used for viewing and the operating conditions for the Backup Input function are met.

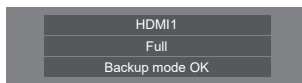

- When the backup input, enabled by the operation of the Backup Input function, is being used for viewing.

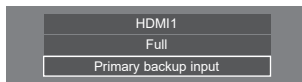

When the conditions for the Backup Input function are met, the following screen is displayed.

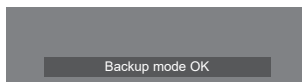

### Note

- This menu will be greyed out and cannot be set under the following conditions.
  - [Input search] is set to the item other than [Off]. (see page 56)

- [Setup] - [Image settings] - [No signal image settings] - [Display setting] is set to [On]. (see page 66)
- [Power management mode] is set to [Input detection]. (see page 61)
- [SLOT power link] is set to [On]. (see page 92)
- When set to the USB input, the unit determines video signals are interrupted by judging the USB memory is not connected to the USB terminal.
- This function may not operate correctly depending on the image playback device.

## Screensaver

Alleviates the occurrence of afterimage when displaying still images or images with 4:3 aspect ratio for a long time.

[Screensaver] - submenu screen

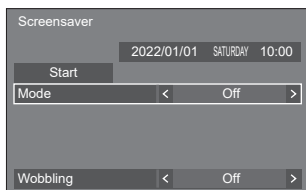

### ■ Screensaver settings

#### Screensaver operation

When the Screensaver is operating, the following 5 patterns are displayed full screen for 5 seconds each, and it will be repeated.

**Black → Dark grey → Grey → Light grey → White → Light grey → Grey → Dark grey**

#### To start Screensaver now

- ① Select [On] in [Mode].
- ② Select [Start] and press <ENTER>.
  - The Screensaver will be activated.

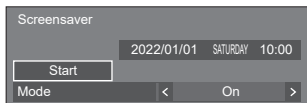

#### Note

- If the following buttons are pressed while the screen saver is operating, the screen saver is cancelled.

Remote control: <RETURN>

Unit: <MENU (Unit)> <INPUT (Unit)>

<+ (Unit)> <- (Unit)> ▲ ▼

<ENTER (Unit)>

- When the display is turned off, the Screensaver will be deactivated.

#### To set interval of Screensaver

- ① Select [Interval] in [Mode].
- ② Set [Periodic time].
  - Press ◀▶ to change the time by 15 minutes.
  - In [ENGLISH(US)] OSD language, [Periodic time] is displayed as [SHOW DURATION].
- ③ Set [Operating time].
  - Press ◀▶ once to change the time by 1 minute. Keep pressing down to change the time by 15 minutes.
  - In [ENGLISH(US)] OSD language, [Operating time] is displayed as [SAVER DURATION].

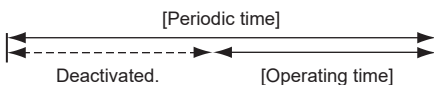
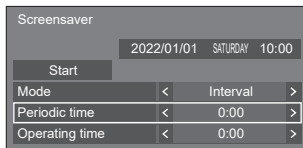

#### Note

- It is not possible to set the duration of [Operating time] longer than that of [Periodic time].

#### To set start and finish time of Screensaver

- ① Select [Time designation] in [Mode].
- ② Set [Start time] and [Finish time].
  - Press ◀▶ once to change the time by 1 minute. Keep pressing down to change the time by 15 minutes.
  - In [ENGLISH(US)] OSD language, [Time designation] is displayed as [TIME OF DAY].

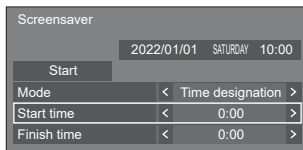

#### Note

- When the current time is displayed as [- -], set [Date and time] before setting [Start time] and [Finish time]. (see page 73)

## To turn the power off after Screensaver

- ① Select [Standby after SCR saver] in [Mode].
- ② Set [Screensaver duration].
  - Press ◀▶ once to change the time by 1 minute. Keep pressing down to change the time by 15 minutes.
- ③ Select [Start] and press <ENTER>.
  - Screensaver will be activated and the power will be turned off (standby) at the time set.

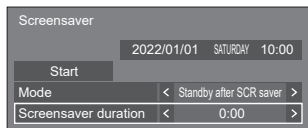

### Note

- [Screensaver duration] can be set from 0:00 to 23:59.  
When this is set to [0:00], [Standby after SCR saver] will not be activated.

## ■ [Wobbling]

Automatically shifts the display image to prevent image retention on the liquid crystal panel.

Setting this to [On] moves the screen position at certain intervals and displays the images.

### Note

- When [Multi display settings] - [Multi screen display] is set to [On], [Wobbling] will not be activated. (see page 68)
- When [Portrait settings] - [Portrait display] is set to [On], [Wobbling] will not be activated. (see page 69)
- When this function is operating, part of the screen may appear to be missing.

## Input label

This function can change the label of the Input signal to be displayed.

[Input label] - submenu screen

Input label		
HDMI1	<	HDMI1 >
HDMI2	<	HDMI2 >
HDMI3	<	HDMI3 >
USB-C	<	USB-C >
SLOT	<	SLOT >
PC	<	PC >
PC[YPbPr]	<	PC[YPbPr] >

<b>[HDMI1]</b>	[HDMI1] / [Blu-ray] / [CATV] / [STB] / [PressIT] / [HDVC] / [User]
<b>[HDMI2]</b>	[HDMI2] / [Blu-ray] / [CATV] / [STB] / [PressIT] / [HDVC] / [User]
<b>[HDMI3]</b>	[HDMI3] / [Blu-ray] / [CATV] / [STB] / [PressIT] / [HDVC] / [User]
<b>[USB-C]</b>	[USB-C] / [Blu-ray] / [CATV] / [STB] / [PressIT] / [HDVC] / [User]
<b>[SLOT]</b>	[SLOT] / [PressIT] / [User]
<b>[PC]</b>	[PC] / [Blu-ray] / [CATV] / [STB] / [PressIT] / [HDVC] / [User]
<b>[PC[YPbPr]]</b>	[PC[YPbPr]] / [Blu-ray] / [CATV] / [STB] / [PressIT] / [HDVC] / [User]

Labels to be displayed can be set by selecting [User].

### [User] setting

- ① Press ▲▼ to select the input.
- ② Press ◀▶ to select [User] and press <ENTER>.
- ③ Press ▲▼◀▶ to enter the label of the input signal to be displayed.
  - Entering characters (see page 169).



## Input skip settings

For all inputs, this function sets whether to skip those inputs when <INPUT> is pressed.

[Input skip settings] - submenu screen

Input skip settings		
HDMI1	< Off >	>
HDMI2	< Off >	>
HDMI3	< Off >	>
USB-C	< Off >	>
SLOT	< Off >	>
PC	< Off >	>
PC[YP <sub>b</sub> P <sub>r</sub> ]	< Off >	>
Screen Transfer	< Off >	>
USB/Internal Memory	< Off >	>
MEMORY VIEWER	< Off >	>
WHITEBOARD	< Off >	>

[Off]: Pressing <INPUT> switches to the corresponding input, and the input is selected.

[On]: Pressing <INPUT> skips the corresponding input (not selectable).

## Power management settings

Set each item to reduce power consumption.

This function works only for the input terminal that is currently selected.

[Power management settings] - submenu screen

Power management settings		
Power management mode	< Custom >	>
No signal power off	< Disable >	>
HDMI1 power management	< Off >	>
HDMI2 power management	< Off >	>
HDMI3 power management	< Off >	>
USB-C power management	< Off >	>
SLOT power management	< Off >	>
PC power management	< Off >	>
Power save	< Off >	>
Extended standby mode	< Mode 1 >	>
Input detection		
Changing delay	< Off >	>

### 1. Setting [Power management mode]

#### Note

- Set the "Power management" function to [On] for terminals to operate this function.

#### 1-1 [Power management mode]: [On]

The following fixed values are set to the menu of power consumption reduction. Individual setting is not available.

[No signal power off]: [Enable]

[HDMI1 power management]: [On]

[HDMI2 power management]: [On]

[HDMI3 power management]: [On]

[USB-C power management]: [On]

[SLOT power management]: [On]

[PC power management]: [On]

[Power save]: [On]

#### 1-2 [Power management mode]: [Custom]

The menu of the power consumption reduction is individually set. This setting is enabled when [Power management mode] is set to [Custom].

#### 1-3 [Power management mode]: [Input detection]

Sets the power consumption reduction menu individually.

This is enabled when [Power management mode] is set to [Input detection]. This mode interlocks between the power management operation and the input detection function for operation. When this mode detects the change from without-signal state to with-signal state by monitoring input signals, the input signal detection function operates, and an input is automatically switched to the input. Also, if the current input signal disappears, it is automatically switched to another input. If all the input signals disappear, the power management function operates, and automatically turns the power off/on. This operation is performed between selected terminals.

#### Note

- [Extended standby mode] is set to [Mode 2], and greyed out.

#### ■ [No signal power off]

When this is set to [Enable], the power supply of the unit goes off automatically (standby) when there is no operation or sync signal for about 10 minutes.

#### Note

- When set to the USB input, the unit determines no signal is present if the USB memory is not connected to the USB terminal, or the connected USB memory does not contain any playable file.
- With Screen Transfer input, the unit determines no signal is present in standby status and when the PC is not connected to Screen Transfer.
- This function operates regardless of the [On] / [Off] settings of [No signal image settings].
- This function may not operate depending on the video output devices.

#### ■ [HDMI1 power management]

When this function is set to [On], it operates under the following conditions to turn the power on or off automatically.

##### When no pictures (sync signal) are detected for 60 seconds or so at HDMI1 input:

Power is turned off (standby); the power indicator lights up purple.

##### When pictures (sync signal) are subsequently detected at HDMI1 input:

Power is turned on; the power indicator lights up blue.

#### Note

- This function may not operate depending on the video output devices.

### ■ [HDMI2 power management]

When this function is set to [On], it operates under the following conditions to turn the power on or off automatically.

#### When no pictures (sync signal) are detected for 60 seconds or so at HDMI2 input:

Power is turned off (standby); the power indicator lights up purple.

#### When pictures (sync signal) are subsequently detected at HDMI2 input:

Power is turned on; the power indicator lights up blue.

#### Note

- This function may not operate depending on the video output devices.

### ■ [HDMI3 power management]

When this function is set to [On], it operates under the following conditions to turn the power on or off automatically.

#### When no pictures (sync signal) are detected for 60 seconds or so at HDMI3 input:

Power is turned off (standby); the power indicator lights up purple.

#### When pictures (sync signal) are subsequently detected at HDMI3 input:

Power is turned on; the power indicator lights up blue.

#### Note

- This function may not operate depending on the video output devices.

### ■ [USB-C power management]

When this function is set to [On], it operates under the following conditions to turn the power on or off automatically.

#### When no pictures (sync signal) are detected for 60 seconds or so at USB-C input:

Power is turned off (standby); the power indicator lights up purple.

#### When pictures (sync signal) are subsequently detected at USB-C input:

Power is turned on; the power indicator lights up blue.

#### Note

- This function may not operate depending on the video output devices.
- When this function is set to [On], set [Quick start] to [On] to enable the operation.
- When [Quick start] is set to [Off], if images are not detected, the unit enters the standby state even if it is set to [On]. However, the unit does not start up even if images are detected again. To operate the power management function, it is necessary to set both [Quick start] and [USB-C power management] to [On] respectively.

### ■ [SLOT power management]

When this function is set to [On], it operates under the following conditions to turn the power on or off automatically.

#### When no pictures (sync signal) are detected for 60 seconds or so at SLOT input:

Power is turned off (standby); the power indicator lights up purple.

#### When pictures (sync signal) are subsequently detected at SLOT input:

Power is turned on; the power indicator lights up blue.

#### Note

- This function may not operate depending on the video output devices.
- This function is enabled only when the DIGITAL LINK Terminal Board is attached to the expansion slot (SLOT).

### ■ [PC power management] (DPMS function)

When this function is set to [On], it operates under the following conditions to turn the power on or off automatically.

#### When no pictures (sync signal) are detected for 60 seconds or so at PC input:

Power is turned off (standby); the power indicator lights up purple.

#### When pictures (sync signal) are subsequently detected at PC input:

Power is turned on; the power indicator lights up blue.

#### Note

- This function is effective when [PC input mode] is [PC]. (see page 90)
- This function may not operate depending on the video output devices.

### ■ [Power save]

This function adjusts the brightness of the backlight to reduce power consumption.

#### [Off]:

The power save function does not operate.

#### [On]:

Backlight brightness is reduced.

### ■ [Extended standby mode]

Sets the operation in standby mode by the "Power management" function for the input terminal for which the "Power management" function is set to [On].

#### [Mode 1]:

If a video signal (synchronized signal) is detected at the input terminal with which the standby mode is entered, the power is turned "ON" with the input.

**[Mode 2]:**

If a video signal (synchronized signal) is detected at any of the input terminals for which the "Power management" function is set to [On], the power is turned "ON", and the input is switched to the detected input.

**[Mode 3]:**

Even when the power is turned off using the remote control, if a video signal (synchronized signal) is newly detected at any of the input terminals for which the "Power management" function is set to [On], the power is turned "ON", and the input is switched to the detected input.

This function does not operate if the power plug is removed from the outlet. Turn the power "ON" once to use this function.

**Note**

- When [Input search] is [All inputs] or [Custom], the [Input search] function is prioritised. (The "Power management" function does not operate for each terminal.) (For details of [Input search] function, see page 56.)
- When [Failover/Failback] - [Input change mode] is set to items other than [Off], the [Failover/Failback] function is prioritised. (The "Power management" function does not operate for each terminal.) (For details of [Failover/Failback] function, see page 57.)
- When this function is set to [Mode 3], set [Quick start] to [On] to enable the operation.
- When [Quick start] is set to [Off], this function works as it is set to [Mode 2] even if it is set to [Mode 3].

**■ [Changing delay]**

Sets the delay time until the input is switched when [Power management mode] is [Input detection].

**[Off]:**

Switches the input if a signal is interrupted even for a very short period.

**1 to 10:**

Sets the delay time (sec.). Switches the input when the set time has elapsed after detecting no signal is present. However, if the detection period during which no signal is present is shorter than the set delay time, the input is not switched.

**Note**

- The operation when [Input detection] is selected is the same as the operation when [Input search] is set to [Input detection]. (see page 56)

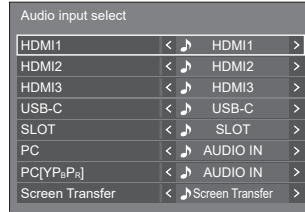
**Audio input select****[Audio input select] - submenu screen****Video input****Audio input**

<b>HDMI1</b>	HDMI1 / AUDIO IN / No audio
<b>HDMI2</b>	HDMI2 / AUDIO IN / No audio
<b>HDMI3</b>	HDMI3 / AUDIO IN / No audio
<b>USB-C</b>	USB-C / AUDIO IN / No audio
<b>SLOT</b>	SLOT / AUDIO IN / No audio
<b>PC</b>	AUDIO IN / No audio
<b>PC[YpPr]</b>	AUDIO IN / No audio
<b>Screen Transfer</b>	Screen Transfer / AUDIO IN / No audio

- No audio: No audio input (Mute)

When the setting for the audio input has been changed from the factory settings, the audio input is displayed as below.

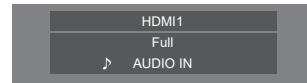

## External device link settings

Sets external device link.

[External device link settings]- submenu screen

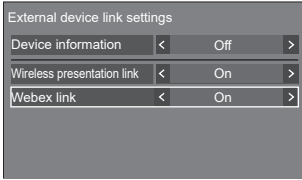

### ■ [Device information]

Sets whether to display or hide the information of the device connected to the HDMI terminal or SLOT terminal.

**[Off]:** Connected device information is not displayed.

**[On]:** Connected device information is displayed as shown below.



#### Note

- The obtained information of either signal or HDMICEC is displayed.
- Up to the first 16 characters obtained are displayed.

### ■ Wireless presentation link

This menu configures the settings for wireless presentation system connection.

For details, refer to the operating instructions on the following support site.

(<https://panasonic.net/cns/prodisplays/wps2/>)

### ■ [Webex link]

Sets the link of a Webex device.

**[Off]:**

Does not link with a Webex device.

**[On]:**

Links with a Webex device.

#### Note

- When a Webex device is connected to the HDMI IN 1, HDMI IN 2 or HDMI IN 3 terminal, the link function works.
- The following functions are fixed.
  - [Video conference mode settings] of the corresponding input is fixed to [On].

For details of operation when [Video conference mode settings] is set to [On], refer to [Video conference mode settings] (see page 71).

- [Picture mode] is set to the suitable value.
- [Over scan] is fixed to [Off].

- [HDMI-CEC control] is fixed to [Enable]. [Display → Device] is fixed to [Power off / on]. [Device → Display] is fixed to [Power off / on].
- [Quick start] is fixed to [On].
- [Audio input select] is fixed to the corresponding input.
- [HDMI-CEC control] is set to [Enable].

When another device is connected to an HDMI terminal other than the HDMI terminal to which a Webex device is connected, if the HDMI-CEC control is unnecessary, turn off the HDMI-CEC function using that device.

- When the link operation is in progress with a Webex device connected, [Webex] is displayed on the setup menu, etc.
- Due to the specification of a Webex device, the Webex device cannot be set to standby mode by turning off (standby) the power of the display. (As of April 2022)

## HDMI-CEC settings

Set for HDMI-CEC function.

For details of HDMI-CEC function, refer to "Using HDMI-CEC function". (see page 158)

[HDMI-CEC settings] - submenu screen

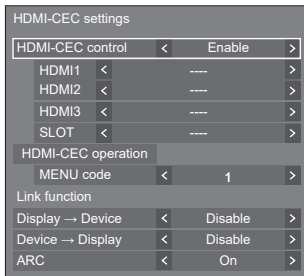

### ■ [HDMI-CEC control]

Enables/Disables the HDMI-CEC function.

**[Disable]:** Disables HDMI-CEC control.

**[Enable]:** Enables HDMI-CEC control.

#### Note

- Set to [Enable] to operate HDMI-CEC compatible device with remote control of the unit.

### ■ [HDMI1]

Displays the device to operate when HDMI-CEC compatible device is connected to HDMI IN 1 terminal.

The control subject can be changed with ◀▶.

#### Note

- When there is no connected device, [----] will be displayed.

### ■ [HDMI2]

Displays the device to operate when HDMI-CEC compatible device is connected to HDMI IN 2 terminal.

The control subject can be changed with ◀▶.

#### Note

- When there is no connected device, [----] will be displayed.

### ■ [HDMI3]

Displays the device to operate when HDMI-CEC compatible device is connected to HDMI IN 3 terminal.

The control subject can be changed with ◀▶.

#### Note

- When there is no connected device, [----] will be displayed.

### ■ [SLOT]

Displays the device to operate when HDMI-CEC compatible device is connected to SLOT terminal.

#### Note

- The setting item [SLOT] is displayed only when the function board is inserted into the SLOT. When the HDMI-CEC compatible SLOT is not connected, [----] will be displayed.

### ■ [HDMI-CEC operation]

Displays the operation screen of the HDMI-CEC compatible device.

Press <RETURN> to hide the operation screen.

### ■ [MENU code]

Changes the code to assign for the [MENU] operation on the HDMI-CEC operation screen.

Adjust the code to that of the connected HDMI-CEC compatible device.

### ■ [Display → Device]

Enables/Disables this unit to perform interlocking control of the HDMI-CEC compatible device.

**[Disable]:**

Disables this unit to perform interlocking control of the HDMI-CEC compatible device.

Even if the power status of this unit changes, the power status of the device will not be affected.

**[Power off]:**

Turning this unit off (standby) turns off (standby) all the devices connected to the HDMI IN 1, HDMI IN 2, HDMI IN 3 or SLOT terminal. The power-on operation is not interlocked.

**[Power off / on]:**

The device turns off/on (standby) in conjunction with the power-off/on (standby) operation of this unit.

#### Note

- For details of operation, refer to "Using HDMI-CEC function". (see page 158)

### ■ [Device → Display]

Enables/Disables the HDMI-CEC compatible device to perform interlocking control of this unit.

**[Disable]:**

Disables the device to perform interlocking control of this unit.

Even if the power status of the device changes, the power status of this unit will not be affected.

**[Power on]:**

Turning on the device turns on this unit, and the input (HDMI1 / HDMI2 / HDMI3 / SLOT) is switched to that of the device.

**[Power off / on]:**

The power status of this unit interlocks with the power-off/on operation of the device.

#### Note

- For details of operation, refer to "Using HDMI-CEC function". (see page 158)
- Input will not be switched when [Setup] - [Input lock] is set.

## ■ [ARC]

Sets the audio output for the HDMI IN 3 (ARC) terminal.

### [Auto]:

Automatically outputs audio from the HDMI IN 3 terminal when an amplifier is connected.

### [Off]:

Always outputs audio from the built-in speaker or the AUDIO OUT terminal.

### [On]:

Always outputs audio from the HDMI IN 3 terminal.

### Note

- For details of the operations, refer to "Using ARC function" (see page 160).

## Image settings

Sets the image displayed on the screen when the power is turned on or no signal is input.

[Image settings] - submenu screen

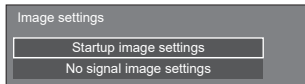

### [Startup image settings]:

Sets the image displayed when the power is turned on.

### [No signal image settings]:

Sets the image displayed when there is no signal at the selected input terminal.

### Conditions of the image that can be set in [Read user image]

- Image size: 3 840 x 2 160, 1 920 x 1 080 only
- jpg files / bmp files (except for the ones that cannot be played back with USB media player (see page 120))

File and folder names are displayed on the file list with conditions as below.

– If a file or folder is placed directly under the root directory of the USB device.

- Up to 246 characters of file name (including the extension) are properly displayed.

Note that the file list may disappear due to the display time of the on-screen menu before the entire display of file names completely appears.

- Up to 244 characters of folder name are properly displayed.
  - If the folder is placed hierarchically, the number of characters displayed decreases by the number of characters for the file path (folder information).

– Only the files with file names described with ASCII characters excluding control code are displayed.

### Note

- [Picture] cannot be adjusted when setting the startup image.

- Only [Backlight], [Gamma], [Colour temperature] and [Blue light reduction] can be adjusted when setting the no-signal image.
- Images displayed for the startup image and no-signal image may slightly differ from images confirmed on the computer.
- When [No signal image settings] is set to [On], [Input search] and [Failover/Failback] will be disabled, and the menu will be greyed out.

## ■ [Startup image settings] / [No signal image settings]

Operate [No signal image settings] in the same way as [Startup image settings].

[Startup image settings] - submenu screen

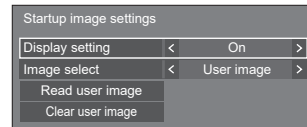

### [Display setting]

Sets the image display when the power is turned on.

[Off]: Disables each image setting function.

[On]: Enables each image setting function.

### Note

- When no-signal image is displayed, the screen position moves at certain intervals and images are displayed to alleviate image retention on the LCD panel.
- Shifts the display position regardless of the setting of [Wobbling] (see page 60).
- When this function is operating, part of the screen may appear to be missing.

### [Image select]

Select the image to display.

[Default image]: Panasonic logo (blue background)

[User image]: Image registered by the user

### Note

- Only when [Default image] is displayed, the logo automatically rotates according to the [Display orientation] (see page 89) setting or installation orientation.
- When [User image] is selected, the image does not rotate according to the [Display orientation] setting or installation orientation. Prepare an image of 3 840 × 2 160 or 1 920 × 1 080 aspect ratio compatible with the installation orientation.
- [Default image] of [No signal image settings] is the Panasonic logo (black background).

## [Read user image]

Register the image read from a USB memory device.

[Read user image] - submenu screen

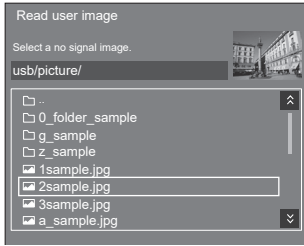

### Note

- Set the input to something other than [USB], [MEMORY VIEWER] or [WHITEBOARD], and read the image.
- One user image can be registered for [Startup image settings] and [No signal image settings] respectively.
- Do not turn the power off while reading the user image.
- The selected image is previewed on the [Read user image] submenu screen.
- When USB memory device is not connected to the USB terminal, [Read user image] is greyed out and cannot be selected.
- If starting to read the image while creating the preview image, an access error will occur, and the image may not be recognized as a image file.  
Confirm the preview image display, and then start reading process.
- The displayed file names are restricted as follows.
  - Applicable extension: jpg, jpe, jpeg or bmp
  - The file name is not “.jpg”, “.jpe”, “.jpeg”, or “.bmp” which start with dot (.).
- Depending on the OS setting, folders or files in the USB memory invisible on your computer may be displayed on this unit.
- If an image of 3 840 × 2 160 is registered for [Startup image settings], and [Image select] is set to [User image], the start-up time will be longer at power-on.
- If an image of 3 840 × 2 160 is registered for [No signal image settings], the displayed image quality will be equivalent of 1 920 × 1 080.
- Even when [Internal memory] is selected for [Use memory select], images are loaded from the USB memory device. (images cannot be loaded from the internal memory.)

## [Clear user image]

Clears the image read in [Read user image].

[Startup image settings] - submenu screen

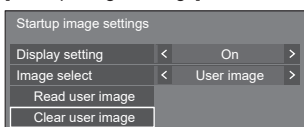

### Note

- When there is no [User image] that have been read, [Clear user image] is greyed out and cannot be selected.
- When [Image select] is set to [User image], performing [Clear user image] will change the setting of [Image select] to [Default image].

## Input lock

Disables [Input] operation by locking the input.

[Off] / [HDMI1] / [HDMI2] / [HDMI3] / [USB-C] / [SLOT] / [PC] / PC [YPbPr] / [Screen Transfer] / [USB/Internal Memory] / [MEMORY VIEWER] / [WHITEBOARD]

### Note

- Input switch can be used when this is set to [Off].

## Off-timer function

Enables / disables [Off-timer function].

### [Enable]:

Enables [Off-timer function].

### [Disable]:

Disables [Off-timer function].

### Note

- When [Disable] is set, the Off-timer is cancelled.

## No activity power off

When this function is set to [Enable], the power is turned off (standby) automatically when there is no operation of the Display for 4 hours.

Starting from 3 minutes before the turn off, the remaining time will be displayed.

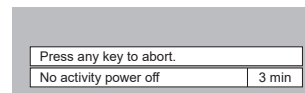

When the power is turned off due to this function, a message [Last turn off due to 'No activity power off'.] is displayed next time the power is turned on.

When the image set in [No signal image settings] (see page 66) is displayed, remaining time is not displayed even when the power is going to be turned off in 3 minutes. Instead, the image is displayed until the power is turned off.

### Note

- While the screensaver is running, this function is disabled.

## OSD language

Select your preferred language.

Selectable languages

English(UK)

Deutsch

Français

Italiano

Español

ENGLISH(US)

中文 : Chinese

日本語 : Japanese

Русский : Russian

## Multi display settings

Set the screen display mode.

### Note

- Set the input to something other than [Screen Transfer] / [MEMORY VIEWER] / [WHITEBOARD], and then set [Multi display settings].
- While this menu is displayed, aspect mode will be [16:9].

## 1. [Multi display settings]

### ■ [Multi screen display]

[Off]:

The display is not divided when enlarged.

[On]:

The display is divided when enlarged.

When [On] is set, the display aspect is [Full].

### Note

- When [Portrait display] is [On], this menu will be greyed out and cannot be set. (see page 69)

## 2. [Multi screen display]

1 to 10 displays can be aligned in horizontal direction and vertical direction respectively, and those displays are regarded as one group. The enlarged image is shown on the combined display.

[Multi display settings] - submenu screen  
([Multi screen display])

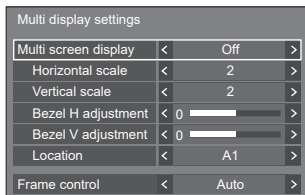

### Note

- The settings are memorised separately for each input terminal.

- When [Multi screen display] is set to [Off], adjust to the same angle of view for [Position] (see page 43). Then, set [Multi screen display] to [On]. Again, make fine adjustment of the angle of view for [Position].
- The [Position] menu can be adjusted in the multi screen display status.
- When USB/Internal Memory, MEMORY VIEWER, Screen Transfer or WHITEBOARD input is selected, [Frame control] cannot be set.
- The [Frame control] function is effective when all of the vertical synchronizations input into each display are the same.
- In multi screen display, the aspect is set to [Full].
- For USB/Internal Memory input, [Horizontal scale] and [Vertical scale] can be set only with the following combinations.  
1 × 2, 1 × 3, 1 × 4, 2 × 1, 2 × 2, 3 × 1, 4 × 1

### ■ [Horizontal scale]

Set the horizontal scale in the multi screen display.

1 to 10

### ■ [Vertical scale]

Set the vertical scale in the multi screen display.

1 to 10

Example:

[Horizontal scale] [5] and [Vertical scale] [5] is set in the multi screen display

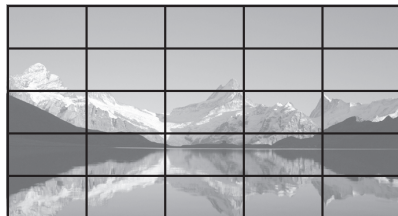

### ■ [Bezel H adjustment] / [Bezel V adjustment]

Adjust the area of image hidden in the joint horizontally and vertically respectively.

0 to 100

Display example:

Setting value: 0

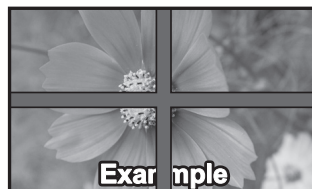

Displays the entire image including the joint area. (Suitable when displaying character information on PC.)



Setting value: 100



Does not display the image of the joint area.  
(Suitable when displaying motion pictures.)

## ■ [Location]

Assign screen positions on the multi-screen.

Example:

[Horizontal scale] [10], [Vertical scale] [10]

A1	A2	...	A9	A10
B1	B2	...	B9	B10
...	...	...	...	...
I1	I2	...	I9	I10
J1	J2	...	J9	J10

Select from A1 - J10.

- The displayed content for setting changes according to the settings for the [Horizontal scale] and [Vertical scale].
- By setting [Multi screen display] to [Off], it is possible to check the location on the screen while the setting menu is displayed.
- If [Image rotation] is set to [180 degrees], the enlarged location also rotates. (see page 89)

### Note

- [Horizontal scale] [1] / [Vertical scale] [1] cannot be set.

## ■ Frame control

Adjusts the image display timing to display motion pictures more naturally in one screen with multiple screen configuration.

### Auto:

When [Multi screen display] is set to [On], the image display timing is automatically adjusted according to [Location] in vertical direction. However, when [Multi screen display] is set to [Off], the adjusted value of the image display timing is fixed to [0] (no adjustment).

### 1 to 4:

Adjusted value of the image display timing (manual setting)

Operation is performed regardless of [On] / [Off] setting for [Multi screen display].

### Note

- [Video conference mode settings] and [Frame control] cannot be used simultaneously. Only one of them can be used.
- When any of [1] to [4] is set, and signals over a vertical frequency of 60Hz are input, the unit may not perform control operation as intended. Also, if signals over 2 160 dots in vertical direction are input, a screen error may occur.
- When the setting of this function is changed, image noise may occur. This is not a malfunction.

## Portrait settings

This function displays input images by rotating 90°.

### Note

- Set to the input other than [Screen Transfer] / [MEMORY VIEWER] / [WHITEBOARD], and then set [Portrait settings].
- For video or picture you want to display, use the ones with 16:9 resolutions.
- About playing back with USB/Internal Memory input, refer to "Using "USB media player"" (see page 119).
- While this menu is displayed, aspect mode will be [16:9].

[Portrait settings] - submenu screen

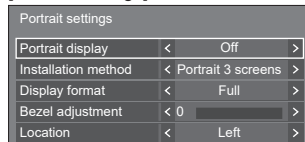

## ■ [Portrait display]

### [Off]:

Disables portrait display.

### [On]:

Enables portrait display.

When it is set to [On], aspect mode will be [Full].

## ■ [Installation method]

Sets the installation method of displays that make up the portrait display.

**[Portrait 1 screen]:** Setting configuration of [Portrait 1 screen]



**[Portrait 3 screens]:** Setting configuration of [Portrait 3 screens]



**[Landscape 3 screens]:** Setting configuration of [Landscape 3 screens]



## ■ [Display format]

**[Full]:**

Displays the entire input images so that the image is displayed without missing portion.

**When [Installation method] is [Landscape 3 screens]**

**[16:9 V fit]:**

Displays images without missing portion, however, some portion of the input images on the top and bottom is cut.

**[16:9 H fit]:**

Displays the entire input images, however, some portion of the images on right and left is not displayed.

**When [Installation method] is [Portrait 3 screens]**

**[16:9 V fit]:**

Displays images without missing portion, however, some portion of the input images on the right and left is cut.

**[16:9 H fit]:**

Displays the entire input images, however, some portion of the images on top and bottom is not displayed.

## Note

- [16:9 V fit] and [16:9 H fit] keep the aspect ratio 16:9 but [Full] doesn't.

## ■ [Bezel adjustment]

Adjusts the area of image hidden in the joint area on the portrait screen.

**0 to 100**

## ■ [Location]

Assign the positions of portrait screens.

**When [Installation method] is [Landscape 3 screens]**

[Upper] / [Centre] / [Lower]

**When [Installation method] is [Portrait 3 screens]**

[Left] / [Centre] / [Right]

**Portrait screen display example**

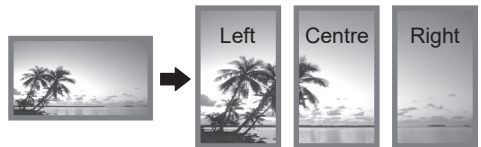

- When [Portrait display] is set to [Off], the enlarged position can be confirmed on the screen if [Installation method] is set to [Portrait 3 screens].

## Note

- The settings are memorised separately for each input terminal.
- It is possible to set [Display format], [Bezel adjustment] and [Location] when [Installation method] is [Portrait 3 screens] or [Landscape 3 screens].
- This menu will be greyed out and cannot be set under the following conditions.
  - When [Multi display settings] - [Multi screen display] is [On] (see page 68)
- When [Portrait display] is [On], the aspect mode cannot be changed. (see page 38)

## Whiteboard settings

Configure settings for the WhiteBoard function.

[Whiteboard settings] sub menu dialog

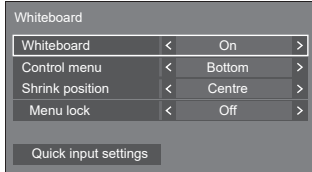

### ■ Whiteboard

**[Off]:** The WhiteBoard function is disabled.

**[On]:** The WhiteBoard function is enabled.

### ■ Control menu

**[Top]:** The Control menu is displayed at the top of the screen.

**[Bottom]:** The Control menu is displayed at the bottom of the screen.

### ■ Shrink position

Sets the position where the Control menu is minimized.

**[Left]:** Sets the shrink position to the left.

**[Centre]:** Sets the shrink position to the centre.

**[Right]:** Set the shrink position to the right.

**[Left2]:** Sets the shrink position to the left (one level inside).

**[Centre2]:** Sets the shrink position to the centre (one level inside).

**[Right2]:** Sets the shrink position to the right (one level inside).

### ■ Menu lock

**[Off]:** Enables the operation for the menu display button in the Control menu.

**[On]:** Disables the operation for the menu display button in the Control menu.

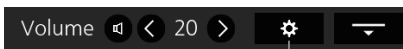

Menu display button

### Note

- Regardless of whether [Menu lock] is set to Off/On, operations after the menu is displayed by remote control operation are valid.

### ■ Quick input settings

Sets the input signal assigned to the input selector button on the Control menu.

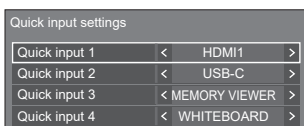

## Video conference mode settings

Shortens the delay time from input to video display to configure the setting suitable for a video conference device connected externally. Accordingly, functions to change the picture size and position can no longer be used.

[Video conference mode settings] - submenu screen

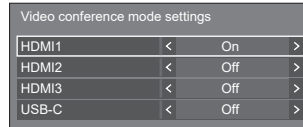

**[HDMI1]:** Setting this to [On] configures the setting of input from the HDMI IN 1 terminal suitable for video conferences.

**[HDMI2]:** Setting this to [On] configures the setting of input from the HDMI IN 2 terminal suitable for video conferences.

**[HDMI3]:** Setting this to [On] configures the setting of input from the HDMI IN 3 terminal suitable for video conferences.

**[USB-C]:** Setting this to [On] configures the setting of input from the USB-C HOST terminal suitable for video conferences.

### Note

- [Video conference mode settings] and [Frame control] cannot be used simultaneously. Only one of them can be used.
- Aspect is [Full].
- The adjustment value of [Position] is invalid.
- [Display orientation] is [Landscape].
- The following functions cannot be used.
  - Digital zoom
  - [Screensaver] - [Wobbling]
  - [Multi display settings]
  - [Portrait settings]
  - [Image rotation]
- The following WhiteBoard-related functions cannot be used.
  - Built-in WhiteBoard
  - Comparison mode
  - Capture
  - Zoom

## Set up timer

Sets the program to turn the power on with the specified time and video input, or to turn the power off at the specified time. Up to 20 programmes can be set.

### Note

- When the current time is displayed as [- -], set [Date and time] before setting [Set up timer]. (see page 73)
- When multiple programs are set at the same time, the program with the smallest program number is enabled.
- If [Power mode] is set to [Power on], executing the program at power-on will switch to the input set for [Input].

[Set up timer] - submenu screen

Setting Example:

Program 1, Every Monday, 12:00,

Power On, Input: HDMI1

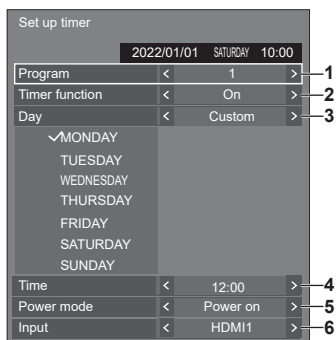

1 Set the program number.

2 To execute the program, set to [On].

The program is disabled when [Off] is set.

3 Set the day.

[Everyday]:

Executes the program every day.

[Weekday]:

Executes the program from every Monday to Friday.

[Weekend]:

Executes the program on Saturdays and Sundays.

[Custom]:

Executes the program on selected days. (Refer to "Customized setting for days of the week".)

4 Set the time.

Pressing ◀▶ once changes time 1 minute.

Pressing continuously changes time by 15 minutes.

5 Set the power On/Off.

6 Set the input.

## ■ Customized setting for days of the week

1 Set [Day] to [Custom].

2 While [Day] is selected, press <ENTER>.

The [Day] screen appears.

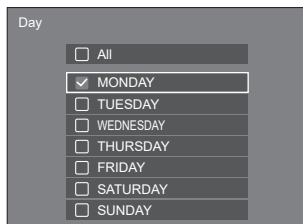

▲▼◀▶ Moves the focus.

<VOL +> Selects days. (Put check marks on days to select.)

<VOL -> Cancels the day selection. (Delete a check mark if it has been put.)

<ENTER> Saves the current setting, and returns to the timer setup screen.

<RETURN> Returns to the timer setup screen without saving the current setting.

3 Change the setting, press <ENTER>, and return to the timer setup screen.

- With [All], all days are selected/cancelled.

### Note

- Use the remote control for the "Customized setting for days of the week" operation.
- If the [Day] screen is deleted without pressing <ENTER>, the setting is not saved.

## Date and time

Set date and time. ([- -] shows no programme is set.)

[Date and time] - submenu screen

Date and time	
2022/01/01 SATURDAY 10:00	
Year	< 2022 >
Month	< 1 >
Day	< 1 >
Hour	< 10 >
Minute	< 0 >
Set	
Clock display < Off >	
Synchronize display setting	
Synchronize display	< Off >
Parent or child setting	< Child >
NTP status	
NTP synchronization	Off
Time zone	(GMT + 00:00)

### ■ Set date and time

- ① Select [Year / Month / Day / Hour / Minute].
- ② Set the selected item.



Date and time	
2022/01/01 SATURDAY 10:00	
Year	< 2022 >
Month	< 1 >
Day	< 1 >
Hour	< 10 >
Minute	< 0 >
Set	

- ③ Select [Set] and press <ENTER>.

Date and time	
2022/02/06 SUNDAY 18:00	
Year	< 2022 >
Month	< 2 >
Day	< 6 >
Hour	< 18 >
Minute	< 0 >
Set	

#### Note

- If the present date and time are not set, the time settings for [Set up timer], [Screensaver], etc. cannot be made.

- The present date and time setting is reset in the following case.

When the main unit is left unattended for 7 days or longer after the main unit is turned off with the <Main Power On / Off button>, the power plug is removed, or power failure has occurred, etc.

\* If the unit is used for long periods or in a high temperature environment, days to reset may be shorter than 7 days.

- Date and time cannot be set when [Year / Month / Day / Hour / Minute] are set to [- -].

- The upper limit of date and time that can be set is, Year 2035, Month 12, Day 31, Hour 23 and Minute 59.

### ■ [Clock display]

Sets to display / hide the clock.

[Off]:

Hides the clock.

[On]:

Displays the clock.

#### Note

- The clock is displayed at the lower left of the screen when <RECALL> button is pressed. Display duration is approx. 5 seconds.
- When current date and time is not set, the clock is not displayed even when [Clock display] is [On].

### ■ [Synchronize display setting]

Synchronizes the time of all the displays connected on the network.

#### Note

- This function does not operate if the displays to synchronize the time are not connected via a LAN.
- This function operates only when the devices connected via a LAN are connected with different IP addresses.
- The time synchronization operates only in power-on state or in schedule standby state.
- Normal operation is achieved only when the display synchronization function is enabled among the units. If other devices are connected on the same network, operation may not be normal.

### [Synchronize display]:

Enables/Disables display synchronization function.

### [Parent or child setting]:

Set this unit to [Parent] or [Child] for display synchronization.

Operates when [Synchronize display] is [On].

### [Parent]:

Set the time as a source of synchronization.

### [Child]:

Synchronizes with the time of the parent.

#### Note

- When [Synchronize display] is [On], and [Parent or child setting] is [Child], date and time cannot be set.
- When [Synchronize display] is [On], and [Parent or child setting] is [Child], [NTP synchronization] off-operation is performed.
- If two or more displays with [Parent] set are present on one network, display synchronization does not operate properly.
- Time is not synchronized if no displays with [Parent] set is present on one network.
- Time is not synchronized if the time is not set for the display with [Parent] set on the network.

- Depending on the network environment, synchronization may be largely lost.
- Synchronization is not possible if a router is placed between the displays with [Parent] and [Child] set.
- Synchronization is not possible via a wireless LAN.
- This function is disabled during communication with IPv6 settings.

### ■ [NTP status]

Displays the current [NTP synchronization] and [Time zone] (see page 103) settings.

#### Note

- When [NTP synchronization] is set to [On], and if [Synchronize display] and [Parent or child setting] are set to [On] and [Child] respectively, [NTP synchronization] shows [--], and the off-operation is performed.
- When [NTP synchronization] is [On], date and time cannot be set.
- The settings for [NTP synchronization] and [Time zone] cannot be changed with this menu. Change the settings with WEB browser. (see page 103)
- [NTP synchronization] operates only in power-on state or in schedule standby state.

## Network settings

Set when networking with a computer.

#### Note

- The DIGITAL LINK-related menus are displayed when the DIGITAL LINK Terminal Board is attached to the expansion slot (SLOT).

[Network settings] submenu will be displayed

- For the main software version of 1.5000 and later, the current setting is displayed to the right of [LAN setup].

### Lower than Version 1.5000 (before IPv6 compatible)

Network settings	
Administrator account settings	
Network control	< Off >
PJLink settings	
AMX D. D.	< Off >
Crestron Connected™	< Off >
LAN setup	
Network status	
DIGITAL LINK mode	< Auto >
DIGITAL LINK status	
DIGITAL LINK menu	
Extron XTP	< Off >
Auto display name	< Off >
Display name	EQ2-000
USB memory network settings	< Permit >
LAN control protocol	< Protocol 2 >
Reset	

### Version 1.5000 and later (after IPv6 compatible)

Network settings	
Administrator account settings	
Network control	< Off >
PJLink settings	
AMX D. D.	< Off >
Crestron Connected™	< Off >
LAN setup	
IPv4 & IPv6	
Network status (IPv4)	
Network status (IPv6)	
DIGITAL LINK mode	< Auto >
DIGITAL LINK status	
DIGITAL LINK menu	
Extron XTP	< Off >
Auto display name	< Off >
Display name	EQ2-000
USB memory network settings	< Permit >
LAN control protocol	< Protocol 2 >
Reset	

## ■ [Administrator account settings]

Configure the administrator account settings.

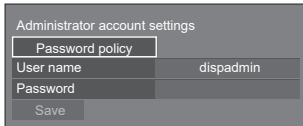

Administrator account settings	
Password policy	
User name	dispadmin
Password	
Save	

### [Password policy]:

Precautions for password settings of this item will be displayed in a new window.

### [User name]:

The keyboard for setting the user name is displayed. Enter the user name.

- Entering characters (see page 169)

### [Password]:

The keyboard for setting the password is displayed. After entering the password, select [OK]; the confirmation screen is displayed. Enter the password again and select [OK]; the password is determined.

### [Save]:

Saves the user name and password determined above in the display unit.

#### Note

- Once determined, it is necessary to enter the user name and password to display the settings.

## ■ [Network control]

Set when controlling with the unit's LAN terminal.

### [Off]:

Invalidates control with LAN terminal.

(In this case, the power consumption of Standby condition (when the power is turned off with the remote control) will be slightly reduced.)

### [On]:

Controls via LAN using the LAN terminal. The power indicator lights purple when the power is turned off with the remote control (standby).

#### Note

- When using the LAN control function which is described in "Using Network Function" (see page 93 – 118), set this function to [On].
- Even if the setting is set to [Off], the Web browser control screens that do not control this unit (display information [Status], detailed settings [Detailed set up] and password change [Change password]) operate.
- To enable the operation, set [Quick start] to [On].
- When [Quick start] is set to [Off], the power can be turned off via network control even if [Network control] is set to [On]. However, the power cannot be turned on from standby state with the exception after a wake-up message (magic packet) is sent from the network equipment in the network. To control both, it is necessary to set both [Quick start] and [Network control] to [On] respectively.

## ■ [PJLink settings]

Configure the PJLink settings to enable PJLink communication on the unit.

### Lower than Version 1.5000 (before IPv6 compatible)

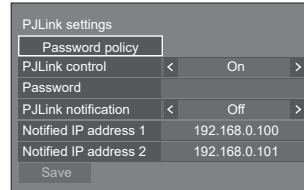

PJLink settings	
Password policy	
PJLink control	On
Password	
PJLink notification	Off
Notified IP address 1	192.168.0.100
Notified IP address 2	192.168.0.101
Save	

### Version 1.5000 and later (after IPv6 compatible)

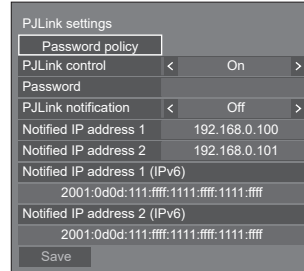

PJLink settings	
Password policy	
PJLink control	On
Password	
PJLink notification	Off
Notified IP address 1	192.168.0.100
Notified IP address 2	192.168.0.101
Notified IP address 1 (IPv6)	2001:0d0d:111:fff:1111:fff:1111:fff
Notified IP address 2 (IPv6)	2001:0d0d:111:fff:1111:fff:1111:fff
Save	

### [Password policy]:

Precautions for password settings of this item will be displayed in a new window.

### [PJLink control]:

Specifies the PJLink communication settings.

**Off:** Disables PJLink control.

**On:** Enables PJLink control.

### [Password]:

The keyboard for setting the password is displayed. After entering the password, select [OK]; the confirmation screen is displayed. Enter the password again and select [OK]; the password is determined.

- Entering characters (see page 169)

### [PJLink notification]:

Set this item when using the PJLink notification.

### [Off]:

Disables the notification.

### [On]:

Enables the notification.

### [Notified IP address 1], [Notified IP address 2]:

Set the IP address of the PC where the status of this unit is notified.

### [Notified IP address 1 (IPv6)], [Notified IP address 2 (IPv6)]

Set the IP address (IPv6) of the PC where the status of this unit is notified.

#### Note

- For IPv6 IP address entering method, refer to "Entering numbers" (see page 78).
- Initial values for notified IP addresses of IPv6 are blank.

**[Save]:**

Saves the password determined above in the display unit.

**Note**

- Once determined, it is necessary to enter the password to display the settings.
- To set the setting to [On], you must configure [Administrator account settings] in advance.
- To use PLink control, you need to set [On] to the setting and set [Network control] to [On].
- The password for the setting is different from the password for [LAN setup].

**■ [AMX D. D.]**

Set whether to allow the Display to be detected by AMX Device Discovery.

**[Off]:**

Disables detection by AMX Device Discovery.

**[On]:**

Enables detection by AMX Device Discovery.

- For more details, visit the following web site.  
<http://www.amx.com/>

**Note**

- To set the setting to [On], you must configure [Administrator account settings] in advance.
- This function is disabled during communication with IPv6 settings.

**■ [Crestron Connected]**

When this function is set to [On], the Display can be monitored or controlled via the network using equipment and application software of Crestron Electronics, Inc.

This Display supports the following application software from Crestron Electronics, Inc.

- Crestron Fusion

Crestron Connected is a function to connect to a system developed by Crestron Electronics, Inc. which manages and controls multiple system devices connected to the network.

- For details of Crestron Connected, refer to the Crestron Electronics, Inc. web site (Provided only in English).

<http://www.crestron.com/>

**Note**

- To set the setting to [On], you must configure [Administrator account settings] in advance.
- This function is disabled during communication with IPv6 settings.

**■ [LAN setup]****Lower than Version 1.5000 (before IPv6 compatible)**

Detailed network settings for the LAN can be configured.

The screen configuration of this menu screen differs before and after IPv6 compatible.

Select [LAN setup] with ▲ ▼ and press <ENTER>.

LAN setup	
DHCP	< Off >
IP address	192.168. 0. 8
Subnet mask	255.255.255. 0
Gateway	192.168. 0. 1
Save	
Command port	1024
EAP	< None >
User name	
Password	
MAC address	12:34:56:78:9A:BC

**[DHCP], [IP address], [Subnet mask], [Gateway]****① Press ◀▶ to set [On] / [Off] of [DHCP].**

When [Off] is selected, IP address and other settings can be set manually.

**[DHCP]:**

(DHCP client function)

**[On]:**

Obtains an IP address automatically when a DHCP server exists in the network the Display is going to be connected.

**[Off]:**

When a DHCP server does not exist in the network the Display is going to be connected, set [IP address], [Subnet mask] and [Gateway] manually.

**[IP address]:**

(IP address display and setting)

Enter an IP address when DHCP server is not used.

**[Subnet mask]:**

(Subnet mask display and setting)

Enter a Subnet mask when DHCP server is not used.

**[Gateway]:**

(Gateway address display and setting)

Enter a gateway address when DHCP server is not used.

**Note**

- When [DHCP] is set to [On], the IP address, etc. will be displayed in grey.



## Entering numbers

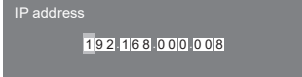

1. Select the address and press <ENTER>.
2. Select digits with ◀▶.
3. Change numbers with ▲▼.
4. Press <ENTER>.

You can cancel the change by pressing <RETURN>.

### ② Select [Save] and press <ENTER>.

Save the current network Setup.

#### Note

- To use a DHCP server, make sure the DHCP server is started.
- Contact your network administrator for details on [IP address], [Subnet mask] and [Gateway].
- Shipping condition  
[DHCP]: Off  
[IP address]: 192.168.0.8  
[Subnet mask]: 255.255.255.0  
[Gateway]: 192.168.0.1

### [Command port]

Set the port number used for command control.

Select [Command port] and press <ENTER> to set the number.

- The available setting range is 1024 – 65535.
- Entering numbers (see page 77)

#### Note

- When the PLink protocol is used, the port setting is not necessary.

### [EAP]

Select the EAP that has been set for the RADIUS server. If the EAP has not been set, select [None].

The types of EAPs that can be set are as follows.

[PEAP(MS-CHAPv2)], [PEAP(GTC)], [EAP-TTLS(MD5)], [EAP-TTLS(MS-CHAPv2)], [EAP-FAST(MS-CHAPv2)], [EAP-FAST(GTC)], [EAP-TLS]

### [User name]

Enter the user name for authentication with one-byte alphanumeric characters (excluding space). (Up to 64 characters)

This can be set only when [EAP] is set to items other than [None] or [EAP-TLS].

### [Password]

Enter the password for authentication with one-byte alphanumeric characters. (Up to 64 characters)

This can be set only when [EAP] is set to items other than [None] or [EAP-TLS].

#### Note

- When EAP is used, this unit needs to be configured according to the settings of the RADIUS server.  
For the settings of the RADIUS server, consult with the network administrator.
- When [EAP] is set to [EAP-TLS], set [Date and time] (see page 73) and register the certificate on the WEB browser control. (see page 101)

### [MAC address]

Displays the MAC address of this unit.

## ■ [LAN setup]

### Version 1.5000 and later (after IPv6 compatible)

Configure the IPv4/IPv6 settings.

Select [LAN setup] with ▲▼ and press <ENTER>.

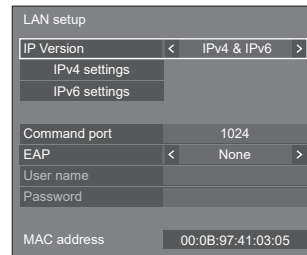

### [IP Version]

Set the LAN operation mode.

[IPv4]: Operates in IPv4 mode.

[IPv6]: Operates in IPv6 mode.

[IPv4 & IPv6]: Operates in both IPv4 and IPv6 modes.

### [IPv4 settings]

Detailed network settings for IPv4 can be made.

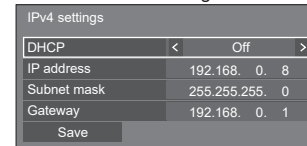

### [DHCP], [IP address], [Subnet mask], [Gateway]

#### ① Press ◀▶ to set [On] / [Off] of [DHCP].

When [Off] is selected, IP address and other settings can be set manually.

#### [DHCP]:

(DHCP client function)

#### [On]:

Obtains an IP address automatically when a DHCP server exists in the network the Display is going to be connected.

#### [Off]:

When a DHCP server does not exist in the network the Display is going to be connected, set [IP address], [Subnet mask] and [Gateway] manually.

**[IP address]:**

(IP address display and setting)

Enter an IP address when DHCP server is not used.

**[Subnet mask]:**

(Subnet mask display and setting)

Enter a Subnet mask when DHCP server is not used.

**[Gateway]:**

(Gateway address display and setting)

Enter a gateway address when DHCP server is not used.

**Note**

- When [DHCP] is set to [On], the IP address, etc. will be displayed in gray.

**Entering numbers**



1. Select the address and press <ENTER>.
2. Select digits with ◀▶.
3. Change numbers with ▲▼.
4. Press <ENTER>.

You can cancel the change by pressing <RETURN>.

② **Select [Save] and press <ENTER>.**

Save the current network Setup.

**Note**

- To use a DHCP server, make sure the DHCP server is started.
- Contact your network administrator for details on [IP address], [Subnet mask] and [Gateway].
- Shipping condition

[DHCP]: Off

[IP address]: 192.168.0.8

[Subnet mask]: 255.255.255.0

[Gateway]: 192.168.0.1

**[IPv6 settings]**

Detailed network settings for IPv6 can be made.

① **Press ◀▶ to set [Auto setting] and [Temporary address] to [On] or [Off].**

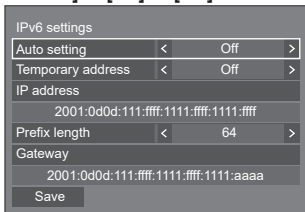

**[Auto setting]**

Set whether to make the IP setting for IPv6 automatically.

**[On]:** Obtain the IP address automatically.

**[Off]:** Sets the IP address manually.

**[Temporary address]**

With [Auto setting] set to [On], set whether to use the temporary IP address.

**[On]:** Uses the temporary address.

**[Off]:** Does not use the temporary address.

**[IP address]**

(IPv6 address display and setting)

With [Auto setting] set to [Off], enter the IP address.

**[Prefix length]**

With [Auto setting] set to [Off], set the prefix length (netmask).

**[Gateway]**

(Gateway address display and setting)

With [Auto setting] set to [Off], enter the Gateway address.

**Note**

- Initial values for [IP address] and [Gateway] for [IPv6 settings] are blank.
- When [Auto setting] is set to [On], the IP address, etc. will be displayed in gray.

**Entering numbers**

- When IPv6 address is set

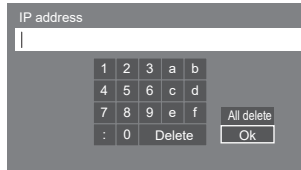

1. Select the address to be set, and press <ENTER>.
2. Press ▲▼◀▶ to select the numbers to be set, and press <ENTER>.
3. Select [OK] and press <ENTER>.

② **Select [Save] and press <ENTER>.**

The current network settings are saved.

**[Command port]**

Set the port number used for command control.

**Select [Command port] and press <ENTER> set the number.**

- The available setting range is 1024 – 65535.
- Entering numbers (see page 78)

**Note**

- When the PjLink protocol is used, the port setting is not necessary.

## [EAP]

Select the EAP that has been set for the RADIUS server. If the EAP has not been set, select [None].

The types of EAPs that can be set are as follows.

[PEAP(MS-CHAPv2)], [PEAP(GTC)], [EAP-TTLS(MD5)], [EAP-TTLS(MS-CHAPv2)], [EAP-FAST(MS-CHAPv2)], [EAP-FAST(GTC)], [EAP-TLS]

## [User name]

Enter the user name for authentication with one-byte alphanumeric characters (excluding space). (Up to 64 characters)

This can be set only when [EAP] is set to items other than [None] or [EAP-TLS].

## [Password]

Enter the password for authentication with one-byte alphanumeric characters. (Up to 64 characters)

This can be set only when [EAP] is set to items other than [None] or [EAP-TLS].

### Note

- When EAP is used, this unit needs to be configured according to the settings of the RADIUS server.

For the settings of the RADIUS server, consult with the network administrator.

- When [EAP] is set to [EAP-TLS], set [Date and time] (see page 73) and register the certificate on the WEB browser control. (see page 101)

## [MAC address]

Displays the MAC address of this unit.

## ■ [Network status]

### Lower than Version 1.5000 (before IPv6 compatible)

Checks the current Network settings status.

The screen configuration of this menu screen differs before and after IPv6 compatible.

Network status	
DHCP	Off
IP address	192.168.0.8
Subnet mask	255.255.255.0
Gateway	192.168.0.1
EAP	None
MAC address	12:34:56:78:9A:BC

## ■ [Network status (IPv4)]

### Version 1.5000 and later (after IPv6 compatible)

Network status (IPv4)	
DHCP	Off
IP address	192.168.0.8
Subnet mask	255.255.255.0
Gateway	192.168.0.1
EAP	None
MAC address	12:34:56:78:9A:BC

## ■ [Network status (IPv6)]

### Version 1.5000 and later (after IPv6 compatible)

Confirm the current IPv6 network setting status.

### Note

- Depending on whether [IPv6 settings] - [Auto setting] is set to [On] or [Off], the displayed items change.

### Auto setting: Off

Network status (IPv6)	
Auto setting	Off
Link local address	fe80::20b:97ff:fe41:305/64
IP address	2001:db8:222:ffff:1111:ffff:1111:ffff/64
Gateway	2001:db8:222:ffff::1/64
DNS1	2001:db8:222:ffff::1/64
DNS2	2001:db8:222:ffff::2/64
MAC address	00:0B:97:41:03:05

### Auto setting: On

Network status (IPv6)	
Auto setting	On
Link local address	fe80::20b:97ff:fe41:305/64
Stateful address	2001:db8:222:ffff:1111:ffff:1111:ffff/64
Stateless address	2001:db8:111:ffff:20b:97ff:fe41:305/64
Temporary address	2001:db8:111:ffff:1111:ffff:1111:aaa1/64
Gateway	2001:db8:222:ffff::1/64
DNS1	2001:db8:222:ffff::1/64
DNS2	2001:db8:222:ffff::2/64
MAC address	00:0B:97:41:03:05

### [Link local address]

Displays the link local IP address for IPv6.

### [DNS1], [DNS2]

Displays the link local IP address for IPv6.

### [Stateful address]

Displays the stateful IP address for IPv6.

### [Stateless address]

Displays the stateless IP address for IPv6.

### [Temporary address]

Displays the temporary IP address for IPv6.

### Note

- With [IPv6 settings] - [Auto setting] set to [On], when you select [Stateless address] or [Temporary address] and press <ENTER>, their list display screens are displayed. (Up to 8 items are displayed)

### [Stateless address] list screen

Stateless address
2001.db8:111:ffff:20b:97ff:fe41:305/64
2001.db8:111:eeee:20b:97ff:fe41:305/64
2001.db8:111:dddd:20b:97ff:fe41:305/64
2001.db8:111:cccc:20b:97ff:fe41:305/64
2001.db8:111:bbbb:20b:97ff:fe41:305/64
2001.db8:111:aaaa:20b:97ff:fe41:305/64
2001.db8:111:9999:20b:97ff:fe41:305/64
2001.db8:111:8888:20b:97ff:fe41:305/64

### [Temporary address] list screen

Temporary address
2001.db8:111:ffff:111:ffff:1111:aaa1/64
2001.db8:111:eeee:1111:ffff:1111:aaa2/64
2001.db8:111:dddd:1111:ffff:1111:aaa3/64
2001.db8:111:cccc:1111:ffff:1111:aaa4/64
2001.db8:111:bbbb:1111:ffff:1111:aaa5/64
2001.db8:111:aaaa:1111:ffff:1111:aaa6/64
2001.db8:111:9999:1111:ffff:1111:aaa7/64
2001.db8:111:8888:1111:ffff:1111:aaa8/64

## ■ [DIGITAL LINK mode]

Switches communication method of DIGITAL LINK terminal.

### [Auto]:

Communication method is selected automatically.

HDMI, LAN, serial communication are possible.

Ethernet connection is possible.

### [DIGITAL LINK]:

HDMI, LAN, serial communication are possible via a twisted pair cable transmitter.

### [Ethernet]:

LAN communication is performed.

### [Long reach]:

Communication method is fixed to Long reach.

### Modes allowing communication

✓ : Valid

— : Invalid

Settings		Communication validity			
		Picture transmission		Ethernet	RS-232C
		100 m	150 m		
Auto	For DIGITAL LINK	✓	—	✓	✓
	For Long reach	—	✓	✓	✓
	For Ethernet	—	—	✓	—
DIGITAL LINK		✓	—	✓	✓
Long reach		—	✓	✓	✓
Ethernet		—	—	✓	—

## Note

- When connected with the [Long reach] communication method, the maximum transmission distance is 150 m. In this case, this unit can receive the signals of up to 1080/60p (148.5 MHz).
- If the communication method of the twisted pair cable transmitter is set to [Long reach], set [DIGITAL LINK mode] to [Auto]. Then, connection is enabled with the [Long reach] communication method.

When connecting with the separately sold DIGITAL LINK Switcher (ET-YFB200G) with the [Long reach] communication method, set [DIGITAL LINK mode] to [Long reach].

- Even if [DIGITAL LINK mode] is set to [Long reach], when the twisted pair cable transmitter does not support the communication method of [Long reach], it will not be connected properly.
- When [LAN terminal setting] is set to [LAN terminal], even if [DIGITAL LINK mode] is set to [Ethernet], the Ethernet connection cannot be made.

## ■ [DIGITAL LINK status]

Display the DIGITAL LINK connection environment.

Select [DIGITAL LINK status] with ▲▼ and press <ENTER>.

DIGITAL LINK status	
LINK status	No link
HDMI status	No HDMI
Signal quality	
Min	-XX dB
Max	-YY dB

### [LINK status]:

1 of the followings will be displayed.

#### [No link]:

No LAN connection, etc.

#### [DIGITAL LINK]:

Connected to the DIGITAL LINK device by LAN.

#### [Long reach]:

Communication method is set to [Long reach] and is connected to the DIGITAL LINK device by LAN.

#### [Ethernet]:

The PC is connected to the DIGITAL LINK / LAN terminal of this product and is LAN connected.

### [HDMI status]:

Displays the connection status of the HDMI format.

1 of the followings will be displayed.

#### [No HDMI]:

DIGITAL LINK not connected

#### [HDMI on]:

DIGITAL LINK connected

#### [HDCP on]:

HDCP supported on DIGITAL LINK

### [Signal quality]:

It is the quantified minimum and maximum numbers of errors that have occurred. The display colours are red, yellow, or blue, depending on the number.

Signal quality	Display Colours	Reception Status
-12dB or below	Blue	Good
-11 to -8dB	Yellow	Bad
-7dB or above	Red	Terrible

- The number is represented by yellow or red if the LAN cable is disconnected or the cable is not shielded.
- This signal quality shows figures between the twisted pair cable transmitter that is connected and the display.

### ■ [DIGITAL LINK menu]

Displays the setting menu of Digital Interface Box.

Select [DIGITAL LINK menu] with ▲ ▼ and press <ENTER>.

#### Note

- This function can only be selected when the Panasonic device that supports DIGITAL LINK output (ET-YFB100G, ET-YFB200G) is connected to a DIGITAL LINK IN terminal of DIGITAL LINK Terminal Board and its power is on.
- For details, refer to the manuals of the devices that support DIGITAL LINK output.

### ■ [Extron XTP]

Set to [On] when connecting XTP Transmitter made by Extron to DIGITAL LINK IN terminal of DIGITAL LINK Terminal Board.

- For more details on Extron, visit the following web site.

<http://www.extron.com>

#### Note

- When this item is set to [On], [Administrator account settings] needs to be set.

### ■ [Auto display name]

Sets whether to change the display name automatically.

#### [Off]:

The display name is not changed automatically.

#### [On]:

Changes the display name automatically in accordance with the set point of the display ID.

### ■ [Display name]

The name of the Display that is shown on the network can be changed.

#### Note

- The name can be changed only when [Auto display name] is set to [Off].
- Display ID is not reset to default with [Network settings] - [Reset].

### ■ [USB memory network settings]

Sets whether to permit the network setting using the USB memory device. (see page 166)

#### [Permit]:

Permits USB memory network settings.

#### [Prohibit]:

Prohibits USB memory network settings.

#### Note

- This function is set to [Permit] as factory default.
- Once the network setting is done with USB memory device, this function is set to [Prohibit].

### ■ [LAN control protocol]

Select the LAN control protocol.

#### [Protocol 1]:

Control with the Panasonic Display sequence.

#### [Protocol 2]:

Control with the sequence that is compatible with Panasonic Projector.

#### Note

- For PJLink and WEB browser control, the operation is possible regardless of the setting.
- When operating the "Multi Monitoring & Control Software", select [Protocol 2].

### ■ [Reset]

You can reset the network setting to the factory default of the Display.

Select [Yes] with ◀▶ and press <ENTER>.

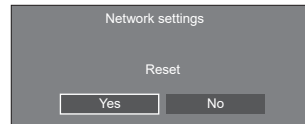

#### Note

- The settings for [NTP synchronization], NTP server and [Time zone] will be reset to the factory default.
- When [Security password] - [Security password] is set to [On], it is necessary to input the password when commanding [Reset].

## USB media player settings

Set for "USB media player".

For details of the function, refer to "USB media player" (see page 119).

### Note

- Depending on the setting for [Use memory select], accessing devices differ. When [USB] is selected, a USB memory device inserted to the USB terminal is used. When [Internal memory] is selected, the internal memory is used.

[USB media player settings] - submenu screen

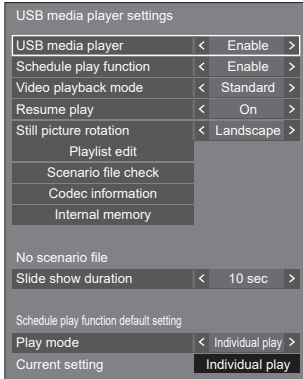

### [USB media player]

Set to enable or disable the USB media player function.

### [Schedule play function]

Enables/Disables the schedule playback function using "Content Management Software".

### Note

- When [Schedule play function] is set to [Enable], if both the scenario file of the existing "USB media player" and the schedule file of this function are present, the [Schedule play function] operation takes priority.
- [USB media player] cannot be changed during the schedule playback mode.
- When this function is set to [Enable], set [Quick start] to [On] to enable the operation.
- When [Quick start] is set to [Off], the unit enters the standby state according to the schedule even if it is set to [Enable]. However, the unit does not start up. To operate the Schedule play function, it is necessary to set [Quick start] to [On] and [Schedule play function] to [Enable].

### [Video playback mode]

Sets the video playback mode.

If image disturbance occurs at the switching timing of motion picture files during playback in [Standard] mode, switch to [Adjust] mode.

**[Standard]:** Plays without a black image at the joint between video files.

**[Adjust]:** Plays with a black image (approx. 2 seconds) inserted at the joint between video files.

### Note

- When using the Multi Media Player, a black screen is displayed for a certain period of time at the switching timing of motion picture files regardless of the [Video playback mode] settings.
- The display may be disturbed at the switching timing of files during playback in [Standard] mode.
- When the schedule playback is proceeding using "Content Management Software", [Video playback mode] can be switched both in single mode and multi mode.

### [Resume play]

Set resume play off/on.

### [Still picture rotation]

Sets the display method of still pictures by USB/Internal Memory input.

#### [Landscape]:

Displays still pictures horizontally.

#### [Portrait]:

Displays still pictures vertically.

#### [Exif information]:

The display rotates according to the file information.

### Note

- [Exif information] performs the rotation operation only in the JPEG format to which Exif information is added. In the JPEG format or BMP format where EXIF information is not detected, the operation when [Landscape] is selected is performed.

### [Playlist edit]

Creates / Edits the scenario file (scenario.dat).

For details of [Playlist edit], refer to "Playlist edit function" (see page 126).

### [Scenario file check]

Checks the memory selected for [Use memory select]. When an error is detected, the error code and file name are displayed.

For details of the error codes, refer to "USB memory contents check". (see page 124)

**Select [Scenario file check] with ▲ ▼ and press <ENTER>.**

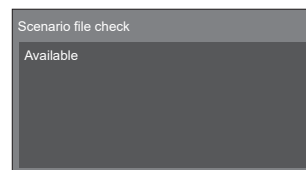

### Note

- When the schedule playback is proceeding using "Content Management Software", [Scenario file check] is disabled.

## ■ [Codec information]

Displays the codec information of a motion picture/still picture file being played on the USB media player.

The file is analysed on execution, and the codec information is displayed after the completion of the analysis.

### Note

- The file analysis takes time in proportion to the number of files in the USB memory device.
- A black screen appears during analysis because playback is stopped.
- Incompatible with the schedule play mode.

## ■ [Internal memory]

Performs operation of data within the internal memory.

### Note

- [Internal memory] to be operated is the one used for the USB media player. (It is different from [Internal memory] in the WhiteBoard function.)
  - When using the internal memory, refer to [Use memory select]. (see page 90)
  - The capacity of the internal memory is approx. 3 GB.
- [Internal memory] - submenu screen

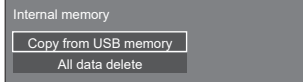

### [Copy from USB memory]:

Copies data from the USB memory device to the internal memory.

### [All data delete]:

Deletes data in the internal memory.

## ■ [Slide show duration]

Select the displaying duration for still images.

[10 sec] to [600 sec]

### Note

- When the schedule playback is proceeding using "Content Management Software", [Slide show duration] is disabled.

## ■ Play mode

Specifies the playback mode operating with [Schedule play function]. To apply this setting to the schedule playback operation, restart this unit.

Also, if the playback mode is specified for the schedule data of "Content Management Software" during the schedule playback, it takes priority.

### [Individual play]:

- Plays in the individual playback mode.
- Content is played only on one display.

### [Synchronize play]:

- Plays in the synchronized playback mode.
- Content is played on multiple displays in synchronization.

Note approx. 5 seconds of preparation time are added in switching content to synchronize the playback timing.

### Note

- The synchronized playback operates properly only when [Date and time] - [Synchronize display] is set to [On] and the time is synchronized.
- [Current setting] shows [Play mode] when the schedule playback is performed by this unit.
- The synchronized playback does not operate during communication with IPv6 setting.

## Memory viewer settings

Set for "Memory viewer".

For details of the function, refer to "Memory viewer" (see page 131).

### Note

- Depending on the setting for [Use memory select], accessing devices differ. When [USB] is selected, a USB memory device inserted to the 6074 terminal is used. When [Internal memory] is selected, the internal memory is used.

[Memory viewer settings] - submenu screen

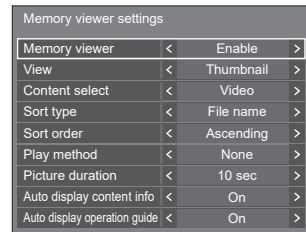

## ■ [Memory viewer]

Enables/Disables "Memory viewer".

## ■ [View]

Sets the display format of the content in the USB memory or internal memory device to the thumbnail display or the list display.

## ■ [Content select]

Sets the type of content to display.

### [All]:

Displays all the files including picture, video and music files.

### [Picture / Video]:

Displays picture files and video files.

### [Picture / Music]:

Displays picture files and music files.

### [Video / Music]:

Displays video files and music files.

### [Picture]:

Displays picture files only.

### [Video]:

Displays video files only.

### [Music]:

Displays music files only.

## ■ [Sort type]

Sets the order of content in combination with [Sort order].

## ■ [Sort order]

Sets the order of content in combination with [Sort type].

## ■ [Play method]

Sets the playback method of content.

### [None]:

Automatically returns to the content display screen when the playback of the selected file has finished.

### [Single]:

Plays the selected file repeatedly.

### [All]:

Plays the content displayed on the content display screen repeatedly in displayed order.

### [Random]:

Plays the content displayed on the content display screen at random.

### [Select]:

Plays the selected files in the sorting order shown on the content display screen.

### [Program]:

Plays the selected file in selected order.

## ■ [Picture duration]

Sets the display time of still picture files.

**10 sec to 600 sec**

## ■ [Auto display content info]

When this is set to [On], the content information is automatically displayed at the beginning of the content playback, and the information is automatically erased after a certain period of time.

## ■ [Auto display operation guide]

When this is set to [On], the operation guide is automatically displayed at the beginning of the content playback, and the information is automatically erased after a certain period of time.

The playback control (see page 134) is performed only while the operation guide is being displayed. If it is not displayed, the unit shows the operation guide without performing the playback control.

When this is set to [Off], the operation guide is not displayed at the beginning of the content playback. The playback control is performed regardless of Show/Hide of the operation guide.

### Note

- When [Play method] is set to [Single], playback information and operation guide are automatically displayed only at the beginning of the first playback of content.
- When [Play method] is [Select] or [Program], up to 99 files can be selected.
- This menu will be greyed out and cannot be set while content is being played.

## Screen Transfer settings

[Screen Transfer settings] - submenu screen

Screen Transfer settings		
Screen Transfer function	<	Enable >
Cut in	<	Off >
PIN code	<	On >

## ■ [Screen Transfer function]

Set the function to display images using Panasonic's dedicated application "Screen Transfer" to enable or disable.

### ■ [Cut in]

Sets whether to allow video interruption by another user while displaying a video using "Screen Transfer".

#### [Off]:

Disables video interruption.

#### [On]:

Enables video interruption.

## ■ [PIN code]

Sets whether to require the input of PIN code when connecting to this unit using "Screen Transfer".

#### [Off]:

Does not require the input of PIN code.

#### [On]:

Requires the input of PIN code.

### Note

- This function does not operate during communication with IPv6 settings.

## Wireless presentation settings

This menu configures the settings for wireless presentation system connection.

For details, refer to the operating instructions on the following support site.

(<https://panasonic.net/cns/prodisplays/wps2/>)

[Wireless presentation settings] - sub menu screen

Wireless presentation settings		
Background colour setting	<	Black >
Date/Time setting	<	Y/M/D >
Language link	<	Enable >



## Function button settings

Assigns specific functions to the numeric buttons (<1> to <6>). The buttons can be used as shortcut keys by assigning frequently used operations.

### 1 Select the numeric button with ▲ ▼ and press <ENTER>.

[Function button settings] - submenu screen

Function button settings	
Function button 1	HDMI1
Function button 2	HDMI2
Function button 3	HDMI3
Function button 4	USB-C
Function button 5	PC
Function button 6	MEMORY VIEWER
Function button guide	< On >

### 2 Switch [Group] with ◀ ▶.

Function button 1	
Group	< Input >
Input	< HDMI1 >

### 3 Select the function (Input / Memory load / Shortcut) with ▲ ▼ and set the function to assign with ◀ ▶.

#### [Input] (Direct input select)

Input can be selected with single-touch operation.

[HDMI1] / [HDMI2] / [HDMI3] / [USB-C] / [SLOT] / [PC] / [PC [YPbPr]] / [Screen Transfer] / [USB/Internal Memory] / [MEMORY VIEWER] / [WHITEBOARD]

#### [Memory load]

Memory can be loaded with single-touch operation. Refer to "Memory load". (see page 50)

#### [MEMORY1] to [MEMORY6]

- [MEMORY1] to [MEMORY6] load functions are already assigned to <1> to <6> respectively. These settings cannot be changed.

#### [Shortcut]

[Signal], [Screensaver], [Set up timer], [Power management settings], [Network settings], [Multi display settings], [Portrait settings]

- Pressing the numeric button displays the menu screen. Pressing the button again exits the menu screen.

#### [Power off]

- Pressing the numeric button turns the power "OFF".

#### [Power on]

- Pressing the numeric button turns the power "ON".

#### [AV mute]

- Pressing the numeric button mutes the audio and pictures.

To cancel, press any button on the remote control except the <Standby (ON/OFF) button>.

#### [Digital zoom]

- Switches to [Digital zoom] mode by pressing numeric buttons. (see page 40)

#### [Display ID / Display name]

- Pressing the numeric button enlarges [Display ID] and [Display name].

#### [HDMI-CEC operation]

- Press the numeric buttons to display the operation screen of the HDMI-CEC compatible device.

#### [Playlist edit]

- Pressing the numeric button displays [Playlist edit] screen. (see page 126)

#### [Portrait display switching]

- Pressing the numeric button switches [Portrait settings] - [Portrait display] between [On] and [Off].

#### [Multi display switching]

- Pressing the numeric button switches [Multi display settings] - [Multi screen display] between [On] and [Off].

#### [USB (DEVICE) connection switching]

(Compatible with version 1.5000 and later)

- Pressing the numeric button switches the connection destination of the USB DEVICE terminal among [Internal], [USB-C] and [SLOT].

#### Note

- Pressing ▲ ▼ of the main unit while the menu screen is not displayed switches the connection destination of the USB DEVICE terminal.
- Power off operation or input switching operation restores the connection destination set for [USB (DEVICE) connection switching] function to the set value on the menu.
- This function does not operate with USB / Internal Memory / MEMORY VIEWER / WHITEBOARD inputs.

#### Shipping condition

The following functions are assigned to the numeric buttons as factory default.

	[Input]
1	HDMI1
2	HDMI2
3	HDMI3
4	USB-C
5	PC
6	MEMORY VIEWER

## ■ [Function button guide]

Sets the function display when numeric buttons are pressed. Set this for each function group.

### [On]:

Displays the function list for the numeric buttons.

### [Off]:

Does not display the function list. Operation starts when numeric buttons are pressed.

### Note

- When <FUNCTION> is pressed, [Function button guide] will be displayed regardless of the [On] / [Off] settings.

## ■ To use shortcut (numeric buttons)

### 1 Press <FUNCTION> or <1> – <6>.

[Function button guide] will be displayed.

[Function button guide]: When [Off] is set, pressing the numeric button starts operation.

Example: Input

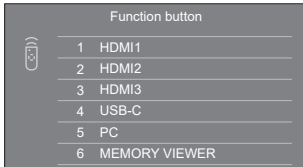

### 2 Press <1> – <6>.

The function for the pressed button starts to operate.

## Colour design settings

Sets COLOUR DESIGN

[Colour design settings] - submenu screen

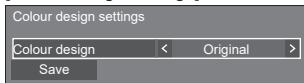

- Set [Universal] or [Original] and select [Save].

**[Original]:** The number of color palettes that can be used on the WhiteBoard increases.

**[Universal]:** Enables color combinations giving consideration to universal design.

Palettes of colors easy to see on the WhiteBoard are used.

- A confirmation screen is displayed.

Select [Yes] to apply the setting.

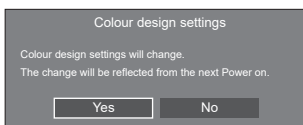

### Note

- After the setting is changed, the changed setting will be applied after the power is turned on next time.  
Turn the power off pressing <Main Power On / Off button> (⏻/⏻). If the <Main Power On / Off button> is locked, please disconnect the AC cord plug from the wall outlet.
- When it is set to [Universal], a message is displayed at startup.

## OSD settings

Makes various settings for the on-screen menus.

[OSD settings] - sub menu screen

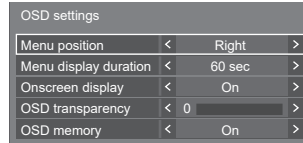

## ■ [Menu position]

Sets the display position of the on-screen menu.

Each time ◀ or ▶ is pressed, the display position of the on-screen menu changes.

Display example:

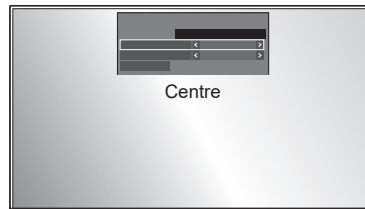
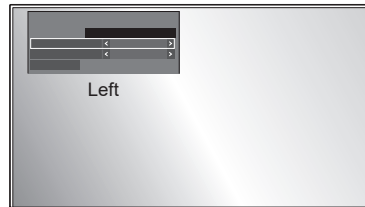

## ■ [Menu display duration]

Sets the display duration time for the on-screen menu.

**[5 sec] to [180 sec]**

## ■ [Onscreen display]

Set to display / hide the following Onscreen display.

- Power on display
- Input signal switch display
- No signal display
- No external media display (at USB input)
- MUTE display after displaying the menu screen
- Off timer remaining time display when 3 minutes remaining

- Display when responding to commands from external control

**[On]:**

Displays the Onscreen display.

**[Off]:**

Hides the Onscreen display.

■ **[OSD transparency]**

Sets the transparency rate of the on-screen display background.

0 to 100

■ **[OSD memory]**

Sets whether or not to hold the cursor position on the menu screen.

**[Off]:**

The cursor position is not held.

**[On]:**

The cursor position is held.

**Note**

- Even if it is set to [On], if the power of the main unit is turned off, the cursor position is not held.

**Options**

This menu displays the information of this unit, and restores data to the factory default state.

[Options] - submenu screen

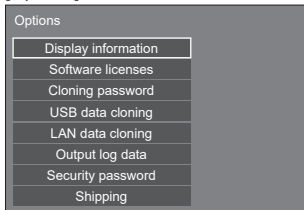

■ **[Display information]**

Displays the serial number, software version and use time of this unit.

■ **[Software licenses]**

Displays the software license.

■ **[Cloning password]**

Sets the password for the cloning function.

For more detail of the settings, see “Changing the cloning password”. (see page 165)

**Note**

- The initial password in the factory default state is [AAAA].
- Change the password periodically, and set one which is difficult to guess.
- For initialization method for the cloning password, consult the dealer where you purchased the product.

■ **[USB data cloning], [LAN data cloning]**

Copies the data of a single display to multiple displays by using the USB memory device or via LAN. For more detail of the settings, see “Using data cloning”. (see page 161)

■ **[Output log data]**

Saves a log for servicing to the USB memory device.

■ **[Security password]**

Set a password to protect the settings of this unit.

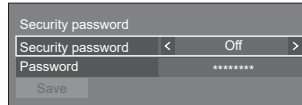

**[Security password]**

**[Off]:**

Disables security password control.

**[On]:**

Enables security password control.

**[Password]**

The keyboard for setting the password is displayed. After entering the password, select [OK]; the confirmation screen is displayed. Enter the password again and select [OK]; the password is determined.

- Entering characters (see page 169)

**[Save]**

Saves the settings above in the display unit.

**Note**

- The default password is “1111”.
- The security password is used when performing [Shipping] and [Network settings] - [Reset].
- Change the password at a regular interval to make it hard to be guessed.
- For how to initialize the security password, consult your dealer.

■ **[Shipping]**

Restores the data of this unit to the factory default state. For more detail of the settings, see “Shipping condition”. (see page 173)

## Control settings

Sets each item of the function which enables to control multiple displays at the same time, or individually.

### Note

- The DIGITAL LINK related menus are displayed when the DIGITAL LINK Terminal Board is attached to the expansion slot (SLOT).

[Control settings] - submenu screen

Control settings		
Serial control	< SERIAL IN	>
Display ID	< 0	>
Controller ID function	< Off	>
Serial ID function	< Off	>
Serial response (Normal)	< On	>
Serial response(ID all)	< Off	>
Serial ID group	< A	>
Serial response(ID group)	< Off	>
Serial daisy chain position	< ---	>

### ■ [Serial control]

Selects the RS232-C control terminal.

#### [SERIAL IN]:

Controls using the SERIAL IN terminal of the display.

#### [SLOT]:

Controls via the function board inserted to the SLOT of this unit.

### ■ [Display ID]

Set ID number when controlling the Display with [Controller ID function] and [Serial ID function].

0 to 100 (Standard value: 0)

### ■ [Controller ID function]

Enables/disables the [Controller ID function].

#### [Off]:

Disables the [Controller ID function]. (Can be operated as normal remote control.)

#### [On]:

Enables the [Controller ID function]. Effective on switching to [On].

### Note

- To use the [Controller ID function], setting ID numbers both for the remote control and for the display unit is required.

For ID number setting for the remote control, see page 168.

- About how to reset the settings to defaults, refer to "Initialization". (see page 174)

### ■ [Serial ID function]

Set to control external control with the PC connected to SERIAL terminal according to the Display's ID number.

#### [Off]:

Disables external control by the ID.

#### [On]:

Enables the external control by the ID.

### ■ [Serial response (Normal)]

Sets whether to send the response command to normal commands without ID.

#### [Off]:

Does not respond. (Including the inquiry command)

#### [On]:

Responds.

### ■ [Serial response(ID all)]

Set whether to respond to the command or not, when serial command of ID number "0" is received.

#### [Off]:

Does not respond.

#### [On]:

Responds.

### ■ [Serial ID group]

When controlling multiple displays simultaneously via serial communication, those displays are grouped as one.

A to G (7 groups)

### ■ [Serial response(ID group)]

Sets whether to respond to the command or not, when serial command, which the group is specified, is received.

#### [Off]:

Does not respond.

#### [On]:

Responds.

### ■ [Serial daisy chain position]

Sets the first and the last terminals of the daisy chain connection when serial-controlling this unit by the daisy chain connection via DIGITAL LINK.

#### [---]:

When controlling this unit alone with serial control, or connecting at a position other than the first and last terminals in a daisy chain

#### [Top]:

When connecting at the first terminal in a daisy chain

#### [End]:

When connecting at the last terminal in a daisy chain

## Information timing

Set up the informing manner for no signal or temperature rising.

### RS-232C controls:

Warning or error message sent from the display automatically.

### LAN controls:

Acquire the warning or error message from the display.

[Information timing] - submenu screen

Information timing		
No signal warning	< On >	
No signal warning timing	< 5min >	
No signal error	< On >	
No signal error timing	< 10min >	
Temperature warning	< On >	

### ■ [No signal warning]

When set to [On], the display sends out the no signal warning.

### ■ [No signal warning timing]

Set up the detecting time for no signal warning.  
(Range: 01 – 60, Interval: 1 minute)

### ■ [No signal error]

When set to [On], the display sends out the no signal error.

### ■ [No signal error timing]

Set up the detecting time for no signal error.  
(Range: 01 – 90, Interval: 1 minute)

- The warning of [No signal warning] and the error of [No signal error] are not sent when the no signal state is detected through any of the following functions:

[No signal power off], "Power management" function for each input (see page 61)

Setting Example:

- If there is no signal when [HDMI1] is input, [HDMI1 power management] is activated first and the Display enters the standby mode.  
[No signal warning timing]: 5 minutes  
[No signal error timing]: 10 minutes  
[HDMI1 power management]: [On] (60 seconds)

#### Note

- The [No signal error timing] cannot be set shorter than [No signal warning timing].
- Even when a USB memory or internal memory is connected, if there is no playable file, the unit determines no signal is present.

### ■ [Temperature warning]

When set to [On], the display sends out the warning message.

## Mode settings

Sets various operations.

[Mode settings] - sub menu screen

Mode settings		
Display orientation	< Landscape >	
Image rotation	< Off >	
POWER button control setting	< Off >	
Power LED light-up setting	< Off >	
PC input mode	< PC >	
Use memory select	< USB >	
USB (DEVICE) connect setting	< Auto >	
USB-C/SLOT select	< USB-C+SLOT >	
LAN terminal setting	< LAN terminal >	

### ■ [Display orientation]

Sets the on-screen display orientation in the portrait setting.

#### [Landscape]:

On-screen display angle is for horizontal installation.

#### [Portrait]:

The on-screen display rotates clockwise by 90 degrees for easy view in the portrait setting.

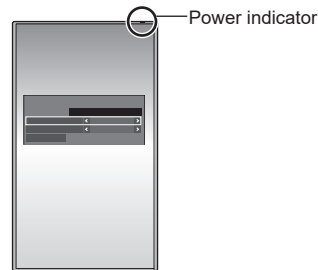

#### Note

- In the portrait setting, the power indicator shall come to the upper side.

### ■ [Image rotation]

Sets the picture rotation in the portrait setting.

#### [Off]:

Pictures are not rotated.

#### [180 degrees]:

Pictures are rotated 180 degrees.

#### Setting [Position] when [Image rotation] is set to [180 degrees]

When [Image rotation] is set to [180 degrees], the adjustment direction becomes opposite of that in [Off] state. (see page 43)

Note these points for adjustment.

### ■ [POWER button control setting]

Sets the operation when the power button (⏻/⏻) of the main unit is pressed.

#### [Off]:

Turns off the power.

#### [Standby]:

Enters the standby mode.

### ■ [Power LED light-up setting]

Sets the display operation of the power indicator of the main unit.

#### [Off]:

Does not illuminate.

#### [On]:

Illuminates according to the power status.

### ■ [PC input mode]

Set this mode according to the input signal format of the PC IN terminal.

#### [PC]:

RGB signal

#### [PC[YPbPR]]:

YPbPR/YCbCr signal

#### Note

- The synchronized signal supports the following inputs only.

[PC]: HD/VD signal input only

[PC[YPbPR]]: Only the synchronized signal superimposed on Y signal input

### ■ [Use memory select]

Selects a memory to use.

#### [USB]:

Uses a USB memory.

#### [Internal memory]:

Uses the internal memory.

### ■ [USB (DEVICE) connect setting]

Sets the connection destination of the USB DEVICE terminal.

#### [Auto]:

Switches the connection destination by the input setting.

USB-C: Connects to the USB-C HOST terminal.

SLOT: Connects to the SLOT.

Other inputs: Connects to the internal system of the main unit.

#### [USB-C]:

Connects to the USB-C HOST terminal.

#### [SLOT]:

Connects to the SLOT.

Other inputs: Connects to USB.

#### [Internal]:

Connects to the internal system of the main unit.

The same operation as that for the USB terminal is performed.

#### Note

- When [USB (DEVICE) connection switching] function is executed, this setting is disabled. It is enabled by setting again.

### ■ [USB-C/SLOT select]

Controls the power supply to the USB-C HOST terminal and the SLOT terminal.

#### [USB-C]:

A maximum power supply of 60 W to the USB-C HOST terminal is possible. In this case, SLOT cannot be used.

#### [USB-C+SLOT]:

Both the USB-C HOST terminal and the SLOT terminal can be used. Note that a maximum power supply to USB is restricted to 7.5 W.

#### Note

- When the setting is changed, turn off and on the Main power switch, or disconnect and connect the power plug.

### ■ [LAN terminal setting]

Selects a terminal for LAN control.

#### [LAN terminal]:

Controls from the LAN terminal of the main unit.

#### [DIGITAL LINK SLOT]:

Controls from the LAN control terminal of the DIGITAL LINK Terminal Board.

#### Note

- When the DIGITAL LINK Terminal Board is not attached, the menu is not displayed, and forced control is performed by the LAN terminal of the main unit.
- The LAN control terminal of the DIGITAL LINK Terminal Board does not support daisy chain connection for LAN control.

## Restriction settings

Sets various operation restrictions.

[Restriction settings] - sub menu screen

Restriction settings		
Maximum VOL function	< Off >	>
Maximum VOL level	< 0 >	>
Button lock	< Off >	>
POWER button lock	< Off >	>
Controller user level	< Off >	>

### ■ [Maximum VOL function]

Enables/Disables [Maximum VOL function].

#### [Off]:

The sound volume level can be set up to 100 (maximum).

#### [On]:

The volume cannot be set to the level higher than the level set for [Maximum VOL level].

### ■ [Maximum VOL level]

Sets the sound volume when [Maximum VOL function] is enabled.

#### Note

- Outputs with the set volume when [Maximum VOL level] in [On] state is selected on the menu.
- When the [Maximum VOL function] is switched from [Off] to [On], if the [Maximum VOL level] is set lower than the [Initial VOL level], the [Initial VOL level] automatically becomes the same as the [Maximum VOL level].

### ■ [Button lock]

Limits operation of the buttons on the unit.

#### [Off]:

All the buttons on main unit can be used.

#### [On]:

All button operations except for the <Main Power On / Off button> are disabled.

#### [MENU & ENTER]:

Locks <MENU (Unit)> and <ENTER (Unit)> buttons.

### To set [Button lock]

Set with the buttons on the unit.

#### [Off]:

- ① Press <+ (Unit)> for 4 times.
- ② Press <INPUT (Unit)> for 4 times.
- ③ Press <- (Unit)> for 4 times.
- ④ Press <ENTER (Unit)>.

#### [On]:

- ① Press <- (Unit)> for 4 times.
- ② Press <ENTER (Unit)> for 4 times.
- ③ Press <+ (Unit)> for 4 times.
- ④ Press <ENTER (Unit)>.

#### [MENU & ENTER]:

- ① Press <ENTER (Unit)> for 4 times.
- ② Press <+ (Unit)> for 4 times.
- ③ Press <INPUT (Unit)> for 4 times.
- ④ Press <ENTER (Unit)>.

#### Note

- About how to reset the settings to defaults, refer to "Initialization". (see page 174)

### ■ [POWER button lock]

Sets the lock setting for the display <Main Power On / Off button>.

#### [Off]:

<Main Power On / Off button> operation is enabled.

#### [On]:

<Main Power On / Off button> operation is disabled.

### ■ [Controller user level]

Limits operation of the buttons on the remote control.

#### [Off]:

You can use all of the buttons on the remote control.

#### [User1]:

You can only use <Standby (ON/OFF) button>, <INPUT>, <RECALL>, <MUTE>, <VOL +> and <VOL -> buttons on the remote control.

#### [User2]:

You can only use <Standby (ON/OFF) button> on the remote control.

#### [User3]:

Locks all the buttons on the remote control.

#### Note

- About how to reset the settings to defaults, refer to "Initialization". (see page 174)

## SLOT settings

Set for SLOT.

This menu is displayed only when a function board is inserted into the SLOT.

[SLOT settings] - submenu screen

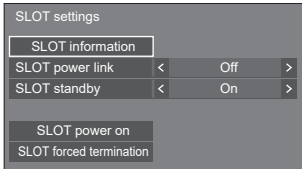

### ■ [SLOT information]

Displays the information of the function board inserted to the SLOT.

### ■ [SLOT power link]

Links the power operation of the SLOT with the power operation of this unit.

**[Off]:**

Does not link.

**[On]:**

The power of the unit is turned off when the power of the inserted function board is turned off during SLOT input or enters the power save mode. After that, when the power of the function board is turned on or returns from the power save mode, the power of the unit is turned on.

#### Note

- When [HDMI-CEC control] is set to [Enable], this menu will be greyed out and cannot be set. (see page 65)
- When the DIGITAL LINK Terminal Board is attached, [SLOT power link] is greyed out and cannot be set.

### ■ [SLOT standby]

Sets the power supply status for the SLOT when the unit is in standby mode.

**[Off]:**

The power is not supplied to the SLOT when the power is turned off by the remote control, etc.

**[On]:**

The power is supplied to the SLOT when the power is turned off by the remote control, etc.

#### Note

- When [SLOT standby] is set to [On], the power indicator in standby mode lights purple.
- When [HDMI-CEC control] is set to [Enable], this menu will be greyed out and cannot be set. (see page 65)
- When the DIGITAL LINK Terminal Board is used, set [SLOT standby] to [On].

### ■ [SLOT power on]

Starts up the power of the SLOT.

### ■ [SLOT forced termination]

Forcibly turns off the power of the SLOT. Use this only when the power cannot be turned off manually due to the problem of the operating system, etc.



# Using Network Function

This unit has a network function and you can control the Display connected to the network using your computer.

## Necessary environment for computers to be connected

First of all, confirm your computer whether it has a wired LAN.

Before connecting the Display to the computer, be sure to check the following settings.

### Check 1: About LAN cable

- Connect the cable properly.
- Use LAN cable that is compatible with category 5e or above.

### Check 2: Wired LAN settings

#### Computer with a built-in wired LAN function

- Switch on the wired LAN.

#### Computer without a built-in wired LAN function

- Check that your wired LAN adapter is recognized properly and it is switched on.
- Install the wired LAN adapter driver beforehand.

For details on how to install the driver, refer to the instructions accompanying the wired LAN adapter.

## About Web Browser

Web Browser is necessary to use WEB control.

- Compatible OS:  
Windows, Mac OS
- Compatible Web Browser:  
Internet Explorer 11.0, Microsoft Edge (Windows)  
Safari 10.0/ 11.0/12.0/13.0/14.0 (Mac OS)

## Example of network connection

### Note

- To use the network function, set each item in [Network settings] and make sure to set [Network control] to [On].

(see page 74)

When it is set to [On], power indicator lights purple under the condition of power "Off" with remote control (stand-by state).

- When using the DIGITAL LINK IN / LAN terminal of DIGITAL LINK Terminal Board for LAN control, select [Setup] - [Mode settings], and set [LAN terminal setting] to [DIGITAL LINK SLOT]. (see page 90)

- When [Quick start] is set to [Off], the power can be turned off via network control even if [Network control] is set to [On]. However, the power cannot be turned on from standby state with the exception after a wake-up message (magic packet) is sent from the network equipment in the network. To control both, it is necessary to set both [Quick start] and [Network control] to [On] respectively.

## LAN Terminal connection

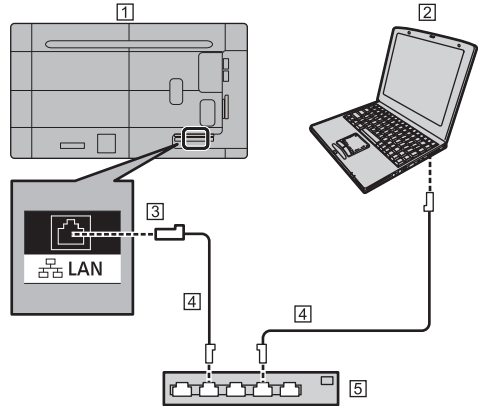

① Display (Back of the unit)

② PC

③ LAN terminal

④ LAN cable (commercially available)

⑤ Hub or broadband router

### Note

- For LAN cable, use shielded cable, otherwise picture noise may be caused.
- Make sure the broadband router or hub supports 10BASE-T / 100BASE-TX.
- Touching the LAN Terminal with a statically charged hand (body) may cause damage to the device due to its discharge.

Do not touch the LAN Terminal or the metal part of the LAN cable.

- For instructions on connection, consult your network administrator.

## Command control

Network function of the unit can control the unit in the same way as serial control from a network.

### Supported commands

Commands used in the serial control are supported. (see page 25)

## Control Command via LAN

The communication differs whether [Setup] - [Network settings] - [LAN control protocol] is set to [Protocol 1] or [Protocol 2].

### 1. When [LAN control protocol] is set to [Protocol 1].

Communicates using the display-specific protocol.

#### Connection method

1 Obtain the display's IP address and the port number (Default is 1024), and request connection to the display.

The IP address and the port number can be obtained from the following menus.

- IP address:  
[Setup] → [Network settings] → [LAN setup] or [Network status]
- Port number:  
[Setup] → [Network settings] → [LAN setup]
- For more detail of the settings, see page 76.

2 The display responds.

Response data

Data part	Space	Mode	Space	Random number part	Last terminal symbol
[PDPCONTROL] (ASCII character string)	[ ] 0x20	[1] 0x31	[ ] 0x20	[zzzzzz] (ASCII code hex number)	(CR) 0x0d
10 bytes	1 byte	1 byte	1 byte	8 bytes	1 byte

Mode: 1 = Protect mode

3 Hash the following data with the MD5 algorithm, and generate a 32-byte hash value.

[zzzzzzzzyyyyyy]

zzzzzzzz :

8-byte random number obtained in step 2

yyyyyy :

Password set for [Administrator account settings]

#### Command transmission method

Transmit in the following command format

Transmitted data

Header	Control symbol	Data part	Control symbol	Last terminal symbol
Hash value (see "Connection method")	(STX) 0x02	Control command (ASCII character string)	(ETX) 0x03	(CR) 0x0d
32 bytes	1 byte	Undefined	1 byte	1 byte

Received data

Control symbol	Data part	Control symbol	Last terminal symbol
(STX) 0x02	Control command (ASCII character string)	(ETX) 0x03	(CR) 0x0d
1 byte	Undefined	1 byte	1 byte

Error response

Error message	Last terminal symbol
"ERR1" : Undefined control command	(CR) 0x0d
"ERR2" : Out of parameter range	
"ERR3" : Busy status or reception invalid period	
"ERR4" : Timeout or reception invalid period	
"ERR5" : Wrong data length	
"PDPCONTROL ERRA" : Mismatching of password	
4 bytes or 15 bytes	1 byte

### 2. When [LAN control protocol] is set to [Protocol 2].

Communicates with the same protocol as that of a Panasonic projector

#### Connection method

1 Obtain the display's IP address and the port number (Default is 1024), and request connection to the display.

The IP address and the port number can be obtained from the following menus.

- IP address:  
[Setup] → [Network settings] → [LAN setup] or [Network status]
- Port number:  
[Setup] → [Network settings] → [LAN setup]
- For more detail of the settings, see page 76.

2 The display responds.

Response data

Data part	Space	Mode	Space	Random number part	Last terminal symbol
[NTCONTROL] (ASCII character string)	[ ] 0x20	[1] 0x31	[ ] 0x20	[zzzzzzz] (ASCII code hex number)	(CR) 0x0d
9 bytes	1 byte	1 byte	1 byte	8 bytes	1 byte

Mode: 1 = Protect mode

3 Hash the following data with the MD5 algorithm, and generate a 32-byte hash value.

[xxxxxx:yyyyy:zzzzzzz]

xxxxxx :

User name set for [Administrator account settings]

yyyyy :

Password set for the above [Administrator account settings]

zzzzzzz :

8-byte random number obtained in step 2

Command transmission method

Transmit in the following command format

Transmitted data

Header			Data part	Last terminal symbol
Hash value (see "Connection method")	'0' 0x30	'0' 0x30	Control command (ASCII character string)	(CR) 0x0d
32 bytes	1 byte	1 byte	Undefined	1 byte

Received data

Header		Data part	Last terminal symbol
'0' 0x30	'0' 0x30	Control command (ASCII character string)	(CR) 0x0d
1 byte	1 byte	Undefined	1 byte

Error response

Error message	Last terminal symbol
"ERR1" : Undefined control command	(CR) 0x0d
"ERR2" : Out of parameter range	
"ERR3" : Busy status or reception invalid period	
"ERR4" : Timeout or reception invalid period	
"ERR5" : Wrong data length	
"ERRA" : Mismatching of password	
4 bytes	1 byte

Note

- With some of the commands, a part of character string of the transmitted data may not be included in the received data.
- Consult your local Panasonic dealer for detail instructions on command usage.

For more details, visit the following web site.

<https://panasonic.net/cns/prodisplays/>

## PJLink protocol

The unit's Network function is compatible with PJLink Class 1 and Class 2. The following operations can be performed from a computer when PJLink protocol is used.

- Setting the Display
- Querying the Display status

### Supported commands

The commands to control the unit with PJLink protocol are as follows.

Class	Command	Control
1	POWR	Power control 0: Standby 1: Power On
1	POWR?	Power status query 0: Standby 1: Power On
1,2	INPT	Input switch * Refer to INST? parameters.
1,2	INPT?	Input switch query * Refer to INST? parameters.
1	AVMT	Shutter control 10: Picture On (picture mute deactivated) 11: Picture Off (picture on mute) 20: Audio On (audio mute deactivated) 21: Audio Off (audio on mute) 30: Shutter mode Off (picture and audio mute deactivated) 31: Shutter mode On (picture and audio on mute)
1	AVMT?	Shutter control query 11: Picture Off (picture on mute) 21: Audio Off (audio on mute) 30: Shutter mode Off (picture and audio mute deactivated) 31: Shutter mode On (picture and audio on mute)

Class	Command	Control
1	ERST?	Error status query First byte: 0 Second byte: 0 Third byte: 0 Fourth byte: 0 Fifth byte: 0 Sixth byte: Other error. 0 or 2. • Meaning of 0, 2. 0: Error is not detected, 2: Error
1,2	INST?	Input switch list query 11: PC IN input (PC / PC [YPbPr]) 31: HDMI IN 1 input (HDMI1) 32: HDMI IN 2 input (HDMI2) 33: HDMI IN 3 input (HDMI3) 34: USB-C HOST input (USB-C) 35: SLOT input (SLOT) 36: WHITEBOARD input (WHITEBOARD) 41: USB / Internal Memory input (USB / Internal memory) 42: MEMORY VIEWER input (MEMORY VIEWER) 51: Screen Transfer input (Screen Transfer)
1	NAME?	Display name query The name selected in [Display name] is returned.
1	INF1?	Manufacturer name query Returns "Panasonic".
1	INF2?	Model name query Returns "55EQ2W". (Example: 55-inch EQ2W model)
1	INFO?	Other information query Returns version number.
1	CLSS?	Class information query Returns "2".
2	SNUM?	Serial number query Returns the serial number.
2	SVER?	Software version query Returns the version number.

Class	Command	Control
2	INNМ?	Input terminal name query Returns the input terminal name. 11: PC 31: HDMI1 32: HDMI2 33: HDMI3 34: USB-C 35: SLOT 36: WHITEBOARD 41: USB / Internal Memory 42: MEMORY VIEWER 51: Screen Transfer
2	IREС ?	Input signal resolution query Returns the input signal resolution.
2	RRES ?	Recommended resolution query Returns "3840x2160".
2	SVOL	Speaker volume 0: Turns down the volume. 1: Turns up the volume.
2	LKUP	Linkup notification Notifies the MAC address when PJLink communication is available.
2	SRCH	Display search A device that is connected on the same network and can perform PJLink class 2 communication returns the MAC address.

### PJLink security authentication

Set the password used for PJLink in [PJLink settings] - [Password]. (see page 75)

When using PJLink without security authorization, set use without the password (field blank).

- Concerning the specification of PJLink, see the web site of Japan Business Machine and Information System Industries Association (JBMIА) below:  
<http://pjlink.jbmia.or.jp/english/index.html>

## Multi Monitoring & Control Software

This unit supports the early warning software "Multi Monitoring & Control Software" which monitors and controls devices (projectors or displays) connected to an intranet, and detects signs of abnormality of such devices that may arise in future.

As for the early warning function, the maximum number of devices that can be registered to monitor differs according to the type of license.

Up to 2 048 devices can be registered for free for a maximum of 90 days after the installation to the computer has completed.

- For more details, visit the following web site.  
<https://panasonic.net/cns/prodisplays/>
- About early warning function, visit the following web site.  
<https://panasonic.net/cns/prodisplays/pass/>

## Video Wall Manager

This unit supports the "Video Wall Manager" software which adjusts multiple displays simultaneously or separately on one computer without rearranging cables.

- For more details, visit the following web site.  
<https://panasonic.net/cns/prodisplays/>

### Note

- This unit does not support the Auto Display Adjustment Upgrade Kit (TY-VUK10).

## Content Management Software

This unit supports "Content Management Software" to create schedule data on a PC required to play back still pictures and motion pictures. (Supports Ver.3.0 or later.)

- For more details, visit the following web site.  
<https://panasonic.net/cns/prodisplays/>

## Screen Transfer

This unit supports the software [Screen Transfer] that sends the PC screen to the display via wired LAN.

[Screen Transfer] can be downloaded from [Download] for the Web browser control. (see page 118)

- For more details, visit the following web site.  
<https://panasonic.net/cns/prodisplays/>

# Connecting with LAN

## Note

- To use the network function, set each item in [Network settings] and be sure to set [Network control] to [On]. (see page 74)

## Computer operation

- 1 Turn on the computer.
- 2 Make the network setting according to your system administrator.

When the Display settings are the default settings (see page 77), the computer can be used with the following network settings.

IP address	192.168.0.9
Subnet mask	255.255.255.0
Gateway	192.168.0.1

# Using Web Browser Control

You can use a Web browser to control the unit and set up a network and password.

## Before Using Web Browser Control

To use the Web browser control, the unit and computer set ups are required.

### ■ About Web Browser

Set each item in [Network settings] and be sure to set [Network control] to [On]. (see page 74)

## Note

- Even if the setting is set to [Off], the Web browser control screens that do not control this unit (display information [Status], detailed settings [Detailed set up] and password change [Change password]) operate.

### ■ Computer Setup

Disable the proxy server settings and enable JavaScript.

- The setting procedure differs depending on the software version.

Please refer to description in HELP, etc. of the software.

### (Windows)

Windows 10 is used as an example.

#### Disable proxy server settings

- 1 Display [Internet Properties] window.  
Click [Start] → [Settings] → [Network & Internet] → [Ethernet] → [Network and Sharing Center] → [Internet Options].
- 2 Click the [Connections] tab and then [LAN Settings].
- 3 Deselect the [Use automatic configuration script] and [Use a proxy server for your LAN] boxes.
- 4 Click [OK].

#### Enable JavaScript

- 1 Display [Internet Properties] window.  
Click [Start] → [Settings] → [Network & Internet] → [Ethernet] → [Network and Sharing Center] → [Internet Options].
- 2 Set the security level on the [Security] tab to [Default Level]. Alternatively enable [Active scripting] from the [Custom Level] button.

### (Mac)

Disable proxy server settings

- 1 From the [Safari] menu, click [Preferences].  
General screen is displayed.
- 2 From the [Advanced] tab, click the [Change Settings...] button next to [Proxies].  
Click [Proxies] and set up a proxy server.

- 3 Deselect the [Web Proxy] and [Automatic Proxy Configuration] boxes.
- 4 Click [Apply Now].

### Enable JavaScript

- 1 Display [Security] of Safari.
- 2 Select [Enable JavaScript] under [Web content].

## Access from Web Browser

Access to the TOP screen of the Web browser control using a Web browser.

- 1 Start your Web browser.
- 2 Enter the IP address set with the [LAN setup] of the unit.

(see page 76)



When the user name and password have been set in [Administrator account settings] (see pages 34 and 75) or with the WEB control function, proceed to step 3.

When they have not been set and the WEB control function is used for the first time, proceed to step 4.

Do the same in the case of user privileges.

- 3 Enter the user name and password when the Authentication screen is displayed.

Proceed to step 7.

When the password has not been set with the user privileges, click [OK] and proceed to step 4.

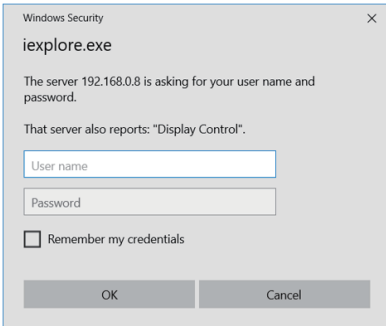

- 4 Set user name and password.

Change User name / Password page is displayed.

### For [Administrator]

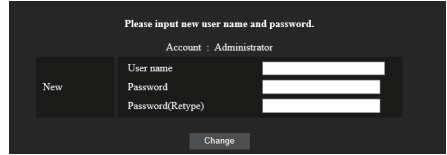

### For [User]

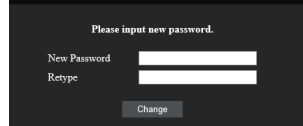

- 5 Enter the new user name and password, and then click [Change].

The screen of step 3 is displayed again.

- 6 Enter the new user name and password.

Enter the new user name and password set in step 5.

- 7 Click [OK].

### Note

- The password used here is common to the password specified in [Network settings] - [Administrator account settings]. (see page 75)
- The default settings are as described below:
  - Administrator privilege  
Specify the user name and password you set for [Administrator account settings]. (see page 34)
  - User permission  
User name: dispuser  
Password: None  
Change password first.
- When [Reset] for [Network settings] of this unit is executed, the password change is also required after log-in. (see page 81)
- The password can be changed on the Password Setup screen after logging in (see page 105). The user name can be changed when connecting by logging in with administrator privileges.
- If a wrong user name/password is entered 3 times when you log in, the field will be locked for several minutes.
- When using [Detailed set up] (see page 101), log in with the administrator rights.
- Depending on the browser, displayed operations may change.
- Under no circumstances, Panasonic Connect Co., Ltd. or its associated companies will ask customers their password directly.

Even if you are asked directly, please do not reveal your password.

# Operating with Web Browser

## ■ Description of each section



### ① Page tab

Click these to switch pages.

### ② [Status]

Click this item, and the status of the Display is displayed.

### ③ [Display control]

Click this item to display the Display control page.

### ④ [Detailed set up]

Click this item to display the advanced settings page.

### ⑤ [Change password]

### ⑥ [Download]

Click this item to display the page to download the dedicated application, [Screen Transfer].

### ⑦ [Browser Remote Control]

Click this item to display the Browser Remote Control on the WEB browser, which is the same as the supplied remote control.

## ■ Display status page

Displays the display status.

Click [Status] → [Display status].

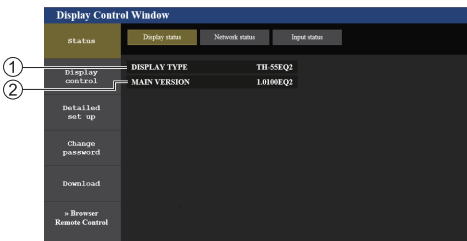

① Displays the type of Display.

② Displays the firmware version of the display.

## ■ Network status page

Displays the current configuration information of the network.

Click [Status] → [Network Status].

### Lower than Version 1.5000 (before IPv6 compatible)

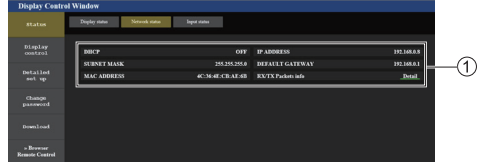

① Displays the configuration details of wired LAN.

### Version 1.5000 and later (after IPv6 compatible)

#### (1) For IPv4 setting

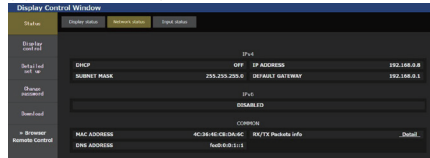

#### (2) For IPv6 setting

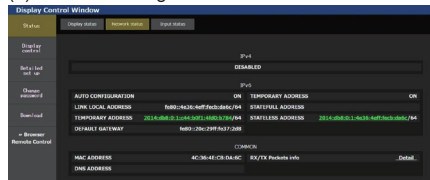

#### (3) For IPv4 & IPv6 setting

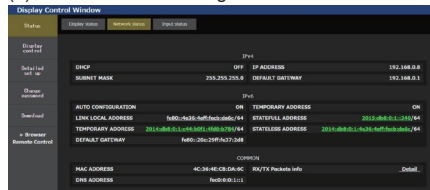



## ■ Input information page

Displays the input information of this unit.

Click [Status] → [Input status].

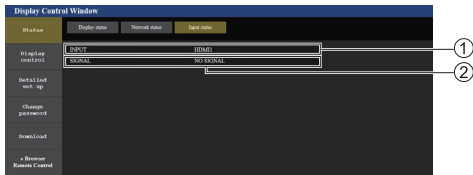

- ① Displays the information of the input terminal.
- ② Displays the information of the input signal.

### Note

- If an input is other than USB/Internal Memory input or MEMORY VIEWER input, the name of the input signal is displayed.
- In the case of USB/Internal Memory input and MEMORY VIEWER input, the name of the file being played is displayed.
- [---] is displayed in standby mode.

## ■ Basic control page

The basic operations of the unit can be performed.

Click [Display control] → [Basic control].



- ① Power On/Off control
- ② Use these to select the input signals
- ③ AUDIO mute
- ④ Switches aspect mode

## ■ Detail control page

The detailed functions of the unit can be performed.

Click [Display control] → [Advanced control].

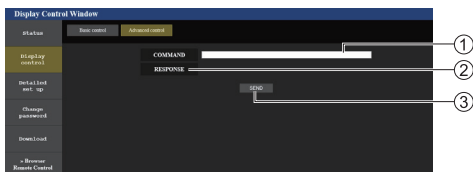

- ① Enter a command. Use the same command used for the serial control.
- ② Response from the unit is displayed.
- ③ Command is sent and run.

### Note

- After the settings are changed, it may take a while till the display status is displayed.

## ■ Detailed set up

When connecting by logging in with administrator privileges, you can make detailed settings for network related to display.

## ■ LAN settings page

### 1 Click [Detailed set up] in the menu.

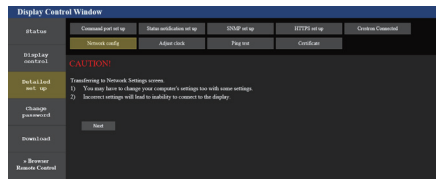

### 2 Click [Next].

The settings window appears, showing the current settings.

- To change the LAN settings, click [Change].
- To return to the previous window, click [Back].

### Lower than Version 1.5000 (before IPv6 compatible)

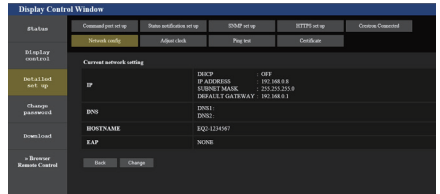

### Version 1.5000 and later (after IPv6 compatible)

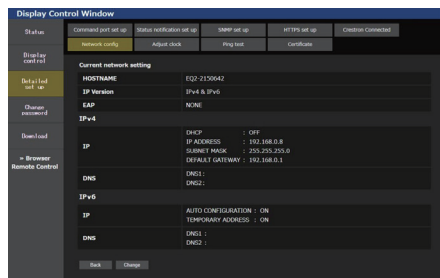

### 3 Complete the detailed settings and click [Next].

In this window, DNS server and HOSTNAME (up to 20 characters) settings can be made as well as address information set on the [LAN setup] menu of the display.

After all required items have been entered, click [Next]. Then, a confirmation window appears when [EAP] is set to [NONE].

When [EAP] is set to items other than [NONE], the next page appears.

## Lower than Version 1.5000 (before IPv6 compatible)

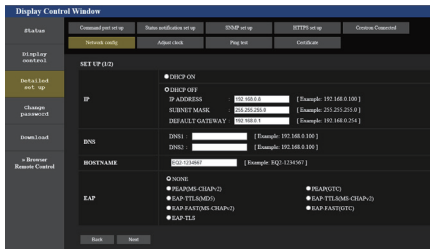

## Version 1.5000 and later (after IPv6 compatible)

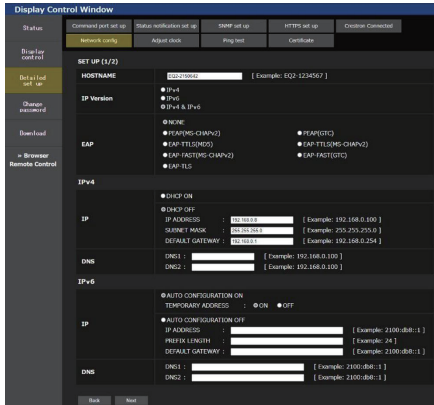

### Note

- When [DHCP ON] is set, if the DNS server address is acquired from the DHCP server, the acquired address is valid.

When [EAP] is set to items other than [NONE] or [EAP-TLS]



When [EAP] is set to [EAP-TLS]

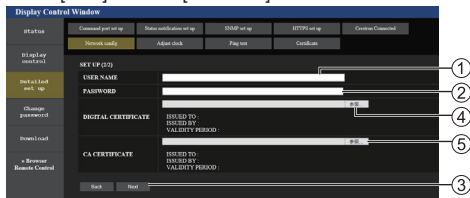

### ① [USER NAME]

Enter the user name for authentication with one-byte alphanumeric characters (excluding space). (Up to 64 characters)

### ② [PASSWORD]

Enter the password for authentication with one-byte alphanumeric characters. (Up to 64 characters)

### ③ [Back], [Next]

Click [Back] to return to the previous screen.

Click [Next] to display the screen to confirm the setting contents.

### ④ [DIGITAL CERTIFICATE]

Register the electronic certificate (extension: PFX) for authentication.

### ⑤ [CA CERTIFICATE]

Register the CA certificate (extension: CER) for authentication.

### Note

- When [EAP] is [EAP-TLS], date and time need to be set on the adjust clock page (see page 103).

## 4 Click [Submit].

The settings will be registered.

## Lower than Version 1.5000 (before IPv6 compatible)

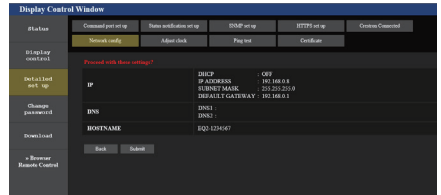

## Version 1.5000 and later (after IPv6 compatible)

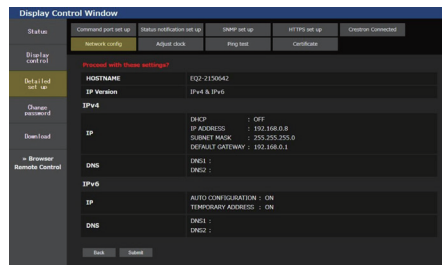

### Note

- Changing the setting of LAN while connected with LAN might disconnect the connection.
- Depending on the settings for [LAN setup] and [Auto setting], contents displayed on the screen change.

## ■ Adjust clock page

Sets the clock-related items of this unit.

Click [Detailed set up] → [Adjust clock].

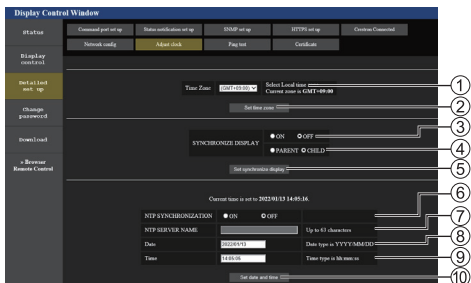

- ① Time zone selection field
- ② Time zone setting refresh button
- ③ Display synchronization selection field
- ④ Parent/Child selection field for display synchronization
- ⑤ Display synchronization setting refresh button
- ⑥ NTP synchronization selection field
- ⑦ NTP server input field  
(When setting date and time with NTP synchronization, enter the IP address or server name. To enter the server name, setting the DNS server is required.)
- ⑧ Date entry field
- ⑨ Time entry field
- ⑩ NTP synchronization setting and date setting refresh button

### Note

- Date and time is displayed as [- -] when they are not set.
- When [Network control] is set to [On] and it is in standby mode, date and time display will be blank and they cannot be set. [Time zone], [Synchronize display] and [NTP synchronization] cannot be set as well.
- When [SYNCHRONIZE DISPLAY] is set to [ON] / [CHILD], it is not possible to set [NTP SYNCHRONIZATION], [Date] or [Time].
- When [NTP SYNCHRONIZATION] is set to [ON], it is not possible to set [Date] or [Time].
- If the time becomes incorrect immediately after setting the correct time, contact the dealer where you bought the Display.
- [NTP synchronization] operates only in power-on state or in schedule standby state.

## ■ Ping test page

This page makes it possible to check whether the network is connected to the DNS server, etc.

Click [Detailed set up] → [Ping test].



- ① Enter the IP address of the server to be tested.
- ② Button for conducting the test

Display which appears when the connection was successful.

```
PING 192.168.0.60 (192.168.0.60): 56 data bytes
64 bytes from 192.168.0.60: seq=0 ttl=128 time=1.474 ms
64 bytes from 192.168.0.60: seq=1 ttl=128 time=1.255 ms
64 bytes from 192.168.0.60: seq=2 ttl=128 time=1.146 ms
64 bytes from 192.168.0.60: seq=3 ttl=128 time=1.052 ms

--- 192.168.0.60 ping statistics ---
4 packets transmitted, 4 packets received, 0% packet loss
round-trip min/avg/max = 1.052/1.231/1.474 ms
```

Display which appears when the connection failed.

```
PING 192.168.0.100 (192.168.0.100): 56 data bytes

--- 192.168.0.100 ping statistics ---
4 packets transmitted, 0 packets received, 100% packet loss
```

## ■ Command port set up page

Set the port number to be used with command control.

Click [Detailed set up] → [Command port set up].

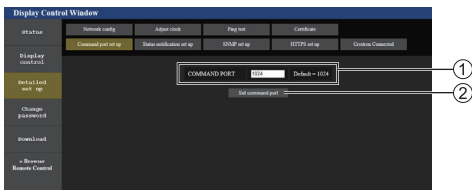

- ① Input the port number to be used with command control.
- ② Setting update button.

## ■ Status notification set up page

Sets the IP address and port number of the PC where "Multi Monitoring & Control Software (see page 97)" is operating when informing the PC of the status of this unit.

Click [Detailed set up] → [Status notification set up].

When the status notification is set, if the unit is malfunctioning and its power indicator is blinking orange, the trouble content can be recognized even at a remote location where the power indicator cannot be directly checked.

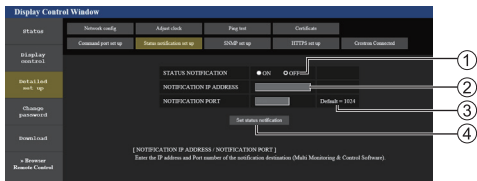

- ① Selection field of status notification
- ② IP address input field for notification destination PC
- ③ Port number input field for notification destination PC
- ④ Update button for the settings

## ■ SNMP set up page

Sets the various items for SNMP.

SNMP (Simple Network Management Protocol) is a protocol to manage devices connected to the network.

If the SNMP manager is used for connection, the information of the target device can be obtained, and its settings can be changed.

Click [Detailed set up] → [SNMP set up].

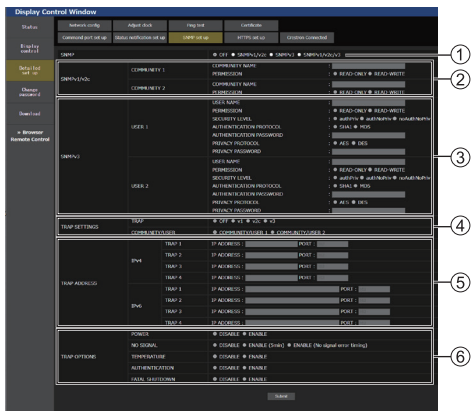

- ① [SNMP]:  
Select the SNMP version to use.

## ② [SNMP v1/v2c] [COMMUNITY]

**[COMMUNITY NAME]:**

Enter the community name of SNMP v1/v2c.

**[PERMISSION]:**

Select whether to obtain only information via SNMP v1/v2c or to both obtain information and make the setting.

## ③ [SNMP v3] [USER]

**[USER NAME]:**

Enter the user name of SNMP v3.

**[PERMISSION]:**

Select whether to obtain only information via SNMP v3 or to both obtain information and make the setting.

**[SECURITY LEVEL]:**

Select the security level for SNMP v3.

**[AUTHENTICATION PROTOCOL]:**

Select the authentication method for SNMP v3 from SHA1 and MD5.

**[AUTHENTICATION PASSWORD]:**

Set the authentication password of SNMP v3.

**[PRIVACY PROTOCOL]:**

Select the encryption method for SNMP v3 from AES and DES.

**[PRIVACY PASSWORD]:**

Set the encryption password of SNMP v3.

## ④ [TRAP SETTINGS]

**[TRAP]:**

Select the SNMP version to use when sending TRAP.

**[COMMUNITY/USER]:**

Select COMMUNITY/USER to use when sending TRAP.

When SNMP v1/v2c is selected as a SNMP version of TRAP, the COMMUNITY 1/2 setting is used. When SNMP v3 is selected, the USER 1/2 setting is used.

## ⑤ [TRAP ADDRESS] Lower than Version 1.5000 (before IPv6 compatible)

**[ADDRESS]:**

Set the IP address of the SNMP manager that gives notice of TRAP.

**[PORT]:**

Set the TRAP reception port number of the SNMP manager that gives notice of TRAP.

⑤ [TRAP ADDRESS] Version 1.5000 and later (after IPv6 compatible)



**[IPv4-ADDRESS]** Set the IPv4 address of the SNMP manager that gives notice of TRAP.

**[IPv4-PORT]** Set the TRAP IPv4 reception port number of the SNMP manager that gives notice of TRAP.

**[IPv6-ADDRESS]** Set the IPv6 address of the SNMP manager that gives notice of TRAP.

**[IPv6-PORT]** Set the TRAP IPv6 reception port number of the SNMP manager that gives notice of TRAP.

⑥ [TRAP OPTIONS]

**[POWER]:**

TRAP is sent if the unit enters the standby mode by "Power management", [No signal power off] or [No activity power off].

**[NO SIGNAL]:**

TRAP is sent if no-signal continues in the following conditions.

**When set to [ENABLE(5min)]:**

TRAP is sent if no-signal continues for 5 minutes.

**When set to [ENABLE(No signal error timing)]:**

TRAP is sent if no-signal error set with [Setup] – [Information timing] occurs. (see page 89)

**[TEMPERATURE]:**

TRAP is sent if the temperature error occurs.

**[AUTHENTICATION]:**

TRAP is sent if the SNMP authentication fails.

**[FATAL SHUTDOWN]:**

TRAP is sent if a fatal error that requires the power to be forcibly turned off occurs. However, all the fatal errors do not necessarily support TRAP.

**Note**

- The maximum number of characters that can be used for a community name is 32 with one-byte alphanumeric characters.
  - The maximum number of characters that can be used for a user name and password is 32 with one-byte alphanumeric characters.
- Note that the password must be set with 8 characters or more.
- Change the password periodically, and set one which is difficult to guess.
  - The SNMP manager must be operating in the system configuration used.
  - For MIB (Management Information Base) of this unit, see the web site below.  
<https://panasonic.net/cns/prodisplays>
  - For the settings of the SNMP manager, consult with the network administrator.

■ Change User name / Password page

Sets the password.

Click [Change password].

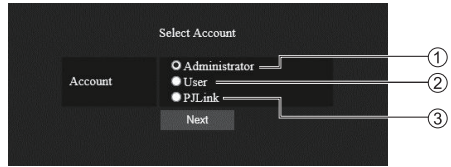

- ① Select [Administrator].
- ② Select [User].
- ③ Select [PjLink].

About [Administrator]

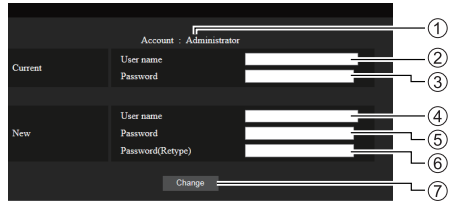

- ① Account
- ② Current user name input field
- ③ Current password input field
- ④ New user name input field
- ⑤ New password input field
- ⑥ New password input field (re-enter for confirmation)
- ⑦ Button for executing password change

**Note**

- If this unit has already been registered to application software such as "Multi Monitoring & Control Software" that uses communication control via LAN, changing an "Administrator" user name or password will disable the communication with this unit. If the "Administrator" user name or password is changed, update the registration information of applicable application software.

About [User]

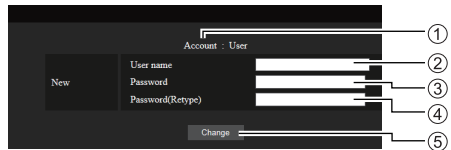

- ① Account
- ② New user name input field
- ③ New password input field
- ④ New password input field (re-enter for confirmation)
- ⑤ Button for executing password change

## Password change (user rights)

A user can change password only.



- ① Current password input field
- ② New password input field
- ③ New password input field (re-enter for confirmation)
- ④ Button for executing password change

### Note

- Alphanumeric characters can be used for a user name.
- Up to 16 characters can be used for a user name and a password.
- When changing the administrator account, both “current user name” and “current password” are required.
- See below when you log in with administrator privileges and change the account.
  - It is recommended not to use the current user name/password or default values for a new user name/password.
- See below when you log in with user privileges and change the password.
  - It is recommended not to use the current password or default value for a new password.
- It is recommended to use a password different from passwords of PC and other devices.
- The following are recommendations in complexity when changing passwords. (For both administrator privileges and user privileges)

Include at least 3 kinds of characters from the following 4, and the number of characters should be 8 or more.

- Alphabet upper case character (A to Z)
- Alphabet lower case character (a to z)
- Number (0 to 9)
- Special character  
(~ ! @ # \$ % ^ & \* ( ) \_ + | } { [ ] < > . , / ? ' , etc.)

It is recommended to set the password using the above types of characters without leaving the password field blank.

## About [PJLink]



- ① Password input field

### Note

- You have to set only the password for PJLink.
- Up to 16 characters can be used for a password.
- See below when you log in with user privileges and change the password.
  - It is recommended not to use the current password or default value for a new password.
- It is recommended to use a password different from passwords of PC and other devices.
- The following are recommendations in complexity when changing passwords. (For both administrator privileges and user privileges)  
Include at least 3 kinds of characters from the following 4, and the number of characters should be 8 or more.
  - Alphabet upper case character (A to Z)
  - Alphabet lower case character (a to z)
  - Number (0 to 9)
  - Special character  
(~ ! @ # \$ % ^ & \* ( ) \_ + | } { [ ] < > . , / ? ' , etc.)

## ■ [Certificate] page

To perform the HTTPS communication or use the control system or application software of Crestron Electronics, Inc., it is necessary to install the certificate for authentication into the Display.

Click [Detailed set up] → [Certificate].

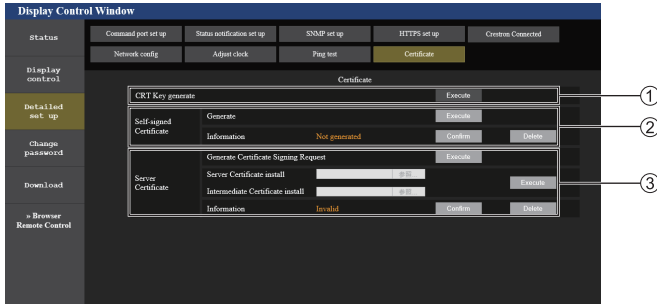

### ① [CRT Key generate]

Generates the CRT (Certificate) key.

The page to generate the CRT key is displayed by clicking [Execute].

For details, refer to “Generating the CRT key” (see page 109).

### ② [Self-signed Certificate]

#### [Generate]:

Generates the self-signed certificate by the Display. The page to generate the self-signed certificate is displayed by clicking [Execute].

For details, refer to “Generating the self-signed certificate” (see page 113).

#### [Information]:

Displays the status of the self-signed certificate.

- **[Not generated]:**

Self-signed certificate is not generated.

- **[(host name)]:**

Self-signed certificate is generated and valid.

The host name registered in the self-signed certificate is displayed.

- **[Invalid (Reason: Server Certificate installed)]:**

The server certificate is valid, so the generated self-signed certificate is invalid.

Information of the generated self-signed certificate is displayed by clicking [Confirm].

The generated self-signed certificate can be deleted by clicking [Delete].

For details, refer to “Confirming the information of the self-signed certificate” (see page 114)

### ③ [Server Certificate]

#### [Generate Certificate Signing Request]:

Generates signing request (Generate Certificate Signing Request).

The page to generate the signing request is displayed by clicking [Execute].

For details, refer to “Generating the signing request” (see page 111)

#### [Server Certificate install]/[Intermediate Certificate install]:

Installs the server certificate and the intermediate certificate.

The certificate is installed into the Display by specifying the certificate file and clicking [Execute].

For details, refer to “Installing the certificate” (see page 112).

#### [Information]:

Displays the status of the server certificate.

- **[Invalid]:** The server certificate is not installed. Or, the current CRT key is different from the CRT key used for requesting the installed server certificate.

- **[(host name)]:** The server certificate is installed and valid.

The host name registered in the server certificate is displayed.

- **[Expired]:** Valid period of the server certificate has expired.

The host name registered in the server certificate is displayed when the server certificate is installed and valid.

Information of the installed server certificate is displayed by clicking [Confirm].

The installed server certificate and the intermediate certificate can be deleted by clicking [Delete].

For details, refer to “Confirming the information of the server certificate” (see page 112)

#### Note

- Installation operation of the certificate may not be possible depending on the computer or web browser in use.

## Flow for setting

The flow for setting differs depending on which certificate is to be used as the security certificate, either the server certificate or the self-signed certificate.

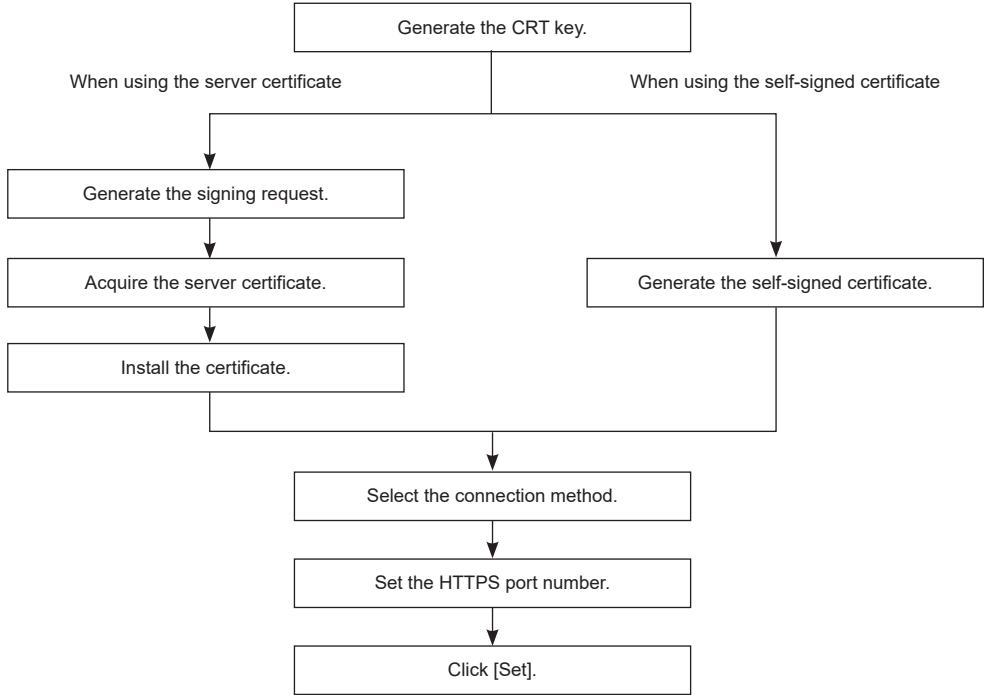

### Note

- When using the server certificate, the procedure from application to the certification organization to issuing of the server certificate is required to be performed between the customer and the certification organization. For the application method, etc., contact the certification organization.



## Generating the CRT key

Generate the CRT key used for encryption with the RSA (Rivest-Shamir-Adleman cryptosystem) public key encryption method. CRT key is a type of the private key.

### 1 Click [Certificate] → [CRT Key generate] → [Execute].

The page to generate the CRT key is displayed.

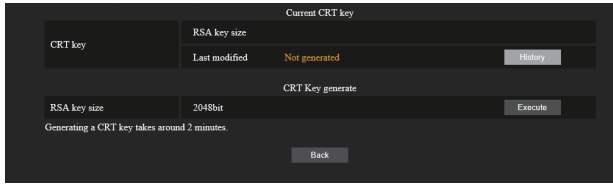

### 2 Click [Execute].

When generating the CRT key for the first time, the following message is displayed after the CRT is generated. Proceed to Step 4).

"CRT key - Generated"

When generating the CRT key for the second time or later, the following message is displayed.

"The CRT key will be generated. In updating the CRT key, the Server Certificate corresponds to the current CRT key will become unavailable. Continue?"

### 3 Click [OK].

CRT key will be generated and the following message will be displayed.

"CRT key - Generated"

### 4 Click [OK].

Clicking [Certificate] → [CRT Key generate] → [Execute] again can confirm the key length and generation date and time of the current CRT key with the [RSA key size] and [Last modified] of [Current CRT key] at the upper row of the CRT key generation page.

#### Note

- [Not generated] displayed in [Last modified] indicates that the CRT has not been generated.
- [RSA key size] is fixed to [2048bit]. The server certificate may not be issued depending on the certification organization to apply if the key length is 2048-bit.
- Generation of the CRT key may take up to approximately two minutes.
- When the CRT key is updated, apply for the server certificate or generate the self-signed certificate again using that CRT key. A certificate linked to the CRT key is required.
- Previously generated CRT key information is saved even if the CRT key is updated. To return to the previous CRT key, refer to "Cancelling the update of the CRT key" (see page 110).

## Canceling the update of the CRT key

It is possible to return to the previously generated CRT key only once even if the CRT key is updated.

### 1 Click [Certificate] → [CRT Key generate] → [Execute].

The page to generate the CRT key is displayed.

Current CRT key			
CRT key	RSA key size	2048bit	
	Last modified	2022/01/13 14:10:26	<a href="#">History</a>
CRT Key generate			
RSA key size	2048bit	<a href="#">Execute</a>	

Generating a CRT key takes around 2 minutes.

[Back](#)

### 2 Click [History].

Following contents are displayed.

Previous CRT Key		
History	RSA key size	2048bit
	Last modified	2022/01/13 14:09:50

[Back](#)

### 3 Confirm [RSA key size] and [Last modified] of the CRT key to restore.

### 4 Click [Apply].

Following confirmation message is displayed.

"The previous CRT key will be loaded. Please generate Self-signed Certificate or install the Server Certificate corresponds to the CRT key. Continue?"

### 5 Click [OK].

Previously generated CRT key is reflected as the current CRT key.

#### Note

- When returned to the previously generated CRT key, a certificate linked to that CRT key is required.

## Generating the signing request

When using the server certificate issued by the certification organization as a security certificate, generate a signing request necessary for application of issuing to the certification organization. Generate the signing request after generating the CRT key.

### 1 Click **[Certificate]** → **[Generate Certificate Signing Request]** → **[Execute]**.

The page to generate the signing request is displayed.



### 2 Enter the information required for application.

The details of each item are as follows. Enter the information following the requirement of the certification organization to apply.

Item	Details	Character length limit	
<b>[Common Name]</b>	Enter the Display name or the IP address set in the Display.	664 characters	
<b>[Country]</b>	Enter the country code defined in ISO 3166-1 alpha-2 (two upper case alphabets).	—	
<b>[State]</b>	Enter the State, etc.	128 characters	
<b>[Locality]</b>	Enter the locality.	128 characters	
<b>[Organization]</b>	Enter the organization name.	64 characters	
<b>[Organization Unit]</b>	Enter the organization unit name.	64 characters	
<b>[CRT key]</b>	<b>[RSA key size]</b>	The key length of the current CRT key is displayed.	—
	<b>[Last modified]</b>	The generation date and time of the current CRT key is displayed.	—

### 3 Click **[OK]**.

The signing request file is generated. Enter a file name and save the file in the desired folder.

### 4 Enter a file name and click **[Save]**.

The file for signing request is saved in the specified folder.

#### Note

- The characters that can be input are as follows.
  - Single-byte numbers: 0 to 9
  - Single-byte alphabets: A to Z, a to z
  - Single-byte symbols: - . \_ , + / ( )
- The signing request generated by the Display is PEM format (file extension: pem).
- Apply issuing of the server certificate to the certification organization using the saved signing request file (PEM format).

## Installing the certificate

Install the server certificate and the intermediate certificate issued by the certification organization into the Display.

### 1 Click **[Generate]** → **[Server Certificate install]** → **[Browse]**.

A dialog to select the file is displayed.

### 2 Select the server certificate file and click **[Open]**.

If the intermediate certificate is issued from the certification organization together with the server certificate, proceed to Step 3).

If only the server certificate is issued from the certification organization, proceed to Step 5).

### 3 Click **[Browse]** in **[Intermediate Certificate install]**.

A dialog to select the file is displayed.

### 4 Select the intermediate certificate file and click **[Open]**.

### 5 Click **[Execute]**.

The server certificate and the intermediate certificate are installed into the Display.

### 6 Click **[OK]**.

#### Note

- To confirm the information of the installed server certificate, refer to “Confirming the information of the server certificate” (see page 112).

## Confirming the information of the server certificate

Confirm the information of the server certificate installed in the Display.

### 1 Click **[Certificate]** → **[Server Certificate]** → **[Information]** → **[Confirm]**.

The information of the installed server certificate is displayed. The details of each item are as follows.

Item	Details
<b>[Common Name]</b>	The Display name or the IP address is displayed.
<b>[Country]</b>	The country code defined in ISO 3166-1 alpha-2 (two upper case alphabets) is displayed.
<b>[State]</b>	The State, etc. is displayed.
<b>[Locality]</b>	The locality is displayed.
<b>[Organization]</b>	The organization name is displayed.
<b>[Organization Unit]</b>	The organization unit name is not displayed. It is displayed as an asterisk.
<b>[Not Before]</b>	Displays the date and time that the self-signed certificate was issued.
<b>[Not After]</b>	Displays the date and time that the self-signed certificate will expire.
<b>[CRT key]</b>	<b>[RSA key size]</b> The key length of the CRT key is displayed.
	<b>[Last modified]</b> The generation date and time of the CRT key is displayed.

#### Note

- The installed server certificate and the intermediate certificate can be deleted by clicking **[Certificate]** → **[Server Certificate]** → **[Delete]**.

However, it cannot be deleted when **[HTTPS set up]** → **[Connection]** is set to **[HTTPS]**. Delete it after changing the setting to perform the HTTP communication.

To delete the server certificate within the valid period, confirm that the certificate file used for installing is available on hand. It will be necessary when installing the server certificate again.

## Generating the self-signed certificate

When the server certificate issued by the certification organization is not to be used as the security certificate, it is possible to use the self-signed certificate generated in the Display. Generate the self-signed certificate after generating the CRT key.

### 1 Click [Certificate] → [Self-signed Certificate] → [Generate] → [Execute].

The page to generate the self-signed certificate is displayed.

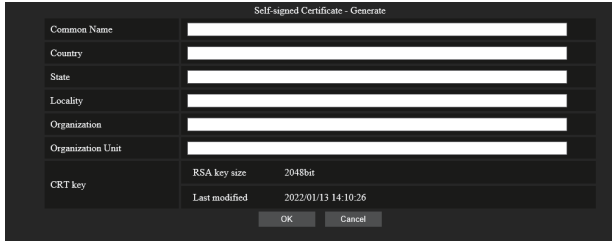

### 2 Enter the information required for generation.

The details of each item are as follows.

Item	Details	Character length limit	
[Common Name]	Enter the Display name or the IP address set in the Display.	64 characters	
[Country]	Enter the country code defined in ISO 3166-1 alpha-2 (two upper case alphabets).	—	
[State]	Enter the State, etc.	128 characters	
[Locality]	Enter the locality.	128 characters	
[Organization]	Enter the organization name.	64 characters	
[Organization Unit]	Enter the organization unit name.	64 characters	
[CRT key]	[RSA key size]	The key length of the current CRT key is displayed.	—
	[Last modified]	The generation date and time of the current CRT key is displayed.	—

### 3 Click [OK].

Self-signed certificate is generated.

#### Note

- The characters that can be input are as follows.
  - Single-byte numbers: 0 to 9
  - Single-byte alphabets: A to Z, a to z
  - Single-byte symbols: - . \_ , + / ( )

## Confirming the information of the self-signed certificate

Confirm the information of the self-signed certificate generated by the Display.

### 1 Click [Certificate] → [Self-signed Certificate] → [Information] → [Confirm].

The information of the generated self-signed certificate is displayed. The details of each item are as follows.

Item	Details	
[Common Name]	The Display name or the IP address is displayed.	
[Country]	The country code defined in ISO 3166-1 alpha-2 (two upper case alphabets) is displayed.	
[State]	The State, etc. is displayed.	
[Locality]	The locality is displayed.	
[Organization]	The organization name is displayed.	
[Organization Unit]	The organization unit name is displayed.	
[Not Before]	Displays the date and time that the self-signed certificate was issued.	
[Not After]	Displays the date and time that the self-signed certificate will expire (local time corresponding to 23:59, December 31, 2035 in Greenwich Mean Time).	
[CRT key]	[RSA key size]	The key length of the CRT key is displayed.
	[Last modified]	The generation date and time of the CRT key is displayed.

#### Note

- The generated self-signed certificate can be deleted by clicking [Certificate] → [Self-signed Certificate] → [Delete]. However, it cannot be deleted when [HTTPS set up] → [Connection] is set to [HTTPS]. Delete it after changing the setting to perform the HTTP communication.

## ■ [HTTPS set up] page

Set this page when HTTPS (Hypertext Transfer Protocol Secure) communication encrypted with the SSL/TLS protocol is to be performed between the computer and the Display while the web control function is used.

Click [Detailed set up] → [HTTPS set up].

To perform the HTTPS communication, it is necessary to install the certificate for authentication into the Display in advance. For details of installing the certificate, refer to "[Certificate] page" (see page 107).

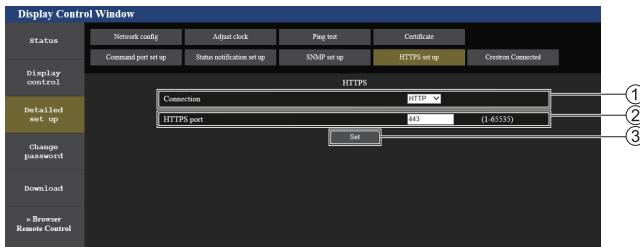

#### ① [Connection]

Sets the connection method to the Display.

**[HTTP]:** Uses the HTTP communication. (Factory default setting)

**[HTTPS]:** Uses the HTTPS communication.

#### ② [HTTPS port]

Sets the port number to be used with the HTTPS communication.

Allowed port number: 1 to 65535

Factory default setting: 443

#### ③ [Set]

Enables the setting.

#### Note

- When the [Connection] setting is changed from [HTTPS] to [HTTP], the screen may not be displayed when the operation or update of the web control screen is performed. In such case, delete the cache of the web browser.

## ■ [Crestron Connected] page

Set the information required for connecting the control system of Crestron Electronics, Inc. to the Display, and the information to monitor/control the Display using the control system of Crestron Electronics, Inc.

Click [Detailed set up] → [Crestron Connected].

The screenshot shows the 'Display Control Window' interface. At the top, there are several status tabs: 'Network config', 'Adjust clock', 'Page test', 'Certificate', 'Command port set up', 'Status notification set up', 'SNMP set up', 'RTSP set up', and 'Crestron Connected' (which is highlighted). Below these tabs, there is a sidebar with options like 'Detailed set up', 'Change password', 'Download', and 'Remote Control'. The main area is titled 'Control System' and contains a form with the following fields:

- Use TLS:  Disable,  Enable
- IP Address / Hostname:
- IP ID:  (Default = 3)
- Room ID:  (Up to 32 characters)
- Non Secure Port:  (Default = 41794)
- Secure Port:  (Default = 41796)
- Authentication:  Disable,  Enable
- User Name:  (Up to 20 characters)
- Password:  (Up to 20 characters)

At the bottom of the form is a 'Submit' button. Below the form, there are additional options for 'Server' and 'Use TLS'.

## [Control System]

Configure the setting for the control system required to connect to the Display as a client.

This is a close-up of the 'Control System' configuration form. It features the following fields and callouts:

- 1: Use TLS (radio buttons for Disable and Enable)
- 2: IP Address / Hostname (text input)
- 3: IP ID (text input with value 3, Default = 3)
- 4: Room ID (text input, Up to 32 characters)
- 5: Non Secure Port (text input with value 41794, Default = 41794)
- 6: Secure Port (text input, Default = 41796)
- 7: Authentication (radio buttons for Disable and Enable)
- 8: User Name (text input, Up to 20 characters)
- 9: Password (text input, Up to 20 characters)
- 10: Submit button

### ① [Use TLS]

Sets the secure communication.

#### [Disable]:

Performs the unsecured communication.

#### [Enable]:

Performs the secure communication using TLS (Transport Layer Security).

### ② [IP Address / Hostname]

Enter the IP address or the host name of the connection destination.

### ③ [IP ID]

Sets the IP ID used to determine the Display on the network. (A number up to four digits)

Default value: 3

### ④ [Room ID]

Sets the Room ID used to determine the Display on the network. (Up to 32 half-width characters)

### ⑤ [Non Secure Port]

Sets the port number to be used with the unsecured communication.

Default value: 41794

### ⑥ [Secure Port]

Sets the port number to be used with the secure communication.

Default value: 41796

### ⑦ [Authentication]

Select the authentication with the connection destination used with the secure communication.

#### [Disable]:

Does not perform the connection authentication.

#### [Enable]:

Performs the connection authentication.

### ⑧ [User Name]

Enter the user name used for the connection authentication. (Up to 20 half-width characters)

### ⑨ [Password]

Enter the password used for the connection authentication. (Up to 20 half-width characters)

### ⑩ [Submit]

Updates the [Control System] setting.

## Note

- When [Use TLS] is set to [Disable], [Authentication] is fixed to [Disable], and [Secure Port] cannot be set.

## [Server]

Configure the setting required to access the Display assigned to a server using the control system.

The screenshot shows a 'Server' configuration page with the following settings:

Setting	Value	Default
1 Use TLS	<input type="radio"/> Disable <input checked="" type="radio"/> Enable	
2 IP ID	5	
3 Non Secure Port	41794	Default = 41794
4 Secure Port		Default = 41796
5 Authentication	<input type="radio"/> Disable <input checked="" type="radio"/> Enable	
6 User Name		Up to 20 characters
7 Password		Up to 20 characters
8 Crestron Fusion in the Cloud (FITC)	<input type="radio"/> Disable <input checked="" type="radio"/> Enable	
9 FITC URL		

10 [Submit]

### ① [Use TLS]

Sets the secure communication.

**[Disable]:**

Performs the unsecured communication.

**[Enable]:**

Performs the secure communication using TLS (Transport Layer Security).

### ② [IP ID]

Sets the IP ID used to determine the Display on the network. (A number up to four digits)

### ③ [Non Secure Port]

Sets the port number to be used with the unsecured communication.

Default value: 41794

### ④ [Secure Port]

Sets the port number to be used with the secure communication.

Default value: 41796

### ⑤ [Authentication]

Select the authentication with the connection destination used with the secure communication.

**[Disable]:**

Does not perform the connection authentication.

**[Enable]:**

Performs the connection authentication.

### Note

- [Use TLS] will be fixed to [Disable] if neither the server certificate nor the self-signed certificate is installed.
- When [Use TLS] is set to [Disable], [Authentication] is fixed to [Disable], and [Secure Port] cannot be set.
- When [Crestron Fusion in the Cloud (FITC)] is set to [Disable], [FITC URL] cannot be entered.

### ⑥ [User Name]

Enter the user name used for the connection authentication. (Up to 20 half-width characters)

### ⑦ [Password]

Enter the password used for the connection authentication. (Up to 20 half-width characters)

### ⑧ [Crestron Fusion in the Cloud (FITC)]

Sets whether to use the Fusion server in the Cloud.

**[Disable]:**

Does not use the Fusion server in the Cloud.

**[Enable]:**

Uses the Fusion server in the Cloud.

### ⑨ [FITC URL]

Enter the URL of the Fusion server in the Cloud.

### ⑩ [Submit]

Updates the [Server] setting.



## [Auto Discovery]

Set the standby process against the search protocol of the control system and the application software.



The screenshot shows a dark-themed control panel for 'Auto Discovery'. At the top, the text 'Auto Discovery' is centered. Below it, there are two radio button options: 'Disable' (which is currently unselected) and 'Enable' (which is selected, indicated by a filled circle). To the left of these options, the text 'Auto Discovery' is also present. Below the radio buttons is a 'Submit' button. A circled '1' is positioned at the top right of the panel, with a line pointing to the 'Auto Discovery' text on the left. A circled '2' is positioned at the bottom right of the panel, with a line pointing to the 'Submit' button.

### ① [Auto Discovery]

#### [Disable]:

Disables the standby process.

#### [Enable]:

Enables the standby process and enables the automatic detection of the Display.

### ② [Submit]

Update the [Auto Discovery] setting.

## ■ [Download]

“Screen Transfer” software that sends a screen of PC to the display via wired LAN can be downloaded.

Click [Download].

The download screen appears.

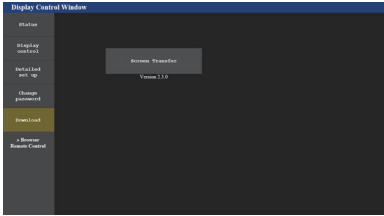

Click [Screen Transfer] to download the installer “setup.msi”.

After “Screen Transfer” is installed, the screen of PC can be sent to this unit via wired LAN.

- For more details, visit the following web site.

<https://panasonic.net/cns/prodisplays/>

## ■ [Browser Remote Control]

It is possible to operate the display with the operation buttons displayed on the WEB browser.

Click [Browser Remote Control].

The [Browser Remote Control] screen is displayed.

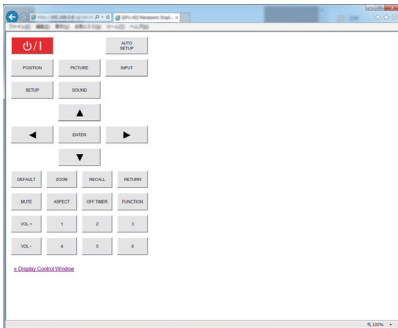

### Browser Remote Control

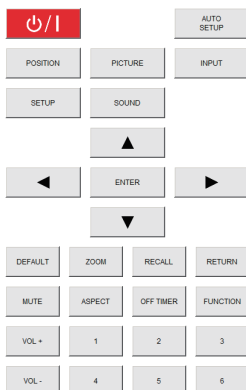

The Browser Remote Control can be operated in the same way as the supplied remote control.

For allocation / function of each button, see page 32.

To finish the Browser Remote Control, click [Display Control Window] or exit the browser.

### Note

- To use this function, set [Network control] to [On]. (see page 75)
- The Browser Remote Control can also be displayed by entering “http://xxx.xxx.xxx.xxx/remote/” in the WEB browser URL entry field.
  - xxx.xxx.xxx.xxx is the IP address set for this display.
- The button long press operation is invalid.
- The restriction for the remote control button operation set for [Setup] - [Controller user level] (see page 91) does not apply.
- Avoid operating the multiple Browser Remote Control simultaneously.
- The same operations are applicable to both administrator privileges and user privileges.
- If the Browser Remote Control screen is not displayed, consult your network administrator.
- The screen may turn white for a moment when updating the Browser Remote Control screen, but it is not a malfunction.
- While operating the Browser Remote Control, do not operate the unit by other methods such as WEB control screen, remote control and external control command.
- If the “Back” or “Forward” functions on the WEB browser is used, the screen display may be abnormal. In this case, the subsequent operations are not guaranteed. Update the WEB browser.

# Using “USB media player”

## Note

- This section describes the function on the premise that a USB memory device connected to the USB terminal is used.

When [Use memory select] is set to [Internal memory], the internal memory is used.

## Function description

The USB media player displays still pictures and motion pictures saved in a USB memory by inserting the USB memory device into the display.

## Note

- To use this function, set [USB media player] to [Enable] in [Setup] - [USB media player settings]. (see page 82)
- When using the “Single Media Player”, the unit prevents a black screen from appearing at the switching timing of still pictures or motion pictures. Note the following restrictions.
  - (1) A black screen may appear when switching a motion picture codec.
  - (2) A black screen may appear or images may be disturbed when switching to motion pictures of a different frame rate or aspect ratio.

If an angle of view for something other than for 16:9 is used, images may be disturbed near the end of playback.

Inserting a black screen (approx. 2 sec.) at the switching timing for all the motion pictures can avoid image disturbance in above (2).

([USB media player settings] (see page 82))

- Using the content list delivery function of the Multi Monitoring & Control Software (see page 97), content (still/motion pictures) played back on a USB media player and the playback list can be delivered. (Still pictures in jpg files and motion pictures other than H.265/HEVC can only be delivered.)

For details, refer to the manual of Multi Monitoring & Control Software.

## Single Media Player

Files are played by a single unit.



## Multi Media Player

Connecting more than one unit using LAN cables plays back files in the USB memory simultaneously.

One of the multiple units becomes the parent, and the others are children. The two-unit configuration example is shown below.

For LAN connection, see “Network environment (Multi Media Player only)” (see page 125).

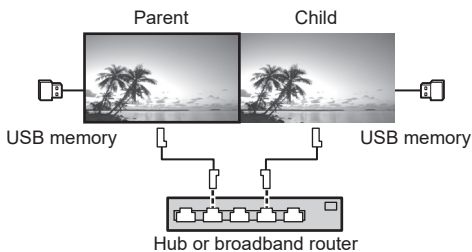

## Note

- For Multi Media Player, one USB memory device is required for one unit.
- For Multi Media Player, the parent requires both “scenario.dat” and “filelist.dat”, and the child requires “filelist.dat” only.
- Describe “GroupID:G01” without changing characters other than numbers (2-digit description required). Without description, the Multi Media Player does not function.
- When motion pictures are played on the multi media player, a black screen may be displayed for a certain period of time at the switching timing of motion pictures.

## Preparation

### ■ Supported device

- Commercially available USB memory devices are supported. (Those with security functions are not supported. Operation is not guaranteed.)
- USB memory devices other than those formatted in FAT16 or FAT32 cannot be used.
- Up to 32 GB of USB memory in size are supported.
- Only single partition configuration is supported.

### ■ Preparation

Prepare the following files immediately below root in USB memory for the media player.

- Play file
- Scenario (as necessary)
- File list (as necessary)

#### Note

- Delete files irrelevant to playback from the USB memory device.
  - Up to 999 files can be played back. If more than the maximum number of files are present, some files are not played back.
- An error is displayed by the scenario file check (see page 82).
- Up to 999 lines of Scenario files are valid.

### ■ Play file

The unit's Media Player supports the formats below. Save immediately below root in USB memory.

#### Still pictures

Extension	Format	Limitation
jpg/ jpeg/ jpe	JPEG	Number of pixels: Minimum 32 x 18 Maximum 4 096 x 4 096 (supports baseline only) YUV format: supports YUV444, YUV442 and YUV440 Colour mode: supports RGB only
bmp	Windows Bitmap	Number of pixels: Minimum 32 x 18 Maximum 4 096 x 4 096 (1 bit, 4 bits, 8 bits, 24 bits) Following formats are not supported: Run-length encoding, bit field, top-down, transparent data

## Motion pictures

Extension	Codec	
	Video	Audio
avi	H.264/MPEG4 AVC MPEG4 Visual VC-1 Advanced VC-1 Simple & Main	AAC-LC/LPCM/MP/ WMA Standard
mkv	H.264/MPEG4 AVC MPEG4 Visual VC-1 Advanced VC-1 Simple & Main H.265/HEVC	AAC-LC/HE-AAC/LPCM/ MP3
wmv asf	H.264/MPEG4 AVC MPEG4 Visual VC-1 Advanced VC-1 Simple & Main	LPCM/MP3/ WMA Standard/WMA9/ WMA10 Pro
mp4/ mov/flv	H.264/MPEG4 AVC MPEG4 Visual H.265/HEVC	AAC-LC/HE-AAC/MP3
ts/mts	H.264/MPEG4 AVC H.265/HEVC	AAC-LC/HE-AAC/LPCM/ MP3

#### Limitation

Video	
Codec	Resolution
H.264/ MPEG4 AVC MP@L5.1/ HP@L5.1	1 920 x 1 080p@60.0 3 840 x 2 160p@30.0 Bit rate: Maximum 80Mbps • MVC (Multi-view Video Coding) is not supported.
H.265 MP@L5.1/ MP10@L5.1	3 840 x 2 160p@60.0 1 920 x 1 080p@60.0 Bit rate: Maximum 80Mbps • Only 1 warp-point GMC supported • Data Partitioning is not supported.
MPEG4 Visual SP@L5/ ASP@L5	1 920 x 1 080p@30.0 Bit rate: Maximum 40Mbps • Video standard specified by MPEG4 Part2
VC-1 Advanced AP@L3	1 920 x 1 080i@30.0 1 920 x 1 080p@24.0 Bit rate: Maximum 40Mbps
VC-1 Simple & Main SP@LL/SP@ ML/MP@LL/ MP@ML/ MP@HL	1 920 x 1 080p@30.0 Bit rate: Maximum 40Mbps

Audio		
Codec	Sampling frequency (kHz)	Bit rate (kbps)
MP3	8/11.025/12/16/	8 – 320
WMA Standard	22.05/24/32/44.1/48	32 – 384
WMA 9		32 – 384
WMA 10 Pro		32 – 384
LPCM		64 – 1 536
		Supported quantization bit: 8/16/24/32
AAC(LC)		8 – 1 440
HE-AAC (Ver.2 Level4)		8 – 256

#### Note

- A maximum bit rate is the upper limit on the USB 3.0 memory, and depends on the performance of a USB memory device to be used.
- Maximum size per one file is 2 GB.
- Some files may not be played back even if their formats are supported as described here.
- Files protected by Digital Rights Management (DRM) cannot be played back.
- If files or folders include characters other than one-byte alphanumeric characters, they may not be displayed correctly, or the playback may not be done properly.

It is recommended to use only one-byte alphanumeric characters for files and folders.

- Make sure that both audio codec and video codec are supported. If the audio codec of motion picture file is incompatible in format, the pictures may not be correctly displayed. In addition, files which contain only audio cannot be played back.
- Playback is not possible if the maximum bit rate specified in the codec Profile or Level is exceeded. Also, depending on the USB memory device, playback may be impossible even if the bit rate is less than the indicated maximum bit rate.
- If the number of pixels of a file exceeds the screen size, the picture quality will change.
- Depending on the type of motion picture, the images may be distorted momentarily during playback.
- A part of information of still pictures/motion pictures can be confirmed on the computer accessible to the target files.

Example of an operation

#### (Windows)

1. Right-click the file, and then click [Properties].
2. Click the [Details] tab.

#### (Mac)

1. Control-click the file, and then click [Get Info].
2. Click [Details].

## ■ Scenario

The play order and time can be specified for a play file. Save under the name (one-byte alphabetical characters) “scenario.dat” immediately below root in USB memory.

- Save files as UTF-8N format.
- 1 to 999 lines can be specified for Scenario.

## ■ File list

It is a list of play files.

Save under the name (one-byte alphabetical characters) “filelist.dat” immediately below root in USB memory.

- Save files as UTF-8N format.

## ■ Scenario- / File list-associated terms

### File name

It is the name of a play file.

A file name needs to include its extension.

Example:

Introduction.jpg  
Contents\_Video01.wmv

- Enter the extension of a file name using one-byte alphanumeric characters.

### File definition

It is a file definition that is shared among scenarios and files.

PHOTO\_xxx: still image file definition  
VIDEO\_xxx: moving image file definition

- The “xxx” portion can be set from 001 to 999.
- Enter a file definition using one-byte alphanumeric characters.

### Play time

It is the play time of a file.

Play time can be specified from 3 seconds to 24 hours. (Unit: second)

Example:

10: 10 seconds  
86400: 24 hours  
10.5: 10.5 seconds

It can be set down to one-tenth (1/10) of a second using a decimal point (full stop).

Play time is omissible.

For still images, a file will be played for the period of time that you selected in [USB media player settings] - [Slide show duration]. (see page 83)

For moving images: a file will be played for the duration of the play time of the file.

- Enter play time using one-byte numeric characters.
- When playing back large sized files, if you set the playing back duration short, it may not be played back properly, for example, noise appears on the screen.

In that case, set the playing back duration longer (10 seconds or longer).

- If play time for a motion picture longer than the play time of the motion picture file is specified, the last image of the file is displayed after the playback of the motion picture has finished.

## Group ID (for Multi Media Player)

It is an ID used for grouping on a network during Multi Media Player conditions.

GroupID:Gxx : Group xx

- The "xx" portion can be set from 01 to 10.
- Enter a group ID using one-byte alphanumeric characters.

### Note

- "UTF-8N": UTF-8 encoding without BOM. Notepad for windows doesn't support this encoding.  
Please use another editor supported UTF-8 encoding without BOM.

## Playing back the files

### ■ Example of setting in each mode

#### Single Media Player (Type 1)

Files will be played in the order in which their names appear in USB memory.

##### Scenario, file list

Scenario:

Unnecessary

File list:

Unnecessary

#### Setting example

##### USB memory contents

```
├─ 000_Introduction.jpg
├─ 001_Contents_Video1.wmv
├─ 002_Contents_Video2.wmv
├─ 003_Contents_Video3.wmv
```

##### Play contents

For the above setting example, the following contents will be played on repeat (loop).

1. 000\_Introduction.jpg (\*1)
2. 001\_Contents\_Video1.wmv (\*2)
3. 002\_Contents\_Video2.wmv (\*2)
4. 003\_Contents\_Video3.wmv (\*2)

\*1: Played for the duration set in [Slide show duration].

\*2: Played for the duration of the play time of the file.

## Single Media Player (Type 2)

Files will be played in the order they were listed in a scenario.

##### Scenario, file list

Scenario:

Enter [File name: Play time].

File list:

Unnecessary

#### Setting example

##### USB memory contents

```
├─ scenario.dat
├─ Introduction.jpg
├─ Contents_Video1.wmv
├─ Contents_Video2.wmv
├─ Contents_Video3.wmv
```

##### scenario.dat (scenario)

```
Introduction.jpg:10
Contents_Video1.wmv:10
Contents_Video2.wmv:20
Contents_Video3.wmv:
```

##### Play contents

For the above setting example, the following contents will be played on repeat (loop).

1. Introduction.jpg (10 seconds)
2. Contents\_Video1.wmv (10 seconds)
3. Contents\_Video2.wmv (20 seconds)
4. Contents\_Video3.wmv (Played for the duration of the play time of the file)

#### Single Media Player (Type 3)

Files will be played in the order they were listed in a scenario.

##### Scenario, file list

Scenario:

Enter [File definition: Play time].

File list:

Enter [File definition: File name].

## Setting example

### USB memory contents

```
└─ filelist.dat
  └─ scenario.dat
    └─ Introduction.jpg
      └─ Contents_Video1.wmv
        └─ Contents_Video2.wmv
          └─ Contents_Video3.wmv
```

### scenario.dat (scenario)

```
PHOTO_001:10
VIDEO_001:10
VIDEO_002:20
VIDEO_003:
```

### filelist.dat (file list)

```
PHOTO_001:Introduction.jpg
VIDEO_001:Contents_Video1.wmv
VIDEO_002:Contents_Video2.wmv
VIDEO_003:Contents_Video3.wmv
```

### Play contents

For the above setting example, the following contents will be played on repeat (loop).

1. Introduction.jpg (10 seconds)
2. Contents\_Video1.wmv (10 seconds)
3. Contents\_Video2.wmv (20 seconds)
4. Contents\_Video3.wmv (Played for the duration of the play time of the file)

## Multi Media Player

Files will be played in the order they were listed in the scenario for Parent.

### Scenario and file list

#### Parent side

Scenario:

Enter [File definition: Play time].

File list - The first line:

Enter [Group ID].

File list - The second and subsequent lines:

Enter [File definition: File name].

#### Child side

Scenario:

Unnecessary

File list - The first line:

Enter [Group ID].

File list - The second and subsequent lines:

Enter [File definition: File name].

## Setting example

### Parent side

#### USB memory contents

```
└─ filelist.dat
  └─ scenario.dat
    └─ L_Introduction.jpg
      └─ L_Contents_Video1.wmv
        └─ L_Contents_Video2.wmv
          └─ L_Contents_Video3.wmv
```

### scenario.dat (scenario)

```
PHOTO_001:10
VIDEO_001:10
VIDEO_002:20
VIDEO_003:
```

### filelist.dat (file list)

```
GroupID:G01
PHOTO_001:L_Introduction.jpg
VIDEO_001:L_Contents_Video1.wmv
VIDEO_002:L_Contents_Video2.wmv
VIDEO_003:L_Contents_Video3.wmv
```

### Child side

#### USB memory contents

```
└─ filelist.dat
  └─ R_Introduction.jpg
    └─ R_Contents_Video1.wmv
      └─ R_Contents_Video2.wmv
        └─ R_Contents_Video3.wmv
```

### filelist.dat (file list)

```
GroupID:G01
PHOTO_001:R_Introduction.jpg
VIDEO_001:R_Contents_Video1.wmv
VIDEO_002:R_Contents_Video2.wmv
VIDEO_003:R_Contents_Video3.wmv
```

### Play contents

For the above setting example, the following contents will be played on repeat (loop).

#### Parent side

1. L\_Introduction.jpg (10 seconds)
2. L\_Contents\_Video1.wmv (10 seconds)
3. L\_Contents\_Video2.wmv (20 seconds)
4. L\_Contents\_Video3.wmv (\*1)

#### Child side

1. R\_Introduction.jpg (10 seconds)
2. R\_Contents\_Video1.wmv (10 seconds)
3. R\_Contents\_Video2.wmv (20 seconds)
4. R\_Contents\_Video3.wmv (\*1)

\*1: Played for the duration of the play time of L\_Contents\_Video3.wmv (Parent side).

### Note

- While the menu screen is not displayed, you can skip to the next playback file with ►, to the previous playback file with ◀, or play back again from the beginning of the file with ▼ (Remote control operation only).

When this operation is performed, a black screen is inserted before playback.

When the [Schedule play function] is enabled, the skip operation is disabled.

- If the date and time are changed by the [Date and time] (see page 73) setting, the playback of the file currently being played is stopped, and the playback will be performed again from the beginning of the file.
- The Multi Media player does not operate during communication with IPv6 setting.

### ■ USB memory contents check

You can run a USB memory contents check in [USB media player settings] - [Scenario file check]. (see page 82)

If an error is present, the information is given with the following details.

A(B): C

D

A: Name of the file with an error

B: Row with an error

C: Error code

D: Detail of the error

### Note

- Shows leading error codes.

Details of the detected errors are as follows.

Error code	Detail of the error
1.	No USB memory is inserted.
2.	scenario.dat/filelist.dat cannot be opened.
3.	There is an error in the contents of scenario.dat/filelist.dat.
4.	The play file format is not supported.
5.	No play file exists.
6.	The necessary group ID for Multi Media Player has not been specified.
7.	There are several identical file definitions.
8.	The scenario's play time is over the limit.
9.	The file definition listed in the scenario is not in the file list.
10.	The scenario contains 0 or over 1000 play files.
11.	There are 0 or over 1000 play files. (Single Media Player (Type 1) only)
12.	Only the group ID is listed on the file list. (Multi Media Player only)

- For error code 1 and 11, only the error code and the detail of the error are displayed as shown below.

1

No USB memory is inserted.

### Supplementary note

The USB memory contents check does not determine whether or not a play file is playable.

If a file cannot be played while Media Player is active, an error message will be displayed.

When performing the synchronized playback on the Multi Media Player, check in the menu [USB media player settings] - [Scenario file check] that the file is playable.



## Network environment (Multi Media Player only)

### ■ Example of setting up LAN connection and IP address / Subnet mask

As mentioned below, connect several units together with LAN cables and set up IP addresses / Subnet masks so that all the displays exist on the same network.

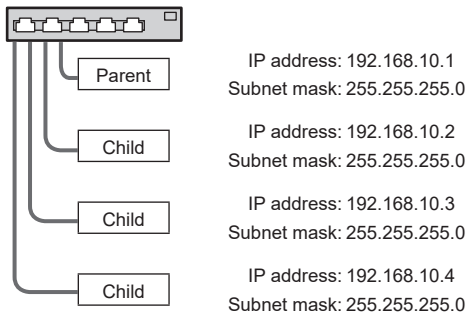

#### Note

- Set [Network control] of all displays to [On]. (see page 75)
- Depending on the network environment, synchronization may be largely lost.
- Do not connect other devices to prevent network traffic jam.
- With a router put in between the displays, you cannot set up connection. Use them within the same subnet.
- Do not use wireless LAN for connection since playback may not be performed normally.

## Starting / ending Media Player

### ■ For Single Media Player

#### Start

1. Insert the USB memory device for Media Player to the USB terminal on the side of the display.

#### Note

- Depending on the type of a USB memory device, it may come in contact with the periphery such as a back cover, and cannot be attached. Use a USB memory device connectable to this unit.

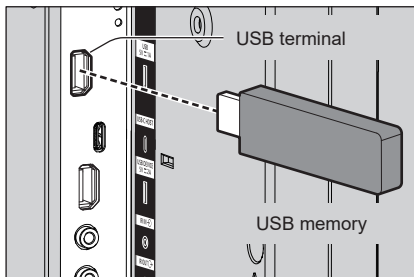

2. Run a USB memory contents check.
3. Change INPUT to [USB].

#### Ending

Change INPUT to other than [USB].

### ■ For Multi Media Player

#### Start

1. Connect several units with LAN cables.  
(See "Example of setting up LAN connection and IP address / Subnet mask" in the previous section.)
2. Insert USB memory for Media Player into each Display.
3. Executes USB memory contents check on each Display.
4. Change INPUT for Child to [USB].
5. Change INPUT for Parent to [USB].

#### Ending

Change INPUT for Parent to other than [USB].

## Resume Play function

After Media Player ends, the file to be played back next time varies depending on the setting of [USB media player settings] - [Resume play].

### When set to [On]:

The file played prior to the end of Media Player starts playing from the beginning.

### When set to [Off]:

Play starts from the beginning of the first file of the scenario.

### Note

- The resume play function is retained until the unit is turned off or the USB memory device is taken out.

## Playlist edit function

This function creates and edits a scenario file for the USB media player. Select [Setup] – [USB media player settings] – [Playlist edit] to select the desired content, set the playback order and play time, and output the file (scenario.dat) to the USB memory device.

### Note

- This section describes the function on the premise that a USB memory device connected to the USB terminal is used.
- When [Use memory select] is set to [Internal memory], the internal memory is used.
- Descriptions for the scenario (scenario.dat) are restricted by the USB media player.
- After the playlist is edited, "Single Media Player (Type 2)" operates.
- If a scenario file (scenario.dat) already exists in the USB memory device or internal memory, delete it or internal memory, and create a new one.
- If a file list file (filelist.dat) already exists in the USB memory device or internal memory, delete them.
- While editing the playlist, the following functions are disabled.

[Position]

[Sound]

[Picture]

[Setup]

- [Signal]
- [Input label]
- [Power management settings] - [No signal power off]
- [Image settings] - [Read user image]
- [Multi display settings]
- [Function button settings]
- [Failover/Failback]
- [Audio input select]
- [Portrait settings]

[Digital zoom]

- The screen and audio quality while editing the playlist is adjusted with the same content as that for the MEMORY VIEWER input.

- Editing the playlist requires 2 MB or more of space in the USB memory device.
- Use a USB memory device for which file reading and writing can be normally performed.
- Use the remote control for the playlist editing function operation.

### 1. File selection screen

Select content files to play.

After selecting the files, press <6> to go to the next editing screen.

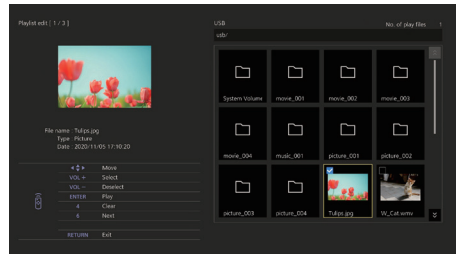

Press the remote control buttons to perform the following operations.

- <VOL +> Selects content files. (Add a check mark on the upper left of the thumbnail.)
- <VOL -> Cancels content selection. (Delete a check mark on the upper left of the thumbnail if there is.)
- ▲ ▼ ◀ ▶ Moves the focus.
- <4> Deletes all the check marks.
- <ENTER> Plays content files or moves to a different hierarchy.
- <RETURN> Finishes editing the playlist or moves to a higher hierarchy.
- <6> Goes to the next editing screen.

### Note

- If a scenario (scenario.dat) exists in the USB memory device or internal memory, it will be loaded automatically. If applicable files are present, they are already in the selected status on the content selection screen.
- Up to 999 lines can be read from a scenario (scenario.dat).
- If a file list (filelist.dat) exists in the USB memory device or internal memory, it will not be loaded even if a scenario (scenario.dat) is present, and then the content selection screen appears with no content files selected.
- In addition to files immediately below root in the USB memory device, files in folders can also be selected.
- A maximum of 999 content files can be selected.
- If 999 files are selected, pressing <VOL +> for files not selected cannot select such files.
- When all the check marks are removed with <4>, a confirmation screen is displayed before removal.

## 2. Play order / Play time setting screen

Arrange the selected content files in playback order, and set the playback time.

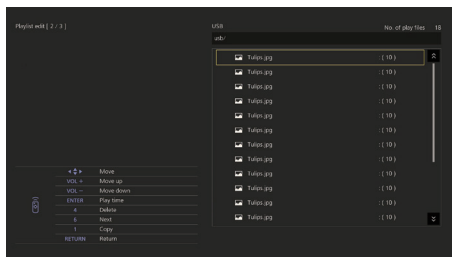

Press the remote control buttons to perform the following operations.

- <VOL +> Moves a content file up by one position.
- <VOL -> Moves a content file down by one position.
- ▲▼◀▶ Moves the focus.
- <1> Copies the currently selected content file to add it to the list.
- <4> Deletes the currently selected content file from the list.
- <ENTER> Displays a screen to set playback time.
- <RETURN> Returns to the previous editing screen.
- <6> Goes to the next editing screen.

Pressing <ENTER> will display a screen to set playback time.

Entering numbers (see page 77)

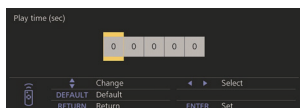

### Note

- The setting range for playback time is 0, 3 (minimum) to 86400 (maximum). If 0 is set, the playback time setting is deleted.
- Playback time can be set in one second increments with the playlist editing function. If a scenario (scenario.dat) is already present and the playback time of the applicable files are specified with decimal points, writing the scenario file will convert the playback time to that in one second increments.
- For content files whose playback time is set, “:(number)” is displayed on the right side of the file name.

For content files whose playback time is not set, “:(number)” is displayed on the right side of the file name if they are still picture files. (The numbers are values set for [USB media player settings] - [Slide show duration] (see page 83).) For motion picture files, “:(---)” is displayed on the right side of the file name.

- When the content file is deleted with <4>, a confirmation screen is displayed before deletion.
- If 999 content files already exist, another file cannot be added even if <1> is pressed.

## 3. File output screen

Select [Yes] with ◀▶ and press <ENTER>.

File output to the USB memory device or internal memory, starts.

## 4. Exit screen

The exit screen appears.

## Schedule playback function using “Content Management Software”

This unit supports “Content Management Software” to create schedule data on a PC required to play back still pictures and motion pictures.

Functions that can be set with “Content Management Software” are as follows.

- Content playback (Still pictures/Motion pictures)
- Music playback
- Input switch
- Power control
- Multi display setting
- Caption display

For setting method and details of each function, refer to the manual of “Content Management Software”.

### Note

- This section describes the function on the premise that a USB memory device connected to the USB terminal is used.
  - When [Use memory select] is set to [Internal memory], the internal memory is used.
- The schedule playback function does not operate on the “Content Management Software” during communication with IPv6 setting.
- To use this function, set [USB media player] and [Schedule play function] to [Enable] in [Setup] - [USB media player settings]. (see page 82)
- About supported devices, refer to “Supported device”. (see page 120)
- When using this function, insert the USB memory device in power-on state or in schedule standby state. If the USB memory device is inserted in conditions other than the said states, the schedule playback is not performed.
- Functions restricted when using the “USB media player” are also restricted when using the schedule playback function.

## ■ Schedule play mode

When [USB media player] is set to [Enable] and [Schedule play function] is set to [Enable], this unit enters schedule play mode, and the content is played back according to the set schedule.

If it entered schedule play mode at the time when the schedule is already specified, the unit operates as follows according to [Play mode] (see page 83).

- In [Individual play] mode  
Playback starts from the beginning of the specified schedule.
- In [Synchronize play] mode  
Synchronized playback starts at the next content start time.

### Note

- When the unit enters schedule play mode, the input is automatically switched to [USB] or [Internal Memory].
- Some of the main unit's functions are disabled during schedule play mode.
- If the input is switched during schedule play mode, the schedule playback is suspended.  
To resume the schedule playback
  - Switching the input to [USB] or [Internal Memory] will resume playback from the next schedule.
  - If the power is turned off using the remote control, the power is turned on at the next power-on schedule. Then the schedule playback starts.
 The schedule playback is restored by the above operations.
- When <RECALL> is pressed during schedule play mode, the [Schedule play mode] display appears.
- The scenario playback function of the media player does not operate in [Schedule play mode].

## ■ Content playback

Specified content is played back at the time set for schedule.

Playback files in the following formats are supported.

### Still pictures

Extension	Format	Limitation
jpg/ jpeg/ jpe	JPEG	Number of pixels: Minimum 32 x 18 Maximum 4 096 x 4 096 (supports baseline only) YUV format: supports YUV444, YUV442 and YUV440 Colour mode: supports RGB only
bmp	Windows Bitmap	Number of pixels: Minimum 32 x 18 Maximum 2 000 x 2 000 (1 bit, 4 bits, 8 bits, 24 bits) Following formats are not supported: Run-length encoding, bit field, top-down, transparent data

## Motion pictures

Extension	Codec	
	Video	Audio
avi	H.264/MPEG4 AVC  MPEG4 Visual VC-1 Advanced VC-1 Simple & Main	AAC-LC/LPCM/MP3  WMA Standard
wmv	H.264/MPEG4 AVC  MPEG4 Visual VC-1 Advanced VC-1 Simple & Main	LPCM/MP3/ WMA Standard/WMA9/ WMA10 Pro
mp4 / mov	H.264/MPEG4 AVC  MPEG4 Visual H.265/HEVC	AAC-LC/HE-AAC/MP3

### Note

- Some files may not be played back even if they are supported formats described above.
- As for restrictions for movie codecs of playback files, see "Play file" (see page 120).
- If the contents of setting files (under [PRIVATE] folder) created and delivered using "Content Management Software" are changed, operations are not guaranteed.
- During a time period for which no content is set, the screen is black with nothing displayed.  
During this period, the [Schedule waiting] message is displayed on the upper right of the screen.  
To hide this display on the screen, set [Setup] - [OSD settings] - [Onscreen display] to [Off].
- For details of each CODEC of content, check the restriction items for playback content of the USB media player function.

## ■ Music playback

Music content is played back at the time set with the schedule data.

Playback files in the following formats are supported.

### Music

Extension	Codec	Format
mp3	MPEG-1/2	Sample rate: Maximum 48 kHz
	Audio Layer-3 AAC(LC)	Channel: Maximum 2 ch
wma	WMA	Bit rate: Maximum 320kbps

#### Note

- Some files may not be played back even if they are supported formats described above.
- If incompatible music content is scheduled, the music content is not played back.
- Music content can be played back only with the [USB] or [Internal Memory] input.
- Video content and music content cannot be played back simultaneously. If 2 pieces of content are set for playback at the same time, video content takes priority.
- If video content starts to be played back while music content is being played, the playback of the music content stops.
- When playing back music content after playback of video content has finished, the playback starts from the beginning of the music content.
- Music content cannot be played back in synchronization with other displays.
- Several minutes of preparation time are added in switching music content.

## ■ Input switch

The input is switched to the specified input at the time set with the schedule data. When the set time has passed, the [USB] or [Internal Memory] input is restored.

#### Note

- The input is switched even if no signal is present at the input switch destination.
- When the input is switched, the input display does not appear.

## ■ Power control

The power is turned on/off at the time set with the schedule data.

#### Note

- If the power is turned off during schedule play mode, the unit enters the schedule standby mode.
- The standby electricity will be more than normal during the schedule standby mode.
- Some of the main unit functions in schedule play mode remain invalid during the schedule standby mode.
- The power-on schedule operates one minute before the specified schedule time.

- If the unit enters the schedule standby mode after one minute before the power-on schedule, the power is not turned on at the specified time by the schedule playback function.
- The power-on operation by [Schedule play function] does not work in standby states other than the schedule standby mode.

## ■ Multi screen display setting of the multi display

Sets the following for playback content.

- Plays in the single playback mode.
- Plays in the synchronized playback mode.
- Changes the setting of [Multi display settings] - [Multi screen display] of the main unit.

### In [Individual play] mode

Content is played only on one display.

### In [Synchronize play] mode

Content is played on multiple displays in synchronization.

To play back in the synchronized playback mode, set the following for correct operation.

- Set [USB media player] to [Enable].
- Set [Schedule play function] to [Enable].
- Set [Synchronize display] to [On].
- For [Parent or child setting], set one display with reference time to [Parent] and other displays to [Child].

#### Note

- The operations of the single playback mode and the synchronized playback mode are different from those of Single Media Player and Multi Media Player of the existing USB media player.
- For playback in the synchronized playback mode, approx. 5 seconds of preparation time are added in switching content.
- To perform the synchronized playback with multiple displays, set the [Synchronize display] function to [On], and set the same time for all the displays for playback.
- If the time is not synchronized correctly with [Synchronize display] set to [On], the unit may not operate properly. Confirm the operation conditions of [Synchronize display]. (see page 73)
- If [Multi display settings] - [Multi screen display] is specified in the schedule data of "Content Management Software", the setting is switched to the specified multi screen display. The setting of [Multi screen display] cannot be changed during the specified schedule playback. When the specified schedule has finished, the setting of [Multi screen display] is restored to the state before setting.

## ■ Caption display

A caption is displayed at the time set for the schedule data.

### Note

- The caption is displayed on top of an image.
- A maximum of 600 characters can be displayed with caption.
- Scrolling of the caption may stop at switching timing of content playback or music playback.
- The caption is hidden by switching input. If the input is switched with the schedule playback function, the caption display continues.
- Also, if the schedule playback function is resumed, the caption is displayed from the beginning.
- Changing the settings of [OSD language], [Display orientation] or [Image rotation], or displaying the display ID/display name will delete the caption being displayed.
- When creating schedule data, if a caption with many characters is displayed with [Scroll] set to [No], the characters will run over on the screen.
- The caption does not synchronize with other displays even if [Play mode] is [Synchronize play].

## ■ Disabled functions

The following main unit's functions are set to [Disable (Off)] during schedule play mode.

- [Set up timer]
- [Screensaver]
- "Power management" function
- [No signal power off]
- [HDMI-CEC settings]
- [No activity power off]
- [OSD transparency]
- [Image settings] (Reading user image is disabled.)
- [Input search]
- [Initial input]
- [Input lock]
- [Failover/Failback]

### Note

- Disabled functions are greyed out on the on-screen menu. Also, serial commands are in [ER401] state (Including the inquiry command).
- During schedule play mode, disabled functions are set to [Disable (Off)], and those operations are forcibly stopped.
- When schedule play mode has finished, the disabled functions are restored to the original setting values.
- For [Multi display settings] – [Multi screen display], only [Horizontal scale], [Vertical scale] and [Location] can be set. [Bezel H adjustment] and [Bezel V adjustment] cannot be set.
- ARC function cannot be used. Select [Setup] - [HDMI-CEC settings], and set [ARC] to [Off]. (see page 66)

## ■ Resume play

Sets the operation when the schedule playback is restored again after schedule play mode is stopped once.

### When set to [On]:

The previous content before schedule play mode is stopped is played back from the beginning.

### When set to [Off]:

The playlist scheduled to be played back at the current time is played back from the beginning.

### Note

- When playback is scheduled in the synchronized playback mode, the playback is performed according to the set time in both [On] and [Off] cases.

# Using “Memory viewer”

The “Memory viewer” selects still pictures and motion pictures stored in a USB memory device or internal memory, and show them on the display.

### Note

- This section describes the function on the premise that a USB memory device connected to the USB terminal is used.  
When [Use memory select] is set to [Internal memory], the internal memory is used.

## Preparation

### ■ The files you can display with the “Memory viewer”

The following files are supported.

#### Still pictures

Extension	Format	Limitation
jpg/ jpeg/ jpe	JPEG	Number of pixels: Minimum 32 x 32, Maximum 4 096 x 4 096 (supports baseline only) YUV format: supports YUV444, YUV442 and YUV440 Colour mode: supports RGB only
bmp	Windows Bitmap	Number of pixels: Minimum 32 x 32, Maximum 4 096 x 4 096 (1 bit, 4 bits, 8 bits, 24 bits) Following formats are not supported: Run-length encoding, bit field, top-down, transparent data If the number of pixels exceeds 1 920 x 1 080, a long time may be required to display content.

#### Motion pictures

Extension	Codec	
	Video	Audio
avi	H.264/MPEG4 AVC MPEG4 Visual VC-1 Advanced VC-1 Simple & Main	AAC-LC/LPCM/MP/ WMA Standard

mkv	H.264/MPEG4 AVC MPEG4 Visual VC-1 Advanced VC-1 Simple & Main H.265/HEVC	AAC-LC/HE-AAC/LPCM/MP3
wmv asf	H.264/MPEG4 AVC MPEG4 Visual VC-1 Advanced VC-1 Simple & Main	LPCM/MP3/ WMA Standard/WMA9/ WMA10 Pro
mp4/ mov/flv	H.264/MPEG4 AVC MPEG4 Visual H.265/HEVC	AAC-LC/HE-AAC/MP3
ts/mts	H.264/MPEG4 AVC H.265/HEVC	AAC-LC/HE-AAC/LPCM/MP3

Limitation	
Video	
Codec	Resolution
H.264/ MPEG4 AVC	1 920 x 1 080p@60.0 3 840 x 2 160p@30.0
MP@L5.1/ HP@L5.1	Bit rate: Maximum 80Mbps • MVC (Multi-view Video Coding) is not supported.
H.265	3 840 x 2 160p@60.0
MP@L5.1/ MP10@L5.1	1 920 x 1 080p@60.0 Bit rate: Maximum 80Mbps • Only 1 warp-point GMC supported • Data Partitioning is not supported.
MPEG4 Visual	1 920 x 1 080p@30.0 Bit rate: Maximum 40Mbps
SP@L5/ ASP@L5	• Video standard specified by MPEG4 Part2
VC-1 Advanced	1 920 x 1 080i@30.0 1 920 x 1 080p@24.0
AP@L3	Bit rate: Maximum 40Mbps
VC-1 Simple & Main	1 920 x 1 080p@30.0
SP@LL/SP@ ML/MP@LL/ MP@ML/ MP@HL	Bit rate: Maximum 40Mbps

Audio		
Codec	Sampling frequency (kHz)	Bit rate (kbps)
MP3	8/11.025/12/16/	8 – 320
WMA Standard	22.05/24/32/44.1/48	32 – 384
WMA 9		32 – 384
WMA 10 Pro		32 – 384
LPCM		64 – 1 536
		Supported quantization bit: 8/16/24/32
AAC(LC)		8 – 1 440
HE-AAC (Ver.2 Level4)		8 – 256

- If the file name including the file path (folder information) and extension has 248 one-byte alphanumeric characters or more, the thumbnail is not displayed. (see page 133)
- When playing back in series several kinds of content with different aspect ratios, the image may be distorted momentarily when switching content. It is recommended to unify the aspect ratio for consecutive playback.
- Depending on the type of motion picture, the images may be distorted momentarily during playback or thumbnail display.

## Music

Extension	Codec
mp3	MPEG-1/2 Audio Layer-3 AAC(LC) HE-AAC (Ver.1) Bit rate: Maximum 320kbps
wma	WMA

### Note

- A maximum bit rate is the upper limit on the USB 3.0 memory, and depends on the performance of a USB memory device to be used.
- Some information for still image/movie files can be viewed with a computer where relevant files are accessible.
- About supported devices, refer to “Supported device”. (see page 120)
- Some files may not be played back even if they are supported formats described above.
- If the number of pixels of a file exceeds the screen size, the picture quality will change.

## Operation example

-For Windows computer

1. Right-click a file, and click [Properties].
2. Click the [Details] tab.

-For Mac

1. Click a file while holding down the “Control” key, and click [Get Info].
  2. Click [More Info].
- The maximum size of file is 2 GB.
  - The maximum number of file/folder is up to 2 000. If the number exceeds, 2 000 files/folders are displayed.
  - You cannot play the files which are protected by Digital Rights Management (DRM).
  - If files or folders include characters other than one-byte alphanumeric characters, they may not be displayed correctly, or the playback may not be done properly.  
It is recommended to use only one-byte alphanumeric characters for files and folders.
  - Thumbnails of files may not be correctly displayed even if they are playable.



## Displaying the “Memory viewer” screen

Press <INPUT> to switch the input to [MEMORY VIEWER].

Assigning [Input] function to the numeric buttons (<1> to <6>) can switch to [MEMORY VIEWER] with a single touch of a button. (see page 83)

The thumbnails or the file list is displayed.

You can switch the display between the thumbnail view and file list view by setting [Setup] - [Memory viewer settings]. (see page 83)

### Note







- Use the remote control to operate “Memory viewer”.

### Thumbnail view



### 1. Thumbnails

Displays folders, pictures, videos and music files. The following icons will be displayed.

-  Moves to the upper level when selected.
-  Moves to the lower level when selected.
-  Picture file.
-  Video file.
-  Music file.
-  The file has a supported extension but cannot be played.

In the thumbnail view, if images for thumbnails can be displayed, icons are replaced with automatically created thumbnail images.

### Note

- If the image includes Exif information, orientations of the thumbnail image and the playback image may differ.

- Information of the selected file.
- Remote control operation guide
- Status indicator icon

Displays the type of content, display order and playback method with icons.

### Type of content

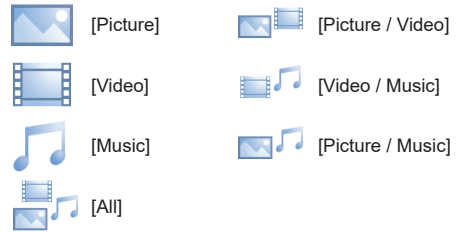

### Display order

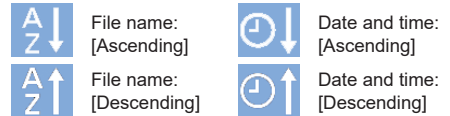

### Play method

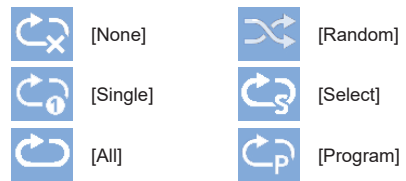

### File list view



### 1. File list

Displays folders, pictures, videos and music files.

### 2. Displays information of the selected file.

### 3. Remote control operation guide

## Playing the pictures

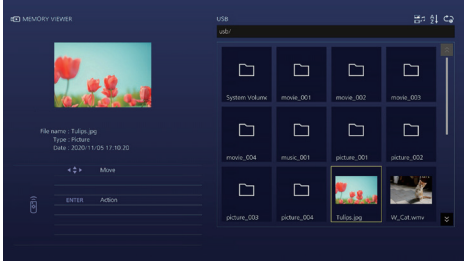

Select a file in the same manner in the file list view.

### 1 In the thumbnail view / the file list view, press ▲▼◀▶ to select the file you want to play.

#### Note

- When [Play method] is [Select] or [Program], press <VOL +> <VOL -> to specify the file you want to play. (see page 84)

File selection is cancelled by the following operations.

- Folder movement
- [Play method] change
- Removal of USB memory device
- Input switch
- Power-off

### 2 Press <ENTER>.

The picture will be displayed on the full screen.

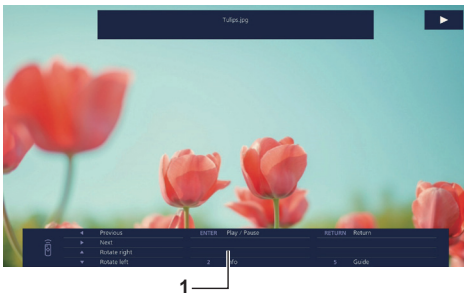

#### 1. Remote control operation guide

Press the remote control buttons to perform the following operations.

◀: Skip to the previous file.

▶: Skip to the next file.

▲: Rotate the picture clockwise (90°).

▼: Rotate the picture counterclockwise (90°).

<ENTER> : Pause / Restart playing.

<RETURN> : Return to the list view.

<1> : Not used

<2> : Display / Hide the detail of the content that is being played back.

<3> : Not used

<4> : Not used

<5> : Display / Hide the remote control operation guide.

<6> : Not used

Pressing <ENTER> during play stops the play temporarily. Press it again to restart the play.

Pressing ◀ during play starts the play from the previous picture and pressing ▶ from the next picture.

It is possible to set play interval in [Setup] - [Memory viewer settings]. (see page 83)

### 3 Press <RETURN>.

Returns to the thumbnail view or file list view.

## Playing the video / music

### 1 Select the file you want to play in the same manner as “Playing the pictures”. (see page 134)

### 2 Press <ENTER>.

The video will be displayed on the full screen.

#### Note

- The music icon is displayed on the screen for music playback.



3

#### 1. Fast forward / Rewind / Pause indication

▶ Normal play

⏸ Pause

▶▶▶ Fast forward (first stage)

▶▶▶▶ Fast forward (second stage)

◀◀◀ Rewind (first stage)

◀◀◀◀ Rewind (second stage)

#### 2. Time bar

#### 3. Remote control operation guide

Press the remote control buttons to perform the following operations.

Pressing <4> during play will rewind and <6> will fast forward the video. The speed changes in 2 steps each time you press the button, and returns to the normal play.

◀: Skip to the previous file.

▶: Skip to the next file.

▲: Play from the beginning. (Plays the current file from the beginning.)

▼: Play from the beginning. (Plays the current file from the beginning.)

<ENTER> : Pause / Restart playing.

<RETURN> : Return to the list view.

<1> : Skip 10 seconds backward.

<2> : Display / Hide the detail of the content that is being played back.

<3> : Skip 30 seconds forward.

<4> : Rewind.

<5> : Display / Hide the remote control operation guide.

<6> : Fast forward.

#### Note

- Depending on the content to be played, "Skip 10 seconds backward" or "Skip 30 seconds forward" may not operate correctly.

### 3 Press <RETURN>.

Returns to the thumbnail view or file list view.

#### ■ Disabled functions

While using the "Memory viewer", the following main unit's functions are disabled.

- [Read user image] in [Image settings]
  - Multi screen display of the multi display
  - [Digital zoom]
  - [No signal power off]
  - [Position]
  - [Function button settings]
- (Disabled while content is being played)

#### Note

- To prevent image retention on the liquid crystal panel, using the screensaver function is recommended. (see page 59)

# Using the WhiteBoard function

## Note

- To use the WhiteBoard function, an external touch panel or mouse is required.
- When using the WhiteBoard function, select [Setup] - [Whiteboard settings], and set [Whiteboard] to [On]. (see page 71)
- When using a mouse, use click operation.
- When using an external touch panel, use touch operation.
- The following cases do not support the operation.
  - When [Display orientation] is set to [Portrait] (page 89)
  - When [Image rotation] is set to [180 degrees] (page 89)

## Control menu

From the Control menu displayed at the bottom of the screen, click the function you want to use.

To show the Control menu, navigate to [Setup] - [Whiteboard settings], and set [Control menu]. (see page 71)

### When [Control menu]: [Bottom]



### When [Control menu]: [Top]

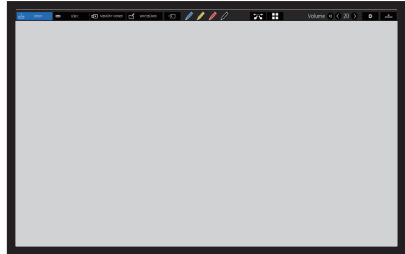

## Control menu

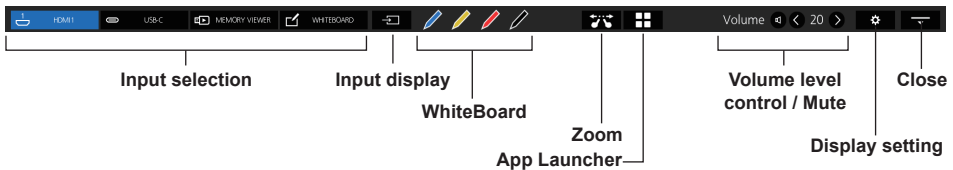

### Input selection

Switches the input source to the one you click.

You can select the input sources displayed on the Control menu. “Quick input settings” (see page 71)

### Input display

Lists the selectable input sources.

### WhiteBoard

Transparent mode or WhiteBoard mode is set.

WhiteBoard is started up with the pen colour clicked.

You can start it up with blue, yellow, red, or black.

## Note

- The buttons are grayed out and you cannot start up WhiteBoard in the following cases:
  - Several seconds after the input source is switched
- In the following cases, instead of WhiteBoard, the simple drawing function starts up:
  - When USB input is active
  - When the comparison mode is activated

**Zoom**

Sets zoom mode in which you can expand or shrink the image.

**App Launcher**

Starts up App Launcher on this unit. (see page 155)

**Volume level control / Mute**

You can adjust the volume level by clicking the < > buttons.

Click  to mute the sound;  changes to  and the volume level control is disabled. To cancel the muting, click it again.

**Display setting**

Displays a screen to select the menu.

**Close**

Click "Close" to minimize Control menu.

Click the minimized tab to restore Control menu.

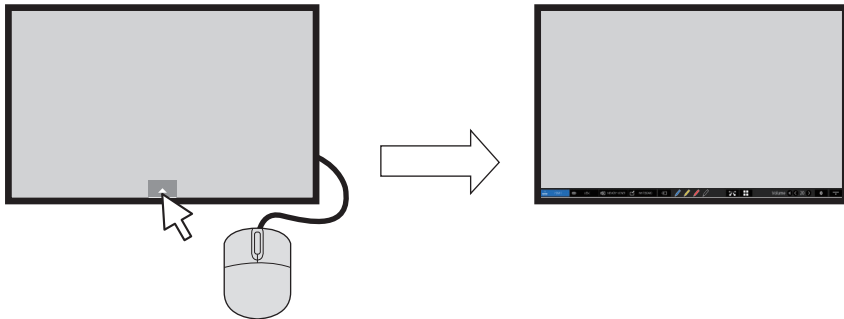

When a menu other than Control menu is displayed, Control menu is not displayed.

When the displayed object is closed, Control menu is displayed.

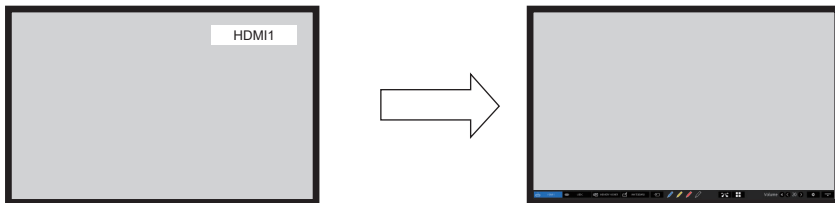

# Using Built-in WhiteBoard

The built-in WhiteBoard allows you to use the display as a whiteboard and perform pen drawing such as marking on an image.

## ■ About the built-in WhiteBoard

- To enable pen drawing, select [Setup] - [Whiteboard settings], and set [Whiteboard] to [On]. (see page 71)
- Use a finger to perform pen drawing.
- Images with markings can be saved in the built-in memory or USB memory with its background.

### Note

- In the case that you use this Display by entering the data or the work, including but not limited to, motion picture and photography through external input to this Display, the data or the work you are permitted to use in this Display except for the quoting shall be created by yourself or shall be authorized to use by the author of the data or the work.

There are two modes of pen drawing.

## WhiteBoard mode

With the WHITEBOARD input, drawing will be made on the white background.

### Select the [WHITEBOARD] input.

#### Remote control operation

Press <INPUT> to select the [WHITEBOARD] input.

If the function of a numeric button accessible through [Setup] - [Function button settings] has been assigned to [Input (WHITEBOARD)], simply pressing it can switch the input to [WHITEBOARD].

#### Mouse operation

Click [WHITEBOARD] in Control menu.



About Control menu (see page 136)

The display enters the WhiteBoard mode allowing you to perform pen drawing on the white background.

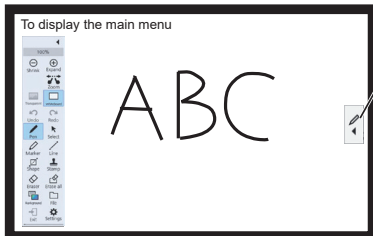

#### To display the main menu

Click  to display the main menu for pen drawing.

About main menu, see page 140

The background can be changed in the main menu. (see page 140)

The background of WhiteBoard can be changed to any other colour than white in the setting menu for the built-in applications. (see page 141)

If the input is not [WHITEBOARD], switch the mode to WhiteBoard in [Whiteboard] of the main menu. (see page 140, 144)

How to perform pen drawing, see page 142

### Note

- At the time of the [WHITEBOARD] input, the Exit button  is disabled.

## Transparent mode (Drawing on video and still image)

Drawing will be made on the image of the computer or HDMI input shown on the display.

- 1 Switch to an input source.**
- 2 Start up WhiteBoard from Control menu.**

The display enters the transparent mode allowing you to draw on video or still image.



Click the function button on the Main menu to switch between the modes.

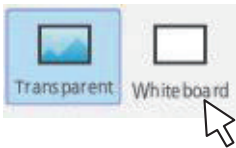

**Transparent:** Switches to transparent mode.  
**Whiteboard:** Switches to WhiteBoard mode.

- 3 Exit from WhiteBoard mode.** Click  in the Main menu.

## Main menu

Click the function button of the main menu to activate the desired function.

The function buttons displayed differ depending on the mode.

### Display Main menu

The main menu will appear on the side where you click  shown in the right or left of the screen.

Main menu

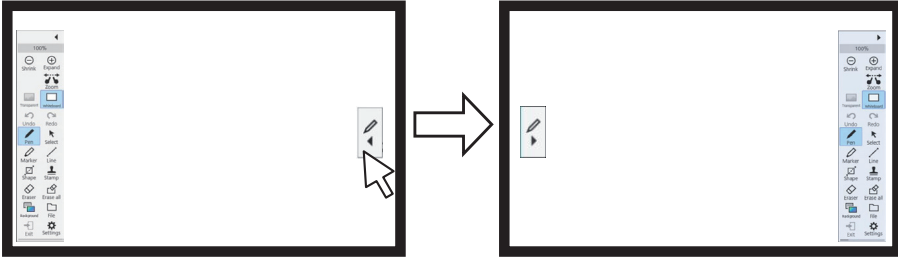

Main menu

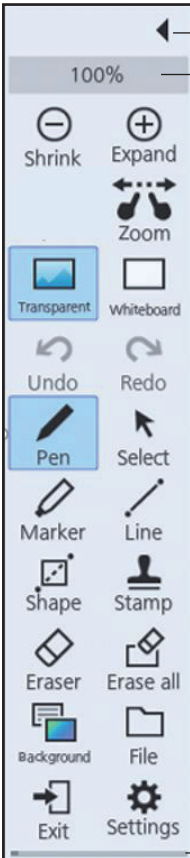

Minimizes the menu.

Zoom magnification display

**[Shrink]** Zooms down the view. (up to 100%)

**[Expand]** Zooms up the view. (up to 400%)

**[Zoom]** Sets zoom mode.

**[Transparent]** Sets background transparent mode on WhiteBoard.

**[Whiteboard]** Sets white background mode on WhiteBoard. (A colour other than white can also be set.)

**[Undo]** Cancels the previous action. (Up to 20 actions)

**[Redo]** Redos the action you canceled.

**[Pen]** Used to draw free lines such as characters and figures.

**[Select]** Used to select a drawing object.

**[Marker]** Is a translucent pen.

**[Line]** Used to draw a straight line and arrow.

**[Shape]** Used to draw a square or circle.

**[Stamp]** Used to paste an image like a stamp.

**[Eraser]** Erases one object drawn on the screen.

**[Erase all]** Removes all drawn objects.

**[Background]** Sets the background of WhiteBoard.

**[File]** Used to save data, read data, or perform other file handling operations.

**[Exit]** Closes WhiteBoard.

**[Settings]** Used to configure WhiteBoard function and control settings.

**Utilization memory gauge** Memory utilization amount gauge. It extends to the right according to the utilization. It turns red when the remaining amount becomes low.



## ■ Setting menu

The setting menu for the built-in applications including WhiteBoard is as follows.

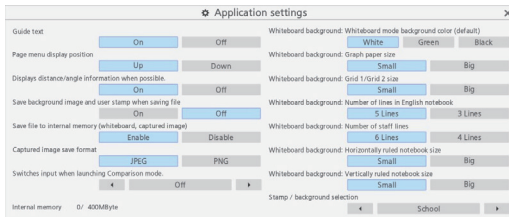

**Guide text:** Used to set the text displayed under the buttons on the Main menu.

**Page menu display position:** Used to set the position at which the page menu is displayed.

**Displays distance/angle information when possible.:**

Used to set the display of information about the length (distance) and angle in line or figure drawing.

**Save background image and user stamp when saving file:**

Used to select whether to save the background image and user stamp used during drawing when saving the file in the pwb format (file for built-in WhiteBoard).

**Save file to internal memory (whiteboard, captured image):**

Used to set saving of target data to internal memory in this unit.

**Captured image save format:** Used to set the format to save screen-captured images.

**Switches input when launching Comparison mode.:**

Used to set the input automatically switched to when the comparison mode application is started up.

**Internal memory \*\*\*/\*\*\* Mbyte:** Displays the utilization and total capacity of the built-in memory.

### Whiteboard background

- **Whiteboard mode background color (default):** Used to set the background colour applied in WhiteBoard mode.
- **Graph paper size:** Used to set the grid cell size of the background graph paper.
- **Whiteboard background: Grid 1/Grid 2 size:** Used to set the cell size.
- **Number of lines in English notebook:** Used to set the number of lines to display on one screen of the background English note.
- **Number of staff lines:** Used to set the number of lines to display on one screen of the background staff notation.
- **Horizontally ruled notebook size:** Used to set the size of the horizontal ruled note.
- **Vertically ruled notebook size:** Used to set the size of the vertical ruled note.

### Stamp / background selection:

Used to switch displayed stamp or background according to the intended use of this unit.

#### Note

- Selecting [Captured image save format] for [PNG] makes the saving / reading speed slow.
- When data is saved with [Save background image and user stamp when saving file] set to [Off], those images will not be displayed when data reference is made on another unit.

## ■ Memory usage and warning

It operates as follows depending on the amount of memory used.

### When memory usage exceeds 60%:

The following warning message will be displayed.

[Memory usage has exceeded 60%. Data cannot be written if it exceeds 80%.]

### When memory usage exceeds 80%:

The following warning message will be displayed.

[Memory usage has exceeded 80%. You can continue using the whiteboard, but cannot add pages or write data. Save the file and restart the whiteboard.]

## How to perform pen drawing

Select a function in the main menu before starting drawing.

### 1 Click a drawing button.

**Pen / Marker / Line / Shape / Stamp**

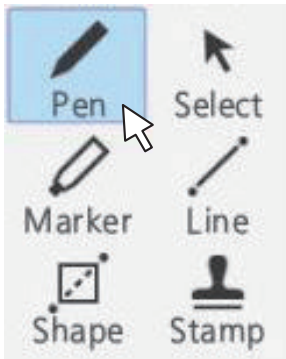

### Changing drawing settings

The colour and thickness of the Pen and Marker can be changed separately.

The Shape and Line colours are the same as the pen settings.

The changed items are displayed in the palette menu, and are displayed in tabs for each category.



Colour select

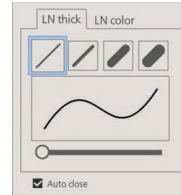

Thickness select

The slider allows you to freely set the thickness of the pen. You can check how thick it is on the preview screen.

### 2 Draw on the display.



### ■ Erasing a drawn object

To remove a small part

### 1 Click [Eraser].

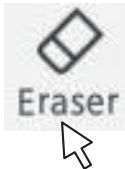

### 2 Drag the mouse and trace the part to erase.

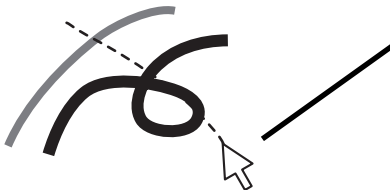

### 3 The drawing object of the traced part is selected and displayed.

#### 4 Drop the mouse, and the lines of the traced part are erased by the object drawn.

All are cleared.  
(By drawing object)

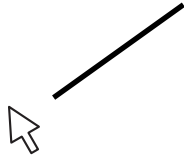

#### Note

- It is not possible to delete only part of a drawing object. If you accidentally delete one, Click the [Undo] button on the menu to restore it.

To clear all

**Click [Erase all].**

All the drawn objects are removed.



## Selecting the mode

Click [Whiteboard] or [Transparent] on the main menu to switch the drawing mode.

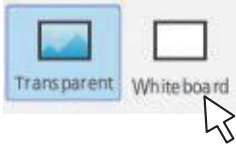

**Transparent:** Switches to transparent mode

**Whiteboard:** Switches to WhiteBoard mode

The input does not switch to [WHITEBOARD].

### Note

- When the input is [WHITEBOARD], only the WhiteBoard mode can be used. It is not possible to change the mode.

## Saving pen drawings (File menu)

Drawings can be saved in the internal memory or USB memory together with the background image, and read as a page.

USB memories are used by connecting to the USB terminal on the display.

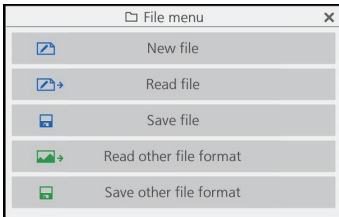

**New file:** Creates a new project file.

**Read file:** Loads a saved project file.

**Save file:** Saves created data in a file.

**Read other file format:** Reads image data in a format other than the project file format, image data saved sequentially for each page, and PDF.

**Save other file format:** Saves data on WhiteBoard in image format and PDF format, which are saved sequentially for each image and page.

### Note

- For security reasons, it is recommend to delete the stored files after using the internal memory.

### Format of saved files

Pages are managed in files and are stored in the internal memory and USB memory.

Normally, all page / drawing objects are saved in one file in a proprietary format called "pwb".

Files are normally named in the form of "Wbyyyymmdd-\*\*\* (serial number) .pwb".

It is also possible to save files in JPEG format for each page.

In that case, save using single image save / sequentially numbered images save.

## File menu operation

The setting menu for WhiteBoard is illustrated below:

### New file (no change in advance)

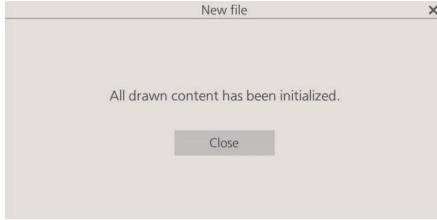

### New file (drawing data changed)

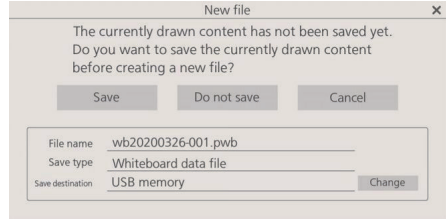

Select [New file] to create a new file. At that time, if any changes have been made on WhiteBoard in advance, a dialog prompting you to save the data will be displayed. Click [Do not save] to discard the current drawing objects without saving them and create a new one.

## Read file

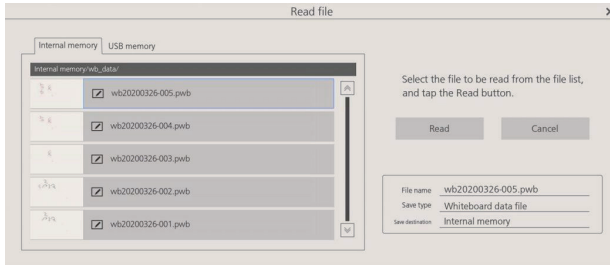

Loads created whiteboard data (pwb).

On the left pane, you can select [Internal memory] or [USB memory] for the source to load data from.

When you select a file, the file name, format, and location are displayed at the lower right.

Click [Read] to load the selected data and display it on WhiteBoard.

## Save file

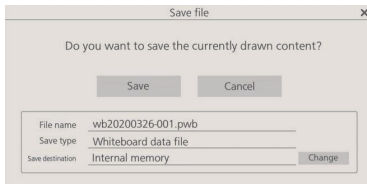

Saves the current drawing objects. For the destination, [Internal memory] or [USB memory] is selectable.

### Note

- If you want to print the drawing object on WhiteBoard, you can save it to a USB memory in the PDF format and print it from a PC. (see page 146)

## Read other file format

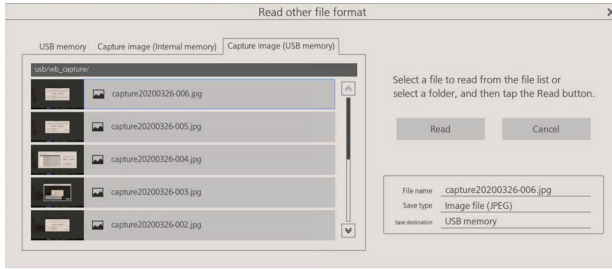

Loads a file in a format other than the pwb format. Usable formats are “JPEG”, “PNG”, “SVG”, “PDF”, and folder (all loadable images in the folder are loaded).

On the left pane, you can select capture data or USB memory for the location from which a file is loaded. When you select a file, the file name, format, and location are displayed at the lower right.

Click [Read] to load the selected data and display it on WhiteBoard.

While selecting USB memory, double click the folder name displayed in the file list on the left to move to that folder.

## Save other file format

### Single image

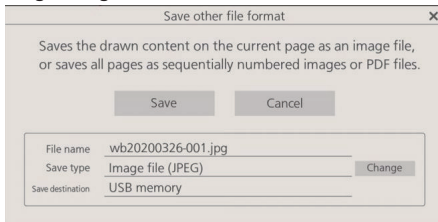

### Sequentially numbered images

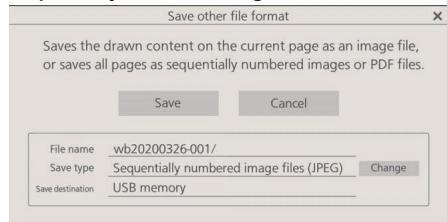

Drawn whiteboard data is saved. For the destination, only [USB memory] is selectable. The usable save formats are [Image file (JPEG)], [Image file (PNG)], [PDF file], [Sequentially numbered image files (JPEG)], and [Sequentially numbered image files (PNG)].

### Note

- With PDF, all pages are saved in one file.
- For sequentially numbered images, files are created for each page in the specified format and saved in the displayed folder.

## Switching the drawing page (Page menu)

When drawing with the WhiteBoard function, you can add a page.

Use the Page menu at the right and left on the top or bottom of the screen to add or move pages.



Click < and > to switch and display the project data pages in order.

The number on the left indicates the current page number, and the number on the right indicates the last page number.

Click ▲ to display a list of thumbnails.

Click ► to minimize the Page menu.

# Using the simple drawing function

In addition to the WhiteBoard function, this unit has a “simple drawing function” that allows you to make drawings easily with a pen or marker.

- It operates under the following conditions where WhiteBoard cannot be used:
  - When USB input is active
  - When the comparison mode is activated

## Simple drawing function

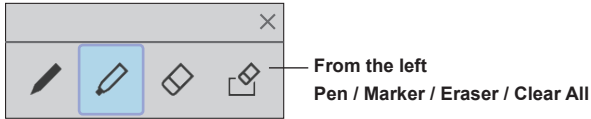

- The color of the pen and marker is set to the color selected in the Control menu.
- Eraser erases a zone to which it is applied. (This is different from the WhiteBoard operation.)
- Drawing data is deleted when the screen is refreshed.
- Drawing data cannot be saved. (It becomes a function to draw temporarily.)

### Note

- [Capture] during the simple drawing function is active gets captures excluding video parts (drawing contents, etc.).
- The range where the simple drawing function can draw is different from that of the WhiteBoard function.

# Using Comparison mode

Use the Comparison mode function to compare the image from the real projector with the data on the internal memory or USB memory.

## ■ About Comparison mode

- When starting this function, it is possible to automatically switch to the input to which a real projector is connected. (see page 141)
- When comparing using a USB memory, the first one inserted is valid.

## Activating the Comparison mode function

Select **App Launcher** in the **Control menu** and click **[Comparison mode]** from the launcher to launch it.

When it is started, the following screen is displayed:

[Comparison mode] menu

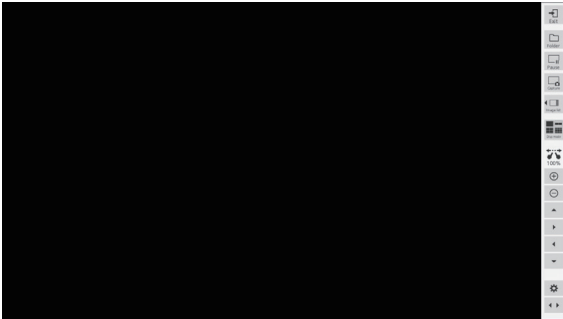

The Comparison mode has the following functions:

## Capturing a video

Capture the video displayed on the screen and saves it into the internal memory and USB memory.



Click the **[Capture]** button in the comparison mode menu

The video at the time of clicking is captured and saved in the internal memory and USB memory.

**On one screen:** Only the video is captured.

**On a screen other than one screen (on a split display, during simple drawing, etc.):**

All other than video parts (drawing contents, etc.) are captured.

During zooming, simple drawing, split screen, and image display, screen shots including drawing contents are saved.

When saving, the captured image is displayed on the screen.

The save destination is the captured image folder. The folder that opens by default changes depending on whether or not a USB memory device is used.

### Note

- Because there is a gap between the click of the [Capture] button and the actual capture timing, it may not be possible to capture the intended image for a movie with large actions.
- If you click [Image list] or [Disp mode] before selecting a comparison image, only the data captured on the Live 1 screen will be displayed in the new order. To display other captured data, select it using the comparison image selection function.



## Displaying a captured image

Select a captured image and display it on the screen.

Click the **[Image list]** button in the **[Comparison mode]** menu



Click to display a list of captured images inside the menu.



If you click the image part of the displayed image list, the image will be enlarged on the screen.

If the displayed image list does not fit on the screen, use the up and down arrows to switch.



Go to the first page



Move forward by one page



Move back by one page



Go to the last page

## Changing screen mode

Switch the screen display to 1/2/4/9 screens.

Click the **[Disp mode]** button in the **[Comparison mode]** menu



Click it to change the screen display pattern.

Each time you click, the number of screen splits changes from 1 → 2 → 4 → 9 → 1.

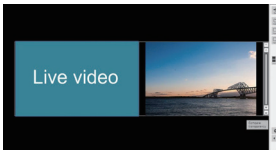

2-split screen

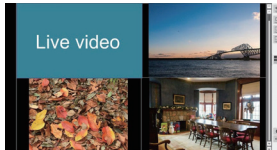

4-split screen

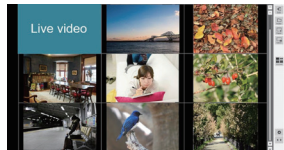

9-split screen

On a split screen, the live video is displayed on the left pane (when the 2-split screen) / upper left pane (when other than the 2-split screen).

If the displayed image list does not fit on the screen, use the up and down arrows to switch.

**Overlaying two data layers transparently to compare them (valid only when displaying a 2-split screen)**

Click the **[Compare transparency]** button



You can compare two data layers by overlaying them transparently.

In this mode, the slider for setting the degree of transparency is displayed in the **[Comparison mode]** menu and can be adjusted.

Click the **[Return]** button at the top right of the menu to return to the regular 2-split screen.

### Note

- The live video display function cannot be used when an arbitrary folder on a USB memory is specified.

## Selecting an image file for comparison

Select an image file to compare.

Click the **[Folder]** button in the **[Comparison mode]** menu



The image file selection screen is displayed.

At that time, the **[Comparison mode]** menu is disabled.



The image file selection pane is displayed on the left side of the screen, and the image files of the selected folder are displayed on the right side.

There are two types of image file selection, **[Capture]** and **[USB memory]**, which can be switched and selected on the **TAB** display.

### **[Capture]** image

Select **[Internal memory]** or **[USB memory]**. When selected, a list of captured images in the memory is displayed on the right side of the screen.

### **[USB memory]** image

Double click a folder to move to the folder.

The image file list in the selected folder is displayed on the right side of the screen.

#### **Note**

- To go back to the folder by one level above, select “..”.
- If the displayed image file list does not fit on the screen, use the up and down arrows to switch.

### **Selecting whether to display live video**

Select whether to make one of the comparison images (left/upper left) live video.

Click the **[Enable live]** check box to display the live image on the left or upper left when making a comparison. When unchecked, only the selected image is displayed.

### **Selecting an image**

Select to narrow down the images used for comparison from the images in the selected folder.

The image is selected by clicking the check box on the upper right of the image displayed on the right. Click again to cancel the selection.

Click the **[Select all/Deselect all]** check box to select/deselect all images in the folder together.

Click **[OK]** with images selected; the normal comparison mode screen is displayed with the images selected.

Click **[Cancel]** to go back without the images selected.

## Expanding / Shrinking the screen

You can expand the screen display.

A zoom icon is displayed when zooming is enabled.



Zoom enabled / Magnification display



Expand



Shrink



Move up



Move right



Move left



Move down

### Note

- Use "Expand/Shrink" button to zoom up/down the screen.
- Use the 4-way move button to move the image in that direction.
- When the zoom function is canceled, the magnification returns to 100%.
- The zoom is canceled when the display mode (Disp mode) is changed.

## Drawing on screen

Click the pen button in the Control menu while the comparison mode is set

















A simple drawing menu is displayed instead of the comparison mode menu.

### Note

- It is different from the drawing function of WhiteBoard. (Simple drawing function see page 147)
  - Pen and marker can be selected for drawing.
  - The colors available for drawing are limited (4 colors. Related with the pen button color in the Control menu).
  - If you perform an operation other than drawing, all drawn data will be erased.
- Drawing data written using the simple drawing function will not be zoomed. However, if you have already zoomed, the magnification will be retained.

### [Comparison mode] menu commands

	<b>[Exit]:</b> Quits Comparison mode
	<b>[Folder]:</b> Displays the data selection screen.
	<b>[Pause]:</b> Pauses the video on the display screen.
	<b>[Capture]:</b> Captures the displayed image. (Menus and other UI objects cannot be captured. The zoom is applied to image-capturing.)
	<b>[Image list]:</b> Displays a data list for comparison when the screen is set to one screen.
	<b>[Disp mode]:</b> Switches the number of screen splits. The number of screen splits changes each time you click it (1 → 2 → 4 → 9 → 1).
	<b>Zoom magnification display</b>
	<b>Expand</b>
	<b>Shrink</b>
	<b>Move up</b>
	<b>Move right</b>
	<b>Move left</b>
	<b>Move down</b>
	<b>Settings:</b> Displays the application setting screen.
	<b>Switch menu display position:</b> Switches the menu display position (right / left).

# Performing a capture operation

## 1 Start “App Launcher” from the control menu.



## 2 Start [Capture] from App Launcher.

Capture App will start.

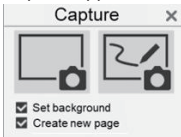

## 3 Click the Capture button (on the right or left)

An image is captured according to the function.

The capture function of this unit has the following two modes:

**Video only (left button): Captures only a video, not including drawings on WhiteBoard**

Screen shots are saved during zooming, simple drawing, screen splitting, or image display is active.

With USB input, screen shots are always saved.

**WhiteBoard capture (right button): Captures an image, superimposing drawing on WhiteBoard on it**

**[Set background]:**

Sets the captured image to the background of the WhiteBoard page when checked.

**[Create new page]:**

Sets the captured image to the background of a new page when checked. When it is not checked, it will be set to the background of the current page.

### Note

- This item is valid only when [Set background] is checked.

The operating conditions for both modes are as described below. When it is disabled, it will be grayed out and you cannot click it.

Status	Video only button	WhiteBoard Capture button	[Set background] checked	[Create new page] checked
WhiteBoard not activated	Enabled	Disabled	Disabled	Disabled
WhiteBoard activated (WhiteBoard mode)	Disabled	Enabled	Disabled	Disabled
WhiteBoard activated (Transparent mode)	Enabled	Enabled	Enabled	Disabled
WhiteBoard activated (Transparent mode + [Set background] checked)	Enabled	Enabled	Enabled	Enabled

When you click a capture button, the captured image file is saved.

The file is saved in the USB memory when a USB memory is connected, and in the internal memory when it is not connected.

A dialog is displayed when a file is saved.

### Note

- The capture operation during simple drawing is different. (see page 147)
- Depending on the settings, colors of the captured data may differ from those of the original image.

# Using the video mask function

---

## 1 Start “App Launcher” from the control menu.



## 2 Start [Mask picture] from App Launcher.

Two functions are available.

### Spotlight mode

The entire screen is masked and a part is cut out in a square to show the image.

You can move it by dragging and pinch the four corners to change the size.

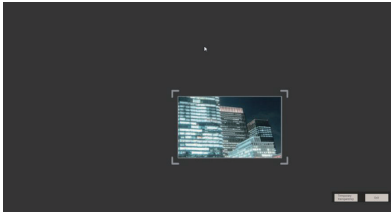

### Shade mode

Sliding the mask, show the screen little by little.

You can adjust the mask width of the full screen width by pinching the four corners.

Also, you can move the mask position by pinching other positions.

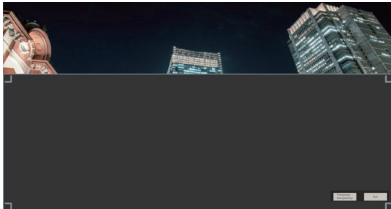

# Use various application functions

This unit has various other built-in applications.

A list is displayed on App Launcher.

## File Utility

It exchanges data between the internal memory and USB memory.

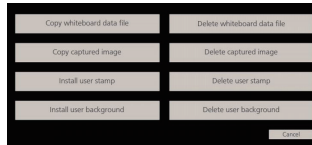

Selecting a function displays the screen for it.

- Copy whiteboard data file:** Copies saved data on built-in WhiteBoard.
- Delete whiteboard data file:** Deletes saved data from built-in WhiteBoard.
- Copy captured image:** Copies the captured image data.
- Delete captured image:** Deletes the captured image data.
- Install user stamp:** Copies the user stamp to be added from a USB memory to the internal memory.
- Delete user stamp:** Deletes the user stamp in the internal memory.
- Install user background:** Copies the user background to add to the internal memory from a USB memory.
- Delete user background:** Deletes the user background in the internal memory.
- Cancel:** Quits the menu.

### Note

- The supported formats that can be installed with user data are as follows:
  - JPEG, PNG, SVG
- It is recommend to use square size stamp data. (For other formats, margins are added.)

## Calculator

Allows you to perform simple calculations using only the four arithmetic operations.



## Stopwatch

Provides a stopwatch function.

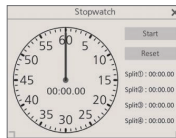

## Clock

Displays a clock on the screen.

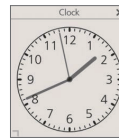

### Note

- To display the clock, set [Date and time].

## Clock learning mode

Displays a clock model used in arithmetic classes. The big and small hands can be operated manually, and one hand rotates in conjunction with the other hand.

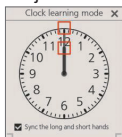

## Timer

Displays a count-down timer. It can be set up to 2 hours, and it counts down in 1 second steps.

At 0 second, the alarm dialog is displayed.

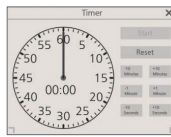

# Using the WhiteBoard function (Mouse Annotation)

Connecting a mouse to this unit enables operations of the WhiteBoard menu.

Also, the zoom function can be operated using the mouse wheel.

## Note

- The WhiteBoard menu does not support vertical installation of the main unit and image rotation.

## Mouse menu

When the mouse is connected, the setting menu is displayed by right-clicking.

Other than WHITEBOARD input

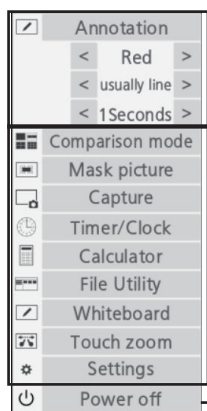

[Annotation] setting  
Makes the marker settings.  
Drawing color setting:  
[Red], [Blue], [Yellow], and [Black]  
Line thickness setting:  
[usually line], [thick line], and [thin line]  
Setting of the time until erasure

Mask picture  
Capture  
Timer/Clock  
Calculator  
File Utility  
Whiteboard  
Touch zoom  
Settings  
Power off

App launcher and settings (see page 155)  
Turns off the power.

WHITEBOARD input

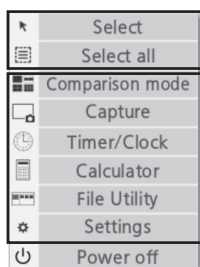

Select  
Select all  
Comparison mode  
Capture  
Timer/Clock  
Calculator  
File Utility  
Settings  
Power off

Sets the object selection method.  
App launcher and settings (see page 155)  
Turns off the power.

## Screen zoom

Operating the mouse wheel enlarges or reduces an image.

### Zoom in

Forward rotation of the wheel

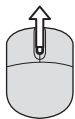

### Zoom out

Backward rotation of the wheel

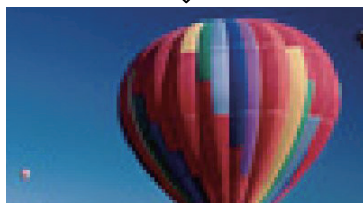



## Annotation

A marker is drawn by moving the mouse while left-clicking.

The drawn marker is erased after the time set on the menu has elapsed.

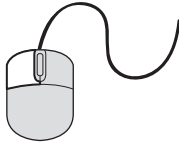
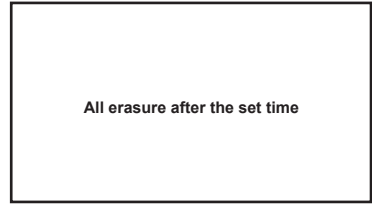
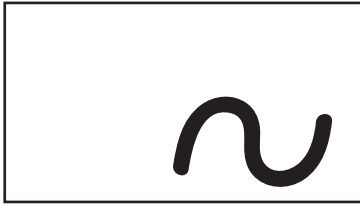

1. A marker is drawn by moving the mouse while left-clicking in [Annotation] operation state.
2. After drawing is complete, all drawing is erased after the set time has elapsed

### Note

- Drawing is not possible while the app is starting up.
- The pen icon works as a color selection button for [Annotation] until timeout after drawing.

## Multi-mouse support

Annotation is enabled with multiple mice.

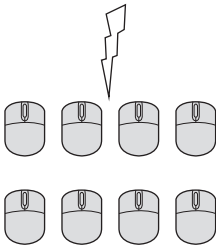
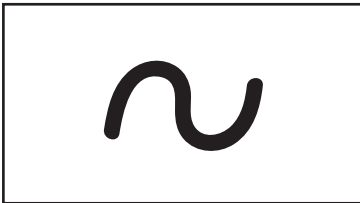

### Note

- When mice more than the number of the USB terminals are connected, a USB hub is required.
- Up to 8 mice can be connected. However, simultaneous annotation is possible with one mouse only.
- When one mouse is performing annotation, other mice do not operate.

# Using HDMI-CEC function

The HDMI-CEC function enables the remote control of this unit alone to operate the basics of HDMI-CEC compatible devices by the interlocking control between this unit and such devices. Also, this function enables the remote control (or main unit's buttons) of a HDMI-CEC compatible device alone to turn on/off this unit and switch input.

## Connection example

Connect the HDMI-CEC compatible device to the HDMI IN 1, HDMI IN 2, HDMI IN 3 or SLOT terminal.

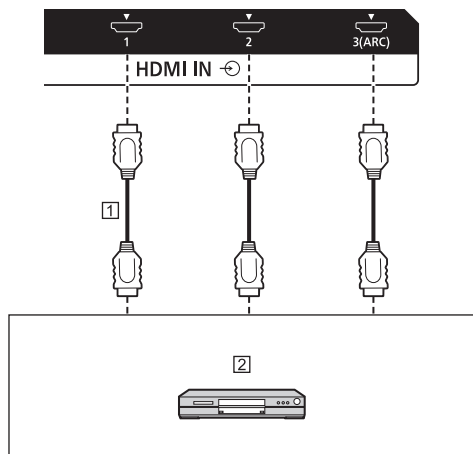

① HDMI cable (commercially available)

② Blu-ray disc player

## Setting

- ① Make the setting on the connected device (HDMI-CEC compatible device) so this function can operate.
- ② Set [HDMI-CEC settings] - [HDMI-CEC control] to [Enable]. (see page 65)
- ③ Turn on all the devices, and turn this unit off and on. Then check if images can be seen correctly with HDMI1, HDMI2, HDMI3 or SLOT input.

## Interlocking devices

Performs the following interlocking operations by setting each item of [Link function] for [HDMI-CEC settings].

### ■ [Display → Device] interlocking

- **When set to [Power off] or [Power off / on]:**  
Turning this unit off turns off all the connected HDMI-CEC compatible devices.
- **When set to [Power off / on]:**  
Turning this unit on turns on the HDMI-CEC compatible device connected to [HDMI1], [HDMI2], [HDMI3] or [SLOT] when the input is [HDMI1], [HDMI2], [HDMI3] or [SLOT].
- Switching the input of this unit to [HDMI1], [HDMI2], [HDMI3] or [SLOT] turns on the connected HDMI-CEC compatible device.

### Note

- When multiple devices are connected with the [HDMI1], [HDMI2], [HDMI3] or [SLOT] input and this unit is turned on with the [Power off / on] setting, the device that was viewed or listened last is turned on.
- When this unit is turned on with the [Power off / on] setting and the device that was viewed or listened last with the [HDMI1], [HDMI2], [HDMI3] or [SLOT] input is not connected, a device displayed for [HDMI1], [HDMI2], [HDMI3] or [SLOT] of [HDMI-CEC settings] is turned on.

### ■ [Device → Display] interlocking

**When set to [Power on] or [Power off / on]:**

- Turning on the HDMI-CEC compatible device turns this unit on, and switches the input to [HDMI1], [HDMI2], [HDMI3] or [SLOT] to which the device is connected.
- Starting to play back on the HDMI-CEC compatible device turns this unit on, and switches the input to [HDMI1], [HDMI2], [HDMI3] or [SLOT] to which the device is connected.
- Starting to play back on the HDMI-CEC compatible device switches the input of this unit to [HDMI1], [HDMI2], [HDMI3] or [SLOT] to which the device is connected.

**When set to [Power off / on]:**

- Turning off the HDMI-CEC compatible device of input (HDMI1 / HDMI2 / HDMI3 / SLOT) with which you are currently viewing or listening turns off this unit.

### Note

- The device interlocking function, which turns off this unit, realizes the interlocking operations by monitoring signal statuses of devices.

Depending on the setting, the device continues to output signals even in the power-off state. In this case, the interlocking function does not operate.

In this case, refer to the manuals of the devices.

- Input will not be switched when [Setup] - [Input lock] is set.
- Depending on the display status or video equipment status, such as during start-up, the interlocking operation may not be performed.

## Operating a device (using the remote control of this unit)

Display the operation screen in [Setup] - [HDMI-CEC settings] - [HDMI-CEC operation].

### Operation screen

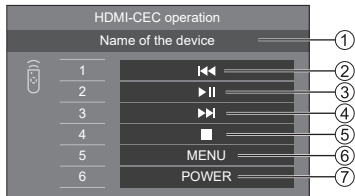

- ① Displays the name of the device to operate.
- ② Plays from the position where programs or scenes are skipped backward by the number of pressed times.
- ③ Play/Pause (Toggle operation)
- ④ Plays from the position where programs or scenes are skipped forward by the number of pressed times.
- ⑤ Stop
- ⑥ Displays the setting menu of the device.  
([MENU code] (see page 65))
- ⑦ Controls the power of the device.

#### Note

- It is possible to operate HDMI-CEC compatible device with the numeric buttons <1> to <6>.

## Menu operation of HDMI-CEC compatible devices

When the setting menu of the HDMI-CEC compatible device is displayed, it is possible to operate the menu with the remote control of this unit (<ENTER>, ▼▲◀▶, <RETURN>).



#### Note

- It is not possible to operate the menu of the HDMI-CEC compatible device in the following condition.
  - When the menu ([Setup] / [Picture] / [Sound] / [Position]) or submenu of this unit is displayed

# Using ARC function

ARC (Audio Return Channel) is a function that sends digital audio signals from an HDMI terminal.

It is a function that enables the audio input into the HDMI terminal, audio input terminal, etc. of this unit to be sent to an ARC-compatible device, on behalf of the built-in speaker or external output.

## Connection example

Connect an ARC-compatible device to the HDMI IN 3 terminal.

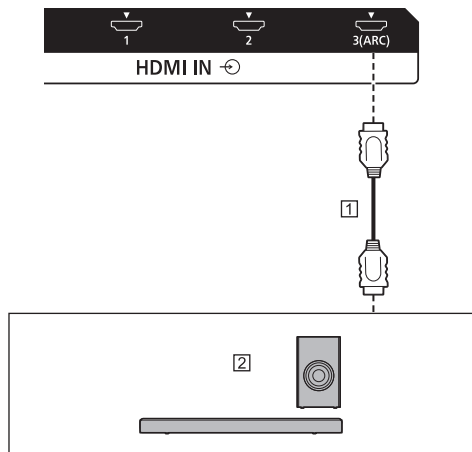

① HDMI cable (commercially available)

② ARC-compatible audio device

## Setting

- ① Make the setting on the connected device (ARC-compatible device) so this function can operate.
- ② Set [Setup] - [HDMI-CEC settings] - [HDMI-CEC control] to [Enable]. (see page 65)
- ③ Set [HDMI-CEC settings] - [Link function] - [ARC] to [Auto] or [On].
- ④ Turn on all the devices, and turn this unit off and on. Then ensure that audio input into this unit or audio of reproduced video, etc. is correctly played back on the ARC-compatible device.

## Switching audio output destination

Performs the following operations by setting [ARC] related items for [HDMI-CEC settings].

### ■ [ARC]: [Auto]

- When the ARC-compatible device is connected to the HDMI IN 3 terminal:  
Outputs audio from the ARC-compatible device.
- When the ARC-compatible device is not connected to the HDMI IN 3 terminal, or the ARC-compatible device is not turned on:  
Outputs audio to the output destination set for [Sound] - [Output select].

### ■ [ARC]: [On]

- Always outputs audio from the ARC-compatible device.
- When the ARC-compatible device is not connected, audio is not output.

### ■ [ARC]: [Off]

- Always outputs audio to the output destination set for [Sound] - [Output select].
- Even if the ARC-compatible device is connected to the HDMI IN 3 terminal, audio is not output to the ARC-compatible device.

### Note

- When audio is played back on the ARC-compatible device, audio is not output from the built-in speaker or external output. The setting items in [Sound] are grayed out, and cannot be set.
- When switching audio output to the built-in speaker or the external output, set [Setup] - [HDMI-CEC settings] - [ARC] to [Off].
- When the ARC-compatible device is operated using the buttons or remote control of the ARC-compatible device, such operations may not be reflected in the display operation or on the display.
- When the ARC-compatible device is disconnected from or connected to the display, be sure to turn off/on the power of this unit.
- When the ARC-compatible device is connected and [ARC] is set to [Auto] or [On], the ARC-compatible device is turned on regardless of the setting of [Display → Device].

# Using data cloning

Menu settings and adjusted values of a single display can be copied to multiple displays by using a USB memory or via LAN.

## Note

- If the sizes of the displays are different, the cloning function does not operate. Use the common sized displays.
- Set the input to something other than [USB], [MEMORY VIEWER] or [WHITEBOARD], and perform the data cloning.
- The cloning password is the one set for [Cloning password].
- The initial password in the factory default state is [AAAA].
- The remote control is necessary to operate [LAN data cloning].

## ■ Data that can be copied

Settings and set values of [Picture], [Sound], [Setup] and [Position] menus

User image registered in [Setup] - [Image settings]

The following contents of the [Detailed set up] page on the Web control screen

[Status notification set up]

Settings for built-in applications such as WhiteBoard

- The following data cannot be copied. Setting is required for each display.

[Cloning password]

[Security password]

[Date and time]

[Network settings] - [Administrator account settings]

[Network settings] - [PJLink settings]

[Network settings] - [Display name]

Setting for [Network settings] - [LAN setup]

[Synchronize display setting]

[Time zone]

[NTP synchronization]

NTP server name

DNS server

[Control settings] - [Display ID]

The setting contents of the [Change password] page on the Web control screen

The following contents of the [Detailed set up] page on the Web control screen

[Network config]

[Adjust clock]

[Command port set up]

[Certificate]

[Crestron Connected]

[HTTPS set up]

The setting contents of the [Crestron Connected] page on the Web control screen

Content in the internal memory

## ■ Supported device

- Commercially available USB memory devices are supported. (Those with security functions are not supported.)
- USB memory devices other than those formatted in FAT16 or FAT32 cannot be used.
- Up to 32 GB of USB memory in size are supported.
- Only single partition configuration is supported.

## Copying the display data to the USB memory

- 1 Insert the USB memory device to the USB terminal on the side of the display.

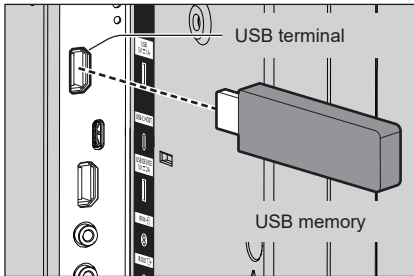

### Note

- Depending on the type of a USB memory device, it may come in contact with the periphery such as a back cover, and cannot be attached. Use a USB memory device connectable to this unit.
- Failure to save in or read from the USB memory device displays an error message.

- 2 After the [Cloning password] screen is displayed, go to the step 6.

When the [Cloning password] screen is not displayed, follow the steps 3 to 5 to display.

- 3 Display [Setup] menu pressing <SETUP>.

- 4 Select [Options] with ▲ ▼ and press <ENTER>.

The following display appears.

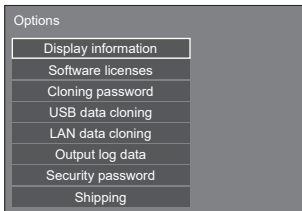

- 5 Select [USB data cloning] with ▲ ▼ and press <ENTER>.

[Cloning password] screen is displayed.

- 6 Enter the cloning password, and then press <ENTER>.

Data cloning screen is displayed.

- 7 Select [Display → USB memory] with ▲ ▼ and press <ENTER>.



- 8 Select [Yes] with ◀ ▶ and press <ENTER>.

Data copy to the USB memory starts.

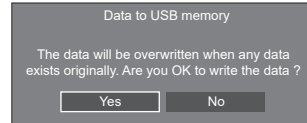

The following message is displayed after data copy has finished.

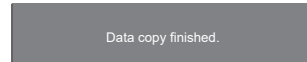

- 9 After data copy has finished, remove the USB memory device from the USB terminal.

## Copying (cloning) the USB memory data to the display

- 1 Insert the USB memory device, which the data has been copied, to the USB terminal of the display for data copy (same as the step 1 on page 162).

- 2 After the [Cloning password] screen is displayed, go to the step 6.

When the [Cloning password] screen is not displayed, follow the steps 3 to 5 to display.

### Note

- If the USB memory containing the data for cloning is connected in power-on state, the [Cloning password] screen is displayed.

- 3 Display [Setup] menu pressing <SETUP>.

- 4 Select [Options] with ▲ ▼ and press <ENTER>.

The following display appears.

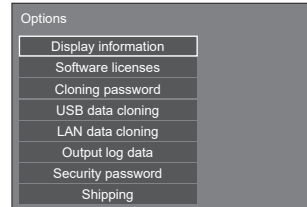

- 5 Select [USB data cloning] with ▲ ▼ and press <ENTER>.

[Cloning password] screen is displayed.

**6 Enter the cloning password, and then press <ENTER>.**

Data cloning screen is displayed.

**7 Select [USB memory → Display] with ▲ ▼ and press <ENTER>.**



**8 Select [Yes] with ◀ ▶ and press <ENTER>.**

Data cloning to the display starts.

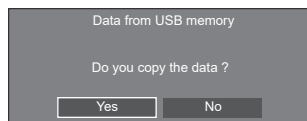

The following message is displayed after data cloning has finished.

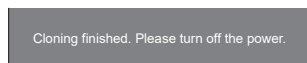

**9 After data cloning has finished, remove the USB memory device from the USB terminal.**

**10 Press the power button on the remote control to turn the power off, and then turn the power on. Or remove the power plug from the outlet once, wait for 30 seconds or more, and then insert the power plug.**

The cloned content is applied to the display.

- When USB memory is not removed in the step 9, the [Cloning password] screen is displayed.

## Copying data to other display via LAN

**1 Display [Setup] menu pressing <SETUP>.**

**2 Select [Options] with ▲ ▼ and press <ENTER>.**

The following display appears.

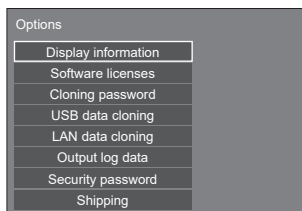

**3 Select [LAN data cloning] with ▲ ▼ and press <ENTER>.**

[Cloning password] screen is displayed.

**4 Enter the cloning password, and then press <ENTER>.**

[LAN data cloning] screen is displayed.

**5 Select [Select display] with ▲ ▼ and press <ENTER>.**

Displays on the same subnet are listed.

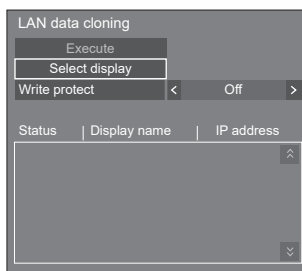

**6 Select the display to copy the data to with ▲ ▼ and press <VOL +>.**

Select all the displays to copy the data to.

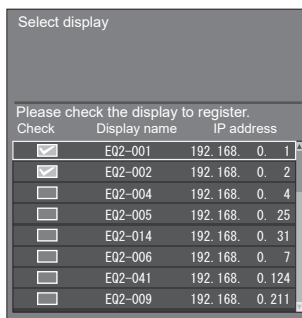

## 7 Press <ENTER>.

## 8 Select [Execute] with ▲▼ and press <ENTER>.

LAN data cloning

Execute

Select display

Write protect Off

Status	Display name	IP address
<input checked="" type="checkbox"/>	E02-001	192.168.0.1
<input checked="" type="checkbox"/>	E02-002	192.168.0.2
<input checked="" type="checkbox"/>	E02-004	192.168.0.4
<input checked="" type="checkbox"/>	E02-005	192.168.0.25
<input checked="" type="checkbox"/>	E02-014	192.168.0.31
<input checked="" type="checkbox"/>	E02-006	192.168.0.7
<input checked="" type="checkbox"/>	E02-041	192.168.0.124
<input checked="" type="checkbox"/>	E02-009	

### Note

- Data cannot be copied to the display for which [Write protect] is set to [On]. Set this to [On] to prevent [LAN data cloning] from being performed mistakenly when data copy is not necessary.
- Once [LAN data cloning] is performed, [Write protect] is set to [On].

## 9 A confirmation window appears.

### Select [Execute] with ◀▶ and press <ENTER>.

LAN data cloning

All data for the selected displays will be changed.

Are you sure you want to execute?

Execute Return

Data copy to the display starts.

LAN data cloning

DO NOT unplug your Display!

Cloning in progress, please wait.

## 10 The exit screen appears.

The blue mark on the list shows the data has been copied successfully. The red mark shows failure. If the red mark appears, check the LAN cable connection or power status of the display of the copy destination.

LAN data cloning

Cloning finished.

Status	Display name	IP address
<input checked="" type="checkbox"/>	E02-001	192.168.0.1
<input checked="" type="checkbox"/>	E02-002	192.168.0.2
<input checked="" type="checkbox"/>	E02-004	192.168.0.4
<input checked="" type="checkbox"/>	E02-005	192.168.0.25
<input checked="" type="checkbox"/>	E02-014	192.168.0.31
<input checked="" type="checkbox"/>	E02-006	192.168.0.7
<input checked="" type="checkbox"/>	E02-041	192.168.0.124
<input checked="" type="checkbox"/>	E02-009	192.168.0.211

If the data copy has finished, the message appears on the display of the copy destination.

Cloning finished. Please turn off the power.

## 11 Press the power button on the remote control to turn the power off, and then turn the power on. Or remove the power plug from the outlet once, wait for 30 seconds or more, and then insert the power plug.

The copied content is applied to the display.

### Note

- When a display with IPv6 address is connected in LAN data cloning operation, the IP address is displayed as (IPv6). Note that if the display can communicate with both IPv4 and IPv6, the IPv4 address is displayed.

Select display

Please check the display to register.

Check	Display name	IP address
<input checked="" type="checkbox"/>	E02-001	192.168.0.1
<input checked="" type="checkbox"/>	E02-002	192.168.0.2
<input type="checkbox"/>	E02-004	(IPv6)
<input type="checkbox"/>	E02-005	192.168.0.25
<input type="checkbox"/>	E02-014	192.168.0.31
<input type="checkbox"/>	E02-006	192.168.0.7
<input type="checkbox"/>	E02-041	192.168.0.124
<input type="checkbox"/>	E02-009	192.168.0.211



## Changing the cloning password

Changes the cloning password required to use the cloning function.

- 1 Display [Setup] menu pressing <SETUP>.
- 2 Select [Options] with ▲▼ and press <ENTER>.

The following display appears.

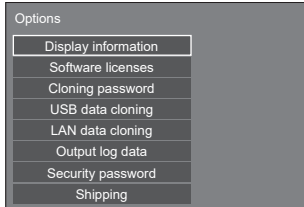

- 3 Select [Cloning password] with ▲▼ and press <ENTER>.  
[Cloning password] screen is displayed.
- 4 Enter the current password, and press [Ok].
- 5 Enter the new password, and press [Ok].
- 6 Enter the new password again for confirmation, and press [Ok].

### Note

- The initial password in the factory default state is [AAAA].
- Change the password periodically, and set one which is difficult to guess.
- For initialization method for the cloning password, consult the dealer where you purchased the product.

# USB memory network settings

Using a USB memory device, the network setting can be made for multiple displays.

## ■ About the setting

The following items in [Network settings] - [LAN setup] can be set.

[IP address], [Subnet mask], [Gateway], [Command port], [EAP]

### Note

- [Network settings] - [LAN setup] - [DHCP] is set to [Off].
- [Network settings] - [Network control] is set to [On].
- Make sure that [Network settings] - [USB memory network settings] is set to [Permit].  
If it is set to [Prohibit], network setting cannot be made with this function. (see page 81)
- Once the network setting is done with USB memory device, [Network settings] - [USB memory network settings] is set to [Prohibit].
- Network settings cannot be made with this function during communication with IPv6 setting.

## ■ Supported device

- Commercially available USB memory devices are supported. (Those with security functions are not supported. Operation is not guaranteed.)
- USB memory devices other than those formatted in FAT16 or FAT32 cannot be used.
- Up to 32 GB of USB memory in size are supported.
- Only single partition configuration is supported.
- Use a writable USB memory device.

## Saving the LAN setting file to the USB memory device

Create the following files, and save them to the USB memory device.

File name: **th-55eq2\_network.sh**

Setting Example

```
TH-55EQ2_LAN_SETTINGS
A:192.168.0.18
S:255.255.255.0
G:192.168.0.1
P:1024
I:ON
E:EAP-TLS
E_U:EAPUSER
E_P:eappassword
E_D:digitalcertificate.pfx
E_C:cacertificate.cer
```

### TH-55EQ2\_LAN\_SETTINGS:

Fixed characters represent the model name. Be sure to input as follows.

TH-(inch size)(Model name)\_LAN\_SETTINGS

**A:** Specifies the IP address.

**S:** Specifies the subnet mask.

**G:** Specifies the gateway address.

**P:** Specifies the port number to use for the command control.

**I:** Setting this to [ON] can set individual IP addresses for each main unit.

One IP address is assigned to each main unit in the range that can be specified as an IP address.

**E:** Selects the EAP setting. Describe the setting referring to the following.

- NONE
- PEAP(MS-CHAPv2)
- PEAP(GTC)
- EAP-TTLS(MD5)
- EAP-TTLS(MS-CHAPv2)
- EAP-FAST(MS-CHAPv2)
- EAP-FAST(GTC)
- EAP-TLS

**E\_U:** Specifies the EAP user name. This is referred to only when EAP is set to something other than [NONE].

**E\_P:** Specifies the EAP password. This is referred to only when EAP is set to something other than [NONE].

**E\_D:** Describe the file name of the electronic certificate (extension: PFX) used for authentication. This is referred to only when EAP is set to [EAP-TLS].

**E\_C:** Describe the file name of the CA certificate (extension: CER) used for authentication. This is referred to only when EAP is set to [EAP-TLS].

### Note

- Deleting the rows "S", "G", "P" or "E" will not overwrite the deleted setting items. The original setting contents are retained.
- When the row "I" is deleted, it will be set to [ON] automatically.
- Be sure to fill in the rows of the fixed character and IP address.
- If the network setting fails with this function, an error message is displayed.  
If fails, the network setting is not changed.  
Be sure to confirm the file description, and insert the USB memory device again.
- This function operates only when a file with the above file name exists in the USB memory device.
- Use one-byte alphanumeric characters to describe file contents.

## Copying the USB memory data to the display

- 1 Insert the USB memory device to the USB terminal on the side of the display.**

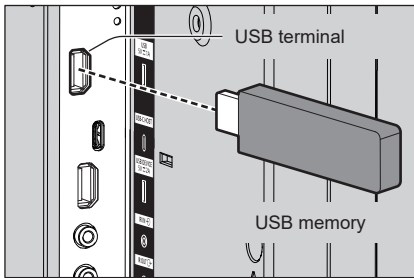

- 2 The [LAN setup] screen is displayed after data copy has finished.**
- 3 Remove the USB memory device from the USB terminal.**

# ID Remote Control Function

You can set the remote control ID when you want to use this remote control on one of several different displays. In that case, you need to set the remote control's ID number to match the Display's ID number you have set in [Control settings] - [Display ID] following the steps below.

## Note

- To operate this function, please purchase ID remote controller sold separately.  
Object model: N2QAYA000093



## Setting the remote control's ID number

- 1 Set [Control settings] - [Controller ID function] to [On].  
(see page 88)
- 2 Set the remote control's <ID MODE> switch to <ON>.
- 3 Pointing the remote control at the Display you want to control, press <ID SET>.

ID set	
Display ID	0
Controller ID	?

- 4 Press one of <0> – <9>.  
Sets the tens digit.
- 5 Press one of <0> – <9>.

Sets the units digit.

- The steps from 3 to 5 need to be done within 5 seconds.
- Adjustable ID number range is 0 – 100.

Example:

- To set the ID to "1": After step 3, press <0> and then <1>.
- To set the ID to "12": After step 3, press <1> and then <2>.
- To set the ID to "100": After step 3, press <1> <0> <0>.

## Cancelling the setting of remote control's ID number (ID "0")

You can operate even if the ID does not match the ID set in [Control settings] - [Display ID].

**Press <ID SET> for more than 3 seconds.**

This has the same effect as pressing <ID SET> <0> <0>.

# Entering characters

Some settings require to enter characters.

To enter text, select characters in the on-screen keyboard.

Example: Entering profile names ([Memory save])



The default profile name is [MEMORY1], here, we are changing it to [MY PICTURE] as an example.

## 1 Select [All delete] with ▲ ▼ ◀ ▶, and press <ENTER>.

MEMORY1

All text is deleted.

To delete individual characters, select [Delete].

## 2 Select [a / A / @] with ▲ ▼ ◀ ▶, and press <ENTER>.



Switches the keyboard to the upper case alphabet.

Each time <ENTER> is pressed, the keyboard is switched in the order of lower case, upper case and symbols.

## 3 Select [M] with ▲ ▼ ◀ ▶, and press <ENTER>.

M

Repeat this process to enter the next character.

## 4 Select Space key with ▲ ▼ ◀ ▶, and press <ENTER>.



Space key

As shown in step 3, select the characters to enter [PICTURE].

## 5 When you finished entering the profile name, select [Ok] with ▲ ▼ ◀ ▶ and press <ENTER>.



- To cancel saving the profile, select [Cancel].

# Preset Signals

This unit can display the video signals shown in the table below.

Corresponding signal	Resolution (Dot)	Scanning frequency		Dot clock frequency (MHz)	Format*2	Plug and Play-supported signal*5							
		Horizontal (kHz)	Vertical (Hz)			HDMI			USB-C			DL	DP
						4K/60p*6	4K/30P	2K	4K/60p	4K/30P	2K		
480/60i	720 x 480i	15.73	59.94	13.50	Y	—	—	—	—	—	—	—	—
576/50i	720 x 576i	15.63	50.00	13.50	Y	—	—	—	—	—	—	—	—
480/60i	720 (1 440) x 480i*1	15.73	59.94	27.00	H/UC/DL	○	○	○	—	—	—	○	—
576/50i	720 (1 440) x 576i*1	15.63	50.00	27.00	H/UC/DL	○	○	○	—	—	—	○	—
480/60p	720 x 483	31.47	59.94	27.00	Y/H/UC/DL	○	○	○	○	○	○	○	—
576/50p	720 x 576	31.25	50.00	27.00	Y/H/UC/DL	○	○	○	○	○	○	○	—
720/60p	1 280 x 720	45.00	60.00	74.25	Y/H/UC/DL	○	○	○	○	○	○	○	—
720/50p	1 280 x 720	37.50	50.00	74.25	Y/H/UC/DL	○	○	○	○	○	○	○	—
1080/60i	1 920 x 1 080i	33.75	60.00	74.25	Y/H/UC/DL	○	○	○	○	○	○	○	—
1080/50i	1 920 x 1 080i	28.13	50.00	74.25	Y/H/UC/DL	○	○	○	○	○	○	○	—
1080/24p	1 920 x 1 080	27.00	24.00	74.25	Y/H/UC/DL	○	○	○	○	○	○	○	—
1080/24PsF	1 920 x 1 080i	27.00	48.00	74.25	Y/H/UC/DL	—	—	—	—	—	—	—	—
1080/25p	1 920 x 1 080	28.13	25.00	74.25	Y/H/UC/DL	○	○	○	○	○	○	○	—
1080/30p	1 920 x 1 080	33.75	30.00	74.25	Y/H/UC/DL	○	○	○	○	○	○	○	—
1080/60p	1 920 x 1 080	67.50	60.00	148.50	Y/H/UC/DL	○	○	○	○	○	○	○	—
1080/50p	1 920 x 1 080	56.25	50.00	148.50	Y/H/UC/DL	○	○	○	○	○	○	○	—
2K/24p	2 048 x 1 080	27.00	24.00	74.25	H/UC/DL	—	—	—	—	—	—	—	—
2K/25p	2 048 x 1 080	28.13	25.00	74.25	H/UC/DL	—	—	—	—	—	—	—	—
2K/30p	2 048 x 1 080	33.75	30.00	74.25	H/UC/DL	—	—	—	—	—	—	—	—
2K/48p	2 048 x 1 080	54.00	48.00	148.50	H/UC/DL	—	—	—	—	—	—	—	—
2K/60p	2 048 x 1 080	67.50	60.00	148.50	H/UC/DL	—	—	—	—	—	—	—	—
2K/50p	2 048 x 1 080	56.25	50.00	148.50	H/UC/DL	—	—	—	—	—	—	—	—
3840 x 2160/24p	3 840 x 2 160	54.00	24.00	297.00	H/UC/DL	○	○	—	○	○	—	○	—
3840 x 2160/25p	3 840 x 2 160	56.25	25.00	297.00	H/UC/DL	○	○	—	○	○	—	○	—
3840 x 2160/30p	3 840 x 2 160	67.50	30.00	297.00	H/UC/DL	○	○	—	○	○	—	○	—
3840 x 2160/60p	3 840 x 2 160	135.00	60.00	594.00	H/UC/DL*4	○	—	—	○	—	—	—	—
3840 x 2160/50p	3 840 x 2 160	112.50	50.00	594.00	H/UC/DL*4	○	—	—	○	—	—	—	—
4096 x 2160/24p	4 096 x 2 160	54.00	24.00	297.00	H/UC/DL	○	○	—	○	○	—	○	—
4096 x 2160/25p	4 096 x 2 160	56.25	25.00	297.00	H/UC/DL	○	○	—	○	○	—	○	—
4096 x 2160/30p	4 096 x 2 160	67.50	30.00	297.00	H/UC/DL	○	○	—	○	○	—	○	—
4096 x 2160/60p	4 096 x 2 160	135.00	60.00	594.00	H/UC/DL*4	○	—	—	○	—	—	—	—
4096 x 2160/50p	4 096 x 2 160	112.50	50.00	594.00	H/UC/DL*4	○	—	—	○	—	—	—	—
640 x 400/70	640 x 400	31.47	70.09	25.18	R/H/UC/DL	—	—	—	—	—	—	—	—
640 x 400/85	640 x 400	37.86	85.08	31.50	R/H/UC/DL	—	—	—	—	—	—	—	—
640 x 480/60	640 x 480	31.47	59.94	25.18	R/H/UC/DL	○	○	○	○	○	○	○	○
640 x 480/67	640 x 480	35.00	66.67	30.24	R/H/UC/DL	—	—	—	—	—	—	—	—
640 x 480/73	640 x 480	37.86	72.81	31.50	R/H/UC/DL	—	—	—	—	—	—	—	—

Corresponding signal	Resolution (Dot)	Scanning frequency		Dot clock frequency (MHz)	Format*2	Plug and Play-supported signal*5							
		Horizontal (kHz)	Vertical (Hz)			HDMI			USB-C			DL	DP
						4K/60p*6	4K/30P	2K	4K/60p	4K/30P	2K		
640 x 480/75	640 x 480	37.50	75.00	31.50	R/H/UC/DL	—	—	—	—	—	—	—	—
640 x 480/85	640 x 480	43.27	85.01	36.00	R/H/UC/DL	—	—	—	—	—	—	—	—
800 x 600/56	800 x 600	35.16	56.25	36.00	R/H/UC/DL	—	—	—	—	—	—	—	—
800 x 600/60	800 x 600	37.88	60.32	40.00	R/H/UC/DL	○	○	○	○	○	○	○	○
800 x 600/72	800 x 600	48.08	72.19	50.00	R/H/UC/DL	—	—	—	—	—	—	—	—
800 x 600/75	800 x 600	46.88	75.00	49.50	R/H/UC/DL	—	—	—	—	—	—	—	—
800 x 600/85	800 x 600	53.67	85.06	56.25	R/H/UC/DL	—	—	—	—	—	—	—	—
832 x 624/75	832 x 624	49.72	74.55	57.28	R/H/UC/DL	—	—	—	—	—	—	—	—
852 x 480/60	852 x 480	31.47	59.94	34.24	H/UC/DL	—	—	—	—	—	—	—	—
1024 x 768/50	1 024 x 768	39.55	50.00	51.89	H/UC/DL	—	—	—	—	—	—	—	—
1024 x 768/60	1 024 x 768	48.36	60.00	65.00	R/H/UC/DL	○	○	○	○	○	○	○	○
1024 x 768/70	1 024 x 768	56.48	70.07	75.00	R/H/UC/DL	—	—	—	—	—	—	—	—
1024 x 768/75	1 024 x 768	60.02	75.03	78.75	R/H/UC/DL	—	—	—	—	—	—	—	—
1024 x 768/82	1 024 x 768	65.55	81.63	86.00	R/H/UC/DL	—	—	—	—	—	—	—	—
1024 x 768/85	1 024 x 768	68.68	85.00	94.50	R/H/UC/DL	—	—	—	—	—	—	—	—
1066 x 600/60	1 066 x 600	37.64	59.94	53.00	H/UC/DL	—	—	—	—	—	—	—	—
1152 x 864/60	1 152 x 864	53.70	60.00	81.62	H/UC/DL	—	—	—	○	○	○	—	—
1152 x 864/70	1 152 x 864	63.99	70.02	94.20	R/H/UC/DL	—	—	—	—	—	—	—	—
1152 x 864/75	1 152 x 864	67.50	75.00	108.00	R/H/UC/DL	—	—	—	—	—	—	—	—
1152 x 864/85	1 152 x 864	77.09	85.00	119.65	R/H/UC/DL	—	—	—	—	—	—	—	—
1152 x 870/75	1 152 x 870	68.68	75.06	100.00	R/H/UC/DL	—	—	—	—	—	—	—	—
1280 x 720/60	1 280 x 720	44.76	60.00	74.48	R/H/UC/DL	—	—	—	○	○	○	—	○
1280 x 768/50	1 280 x 768	39.55	49.94	65.18	R/H/UC/DL	—	—	—	—	—	—	—	—
1280 x 768/60	1 280 x 768	47.70	60.00	80.14	R/H/UC/DL	—	—	—	—	—	—	—	—
1280 x 768/60	1 280 x 768	47.78	59.87	79.50	R/H/UC/DL	—	—	—	—	—	—	—	—
1280 x 800/50	1 280 x 800	41.20	50.00	68.56	R/H/UC/DL	—	—	—	—	—	—	—	—
1280 x 800/60	1 280 x 800	49.31	59.91	71.00	R/H/UC/DL	—	—	—	—	—	—	—	—
1280 x 800/60	1 280 x 800	49.70	59.81	83.50	R/H/UC/DL	—	—	—	○	○	○	—	○
1280 x 960/60	1 280 x 960	60.00	60.00	108.00	R/H/UC/DL	—	—	—	—	—	—	—	—
1280 x 960/85	1 280 x 960	85.94	85.00	148.50	R	—	—	—	—	—	—	—	—
1280 x 1024/60	1 280 x 1 024	63.98	60.02	108.00	R/H/UC/DL	○	○	○	○	○	○	○	○
1280 x 1024/75	1 280 x 1 024	79.98	75.02	135.00	R/H/UC/DL	—	—	—	—	—	—	—	—
1280 x 1024/85	1 280 x 1 024	91.15	85.02	157.50	R/H/UC/DL	—	—	—	—	—	—	—	—
1360 x 768/60	1 360 x 768	47.71	60.02	85.50	H/UC/DL	—	—	—	—	—	—	—	—
1360 x 768/60	1 360 x 768	47.70	60.00	84.72	H/UC/DL	—	—	—	—	—	—	—	—
1360 x 768/60	1 360 x 768	47.72	59.80	84.75	H/UC/DL	—	—	—	—	—	—	—	—
1366 x 768/50	1 366 x 768	39.55	50.00	69.92	H/UC/DL	—	—	—	—	—	—	—	—
1366 x 768/60	1 366 x 768	48.39	60.03	86.71	R/H/UC/DL	—	—	—	—	—	—	—	—
1366 x 768/60	1 366 x 768	48.00	60.00	72.00	R/H/UC/DL	—	—	—	—	—	—	—	—
1366 x 768/50	1 366 x 768	39.56	49.89	69.00	R/H/UC/DL	—	—	—	—	—	—	—	—
1366 x 768/60	1 366 x 768	47.71	59.79	85.50	R/H/UC/DL	—	—	—	—	—	—	—	—
1400 x 1050/60	1 400 x 1 050	65.22	60.00	122.61	H/UC/DL	—	—	—	—	—	—	—	—
1400 x 1050/75	1 400 x 1 050	82.20	75.00	155.85	R/H/UC/DL	—	—	—	—	—	—	—	—

Corresponding signal	Resolution (Dot)	Scanning frequency		Dot clock frequency (MHz)	Format*2	Plug and Play-supported signal*5							
		Horizontal (kHz)	Vertical (Hz)			HDMI			USB-C			DL	DP
						4K/60p*6	4K/30P	2K	4K/60p	4K/30P	2K		
1440 x 900/60	1 440 x 900	55.47	59.90	88.75	R/H/UC/DL	—	—	—	—	—	—	—	—
1440 x 900/60	1 440 x 900	55.92	60.00	106.47	R/H/UC/DL	—	—	—	—	—	—	—	—
1600 x 900/50	1 600 x 900	46.30	50.00	97.05	H/UC/DL	—	—	—	—	—	—	—	—
1600 x 900/60	1 600 x 900	60.00	60.00	108.00	H/UC/DL	—	—	—	—	—	—	—	—
1600 x 900/60	1 600 x 900	55.99	59.95	118.25	H/UC/DL	—	—	—	—	—	—	—	—
1600 x 900/60	1 600 x 900	55.92	60.00	119.00	H/UC/DL	—	—	—	○	○	○	—	—
1600 x 1200/60	1 600 x 1 200	75.00	60.00	162.00	R/H/UC/DL	—	—	—	—	—	—	—	—
1680 x 1050/60	1 680 x 1 050	65.29	59.95	146.25	R/H/UC/DL	—	—	—	—	—	—	—	—
1920 x 1080/60	1 920 x 1 080*3	66.59	59.93	138.50	R/H/UC/DL	—	—	—	—	—	—	—	—
1920 x 1080/60	1 920 x 1 080	67.50	60.00	148.50	R/H/UC/DL	○	○	○	○	○	○	○	○
1920 x 1200/60	1 920 x 1 200	74.04	59.95	154.00	R/H/UC/DL	○	○	○	○	○	○	○	○
1920 x 2160/60	1 920 x 2 160	133.29	59.99	277.25	H/UC	—	—	—	—	—	—	—	—
1920 x 2160/60	1 920 x 2 160	135.00	60.00	297.00	H/UC	—	—	—	—	—	—	—	—
2560 x 1440/60	2 560 x 1 440	88.79	59.95	241.50	H/UC	—	○	—	○	○	—	○	—
2560 x 1600/50	2 560 x 1 600	82.37	49.95	286.00	H/UC	—	—	—	—	—	—	—	—
2560 x 1600/60	2 560 x 1 600	98.71	59.97	268.50	H/UC	—	—	—	—	—	—	—	—
3840 x 1080/60	3 840 x 1 080	66.63	59.97	266.50	H/UC	—	—	—	—	—	—	—	—
3840 x 2160/30	3 840 x 2 160	65.69	29.98	262.75	H/UC	—	—	—	○	○	—	—	—
3840 x 2160/60	3 840 x 2 160	133.31	60.00	533.25	H/UC	—	—	—	○	—	—	—	—

\*1: Pixel-Repetition signal (dot clock frequency 27.0 MHz) only

\*2: Signals to represent formats are as follows.

R: D-sub RGB (PC IN)

Y: YPbPr/YCbCr (PC IN)

H: HDMI (HDMI IN 1, HDMI IN 2, HDMI IN 3)

UC: USB-C DP Alt Mode (USB-C HOST)

DL: DIGITAL LINK (DIGITAL LINK IN) of DIGITAL LINK Terminal Board

\*3: Based on VESA CVT-RB (Reduced Blanking) standard

\*4: YCbCr 4:2:0 format only supported.

\*5: Signals with ○ in the Plug and Play-supported signal column are the ones written in EDID (Extended Display Identification Data) of this unit.

For signals without ○ in the Plug and Play-supported signal column, resolutions may not be selected on the PC side even if this unit supports those signals.

\*6: 4K/60p means 4K/60p/HDR and 4K/60p/SDR.

**Note**

- An auto detected signal format may be differently displayed from the actual input signal.
- [ i ] shown after the number of dots of resolution means the interlace signal.
- When 1080/30PsF signal and 1080/25PsF signal are input, they are processed as 1080/60i signal and 1080/50i signal, and then displayed.
- When 1920 x 2160/60 signal (dot clock frequency 297.00 MHz, DIGITAL LINK format) is input, 3840x2160/60p is displayed.



# Shipping condition

It is possible to reset the following data to the factory settings.

Settings and set values of [Picture], [Sound], [Setup] and [Position] menus and user image registered in [Setup] - [Image settings]

## ■ Remote control

**1 Press <SETUP> to display the [Setup] menu.**

**2 Select [Options] with ▲ ▼ and press <ENTER>.**

The following screen will be displayed.

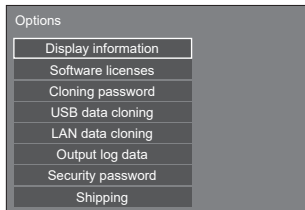

**3 Select [Shipping] with ▲ ▼ and press <ENTER>.**

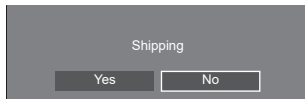

**4 Select [Yes] with ◀▶ and press <ENTER>.**

The message [Shipping ( Wait a moment )] will be displayed.

**5 After the message [Please turn off the power.] is displayed, turn the power off pressing <Main Power On / Off button> (⏻/⏷).**

- If the <Main Power On / Off button> is locked, please disconnect the AC cord plug from the wall outlet.

## ■ Unit

**1 Press <MENU (Unit)> for several times and display the [Setup] menu.**

**2 Select [OSD language] with ▲ ▼, and then press and hold <ENTER (Unit)> for more than 5 seconds.**

**3 Select [Yes] with <- (Unit)> and press <ENTER (Unit)>.**

The message [Shipping ( Wait a moment )] will be displayed.

**4 After the message [Please turn off the power.] is displayed, turn the power off pressing <Main Power On / Off button> (⏻/⏷).**

- If the <Main Power On / Off button> is locked, please disconnect the AC cord plug from the wall outlet.

# Initialization

---

When both main unit buttons and remote control buttons are disabled due to the [Button lock], [Controller user level] and [Controller ID function] settings, set all the values [Off] so that all the buttons are enabled again.

**Press <- (Unit)> together with <RETURN> and hold for more than 5 seconds.**

[Shipping] is displayed and the lock is released when it disappears.

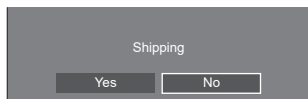

- Settings for [Button lock], [Controller user level] and [Controller ID function] will be back to [Off].

# Initializing the [Controller user level]

---

When remote control buttons are disabled due to the [Controller user level] (page 91) setting, set the value [Off] so that all the buttons are enabled again.

**Press <SETUP> and hold for more than 5 seconds.**

- Setting for [Controller user level] will be back to [Off].

# Software on this unit

---

The following functions in these operating instructions cannot be used with the main microcomputer lower than Version 1.5000 of the main unit software.

① [IPv6 settings] (see page 78)

The version of the main microcomputer can be checked by accessing [Setup]-[Options]-[Display information]. (see page 87)











To use the above ① function, update the main unit software to the latest version.

For the main unit software information, visit the following website.

<https://panasonic.net/cns/prodisplays/pass/>

# Troubleshooting

Before you call for service, determine the symptoms and make a few simple checks as shown below.

Symptoms		Check
Picture	Sound	
 Interference	 Noisy Sound	Electrical Appliances Cars / Motorcycles Fluorescent light
 Normal Picture	 No Sound	Volume (Check whether the mute function has been activated on the remote control.)
 No Picture	 No Sound	Not plugged into AC outlet Not switched on Picture and Brightness/Volume setting (Check by pressing the <Main Power On / Off button> or the <Standby (ON/OFF) button>.)
 No Picture	 Normal Sound	If a signal with a non-applicable colour system format, or frequency is input, only the input terminal indication is displayed.
 No Colour	 Normal Sound	Colour controls set at minimum level (see page 46, 48)
A display error such as “no picture” occurs, or remote control operation is suddenly disabled.		This unit incorporates highly-advanced software. If you notice an abnormal operation such as “Remote control cannot be operated” or “Display is disturbed”, remove the power plug from the socket outlet, and inset it again after 5 seconds or more to turn the power on. (see page 33)
Power automatically turns off unexpectedly.		Check the settings of [No signal power off], “Power management” function for each input and [No activity power off]. Any of them may be set to [On (Enable)]. (see page 61)
Power indicator is blinking in orange.		There is possibility of malfunction. Please contact an Authorized Service Centre.
No remote control operations can be performed.		Check whether the batteries have discharged completely and, if they have not, whether they were inserted properly. Check whether the remote control sensor is exposed to an outdoor light or a strong fluorescent light. Check whether any obstacle is present between the remote control sensor and the remote control. (see page 30) Check whether the remote control designed specifically for use with the unit is being used. (The unit cannot be operated by any other remote control.) Check whether the option other than [Off] is selected in [Controller user level]. (see page 91) Check whether [Controller ID function] is set to [On]. (see page 88) Check whether <ID MODE> switch is set to <ON>. (When using ID remote controller) (see page 168)
[Controller ID function] function cannot be used. (When using ID remote controller)		Check whether [Controller ID function] is set to [On], or <ID MODE> switch is set to <ON>. (see page 88) (When [Controller ID function] is set to [On], you need to set <ID MODE> switch to <ON> and set the ID number.)

Symptoms	Check
The top or bottom of the picture on the screen is cut off.	The image position has been adjusted in the [Position] menu. Adjust the position of the picture on the screen. (see page 43, 44)
There are areas at the top and bottom of the screen where picture is not displayed.	When using a video software program (such as a cinema size program) with a screen wider than one in the 16:9 mode, blank areas separate from the images are formed at the top and bottom of the screen.
Parts of the unit become hot.	Even when the temperature of parts of the front, top and rear panels has risen, these temperature rises will not pose any problems in terms of performance or quality.
There is no picture displayed or sound output sometimes.	When HDMI signal is input to the Display using a selector or distributor, sound or images may not be output in the normal fashion depending on the selector or distributor used.  The symptoms may be improved by turning the power off and on again, or by replacing the selector or distributor.
A small sound becomes loud or the volume of a large sound is restricted. Noise is disturbing. The volume balance between vocals and musical instruments is poor when listening to music.	Check that [Auto volume] is not active (Min / Mid / Max). (see page 45)
Sound distortion or noise annoys you.	Check whether the rated (0.5 Vrms) audio or more is input to audio input terminals (AUDIO IN). Use the unit within the rated audio input. (see page 179)
The RS-232C is uncontrollable.	Check whether the connection has been made properly. (see page 24)
The LAN is uncontrollable.	Check that the connection has been made properly. (see page 93)  To control with WEB browser control or command control, check that [Network settings] - [Network control] is set to [On]. (see page 75)  Check that [LAN setup] is set properly. (see page 76)  When connecting to a device of AMX, Extron or Crestron Electronics, Inc., set [AMX D. D.], [Extron XTP] or [Crestron Connected™] according to the device to use. (see page 76, 81)  See the [DIGITAL LINK status] - [Signal quality] information to check the LAN cable status such as whether the LAN cable is disconnected or the cable is not shielded. (see page 80)
There is no picture displayed or sound output from the [DIGITAL LINK IN] terminal of DIGITAL LINK Terminal Board.	Check whether the connection has been made properly between the video (output) equipment and twisted pair cable transmitter and between the twisted pair cable transmitter and this product.  Check that [Network settings] - [DIGITAL LINK mode] is not set to [Ethernet]. (see page 80)
The file can be played back with "USB media player", but not with "Memory viewer"	Check the playback file specifications of "USB media player" (see page 120) and "Memory viewer" (see page 131).
WhiteBoard operations do not work.	Check whether [Whiteboard settings] - [Whiteboard] in the [Setup] menu is not set to [Off]. (see page 71)  The microcomputer in the touch panel may malfunction due to strong external noise, so keep the noise source as far as possible.

## LCD Display panel

Symptoms	Check
The screen darkens slightly when bright pictures with minimal movements are shown.	The screen will darken slightly when photos, still images of a computer or other pictures with minimal movements are shown for an extended period. This is done to reduce image retention on the screen and the shortening of the screen's service life: It is normal and not indicative of malfunctioning.
It takes a while for the picture to appear.	The unit digitally processes the various signals in order to reproduce esthetically pleasing images. As such, it sometimes takes a few moments for the picture to appear when the power has been turned on, when the input has been switched.
The edges of the images flicker.	Due to the characteristics of the system used to drive the liquid crystal panel, the edges may appear to flicker in the fast-moving parts of the images: This is normal and not indicative of malfunctioning.
There may be red spots, blue spots, green spots and black spots on the screen.	This is a characteristic of liquid crystal panels and is not a problem. The liquid crystal panel is built with very high precision technology giving you fine picture details. Occasionally, a few non-active pixels may appear on the screen as fixed points of red, blue, green, or black. Please note this does not affect the performance of your LCD.
 <p data-bbox="132 614 333 635">Image retention appears</p>	Image retention may occur. If you display a still picture for an extended period, the image might remain on the screen. However, it will disappear when a general moving picture is displayed for a while. This is not considered as malfunction.

This LCD Display uses special image processing. Hence a slight time lag may occur between image and audio, depending on the type of input signal. However, this is not a malfunction.

# Specifications

## Model No.

86-inch model : TH-86EQ2W

75-inch model : TH-75EQ2W

65-inch model : TH-65EQ2W

55-inch model : TH-55EQ2W

50-inch model : TH-50EQ2W

43-inch model : TH-43EQ2W

## Power Consumption

86-inch model

580 W

75-inch model

385 W

65-inch model

340 W

55-inch model

280 W

50-inch model

255 W

43-inch model

225 W

### Stand-by condition

0.5 W (Quick start: Off)

## LCD Display panel

86-inch model

86-inch ADS panel (Direct LED backlight),  
16:9 aspect ratio

75-inch model

75-inch ADS panel (Direct LED backlight),  
16:9 aspect ratio

65-inch model

65-inch ADS panel (Direct LED backlight),  
16:9 aspect ratio

55-inch model

55-inch ADS panel (Direct LED backlight),  
16:9 aspect ratio

50-inch model

50-inch VA panel (Direct LED backlight),  
16:9 aspect ratio

43-inch model

43-inch ADS panel (Direct LED backlight),  
16:9 aspect ratio

## Screen size

86-inch model

1 895.0 mm (W) × 1 065.9 mm (H) × 2 174.2  
mm (diagonal) / 74.60" (W) × 41.96" (H) × 85.60"  
(diagonal)

75-inch model

1 649.6 mm (W) × 927.9 mm (H) × 1 892.7 mm  
(diagonal) / 64.94" (W) × 36.53" (H) × 74.51"  
(diagonal)

65-inch model

1 428.4 mm (W) × 803.5 mm (H) × 1 638.9 mm  
(diagonal) / 56.23" (W) × 31.63" (H) × 64.52"  
(diagonal)

55-inch model

1 209.6 mm (W) × 680.4 mm (H) × 1 387.8 mm  
(diagonal) / 47.62" (W) × 26.78" (H) × 54.63"  
(diagonal)

50-inch model

1 095.8 mm (W) × 616.4 mm (H) × 1 257.3 mm  
(diagonal) / 43.14" (W) × 24.26" (H) × 49.50"  
(diagonal)

43-inch model

941.1 mm (W) × 529.4 mm (H) × 1 079.8 mm  
(diagonal) / 37.05" (W) × 20.84" (H) × 42.51"  
(diagonal)

## No. of pixels

8 294 400

(3 840 (Horizontal) × 2 160 (Vertical))

## Dimensions (W × H × D)

86-inch model

1 929 mm × 1 100 mm × 96 mm  
(excluding handles: 70 mm) /  
75.95" × 43.31" × 3.76"  
(excluding handles: 2.74")

75-inch model

1 684 mm × 962 mm × 96 mm  
(excluding handles: 70 mm) /  
66.28" × 37.87" × 3.76"  
(excluding handles: 2.74")

65-inch model

1 463 mm × 838 mm × 94 mm  
(excluding handles: 69 mm) /  
57.58" × 32.97" × 3.68"  
(excluding handles: 2.72")

55-inch model

1 242 mm × 713 mm × 66 mm /  
48.89" × 28.06" × 2.60"

50-inch model

1 129 mm × 649 mm × 66 mm /  
44.43" × 25.56" × 2.60"

43-inch model

973 mm × 562 mm × 65 mm /  
38.31" × 22.10" × 2.56"

## Mass

---

86-inch model

Approx. 50.7 kg / 111.8 lbs net

75-inch model

Approx. 37.3 kg / 82.2 lbs net

65-inch model

Approx. 29.7 kg / 65.5 lbs net

55-inch model

Approx. 18.0 kg / 39.7 lbs net

50-inch model

Approx. 15.5 kg / 34.2 lbs net

43-inch model

Approx. 11.7 kg / 25.8 lbs net

## Power source

---

110 – 240 V ~ (110 – 240 V alternating current),  
50/60 Hz

## Operating condition

---

### Temperature

0 °C – 40 °C (32 °F – 104 °F)\*1

### Humidity

20 % – 80 % (no condensation)

## Operating Time

---

18 hours/day

## Supply power for SLOT

---

3.3 V/max 1.1 A, 12 V/max 5.5 A

## Connection terminals

---

### HDMI IN 1

### HDMI IN 2

### HDMI IN 3

TYPE A Connector\*2 × 3 (Supports 4K)

Compatible with HDCP 2.2

Audio signal:

Linear PCM (sampling frequencies: 48 kHz,  
44.1 kHz, 32 kHz)

---

### PC IN

Mini D-sub 15 Pin (Compatible with DDC2B) × 1  
Y/G:

1.0 Vp-p (75 Ω) (with sync signal)

0.7 Vp-p (75 Ω) (without sync signal)

P<sub>B</sub>/C<sub>B</sub>/B:

0.7 Vp-p (75 Ω) (without sync signal)

P<sub>R</sub>/C<sub>R</sub>/R:

0.7 Vp-p (75 Ω) (without sync signal)

HD/VD:

TTL (high impedance)

## AUDIO IN

Stereo mini jack (M3) (φ3.5 mm) × 1, 0.5 Vrms

## AUDIO OUT

Stereo mini jack (M3) (φ3.5 mm) × 1, 0.5 Vrms

Output: Variable (-∞ – 0 dB)  
(1 kHz 0 dB input, 10 kΩ load)

## SERIAL IN

External Control Terminal

D-sub 9 Pin × 1:

RS-232C compatible

## LAN

RJ45 × 1:

For network connection, compatible with PLink

Communication method:

RJ45, 10BASE-T / 100BASE-TX

## IR IN

Stereo mini jack (M3) (φ 3.5 mm) × 1

## IR OUT

Stereo mini jack (M3) (φ 3.5 mm) × 1

## USB

USB connector × 1, TYPE A

DC 5 V / max 1 A, Compatible with USB 3.0

## USB-C HOST

USB connector × 1, TYPE C

Max. 60 W (compatible with Power Delivery),  
Compatible with USB 2.0, Compatible with DP Alt  
Mode

## USB DEVICE

USB connector × 1, TYPE A

DC 5 V / max 2 A, Compatible with USB 2.0

## Sound

---

### Speakers

86-inch model 75-inch model :

15 mm × 25 mm × 1 / φ 70 mm × 1 × 2 pieces

65-inch model 55-inch model 50-inch model

43-inch model :

φ 30 mm × 2 × 2 pieces

### Audio Output

20 W [10 W + 10 W] (10 % THD)

## Remote Control Transmitter

---

### Power source

DC 3 V (battery (AAA/R03/LR03 type) × 2)

### Operating range

Approx. 7 m (22.9 ft)

(when operated directly in front of remote control sensor)

### Mass

Approx. 63 g / 2.22 oz (including batteries)

### Dimensions (W × H × D)

48 mm × 134 mm × 20 mm / 1.89" × 5.28" × 0.76"

---

\*1: Environmental temperature to use this unit at high altitudes (1 400 m (4 593 ft) and higher and below 2 800 m (9 186 ft) above sea level): 0 °C to 35 °C (32 °F to 95 °F)

\*2: VIERA LINK is not supported.

### Note

- Design and specifications are subject to change without notice. Mass and dimensions shown are approximate.



# Software License

---

This product incorporates the following software:

- (1) the software developed independently by or for Panasonic Connect Co., Ltd.,
- (2) the software owned by third party and licensed to Panasonic Connect Co., Ltd.,
- (3) the software licensed under the GNU General Public License, Version 2.0 (GPL V2.0),
- (4) the software licensed under the GNU LESSER General Public License, Version 2.0 (LGPL V2.0),
- (5) the software licensed under the GNU LESSER General Public License, Version 2.1 (LGPL V2.1), and/or
- (6) open source software other than the software licensed under the GPL V2.0, LGPL V2.0 and/or LGPL V2.1.

The software categorized as (3) - (6) are distributed in the hope that it will be useful, but WITHOUT ANY WARRANTY, without even the implied warranty of MERCHANTABILITY or FITNESS FOR A PARTICULAR PURPOSE. For details, see the license conditions displayed by selecting [Software licenses], following the specified operation from the [Setup] menu of this product.

At least three (3) years from delivery of this product, Panasonic Connect Co., Ltd. will give to any third party who contacts us at the contact information provided below, for a charge no more than our cost of physically performing source code distribution, a complete machine-readable copy of the corresponding source code covered under GPL V2.0, LGPL V2.0, LGPL V2.1 or the other licenses with the obligation to do so, as well as the respective copyright notice thereof.

Contact Information:

oss-cd-request@gg.jp.panasonic.com

## Notice about AVC/VC-1/MPEG-4

This product is licensed under the AVC Patent Portfolio License, VC-1 Patent Portfolio License and MPEG-4 Visual Patent Portfolio License for the personal use of a consumer or other uses in which it does not receive remuneration to (i) encode video in compliance with the AVC Standard, VC-1 Standard and MPEG-4 Visual Standard ("AVC/VC-1/MPEG-4 Video") and/or (ii) decode AVC/VC-1/MPEG-4 Video that was encoded by a consumer engaged in a personal activity and/or was obtained from a video provider licensed to provide AVC/VC-1/MPEG-4 Video. No license is granted or shall be implied for any other use. Additional information may be obtained from MPEG LA, LLC. See <http://www.mpegla.com>.

## Disposal of Old Equipment and Batteries

### Only for European Union and countries with recycling systems



These symbols on the products, packaging, and/or accompanying documents mean that used electrical and electronic products and batteries must not be mixed with general household waste. For proper treatment, recovery and recycling of old products and used batteries, please take them to applicable collection points in accordance with your national legislation.

By disposing of them correctly, you will help to save valuable resources and prevent any potential negative effects on human health and the environment.

For more information about collection and recycling, please contact your local authority.

Penalties may be applicable for incorrect disposal of this waste, in accordance with national legislation.



#### Note for the battery symbol (bottom symbol)

This symbol might be used in combination with a chemical symbol. In this case it complies with the requirement set by the Directive for the chemical involved.

#### Notice (U.S.A. only)

Disposal may be regulated in your community due to environmental considerations. For disposal or recycling information, please visit Panasonic website:

<https://holdings.panasonic/global/corporate/sustainability.html>

or call 1-888-769-0149.

#### Customer's Record

The model number and serial number of this product may be found on its rear panel. You should note this serial number in the space provided below and retain this book, plus your purchase receipt, as a permanent record of your purchase to aid in identification in the event of theft or loss, and for Warranty Service purposes.

**Model Number**

**Serial Number**

#### Panasonic Connect North America

Unit of Panasonic Corporation of North America

#### Executive Office :

Two Riverfront Plaza, Newark, New Jersey 07102

#### Panasonic Canada Inc.

5770 Ambler Drive, Mississauga, Ontario L4W 2T3

Authorized Representative in EU:

Panasonic Connect Europe GmbH

Panasonic Testing Centre

Winsbergring 15, 22525 Hamburg, Germany

Importer for UK:

Panasonic Connect UK,

a branch of Panasonic Connect Europe GmbH,

Maxis 2, Western Road, Bracknell, Berkshire, RG12 1RT

## Panasonic Connect Co., Ltd.

4-1-62 Minoshima, Hakata-ku, Fukuoka 812-8531, Japan

Web Site: <https://panasonic.net/cns/prodisplays/>

© Panasonic Connect Co., Ltd. 2022

English