



User's Manual

ColorEdge[®] CG2700S

Color Management LCD Monitor

Important

Please read this "User's Manual", and "PRECAUTIONS" (separate volume) carefully to familiarize yourself with safe and effective usage.

- See the Setup Guide for monitor installation and connection.
- For the latest product information including the "User's Manual", refer to our web site:

www.eizoglobal.com

Location of Caution Statement

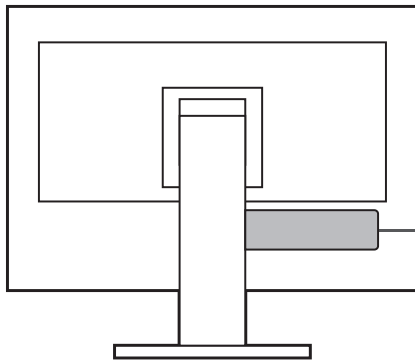

WARNING
RISK OF ELECTRIC SHOCK. DO NOT OPEN.
AVERTISSEMENT
RISQUE DE CHOC ELECTRIQUE. NE PAS OUVRIR.
WARNUNG
GEFAHR DES ELEKTRISCHEN SCHLAGES. RÜCKWAND NICHT ENTFERNEN.
警告
触电危険、请勿打开后盖。
警告
感電の恐れあり、カバーをあけないでください。
The equipment must be connected to a grounded main outlet.
L'appareil doit être relié à une prise avec terre.
Jordet stikkontakt skal benyttes når apparatet tilkobles datanett.
Apparaten skall anslutas till jordat nätuttag.
设备必须连接到接地式的电源插座。
電源コードのアースは必ず接地してください。

This product has been adjusted specifically for use in the region to which it was originally shipped.

If operated outside this region, the product may not perform as stated in the specifications.

No part of this manual may be reproduced, stored in a retrieval system, or transmitted, in any form or by any means, electronic, mechanical, or otherwise, without the prior written permission of EIZO Corporation.

EIZO Corporation is under no obligation to hold any submitted material or information confidential unless prior arrangements are made pursuant to EIZO Corporation's receipt of said information. Although every effort has been made to ensure that this manual provides up-to-date information, please note that EIZO product specifications are subject to change without notice.

Notice for This Product

About the Usage of This Product

- Aside from general purposes like creating documents and viewing multimedia content, this product is also suited to applications such as creating images and graphics, and digital photo processing, where accurate color reproduction is a priority.
- This product has been adjusted specifically for use in the region to which it was originally shipped. If the product is used outside the region, it may not operate as specified in the specifications.
- This product may not be covered by warranty for uses other than those described in this manual.
- The specifications noted in this manual are only applicable when the following are used:
 - Power cords provided with the product
 - Signal cables specified by us
- Only use optional products manufactured or specified by us with this product.

About the LCD Panel

- It takes about 3 minutes (under our measurement conditions) for the monitor display to stabilize. Please wait 3 minutes or more after the monitor power has been turned on, and then adjust the monitor.
- Monitors should be set to a lower brightness to prevent a loss in the screen quality caused by long-term use and to maintain stable use.
- When the screen image is changed after displaying the same image for extended periods of time, an afterimage may appear. Use the screensaver or power save function to avoid displaying the same image for extended periods of time. Depending on the image, an afterimage may appear even if it was displayed for a short period of time. To remove such a phenomenon, change the image or keep the power turned off for several hours.
- If the monitor displays continuously over a long period of time, smudges or burn-in may appear. To maximize the life of the monitor, we recommend the monitor be turned off periodically.
- The LCD panel is manufactured using high-precision technology. Although, missing pixels or lit pixels may appear on the LCD panel, this is not a malfunction. Percentage of effective dots: 99.9994 % or higher.
- The backlight of the LCD panel has a fixed lifetime. Depending on the usage pattern, such as usage for long continuous periods, the lifespan of the backlight may run out sooner, requiring replacement. When the screen becomes dark or begins to flicker, please contact your local EIZO representative.
- Do not press on the LCD panel surface or edge of the frame strongly, as this may result in display malfunctions, such as moiré patterns, etc. If pressure is continuously applied to the LCD panel surface, the liquid crystal may deteriorate or the LCD panel may be damaged. (If the pressure marks remain on the LCD panel, leave the monitor with a black or white screen. The symptom may disappear.)
- Do not scratch or press on the LCD panel with any sharp objects, at this may result in damage to the LCD panel. Do not attempt to brush with tissues as this may scratch the panel.

About the Installation

- If you place this product on a lacquer-coated desk, the color may adhere to the bottom of the stand due to the composition of the rubber. Check the desk surface before use.
- When the product is cold and brought into a room or the room temperature goes up quickly, dew condensation may occur on the interior and exterior surfaces of the product. In that case, do not turn the product on. Instead wait until the dew condensation disappears, otherwise it may cause some damage to the product.

Cleaning

Periodic cleaning is recommended to keep the product looking new and to prolong its operation lifetime.

The stains on the cabinet and LCD panel surface can be removed by using the provided ScreenCleaner.

Attention
<ul style="list-style-type: none">• Chemicals such as alcohol and disinfectant may cause gloss variation, tarnishing, and fading of the cabinet or LCD panel surface, and also quality deterioration of the image.• Never use thinner, benzene, wax, or abrasive cleaner as they may damage the cabinet or LCD panel surface.

To Use the Monitor Comfortably

- An excessively dark or bright screen may affect your eyes. Adjust the brightness of the monitor according to the environmental conditions.
- Staring at the monitor for a long time tires your eyes. Take a 10-minute rest every hour.

CONTENTS

Location of Caution Statement	2
Notice for This Product.....	3
About the Usage of This Product.....	3
About the LCD Panel.....	3
About the Installation	4
Cleaning.....	4
To Use the Monitor Comfortably.....	4
1 Introduction.....	8
1.1 Features.....	8
1.1.1 Support for HDR (High Dynamic Range) video	8
1.1.2 Built-in mode for automatically switching to the optimal color settings ...	8
1.1.3 Various functions that support color grading work.....	8
1.1.4 Support for DisplayPort Alt Mode/USB Power Delivery	9
1.1.5 Includes Docking Station Function.....	9
1.2 Controls and Functions.....	10
1.2.1 Front.....	10
1.2.2 Rear	11
2 Basic Adjustments/Settings	12
2.1 Switch Operation Method	12
2.2 Switching Input Signals.....	12
2.3 Switching the Display Mode (color mode)	13
2.3.1 Display Modes	13
2.3.2 Color Mode Setting Values	14
3 Advanced Adjustments/Settings	16
3.1 Basic Operation of the Setting Menu	16
3.2 Setting Menu Functions	17
3.2.1 Signal	17
3.2.2 Color	18
3.2.3 SelfCalibration.....	26
3.2.4 Screen.....	26
3.2.5 Preferences.....	30
3.2.6 Languages	32
3.2.7 Information	32
4 SelfCalibration	34
4.1 SelfCalibration Functions.....	35
4.2 Setting Targets	37
4.3 Executing	37
4.3.1 Immediately executing manually	37

CONTENTS

4.3.2	Automatically executing by setting a schedule	38
4.3.3	Activating SelfCalibration in Standard Mode.....	38
4.3.4	Activating SelfCalibration in Advanced Mode	38
4.4	Checking Results	38
5	Custom Key Settings	39
5.1	Basic Operation of the Custom Keys	39
5.2	Assigning a Function to a Custom Key	39
5.2.1	Functions that can be Assigned to Custom Keys	41
6	Administrator Settings	42
6.1	Basic Operation of the "Administrator Settings" Menu	42
6.2	Functions of the "Administrator Settings" Menu	43
7	SDR/HDR Settings	45
7.1	About Each Color Mode.....	45
7.1.1	Types and Applications of Color Modes for Image Creation.....	45
7.1.2	BT.2020	45
7.1.3	BT.709	48
7.1.4	DCI-P3	50
7.1.5	PQ_DCI-P3	51
7.1.6	HLG_BT.2100	53
7.2	Setting Procedure	55
7.3	Settings with ColorNavigator 7	56
7.3.1	Setting Procedure	56
7.3.2	Target Settings of ColorNavigator 7.....	56
8	Troubleshooting	58
8.1	No Picture Displayed	58
8.2	Imaging Problems.....	59
8.3	SelfCalibration Problems	60
8.4	Other Problems.....	61
9	Attaching/Removing the Stand	63
9.1	Removing the Stand	63
9.2	Attaching the Optional Arm.....	64
9.3	Attaching the Original Stand	65
10	Reference	66
10.1	Using the Docking Station Function.....	66
10.2	Connecting Multiple External Devices	68
10.3	Setting of PQ Option and Display	69
10.4	Specifications.....	71
10.4.1	LCD Panel.....	71

10.4.2 Video Signals	71
10.4.3 USB.....	72
10.4.4 Network.....	72
10.4.5 Power.....	72
10.4.6 Physical Specifications	72
10.4.7 Operating Environmental Requirements.....	73
10.4.8 Transportation / Storage Environmental Requirements.....	73
10.4.9 Accessories.....	73
Appendix	74
Trademark	74
License	74

1 Introduction

This chapter describes the features of the monitor and the name of each control.

1.1 Features

1.1.1 Support for HDR (High Dynamic Range) video

- Complies with the international HDR standards for movies and broadcasts
Supports both the HDR "PQ format" for streaming and movie production, and the HDR "Hybrid Log Gamma format" for broadcasts. The "PQ format" complies with the ITU-R BT.2100^{*1} and SMPTE ST.2084^{*2} international HDR standards, and the "Hybrid Log Gamma format" complies with the ITU-R BT.2100 international HDR standard. This makes it possible to use the monitor for the color grading of a wide range of HDR content, such as movies and broadcasts.

*1 ITU-R is the International Telecommunication Union-Radio communication Sector.

*2 SMPTE is the Society of Motion Picture and Television Engineers.

- Built-in color mode function
Reproduces a color temperature, gamma, and color gamut compliant with ITU-R BT.2100 and other standards.
See [Color Mode \[▶ 19\]](#).

1.1.2 Built-in mode for automatically switching to the optimal color settings

- Color Mode "SYNC_SIGNAL"
This monitor is equipped with a color mode (SYNC_SIGNAL) so you can automatically set the optimal values for the color settings of the monitor according to the input signal. If you use this mode, the color settings of the monitor automatically switch to the optimal color settings for HDR when the input signal is switched from SDR to HDR, so setting the colors manually is not necessary.

1.1.3 Various functions that support color grading work

- Dedicated video production functions, such as a Gamut Warning function and a Luminance Warning function
See [Advanced Adjustments/Settings \[▶ 16\]](#).
- User-defined custom key function
Work efficiency can be improved by assigning frequently used functions to the buttons on the front of the monitor.
See [Custom Key Settings \[▶ 39\]](#).
- Displays HDCP (High Bandwidth Digital Protection) protected content
- Monitor hood included as standard
Includes a monitor hood that effectively prevents reflections from external light, such as the reflected glare of a light. The monitor hood uses magnets for easy attachment and removal.
- SelfCalibration function
The built-in calibration sensor enables the monitor to calibrate itself by using SelfCalibration.
See [SelfCalibration \[▶ 34\]](#).

1.1.4 Support for DisplayPort Alt Mode/USB Power Delivery

- Includes USB Type-C® (hereinafter USB-C®) connector
Supports the transmission of video signals (DisplayPort Alt Mode) as well as the charging of USB devices (USB Power Delivery).
It supplies a maximum of 92 W of power to a connected notebook PC when used as an external monitor.

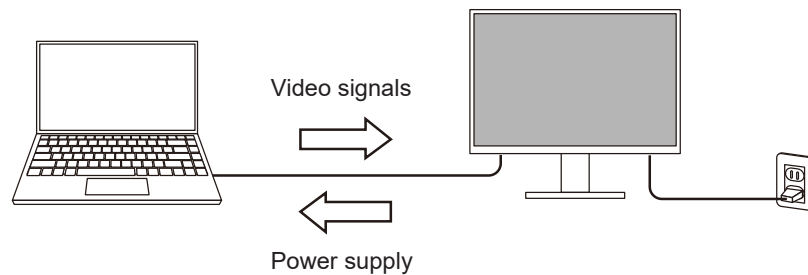

Note

- To display video signals, the connected device must support transmission of video signals (DisplayPort Alt Mode).
- To use the charging function, the connected device must support device charging by using USB Power Delivery.
- Only when the following USB cables are used, a maximum of 92 W of power can be supplied:
 - CC200SS-5A (Included)
 - CC100 (Optional accessory)
- Connected devices can be charged even when the monitor is in power saving mode.

1.1.5 Includes Docking Station Function

- Includes LAN port and USB hub
Connecting via USB-C allows you to use a stable network environment even with laptops or tablets that lack LAN ports. In addition, peripheral devices that support USB can be used, and smartphones can be charged.
See [Using the Docking Station Function \[▶ 66\]](#).

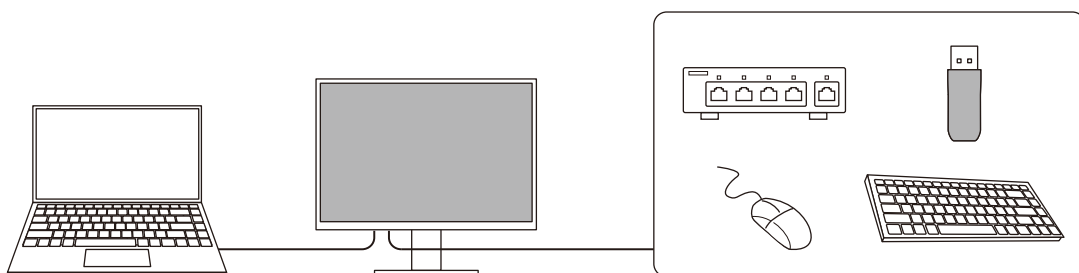

1.2 Controls and Functions

1.2.1 Front

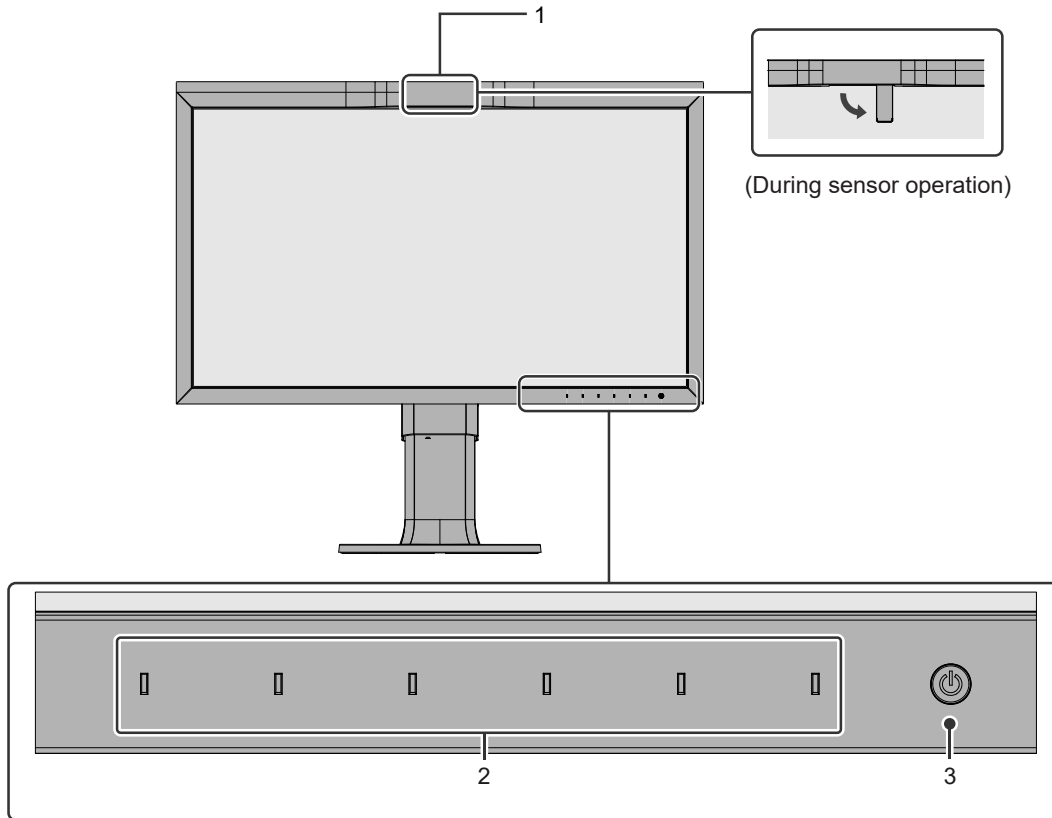

<p>1. Built-in calibration sensor</p>	<p>This sensor is used to perform monitor calibration. When SelfCalibration is executed, the calibration sensor automatically operates and regularly calibrates the monitor. (see SelfCalibration [▶ 34]).</p>
<p>2. Operation switches</p>	<p>Displays menus. Operate the switches according to the operation guide (see Basic Operation of the Setting Menu [▶ 16]).</p>
<p>3. Power switch</p>	<p>Turns the power on or off.</p> <p>Touching the switch turns on the power.</p> <p>The switch indicator lights up when you turn the power on. The indicator color differs depending on the monitor's operation status.</p> <p>White: Normal operation mode Orange: Power saving mode OFF: Main power/power off</p>

1.2.2 Rear

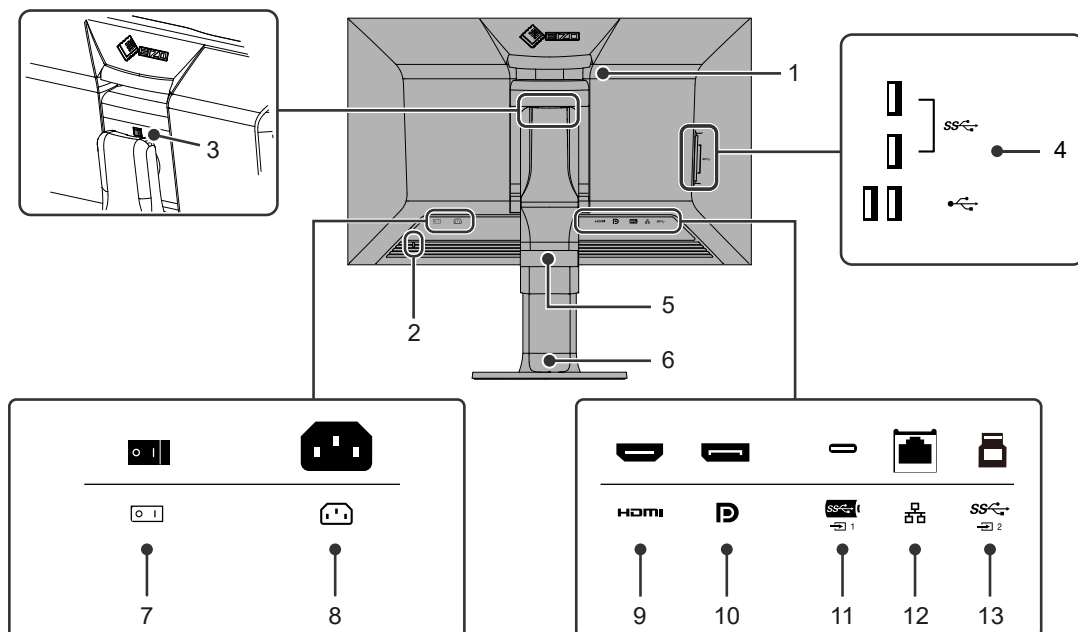

1. Handle	This handle is used for transportation.
2. Security lock slot	Complies with Kensington's MicroSaver security system.
3. Lock button	Use this button to remove the monitor from the stand.
4. USB-A connector (downstream)	Connects to a peripheral USB device (see Using the Docking Station Function [▶ 66]).
5. Cable holder	Holds the monitor cables.
6. Stand^{*1}	Adjusts the height and angle (tilt and swivel) of the monitor. The monitor can also be rotated vertically.
7. Main power switch	Turns the main power on or off. : On, ○ : Off
8. Power connector	Connects the power cord.
9. HDMI connector	Connects to an external device with HDMI output.
10. DisplayPort connector	Connects to an external device with DisplayPort output.
11. USB-C connector (upstream)	Connects to an external device with USB-C output. This also transmits the USB signal that is necessary for using software that requires a USB connection or the Docking Station Function (see Using the Docking Station Function [▶ 66]).
12. LAN port (RJ-45)	When using the network connection of the Docking Station Function, connect the modem or router using a LAN cable (see Using the Docking Station Function [▶ 66]). A USB-C connection is required for network connection.
13. USB-B connector (upstream)	Connect using USB cable when using software that requires a USB connection. The blue connector.

^{*1} An optional arm (or optional stand) can be attached by removing the stand section.

2 Basic Adjustments/Settings

This chapter describes the basic functions that can be set by pressing the buttons on the front of the monitor.

For advanced adjustment and setting procedures using the Setting menu, see [Advanced Adjustments/Settings ▶ 16](#)].



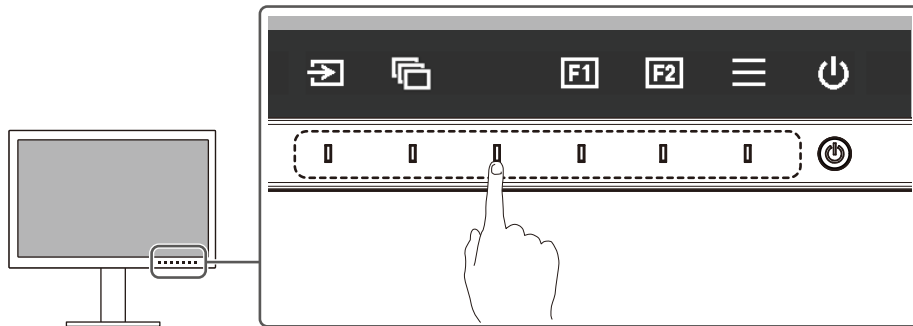

2.1 Switch Operation Method

1. Touch any switch (except )
The operation guide appears on the screen.



Note

- Do not directly touch the operation guide that appears on the screen. There are switches below the operation guide that can be touched to perform adjustment/setting.

2. Touch a switch for adjustment/setting.
The Adjustment/Setting menu appears.
(A sub menu may also be displayed. In this case, select the item for adjustment/setting using   and select .)
3. Perform adjustment/setting with the switches and select  to accept the changes.
4. Select  to exit the menu.

2.2 Switching Input Signals

When a monitor has multiple signal inputs, the signal to display on-screen can be changed.

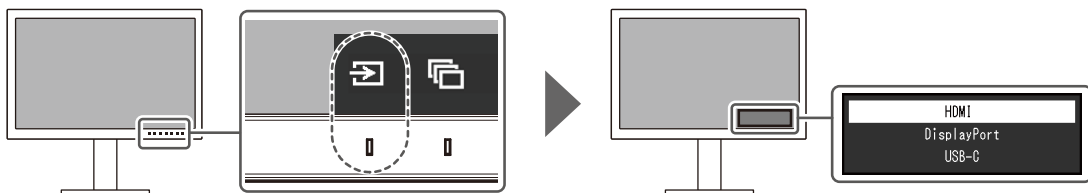

2.3 Switching the Display Mode (color mode)

This function allows easy selection of a display mode according to monitor application.

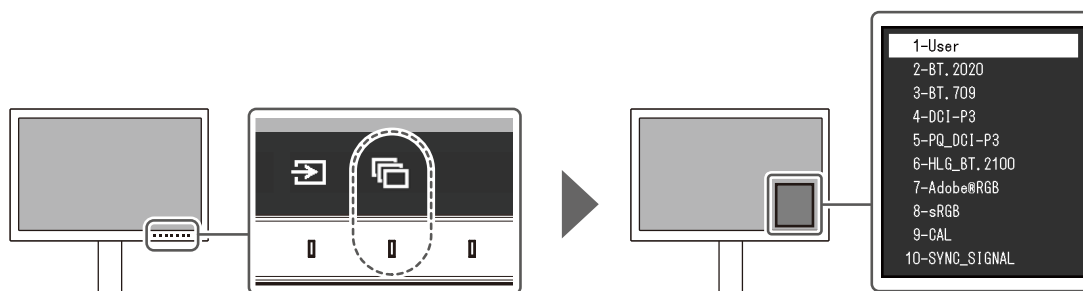

2.3.1 Display Modes

Standard Mode

Adjust color using the monitor's Setting menu.

Color Mode	Purpose
User	See Color Mode Setting Values [▶ 14] for detailed setting values for each color mode.
BT.2020	
BT.709	
DCI-P3	
PQ_DCI-P3	
HLG_BT.2100	
Adobe®RGB	
sRGB	
SYNC_SIGNAL	

Note

- If you switch between SDR color modes ("BT.2020", "BT.709", and "DCI-P3") and HDR color modes ("PQ_DCI-P3" and "HLG_BT.2100"), wait 30 minutes or more after switching the color modes, and then adjust the monitor.

Advanced Mode

Adjust the monitor's display using the monitor's SelfCalibration function or color management software "ColorNavigator 7".

Color Mode	Purpose
CAL	Displays the screen adjusted by SelfCalibration or ColorNavigator 7.

2.3.2 Color Mode Setting Values

Item		Color Mode										
		User	BT.2020	BT.709	DCI-P3	PQ_DCI-P3	HLG_BT.2100	Adobe®RGB	sRGB	CAL	SYNC_SIGNAL	
Brightness (cd/m²)		100	100	100	48	300	300	100	100	-	100 ¹¹	
Temperature		6500 K	D65	D65	D65	D65	D65	D65	D65	-	D65	
Gamma (EOTF)		2.2	2.4	2.4	2.6	PQ	HLG	2.2	sRGB	-	2.4 ¹¹	
PQ Option		-	-	-	-	1000cd/m² Emulation	-	-	-	-	-	
HLG Option		-	-	-	-	-	Off	-	-	-	-	
HLG System Gamma		-	-	-	-	-	1.2	-	-	-	-	
Color Gamut		Native	BT.2020	BT.709	DCI-P3	DCI-P3	BT.2020	Adobe®RGB	sRGB	-	BT.709 ¹¹	
Advanced Settings	Hue	0	0	0	0	0	0	0	0	-	0	
	Saturation	0	0	0	0	0	0	0	0	-	0	
	Gamut Clipping	On	On	On	On	On	On	Off	Off	-	On	
	XYZ Format	-	-	-	Off	Off	-	-	-	-	-	
	Gain	Red	Calculated from color temperature								-	Calculated from color temperature
		Green									-	
		Blue									-	
	Black Level	All	0	0	0	0	0	0	0	0	-	0
		Red	0	0	0	0	0	0	0	0	-	0
		Green	0	0	0	0	0	0	0	0	-	0
Blue		0	0	0	0	0	0	0	0	-	0	
6 Colors	Magenta	Hue	0	0	0	0	0	0	0	0	-	0
		Saturation	0	0	0	0	0	0	0	0	-	0
		Ligh tness	0	0	0	0	0	0	0	0	-	0
	Red	Hue	0	0	0	0	0	0	0	0	-	0
		Saturation	0	0	0	0	0	0	0	0	-	0
		Ligh tness	0	0	0	0	0	0	0	0	-	0
	Yellow	Hue	0	0	0	0	0	0	0	0	-	0
		Saturation	0	0	0	0	0	0	0	0	-	0
		Ligh tness	0	0	0	0	0	0	0	0	-	0

Item			Color Mode									
			User	BT.2020	BT.709	DCI-P3	PQ_DCI-P3	HLG_BT.2100	Adobe®RGB	sRGB	CAL	SYNC_SIGNAL
	Green	Hue	0	0	0	0	0	0	0	0	-	0
		Saturation	0	0	0	0	0	0	0	0	-	0
		Ligh tness	0	0	0	0	0	0	0	0	-	0
	Cyan	Hue	0	0	0	0	0	0	0	0	-	0
		Saturation	0	0	0	0	0	0	0	0	-	0
		Ligh tness	0	0	0	0	0	0	0	0	-	0
	Blue	Hue	0	0	0	0	0	0	0	0	-	0
		Saturation	0	0	0	0	0	0	0	0	-	0
		Ligh tness	0	0	0	0	0	0	0	0	-	0

*1 This is set automatically according to the input signal. If the value cannot be retrieved from the input signal, the value shown in the table is set.



Note

- Use ColorNavigator 7 or SelfCalibration to set "CAL".
- A color mode can be set for each input signal.
- See [Color \[▶ 18\]](#) for details about each item.
- You can disable specific mode selections. For more information, see [Mode Skip \[▶ 31\]](#).



3 Advanced Adjustments/Settings

This chapter describes the advanced monitor adjustment and setting procedures using the Setting menu. For the basic setting functions using the buttons on the front of the monitor, see [Basic Adjustments/Settings \[▶ 12\]](#).

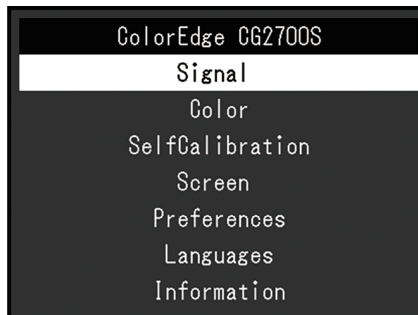

3.1 Basic Operation of the Setting Menu

1. Touch any switch (except )
The operation guide appears.
2. Select 
The Setting menu appears.



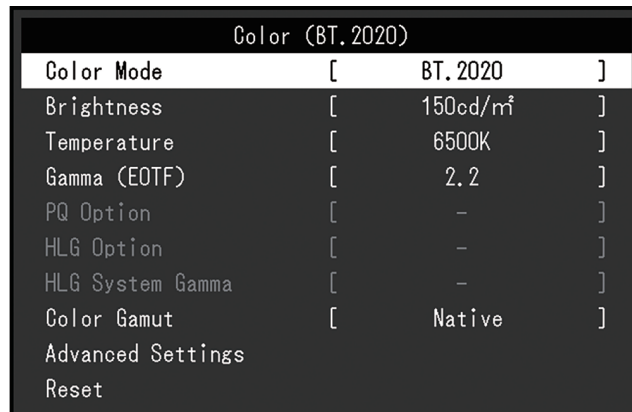





3. Select a menu to adjust/set with   and select 
The Sub menu appears.



4. Select a menu to adjust/set with   and select 
The Adjustment/Setting menu appears.



5. Perform adjustment/setting with   or   and select  to accept the changes.
The Sub menu appears.
Selecting  during adjustment/setting will cancel the adjustment/setting and restore the state prior to making changes.
6. Selecting  several times will terminate the Setting menu.

3.2 Setting Menu Functions

3.2.1 Signal

The signal settings are used to configure advanced settings for input signals, such as the color format and input range.

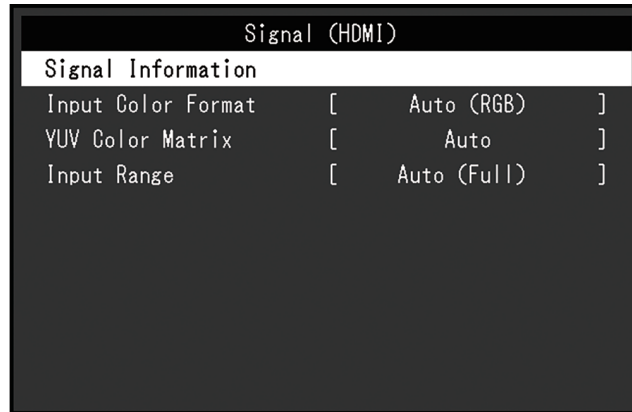

Signal Information

You can check the information for the input signal.

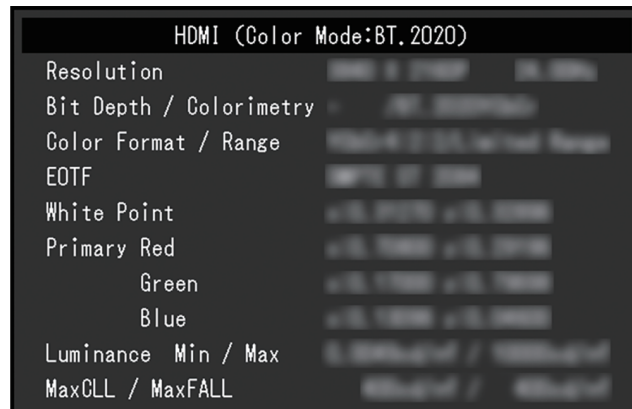

Input Color Format

Settings: "Auto" / "YUV 4:2:2^{*1}" / "YUV 4:4:4^{*1}" / "YUV^{*2}" / "RGB"

*1 Only enabled during HDMI input

*2 Only valid for DisplayPort or USB-C input

The color space of the input signal can be specified.

Try changing this setting if colors are not displayed correctly. Normally, select "Auto".

YUV Color Matrix

Settings: "Auto" / "BT.601" / "BT.709" / "BT.2020"

Select the YUV format of the input signal. Use this setting for gradation collapse or other occurrences where the screen is displayed incorrectly because of a problem with the input signal.

Input Range

Settings: "Auto" / "Auto 109%" / "Full" / "Limited (109% White)" / "Limited" / "SDI Full"

Depending on the external device, the black and white levels in the video signal output to the monitor may be restricted. If the signal is displayed on the monitor in its restricted form, the blacks will be faint, the whites dull, and contrast will be reduced. The video range displayed on the monitor can be switched to make these signals the actual contrast ratio of the monitor.

- "Auto"
 - The monitor automatically recognizes the range of input signals and displays images appropriately.
 - If the input signals are the full range, it displays them as "Full".
 - If the input signals are a limited range, it displays them as "Limited".
- "Auto 109%"
 - The monitor automatically recognizes the range of input signals and displays images appropriately.
 - If the input signals are the full range, it uses them as "Full".
 - If the input signals are a limited range, it uses them as "Limited (109% White)".
- "Full"
 - The brightness range of the input signal is displayed as 0 – 255 (10 bits: 0 – 1023).
- "Limited (109% White)"
 - If "Gamma (EOTF)" is from "1.6" to "2.7" then the brightness range of the input signal is displayed as 16 – 254 (10 bits: 64 to 1019). Otherwise, it is displayed as 16 – 235 (10 bits: 64 – 940).
- "Limited"
 - The brightness range of the input signal is displayed as 16 – 235 (10 bits: 64 – 940).
- "SDI Full"
 - The brightness range of the input signal is displayed as 1 – 254 (10 bits: 4 – 1019).

3.2.2 Color

The setting details differ depending on the color mode selected.

3.2.2.1 When Color Mode is Standard Mode (User / BT.2020 / BT.709 / DCI-P3 / PQ_DCI-P3 / HLG_BT.2100 / Adobe®RGB / sRGB / SYNC_SIGNAL)

Each color mode setting can be adjusted according to personal preference.

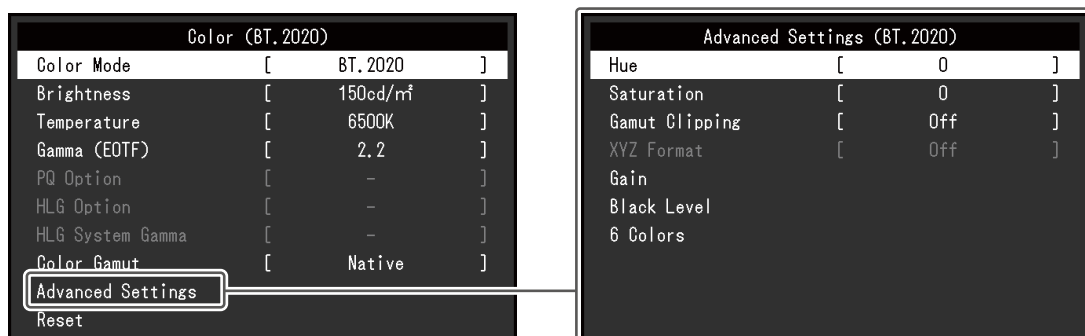

Attention

- The same image may be seen in different colors on multiple monitors due to differences between individual monitors. Make fine color adjustment visually when matching colors on multiple monitors.

Note

- If "Color Mode" is "SYNC_SIGNAL", the "Brightness", "Gamma (EOTF)", and "Color Gamut" are automatically set according to the input signal and cannot be changed.
- Use the values shown in "cd/m²" and "K" as a guide only.

Color Mode

Settings: "User" / "BT.2020" / "BT.709" / "DCI-P3" / "PQ_DCI-P3" / "HLG_BT.2100" / "Adobe®RGB" / "sRGB" / "CAL" / "SYNC_SIGNAL"

Select the desired mode according to the monitor application.

Note

- For more information on how to switch modes, see [Switching the Display Mode \(color mode\) \[▶ 13\]](#).
- For "CAL", see [When Color Mode is Advanced Mode \(CAL\) \[▶ 23\]](#).

Brightness

Settings: "40 cd/m²" – "450 cd/m²"

The screen brightness is adjusted by changing the brightness of the backlight (light source from the LCD back panel).

Note

- If a value that cannot be set is selected, the value will appear in magenta. In such a case, change the value.

Temperature

Settings: "Native" / "4000 K" – "10000 K" / "D50" / "D65" / "DCI" / "User"

Adjusts the color temperature.

The color temperature is used to express the chromaticity of "White". The value is expressed in degrees "K" (Kelvin).

The screen becomes reddish at a low color temperature, and bluish at a high color temperature, like the temperature of a flame.

Specify a color temperature in units of 100 K, or select a standard name.

Note

- Select "Native" to display the original colors of the LCD panel.
- "Gain" allows you to perform more advanced adjustment. When gain is changed, the color temperature is changed to "User".
- The gain preset values are set for each color temperature setting value.

Gamma (EOTF)

Settings: "1.6" – "2.7" / "sRGB" / "EBU(2.35)" / "PQ" / "HLG"

Adjust the gamma.

The brightness of the monitor varies depending on the input signal, however, the variation rate is not simply proportional to the input signal. The control performed to keep the balance between the input signal and the brightness of the monitor is called Gamma correction.

Set the gamma, or select a standard name.

Note

- If you select "HLG", you must set "HLG System Gamma".

PQ Option

Settings: "300cd/m² Clipping" / "500cd/m² Emulation" / "1000cd/m² Emulation" / "4000cd/m² Emulation" / "10000cd/m² Emulation"

Areas with brightness equal to or greater than the value set here are displayed as clipping or emulation at this setting value for the PQ signal that is input to the monitor.

- "300cd/m² Clipping"
Setting used to check the display of monitor with maximum brightness of 300 cd/m². Input video level of 637 (10 bits) or more is clipped.
- "500cd/m² Emulation"
Setting with which the image is properly displayed when monitor brightness is set to 500 cd/m². This setting is used for a temporary check because this monitor cannot display 500 cd/m². All gradients are emulated.
- "1000cd/m² Emulation"
Setting with which the image is properly displayed when monitor brightness is set to 1000 cd/m². This setting is used for a temporary check because this monitor cannot display 1000 cd/m². All gradients are emulated.
- "4000cd/m² Emulation"
Setting with which the image is properly displayed when monitor brightness is set to 4000 cd/m². This setting is used for a temporary check because this monitor cannot display 4000 cd/m². All gradients are emulated.
- "10000cd/m² Emulation"
Setting with which the image is properly displayed when monitor brightness is set to 10000 cd/m². This setting is used for a temporary check because this monitor cannot display 10000 cd/m². All gradients are emulated.

Note

- This can be set when "PQ" is specified for "Gamma (EOTF)".
- You can check the areas where clipping or emulation occurs. For more information, see [Luminance Warning \[▶ 28\]](#).
- For relation between input and output for each setting, see [Setting of PQ Option and Display \[▶ 69\]](#).

HLG Option

Settings: "Off" / "HLG300"

When selecting "HLG300" with the brightness set to 300 cd/m² for the HLG signal input to the monitor, any areas exceeding 300 cd/m² will be clipped. Selecting "Off" will not clip these areas.

Note

- This can be set when "HLG" is specified for "Gamma (EOTF)".

HLG System Gamma

Settings: "1.0" – "1.5"

Adjust the system gamma value for the HLG signal that is input to the monitor.

Note

- This can be set when "HLG" is specified for "Gamma (EOTF)".

Color Gamut

Settings: "Native" / "Adobe®RGB" / "sRGB" / "EBU" / "BT.709" / "BT.2020" / "SMPTE-C" / "DCI-P3"

Set the color reproduction area (color gamut) of the monitor.

"Color Gamut" is the range of colors that can be represented. Multiple standards are defined.

Note

- Select "Native" to display the original color gamut of the LCD panel.
- The method of displaying colors outside the monitor's displayable range within the defined color gamut can be set. For more information, see [Advanced Settings - Gamut Clipping \[▶ 22\]](#).

Advanced Settings - Hue

Settings: "-100" – "100"

The hue can be adjusted.

Note

- Using this function may make some color gradations unavailable for display.

Advanced Settings - Saturation

Settings: "-100" – "100"

The saturation can be adjusted.

Note

- Using this function may make some color gradations unavailable for display.
- The minimum value (-100) changes the screen to monochrome.

Advanced Settings - Gamut Clipping

Settings: "On" / "Off"

The method of displaying colors outside the monitor's displayable range within the color gamut specified in accordance with [Color Gamut \[▶ 21\]](#) can be set.

- "On"
The range of colors that are displayable on the monitor will be accurately displayed in accordance with the standard. Colors outside the displayable range will be saturated.
- "Off"
Displays colors with priority on the color gradation rather than the color accuracy. The vertices of the color gamut defined in the standard move to a range that can be displayed by the monitor. This allows the closest colors displayable by the monitor to be displayed.

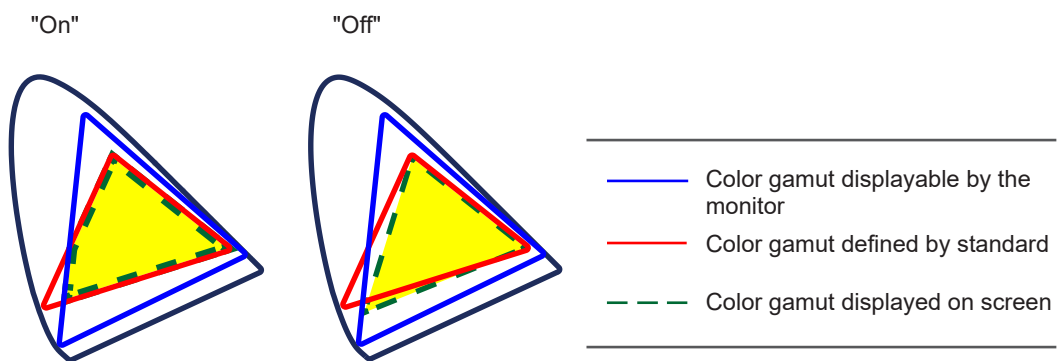

Note

- The diagrams shown above are conceptual diagrams, and they do not display the actual color gamut of the monitor.
- This setting will be disabled if "Native" is selected at [Color Gamut \[▶ 21\]](#).

Advanced Settings - XYZ Format

Settings: "On" / "Off"

If this function is set to "On", the XYZ signal for digital cinema can be displayed on the monitor.

Note

- This can be set only when [Color Gamut \[▶ 21\]](#) is set to "DCI-P3".
- If you select "On", you cannot set "Color Gamut".

Advanced Settings - Gain

Settings: "0" – "2000"

The brightness of each color component red, green, and blue is called Gain. The chromaticity of "white" can be changed by adjusting the gain.

Note

- Using this function may make some color gradations unavailable for display.
- The gain value changes according to the color temperature.
- When gain is changed, the color temperature is changed to "User".

Advanced Settings - Black Level

Settings: "0" – "1500"

You can adjust the brightness and chromaticity for black by adjusting the levels of red, green, and blue, or by adjusting all of the black levels. Display the black test pattern or the background and adjust the black level.

Advanced Settings - 6 Colors

Settings: "-100" – "100"

The hue, saturation and lightness (brightness) can each be adjusted for the colors Magenta, Red, Yellow, Green, Cyan, and Blue.

Reset

Resets any color adjustments for the currently selected color mode back to the default settings.

3.2.2.2 When Color Mode is Advanced Mode (CAL)

You can set targets for SelfCalibration and execute calibration.

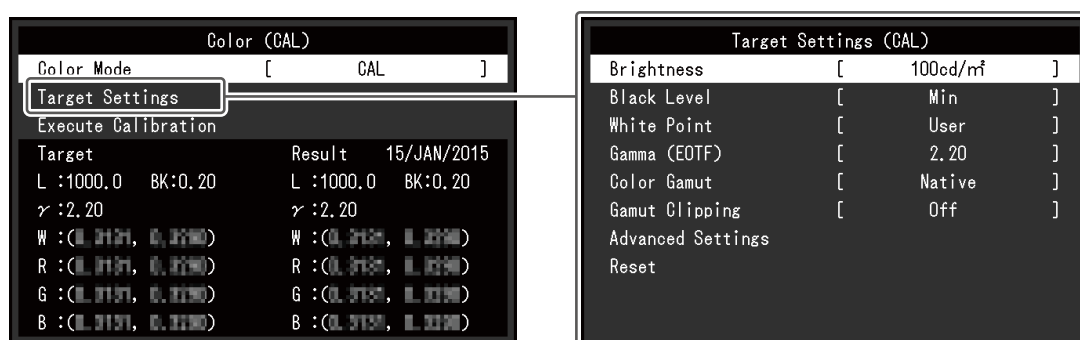
**Color Mode**

Settings: "User" / "BT.2020" / "BT.709" / "DCI-P3" / "PQ_DCI-P3" / "HLG_BT.2100" / "Adobe®RGB" / "sRGB" / "CAL" / "SYNC_SIGNAL"

Select the desired mode according to the monitor application.

Note

- For more information on how to switch modes, see [Switching the Display Mode \(color mode\) \[▶ 13\]](#).
- Regarding "User / BT.2020 / BT.709 / DCI-P3 / PQ_DCI-P3 / HLG_BT.2100 / Adobe®RGB / sRGB / SYNC_SIGNAL", see [When Color Mode is Standard Mode \(User / BT.2020 / BT.709 / DCI-P3 / PQ_DCI-P3 / HLG_BT.2100 / Adobe®RGB / sRGB / SYNC_SIGNAL\) \[▶ 18\]](#).

Target Settings - Brightness

Settings: "Min" / "40 cd/m²" – "450 cd/m²" / "Max"

Set the brightness that will be used as a calibration target for SelfCalibration.

Target Settings - Black Level

Settings: "Min" / "0.2" – "3.5"

Set the black level that will be used as a calibration target for SelfCalibration.

Target Settings - White Point - Temperature

Settings: "4000 K" – "10000 K" / "User" / "D50" / "D65" / "DCI"

Set the White Point that will be used as a calibration target for SelfCalibration.

Set the White Point using the color coordinates (White(x) / White(y)) or color temperature.

When specifying color coordinates, set the values for "White(x)" and "White(y)", respectively.

When specifying the color temperature, set the color temperature in units of 100 K or select a color temperature according to each standard.

Note

- When color coordinates are specified, the color temperature is changed to "User".

Target Settings - White Point - White(x) / White(y)

Settings: "0.2400" – "0.4500"

For more information, see [Target Settings - White Point - Temperature \[▶ 24\]](#).

Target Settings - Gamma (EOTF) - Gamma (EOTF)

Settings: "1.00" – "2.70" / "sRGB" / "EBU(2.35)" / "L*" / "PQ" / "HLG" / "User" / "Fixed"

Set the gamma that will be used as the calibration target for SelfCalibration.

Set the gamma, or select the gamma curve defined by each standard.

Target Settings - Gamma (EOTF) - Gamma Policy

Settings: "Standard" / "Gray Balance" / "Fixed Gamma"

Select the gamma adjustment method for SelfCalibration.

- "Standard"
Adjust the gray balance while retaining the contrast.
- "Gray Balance"
Adjust the monitor so that the chromaticity of the middle tone area equals the white point.
- "Fixed Gamma"
Select to use specific gamma settings.

Attention

- If "HLG" is specified for "Gamma (EOTF)", "Fixed Gamma" is selected and this setting cannot be changed.
- With "Gray Balance", all points of the grayscale are adjusted toward the target white point. Select this to prioritize whiteness when correcting the middle tone area. However, the following restrictions apply when "Gray Balance" is selected:
 - The contrast may decrease.
 - The color gamut may be narrower than when adjusting with "Fixed Gamma".

Target Settings - Gamma (EOTF) - PQ Option

Settings: "300cd/m² Clipping" / "500cd/m² Emulation" / "1000cd/m² Emulation" / "4000cd/m² Emulation" / "10000cd/m² Emulation"

Set the PQ option that will be used as the calibration target for SelfCalibration.

Note

- This can be set when "PQ" is specified for "Gamma (EOTF)".

Target Settings - Gamma (EOTF) - HLG Option

Settings: "Off" / "HLG300"

Set the HLG option that will be used as the calibration target for SelfCalibration.

Note

- This can be set when "HLG" is specified for "Gamma (EOTF)".

Target Settings - Gamma (EOTF) - HLG System Gamma

Settings: "1.0" – "1.5"

Set the HLG system gamma that will be used as a calibration target for SelfCalibration.

Note

- This can be set when "HLG" is specified for "Gamma (EOTF)".

Target Settings - Color Gamut

Settings: "Native" / "Adobe@RGB" / "sRGB" / "EBU" / "BT.709" / "BT.2020" / "SMPTE-C" / "DCI-P3" / "User"

Set the color gamut that will be used as a calibration target for SelfCalibration.

In "Color Gamut", the color gamut defined by each standard can be selected.

To set a color gamut other than those specified by each standard, specify the color coordinates of each RGB color, and the display method ("Gamut Clipping") of colors outside the color gamut of the monitor.

Note

- When you select "Native" in "Color Gamut", the preset color gamut of the LCD panel is displayed.
- When color coordinates are specified in the color gamut settings, the "Color Gamut" is changed to "User".

Target Settings - Color Gamut - Red(x) / Red(y) / Green(x) / Green(y) / Blue(x) / Blue(y)

Settings: "0.0000" – "1.0000"

For more information, see [Target Settings - Color Gamut \[▶ 25\]](#).

Target Settings - Gamut Clipping

Settings: "On" / "Off"

For more information, see [Target Settings - Color Gamut \[▶ 25\]](#).

Target Settings - Advanced Settings - Limited (109% White)

Settings: "On" / "Off"

If this function is set to "On" then, if "Gamma (EOTF)" is from "1.6" to "2.7", the brightness range of the input signal is displayed as 16 – 254 (10 bits: 64 – 1019). If "Gamma (EOTF)" is anything other than "1.6" to "2.7", it is displayed as 16 – 235 (10 bits: 64 – 940).

Note

- This can be set when "1.00 to 2.70" is specified for "Gamma (EOTF)".

Target Settings - Reset

Resets any calibration targets for the currently selected color mode back to the default settings.

Execute Calibration

SelfCalibration can be executed manually regardless of the schedule.

3.2.3 SelfCalibration

See [SelfCalibration Functions \[▶ 35\]](#).

3.2.4 Screen

Set the details regarding input signal, such as the screen size and color format.

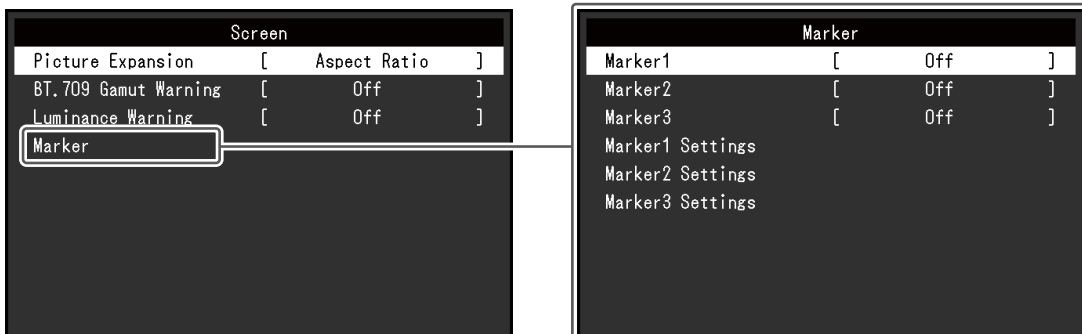
**Picture Expansion**Settings: "Auto"^{*1} / "Full Screen" / "Aspect Ratio" / "Dot by Dot"

^{*1} Only enabled during HDMI input

The screen size of the monitor display can be changed.

- "Auto"

The monitor automatically changes the screen size according to the resolution information and aspect ratio information from the input signal.
- "Full Screen"

Images are stretched to full screen. However, as aspect ratios are not maintained, images may be distorted in some cases.
- "Aspect Ratio"

Images are enlarged to full screen without changing the aspect ratio. Since aspect ratios are maintained, blank horizontal or vertical borders may appear.
- "Dot by Dot"

Displays the image at the set resolution or size specified by the input signal.

Note

- Setting example

Full-screen

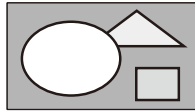

Fixed aspect ratio

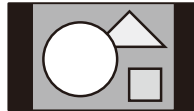

Actual size (input signal)



BT.709 Gamut Warning

Settings: "Off" / "Clip" / "On"

If a signal that complies with the ITU-R BT.2020 standard is input, you can set the display method for colors that exceed the color gamut for the BT.709 standard.

- "Off"

Images are displayed according to the color gamut for BT.2020.

(The actual color gamut that is displayed on the monitor will depend on the setting for [Advanced Settings - Gamut Clipping](#) [▶ 22].)

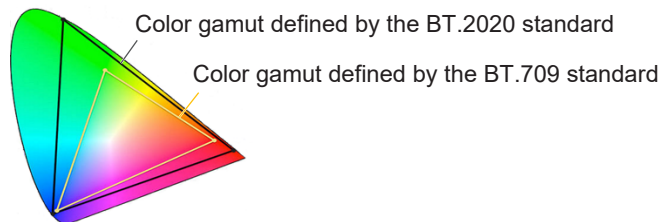

- "Clip"

Colors that are outside of the color gamut for BT.709 are expressed within the color gamut for BT.709 (clipping occurs).

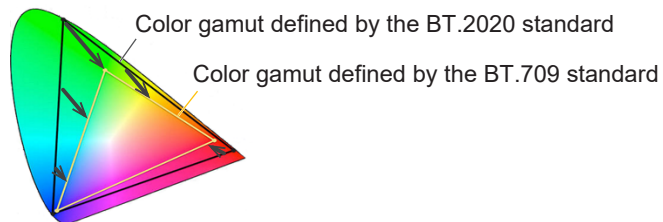

- "On"

Colors that are outside of the color gamut for BT.709 are displayed in gray.

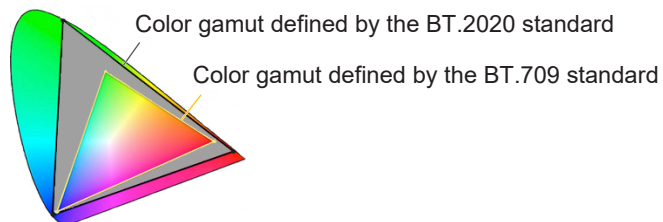

Note

- This function can be set only when [Color Gamut \[▶ 21\]](#) is set to "BT.2020".
- This function and "Luminance Warning" cannot be enabled at the same time. If this function is set to "On" or "Clip", the "Luminance Warning" function is automatically set to "Off".

Luminance Warning

Settings: "Off" / "On(Yellow)" / "On(Magenta)"

You can check areas with a brightness that is higher than the brightness that is set for "PQ Option" for the input signal (areas where clipping occurs).



Example: Setting On (Magenta)

Note

- This function and "BT.709 Gamut Warning" cannot be enabled at the same time. If this function is set to "On", the "BT.709 Gamut Warning" function is automatically set to "Off".

Marker - Marker1

Settings: "Off" / "On" / "On (3 division grid)"

If this function is set to "On", markers are displayed. If "On (3 division grid)" is set, boundary lines are displayed that divide the image into three equal parts with Marker 1 and Marker 1.

Note

- If "On (3 division grid)" is set, "Marker2" and "Marker3" are disabled.

Marker - Marker2 / Marker3

Settings: "Off" / "On"

If this function is set to "On", markers are displayed.

Marker - Marker1Settings / Marker2Settings / Marker3Settings - Type

Settings: "Aspect" / "Dots (Center)" / "Dots (Free)"

You can select the type (method to specify position and size) of the marker.

Marker - Marker1Settings / Marker2Settings / Marker3Settings - Aspect

Settings: "4:3" / "13:9" / "14:9" / "15:9" / "16:9" / "21:9" / "1.85:1" / "2.35:1" / "2.39:1" / "User"

You can set the aspect ratio for the displayed marker.

Marker - Marker1Settings / Marker2Settings / Marker3Settings - Aspect (User)

Settings: "1.00:1" – "3.00:1"

You can set the aspect ratio for the displayed marker freely. This can only be set when "User" is selected for "Aspect".

Marker - Marker1Settings / Marker2Settings / Marker3Settings - Area Size

Settings: "50.0%" – "100.0%" / "User"

You can set the size of the area. This can only be set when "Aspect" is selected for "Type".

Marker - Marker1Settings / Marker2Settings / Marker3Settings - Hor. Position

Settings: "*1"

You can set the horizontal position of the marker. This can only be set when "Dots (Free)" is selected for "Type".

*1 The values that can be set may differ depending on the resolution of the input signal.

Marker - Marker1Settings / Marker2Settings / Marker3Settings - Ver. Position

Settings: "*1"

Sets the vertical position of the marker. This can only be set when "Dots (Free)" is selected for "Type".

*1 The values that can be set may differ depending on the resolution of the input signal.

Marker - Marker1Settings / Marker2Settings / Marker3Settings - Width

Settings: "*1"

Sets the width of the marker. This can only be set when "Dots (Free)" or "Dots (Center)" is selected for "Type", or when "Aspect" is selected for "Type" and "User" is selected for "Area Size".

*1 The values that can be set may differ depending on the resolution of the input signal.

Marker - Marker1Settings / Marker2Settings / Marker3Settings - Height

Settings: "*1"

You can set the vertical position of the marker. This can only be set when "Dots (Free)" or "Dots (Center)" is selected for "Type", or when "Aspect" is selected for "Type" and "User" is selected for "Area Size".

*1 The values that can be set may differ depending on the resolution of the input signal.

Marker - Marker1Settings / Marker2Settings / Marker3Settings - Thickness

Settings: "1 dot" – "6 dots"

You can set the thickness of the marker.

Marker - Marker1Settings / Marker2Settings / Marker3Settings - Color

Settings: "White" / "Red" / "Green" / "Blue" / "Cyan" / "Magenta" / "Yellow" / "Gray"

You can set the color of the marker.

3.2.5 Preferences

The monitor's settings can be configured to suit the usage environment or personal preference.

Preferences		
Menu Rotation	[0°]
Power Save	[On]
Indicator	[4]
Beep	[On]
Input Skip		
Mode Skip		
Custom Key		
USB Selection		
Monitor Reset		

Menu Rotation

Settings: "0°" / "90°"

When the monitor is used in a portrait position, the direction of the Setting menu can also be changed.

Note

- Check whether the cables are connected properly.
- It is necessary to configure the settings of the external device to use the monitor in a portrait position. For details, refer to our web site (www.eizoglobal.com).

Power Save

Settings: "On" / "Off"

This function allows you to set the monitor to the power saving mode, depending on the state of the external device connected to it.

The monitor changes to power saving mode about 15 seconds after signal input ceases to be detected. When the monitor has shifted to power saving mode, images are not displayed on the screen.

- Exiting power saving mode
 - The monitor receives input.

Note

- At the time of shifting to power saving mode, a message that indicates the transition is displayed five seconds in advance.
- When not using the monitor, you can turn off the main power supply or disconnect the power plug so that the power is cut completely.
- Even if the monitor shifts to power saving mode, devices connected to the USB downstream port will still work. In addition, power is supplied to devices connected to the USB-C connector. Therefore, power consumption of the monitor varies depending on the connected devices, even in power saving mode.

Indicator

Settings: "Off" / "1" – "7"

The brightness of the power button and the control buttons when the screen is displayed can be set. (Default setting: 4)

Beep

Settings: "On" / "Off"

The sound played when switches are used can be set.

Input Skip

Settings: "Skip" / "-"

This function allows skipping of input signals that will not be used when the input signals are switched.

Note

- Not all input signals can be set to "Skip".

Mode Skip

Settings: "Skip" / "-"

This function allows skipping of modes that will not be used when selecting modes. Please use this function if display modes are limited, or if you want to prevent randomly changing the display status.

Note

- Not all modes can be set to "Skip".

Custom Key - [F1]

Settings: "Off" / "Input Range" / "BT.709 Gamut Warning" / "Luminance Warning" / "Prev. Color Mode" / "Information" / "Marker1" / "Marker2" / "Marker3" / "PQ Option" / "HLG Option"

You can set the function that is assigned to the [F1] key.

Note

- By default, this key is set to the "Information" function.
- Regarding the custom keys, see [Custom Key Settings \[▶ 39\]](#).

Custom Key - [F2]

Settings: "Off" / "Input Range" / "BT.709 Gamut Warning" / "Luminance Warning" / "Prev. Color Mode" / "Information" / "Marker1" / "Marker2" / "Marker3" / "PQ Option" / "HLG Option"

You can set the function that is assigned to the [F2] key.

Note

- By default, this key is set to the "Off" function.
- Regarding the custom keys, see [Custom Key Settings \[▶ 39\]](#).

USB Selection – HDMI / DisplayPort / USB-C

Settings: "USB-1 (USB-C)" / "USB-2"

If two external devices are connected to a single monitor, then the input signals and USB upstream ports can be linked. This means that the USB port will automatically switch when the input signal is switched. There is no need to re-connect the USB cable even when calibrating a single monitor using two external devices. In addition, USB devices such as a mouse or keyboard can be connected to the monitor and used with two external devices.

Default settings differ depending on the input signal.

Input signal	Default settings
HDMI, DisplayPort	USB-2
USB-C	USB-1 (USB-C)

Note

- Before changing the setting, remove all connected USB memory devices from the monitor. Otherwise, data may be lost or damaged.
- The USB downstream port operates from the external device being displayed.

Monitor Reset

Restores all settings to their default values, except for the settings in the "Administrator Settings" menu.

3.2.6 Languages

Settings: "English" / "German" / "French" / "Spanish" / "Italian" / "Swedish" / "Japanese" / "Simplified Chinese" / "Traditional Chinese"

The display language for menus and messages can be selected.

**3.2.7 Information**

You can check the monitor information (model name, serial number (S/N), firmware version, usage time) and the input signal information.

Example:

```
Information
ColorEdge 000000 S/N: 00000001
Version    10000-10000
Usage Time (h) 0

DisplayPort
0000 X 0000
fH: 00.00 kHz
fV: 00.00 Hz
fD: 000.00 MHz
```

4 SelfCalibration

This product is equipped with a built-in calibration sensor. By setting the calibration targets and execution schedule in advance, the calibration sensor automatically operates and regularly calibrates the monitor. This automatic calibration function is called "SelfCalibration".

The adjustment content of SelfCalibration differs depending on the color mode that is executed.

- Standard Mode (color modes excluding "CAL"):
 - the monitor's color reproduction gamut is updated and the display mode in each mode is adjusted as follows.
 - The temperature is adjusted so that it is as close as possible to the standard value.
 - The color gamut values are adjusted so that they are close to each standard value.
 - Information on brightness is updated.
- Advanced Mode (color mode "CAL"):
 - When performing SelfCalibration on the monitor itself, calibrate the monitor to match the set targets.
 - When using ColorNavigator 7, use a measurement device with the software to maintain the calibrated state of the monitor.

Attention

- Touching the internal calibration sensor can affect its measurement accuracy.
 - Do not touch the sensor during use.
- Large changes in the amount of ambient light entering the internal calibration sensor light receiver can affect measurement accuracy.
 - Calibration is best done in a darkened room.
 - Do not put your face or objects close to the monitor, or look into the sensor, during measurement.
 - Installation of a monitor hood is recommended.
- High temperatures or humidity levels can affect the measurement accuracy of the internal calibration sensor.

The monitor is best used in the following environment.

 - Temperature: 30°C or below
 - Humidity: 70% or below
- Avoid using in direct sunlight.

Note

- SelfCalibration can be executed 30 minutes after turning on the monitor.
- SelfCalibration can also be executed when there are no external device signals being input.
- To preserve adjustments that you set by using ColorNavigator 7, it is recommended to execute SelfCalibration.
- Because brightness and chromaticity will change as you use the monitor, it is recommended to calibrate the monitor periodically.
- The measurement results from the built-in calibration sensor can be correlated with the measurement results from the external measurement device that you want to use as a reference. For details, refer to the ColorNavigator 7 User's Manual.

You can set the calibration targets and execution schedule by using ColorNavigator 7 or the monitor's Setting menu.

You can download the ColorNavigator 7 software and User's Manual from our web site: (www.eizoglobal.com)

Note

- When using the software, you will need to connect the external device to the monitor with the supplied USB cable.
- For details on the USB cable connection, see [Using the Docking Station Function \[▶ 66\]](#).
- While using the software, do not operate the power button or control buttons on the front side of the monitor.

4.1 SelfCalibration Functions

Set the details for SelfCalibration.



Execute

SelfCalibration can be executed manually regardless of the schedule.

Note

- After selecting "Execute", warming up (after the power to the monitor is switched on, leaving the monitor on for a certain period of time until the display becomes stable) may be executed before the built-in calibration sensor comes out.

Settings - Mode Settings - Standard Mode

Settings: "On" / "Off"

Switch between enabling/disabling SelfCalibration in Standard Mode.

Settings - Mode Settings - Advanced Mode (CAL)

Settings: "On" / "Off"

Switch between enabling/disabling SelfCalibration in Advanced Mode.

Settings - Schedule - Start time

Settings: "Power Save" / "Immediately" / "Application" / "Off"

Select the timing to execute SelfCalibration upon reaching the time set in the schedule.

- "Power Save"
 - To be executed under any of the following conditions.
 - When the monitor is in "Power Save" mode or power is off at the set time.
 - The monitor shifts to the power saving mode or the power is turned off when the set time in the schedule is exceeded.

- "Immediately"
SelfCalibration is executed immediately at the set time.
- "Application"
Executes SelfCalibration according to the timing set using ColorNavigator Network. For details on ColorNavigator Network, refer to our web site (www.eizoglobal.com).
- "Off"
SelfCalibration is not executed.

Settings - Schedule - Frequency

Settings: "Daily" / "Weekly" / "Monthly" / "Quarterly" / "Biannually" / "Annually" / "Usage Time"

Select the SelfCalibration execution cycle.

Settings - Schedule - Timing

Settings: "Jan/Apr/Jul/Oct" / "Feb/May/Aug/Nov" / "Mar/Jun/Sep/Dec" / "Jan/Jul" / "Feb/Aug" / "Mar/Sep" / "Apr/Oct" / "May/Nov" / "Jun/Dec" / "January" - "December" / "50 h" – "500 h"

When the execution cycle is "Quarterly", "Biannually", "Annually", or "Usage Time", select the timing for executing SelfCalibration.

The settings differ depending on the execution cycle setting.

- "Quarterly":
"Jan/Apr/Jul/Oct", "Feb/May/Aug/Nov", "Mar/Jun/Sep/Dec"
- "Biannually":
"Jan/Jul", "Feb/Aug", "Mar/Sep", "Apr/Oct", "May/Nov", "Jun/Dec"
- "Annually":
"January" – "December"
- "Usage Time":
"50 h" – "500 h"

Settings - Schedule - Week

Settings: "1st week" – "5th week"

When the execution cycle is "Monthly", "Quarterly", "Biannually", or "Annually", select the week for executing SelfCalibration.

Note
<ul style="list-style-type: none">• When no day has been selected for "Day" in the selected week, the week of execution will be as follows:<ul style="list-style-type: none">– When the selected week is "1st week": 2nd week– When the selected week is "5th week": 4th week

Settings - Schedule - Day

Settings: "Sunday" – "Saturday"

When the execution cycle is "Weekly", "Monthly", "Quarterly", "Biannually", or "Annually", select the day for executing SelfCalibration.

Settings - Schedule - Time

Settings: "0:00" – "23:55"

When the execution cycle is "Daily", "Weekly", "Monthly", "Quarterly", "Biannually", or "Annually", select the time for executing SelfCalibration.

Settings - Clock Adjustment

Set the monitor date and time.

Note
<ul style="list-style-type: none"> • When the clock has not been set, the schedule will not be applied. • If the main power supply is disconnected for an extended period of time, the clock may need resetting. • When ColorNavigator 7 is started, the date and time are automatically set.

Result

The SelfCalibration execution result is displayed.

Next Calibration

The next SelfCalibration scheduled execution date is displayed.

4.2 Setting Targets

Set calibration targets for Advanced Mode. You can set targets by using ColorNavigator 7 or on the monitor itself.

When using the monitor itself, set the following functions in the "Color" menu.

- "Color Mode"
Select "CAL".
- "Target Settings"
Set a calibration target for SelfCalibration.

4.3 Executing

SelfCalibration can be executed manually, which does it immediately, or by setting a schedule to do it automatically.

You can set a schedule by using ColorNavigator 7 or on the monitor itself.

When executing SelfCalibration by setting a schedule on the monitor itself, the method to enable SelfCalibration differs depending on the type of color mode (Standard Mode or Advanced Mode).

Attention
<ul style="list-style-type: none"> • If there is a change in the video signal from the external device during SelfCalibration (the signal disappears, a signal is input during a no-signal state, or other), SelfCalibration is automatically canceled.

4.3.1 Immediately executing manually

Manually execute SelfCalibration.

There are two methods for executing SelfCalibration, as follows.

- Executing from the "SelfCalibration" menu
In the "SelfCalibration" menu, select "Execute".
SelfCalibration is executed for all the color modes selected as "On" in "Settings" - "Mode Settings" of the "SelfCalibration" menu.
- Executing from the "Color" menu
In "Color Mode" in the "Color" menu, select "CAL", and then select "Execute Calibration".
Executes SelfCalibration for the displayed color mode.

4.3.2 Automatically executing by setting a schedule

Set the calibration schedule for SelfCalibration.

In "Settings" in the "SelfCalibration" menu, set the calibration schedule and monitor date and time for SelfCalibration.

Attention
<ul style="list-style-type: none">• If a scheduled SelfCalibration is automatically canceled, it is executed again when the monitor transitions to the power saving mode an hour or more after cancellation or when the monitor is turned off using .

4.3.3 Activating SelfCalibration in Standard Mode

Execute SelfCalibration in Standard Mode.

In "Settings" in the "SelfCalibration" menu, set the following functions:

- "Mode Settings"
Set "Standard Mode" to "On".

4.3.4 Activating SelfCalibration in Advanced Mode

Execute SelfCalibration in Advanced Mode.

In "Settings" in the "SelfCalibration" menu, set the following functions:

- "Mode Settings"
Select "Advanced Mode".
- "Advanced Mode"
Select "CAL", and set "On".

4.4 Checking Results

Check the SelfCalibration calibration results by using the monitor.

In the "Color" menu, set the following functions:

- "Color Mode"
Select "CAL".
- "Result"
Check the calibration result of SelfCalibration.

5 Custom Key Settings





You can assign functions to the custom keys to easily start specified functions.

This chapter describes how to operate the custom keys and how to assign functions to the custom keys.

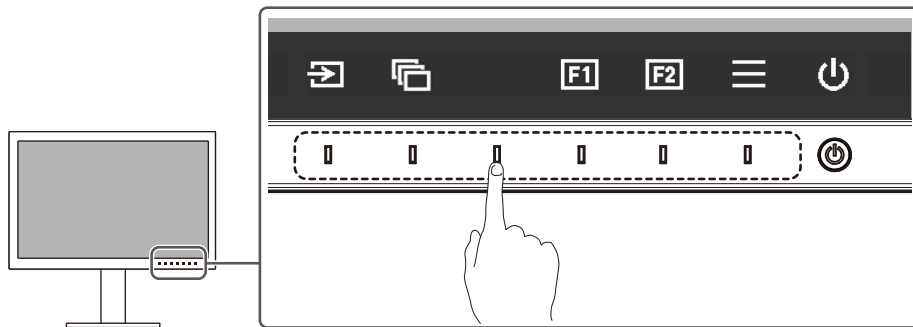
5.1 Basic Operation of the Custom Keys

1. Touch any switch (except ).
The operation guide appears.





2. Select  or .
- The function assigned to  or  is executed.

Note

- If you touch a custom key to which no function has been assigned, the menu for assigning a function to that custom key appears.

5.2 Assigning a Function to a Custom Key

1. Touch any switch (except ).
The operation guide appears.
 2. Select .
- The Setting menu appears.



3. Use **▲ ▼** to select "Preferences", and then select **✓**.
The Preferences menu appears.

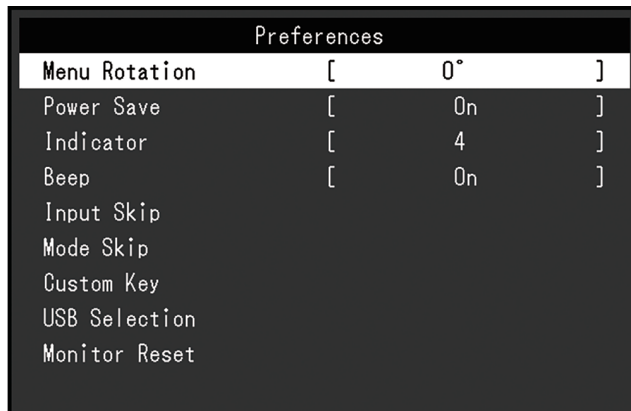

4. Use **▲ ▼** to select "Custom Key", and then select **✓**.
The Custom Key menu appears.

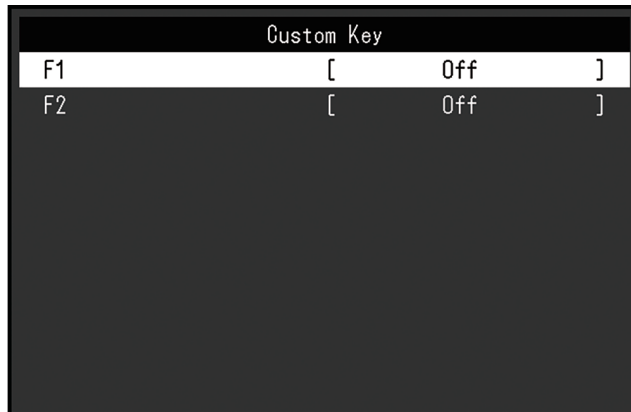

5. Use **▲ ▼** to select the custom key to which you want to assign a function, and then select **✓**.
The menu for assigning a function appears.

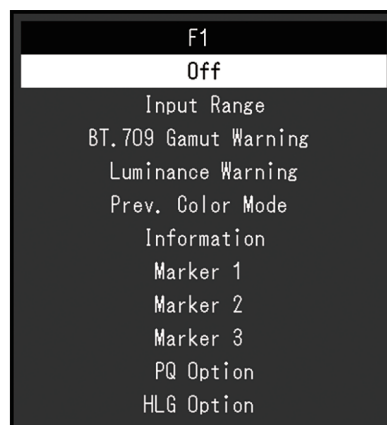

6. Use **▲ ▼** to select the function that you want to assign, and then select **✓**.
That function is assigned to the custom key.
7. Press **✕** several times.
The Setting menu exits.

5.2.1 Functions that can be Assigned to Custom Keys

Function	Description
Off	Disables the custom key.
Input Range	Sets the Input Range function. See Input Range [▶ 18] .
BT.709 Gamut Warning	Sets the BT.709 Gamut Warning function. See BT.709 Gamut Warning [▶ 27] .
Luminance Warning	Sets the Luminance Warning function. See Luminance Warning [▶ 28] .
Prev. Color Mode	You can return to the previous color mode. This is convenient for checking the differences between two color modes. Attention <ul style="list-style-type: none"> When using ColorNavigator 7, it is necessary to reselect the color mode after exiting the software.
Information	You can view the input signal information and color information. Note <ul style="list-style-type: none"> You can check the monitor information under Information [▶ 32] on the Setting menu.
Marker1	Sets the Marker 1 function. See Marker - Marker1 [▶ 28] .
Marker2	Sets the Marker 2 function. See Marker - Marker2 / Marker3 [▶ 28] .
Marker3	Sets the Marker 3 function. See Marker - Marker2 / Marker3 [▶ 28] .
PQ Option	Sets the PQ Option function. See PQ Option [▶ 20] .
HLG Option	Sets the HLG option function. See HLG Option [▶ 20] .

6 Administrator Settings

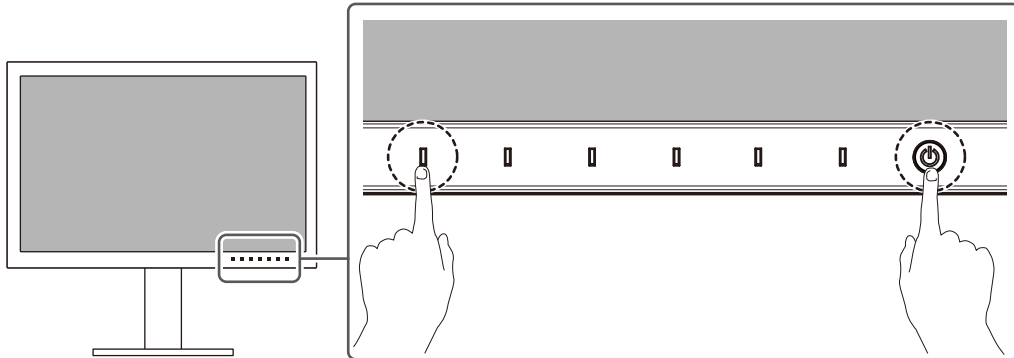

6.1 Basic Operation of the "Administrator Settings" Menu

1. Touch  to turn off the monitor.
2. While touching the leftmost switch, touch  for more than 2 seconds to turn on the monitor.



The "Administrator Settings" menu appears.

Administrator Settings		
Auto Input Detection	[Off]
On-Screen Logo	[On]
Information Display	[On]
Key Lock	[Off]
Compatibility Mode	[Off]
Ethernet	[On]
DUE Priority	[Brightness]
Signal Format		
Apply		

3. Select an item to set with   and select .

The Adjustment/Setting menu appears.

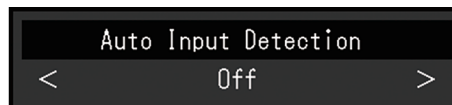

4. Set with   and select .

The "Administrator Settings" menu appears.

5. Select "Apply" and then .

The settings are applied and the "Administrator Settings" menu exits.

6.2 Functions of the "Administrator Settings" Menu

Administrator Settings		
Auto Input Detection	[Off]
On-Screen Logo	[On]
Information Display	[On]
Key Lock	[Off]
Compatibility Mode	[Off]
Ethernet	[On]
DUE Priority	[Brightness]
Signal Format		
Apply		

Auto Input Detection

Settings: "On" / "Off"

This function automatically recognizes the connector through which PC signals are input, and displays images on the screen accordingly.

- "On"
When the monitor is connected to multiple external devices, if a specific external device enters power saving mode or no signals are input to the monitor, the connector is automatically changed to another one to which signals are input.
- "Off"
To be set to this when manually selecting input signals. Select the input signal to display using the operation switch () on the front of the monitor. For details, see [Switching Input Signals](#) [▶ 12].

Note

- This product automatically recognizes the connector through which PC signals are input, and displays images on the screen accordingly regardless of whether this function is set to On or Off just after the main power switch on the back of the monitor has been turned on.
- When this function is set to "On", the monitor only enters power saving mode when signals are not input from any external device.

On-Screen Logo

Settings: "On" / "Off"

When the monitor is turned on, the logo appears on the screen.

When this function is set to "Off", the logo does not appear.

Information Display

Settings: "On" / "Off"

If this function is set to "On", [Signal Information](#) [▶ 17] is displayed when the signal is switched.

When set to "Off", [Signal Information](#) [▶ 17] is not displayed when the signal is switched.

Key Lock

Settings: "Off" / "Menu" / "All"

In order to prevent changes to settings, the operation switches on the front of the monitor can be locked.

- "Off" (default setting)
Enables all switches.
- "Menu"
Locks the  switch.
- "All"
Locks all switches except the power switch.

Compatibility Mode

Settings: "On" / "Off"

If you want to avoid the following phenomena, set this function to "On":

- The positions of windows and icons are shifted when the monitor is turned off/on or has returned from the power saving mode.
- Even when the mouse or keyboard are used, the external device does not wake from sleep.

Ethernet

Settings: "On" / "Off"

You can switch between enabling and disabling of the LAN port of the monitor.

- "On"
Enables the LAN port and allows network connections from external devices connected via USB-C.
- "Off"
Disables the LAN port.

DUE Priority

Settings: "Uniformity" / "Brightness"

This product contains a Digital Uniformity Equalizer (DUE) function to reduce screen display variance. The DUE settings can be changed.

- "Uniformity"
Emphasizes reducing display variances.
- "Brightness"
Emphasizes high brightness and high contrast ratios.

Note
<ul style="list-style-type: none">• When the DUE settings are changed, the monitor where the screen is being adjusted will need to be recalibrated. Please recalibrate the monitor.

Signal Format – HDMI / DisplayPort / USB-C

Settings: "RGB"^{*1} / "YUV/HDR" / "RGB/HDR"^{*2}

*1 Only enabled during HDMI or DisplayPort input

*2 Only valid for DisplayPort or USB-C input

The type of signal that can be displayed on the monitor can be changed. Try changing this setting if the input signal is not displayed correctly or the intended display does not show.

7 SDR/HDR Settings

This chapter describes how to configure the monitor settings to use this monitor for image creation.

[About Each Color Mode \[▶ 45\]](#) describes applications and configurations of each color mode.

[Setting Procedure \[▶ 55\]](#) describes the procedure to configure each color mode settings suitable for the display of each application.

[Settings with ColorNavigator 7 \[▶ 56\]](#) describes the overview of procedure to configure settings using software.

Attention

- See [Information \[▶ 32\]](#) to check the firmware version of your monitor before configuring the settings. Select "Software and Drivers" in "Support" from our web site (www.eizoglobal.com), enter the model name, and perform a search. Download the program and update the firmware if its version is different from the latest version.

Note

- It takes about 3 minutes (under our measurement conditions) for the monitor display to stabilize. For highly accurate adjustments, please wait 20 minutes or more after the monitor power has been turned on.
- If you switch between SDR color modes ("BT.2020", "BT.709", and "DCI-P3") and HDR color modes ("PQ_DCI-P3" and "HLG_BT.2100"), wait 30 minutes or more after switching the color modes, and then adjust the monitor.

7.1 About Each Color Mode

7.1.1 Types and Applications of Color Modes for Image Creation

Color Mode	Application
BT.2020	(SDR) This color mode is suitable for reproducing ITU-R BT.2020 standard-compliant color gamut and gamma.
BT.709	(SDR) This color mode is suitable for reproducing ITU-R BT.709 standard-compliant color gamut and gamma.
DCI-P3	(SDR) This color mode is suitable for reproducing DCI standard-compliant color gamut and gamma.
PQ_DCI-P3	(HDR) This color mode is suitable for reproducing DCI standard-compliant color gamut in PQ format gamma (EOTF).
HLG_BT.2100	(HDR) This color mode is suitable for reproducing ITU-R BT.2100 standard-compliant color gamut in HLG format gamma (EOTF).

The relation between input signal (10 bits: 0 to 1023) and the brightness displayed on the monitor when each color mode is configured properly is described below. For more information about how to configure the settings, see [Setting Procedure \[▶ 55\]](#).

7.1.2 BT.2020

The relation between input signal (0 to 1023) and the brightness displayed on the monitor is described below.

When displaying using an input signal brightness range of 64 – 940, set "Input Range" to "Auto", and when displaying using 64 – 1019, set to "Auto 109%".

- "Input Range" : "Auto"

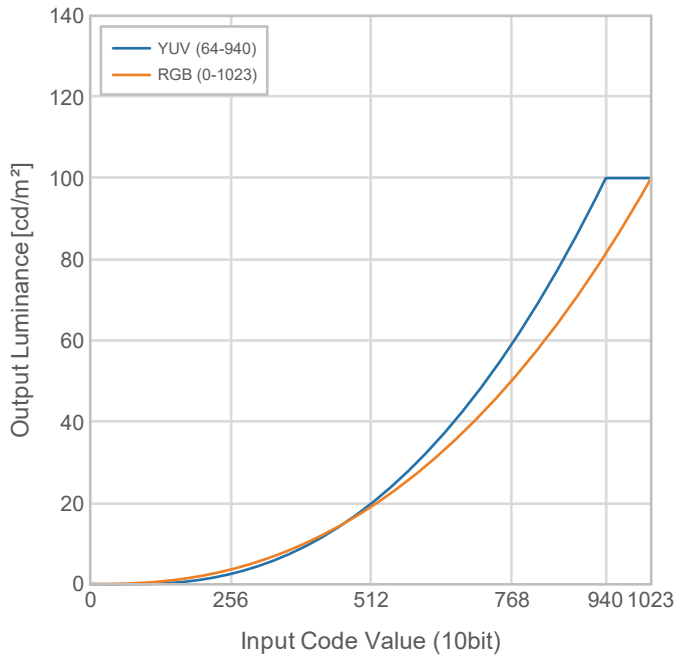

- "Input Range" : "Auto 109%"

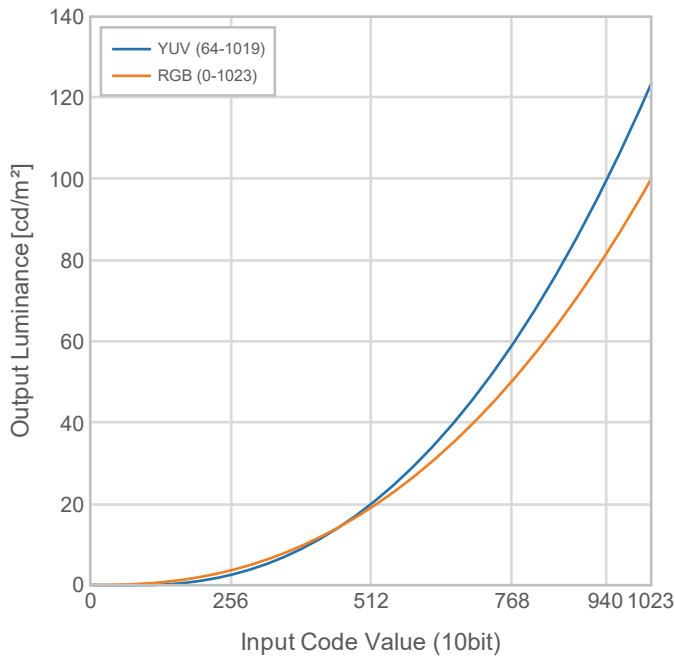

Main Setting Items of Setting Menu

For more information about procedure to configure the settings, see [Setting Procedure](#) [▶ 55](#).

Item		Input signal brightness range: 64 – 940	Input signal brightness range: 64 – 1019
Signal	YUV Color Matrix	Auto	Auto

Item		Input signal brightness range: 64 – 940	Input signal brightness range: 64 – 1019
	Input Range	Auto	Auto 109%
Color	Brightness (cd/m ²)	100	100
	Temperature	D65	D65
	Gamma (EOTF)	2.4	2.4
	Color Gamut	BT.2020	BT.2020

7.1.3 BT.709

The relation between input signal (0 to 1023) and the brightness displayed on the monitor is described below.

When displaying using an input signal brightness range of 64 – 940, set "Input Range" to "Auto", and when displaying using 64 – 1019, set to "Auto 109%".

- "Input Range" : "Auto"

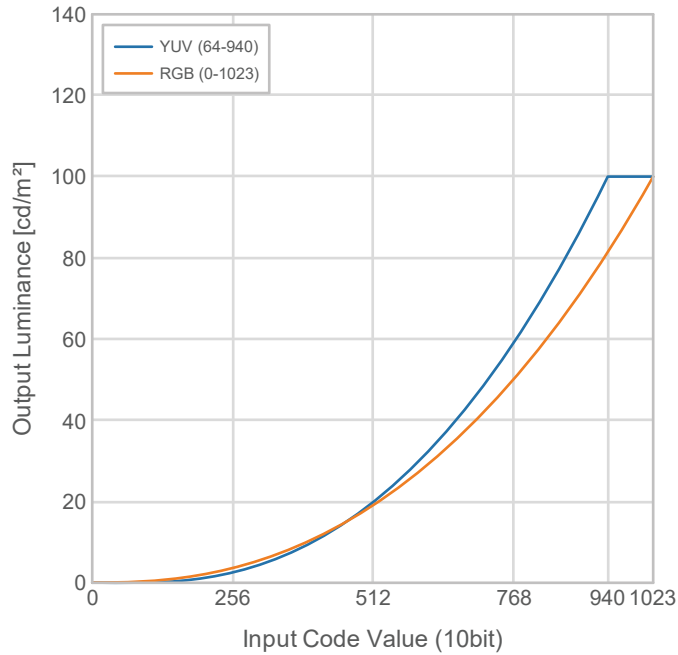

- "Input Range" : "Auto 109%"

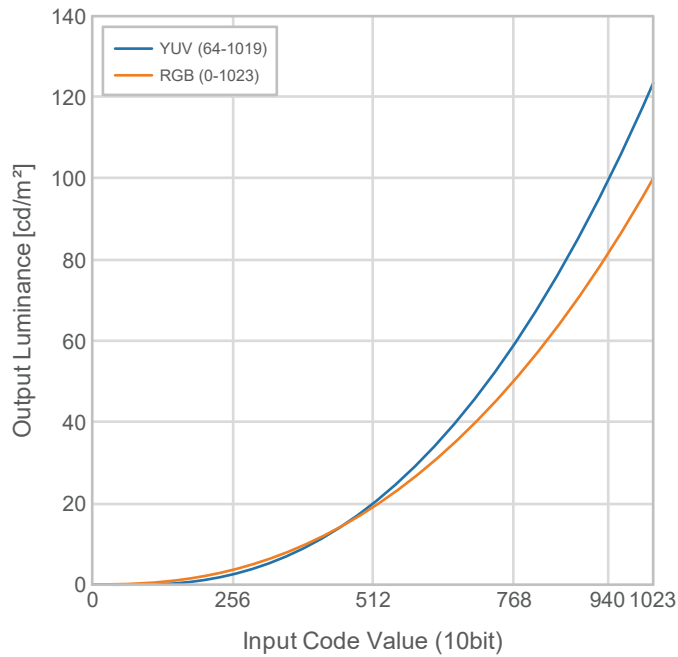

Main Setting Items of Setting Menu

For more information about procedure to configure the settings, see [Setting Procedure \[▶ 55\]](#).

Item		Input signal brightness range: 64 – 940	Input signal brightness range: 64 – 1019
Signal	YUV Color Matrix	Auto	Auto
	Input Range	Auto	Auto 109%
Color	Brightness (cd/m ²)	100	100
	Temperature	D65	D65
	Gamma (EOTF)	2.4	2.4
	Color Gamut	BT.709	BT.709

7.1.4 DCI-P3

The relation between input signal (0 to 1023) and the brightness displayed on the monitor is described below.

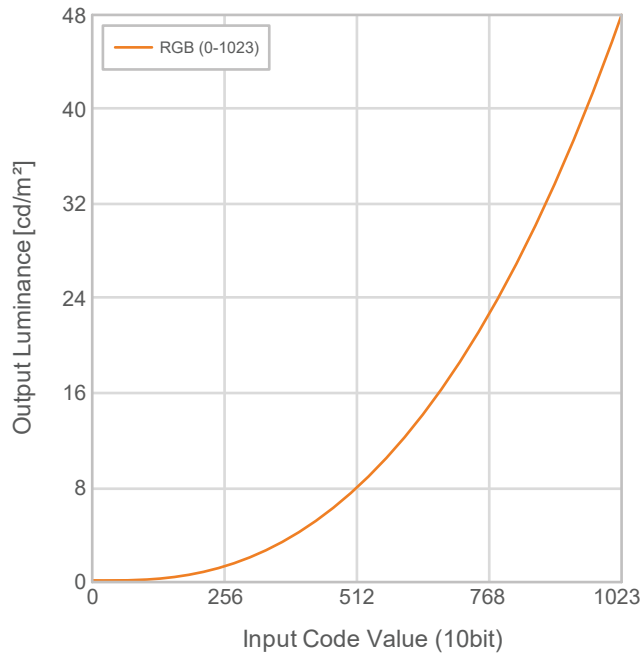

Main Setting Items of Setting Menu

For more information about procedure to configure the settings, see [Setting Procedure](#) [▶ 55].

Item		Setting value
Signal	YUV Color Matrix	Auto
	Input Range	Auto
Color	Brightness (cd/m²)	48
	Temperature	D65
	Gamma (EOTF)	2.6
	Color Gamut	DCI-P3

7.1.5 PQ_DCI-P3

The relation between input signal (0 to 1023) and the brightness displayed on the monitor is described below.

To display a PQ method gamma curve with a peak brightness of 1000 cd/m² compressed on a monitor with a set brightness of 300 cd/m², set "PQ Option" to "1000cd/m² Emulation". To display PQ method gamma curves uncompressed up to 300 cd/m², and clipped from 300 cd/m² up, set to "300cd/m² Clipping".

- "PQ Option" : "1000cd/m² Emulation"

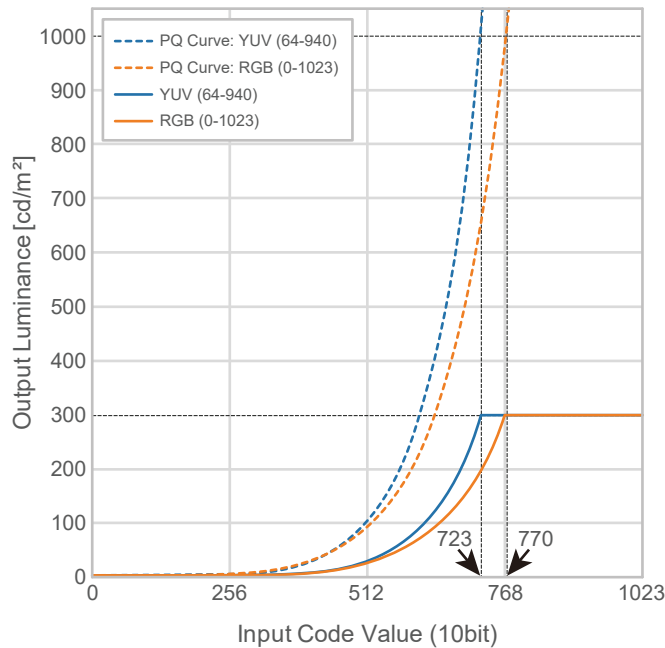

- "PQ Option" : "300cd/m² Clipping"

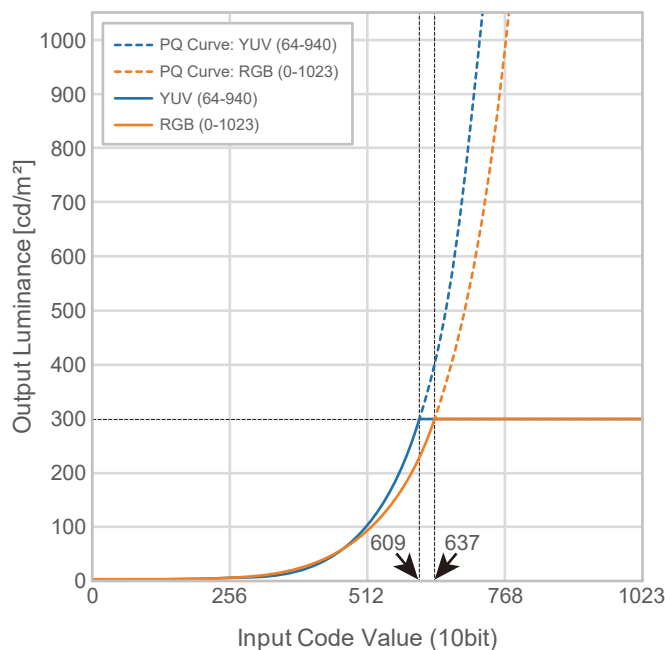

Main Setting Items of Setting Menu

For more information about procedure to configure the settings, see [Setting Procedure \[▶ 55\]](#).

Item		Compressed PQ curve display	Uncompressed PQ curve display
Signal	YUV Color Matrix	Auto	Auto
	Input Range	Auto ^{*1}	Auto ^{*1}
Color	Brightness (cd/m ²)	300	300
	Temperature	D65	D65
	Gamma (EOTF)	PQ	PQ
	PQ Option ^{*2}	1000cd/m ² Emulation	300cd/m ² Clipping
	Color Gamut	DCI-P3	DCI-P3

*1 It will work the same as "Auto" even when "Auto 109%" is selected.

*2 For more information, see [PQ Option \[▶ 20\]](#) and [Setting of PQ Option and Display \[▶ 69\]](#).

7.1.6 HLG_BT.2100

The relation between input signal (0 to 1023) and the brightness displayed on the monitor is described below.

To display a HLG method gamma curve with a peak brightness of 1000 cd/m² compressed on a monitor with a set brightness of 300 cd/m², set "HLG Option" to "Off". To display HLG method gamma curves uncompressed up to 300 cd/m², and clipped from 300 cd/m² up, set to "HLG300".

- "HLG Option" : "Off"

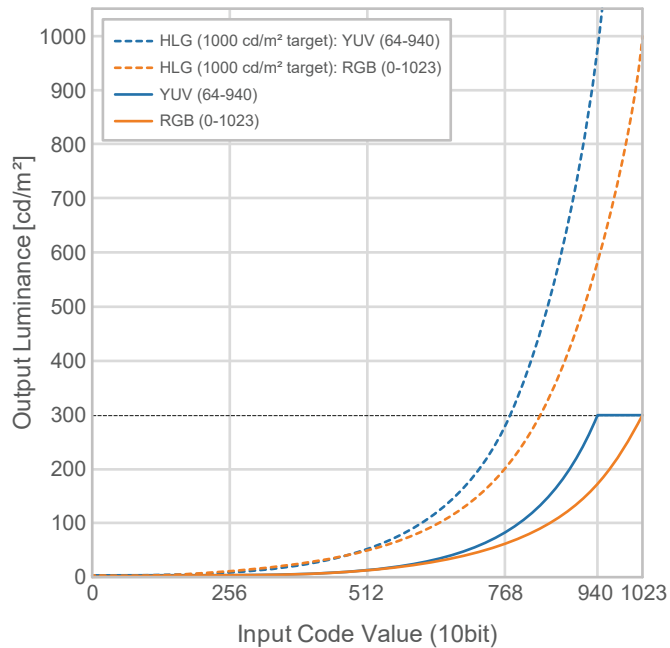

- "HLG Option" : "HLG300"

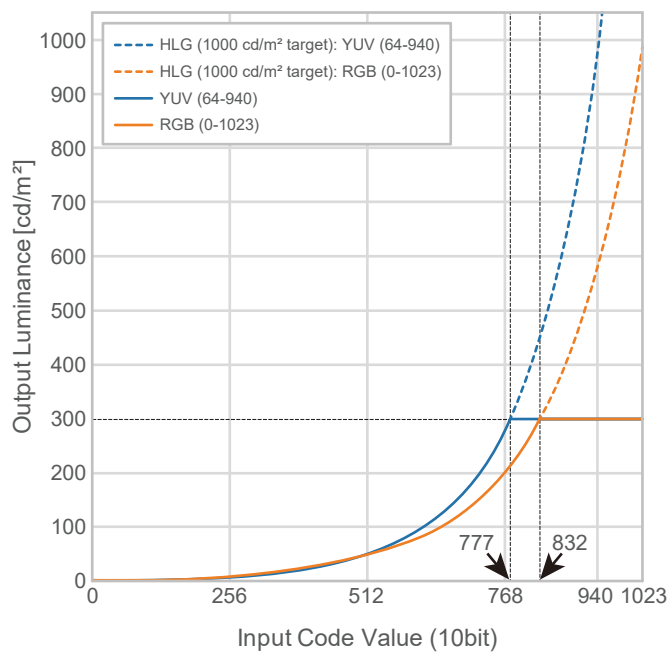

Main Setting Items of Setting Menu

For more information about procedure to configure the settings, see [Setting Procedure \[▶ 55\]](#).

Item		Compressed HLG curve display	Uncompressed HLG curve display
Signal	YUV Color Matrix	Auto	Auto
	Input Range	Auto ^{*1}	Auto ^{*1}
Color	Brightness (cd/m ²)	300	300
	Temperature	D65	D65
	Gamma (EOTF)	HLG	HLG
	HLG Option	Off	HLG300
	HLG System Gamma	1.2	1.0
	Color Gamut	BT.2020	BT.2020

^{*1} It will work the same as "Auto" even when "Auto 109%" is selected.

7.2 Setting Procedure

This section describes the procedure to use the monitor with the settings suitable for displaying SDR or HDR image.

Note

- For more information about basic operation of the Setting menu, see [Basic Operation of the Setting Menu \[▶ 16\]](#).
- For more information about SDR/HDR setting procedure with ColorNavigator 7, see [Settings with ColorNavigator 7 \[▶ 56\]](#).

1. Select a color mode suitable for the application. For details of color modes, see [Types and Applications of Color Modes for Image Creation \[▶ 45\]](#).

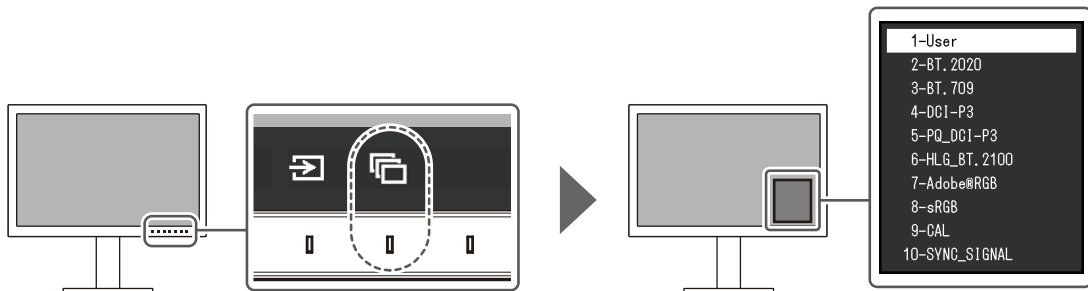

2. Set "Input Range" and "YUV Color Matrix" in the "Signal" menu. See [About Each Color Mode \[▶ 45\]](#) for settings.

Signal (HDMI)		
Signal Information		
Input Color Format	[Auto (RGB)]
YUV Color Matrix	[Auto]
Input Range	[Auto (Full)]

3. Display "Color" in the Setting menu, and configure the settings required. See [About Each Color Mode \[▶ 45\]](#) for settings.

Color (BT.2020)		
Color Mode	[BT.2020]
Brightness	[150cd/m ²]
Temperature	[6500K]
Gamma (EOTF)	[2.2]
PQ Option	[-]
HLG Option	[-]
HLG System Gamma	[-]
Color Gamut	[Native]
Advanced Settings		
Reset		

Settings for "Advanced Settings" are left default. For details, see [Color Mode Setting Values \[▶ 14\]](#).

Note

- It is recommended to perform "Reset" in "Color" before configuring the settings.

7.3 Settings with ColorNavigator 7

You can use ColorNavigator 7 to configure monitor settings suitable for SDR or HDR display. It is recommended to use ColorNavigator 7 to calibrate the monitor for the following cases.

- To perform regular calibration
ColorNavigator 7 has a function to notify when to perform calibration.
- To verify whether the monitor is properly calibrated
ColorNavigator 7 has a function to verify calibration status.

Note

- For more information about how to perform adjustment by operating only the Setting menu of the monitor, see [Setting Procedure \[▶ 55\]](#).
- For more information about ColorNavigator 7, refer to our web site.
(www.eizoglobal.com/products/coloredge/cn7)

7.3.1 Setting Procedure

1. Select a color mode in the Setting menu in the monitor.
See step 1 in [Setting Procedure \[▶ 55\]](#) to configure the setting.
2. Display "Signal" in the Setting menu of the monitor, and configure the settings required.
See step 2 in [Setting Procedure \[▶ 55\]](#) to configure the setting.
3. Start ColorNavigator 7.
4. Point at the color mode selected in the color mode list, right-click, and set the color mode type to "Advanced".
5. Set the adjustment target according to the application.
For more information, see [Target Settings of ColorNavigator 7 \[▶ 56\]](#).

7.3.2 Target Settings of ColorNavigator 7

-: Cannot be changed

	BT.2020	BT.709	DCI-P3	PQ_DCI-P3	HLG_BT.2100
Color Mode Type	Advanced ^{*1}	Advanced ^{*1}	Advanced ^{*1}	Advanced ^{*1}	Advanced ^{*1}
Brightness (cd/m ²)	100	100	48	100	100
White Point	D65	D65	D65	D65	D65
Gamma (EOTF)	2.4	2.4	2.6	PQ	HLG
PQ Option	-	-	-	300cd/m ² Clipping or 1000cd/m ² Emulation ^{*2}	-
HLG Option	-	-	-	-	Off or HLG300 ^{*2}
HLG System Gamma	-	-	-	-	1.0 or 1.2 ^{*2}
Adjustment Method	Standard	Standard	Standard	Standard	Standard
Color Gamut (Standard Value)	BT.2020	BT.709	DCI-P3	DCI-P3	BT.2020
Gamut Clipping	On	On	On	On	On

	BT.2020	BT.709	DCI-P3	PQ_DCI-P3	HLG_BT.2100
Accessories	On ^{*2*}	On ^{*2*}	Off ^{*2*}	-	-

*1 This item is changed from the default setting.

*2 Set according to preference or application.

*3 This is the setting for "Optimize to Limited (109% White)".

8 Troubleshooting

8.1 No Picture Displayed

Power indicator does not light up.

- Check whether the power cord is connected properly.
- Turn on the main power switch on the back of the monitor.
- Touch .
- Turn off the main power switch on the back of the monitor, and then turn it on again a few minutes later.

Power indicator is lighting white.

- Increase the various adjustment values for "Brightness" and "Gain" in the Setting menu (see [Color](#)  18]).

Power indicator is lighting orange.

- Switch the input signal.
- Turn the setting "On" for "Compatibility Mode" on the "Administrator Settings" menu (see [Compatibility Mode](#)  44]).
- Move the mouse or press any key on the keyboard.
- Check whether the external device is turned on.
- Turn off the main power switch on the back of the monitor, and then turn it on again.

The message "No Signal" appears in the screen.

Example:



- The message shown above may appear as some external devices do not output a signal immediately after power-on.
- Check whether the external device is turned on.
- Check whether the signal cable is connected properly.
- Switch the input signal.
- Turn off the main power switch on the back of the monitor, and then turn it on again.
- Try setting "Auto Input Detection" in the "Administrator Settings" menu to "Off" and switching the input signal manually (see [Auto Input Detection](#)  43]).

The message "Signal Error" appears in the screen.

Example:

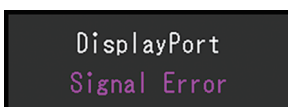

- Check whether the external device is configured to meet the resolution and vertical scan frequency requirements of the monitor. The list of compatible resolutions for this product

is available for download from our web site:
(www.eizoglobal.com)

- Reboot the external device.
- Select an appropriate setting using the graphics board's utility. Refer to the User's Manual of the graphics board for details.

The message "DP Unsupported" appears in the screen.

Example:

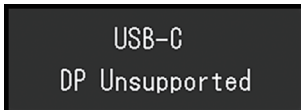

- Check whether the connected cable is a signal cable recommended by us.
- Check whether the USB-C of the connected device supports video signal output (DisplayPort Alt Mode). For details, contact the manufacturer of the device.
- Connect a DisplayPort cable or an HDMI cable.

8.2 Imaging Problems

The screen is too bright or too dark.

- Adjust "Brightness" in the Setting menu (see [Color \[▶ 18\]](#)). (The LCD monitor backlight has a limited life span. If the screen becomes dark or begins to flicker, contact your local EIZO representative.)

Characters and images are blurred.

- Check whether the external device is configured to meet the resolution and vertical scan frequency requirements of the monitor. The list of compatible resolutions for this product is available for download from our web site: (www.eizoglobal.com)
- Try setting the magnification of display on the OS to "100 %". When using multiple monitors, try setting the magnification of display to "100 %" on all monitors.

Afterimage visible

- This phenomenon is characteristic of LCD panels. We recommend avoiding displaying static images for extended periods of time.
- Use the external device's screensaver or power save function if displaying the same image for extended periods of time.
- Depending on the image, an afterimage may appear even if it was displayed for a short period of time. To remove such a phenomenon, change the image or keep the power turned off for several hours.

Green / red / blue / white / dark dots remain on the screen.

- This is due to LCD panel characteristics and not a malfunction.

Interference patterns or pressure marks remain on the LCD panel.

- Leave the monitor with a white or black screen. The symptom may disappear.

Noise appears on the screen.

- When inputting HDCP system signals, normal images may not be displayed immediately.

The positions of windows and icons are shifted when the monitor is turned off/on or when restored from power saving mode.

- Turn the setting "On" for "Compatibility Mode" on the "Administrator Settings" menu (see [Compatibility Mode \[▶ 44\]](#)).

The color shown on the screen is not correct.

- Try changing "Input Color Format" in the Setting menu (see [Input Color Format \[▶ 17\]](#)).

Images are not displayed over the entire area of the screen.

- Try changing "Picture Expansion" in the Setting menu (see [Picture Expansion \[▶ 26\]](#)).
- Check whether the setting for the resolution of the external device matches the resolution of the monitor.

8.3 SelfCalibration Problems

The built-in calibration sensor does not come out/stays out.

- Turn off the main power, and then turn it on again a few minutes later.

SelfCalibration cannot be executed.

- Check whether a color mode for executing SelfCalibration has been set (see [Settings - Mode Settings - Standard Mode \[▶ 35\]](#) or [Settings - Mode Settings - Advanced Mode \(CAL\) \[▶ 35\]](#)).
- Check whether the date and time are set correctly on the monitor (see [Settings - Clock Adjustment \[▶ 37\]](#)).
- Check whether the execution schedule been set (see [Settings - Schedule - Start time \[▶ 35\]](#)).
- Check whether the calibration targets are set correctly (see "Target Settings" below).
 - [Target Settings - Brightness \[▶ 23\]](#)
 - [Target Settings - Black Level \[▶ 24\]](#)
 - [Target Settings - White Point - Temperature \[▶ 24\]](#)
 - [Target Settings - White Point - White\(x\) / White\(y\) \[▶ 24\]](#)
 - [Target Settings - Gamma \(EOTF\) - Gamma \(EOTF\) \[▶ 24\]](#)
 - [Target Settings - Gamma \(EOTF\) - Gamma Policy \[▶ 24\]](#)
 - [Target Settings - Gamma \(EOTF\) - PQ Option \[▶ 25\]](#)
 - [Target Settings - Gamma \(EOTF\) - HLG Option \[▶ 25\]](#)
 - [Target Settings - Gamma \(EOTF\) - HLG System Gamma \[▶ 25\]](#)
 - [Target Settings - Color Gamut \[▶ 25\]](#)
 - [Target Settings - Color Gamut - Red\(x\) / Red\(y\) / Green\(x\) / Green\(y\) / Blue\(x\) / Blue\(y\) \[▶ 25\]](#)
 - [Target Settings - Gamut Clipping \[▶ 25\]](#)
 - [Target Settings - Advanced Settings - Limited \(109% White\) \[▶ 26\]](#)

- Try calibrating the monitor by using ColorNavigator 7.

SelfCalibration failure

- Refer to the error code table. If an error code that does not appear in the error code table is displayed, contact your local EIZO representative.

SelfCalibration is canceled while in progress.

- If there is a change in the video signal from the external device during SelfCalibration (the signal disappears, a signal is input during a no-signal state, or other), SelfCalibration is canceled.
- Prevent any changes in the video signal while executing SelfCalibration.
- If a scheduled SelfCalibration is canceled, it is executed again when the monitor transitions to the power saving mode after an hour or more or when the monitor is turned off using . SelfCalibration can also be executed regardless of the schedule (see [Executing \[▶ 37\]](#)).

Error Code Table

If an error related to a calibration target value, adjustable brightness settings, or adjustable black level settings occurs, the error code and error message are displayed in the "Color" menu.

Error Code	Error Message
000020	The sensor failed to open.
000021	Check whether there is any foreign object near the sensor.
010141	Invalid target value has been set. Check the target value.
****52	The target black level is too low. Up the target black level or set "Min".

8.4 Other Problems

The Setting menu does not appear.

- Check whether the operation switch lock function is active (see [Key Lock \[▶ 43\]](#)).

Cannot select items in the Setting menu.

- Items that are displayed with gray text cannot be changed.
- "Color" items cannot be changed in some color modes. Setting the color mode to "User" will allow you to change all items (see [Color \[▶ 18\]](#)).

No audio output

- This product does not contain speakers.

USB peripheral devices connected to the monitor do not work / Cannot use the Docking Station Function

- Check whether the USB cable is correctly connected between the external device and the monitor.
- Check whether the USB cable is correctly connected between the peripheral device and the monitor.

- Try using a different USB port on the monitor.
- Try using a different USB port on the external device.
- Update the USB drivers for the peripheral devices.
- Reboot the external device.
- When "Ethernet" is set to "Off" in the "Administrator Settings" menu, the LAN port cannot be used. Set "Ethernet" to "On" (see [Ethernet \[▶ 44\]](#)).
- Depending on the settings in "USB Selection" in the "Administrator Settings" menu or the input signal, the monitor's USB hub may not be able to be operated from the external device connected via USB. Try switching the "USB Selection" settings or the input signal (see [USB Selection – HDMI / DisplayPort / USB-C \[▶ 32\]](#) and [Switching Input Signals \[▶ 12\]](#)).
- If the peripheral devices work correctly when they are directly connected to the external device, contact your local EIZO representative.
- Check the external device's BIOS setting for USB when using Windows. (Refer to the User's Manual of the external device for details.)
- Update the external device's OS.

Power indicator is flashing orange and white.

- This symptom may occur when the external device is connected to the DisplayPort connector. Use a signal cable recommended by us for the connection. Turn the monitor off and on.
- Check the connection and condition of the USB peripheral devices connected to the monitor.
- Turn off the main power switch on the back of the monitor, and then turn it on again.

Even when the mouse or keyboard are used, the external device does not wake from sleep.

- Turn the setting "On" for "Compatibility Mode" on the "Administrator Settings" menu (see [Compatibility Mode \[▶ 44\]](#)).

The external device does not operate with the power supply (USB Power Delivery) from the monitor.

- Check whether the external device has the specifications to operate with a 92 W power supply.
- For a 92 W power supply, use the following USB cables:
 - CC200SS-5A (Included)
 - CC100 (Optional accessory)

9 Attaching/Removing the Stand

9.1 Removing the Stand

The stand section of this product can be removed.

Attention

- Do not move the stand up and down after removing it. If you move the stand up and down while it is not attached to the monitor, this may cause damage or injury.
- If you drop the monitor or stand, this may cause damage or injury due to the weight of the monitor and stand.

1. Raise the height of the monitor to the maximum height.

Attention

- If the monitor is not raised to the maximum height, there may be cases when the height of the monitor accidentally changes while removing the stand. This may be the cause of injury or damage.

2. **Lay the LCD monitor on a soft cloth spread over a stable and flat surface with the LCD panel surface facing down.**

3. Remove the stand.

As shown in the diagram, press the lock button (1) while holding firmly onto the brace of the stand, and slide the stand in the direction of the pedestal on the bottom (2). Next, pull the stand upwards to remove it (3).

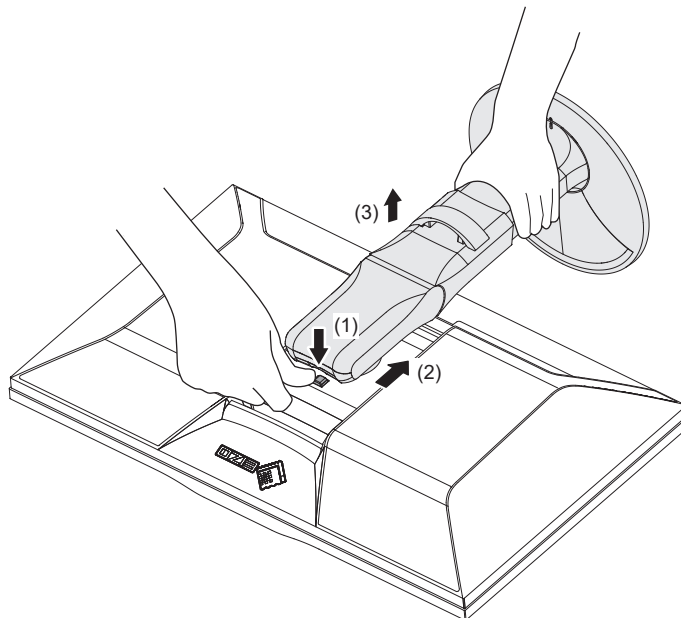

9.2 Attaching the Optional Arm

The optional arm (or optional stand) can be attached by removing the stand section. Please refer to our web site for the supported optional arms (or optional stands).

(www.eizoglobal.com)

When attaching an arm or stand, the installable orientations and movement range (tilt angle) are as follows:

- Orientation

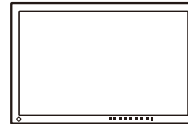
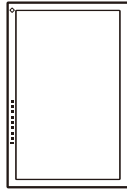

- Movement range (tilt angle)

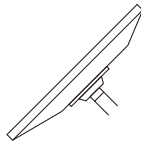

Up: 45°

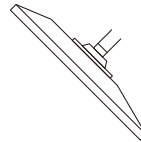

Down: 45°

Attention

- When attaching an arm or stand, follow the instructions of the respective User's Manual.
- When using another manufacturer's arm or stand, confirm the following in advance and select one that conforms to the VESA standard:
 - Clearance between screw holes: 100 mm x 100 mm
 - Arm or stand VESA mount dimensions: 122 mm x 122 mm or less
 - Plate thickness: 2.6 mm
 - Strong enough to support weight of the monitor unit (excluding the stand) and attachments such as cables
- Connect the cables after attaching an arm or stand.
- Do not move the removed stand up and down. Doing so may result in injury or device damage.
- The monitor, arm, and stand are heavy. Dropping them may result in injury or equipment damage.
- Periodically check the tightness of the screws. If the screws are not tight enough, the monitor may come unattached. This may be the cause of injury or damage.

1. Attach the arm or stand to the monitor.

For installation, use commercially available screws that meet the following conditions:

- Nominal diameter: M4
- Length: Between 8.4 mm and 12.9 mm (if using washers, add the washer thickness)

9.3 Attaching the Original Stand

1. Lay the LCD monitor on a soft cloth spread over a stable and flat surface with the LCD panel surface facing down.
2. Remove the fixing screws on the optional arm (or optional stand), and detach the optional arm (or optional stand).
3. Attach the original stand.
Insert the four tabs on the stand into the four holes on the back panel (1), and slide the stand towards the upper portion of the monitor (2). The stand clicks when it is attached correctly. Check that the stand is properly attached by pushing it side to side and back to front.

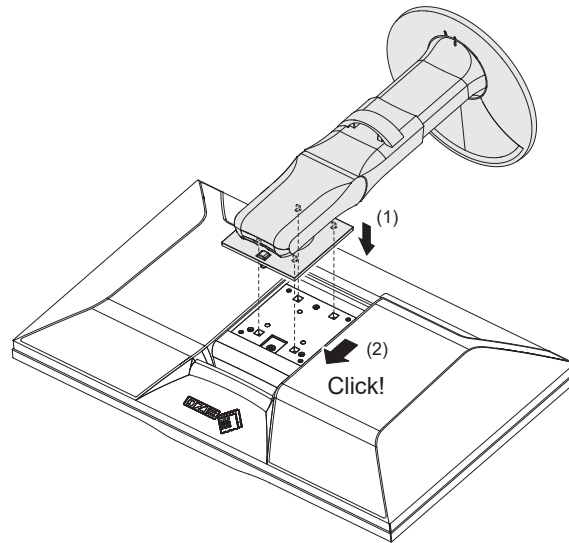

10 Reference

10.1 Using the Docking Station Function

This monitor is equipped with a LAN port and USB hub to serve as a Docking Station Function. Connecting via USB allows you to use a stable network environment even with laptops or tablets that lack LAN ports. In addition, peripheral devices that support USB can be used, and smartphones can be charged.

If the external device has a USB-C connector

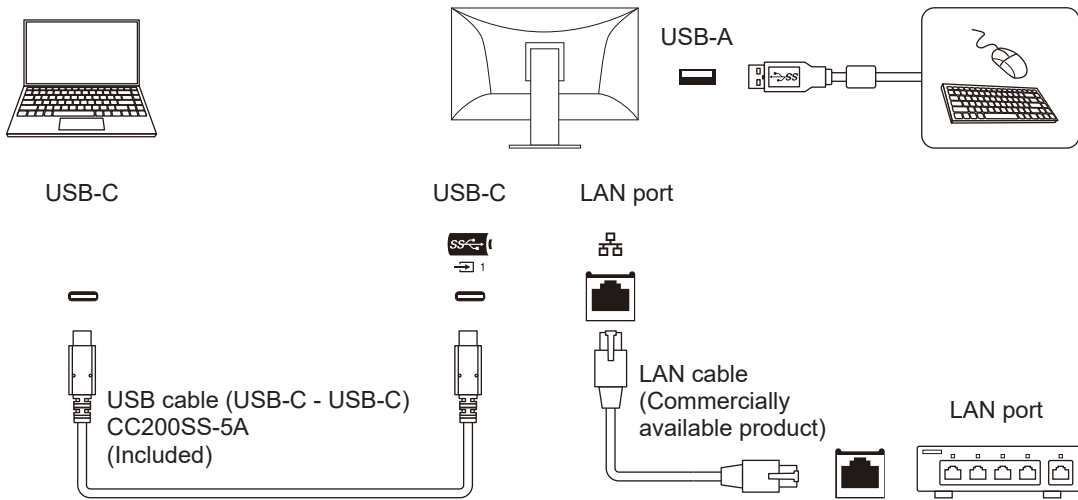

If the external device does not have a USB-C connector

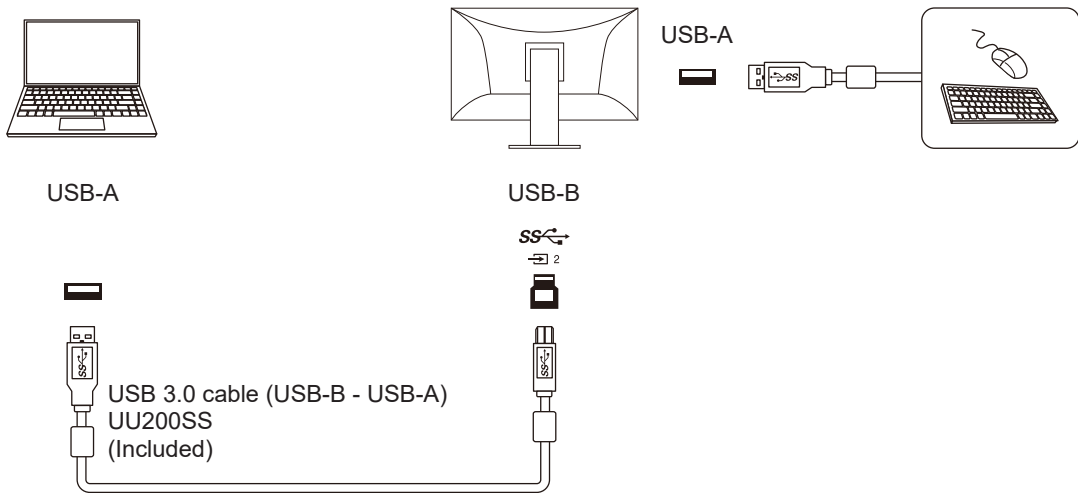

Attention

- If the external device OS is Windows 8.1, a driver will need to be installed to use the LAN port. The driver is stored in the monitor, so when the external device and monitor are connected with a USB cable, the screen to install the driver will be displayed. Install the driver in accordance with the on-screen instructions.
- This function may not work depending on the external device you are using, your OS, and your peripheral devices. Contact the manufacturer of each device for information about USB compatibility.
- Even when the monitor is in power saving mode, devices connected to the USB downstream port are operational. Therefore, power consumption of the monitor varies depending on the connected devices, even in power saving mode.
- When the main power switch of the monitor is off, a device connected to the USB downstream port will not operate.

Note

- The MAC address is shown on the label on the back of the monitor. MAC address pass-through is not supported.
- This product supports USB 3.1 Gen 1. When connecting to peripheral devices that support USB 3.1 Gen 1, high-speed data communication is possible. (Only when the USB cable used to connect to the external devices or peripheral devices supports USB 3.1 Gen 1.)

10.2 Connecting Multiple External Devices

This product can be connected to multiple external devices and allows you to switch between the connections for display.

Connection Examples

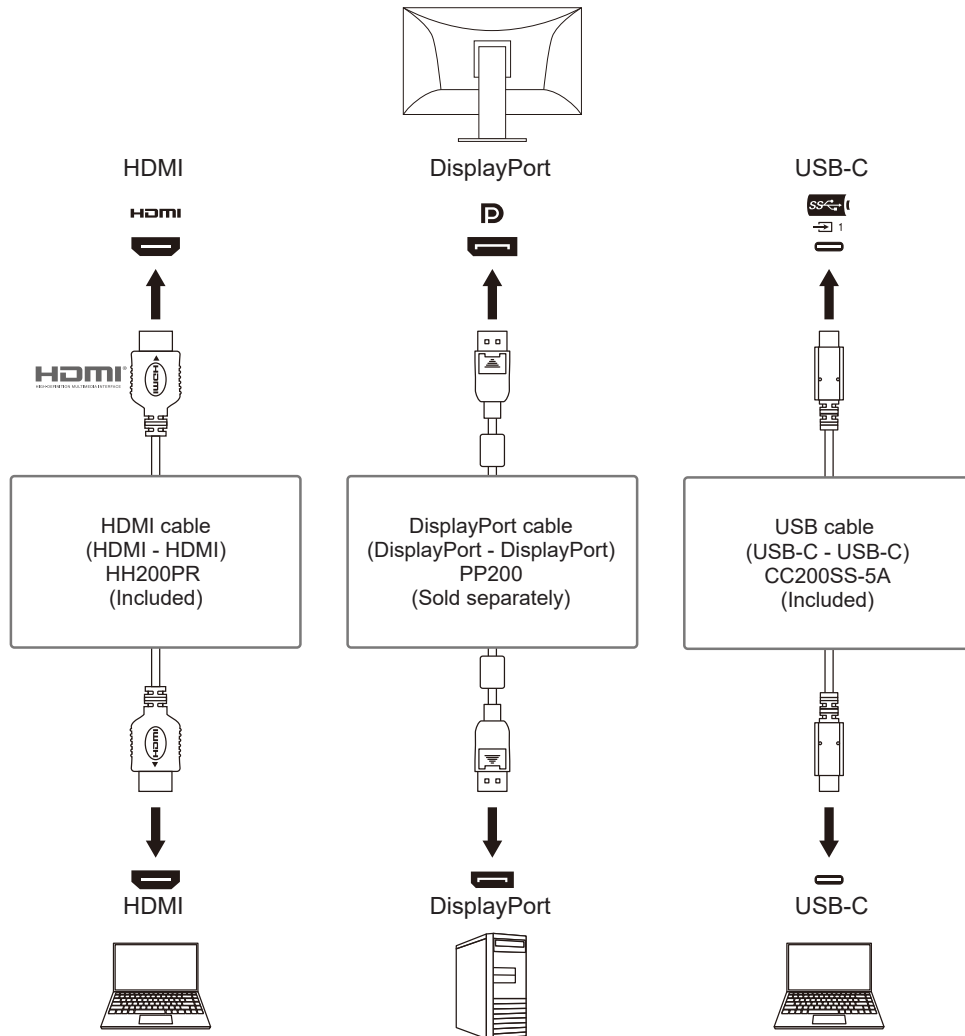

If two external devices are connected to a single monitor, then the input signals and USB ports can be linked, and the USB device connected to the monitor can be switched using two external devices. For details, see [USB Selection – HDMI / DisplayPort / USB-C](#) [▶ 32].

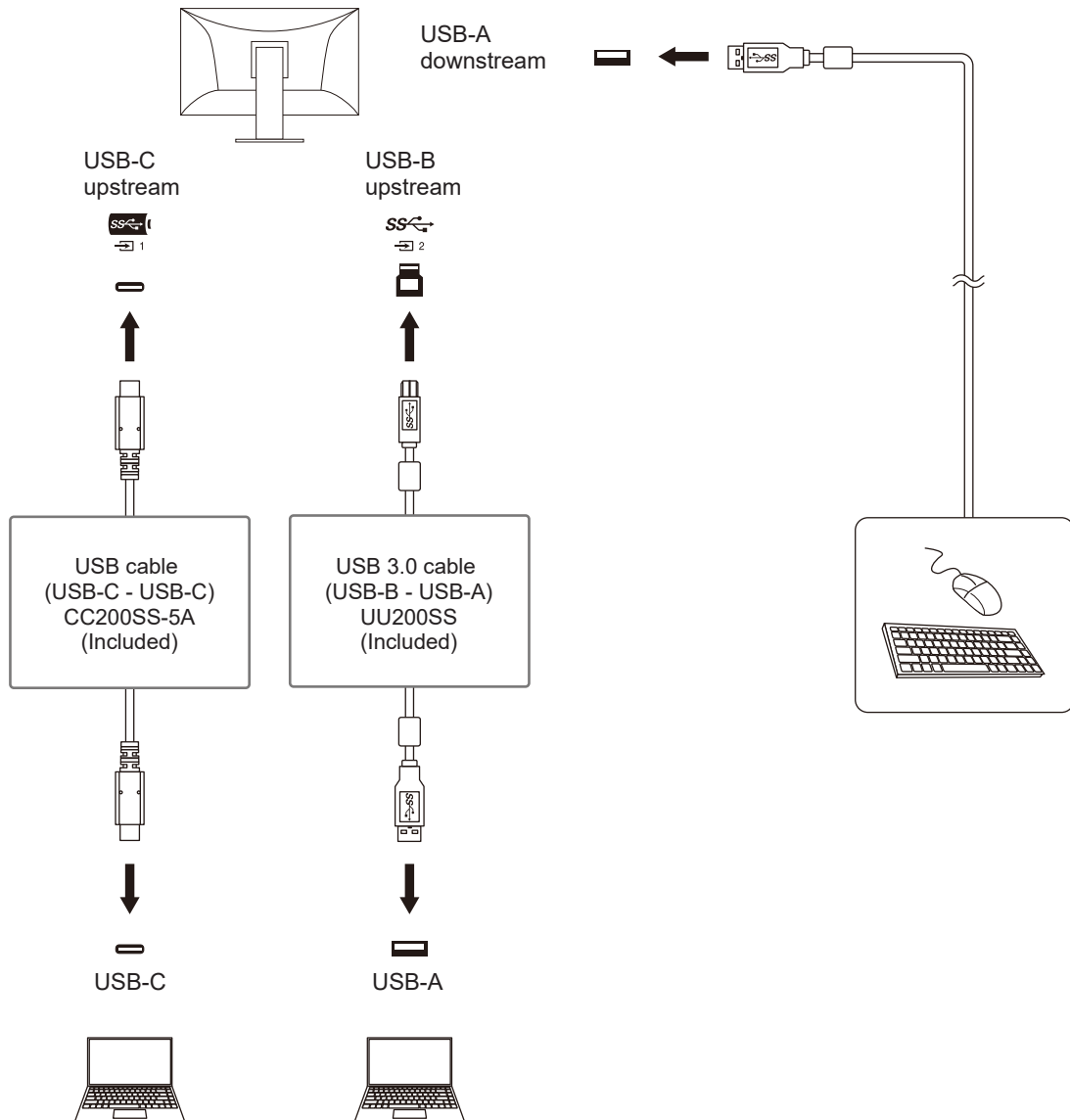

Note

- You can select the input signal to display using the operation switch () on the front of the monitor. For details, see [Switching Input Signals](#) [▶ 12].
- This product provides a function that automatically recognizes the connector through which signals are input, and displays images on the screen accordingly. For details, see [Auto Input Detection](#) [▶ 43].

10.3 Setting of PQ Option and Display

This section describes the setting of "PQ Option" and the relation between the input signal (10 bits: 0 to 1023) and the brightness displayed on the monitor.

Note

- This relation assumes that the input signal is full range (and that "Input Range" in "Signal" is set to "Full").

For "300cd/m² Clipping"

- Set the brightness to the specified value to display properly.
 - Example: When "PQ Option" is set to "300cd/m² Clipping", set the monitor brightness to 300 cd/m².

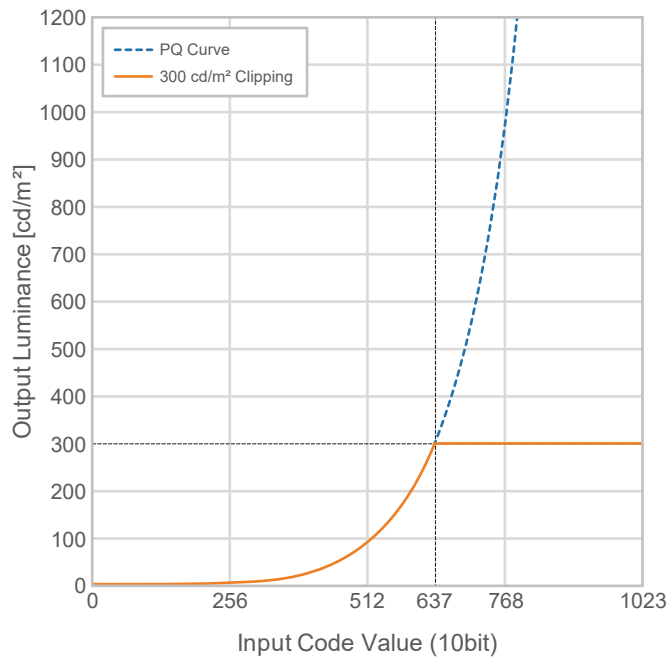
**For "500cd/m² Emulation", "1000cd/m² Emulation", "4000cd/m² Emulation", "10000cd/m² Emulation" (Monitor brightness setting: 300cd/m²)**

- This setting is used for temporary checks.
 - Example: When "PQ Option" is set to "4000cd/m² Emulation", the representation of gradation is equivalent to that of the monitor with the maximum brightness of 4000 cd/m². In this case, the representation of gradation is decreased according to the brightness setting of this monitor because it has the maximum brightness of 4000 cd/m² or less.

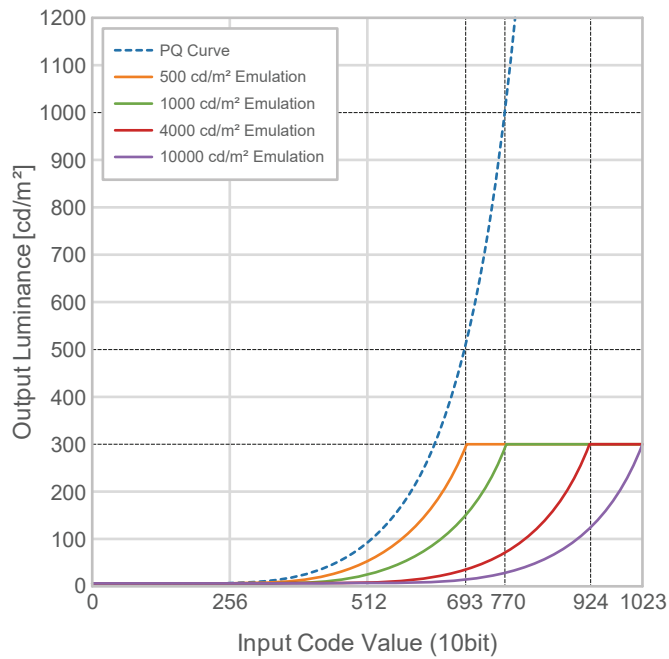

10.4 Specifications

10.4.1 LCD Panel

Type	IPS (Anti-Glare)	
Backlight	LED	
Size	27" (68.5 cm)	
Resolution	2560 dots x 1440 lines	
Display Size (H x V)	596.7 mm x 335.7 mm	
Pixel Pitch	0.233 mm x 0.233 mm	
Display Colors	10-bit color	Approx. 1.07 billion colors (using 10-bit input)
Viewing Angle (H / V, typical)	178° / 178°	
Brightness (typical)	400 cd/m ²	
Contrast Ratio (typical)	1600:1	
Response Time (typical)	Black -> White -> Black	22 ms
	Gray-to-gray	19 ms
Color Gamut (typical)	99% of Adobe RGB, 98% of DCI-P3	

10.4.2 Video Signals

Input Terminals	DisplayPort (supports HDCP 2.3) ¹ ×1, HDMI (supports HDCP 2.3) ² ×1, USB-C (supports DisplayPort Alt Mode, HDCP 2.3)×1	
Digital Scanning Frequency (H / V)	DisplayPort	26 kHz – 89 kHz / 23 Hz – 61 Hz, 69 Hz – 71 Hz (at 720 x 400)
	HDMI	15 kHz – 89 kHz / 23 Hz – 61 Hz, 69 Hz – 71 Hz (at 720 x 400)
	USB-C (DisplayPort Alt Mode)	26 kHz – 89 kHz / 23 Hz – 61 Hz, 69 Hz – 71 Hz (at 720 x 400)
Frame Synchronization Mode	23.8 Hz – 30.5 Hz, 47.5 Hz – 61.0 Hz	
Max. Dot Clock	242 MHz	

*1 Supports HDCP 1.3 if "Input Color Format" in the Setting menu is "RGB".

*2 HDMI CEC (or mutual control) is not supported.

10.4.3 USB

Port	Upstream	USB-C (USB 3.1 Gen 1) ^{*1} x 1, USB-B (USB 3.1 Gen 1) x 1
	Downstream	USB-A (USB 3.1 Gen 1) x 2, USB-A (USB 2.0) x 2
Standards		USB Specification Revision 3.1 Gen 1, USB Specification Revision 2.0
Communication Speed		5 Gbps (super), 480 Mbps (high), 12 Mbps (full), 1.5 Mbps (low)
Supply Current	Upstream	USB-C (USB 3.1 Gen 1): Maximum 92 W (5 V/3 A, 9 V/3 A, 15 V/3 A, 20 V/4.6A)
	Downstream ^{*2}	USB-A (USB 3.1 Gen 1): Maximum 900 mA per port USB-A (USB 2.0): Maximum of 500 mA per port

*1 Supports Pin Assignment E. The optional accessory CP200 (USB-C - DisplayPort) can be connected to the DisplayPort connector of the external device.

*2 Power will not be supplied if the external device and the monitor are not connected by USB.

10.4.4 Network

Port	RJ-45 (USB LAN adapter)
Wired LAN	IEEE802.3ab (1000BASE-T), IEEE802.3u (100BASE-TX), IEEE802.3 (10BASE-T)

10.4.5 Power

Input	100 – 240 VAC ±10 %, 50 / 60 Hz 1.90 – 0.85 A
Maximum Power Consumption	187 W or less
Power Save Mode	0.5 W or less (only for DisplayPort input, "Compatibility Mode" : "Off", when not connected to a USB device)
Standby Mode	0.3 W or less ("Compatibility Mode" : "Off", when not connected to a USB device)

10.4.6 Physical Specifications

Dimensions	638.0 mm x 439.9 mm – 584.9 mm x 263.3 mm (W x H x D) (Tilt: 35°)
	638.0 mm x 415.9 mm – 570.9 mm x 245.0 mm (W x H x D) (Tilt: 0°)
Dimensions (without stand)	638.0 mm x 390.0 mm x 86.2 mm (W x H x D)
Net Weight (without monitor hood)	Approx. 9.4 kg
Net Weight (without stand)	Approx. 6.4 kg
Height Adjustment Range	145.0 mm (Tilt: 35°) / 155.0 mm (Tilt: 0°)
Tilt	Up 35°, down 5°
Swivel	344°
Vertical Rotation	Right 90°

10.4.7 Operating Environmental Requirements

Temperature	0°C – 35°C
Humidity	20 % – 80 % R.H. (no dew condensation)
Air Pressure	540 hPa – 1060 hPa

10.4.8 Transportation / Storage Environmental Requirements

Temperature	-20 °C – 60 °C
Humidity	10 % – 90 % R.H. (no dew condensation)
Air Pressure	200 hPa – 1060 hPa

10.4.9 Accessories

For the latest information about accessories, refer to our web site.

(www.eizoglobal.com)

Appendix

Trademark

The terms HDMI and HDMI High-Definition Multimedia Interface, and the HDMI Logo are trademarks or registered trademarks of HDMI Licensing, LLC in the United States and other countries.

The DisplayPort Compliance Logo and VESA are registered trademarks of the Video Electronics Standards Association.

The SuperSpeed USB Trident Logo is a registered trademark of USB Implementers Forum, Inc.



The USB Power Delivery Trident Logos are trademarks of USB Implementers Forum, Inc.



USB Type-C and USB-C are registered trademarks of USB Implementers Forum, Inc.

DICOM is the registered trademark of the National Electrical Manufacturers Association for its standards publications relating to digital communications of medical information.

Kensington and Microsaver are registered trademarks of ACCO Brands Corporation.

Thunderbolt is a trademark of Intel Corporation in the United States and/or other countries.

Adobe is a registered trademark of Adobe Inc. in the United States and other countries.

Microsoft and Windows are registered trademarks of Microsoft Corporation in the United States and other countries.

Apple, macOS, Mac OS, OS X, macOS Sierra, Macintosh, and ColorSync are registered trademarks of Apple Inc.

ENERGY STAR is a registered trademark of the United States Environmental Protection Agency in the United States and other countries.

EIZO, the EIZO Logo, ColorEdge, CuratOR, DuraVision, FlexScan, FORIS, RadiCS, RadiForce, RadiNET, Raptor, and ScreenManager are registered trademarks of EIZO Corporation in Japan and other countries.

ColorEdge Tablet Controller, ColorNavigator, EcoView NET, EIZO EasyPIX, EIZO Monitor Configurator, EIZO ScreenSlicer, G-Ignition, i•Sound, Quick Color Match, RadiLight, Re/Vue, SafeGuard, Screen Administrator, Screen InStyle, ScreenCleaner, and UniColor Pro are trademarks of EIZO Corporation.

All other company names, product names, and logos are trademarks or registered trademarks of their respective owners.

License

The bitmap font used for this product is designed by Ricoh Industrial Solutions Inc.

