

ThinkPad X13 Yoga Gen 3 User Guide

ThinkPad



Lenovo

Read this first

Before using this documentation and the product it supports, ensure that you read and understand the following:

- *Safety and Warranty Guide*
- *Setup Guide*
- [Generic Safety and Compliance Notices](#)

First Edition (May 2022)

© Copyright Lenovo 2022.

LIMITED AND RESTRICTED RIGHTS NOTICE: If data or software is delivered pursuant to a General Services Administration "GSA" contract, use, reproduction, or disclosure is subject to restrictions set forth in Contract No. GS-35F-05925.

Contents

Discover your Lenovo notebook.iii

Chapter 1. Meet your computer. 1

Front view	1
Side view	3
Bottom view	4
Features and specifications	5
USB specifications.	5

Chapter 2. Get started with your computer. 7

Access networks	7
Connect to Wi-Fi networks.	7
Connect to the wired Ethernet	7
Connect to a cellular network (for selected models)	7
Turn on the Airplane mode.	8
Interact with your computer	8
Use the keyboard shortcuts	8
Use the TrackPoint pointing device	10
Use the trackpad	11
Use the touch screen	12
Connect to an external display	14
Get to know YOGA modes	15
Use Lenovo Integrated Pen (for selected models)	16

Chapter 3. Explore your computer 17

Lenovo apps	17
The Vantage app	17
Lenovo Quick Clean / Clean Your Device	17
Smart features (for selected models).	18
Intelligent cooling	20
Manage power	21
Check the battery status	21
Charge the computer	21
Change the power settings	22
Transfer data	23
Set up a Bluetooth connection	23
Set up an NFC connection	23
Use a smart card (for selected models)	23
Accessories	24
Purchase accessories	24

Chapter 4. Secure your computer and information 25

Lock the computer	25
Log in with your fingerprint (for selected models)	25

Log in with your face ID (for selected models)	26
Protect your privacy (for selected models)	26
Protect data against power loss (for selected models)	26
UEFI BIOS passwords	27
Password types	27
Set, change, and remove a password	28
Associate your fingerprints with passwords (for selected models)	29
Certificate based BIOS management	29

Chapter 5. Configure advanced settings. 31

UEFI BIOS	31
Enter the UEFI BIOS menu.	31
Navigate in the UEFI BIOS interface	31
Set the system date and time.	31
Change the startup sequence	31
View UEFI BIOS Event log	31
Detect memory retraining	32
Reset system to factory defaults	33
Update UEFI BIOS	33
FIDO (Fast ID) Online authentication	34
Install a Windows operating system and drivers	34

Chapter 6. CRU replacement 37

CRU list	37
Disable Fast Startup and the built-in battery.	37
Replace a CRU	38
Base cover assembly	38
Wireless WAN card (for selected models)	39
M.2 solid-state drive and M.2 solid-state drive bracket (for selected models).	40
Pen dummy (for selected models)	42

Chapter 7. Help and support 45

Frequently asked questions	45
Error messages	46
Beep errors	47
Self-help resources	48
Windows label	49
Call Lenovo	49
Before you contact Lenovo	49
Lenovo Customer Support Center.	50
Purchase additional services.	51

Appendix A. Compliance information. 53

**Appendix B. Notices and
trademarks. 57**

Discover your Lenovo notebook

Thank you for choosing a Lenovo® notebook! We are dedicated to delivering the best solution to you.









Before starting your tour, please read the following information:

- Illustrations in this documentation might look different from your product.
- Depending on the model, some optional accessories, features, software programs, and user interface instructions might not be applicable to your computer.
- Documentation content is subject to change without notice. To get the latest documentation, go to <https://pcsupport.lenovo.com>.

Chapter 1. Meet your computer

Front view



	Infrared (IR) camera / Camera		Webcam privacy shutter
	Microphone		Touch screen
	Power button with or without fingerprint reader		TrackPoint® pointing stick
	Near field communication (NFC) mark		Trackpad
	TrackPoint buttons		

* for selected models



Webcam privacy shutter







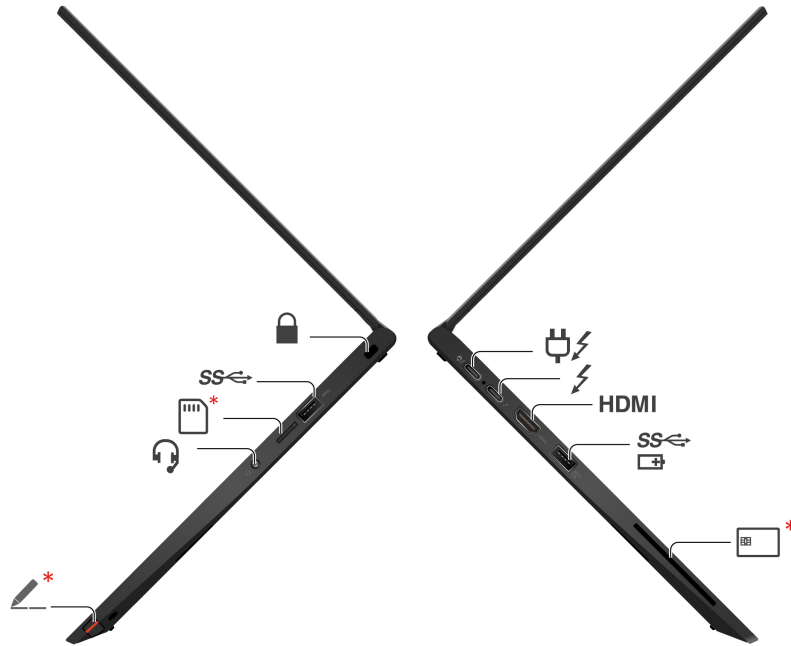

Slide webcam privacy shutter to cover or uncover the camera lens. It is designed to protect your privacy.

Related topics

- “Use the TrackPoint pointing device” on page 10
- “Use the trackpad” on page 11
- “Use the touch screen” on page 12
- “Set up an NFC connection” on page 23
- “Log in with your fingerprint (for selected models)” on page 25
- “Log in with your face ID (for selected models)” on page 26

Side view



	USB-C® (Thunderbolt™ 4) power connector		USB-C (Thunderbolt 4) connector
HDMI	HDMI™ connector		Always on USB 3.2 connector Gen 1
	Smart card reader		Lenovo Integrated Pen
	Audio connector		Nano-SIM-card tray
	USB 3.2 connector Gen 1		Security-lock slot

* for selected models

Related topics

- “USB specifications” on page 5
- “Connect to a cellular network (for selected models)” on page 7
- “Charge the computer” on page 21
- “Use a smart card (for selected models)” on page 23
- “Lock the computer” on page 25

Bottom view



Speaker



Emergency-reset hole



Emergency-reset hole

If the computer stops responding and you cannot turn it off by pressing the power button, reset your computer:

1. Disconnect your computer from ac power.
2. Insert a straightened paper clip into the hole to cut off power supply temporarily.
3. Connect your computer to ac power and then turn on your computer.

CAUTION:

When the computer is operating, it should be placed on a hard and flat surface with its bottom area not in contact with user's bare skin. Under normal operating conditions, the temperature of the bottom surface will remain within an acceptable range as defined in IEC 62368-1, but such temperatures can still be high enough to cause discomfort or harm to the user if directly touched for over one minute at a time. As such, it is recommended that users avoid prolonged direct contact with the bottom of the computer.

Note: Some Lenovo computers include a display that can be rotated 360 degrees. When those products are used as a tablet computer, the temperatures of all the accessible parts are within an acceptable range as defined in IEC 62368-1.

Features and specifications

For detailed specifications of your computer, go to <https://psref.lenovo.com> and search by product.

Memory	Low power double data rate 4x (LPDDR4x), soldered on board, up to 32 GB
Storage device	<ul style="list-style-type: none">• One slot, 2280 M.2 solid-state drive, up to 2 TB
Audio	<ul style="list-style-type: none">• Dolby Audio™ Speaker System• Dolby Voice®
Display	<ul style="list-style-type: none">• Color display with In-Plane Switching (IPS) technology• Display ratio: 16:10• Display resolution: 1920 x 1200 pixels or 2560 x 1600 pixels• Multi-touch technology
Security features	<ul style="list-style-type: none">• Face authentication*• Fingerprint reader* (integrated in power button)• Glance Privacy Guard*• Glance Privacy Alert*• Trusted Platform Module (TPM)*
Wireless features	<ul style="list-style-type: none">• Bluetooth• NFC*• GPS (on wireless WAN model)*• Wireless LAN• Wireless WAN (4G)* <p>Note: The 4G cellular service is provided by authorized mobile service carriers in some countries or regions. You must have a cellular plan from a service carrier to connect to the cellular network. The cellular data plan might vary by location.</p>

* for selected models

USB specifications

Note: Depending on the model, some USB connectors might not be available on your computer.

Connector name	Description
----------------	-------------

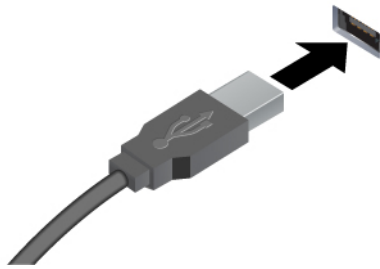

Connect USB-compatible devices, such as a USB keyboard, USB mouse, USB storage device, or USB printer.

- USB 2.0 connector
- USB 3.2 connector Gen 1

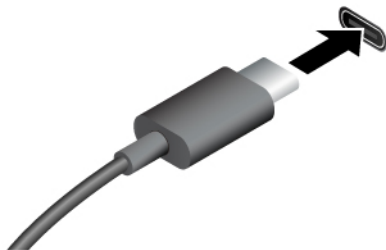

- Charge USB-C compatible devices with the output voltage and current of 5 V and 3 A.
- Connect to an external display:
 - USB-C to VGA: up to 1920 x 1200 pixels, 60 Hz
 - USB-C to DP: up to 5120 x 3200 pixels, 60 Hz
- Connect to USB-C accessories to help expand your computer functionality. To purchase USB-C accessories, go to <https://www.lenovo.com/accessories>.

- USB-C (3.2 Gen 1) connector
- USB-C (3.2 Gen 2) connector
- USB-C (Thunderbolt 3) connector
- USB-C (Thunderbolt 4) connector
- USB-C (USB 4) connector

Statement on USB transfer rate

Depending on many factors such as the processing capability of the host and peripheral devices, file attributes, and other factors related to system configuration and operating environments, the actual transfer rate using the various USB connectors on this device will vary and will be slower than the data rate listed below for each corresponding device.

USB device	Data rate (Gbit/s)
3.2 Gen 1 / 3.1 Gen 1	5
3.2 Gen 2 / 3.1 Gen 2	10
3.2 Gen 2 × 2	20
4 Gen 2 × 2	20
4 Gen 3 × 2	40
Thunderbolt 3	40
Thunderbolt 4	40

Chapter 2. Get started with your computer

Access networks

This section helps you connect to a wireless or wired network.

Connect to Wi-Fi networks

Click the network icon in the Windows® notification area, and then select a network for connection. Provide required information, if needed.

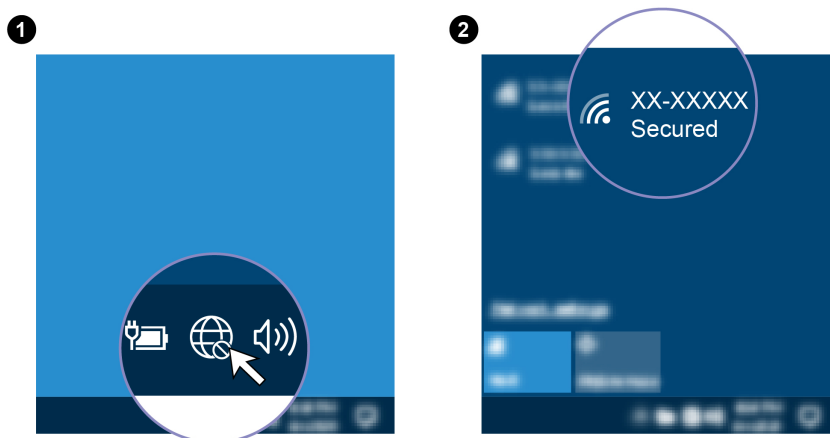

Connect to the wired Ethernet

To connect your computer to a local network, you need a Lenovo USB-C to Ethernet Adapter. Lenovo USB-C to Ethernet Adapter is available as an option and shipped with some computer models. You can purchase one from Lenovo at <https://www.lenovo.com/accessories>.

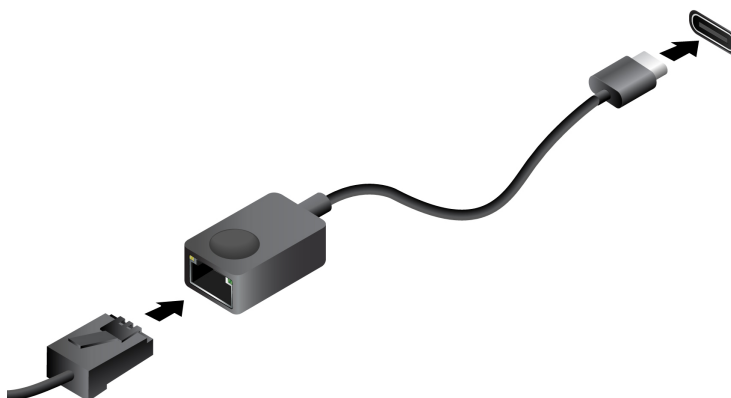

Connect to a cellular network (for selected models)

To connect a 4G cellular data network, you must have a wireless wide area network (WWAN) card and a nano-SIM card installed. The nano-SIM card might come with your computer by countries or regions. If no nano-SIM card is shipped, you will need to purchase one from authorized service carriers.

Depending on model, your computer might have no WWAN card installed. For installation procedures of the WWAN card, see “Wireless WAN card (for selected models)” on page 39.

Notes:

- The 4G cellular service is provided by authorized mobile service carriers in some countries or regions. You must have a cellular plan from a service carrier to connect to the cellular network. The cellular data plan might vary by location.
- Network connection speeds might also vary by location, environment, network conditions and other factors.

To establish a cellular connection:

1. Turn off the computer.
2. Locate the nano-SIM card slot and insert the nano-SIM card as shown. Note the orientation of the card and ensure that it is seated correctly.

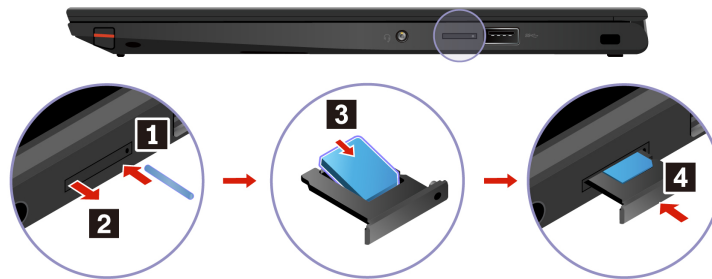

3. Turn on the computer.
4. Click the network icon, and then select the cellular network icon  from the list. Provide required information, if needed.

Turn on the Airplane mode

When the Airplane mode is enabled, all wireless features are disabled.

1. Type Airplane mode in the Windows search box and then press Enter.
2. Turn on the Airplane mode.

Interact with your computer



















Your computer provides you various ways to navigate the screen.







Use the keyboard shortcuts

The special keys on the keyboard help you work more effectively.



<https://support.lenovo.com/us/en/videos/vid500145>

	<p>Invoke the special function printed as an icon on each key or standard function of F1–F12 function keys.</p>
	<p>FnLock indicator on: standard function</p>
	<p>FnLock indicator off: special function</p>
	<p>Enable / disable speakers</p>
	<p>Decrease volume</p>
	<p>Increase volume</p>
	<p>Enable / disable microphones</p>
	<p>Darken display</p>
	<p>Brighten display</p>
	<p>Manage external displays</p>
	<p>Enable / disable airplane mode</p>
	<p>Open / collapse notification center</p>
	<p>Answer incoming calls on Microsoft Teams®</p>
	<p>Decline incoming calls on Microsoft Teams</p>
	<p>Customize the function of this key on the Vantage app</p>
	<p>Open Snipping Tool</p>
	<p>Toggle keyboard backlight (for selected models)</p>
	<p>Break operation</p>
	<p>Pause operation</p>
	<p>Scroll contents</p>
	<p>Send system request</p>

 + 	Enter sleep mode To wake up the computer, press Fn or the power button.
 + 	Go to beginning
 + 	Go to end

Use the TrackPoint pointing device

The TrackPoint pointing device enables you to perform all the functions of a traditional mouse, such as pointing, clicking, and scrolling.

Use the TrackPoint pointing device

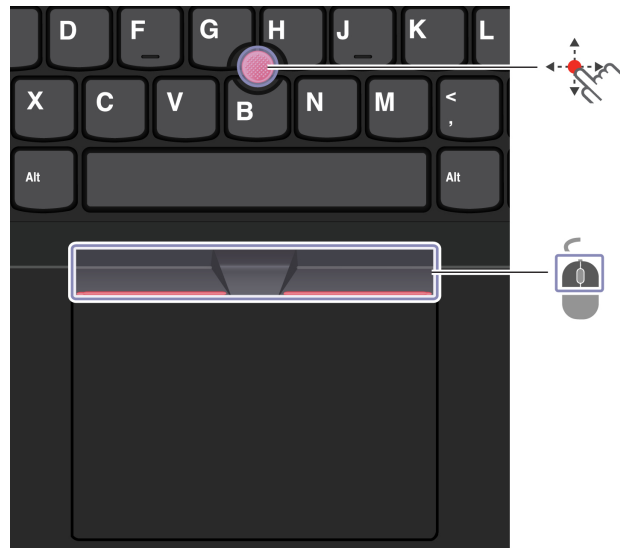

TrackPoint pointing stick

Use your finger to apply pressure to the pointing-stick nonslip cap in any direction parallel to the keyboard. The pointer on the screen moves accordingly. The higher the pressure applied, the faster the pointer moves.



TrackPoint buttons

The left-click button and right-click button correspond to the left and right buttons on a traditional mouse. Press and hold the dotted middle button while using your finger to applying pressure to the pointing stick in the vertical or horizontal direction. Then, you can scroll through the document, Web site, or apps.

Disable the TrackPoint pointing device

The TrackPoint pointing device is active by default. To disable the device:

1. Open the **Start** menu, and then click **Settings → Devices → Mouse**.
2. Follow the on-screen instructions to disable TrackPoint.

Replace the pointing-stick nonslip cap

Note: Ensure that the new cap has grooves **a**.

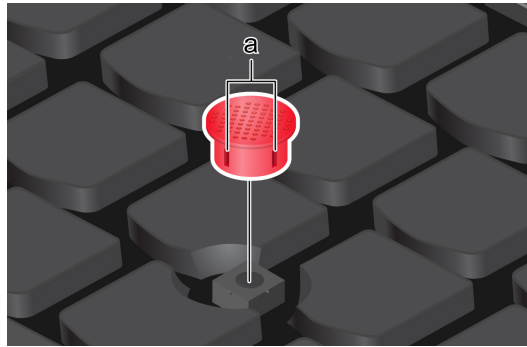

Use the trackpad

You can use the trackpad to perform all the pointing, clicking, and scrolling functions of a traditional mouse.

Use the trackpad

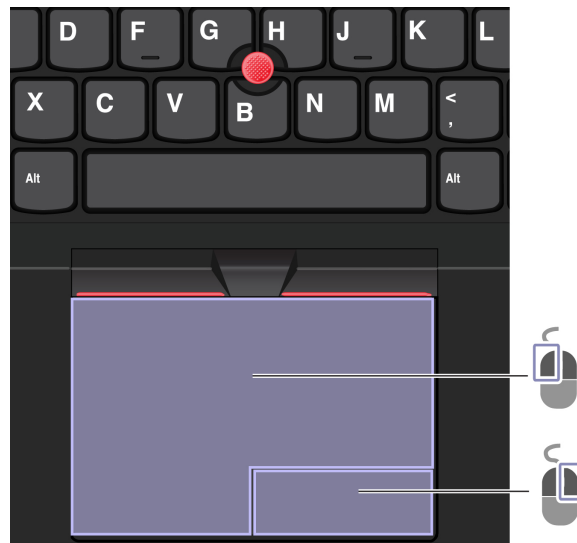

Use the touch gestures

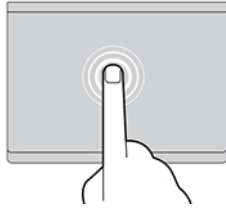

Tap once to select or open an item.

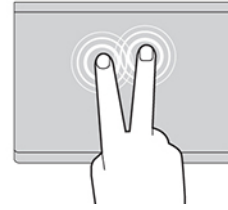

Tap twice quickly to display a shortcut menu.

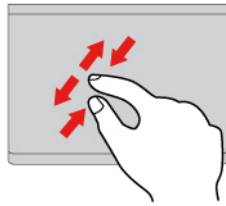

Two-finger zoom in or zoom out.

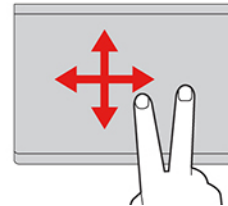

Scroll through items.

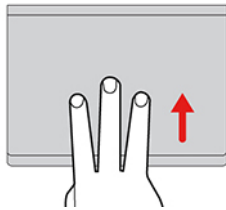

Open the task view to see all open windows.

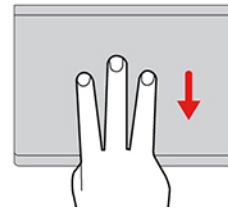

Show the desktop.

Notes:

- When using two or more fingers, ensure that you position your fingers slightly apart.
- Some gestures are not available if the last action was done from the TrackPoint pointing device.
- Some gestures are only available when you are using certain apps.
- If the trackpad surface is stained with oil, turn off the computer first. Then, gently wipe the trackpad surface with a soft and lint-free cloth moistened with lukewarm water or computer cleaner.

For more gestures, see the help information of the pointing device.

Disable the trackpad

The trackpad is active by default. To disable the device:

1. Open the **Start** menu, and then click **Settings** → **Devices** → **Touchpad**.
2. In the Touchpad section, turn off the **Touchpad** control.

Use the touch screen

If your computer display supports the multi-touch function, you can navigate the screen with simple touch gestures. For more touch gestures, refer to <https://support.microsoft.com/windows>.

Note: Some gestures might not be available when you are using certain apps.



Tap once to single click



Tap twice quickly to double-click



Tap and hold to right-click

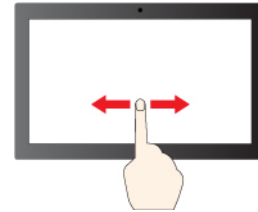

Slide to scroll through items

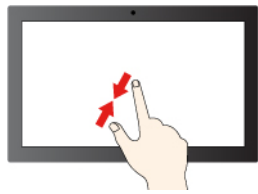

Zoom out

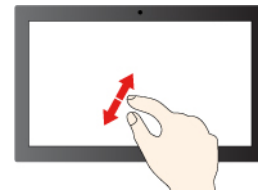

Zoom in

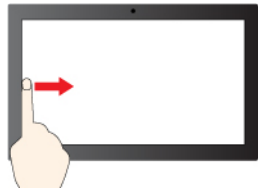

Swipe from the left: view all open windows (Windows 10)

Swipe from the left: open widget panel (Windows 11)



Swipe from the right: open action center (Windows 10)

Swipe from the right: open notification center (Windows 11)

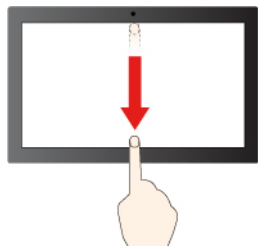

Swipe downwards shortly: show title bar

Swipe downwards: close the current app

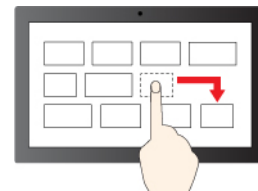

Drag

Maintenance tips:

- Turn off the computer before cleaning the touch screen.
- Use a dry, soft, and lint-free cloth or a piece of absorbent cotton to remove fingerprints or dust from the touch screen. Do not apply solvents to the cloth.
- The touch screen is a glass panel covered with a plastic film. Do not apply pressure or place any metallic object on the screen, which might damage the touch panel or cause it to malfunction.
- Do not use fingernails, gloved fingers, or inanimate objects for input on the screen.
- Regularly calibrate the accuracy of the finger input to avoid a discrepancy.

Connect to an external display

Connect your computer to a projector or a monitor to give presentations or expand your workspace.

Connect to a wired display

If your computer cannot detect the external display, right-click a blank area on the desktop and select display settings. Then follow the on-screen instructions to detect the external display.

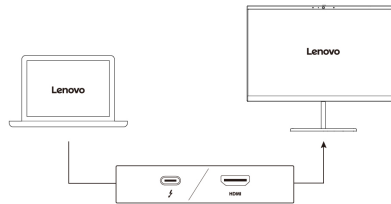

Supported resolution

The following table lists the supported maximum resolution of the external display.

Connect the external display to	Supported resolution
USB-C (Thunderbolt 4) connector	Up to 5K / 60 Hz
HDMI connector	Up to 4K / 60 Hz



Note: The refresh rate higher than 60 Hz can also be supported. If you set the refresh rate higher than 60 Hz, the maximum resolution might be limited.

Connect to a wireless display

To use a wireless display, ensure that both your computer and the external display support the Miracast® feature.

Press Windows logo key + K and then select a wireless display to connect with.

Set the display mode

Press  or  +  and then select a display mode of your preference.

Change display settings

1. Right-click a blank area on the desktop and select display settings.
2. Select the display that you want to configure and change display settings of your preference.

You can change the settings for both the computer display and the external display. For example, you can define which one is the main display and which one is the secondary display. You also can change the resolution and orientation.

Get to know YOGA modes

Rotate the display to switch among different YOGA modes according to your preference. The keyboard and the pointing devices are automatically disabled in the stand mode, tent mode, and tablet mode. Use the touch screen to control your computer instead.

Attention: Do not rotate the computer display with too much force, or apply too much force to the upper-right or upper-left corner of the computer display. Otherwise the computer display or hinges might get damaged.



Notebook mode



Stand mode



Tent mode

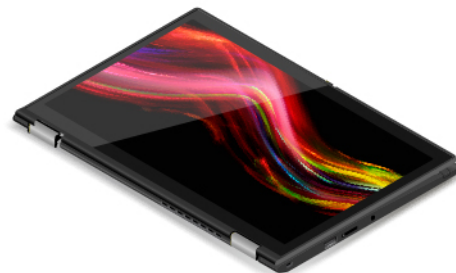

Tablet mode

Use Lenovo Integrated Pen (for selected models)

The following information refers to the Lenovo Integrated Pen, model: SD61A41286. The Lenovo Integrated Pen enables a more precise and easier way of writing and sketching.

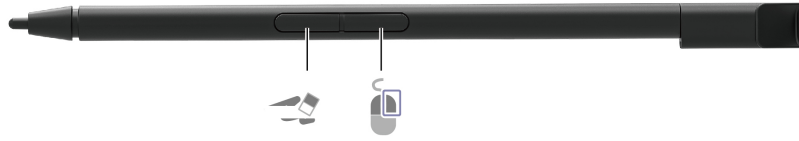

Eraser button



Click button

Lenovo Integrated Pen is not waterproof. Keep the pen away from water and excessive moisture. To purchase Lenovo Integrated Pen, go to <https://www.lenovo.com/accessories>.

Charge Lenovo Integrated Pen

1. Ensure that your computer is on or in sleep mode.
2. Insert the pen back into the pen slot. The pen is 80% charged in about 15 seconds and 100% charged in about five minutes.

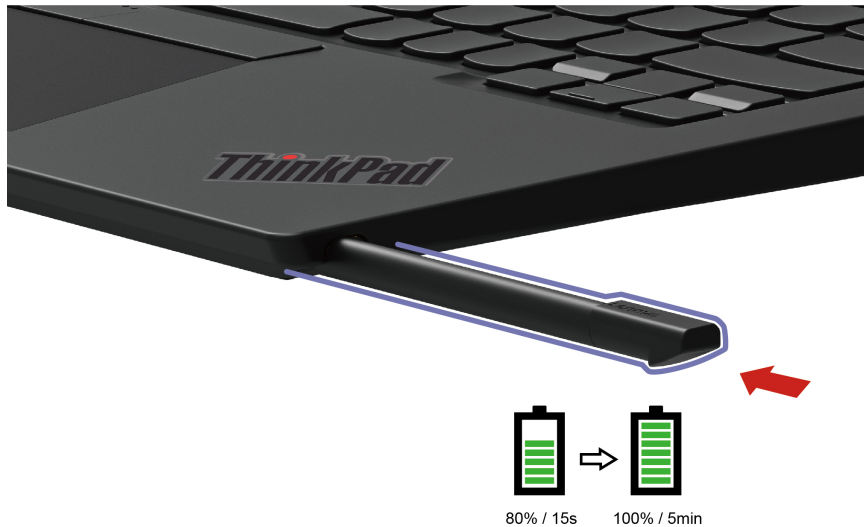

Chapter 3. Explore your computer

Lenovo apps

This section provides introduction to the Vantage and Lenovo Quick Clean / Clean Your Device apps.

The Vantage app

The preinstalled Vantage app is a customized one-stop solution to help you maintain your computer with automated updates and fixes, configure hardware settings, and get personalized support.

To access the Vantage app, type Vantage in the Windows search box.

Key features

The Vantage app enables you to:

- Know the device status easily and customize device settings.
- Download and install UEFI BIOS, firmware, and driver updates to keep your computer up-to-date.
- Monitor your computer health, and secure your computer against outside threats.
- Scan your computer hardware and diagnose hardware problems.
- Look up warranty status (online).
- Access *User Guide* and helpful articles.

Notes:

- The available features vary depending on the computer model.
- The Vantage app makes periodic updates of the features to keep improving your experience with your computer. The description of features might be different from that on your actual user interface.

Lenovo Quick Clean / Clean Your Device



Depending on the model, your computer might support the Lenovo Quick Clean / Clean Your Device feature. The preinstalled Lenovo Quick Clean / Clean Your Device enables you to temporarily disable the keyboard, screen, trackpad, and TrackPoint pointing device for cleaning.

To access Lenovo Quick Clean / Clean Your Device, do one of the following:

- Type Lenovo Quick Clean / Clean Your Device in the Windows search box.
- Press Fn and the right Shift key at the same time.

To download the latest version of Lenovo Quick Clean / Clean Your Device, go to <https://pcsupport.lenovo.com>.

Smart features (for selected models)

Your computer might be preinstalled with Glance by Mirametrix®. Glance can capture your head movement through camera and makes your computer smarter and more efficient.

Access Glance by Mirametrix

Type Glance in the Windows search box and then press Enter.

Note: If Glance is uninstalled, you can request it through <https://support.lenovo.com/contactus>.

Explore key features

Depending on the model, some features might not be available on your computer.

- **Protect privacy**

- **Presence Detection:** Keep your computer awake when in use and automatically lock the computer when your head moves out of the camera range.

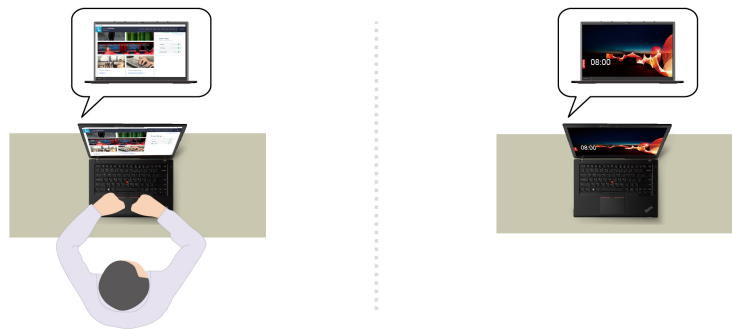

- **Privacy Alert:** When a shoulder surfer is detected, an alert icon appears on your computer screen.

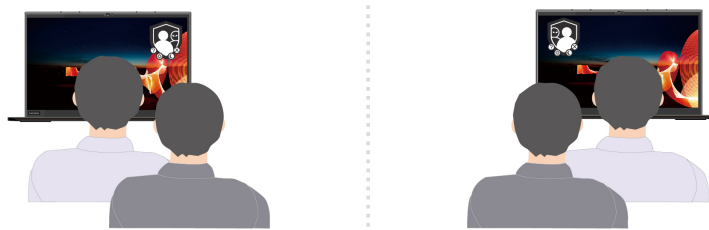

- **Privacy Guard:** When a shoulder surfer is detected, your screen is blurred. Press Alt+F2 to cancel the blur effect.

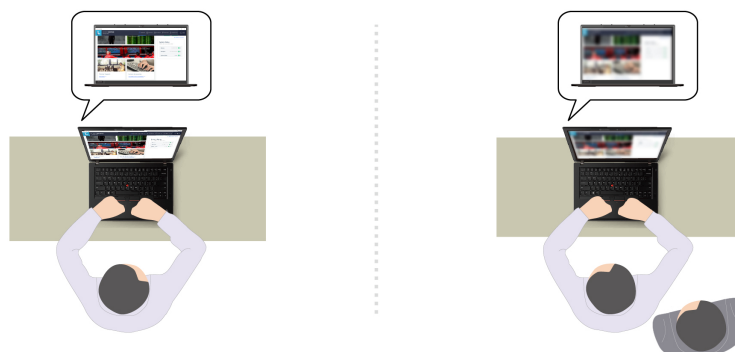

- **Smart Display:** Blur screens you are not looking at. If you are not facing any screen, all screens are blurred. Press Alt+F2 to cancel the blur effect.



Note: If your computer comes with an ePrivacy screen, it can work with Glance to achieve better privacy protection. For details, go to <https://support.lenovo.com/us/en/videos/vid500144>.

- **Improve productivity**

- **Snap Window:** When you select a window on one screen and turn your face to another, the window automatically snaps to the top center of the screen you are facing.

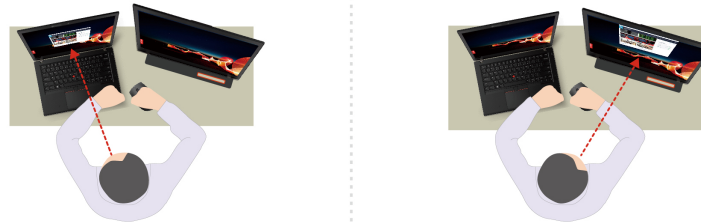

- **Smart Pointer:** Relocate the pointer to the screen you are facing. When the pointer moves from one screen to another, it is temporarily drawn large.



Note: Snap Window and Smart Pointer only work when your computer is connected to external displays. Ensure that external displays are placed at the same height of your computer.

- **Promote digital wellness**

- **Posture check:** Remind you to adjust your posture once you hunch toward the screen.
- **20/20/20 Alert:** Remind you to look away from the screen and relax your eyes for 20 seconds every 20 minutes.

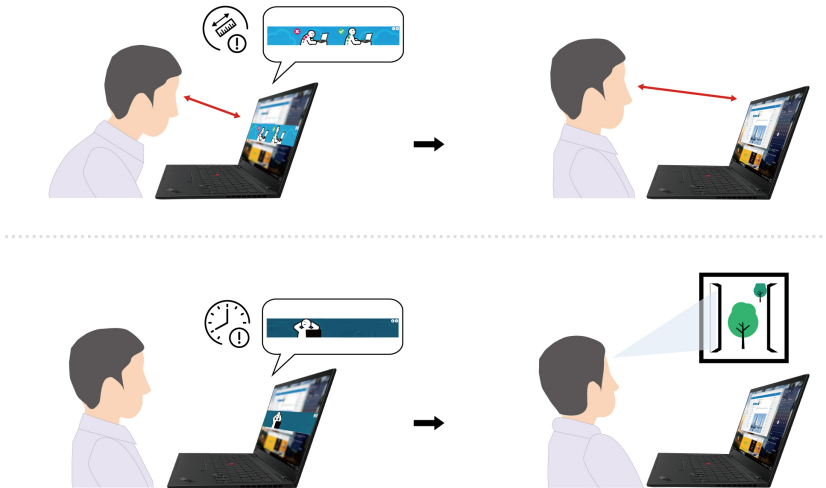

Intelligent cooling

The Intelligent Cooling feature helps you adjust power consumption, fan speed, computer temperature, and performance.

For models with Windows 10

Intelligent Cooling feature is adjusted through Windows Power Slider. This feature works in auto mode by default. Press Fn+T to enable or disable the auto mode.

When the auto mode is disabled:

Do the following to select a preferred mode:

1. Click the battery status icon in the Windows notification area.
 2. Move the slider to the left or right to select a preferred mode.
- Eco mode: power consumption, fan speed, and performance are lowered to get your computer cooler, quieter, and more eco-friendly, and to get the best battery life.
 - Balanced mode: power consumption, fan speed, and performance are dynamically balanced for better experience.
 - Performance mode: The performance is prioritized, allowing higher temperature and fan speed.

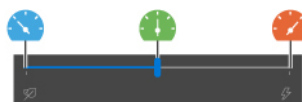

on ac power



on battery power

When the auto mode is enabled:

- Auto mode: your computer is adjusted automatically to achieve the best mix of power consumption, battery life, computer performance, and fan speed based on the amount of system activity.

For models with Windows 11

Intelligent Cooling feature is adjusted through Windows Settings. This feature works in auto mode by default. Press Fn+T to enable or disable the auto mode.

Note: Auto mode is for Intel models only.

1. Right-click the battery icon in the task bar to access power and sleep settings.
2. Locate the Power section and choose one of the following power modes.
 - **When the auto mode is disabled:**
 - **Best Power efficiency:** power consumption, fan speed, and performance are lowered to get your computer cooler, quieter, and more eco-friendly, and to get the best battery life.
 - **Balanced:** power consumption, fan speed, and performance are dynamically balanced for better experience.
 - **Best Performance:** the performance is prioritized, allowing higher temperature and fan speed.
 - **When the auto mode is enabled,** it is recommended to set the power mode to **Balanced**. Then your computer will be adjusted automatically to achieve the best mix of power consumption, battery life, computer performance, and fan speed based on the amount of system activity.

Manage power

Use the information in this section to achieve the best balance between performance and power efficiency.

Check the battery status

Go to **Settings** → **System** to check the battery status. For more details about your battery, refer to the Vantage app.

Charge the computer

Use ac power

Power source of the ac power adapter:

- Power: 45 W or 65 W
- Sine-wave input at 50 Hz to 60 Hz
- Input rating of the ac power adapter: 100 V to 240 V ac, 50 Hz to 60 Hz
- Output rating of the ac power adapter: 20 V dc, 2.25 A or 3.25 A

When the battery power is low, charge your battery by connecting your computer to ac power with the supplied power adapter. The 65 W ac power adapter supports the rapid charge function, the battery is 80% charged in about one hour when the computer is turned off. The actual charging time depends on the battery size, the physical environment, and whether you are using the computer.

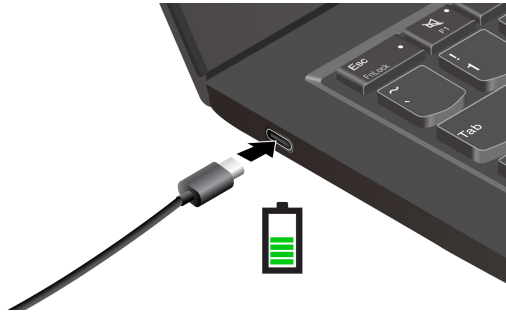

Notes: To maximize the life of the battery:

- Use the battery until the charge is depleted and recharge the battery completely before using it. Once the battery is fully charged, it must discharge to 94% or lower before it will be allowed to recharge again.
- The battery may optimize its full charge capacity based on your usage. After prolonged periods of limited use, full battery capacity may not be available until you discharge to as low as 20% and recharge completely. For more information, refer to the power section of the Vantage app.

Use P-to-P 2.0 (Peer to Peer 2.0) charging function

Both USB-C (Thunderbolt 4) connectors on the computer feature the Lenovo-unique P-to-P 2.0 charging function. To use the function, ensure that **Always On USB** and **Charge in Battery Mode** are enabled in UEFI BIOS of your computers, so that the function works even when the computers are off or in hibernation mode.

To enable **Always On USB** and **Charge in Battery Mode**:

1. Press F1 to enter the UEFI BIOS menu.
2. Click **Config** → **USB**, and then to enable **Always On USB** and **Charge in Battery Mode**.

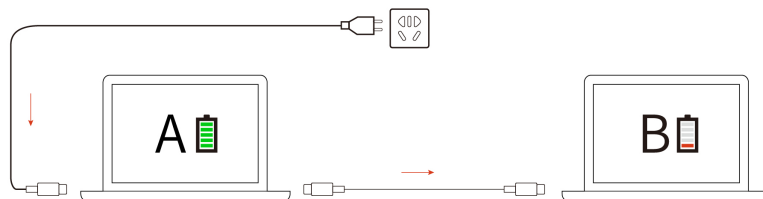

Note: The actual charging speed of your computer depends on many factors, such as the remaining battery power of the computers, the wattage of the ac power adapter, and whether you are using the computers.

Change the power settings

For ENERGY STAR® compliant computers, the following power plan takes effect when your computer has been idle for a specified duration:

- Turn off the display: After 10 minutes
- Put the computer to sleep: After 10 minutes

To reset the power plan:

1. Right-click the battery status icon and select **Power Options**.
2. Choose or customize a power plan of your preference.

To reset the power button function:

1. Right-click the battery status icon and select **Power Options** → **Change what the power buttons do**.

2. Change the settings as you prefer.

Transfer data

Quickly share your files using the built-in Bluetooth or NFC technology among devices with the same features. You also can insert a smart card to transfer data.

Set up a Bluetooth connection

You can connect all types of Bluetooth-enabled devices to your computer, such as a keyboard, a mouse, a smartphone, or speakers. To ensure successful connection, place the devices at most 10 meters (33 feet) from the computer.

1. Type Bluetooth in the Windows search box and then press Enter.
2. Turn on Bluetooth, if it is off.
3. Select a Bluetooth device, and then follow the on-screen instructions.

Set up an NFC connection

If your computer supports NFC, you will see an NFC mark or label  around the trackpad area.

To turn on NFC:

1. Type Airplane mode in the Windows search box and then press Enter.
2. Ensure that the Airplane mode is off and turn on the NFC function.

By using NFC, you can simply tap and connect your computer and another NFC-enabled device over a few centimeters or inches. To pair with an NFC card or smartphone:



Note: Ensure that the NFC card is in NFC Data Exchange Format (NDEF), otherwise the card cannot be detected.

Use a smart card (for selected models)

You can insert a smart card to transfer data.

Supported smart card

Supported smart card specifications: 85.60 mm (3.37 inches) x 53.98 mm (2.13 inches)

Attention: Smart cards with slits are not supported. Do not insert such a smart card into the smart-card slot of your computer. Otherwise, the reader might get damaged.

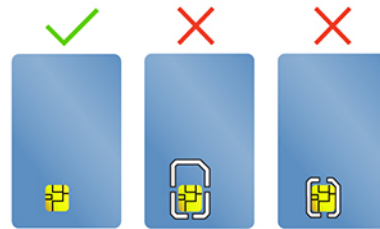

Install or remove a card

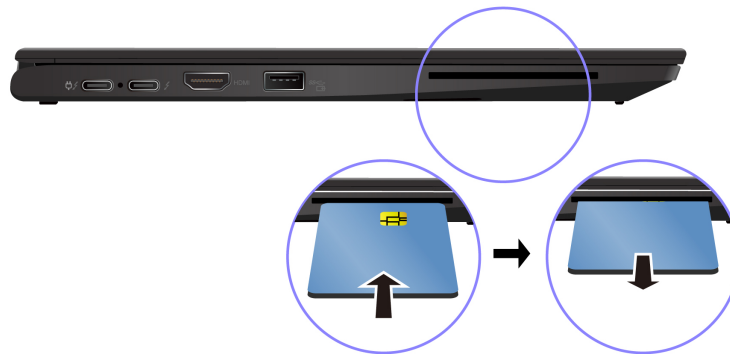

Attention: Before removing the card:

1. Click the triangular icon in the Windows notification area to show hidden icons. Right-click the icon prompting you to safely remove hardware and eject media.
2. Select the corresponding item to eject the card from the Windows operating system.
3. Press the card and remove it from your computer. Store the card safely for future use.

Accessories

This section provides instructions on how to use hardware accessories to expand your computer functionalities.

Purchase accessories

Lenovo has a number of hardware accessories and upgrades to help expand the functionalities of your computer. Options include memory modules, storage devices, network cards, port replicators or docking stations, batteries, power adapters, keyboards, mice, and more.

To shop at Lenovo, go to <https://www.lenovo.com/accessories>.

Chapter 4. Secure your computer and information

Lock the computer

Lock your computer to a desk, table, or other fixtures through a compatible security cable lock.

Note: The slot supports cable locks that conform to the Kensington NanoSaver® lock standards using Cleat™ locking technology. You are responsible for evaluating, selecting, and implementing the locking device and security feature. Lenovo is not responsible for the locking device and security feature. You can purchase the cable locks at <https://smartfind.lenovo.com>.

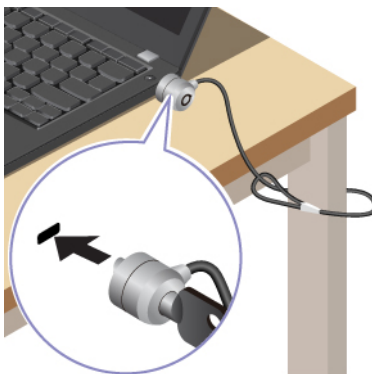

Log in with your fingerprint (for selected models)

The fingerprint reader is integrated with the power button. After enrolling your fingerprint, you can power on and log in to the computer with a simple press on the power button, or unlock the screen with a single touch. It eliminates the need to enter complex passwords, saving your time and boosting your productivity.

1. Type Sign-in options in the Windows search box and then press Enter.
2. Select the fingerprint setting and then follow the on-screen instruction to enroll your fingerprint.

Note: It is recommended that you put your finger at the center of the power button during enrollment and enroll more than one fingerprint in case of any injuries to your fingers. After the enrollment, the fingerprints are associated with the Windows password automatically.

3. Log in with your fingerprint. When the fingerprint reader indicator is solid green, tap your finger on the fingerprint reader for authentication.

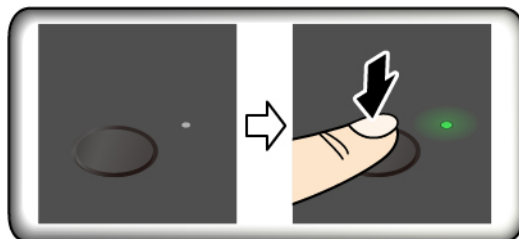

Associate your fingerprints with UEFI BIOS passwords

You can associate your fingerprints with your power-on password and NVMe password. See “Associate your fingerprints with passwords (for selected models)” on page 29.

Maintenance tips:

- Do not scratch the surface of the reader with anything hard.
- Do not use or touch the reader with a wet, dirty, wrinkled, or injured finger.

Log in with your face ID (for selected models)



For models come with a webcam privacy shutter, slide the webcam privacy shutter to uncover the camera lens before using the Windows Hello face recognition.

Create your face ID and unlock your computer by scanning your face:

1. Type Sign-in options in the Windows search box and then press Enter.
2. Select the face ID setting and then follow the on-screen instruction to create your face ID.

Protect your privacy (for selected models)

Use the ePrivacy screen



Your computer might come with an ePrivacy screen. It can reduce screen visibility from side angles to protect screen content against visual hacking. By default, this function is disabled. You can press F12 or Fn +D to enable it. You will be prompted by the on-screen icon  or  every time the function is enabled or disabled.

Your ePrivacy screen can be automatically enabled in case that you are required to input passwords. By default, this automatic function for passwords is disabled. You can enable it on the Vantage app.

The ePrivacy screen also can work with the preinstalled Glance app to better protect your privacy. For details, go to <https://support.lenovo.com/us/en/videos/vid500144>.

Set the privacy level

The privacy level of this function varies depending on the screen brightness level, the contrast ratio, and the physical environment where you are using this function.

- Press  to increase the privacy level.
- Press  to decrease the privacy level.

Protect data against power loss (for selected models)

NVMe (Non-Volatile Memory express) M.2 solid-state drive features the Lenovo-unique PLP (Power Loss Protection) function to avoid data loss or damage. If your computer is not responding and you might have to shut down your computer by pressing and holding the power button for several seconds. In this case, the PLP function enables your computer data to be saved timely. However, there is no guarantee that all data is saved in any situation. To check the type of your M.2 solid-state drive:

1. Restart the computer. When the logo screen is displayed, press F10 to enter the Lenovo diagnostics window.
2. On the TOOLS tab, select **SYSTEM INFORMATION** → **STORAGE** using the arrow keys.
3. Locate the **Device Type** section to check the information

UEFI BIOS passwords

You can set passwords in UEFI (Unified Extensible Firmware Interface) BIOS (Basic Input/Output System) to strengthen the security of your computer.

Password types

You can set a power-on password, supervisor password, system management password, or NVMe password in UEFI BIOS to prevent unauthorized access to your computer. However, you are not prompted to enter any UEFI BIOS password when your computer resumes from sleep mode.

Power-on password

If you set a power-on password, a window is displayed on the screen when you turn on the computer. Enter the correct password to use the computer.

Supervisor password

The supervisor password protects the system information stored in UEFI BIOS. When entering the UEFI BIOS menu, enter the correct supervisor password in the window prompted. You also can press Enter to skip the password prompt. However, you cannot change most of the system configuration options in UEFI BIOS.

If you have set both the supervisor password and power-on password, you can use the supervisor password to access your computer when you turn it on. The supervisor password overrides the power-on password.

System management password

The system management password can also protect the system information stored in UEFI BIOS like a supervisor password, but it has lower authority by default. The system management password can be set through the UEFI BIOS menu or through Windows Management Instrumentation (WMI) with the Lenovo client-management interface.

You can enable the system management password to have the same authority as the supervisor password to control security-related features. To customize the authority of the system management password through the UEFI BIOS menu:

1. Restart the computer. When the logo screen is displayed, press F1 to enter the UEFI BIOS menu.
2. Select **Security → Password → System Management Password Access Control**.
3. Follow the on-screen instructions.

If you have set both the supervisor password and the system management password, the supervisor password overrides the system management password. If you have set both the system management password and the power-on password, the system management password overrides the power-on password.

NVMe passwords

The NVMe password prevents unauthorized access to the data on the storage drive. When an NVMe password is set, you are prompted to type a correct password each time you try to access the storage drive.

- **Single Password**

When a Single NVMe password is set, the user must enter the user NVMe password to access files and applications on the storage drive.

- **Dual Password (User + Admin)**

The admin NVMe password is set and used by a system administrator. It enables the administrator to access any storage drive in a system or any computer connected in the same network. The administrator can also assign a user NVMe password for each computer in the network. The user of the computer can change the user NVMe password as desired, but only the administrator can remove the user NVMe password.

When prompted to enter an NVMe password, press F1 to switch between the admin NVMe password and user NVMe password.

Notes: The NVMe password is not available in the following situations:

- A Trusted Computing Group (TCG) Opal-compliant storage drive and a TCG Opal management software program are installed in the computer, and the TCG Opal management software program is activated.
- An eDrive storage drive is installed in the computer preinstalled with the Windows operating system.

Set, change, and remove a password

Before you start, print these instructions.

1. Restart the computer. When the logo screen is displayed, press F1 to enter the UEFI BIOS menu.
2. Select **Security** → **Password** by using the arrow keys.
3. Select the password type. Then, follow the on-screen instructions to set, change, or remove a password.

You should record all your passwords and store them in a safe place. If you forget any of your passwords, any potential repair actions required are not covered under warranty.

What to do if you forget your power-on password

If you forget your power-on password, do the following to remove the power-on password:

- If you have set a supervisor password and remember it:
 1. Restart the computer. When the logo screen is displayed, immediately press F1.
 2. Type the supervisor password to enter the UEFI BIOS menu.
 3. Select **Security** → **Password** → **Power-On Password** by using the arrow keys.
 4. Type the current supervisor password in the **Enter Current Password** field. Then, leave the **Enter New Password** field blank, and press Enter twice.
 5. In the Changes have been saved window, press Enter.
 6. Press F10 to save changes and exit the UEFI BIOS menu.
- If you have not set a supervisor password, contact a Lenovo authorized service provider to have the power-on password removed.

What to do if you forget your NVMe password

If you forget your NVMe password (Single password) or both user and admin NVMe passwords (Dual password), Lenovo cannot reset your passwords or recover data from the storage drive. You can contact a Lenovo authorized service provider to have the storage drive replaced. A fee will be charged for parts and service. If the storage drive is a CRU (Customer Replaceable Unit), you can also contact Lenovo to purchase a new storage drive to replace the old one by yourself. To check whether the storage drive is a CRU and the relevant replacement procedure, see “CRU list” on page 37.

What to do if you forget your supervisor password

If you forget your supervisor password, there is no service procedure to remove the password. You have to contact a Lenovo authorized service provider to have the system board replaced. A fee will be charged for parts and service.

What to do if you forget your system management password

If you forget your system management password, do the following to remove the system management password:

- If you have set a supervisor password and remember it:
 1. Restart the computer. When the logo screen is displayed, immediately press F1.
 2. Type the supervisor password to enter the UEFI BIOS menu.
 3. Select **Security** → **Password** → **System Management Password** by using the arrow keys.
 4. Type the current supervisor password in the **Enter Current Password** field. Then, leave the **Enter New Password** field blank, and press Enter twice.
 5. In the Changes have been saved window, press Enter.
 6. Press F10 to save changes and exit the UEFI BIOS menu.
- If you have not set a supervisor password, contact a Lenovo authorized service provider to have the system management password removed.

Associate your fingerprints with passwords (for selected models)

Do the following to associate your fingerprints with the power-on password and NVMe password:

1. Turn off and then turn on the computer.
2. When prompted, scan your finger on the fingerprint reader.
3. Enter your power-on password, NVMe password, or both as required. The association is established.

When you start the computer again, you can use your fingerprints to log in to the computer without entering your Windows password, power-on password, or NVMe password. To change settings, press F1 to enter the UEFI BIOS menu, and then select **Security** → **Fingerprint**.

Attention: If you always use your fingerprint to log in to the computer, you might forget your passwords. Write down your passwords, and keep them in a safe place.

Certificate based BIOS management

Certificate-based BIOS authentication (also called the password-less management mode) provides more secure UEFI BIOS management with password-free solution. It is used to replace the supervisor password / system management password for authentication if you have set one.

Note: Supervisor password / system management password are disabled automatically when certificate mode is enabled. But the power-on password / NVMe password still can be used normally in certificate mode if you have set one.

For certificate enrollment, see *Certificate Enrollment Guide* at: https://support.lenovo.com/docs/certificate_enrollment_guide

Enter the BIOS menu with certificate

Once you have enrolled the certificate, you can enter the BIOS menu with the certificate.

1. Restart the computer. When the logo screen is displayed, press F1 or Fn+F1 to enter the BIOS menu.

2. The request data is displayed. Click **Save to File** to save the request data in a USB key and send the request data to IT admin by e-mail or phone.
3. Enter the unlock code provided by IT admin and click **OK**.

Notes:

- The unlock encode is a one-time password and is valid only during logon prompt (in one power-on cycle) for up to two hours.
- If you click **Skip**, you can enter the BIOS setup menu without BIOS management authority. But certificate reset is allowed.

Reset certificate

The enrolled certificate cannot be disabled. You can reset or remove it:

1. Restart the computer. When the logo screen is displayed, press F1 or Fn+F1.
2. Enter the BIOS menu with the certificate or skip the certification authentication process.
3. Select **Security** → **Reset Certificate**.
4. Follow the on-screen instructions to enter the reset code provided by IT admin.

Chapter 5. Configure advanced settings

UEFI BIOS

UEFI BIOS is the first program that the computer runs. When the computer turns on, UEFI BIOS performs a self test to make sure that various devices in the computer are functioning.

Enter the UEFI BIOS menu

Restart the computer. When the logo screen is displayed, press F1 to enter the UEFI BIOS menu.

Navigate in the UEFI BIOS interface

You can navigate in the UEFI BIOS interface by pressing the following keys:

- F1: General Help
- F9: Setup Defaults
- F10: Save and Exit
- F5 / F6: Change boot priority order
- ↑ ↓ or PgUp / PgDn: Select / Scroll page
- ← →: Move keyboard focus
- Esc: Back / Close dialog
- Enter: Select / Open submenu

Set the system date and time

1. Restart the computer. When the logo screen is displayed, press F1.
2. Select **Date/Time** and set the system date and time as desired.
3. Press F10 to save changes and exit.

Change the startup sequence

1. Restart the computer. When the logo screen is displayed, press F1.
2. Select **Startup → Boot**. Then, press Enter. The default device order list is displayed.

Note: No bootable device is displayed if the computer cannot start from any devices or the operating system cannot be found.

3. Set the startup sequence as desired.
4. Press F10 to save the changes and exit.

To change the startup sequence temporarily:

1. Restart the computer. When the logo screen is displayed, press F12.
2. Select the device that you want the computer to start from and press Enter.

View UEFI BIOS Event log

1. Restart the computer. When the logo screen is displayed, press F1.
2. Select **Main → BIOS Event log**. Then, press Enter. The BIOS Event log interface is displayed.

3. Navigate the interface by pressing the following keys, and then see details by selecting each item.

- ↑ ↓: Move keyboard focus
- PgUp / PgDn: Scroll page
- Enter: Select
- F3: Exit

The following BIOS event logs might be listed on your screen depending on the UEFI BIOS activities. Each log consists of date, time, and a description of the event.

- **Power On** event: this log shows Power On Self Test (POST) routine has started with power-on process. It includes power on reason, boot mode and shutdown reason.
- **Subcomponent Code Measurement** event: this log shows subcomponent code measurement has worked. It includes validation result of each component.
- **System Preboot Authentication** event: this log shows what credential was provided to gain preboot authentication. It includes installed password, password type, input device and authentication result.
- **BIOS Password Change** event: this log shows changes of the UEFI BIOS passwords. It includes password type, event type and result.
- **Subcomponent Self-healing** event: this log shows information about the subcomponent where the recovery event occurred. It includes event cause, recovered firmware version and result.
- **BIOS Setup Configuration Change** event: this log shows changes of UEFI BIOS Setup configuration. It includes item name and value.
- **Device Change** event: this log shows changes of devices. It includes event cause and event type.
- **System Boot** event: this log shows which boot device was utilized to boot the system. It includes boot option, description and file path list.
- **System Tamper** event: this log shows occurrence of system tamper events. It includes event cause and event type.
- **Runtime Intrusion Detection of SPI Flash** event: this log shows system has detected unauthorized/ suspicious access to SPI Flash. It includes event cause and region.
- **On-Demand Measurement** event: this log shows On- Demand measurement has worked. It includes validation result of each component.
- **POST Error** event: this log shows occurrence of errors during POST routine. It includes the error code.
- **Flash Update** event: this log shows occurrence of flash update. It includes event cause, updated firmware version and result.
- **Set On-Premise** event: this logs shows changes of on-premise boot setting. It includes on-premise setting value and change method.
- **Capsule Update** event: this log shows occurrence of UEFI capsule firmware update. It includes event cause, updated firmware version and result.
- **Log Cleared** event: this log shows clearing BIOS event log has executed. It includes event cause and result.
- **Shutdown / Reboot** event: this log shows UEFI BIOS is successfully shut down or the system is rebooted. It includes event cause and event type.

Detect memory retraining

Memory retraining is a process to initialize the memory module and run diagnostic tests for the memory module in your computer. The memory retraining might occur during POST if any of the following situations is detected:

- Memory module replacement

- Total Memory Encryption setting change in UEFI BIOS
- UEFI BIOS update (Memory Reference Code [MRC] change)

When memory retraining occurs, the screen cannot display the progress information and might be blank. You might see the LED indicators on ESC, F1, and F4 blinking sequentially to indicate the progress. Do not press the power button to interrupt the process. Wait a few minutes until the logo screen is displayed.

Reset system to factory defaults

This feature allows you to initialize the UEFI BIOS to the factory default state, including all UEFI BIOS settings and internal data. It helps you wipe user data in case that you want to dispose of or reuse your computer.

Note: If you permanently disable **Intel AMT control** and **Absolute Persistence(R) Module** in UEFI BIOS, you can not reset even if you reset the system to factory default.

How to reset system to factory default

1. Restart the computer. When the logo screen is displayed, press F1 to enter the UEFI BIOS menu.
2. Select **Security** → **Reset System to Factory Defaults** and press Enter.
3. A series of warning windows might pop up. You might be required to do the following before resetting the system to factory default.
 - a. Reset the Certificate-based BIOS Authentication. Refer to “Associate your fingerprints with passwords (for selected models)” on page 29.
 - b. Deactivate the Absolute Persistence Module.
 - c. Remove the NVMe password if you have set one.
4. For computer model with RAID settings, a window pops up to remind you of data damage.
5. If you select **Yes**, a window pops up to confirm your current operation.
6. If you select **Yes**, a window pops up. Enter your supervisor password, system management password or power-on password.
7. Then, your computer will restart immediately. It takes several minutes to complete the initialization.

Note: This initialization process may require the screen to be blank. This is normal and you should not interrupt the process.

Update UEFI BIOS

When you install a new program, device driver, or hardware component, you might need to update UEFI BIOS.

Download and install the latest UEFI BIOS update package by one of the following methods:

- Open the Vantage app to check the available update packages. If the latest UEFI BIOS update package is available, follow the on-screen instructions to download and install the package.
- Go to <https://pcsupport.lenovo.com> and select the entry for your computer. Then, follow the on-screen instructions to download and install the latest UEFI BIOS update package.

Note: During the UEFI BIOS update process, Memory Reference Code (MRC) change might cause memory retraining. Memory retraining is a process to initialize the memory module and run diagnostic tests for the memory module in your computer. When memory retraining occurs, the screen can't display the progress information and might be blank. You might see the LED indicators on ESC, F1, and F4 blinking sequentially to indicate the progress. Do not press the power button to interrupt the process. Wait a few minutes until the logo screen is displayed.

To know more about UEFI BIOS, visit Knowledge Base of your computer at <https://pcsupport.lenovo.com>.

FIDO (Fast ID) Online authentication

Your computer supports FIDO (Fast ID) Online authentication, which works as an alternative to password-based authentication to help you achieve passwordless authentication. This new BIOS feature only works when a power-on password is set in UEFI BIOS and a FIDO2 USB device is registered in ThinkShield™ Passwordless Power-On Device Manager. With this feature, you can input a power-on password or use the registered USB FIDO2 device to power on your computer.

Register your FIDO2 USB device in ThinkShield Passwordless Power-On Device Manager

1. Turn on the computer.
2. Press F12 during the power-on process.
3. If you set a power-on password, a window pops up on the screen when you turn on the computer. Enter the correct password to use the computer.
4. Select **App Menu → ThinkShield Passwordless Power-On Device Manager** and press Enter.
5. Insert FIDO2 device to register the FIDO2 device by following steps:
 - a. Select the available FIDO2 device that you want to register in the **Discovered Devices** area.
 - b. The first window pops up to confirm the device you selected. Click **Yes**.
 - c. If you set a power-on password, a window pops up. Enter the correct password.
 - d. The **User operation request** window pops up. You are required to press a button on the connected FIDO2 device, and then follow the on-screen instruction to close the window.
 - e. Press ESC to exit and restart your computer.

Notes:

- If you want to unregister your devices, click the available FIDO2 device that you want to unregister in the **My Device** area and enter the correct power-on password for verification.
- If you use more than one FIDO2 device with a common identifier for registration, only one device could be available.

Log in to the System with Passwordless Power-On Authentication

1. Restart the computer.
2. **ThinkShield Passwordless Power-On Authentication** window appears.
3. Insert your registered FIDO2 device for detection.
4. Then follow the on-screen instruction to press the button on your FIDO2 device for verification.
5. After your device is verified, the power-on process continues.

Note: You should insert the FIDO2 device or enter a power-on password within 60 seconds. Otherwise, your computer will shut down automatically.

Install a Windows operating system and drivers

This section provides instructions on installing a Windows operating system and device drivers.

Install a Windows operating system

Microsoft constantly makes updates to the Windows operating system. Before installing a particular Windows version, check the compatibility list for the Windows version. For details, go to <https://support.lenovo.com/us/en/solutions/windows-support>.

Attention:

- It is recommended that you update your operating system through official channels. Any unofficial update might cause security risks.
 - The process of installing a new operating system deletes all the data on your internal storage drive, including the data stored in a hidden folder.
1. If you are using the Windows BitLocker® Drive Encryption feature and your computer has a Trusted Platform Module, ensure that you have disabled the feature.
 2. Ensure that the security chip is set to **Active**.
 - a. Restart the computer. When the logo screen is displayed, press F1 to enter the UEFI BIOS menu.
 - b. Select **Security → Security Chip** and press Enter. The **Security Chip** submenu opens.
 - c. Ensure that the security chip for TPM 2.0 is set to **Active**.
 - d. Press F10 to save the settings and exit.
 3. Connect the drive that contains the operating system installation program to the computer.
 4. Restart the computer. When the logo screen is displayed, press F1 to enter the UEFI BIOS menu.
 5. Select **Startup → Boot** to display the **Boot Priority Order** submenu.
 6. Select the drive that contains the operating system installation program, for example, **USB HDD**. Then, press Esc.

Attention: After you change the startup sequence, ensure that you select the correct device during a copy, a save, or a format operation. If you select the wrong device, the data on that device might be erased or overwritten.
 7. Select **Restart** and ensure that **OS Optimized Defaults** is enabled. Then, press F10 to save the settings and exit.
 8. Follow the on-screen instructions to install the device drivers and necessary programs.
 9. After installing the device drivers, apply Windows Update to get the latest updates, for example the security patches.

Install device drivers

You should download the latest driver for a component when you notice poor performance from that component or when you added a component. This action might eliminate the driver as the potential cause of a problem. Download and install the latest driver by one of the following methods:

- Open the Vantage app to check the available update packages. Select the update packages you want, and then follow the on-screen instructions to download and install the packages.
- Go to <https://pcsupport.lenovo.com> and select the entry for your computer. Then, follow the on-screen instructions to download and install necessary drivers and software.

Chapter 6. CRU replacement

Customer Replaceable Units (CRUs) are parts that can be upgraded or replaced by the customer. The computers contain the following types of CRUs:

- **Self-service CRUs:** Refer to parts that can be installed or replaced easily by customer themselves or by trained service technicians at an additional cost.
- **Optional-service CRUs:** Refer to parts that can be installed or replaced by customers with a greater skill level. Trained service technicians can also provide service to install or replace the parts under the type of warranty designated for the customer's machine.

If you intend on installing a CRU, Lenovo will ship the CRU to you. CRU information and replacement instructions are shipped with your product and are available from Lenovo at any time upon request. You might be required to return the defective part that is replaced by the CRU. When return is required: (1) return instructions, a prepaid shipping label, and a container will be included with the replacement CRU; and (2) you might be charged for the replacement CRU if Lenovo does not receive the defective CRU within thirty (30) days of your receipt of the replacement CRU. For full details, see the Lenovo Limited Warranty documentation at https://www.lenovo.com/warranty/llw_02.

CRU list

The following is a list of CRUs of your computer.

Self-service CRUs

- ac power adapter*
- Base cover assembly
- Lenovo Integrated Pen*
- Pen dummy*
- M.2 solid-state drive*
- M.2 solid-state drive bracket*
- Nano-SIM card tray*
- Power cord*
- Wireless WAN card*

* for selected models

Note: Replacement of any parts not listed above, including the built-in rechargeable battery, must be done by a Lenovo-authorized repair facility or technician. Go to <https://support.lenovo.com/partnerlocation> for more information.

Disable Fast Startup and the built-in battery

Before replacing any CRU, ensure that you disable Fast Startup first and then disable the built-in battery.

To disable Fast Startup:

1. Go to **Control Panel** and view by Large icons or Small icons.
2. Click **Power Options**, and then click **Choose what the power buttons do** on the left pane.
3. Click **Change settings that are currently unavailable** at the top.

4. If prompted by User Account Control (UAC), click **Yes**.
5. Clear the **Turn on fast startup** check box, and then click **Save changes**.

To disable the built-in battery:

1. Restart your computer. When the logo screen is displayed, immediately press F1 to enter the UEFI BIOS menu.
2. Select **Config → Power**. The **Power** submenu is displayed.
3. Select **Disable Built-in Battery** and press Enter.
4. Select **Yes** in the Setup Confirmation window. The built-in battery is disabled and the computer turns off automatically. Wait three to five minutes to let the computer cool.

Replace a CRU

Follow the replacement procedure to replace a CRU.

Base cover assembly

Prerequisite

Before you start, read [Generic Safety and Compliance Notices](#) and print the following instructions.

Note: Do not remove the base cover assembly when your computer is connected to ac power. Otherwise, there might be a risk of short circuits.

For access, do the following:

1. Disable the built-in battery. See “Disable Fast Startup and the built-in battery” on page 37.
2. Turn off the computer and disconnect the computer from ac power and all connected cables.
3. Remove the pen from the pen slot.
4. Close the computer display and turn over the computer.

Removal procedure

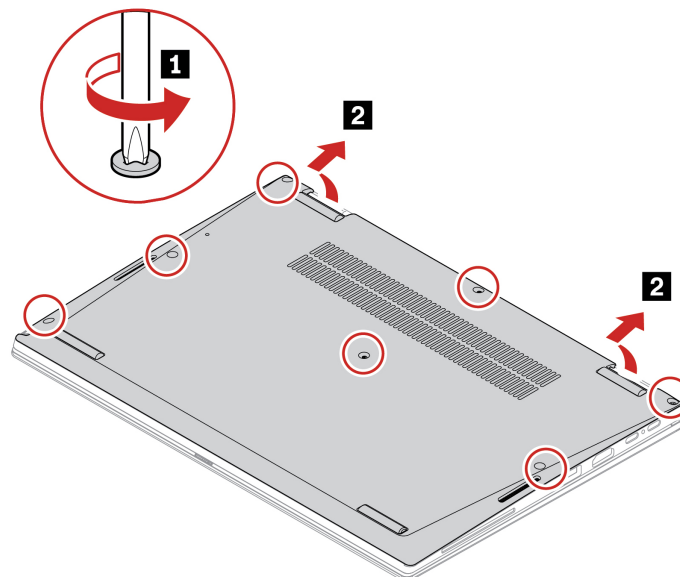

Installation procedure

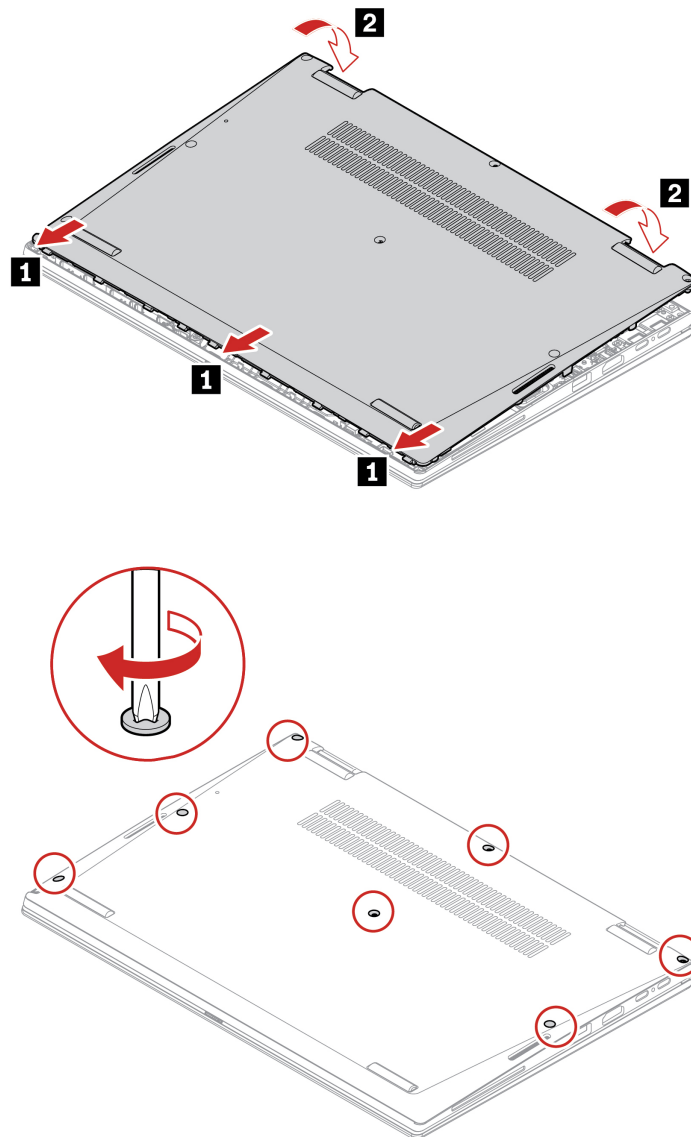

Troubleshooting

If the computer does not start up after you reinstall the base cover assembly, disconnect the ac power adapter and then reconnect it to the computer.

Wireless WAN card (for selected models)

The following information is only for the computer with user-installable modules. Ensure that you use only a Lenovo-authorized wireless module specifically tested for this computer model. Otherwise, the computer will generate an error-code beep sequence when you turn on the computer.

Prerequisite

Before you start, read [Generic Safety and Compliance Notices](#) and print the following instructions.

Attention: Do not touch the contact edge of the wireless WAN card. Otherwise, the wireless WAN card might get damaged.

For access, do the following:

1. Disable the built-in battery. See “Disable Fast Startup and the built-in battery” on page 37.
2. Turn off the computer and disconnect the computer from ac power and all connected cables.
3. Close the computer display and turn the computer over.
4. Remove the base cover assembly. See “Base cover assembly” on page 38.

Removal procedure

Note: A Mylar film might cover the wireless WAN card. To access the wireless WAN card, peel off the film first.

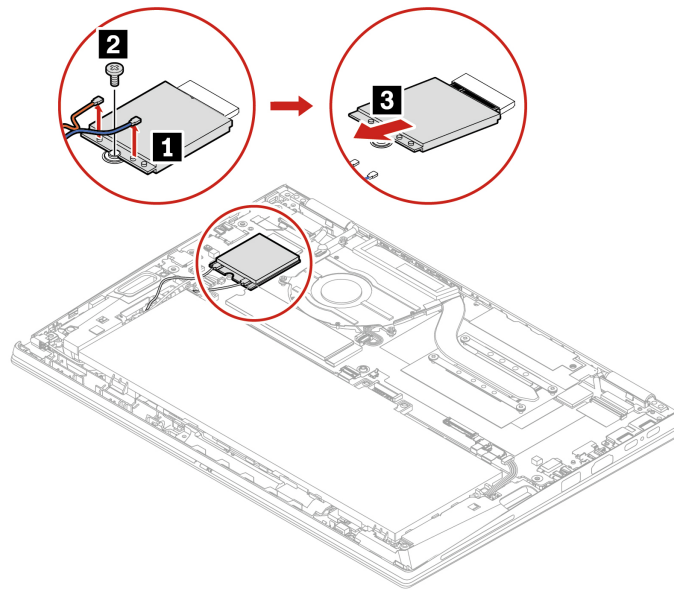

Note: During installation, ensure that you connect the cables with different colors to the corresponding connectors on the card: the orange cable to the connector labeled ORANGE, and the blue cable to the connector labeled BLUE.

M.2 solid-state drive and M.2 solid-state drive bracket (for selected models)

Prerequisite

Before you start, read [Generic Safety and Compliance Notices](#) and print the following instructions.

Attention: If you replace a M.2 solid-state drive, you might need to install a new operating system. For details on how to install a new operating system, see “Install a Windows operating system and drivers” on page 34. The M.2 solid-state drive is sensitive. Inappropriate handling might cause damage and permanent loss of data.

When handling the M.2 solid-state drive, observe the following guidelines:

- Replace the M.2 solid-state drive only for upgrade or repair. The M.2 solid-state drive is not designed for frequent changes or replacement.
- Before replacing the M.2 solid-state drive, make a backup copy of all the data that you want to keep.
- Do not apply pressure to the M.2 solid-state drive.

- Do not touch the contact edge or circuit board of the M.2 solid-state drive. Otherwise, the M.2 solid-state drive might get damaged.
- Do not make the M.2 solid-state drive subject to physical shocks or vibration. Put the M.2 solid-state drive on a soft material, such as cloth, to absorb physical shocks.

For access, do the following:

1. Disable the built-in battery. See “Disable Fast Startup and the built-in battery” on page 37.
2. Turn off the computer and disconnect the computer from ac power and all connected cables.
3. Close the computer display and turn the computer over.
4. Remove the base cover assembly. See “Base cover assembly” on page 38.

Removal procedures

Type 1: Remove the screw that secures the M.2 solid-state drive **1**, and carefully remove the drive with folio mylar out of the slot **2**. Then, take the drive out from the folio mylar **3**.

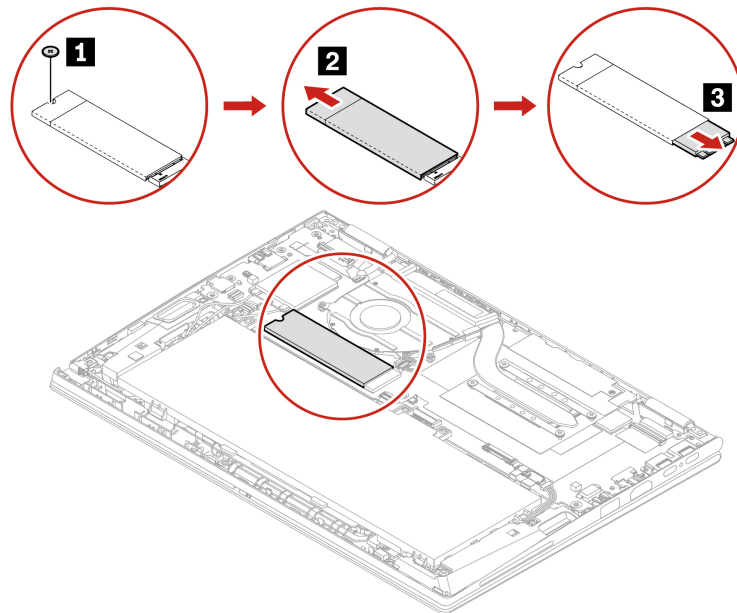

Note: Ensure that you put the new M.2 solid state drive into the folio mylar before installation.

Type 2: Remove the screws that secure the M.2 solid-state drive bracket **1**, and remove the bracket **2**. Then, remove the drive out of the slot **3**.

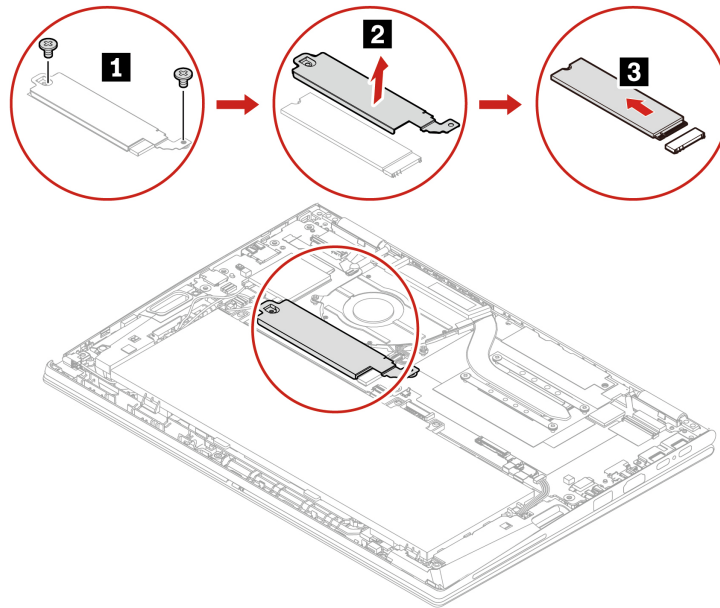

Pen dummy (for selected models)

Depending on models, a pen dummy might come with your computer. If you need replace the pen dummy with a Lenovo integrated pen, do the following:

Prerequisite

Before you start, read [Generic Safety and Compliance Notices](#) and print the following instructions.

For access, do the following:

1. Disable the built-in battery. See “Disable Fast Startup and the built-in battery” on page 37.
2. Turn off the computer and disconnect the computer from ac power and all connected cables.
3. Close the computer display and turn the computer over.
4. Remove the base cover assembly. See “Base cover assembly” on page 38.

Removal procedure

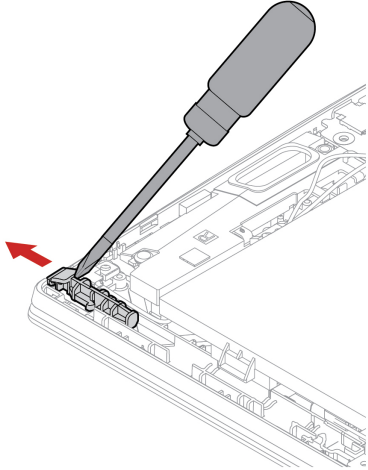

Chapter 7. Help and support

Frequently asked questions

How do I access Control Panel ?	Type Control Panel in the Windows search box and then press Enter.
How do I turn off my computer?	Open the Start menu and click  Power . Then, click Shut down .
How do I partition my storage drive?	https://support.lenovo.com/solutions/ht503851
What do I do if my computer stops responding?	<ol style="list-style-type: none">1. Press and hold the power button until the computer turns off. Then, restart the computer.2. If step 1 does not work:<ul style="list-style-type: none">• For models with an emergency reset hole: Insert a straightened paper clip into the emergency reset hole to cut off power supply temporarily. Then, restart the computer with ac power connected.• For models without an emergency reset hole:<ul style="list-style-type: none">– For models with the removable battery, remove the removable battery and disconnect all power sources. Then, reconnect to ac power and restart the computer.– For models with the built-in battery, disconnect all power sources. Press and hold the power button for about seven seconds. Then, reconnect to ac power and restart the computer.
What do I do if I spill liquid on the computer?	<ol style="list-style-type: none">1. Carefully unplug the ac power adapter and turn off the computer immediately. The more quickly you stop the current from passing through the computer the more likely you will reduce damage from short circuits. Attention: Although you might lose some data or work by turning off the computer immediately, leaving the computer on might make your computer unusable.2. Do not try to drain out the liquid by turning over the computer. If your computer has keyboard drainage holes on the bottom, the liquid will be drained out through the holes.3. Wait until you are certain that all the liquid is dry before turning on your computer.
How do I enter the UEFI BIOS menu?	Restart the computer. When the logo screen is displayed, press F1 to enter the UEFI BIOS menu.
Where can I get the latest device drivers and UEFI BIOS?	<ul style="list-style-type: none">• From the Vantage app. See “Install a Windows operating system and drivers” on page 34 and “Update UEFI BIOS” on page 33.• Download from Lenovo Support Web site at https://pcsupport.lenovo.com.

Error messages

If you see a message that is not included in the following table, record the error message first, then shut down the computer and call Lenovo for help. See “Lenovo Customer Support Center” on page 50.

Message	Solution
0190: Critical low-battery error	The computer turned off because the battery power is low. Connect the ac power adapter to the computer and charge the batteries.
0191: System Security - Invalid remote change requested	The system configuration change has failed. Confirm the operation and try again.
0199: System Security - Security password retry count exceeded.	This message is displayed when you enter a wrong supervisor password more than three times. Confirm the supervisor password and try again.
0271: Check Date and Time settings.	The date or the time is not set in the computer. Enter the UEFI BIOS menu and set the date and time.
210x/211x: Detection/Read error on HDDx/SSDx	The storage drive is not working. Reinstall the storage drive. If the problem still exists, replace the storage drive.
Error: The non-volatile system UEFI variable storage is nearly full.	<p>Note: This error indicates that the operating system or programs cannot create, modify, or delete data in the non-volatile system UEFI variable storage due to insufficient storage space after POST.</p> <p>The non-volatile system UEFI variable storage is used by the UEFI BIOS and by the operating system or programs. This error occurs when the operating system or programs store large amounts of data in the variable storage. All data needed for POST, such as UEFI BIOS setup settings, chipset, or platform configuration data, are stored in a separate UEFI variable storage. Press F1 after the error message is displayed to enter the UEFI BIOS menu. A dialog asks for confirmation to clean up the storage. If you select “Yes”, all data that were created by the operating system or programs will be deleted except global variables defined by the Unified Extensible Firmware Interface Specification. If you select “No”, all data will be kept, but the operating system or programs will not be able to create, modify, or delete data in the storage.</p> <p>If this error happens at a service center, Lenovo authorized service personnel will clean up the non-volatile system UEFI variable storage using the preceding solution.</p>
Fan error. Press ESC to startup with limited performance.	The thermal fan might not work correctly. After the error message is displayed, press ESC within five seconds to start up the computer with limited performance. Otherwise, the computer will shut down immediately. If the problem still exists when you starts up next time, have your computer serviced.

Beep errors

Lenovo SmartBeep technology enables you to decode beep errors with your smartphone when a black screen occurs with beeps from your computer. To decode the beep error with Lenovo SmartBeep technology:

1. Go to <https://support.lenovo.com/smartbeep> or scan the following QR Code.



2. Download the proper diagnostic app and install it on your smartphone.
3. Run the diagnostic app and place the smartphone near the computer.
4. Press Fn on your computer to emit the beep again. The diagnostic app decodes the beep error and shows possible solutions on the smartphone.

Note: Do not attempt to service a product yourself unless instructed to do so by the Customer Support Center or product documentation. Only use a Lenovo-authorized service provider to repair your product.

Self-help resources

Use the following self-help resources to learn more about the computer and troubleshoot problems.

Resources	How to access?
Troubleshooting and FAQ	<ul style="list-style-type: none">• https://www.lenovo.com/tips• https://forums.lenovo.com
Accessibility information	https://www.lenovo.com/accessibility
Reset or restore Windows	<ul style="list-style-type: none">• Use Lenovo recovery options.<ol style="list-style-type: none">1. Go to https://support.lenovo.com/HowToCreateLenovoRecovery.2. Follow the on-screen instructions.• Use Windows recovery options.<ol style="list-style-type: none">1. Go to https://pcsupport.lenovo.com.2. Detect your computer or manually select your computer model.3. Navigate to the troubleshooting menu to diagnose the operating system for recovery instructions.
Use the Vantage app to: <ul style="list-style-type: none">• Configure device settings.• Download and install UEFI BIOS, drivers, and firmware updates.• Secure your computer from outside threats.• Diagnose hardware problems.• Check the computer warranty status.• Access <i>User Guide</i> and helpful articles. <p>Note: The available features vary depending on the computer model.</p>	Type Vantage in the Windows search box and then press Enter.
Product documentation: <ul style="list-style-type: none">• <i>Safety and Warranty Guide</i>• <i>Generic Safety and Compliance Notices</i>• <i>Setup Guide</i>• <i>This User Guide</i>• <i>Regulatory Notice</i>	Go to https://pcsupport.lenovo.com . Then, follow the on-screen instructions to filter out the documentation you want.

Resources	How to access?
<p>Lenovo Support Web site with the latest support information of the following:</p> <ul style="list-style-type: none"> • Drivers and software • Diagnostic solutions • Product and service warranty • Product and parts details • Knowledge base and frequently asked questions 	<p>https://pcsupport.lenovo.com</p>
<p>Windows help information</p>	<ul style="list-style-type: none"> • Open the Start menu and click Get Help or Tips. • Use Windows Search or the Cortana® personal assistant. • Microsoft support Web site: https://support.microsoft.com

Windows label

Your computer might have a Windows Genuine Microsoft label affixed to its cover depending on the following factors:

- Your geographic location
- Edition of Windows that is preinstalled

Go to <https://www.microsoft.com/en-us/howtotell/Hardware.aspx> for illustrations of the various types of Genuine Microsoft labels.

- In the People's Republic of China, the Genuine Microsoft label is required on all computer models preinstalled with any edition of the Windows operating system.
- In other countries and regions, the Genuine Microsoft label is required only on computer models licensed for Windows Pro editions.

The absence of a Genuine Microsoft label does not indicate that the preinstalled Windows version is not genuine. For details on how to tell whether your preinstalled Windows product is genuine, refer to the information provided by Microsoft at <https://www.microsoft.com/en-us/howtotell/default.aspx>.

There are no external, visual indicators of the Product ID or Windows version for which the computer is licensed. Instead, the Product ID is recorded in the computer firmware. Whenever a Windows product is installed, the installation program checks the computer firmware for a valid, matching Product ID to complete the activation.

In some cases, an earlier Windows version might be preinstalled under the terms of the Windows Pro edition license downgrade rights.

Call Lenovo

If you have tried to correct the problem yourself and still need help, you can call Lenovo Customer Support Center.

Before you contact Lenovo

Prepare the following before you contact Lenovo:

1. Record the problem symptoms and details:

- What is the problem? Is it continuous or intermittent?
- Any error message or error code?
- What operating system are you using? Which version?
- Which software applications were running at the time of the problem?
- Can the problem be reproduced? If so, how?

2. Record the system information:

- Product name
- Machine type and serial number

The following illustration shows where to find the machine type and serial number of your computer.

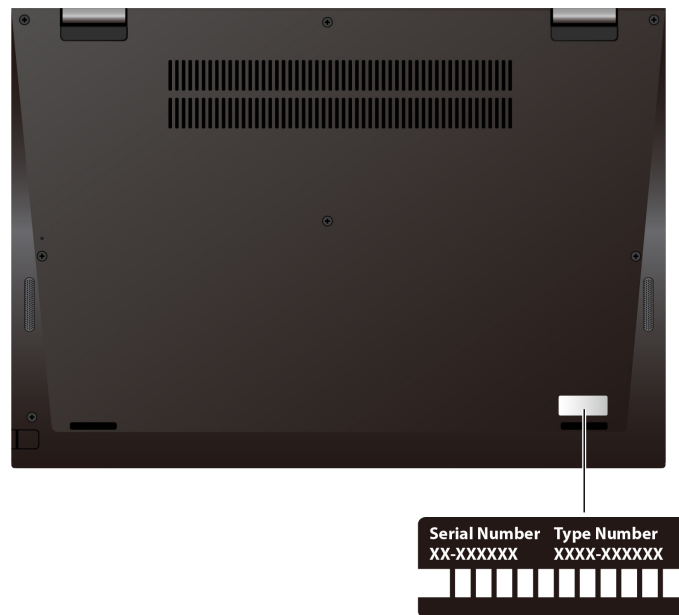

Lenovo Customer Support Center

During the warranty period, you can call Lenovo Customer Support Center for help.

Telephone numbers

For a list of the Lenovo Support phone numbers for your country or region, go to <https://pcsupport.lenovo.com/supportphonenumberlist> for the latest phone numbers.

Note: Phone numbers are subject to change without notice. If the number for your country or region is not provided, contact your Lenovo reseller or Lenovo marketing representative.

Services available during the warranty period

- Problem determination - Trained personnel are available to assist you with determining if you have a hardware problem and deciding what action is necessary to fix the problem.
- Lenovo hardware repair - If the problem is determined to be caused by Lenovo hardware under warranty, trained service personnel are available to provide the applicable level of service.

- Engineering change management - Occasionally, there might be changes that are required after a product has been sold. Lenovo or your reseller, if authorized by Lenovo, will make selected Engineering Changes (ECs) that apply to your hardware available.

Services not covered

- Replacement or use of parts not manufactured for or by Lenovo or nonwarranted parts
- Identification of software problem sources
- Configuration of UEFI BIOS as part of an installation or upgrade
- Changes, modifications, or upgrades to device drivers
- Installation and maintenance of network operating systems (NOS)
- Installation and maintenance of programs

For the terms and conditions of the Lenovo Limited Warranty that apply to your Lenovo hardware product, go to:

- https://www.lenovo.com/warranty/llw_02
- <https://pcsupport.lenovo.com/warrantylookup>

Purchase additional services

During and after the warranty period, you can purchase additional services from Lenovo at <https://pcsupport.lenovo.com/warrantyupgrade>.

Service availability and service name might vary by country or region.

Appendix A. Compliance information

For compliance information, refer to *Regulatory Notice* at <https://pcsupport.lenovo.com> and *Generic Safety and Compliance Notices* at https://pcsupport.lenovo.com/docs/generic_notices.

Certification-related information

Product name	Compliance ID	Machine type(s)
<ul style="list-style-type: none">• ThinkPad X13 Yoga Gen 3• ThinkPad X13 Yoga Gen 3 LTE¹• ThinkPad X13 Yoga Gen 3 LTE²	TP00127B / TP00127B0 ² / TP00127B1 ²	21AW and 21AX

¹ for mainland China only / ² for India only

Further compliance information related to your product is available at <https://www.lenovo.com/compliance>.

Locate the UltraConnect wireless antennas

Your computer has an UltraConnect™ wireless antenna system. You can enable wireless communication wherever you are.

The following illustration shows the antenna locations on your computer:



- 1 Wireless LAN antenna (main)
- 2 Wireless LAN antenna (auxiliary)
- 3 Wireless WAN antenna (auxiliary, for selected models)
- 4 Wireless WAN antenna (main, for selected models)

Operating environment

Maximum altitude (without pressurization)

3048 m (10 000 ft)

Temperature

- Operating: 5°C to 35°C (41°F to 95°F)
- Storage and transportation in original shipping packaging: -20°C to 60°C (-4°F to 140°F)
- Storage without packaging: 5°C to 43°C (41°F to 109°F)

Note: When you charge the battery, its temperature must be no lower than 10°C (50°F).

Relative humidity

- Operating: 8% to 95% at wet-bulb temperature 23°C (73°F)

- Storage and transportation: 5% to 95% at wet-bulb temperature 27°C (81°F)

Appendix B. Notices and trademarks

Notices

Lenovo may not offer the products, services, or features discussed in this document in all countries. Consult your local Lenovo representative for information on the products and services currently available in your area. Any reference to a Lenovo product, program, or service is not intended to state or imply that only that Lenovo product, program, or service may be used. Any functionally equivalent product, program, or service that does not infringe any Lenovo intellectual property right may be used instead. However, it is the user's responsibility to evaluate and verify the operation of any other product, program, or service.

Lenovo may have patents or pending patent programs covering subject matter described in this document. The furnishing of this document does not give you any license to these patents. You can send license inquiries, in writing, to:

*Lenovo (United States), Inc.
8001 Development Drive
Morrisville, NC 27560
U.S.A.
Attention: Lenovo Director of Licensing*

LENOVO PROVIDES THIS PUBLICATION "AS IS" WITHOUT WARRANTY OF ANY KIND, EITHER EXPRESS OR IMPLIED, INCLUDING, BUT NOT LIMITED TO, THE IMPLIED WARRANTIES OF NON-INFRINGEMENT, MERCHANTABILITY OR FITNESS FOR A PARTICULAR PURPOSE. Some jurisdictions do not allow disclaimer of express or implied warranties in certain transactions, therefore, this statement may not apply to you.

Changes are made periodically to the information herein; these changes will be incorporated in new editions of the publication. To provide better service, Lenovo reserves the right to improve and/or modify the products and software programs described in the manuals included with your computer, and the content of the manual, at any time without additional notice.

The software interface and function and hardware configuration described in the manuals included with your computer might not match exactly the actual configuration of the computer that you purchase. For the configuration of the product, refer to the related contract (if any) or product packing list, or consult the distributor for the product sales. Lenovo may use or distribute any of the information you supply in any way it believes appropriate without incurring any obligation to you.

The products described in this document are not intended for use in implantation or other life support applications where malfunction may result in injury or death to persons. The information contained in this document does not affect or change Lenovo product specifications or warranties. Nothing in this document shall operate as an express or implied license or indemnity under the intellectual property rights of Lenovo or third parties. All information contained in this document was obtained in specific environments and is presented as an illustration. The result obtained in other operating environments may vary.

Lenovo may use or distribute any of the information you supply in any way it believes appropriate without incurring any obligation to you.

Any references in this publication to non-Lenovo Web sites are provided for convenience only and do not in any manner serve as an endorsement of those Web sites. The materials at those Web sites are not part of the materials for this Lenovo product, and use of those Web sites is at your own risk.

Any performance data contained herein was determined in a controlled environment. Therefore, the result obtained in other operating environments may vary significantly. Some measurements may have been made on development-level systems and there is no guarantee that these measurements will be the same on generally available systems. Furthermore, some measurements may have been estimated through extrapolation. Actual results may vary. Users of this document should verify the applicable data for their specific environment.

This document is copyrighted by Lenovo and is not covered by any open source license, including any Linux® agreement(s) which may accompany software included with this product. Lenovo may update this document at any time without notice.

For the latest information or any questions or comments, contact or visit the Lenovo Web site:

<https://pcsupport.lenovo.com>

Trademarks

LENOVO, LENOVO logo, THINKPAD, THINKPAD logo, TRACKPOINT, and ULTRACONNECT are trademarks of Lenovo. Intel and Thunderbolt are trademarks of Intel Corporation or its subsidiaries in the U.S. and/or other countries. Microsoft, Windows, BitLocker, and Cortana are trademarks of the Microsoft group of companies. Dolby, Dolby Voice, and Dolby Audio are trademarks of Dolby Laboratories Licensing Corporation. The terms HDMI and HDMI High-Definition Multimedia Interface are trademarks or registered trademarks of HDMI Licensing LLC in the United States and other countries. USB-C is a registered trademark of USB Implementers Forum. Wi-Fi and Miracast are registered trademarks of Wi-Fi Alliance. All other trademarks are the property of their respective owners.