

SAMSUNG

FULL MANUAL

HW-S60B / HW-S61B

Imagine the possibilities









Thank you for purchasing this Samsung product.

To receive more complete service, please register
your product at www.samsung.com/register

SAFETY INFORMATION

SAFETY WARNINGS

TO REDUCE THE RISK OF ELECTRIC SHOCK, DO NOT REMOVE THE COVER (OR BACK). NO USER-SERVICEABLE PARTS ARE INSIDE. REFER SERVICING TO QUALIFIED SERVICE PERSONNEL.
Refer to the table below for an explanation of symbols which may be on your Samsung product.

	<p style="text-align: center;">CAUTION RISK OF ELECTRIC SHOCK. DO NOT OPEN.</p>	
	<p>This symbol indicates that high voltage is present inside. It is dangerous to make any kind of contact with any internal part of this product.</p>	
	<p>This symbol indicates that this product comes with important literature concerning operation and maintenance.</p>	
	<p>Class II product : This symbol indicates that a safety connection to electrical earth (ground) is not required. If this symbol is not present on a product with a power cord, the product MUST have a reliable connection to protective earth (ground).</p>	
	<p>AC voltage : Rated voltage marked with this symbol is AC voltage.</p>	
	<p>DC voltage : Rated voltage marked with this symbol is DC voltage.</p>	
	<p>Caution. Consult Instructions for use : This symbol instructs the user to consult the user manual for further safety related information.</p>	

WARNING

- To reduce the risk of fire or electric shock, do not expose this appliance to rain or moisture.
- To prevent injury, this apparatus must be securely attached to the floor/wall in accordance with the installation instructions.
- This product contains chemicals known to the State of California to cause cancer and birth defects or other reproductive harm.

CAUTION

- Do not expose this apparatus to dripping or splashing. Do not put objects filled with liquids, such as vases, on the apparatus.
- To turn this apparatus off completely, you must pull the power plug out of the wall socket. Consequently, the power plug must be easily and readily accessible at all times.

FCC NOTE (for U.S.A):

FCC Supplier's Declaration of Conformity

Responsible Party - U.S. Contact Information:

Samsung Electronics America, Inc.
85 Challenger Road.
Ridgefield Park, NJ 07660
Phone: 1-800-SAMSUNG (726-7864)

FCC Compliance Statement :

This device complies with Part 15 of the FCC Rules. Operation is subject to the following two conditions:

- (1) This device may not cause harmful interference, and (2) this device must accept any interference received, including interference that may cause undesired operation.

FCC Caution :

- Any changes or modifications not expressly approved by the party responsible for compliance could void the user's authority to operate this equipment.
- This product satisfies FCC regulations when shielded cables and connectors are used to connect the unit to other equipment. To prevent electromagnetic interference with electric appliances, such as radios and televisions, use shielded cables and connectors for connections.

Class B FCC Statement

This equipment has been tested and found to comply with the limits for a Class B digital device, pursuant to Part 15 of the FCC Rules. These limits are designed to provide reasonable protection against harmful interference in a residential installation. This equipment generates, uses and can radiate radio frequency energy and, if not installed and used in accordance with the instructions, may cause harmful interference to radio communications. However, there is no guarantee that interference will not occur in a particular installation. If this equipment does cause harmful interference to radio or television reception, which can be determined by turning the equipment off and on, the user is encouraged to try to correct the interference by one of the following measures:

- Reorienting or relocating the receiving antenna.
- Increasing the separation between the equipment and receiver.
- Connecting the equipment to an outlet that is on a different circuit than the radio or TV.
- Consulting the dealer or an experienced radio/TV technician for help.

FCC Radiation Exposure Statement :

This equipment complies with FCC radiation exposure limits set forth for an uncontrolled environment. This equipment should be installed and operated so there is at least 8 inches (20 cm) between the radiator and your body. This device and its antenna(s) must not be co-located or operated in conjunction with any other antenna or transmitter.

CALIFORNIA USA ONLY (Applicable for networking models only.)

This Perchlorate warning applies only to primary CR(Manganese Dioxide) Lithium coin cells in the product sold or distributed ONLY in California USA "Perchlorate Material - special handling may apply, See www.dtsc.ca.gov/hazardouswaste/perchlorate."

Dispose unwanted electronics through an approved recycler. To find the nearest recycling location, go to our website:www.samsung.com/recycling Or call, 1-800-SAMSUNG

 **WARNING: Cancer and Reproductive Harm**
- www.P65Warnings.ca.gov.

Important Safety Instructions

Read these operating instructions carefully before using the unit. Follow all the safety instructions listed below. Keep these operating instructions handy for future reference.

1. Read these instructions.
2. Keep these Instructions.
3. Heed all warnings.
4. Follow all instructions.
5. Do not use this apparatus near water.
6. Clean only with dry cloth.

7. Do not block any ventilation openings.
Install in accordance with the manufacturer's instructions.
8. Do not install near any heat sources such as radiators, heat registers, stoves, or other apparatus (including amplifiers) that produce heat.
9. Do not defeat the safety purpose of the polarized or grounding-type plug.
A polarized plug has two blades with one wider than the other. A grounding type plug has two blades and a third grounding prong. The wide blade or the third prong are provided for your safety. If the provided plug does not fit into your outlet, consult an electrician for replacement of the obsolete outlet.
10. Protect the power cord from being walked on or pinched particularly at plugs, convenience receptacles, and the point where they exit from the apparatus.
11. Only use attachments/accessories specified by the manufacturer.
12. Use only with the cart, stand, tripod, bracket, or table specified by the manufacturer, or sold with the apparatus.
When a cart is used, use caution when moving the cart/apparatus combination to avoid injury from tip-over.
13. Unplug this apparatus during lightning storms or when unused for long periods of time.



14. Refer all servicing to qualified service personnel. Servicing is required when the apparatus has been damaged in any way, such as power-supply cord or plug is damaged, liquid has been spilled or objects have fallen into the apparatus, the apparatus has been exposed to rain or moisture, does not operate normally, or has been dropped.

PRECAUTIONS

1. Ensure that the AC power supply in your house complies with the power requirements listed on the identification sticker located on the bottom of your product. Install your product horizontally, on a suitable base (furniture), with enough space around it for ventilation (3~4 inches). Make sure the ventilation slots are not covered. Do not place the unit on amplifiers or other equipment which may become hot. This unit is designed for continuous use. To fully turn off the unit, disconnect the AC plug from the wall outlet. Unplug the unit if you intend to leave it unused for a long period of time.
2. During thunderstorms, disconnect the AC plug from the wall outlet. Voltage peaks due to lightning could damage the unit.
3. Do not expose the unit to direct sunlight or other heat sources. This could lead to overheating and cause the unit to malfunction.

4. Protect the product from moisture (i.e. vases), and excess heat (e.g. a fireplace) or equipment creating strong magnetic or electric fields. Unplug the power cable from the AC wall socket if the unit malfunctions. Your product is not intended for industrial use. It is for personal use only. Condensation may occur if your product has been stored in cold temperatures. If transporting the unit during the winter, wait approximately 2 hours until the unit has reached room temperature before using.
5. The battery used with this product contains chemicals that are harmful to the environment. Do not dispose of the battery in the general household trash. Do not expose the battery to excess heat, direct sunlight, or fire. Do not short circuit, disassemble, or overheat the battery.

CAUTION : Danger of explosion if the battery is replaced incorrectly. Replace only with the same or equivalent type.

CONTENTS

01	Checking the Components	8
02	Product Overview	9
	Front Panel / Top Panel of the Soundbar	9
	Bottom Panel of the Soundbar	11
03	Using the Remote Control	12
	Inserting Batteries before using the Remote Control (AAA batteries X 2)	12
	How to Use the Remote Control	12
	Active Voice Amplifier (AVA)	16
	Using the Hidden Buttons (Buttons with more than one function)	16
	Output specifications for the different sound effect modes	17
	Adjusting the Soundbar volume with a TV remote control	18
04	Connecting the Soundbar	19
	Connecting Electrical Power	19
	Connecting the Samsung Wireless Rear Kit and Subwoofer to your Soundbar	19
05	Connecting to a TV	20
	Connecting the TV that supports HDMI ARC (Audio Return Channel)	20
	Connecting using an Optical Cable	22
	Connecting via Bluetooth	23
	Connecting via Wi-Fi	25
	Connecting to a TV that supports Dolby Atmos®	26
	Using the Q-Symphony Function	28
	Using the SpaceFit Sound	29

06	Connecting an External Device	30
	Connecting using an Optical Cable	30
07	Connecting a Mobile Device	31
	Method 1. Connecting via Bluetooth	31
	Method 2. Connecting via Wi-Fi (Wireless Network)	34
	Using the Tap Sound	35
08	Connecting via Apple AirPlay 2	36
09	Installing the Wall Mount	37
	Installation Precautions	37
	Wallmount Components	37
10	Installing the Soundbar in front of TV	39
11	Software Update	40
	Auto Update	40
	USB Update	40
	Reset	41
12	Troubleshooting	42
13	License	44
14	Open Source License Notice	45
15	Important Notes About Service	45
16	Specifications and Guide	46
	Specifications	46

01 CHECKING THE COMPONENTS



Soundbar Main Unit



**Soundbar Remote Control
(AH81-15047A) / Batteries**



**HDMI Cable
(BN39-02661A)**

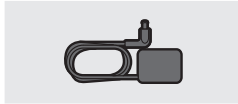

**AC/DC Adapter
(Soundbar)
(BN44-01014A)**



**Power Cord
(Soundbar)
(3903-001117)**

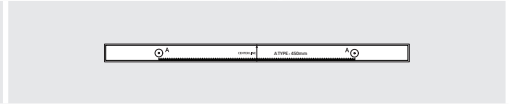

Wall Mount Guide (AH81-15186A)



Holder-Screw (AH61-04110A)



**Bracket-Wall Mount
(AH61-04235A)**

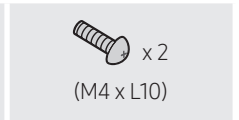









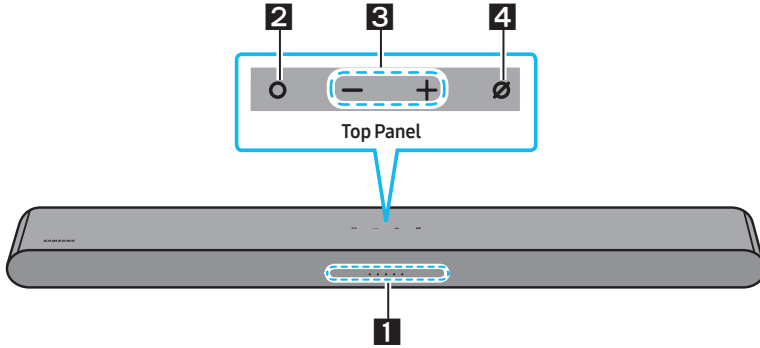

















Screw (6001-001202)

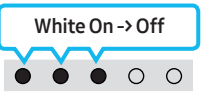
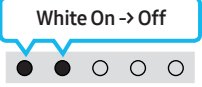

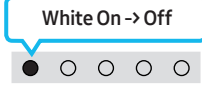
- For more information about the power supply and power consumption, refer to the label attached to the product. (Label: Bottom of the Soundbar Main Unit)
- To purchase additional components or optional cables, contact a Samsung Service Center or Samsung Customer Care.
- For more information about the wallmount see page 37.
- Design, specifications, and App screen are subject to change without prior notice.
- The appearance of the accessories may differ slightly from the illustrations above.

02 PRODUCT OVERVIEW

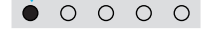
Front Panel / Top Panel of the Soundbar

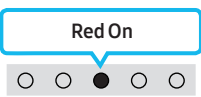

<p>1</p>	<p>LED indicator</p>	<p>The LED Indicator flashes, glows, or changes color depending on the Soundbar's current mode or status. The color of the LED indicator and the number of lights indicate the active mode as described below.</p> <table border="1" data-bbox="266 753 1028 834"> <tr> <td style="text-align: center;">  White LED </td> <td style="text-align: center;">  White LED </td> <td style="text-align: center;">  Multicolor LED </td> <td style="text-align: center;">  White LED </td> <td style="text-align: center;">  White LED </td> </tr> </table> <ul style="list-style-type: none"> The Multicolor LED changes to White, Cyan, Green, Red, and Blue depending on the mode or status. 	 White LED	 White LED	 Multicolor LED	 White LED	 White LED			
 White LED	 White LED	 Multicolor LED	 White LED	 White LED						
<p>2</p>	<p>Multi Function Button</p>	<ul style="list-style-type: none"> In standby mode, press the ○ (Multi Function) button to turn on the Soundbar. Press the ○ (Multi Function) button to change the mode. Each time you change the mode, the LED lights in white and then turns off. <table border="1" data-bbox="266 1026 1028 1209"> <tr> <td style="text-align: center;">LED Indicator</td> <td style="text-align: center;">  </td> <td style="text-align: center;">  </td> <td style="text-align: center;">  </td> </tr> <tr> <td style="text-align: center;"></td> <td style="text-align: center;"> "Digital Audio In" or "TV ARC" </td> <td style="text-align: center;"> "Wi-Fi" </td> <td style="text-align: center;"> "Bluetooth" </td> </tr> </table>	LED Indicator					"Digital Audio In" or "TV ARC"	"Wi-Fi"	"Bluetooth"
LED Indicator										
	"Digital Audio In" or "TV ARC"	"Wi-Fi"	"Bluetooth"							
<p>3</p>	<p>Volume Button</p>	<p>Press the - + (Volume) button to adjust the volume.</p>								

4	Mic On/Off Button	Press the  (Mic On/Off) button to turn the microphone on or off. When the microphone is off, the LED Indicator will light red.		
		LED Indicator		
			"Mic Off"	"Mic On"

- When you plug in the AC cord, the power button will begin working in 4 to 6 seconds.
- When you turn on this unit, there will be a 4 to 5 second delay before it produces sound.
- If you hear sounds from both the TV and Soundbar, go to the **Settings** menu for the TV audio and change the TV speaker to **External Speaker**.
- You can turn on and off audio feedback by using **SmartThings** app. To learn about using the **SmartThings** app, refer to "**Method 2. Connecting via Wi-Fi (Wireless Network)**".

Bottom Panel of the Soundbar

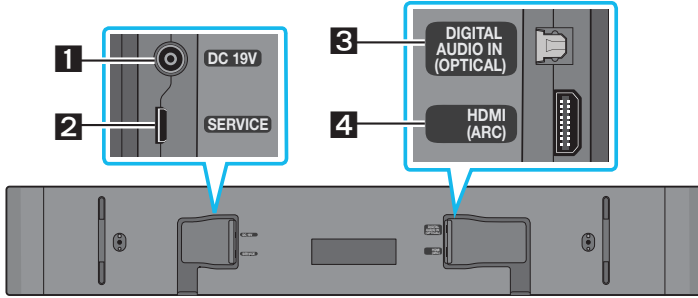

1	DC 19V (Power Supply In) Connect the AC/DC power adapter. (See page 19)
2	SERVICE Connect a USB storage device to upgrade the product's software.
3	DIGITAL AUDIO IN (OPTICAL) Connect to the digital (optical) output of an external device. (See page 30)
4	HDMI (ARC) Connect to the HDMI (ARC) port on a TV. (See page 20)

- When disconnecting the power cable of the AC/DC power adapter from a wall outlet, pull the plug. Do not pull the cable.
- Do not connect this unit or other components to an AC outlet until all connections between components are complete.

03 USING THE REMOTE CONTROL

Inserting Batteries before using the Remote Control (AAA batteries X 2)

Slide the back cover in the direction of the arrow until it is completely removed.

Insert 2 AAA batteries (1.5V) oriented so that their polarity is correct. Slide the back cover back into position.

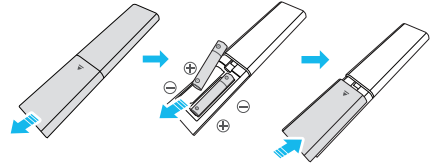

How to Use the Remote Control

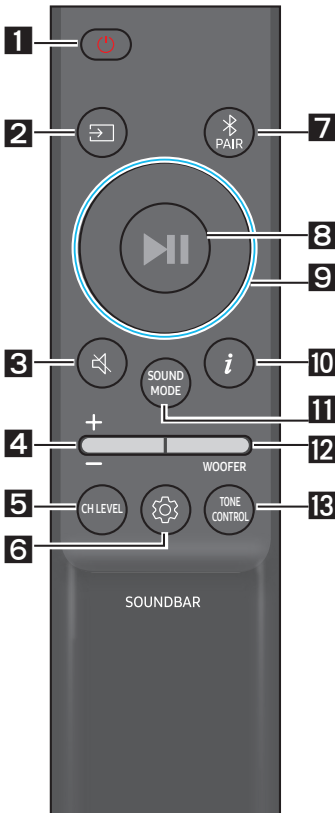

1

Power

Turns the Soundbar on and off.

LED Indicator	Cyan Blinks X1	Red Blinks X3
	○ ○ ● ○ ○	○ ○ ● ○ ○
	On	Off

- Auto Power Down Function**

The unit turns off automatically in the following situations:

- In "Digital Audio In" or "TV ARC" / "Wi-Fi" / "Bluetooth" mode if there is no audio signal for 18 minutes.

2

Source

Press to select a source connected to the Soundbar.

- Audio Feedback On/Off**

You can turn the Audio Feedback on or off. Press and hold the **Source** button on the remote control for 5 seconds while the Soundbar is off (Standby mode).

LED Indicator	Cyan Blinks X1	Red Blinks X1
	○ ○ ● ○ ○	○ ○ ● ○ ○
	On	Off

3**Mute**

Press the **Mute** button to mute the sound.
Press it again to unmute the sound.

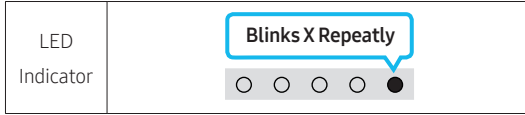
**4****Volume**

Push the button up or down to adjust the volume.

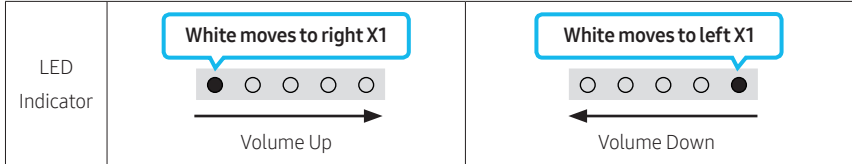
**5****CH LEVEL**

By pressing the button, you can adjust the volume of the each speaker.

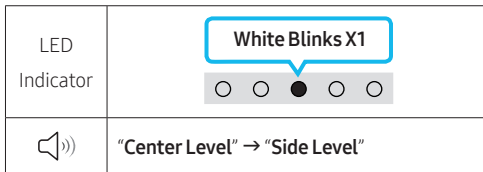

- If the Rear Speakers (sold separately) are connected, the setting **"Rear Level"** is supported. To adjust the volume of the **"Rear Level"** between -6 to +6 by using the **Up/Down** buttons.

6**⚙️ (Sound Control)**

By pressing the button, you can set the audio function. The desired item can be adjusted using the **Up/Down** buttons. Each time the mode changes, the Multicolor LED blinks in white.

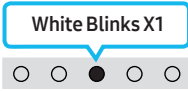
LED Indicator	
🔊	<p>“SpaceFit Sound” → “Active Voice Amplifier” → “Voice enhancement” → “Night mode” → “Sync” → “Virtual”</p>

- Press and hold the **⚙️ (Sound Control)** button for about 5 seconds to adjust the sound for each frequency band. 150Hz, 300Hz, 600Hz, 1.2kHz, 2.5kHz, 5kHz, and 10kHz are selectable using the **Left/Right** buttons and each can be adjusted to a setting between -6 to +6 using the **Up/Down** buttons. (Make sure the Sound mode is set to “Standard”.)
- “**Voice enhancement**” makes it easier to hear spoken dialog in movies and TV.
- “**Night mode**” is optimized for night time viewing with the settings adjusted to bring the volume down but keep the dialog clear.
- If the video on the TV and audio from the Soundbar are not synchronized, select “**Sync**” in Sound Control, and then set the audio delay between 0~300 milliseconds by using the **Up/Down** buttons.
- “**Sync**” is only supported for some functions.
- The “**Virtual**” function can be turned On/Off by using the **Up/Down** buttons.

7**📶 Bluetooth PAIR**

Switch the Soundbar to Bluetooth pairing mode.

When you press the button, the LED display changes as shown below.

- Until pairing is complete, the Multicolor LED changes as **Red → Green → Blue** in turn.

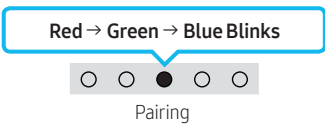
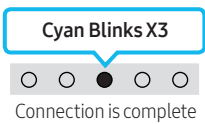
LED Indicator		
🔊	<p>“Ready to connect via Bluetooth.”</p>	

8**▶|| (Play / Pause)**

You can also play or pause music by pressing the button.

9**Up/Down/Left/Right**

Press **Up/Down/Left/Right** on the button to select or set functions.

- **Music Skip**

Press the **Right** button to select the next music file. Press the **Left** button to select the previous music file.

- **ID SET**

Press and hold the **Up** button for 5 seconds to complete **ID SET** (when connecting to a wireless subwoofer or wireless rear speakers).



10**i (Info)**

Press the button to display information about the current function. (See page 9.)

When connected to Dolby Atmos®, the LED indicator blinks cyan 3 times.

11**SOUND MODE**

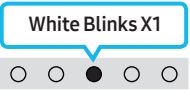
By pressing the button, you can select the desired audio mode. Each time the mode changes, the Multicolor LED blinks in white.

LED Indicator	
	<p>“Adaptive Sound” → “DTS Virtual:X” → “Music” → “Game” → “Standard”</p>

- **Adaptive Sound**

Analyzes the content in real time and automatically provides the optimal sound field based on the characteristics of the content.

- **DTS Virtual:X**

Immersive 3D sound from any content.

- **Music**

Provides more natural and room filling sound for music content.

- **Game**

Provides stereoscopic sound to immerse you in the action while gaming.

- **Standard**



Outputs the original sound.

12**WOOFER (BASS) LEVEL**

Push the button up or down to adjust the level of the woofer (bass) to -12 or between -6 to +6. To set the woofer (bass) volume level to 0 (Default), press the button.

13**TONE CONTROL**

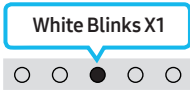

By pressing the button, you can adjust the volume of the treble or bass sound. The desired item can be adjusted using the **Up/Down** buttons. (This feature is available in all sound modes except “**Standard**” mode.)

LED Indicator	
	<p>“Treble” → “Bass”</p>

Active Voice Amplifier (AVA)

- Analyzes external noise in real time while soundbar is playing, so that voice audio can always be heard clearly.
- No data is saved during the analysis.

Using the Hidden Buttons (Buttons with more than one function)

Hidden Button		Reference page
Remote Control Button	Function	
WOOFER (Up)	TV remote control On/Off (Standby)	page 18
Up	ID SET	page 15
 (Sound Control)	7 Band EQ	page 14
 (Source)	Audio Feedback On/Off (Standby)	page 12

Output specifications for the different sound effect modes

Effect	Input	Output	
		With Subwoofer Only	With Subwoofer & Wireless Rear Speaker Kit
Adaptive Sound	2.0 ch	5.1 ch	7.1 ch
	5.1 ch	5.1 ch	7.1 ch
	Dolby Atmos®	5.1 ch	7.1 ch
DTS Virtual:X	2.0 ch	5.1 ch	7.1 ch
	5.1 ch	5.1 ch	7.1 ch
	Dolby Atmos®	5.1 ch	7.1 ch
Music	2.0 ch	5.1 ch	7.1 ch
	5.1 ch	5.1 ch	7.1 ch
	Dolby Atmos®	5.1 ch	7.1 ch
Game	2.0 ch	5.1 ch	7.1 ch
	5.1 ch	5.1 ch	7.1 ch
	Dolby Atmos®	5.1 ch	7.1 ch
Standard	2.0 ch	2.1 ch	2.1 ch
	5.1 ch	5.1 ch	5.1ch
	Dolby Atmos®	5.1 ch	7.1 ch

- The Samsung Wireless Rear Speaker Kit, and Subwoofer can be purchased separately. To purchase a Kit or the Subwoofer, contact the vendor you purchased the Soundbar from.
- When the input source is Dolby Atmos® the Subwoofer-only setup provides 5.1 channel audio, while the Subwoofer & Wireless Rear Speaker Kit setup provides 7.1 channel audio.

Adjusting the Soundbar volume with a TV remote control







Adjust the Soundbar volume using the TV's remote control.

- This function can be used with IR remote controls only. Bluetooth remote controls (remote controls that require pairing) are not supported.
- Set the TV speaker to **External Speaker** to use this function.
- Manufacturers supporting this function:
Samsung, VIZIO, LG, Sony, Sharp, PHILIPS, PANASONIC, TOSHIBA, Hisense, RCA

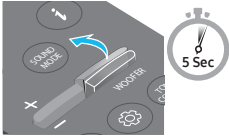
1. Turn Off the Soundbar.
2. Push up and hold the **WOOFER** button for 5 seconds.

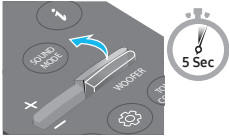
Each time you push the **WOOFER** button up and hold it for 5 seconds, the mode switches in the following order: "**Off-TV Remote**" (Default mode), "**Samsung-TV Remote**", "**All-TV Remote**".

The LED indicator status changes each time the mode is changed, as shown below.

Remote Control Button	LED Indicator	Status
	<p>Red Blinks X1</p>  <p>"Off-TV Remote" (Default mode)</p>	Disable the TV remote control.
	<p>Cyan Blinks X1</p>  <p>"Samsung-TV Remote"</p>	Enable a Samsung TV's IR remote control.
	<p>Blue Blinks X1</p>  <p>"All-TV Remote"</p>	Enable a third-party TV's IR remote control.

04 CONNECTING THE SOUNDBAR

Connecting Electrical Power

Use the power components to connect the Soundbar to an electrical outlet in the following order:

- For more information about the required electrical power and power consumption, refer to the label attached to the product. (Label: Bottom of the Soundbar Main Unit)

1. First connect the power cable to the AC/DC adapter.
Connect the AC/DC adapter (with the power cable) to the Soundbar.
2. Connect the power cord to a wall socket.

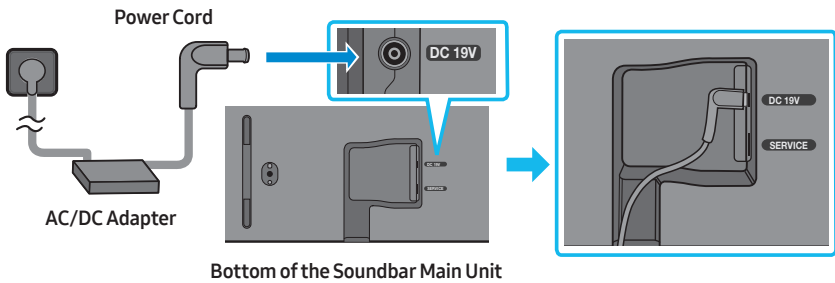

NOTES

- If you unplug and reconnect the power cord when the product is turned on, the Soundbar turns on automatically.
- Make sure to rest the AC/DC Adapter flat on a table or the floor. If you place the AC/DC Adapter so that it is hanging with the AC cord input facing upwards, water or other foreign substances could enter the Adapter and cause the Adapter to malfunction.

Connecting the Samsung Wireless Rear Kit and Subwoofer to your Soundbar

Expand to true wireless surround sound by connecting the Samsung Wireless Rear Speaker Kit (SWA-9100S or SWA-9200S, sold separately) and Wireless Subwoofer (SWA-W510, sold separately) to your Soundbar.

For detailed information on connections, see the Samsung Wireless Rear Speaker Kit and Wireless Subwoofer manual.

05 CONNECTING TO A TV

Connecting the TV that supports HDMI ARC (Audio Return Channel)

⚠ CAUTION

- When both the HDMI cable and optical cable are connected, the HDMI signal is received first.
- To connect the HDMI cable between the TV and Soundbar, be sure to connect the terminals marked ARC. Otherwise, the TV sound may not be output.
- The recommended cable is **High Speed HDMI Cable with Ethernet**.

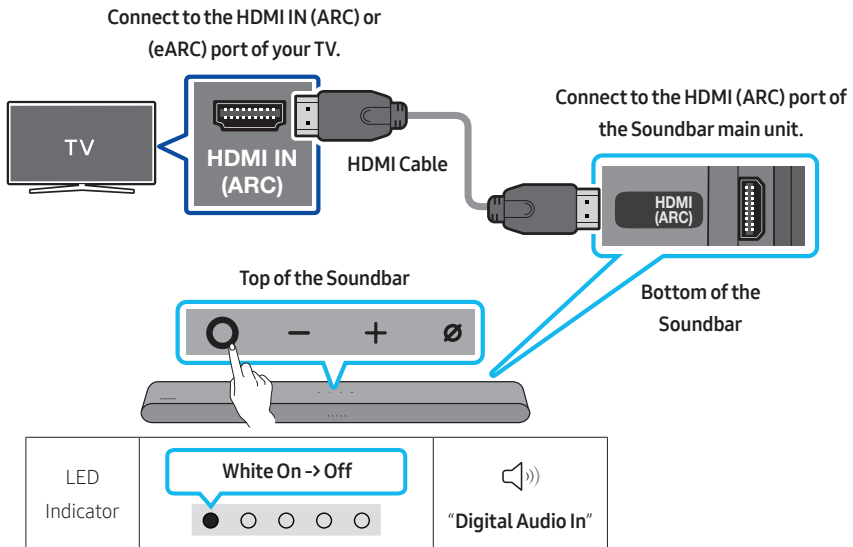

1. With the Soundbar and TV turned off, connect the HDMI cable as shown in the figure.
2. Turn on the Soundbar and TV.
3. TV sound is output from the Soundbar.
 - When the TV sound is not output, press the **○ (Multi Function)** button at the top of the Soundbar or the **📺 (Source)** button on the remote control to select the **"Digital Audio In"** mode.
 - When the sound is not output, check the HDMI Cable connection again.
 - Use the volume buttons on the TV's remote control to change the volume on the Soundbar.

NOTES

- When you connect the TV that supports the HDMI ARC (Audio Return Channel) to the Soundbar with an HDMI cable, you can transmit the digital video and audio data without connecting a separate optical cable.
- We recommend you use a coreless HDMI cable if possible. If you use a cored HDMI cable, use one whose diameter is less than 0.55 inches (14 mm).
- This function is not available if the HDMI cable does not support ARC.
- When the audio in a broadcast is encoded in Dolby Digital and the “Digital Output Audio Format” on your TV is set to PCM, we recommend that you change the setting to Dolby Digital. When the setting on the TV is changed, you will experience better sound quality. (The TV menu may use different words for Dolby Digital and PCM depending on the TV manufacturer.)

Connecting using an Optical Cable

Pre-connection Checklist

- When both the HDMI cable and optical cable are connected, the HDMI signal is received first.
- When you use an optical cable and the terminals have covers, be sure to remove the covers.

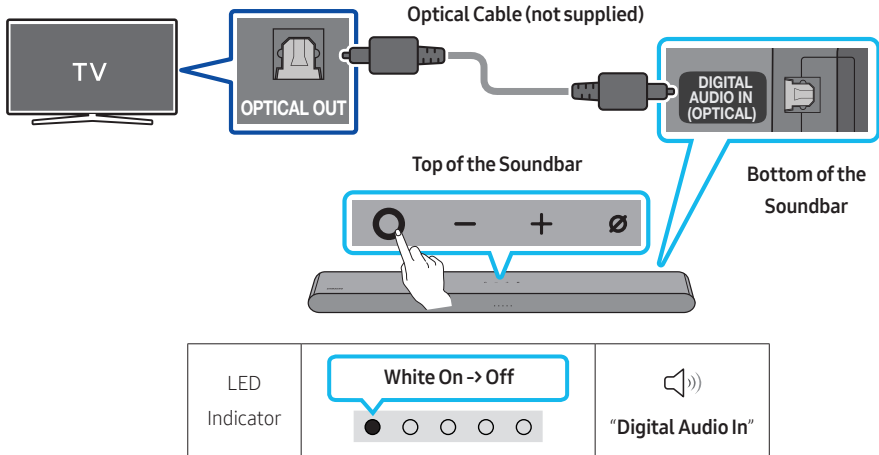

1. With the TV and Soundbar turned off, connect the **DIGITAL AUDIO IN (OPTICAL)** port on the Soundbar and the **OPTICAL** output port on the TV with the optical cable (not supplied), as shown in the figure.
2. Turn on the Soundbar and TV.
3. Press the **○ (Multi Function)** button at the top of the Soundbar or the **📡 (Source)** button on the remote control and then select the **"Digital Audio In"** mode. Then the announcement, **"Digital Audio In"** is output.
4. The TV sound is output from the Soundbar.



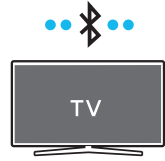

Connecting via Bluetooth

When a Samsung TV is connected using Bluetooth, you can hear stereo sound without the hassle of cabling.

- Only one Samsung TV can be connected at a time.
- Samsung TV that supports Bluetooth can be connected. Check the specifications of your TV.



The initial connection

<p>1. Bluetooth Pairing button</p>  <p>OR</p> <p>When in "Bluetooth" mode</p> 	<p>LED Indicator</p> <div data-bbox="420 478 744 598"><p>Red → Green → Blue Blinks</p><p>Pairing</p></div> <p>→</p> <div data-bbox="812 478 1024 598"><p>Cyan Blinks X3</p><p>Connection is complete</p></div> <ul style="list-style-type: none">• Until pairing is complete, the Multicolor LED changes as Red → Green → Blue in turn. <p> "Ready to connect via Bluetooth."</p>
--	--

2. Select Bluetooth mode on the Samsung TV.

(e.g. Home (🏠) → Menu → Settings (⚙️) → All Settings (⚙️) → Sound → Sound Output → Bluetooth Speaker List → [AV] Samsung Soundbar S60B / [AV] Samsung Soundbar S61B (Bluetooth))

3. Select "[AV] Samsung Soundbar S60B / [AV] Samsung Soundbar S61B" from the list on TV's screen.

An available Soundbar is indicated with **"Need Pairing"** or **"Paired"** on the TV's Bluetooth device list. To connect the Samsung TV to the Soundbar, select the message, and then establish a connection.

4. You can now hear Samsung TV sound from the Soundbar.

- If there is a connection log between the Soundbar and Samsung TV, the Soundbar is automatically connected by changing its mode to **"Bluetooth"**

If the device fails to connect

- If you have an existing Soundbar (e.g., **[AV] Samsung Soundbar S60B / [AV] Samsung Soundbar S61B**) on the list of speakers on the Samsung TV, delete it.
- Then repeat steps 1 through 3.

Disconnecting the Soundbar from the Samsung TV

Press the **○ (Multi Function)** button at the top of the Soundbar or the  **(Source)** button on the remote control to select the mode other than “**Bluetooth**”.

- Disconnecting takes time because the Samsung TV must receive a response from the Soundbar. (The time required may differ, depending on the Samsung TV model.)

Notes on Bluetooth connection

- Locate a new device within 3.28 ft (1 m) to connect via Bluetooth communication.
- If asked for a PIN code when connecting a Bluetooth device, enter <0000>.
- The Soundbar automatically turns off after 18 minutes in the Ready state.
- The Soundbar may not perform Bluetooth search or connection correctly under the following circumstances:
 - If there is a strong electrical field around the Soundbar.
 - If several Bluetooth devices are simultaneously paired with the Soundbar.
 - If the Bluetooth device is turned off, not in place, or malfunctions.
- Electronic devices may cause radio interference. Devices that generate electromagnetic waves must be kept away from the Soundbar main unit - e.g., microwaves, wireless LAN devices, etc.

Connecting via Wi-Fi

Pre-connection Checklist

- Wi-Fi connection is available only on Samsung TV.
- Check whether **the wireless router (Wi-Fi)** is turned on and the **TV is connected to the router**.
- The TV and Soundbar must be connected to the same wireless network (Wi-Fi).
- If your wireless router (Wi-Fi) uses a DFS channel, you will not be able to establish a Wi-Fi connection between the TV and Soundbar. Contact your Internet service provider for details.
- Because the menus may differ depending on the year of manufacture, refer to your TV manual.
- To connect the TV to the Soundbar via Wi-Fi, connect the Soundbar to the wireless router first. See page 34, for details on how to establish a Wi-Fi connection.

1. For more information about Wi-Fi connection to the Soundbar, see page 34, "**Method 2.**

Connecting via Wi-Fi (Wireless Network)".

2. Change the input source of the TV by using the Audio menu to Soundbar.

- **Samsung TVs released in 2017 or later**

Home (🏠) → Menu → Settings (⚙️) → All Settings (⚙️) → Sound → Sound Output → [AV]

Samsung Soundbar S60B / [AV] Samsung Soundbar S61B (Wi-Fi)

Connecting to a TV that supports Dolby Atmos®

Pre-connection Checklist

- Dolby Atmos® is supported in "TV ARC" or "Wi-Fi" mode.
- Make sure that the content supports Dolby Atmos®.

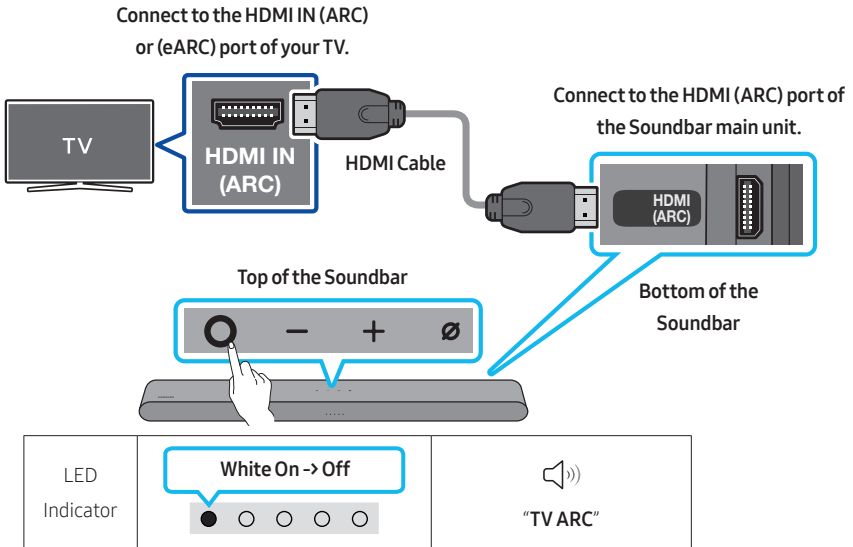

1. With the Soundbar and TV turned off, connect the HDMI cable as shown in the figure.
2. Turn on the Soundbar and TV.
3. TV sound is output from the Soundbar.

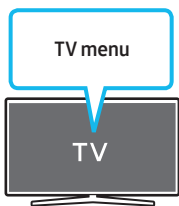

LED Indicator	A row of five circular indicators. The first two are filled black, and the last three are empty white. A speech bubble above them contains the text "White On -> Off".
A speaker icon with sound waves.	"Wi-Fi"

1. Connect the Soundbar and TV to the same wireless network (Wi-Fi).
2. For sound output of the TV, select Soundbar.
3. TV sound is output from the Soundbar.

NOTES

- **Configuring Dolby Atmos® on a BD player or other device connected to the TV.**

Open the audio output options on the settings menu of your BD player or other device and make sure that "No Encoding" is selected for Bitstream. For example, on a Samsung BD Player, go to Home Menu → Sound → Digital Output and then select Bitstream (unprocessed).

- **This function is available in some Samsung TVs and some Soundbar models.**

Using the Q-Symphony Function

For Q-Symphony, the Soundbar syncs with a Samsung TV to output sound through two devices for optimum surround effect. When the Soundbar is connected, the menu, “TV+Soundbar” appears under the **Sound Output** menu of the TV. Select the corresponding menu.

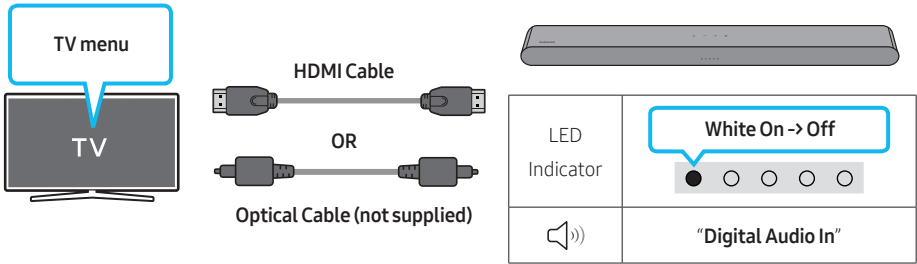

- TV menu example: **TV + [AV] Soundbar series name (HDMI)**

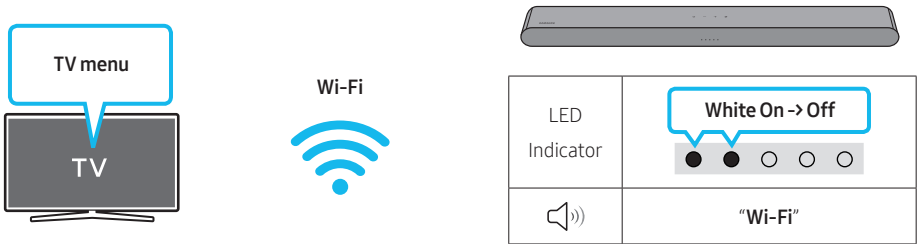

- TV menu example: **TV + [AV] Soundbar series name (Wi-Fi)**

NOTES

- It can operate according to the Codec supported by TV.
- This function is supported only when the HDMI Cable or Optical Cable (not supplied) or Wi-Fi is connected.
- The message displayed may differ with the TV model.
- Ensure that your TV and Soundbar are connected to the same wireless router/frequency.
- This function is available in some Samsung TVs and some Soundbar models.

Using the SpaceFit Sound

Provides optimized sound quality by analyzing the listening spaces.

Method 1. Connecting via Soundbar



To enable this function, turn on the SpaceFit Sound mode with the remote control of the Soundbar.

( (Sound Control) → "SpaceFit Sound Off" → ▲ (Up) → "SpaceFit Sound On")

- This is available in all Sound modes.

Method 2. Connecting via TV

To enable this function, turn on the **Adaptive Sound+** mode on your Samsung TV menu.

(Home () → Menu → Settings () → All Settings () → General → Intelligent Mode Settings → Adaptive Sound+)

- The sound mode on your Soundbar will automatically change to **Adaptive Sound+** if you enable the **Adaptive Sound+** mode on your TV.

NOTE

- This function works when the Soundbar connects to some of the Samsung TVs.

06 CONNECTING AN EXTERNAL DEVICE

Connecting using an Optical Cable

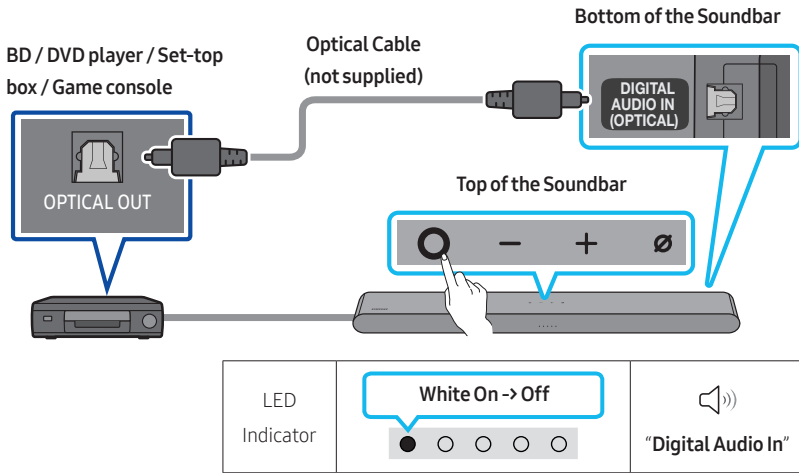

1. With the external device and Soundbar turned off, connect the **DIGITAL AUDIO IN (OPTICAL)** port on the Soundbar and the **OPTICAL** output port on the external device with the optical cable (not supplied), as shown in the figure.
2. Turn on the Soundbar and external device.
3. Press the **○ (Multi Function)** button at the top of the Soundbar or the **📡 (Source)** button on the remote control and then select the **"Digital Audio In"** mode. Then the announcement, **"Digital Audio In"** is output.
4. The external device sound is output from the Soundbar.

07 CONNECTING A MOBILE DEVICE

Method 1. Connecting via Bluetooth

When a mobile device is connected using Bluetooth, you can hear stereo sound without the hassle of cabling.





- When you connect a paired Bluetooth device with the Soundbar off, the Soundbar automatically turns on.



mobile device

The initial connection

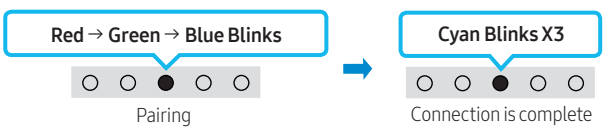
- When connecting to a new Bluetooth device, make sure the device is within 3.28 ft (1 m) distance.

1. Bluetooth Pairing button	LED Indicator
 <p>OR</p> <p>When in "Bluetooth" mode</p> 	 <p>Red → Green → Blue Blinks</p> <p>Pairing</p> <p>→</p> <p>Cyan Blinks X3</p> <p>Connection is complete</p> <ul style="list-style-type: none">• Until pairing is complete, the Multicolor LED changes as Red → Green → Blue in turn. <p> "Ready to connect via Bluetooth."</p>

2. On your device, select "[AV] Samsung Soundbar S60B / [AV] Samsung Soundbar S61B" from the list that appears.
3. Play music files from the device connected via Bluetooth through the Soundbar.

If the device fails to connect

- If you have an existing Soundbar (e.g., [AV] Samsung Soundbar S60B / [AV] Samsung Soundbar S61B) on the list of speakers on the Mobile device, delete it.
- Then repeat steps 1 and 2.

Notes on Bluetooth connection

- Locate a new device within 3.28 ft (1 m) to connect via Bluetooth communication.
- If asked for a PIN code when connecting a Bluetooth device, enter <0000>.
- The Soundbar automatically turns off after 18 minutes in the Ready state.
- The Soundbar may not perform Bluetooth search or connection correctly under the following circumstances:
 - If there is a strong electrical field around the Soundbar.
 - If several Bluetooth devices are simultaneously paired with the Soundbar.
 - If the Bluetooth device is turned off, not in place, or malfunctions.
- Electronic devices may cause radio interference. Devices that generate electromagnetic waves must be kept away from the Soundbar main unit - e.g., microwaves, wireless LAN devices, etc.
- The Soundbar supports SBC data (44.1kHz, 48kHz).
- Connect only to a Bluetooth device that supports the A2DP (AV) function.
- You cannot connect the Soundbar to a Bluetooth device that supports only the HF (Hands Free) function.
- When connecting the Soundbar to a Bluetooth device, place them as close to each other as possible.
- The farther the Soundbar and Bluetooth device are from each other, the lower the sound quality will become.

The Bluetooth connection may break when the devices are out of the effective range.

- The Bluetooth connection may not function as intended in areas with poor reception.
- A Bluetooth device may experience noise or malfunction under in the following conditions:
 - When the body is in contact with the signal transceiver on the Bluetooth device or Soundbar
 - In corners or when there is an obstacle in proximity, such as a wall or partition, where electrical changes may occur.
 - When exposed to radio interferences by other products operating on the same frequency ranges, such as medical equipment, microwave ovens, and wireless LAN devices.
 - Obstacles such as doors and walls may still impact the sound quality even when the devices are within the effective range.
- Note that your Soundbar cannot be paired with other Bluetooth devices while using the Bluetooth option.
- This wireless device may cause electrical interference during operation.

Disconnecting the Bluetooth device from a Soundbar

You can disconnect a Bluetooth device from the Soundbar. For instructions, see the Bluetooth device's user manual.

- The Soundbar will be disconnected.
- If the Soundbar is disconnected from the Bluetooth device, the multicolor LED indicator on the Soundbar blinks "**Red**" three times.

Disconnecting the Soundbar from the Bluetooth device

Press the  (**Multi Function**) button at the top of the Soundbar or the  (**Source**) button on the remote control to select the mode other than "**Bluetooth**".

- Disconnecting takes time because the Bluetooth device must receive a response from the Soundbar. (Disconnection time may differ, depending on the Bluetooth device)

Method 2. Connecting via Wi-Fi (Wireless Network)

To connect a Soundbar to a mobile device via a wireless network (Wi-Fi), the **SmartThings** app is required.

The initial connection

1. Install and launch the **SmartThings** app from your mobile device (smartphone or tablet).
2. On the app, follow the screen instructions to add the Soundbar.
 - The automatic pop-up (the second screenshot below) may not show on some devices. If the pop-up window does not appear, press “+” on the **Home** screen. The Soundbar is added to the app.
 - The illustration below may differ according to the app version.

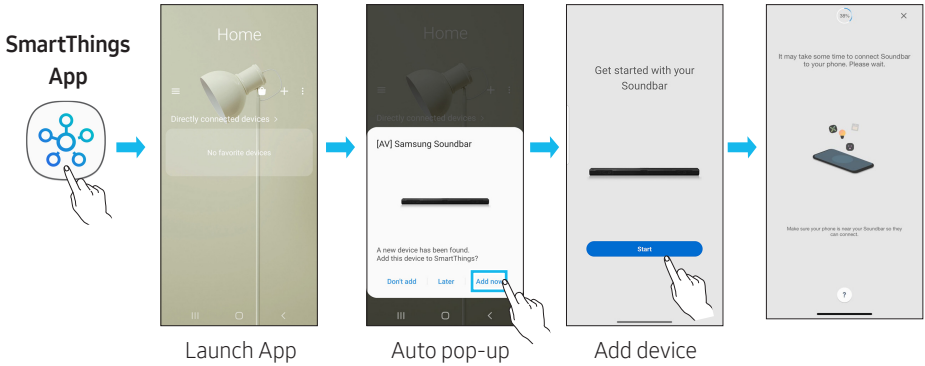

Using the Tap Sound

Tap the Soundbar with your mobile device to play audio from the mobile device through the Soundbar.

- This function may not be supported, depending on the mobile device.
- This function is only compatible with Samsung mobile devices with Android 8.1 or later.

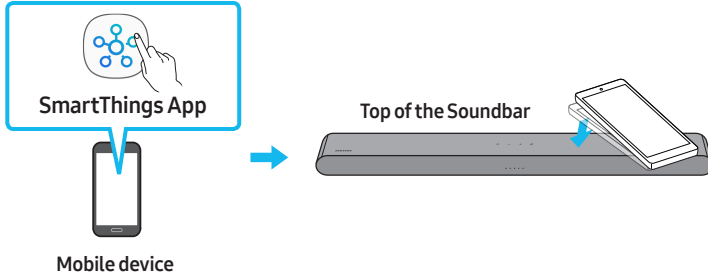

1. Turn on the **Tap Sound** function on your mobile device.
 - For details on how to turn on the function, refer to “**Enable the Tap Sound function**” below.
2. Tap the Soundbar with the mobile device. Select “**Start now**” in the displayed message window. A connection is established between the mobile device and Soundbar via Bluetooth.
3. Play audio from the mobile device through the Soundbar.
 - This function connects a mobile device to the Soundbar via Bluetooth by detecting vibration that occurs when the device touches the Soundbar.
 - Make sure the mobile device does not tap a sharp corner of the Soundbar. The Soundbar or mobile device may become scratched or damaged.
 - It is recommended that the mobile device be covered with a case. Lightly tap the wide area in the upper portion of the Soundbar, without using excessive force.
 - To use this function, update the **SmartThings** app to the latest version. The function may not be supported, depending on the app version.

Enable the Tap Sound function

Use the **SmartThings** app to turn on the **Tap View, Tap Sound** function.

1. On the mobile device, run the **SmartThings** app.
2. Select (☰ → ⚙) in the **SmartThings** app screen displayed on the mobile device.
3. Set “**Tap View, Tap Sound**” to On to allow the function to work when a mobile device moves close to the Soundbar.

NOTES

- When the mobile device is in power-saving mode, the **Tap Sound** function does not work.
- The **Tap Sound** function may not work if there are devices near the Soundbar that cause radio interference such as electric devices. Make sure devices that may cause radio interference are placed at a sufficient distance away from the Soundbar.

08 CONNECTING VIA APPLE AIRPLAY 2

- This feature may not be available in some countries.
- This Samsung Soundbar supports AirPlay 2 and requires iOS 11.4 or later.

With AirPlay 2, you can stream music, podcasts, and other audio from your Apple devices to the Samsung Soundbar.

- Make sure the Soundbar is powered on and connected to the same Wi-Fi network as your Apple device.
- Select  from an AirPlay-supported app or Control Center on your iPhone, iPad, or Mac.
- Select the Soundbar from the list of available devices to play the current audio to.

09 INSTALLING THE WALL MOUNT

Installation Precautions

- Install on a vertical wall only.
- Do not install in a place with high temperature or humidity.
- Verify whether the wall is strong enough to support the product's weight. If not, reinforce the wall or choose another installation point.
- Purchase and use the fixing screws or anchors appropriate for the kind of wall you have (plaster board, iron board, wood, etc.). If possible, fix the support screws into wall studs.
- Purchase wall mounting screws according to the type and thickness of the wall you want to mount the Soundbar on.
 - Diameter: M5
 - Length: 1 3/8 inches (35 mm) or longer recommended.
- Connect cables from the unit to external devices before you install the Soundbar on the wall.
- Make sure the unit is turned off and unplugged from the power source before you install it. Otherwise, it may cause an electric shock.

Wallmount Components



Wall Mount Guide (AH81-15186A)



Holder-Screw
(AH61-04110A)

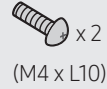

Screw
(6001-001202)



Bracket-Wall Mount (AH61-04235A)

1. Place the **Wall Mount Guide** against the wall surface.
 - The **Wall Mount Guide** must be level.
 - If your TV is mounted on the wall, install the Soundbar at least 2 inches (5 cm) below the TV.



2 inches (5 cm) or more

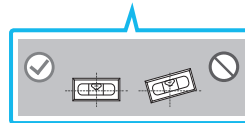

2. Align the **Wall Mount Guide's Center Line** with the center of your TV (if you are mounting the Soundbar below your TV), and then fix the **Wall Mount Guide** to the wall using tape.

- If you are not mounting below a TV, place the **Center Line** in the center of the installation area.

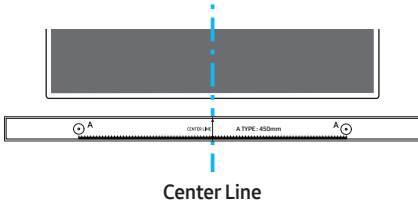

3. Use a pen to mark the positions of the holes and remove the **Wall Mount Guide**.

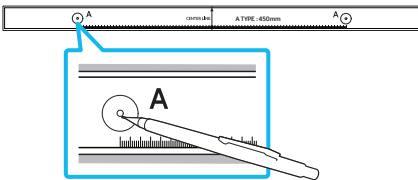

4. Using an appropriately sized drill bit, drill a hole in the wall at each marking.

- If the markings do not correspond to the positions of studs, make sure you insert appropriate anchors into the holes before you insert the support screws. If you use anchors, make sure the holes you drill are large enough for the anchors you use.

5. Push a screw (not supplied) through each **Holder-Screw**, and then screw each screw firmly into a support screw hole.

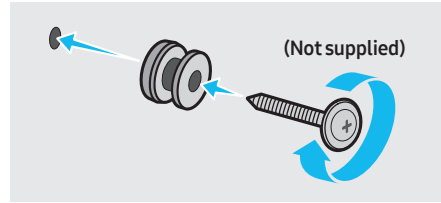

6. Install the 2 **Bracket-Wall Mounts** in the correct orientation on the bottom of the Soundbar using 2 **Screws**.

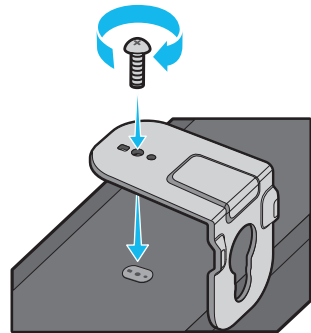

• When assembling, make sure the hanger part of the **Bracket-Wall Mounts** are located behind the rear of the Soundbar.

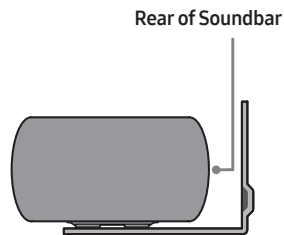

Right end of Soundbar

• The actual product may look different from the above image, depending on the model.

7. Install the Soundbar with the attached **Bracket-Wall Mounts** by hanging the **Bracket-Wall Mounts** on the **Holder-Screws** on the wall.

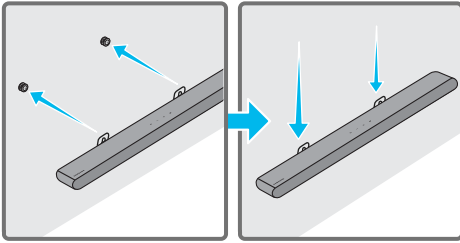

8. Slide the Soundbar down as shown below so that the **Bracket-Wall Mounts** rest securely on the **Holder-Screws**.

- Insert the **Holder-Screws** into the wide (bottom) part of the **Bracket-Wall Mounts**, and then slide the **Bracket-Wall Mounts** down so that the **Bracket-Wall Mounts** rest securely on the **Holder-Screws**.

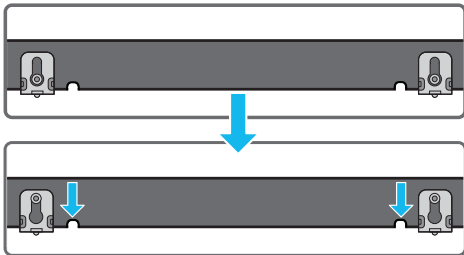

10 INSTALLING THE SOUNDBAR IN FRONT OF TV

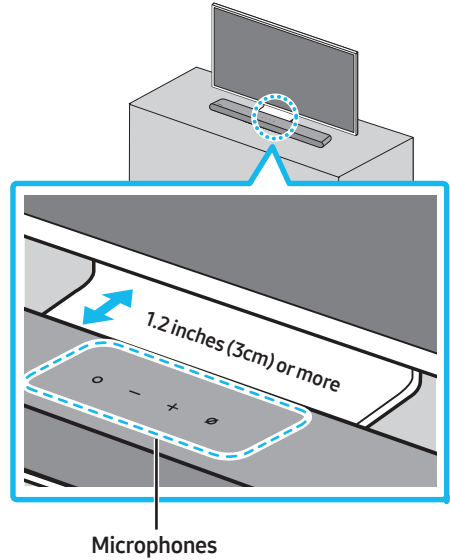

Align the center of the Soundbar to the center of the TV as illustrated in the image. At this time, place the Soundbar at least 1.2 inches (3cm) away from the TV so that there is no interference with voice recognition.

NOTES

- Make sure the Soundbar is placed on a flat and solid surface.
- Insufficient gap from the TV may cause voice recognition and acoustic problems.

11 SOFTWARE UPDATE

Auto Update

When the Soundbar is connected to the Internet, software updates automatically occur even when the Soundbar is turned off.

- To use the Auto Update function, the Soundbar must be connected to the Internet. The Wi-Fi connection to the Soundbar will be terminated if the Soundbar's power cord is disconnected or the power is cut off. If the power is cut off, when the power comes back on or you reconnect the power cord, turn on the Soundbar, and then reconnect it to the Internet.

USB Update

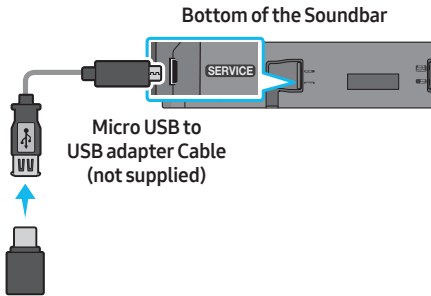

Samsung may offer updates for the Soundbar's system firmware in the future.

When an update is available, you can update the Soundbar by connecting the USB drive that contains the update firmware to the **SERVICE** port of the Soundbar.

- Go to (www.samsung.com) → search for the model name from the customer support menu option.
 - For more information about update, refer to Upgrade Guide.
- Download the upgrade file (USB type).
- Unzip the file to create a folder with the file name.
- Store the created folder in a USB and then connect it to the Soundbar.
- Turn on the Soundbar. Then the product is updated within 3 minutes.

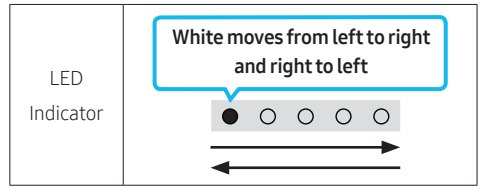

- During update, do not turn it off or remove the USB.
- If the yellow LED is on after the software update is completed, this means that an additional update is in progress. When this happens, don't turn off the power or remove the USB.
- If update does not proceed, reconnect the Soundbar power cord.
- When the latest version is installed, no update is performed.
- Depending on the USB type, update may not be supported.
- If there is no update file available

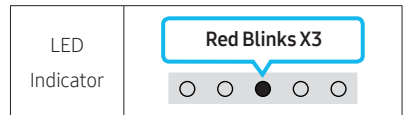

- If the update file is for the same version or lower

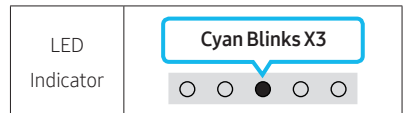

Reset

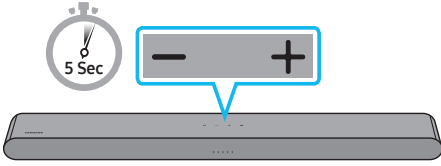

With the Soundbar on, press the **- + (Volume)** buttons on the body at the same time for at least 5 seconds. The LED display changes as shown below and then the Soundbar is reset.

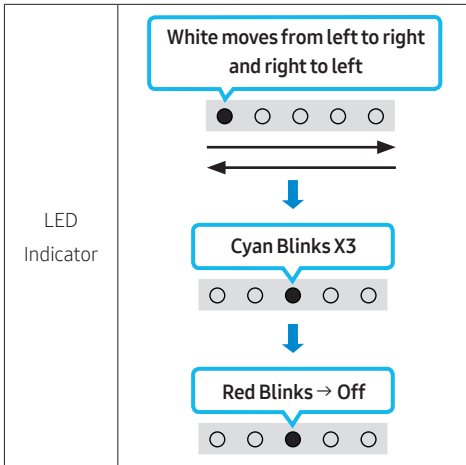

CAUTION

- All the settings of the Soundbar are reset. Be sure to perform this only when a reset is required.

12 TROUBLESHOOTING

Refer to the instructions below if this product does not function properly. If the problem you are experiencing is not listed below or if the instructions below do not help, turn off the product, disconnect the power cord, and contact Samsung Electronics at 1-800-SAMSUNG (1-800-726-7864).

Soundbar does not turn on.

- Check whether the power cord of the Soundbar is correctly inserted into the outlet.

Soundbar works erratically.

- After removing the power cord, insert it again.
- Power cycle the external device and try again.
- If there is no signal, the Soundbar automatically turns off after a certain period of time. Turn on the power. (See page 12.)

Remote control does not work.

- Point the remote directly at the Soundbar.
- Replace the batteries with new ones.

The red LED indicator light on the soundbar stays on.

- The microphone is turned off. Turn on the microphone. (See page 10.)

The Soundbar does not output any sound.

- The volume of the Soundbar is too low or muted. Adjust the volume.
- When any external device (STB, Bluetooth device, mobile device, etc.) is connected, adjust the volume of the external device.
- For sound output of the TV, select Soundbar. (Samsung TV: Home (🏠) → Menu → Settings (⚙️) → All Settings (⚙️) → Sound → Sound Output → Select Soundbar)

- The cable connection to the Soundbar may not be loose. Remove the cable and connect again.
- Remove the power cord completely, reconnect, and turn the power on.
- Reset the product and try again. (See page 41.)





If the TV is not connected via HDMI (ARC).

- Check whether the HDMI cable is correctly connected to the ARC terminal. (See page 20)
- Connection may not be possible due to the connected external device (set-top box, game console, etc.). Directly connect the Soundbar.
- HDMI-CEC may not be activated on the TV. Turn on the CEC on the TV menu. (Samsung TV: Home (🏠) → Menu → Settings (⚙️) → All Settings (⚙️) → Connection → External Device Manager → Anynet+ (HDMI-CEC ON))

There is no sound in when connecting to the TV in HDMI (ARC) mode.

- Your device is unable to play the input signal. Change the TV's audio output to PCM or Dolby Digital. (For a Samsung TV: Home (🏠) → Menu → Settings (⚙️) → All Settings (⚙️) → Sound → Expert Settings → Digital Output Audio Format)

The Soundbar will not connect via Bluetooth.

- When connecting a new device, switch to Bluetooth Pairing for connection. (Press the  PAIR button on the remote control or press the  (Mic On/Off) button on the body for at least 5 seconds.)
- If the Soundbar is connected to another device, disconnect that device first to switch the device.
- Reconnect it after removing the Bluetooth speaker list on the device to connect. (Samsung TV: Home () → Menu → Settings () → All Settings () → Sound → Sound Output → Bluetooth Speaker List)
- Remove and reconnect the power plug, then try again.
- Reset the product and try again. (See page 41.)

The sound drops out when connected via Bluetooth.

- Some devices can cause radio interference if they are located too close to the Soundbar. e. g. microwaves, wireless routers, etc.
- If your device that is connected via Bluetooth moves too far away from the Soundbar, it may cause the sound to drop out. Move the device closer to the Soundbar.
- If a part of your body is in contact with the Bluetooth transceiver or the product is installed on metal furniture, the sound may drop out. Check the installation environment and conditions for use.

Unable to connect to Wi-Fi.

- Check whether your wireless router is on.
- Turn off the router, turn it back on, and then try again.
- The Soundbar will not connect if the wireless signal is too weak. Try moving the router closer to the Soundbar, or eliminating any obstacles that are between the Soundbar and the router, if possible.
- If your wireless router is new, you will need to reconfigure the speaker's network settings.

The Soundbar does not turn on automatically with the TV.

- When you turn off the Soundbar while watching TV, power synchronization with the TV is disabled. First turn off the TV.

The AVA function is not available in the following cases.

- The AVA function will not be available using Q-Symphony function.
- The AVA function will not be available when the microphone is turned off.

After connecting the TV to the Soundbar, I switched the Soundbar mode. Then no sound is output from the TV.

- If you connect your Soundbar to a mobile device while the Soundbar is connected to the TV, the Soundbar outputs sound from the mobile device while keeping the TV connection. So the TV sound will not be delivered anywhere.
- Disconnect the mobile device, and the TV sound will be output from the Soundbar again.

13 LICENSE



Dolby, Dolby Atmos, and the double-D symbol are registered trademarks of Dolby Laboratories Licensing Corporation. Manufactured under license from Dolby Laboratories. Confidential unpublished works. Copyright © 2012-2021 Dolby Laboratories. All rights reserved.



For DTS patents, see <http://patents.dts.com>. Manufactured under license from DTS, Inc. (for companies headquartered in the U.S./Japan/Taiwan) or under license from DTS Licensing Limited (for all other companies). DTS, Digital Surround, Virtual:X, and the DTS logo are registered trademarks or trademarks of DTS, Inc. in the United States and other countries. © 2021 DTS, Inc. ALL RIGHTS RESERVED.



The terms HDMI and HDMI High-Definition Multimedia Interface, and the HDMI Logo are trademarks or registered trademarks of HDMI Licensing Administrator, Inc. in the United States and other countries.



- Use your phone, tablet or computer as a remote control for Spotify. Go to spotify.com/connect to learn how
 - The Spotify Software is subject to third party licenses found here : <https://www.spotify.com/connect/third-party-licenses>.
-



- Apple, Airplay, iPhone, iPad, and Mac are trademarks of Apple Inc., registered in the U.S. and other countries.
 - Use of the Works with Apple badge means that an accessory has been designed to work specifically with the technology identified in the badge and has been certified by the developer to meet Apple performance standards.
-



[ENERGY STAR]

ENERGY STAR qualified model only

- Your Samsung product is ENERGY STAR qualified in its factory default setting. Change to certain features, settings and functionality in this product can change the power consumption, possibly beyond the limits required for ENERGY STAR qualification.
- Environmental Protection Agency and Department of Energy. ENERGY STAR is a joint program of the Government agencies, designed to promote energy efficient products and practices.

Refer to www.energystar.gov for more information of the ENERGY STAR Program.

ENERGY STAR qualified model only (Applicable to Thin Client models only)

As an ENERGY STAR® Partner, SAMSUNG has determined that this product meets the ENERGY STAR® guidelines for energy efficiency.

- The ENERGY STAR Program has been to reduced greenhouse gas emissions and save energy through voluntary labeling.
- Power management setting of this product have been enabled by default, and have various timing setting from 1 minutes to 5 hours.
- The product can wake with a button press on the chassis from sleep mode.

ENERGY STAR qualified model only (The other models)

- As an ENERGY STAR Partner, Samsung has determined that this product or product models meets the ENERGY STAR guideline for energy efficiency.
-

14 OPEN SOURCE LICENSE NOTICE

To send inquiries and requests for questions regarding open sources, contact Samsung Open Source (<http://opensource.samsung.com>)

15 IMPORTANT NOTES ABOUT SERVICE

- Figures and illustrations in this User Manual are provided for reference only and may differ from actual product appearance.
- An administration fee may be charged if either:
 - a. An engineer is called out to your home at your request and there is no defect in the product.
 - b. You bring the unit to a repair center and there is no defect in the product.
- You will be advised of the amount of the administration fee before any work is done or a home visit is made.
- If you have a problem with this product, we strongly recommend you read the appropriate section of this manual, visit the Support page for your product at www.samsung.com, or call Samsung Product Support (1-800-726-7864) to find an answer before you contact a service center for a repair.

16 SPECIFICATIONS AND GUIDE

Specifications

Model Name	HW-S60B / HW-S61B
Weight	6.0 lbs (2.7 kg)
Dimensions (W x H x D)	26.4 x 2.4 x 4.1 inches (670.0 x 62.0 x 105.0 mm)
Operating Temperature Range	+41°F to +95°F (+5°C to +35°C)
Operating Humidity Range	10 % ~ 75 %
AMPLIFIER Rated Output power	(30W x 2) + (30W x 2) + (30W x 2) + 20W
Supported play formats	Dolby 5.1ch / Dolby Digital Plus / Dolby ATMOS (Dolby Digital Plus) / DTS 5.1ch / LPCM 2ch

NOTES

- Samsung Electronics Co., Ltd reserves the right to change the specifications without notice.
- Weight and dimensions are approximate.

Precaution : The Soundbar will restart automatically if you turn on/turn off Wi-Fi.

Wi-Fi Port deactivation method	Press the CH LEVEL button on the remote control of the Soundbar for 30 seconds to turn Wi-Fi On / Off.
Bluetooth Port deactivation method	Press the TONE CONTROL button on the remote control of the Soundbar for 30 seconds to turn Bluetooth On / Off.

LIMITED WARRANTY TO ORIGINAL PURCHASER

This SAMSUNG brand product, as supplied and distributed by SAMSUNG and delivered new, in the original carton to the original consumer purchaser, is warranted by SAMSUNG against manufacturing defects in materials and workmanship for a limited warranty period of:

One (1) Year Parts and Labor* **(*90 Days Parts and Labor for Commercial Use)**

This limited warranty begins on the original date of purchase, and is valid only on products purchased and used in the United States. To receive warranty service, the purchaser must contact SAMSUNG for problem determination and service procedures. Warranty service can only be performed by a SAMSUNG authorized service center. The original dated bill of sale must be presented upon request as proof of purchase to SAMSUNG or SAMSUNG's authorized service center. Transportation of the product to and from the service center is the responsibility of the purchaser. SAMSUNG will repair or replace this product, at our option and at no charge as stipulated herein, with new or reconditioned parts or products if found to be defective during the limited warranty period specified above. All replaced parts and products become the property of SAMSUNG and must be returned to SAMSUNG. Replacement parts and products assume the remaining original warranty, or ninety (90) days, whichever is longer. SAMSUNG's obligations with respect to software products distributed by SAMSUNG under the SAMSUNG brand name are set forth in the applicable end user license agreement. Non-SAMSUNG hardware and software products, if provided, are on an "AS IS" basis.

Non-SAMSUNG manufacturers, suppliers, publishers, and service providers may provide their own warranties. This limited warranty covers manufacturing defects in materials and workmanship encountered in normal, and except to the extent otherwise expressly provided for in this statement, noncommercial use of this product, and shall not apply to the following, including, but not limited to: damage which occurs in shipment; delivery and installation; applications and uses for which this product was not intended; altered product or serial numbers; cosmetic damage or exterior finish; accidents, abuse, neglect, fire, water, lightning or other acts of nature; use of products, equipment, systems, utilities, services, parts, supplies, accessories, applications, installations, repairs, external wiring or connectors not supplied and authorized by SAMSUNG, or which damage this product or result in service problems; incorrect electrical line voltage, fluctuations and surges; customer adjustments and failure to follow operating instructions, cleaning, maintenance and environmental instructions that are covered and prescribed in the instruction book; product removal or reinstallation; reception problems and distortion related to noise, echo, interference or other signal transmission and delivery problems. SAMSUNG does not warrant uninterrupted or error-free operation of the product.

THERE ARE NO EXPRESS WARRANTIES OTHER THAN THOSE LISTED AND DESCRIBED ABOVE, AND NO WARRANTIES WHETHER EXPRESS OR IMPLIED, INCLUDING, BUT NOT LIMITED TO, ANY IMPLIED WARRANTIES OF MERCHANTABILITY OR FITNESS FOR A PARTICULAR PURPOSE, SHALL APPLY AFTER THE EXPRESS WARRANTY PERIODS STATED ABOVE, AND NO OTHER EXPRESS WARRANTY OR GUARANTY GIVEN BY ANY PERSON, FIRM OR CORPORATION WITH RESPECT TO THIS PRODUCT SHALL BE BINDING ON SAMSUNG. SAMSUNG SHALL NOT BE LIABLE FOR LOSS OF REVENUE OR PROFITS, FAILURE TO REALIZE SAVINGS OR OTHER BENEFITS, OR ANY OTHER SPECIAL, INCIDENTAL OR CONSEQUENTIAL DAMAGES CAUSED BY THE USE, MISUSE OR INABILITY TO USE THIS PRODUCT, REGARDLESS OF THE LEGAL THEORY ON WHICH THE CLAIM IS BASED, AND EVEN IF SAMSUNG HAS BEEN ADVISED OF THE POSSIBILITY OF SUCH DAMAGES. NOR SHALL RECOVERY OF ANY KIND AGAINST SAMSUNG BE GREATER IN AMOUNT THAN THE PURCHASE PRICE OF THE PRODUCT SOLD BY SAMSUNG AND CAUSING THE ALLEGED DAMAGE. WITHOUT LIMITING THE FOREGOING, PURCHASER ASSUMES ALL RISK AND LIABILITY FOR LOSS, DAMAGE OR INJURY TO PURCHASER AND PURCHASER'S PROPERTY AND TO OTHERS AND THEIR PROPERTY ARISING OUT OF THE USE, MISUSE OR INABILITY TO USE THIS PRODUCT SOLD BY SAMSUNG NOT CAUSED DIRECTLY BY THE NEGLIGENCE OF SAMSUNG. THIS LIMITED WARRANTY SHALL NOT EXTEND TO ANYONE OTHER THAN THE ORIGINAL PURCHASER OF THIS PRODUCT, IS NONTRANSFERABLE AND STATES YOUR EXCLUSIVE REMEDY.

Some states do not allow limitations on how long an implied warranty lasts, or the exclusion or limitation of incidental or consequential damages, so the above limitations or exclusions may not apply to you. This warranty gives you specific legal rights, and you may also have other rights which vary from state to state.

To obtain warranty service, please contact SAMSUNG customer care center.

The benefits of this Limited Warranty extend only to the original purchaser of Samsung products from an authorized Samsung reseller. THIS LIMITED WARRANTY SHALL NOT APPLY TO ANY SAMSUNG PRODUCTS PURCHASED FROM UNAUTHORIZED RESELLERS OR RETAILERS, EXCEPT IN STATES WHERE SUCH RESTRICTION MAY BE PROHIBITED. For a list of Samsung authorized retailers, please go to:

http://www.samsung.com/us/peaceofmind/authorized_resellers.html.

SAMSUNG

QUESTIONS OR COMMENTS?

Country	Samsung Service Center 📞	Web Site	Address
IN THE US	1-800-SAMSUNG (726-7864)	www.samsung.com/us/support	Samsung Electronics America, Inc. 85 Challenger Road Ridgefield Park, NJ 07660

© 2022 Samsung Electronics Co., Ltd. All rights reserved.