

Latitude 5430 Rugged

Setup and Specifications

Notes, cautions, and warnings

 **NOTE:** A NOTE indicates important information that helps you make better use of your product.

 **CAUTION:** A CAUTION indicates either potential damage to hardware or loss of data and tells you how to avoid the problem.

 **WARNING:** A WARNING indicates a potential for property damage, personal injury, or death.

Chapter 1: Set up your Latitude 5430 Rugged.....	5
Chapter 2: Views of Latitude 5430 Rugged.....	7
Right.....	7
Left.....	7
Top.....	8
Front.....	9
Bottom.....	10
Back.....	10
Service Tag.....	11
Battery charge and status light	11
Chapter 3: Specifications of Latitude 5430 Rugged.....	12
Dimensions and weight.....	12
Processor.....	12
Chipset.....	13
Memory.....	13
External ports.....	13
Internal slots.....	14
Ethernet.....	14
Wireless module.....	15
WWAN module.....	15
Audio.....	16
Storage.....	16
Media-card reader.....	17
Keyboard.....	17
Camera (optional).....	18
Touchpad.....	18
Power adapter.....	19
Battery.....	19
Display.....	20
Fingerprint reader on the power button (optional).....	21
Sensor.....	21
GPU—Integrated.....	22
GPU—Discrete.....	22
Multiple display support matrix.....	22
Hardware security.....	22
Smart-card reader.....	23
Contacted smart-card reader.....	23
Contactless smart-card reader.....	24
Operating and storage environment.....	25
Chapter 4: Color, material, and finish	27

Chapter 5: Keyboard shortcuts of Latitude 5430 Rugged.....	28
Chapter 6: Getting help and contacting Dell.....	30

Set up your Latitude 5430 Rugged

About this task

NOTE: The images in this document may differ from your computer depending on the configuration you ordered.

Steps

1. Connect the power adapter and press the power button.



NOTE: To conserve battery power, the battery might enter power saving mode. Connect the power adapter and press the power button to turn on the computer.

2. Finish operating system setup.

For Ubuntu:

Follow the on-screen instructions to complete the setup. For more information about installing and configuring Ubuntu, see the knowledge base articles [SLN151664](#) and [SLN151748](#) at www.dell.com/support.





For Windows:

Follow the on-screen instructions to complete the setup. When setting up, Dell recommends that you:

- Connect to a network for Windows updates.
 - NOTE:** If connecting to a secured wireless network, enter the password for the wireless network access when prompted.
- If connected to the internet, sign-in with or create a Microsoft account. If not connected to the internet, create an offline account.
- On the **Support and Protection** screen, enter your contact details.

3. Locate and use Dell apps from the Windows Start menu—Recommended.

Table 1. Locate Dell apps

Resources	Description
	<p>Dell Product Registration Register your computer with Dell.</p>
	<p>Dell Help & Support Access help and support for your computer.</p>
	<p>SupportAssist SupportAssist is the smart technology that keeps your computer running at its best by optimizing settings, detecting issues, removing viruses and notifies when you need to make system updates. SupportAssist proactively checks the health of your system's hardware and software. When an issue is detected, the necessary system state information is sent to Dell to begin troubleshooting. SupportAssist is preinstalled on most of the Dell devices running Windows operating system. For more information, see SupportAssist for Home PCs User's Guide on www.dell.com/serviceabilitytools.</p> <p>NOTE: In SupportAssist, click the warranty expiry date to renew or upgrade your warranty.</p>
	<p>Dell Update Updates your computer with critical fixes and latest device drivers as they become available. For more information about using Dell Update, see the knowledge base article 000149088 at www.dell.com/support.</p>
	<p>Dell Digital Delivery Download software applications, which are purchased but not pre-installed on your computer. For more information about using Dell Digital Delivery, see the knowledge base article 000129837 at www.dell.com/support.</p>

Views of Latitude 5430 Rugged

Right

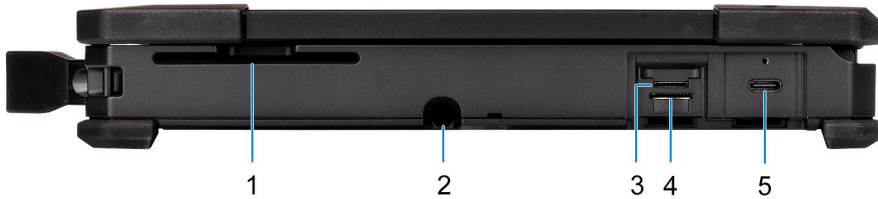

1. Smart-card reader slot (optional)
2. Stylus slot (optional)
3. Nano SIM card slot
4. microSD-card slot
5. Thunderbolt 4/USB 3.2 Gen 2 Type-C port with PowerDelivery 3.0 (optional)

Left



1. Thunderbolt 4/USB 3.2 Gen 2 Type-C port with Power Delivery 3.0
2. USB 3.2 Gen 1 port with PowerShare
3. USB 3.2 Gen 1 port
4. Headset (headphone and microphone combo) port

Top

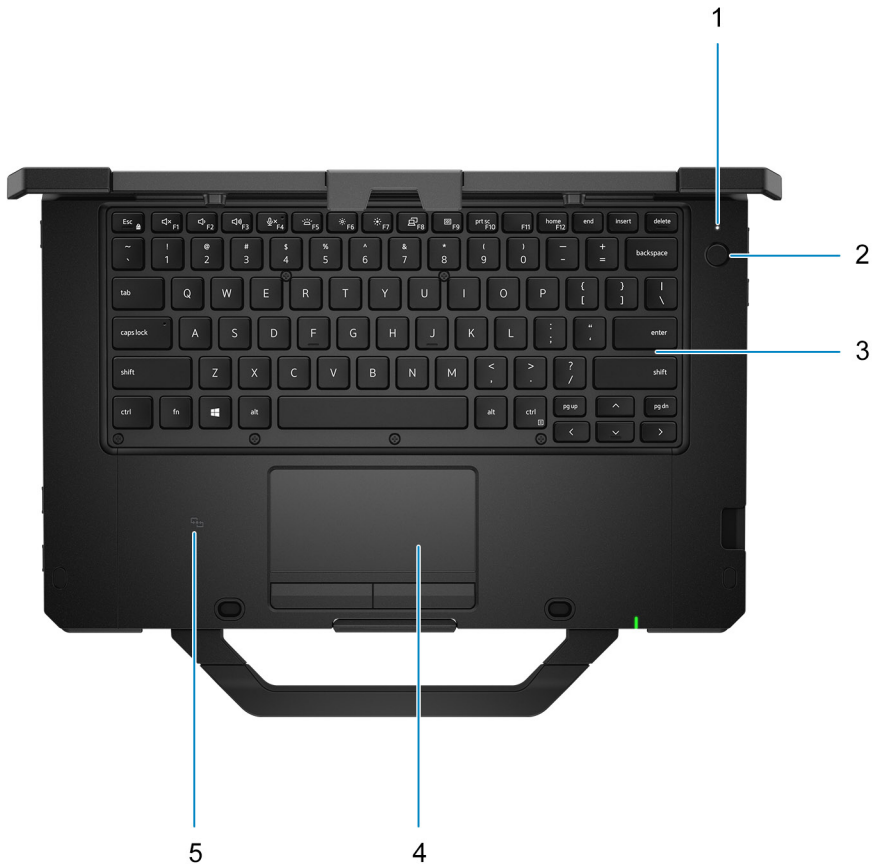

1. Power status light
2. Power button with optional fingerprint reader
3. Keyboard
4. Touchpad
5. Near Field Communication (NFC)

Front

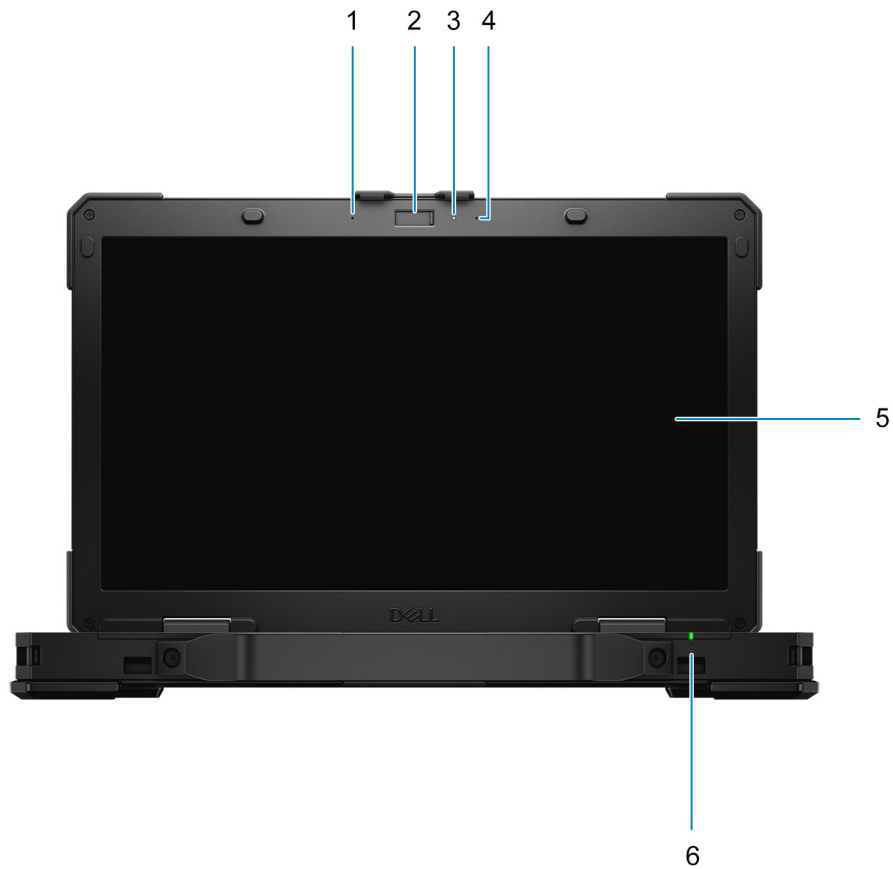

1. Microphone
2. Privacy shutter
3. LED/IR lens
4. Microphone
5. Display
6. Battery-status light/Diagnostic-status light

Bottom

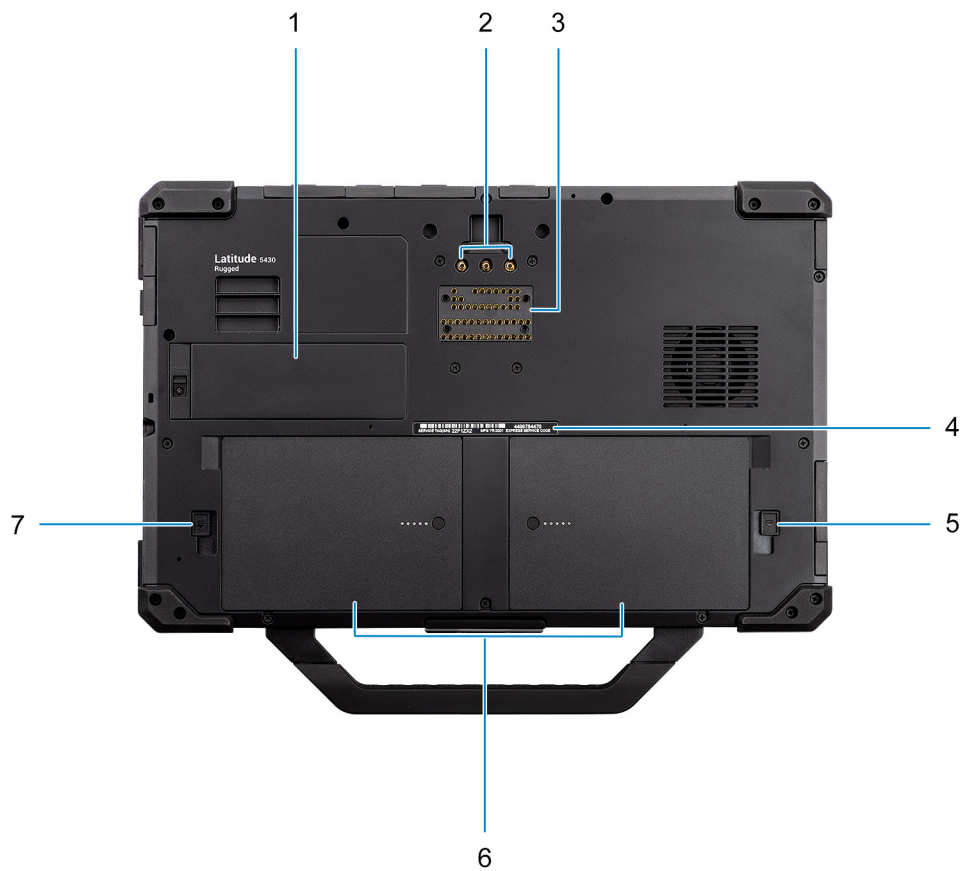

1. Solid-state drive door
2. Radio frequency pass-through connectors
3. Docking port
4. Service tag label
5. Battery 1 latch
6. Batteries
7. Battery 2 latch

Back

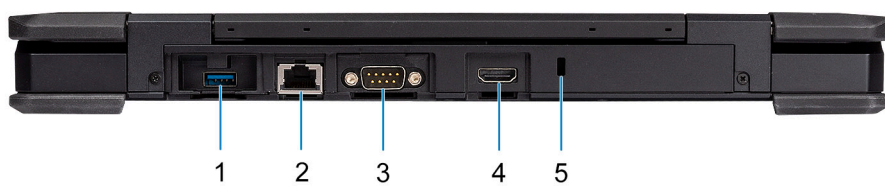

1. Optional I/O bay (RJ45/USB Type-A/Native Serial/Fischer USB 3.0 9-pin/Blank)
2. RJ45 Ethernet port
3. Serial RS-232 port

4. HDMI 2.0 port
5. Kensington lock slot

Service Tag

The service tag is a unique alphanumeric identifier that allows Dell service technicians to identify the hardware components in your computer and access warranty information.

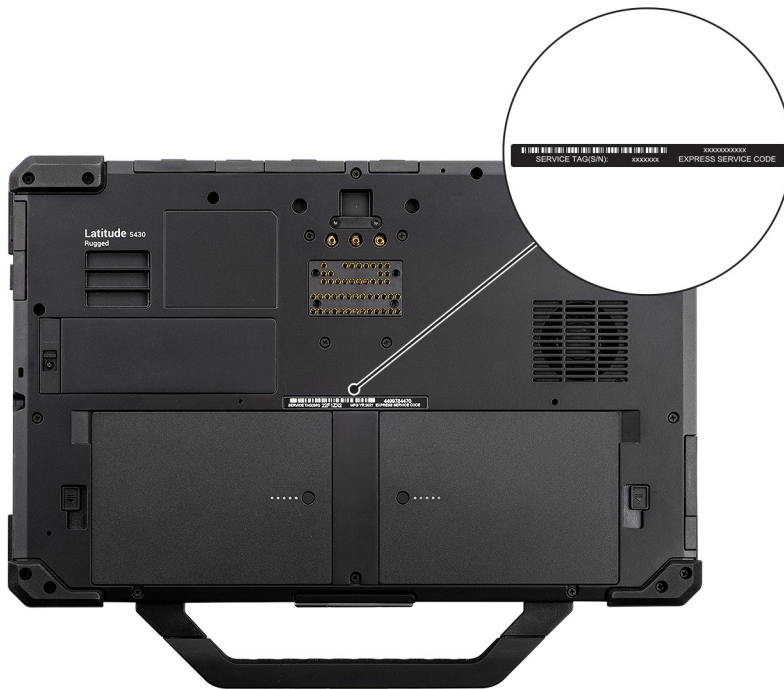

Battery charge and status light

The following table lists the battery charge and status light behavior of your Latitude 5430 Rugged.

Table 2. Battery charge and status light behavior

Power Source	LED Behavior	System Power State	Battery Charge Level
AC Adapter	Off	S0 - S5	Fully Charged
AC Adapter	Green	S0 - S5	< Fully Charged
Battery	Off	S0 - S5	10%<RSOC <=100%
Battery	Solid Amber (590+/-3 nm)	S0	<= 10%

- S0 (ON) - System is turned on.
- S4 (Hibernate) - The system consumes the least power compared to all other sleep states. The system is almost at an OFF state, except for a trickle power. The context data is written to hard drive.
- S5 (OFF) - The system is in a shutdown state.

Specifications of Latitude 5430 Rugged

Dimensions and weight

The following table lists the height, width, depth, and weight of your Latitude 5430 Rugged.

Table 3. Dimensions and weight

Description	Values
Height:	
Front height	33.60 mm (1.32 in.)
Rear height	33.60 mm (1.32 in.)
Width	340.00 mm (13.38 in.)
Depth	220.00 mm (8.66 in.)
Weight (minimum)	1.97 kg (4.35 lb)  NOTE: The weight of your computer depends on the configuration ordered and manufacturing variability.

Processor

The following table lists the details of the processors supported by your Latitude 5430 Rugged.

Table 4. Processor

Description	Option one	Option two	Option three
Processor type	11 th Generation Intel Core i5-1135G7	11 th Generation Intel Core i5-1145G7 vPro	11 th Generation Intel Core i7-1185G7 vPro
Processor wattage	28 W	28 W	28 W
Processor core count	4	4	4
Processor thread count	8	8	8
Processor speed	2.40 GHz to 3.80 GHz	2.60 GHz to 4.0 GHz	3.0 GHz to 4.30 GHz
Processor cache	8 MB	8 MB	12 MB
Integrated graphics	Intel Iris X ^e Graphics	Intel Iris X ^e Graphics	Intel Iris X ^e Graphics

Chipset

The following table lists the details of the chipset supported by your Latitude 5430 Rugged.

Table 5. Chipset

Description	Values
Chipset	Intel TGL UP3
Processor	11 th Generation Intel Core i5/i7
DRAM bus width	64-bit
Flash EPROM	32 MB
PCIe bus	Gen 4 for Discrete graphics

Memory

The following table lists the memory specifications of your Latitude 5430 Rugged.

Table 6. Memory specifications

Description	Values
Memory slots	Two SoDIMM slots
Memory type	DDR4
Memory speed	3200 MHz
Maximum memory configuration	64 GB
Minimum memory configuration	8 GB
Memory size per slot	8 GB, 16 GB, 32 GB
Memory configurations supported	<ul style="list-style-type: none">• 8 GB, 1 x 8 GB, DDR4, 3200 MHz, Non-ECC• 16 GB, 2 x 8 GB, DDR4, 3200 MHz, Non-ECC, dual-channel• 32 GB, 2 x 16 GB, DDR4, 3200 MHz, Non-ECC, dual-channel• 64 GB, 2 x 32 GB, DDR4, 3200 MHz, Non-ECC, dual-channel

External ports

The following table lists the external ports of your Latitude 5430 Rugged.

Table 7. External ports

Description	Values
Network port	One RJ45 Ethernet port
USB ports	<ul style="list-style-type: none">• One USB 3.2 Gen 1 port• One USB 3.2 Gen 1 port with PowerShare

Table 7. External ports (continued)

Description	Values
	<ul style="list-style-type: none"> One Thunderbolt 4/USB 3.2 Gen 2 Type-C port with PowerDelivery 3.0 One Thunderbolt 4/USB 3.2 Gen 2 Type-C port with PowerDelivery 3.0 (optional) One Optional I/O bay (RJ45/USB Type-A/Native Serial/Fischer USB 3.0 9-pin/Blank)
Audio port	Headset (headphone and microphone combo) port
Video port	One HDMI 2.0 port
I/O port	<ul style="list-style-type: none"> One Serial RS-232 port Nano SIM card slot Smart card reader (optional)
Media-card reader	One microSD-card slot
Power-adaptor port	One USB Type-C port
Security-cable slot	One Kensington lock slot

Internal slots

The following table lists the internal slots of your Latitude 5430 Rugged.

Table 8. Internal slots

Description	Values
M.2	<ul style="list-style-type: none"> One M.2 2230 slot for Wi-Fi and Bluetooth card One M.2 2230/2280 slot for solid-state drive One M.2 3042 slot for upsell WWAN card <p> NOTE: To learn more about the features of different types of M.2 cards, see the knowledge base article 000144170 at www.dell.com/support.</p>

Ethernet

The following table lists the wired Ethernet Local Area Network (LAN) specifications of your Latitude 5430 Rugged.

Table 9. Ethernet specifications

Description	Values
Model number	Intel i219LM
Transfer rate	10/100/1000 Mbps

Wireless module

The following table lists the Wireless Local Area Network (WLAN) modules supported on your Latitude 5430 Rugged.

Table 10. Wireless module specifications

Description	Option one	Option two
Model number	Qualcomm WCN6856-DBS	Intel AX210
Transfer rate	Up to 3571 Mbps	Up to 2400 Mbps
Frequency bands supported	2.4 GHz/5 GHz/6 GHz	2.4 GHz/5 GHz/6 GHz
Wireless standards	802.11ax (Wi-Fi 6E)	802.11ax (Wi-Fi 6E)
Encryption	<ul style="list-style-type: none"> 64-bit and 128-bit WEP 128-bit AES-CCMP TKIP 	<ul style="list-style-type: none"> 64-bit and 128-bit WEP 128-bit AES-CCMP TKIP
Bluetooth	5.2	5.2

WWAN module

The following table lists the Wireless Wide Area Network (WWAN) module that is supported on your Latitude 5430 Rugged.

Table 11. WWAN module specifications

Description	Option one	Option two
Model number	DW5821e, Qualcomm Snapdragon SDX20 Global Gigabit LTE	DW5930e, Qualcomm Snapdragon SDX55 5G
Transfer rate	Up to 1.2 Gbps DL/150 Mbps UL (Cat 16)	Up to 3 Gbps DL/250 Mbps UL (3GPP Release15 NR/LTE CAT20)
Frequency bands supported	<ul style="list-style-type: none"> LTE FDD: (1, 2, 3, 4, 5, 7, 8, 12, 13, 14, 17, 18, 19, 20, 25, 26, 28, 29, 30, 32, 38, 39, 40, 41, 42, 43, 46, 66) HSPA+: (1, 2, 4, 5, 6, 8, 9, 19) 	<ul style="list-style-type: none"> NR: (1, 2, 3, 5, 7, 8, 12, 20, 28, 38, 41, 66, 71, 77, 78, 79) LTE: (1, 2, 3, 4, 5, 7, 8, 12, 13, 14, 17, 18, 19, 20, 25, 26, 28, 29, 30, 32, 38, 39, 40, 41, 42, 43, 46, 66) HSPA+: (1, 2, 4, 5, 6, 8, 9, 19)
Wireless standards	<ul style="list-style-type: none"> LTE FDD/TDD WCDMA/HSPA+ GPS/GLONASS/Beidou/Galileo 	<ul style="list-style-type: none"> NR FR1(Sub6) FDD/TDD LTE FDD/TDD WCDMA/HSPA+ GPS/GLONASS/Beidou/Galileo
Encryption	Not supported	Not supported
Global Navigation Satellite System (GNSS)	Supports GPS, and GLONASS	Supports GPS, and GLONASS

NOTE: For instructions on how to find your computer's IMEI (International Mobile Station Equipment Identity) number, see the knowledge base article [000143678](https://www.dell.com/support) at www.dell.com/support.

Audio

The following table lists the audio specifications of your Latitude 5430 Rugged.

Table 12. Audio specifications

Description		Values
Audio controller		Realtek ALC3254
Stereo conversion		Supported
Internal audio interface		High definition audio
External audio interface		Headset (headphone and microphone combo) port
Number of speakers		Two
Internal-speaker amplifier		Supported (audio codec integrated)
External volume controls		Keyboard shortcut controls
Speaker output:		
	Average speaker output	2 W
	Peak speaker output	2.5 W
Subwoofer output		Not supported
Microphone		Dual-array microphones

Storage

This section lists the storage options on your Latitude 5430 Rugged.

Your computer supports one of the following configurations:

- One M.2 2230/2280 solid-state drive (Class 35 or Class 40)

The primary drive of your computer varies with the storage configuration. For systems with a M.2 drive, the M.2 drive is the primary drive.

Table 13. Storage specifications

Storage type	Interface type	Capacity
M.2 2230 solid-state drive	PCIe 3 Gen x4 NVMe, Class 35	Up to 1 TB
M.2 2280 solid-state drive	PCIe 4 Gen x4 NVMe, Class 40	Up to 2 TB
M.2 2280 solid-state drive	PCIe 4 Gen x4 NVMe, Class 40, self-encrypting drive	512 GB

Media-card reader

The following table lists the media cards supported by your Latitude 5430 Rugged.

Table 14. Media-card reader specifications

Description	Values
Media-card type	microSD-card
Media-cards supported	<ul style="list-style-type: none"> Secure Digital (MS) Secure Digital High Capacity (SDHC) Secure Digital Extended Capacity (SDXC)
<p> NOTE: The maximum capacity supported by the media-card reader varies depending on the standard of the media card installed in your computer.</p>	

Keyboard

The following table lists the keyboard specifications of your Latitude 5430 Rugged.

Table 15. Keyboard specifications

Description	Values
Keyboard type	<ul style="list-style-type: none"> Standard, non-backlit keyboard Standard, RGB backlit keyboard Rubberized Sealed RGB backlit keyboard
Keyboard layout	<ul style="list-style-type: none"> QWERTY AZERTY Kanji
Number of keys	<ul style="list-style-type: none"> United States and Canada: 82 keys United Kingdom: 83 keys Brazil: 84 keys Japan: 86 keys
Keyboard size	<p>X= 19.05 mm key pitch</p> <p>Y= 19.05 mm key pitch</p>
Keyboard shortcuts	<p>Some keys on your keyboard have two symbols on them. These keys can be used to type alternate characters or to perform secondary functions. To type the alternate character, press Shift and the desired key. To perform secondary functions, press Fn and the desired key.</p> <p> NOTE: You can define the primary behavior of the function keys (F1–F12) changing Function Key Behavior in BIOS setup program.</p>

Camera (optional)

The following table lists the camera specifications of your Latitude 5430 Rugged.

Table 16. Camera specifications

Description		Values
Number of cameras		One
Camera type		HD RGB camera
Camera location		Front camera
Camera sensor type		CMOS sensor technology
Camera resolution:		
	Still image	0.92 megapixel
	Video	1280 x 720 (HD) at 30 fps
Infrared camera resolution:		
	Still image	2.07 megapixel
	Video	1920 x 1080 (FHD) at 30 fps
Diagonal viewing angle:		
	Camera	78.60 degrees
	Infrared camera	87.60 degrees

Touchpad

The following table lists the touchpad specifications of your Latitude 5430 Rugged.

Table 17. Touchpad specifications

Description		Values
Touchpad resolution:		
	Horizontal	1196
	Vertical	600
Touchpad dimensions:		
	Horizontal	101.70 mm (4.00 in.)
	Vertical	52.00 mm (2.04 in.)
Touchpad gestures		For more information about touchpad gestures available on Windows, see the Microsoft knowledge base article 4027871 at support.microsoft.com .

Power adapter

The following table lists the power adapter specifications of your Latitude 5430 Rugged.

Table 18. Power adapter specifications

Description	Option one	Option two
Type	65 W AC adapter, USB-C	90 W AC adapter, USB-C
Power-adapter dimensions:		
Height	0.87 mm (0.034 in.)	0.87 mm (0.034 in.)
Width	2.60 mm (0.102 in.)	2.60 mm (0.102 in.)
Depth	5.12 mm (0.201 in.)	5.12 mm (0.201 in.)
Input voltage	100 VAC to 240 VAC	100 VAC to 240 VAC
Input frequency	50 Hz to 60 Hz	50 Hz to 60 Hz
Input current (maximum)	1.5 A	1.8 A
Output current (continuous)	<ul style="list-style-type: none"> ● 20 V/3.25 A ● 15 V/3 A ● 9 V/3 A ● 5 V/3 A 	<ul style="list-style-type: none"> ● 20 V/4.50 A ● 15 V/3 A ● 9 V/3 A ● 5 V/3 A
Rated output voltage	<ul style="list-style-type: none"> ● 20 VDC ● 15 VDC ● 9 VDC ● 5 VDC 	<ul style="list-style-type: none"> ● 20 VDC ● 15 VDC ● 9 VDC ● 5 VDC
Temperature range:		
Operating	0°C to 40°C (32°F to 104°F)	0°C to 40°C (32°F to 104°F)
Storage	-40°C to 70°C (-40°F to 158°F)	-40°C to 70°C (-40°F to 158°F)
 CAUTION: Operating and storage temperature ranges may differ among components, so operating or storing the device outside these ranges may impact the performance of specific components.		



Battery

The following table lists the battery specifications of your Latitude 5430 Rugged.

Table 19. Battery specifications

Description	Option one	Option two
Battery type	3-cell, 53.5 Wh, lithium-ion, ExpressCharge	3-cell, 53.5 Wh, lithium-ion, Long Life Cycle
Battery voltage	11.4 VDC	11.4 VDC
Battery weight (maximum)	0.265 kg (0.584 lb)	0.265 kg (0.584 lb)
Battery dimensions:		

Table 19. Battery specifications (continued)

Description		Option one	Option two
	Height	15.30 mm (0.60 in.)	15.30 mm (0.60 in.)
	Width	86.29 mm (3.39 in)	86.29 mm (3.39 in)
	Depth	128.44 mm (5.05 in.)	128.44 mm (5.05 in.)
Temperature range:			
	Operating	-20°C to 60°C (-4°F to 140°F)	-20°C to 60°C (-4°F to 140°F)
	Storage	-20°C to 65°C (-4°F to 149°F)	-20°C to 65°C (-4°F to 149°F)
Battery operating time		Varies depending on operating conditions and can significantly reduce under certain power-intensive conditions.	Varies depending on operating conditions and can significantly reduce under certain power-intensive conditions.
Battery charging time (approximate)		Two hours	Two hours
 NOTE: Control the charging time, duration, start and end time, and so on using the Dell Power Manager application. For more information on the Dell Power Manager see, <i>Me and My Dell</i> on www.dell.com .			
Coin-cell battery		CR2032	CR2032
 CAUTION: Operating and storage temperature ranges may differ among components, so operating or storing the device outside these ranges may impact the performance of specific components.			
 CAUTION: Dell recommends that you charge the battery regularly for optimal power consumption. If your battery charge is completely depleted, connect the power adapter, turn on your computer, and then restart your computer to reduce the power consumption.			

Display

The following table lists the display specifications of your Latitude 5430 Rugged.

Table 20. Display specifications

Description		Option one	Option two
Display type		14-inch, Full High Definition (FHD)	14-inch, Full High Definition (FHD)
Display-panel technology		Wide-viewing angle (WVA)	Wide-viewing angle (WVA)
Display-panel dimensions (active area):			
	Height	173.95 mm (6.84 in.)	173.95 mm (6.84 in.)
	Width	309.40 mm (12.18 in.)	309.40 mm (12.18 in.)
	Diagonal	355.60 mm (14.00 in.)	355.60 mm (14.00 in.)
Display-panel native resolution		1920 x 1080	1920 x 1080
Luminance (typical)		400 nits	1100 nits

Table 20. Display specifications (continued)

Description	Option one	Option two
Megapixels	16.7	16.7
Color gamut	sRGB 100% typical	sRGB 100% typical
Pixels Per Inch (PPI)	157	157
Contrast ratio (min.)	1500:1	1500:1
Response time (max.)	35 ms	35 ms
Refresh rate	60 Hz	60 Hz
Horizontal view angle	85 degrees	88 degrees
Vertical view angle	85 degrees	88 degrees
Pixel pitch	0.161 x 0.161 mm	0.161 x 0.161mm
Power consumption (maximum)	2.5 W	5.95 W
Anti-glare vs glossy finish	Anti-glare	Anti-glare
Touch options	No	Yes with 10 touch points

Fingerprint reader on the power button (optional)

The following table lists the fingerprint-reader specifications of your Latitude 5430 Rugged.

Table 21. Fingerprint reader specifications

Description	Values
Fingerprint-reader sensor technology	Capacitive
Fingerprint-reader sensor resolution	363 dpi
Fingerprint-reader sensor pixel size	108 x 88

Sensor

The following table lists the sensor of your Latitude 5430 Rugged.

Table 22. Sensor

Sensor
Hall Effect sensor

GPU—Integrated

The following table lists the specifications of the integrated Graphics Processing Unit (GPU) supported by your Latitude 5430 Rugged.

Table 23. GPU—Integrated

Controller	Memory size	Processor
Intel Iris X ^e Graphics	Shared system memory	11 th Generation Intel Core i5/i7

GPU—Discrete

The following table lists the specifications of the discrete Graphics Processing Unit (GPU) supported by your Latitude 5430 Rugged.

Table 24. GPU—Discrete

Controller	Memory size	Memory type
NVIDIA T500	4 GB	GDDR6

Multiple display support matrix

Table 25. Integrated graphics card

Graphics Card	Intel Iris X ^e graphics
Video ports on Integrated Graphics Card	<ul style="list-style-type: none"> 1 x USB Type-C port + 1 x USB Type-C port (optional) 1 x HDMI2.0 port
Number of displays	4

Table 26. Discrete graphics card

Graphics Card	NVIDIA T500
Memory	4 GB GDDR6
Total Power	18 W

Hardware security

The following table lists the hardware security of your Latitude 5430 Rugged.

Table 27. Hardware security

Hardware security
Kensington lock slot
Mechanical camera privacy shutter
Trusted Platform Module (TPM) 2.0 discrete
FIPS (Federal Information Processing Standards) 140-2 certification for Trusted Platform Module (TPM)
Trusted Computing Group (TCG) Certification for TPM
Self-Encrypting Drive (SED), Opal 2.0 only - PCIe Interface
ControlVault 3 Advanced Authentication with FIPS 140-2 Level 3 Certification

Table 27. Hardware security (continued)

Hardware security
Optional Fingerprint Reader with Control Vault 3 (optional)
Optional Contacted Smart-Card and Control Vault 3 (optional)
Optional Contactless Smart-Card, NFC, and Control Vault 3 (optional)
Statement of Non-Volatility
Chassis Intrusion Detection
Dell Trusted Device Agent Validation

Smart-card reader

The following table lists the smart-card reader specifications that are supported by your Latitude 5430 Rugged.

Table 28. Contactless smart-card reader

Type	FIPS 201 Contacted/Contactless Smart-card reader
ISO certification	ISO14443A

Contacted smart-card reader

The following table lists the contacted smart-card reader specifications supported by your Latitude 5430 Rugged.

Table 29. Contacted smart-card reader

Title	Description	Dell ControlVault 3 Smart-card reader
ISO 7816 -3 Class A Card Support	Reader capable of reading 5 V powered smart-card	Yes
ISO 7816 -3 Class B Card Support	Reader capable of reading 3 V powered smart-card	Yes
ISO 7816 -3 Class C Card support	Reader capable of reading 1.8 V powered smart-card	Yes
T=0 support	Cards support character level transmission	Yes
T=1 support	Cards support block level transmission	Yes
EMVCo Compliant	Compliant with EMVCo (for electronic payment standards) smart-card standards as posted to www.emvco.com	Yes
EMVCo Certified	Formally certified based on EMVCO smart-card standards	Yes
PC/SC OS interface	Personal Computer/Smart-Card specification for integration of hardware readers into personal computer environments	Yes
CCID driver compliance	Common driver support for Integrated Circuit Card Interface Device for OS level drivers.	Yes
Windows Certified	Device certified by WHCK	Yes

Table 29. Contacted smart-card reader (continued)

Title	Description	Dell ControlVault 3 Smart-card reader
FIPS 201 (PIV/HSPD-12) Compliant via GSA	Device compliant with FIPS 201/PIV/HSPD-12 requirements	Yes
ISO 7816-1 Compliant	Specification for the reader	Yes
ISO 7816 -2 Compliant	Specification for smart-card device physical characteristics (size, location of connection points, etc.)	N/A
Dell ControlVault support	Device connects to Dell ControlVault for usage and processing	Yes

Contactless smart-card reader

The following table lists the contactless smart-card reader specifications supported by your Latitude 5430 Rugged.

Table 30. Contactless smart-card reader

Title	Description	Dell ControlVault 3 Contactless Smart-card reader with NFC
Felica Card Support	Reader and software capable of supporting Felica contactless cards	Yes
Prox (Proximity) (125 kHz) Card support	Reader and software capable of supporting Prox/Proximity/125 kHz contactless cards	No
ISO 14443 Type A Card Support	Reader and software capable of supporting ISO 14443 Type A contactless cards	Yes
ISO 14443 Type B Card Support	Reader and software capable of supporting ISO 14443 Type B contactless cards	Yes
ISO/IEC 21481	Reader and software capable of supporting ISO/IEC 21481 compliant contactless cards and tokens	Yes
ISO/IEC 18092	Reader and software capable of supporting ISO/IEC 21481 compliant contactless cards and tokens	Yes
ISO 15693 Card Support	Reader and software capable of supporting ISO15693 contactless cards	Yes
NFC Tag Support	Supports reading and processing of NFC compliant tag information	Yes
NFC Reader Mode	Support for NFC Forum Defined Reader mode	Yes
NFC Writer Mode	Support for NFC Forum Defined Writer mode	Yes
NFC Peer-to-Peer Mode	Support for NFC Forum Defined Peer to Peer mode	Yes
NFC Proximity OS Interface	Enumerates NFP (Near Field Proximity) device for OS to utilize	Yes
PC/SC OS interface	Personal Computer/Smart-Card specification for integration of hardware	Yes

Table 30. Contactless smart-card reader (continued)

Title	Description	Dell ControlVault 3 Contactless Smart-card reader with NFC
	readers into personal computer environments	
CCID driver compliance	Common driver support for Integrated Circuit Card Interface Device for OS level drivers	Yes
Dell ControlVault support	Device connects to Dell ControlVault for usage and processing	Yes

NOTE: 125 Khz proximity cards are not supported.

Table 31. Supported cards

Manufacturer	Card	Supported
HID	jCOP readertest3 A card (14443a)	Yes
	1430 1L	
	DESFire D8H	
	iClass (Legacy)	
	iClass SEOS	
NXP/Mifare	Mifare DESFire 8K White PVC Cards	Yes
	Mifare Classic 1K White PVC Cards	
	NXP Mifare Classic S50 ISO Card	
G&D	idOnDemand - SCE3.2 144K	Yes
	SCE6.0 FIPS 80K Dual+ 1 K Mifare	
	SCE6.0 nonFIPS 80K Dual+ 1 K Mifare	
	SCE6.0 FIPS 144K Dual + 1K Mifare	
	SCE6.0 nonFIPS 144K Dual + 1 K Mifare	
	SCE7.0 FIPS 144K	
Oberthur	idOnDemand - OCS5.2 80K	Yes
	ID-One Cosmo 64 RSA D V5.4 T=0 card	
	ID-One Cosmo 128K V5.5 card	
Gemalto	TOP DL GX4 144K card	Yes
Sony	Felica RC-S962	Yes
	Felica RC-S966	Yes
PIVKey	C910 PKI	Yes
IDENTIV	PIV programmed cards	Yes

Operating and storage environment

This table lists the operating and storage specifications of your Latitude 5430 Rugged.

Airborne contaminant level: G1 as defined by ISA-S71.04-1985

Table 32. Computer environment

Description	Operating	Storage
Temperature range	-29°C to 63°C (-20.2°F to 145.4°F)	-51°C to 71°C (-59.8°F to 159.8°F)
Relative humidity (maximum)	<ul style="list-style-type: none"> ● minimum: 10% (non-condensing) ● maximum: 90% (non-condensing) 	<ul style="list-style-type: none"> ● minimum: 0% (non-condensing) ● maximum: 95% (non-condensing)
Vibration (maximum)*	<ul style="list-style-type: none"> ● Vertical - 1.04 GRMS ● Transverse - 0.20 GRMS ● Longitudinal - 0.74 GRMS 	<ul style="list-style-type: none"> ● Vertical - 2.24 GRMS ● Transverse - 1.45 GRMS ● Longitudinal - 1.32 GRMS
Shock (maximum)	160 G [†]	185 G [†]
Altitude range	12192 m (40,000 ft)	12192 m (40,000 ft)
<p>⚠ CAUTION: Operating and storage temperature ranges may differ among components, so operating or storing the device outside these ranges may impact the performance of specific components.</p>		

* Measured using a random vibration spectrum that simulates user environment.

† Measured using a 2 ms half-sine pulse.

Color, material, and finish

This section details the color, material, and finish (CMF) specifications of your Latitude 5430 Rugged.

Table 33. CMF specifications

A Cover (Top)	<ul style="list-style-type: none"> • Dell standard black, resin • Resin + Carbon Fiber + TPE • 5.5±1.5 GU, MT11010
B Cover (Hinge up)	<ul style="list-style-type: none"> • Maluck black, matte • Resin • 5.5±1.5 GU, MT11010
C Cover (Palmrest)	<ul style="list-style-type: none"> • Maluck black, matte • Magnesium • 5.5±1.5 GU
D Cover (Bottom)	<ul style="list-style-type: none"> • Maluck black, matte • Magnesium • 5.5±1.5 GU

Keyboard shortcuts of Latitude 5430 Rugged

NOTE: Keyboard characters may differ depending on the keyboard language configuration. Keys that are used for shortcuts remain the same across all language configurations.

Some keys on your keyboard have two symbols on them. These keys can be used to type alternate characters or to perform secondary functions. The symbol that is shown on the lower part of the key refers to the character that is typed out when the key is pressed. If you press shift and the key, the symbol that is shown on the upper part of the key is typed out. For example, if you press **2**, **2** is typed out; if you press **Shift + 2**, **@** is typed out.

The keys F1-F12 at the top row of the keyboard are function keys for multi-media control, as indicated by the icon at the bottom of the key. Press the function key to invoke the task represented by the icon. For example, pressing F1 mutes the audio (refer to the table below).

However, if the function keys F1-F12 are needed for specific software applications, multi-media functionality can be disabled by pressing **Fn + Esc**. Subsequently, multi-media control can be invoked by pressing **Fn** and the respective function key. For example, mute audio by pressing **Fn + F1**.

NOTE: You can also define the primary behavior of the function keys (F1–F12) by changing **Function Key Behavior** in BIOS setup program.

Table 34. List of keyboard shortcuts

Function key	Primary behavior
F1	Mute audio
F2	Decrease volume
F3	Increase volume
F4	Microphone Mute
F5	KB Illumination/Backlight
F6	Decrease brightness
F7	Increase brightness
F8	Switch to external display
F9	Scroll Lock
F10	Print screen
F12	Home

The **Fn** key is also used with selected keys on the keyboard to invoke other secondary functions.

Table 35. Secondary behavior

Function key	Secondary behavior
Fn + F1	Operating system and application specific F1 behavior
Fn + F2	Operating system and application specific F2 behavior
Fn + F3	Operating system and application specific F3 behavior
Fn + F4	Operating system and application specific F4 behavior
Fn + F5	Operating system and application specific F5 behavior
Fn + F6	Operating system and application specific F6 behavior
Fn + F8	Operating system and application specific F8 behavior

Table 35. Secondary behavior (continued)



Function key	Secondary behavior
Fn + F9	Operating system and application specific F9 behavior
Fn + F10	Operating system and application specific F10 behavior
Fn + F11	Operating system and application specific F11 behavior
Fn + F12	Operating system and application specific F12 behavior
Fn + PrtScr	Turn off/on wireless
Fn + B	Pause/Break
Fn + Insert	Sleep
Fn + S	Toggle scroll lock
Fn + H	Toggle between power and battery-status light/hard-drive activity light
Fn + R	System request
Fn + Ctrl	Open application menu
Fn + Esc	Toggle Fn-key lock

Getting help and contacting Dell

Self-help resources

You can get information and help on Dell products and services using these self-help resources:

Table 36. Self-help resources

Self-help resources	Resource location
Information about Dell products and services	www.dell.com
My Dell app	
Tips	
Contact Support	In Windows search, type <code>Contact Support</code> , and press Enter.
Online help for operating system	www.dell.com/support/windows www.dell.com/support/linux
Access top solutions, diagnostics, drivers and downloads, and learn more about your computer through videos, manuals, and documents.	Your Dell computer is uniquely identified by a Service Tag or Express Service Code. To view relevant support resources for your Dell computer, enter the Service Tag or Express Service Code at www.dell.com/support . For more information on how to find the Service Tag for your computer, see Locate the Service Tag on your computer .
Dell knowledge base articles for a variety of computer concerns	<ol style="list-style-type: none"> 1. Go to www.dell.com/support. 2. On the menu bar at the top of the Support page, select Support > Knowledge Base. 3. In the Search field on the Knowledge Base page, type the keyword, topic, or model number, and then click or tap the search icon to view the related articles.

Contacting Dell

To contact Dell for sales, technical support, or customer service issues, see www.dell.com/contactdell.

 **NOTE:** Availability varies by country/region and product, and some services may not be available in your country/region.

 **NOTE:** If you do not have an active Internet connection, you can find contact information about your purchase invoice, packing slip, bill, or Dell product catalog.