

Yealink



WH6X Wireless Headset User Guide

Contents

About This Guide.....	5
Summary of Changes.....	5
Changes for Guide Version 1.4.....	5
Changes for Guide Version 1.3.....	5
Changes for Guide Version 1.2.....	5
Changes for Guide Version 1.1.....	6
How to Power on/off.....	6
Power on the Base.....	6
Power on the Headset.....	7
Power off the Base.....	7
Power off the Headset.....	7
Pair the Headset with Base.....	7
How to Connect WH62/WH63.....	8
WH62/WH63 Port Overview.....	8
Connect to PC via USB Cable.....	8
Connect to Desk Phone via USB Cable.....	9
How to Connect WH66/WH67.....	11
WH66/WH67 Port Overview.....	11
Connect to PC/Desk Phone via the Included USB Cable.....	11
Connect to PC/Desk Phone/Smartphone via Bluetooth.....	12
BT50LED Indicator.....	12
Single Bluetooth Connection.....	12
Two Bluetooth Connections.....	14
Disconnect and Remove Your Bluetooth Device.....	14
Edit Your Bluetooth Information.....	14
Erase All Bluetooth Pairings.....	15
Turn off Bluetooth.....	15
How to Wear.....	15
WH62/WH66 Headset.....	15
How to Replace Ear Cushions.....	16
WH63/WH67 Headset.....	16
Wearing Styles.....	16
Remove the Pre-installed Eartip from the Headset.....	19
Earhook & Eartip Assembly.....	19
Headband Assembly.....	20
Neckband Assembly.....	22
How to Use.....	25

Hardware Overview.....	25
WH62 Base & Headset Hardware.....	25
WH63 Base & Headset Hardware.....	28
WH66 Base & Headset Hardware.....	30
WH67 Base & Headset Hardware.....	31
WH62/WH63 Base Status LEDs.....	32
Status and Busylight LED.....	33
WH66/WH67 Icons and Status Indicators.....	34
Adjust the Playback Volume.....	34
How to Reset to Factory.....	35
Reset Configuration on WH62/WH63 Base.....	35
Reset Configuration on WH66/WH67 Base.....	35
How to Manage Calls.....	35
Basic Call Usage on Headset.....	36
Basic Call Usage on WH62/WH63 Base.....	38
Basic Call Usage on WH66/WH67 Base.....	38
Merge Two Calls on WH62/WH63.....	39
Merge Two Calls on WH66/WH67.....	39
Multi-Headset Conference Calls.....	40
Add Additional Headset(s) During a Call.....	40
Add Additional Headset(s) When the Base is Idle.....	40
Add Additional Headset(s) without Docking.....	41
End or Leave a Conference Call.....	41
Transfer a Call from Desk Phone to Headset.....	41
Transfer a Call from Headset to Desk Phone.....	41
Multiple Calls Handling.....	42
Local Directory.....	42
Local Contacts.....	42
Add a New Local Contact.....	42
View Local Contacts.....	43
Search for Local Contacts.....	43
Edit Local Contacts.....	43
Delete a Local Contact.....	43
Delete Multiple or All Local Contacts.....	44
Move Local Contacts to the Favorite/Blocklist.....	44
Mobile Contacts.....	44
Update the Mobile Contacts.....	44
Save Mobile Contacts to the Local Contacts/Favorite/Blocklist.....	45
Search for Mobile Contacts.....	45
Favorite.....	45
Add a New Contact to Your Favorites.....	45
View Favorites.....	46
Search for Favorites.....	46
Edit Favorites.....	46
Delete a Favorite.....	47
Delete Multiple or All Favorites.....	47
Blocklist.....	47
Add a New Contact to Your Blocklist.....	47
View Blocklist Contacts.....	48
Edit Blocklist Contacts.....	48
Delete a Blocklist Contact.....	48
Delete Multiple or All Blocklist Contacts.....	48

Move Blocklist Contacts to the Local Contacts.....	49
Call History.....	49
Call History Icons.....	49
View History Records.....	49
Add a History Record to Local Contacts.....	49
Add History Records to Local Contacts/Favorite/Blocklist.....	50
Edit Call History before Calling.....	50
Delete History Records.....	51
Yealink USB Connect.....	51
Manually Pair the Base with the BT50.....	51
Download and Install.....	52
Update Firmware.....	53
How to Change Settings on WH62/WH63.....	54
How to Change Settings on WH66/WH67.....	55
Basic Settings.....	55
Advanced Settings.....	56
Optional Accessories.....	59
Use the Busylight BLT60.....	59
Charge the Mobile Phone on WHC60.....	60
Use the EHS60.....	61
Support.....	61
FAQ.....	61
Safety Instructions.....	62

About This Guide

This guide contains instructions for connecting and using your WH6X headset.



Note: This guide mainly takes the Teams version of WH62/WH66 as an example.

Summary of Changes

Changes for Guide Version 1.4

Revision	Updated Section
WH66/WH67 added the Local Contacts function.	Local Directory
WH66/WH67 added the Call History function.	Call History
WH62/WH63 added the feature that the USB phone port supports connection to EHS60 to be compatible with the call control function of Cisco, Polycom, Avaya and Grandstream IP phones.	Use the EHS60
WH62/WH63/WH66/WH67 added the feature that you can connect additional headsets without docking.	Add Additional Headset(s) without Docking
WH66/WH67 added Voice Guidance.	Advanced Settings
WH66/WH67 added the feature that you can place a call from the directory and the call history.	Basic Call Usage on WH66/WH67 Base

Changes for Guide Version 1.3

Revision	Updated Section
You can turn off busylight through Yealink USB Connect, the busylight will be on only when there is an incoming call. It can optimize battery performance.	Status and Busylight LED
WH66/WH67 added Bluetooth discoverable time configurable.	Basic Settings
WH66/WH67 added the feature that you can set base ringtone volume without changing the volume of the headset.	Basic Settings
WH66/WH67 added the feature that you can configure the date format and time format.	Basic Settings
WH62/WH66 added Music Mode.	Advanced Settings
Added Equalizer for Calls.	Advanced Settings
Added Call Recording.	Advanced Settings
Added USB Computer Audio.	Advanced Settings
Added Noise Suppression.	Advanced Settings

Changes for Guide Version 1.2

Make minor corrections.

Changes for Guide Version 1.1

Major updates have occurred to the following sections:

Revision	Updated Section
The headset cannot be upgraded when the battery is low (< 10%).	Update Firmware
<ul style="list-style-type: none"> Switch between headset and speakerphone mode. When the headset disconnects from the base for 1 minute during a call, the call will automatically hang up. The call will automatically switch to the headset channel during a hands-free call after the headset reconnects. 	Basic Call Usage on Headset
Long press the mute button on the headset to switch between headset and speakerphone mode.	WH66 Base & Headset Hardware WH67 Base & Headset Hardware
Updated Mute Reminder support	Advanced Settings
Added Connection Status support	Use the Busylight BLT60
Updated Ring Tones support	Basic Settings

How to Power on/off

Power on the Base

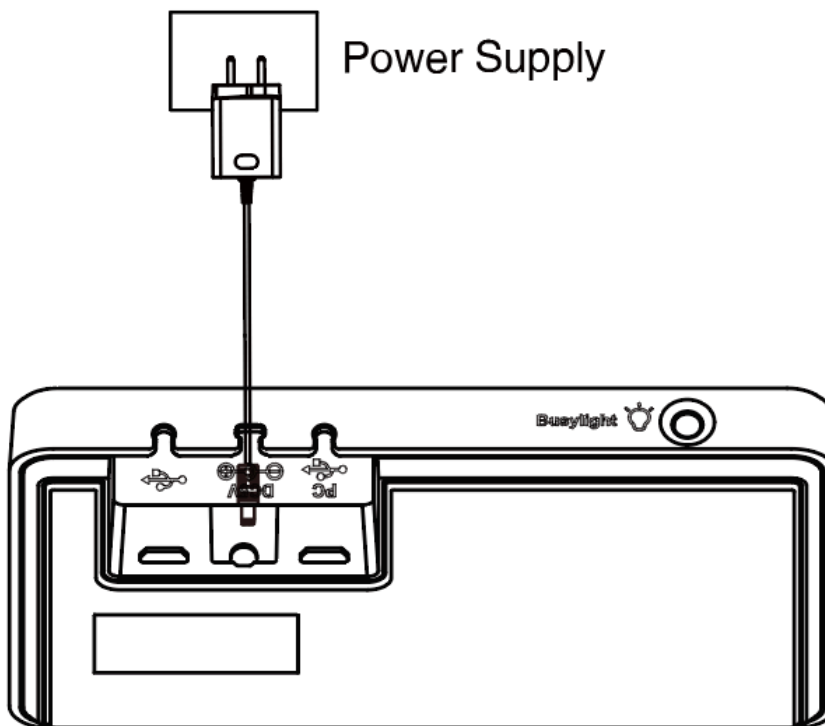

Plug the base into a power supply using the supplied power adapter.

For WH62/WH63 base, all LEDs on the base light up and then go off.

For WH66/WH67, the power LED glows red.

Related information

[WH66 Base & Headset Hardware](#)

[WH67 Base & Headset Hardware](#)

Power on the Headset

Do one of the following:

- Hold the **Call Control** button for 3 seconds.
- Power on the base and dock the headset in the base.



Note: The headset will be charged whenever it is docked in a base that is connected to a power supply.

Related tasks

[Power on the Base](#)

Related information

[Hardware Overview](#)

Power off the Base

1. For WH62/WH66/WH67 base, unplug the power adapter.
2. For WH63 base, unplug the power adapter and disconnect from the USB device.

Power off the Headset

Undock the headset and hold the **Call Control** button for 3 seconds.

You hear a "power off" tone indicating headset status.



Note: Power off the headset will only disconnect the connection between the base and the headset, but will not delete the pairing information between the base and the headset.

Pair the Headset with Base

The base has been connected to a power supply.

Dock the headset in a base.

The headset is successfully paired with the base. The LED on the headset glows green for 5 seconds, and then indicates the charging status.



Note: You can pair up to four headsets to one base. After the headset is paired, it will keep paired even you undock the headset.

Related tasks

[Add Additional Headset\(s\) During a Call](#)

[Add Additional Headset\(s\) When the Base is Idle](#)

How to Connect WH62/WH63

You can connect one or both of the desk phone and the PC.

WH62/WH63 Port Overview

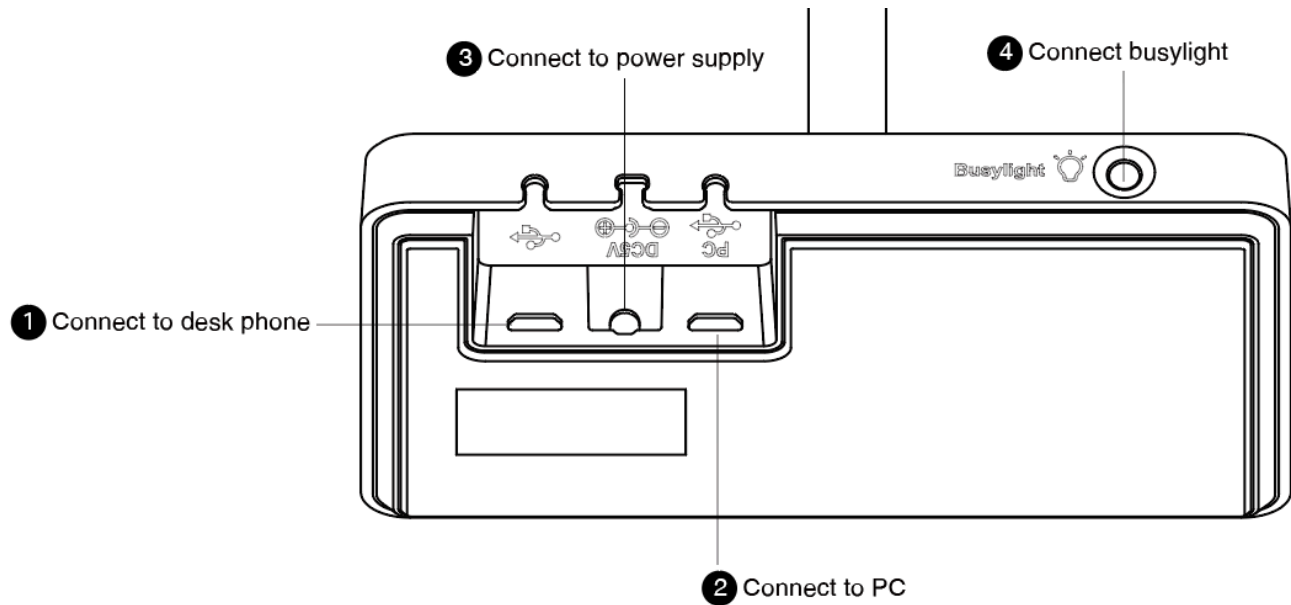



Connect to PC via USB Cable

1. Connect one end of the USB cable to the PC port of the base.

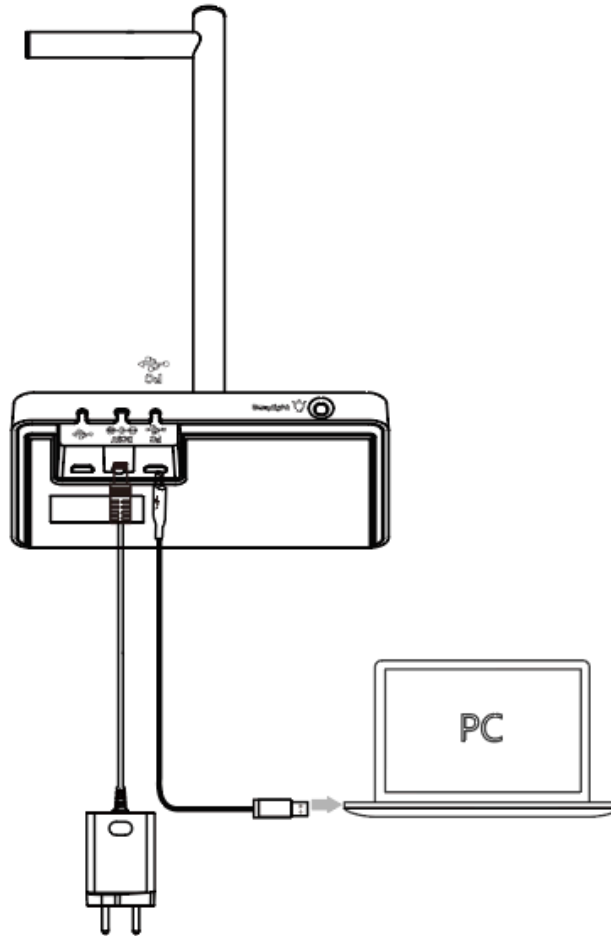
2. Connect the remaining end of the USB cable to the USB port of the PC.





-  **Note:** For more information on the compatible PC, refer to the specific compatible guide.
-  **Important:** You need to connect the PC to the micro USB port of the base marked with the text "PC".

Connect to Desk Phone via USB Cable

1. Connect one end of the USB cable to the USB port of the base.

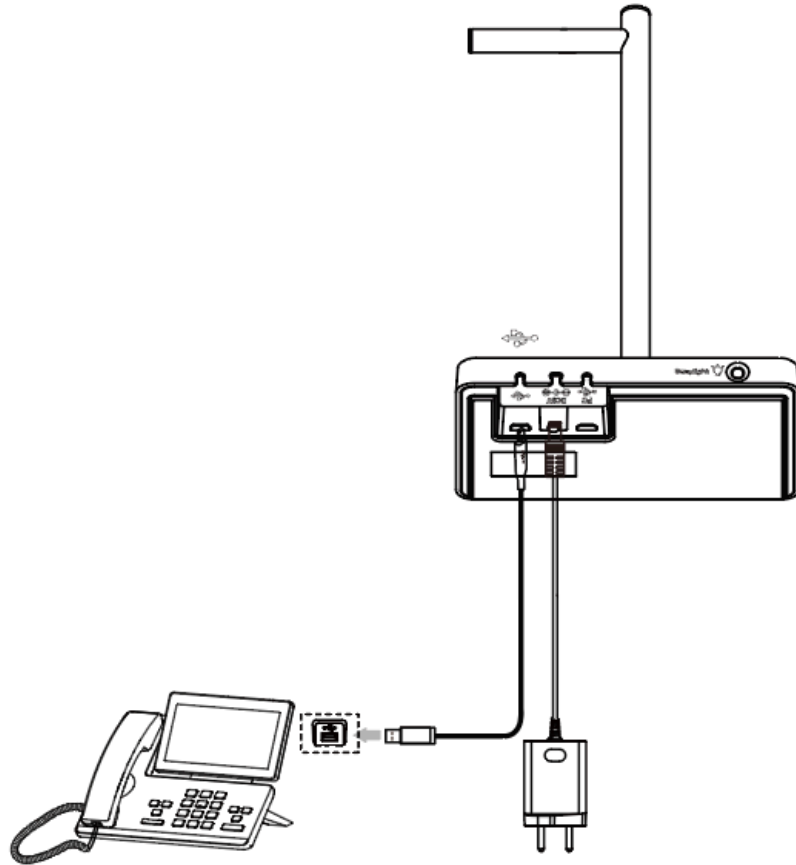
2. Connect the remaining end of the USB cable to the USB port of the desk phone.



 **Note:** For more information on compatible desk phones, refer to the specific compatible guide. If you want to connect to Yealink T3 series phones, you need to purchase Yealink EHS35 wireless headset adapter separately.

How to Connect WH66/WH67

WH66/WH67 Port Overview

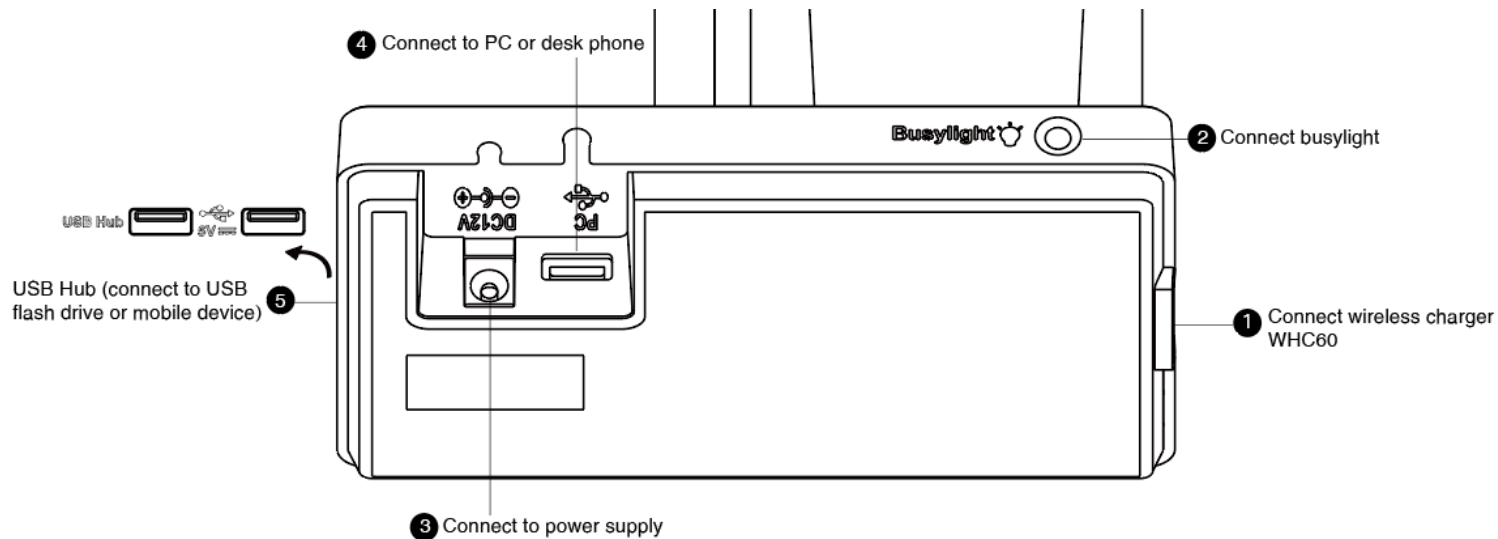



Connect to PC/Desk Phone via the Included USB Cable

1. Connect one end of the included USB cable to the PC port of the base.

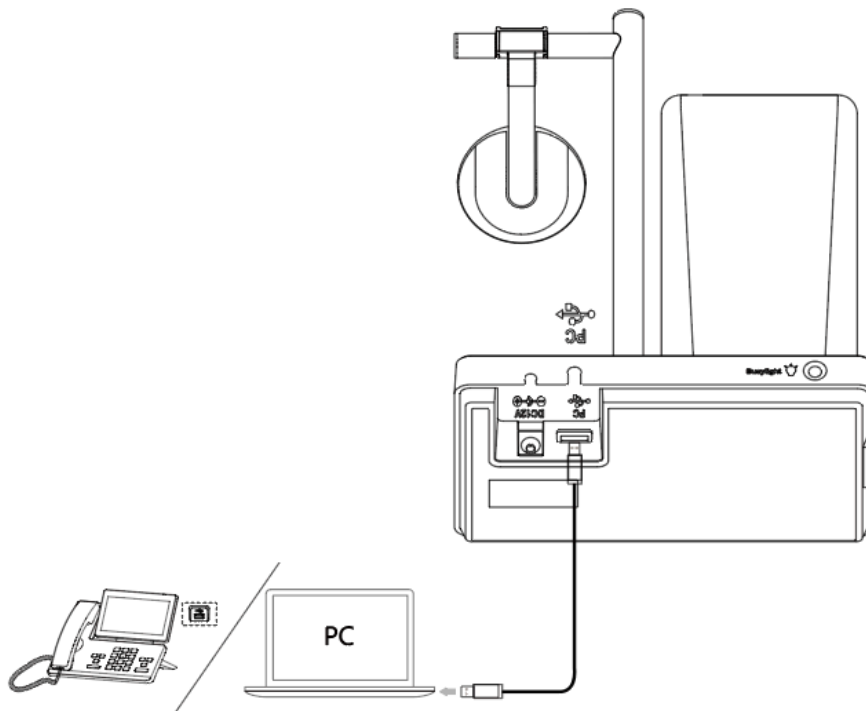
2. Connect the remaining end of the USB cable to the USB port of the PC/desk phone.



-  **Note:** For more information on compatible PC and desk phones, refer to the specific compatible guide.
-  **Important:** You need to connect the PC to the USB port of the base marked with the text "PC".

Connect to PC/Desk Phone/Smartphone via Bluetooth

You can connect your WH66/WH67 base to PC, desk phone, or smartphone via Bluetooth. And then you can use your headset to perform call controls for the softphone/smartphone.

The base can save the pairing information of 8 Bluetooth devices connected recently.

BT50LED Indicator

BT50LED Indicator

LED Indicator	Description
Flashing blue	Bluetooth connecting
Solid blue	Bluetooth connected
Off	Bluetooth disconnected

Single Bluetooth Connection

You can connect to PC, smartphone, or Bluetooth headset via Bluetooth.

Connect to PC

You can connect the base to PC via Bluetooth dongle BT50. The base and the BT50 are pre-paired and ready to use out of the box. The Bluetooth range is 30m/100ft.

-  **Note:** If you connect the base to PC via built-in Bluetooth, the base can only support voice pickup and audio playback.

Connect the BT50 into a USB port on your PC.



After a successful connection, the BT50 LED indicator glows blue.

-  **Note:** To manually pair the base with the BT50, please use Yealink USB connect. For more information on the compatible PC, refer to the specific compatible guide.

Related tasks



[Manually Pair the Base with the BT50](#)

Connect to Smartphone

You can connect the base to a smartphone via built-in Bluetooth.



1. Do the following:

- For Teams version:
 - Tap  or the user account avatar, and tap **Bluetooth**.
- For UC version:
 - Tap .

The base automatically enters the pairing mode.

2. On your smartphone, turn on Bluetooth and select **Yealink WH66/Yealink WH67**.

-  **Note:**
- The Yealink WH66/Yealink WH67 is the default device name. You can edit the base's Bluetooth device name. For more information on the compatible smartphone, refer to the specific compatible guide.
 - You can sync mobile contacts to WH66/WH67 as temporary contacts by enabling **Contact Sharing** permissions on your mobile phone.

Related tasks

[Edit Your Bluetooth Information](#)

Related information



[Mobile Contacts](#)

Connect to Desk Phone

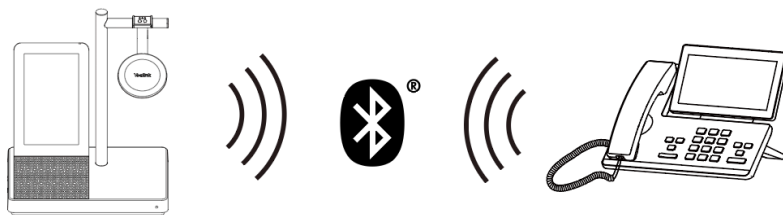
You can connect the base to your desk phone via Bluetooth.



1. Do the following:

- For Teams version:
 - Tap  or the user account avatar, and tap **Bluetooth**.
- For UC version:
 - Tap .

The base automatically enters the pairing mode.

2. On your desk phone, turn on Bluetooth and select **Yealink WH66/Yealink WH67**.

-  **Note:** If your desk phone does not support Bluetooth or you do not want to use the built-in Bluetooth, you can connect the base via the pre-paired BT50. To manually pair the base with the BT50, please use Yealink USB connect. For more information on compatible desk phones, refer to the specific compatible guide.

Related tasks

[Manually Pair the Base with the BT50](#)



Two Bluetooth Connections

You can connect up to two Bluetooth devices at the same time.

Disconnect and Remove Your Bluetooth Device

You can disconnect your Bluetooth device from your base and still keep it paired. When you disconnect a Bluetooth device, it remains paired so that you can reconnect it to your base. You can also remove your Bluetooth device so that it is no longer paired or connected to the base.

1. Do the following:

- For Teams version:
 - Tap  or the user account avatar, and tap **Bluetooth**.
- For UC version:
 - Tap .



2. Tap the connected Bluetooth device, or tap  and select **Disconnect**.
After you disconnect the device, "**Disconnected**" displays below the corresponding device.

3. Tap , and select **Remove**.
The screen prompts you whether to remove the device.

4. Confirm the action.

Edit Your Bluetooth Information

You can change the base's Bluetooth device name to identify your base to other devices.

1. Do the following:
 - For Teams version:
Tap  or the user account avatar, and tap **Bluetooth**.
 - For UC version:
Tap .



2. Tap **My Bluetooth Information**.

3. Select  to edit the device name.

 **Note:** When the Bluetooth is turned off or is starting, you cannot edit the Bluetooth device name.

Erase All Bluetooth Pairings

You can erase all saved Bluetooth device pairings.



1. Do the following:
 - For Teams version:
Tap  or the user account avatar, and tap **Bluetooth**.
 - For UC version:
Tap .

2. Tap / .

The screen prompts you whether to clear the list of paired devices.

3. Confirm the action.

Turn off Bluetooth

1. Do the following:
 - For Teams version:
Tap  or the user account avatar, and tap **Bluetooth**.
 - For UC version:
Tap .

2. Turn off **Bluetooth**.

 **Note:** When Bluetooth is turned off, mobile contacts synchronized as temporary contacts on WH66/WH67 will be cleared, but mobile contacts saved locally will be saved.

How to Wear

WH62/WH66 Headset

The headset can be worn with the microphone on the left or the right.



If necessary, you can bring the microphone closer or farther from your mouth.

How to Replace Ear Cushions

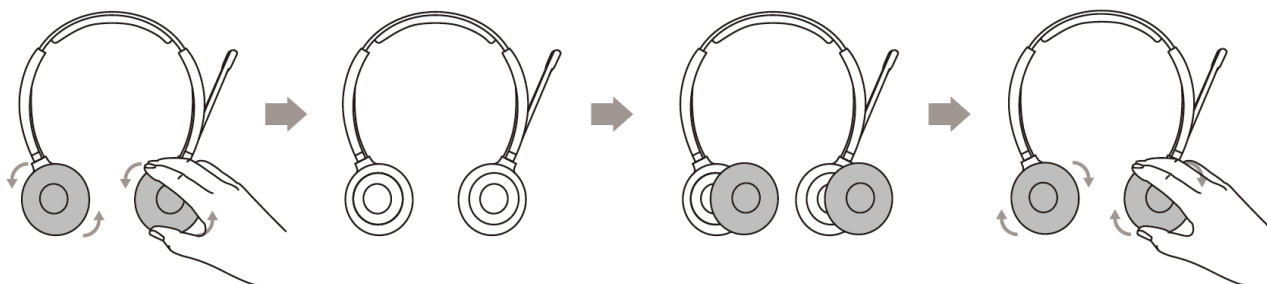

WH63/WH67 Headset

Your headset comes configured for your right ear with a pre-installed large eartip. You can also configure your headset for your left ear, install a different sized eartip and earhook, install the headband, or install the neckband.

Wearing Styles

There are four wearing styles for WH63/WH67 headset.

- Eartip wearing style: faster to wear

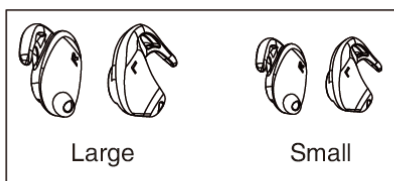

Right Ear (ready to use out of the box)

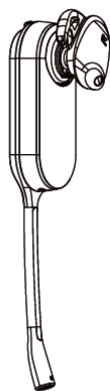

Left Ear

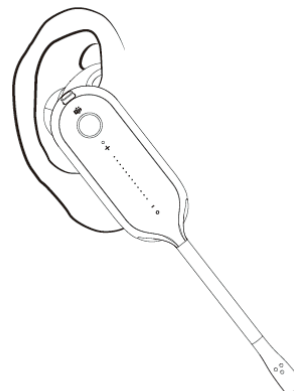
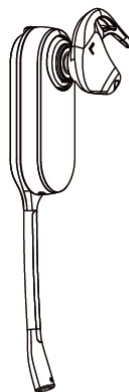

- Earhook & Eartip wearing style: enhance wearing stability

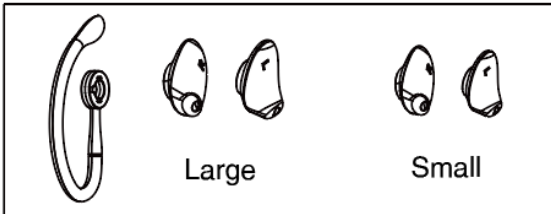

Right Ear

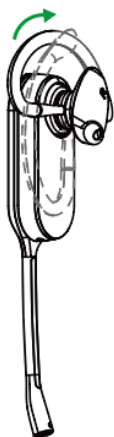

Left Ear

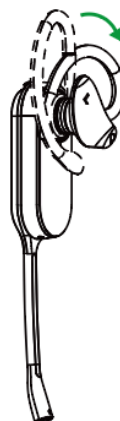

- Headband wearing style: comfortable to wear

The headset can be worn with the microphone on the left or the right.



- Neckband wearing style: preserve your hairstyle

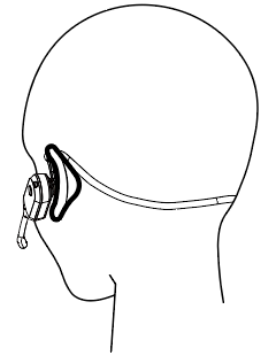
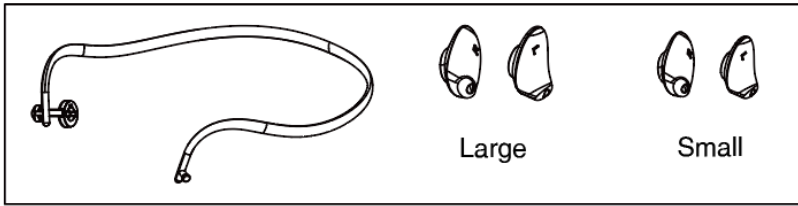

Right Ear

Left Ear

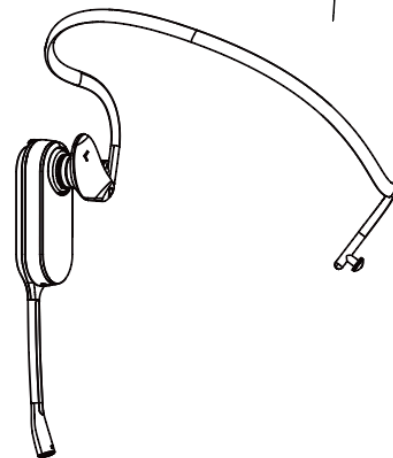
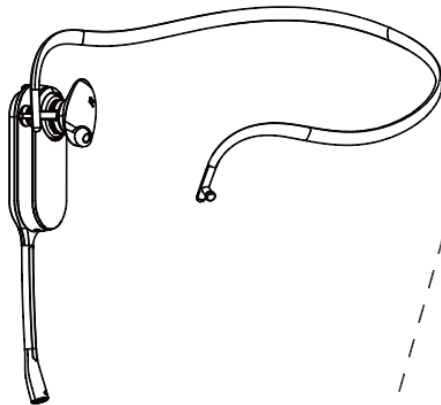

Remove the Pre-installed Eartip from the Headset

When you need to change the wearing styles, you can do the following:

1. Gently pull the eartip from the headset.

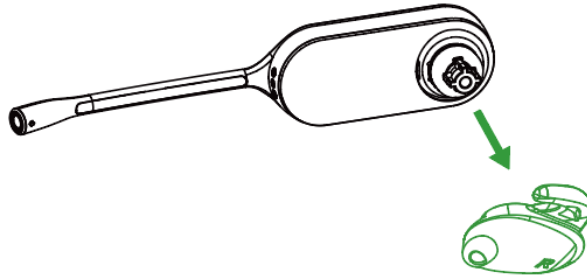

 **Note:** To wear the headset on the right ear but with a different size eartip or wear the headset on the left, select the size you want and reinstall in reverse order as shown.

Earhook & Eartip Assembly

The headset can be assembled for wearing on the left or right ear.

 **Note:** Before installing the earhook & eartip, remove the pre-installed eartip from the headset.

For Right ear:

1. Align the earhook ( port) as shown and insert it onto the headset. Be sure the earhook is flat against the headset and rotate the earhook up 90°.

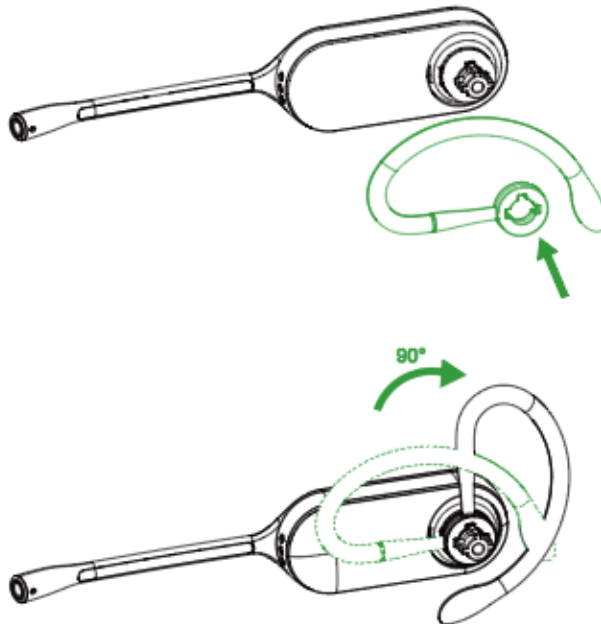

2. Choose the size of eartip that fits most comfortably. Align the eartip with the notch facing the microphone as shown. Press on to attach.

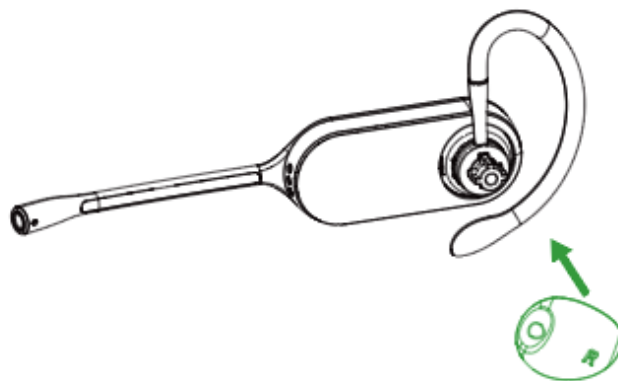

The earhook is flexible, and can be bent to suit your ear for a secure and comfortable fit.

For left ear:

The difference between the right ear and the left ear assembly is that the direction of the earhook is different.

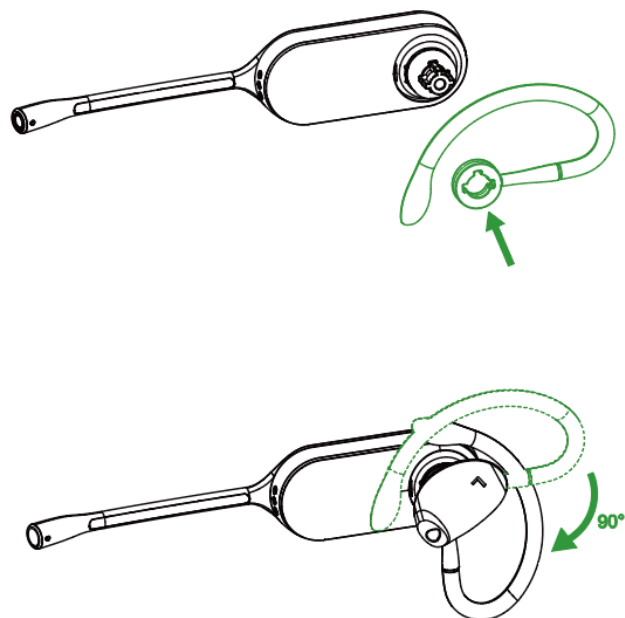

Related information

[Remove the Pre-installed Eartip from the Headset](#)

Headband Assembly

The headset can be rotated for wearing on the left or right ear.



Note: Before installing the headband, remove the pre-installed eartip from the headset.

For Right ear:

1. Hold the headband, so it is aligned to receive the headset as shown and insert the headset into the headband.

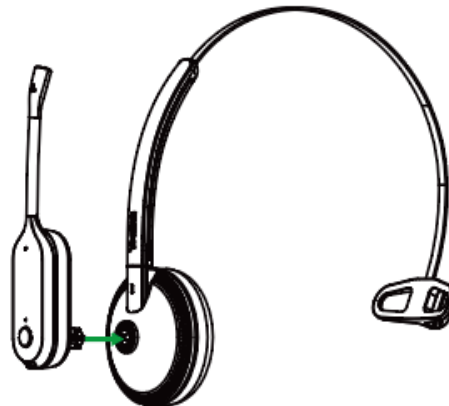

2. Rotate the headset down.



3. To optimize the position of the headset, push the headset in so the microphone is close to the corner of your mouth.

 **Note:** The headband is adjustable, and can be adjusted to the most comfortable fit.

For Left ear:



Related information

[Remove the Pre-installed Eartip from the Headset](#)

Neckband Assembly

The headset can be assembled for wearing on the left or right ear.



Note: Before installing the neckband, remove the pre-installed eartip from the headset.

For Right ear:

1. Align the short shot ( port) as shown and insert it onto the headset.

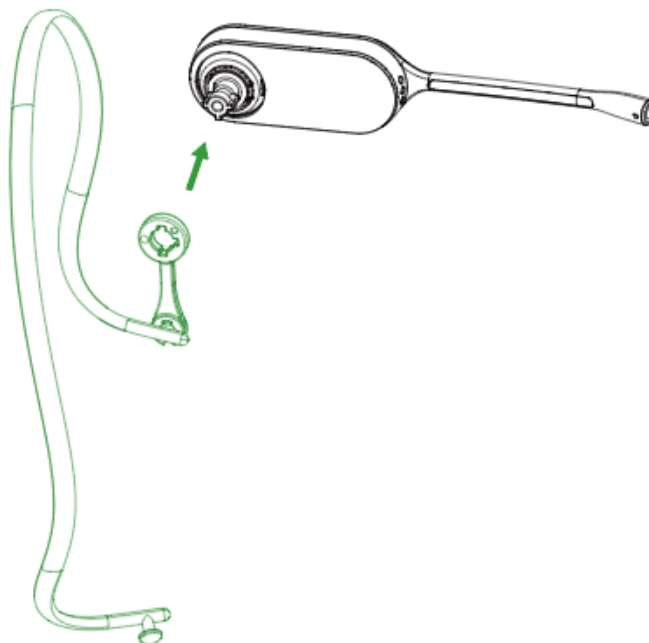

2. Choose the size of eartip that fits most comfortably. Align the eartip with the notch facing the microphone as shown. Press on to attach.

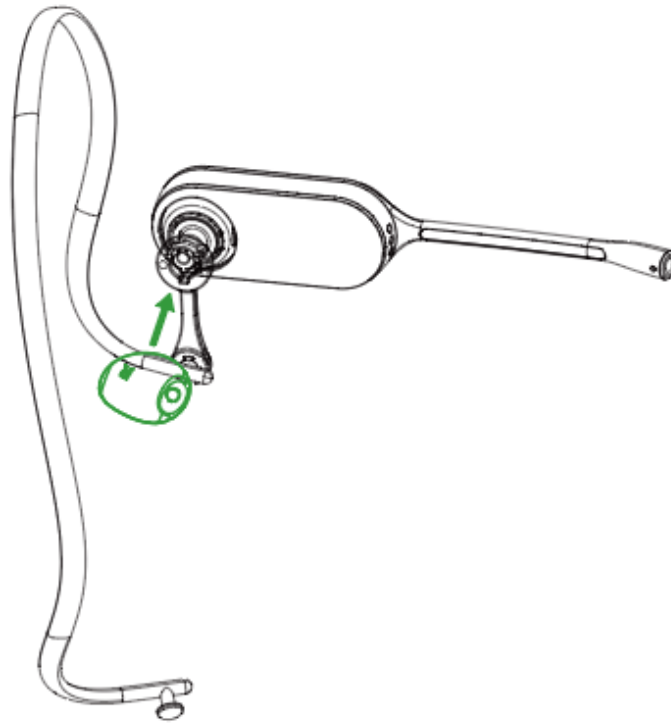

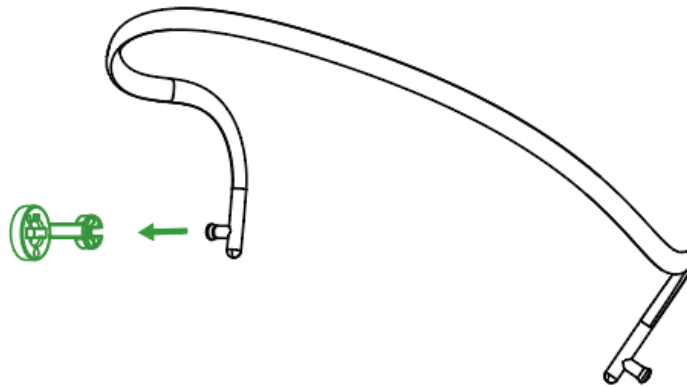

For Left ear:

1. Remove the pre-installed connecting rod.

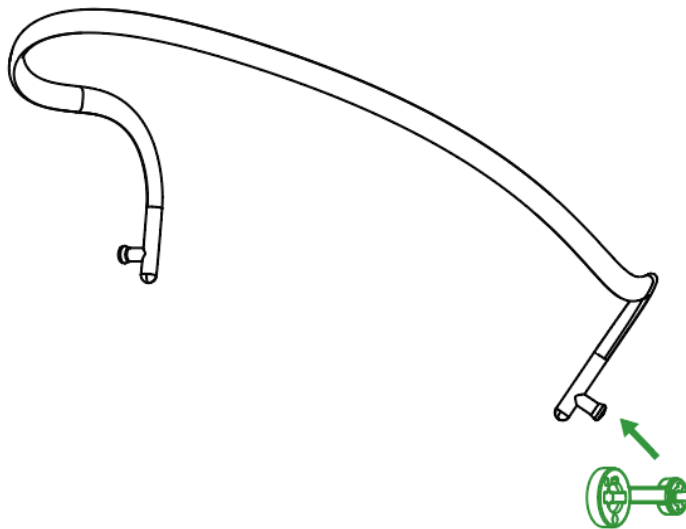

2. Install the connecting rod to the other end of the neckband.



3. Align the short shot ( port) as shown and insert it onto the headset.

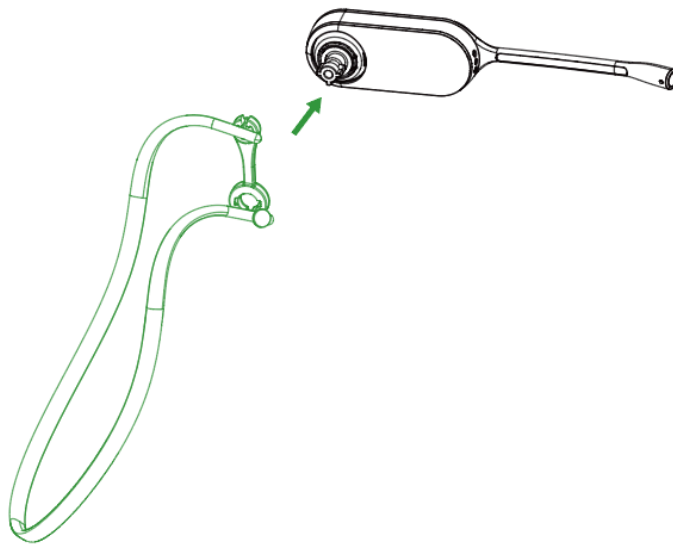

4. Choose the size of eartip that fits most comfortably. Align the eartip with the notch facing the microphone as shown. Press on to attach.

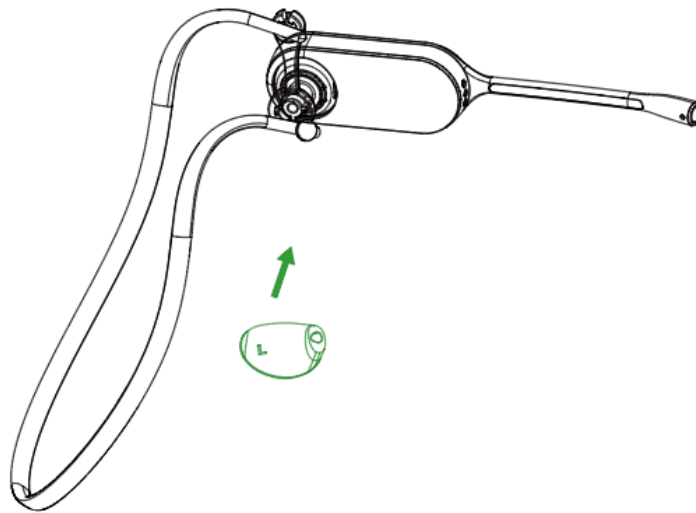

How to Use

Hardware Overview

WH62 Base & Headset Hardware

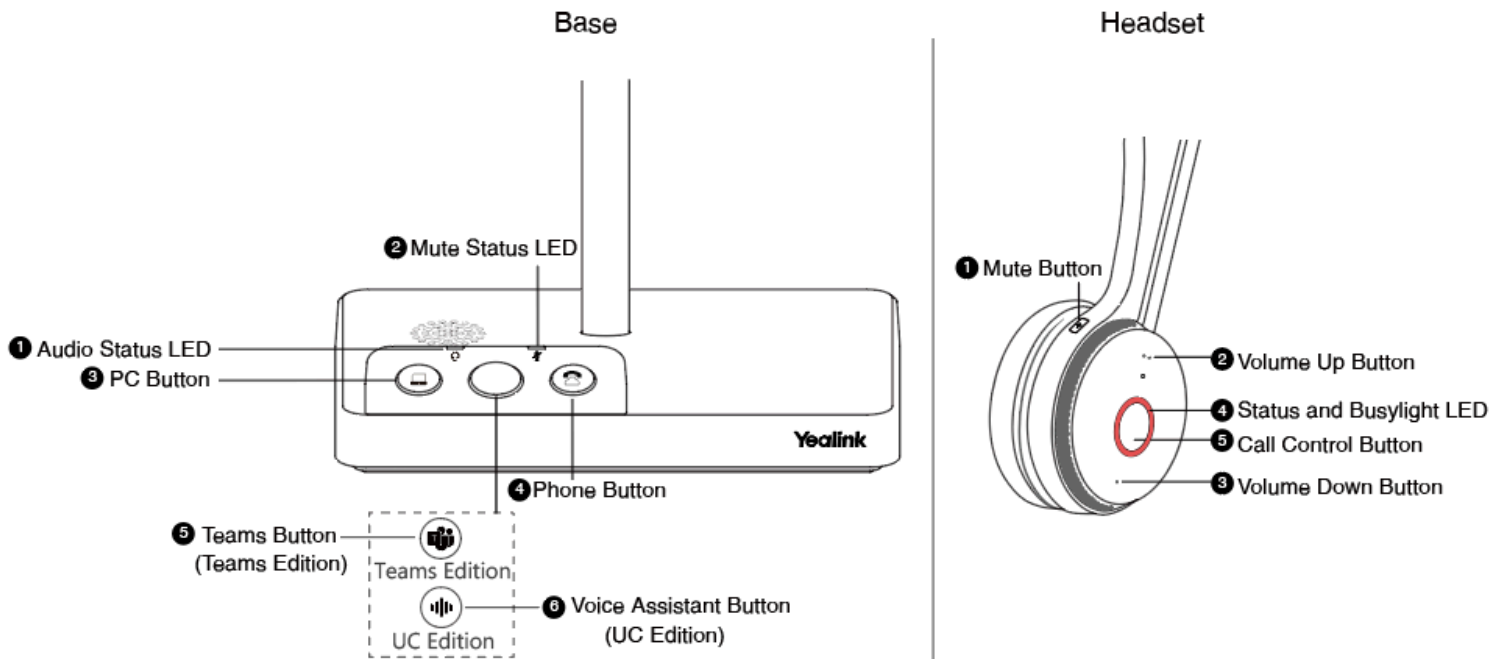

Name	Description
Base	

Name		Description
1	Audio Status LED	Alerts you to the audio status between base and headset. <ul style="list-style-type: none"> • Solid green: the audio connection between base and headset is normal • Flash orange: the headset is disconnected with base
2	Mute Status LED	Alerts you when your headset is muted.
3	PC Button	Press to enter the softphone dialing screen, answer, or end a softphone's call.
4	Phone Button	Press to enter the phone dialing screen, answer, or end a phone's call.
5	(Teams Edition) Teams Button	<ul style="list-style-type: none"> • Hold for 2 seconds to activate Cortana integrated in Teams (this requires Microsoft's support). • Press to invoke the Teams client in the idle state.
6	(UC Edition) Voice Assistant Button	Hold for 2 seconds to activate the voice assistant.
Headset		
1	Mute Button	Toggle the microphone on and off.
2	Volume Up Button	Adjust the volume on your headset.
3	Volume Down Button	
4	Status and Busylight LED	Indicates the charging, Teams, or call status.

Name		Description
5	Call Control Button	<p>Use to power the headset on and off.</p> <ul style="list-style-type: none"> • Hold for 3 seconds to power the headset on. • Hold for 3 seconds to power the headset off. <p>Incoming and active call management depends upon if you have one call or multiple calls.</p> <p>One call:</p> <ul style="list-style-type: none"> • Press once to answer an incoming call. • Double-press to reject an incoming call. • Press once to end a call. <p>Multiple calls:</p> <ul style="list-style-type: none"> • Hold for 2 seconds to answer an incoming call and put the active call on hold. • Hold for 2 seconds to switch between held call and active call. • Press once to end the current call and answer the incoming call. • Double-press to stay on a current call, and to reject a second incoming call. <p>Teams-related features:</p> <ul style="list-style-type: none"> • Hold for 2 seconds to activate Cortana integrated in Teams (this requires Microsoft's support). • Press once to invoke the Teams client in the idle state.

Related concepts

[Status and Busylight LED](#)

[WH62/WH63 Base Status LEDs](#)

WH63 Base & Headset Hardware

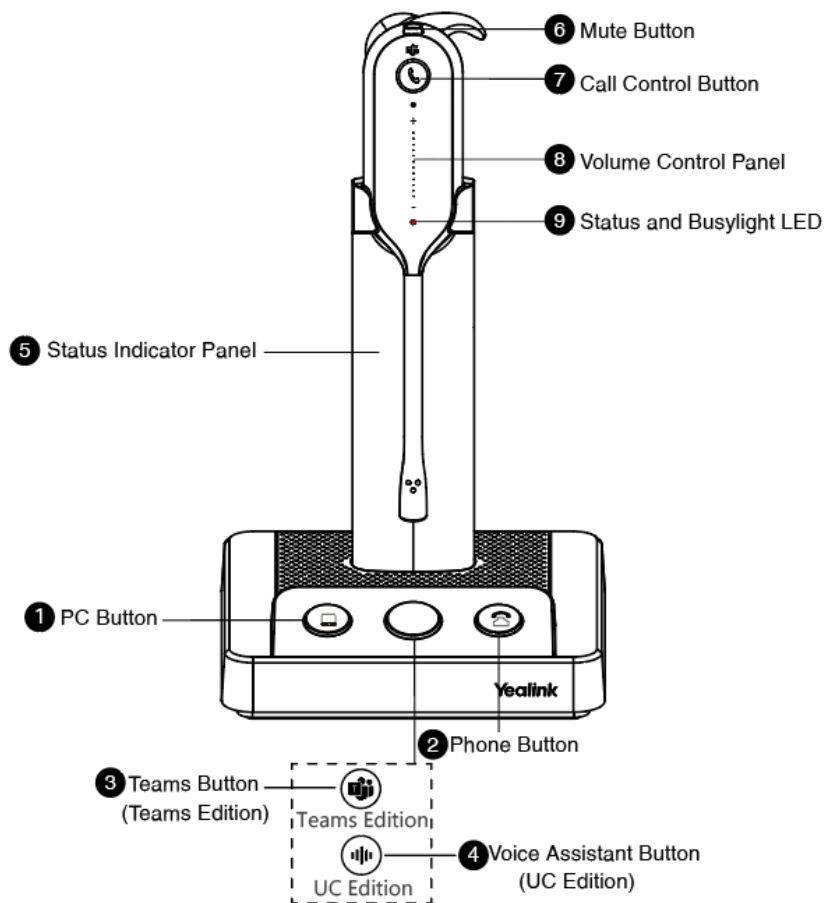

Name		Description
Base		
1	PC Button	Press to enter the softphone dialing screen, answer or end a softphone's call.
2	Phone Button	Press to enter the phone dialing screen, answer or end a phone's call.
3	(Teams Edition) Teams Button	<ul style="list-style-type: none"> Hold for 2 seconds to activate Cortana integrated in Teams (this requires Microsoft's support). Press to invoke the Teams client in the idle state.
4	(UC Edition) Voice Assistant Button	Hold for 2 seconds to activate the voice assistant.

Name		Description
5	Status Indicator Panel	<p>Indicate the mute status, audio status, and the headset battery status.</p> <p>For mute status LED:</p> <ul style="list-style-type: none"> • Solid white: unmuted • Solid red: muted <p>For headset status LED:</p> <ul style="list-style-type: none"> • Solid green: the audio connection between base and headset is normal • Flash orange: the headset is disconnected with base (power off/ out of range) <p>For headset battery status LED: indicates the headset battery status. No display after the headset is disconnected</p>
Headset		
6	Mute Button	Toggle the microphone on and off.
7	Call Control Button	<p>Use to power the headset on and off.</p> <ul style="list-style-type: none"> • Hold for 3 seconds to power the headset on. • Hold for 3 seconds to power the headset off. <p>Incoming and active call management depends upon if you have one call or multiple calls.</p> <p>One call:</p> <ul style="list-style-type: none"> • Press once to answer an incoming call. • Double-press to reject an incoming call. • Press once to end a call. <p>Multiple calls:</p> <ul style="list-style-type: none"> • Hold for 2 seconds to answer an incoming call and put the active call on hold. • Hold for 2 seconds to switch between held call and active call. • Press once to end the current call and answer the incoming call. • Double-press to stay on a current call, and to reject a second incoming call. <p>Teams-related features:</p> <ul style="list-style-type: none"> • Hold for 2 seconds to activate Cortana integrated in Teams (this requires Microsoft's support). • Press once to invoke the Teams client in the idle state.
8	Volume Control Panel	Adjust the volume on your headset.
9	Status and Busylight LED	Indicates the charging, Teams, or call status.

Related concepts

[Status and Busylight LED](#)

[WH62/WH63 Base Status LEDs](#)

WH66 Base & Headset Hardware

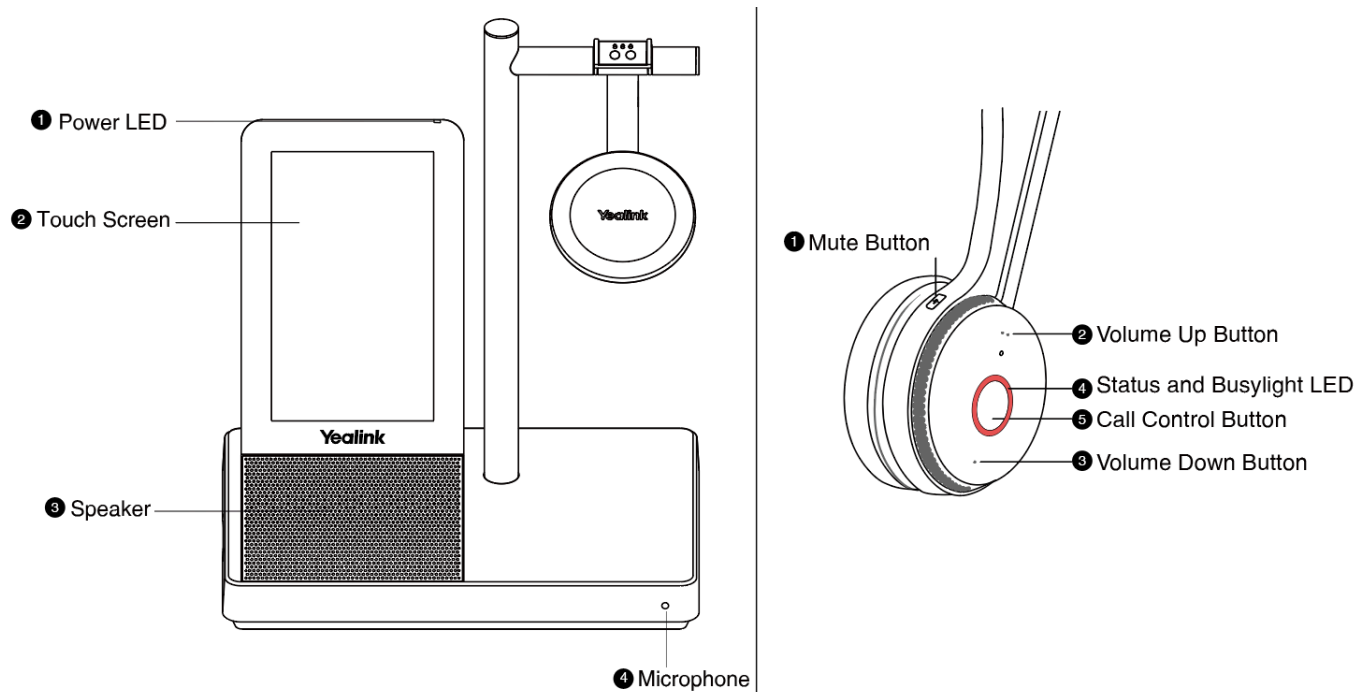

Name		Description
Base		
1	Power LED	Indicates the base status.
2	Touch Screen	<ul style="list-style-type: none"> Shows your headset's battery status, headset connection status, etc. Select items and navigate menus.
3	Speaker	Provide hands-free (speakerphone) audio output.
4	Microphone	Provide hands-free (speakerphone) audio input.
Headset		
1	Mute Button	<ul style="list-style-type: none"> Toggle the microphone on and off. Long press to switch between headset and speakerphone mode.
2	Volume Up Button	Adjust the volume on your headset.
3	Volume Down Button	
4	Status and Busylight LED	Indicates the charging, Teams, or call status.

Name		Description
5	Call Control Button	<p>Use to power the headset on and off.</p> <ul style="list-style-type: none"> • Hold for 3 seconds to power the headset on. • Hold for 3 seconds to power the headset off. <p>Incoming and active call management depends upon if you have one call or multiple calls.</p> <p>One call:</p> <ul style="list-style-type: none"> • Press once to answer an incoming call. • Double-press to reject an incoming call. • Press once to end a call. <p>Multiple calls:</p> <ul style="list-style-type: none"> • Hold for 2 seconds to answer an incoming call and put the active call on hold. • Hold for 2 seconds to switch between held call and active call. • Press once to end the current call and answer the incoming call. • Double-press to stay on a current call, and to reject a second incoming call. <p>Teams-related features:</p> <ul style="list-style-type: none"> • Hold for 2 seconds to activate Cortana integrated in Teams (this requires Microsoft's support). • Press once to invoke the Teams client in the idle state.

Related concepts

[Status and Busylight LED](#)

WH67 Base & Headset Hardware

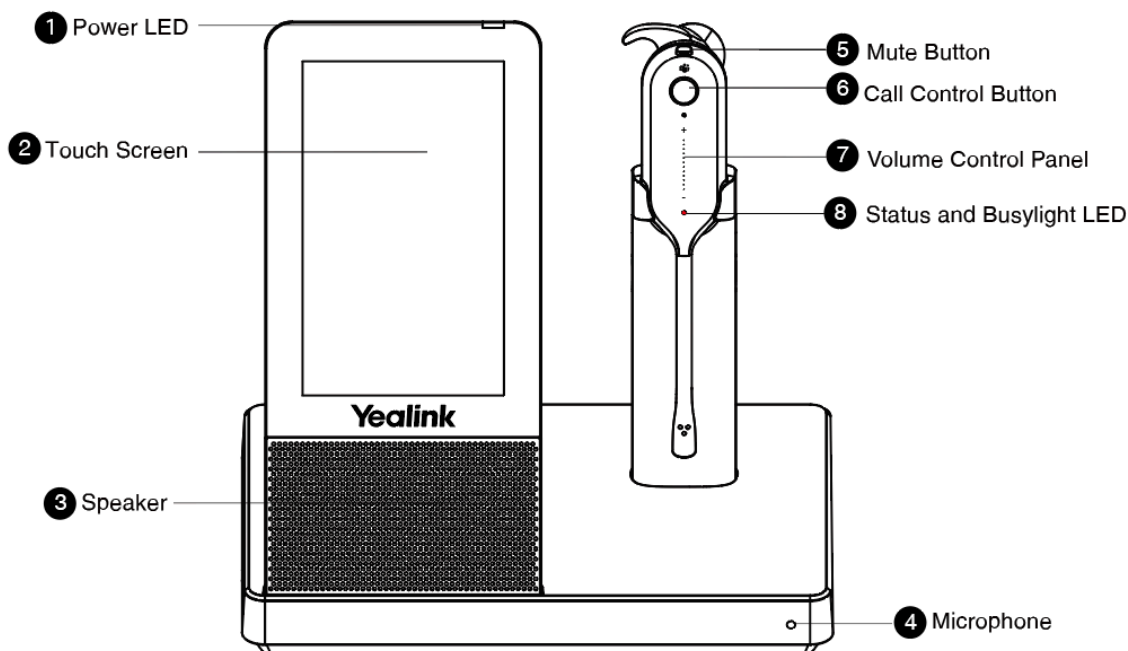

Name		Description
Base		
1	Power LED	Indicates the base status.
2	Touch Screen	<ul style="list-style-type: none"> Shows your headset's battery status, headset connection status, etc. Select items and navigate menus.
3	Speaker	Provide hands-free (speakerphone) audio output.
4	Microphone	Provide hands-free (speakerphone) audio input.
Headset		
5	Mute Button	<ul style="list-style-type: none"> Toggle the microphone on and off. Long press to switch between headset and speakerphone mode.
6	Call Control Button	<p>Use to power the headset on and off.</p> <ul style="list-style-type: none"> Hold for 3 seconds to power the headset on. Hold for 3 seconds to power the headset off. <p>Incoming and active call management depends upon if you have one call or multiple calls.</p> <p>One call:</p> <ul style="list-style-type: none"> Press once to answer an incoming call. Double-press to reject an incoming call. Press once to end a call. <p>Multiple calls:</p> <ul style="list-style-type: none"> Hold for 2 seconds to answer an incoming call and put the active call on hold. Hold for 2 seconds to switch between held call and active call. Press once to end the current call and answer the incoming call. Double-press to stay on a current call, and to reject a second incoming call. <p>Teams-related features:</p> <ul style="list-style-type: none"> Hold for 2 seconds to activate Cortana integrated in Teams (this requires Microsoft's support). Press once to invoke the Teams client in the idle state.
7	Volume Control Panel	Adjust the volume on your headset.
8	Status and Busylight LED	Indicates the charging, Teams, or call status.

Related concepts

[Status and Busylight LED](#)

WH62/WH63 Base Status LEDs















LED	Base State
PC/desk phone button	
Off	PC/desk phone device is not connected
Glows white	PC/desk phone device is connected and in the idle status
Glows green	In the call
Fast flashes green	Ringing
Flashes green in double	Hold
Teams button	
Off	Teams disconnected
Glows white	Teams connected
Slowly-flashing white	Receive missed calls/voice mails/Teams connecting

Status and Busylight LED

The status and busylight LED can indicate the charging or call status of the headset.

LED	Headset State
Off	Power off / idle (not on the base)
Slowly flashes red	Battery < 5% (low battery)
Flashes red and green alternatively	Firmware update
Slowly flashes orange	Out of range
Situations related to Charging	
Flashes red	Battery between 0% and 19%
Flashes green	Battery between 20% and 100%
Glows green	Battery 100% (full)
Situations related to Calls	
Note: You can turn off busylight through Yealink USB Connect, the busylight will be on only when there is an incoming call. It can optimize battery performance.	
Fast flashes red	Ringing
Glows red	In the call / mute
Flashes red in double	Hold
Situations related to Teams	
Glows purple	Connecting with Teams
Flashes purple	Missed call/voice message notification

WH66/WH67 Icons and Status Indicators

Icon	Description
	Battery capacity status
	Battery charging status
	One headset connected (idle)
	Two headsets connected (idle)
	Three headsets connected (idle)
	Four headsets connected (idle)
	One headset in use
	Two headsets in conference mode
	Three headsets in conference mode
	Four headsets in conference mode
	Smartphone
	Desk phone
	PC Note: When the WH66/WH67 is connected to the desk phone using USB, the screen displays the PC icon. It does not affect the performance of the base and phone.
	Bluetooth mode is on, but no mobile device is connected
	Bluetooth mode is on, and a mobile device is connected

Adjust the Playback Volume

1. On the WH66/WH67 base, do one of the following:

- Swipe down from the top of the screen.
Drag the slider to adjust the volume quickly.
- For UC version:

Tap .

Go to **Basic Settings > Speaker Volume**.

Tap the desired value.

- For Teams version:

Tap  or the user account avatar.

Go to **Settings > Basic Settings > Speaker Volume**.

Tap the desired value.

2. On the WH62/WH66 headset, press the **Volume Up/Volume Down** button.

3. On the WH63/WH67 headset, slide up or down on the volume control panel.



Note: For WH66/WH67, while you are on a call, you cannot adjust the playback volume, and you can only adjust the call volume.

How to Reset to Factory

Resetting configuration clears the list of paired devices and resets all settings.

Reset Configuration on WH62/WH63 Base

Hold the **PC** button and **Phone** button for 6 seconds.

The base will reboot and all settings will return to their default values.

Reset Configuration on WH66/WH67 Base

1. Do the following:

- For Teams version:

Tap  or the user account avatar.

Go to **Settings > Advanced Settings > Reset Configuration**.

- For UC version:

Tap .

Go to **Advanced Settings > Reset Configuration**.

The screen prompts you whether to reset configuration or not.

2. Confirm the action.

The base will reboot and all settings will return to their default values.

How to Manage Calls

Basic Call Usage on Headset

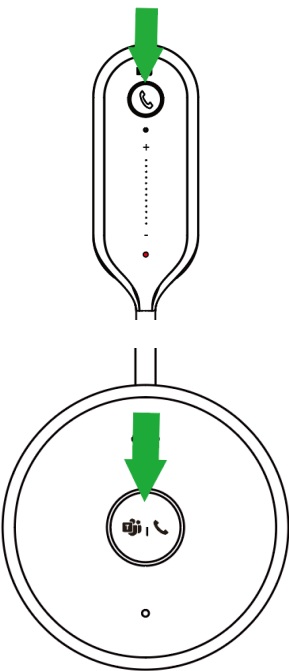
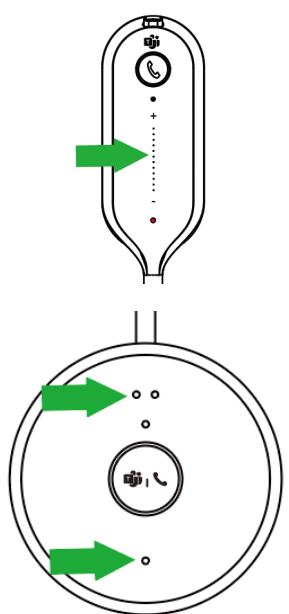
Headset	Function	Action
	Answer call	Press the Call Control button or undock the headset (determined by the value of "Auto Answer when undocked").
	End call	Press the Call Control button or dock the headset. Note: When the headset disconnects from the base for 1 minute during a call, the call will automatically hang up.
	Reject call	Double-press the Call Control button.
	Redial	Double-press the Call Control button.
	Hold/resume call	Hold the Call Control button for 2 seconds.
	Adjust volume	For WH63/WH67: slide up/down on the volume control panel. For WH62/WH66: press the Volume Up/Volume Down button.

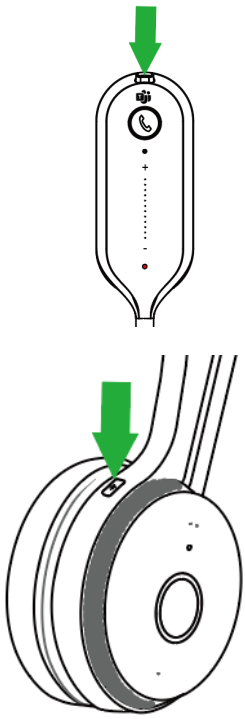
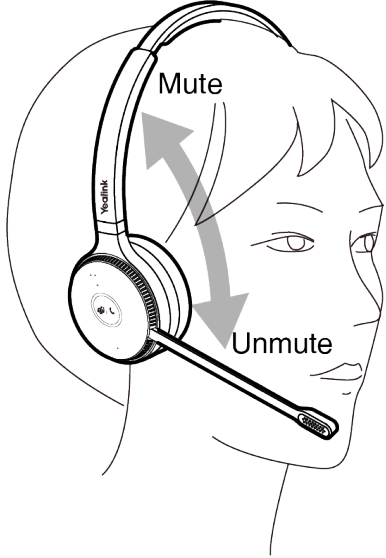
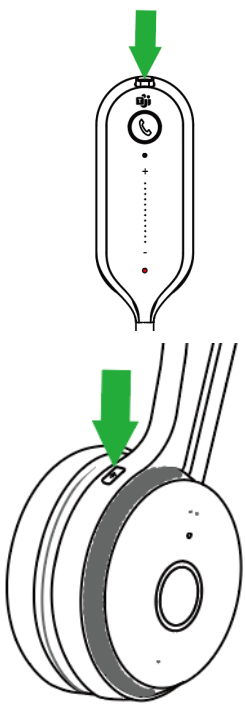
Headset	Function	Action
	<p>Mute/un-mute microphone</p>	<p>Press the Mute button.</p> <p>For WH62/WH66, you can also move the microphone boom-arm up/down to mute/unmute.</p> 
	<p>Switch between headset and speakerphone mode</p>	<p>Long press the Mute button.</p> <p>Note: It is only applicable to WH66/WH67.</p>







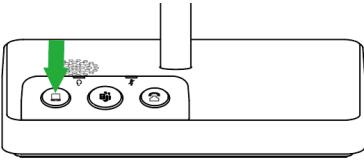
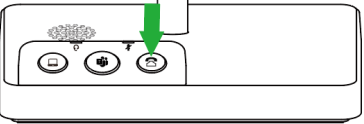
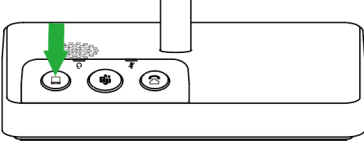
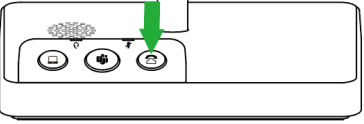
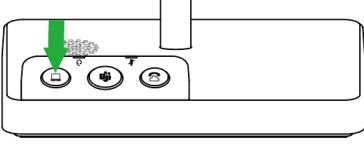
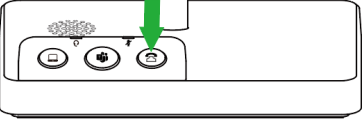























Note: For WH66/WH67, the call will automatically switch to the headset channel during a hands-free call after the headset reconnects.

Basic Call Usage on WH62/WH63 Base

WH62/WH63 Base	Function	Action
	Answer/end a softphone's call	Press the PC button.
	Answer/end a desk phone's call	Press the Phone button.
	Reject a softphone's call	Double-press the PC button.
	Reject a desk phone's call	Double-press the Phone button.
	Redial a softphone's call	Double-press the PC button.
	Redial a desk phone's call	Double-press the Phone button.

Basic Call Usage on WH66/WH67 Base

Function	Action
Place a new call	<ol style="list-style-type: none"> 1. Tap the connected device CARD or  (Teams version)/ (UC version). 2. Enter the desired number. 3. Select the desired outgoing dialing device. 4. Tap Call.
Place a call from the directory	<ol style="list-style-type: none"> 1. Tap  > Contacts (Teams version)/ (UC version). 2. Select the desired contact group and find the desired contact. 3. Tap the contact to enter the detail screen. 4. Tap .

Function	Action
Place a call from the call history	<ol style="list-style-type: none"> 1. Tap  > History or tap  >  (Teams version). Tap  or , and tap  (UC version). 2. Select the desired call record to place a call.
Answer call	Tap  .
End call	Tap  .
Reject call	(Teams version) Tap  . (UC version) Tap  .
Silence a call (UC version)	Tap  .
Hold call	(Teams version) Tap  . (UC version) Tap  > Hold .
Resume call	Tap Resume .
Adjust volume	(Teams version) Tap  and drag the slider. (UC version) Tap  or  .
Mute/un-mute microphone	(Teams version) Tap  /  . (UC version) Tap  /  .
Place a new call during a call	Tap  > New call .
Redial	<ol style="list-style-type: none"> 1. Tap  or the user account avatar. 2. Tap Redial. 3. Select a device to redial. <p> Note: It is only available for Teams version.</p>

Merge Two Calls on WH62/WH63

You can merge two calls into one conference call.

- The base is connected to the PC and phone via USB.
- There is an active softphone call and an active phone call on the base.

1. Hold the **PC** button and **Phone** button for 2 seconds.

Two calls are merged.



2. To split the conference, hold the **PC** button or **Phone** button for 2 seconds.

After splitting the conference, the call corresponding to the button is active, and the other one is placed on hold.

Merge Two Calls on WH66/WH67

You can merge two calls into one conference call.

There are two calls on the base, and one of them is on the connected USB device.

1. Tap  > **Merge Calls**.
2. To split the conference, tap  > **Split Conf**.

Multi-Headset Conference Calls

Up to three additional headsets can be connected to one base for conferencing.

Add Additional Headset(s) During a Call

1. Dock an additional headset in the primary headset's base.
For WH66/WH67, you can also go to  > **Add Headset**.
A tone indication will play in the primary headset.
2. Press the **Call Control** button on the primary headset to accept the additional headset to the conference.

The audio will now be shared between headsets.

Additional headsets are muted by default when they pair.

 **Note:** When the call ends, the additional headset will disconnect from the base. Additional headsets use their own tuning settings while in conferencing mode. You can mute and adjust the volume in your headset without changing the settings on any other paired headsets.

Add Additional Headset(s) When the Base is Idle

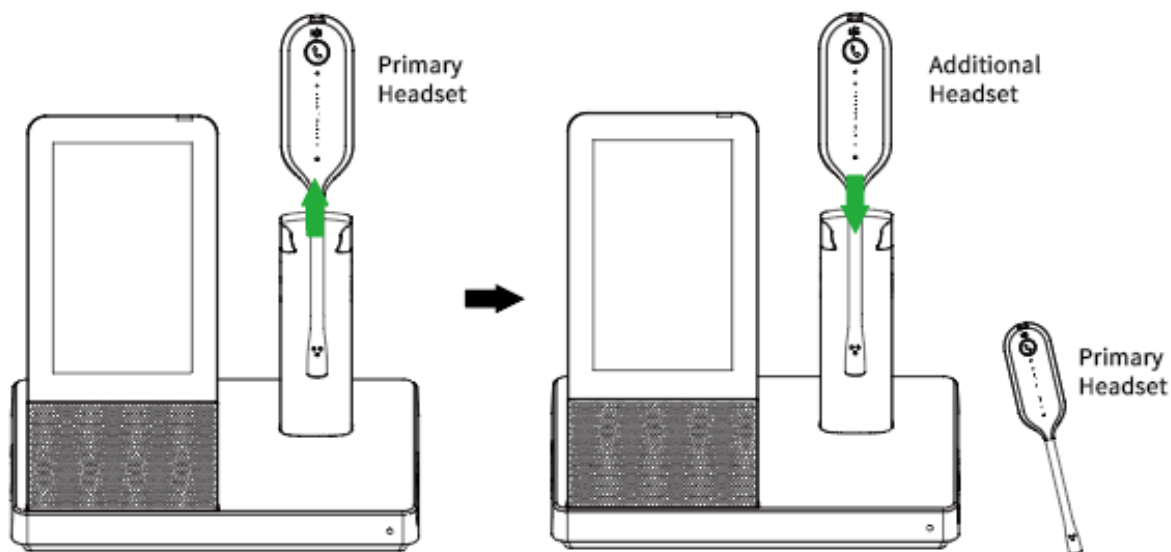

1. Undock the primary headset.
2. Dock an additional headset in the primary headset's base.
For WH66/WH67, you can also tap  or the user account avatar, then go to **Settings > Basic Settings > Add Headset > +**.
3. For WH66/WH67, select **As secondary** to add the headset as an additional conference headset.
A tone indication will play in the primary headset.

4. Press the **Call Control** button on the primary headset within 10s to accept the additional headset to the conference.

Once the call is established by primary headset, the audio will be shared between headsets. When the call ends, the additional headset will disconnect from the base.

By default, the additional headset will be muted.



Note: Additional headsets use their own tuning settings while in conferencing mode. You can mute and adjust the volume in your headset, but it does not affect any other paired headsets.

Add Additional Headset(s) without Docking

1. Power off the additional headset by pressing the **Call Control button** for 3 seconds without docking until you hear "power off".
2. Put the additional headset into pairing mode by pressing the **Call Control button** for 5 seconds until you hear "power on", and the button flashes orange.
3. Put the base into pairing mode.
 - For WH62/WH63 in idle state, press the **PC button** for 5 seconds until the button flashes green and white.
 - For WH66/WH67 during a call, go to **● > Add Headset > Pair without docking**.

A tone indication will play in the primary headset.

4. Press the **Call Control** button on the primary headset within 10s to accept the additional headset.

When the additional headset is added successfully, you will hear "new headset joined" in the primary headset.

End or Leave a Conference Call

- To end the conference for all headsets:
 1. Press the **Call Control** button on the primary headset, or dock the primary headset in the base.
- To leave the conference:
 1. Press the **Call Control** button on the additional headset, the conference call will continue for all other headsets.

Transfer a Call from Desk Phone to Headset

- The base is connected to the Yealink phone via USB.
- A call is answered on the phone using the handset or speakerphone.

1. For WH62/WH63, do one of the following:

- Press the **Call Control** button on the headset.
- Lift the headset from the base.

If necessary, press the HEADSET key on the desk phone. The audio will transfer from the desk phone to the headset.

2. For WH66/WH67, press the HEADSET key on the desk phone.

The audio will transfer from the desk phone to the headset.

Transfer a Call from Headset to Desk Phone

- The base is connected to the Yealink phone.

- A call is answered on the headset.

Do one of the following on the desk phone:

- Pick up the handset.
- Press the speakerphone key.

The audio will transfer from the headset to the desk phone.

Multiple Calls Handling

The headset and base can accept and handle multiple calls at the same time.

Multiple Call Handling	Action
End the current call and answer the incoming call	Press the Call Control button.
Put current call on hold and answer the incoming call	Hold the Call Control button for 2 seconds. For WH66/WH67, you can also answer on the base.
Switch between held call and active call	Hold the Call Control button for 2 seconds. For WH66/WH67, you can also tap  (for Teams version) / tap the held call (for UC version) on the base.
Reject incoming call, while on a current call	Double-press the Call Control button. For WH66/WH67, you can also reject on the base.







Local Directory

WH66/WH67 supports operations such as adding, editing, and deleting contacts through the screen.







Local Contacts

You can store up to 1500 contacts in your Local Contacts.







Add a New Local Contact

1. Do the following:
 - For Teams version:
Tap  > **Contacts** or tap  > .
 - For UC version:
Tap  or tap  > .
2. Select the **Local Contacts** list.
3. Tap .
4. Enter your contact's information.
5. Tap **Done**.

View Local Contacts







- Do the following:
 - For Teams version:
Tap  > **Contacts** or tap  > .
 - For UC version:
Tap  or tap  > .
- Select the **Local Contacts** list.
- Tap the desired contact to view the details.

Search for Local Contacts







- Do the following:
 - For Teams version:
Tap  > **Contacts** or tap  > .
 - For UC version:
Tap  or tap  > .
- Select the **Local Contacts** list.
- Tap .
- Enter your search criteria.

The contacts whose name or phone number matches the search string will be displayed in the result list.







Edit Local Contacts

- Do the following:
 - For Teams version:
Tap  > **Contacts** or tap  > .
 - For UC version:
Tap  or tap  > .
- Select the **Local Contacts** list.
- Tap the desired contact.
- Tap .
- Edit the contact information.
- Tap **Done**.

Delete a Local Contact







- Do the following:
 - For Teams version:
Tap  > **Contacts** or tap  > .
 - For UC version:
Tap  or tap  > .
- Select the **Local Contacts** list.
- Tap the desired contact to enter the detail screen.
- Tap **Delete** > **Yes**.

Delete Multiple or All Local Contacts

1. Do the following:
 - For Teams version:
Tap  > **Contacts** or tap  > .
 - For UC version:
Tap  or tap  > .
2. Select the **Local Contacts** list.
3. Long tap the contact.
4. Select the desired contacts or select all.
5. Tap  > **Delete** > **Yes**.

Move Local Contacts to the Favorite/Blocklist

You can move local contacts to the Favorite/Blocklist. After a contact is moved to Favorite/Blocklist, the contact is automatically deleted from the original list.

1. Do the following:
 - For Teams version:
Tap  > **Contacts** or tap  > .
 - For UC version:
Tap  or tap  > .
2. Select the **Local Contacts** list.
3. Long tap the contact.
4. Select the desired contacts or select all.
5. Tap  > **Favorites**.

Mobile Contacts

You can sync mobile phone contacts to WH66/WH67 via Bluetooth, up to 500 contacts can be stored.







1. Connect your Bluetooth-enabled mobile phone to WH66/WH67.
2. Enable the Contact Sharing feature in your phone.

Related tasks

[Connect to Smartphone](#)







Update the Mobile Contacts



You can update the Mobile Contacts to synchronize the contacts you add, edit, and delete on the mobile phone to your WH66/WH67.

1. Do the following:
 - For Teams version:
Tap  > **Contacts** or tap  > .
 - For UC version:
Tap  or tap  > .
2. Select your Mobile Contacts list.
3. Tap .







Save Mobile Contacts to the Local Contacts/Favorite/Blocklist

You can save any mobile contact to the Local Contacts, to conveniently call this contact after disconnecting the mobile phone from the WH66/WH67.

1. Do the following:
 - For Teams version:
Tap  > **Contacts** or tap  > .
 - For UC version:
Tap  or tap  > .
2. Select your Mobile Contacts list.
3. Tap the desired contact.
4. Tap .
5. Select the contact group such as Local Contacts, Favorite, Blocklist.
6. Optional: Edit your contact's information.
7. Tap **Done**.

-  **Note:** To quickly download more Mobile contacts, do the following:
- a. Long tap any contact.
 - b. Select the desired contacts or select all.
 - c. tap  > **Local Contacts/Favorite/Blocklist**.

Search for Mobile Contacts







1. Do the following:
 - For Teams version:
Tap  > **Contacts** or tap  > .
 - For UC version:
Tap  or tap  > .
2. Select your Mobile Contacts list.
3. Tap .
4. Enter your search criteria.

The contacts whose name or phone number matches the search string will be displayed in the result list.

Favorite

Favorites are the contacts in your Local Directory that you call most often, up to 100 favorite contacts can be stored.

Add a New Contact to Your Favorites

1. Do the following:
 - For Teams version:
Tap  > **Contacts** or tap  > .
 - For UC version:
Tap  or tap  > .
2. Select the **Favorite** list.

3. Tap .
4. Enter your contact's information.
5. Tap **Done**.









Note:

- To quickly move contacts to Favorites, see [Move Local Contacts to the Favorite/Blocklist](#).
- To download a Mobile contact to Favorites, see [Save Mobile Contacts to the Local Contacts/Favorite/Blocklist](#).

View Favorites



1. Do the following:
 - For Teams version:





Tap  > **Contacts** or tap  > .
 - For UC version:

Tap  or tap  > .
2. Select the **Favorite** list.
3. Tap the desired contact to view the details.

Search for Favorites

1. Do the following:
 - For Teams version:



Tap  > **Contacts** or tap  > .
 - For UC version:





Tap  or tap  > .
2. Select the **Favorite** list.
3. Tap .
4. Enter your search criteria.

The contacts whose name or phone number matches the search string will be displayed in the result list.







Edit Favorites

1. Do the following:
 - For Teams version:







Tap  > **Contacts** or tap  > .
 - For UC version:

Tap  or tap  > .
2. Select the **Favorite** list.
3. Tap the desired contact.
4. Tap .
5. Edit the contact information.
6. Tap **Done**.

Delete a Favorite

- Do the following:
 - For Teams version:
 - Tap  > **Contacts** or tap  > .
 - For UC version:
 - Tap  or tap  > .
- Select the **Favorite** list.
- Tap the desired contact to enter the detail screen.
- Tap **Delete** > **Yes**.







Delete Multiple or All Favorites

- Do the following:
 - For Teams version:
 - Tap  > **Contacts** or tap  > .
 - For UC version:
 - Tap  or tap  > .
- Select the **Favorite** list.
- Long tap the contact.
- Select the desired contacts or select all.
- Tap  > **Delete** > **Yes**.

Blocklist

You can store up to 100 contacts in your Blocklist. Incoming calls from the Blocklist will be rejected automatically.

Add a New Contact to Your Blocklist

- Do the following:
 - For Teams version:
 - Tap  > **Contacts** or tap  > .
 - For UC version:
 - Tap  or tap  > .
- Select the **Blocklist** list.
- Tap .
- Enter your contact's information.
- Tap **Done**.









Note:

- To quickly move contacts to Blocklist, see [Move Local Contacts to the Favorite/Blocklist](#).
- To download a Mobile contact to Favorites, see [Save Mobile Contacts to the Local Contacts/Favorite/Blocklist](#).

View Blocklist Contacts



- Do the following:
 - For Teams version:





Tap  > **Contacts** or tap  > .
 - For UC version:

Tap  or tap  > .
- Select the **Blocklist** list.
- Tap the desired contact to view the details.

Edit Blocklist Contacts



- Do the following:
 - For Teams version:



Tap  > **Contacts** or tap  > .
 - For UC version:

Tap  or tap  > .
- Select the **Blocklist** list.
- Tap the desired contact.
- Tap .
- Edit the contact information.
- Tap **Done**.

Delete a Blocklist Contact



- Do the following:
 - For Teams version:





Tap  > **Contacts** or tap  > .
 - For UC version:

Tap  or tap  > .
- Select the **Blocklist** list.
- Tap the desired contact to enter the detail screen.
- Tap **Delete** > **Yes**.







Delete Multiple or All Blocklist Contacts

- Do the following:
 - For Teams version:

Tap  > **Contacts** or tap  > .
 - For UC version:

Tap  or tap  > .
- Select the **Blocklist** list.
- Long tap the contact.
- Select the desired contacts or select all.
- Tap  > **Delete**.

Move Blocklist Contacts to the Local Contacts



1. Do the following:
 - For Teams version:
Tap  > **Contacts** or tap  > .
 - For UC version:
Tap  or tap  > .
2. Select the **Blocklist** list.
3. Long tap the contact.
4. Select the desired contacts or select all.
5. Tap ... > > **Local Contacts/Favorites**.

Call History

WH66/WH67 supports operations such as adding, editing, and outgoing call history, up to 300 histories can be stored.







Call History Icons

Each icon in the Call History indicates the corresponding call history status.

Icons	Description
	Missed Call
	Placed Call
	Received Call









View History Records

The history record saves the call information such as the caller's name, number and call duration.

1. Do the following:
 - For Teams version:
Tap  > **History**.
Or tap  > .
 - For UC version:
Tap  or , and select .
2. Select the desired list to view the history.
3. Select the desired call history and tap .







Add a History Record to Local Contacts

To identify someone's call the next time, you can save a history record to the Local Contacts.









1. Do the following:
 - For Teams version:
Tap  > **History** or tap  > .
 - For UC version:
Tap  or  and select .
2. Select the desired list.
3. Select the desired call history and tap  to enter the detail screen.
4. Tap  > **Add**.
5. Edit the contact information.
6. Tap **Done**.

Add History Records to Local Contacts/Favorite/Blocklist







You can add multiple histories directly to your local contacts/Favorite/Blocklist.

1. Do the following:
 - For Teams version:
Tap  > **History** or tap  > .
 - For UC version:
Tap  or  and select .
2. Select the desired list.
3. Long tap the history.
4. Choose the desired histories or choose all.
5. Tap  > **Local Contacts/Favorite/Blocklist**.

Edit Call History before Calling

1. Do the following:
 - For Teams version:
Tap  > **History** or tap  > .
 - For UC version:
Tap  or  and select .
2. Select the desired list.
3. Select the desired call history and tap  to enter the detail screen.
4. Tap  > **Edit before calling**.
5. Edit the number and tap **Call**.

Delete History Records

- Do the following:
 - For Teams version:
 - Tap  > **History** or tap  > .
 - For UC version:
 - Tap  or  and select .
- Select the desired list.
- Long tap the history.
- Choose the desired histories or choose all.
- Tap  > **Delete** > **Yes**.

Yealink USB Connect

Yealink USB Connect is a computer software designed to manage Yealink USB devices.

With Yealink USB Connect, you can:

- Get an overview of connected Yealink USB devices
- Manage your Yealink USB devices (for example, change basic/advanced settings, BT50 pair management)
- Update your Yealink USB device to enhance its performance and features
- Give feedback on your Yealink USB device

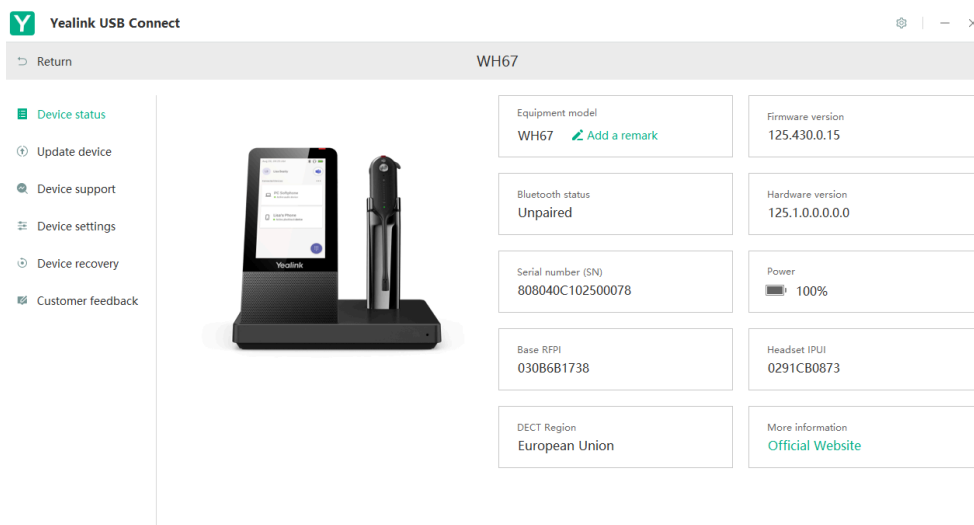

For more information on Yealink USB Connect, refer to [Yealink USB Device Manager Client User Guide](#).

Manually Pair the Base with the BT50

Make sure that the base is in the Bluetooth pairing mode or is connected to the same PC with BT50.

- Select BT50 device CARD.
- Click **Pair Management**.

- In the **Pairable devices List** field, click  to search the pairable device.
- Find the desired device and click **Start pairing**.

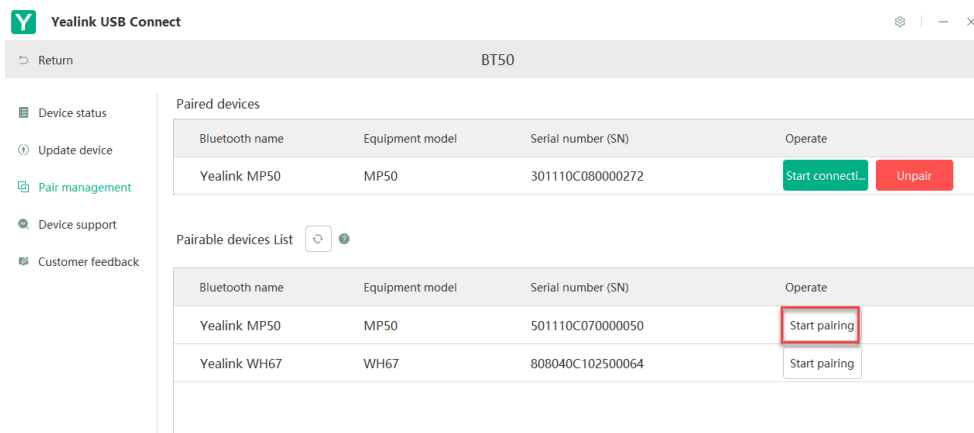

-  **Note:** Once the BT50 is paired with your device, you can delete the corresponding pairing information on WH66/WH67 only when you reset the device to the factory. The WH66/WH67 only saves the pairing information of one BT50. After pairing a new BT50, WH66/WH67 will automatically delete the old BT50 pairing information. For more information on how to pair and delete pairing information on BT50, refer to [Yealink USB Device Manager Client User Guide](#).

Download and Install

Connect the base to your PC.

- If it is the first time to connect the base to your PC, the PC prompts you as shown below:

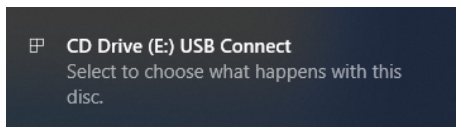

- Click the prompt box and run the program.

CD Drive (E:) USB Connect

Choose what to do with this disc.

Install or run program from your media

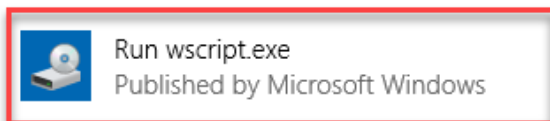

Other choices

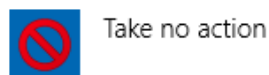
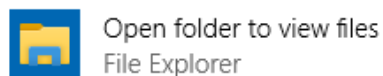

3. Download the Yealink USB Connect on the web page.

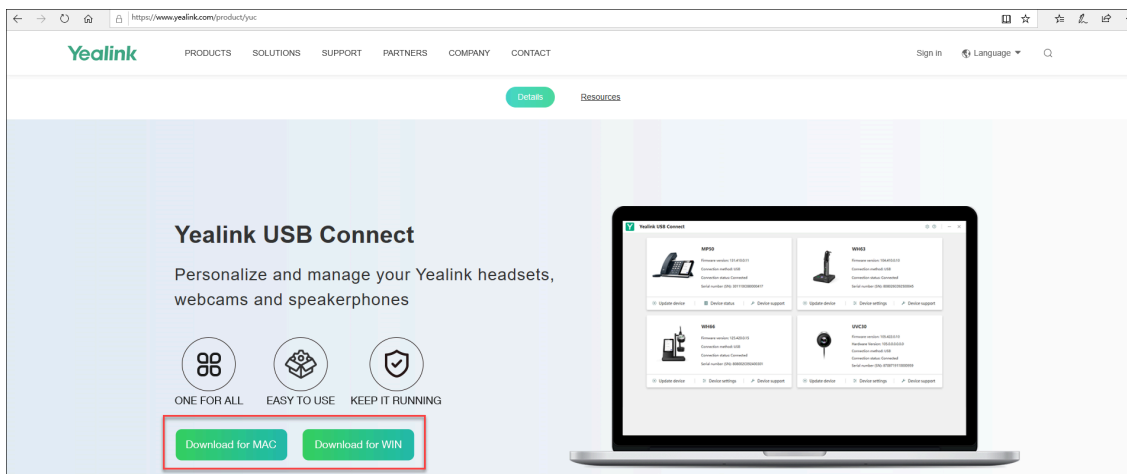

If the prompt box disappears, you can double-click the **CD drive: USB Connect** in the devices and drives list.

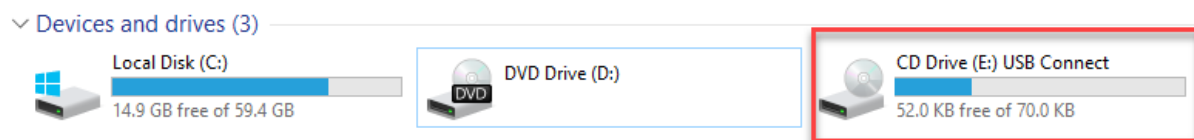

Download the Yealink USB Connect on the web page.



Note: If it detects that Yealink USB Connect has been installed after connecting, Yealink USB Connect will automatically run.

Update Firmware

1. Connect the base to the power supply and PC.
2. Dock the headset in a base.

3. Update the base firmware via Yealink USB Connect.

- Check for updates
- Update manually

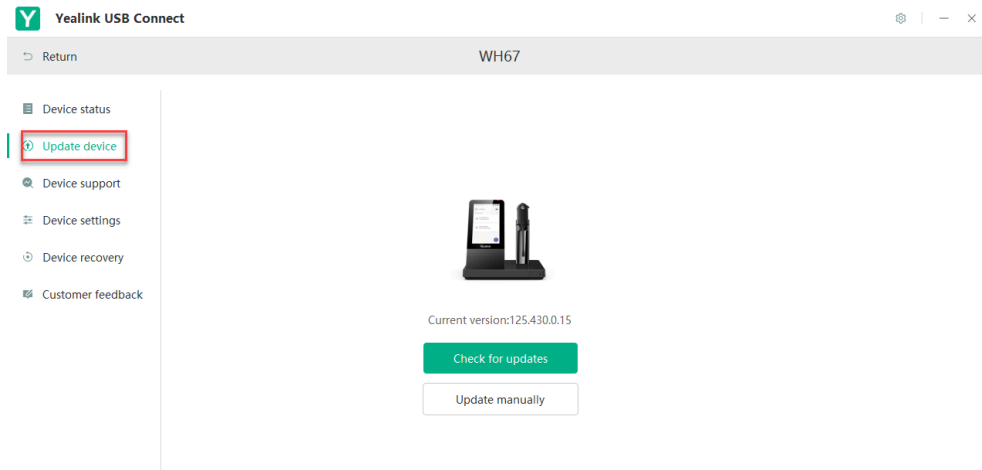

For more information on Yealink USB Connect, refer to [Yealink USB Device Manager Client User Guide](#).

Important: You need to connect the PC to the micro USB port of the headset marked with the text "PC".

Note: Do not undock the headset or power off the base during the upgrade, otherwise the headset upgrade will fail. You can dock the headset in a base to upgrade again. The headset cannot be upgraded when the battery is low (< 10%).

How to Change Settings on WH62/WH63

Headset, base, and general settings can be changed via Yealink USB Connect.

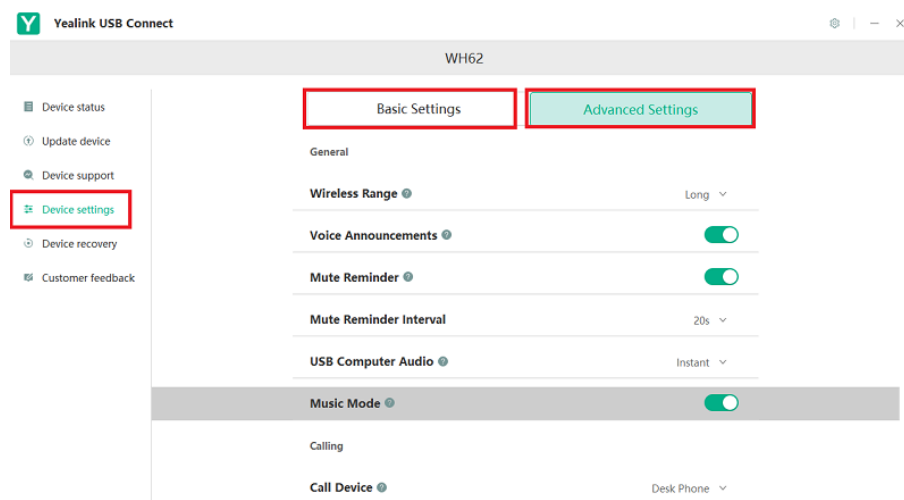

Related information

[Yealink USB Connect](#)

How to Change Settings on WH66/WH67

Headset, base, and general settings can be changed on the WH66/WH67 base.

Basic Settings

For Teams version:

Tap  or the user account avatar, and go to **Settings > Basic Settings** to access the basic settings menu.

For UC version:

Go to  > **Basic Settings** to access the basic settings menu.

General Settings	
Language	Select the screen text language from a list of 13 languages.
Bluetooth	<p>Enable/disable the Bluetooth.</p> <p>Note: Enable this function you can do the following:</p> <ul style="list-style-type: none"> • Open discover: Enable the Bluetooth of WH66/WH67 to be discovered by your mobile device. • Discoverable time: Select timeout period for Bluetooth to be discovered. Default: 5min.
Add Headset	Add additional headsets to the base.
Time&Date	<p>Select the time format and day format.</p> <ul style="list-style-type: none"> • Time Format: 12 Hour/24 Hour can be selected on the device. Default: 24 Hour. • Date Format: Day, Month/Month, Day can be selected on the device. Default: Month, Day. • Manual Time: Enable this function to set the date and time manually.
Display Settings	
Backlight	<p>Set the backlight active level and backlight time.</p> <p>Note: To save power, the backlight will be forcibly turned off if there is no operation for 24 hours.</p>
Screensaver	Change the waiting time for the screen saver.

Teams User Name	<p>Configure whether the Teams user name displays on the home screen when the device disconnects with PC.</p> <p>Default: Personal Mode.</p> <ul style="list-style-type: none"> • Personal Mode: Display the Teams user name when the device disconnects with PC. • Hot Desking Mode: Do not display the Teams user name when the device disconnects with PC. <p>Note: It is only available for Teams version.</p>
Dark Theme	<p>Turn on/off dark theme.</p> <p>The dark theme changes the default bright background color to a darker color, which is easier on the eyes in low-light environments or if you prefer less bright screens.</p> <p>Note: It is only available for Teams version.</p>
Themes	<p>Change the background and card style.</p> <p>Note: It is only available for UC version.</p>
Sound Settings	
Ring Tones	<p>You can choose the mobile device/PC softphone/desk phone to set the followings:</p> <p>Headset Local Ringtone: If there is no ringtone in the headset when the call comes in, you can enable this feature to make the headset play the built-in ringtone.</p> <p>Base Ringtone Volume: Set base ringtone volume between 0-100.</p> <p>Default: 50.</p> <p>When base ringtone volume is 0, the volume of headset and your desk phone or mobile device is not changed. When you change the ringtone volume of headset and your desk phone or mobile device, the base ringtone volume is not changed.</p> <p>Ring Tone Type: Select the ringtone type for the base.</p>
Dial Tone	<p>Enable/disable the paired headset to play a dial tone when entering the dialing screen.</p>
Keypad Tone	<p>Enable/disable the paired headset to produce a sound when pressing the keypad keys.</p>
Speaker Volume	<p>Adjust the playback volume.</p>

Related tasks

[Use the Busylight BLT60](#)

Advanced Settings

For Teams version:

Tap  or the user account avatar, and go to **Settings > Advanced Settings** to access the advanced settings menu.

For UC version:

Go to  > **Settings** > **Advanced Settings** to access the advanced settings menu.

General Settings	
Wireless Range	<p>Select the wireless range between the headset and base.</p> <ul style="list-style-type: none"> • Long: the wireless range is up to 150m. • Medium: the wireless range is up to 30m. • Short: the wireless range is up to 10m.
Voice Announcements	<p>Enable/disable the paired headset to play voice announcements.</p>
Voice Guidance	<p>Select the voice guidance from a list of 4 languages. Or choose Follow screen language.</p> <p>Default: English.</p> <ul style="list-style-type: none"> • English. • Deutsch. • French. • Spanish. • Follow screen language. <p>Note:When you choose Follow screen language, the voice guidance will use the default English if the screen language is not in the voice guidance language list.</p>
USB Computer Audio	<p>This setting determines when your headset receives audio from a connected PC.</p> <p>Default: Instant.</p> <ul style="list-style-type: none"> • Instant: To have the audio (not call audio) turned on instantly. • Delayed: To have the audio (not call audio) turned on automatically with a brief delay. The delay will filter out short notifications sounds from the PC. • Never: To never have audio (not call audio) in the headset. • Always: to always have audio in the headset, this will affect the battery life.
Music Mode	<p>Enable/disable to optimize audio for music. Disable music mode to optimize battery performance.</p> <p>Default: On</p> <p>Note:</p> <ul style="list-style-type: none"> • Audio quality for calls is not affected by this setting. • Enable the music mode will affect the deployment density. For more information about deployment density, refer to Yealink WH6X Deployment and Density White paper. • After you pair multiple headsets on the base, the music mode is automatically disabled, the sound quality is switched to the call mode sound quality. • Only WH62/WH66 support. The dual headsets support stereo audio, the side with microphone is for R.

Mute Reminder	<p>Enable/disable the paired headset to play a periodic audio reminder when the microphone is muted.</p> <p>Note: The detection mechanism of microphone mute status:</p> <ul style="list-style-type: none"> • Headset mode: If the microphone boom-arm is moved down (only for WH62/WH66) and the headset is in the mute status during the call, the headset will play a "Muted" audio reminder when the interval between two sound sources detected by the microphone exceeds 5 seconds. • Speakerphone mode (only for WH66/WH67): The base will play a "Muted" audio reminder when the interval between two sound sources detected by the microphone exceeds 5 seconds.
Mute Reminder Interval	<p>Configure the interval time to play a periodic audio reminder when the microphone is muted.</p> <p>Note: It appears only if Mute Reminder is enabled. Only when you speak continuously, will the headset play the audio reminder according to this configured period.</p>
Platform	Change the platform between UC and Teams.
Calling Settings	
Auto Dial	Enable/disable the base to automatically dial the entered number within 5 seconds.
Call Device	Select which device to use for outgoing call.
Call Priority	<p>Select which call takes priority when a second call is accepted.</p> <ul style="list-style-type: none"> • New call: The first call is placed on hold and the new call is active. • Current call: The first call is active and the new call is placed on hold.
Call Recording	<p>Enable/disable calls from mobile devices or desk phones to be recorded on your PC. The supplied USB cable needs to be connected between the base and the PC, and additional recording software is required.</p> <p>Default: Off.</p>
Auto Answer when Undocked	Enable/disable incoming calls to be answered by undocking the headset.
Open Line when Undocked	Enable/disable to enter the dialing screen when undocking the headset.
Equalizer for Calls	<p>Select an audio preference to use for all calls.</p> <p>Default: Normal.</p> <ul style="list-style-type: none"> • Normal: The bass and treble balanced. • Bass: The bass enhanced. • Treble: The treble enhanced.
Noise Suppression	<p>Enable/disable the base to suppress the environment noises when in a call.</p> <p>When you make a call using WH66/WH67 via speaker mode, enable this function can suppress the environment noises.</p> <p>Default: On.</p>

Smart Noise Block	<p>Enable/disable the base to block out/eliminate the noises when in a call.</p> <p>When you make a call using WH66/WH67 via speaker mode, enable this function can block out/eliminate the noises when there is no speech in a call.</p> <p>Default: Off.</p> <p>Note: It appears only if Noise Suppression is enabled. It can better eliminate environmental noise, but it may make the sound quality worse.</p>
Hearing Protection Settings	
Anti-Startle Protection	Configure which hearing protection technology to be used.
Daily Noise Exposure	Configure the daily noise exposure levels.

Optional Accessories

The base can use optional accessories when you need to extend your base's capabilities.

The following optional accessories need to be purchased separately if required for your base:

1. Busylight BLT60
 2. BT50 (only for WH66/WH67 base)
 3. Wireless charger WHC60 (only for WH66/WH67 base)
 4. EHS60
- [Use the Busylight BLT60](#)
 - [Charge the Mobile Phone on WHC60](#)

Related information

[Connect to PC/Desk Phone/Smartphone via Bluetooth](#)

Use the Busylight BLT60

The busylight can alert you to the status of the phone or softphone. It can only display the Presence status of one device. If multiple devices are connected, please set the device that needs to display the Presence status as the default audio device or outgoing dialer device.

LED States	Description
Connection Status	
LED glows red, green, and blue in sequence	Startup after the busylight is inserted into the base
Presence Status (only for WH66/WH67, sync status requires softphone support)	
LED glows green	Available
LED glows orange	Away
LED glows red	DND/Busy
LED off	Turn off the busylight, softphone does not support
Talking Status	
LED fast flashes red	Ringling

LED States	Description
LED glows red	In a call
LED slowly flashes green	Missed call/voice message notification (this requires softphone support)
LED off	Softphone/phone does not support, turn off the busylight

Related information[Basic Settings](#)

Charge the Mobile Phone on WHC60

If your mobile phone support wireless charging, you can charge it using the Yealink-supplied wireless charger WHC60.

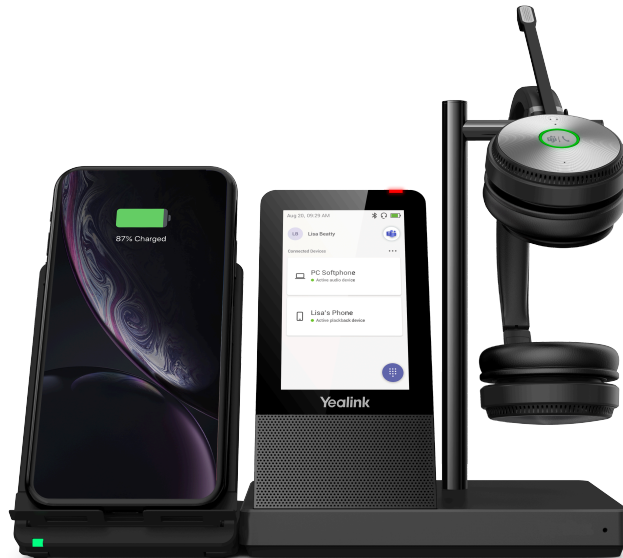

1. Connect the wireless charger to the base directly.

- Place the mobile phone on the wireless charger.

 **Note:** You can also connect the wireless charger to the USB charger adapter via a USB Type-C cable.



Use the EHS60

You can connect the USB phone port of WH62/WH63 to the EHS port of Cisco, Polycom, Avaya and Grandstream IP phones to be compatible with WH62/WH63 for call control.

If the EHS60 is faulty, you can upgrade it using WH62/WH63.

Make sure the product label sticker on your WH62/WH63 base has **EHS60 Supported**. Then you can use the device to upgrade EHS60.

- Upgrade WH62/WH63 to a special version that includes EHS60 firmware via Yealink USB Connect. You can refer to [Update Firmware](#).

 **Note:** Contact Yealink Support to obtain the special software upgrade package.

- Connect EHS60 to the Phone port of the WH62/WH63 Base. If the **Phone** button glows white, the connection is successful.
- Connect the PC port of the WH62/WH63 Base to a PC.

EHS60 automatically triggers the upgrade.

- During the upgrade, the **Phone** button on the WH62/WH63 base flashes white and green alternately.
- If the upgrade is successful, the **Phone** button on the WH62/WH63 base will glow green for 5 seconds and then off.
- If the upgrade fails, the **Phone** button on the WH62/WH63 base will flash white for 5 seconds and then off. Then you can reconnect and it will upgrade again.

 **Note:**

- Reject any call or answer operations during the upgrade.
- You need to upgrade your WH6X to original or the newest version via Yealink USB Connect after upgrading the EHS60,

Support

FAQ

View the FAQ guide on <http://support.yealink.com/>.

Safety Instructions

- Storage temperature: +23 to 113°F (-5 to 45°C).

Charging temperature: +32 to 104°F (0 to 40°C)

- Do not store the headset for extended periods of time without recharging the battery (max. three months).
- If the headset or base becomes dirty, we recommend that you clean them with a soft, lint-free cloth that has been dampened with clean water.