

Blackjack® P-RACK

Servers Powered by DW Spectrum® IPVMS

State of the art hyper-optimized video management platform designed for ease, speed and efficiency.

Blackjack® P-Rack™ — Up to 600Mbps.

Linux OS			Windows OS		
DW-BJP1U-LX	DW-BJP2U-LX	DW-BJPR2U-LX	DW-BJP1U	DW-BJP2U	DW-BJPR2U



DW-BJP1U-LX
DW-BJP1U



DW-BJP2U-LX
DW-BJP2U
DW-BJPR2U-LX
DW-BJPR2U



Default Login Information for DW Spectrum® IPVMS

Username: admin	Password: admin12345
------------------------	-----------------------------

Default login information for the server's OS

Username: dwuser	Password: Dw5pectrum
-------------------------	-----------------------------

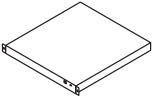
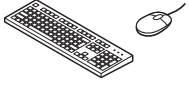
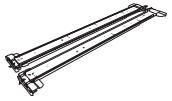
WHAT'S IN THE BOX

P-Rack™ server		1	Keyboard and mouse		1 set	Rail kit		1 set
Quick start guide		1	Power cable		1 set			

NOTE: Download all your support materials and tools in one place.

1. Go to: <http://www.digital-watchdog.com/support-download/>.
2. Search your product by entering the part number in the 'Search by Product' search bar. Results for applicable part numbers will populate automatically based on the part number you enter.
3. Click 'Search'. All supported materials, including manuals, Quick Start Guides (QSG), software and firmware will appear in the results.



Attention: This document is intended to serve as a quick reference for initial setup. See the DW Spectrum® IPVMS full manual for more information on features and functionality.

BLACKJACK® P-RACK™ HARDWARE

Front 1U models



Front 2U models

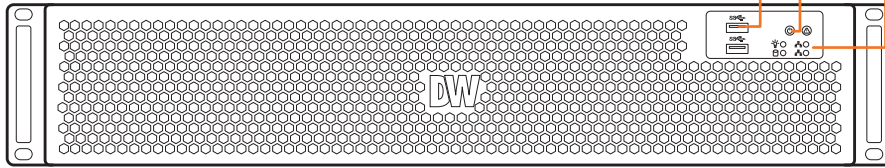

- F1 2x USB 2.0 ports
- F2 Power button
- F3 HDD status LED

Back 1U models

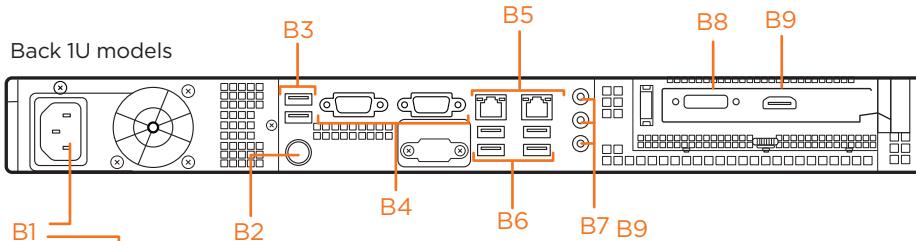

- B1 Power input
- B2 Keyboard port (PS2 type)
- B3 USB 2.0 ports
- B4 Serial ports (Not used)
- B5 Network ports
- B6 USB 3.0 ports
- B7 Audio ports
- B8 DVI-I output
- B9 True HD output

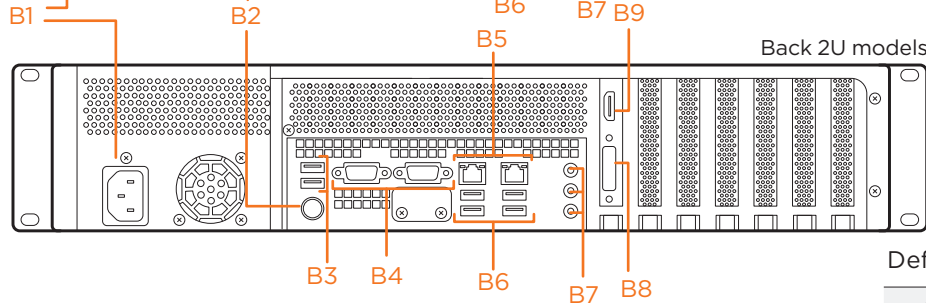

Default login information for DW Spectrum® IPVMS

Username: admin	Password: admin12345
------------------------	-----------------------------

Default Login Information for the server's OS

Username: dwuser	Password: Dw5pectrum
-------------------------	-----------------------------

SPECIFICATIONS

MODEL	Blackjack P-Rack 1U	Blackjack P-Rack 2U	Blackjack P-Rack 2U w/RAID	
Included IP licenses	4	4	4	
Form factor	Rack-mount	Rack mount	Rack mount	
Operating system	Windows® 10	DW-BJP1UXT	DW-BJP2UXT	DW-BJPR2UXXT
	Linux® Ubuntu®	DW-BJP1UXT-LX	DW-BJP2UXT-LX	DW-BJPR2UXXT-LX
	OS on SSD	480GB SSD	480GB SSD	480GB SSD
CPU	Intel® Core™ i5® processor Option: DW-CPUi7 - upgrade processor to i7 *	Intel® Core™ i7® processor		
Memory	16GB			
NIC	1x 1 Gigabit Ethernet port (RJ45) 1x 2.5 Gigabit Ethernet port (RJ45)	1x 1 Gigabit Ethernet port (RJ45) 1x 2.5 Gigabit Ethernet port (RJ45) Option: DW-R2NIC - upgrade dual 1GB NIC card OR DW-R4NIC - upgrade quad 1GB NIC card *		
System	Max video storage rate (Mbps)	360 Mbps	600 Mbps	
Storage	Maximum hard drives	3 x HDD	7x HDD	6 x HDD
	Maximum storage	48TB	112TB	96TB raw storage (80TB usable storage, RAID 5)
Video-out	Outputs	True HD output or DVI		
	Video card	GeForce 210 1024MB		
	Resolution	Max 2560 x 1600 @ 60Hz		
Preloaded VMS software	DW Spectrum® IPVMS			
Unlimited remote clients	Cross platform - Windows®, Linux® and Mac®			
Mobile apps	iOS® and Android®			
Keyboard and mouse	Included			
Rail-kit	Included			
Power	300W**	400W**		
Operating temperature and humidity	41°F-104°F / 20-90% RH			
Dimension (WxDxH)	17.1875 x 20.065" x 1.75" (437 x 510 x 44.45 mm)	17.3" x 21.9" x 3.5" (439.3 x 557.1 x 88.9 mm)		
Warranty	5 year limited			

* Available at time of initial order only / ** UPS recommended
Specifications and components mentioned are subject to change without notice.

SETTING UP THE SERVER

STEP 1: Connect external devices, power and network.

1. Connect a monitor, USB keyboard, USB mouse and network cable to one of the Ethernet ports (B7 on the diagram).
Configure the camera's network first, then configure the server's local network.
2. Connect the server to an appropriate power source. It is recommended to use a UPS system.
* Recommended to use 750VA or higher for the 1U P-RACK and 1000VA or higher for the 2U P-RACK
3. Power up the server if the server does not turn on automatically by pressing the power button on the front of the server. (F2 on the diagram).
* Connecting the power cable to the live power source may turn on the server automatically.

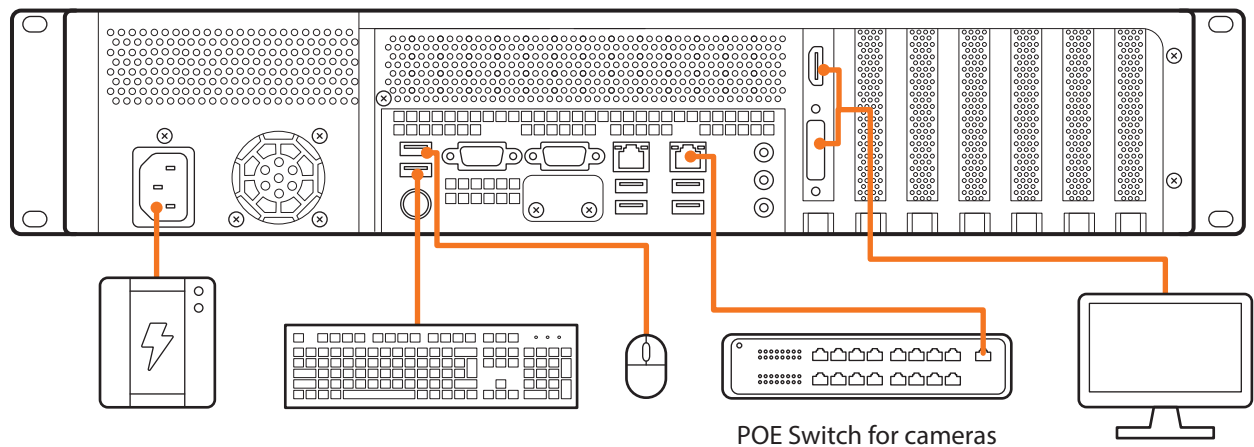
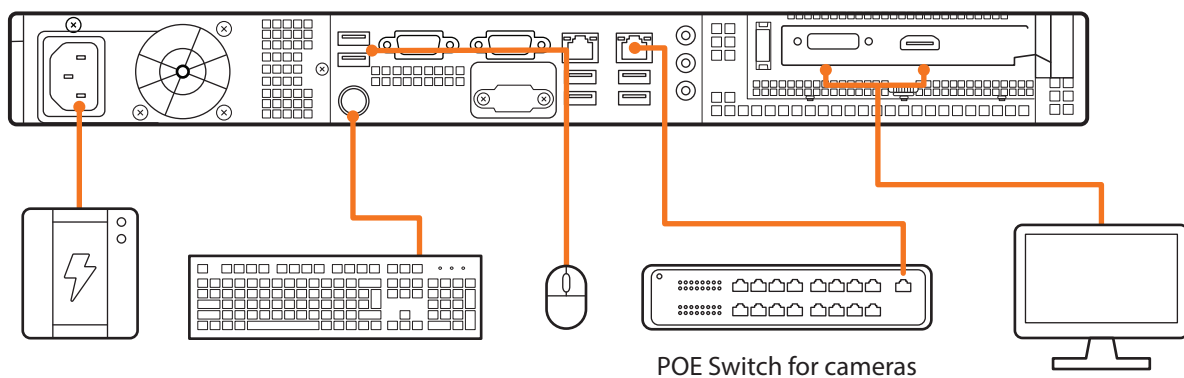

STEP 2: Configure date and time

Windows®

1. Double-click on the date and time icon on the desktop.
2. Change time zone if it is not correct

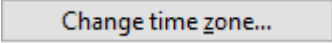

(default is UTC-08:00 Pacific Time).

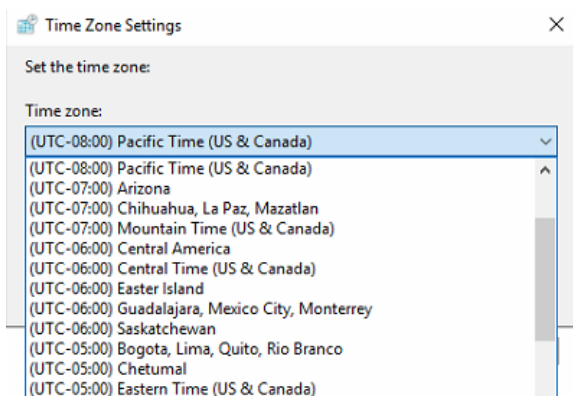

Press OK after selecting the correct time zone.

Click “Change date and time...” to update the date and time if they are not correct.

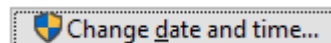

* Verify the time zone before updating the date and time. Time may show 2 or 3 hours off due to incorrect time zone.

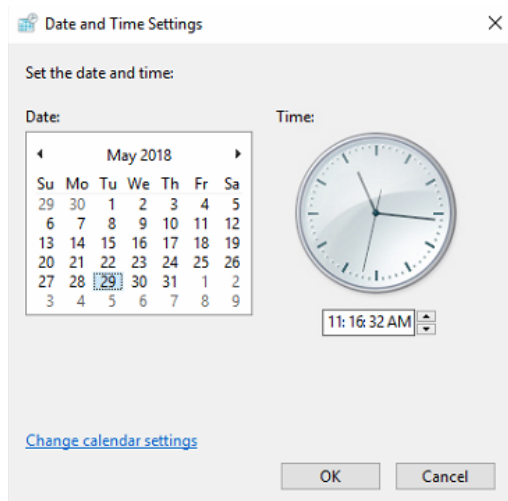

Press OK after adjusting to the correct date and/or time.

4. Press OK to close the date and time when done.

Linux®

1. Open Settings.
2. Click Details.
3. Click Date & Time.

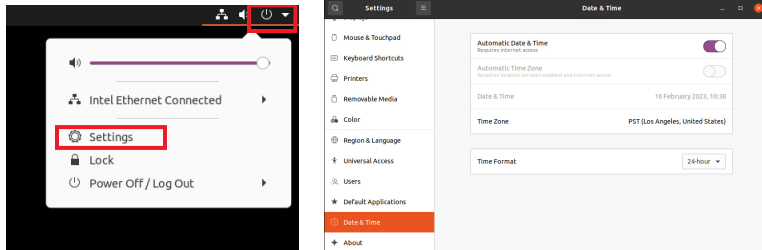

4. Turn OFF Automatic Date & Time and Automatic Time Zone.

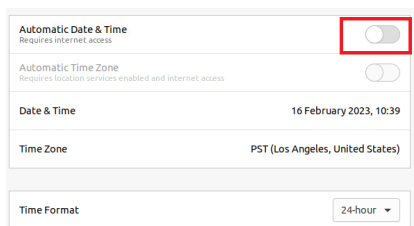

5. Click Date & Time and set correct date and time.

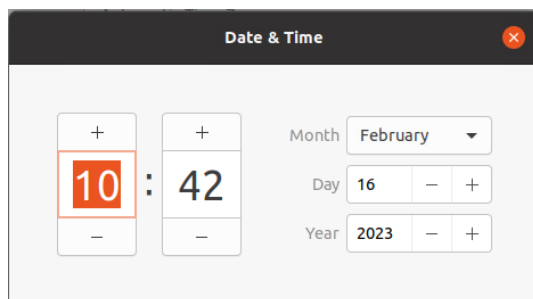

6. Click Time Zone and set to correct Time zone. (Type one of the largest cities in the time zone).



7. Close Settings.

STEP 3: Configure network

Please have the following information ready before starting the network configuration.

	Camera network	Local network (LAN)
IP address		
Subnet mask / Netmask		
Default gateway / Gateway	Not applicable	
DNS servers	Not applicable	

* The camera network and local network cannot be on the same network.

NOTE The Blackjack® server's network settings are set to DHCP as default.

NOTE If you are not sure what information to enter, contact your Network Administrator or Internet Service Provider for the information.

Windows®



1. Double click on the “Network Connections” on the desktop.
2. Right-click on “Ethernet with cable connected” and click “Properties”.

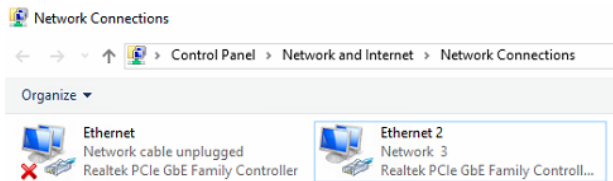

3. Select “Internet Protocol Version 4 (TCP/IPv4)” and click “Properties”.

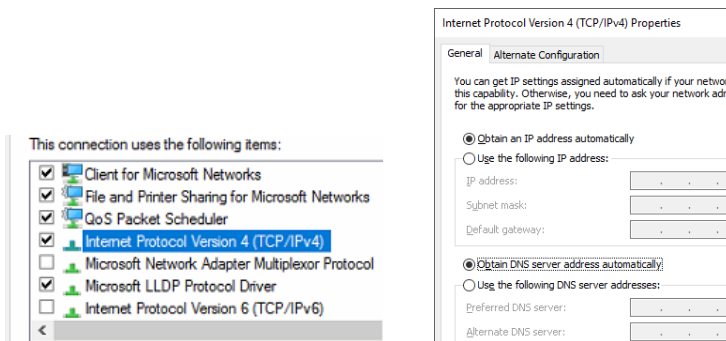

4. Select “Use the following IP address” (Use the following DNS server addresses will be selected automatically).
5. Enter the IP address and Subnet mask of the camera network. (Do not enter anything for the default gateway, preferred DNS server and alternate DNS server).
6. Click OK to close then click close to go back to network connections.

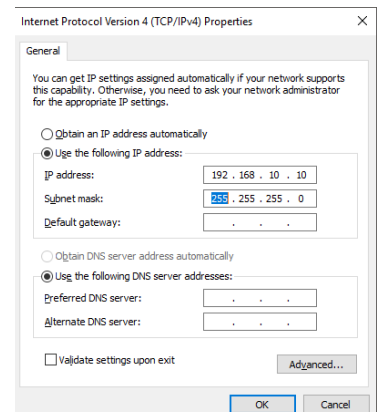

Local Network

7. Right-click on the other Ethernet, the one with network cable unplugged, and click “Properties”.
8. Select “Internet Protocol Version 4 (TCP/IPv4)” and click “Properties”.

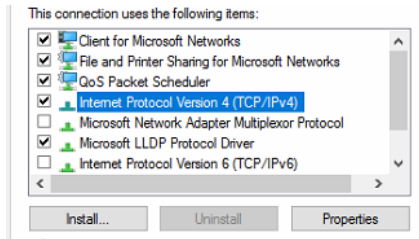

9. Select “Use the following IP address” (Use the following DNS server addresses will be selected automatically).
10. Enter IP address and subnet mask of the camera network.

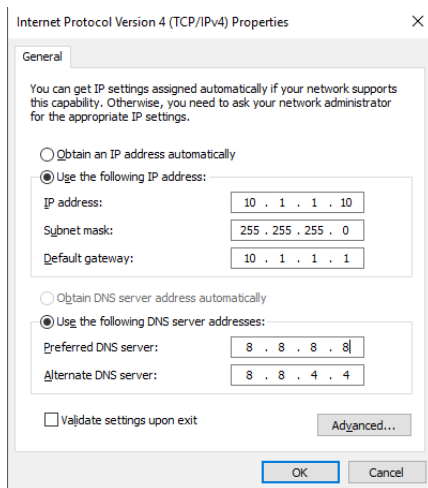

11. Click OK to close then click close to go back to network connections.
12. Connect a network cable to the Ethernet port B2 (1.5G) and B7 (2.5G) on the diagram (page 2) to the switch on the local network.
13. Close the network connections dialog.

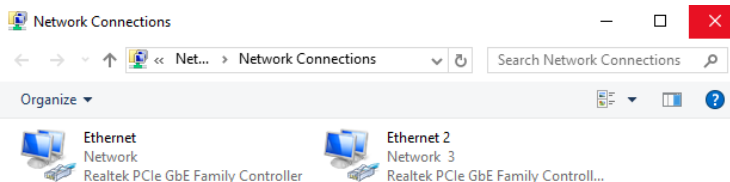

Linux®

1. Open Settings > Network

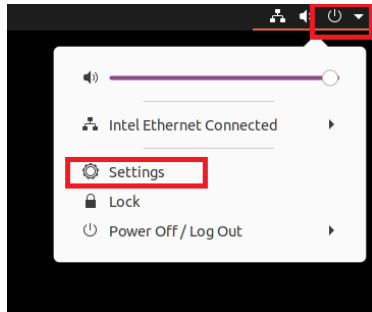

2. Click Setting of the Realtek Ethernet.

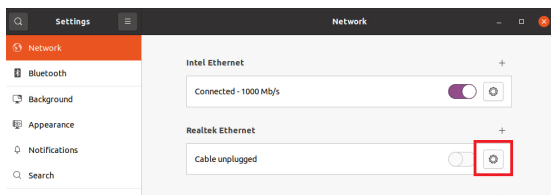

3. Change to Manual then enter Address, Netmask, Gateway.

* Do not enter Gateway information if there is no Gateway in this network.

4. Click Apply to save.

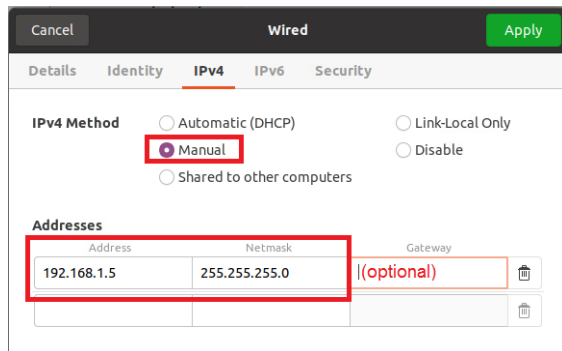

5. Restart the connection by switching OFF then turn ON. If the connection is off, connect the network cable.



6. Click Settings of the Intel Ethernet.

7. Change the settings if needed to access the Internet and for remote access from a local network.

8. Click Apply to save.

9. Restart the connection by switching OFF then turn ON. If the connection is off, connect the network cable.





NOTE If you are not connecting to the Blackjack® from the same network, you may be required to perform port forwarding on your router to access the server. Contact your Network Administrator or Installer for additional information

CONFIGURE CAMERAS USING DW® IP FINDER™

Refer to the camera's QSG to configure any DW® IP camera's IP address using DW® IP finder™.

DW Spectrum® IPVMS client

 <p>Linux OS</p>	<h4>LINUX-BASED SOFTWARE LAUNCH</h4> <p>OPTION 1: Double-click the DW Spectrum® desktop icon.</p> <p>OPTION 2: Go to the dashboard on the top left side. Search 'DW'. Click the DW icon.</p>	 <p>Windows</p>	<h4>WINDOWS-BASED SOFTWARE LAUNCH</h4> <p>OPTION 1: Double-click the DW Spectrum® desktop icon.</p> <p>OPTION 2: Go to 'Start' on the bottom left and select DW Spectrum® in the Digital Watchdog folder</p>
---	--	--	--

SETTING UP DW SPECTRUM® MEDIA SERVER

Login: **admin**
Password: **admin12345**

STEP 1: Initial run from the Blackjack® server

1. Open the DW Spectrum® client by double click on the DW Spectrum® icon.
2. Click on the pre-configured server.
3. If the pre-configured server does not automatically log in, enter the password and click Connect. *Default password: admin12345 (case sensitive).

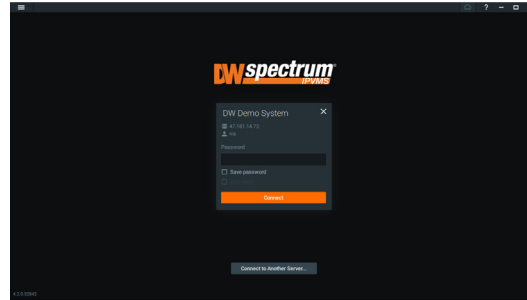
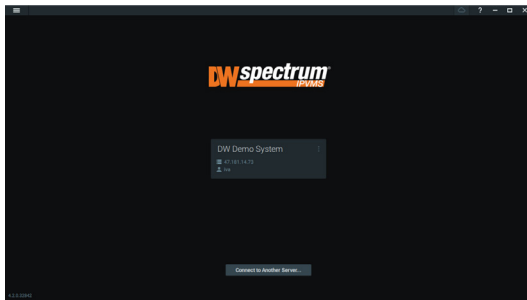

STEP 2: To rename the server

1. Right-click on the server name listed on the resources then click server settings.
2. Go to the general tab and enter the new server name in the name field. Click OK.

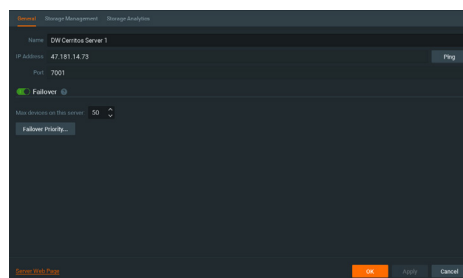

STEP 3: To check for updates

1. Click on the menu  then click “System Administration”.
2. Go to the updates tab. If the system requires updating, click on the update system button.

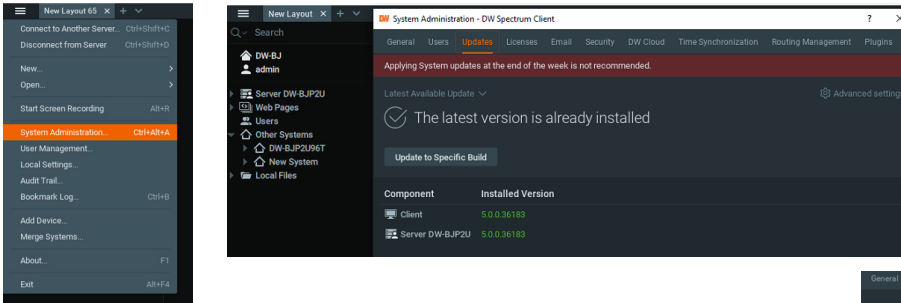

* If you are on the latest version, it will say “You have the latest version installed” and the Update System button will be disabled.

3. Click OK when the update is completed.

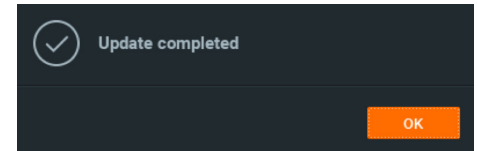
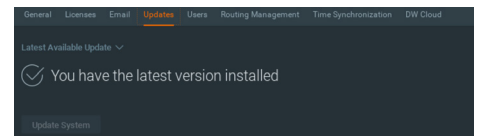

STEP 4: Enter and activate licenses

1. Go to the system administration window and click on the license tab.
2. Enter the license key and click “Activate License”. An Internet connection is required.

* Click on “Activate Trial License” if you have not purchased a valid license key.

3. Click OK to when the license key is activated.

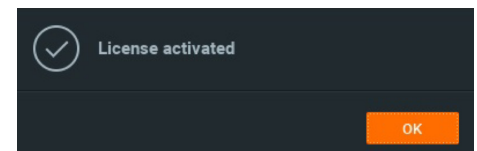
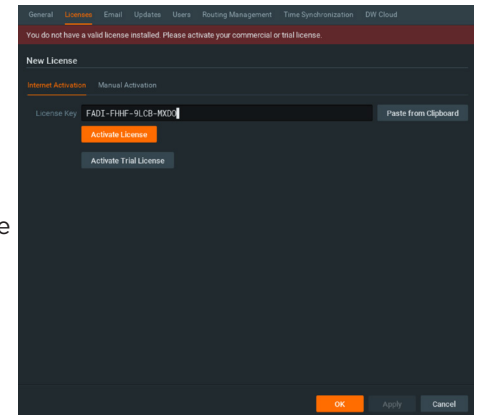

STEP 5: Configure recording

1. Right-click on a camera in the resource tree to setup recording. Click on camera settings from the context menu.
2. Go to the recordings tab.

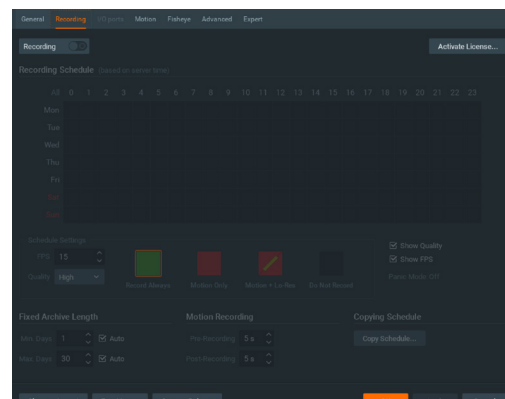
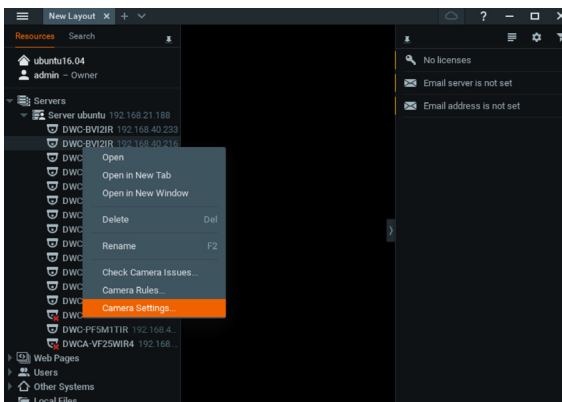

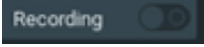
3. Click  to turn on recording.
4. Configure the camera's schedule settings for quality, FPS and recording type.
5. Click and drag the mouse over the recording schedule to apply the settings to multiple days and times.

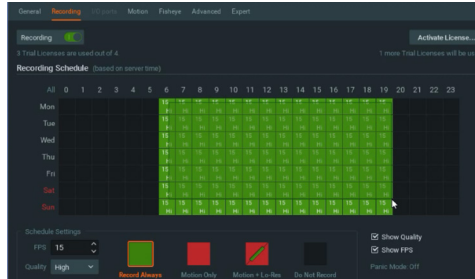

* Click "All" to apply the recording settings to the entire schedule.

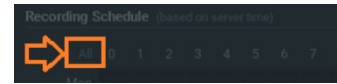

6. A red dot will appear next to the camera in the resource tree once recording is started.

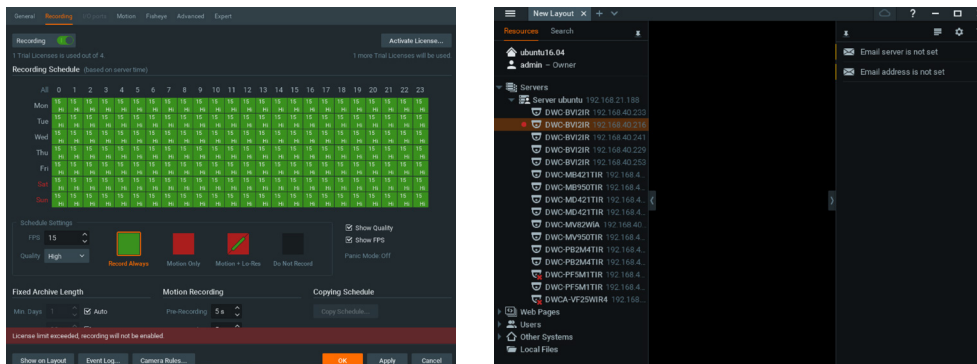

NOTE: A Recording License is required to allow each camera to the archive.

STEP 6: Backup database

1. Go to the system administration window and click on the general tab.
 2. Click "Create Backup...".
 3. Navigate to the folder you want to save the database and enter a name for the backup file. Click save.
- * It is strongly recommended to create a Database Backup to external storage media before and after every update in the event that a system restore point is needed.

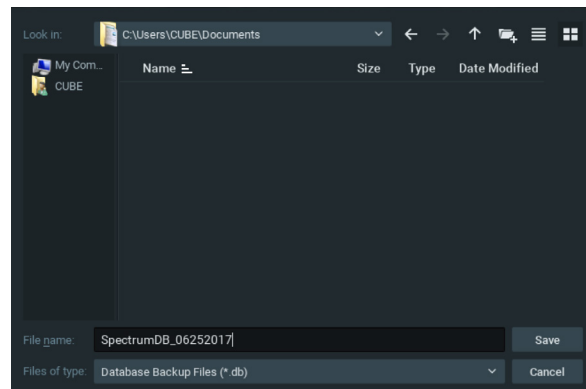
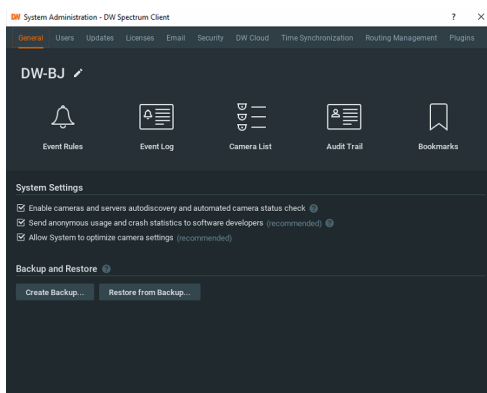

NOTE: More information and instructions are available in the DW Spectrum® IPVMS user manual.

TROUBLESHOOTING TIPS

Problem	Possible solutions
My camera does not auto-discover	<ol style="list-style-type: none"> 1. Is the camera in the same LAN network as the media server? 2. Is your camera compatible with DW Spectrum? (Refer to our website for full list of supported cameras.) 3. Is the camera updated to its latest firmware? 4. If your camera is integrated with DW Spectrum via ONVIF, make sure ONVIF is enabled on your camera. 5. Try adding the camera manually. 6. Try rebooting the server after installation. Allow up to 2 minutes for the server to map your network and detect all supported devices.
Videos are slow	<ol style="list-style-type: none"> 1. Are you accessing the same cameras from multiple clients? (LAN and WAN) 2. Do you have a Gigabit network? Check your network speed.
My camera appears disconnected	<ol style="list-style-type: none"> 1. Under camera settings, make sure the user name and password are correct. 2. Under the camera settings, use the 'Ping' button to make sure the camera is connected to the network properly. 3. If you can connect to the camera's web viewer, try rebooting the camera and/or restore it to factory default. 4. Make sure your camera is using the latest firmware available. 5. Make sure that the camera is connected to the same network as the server. 6. If you are connecting to a camera that is integrated with DW Spectrum via the ONVIF protocol (see list), make sure ONVIF is enabled. 7. Make sure your user has permissions to view that specific camera.
I cannot get playback video from my camera	<ol style="list-style-type: none"> 1. Do you have network connection between client and server (in case server and client are not on the same machine)? 2. Make sure your user has playback viewing permissions for the selected channel. 3. Make sure the camera is set to a recording mode that would provide recorded video for the selected time and environment. 4. On the server side, check the media server log to make sure the camera you are trying to watch has not been unexpectedly disconnected.
I get 'unauthorized' message on my camera	<ol style="list-style-type: none"> 1. Make sure the camera's user name and password are properly entered in the camera's general information under the camera settings menu. 2. If necessary, try rebooting the camera to apply the camera's user name and password.

DW SPECTRUM SYSTEM REQUIREMENTS

Recommended specs for the full client

	Single-monitor DW Spectrum workstation	Dual-monitor DW Spectrum workstation	Quad-monitor DW Spectrum workstation
Processor	Intel i5 8th gen or AMD Ryzen 5 3000 Quad-Core or better	Intel i7 8th gen or AMD Ryzen 7 3000 Quad-Core or better	Intel i9 or AMD Ryzen 9 Quad-Core or better
Video card	Intel HD Graphics onboard GPU or better	Intel HD Graphics onboard GPU or better	GeForce GTX 1650 or better
RAM	8 GB DDR3 1600 MHz or better	16 GB DDR3 1600 MHz or better	32 GB or better
NIC	1Gbps or better	2 x 1 Gbit or better	2 x 1 Gbit or better
Storage	Dedicated SSD or NVME disk for the OS, 128 GB or larger	Dedicated SSD or NVME disk for the OS, 128 GB or larger	Dedicated SSD or NVME disk for the OS, 128 GB or larger
OS supported	Microsoft Windows OS (supported by both DW Spectrum® Server and Client). <ul style="list-style-type: none"> • Windows 8 - Released: October 2012 EoS: 01/2023 • Windows 8.1 - Released: October 2013 EoS: 01/2023 • Windows 10 - Released: July 2015 • Windows Server 2012 - Released: August 2012 EoS: 10/2023 • Windows Server 2012 R2 - Released: October 2013 EoS: 10/2023 • Windows Server 2016 - Released: October 2016 EoS: 01/2027 • Windows Server 2019 - Released: October 2018 EoS: 01/2029 • Windows Server 2022 - Released: August 2021 EoS: 10/2031 **NOTE: DW Spectrum IPVMS for Windows can be installed as a software bundle or the Server and Client software can be installed separately.		
	Ubuntu (Debian-based Linux) OS (supported by both DW Spectrum Server and Client). <ul style="list-style-type: none"> • Ubuntu 16.04 LTS "Xenial Xerus" - Released: April 2016 EoS: 04/2024 • Ubuntu 18.04 LTS "Bionic Beaver" - Released: April 2018 EoS: 04/2028 • Ubuntu 20.04 LTS: "Focal Fossa" - Released: April 2020 EoS: 04/2030 **NOTE: DW Spectrum IPVMS for Ubuntu is only available for separate installations (not bundled).		
	Macintosh OS (supported only by the DW Spectrum Client. DW Spectrum Server is not available for macOS). <ul style="list-style-type: none"> • macOS 10.14 "Mojave" - Released: September 2018 • macOS 10.15 "Catalina" - Released: October 2019 • macOS 11.0, 11.1, 11.2 "Big Sur" - Released: November 2020 • macOS 12 "Monterey" - Released: October 2021 **NOTE: DW Spectrum IPVMS for macOS is only supported by the DW Spectrum Client.		

* Except Storage Server version

Important: OS not listed will be not be supported by DW®

Tech Support

Tel: +1 (866) 446-3595

Fax: (813) 888-9262



www.digital-watchdog.com
sales@digital-watchdog.com

Copyright © Digital Watchdog. All rights reserved. Specifications and pricing are subject to change without notice.