

Acer LCD Monitor

User Guide

Copyright © 2022. Acer Incorporated.
All Rights Reserved.

Acer LCD Monitor User's Guide
Original Issue: 05/2022

Changes may be made periodically to the information in this publication without obligation to notify any person of such revisions or changes. Such changes will be incorporated in new editions of this manual or supplementary documents and publications. This company makes no representations or warranties, either expressed or implied, with respect to the contents hereof and specifically disclaims the implied warranties of merchantability or fitness for a particular purpose.

Record the model number, serial number, purchase date and place of purchase information in the space provided below. The serial number and model number are recorded on the label affixed to your computer. All correspondence concerning your unit should include the serial number, model number and purchase information.

No part of this publication may be reproduced, stored in a retrieval system, or transmitted, in any form or by any means, electronically, mechanically, by photocopy, recording or otherwise, without the prior written permission of Acer Incorporated.

Acer LCD Monitor User's Guide

Model number: _____

Serial number: _____

Date of purchase: _____

Place of purchase: _____

Acer and the Acer logo are registered trademarks of Acer Incorporated. Other companies' product names or trademarks are used herein for identification purposes only and belong to their respective companies.

Special notes on LCD monitors

The following are normal with the LCD monitor and do not indicate a problem.

- Due to the nature of the fluorescent light, the screen may flicker during initial use. Turn off the power switch and then turn it on again to make sure the flicker disappears.
- You may find slightly uneven brightness on the screen depending on the desktop pattern you use.
- The LCD screen has 99.99% or more effective pixels. It may include blemishes of 0.01% or less such as a missing pixel or a pixel lit all the time.
- Due to the nature of the LCD screen, an afterimage of the previous screen may remain after switching the image, when the same image is displayed for hours. In this case, the screen is recovered slowly by changing the image or turning off the power switch for a few hours.

Information for your safety and comfort

Safety instructions

Read these instructions carefully. Keep this document for future reference. Follow all warnings and instructions marked on the product.

Cleaning your monitor

Please carefully follow these guidelines when cleaning the monitor:

- Always unplug the monitor before cleaning.
- Use a soft cloth to wipe the screen and cabinet front and sides.

Connecting/disconnecting the device

Observe the following guidelines when connecting and disconnecting power from the LCD monitor:

- Make sure the monitor is attached to its base before connecting the power cord to the AC power outlet.
- Make sure both the LCD monitor and the computer are turned off before connecting any cable or unplugging the power cord.
- If the system has multiple sources of power, disconnect power from the system by unplugging all power cords from the power supplies.

Accessibility

Be sure that the power outlet you plug the power cord into is easily accessible and located as close to the equipment operator as possible. When you need to disconnect power from the equipment, be sure to unplug the power cord from the electrical outlet.

Safe listening

To protect your hearing, follow these instructions.

- Gradually increase the volume until you can hear it clearly and comfortably and without distortion.
- After setting the volume level, do not increase it after your ears have adjusted.
- Limit the amount of time listening to music at high volume.
- Avoid turning up the volume to block out noisy surroundings.
- Turn the volume down if you can't hear people speaking near you.

Warnings

- Do not use this product near water.
- Do not place this product on an unstable cart, stand or table. If the product falls, it could be seriously damaged.
- Slots and openings are provided for ventilation to ensure reliable operation of the product and to protect it from overheating. These openings must not be blocked or covered. The openings should never be blocked by placing the product on a bed, sofa, rug or other similar surface. This product should never be placed near or over a radiator or heat register, or in a built-in installation unless proper ventilation is provided.
- Never push objects of any kind into this product through cabinet slots as they may touch dangerous voltage points or short-out parts that could result in a fire or electric shock. Never spill liquid of any kind onto or into the product.
- To avoid damage of internal components and to prevent battery leakage, do not place the product on a vibrating surface.
- Never use it under sporting, exercising, or any vibrating environment which will probably cause unexpected short current or damage internal devices.

Using electrical power

This product should be operated from the type of power indicated on the marking label. If you are not sure of the type of power available, consult your dealer or local power company.

- Do not allow anything to rest on the power cord. Do not locate this product where people will walk on the cord.
- If an extension cord is used with this product, make sure that the total ampere rating of the equipment plugged into the extension cord does not exceed the extension cord ampere rating. Also, make sure that the total rating of all products plugged into the wall outlet does not exceed the fuse rating.
- Do not overload a power outlet, strip or receptacle by plugging in too many devices. The overall system load must not exceed 80% of the branch circuit rating. If power strips are used, the load should not exceed 80% of the power strip's input rating.
- This product's power cord is equipped with a three-wire grounded plug. The plug only fits in a grounded power outlet. Make sure the power outlet is properly grounded before inserting the power cord plug. Do not insert the plug into a non-grounded power outlet. Contact your electrician for details.



Warning! The grounding pin is a safety feature. Using a power outlet that is not properly grounded may result in electric shock and/or injury.



Note: The grounding pin also provides good protection from unexpected noise produced by other nearby electrical devices that may interfere with the performance of this product.

- Use the product only with the supplied power supply cord set. If you need to replace the power cord set, make sure that the new power cord meets the following requirements: detachable type, UL listed/CSA certified, rated 7 A 125 V minimum, VDE approved or its equivalent, 4.5 meters (15 feet) maximum length.

Product servicing

Do not attempt to service this product yourself, as opening or removing covers may expose you to dangerous voltage points or other risks. Refer all servicing to qualified service personnel.

Unplug this product from the wall outlet and refer servicing to qualified service personnel when:

- the power cord or plug is damaged, cut or frayed
- liquid was spilled into the product
- the product was exposed to rain or water
- the product has been dropped or the case has been damaged

- the product exhibits a distinct change in performance, indicating a need for service
- the product does not operate normally after following the operating instructions



Note: Adjust only those controls that are covered by the operating instructions, since improper adjustment of other controls may result in damage and will often require extensive work by a qualified technician to restore the product to normal condition.

Potentially explosive environments

Switch off your device in any area with a potentially explosive atmosphere and obey all signs and instructions. Potentially explosive atmospheres include areas where you would normally be advised to turn off your vehicle engine. Sparks in such areas could cause an explosion or fire resulting in bodily injury or even death. Switch off the device near gas pumps at service stations. Observe restrictions on the use of radio equipment in fuel depots, storage and distribution areas; chemical plants; or where blasting operations are in progress. Areas with a potentially explosive atmosphere are often, but not always, marked. They include below deck on boats, chemical transfer or storage facilities, vehicles using liquefied petroleum gas (such as propane or butane), and areas where the air contains chemicals or particles such as grain, dust or metal powders.

Additional safety information

Your device and its enhancements may contain small parts. Keep them out of the reach of small children.

IT Equipment Recycling Information

Acer is strongly committed to environmental protection and views recycling, in the form of salvaging and disposal of used equipment, as one of the company's top priorities in minimizing the burden placed on the environment.

We at Acer are very conscious of the environmental effects of our business and strive to identify and provide the best working procedures to reduce the environmental impact of our products.

Disposal of Waste Equipment

This symbol on the product or on its packaging indicates that this product must not be disposed of with your other household waste. Instead, it is your responsibility to dispose of your waste equipment by handing it over to a designated collection point for the recycling of waste electrical and electronic equipment. The separate collection and recycling of your waste equipment at the time of disposal will help to conserve natural resources and ensure that it is recycled in a manner that protects human health and the environment. For more information about where you can drop off your waste equipment for recycling, please contact your local office, your household waste disposal service or the shop where you purchased the product.



LCD pixel statement

The LCD unit is produced with high-precision manufacturing techniques. Nevertheless, some pixels may occasionally misfire or appear as black or red dots. This has no effect on the recorded image and does not constitute a malfunction.

This product has been shipped enabled for power management:

- Activate the monitor's Sleep mode within 5 minutes of user inactivity.
- Wake the monitor when it is in Active Off mode, move the mouse or press any keyboard key.

Tips and information for comfortable use

Computer users may complain of eyestrain and headaches after prolonged use. Users are also at risk of physical injury after long hours of working in front of a computer. Long work periods, bad posture, poor work habits, stress, inadequate working conditions, personal health and other factors greatly increase the risk of physical injury.

Incorrect computer usage may lead to carpal tunnel syndrome, tendonitis, tenosynovitis or other musculoskeletal disorders. The following symptoms may appear in the hands, wrists, arms, shoulders, neck or back:

- numbness, or a burning or tingling sensation
- aching, soreness or tenderness
- pain, swelling or throbbing

- stiffness or tightness
- coldness or weakness

If you have these symptoms, or any other recurring or persistent discomfort and/or pain related to computer use, consult a physician immediately and inform your company's health and safety department.

The following section provides tips for more comfortable computer use.

Finding your comfort zone

Find your comfort zone by adjusting the viewing angle of the monitor, using a footrest, or raising your sitting height to achieve maximum comfort. Observe the following tips:

- refrain from staying too long in one fixed posture
- avoid slouching forward and/or leaning backward
- stand up and walk around regularly to remove the strain on your leg muscles

Taking care of your vision

Long viewing hours, wearing incorrect glasses or contact lenses, glare, excessive room lighting, poorly focused screens, very small typefaces and low-contrast displays could stress your eyes. The following sections provide suggestions on how to reduce eyestrain.

Eyes

- Rest your eyes frequently.
- Give your eyes regular breaks by looking away from the monitor and focusing on a distant point.
- Blink frequently to keep your eyes from drying out.

Display

- Keep your display clean.
- Keep your head at a higher level than the top edge of the display so your eyes point downward when looking at the middle of the display.
- Adjust the display brightness and/or contrast to a comfortable level for enhanced text readability and graphics clarity.
- Eliminate glare and reflections by:
 - placing your display in such a way that the side faces the window or any light source
 - minimizing room light by using drapes, shades or blinds
 - using a task light

- changing the monitor's viewing angle
- using a glare-reduction filter
- using a display visor, such as a piece of cardboard extended from the display's top front edge

Avoid adjusting your display to an awkward viewing angle.

Avoid looking at bright light sources, such as open windows, for extended periods of time.

Developing good work habits

Develop the following work habits to make your computer use more relaxing and productive:

- Take short breaks regularly and often.
- Perform some stretching exercises.
- Breathe fresh air as often as possible.
- Exercise regularly and maintain a healthy body.

Acer monitor is purposed for video and visual display of information obtained from electronic devices.

Special notes on LCD monitors.....	iii
Information for your safety and comfort.....	iii
Safety instructions	iii
Cleaning your monitor	iii
Connecting/disconnecting the device	iii
Accessibility.....	iv
Safe listening.....	iv
Warnings.....	iv
Using electrical power	iv
Product servicing	v
Potentially explosive environments	vi
Additional safety information	vi
IT Equipment Recycling Information.....	vi
Disposal of Waste Equipment.....	vii
LCD pixel statement.....	vii
Tips and information for comfortable use	vii
Finding your comfort zone.....	viii
Taking care of your vision.....	viii
Developing good work habits	ix
Unpacking	1
Adjusting the viewing angle.....	2
Connecting the power cord	3
Power saving.....	3
Display Data Channel (DDC).....	3
FreeSync Premium Pro (HDMI / DP / Type C)	3
Connector pin assignment.....	4
Standard Timing Table	6
Removing the Securing Strap	7
Setting Up the Monitor.....	8
Installing the headphone hook	8
Connecting the Monitor to Your Computer	9
Follow the steps below to connect the monitor to your computer.	9
Using the Monitor as a USB Hub.....	10
Powering On/Off the Monitor	11
Control Panel.....	12
On Screen Display (OSD) Menu.....	13
Troubleshooting	24

Unpacking

Please check that the following items are present when you unpack the box, and save the packing materials in case you need to ship or transport the monitor in the future.

LCD monitor



Quick start guide

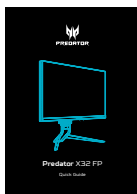

Adapter

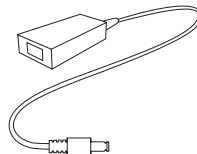

AC Power cord



USB-A to USB-B cable
(optional)

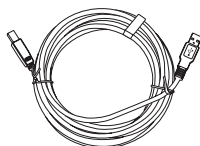

Headset Hook

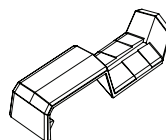

DP cable (optional)

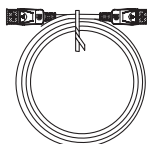

HDMI cable (optional)

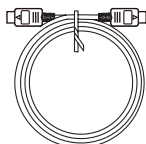

USB-C cable (optional)

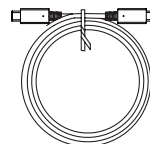

Adjusting the viewing angle

To optimize the viewing experience, you can adjust the tilt or height of the monitor by holding the left and right sides of the monitor. The tilt can be adjusted to a 35-degree angle upwards or a 5-degree angle downwards.

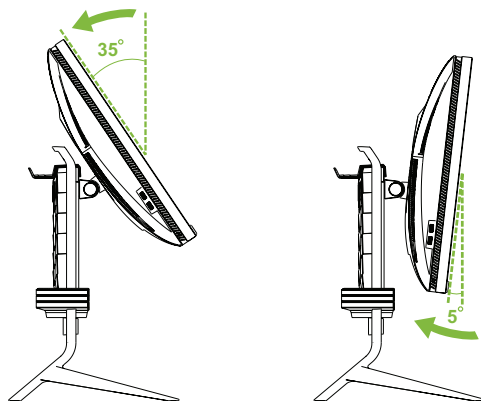

The rotary slide on the base enables you to rotate the monitor with ease.

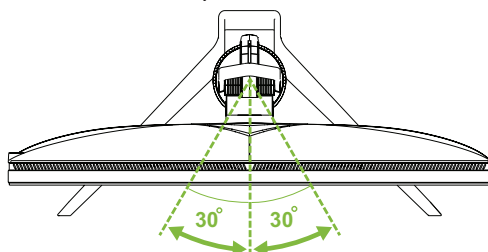

Pull down or lift up to adjust the height by holding the left and right sides of the monitor.

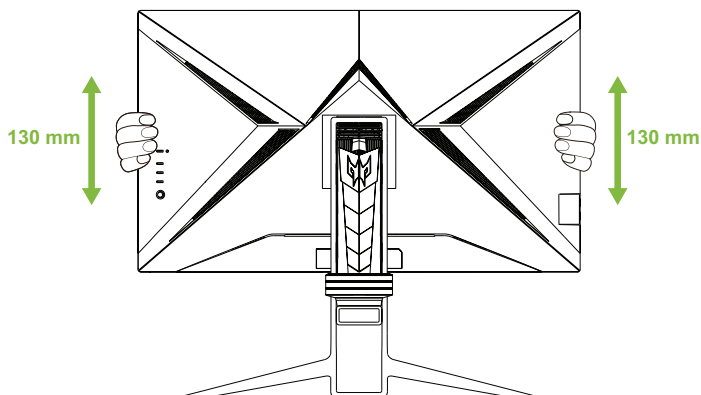

Connecting the power cord

- Check first to make sure that the power cord you use is the correct type required for your area.
- The monitor has a universal power supply that allows operation in either 100/120 V AC or 220/240 V AC voltage area. No user-adjustment is required.
- Plug one end of the power cord to the AC inlet, and plug the other end into an AC outlet.
- For units using 120 V AC:
Use a plug rated 10 A/125 V.
- For units using 220/240 V AC:
Use a plug rated 10 A/250 V. The cord set should have the appropriate safety approvals for the country in which the equipment will be installed.

Power saving

The monitor will be put into “power saving” mode if the monitor does not detect any input signals for about one minute, as indicated by the amber power LED.

Mode	LED light
On	Blue
Power saving	Amber
Off	Off

The power saving mode will be kept until an input signal has been detected or the keyboard or mouse is activated. The recovery time from “power saving” mode back to “on” is around 3 seconds (Auto Source off).

Display Data Channel (DDC)

To make installation easier, so long as your system supports the DDC protocol, the monitor is able to plug-and-play. The DDC is a communication protocol through which the monitor automatically informs the host system about its capabilities; for example, supported resolutions and corresponding timing. The monitor supports the DDC2B standard.

FreeSync Premium Pro (HDMI / DP / Type C)

The monitor allows a FreeSync Premium Pro supported graphics source to dynamically adjust display refresh rate based on typical content frame rates for power efficient, virtually stutter free and low-latency display update.

Connector pin assignment

19-Pin Color Display Signal Cable*

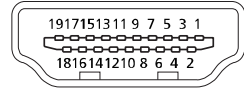

PIN	Meaning	PIN	Meaning
1	TMDS Data2 +	11	TMDS Clock Shield
2	TMDS Data2 Shield	12	TMDS Clock -
3	TMDS Data2 -	13	CEC
4	TMDS Data1 +	14	Reserved (N.C. on device)
5	TMDS Data1 Shield	15	SCL
6	TMDS Data1 -	16	SDA
7	TMDS Data0 +	17	DDC/CEC Ground
8	TMDS Data0 Shield	18	+5V Power
9	TMDS Data 0-	19	Hot Plug Detect
10	TMDS Clock +		

*only for certain models

24-Pin USB 3.1 Type C Cable*

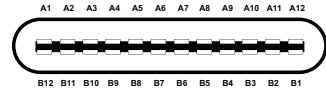

PIN	Meaning	PIN	Meaning
A1	GND	B12	GND
A2	SSTXp1	B11	SSRXp1
A3	SSTXn1	B10	SSRXn1
A4	VBUS	B9	VBUS
A5	CC1	B8	SBU2
A6	Dp1	B7	Dn2
A7	Dn1	B6	Dp2
A8	SBU1	B5	CC2
A9	VBUS	B4	VBUS
A10	SSRXn2	B3	SSTXn2
A11	SSRXp2	B2	SSTXp2
A12	GND	B1	GND

*only for certain models

9-Pin USB 3.0 Type B Cable

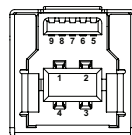

PIN	Meaning	PIN	Meaning
1	VBUS	6	StdA_SSTX+
2	D-	7	GND_DRAIN
3	D+	8	StdA_SSRX-
4	GND	9	StdA_SSRX+
5	StdA_SSTX-	Shell	Shield

20-Pin Color Display Signal Cable*

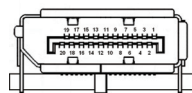

PIN	Meaning	PIN	Meaning
1	Lane 0 (+)	11	Ground
2	Ground	12	Lane 3 (-)
3	Lane 0 (-)	13	Config 1
4	Lane 1 (+)	14	Config 2
5	Ground	15	AUX_channel (-)
6	Lane 1 (-)	16	Ground
7	Lane 2 (+)	17	AUX_channel (+)
8	Ground	18	Hot Plug Detect
9	Lane 2 (-)	19	DP Power_Return
10	Lane 3 (+)	20	DP Power

*only for certain models

9-Pin USB 3.0 Type A Cable

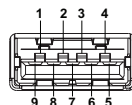

PIN	Meaning	PIN	Meaning
1	VBUS	6	StdA_SSRX+
2	D-	7	GND_DRAIN
3	D+	8	StdA_SSTX-
4	GND	9	StdA_SSTX+
5	StdA_SSRX-		

Standard Timing Table

No.	Mode	Resolution	Refresh Rate	
1	VGA	640x480	60	Hz
2		640x480	72	Hz
3		640x480	75	Hz
4	MAC	640x480	66.66	Hz
5	VESA	720x400	70	Hz
6	SVGA	800x600	56	Hz
7		800x600	60	Hz
8		800x600	72	Hz
9		800x600	75	Hz
10	MAC	832x624	74.55	Hz
11	XGA	1024x768	60	Hz
12		1024x768	70	Hz
13		1024x768	75	Hz
14	MAC	1152x870	75	Hz
15	VESA	1152x864	75	Hz
16		1280x960	60	Hz
17	SXGA	1280x1024	60	Hz
18		1280x1024	75	Hz
19	VESA	1280x720	60	Hz
20	WXGA+	1440x900	60	Hz
21	WSXGA+	1680x1050	60	Hz
22	FHD	1920x1080	60	Hz
23	QHD	2560x1440	60	Hz
24		2560x1440	120	Hz
25		2560x1440	144	Hz
26	UHD	3840x2160	60*	Hz
27		3840x2160	120	Hz
28		3840x2160	144	Hz
29		3840x2160	160	Hz

* Recommended resolution



Note: USB Type-C: 3840x2160 @160Hz, supporting FreeSync Premium Pro and HDR technology. DP: 3840x2160 @160Hz, supporting FreeSync Premium Pro and HDR technology. HDMI1/HDMI2/HDMI3/HDMI4: 3840x2160 @160Hz, supporting FreeSync Premium Pro and HDR technology.

Removing the Securing Strap

Remove the securing strap from the rear side of the monitor before adjusting the height of the monitor.

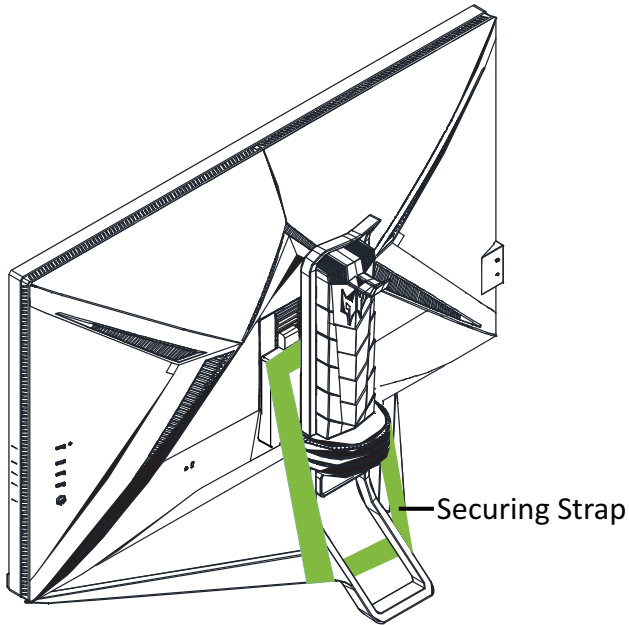

Setting Up the Monitor

Installing the headphone hook

The supplied headphone hook can hold your headset on the rear of the monitor. Follow the steps below to install the headphone hook onto the monitor.

1. Align the headphone hook with the top of the stand.
2. Press the hook down vertically from its top until you hear clicks ensuring that the two tabs on the hook fit securely into the openings on the stand.

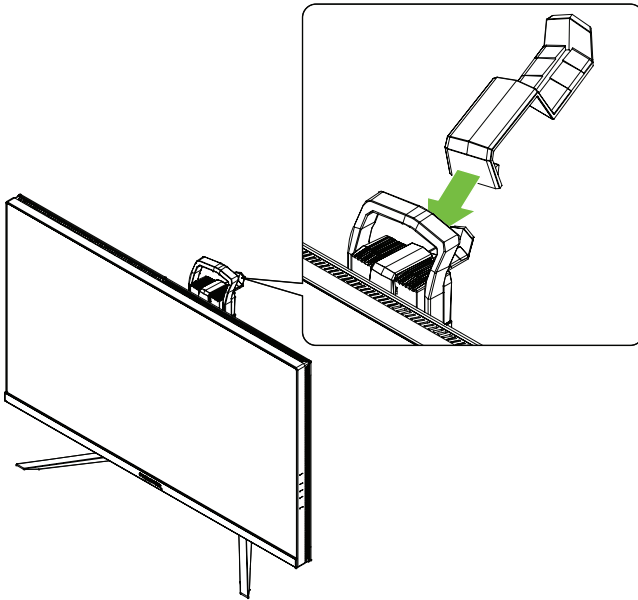

Connecting the Monitor to Your Computer



Note: Before making connections, make sure that the power for all the connected equipment is off.



Note: If you want to move the monitor, hold the bottom side of the monitor. Lifting up the monitor by holding its base may damage the monitor.

Follow the steps below to connect the monitor to your computer.

1. Connect the HDMI cable and/or DP cable to your computer according to your applications.



Note: Both the HDMI cable and DP cable are optional.

2. Connect the power adapter to the DC-in port on the monitor.
3. Connect the power cord to the power adapter.
4. Fully insert the power cord plug into the power outlet socket.

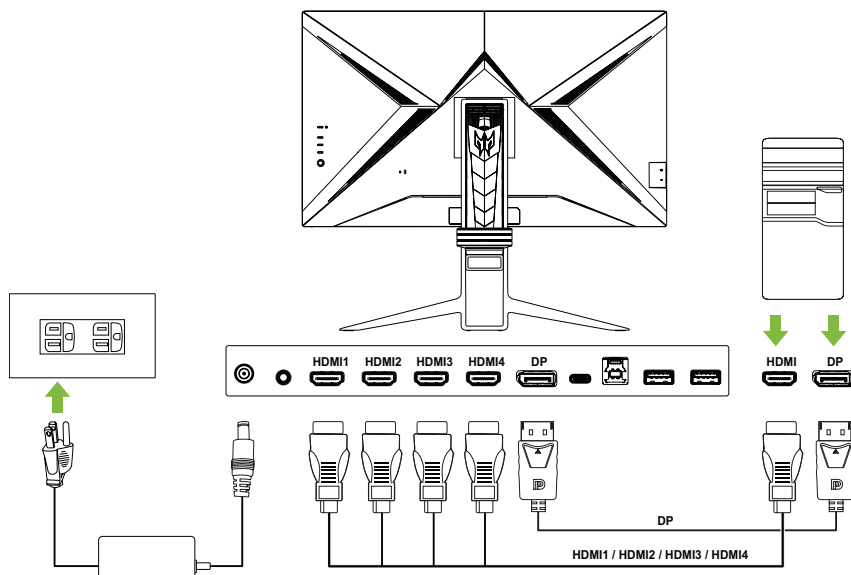

Using the Monitor as a USB Hub

To use the monitor as a USB hub, you need to connect the monitor to your computer using the supplied USB-A to USB-B cable or USB-C cable.

1. Connect the supplied USB-A to USB-B cable or USB-C cable to your computer according to your applications.



Note: If you select the USB 3.1 Type C port as the upstream port, connect the two ends of the USB-C cable to the monitor and your computer. If you select the USB 3.0 Type B port as the upstream port, connect the Type-B end of the USB-A to USB-B cable to the monitor and the Type-A end to your computer.

2. Insert your USB devices, such as USB mouse, USB keyboard, and USB flash drive into the USB 3.0 ports on the monitor.
3. Connect the power adapter to the DC-in port on the monitor.
4. Connect the power cord to the power adapter.
5. Fully insert the power cord plug into the power outlet socket.
6. Select the corresponding upstream port for the **USB Port Select** field in the **System** sub-menu of the OSD menu.

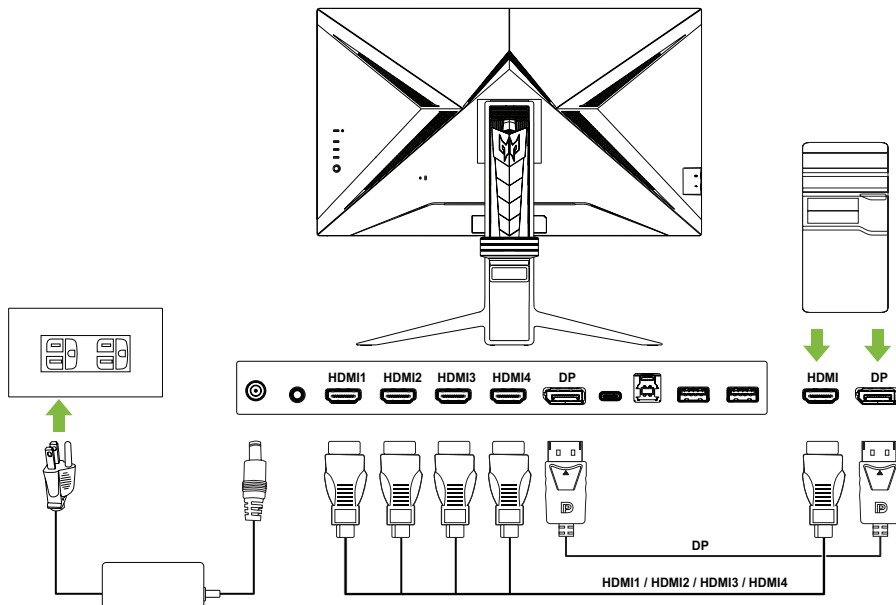



Note: Transmitting the 4K 160 signal via one HDMI 2.1/DP 1.4/Type-C port requires DSC (Display Stream Compression) functionality. If your computer's USB-C port does not have DP-Alt, please connect the HDMI/DP+USB-B to computer 1 and HDMI/DP+USB-C to computer 2.

Powering On/Off the Monitor

To power on the monitor, press the power button located on the left side of the rear panel.

When the monitor is turned on, power off the monitor by pressing the power button.



Note: The display will power on automatically anytime the power cord is plugged into the power outlet socket. It is not recommended to remove the power cord from the power outlet socket in order to shut the monitor down after finishing the installation. Use the power button to power off the monitor.

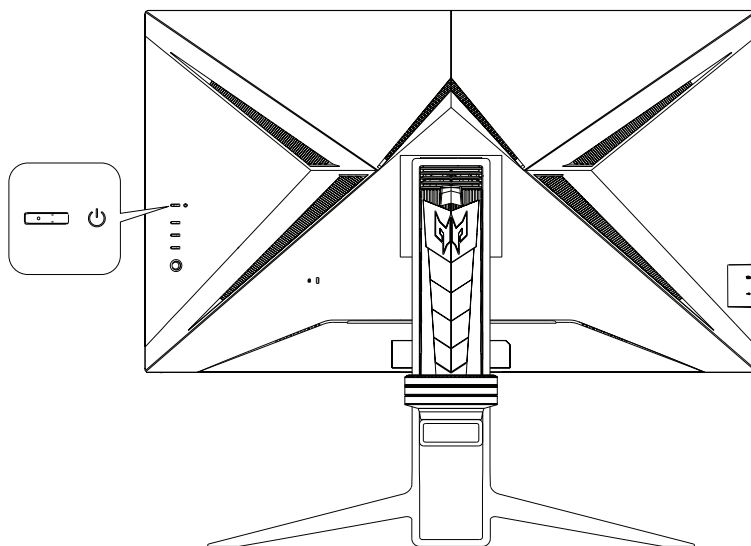

Control Panel

The four buttons and a small joystick located on the left side of the rear panel can be used to control and configure the monitor.

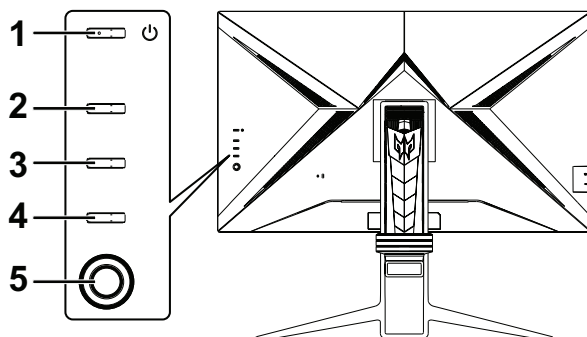

-
- | | | |
|---|--------------|---|
| 1 | Power Button | <ul style="list-style-type: none"> • Turns the monitor on/off. |
|---|--------------|---|
-
- | | | |
|---|-----------|---|
| 2 | Hot Key 1 | <ul style="list-style-type: none"> • Opens the OSD portal. • When the OSD portal is opened, press to enter the assigned hot key function. • Opens Information after entering the main OSD menu. |
|---|-----------|---|
-
- | | | |
|---|-----------|---|
| 3 | Hot Key 2 | <ul style="list-style-type: none"> • Opens the OSD portal. • When the OSD portal is opened, press to enter the assigned hot key function. • Opens Modes after entering the main OSD menu. |
|---|-----------|---|
-
- | | | |
|---|-----------|---|
| 4 | Hot Key 3 | <ul style="list-style-type: none"> • Opens the OSD portal. • When the OSD portal is opened, press to enter the input source menu. • Exits the main OSD menu. |
|---|-----------|---|
-
- | | | |
|---|----------|--|
| 5 | Joystick | <ul style="list-style-type: none"> • Opens the OSD portal. • When the OSD portal is opened, press to enter the main OSD menu. • Toggle the joystick up/down/left/right to navigate the OSD menu. • Press the joystick to confirm selections. • Toggle the joystick left/right to adjust settings. • Press the joystick to confirm changes. |
|---|----------|--|
-

On Screen Display (OSD) Menu



Note: The following content is for general reference only. Actual product specifications may vary.

The OSD (On Screen Display) menu can be used to adjust the monitor's settings. You can use the joystick or hot keys on the rear panel of the monitor to access and navigate the OSD menu.

1. Press the joystick or one of the three hot keys on the rear panel of the monitor to open the OSD portal.
2. Press the joystick to open the OSD menu.
3. Toggle the joystick up/down/left/right to navigate the OSD menu.
4. Press the joystick to confirm selections.
5. Toggle the joystick left/right to adjust settings.
6. Press the joystick to confirm changes.

OSD portal

<p>The screenshot shows the Acer OSD menu with the following options: Mode (Standard), Brightness (100), Input (HDMI 1), and Menu. Each option has a corresponding icon and a horizontal line to its right, indicating it is a selectable menu item.</p>	<ul style="list-style-type: none"> • Hot key 1 (Modes / Brightness / Volume / Gamma / Contrast / Low Blue Light / Over Drive) • Hot key 2 (Modes / Brightness / Volume / Gamma / Contrast / Low Blue Light / Over Drive) • Hot key 3 (Input source, not configurable) • Joystick (Main OSD menu)
--	--

Hot key 1 (default: Standard mode)

Select **Mode** to view more setting options. The options include: **Action, Racing, Sports, User, Standard, ECO, Graphics, and HDR.**

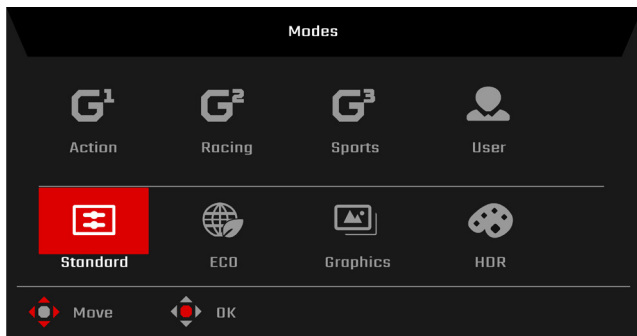

Hot key 2 (default: Brightness)

Select **Brightness** and then adjust the brightness of the monitor.

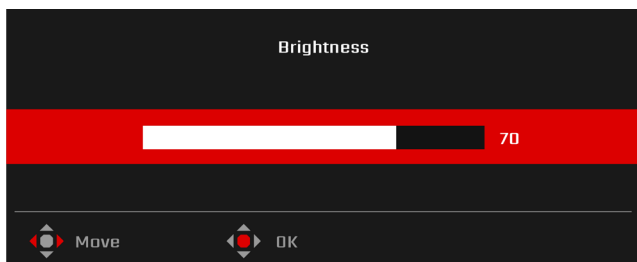

Hot key 3 (default: HDMI1)

Select **Input** to view more setting options. The options include: **HDMI1, HDMI2, HDMI3, HDMI4, DP, DP ALT, and Auto Source.**

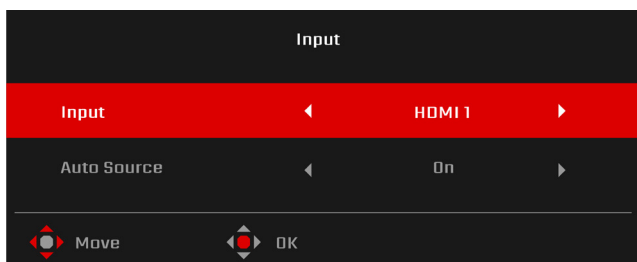







Main OSD menu

The main OSD menu lists all setting options that allow users to make adjustments to the monitor. To open the main OSD menu, select **Menu** in the OSD portal.

Shortcut keys

The OSD menu features three shortcut keys at right side of each sub-menu page.

  	<ul style="list-style-type: none"> • : Opens the Information section. • : Opens the Modes menu. • : Exits the OSD menu.
---	---

Adjusting the Picture settings

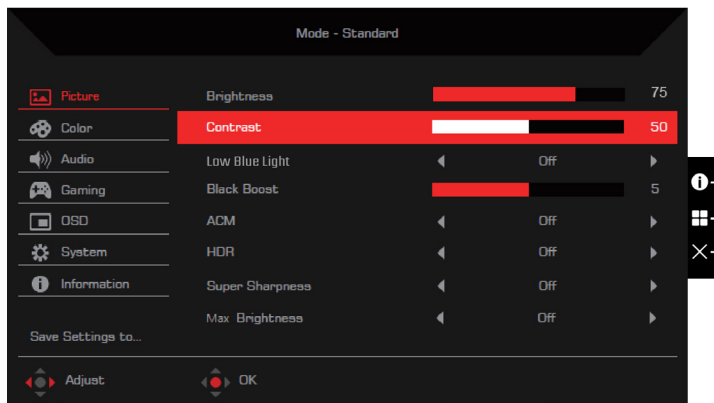

The setting options include:

- **Brightness:** Adjusts the brightness of the monitor (0 to 100). Default: **80**.
- **Contrast:** Adjusts the contrast of the monitor (0 to 100). Default: **50**.



Note: **Contrast** sets the degree of difference between light and dark areas.

- **Low Blue Light:** Filters out blue light to protect your eyes (**Standard / Level 1 / Level 2 / Level 3 / Level 4**). Default: **Standard**.



Note: The lower the level is, the more blue light passes through.

- **Black Boost:** Adjusts the black level of the monitor to make details in shaded areas more visible (0 to 10). Default: **5**.
- **ACM:** Enables/Disables the Adaptive Contrast Management function (**Off /**

On). Default: **Off**.

- **HDR**: Sets the High Dynamic Range function (**Off / Auto**). Default: **Off**.



Note: When HDR is set to **Auto**:

1. If the input source content is in SDR, the brightness of the monitor is configurable. If the input source content is in HDR, the brightness of the monitor will be fixed at 100 and grayed-out.
 2. **ACM, Contrast, Low Blue Light, Black Boost, Grayscale Mode, 6-axis Hue, and 6-axis Saturate** will be grayed-out and cannot be configured.
 3. **Gamma** and **Color Temp.** on the **Color** sub-menu will be hidden.
- **Super Sharpness**: Enables/Disables the Super Sharpness function (**Off / On**). This technology can simulate high-resolution images by enhancing the pixel density in videos and images. Default: **Off**.
 - **Max Brightness**: Default is **Off**.



Note: Due to environmental considerations, the default brightness of the monitor will be low. It can be adjusted to your preference with the following steps:

Step 1: Go to OSD menu > **Picture** > **Max Brightness**, and turn **Off** to **On** to increase the brightness.

Step 2: When **Max Brightness** is turned on, adjust **Brightness** value between 0 and 100 to your preference.

Adjusting the Color settings

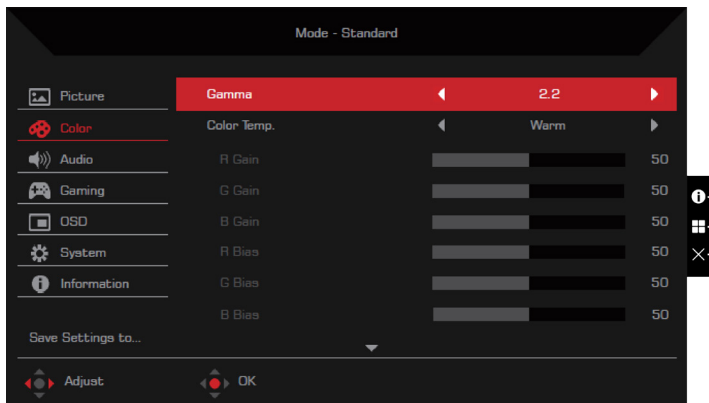

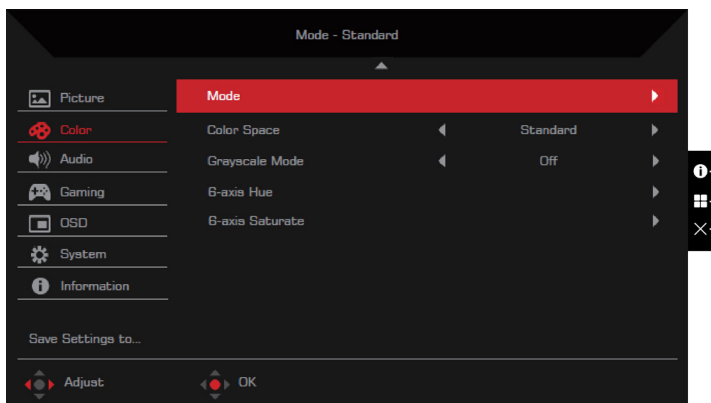

The setting options include:

- **Gamma:** Adjusts the mid-tone contrast of the monitor (**1.8 / 2.0 / 2.2 / 2.4 / 2.6**). Default: **2.2**.
- **Color Temp.:** Adjusts the color temperature of the monitor (**Warm / Normal / Cool / Low Blue Light / User**). Default: **Warm**.
- **R/G/B Gain:** Adjusts R/G/B gain of the monitor (0 to 100). Default: **50**.
- **R/G/B Bias:** Adjusts R/G/B bias of the monitor (0 to 100). Default: **50**.
- **Modes:** Open the **Modes** menu. Default: **Standard**.
- **Color Space:** Sets the color space of the monitor (**sRGB / Rec. 709 / HDR / EBU / DCI / SMPTE-C / Standard**). Default: **Standard**.



Note:

1. When **Color Space** is set to **HDR**, **Modes** will be automatically set to **HDR**.
 2. If **Color Space** is not set to **HDR**, **Modes** will be automatically set to **Standard**.
- **Grayscale Mode:** Enables/Disables the grayscale mode (**Off / On**). Default: **Off**.
 - **6-axis Hue:** Adjusts/Resets the hue of red, green, blue, yellow, magenta or cyan (0 to 100). Default: **50**.
 - **6-axis Saturate:** Adjusts/Resets the saturation of red, green, blue, yellow, magenta or cyan (0 to 100). Default: **50**.

Adjusting the Audio settings

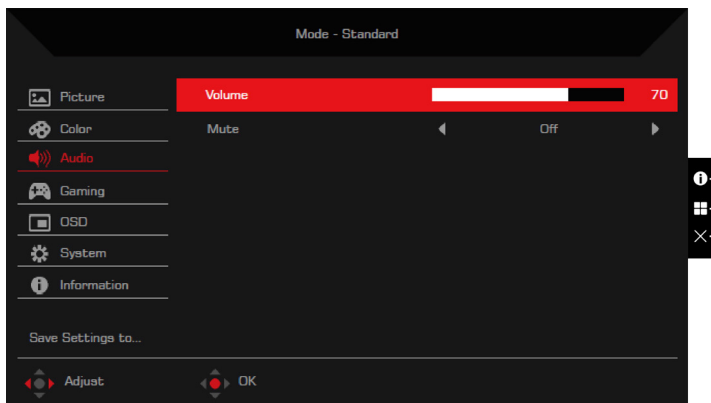

The setting options include:

- **Volume:** Adjusts the volume of the internal speakers (0 to 100). Default: **70**.
- **Mute:** Turns on/off the sound (**Off / On**). Default: **Off**.

Adjusting the Gaming settings

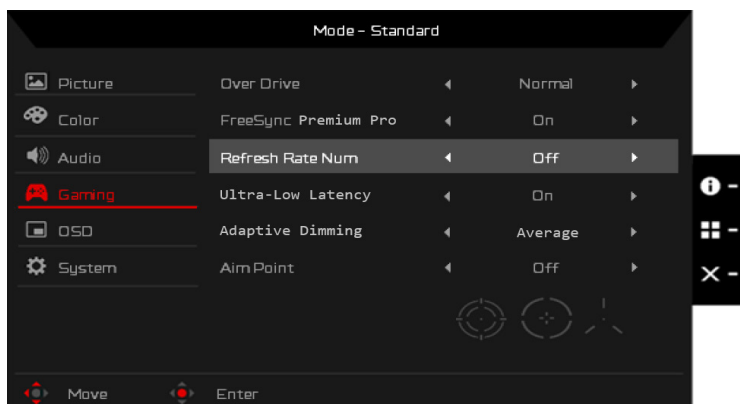

The setting options include:

- **Over Drive:** Configures the monitor to make the pixels transition colors faster (**Off / Normal / Extreme**). Default: **Normal**.
- **FreeSync Premium Pro:** Enables/Disables the FreeSync Premium Pro technology which is supported by AMD's graphic cards (**Off / On**). Default: **On**.



Note:

1. If **FreeSync Premium Pro** is set to **On**, **Over Drive** will be set to **Normal** automatically.
2. If **FreeSync Premium Pro** is set to **Off**, users can set **Over Drive** to any one of the setting options: **Off**, **Normal**, or **Extreme**.
3. Please update FreeSync to the latest AMD driver.

- **Refresh Rate Num:** Displays the monitor's refresh rate (**Off / On**). Default: **Off**.



Note: When **Refresh Rate Num** is set to **On**, the monitor's refresh rate will be displayed on the screen.

- **Ultra-Low Latency:** Enables/Disables the monitor's latency function which helps to speed up the image processing and optimize your gaming experience (**Off / On**). Default: **On**.



Note:

1. If **FreeSync Premium Pro** is set to **On**, **Ultra-Low Latency** will be set to **On** automatically and cannot be configured.
2. If **FreeSync Premium Pro** is set to **Off**, users can set **Ultra-Low Latency** to **Off** or **On**.
3. **Ultra-Low Latency** does not support the resolutions lower than 800x600 and the V-Frequency lower than 48Hz.

- **Adaptive Dimming:** Activates backligh adaptive dimming to synchronize with content brightness of each image block. You can adjust the synchronization speed level to **Fast** (suitable for gaming experiences), **Average** or **Low** (suitable for business or word-processing situations). Default: **Average**.



Note: When **Adaptive Dimming** is set to **Fast**, **Average**, or **Low**, **ACM** will fix on **Off** and grey out.

- **Aim point:** Displays the aim point on the screen of the monitor (**Off / Icon1 / Icon2 / Icon3**). Default: **Off**.

Adjusting the OSD settings

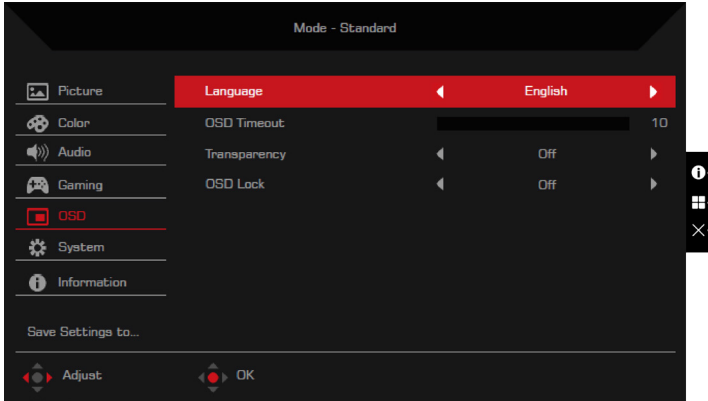

The setting options include:

- **Language:** Changes the OSD menu language. Default: **English**.
- **OSD timeout:** Sets the number of seconds the OSD menu is displayed before it automatically closes (10 to 120 seconds). Default: **10**.
- **Transparency:** Sets the transparency of the OSD menu when using **Gaming** mode (**Off / 20% / 40% / 60% / 80%**). Default: **Off**.
- **OSD Lock:** Sets the OSD lock (**Off / On**). Default: **Off**.



Note: In normal display condition, press the right of the joystick for more than 3 seconds to trigger OSD Unlock.

Adjusting the System settings

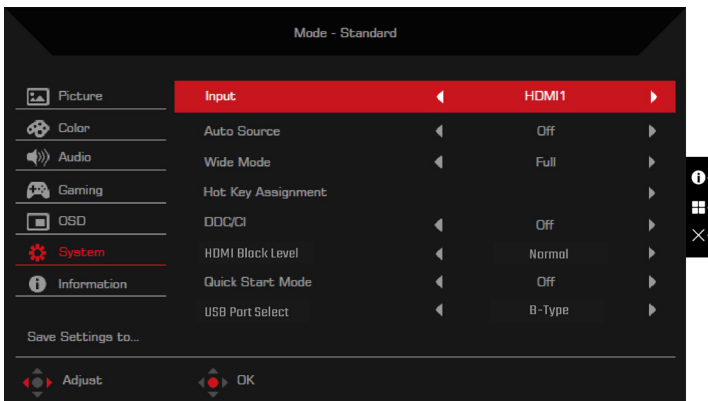

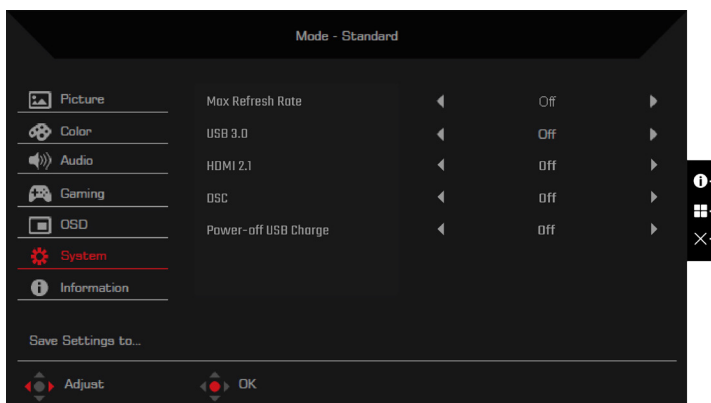

The setting options include:

- **Input:** Selects the input source (**HDMI1 / HDMI2 / HDMI3 / HDMI4 / DP / DP ALT**). Default: **HDMI1**.
- **Auto Source:** Enables/Disables the monitor to automatically search for available input sources (**Off / On**). Default: **On**.
- **Wide Mode:** Adjusts the aspect ratio of the monitor (**Full / Aspect / 1:1**). Default: **Full**.
- **Hot Key Assignment:** Assigns the function that the hot keys on the OSD portal will access.
 - Hot Key 1 (**Modes / Brightness / Volume / Gamma / Contrast / Low Blue Light / Over Drive**). Default: **Modes**.
 - Hot Key 2 (**Modes / Brightness / Volume / Gamma / Contrast / Low Blue Light / Over Drive**). Default: **Brightness**.
- **DDC/CI:** Enables/Disables you to configure the monitor using software installed on your computer (**Off / On**). Default: **On**.



Note: DDC/CI stands for Display Data Channel/Command Interface. It enables users to send commands to adjust the monitor's configurations.

- **HDMI Black Level:** Adjusts the black level range of an HDMI input source (**Normal / Low**). Default: **Normal**.
- **Quick Start Mode:** Speeds up the monitor's boot-up process (**Off / On**). Default: **Off**.

- **USB Port Select:** Selects the upstream port (**B-Type / C-Type**). Default: **C-Type**.



Note: You need to connect the monitor to your computer using the corresponding USB cable after selecting the upstream port.

- **Max Refresh Rate:** Configures the monitor's maximum refresh rate (**144Hz / 160Hz**). Default: **160Hz**.
- **USB 3.0:** Configures the data transmission speed of the USB Type-C port at the bottom side of the rear panel (**Off / On**). Default: **Off**.



Note:

1. If **USB 3.0** is set to **Off**, the transmission speed of the USB Type-C port will be downgraded to the USB 2.0 specification, which allows the DP Alt (DisplayPort Alternate) mode to support resolution 3840x2160 @160Hz.
2. If **USB 3.0** is set to **On**, the transmission speed of the USB Type-C port will comply with the USB 3.0 specification and the DP Alt mode can support resolution 3840x2160 @60Hz.

- **HDMI 2.1:** Enables/Disables the HDMI 2.1 specification (**Off / On**). Default: **On**.
- **DSC:** Enables/Disables the Display Stream Compression function (**Off / On**). Default: **On**.



Note: The monitor's Display Stream Compression function only supports the DP and USB Type-C port.

- **Power-off USB Charge:** Enables/Disables the power charging function of the USB port (**Off / On**). Default: **Off**.



Note:

1. If **Power-off USB Charge** is set to **Off**, when the monitor is powered off, you cannot charge your devices using the USB port.
2. When **Power-off USB Charge** is set to **Off**, the sleep mode cannot be resumed via the USB Type-C input. The user needs to set **Power-off USB Charge** to **On**.

Information

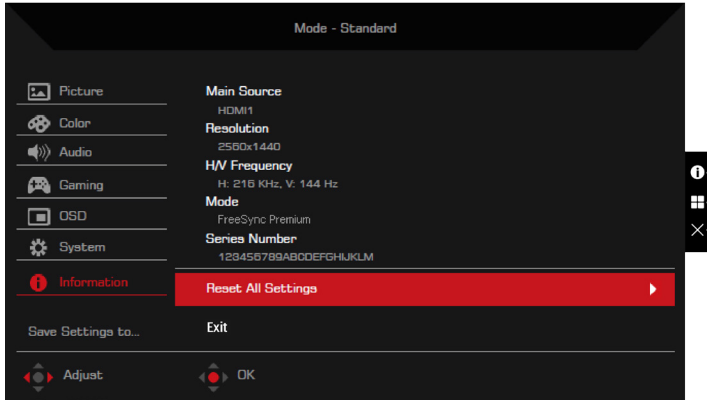

The setting options include:

- **Reset All Settings:** Resets the OSD menu to its default settings.
- **Exit:** Exits the OSD menu.

Save Settings to... (for User Mode only)

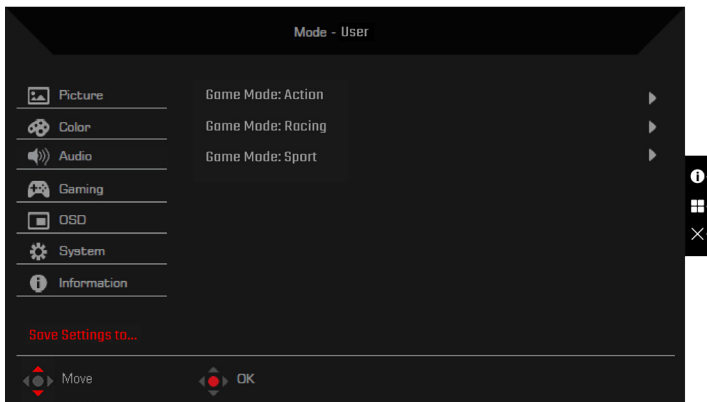

The **Save Settings to...** option will appear when the monitor is set to the **User** mode. It allows you to set up three different game modes for your preference.

Troubleshooting

Before sending your LCD monitor for servicing, please check the troubleshooting list below to see if you can self-diagnose the problem.

HDMI1 / HDMI2 / HDMI3 / HDMI4 / DP / DP Alt Mode

Problem	LED status	Remedy
No picture visible	Blue	Using the OSD menu, adjust brightness and contrast to maximum or reset to their default setting.
	Off	Check the power switch. Check if the AC power cord is properly connected to the monitor.
	Amber	Check if the video signal cable is properly connected at the back of monitor. Check if the computer system is switched on and in power saving/standby mode.



Acer Incorporated
 8F, 88, Sec. 1, Xintai 5th Rd., Xizhi
 New Taipei City 221, Taiwan

Declaration of Conformity

We,

Acer Incorporated

8F, 88, Sec. 1, Xintai 5th Rd., Xizhi, New Taipei City 221, Taiwan

And,

Acer Italy s.r.l.

Viale delle Industrie 1/A, 20044 Arese (MI), Italy

Tel: +39-02-939-921 ,Fax: +39-02 9399-2913

www.acer.it

Product: LCD Monitor
Trade Name: ACER
Model Number: X32
SKU Number: X32 xxxxxxx
 ("x" = 0~9, a ~ z, A ~ Z, or blank)

We, Acer Incorporated, hereby declare under our sole responsibility that the product described above is in conformity with the relevant Union harmonization legislations as below Directive and following harmonized standards and/or other relevant standards have been applied:

EMC Directive: 2014/30/EU

<input checked="" type="checkbox"/> EN55032:2015+AC: 2016 Class B	<input checked="" type="checkbox"/> EN 55035:2010+A1: 2015
<input checked="" type="checkbox"/> EN61000-3-2:2014 Class D	<input checked="" type="checkbox"/> EN61000-3-3:2013

LVD Directive: 2014/35/EU

<input checked="" type="checkbox"/> EN 62368-1: 2014+ A11: 2017

RoHS Directive: 2011/65/EU

<input checked="" type="checkbox"/> EN IEC 6300: 2018

ErP Directive: 2009/125/EC

<input checked="" type="checkbox"/> (EU) 2019/ 2021; EN 50564:2011
--

Year to begin affixing CE marking: 2022.

RU Jan / Sr. Manager
Acer Incorporated (Taipei, Taiwan)

04. 15. 2022
Date



Acer America Corporation
333 West San Carlos St., Suite 1500
San Jose, CA 95110, U. S. A.
Tel : 254-298-4000
Fax : 254-298-4147
www.acer.com



Federal Communications Commission Declaration of Conformity

This device complies with Part 15 of the FCC Rules. Operation is subject to the following two conditions: (1) this device may not cause harmful interference, and (2) this device must accept any interference received, including interference that may cause undesired operation.

The following local Manufacturer /Importer is responsible for this declaration:

Product:	LCD Monitor
Model Number:	X32
SKU Number:	X32 xxxxxxx ("x" = 0~9, a~z, A~Z or Blank)
Name of Responsible Party:	Acer America Corporation
Address of Responsible Party:	333 West San Carlos St. Suite 1500 San Jose, CA 95110 U. S. A.
Contact Person:	Acer Representative
Phone No.:	254-298-4000
Fax No.:	254-298-4147



Product Information for EU Energy



The terms HDMI and HDMI High-Definition Multimedia Interface, and the HDMI Logo are trademarks or registered trademarks of HDMI Licensing LLC in the United States and other countries.

Regulatory Compliance

