

# QuickScan™ 2500

## QUICK REFERENCE GUIDE



General Purpose Corded Handheld  
Area Imager Bar Code Reader

 **DATALOGIC**

---

## **Datalogic S.r.l.**

Via S. Vitalino, 13  
40012 Calderara di Reno (BO)  
Italy  
Tel. +39 051 3147011  
Fax +39 051 3147205

### **©2021 Datalogic S.p.A. and /or its affiliates.**

All rights reserved. Without limiting the rights under copyright, no part of this documentation may be reproduced, stored in or introduced into a retrieval system, or transmitted in any form or by any means, or for any purpose, without the express written permission of Datalogic S.p.A. and/or its affiliates.

Owners of Datalogic products are hereby granted a non-exclusive, revocable license to reproduce and transmit this documentation for the purchaser's own internal business purposes. Purchaser shall not remove or alter any proprietary notices, including copyright notices, contained in this documentation and shall ensure that all notices appear on any reproductions of the documentation.

Electronic versions of this document may be downloaded from the Datalogic website ([www.datalogic.com](http://www.datalogic.com)). If you visit our website and would like to make comments or suggestions about this or other Datalogic publications, please let us know via the "Contact" page.

## **Disclaimer**

Datalogic has taken reasonable measures to provide information in this manual that is complete and accurate, however, Datalogic shall not be liable for technical or editorial errors or omissions contained herein, nor for incidental or consequential damages resulting from the use of this material. Datalogic reserves the right to change any specification at any time without prior notice.

## **Trademarks**

Datalogic and the Datalogic logo are registered trademarks of Datalogic S.p.A. in many countries, including the U.S.A. and the E.U.

QuickScan is a trademark of Datalogic S.p.A. and/or its affiliates, registered in the U.S. All other trademarks and brands are property their respective owners.

## **Patents**

See [www.patents.datalogic.com](http://www.patents.datalogic.com) for patent list.

**See the Regulatory Addendum included with your product for additional regulatory, safety and legal information.**

# TABLE OF CONTENTS

---

<b>END USER SOFTWARE LICENSE AGREEMENT.....</b>	<b>V</b>
Software Product Policy .....	X
<b>About the Scanner .....</b>	<b>1</b>
Omni-Directional Operating.....	2
Decoding.....	2
Imaging.....	2
Hands Free Stand/Holder .....	3
End-Cap Cover .....	4
End-cap cover disassembly procedure .....	4
<b>Setting Up the Reader .....</b>	<b>5</b>
Connecting to the Host Interface.....	5
Disconnecting the Cable .....	6
<b>Using the QuickScan™ 2500 .....</b>	<b>7</b>
QuickScan™ QD2500 .....	7
Relative Size and Location of QuickScan™ QD2500's Aiming System Pattern on Linear bar code .....	8
QuickScan™ QW2500 .....	8
<b>QuickScan™ QW2500's Aiming System .....</b>	<b>8</b>
Relative Size and Location of QuickScan™ QW2500's Aiming System Pattern on 2D Matrix Symbol .....	8
Relative Size and Location of QuickScan™ QW2500's Aiming System Pattern on Linear bar code .....	9
Relative Size and Location of Green Spot (QD2500 and QW2500).....	9
<b>Parts of the Reader .....</b>	<b>10</b>
<b>Selecting the Interface Type .....</b>	<b>10</b>
Interface Selection .....	10
<b>Configuring the Interface.....</b>	<b>11</b>
Keyboard Interface.....	14
Scancode Tables.....	15
Country Mode .....	15
<b>Programming.....</b>	<b>19</b>
Using Programming Bar Codes .....	19
Configure Other Settings .....	19
Resetting Product Defaults .....	19
<b>Numlock.....</b>	<b>20</b>
<b>Caps Lock State .....</b>	<b>21</b>
<b>Reading Parameters.....</b>	<b>22</b>
Aiming System .....	22

Good Read Green Spot Duration .....	22
<b>Operating Modes .....</b>	<b>23</b>
Scan Mode .....	23
<b>Pick Mode .....</b>	<b>26</b>
<b>Multiple Label Reading .....</b>	<b>26</b>
<b>Technical Specifications .....</b>	<b>27</b>
<b>LED and Beeper Indications .....</b>	<b>30</b>
<b>Troubleshooting .....</b>	<b>31</b>
<b>Warranty.....</b>	<b>32</b>
<b>Ergonomic Recommendations .....</b>	<b>33</b>
<b>Technical Support.....</b>	<b>33</b>
Support Through the Website .....	33
Reseller Technical Support.....	33
<b>Cleaning Procedure .....</b>	<b>34</b>
Common Cleaning Solutions .....	34
Cleaning enclosure and window surfaces .....	35

# END USER SOFTWARE LICENSE AGREEMENT

## (EULA) FOR THE QUICKSCAN™ QD2590 AND QW2520 PRODUCT SERIES

**NOTICE TO END USER: BY DOWNLOADING OR INSTALLING THE SOFTWARE, OR BY USING THE DATALOGIC PRODUCT THAT INCLUDES THIS SOFTWARE, THE END USER CONSENTS TO BE BOUND BY THIS AGREEMENT. IF THE END USER DOES NOT AGREE WITH ALL OF THE TERMS OF THIS AGREEMENT, THEN DATALOGIC IS NOT WILLING TO LICENSE THE SOFTWARE AND THE END USER IS NOT ALLOWED TO DOWNLOAD, INSTALL OR USE THE SOFTWARE OR THE DATALOGIC PRODUCT---**

This End User License Agreement ("EULA") is between Datalogic IP Tech S.r.l. having its registered office at Via San Vitalino 13, 40012 Calderara di Reno (Bologna), Italy ("Datalogic"), and you, either an individual or a single entity, ("End User or "You") who has purchased one or more QUICKSCAN™ QD2590 or QW2520 ("Datalogic Product") subject to the terms and conditions provided in any relevant purchase or sale contract. This EULA applies to the software contained in the Datalogic Product ("Embedded Software") and to any other software, to the extent applicable, offered as optional application software ("Application Software" that together with "Embedded Software" is herein referred to as "Software"). Any Open Source used in a conjunction with the Software is subject to the Open Source licenses available at the following website: <http://www.datalogic.com/oss>

### 1. Grant of License

- 1.1 Datalogic grants to End User, a personal, non-exclusive, non-transferable, non sub licensable, revocable, limited license to use the Software, solely on the Datalogic Product in which it is embedded or for which it is intended for use, in machine-readable form only, solely for End User's internal business purposes.
- 1.2 End Users shall not distribute, sublicense, rent, loan, lease, assign, export, re-export, resell, ship or divert or cause to be exported, re-exported, resold, shipped or diverted, directly or indirectly, the Software under this Agreement. End User shall not, and shall not permit others to: (i) modify, translate, decompile, reverse engineer, disassemble, or extract the inner workings of the Software, (ii) copy the functionality of the Datalogic Products; (iii) remove any proprietary notices, marks, labels, or logos from the Datalogic Products; (iv) rent or transfer all or some of the Software to any other party without Datalogic's prior written consent.
- 1.3 Title to the licensed Software shall be and remain with Datalogic or the third party from whom Datalogic has obtained a license right. This Agreement does not grant to End User any intellectual property rights. As used in this Agreement the term "purchase" or its equivalent when applied to the Software shall mean "acquire under license". End User is not entitled to receipt or use of the source code of any licensed Software.
- 1.4 Portions of the Datalogic Product are protected by the relevant and applicable patent and copyright laws, international treaty provisions, and other applicable laws. Therefore, End User must treat the Datalogic Product like any other copyrighted material (e.g., a book or musical recording) except that End User may make one copy of the Software solely for back-up purposes. Unauthorized duplication of the Software constitutes copyright infringement.

- 1.5 Any use of the Software outside of the conditions set forth herein is strictly prohibited and will be deemed a breach of this Agreement resulting in immediate termination of this Agreement. In the event of a breach of this Agreement, Datalogic will be entitled to all available remedies at law or in equity (including but not limiting to immediate termination of the license without notice, immediate injunctive relief and repossession of all Datalogic Products).
- 1.6 Without prejudice of the foregoing, End User grants to Datalogic and its independent accountants or consultants the right to examine End User's books, records and accounts during End User's normal business hours to verify compliance with this Agreement. In the event such audit discloses non-compliance with this Agreement, Datalogic shall be entitled to immediately terminate the Agreement, request End User to promptly pay all (additional) license fees due and any further damages, if any.

### 2. License Fee

License fees shall be due by End User to Datalogic according to the terms provided for in the relevant contract for the purchase of the Datalogic Product.

### 3. Termination

Without prejudice to any other rights or remedies Datalogic may have, Datalogic may terminate this Agreement if End User fails to comply with the terms and conditions of this Agreement. Datalogic may terminate this Agreement by offering you a superseding Agreement for the Software or any replacement or modified version of or upgrade to the Software and conditioning your continued use of the Software or such replacement, modified or upgraded version on your acceptance of such superseding Agreement. In addition, either party may terminate this Agreement at any time. Subject to the foregoing, termination shall be effective upon notice to the other party. In the event that this Agreement terminates for any reason, End User's license to use the Software will immediately terminate, and End User must immediately stop using the Software, destroy all copies of the Software and all of its component parts, and, upon request, provide an affidavit certifying your compliance with the foregoing. The provisions of Sub-sections 1.2, 1.3, 1.4, 1.5, 4, 5, 6, 8, and 11 shall survive termination of this Agreement.

### 4. Limited Warranty

Datalogic warrants that, under normal use and operation, the Software will conform substantially to the applicable Datalogic Product documentation for the period specified in the same, provided that the Software is used with the Datalogic Product. Datalogic's entire liability and End User's sole and exclusive remedy for any breach of the foregoing limited warranty will be, at Datalogic's option, the provision of a downloadable patch or replacement software.

Datalogic does not warrant (i) that Software will meet End User's requirements; (ii) that Software will be uninterrupted or defect error free; (iii) any non conformity derived from unauthorized use, and/or improper installation or repair not in compliance with Datalogic Product documentation. End User agrees that the existence of such non conformities or errors and Datalogic's inability to remedy such errors shall not constitute a breach of this Agreement.

EXCEPT AS PROVIDED IN THIS AGREEMENT, THE DATALOGIC PRODUCT IS PROVIDED "AS IS" AND DATALOGIC MAKES NO WARRANTIES OF ANY KIND, EXPRESS OR IMPLIED, WRITTEN OR ORAL, WITH RESPECT TO THE DATALOGIC PRODUCT OR SOFTWARE, AND SPECIFICALLY DISCLAIMS THE

IMPLIED WARRANTIES OF MERCHANTABILITY AND FITNESS FOR A PARTICULAR PURPOSE.

### **5. Limitation of Liability**

EXCEPT AS PROVIDED IN THIS AGREEMENT, NEITHER DATALOGIC NOR ITS LICENSORS SHALL BE LIABLE FOR ANY CLAIMS AGAINST END USER BY ANY OTHER PARTY. IN NO EVENT SHALL DATALOGIC'S LIABILITY FOR DAMAGES, IF ANY, WHETHER BASED UPON CONTRACT, TORT (INCLUDING NEGLIGENCE), PRODUCT LIABILITY, STRICT LIABILITY, WARRANTY, OR ANY OTHER BASIS, EXCEED THE PRICE OR FEE PAID BY END USER FOR THE DATALOGIC PRODUCT. UNDER NO CIRCUMSTANCES SHALL DATALOGIC OR ITS LICENSORS BE LIABLE TO END USER OR ANY THIRD PARTY FOR LOST PROFITS, LOST DATA, INTERRUPTION OF BUSINESS OR SERVICE, OR FOR ANY OTHER SPECIAL, CONSEQUENTIAL, CONTINGENT, INDIRECT, INCIDENTAL, PUNITIVE, EXEMPLARY, OR OTHER SIMILAR DAMAGES, EVEN IF DATALOGIC OR ITS LICENSORS HAVE BEEN ADVISED OF THE POSSIBILITY OF SUCH DAMAGES. END USER MUST BRING ANY ACTION UNDER THIS AGREEMENT WITHIN 12 (TWELVE) MONTHS AFTER THE CAUSE OF ACTION ARISES.

### **6. Indemnification**

To the maximum extent permitted by law, End User agrees to defend, indemnify and hold harmless Datalogic, its affiliates and their respective directors, officers, employees and agents from and against any and all claims, actions, suits or proceedings, as well as any and all losses, liabilities, damages, costs and expenses (including reasonable attorney's fees) arising out of or accruing from or related to Licensee's failure to comply with the terms of this Agreement, including but not limited to (1) non compliance with any applicable laws or regulations with Datalogic product documentation, (2) unauthorized use or disclosure of Software, and (3) use of Software in combination with software, hardware, systems, or other items not provided by Datalogic.

### **7. Support**

End User may request support for Software from Datalogic at Datalogic's standard support fees and under Datalogic's standard support terms and conditions in effect at the time the support is requested.

### **8. Government Restricted Rights; International Use**

- 8.1 Use, duplication, or disclosure of the Software by the U.S. Government is subject to the restrictions for computer software developed at private expense as set forth in the U.S. Federal Acquisition Regulations at FAR 52.227-14(g), or 52.227-19 or in the Rights in Technical Data and Computer Software clause at DFARS 252.227-7013(c)(1)(ii), whichever is applicable.
- 8.2 If End User is using the Datalogic Product outside of the United States, End User must comply with the applicable local laws of the country in which the Datalogic Product is used and with U.S. export control laws,. Without prejudice of the foregoing, the End User agrees to not export or re-export the Software, any part thereof, or any process or service that is the direct product of the Software to any country, person or entity subject to U.S. export restrictions. End User specifically agrees not to export or re-export any of the Software: (i) to any country to which the U.S. has embargoed or restricted the export of goods or services or to any national of any such country, wherever located, who intends to transmit or transport the Software back to such country; (ii) to any person or entity who you know or have reason to know will utilize the Software in the design, development or production of nuclear, chemical or biological weapons; or (iii) to any person or entity who has been prohib-

ited from participating in U.S. export transactions by any federal agency of the U.S. government. End User warrants and represents that neither the U.S. Commerce Department, Bureau of Export Administration nor any other U.S. federal agency has suspended, revoked or denied its export privileges.

### 9. Third Party Software

The Datalogic Product may contain one or more items of third party software which use is governed by separate third party license, unless otherwise stated.

### 10. Open Source Software

Portions of the Software include or operate with Open Source software ("Open Source Software").

Open Source Software is software covered by a publicly available license governed solely under Copyright law, whereas the complete terms and obligations of such license attach to a licensee solely through the act of copying, using and/or distributing the licensed software, such obligations often include one or more of attribution obligations, distribution obligations, copyleft obligations, and intellectual property encumbrances. The use of any Open Source Software is subject to the terms and conditions of this Agreement as well as the terms and conditions of the corresponding license of each Open Source Software package. If there is a conflict between the terms and conditions of this Agreement and the terms and conditions of the Open Source Software license, the applicable Open Source Software license will take precedence. Datalogic is required to reproduce the software licenses, acknowledgments and copyright notices as provided by the authors and owners, thus, all such information is provided in its native language form, without modification or translation. Please reference and review the above mentioned information to identify which Open Source Software packages have source code provided or available.

### 11. Notices

All notices required or authorized under this Agreement shall be given in writing, and shall be effective when received, with evidence of receipt. Notices to Datalogic shall be sent to the attention of Datalogic IP Tech S.r.l., Legal & IP Department, Via San Vitalino 13, 40012 Calderara di Reno (Bologna), Italy, or such other address as may be specified by Datalogic in writing.

### 12. General Provisions

- 12.1 Entire Agreement; Amendment. This document contains the entire agreement between the parties relating to use of the Datalogic Products and the licensing of the Software and supersedes all prior or contemporaneous agreements, written or oral, between the parties concerning the use of the Datalogic Products and licensing of the Software. This Agreement may not be changed, amended, or modified except by written document signed by Datalogic.
- 12.2 Waiver. A party's failure to enforce any of the terms and conditions of this Agreement shall not prevent the party's later enforcement of such terms and conditions.
- 12.3 Governing Law; Venue: End User agrees to the application of the laws of the country in which End User obtained the license to govern, interpret, and enforce all of End User's and Datalogic's respective rights, duties, and obligations arising from, or relating in any manner to, the subject matter of this Agreement, without regard to conflict of law principles. The United Nations Convention on Contracts for the International Sale of Goods does not apply.



All rights, duties, and obligations are subject to the courts of the country in which End User obtained the license. For licenses granted by Licensee who operates in the countries specified below, the following terms apply.

For Americas:

This Agreement is governed by the laws of the State of Oregon. This Agreement and the rights of the parties hereunder shall be governed by and construed in accordance with the laws of the State of Oregon U.S.A, without regard to the rules governing conflicts of law. The state or federal courts of the State of Oregon located in either Multnomah or Lane counties shall have exclusive jurisdiction over all matters regarding this Agreement, except that Datalogic shall have the right, at its absolute discretion, to initiate proceedings in the courts of any other state, country, or territory in which End User resides, or in which any of End User's assets are located. In the event an action is brought to enforce the terms and conditions of this Agreement, the prevailing party shall be entitled to reasonable attorneys' fees, both at trial and on appeal.

For Europe, Middle East and Africa:

This Agreement is governed by the laws of Italy. This Agreement and the rights of the parties hereunder shall be governed by and construed in accordance with the laws of Italy, without regard to the rules governing conflicts of law. Italian Court of Bologna shall have exclusive jurisdiction over all matters regarding this Agreement, except that Datalogic shall have the right, at its absolute discretion, to initiate proceedings in the courts of any other state, country, or territory in which End User resides, or in which any of End User's assets are located. In the event an action is brought to enforce the terms and conditions of this Agreement, the prevailing party shall be entitled to reasonable attorneys' fees, both at trial and on appeal.

For Asia- Pacific Countries:

The validity, interpretation and construction of the Agreement shall be governed by and construed in accordance with Laws of the Republic of Singapore. Parties expressly disclaim the application of the United Nations Convention for International Sale of Goods.

Any dispute arising out of or in connection with this contract, including any question regarding its existence, validity or termination, shall be referred to and finally resolved by arbitration administered by the Singapore International Arbitration Centre ("SIAC") in accordance with the Arbitration Rules of the Singapore International Arbitration Centre ("SIAC Rules") for the time being in force, which rules are deemed to be incorporated by reference in this clause. The seat of the arbitration shall be Singapore.

The number of arbitrators will be three, with each side to the dispute being entitled to appoint one arbitrator. The two arbitrators appointed by the parties will appoint a third arbitrator who will act as chairman of the proceedings. Vacancies in the post of chairman will be filled by the president of the SIAC. Other vacancies will be filled by the respective nominating party. Proceedings will continue from the stage they were at when the vacancy occurred. If one of the parties refuses or otherwise fails to appoint an arbitrator within 30 days of the date the other party appoints its, the first appointed arbitrator will be the sole arbitrator, provided that the arbitrator was validly and properly appointed. All proceedings will be conducted, including all documents presented in such proceedings, in the English language. The English language version of these terms and conditions prevails over any other language version.

12.4 Attorneys' Fees. In the event an action is brought to enforce the terms and conditions of this Agreement, the prevailing party shall be entitled to reasonable attorneys' fees, both at trial and on appeal.

- END -

## Software Product Policy

Datalogic reserves the right to ship its products with the latest version of software/firmware available. This provides our customers with the very latest in Datalogic software technology.

The only exception to this policy is when the buyer has a signed contract with Datalogic that clearly defines the terms and conditions for making software/firmware changes in products shipped to the buyer.

To arrange for a Software Maintenance and Support Agreement please contact your Datalogic sales person.

# QUICKSCAN™ 2500

---

## ABOUT THE SCANNER

The QuickScan™ 2500 product series represents the hand-held entry level corded scanner by Datalogic. It has been specifically created for small to medium size Retailers, such as groceries and convenience stores, operating in both food and non-food sectors.

Providing the quickest response to the operator for its class of products, the 2500 scanner is able to capture whatever barcode, hard-to-read, poor or damaged. It easily scans from mobile devices and through plexiglass barriers.

Lightweight and easy to handle also for female users, it is a reliable and seamless companion throughout the whole shift.

The 2500 scanner features a precise aiming system developed with the unique intent to reduce visual stress of the operator during the daily scanning activities. While the QW2500 model features a very intuitive blue dot aimer, the more sophisticated, extreme precision aimer of the QD2500 model, consists of two blue LED triangles pointing at the targeted bar code. The Green Spot confirms the good read, being perfectly centered on the barcode and between the two triangles.

Very responsive at the pull of the trigger, the QuickScan 2500 provides a superior robustness for its class of products, thanks to an accurate design and quality of parts, right there where the product is mostly stressed.

Perfect for manual reading, the QuickScan 2500 uses Datalogic's Motionix™ motion detection technology that detects the operator's natural actions to automatically switch the scanner into “ready to read” scan mode.

The product range is wide, with two colors – black and white – and a variety of different stands, holders and accessories to provide the best fit for each working environment.

## Omni-Directional Operating

To read a symbol or capture an image, simply aim the reader and pull the trigger. The QuickScan™ QD2500 and QW2500 are powerful omni-directional readers, so the orientation of the symbol is not important. Datalogic's 'Green Spot' for good-read feedback helps to improve productivity in noisy environments or in situations where silence is required.

**For QuickScan™ QD2500 only** — When positioning the product into the stand, the magnetic coupling will switch the scanner from trigger mode to auto-sense mode and allow to automatically detect a bar code inside the field of view.

## Decoding

The QuickScan™ QD2500 and QW2500 reliably decode all standard 1D (linear) and 2D bar codes, including GS1 DataBar™ linear codes, Postal Codes (China Post), Stacked Codes (such as GS1 DataBar Expanded Stacked, GS1 DataBar Stacked, GS1 DataBar, Stacked Omnidirectional). The data stream - acquired from decoding a symbol - is rapidly sent to the host. The reader is immediately available to read another symbol.

## Imaging

QuickScan™ QD2500 and QW2500 readers can also function as a camera by capturing entire images or image portions of labels, signatures, and other items. See the Datalogic Aladdin configuration tool for information and options for this feature.

## Hands Free Stand/Holder

An accessory is available which holds the reader (except those with integrated stand) at a convenient angle, allowing hands free scanning of items. It can also be used as a holder.

The QuickScan™ QD2500 reader automatically recognizes the insertion and changes its Scan Mode to allow the user to operate in hands-free mode.



**NOTE: For QuickScan™ QD2500, to use the Stand Autosense™ (STD-AUTO-QD25-xx) it is mandatory to remove the End-cap. See page 4.**

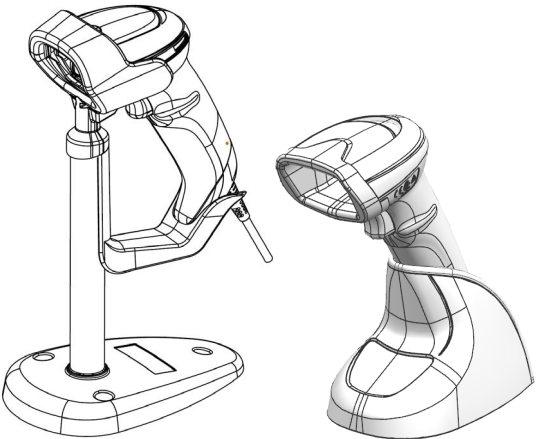

**NOTE: For QuickScan™ QW2500, read the following label to change Scan Mode to allow the user to operate in hands-free mode.**



**Scan Mode = Stand Mode/Object Detection**

## End-Cap Cover



**NOTE: For QuickScan™ QD2500, to use the Stand Autosense™ (STD-AUTO-QD25-xx) it is mandatory to remove the End-cap. See the paragraph below.**

### End-cap cover disassembly procedure

1. Using a small screwdriver or a similar tool pull out the End-Cap from the scanner plastic enclosure.



2. Sequence of extraction of the End-Cap.



3. The End-Cap is completely removed from the scanner.



# SETTING UP THE READER

Follow the steps below to connect and get your reader up and communicating with its host.

1. First connect the Cable to the reader then to the Host as shown below.
2. Configure the Interface ([see page 11](#)).
3. Program the Reader starting on page [page 19](#) (optional, as needed).

## Connecting to the Host Interface

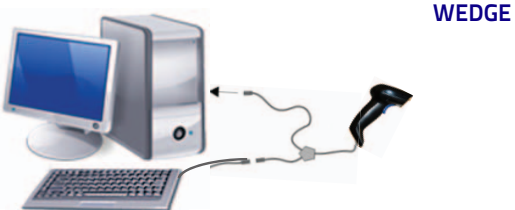

Available only for QuickScan™ QD2500

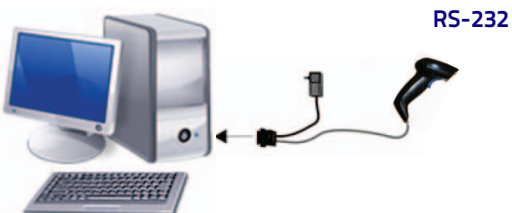

Available only for QuickScan™ QD2500

## Disconnecting the Cable

To remove the interface cable from the reader follow the steps below.

1. Unplug the host end of the cable (also remove the power supply if an auxiliary wall adapter has been used).
2. Locate the hole on the bottom of the handle.
3. Take a paper clip and modify it as shown in the figure below. Insert the end of the paper clip into the hole and press it to push on the clip that holds the connector. As you apply pressure, pull out the cable.
4. When reinserting the cable, make sure the host end of the cable is unplugged and the connector clip is on the same side as the reader release hole. Insert the cable, it should click when it is fully inserted.
5. Plug the other end of the cable into the host port.

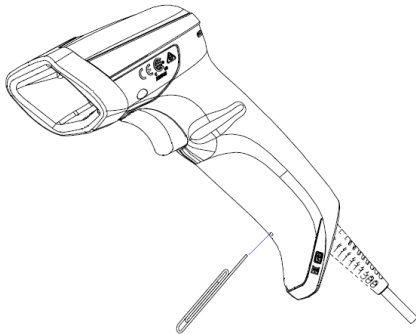



## USING THE QUICKSCAN™ 2500

The QuickScan™ QD2500 and QW2500 normally function by capturing and decoding codes. The reader is equipped with an internal Motionix™ motion-sensing function which activates the aiming system on device motion. The intelligent aiming system indicates the field of view which should be positioned over the bar code.

### QuickScan™ QD2500

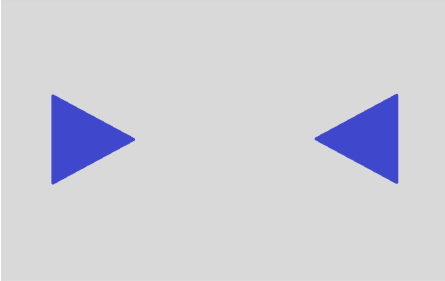

### QuickScan™ QD2500's Aiming System

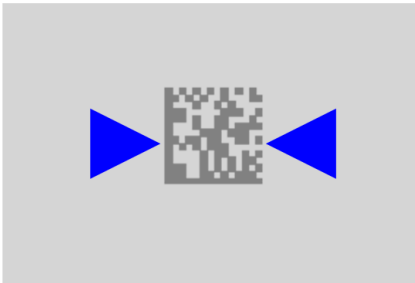

### Relative Size and Location of QuickScan™ QD2500's Aiming System Pattern on 2D Matrix Symbol

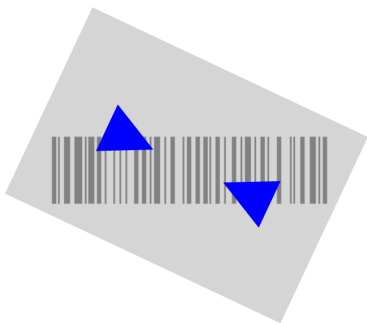

### Relative Size and Location of QuickScan™ QD2500's Aiming System Pattern on Linear bar code

#### QuickScan™ QW2500

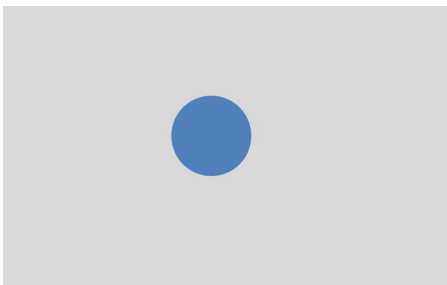

### QuickScan™ QW2500's Aiming System

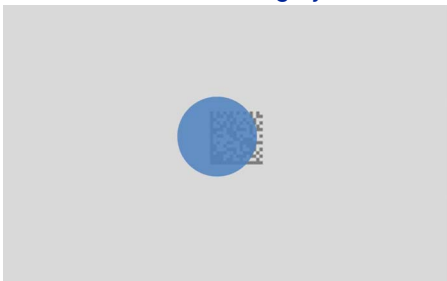

### Relative Size and Location of QuickScan™ QW2500's Aiming System Pattern on 2D Matrix Symbol

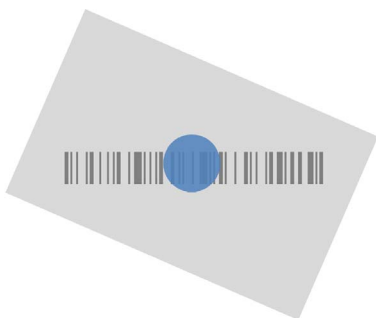

## Relative Size and Location of QuickScan™ QW2500's Aiming System Pattern on Linear bar code

A beam illuminates the label. The projected pattern of the aiming system will be smaller when the reader is closer to the bar code and larger when it is farther from the code. Symbologies with smaller bars or elements (mil size) should be read closer to the unit. Symbologies with larger bars or elements (mil size) should be read farther from the unit. If the aiming system is centered you will get a good read. Successful reading is signaled by an audible tone plus a goodread green spot LED indicator. Reference the QuickScan™ 2500 Product Reference Guide (PRG) on the Datalogic website for more information about this feature and other programmable settings.

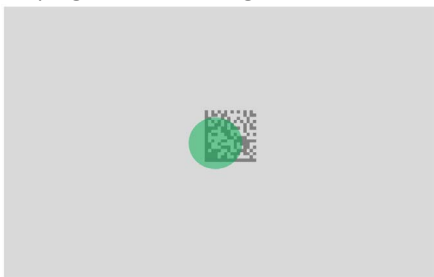

## Relative Size and Location of Green Spot (QD2500 and QW2500)

## PARTS OF THE READER

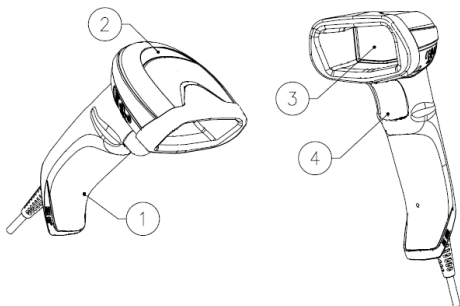

- |                       |            |
|-----------------------|------------|
| 1. Cable Release Hole | 2. LED     |
| 3. Scan Window        | 4. Trigger |

## SELECTING THE INTERFACE TYPE

Upon completing the physical connection between the reader and its host, proceed directly to Interface Selection below for information and programming for the interface type supported by the reader and scan the appropriate bar code to select your system's correct interface type, according to your application.

For interfaces other than those listed in this manual, see the QuickScan™ 2500 Product Reference Guide (PRG), available online at [www.datalogic.com](http://www.datalogic.com).

### Interface Selection

The reader will support all the following host interfaces:

- RS-232 STD<sup>1</sup>
- RS-232 WN<sup>1</sup>
- IBM46XX port 9b (a specific cable's required)<sup>1</sup>
- USB HID POS
- USB Toshiba TEC
- USB (Keyboard, COM, OEM)

---

1. Available only for QuickScan™ QD2500

- USB Composite (Keyboard + COM)
- USB for Magellan Scanners
- Keyboard Wedge<sup>1</sup>

Information and programming options for each interface type are provided in this section. For defaults and additional information associated with each interface, proceed to the corresponding chapter in the QuickScan™ 2500 PRG.

## CONFIGURING THE INTERFACE

Scan the appropriate programming bar code to select the interface type for your system.



**NOTE: Unlike some other programming features and options, interface selections require that you scan only one programming bar code label. DO NOT scan an ENTER/EXIT bar code prior to scanning an interface selection bar code.**

**Some interfaces require the scanner to start in the disabled state when powered up. If additional scanner configuration is desired while in this state, pull the trigger and hold for 5 seconds. The scanner will change to a state that allows programming with bar codes.**

**RS-232**



Select RS232-STD<sup>a</sup>  
RS-232 standard interface



Select RS232-WN<sup>a</sup>  
RS-232 Wincor-Nixdorf



Select RS-232 OPOS<sup>a</sup>  
RS-232 for use with OPOS/UPOS/JavaPOS



Select USB-COM-STD<sup>b</sup>  
USB Com to simulate RS-232 standard interface

- a. Available only for QuickScan™ QD2500
- b. Download the correct USB Com driver from [www.datalogic.com](http://www.datalogic.com)

**USB-OEM**

Select USB-OEM  
USB-OEM (can be used for OPOS/UPOS/JavaPOS)

**USB-COMPOSITE**

Select USB-Composite  
USB-Composite (Keyboard + COM)

**IBM46XX**

Select IBM46xx Port 9b<sup>a</sup>

a. Available only for QuickScan™ QD2500

## Keyboard Interface

Use the programming bar codes to select options for USB-Keyboard and Wedge Interfaces (available only for Quick-Scan™ QD2500).

### KEYBOARD



Select KBD-AT  
(AT, PS/2 25-286, 30-286, 50, 50Z, 60, 70, 80, 90 & 95  
w/standard key encoding)



Select KBD-AT-NK  
(IBM AT PS2 with standard key encoding  
but without external keyboard.)



Select KBD-AT-ALT  
(AT, PS/2 25-286, 30-286, 50, 50Z, 60, 70, 80, 90 & 95  
w/Alternate Key)



Select KBD-AT-ALT-NK  
(Keyboard Wedge for IBM AT PS2 with alternate key encoding  
but without external keyboard)



## KEYBOARD (CONTINUED)



★ **Select USB Keyboard**  
(USB Keyboard with standard key encoding)



**Select USB Alternate Keyboard**  
(USB Keyboard with alternate key encoding)

★ = default value

### Scancode Tables

Refer to QuickScan™ 2500 PRG for information about control character emulation for keyboard interfaces.

### Country Mode

This feature specifies the country/language supported by the keyboard. Only the following interfaces support ALL Country Modes.

- USB Keyboard with alternate key encoding
- USB Keyboard with standard key encoding
- AT, PS/2 25-286, 30-286, 50, 50Z, 60, 70, 80, 90 & 95 w/Std Key Encoding
- Keyboard Wedge for IBM AT PS2 with standard key encoding but without external keyboard
- AT, PS/2 25-286, 30-286, 50, 50Z, 60, 70, 80, 90 & 95 without Alternate Key
- Keyboard Wedge for IBM AT PS2 without alternate key encoding but without external keyboard

All other interfaces support ONLY the following Country Modes: U.S., Belgium, United Kingdom, France, Germany, Italy, Spain, Sweden.

## COUNTRY MODE



ENTER/EXIT PROGRAMMING MODE



★ Country Mode = U.S.



Country Mode = Belgium



Country Mode = Croatia\*



Country Mode = Czech Republic\*



Country Mode = Denmark\*



Country Mode = France

**COUNTRY MODE (CONTINUED)**

Country Mode = French Canadian\*



Country Mode = Germany



Country Mode = Hungary\*



Country Mode = Italy



Country Mode = Japanese 106-key\*



Country Mode = Lithuanian\*



Country Mode = Norway\*

## COUNTRY MODE (CONTINUED)



Country Mode = Poland\*



Country Mode = Portugal\*



Country Mode = Romania\*



Country Mode = Slovakia\*



Country Mode = Spain



Country Mode = Sweden



Country Mode = Switzerland\*

**COUNTRY MODE (CONTINUED)**

**Country Mode = United Kingdom**

★ = default value

\* Supports only the interfaces listed in the Country Mode feature description.

## PROGRAMMING

The reader is factory-configured with a set of standard default features. After scanning the interface bar code from the Interfaces section, select other options and customize your reader through use of the programming bar codes available in the QuickScan™ 2500 PRG. Check the corresponding features section for your interface, and also the Data Editing and Symbologies chapters of the PRG.

### Using Programming Bar Codes

This manual contains bar codes which allow you to reconfigure your reader. Some programming bar code labels, like the "Reset Default Settings" on [page 20](#), require only the scan of that single label to enact the change.

Other bar codes require the reader to be placed in Programming Mode prior to scanning them. Scan an ENTER/EXIT bar code once to enter Programming Mode; scan the desired parameter settings; scan the ENTER/EXIT bar code again to accept your changes, which exits Programming Mode and returns the reader to normal operation.

### Configure Other Settings

Additional programming bar codes are available in the PRG to allow customization of programming features. If your installation requires different programming than the standard factory default settings, refer to the PRG.

### Resetting Product Defaults

If you are not sure what programming options have been set in your reader, or you have changed some options and want your custom factory settings restored, scan the bar code below to reset the reader to its initial configuration. Refer to

the PRG for other options, and a listing of standard factory settings.





**NOTE: Factory defaults are based on the interface type. Be sure your reader is configured for the correct interface before scanning this label. See "Selecting the Interface Type" on page 11 for more information.**



Reset Default Settings

## NUMLOCK





This option specifies the setting of the Numbers Lock (Numlock) key while in keyboard wedge interface. This only applies to alternate key encoding interfaces. It does not apply to USB keyboard.

NUMLOCK
 <b>ENTER/EXIT PROGRAMMING MODE</b>
 <b>★ Numlock = Numlock key unchanged</b>
 <b>Numlock = Numlock key toggled</b>

★ = default value

## CAPS LOCK STATE

This option specifies the format in which the reader sends character data. This applies to keyboard wedge interfaces. This does not apply when an alternate key encoding keyboard is selected.

CAPS LOCK STATE
 ENTER/EXIT PROGRAMMING MODE
 ★ Caps Lock OFF
 Caps Lock ON
 AUTO Caps Lock Enable

★ = default value

## READING PARAMETERS

Move the reader toward the target and center the aiming pattern and illumination system to capture and decode the image. See "[Using the QuickScan™ 2500](#)" on page 7 for more information.

The aiming system will briefly switch off after the acquisition time, and if no code is decoded will switch on again before the next acquisition. The illuminator will remain on until the symbol is decoded.



As you read code symbols, adjust the distance at which you are holding the reader.

### Aiming System

A number of options for customizing control of the Aiming System are available. See the QuickScan™ 2500 PRG for more information and programming bar codes.

### Good Read Green Spot Duration

Successful reading can be signaled by a good read green spot. Use the bar codes that follow to specify the duration of the good read pointer beam after a good read.

GOOD READ GREEN SPOT DURATION
 ENTER/EXIT PROGRAMMING MODE
 Disable
 ★ Short (300 ms)



## GREEN SPOT DURATION (CONTINUED)



Medium (500 ms)



Long (800 ms)

★ = default value

## OPERATING MODES

### Scan Mode

The reader can be set to operate in one of several scanning modes. See the PRG for more information and settings for any of the following options:

**Trigger Single (Default)** This mode is associated with the typical handheld reader operation. When the trigger is pulled, illumination is turned on and the scanner attempts to read a label.

Scanning is activated until one of the following occurs:

- the programmable Scanning Active Time<sup>1</sup> expires
- a label has been read
- the trigger is released

**Trigger Hold Multiple** - When the trigger is pulled, scanning starts and the product scans until the trigger is released or Scanning Active Time<sup>1</sup> expires. Reading a label does not disable scanning. Double Read Timeout<sup>1</sup> prevents undesired multiple reads while in this mode.

**Trigger Pulse Multiple** - Scanning begins when the trigger is pulled and continues after the trigger is released, until the trigger is pulled again or until the programmable Scanning Active Time<sup>1</sup> expires. Reading a label does not disable





1. See the Product Reference Guide (PRG) for these and other programmable features.

scanning. Double Read Timeout<sup>1</sup> prevents undesired multiple reads while in this mode.

**Flashing** - The reader illuminator flashes on and off regardless of the trigger status. Code reading takes place only during the Flash On Time<sup>1</sup>. Double Read Timeout<sup>1</sup> prevents undesired multiple reads.

**Always On** - The illuminator is always ON and the reader is always ready for code reading. Double Read Timeout<sup>1</sup> prevents undesired multiple reads.

**Object Detection** - The scanner looks for changes within its field-of-view. The Aiming Pattern is always on to show the optimum reading area. If a predefined amount of movement is detected, the red illumination switches on. Scanning continues until a label is read or Scanning Active Time<sup>1</sup> expires.

SCAN MODE
 ENTER/EXIT PROGRAMMING MODE
 ★ Trigger Single
 Trigger Hold Multiple
 Trigger Pulse Multiple

1. See the Product Reference Guide (PRG) for these and other programmable features.

**SCAN MODE (CONTINUED)****Scan Mode Flashing<sup>a</sup>****Scan Mode Always ON****Stand Mode**

- a. Controlled by Flash On Time and Flash Off Time. See the PRG to program these parameters.



★ = default value

## PICK MODE

This option specifies the ability of the reader to decode labels only when they are close to the center of the aiming pattern, which is the area indicated by the red cross. Pick Mode is a Decoding and Transmission process where bar codes that are not within the configurable distance from the center of the aiming pattern are not acknowledged or transmitted to the host. It is active only while the scanner is in Trigger Single mode. If the scanner switches to a different Read Mode, Pick Mode is automatically disabled.



**NOTE: This feature is not compatible with Multiple Labels Reading in a Volume. See the PRG for more information.**

PICK MODE
 ENTER/EXIT PROGRAMMING MODE
 ★ Pick Mode = Disable
 Pick Mode = Enable

★ = default value

## MULTIPLE LABEL READING

The reader offers a number of options for multiple label reading. See the PRG or software configuration tool for descriptions of these features and programming labels.

## TECHNICAL SPECIFICATIONS

The following table contains Physical and Performance Characteristics, User Environment and Regulatory information.

PHYSICAL CHARACTERISTICS	
Color	Black White <sup>a</sup>
Dimensions	Height 14.8 cm (5.8") Length 12.6 cm (4.96") Width 6.8 cm (2.7")
Weight	approx. 145gr. (5.1oz.)
ELECTRICAL CHARACTERISTICS	
Power Supply (WLC4190)	5 VDC $\pm$ 5%
Consumption (Typical)	Operating (Typical): <400 mA @ 5V Standby/Idle (Typical): <90 mA @ 5V
Battery Capacity	Li-Ion 3.6V, 3250 mAh (11.7Wh)
Max. Scan Rate	60 frames/sec
Reading Indicators	Top illumination, Good Read Spot, Beep

a. Only for QuickScan™ QD2500

ENVIRONMENTAL CHARACTERISTICS	
Operating Temperature	0 °C to + 50 °C (+32° F to +122 °F)
Storage Temperature	-40 °C to + 70 °C (-40 ° F to +158 °F)
Humidity	95% non condensing
Drop Resistance	IEC 68-2-32 Tested 1.5 m (4.9 ft)
Trigger Resistance	10 Mbits
ESD Protection	16 KV
Protection Class	IP52
Cable Length	Refer to <a href="http://www.datalogic.com">www.datalogic.com</a>
OPTICAL CHARACTERISTICS	
Optical Format	QuickScan™ QD2500: 1/4" QuickScan™ QW2500: 1/6"
Active Imager Size	QuickScan™ QD2500: 3896 $\mu$ m (H) x 2453 $\mu$ m (V) QuickScan™ QW2500: 2396 $\mu$ m (H) x 1797 $\mu$ m (V)
Active Pixels	QuickScan™ QD2500: 1280 H x 800 V QuickScan™ QW2500: 640 H x 480 V
Illumination System	LED source Red Emission (wavelength - 624 nm)

## Technical Specifications

Aiming System	LED source Blue Emission (wavelength - 468 nm)
Ambient Light	Up to 110,000 lux
Tilt Tolerance	0° - 360°
Pitch Tolerance	± 65°
Skew Tolerance	± 65°
Field of View	QuickScan™ QD2500: 35° x 22° QuickScan™ QW2500: 33° x 25°
PCS (Datalogic Test Chart)	QuickScan™ QD2500: minimum 15% QuickScan™ QW2500: minimum 20% (15% with specific configuration)

<b>QUICKSCAN™ QD2500</b>	
<b>DOF - DEPTH OF FIELD (TYPICAL)<sup>A, B</sup></b>	
<b>Symbology</b>	<b>DOF range</b>
Code 39	5 mil: 0.5 - 25.0 cm (0.19" - 9.8") 10 mil: 0.5 - 38 cm (0.19" - 14.9")
EAN13	13 mil: 0.5 - 51.0 cm (0.19" - 20.1")
PDF417	6.7 mil: 0.5 - 21.0 cm (0.19" - 8.3")
Datamatrix	10 mil: 0.5- 21.5 cm (0.19" - 8.5")
Code 128	5 mil: 2 - 21.5 cm (0.8" - 8.5")
QR Code	20 mil: 0- 37 cm (0" - 14.6")
Max Resolution	1D Min = 3 mil PDF417 Min = 3 mil Datamatrix Min = 5 mil

- a. All 1D codes are Code 39. All labels grade A, typical environmental light, 20°C, label inclination 10°
- b. The values are obtained with the item "DOF Enhancement" enabled.

<b>QUICKSCAN™ QW2500</b>	
<b>DOF - DEPTH OF FIELD (TYPICAL)<sup>A</sup></b>	
<b>Symbology</b>	<b>DOF range</b>
Code 39	5 mil: 0.5 - 23.0 cm (0.19" - 9.0") 10 mil: 0.5 - 37 cm (0.19" - 14.5")
EAN13	13 mil: 1 - 40.0 cm (0.39" - 15.7")
PDF417	6.7 mil: 0.5 - 13.5 cm (0.19" - 5.3")
Datamatrix	10 mil: 1.0 - 15.5 cm (0.39" - 6.1")
Code 128	5 mil: 2.5 - 18.0 cm (9.8" - 7.0")
QR Code	20 mil: 1.0 - 33 cm (0.39" - 12.9")
Max Resolution	1D Min = 3 mil PDF417 Min = 5 mil Datamatrix Min = 6 mil

- a. All 1D codes are Code 39. All labels grade A, typical environmental light, 20°C, label inclination 10°

<b>DECODE CAPABILITY</b>
<p><b>1D Bar Codes</b></p> <p>UPC/EAN/JAN (A, E, 13, 8); UPC/EAN/JAN (including P2 /P5); UPC/EAN/JAN (including; ISBN / Bookland &amp; ISSN); UPC/EAN Coupons; Code 39 (including full ASCII); Code 39 Trioptic; Code39 CIP (French Pharmaceutical); LOGMARS (Code 39 w/ standard check digit enabled); Danish PPT; Code 32 (Italian Pharmacode 39); Code 128; Code 128 ISBT; Interleaved 2 of 5; Standard 2 of 5; Interleaved 2 of 5 CIP (HR); Industrial 2 of 5; Discrete 2 of 5; Matrix 2 of 5; IATA 2of5 Air cargo code; Code 11; Codabar; Codabar (NW7); ABC Codabar; EAN 128; Code 93 ; MSI; PZN; Plessey; Anker Plessey; GS1 DataBar Omnidirectional; GS1 DataBar Limited; GS1 DataBar Expanded; GS1 DataBar Truncated; DATABAR Expanded Coupon.</p>
<p><b>2D / Stacked Codes</b></p> <p>The QuickScan™ 2500 scanner is capable of decoding the following symbologies using multiple frames (i.e. Multi-Frame Decoding):</p> <p>Data Matrix; Inverse Data Matrix; Data Matrix is configurable for the following parameters: Normal or Inverted; Square or Rectangular Style; Data length (1 - 3600 characters); Maxicode; QR Codes (QR, Micro QR and Multiple QR Codes); Aztec; Postal Codes - (Australian Post; Japanese Post; KIX Post; Planet Code; Postnet; Royal Mail Code (RM45CC); Intelligent Mail Barcode (IMB); Sweden Post; Portugal Post); LaPoste A/R 39; PDF-417; MacroPDF; Micro PDF417; GS1 Composites (1 - 12); French CIP13<sup>a</sup>; GS1 DataBar Stacked; GS1 DataBar Stacked Omnidirectional; GS1 DataBar Expanded Stacked; GS1 Databar Composites; Chinese Sensible Code; Inverted 2D codes<sup>b</sup>.</p>

- a. It is acceptable to handle this with ULE
- b. The SW can apply the Normal/Reverse Decoding Control to the following symbologies: Data Matrix, QR, Micro QR, Aztec and Chinese Sensible Code.

## REGULATORY

See Regulatory Addendum

## LED AND BEEPER INDICATIONS

The imager's beeper sounds and its illumination flashes or changes color to indicate various functions or errors on the reader. A "Green Spot" also lights to indicate a good read. The tables below list these indications. Reference the PRG for a more detailed list.

INDICATION	LED	BEEPER
Power-up	Upper LED flashes/blinks on power-up, however, this may be too rapid to view. With a USB interface, the LED blinks until enumeration with the host is completed.	Imager beeps four times at highest frequency and volume upon power-up.
Good Read	Upper green LED comes on for programmed time (default). LED behavior for this indication is configurable using Aladdin utility.	One beep at current frequency, volume, mono/bi-tonal setting upon a successful label scan. It is also possible to upload custom jingles with Aladdin.
ROM Failure	200ms on / 200ms off	Imager sounds one error beep at highest volume for 200 mS.
Limited Scanning Label Read	N/A	Imager 'chirps' six times at the highest frequency and current volume.
Imager Disabled	The LED blinks continuously 100mS on / 900 mS off	N/A



# TROUBLESHOOTING

PROBLEM	POSSIBLE CAUSE	POSSIBLE SOLUTION
Nothing happens when the scan button is pulled.	No power to the imager.	Check system power. Ensure power supply is connected.
	Interface or power cables are loose.	Ensure all cable connections are secure.
LED comes on, but bar code is not decoded.	Imager not programmed for correct bar code type.	Ensure reader is programmed to read the type of bar code scanned. Refer to the PRG for more information.
	Bar code label is unreadable.	Check the label to ensure it is not defaced. Try to scan another bar code type.
	Distance between reader and bar code is incorrect.	Move imager closer to or further from the bar code.
Bar code is decoded but not transmitted to the host.	Imager not programmed for the correct host type.	Scan the appropriate host type bar code. Refer to the PRG for more information.



**NOTE: For detailed troubleshooting, refer to the PRG (Product Reference Guide).**

## WARRANTY

Datalogic warrants that the Products shall be free from defects in materials and workmanship under normal and proper use during the Warranty Period. Products are sold on the basis of specifications applicable at the time of manufacture and Datalogic has no obligation to modify or update Products once sold. The Warranty Period shall be **five years** from the date of shipment by Datalogic, unless otherwise agreed in an applicable writing by Datalogic.

Datalogic will not be liable under the warranty if the Product has been exposed or subjected to any: (1) maintenance, repair, installation, handling, packaging, transportation, storage, operation or use that is improper or otherwise not in compliance with Datalogic's instruction; (2) Product alteration, modification or repair by anyone other than Datalogic or those specifically authorized by Datalogic; (3) accident, contamination, foreign object damage, abuse, neglect or negligence after shipment to Buyer; (4) damage caused by failure of a Datalogic-supplied product not under warranty or by any hardware or software not supplied by Datalogic; (5) any device on which the warranty void seal has been altered, tampered with, or is missing; (6) any defect or damage caused by natural or man-made disaster such as but not limited to fire, water damage, floods, other natural disasters, vandalism or abusive events that would cause internal and external component damage or destruction of the whole unit, consumable items; (7) use of counterfeit or replacement parts that are neither manufactured nor approved by Datalogic for use in Datalogic-manufactured Products; (8) any damage or malfunctioning caused by non-restoring action as for example firmware or software upgrades, software or hardware reconfigurations etc.; (9) loss of data; (10) any consumable or equivalent (e.g. cables, power supply, batteries, etc.); or (11) any device on which the serial number is missing or not recognizable.

THE DATALOGIC WARRANTIES ARE EXCLUSIVE AND IN LIEU OF ALL OTHER WARRANTIES, WHETHER WRITTEN, EXPRESS, IMPLIED, STATUTORY OR OTHERWISE, INCLUDING, BUT NOT LIMITED TO, THE IMPLIED WARRANTIES OF MERCHANTABILITY AND FITNESS FOR PARTICULAR PURPOSE. DATALOGIC SHALL NOT BE LIABLE FOR ANY DAMAGES SUSTAINED BY BUYER ARISING FROM DELAYS IN THE REPLACEMENT OR REPAIR OF PRODUCTS UNDER THE ABOVE. THE REMEDY SET FORTH IN THE WARRANTY STATEMENT IS THE BUYER'S SOLE AND EXCLUSIVE REMEDY FOR WARRANTY CLAIMS. NO EXTENSION OF THIS WARRANTY WILL BE BINDING UPON DATALOGIC UNLESS SET FORTH IN WRITING AND SIGNED BY DATALOGIC'S AUTHORIZED REPRESENTATIVE. DATALOGIC'S LIABILITY FOR DAMAGES ON ACCOUNT OF A CLAIMED DEFECT IN ANY PRODUCT DELIVERED BY DATALOGIC SHALL IN NO EVENT EXCEED THE PURCHASE PRICE OF THE PRODUCT ON WHICH THE CLAIM IS BASED. DATALOGIC SHALL NOT BE LIABLE FOR DAMAGES RELATING TO ANY INSTRUMENT, EQUIPMENT, OR APPARATUS WITH WHICH THE PRODUCT SOLD UNDER THIS AGREEMENT IS USED. Further details on warranty coverage, rights and conditions are addressed under and regulated by the Terms and Conditions of Sales of Datalogic available at [https://www.datalogic.com/terms\\_conditions\\_sales](https://www.datalogic.com/terms_conditions_sales).

# ERGONOMIC RECOMMENDATIONS



**CAUTION:** In order to avoid or minimize the potential risk of ergonomic injury, follow the recommendations below. Consult with your local Health & Safety Manager to ensure that you are adhering to your company's safety programs to prevent employee injury.

- Reduce or eliminate repetitive motion
- Maintain a natural position
- Reduce or eliminate excessive force
- Keep objects that are used frequently within easy reach
- Perform tasks at correct heights
- Reduce or eliminate vibration
- Reduce or eliminate direct pressure
- Provide adjustable workstations
- Provide adequate clearance
- Provide a suitable working environment
- Improve work procedures.

## TECHNICAL SUPPORT

### Support Through the Website

Datalogic provides several services as well as technical support through its website. Log on to ([www.datalogic.com](http://www.datalogic.com)).

For quick access, from the home page click on the search icon , and type in the name of the product you're looking for. This allows you access to download Data Sheets, Manuals, Software & Utilities, and Drawings.

Hover over the Support & Service menu for access to Services and Technical Support.

### Reseller Technical Support

An excellent source for technical assistance and information is an authorized Datalogic reseller. A reseller is acquainted with specific types of businesses, application

software, and computer systems and can provide individualized assistance.

# CLEANING PROCEDURE

Exterior surfaces and scan windows exposed to spills, smudges or debris accumulation require periodic cleaning to ensure best performance during scanning operations. Follow the procedures described in this instruction sheet to keep your QuickScan device in good operating condition.



**WARNING: Be sure to turn off power and unplug the device from electrical outlet before cleaning.**



**CAUTION: DO NOT use abrasive pads or cleaning agents.**

## Common Cleaning Solutions

The cleaners and disinfectants listed below are recommended for use on Datalogic's Quickscan 2500 Enclosures:

CLEANERS	DISINFECTANTS
Formula 409® Glass and Surface Cleaner	Clorox® Bleach (diluted 10:1)
70% Isopropyl Alcohol	Hydrogen Peroxide 3%
Windex® Multi-Surface	
100% Gentle dish soap and water	



**NOTE: Disinfectants may be harsh on metal. They are recommended for use only on enclosures.**



**CAUTION: DO NOT spray or pour cleaner directly onto the unit.  
DO NOT use solutions in their concentrated form.  
DO NOT use aerosols, solvents or abrasives.  
DO NOT use paper towels or rough cloths to clean windows.**

## Cleaning enclosure and window surfaces

1. Moisten a soft cloth with a recommended cleaning solution. Be sure to apply the solution to your cloth first. Wring excessive liquid from the cloth.
2. Use the cloth to wipe down the surface of the unit. Use cotton swabs, lightly moistened, to reach in corners and crevices.
3. Use another clean dry cloth to remove any residue of the cleaning agent and ensure the unit is dry.







©2021 Datalogic S.p.A. and /or its affiliates. • All rights reserved • Without limiting the rights under copyright, no part of this documentation may be reproduced, stored in or introduced into a retrieval system, or transmitted in any form or by any means, or for any purpose, without the express written permission of Datalogic S.p.A. and/or its affiliates • Datalogic and the Datalogic logo are registered trademarks of Datalogic S.p.A. in many countries, including the U.S. and the E.U.



**Datalogic S.r.l.**

Via S. Vitalino, 13 | 40012 Calderara di Reno | Bologna - Italy  
Tel. +39 051 3147011 | Fax +39 051 3147205



820115803

Rev D

September 2021