

User's Manual

ME Series Infrared Touch

MultiSync ME431 IR

MultiSync ME501 IR

MultiSync ME551 IR

*Addendum to User's Manuals of
MultiSync ME431 / ME501 / ME551*

MONITOR MODEL: ME431 IR, ME501 IR, ME551 IR

Please find your model name on the label on rear side of the monitor.

Index

Addendum to User's Manuals of MultiSync ME431 / ME501 / ME551.....	Page 03
Registration Information.....	Page 04
Important Information.....	Page 05
Recommended Use & Maintenance.....	Page 11
Shipping Content.....	Page 12
Unpacking.....	Page 13
General Installation.....	Page 14
Connections.....	Page 15
OS Compatibility.....	Page 17
Troubleshooting.....	Page 19
Specifications – ME431 IR.....	Page 22
Specifications – ME501 IR.....	Page 25
Specifications – ME551IR.....	Page 28
Trademark and Software License.....	Page 31
Manufacturer's Recycling and Energy Information.....	Page 33

Addendum to User's Manuals of MultiSync ME431, ME501 & ME551

This user's manual is an addendum to the standard user's manual of the base model monitor ME431, ME501 & ME551.

All specifications listed here supersede those in the standard version of the manual included with this monitor.

NOTE: Following feature sets are not supported by ME431 IR, ME501 IR & ME551 IR:

- **Room Light Sensing Sensor:** Other than the standard monitor, the ME431 IR, ME501 IR & ME551 IR does not allow the monitor to make automatic adjustments to the backlight setting.
- **NEC ornament logo:** Other than the standard monitor, the ME431 IR, ME501 IR & ME551 IR does not have an ornament logo. Therefore changing the position of the NEC logo is not possible.
- **Operating range for the remote control:** Other than the standard monitor, the operating range for the remote control on ME431 IR, ME501 IR & ME551 IR is reduced. The remote control operates within a distance of about 3.5 from the remote control sensor at a horizontal and vertical angle of within 30°.

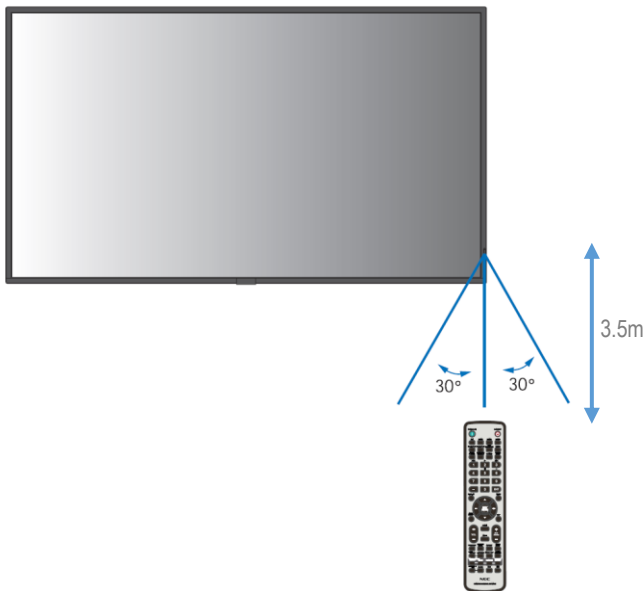

NOTE: The remote control system may not function when direct sunlight or strong illumination strikes the remote control sensor, or when there is an object in the path.

Cable Information

CAUTION: Use the provided specified cables with this product so as not to interfere with radio and television reception.

For USB, please use a shielded signal cable with ferrite core.

For HDMI and DisplayPort, please use a shielded signal cable.

Use of other cables and adapters may cause interference with radio and television reception.

SUPPLIER'S DECLARATION OF CONFORMITY

- The intended primary use of this product is as an Information Technical Equipment in an office or domestic environment.
- The product is intended to be connected to a computer and is not intended for the display of television broadcast signals.



NOTE:

- (1) The contents of this manual may not be reprinted in part or whole without permission.
- (2) The contents of this manual are subject to change without notice.
- (3) Great care has been taken in the preparation of this manual; however, should you notice any questionable points, errors or omissions, please contact us.
- (4) The image shown in this manual is indicative only. If there is inconsistency between the image and the actual product, the actual product shall govern.
- (5) Notwithstanding articles (3) and (4), Sharp/NEC will not be responsible for any claims on loss of profit or other matters deemed to result from using this device.
- (6) This manual is commonly provided to all regions so they may contain descriptions that are pertinent for other countries.



Important Information (1/6)

Safety Precautions and Maintenance



FOR OPTIMUM PERFORMANCE, PLEASE NOTE
THE FOLLOWING WHEN SETTING UP AND
USING THE LCD COLOR MONITOR:







About the Symbols

To ensure safe and proper use of the product, this manual uses a number of symbols to prevent injury to you and others as well as damage to property. The symbols and their meanings are described below. Be sure to understand them thoroughly before reading this manual.







 WARNING	Failing to heed this symbol and handling the product incorrectly could result in accidents leading to major injury or death.
 CAUTION	Failing to heed this symbol and handling the product incorrectly could result in personal injury or damage to surrounding property.

Examples of symbols

	▲ Indicates a warning or caution. This symbol indicates you should be careful of electric shocks.
	⊘ Indicates a prohibited action. This symbol indicates something that must be prohibited.
	● Indicates a mandatory action. This symbol indicates that the power cord should be unplugged from the power outlet.

 WARNING	
1	 UNPLUG THE POWER CORD Unplug the power cord if the product malfunctions. Should the product emit smoke or strange odors or sounds, or if the product has been dropped or the cabinet broken, turn off the product's power, then unplug the power cord from the power outlet. Failure to do so could not only lead to fire or electric shock, it could also result in vision impairment. Contact your dealer for repairs. Never try to repair the product on your own. Doing so is dangerous.
2	   Do not open or remove the product's cabinet. Do not disassemble the product. There are high voltage areas in the product. Opening or removing product covers and modifying the product may expose you to electric shock, fire, or other risks. Refer all servicing to qualified service personnel.
3	 Do not use the product if it has structural damage. If you notice any structural damage such as cracks or unnatural wobbling, please refer servicing to qualified service personnel. If the product is used in this condition, the product may fall or cause personal injury.

Important Information (2/6)

 WARNING		
4		<p>Handle the power cord with care. Damaging the cord could lead to fire or electric shock.</p> <ul style="list-style-type: none"> • Do not place heavy objects on the cord. • Do not place the cord under the product. • Do not cover the cord with a rug, etc. • Do not scratch or modify the cord. • Do not bend, twist or pull the cord with excessive force. • Do not apply heat to the cord. <p>Should the cord be damaged (exposed core wires, broken wires, etc.), ask your dealer to replace it.</p>
5		Do not touch the power plug if you hear thunder. Doing so could result in electric shock.
6		<p>Please use the power cord provided with this product in accordance with the power cord table.</p> <p>If a power cord is not supplied with this product, please contact NEC. For all other cases, please use the power cord with the plug style that matches the power socket where the product is located. The compatible power cord corresponds to the AC voltage of the power outlet and has been approved by, and complies with, the safety standards in the country of purchase.</p>
7		<p>For proper installation it is strongly recommended to use a trained service person.</p> <p>Failure to follow the standard installation procedures could result in damage to the product or injury to the user or installer.</p>
8	 	<p>Please install the product in accordance with the following information.</p> <p>This product cannot be used or installed without the table top stand or other mounting accessory for support.</p> <ul style="list-style-type: none"> • ME651: DO NOT use this product on the floor with the table top stand. Please use this product on a table or with a mounting accessory for support. <p>When transporting, moving, or installing the product, please use as many people as necessary to be able to lift the product without causing personal injury or damage to the product.</p> <p>We recommend two or more people for the ME431/ME501/ME551 and four or more people for the ME651.</p> <p>Please refer to the instructions included with the optional mounting equipment for detailed information about attaching or removing.</p> <p>Do not cover the vent on the product. Improper installation of the product may result in damage to the product, an electric shock or fire.</p> <p>Do not install the product in the locations below:</p> <ul style="list-style-type: none"> • Poorly ventilated spaces. • Near a radiator, other heat sources, or in direct sunshine. • Continual vibration areas. • Humid, dusty, steamy, or oily areas. • Outdoors. • High-temperature environment where humidity changes rapidly and condensation is likely to occur. • A ceiling or wall that is not strong enough to support the product and mounting accessories. <p>Do not mount the product upside down.</p>



WARNING



Prevent tipping and falling for earthquakes or other shocks.

To prevent personal injury or damage to the product caused by tipping over due to earthquakes or other shocks, make sure to install the product in a stable location and take measures to prevent falling.

The measures to prevent falling and tipping are intended for reducing the risk of injury, but may not guarantee the effectiveness against all earthquakes.

The product may tip causing personal injury.

- When using the product with the optional table top stand, fasten the product to a wall using a cord or chain that can support the weight of the product in order to prevent the product from falling. Fasten the cord or chain to the product using the clamps and screws provided with the product or the table top stand.
Depending on the table top stand, the stand has the structure for preventing tipping.
Please refer to the table top stand manual.
- Be sure to remove the cord or chain from the wall before moving the product to prevent personal injury or damage to the product.

The product may fall causing personal injury.

- Do not attempt to hang the product using an installation safety wire.
- Please install the product in an area on the wall or ceiling strong enough to support the weight of the product.
- Prepare the product using mounting accessories, such as hook, eyebolt, or mounting parts, and then secure the product with a safety wire. The safety wire must not be tight.
- Please make sure the mounting accessories are strong enough to support the product weight and size before installing it.

Stability Hazard.







The product may fall, causing serious personal injury or death. To prevent injury, this product must be securely attached to the floor/wall in accordance with the installation instructions.

Many injuries, particularly to children, can be avoided by taking simple precautions such as:











- ALWAYS use stands or installation methods recommended by the manufacturer of the product set.
- ALWAYS use furniture that can safely support the product.
- ALWAYS ensure the product is not overhanging the edge of the supporting furniture.
- ALWAYS educate children about the dangers of climbing on furniture to reach the product or its controls.
- ALWAYS route cords and cables connected to your product so they cannot be tripped over, pulled or grabbed.
- NEVER place a product in an unstable location.
- NEVER place the product on tall furniture (for example, cupboards or bookcases) without anchoring both the furniture and the product to a suitable support.
- NEVER place the product on cloth or other materials that may be located between the product and supporting furniture.
- NEVER place items that might tempt children to climb, such as toys and remote controls, on the top of the product or furniture on which the product is placed.

If the existing product is going to be retained and relocated, the same considerations as above should be applied.





Important Information (4/6)

 WARNING		
10		Do not place this product on a sloping or unstable cart, stand or table. Doing so could lead to falling or tipping and cause personal injury.
11	 	Do not insert objects of any kind into the cabinet slots. It may cause electric shock, fire, or product failure. Keep objects away from children and babies.
12		Do not spill any liquids into the cabinet or use your product near water. Immediately turn off the power and unplug your product from the wall outlet, then refer servicing to qualified service personnel. It may cause an electric shock or start a fire.
13		Do not use flammable gas sprays to remove dust when cleaning the product. Doing so could lead to a fire.
14		Securely fasten the Option Board. Ensure the Option Board is securely fastened using the original screws to prevent the Option Board from falling out the product. A falling Option Board may expose you to danger.



Important Information (5/6)

 CAUTION		
1	  	<p>Handling the power cord.</p> <p>Handle the power cord with care. Damaging the cord could lead to fire or electric shock.</p> <ul style="list-style-type: none"> When connecting the power cord to the product's AC IN terminal, make sure the connector is fully and firmly inserted. Fasten the power cord to the product by attaching the screw and clamp to prevent loose connection. (Recommended Fasten Force: 120 - 190 N•cm). Do not connect or disconnect the power cord with wet hands. When connecting or disconnecting the power cord, pull the power cord out by holding onto its plug. When cleaning the product, for safety purposes, unplug the power cord from the power outlet beforehand. Regularly dust off the power cord by using a soft dry cloth. Before moving the product, make sure the product power is off, then unplug the power cord from the power outlet and check that all cables connecting the product to other devices are disconnected. When you are not planning to use the product for an extended period of time, always unplug the power cord from the power outlet. This equipment is designed to be used in the condition of the power cord connected to the earth. If the power cord is not connected to the earth, it may cause electric shock. Please make sure the power cord is earthed properly.
2		Do not bind the power cord and the USB cable. It may trap heat and cause a fire.
3		Do not connect to a LAN with excessive voltage. When using a LAN cable, do not connect to a peripheral device with wiring that might have excessive voltage. Excessive voltage on the LAN port may cause an electric shock.
4		Do not climb on the table where the product is installed. Do not install the product on a wheeled table if the wheels on the table have not been properly locked. The product may fall, causing damage to the product or personal injury.
5		Installation, removal, and height adjustment of the optional table top stand. <ul style="list-style-type: none"> When installing the table top stand, handle the unit with care to avoid pinching your fingers. Installing the product at the wrong height can cause tipping. Please install your product at proper height to prevent personal injury or damage to the product.
6		Do not push or climb on the product. Do not grab or hang onto the product. The product may fall, causing damage to the product or personal injury.
7		Do not impact the LCD panel surface, it can cause serious damage to the product or personal injury.

Important Information (6/6)

 CAUTION		
8		<p>Incorrect usage of batteries can result in leaks or bursting.</p> <ul style="list-style-type: none"> • Insert batteries matching the (+) and (-) signs on each battery to the (+) and (-) signs of the battery compartment. • Do not mix battery brands. • Do not combine new and old batteries. This can shorten battery life or cause liquid leakage of batteries. • Remove dead batteries immediately to prevent battery acid from leaking into the battery compartment. • Do not touch exposed battery acid, it may injure your skin. • Disposal of a battery into fire or a hot oven, or mechanically crushing or cutting of a battery, can result in an explosion. • Leaving a battery in an extremely high temperature surrounding environment, or a battery subject to extremely low air pressure, can result in an explosion or the leakage of flammable liquid or gas. • Contact your dealer or local authorities when disposing of batteries.
9		Suitable for entertainment purposes at controlled luminous environments, to avoid disturbing reflections from the screen.
10		When running the cooling fan continuously, we recommend wiping clean the ventilation holes a minimum of once a month. Failure to do so could lead to fire or electric shock or damage to the product.
11		To ensure the product's reliability, please clean the ventilation holes at the rear side of the cabinet at least once a year to remove dirt and dust. Failure to do so could lead to fire or electric shock or damage to the product.

Power Cord Table

Plug Type	European Continental	U.K.
Plug Shape		
Region	EU	U.K.
Voltage	230	230

NOTE: This product can only be serviced in the country where it was purchased.

Connecting to a TV^{*}

- Cable distribution system should be grounded (earthed) in accordance with ANSI/NFPA 70, the National Electrical Code (NEC), in particular Section 820.93, Grounding of Outer Conductive Shield of a Coaxial Cable.
- The screen of the coaxial cable is intended to be connected to earth in the building installation.

^{*}: The product you purchased may not have this feature.

NOTE: Continuous operating time and warranty.

This product is designed for a maximum daily use of 18 hours. Continual use in excess of 18 hours per day is not covered by the warranty.

Recommended Use & Maintenance

Recommended Use

Ergonomics

To realize the maximum ergonomic benefits, we recommend the following:

- For optimum performance of the monitor, allow 20 minutes for warming up. Avoid reproduction of still patterns on the monitor for long periods of time to avoid image persistence (after image effects).
- Rest your eyes periodically by focusing on an object at least 5 feet away. Blink often.
- Position the monitor at a 90° angle to windows and other light sources to minimize glare and reflections.
- Adjust the monitor's brightness, contrast and sharpness controls to enhance readability.
- Get regular eye checkups.
- Use the preset Size and Position controls with standard input signals.
- Use the preset color settings.
- Use non-interlaced signals.
- Do not view the primary color blue on a dark background. It is difficult to see and may cause eye fatigue due to insufficient contrast.

Maintenance

Cleaning the LCD Screen

- When the LCD screen is dusty, please gently wipe with a soft cloth.
- Clean the LCD screen surface with a lint-free, non-abrasive cloth. Avoid using any cleaning solution or glass cleaner!
- Please do not rub the LCD screen with a hard or abrasive material.
- Please do not apply pressure to the LCD screen surface.
- Please do not use OA cleaner as it will cause deterioration or discoloration on the LCD screen surface.

Cleaning the Cabinet

- Unplug the power supply.
- Gently wipe the cabinet with a soft cloth.
- To clean the cabinet, dampen the cloth with a neutral detergent and water, wipe the cabinet and follow with a dry cloth.
- DO NOT clean with benzene thinner, alkaline detergent, alcoholic system detergent, glass cleaner, wax, polish cleaner, soap powder, or insecticide. Rubber or vinyl should not be in contact with the cabinet for an extended period of time. These types of fluids and materials can cause the paint to deteriorate, crack or peel.

Shipping Content

MultiSync ME431 IR, ME501 IR & ME551 IR

1. 43" / 50" / 55" Infrared Touch Monitor
2. Remote Control
3. 2x AAA batteries
4. Power Cable
5. HDMI Cable
6. USB Cable
7. Setup Manual
8. Addendum to User's Manuals of MultiSync ME431 / ME501 / ME551

Unpacking

Unpacking the Display

1. **ME431 IR, ME501 IR:** Unpack the display from the carton box by opening the carton box from the top.

NOTE: Due to the weight of the product, for installation and handling 2 people are required. DO NOT start unless you have enough people available. Working with less people may result in injuries and damaged product.

Lift the display upwards and remove from the display from the carton box.

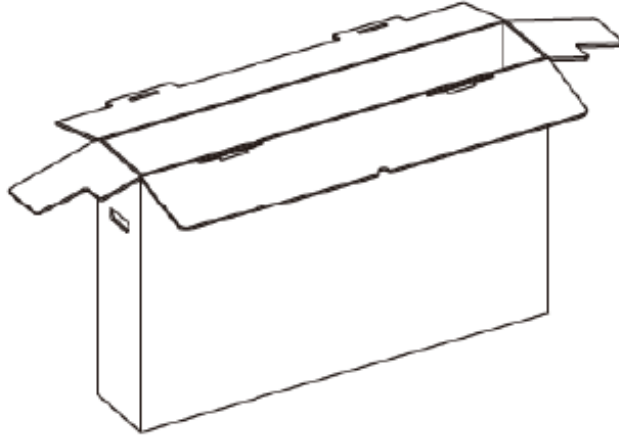

2. **ME551 IR:** Unpack the displays from the carton box by removing the white clips on the bottom of the box.

NOTE: Due to the weight of the product, for installation and handling 2 people are required. DO NOT start unless you have enough people available. Working with less people may result in injuries and damaged product.

Lift the carton box upwards. Make sure to have one additional person to secure the display from tipping over.

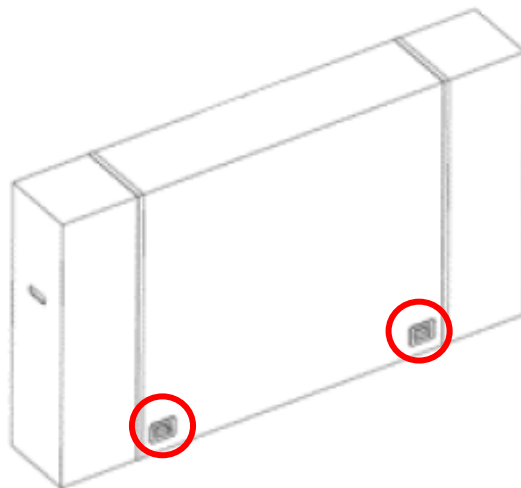

NOTE: Remember to save your original box and packing material to transport or ship the monitor.

For further instructions, please refer to the printed instruction on the carton box.

General Installation

This device cannot be used or installed without a mounting accessory for support. For proper installation it is strongly recommended to use a trained, NEC authorized service person. Failure to follow NEC standard mounting procedures could result in damage to the equipment or injury to the user or installer. Product warranty does not cover damage caused by improper installation. Failure to follow these recommendations could result in voiding the warranty

Mounting

For customer:



CAUTION

DO NOT mount the monitor yourself. For proper installation it is strongly recommended to use a trained, qualified technician. Please contact your supplier, as they may be able to provide a list of qualified installation professionals. Mounting on a wall or ceiling and hiring a technician is the customer's responsibility.

Maintenance

- Periodically check for loose screws, gaps, distortions, or other problems that may occur with the mounting equipment. If a problem is detected, please refer to qualified personnel for service.
- Regularly check the mounting location for signs of damage or weakness that may occur over time.

DO NOT block ventilated openings with mounting accessories or other accessories.

For NEC Qualified Personnel:

Stability Hazard.

The device may fall, causing serious personal injury or death. To prevent injury, this device must be securely attached to the floor/wall in accordance with the installation instructions. Carefully inspect the location where the unit is to be mounted. Not all walls or ceilings are capable of supporting the weight of the unit. Weight of this monitor is mentioned in Specification (ME431 IR, ME501 IR & ME551 IR). Product warranty does not cover damage caused by improper installation, remodeling, or natural disasters. Failure to comply with these recommendations could result in voiding the warranty.

To ensure safe installation, use two or more brackets to mount the unit. Mount the unit to at least two points on the installation location.

NOTE: To achieve optimum performance of touch technology, monitor must be correctly leveled. Only straight upright and titled back position of the monitor is acceptable. Monitor tilted to front will result in convex position of the glass and might negatively influence the touch performance.

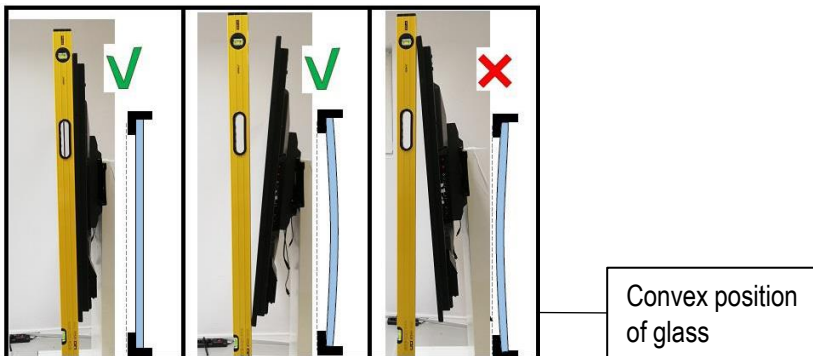

For further instructions, please refer to standard user's manual of the base model monitor ME431, ME501 & ME551.

Connections (1/2)

NOTE: Do not connect or disconnect cables when turning on the monitor's main power or other external equipment's power as this may result in a loss of image.

NOTE: Do not use an attenuating (built-in resistor) audio cable. Use an audio cable without a built-in resistor. Using an audio cable with a built-in resistor will lower the sound level.

Before making connections:

- Turn off the device's power before connecting it to the monitor.
- Refer to the device's user manual for available connection types and instructions for the device.
- We recommend turning off the monitor's main power before connecting or disconnecting a USB storage device or a microSD memory card to avoid data corruption.

Orientation of Displays

- ME431 IR, ME501 IR & ME551 IR support landscape and portrait orientation.

NOTE: Face-up and face-down installation is not supported by ME431 IR, ME501 IR & ME551 IR.

- When using the monitor in the portrait position, it should be rotated counter-clockwise so that the right side is moved to the top and the left side is moved to the bottom. Improper ventilation may shorten the lifetime of the monitor.



For further instructions on connections, please refer to standard user's manual of the base model monitor ME431, ME501 & ME551.

Connections (2/2)

Connecting the Touch Panel

1. Turn off the monitor.
2. Install the equipment.
 - **Using SDM Slot-in PC:** Connect the SDM slot -in PC into the option board slot. Connect the USB cable from the monitor to the USB A type connector to the downstream port on the SDM slot-in PC. Full installation and usage instructions for the SDM Slot-in PC are provided with the individual device or available online.
 - **Using Raspberry Pi Compute Module:** Connect the Raspberry Pi Interface Board and Raspberry Pi Compute Module into the option board slot. Connect the USB cable from the monitor to the USB A type connector to the downstream port on the Compute Module. Full installation and usage instructions for the Raspberry Pi Compute Module and Interface Board are provided with the individual device or available online.
 - **Using external computer:** Connect the B type connector to the USB upstream port on the left back side of the monitor and the A type connector to the downstream port on the external computer.

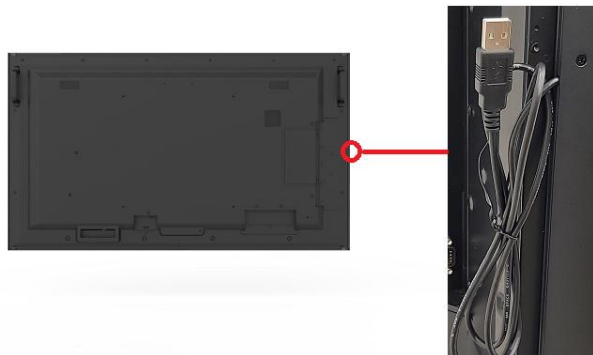

3. Turn on the monitor.

NOTE: The SDM Slot-in PC, the Compute Module Interface Board and Raspberry Pi Compute Module are available separately. Please contact an authorized NEC dealer for more information.

Monitor Setting

Select the input signal.

- **Using SDM Slot-in PC:** Select [OPTION]
- **Using Raspberry Pi Compute Module:** Select [COMPUTE MODULE]
- Using external computer: Select the input signal which is supplied by the computer connected to USB connector. e.g. [DisplayPort, HDMI1, HDMI2]

NOTE: Please refer to “The touch panel does not respond” in “Troubleshooting” when the touch panel function does not work.

OS Compatibility (1/2)

Operating System

OS	Windows						
Sub-OS	Windows 2000	Windows XP	Windows Vista	Windows 7	Windows 8/8.1	Windows 10	Windows CE 6.0
Support	√	√	√	√	√	√	√
Multi-touch	single	single	single	√	√	√	single
Driver	HID compliance ,not need any driver						need driver
Notice:	<ul style="list-style-type: none"> · Performance will be impacted if mentioned systems do not support multi-touch function or · have no copyrights. And Windows 8 must be non OEM version 						

OS	Linux			
Sub-OS	Fedora 10 or above	Ubuntu 10.04 or above	RedFlag 6.2 or above	OpenSuse 11.4 or above
Support	√	√	√	√
Multi-touch	<ul style="list-style-type: none"> · kernel version 3.0+ ,can support multi-touch by adding patch · kernel version 3.5+, HID compliance support multi-touch 			
Driver	HID compliance.			

OS Compatibility (2/2)

OS	Mac OS X	
Sub-OS	10.9 or lower	10.10 or above
Support	√	√
Multi-touch	· Supported by UPDD driver	
Driver	· HID compliance support single touch · Multi-touch supported by UPDD driver	

OS	Android				
Sub-OS	2.1	2.2	2.3	3	4.0/4.1/4.2
Support	N/A	√	√	N/A	√
Driver	HID compliance.				
Multi-touch	· kernel version 2.6.32+, we can provide patch · version 3.5+, HID compliance support Multi-touch				

Troubleshooting (1/3)

For general instructions on troubleshooting, please refer to standard user's manual of the base model monitor ME431, ME501 & ME551.

The touch panel does not respond

- Make sure that PIP (picture in picture), PBP (picture by picture), TILE MATRIX, ROTATE and ZOOM are not selected.
- Check the input signal setting.
- The touch panel function does not support the media player function. Please use the remote control to set the media player while the touch panel function is working.
- Check the PC SOURCE setting in USB in CONTROL.
 - Using SDM Slot-in PC:
 - Make sure that PC SOURCE is AUTO or OPTION, and the input signal is set to OPTION.
 - Make sure the SDM Slot-in PC is connected properly.
 - Make sure the USB cable is connected properly to the USB Type-A input of the SDM Slot-in PC.
 - Using Raspberry Pi Compute Module:
 - Make sure that PC SOURCE is AUTO or COMPUTE MODULE, and the input signal is set to COMPUTE MODULE.
 - Make sure the Raspberry Pi Compute Module and Raspberry Pi Interface Board is connected properly.
 - Make sure the USB cable is connected properly to the USB Type-A input of Raspberry Pi Compute Module.
 - Using external computer:
 - Make sure that PC SOURCE is AUTO or EXTERNAL PC, and the input signal is set to which supplied by the connected computer.
 - Make sure the USB cable is connected properly to the USB Type-A input of the PC.
- The touch panel function may not work depending on the specification of an external computer and connecting method.
- If the TOUCH POWER setting in USB in CONTROL is set to "ON", change it to "OFF" and back to "ON" again after a moment.
- When using touch function at the display edge, there may be a slight gap between touch position on the screen and where you touched. It is the specification and not a failure of product.

The response of the touch screen is not correct

- Avoid direct sunlight or strong light on the screen.
- If there are some obstacles near the TOUCH screen, it may malfunction.
- Sensor bar module may be dusty or dirty, wipe gently with a soft cloth.
- Make sure the connected PC supports 60Hz. 60Hz provides more frames per second and therefore a faster touch response.

Troubleshooting (2/3)

The touch position is not accurate

In this case, please use the touch calibration function provided in Windows 10:

- Open the CONTROL PANEL and select TABLET PC SETTINGS:

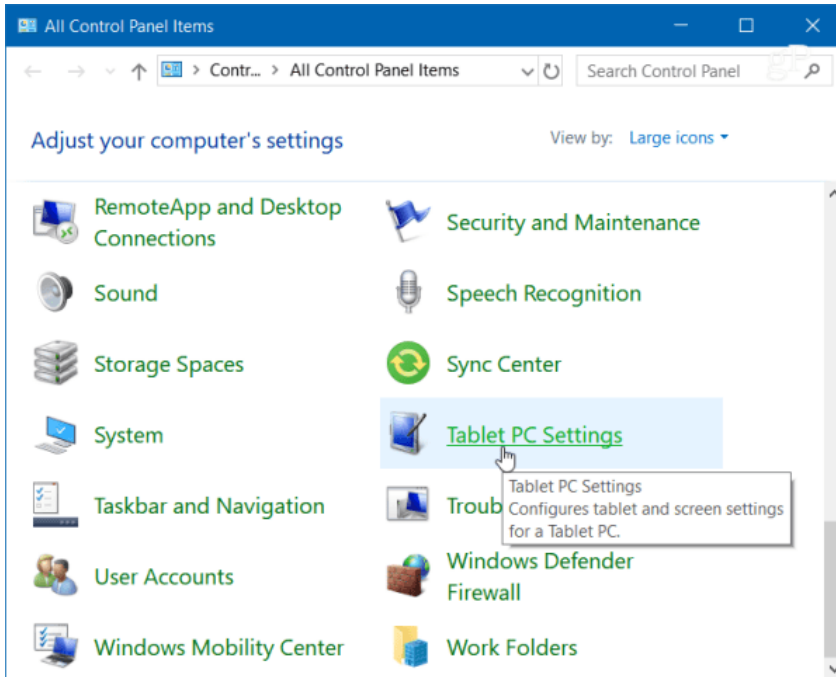

- Or hit the WINDOWS KEY and type "calibrate" and select "Calibrate the screen for pen or touch input":

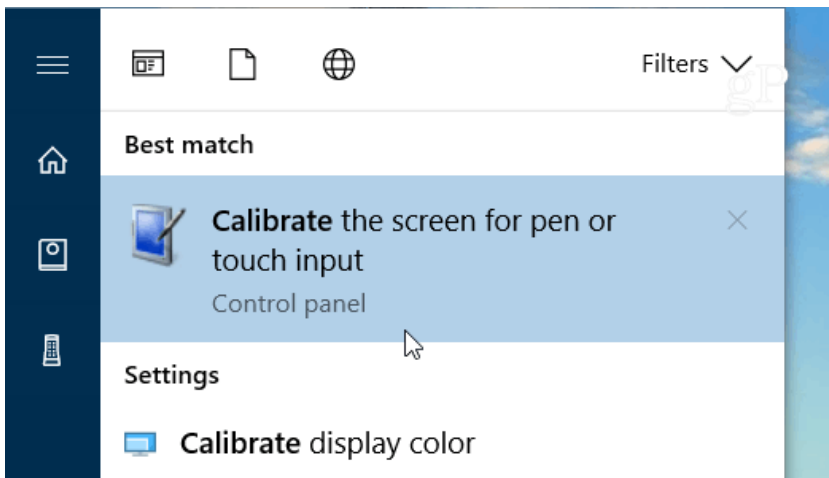

The computer's power management does not work

It is recommended to choose "S1" at the "Power Management" item in the BIOS (abbreviation of Basic Input / Output System) computer's setup screen

Troubleshooting (3/3)

- Select the “Calibrate” button under the “Display” tab.

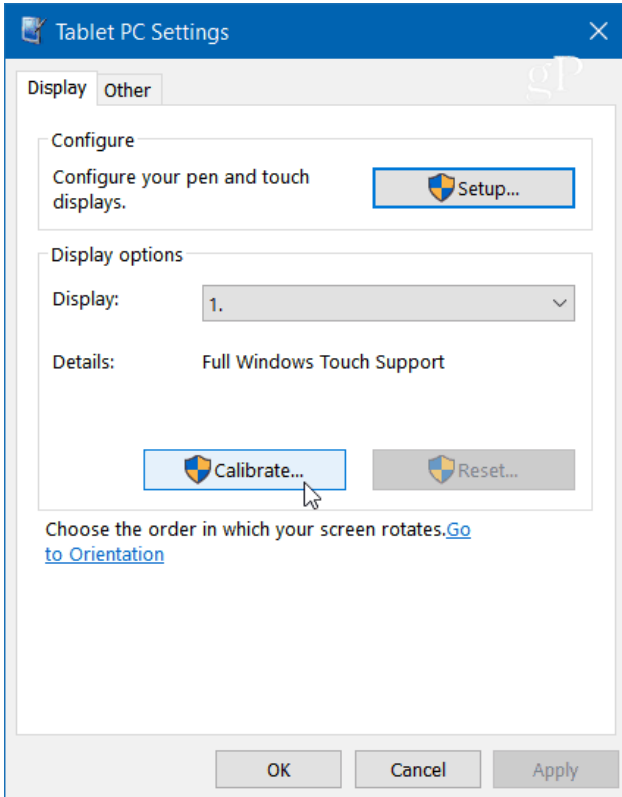

- Next, your screen will go white and display instructions for going through the calibration process. A crosshair will appear on the screen and each time you tap it will move to a different spot. Continue through the entire process, and when you're finished, you'll be prompted to save the results. The touch screen should now be more responsive and accurate when you interact with it.

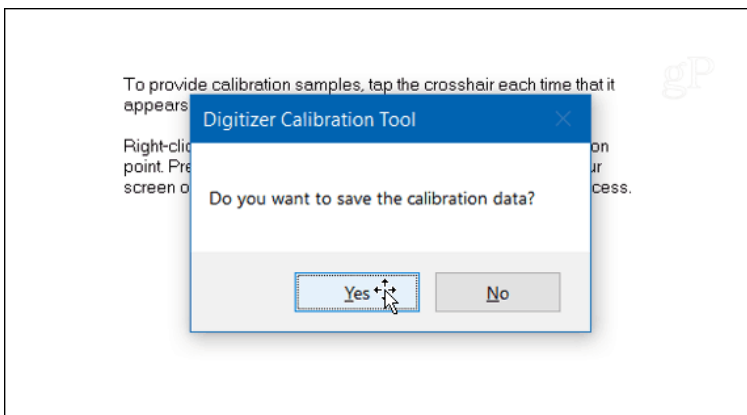

Specifications – ME431 IR (1/3)

Product Information

Product Name	NEC MultiSync® ME431 IR
Product Group	LCD 43" Infrared Touch Display
Order Code	60005077

Display

Panel Technology	IPS with Direct LED backlights
Screen Size [inch/cm]	43 / 108
Aspect Ratio	16:9
Brightness [cd/m ²]	400
Contrast Ratio (typ.)	1200:1
Viewing Angle [°]	178 horizontal / 178 vertical (typ. at contrast ratio 10:1)
Response Time (typ.) [ms]	6
Panel Refresh Rate [Hz]	60
Supported Orientation	Landscape; Portrait

Synchronisation Rate

Horizontal Frequency [kHz]	26 - 135
Vertical Frequency [Hz]	23 - 86

Resolution

Native Resolution	3840 x 2160			
Supported Resolutions	4096 x 2160; 3840 x 2160; 1920 x 2160; 1920 x 1080;	1920 x 1080; 1650 x 1050; 1600 x 1200; 1440 x 900;	1400 x 1050; 1366 x 768; 1360 x 768; 1280 x 1024;	1280 x 720; 1024 x 768

Connectivity

Input Video Digital	1 x DisplayPort (with HDCP); 2 x HDMI (with HDCP)
Input Audio Digital	1 x DisplayPort; 2 x HDMI
Input Control	LAN 100Mbit; remote control wire (3,5mm jack); RS232
Output Audio Analogue	1 x 3,5 mm jack
Input Detect	Custom; First; Last

Open Modular Intelligence

Intel® SDM	accepts Intel® Smart Display Modules Large and Small up to 45 W
Compute Module Slot	RPI Compute Module 4

Sensors

Temperature Sensor	Integrated, 3 sensors, triggered actions programmable
--------------------	---

Electrical

Power Consumption Eco/max. [W]	80 shipping
Power Savings Mode [W]	< 0.5; < 2 (Networked Standby)
Power Management	VESA DPMS
Power Supply	100-240 V AC; 50/60 Hz; internal

Environmental Conditions

Specifications – ME431 IR (2/3)

Operating Temperature [°C]	+0 to +35
Operating Humidity [%]	20 to 80
Storage Humidity [%]	10 to 90
Storage Temperature [°C]	-20 to 60

Mechanical

Dimensions (W x H x D) [mm]	988 x 573.9 x 85.5
Weight [kg]	21.9
Bezel Width [mm]	22.25 (left and right); 23.4 (top and bottom)
VESA Mounting [mm]	200 x 200 (FDMI); 4 holes; M6
Ingress Protection	IP5x (front); IP2x (back)
Packaging Dimensions (W x H x D) [mm]	Box 1: 1,120 x 700 x 203
Packaging Weight [kg]	Box 1: 28

Glass

Thickness [mm]	3
Type	Thermal-tempered, anti-glare coating
Light Transmission [%]	92 (+/- 2 %)
Haze Level [%]	4
Hardness [H]	7

Touch

Touch Technology	Infrared Touch
Number of Touches	Real multi-touch up to 20 touches
Frame Rate [Hz]	125
Touch Method	Finger; Gloves; Stylus (≥ 2 mm)
Supported Operating System	Android; Linux; Mac OS; Raspberry Pi; Windows
Data Interface	USB-HID
Accuracy [mm]	+/- 2

MediaPlayer

Supported File Storage / File System	USB 2.0 / FAT16, FAT32
Supported Image Formats	JPG (baseline, progressive, RGB, CMYK); max. resolution 15360 x 8640
Supported Video Formats	MPG (MPEG1/2/4, max res 1080p@30Hz); MP4 (MPEG2/4, H.263, H.264, HEVC/H.265, max res 3840x2160@60Hz); TS (MPEG2, H.264, HEVC/H.265, max res 3840x2160@60Hz); audio: LPCM, MP3, AAC; WMV (video H.264, Windows Media Video 9, max res 1080p@30Hz, audio WMA 9, WMA 10 Pro)
Supported Audio Formats	MP3 (MP3); max. bit-rate 320 kBit/s

Available Options

Accessories	Feet (ST-43M); Soundbar (SP-ASCM-IQ2; SP-ASCM-2)); Trolley (PD03Tipster); Wall mount (PDW S 32-55 L/P)
-------------	--

Green Features

Energy Efficiency	Energy consumption: 77 kWh/1000 h; LED backlight
Ecological Standards	EnergyStar 8.0

Additional Features

Specifications – ME431 IR (3/3)

Special Characteristics	DICOM Simulation; HDMI ARC; Powered USB Port (10 W)
Pixel Failure Class	ISO 9241-307, Class 1
Audio	Integrated Speakers (10 W + 10 W)
Shipping Content	2x AAA batteries; Display; HDMI Cable; Power Cable; Remote Control; Setup Manual; USB cable; User Manual
Warranty	3 years warranty incl. backlight; additional services available
Operating Hours	18/7
External Control	AMX NetLinx Support; ASCII Control Commands; HDMI CEC; HTTP Browser; PLink; Scheduled Timer; SNMP
Remote Management	Automated Email Alerts; NEC NaViSet Administrator 2
Security	Disable HW Buttons; Disable IR Functionality; Emergency Notification

This document is © 2021 Sharp NEC Display Solutions Europe GmbH.

All rights reserved in favour of their respective owners. All hardware and software names are brand names and/or registered trademarks of the respective manufacturers. All specifications are subject to change without notice. Errors and omissions are excepted. 21.04.2021

Specifications – ME501 IR (1/3)

Product Information

Product Name	NEC MultiSync® ME501 IR
Product Group	LCD 50" Infrared Touch Display
Order Code	60005081

Display

Panel Technology	VA with Direct LED backlights
Screen Size [inch/cm]	50 / 125.7
Aspect Ratio	16:9
Brightness [cd/m ²]	400
Contrast Ratio (default)	> 8000:1
Viewing Angle [°]	178 horizontal / 178 vertical (typ. at contrast ratio 10:1)
Colour Depth [bn]	1,073 (8bit + FRC)
Response Time (typ.) [ms]	8
Panel Refresh Rate [Hz]	60
Supported Orientation	Landscape; Portrait

Synchronisation Rate

Horizontal Frequency [kHz]	26 - 135
Vertical Frequency [Hz]	23 - 86

Resolution

Native Resolution	3840 x 2160			
Supported Resolutions	4096 x 2160;	1920 x 1080;	1400 x 1050;	1280 x 720;
	3840 x 2160;	1650 x 1050;	1366 x 768;	1024 x 768
	1920 x 2160;	1600 x 1200;	1360 x 768;	
	1920 x 1200;	1440 x 900;	1280 x 1024;	

Connectivity

Input Video Digital	1 x DisplayPort (with HDCP); 2 x HDMI (with HDCP)
Input Audio Digital	1 x DisplayPort; 2 x HDMI
Input Control	LAN 100Mbit; remote control wire (3,5mm jack); RS232
Input Data	1 x USB 2.0 (MediaPlayer)
Output Audio Analogue	1 x 3,5 mm jack
Input Detect	Custom; First; Last

Open Modular Intelligence

Intel® SDM	accepts Intel® Smart Display Modules Large and Small up to 66 W
Compute Module Slot	RPI Compute Module 4

Sensors

Temperature Sensor	Integrated, 3 sensors, triggered actions programmable
--------------------	---

Electrical

Power Consumption Eco/max. [W]	85 shipping
Power Savings Mode [W]	< 0.5; < 2 (Networked Standby)
Power Management	VESA DPMS
Power Supply	100-240 V AC; 50/60 Hz

Specifications – ME501 IR (2/3)

Environmental Conditions

Operating Temperature [°C]	+0 to +35
Operating Humidity [%]	20 to 80
Storage Humidity [%]	10 to 90
Storage Temperature [°C]	-20 to 60

Mechanical

Dimensions (W x H x D) [mm]	1,143 x 661.5 x 80
Weight [kg]	27.8
Bezel Width [mm]	18.95 (left and right); 20 (top and bottom)
VESA Mounting [mm]	4 holes; 400 x 400 (FDMI); M6
Ingress Protection	IP5x (front); IP2x (back)
Packaging Dimensions (W x H x D) [mm]	Box 1: 1,298 x 860 x 224
Packaging Weight [kg]	Box 1: 34.6

Glass

Thickness [mm]	3
Type	Thermal-tempered, anti-glare coating
Light Transmission [%]	92 (+/- 2 %)
Haze Level [%]	4
Hardness [H]	7

Touch

Touch Technology	Infrared Touch
Number of Touches	Real multi-touch up to 20 touches
Frame Rate [Hz]	125
Touch Method	Finger; Gloves; Stylus (≥ 2 mm)
Supported Operating System	Android; Linux; Mac OS; Raspberry Pi; Windows
Data Interface	USB-HID
Accuracy [mm]	+/- 2

MediaPlayer

Supported File Storage / File System	USB 2.0 / FAT16, FAT32
Supported Image Formats	JPG (baseline, progressive, RGB, CMYK); max. resolution 15360 x 8640
Supported Video Formats	MPG (MPEG1/2/4, max res 1080p@30Hz); MP4 (MPEG2/4, H.263, H.264, HEVC/H.265, max res 3840x2160@60Hz); TS (MPEG2, H.264, HEVC/H.265, max res 3840x2160@60Hz); audio: LPCM, MP3, AAC; WMV (video H.264, Windows Media Video 9, max res 1080p@30Hz, audio WMA 9, WMA 10 Pro)
Supported Audio Formats	MP3 (MP3); max. bit-rate 320 kBit/s

Available Options

Accessories	Feet (ST-401; ST-43M); Soundbar (SP-ASCM-IQ2; SP-ASCM-2); Speaker (SP-RM3a); Trolley (PD03Tipster); Wall mount (PDW S 32-55 L/P)
-------------	--

Green Features

Energy Efficiency	Energy consumption: 85 kWh/1000 h; LED backlight
Ecological Standards	EnergyStar 8.0

Specifications – ME501 IR (3/3)

Additional Features

Special Characteristics	DICOM Simulation; HDMI ARC; Powered USB Port (10 W)
Pixel Failure Class	ISO 9241-307, Class 1
Audio	Integrated Speakers (10 W + 10 W)
Shipping Content	2x AAA batteries; Display; HDMI Cable; Power Cable; Remote Control; Setup Manual; USB cable
Warranty	3 years warranty incl. backlight; additional services available
Operating Hours	18/7
External Control	AMX NetLinx Support; ASCII Control Commands; HDMI CEC; HTTP Browser; PJLink; Scheduled Timer; SNMP
Remote Management	Automated Email Alerts; NEC NaViSet Administrator 2
Security	Disable HW Buttons; Disable IR Functionality; Disable IR Functionality; Emergency Notification; Emergency Notification

This document is © 2021 Sharp NEC Display Solutions Europe GmbH.

All rights reserved in favour of their respective owners. All hardware and software names are brand names and/or registered trademarks of the respective manufacturers. All specifications are subject to change without notice. Errors and omissions are excepted. 21.04.2021

Specifications – ME551 IR (1/3)

Product Information

Product Name	NEC MultiSync® ME551 IR
Product Group	LCD 55" Infrared Touch Display
Order Code	60005084

Display

Panel Technology	IPS with Direct LED backlights
Screen Size [inch/cm]	55 / 138.8
Aspect Ratio	16:9
Brightness [cd/m ²]	400
Contrast Ratio (default)	> 8000:1
Viewing Angle [°]	178 horizontal / 178 vertical (typ. at contrast ratio 10:1)
Colour Depth [bn]	1.073 (8bit + FRC)
Response Time (typ.) [ms]	8
Panel Refresh Rate [Hz]	60
Supported Orientation	Landscape; Portrait

Synchronisation Rate

Horizontal Frequency [kHz]	26 - 135
Vertical Frequency [Hz]	23 - 86

Resolution

Native Resolution	3840 x 2160			
Supported Resolutions	4096 x 2160; 3840 x 2160; 1920 x 2160; 1920 x 1200;	1920 x 1080; 1650 x 1050; 1600 x 1200; 1440 x 900;	1400 x 1050; 1366 x 768; 1360 x 768; 1280 x 1024;	1280 x 720; 1024 x 768

Connectivity

Input Video Digital	1 x DisplayPort (with HDCP); 2 x HDMI (with HDCP)
Input Audio Digital	1 x DisplayPort; 2 x HDMI
Input Control	LAN 100Mbit; remote control wire (3,5mm jack); RS232
Input Data	1 x USB 2.0 (MediaPlayer)
Output Audio Analogue	1 x 3,5 mm jack
Input Detect	Custom; First; Last

Open Modular Intelligence

Intel® SDM	accepts Intel® Smart Display Modules Large and Small up to 66 W
Compute Module Slot	RPI Compute Module 4

Sensors

Temperature Sensor	Integrated, 3 sensors, triggered actions programmable
--------------------	---

Electrical

Power Consumption Eco/max. [W]	120 shipping
Power Savings Mode [W]	< 0.5; < 2 (Networked Standby)
Power Management	VESA DPMS
Power Supply	100-240 V AC; 50/60 Hz

Specifications – ME551 IR (2/3)

Environmental Conditions

Operating Temperature [°C]	+0 to +35
Operating Humidity [%]	20 to 80
Storage Humidity [%]	10 to 90
Storage Temperature [°C]	-20 to 60

Mechanical

Dimensions (W x H x D) [mm]	1,256.8 x 725.4 x 80
Weight [kg]	31.8
Bezel Width [mm]	22.75 (left and right); 23.9 (top and bottom)
VESA Mounting [mm]	4 holes; 400 x 400 (FDMI); M6
Ingress Protection	IP5x (front); IP2x (back)
Packaging Dimensions (W x H x D) [mm]	Box 1: 1,430 x 920 x 250
Packaging Weight [kg]	Box 1: 41.4

Glass

Thickness [mm]	3
Type	Thermal-tempered, anti-glare coating
Light Transmission [%]	92 (+/- 2 %)
Haze Level [%]	4
Hardness [H]	7

Touch

Touch Technology	Infrared Touch
Number of Touches	Real multi-touch up to 20 touches
Frame Rate [Hz]	125
Touch Method	Finger; Gloves; Stylus (≥ 2 mm)
Supported Operating System	Android; Linux; Mac OS; Raspberry Pi; Windows
Data Interface	USB-HID
Accuracy [mm]	+/- 2

MediaPlayer

Supported File Storage / File System	USB 2.0 / FAT16, FAT32
Supported Video Formats	MPEG (MPEG1/2/4, max res 1080p@30Hz); MP4 (MPEG2/4, H.263, H.264, HEVC/H.265, max res 3840x2160@60Hz); TS (MPEG2, H.264, HEVC/H.265, max res 3840x2160@60Hz); audio: LPCM, MP3, AAC; WMV (video H.264, Windows Media Video 9, max res 1080p@30Hz, audio WMA 9, WMA 10 Pro)
Supported Audio Formats	MP3 (MP3); max. bit-rate 320 kBit/s

Available Options

Accessories	Feet (ST-401; ST-43M); Soundbar (SP-ASCM-IQ2; SP-ASCM-2); Speaker (SP-RM3a); Trolley (PD03Tipster); Wall mount (PDW S 32-55 L/P)
-------------	--

Green Features

Energy Efficiency	Energy consumption: 118 kWh/1000 h; LED backlight
Ecological Standards	EnergyStar 8.0

Additional Features

Specifications – ME551 IR (3/3)

Special Characteristics	DICOM Simulation; HDMI ARC; Powered USB Port (10 W)
Pixel Failure Class	ISO 9241-307, Class 1
Audio	Integrated Speakers (10 W + 10 W)
Shipping Content	2x AAA batteries; Display; HDMI Cable; Power Cable; Remote Control; Setup Manual; USB cable
Warranty	3 years warranty incl. backlight; additional services available
Operating Hours	18/7
External Control	AMX NetLinx Support; ASCII Control Commands; HDMI CEC; HTTP Browser; PJLink; Scheduled Timer; SNMP
Remote Management	Automated Email Alerts; NEC NaViSet Administrator 2
Security	Disable HW Buttons; Disable IR Functionality; Emergency Notification

This document is © 2021 Sharp NEC Display Solutions Europe GmbH.

All rights reserved in favour of their respective owners. All hardware and software names are brand names and/or registered trademarks of the respective manufacturers. All specifications are subject to change without notice. Errors and omissions are excepted. 21.04.2021

Trademark and Software License (1/2)

Trademarks

Microsoft® and Windows® are either registered trademarks or trademarks of Microsoft Corporation in the United States and/or other countries.

NEC is a registered trademark of NEC Corporation.

DisplayPort™ and the DisplayPort™ logo are trademarks owned by the Video Electronics Standards Association (VESA®) in the United States and other countries.



MultiSync is a trademark or registered trademark of NEC Display Solutions, Ltd. in Japan and other countries.

All other brands and product names are trademarks or registered trademarks of their respective owners.

The terms HDMI and HDMI High-Definition Multimedia Interface, and the HDMI Logo are trademarks or registered trademarks of HDMI Licensing Administrator, Inc. in the United States and other countries.



PJLink trademark and logo are trademarks applied for registration or are already registered in Japan, the United States of America and other countries and areas.

CRESTRON and CRESTRON ROOMVIEW are trademarks or registered trademarks of Crestron Electronics, Inc. in the United States and other countries.

NaViSet is a trademark or registered trademark of NEC Display Solutions, Ltd. in Japan and other countries.

Blu-ray is a trademark of Blu-ray Disc Association.

TILE COMP and TILE MATRIX are trademarks or registered trademarks of NEC Display Solutions, Ltd. in Japan and other countries.

Intel and the Intel logo are trademarks of Intel Corporation or its subsidiaries.

[Notice] About the MPEG-4 AVC, MPEG-4 Visual license included in this product

1. MPEG AVC

THIS PRODUCT IS LICENSED UNDER THE AVC PATENT PORTFOLIO LICENSE FOR THE PERSONAL USE OF A CONSUMER OR OTHER USES IN WHICH IT DOES NOT RECEIVE REMUNERATION TO (i) ENCODE VIDEO IN COMPLIANCE WITH THE AVC STANDARD (“AVC VIDEO”) AND/OR (ii) DECODE AVC VIDEO THAT WAS ENCODED BY A CONSUMER ENGAGED IN A PERSONAL ACTIVITY AND/OR WAS OBTAINED FROM A VIDEO PROVIDER LICENSED TO PROVIDE AVC VIDEO. NO LICENSE IS GRANTED OR SHALL BE IMPLIED FOR ANY OTHER USE. ADDITIONAL INFORMATION MAY BE OBTAINED FROM MPEG LA, L.L.C. SEE [HTTP://WWW.MPEGLA.COM](http://www.mpegla.com)

2. MPEG-4 Visual

THIS PRODUCT IS LICENSED UNDER THE MPEG-4 VISUAL PATENT PORTFOLIO LICENSE FOR THE PERSONAL AND NON-COMMERCIAL USE OF A CONSUMER FOR (i) ENCODING VIDEO IN COMPLIANCE WITH THE MPEG-4 VISUAL STANDARD (“MPEG-4 VIDEO”) AND/OR (ii) DECODING MPEG-4 VIDEO THAT WAS ENCODED BY A CONSUMER ENGAGED IN A PERSONAL AND NONCOMMERCIAL ACTIVITY AND/OR WAS OBTAINED FROM A VIDEO PROVIDER LICENSED BY MPEG LA TO PROVIDE MPEG-4 VIDEO. NO LICENSE IS GRANTED OR SHALL BE IMPLIED FOR ANY OTHER USE. ADDITIONAL INFORMATION INCLUDING THAT RELATING TO PROMOTIONAL, INTERNAL AND COMMERCIAL USES AND LICENSING MAY BE OBTAINED FROM MPEG LA, LLC. SEE [HTTP://WWW.MPEGLA.COM](http://www.mpegla.com).

Manufacturer's Recycling and Energy Information (1/3)

NEC DISPLAY SOLUTIONS is strongly committed to environmental protection and sees recycling as one of the company's top priorities in trying to minimize the burden placed on the environment. We are engaged in developing environmentally-friendly products, and always strive to help define and comply with the latest independent standards from agencies such as ISO (International Organisation for Standardization) and TCO (Swedish Trades Union).



For EU: The crossed-out wheeled bin implies that used batteries should not be put to the general household waste! There is a separate collection system for used batteries, to allow proper treatment and recycling in accordance with legislation.

According to EU directive 2006/66/EC and amendments, the battery can't be disposed improperly. The battery shall be separated to collect by local service.

Manufacturer's Recycling and Energy Information (2/3)

Disposing of your old NEC product

The aim of recycling is to gain an environmental benefit by means of re-use, upgrading, reconditioning or reclamation of material. Dedicated recycling sites ensure that environmentally harmful components are properly handled and securely disposed. To ensure the best recycling of our products, **NEC DISPLAY SOLUTIONS offers a variety of recycling procedures** and gives advice on how to handle the product in an environmentally sensitive way, once it has reached the end of its life.

All required information concerning the disposal of the product and country-specific information on recycling facilities can be found on our following websites:

<https://www.nec-display-solutions.com/p/greenvision/en/greenvision.xhtml> (in Europe),

<https://www.nec-display.com> (in Japan) or

<https://www.necdisplay.com> (in USA).

Energy Saving

This monitor features an advanced energy saving capability. When a Display Power Management signal is sent to the monitor, the Energy Saving mode is activated. The monitor enters a single Energy Saving mode.

For additional information visit:

<https://www.necdisplay.com/> (in USA)

<https://www.nec-display-solutions.com/> (in Europe)

<https://www.nec-display.com/global/index.html> (Global)

For ErP requirement/For ErP (Network standby) requirement:

Except for the conditions below: [POWER SAVE] is set to [DISABLE].
[SLOT POWER] is set to [ON].
[CEC] is set to [MODE1] or [MODE2].
The monitor is using an Option Board.
[MODE] in [POWER SAVE SETTING] is set to [LOW POWER].
[AUTO INPUT CHANGE] is set to a setting except for NONE.
[USB POWER] is set to [ON].

Power consumption (Glowing amber): 2.0 W or less.

Time for power management function: 10 sec. (Default setting)

Power consumption (Blinking amber): 0.5 W or less.

Time for power management function: 3 min. (Default setting)

Manufacturer's Recycling and Energy Information (3/3)

WEEE Mark (European Directive 2012/19/EU and amendments)



Disposing of your used product: In the European Union

EU-wide legislation as implemented in each Member State requires that used electrical and electronic products carrying the mark (left) must be disposed of separately from normal household waste. This includes monitors and electrical accessories, such as signal cables or power cords. When you dispose of such products, please follow the guidance of your local authority or ask the shop where you purchased the product, or if applicable, follow applicable legislation or agreement you may have. The mark on electrical and electronic products may only apply to the current European Union Member States.

Outside the European Union

If you wish to dispose of used electrical and electronic products outside the European Union, please contact your local authority and ask for the correct method of disposal.