

> X1000-4K

Smart LED Soundbar Projector User Guide

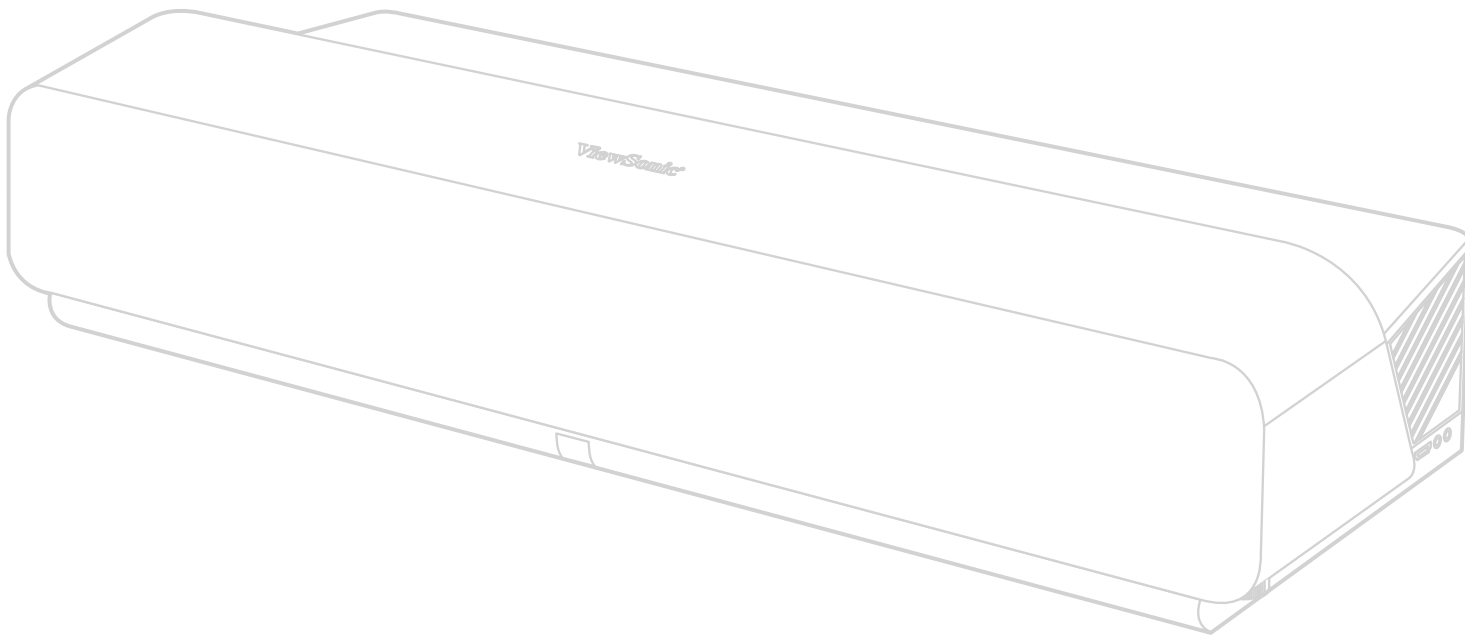

IMPORTANT: Please read this User Guide to obtain important information on installing and using your product in a safe manner, as well as registering your product for future service. Warranty information contained in this User Guide will describe your limited coverage from ViewSonic® Corporation, which is also found on our web site at <http://www.viewsonic.com> in English, or in specific languages using the Regional selection box in the upper right corner of our website.

Model No. VS17679
P/N: X1000-4K

Thank you for choosing ViewSonic®

As a world-leading provider of visual solutions, ViewSonic® is dedicated to exceeding the world's expectations for technological evolution, innovation, and simplicity. At ViewSonic®, we believe that our products have the potential to make a positive impact in the world, and we are confident that the ViewSonic® product you have chosen will serve you well.

Once again, thank you for choosing ViewSonic®!

> Safety Precautions

Please read the following **Safety Precautions** before you start using the projector.

- Keep this user guide in a safe place for later reference.
- Read all warnings and follow all instructions.
- Allow at least 20" (50 cm) clearance around the projector to ensure proper ventilation.
- Place the projector in a well-ventilated area. Do not place anything on the projector that prevents heat dissipation.
- Do not place the projector on an uneven or unstable surface. The projector may fall over, causing personal injury or projector malfunction.
- Do not use if the projector is tilted at an angle of more than 10° degrees left or right, nor at an angle of more than 15° degrees forwards or backwards.
- Do not look straight at the projector lens during operation. The intense light beam may damage your eyes.
- Always open the lens shutter or remove the lens cap when the projector lamp is on.
- Do not block the projection lens with any objects when the projector is under operation as this could cause objects to become heated and deformed or even cause a fire.
- The lamp becomes extremely hot during operation. Allow the projector to cool for approximately 45 minutes prior to removing the lamp assembly for replacement.
- Do not use lamps beyond the rated lamp life. Excessive use of lamps beyond the rated life could cause them to break on rare occasions.
- Never replace the lamp assembly or any electronic component unless the projector is unplugged.
- Do not attempt to disassemble the projector. There are dangerous high voltages inside which may cause death if you should come into contact with live parts.
- When moving the projector, be careful not to drop or bump the projector on anything.
- Do not place any heavy objects on the projector or connection cables.
- Do not stand the projector on end vertically. Doing so may cause the projector to fall over, causing personal injury or projector malfunction.
- Avoid exposing the projector to direct sunlight or other sources of sustained heat. Do not install near any heat sources such as radiators, heat registers, stoves, or other devices (including amplifiers) that may increase the temperature of the projector to dangerous levels.

- Do not place liquids near or on the projector. Liquids spilled into the projector may cause it to fail. If the projector does become wet, disconnect it from the power supply and call your local service center to have the projector serviced.
- When the projector is under operation, you may sense some heated air and odor from its ventilation grill. It is a normal operation and not a defect.
- Do not attempt to circumvent the safety provisions of the polarized or grounding-type plug. A polarized plug has two blades with one wider than the other. A grounding-type plug has two blades and a third grounding prong. The wide and third blade are provided for your safety. If the plug does not fit into your outlet, obtain an adapter and do not attempt to force the plug into the outlet.
- When connecting to a power outlet, DO NOT remove the grounding prong. Please ensure grounding prongs are NEVER REMOVED.
- Protect the power cord from being treaded upon or pinched, particularly at the plug, and at the point where it emerges from the projector.
- In some countries, the voltage is NOT stable. This projector is designed to operate safely within a voltage between 100 to 240 volts AC, but could fail if power cuts or surges of ± 10 volts occur. In areas where voltage may fluctuate or cut out, it is recommended that you connect your projector through a power stabilizer, surge protector, or uninterruptable power supply (UPS).
- If smoke, an abnormal noise, or a strange odor is present, immediately switch the projector off and call your dealer or ViewSonic®. It is dangerous to continue using the projector.
- Use only attachments/accessories specified by the manufacturer.
- Disconnect the power cord from the AC outlet if the projector is not being used for a long period of time.
- Refer all servicing to qualified service personnel.



CAUTION: Possibly hazardous optical radiation is emitted from this product. As with any bright light source, do not stare into the beam, RG2 IEC 62471-5:2015

> Safety Precautions - Ceiling Mounting

Please read the following **Safety Precautions** before you start using the projector.

If you intend to mount the projector on the ceiling, it is strongly recommended that you use a proper fitting projector ceiling mount kit and that you ensure it is securely and safely installed.

If you use an inappropriate projector ceiling mount kit, there is a safety risk that the projector may fall from the ceiling due to an improper attachment through the use of the wrong gauge or length screws.

You can purchase a projector ceiling mount kit from the place you purchased your projector.

> Contents

Safety Precautions.....	3
Introduction	9
Features.....	9
Package Contents	10
Product Overview	11
Projector.....	11
Connection Ports.....	12
Remote Control	14
Initial Setup.....	16
Choosing a Location - Projection Orientation.....	16
Projection Dimensions.....	17
Mounting the Projector	18
Making Connections.....	19
Connecting to Power	19
Connecting to External Devices	20
HDMI Connection	20
Audio Connection.....	21
USB and Network Connection	22
Wireless Screen Mirroring.....	23
Connecting to Networks	24
Wi-Fi Connection.....	24
Custom SSID	26
Wired LAN Connection.....	28
Bluetooth Connection	29
Bluetooth Speaker.....	29
Bluetooth Out.....	31

Using the Projector.....	32
Starting Up the Projector.....	32
First Time Activation.....	32
Image Focus	32
Preferred Language.....	33
Projection Orientation	33
Network Settings.....	34
Source Input	34
Selecting an Input Source	35
Adjusting the Projected Image	36
Adjusting the Projector's Height and Projection Angle	36
Setting Up the Desired Image Size	36
Fine-Tuning the Image Clarity	37
Shutting Down the Projector.....	38
Input Source Selected - On-Screen Display (OSD) Tree.....	39
Operating the Projector.....	52
Home Screen	52
Home Screen - On-Screen Display (OSD) Menu Tree	53
Menu Operations	58
File Management	58
Apps Center.....	63
Bluetooth	65
Setting	66
Screen Mirroring	81

Appendix.....	84
Specifications.....	84
Timing Chart	86
HDMI/USB C PC Timing	87
3D Support Timing.....	89
IR Control Table	90
Glossary	91
Troubleshooting	94
Maintenance.....	95
General Precautions.....	95
Cleaning the Lens	95
Cleaning the Case	95
Storing the Projector	95
LED Indicators.....	96
Regulatory and Service Information	97
Compliance Information.....	97
FCC Compliance Statement.....	97
Industry Canada Statement.....	97
CE Conformity for European Countries.....	97
Declaration of RoHS2 Compliance.....	99
Indian Restriction of Hazardous Substances	100
Product Disposal at End of Product Life	100
Copyright Information	101
Customer Service	102
Limited Warranty	103
Mexico Limited Warranty.....	106

> Introduction

Combining stunning 4K resolution with smart streaming functionality, the ViewSonic® X1000-4K is a dark room projector. With an ultra short throw lens it is easy to install in the home. Additionally, it features multiple HDMI ports and rich connectivity allowing users to stream content from their favorite providers.

Features

- Ultra short throw lens is excellent for home projection. Project a 100" screen from 0.379 meters (Back I/O side to wall).
- 16 GB internal storage (Max. 12 GB available for user storage).
- Various Color modes for different projection purposes.
- Multi-language On-Screen Display (OSD) menus.

Package Contents

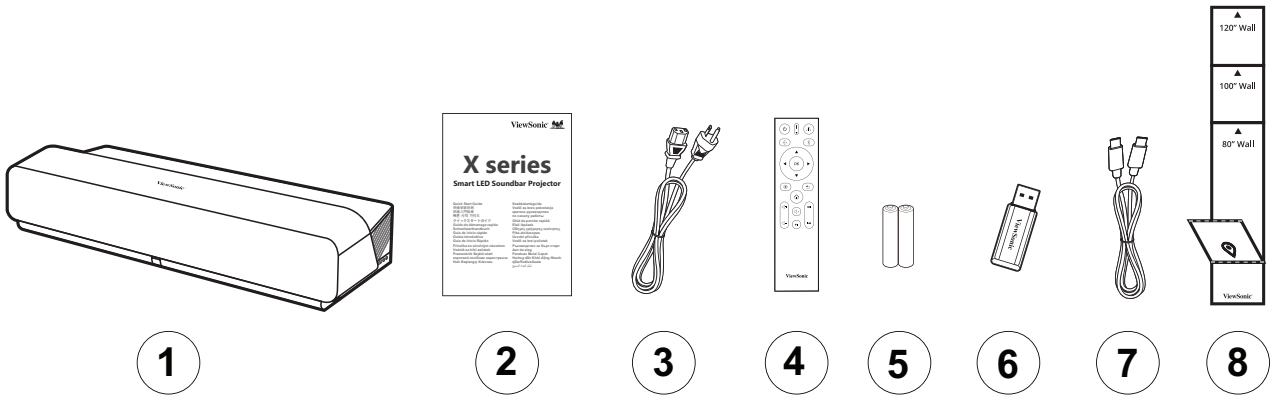

Item	Description
[1]	X1000-4K Projector
[2]	Quick Start Guide
[3]	Power Cord
[4]	Remote Control
[5]	Batteries
[6]	Wi-Fi Dongle
[7]	USB-C Cable
[8]	Distance Card

NOTE: The power cord and remote control included in your package may vary depending on your country. Please contact your local reseller for more information.

Product Overview

Projector

Front

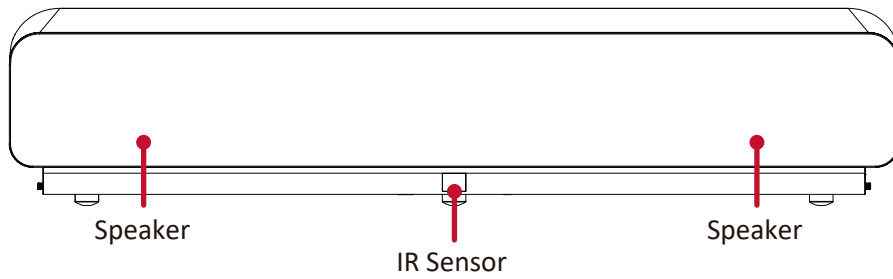

Rear

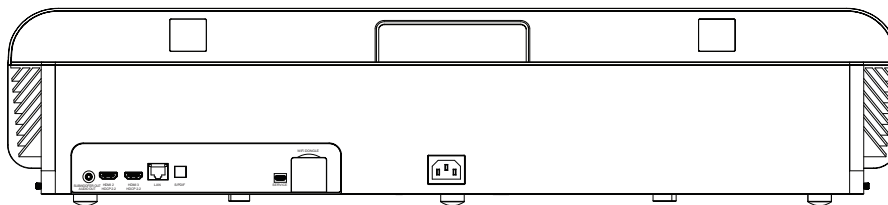

Sides



Top

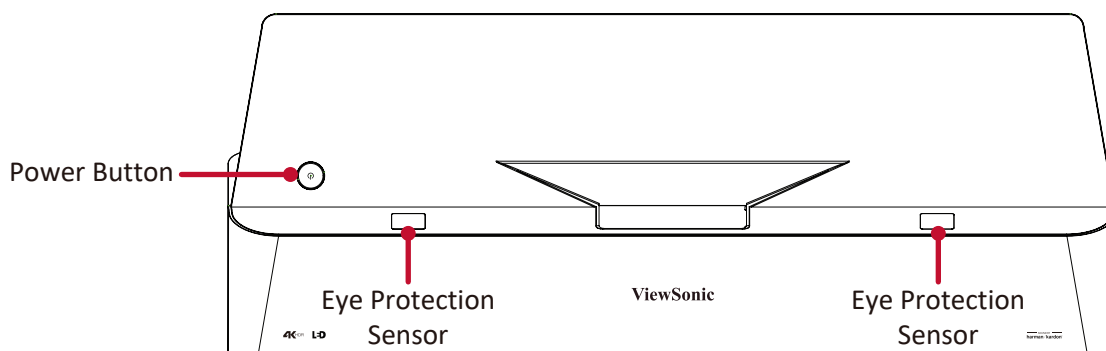

Connection Ports

Side I/O

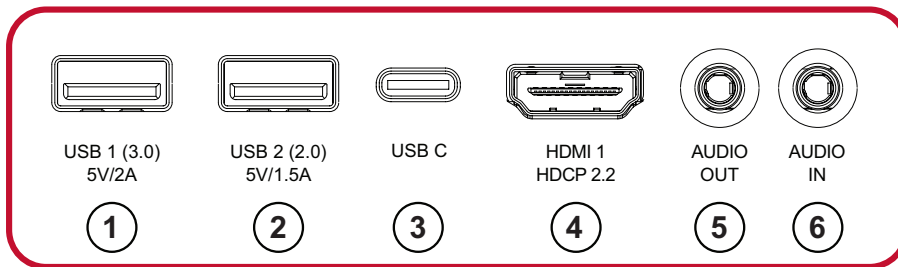
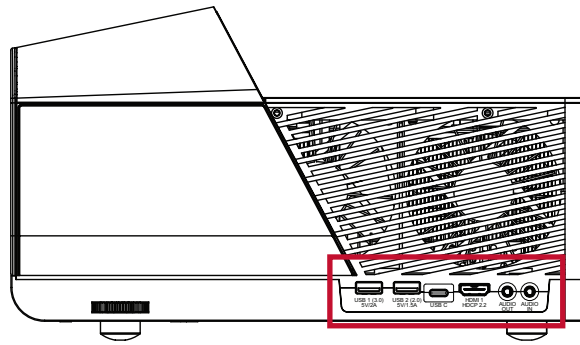

Port	Description
[1] USB (5V/2A Out)	USB 3.0 Type-A port (USB Reader - FAT32/NTFS ¹)
[2] USB (5V/1.5A Out)	USB 2.0 Type-A port (USB Reader - FAT32/NTFS ¹)
[3] USB-C	USB Type-C port
[4] HDMI 1 ²	HDMI port ³
[5] AUDIO OUT (3.5 mm jack)	Audio signal output socket
[6] AUDIO IN (3.5 mm jack)	Audio signal input socket

¹ USB reader supports FAT32/NTFS format. For more information, see page 62.

² Supports HDCP 2.0/HDMI 2.2.

³ iPhone/iPad users will need to buy an additional adapter. To avoid compatibility issues, please use Apple authorized accessories.

Rear I/O

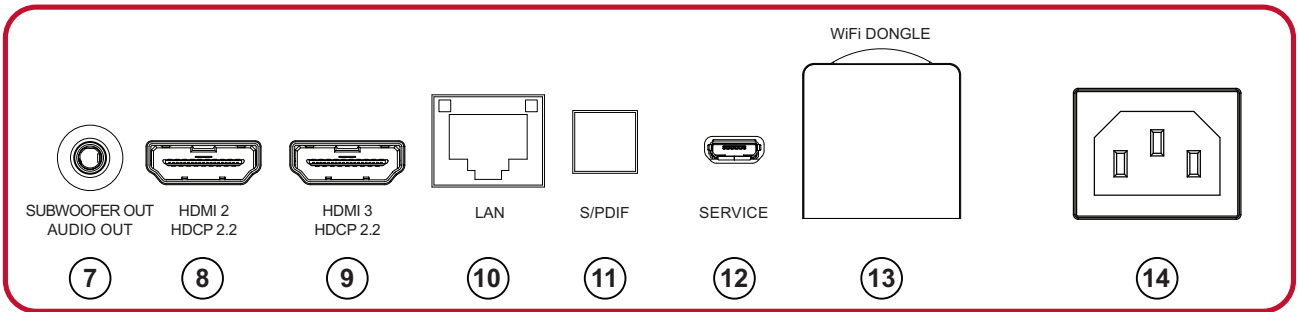
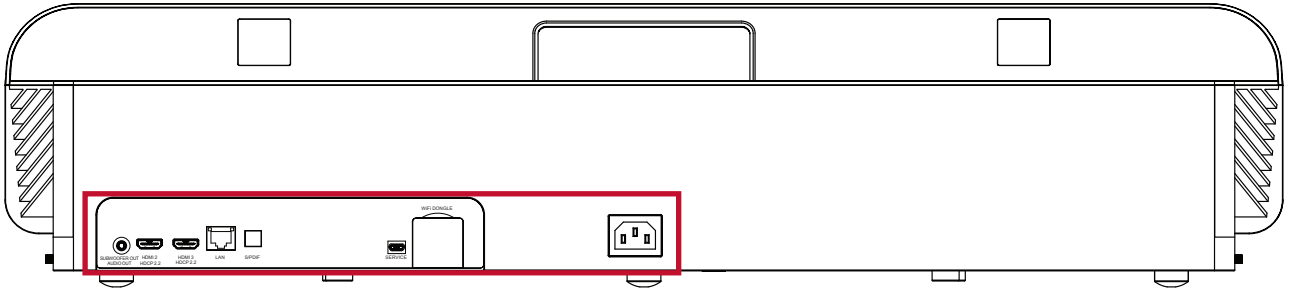











Port	Description
[7] AUDIO OUT / SUBWOOFER OUT (3.5 mm jack)	Audio signal output socket
[8] HDMI 2 ¹	HDMI port ²
[9] HDMI 3 ¹	HDMI port ²
[10] LAN	RJ45 LAN port
[11] S/PDIF	S/PDIF signal output socket
[12] Service	For Firmware updates
[13] Wi-Fi Dongle	USB 2.0 for Wi-Fi Dongle
[14] AC IN	AC IN socket

¹ Supports HDCP 2.0/HDMI 2.2.

² iPhone/iPad users will need to buy an additional adapter. To avoid compatibility issues, please use Apple authorized accessories.

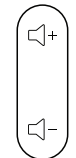
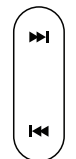
Remote Control

Button		Description
[1]	Power	 Turns the projector On or Off
[2]	Source	 Displays the input source selection bar.
[3]	Focus	 Automatically focus the image.
[4]	Bluetooth	 Launch Bluetooth search.
[5]	OK	 Confirms the selection.
[6]	Up/Down/Left/Right	 Navigates and selects the desired menu items and make adjustments.
[7]	Setting	 Displays the Setting menu.
[8]	Return	 Returns to the previous screen.
[9]	Home	 Access the Home screen.
[10]	Volume	 Increase/Decrease the volume level.
[11]	Forwards/Backwards	 Move content forwards/backwards.
[12]	Mute	 Mute/Unmute.
[13]	Play/Pause	 Play/Pause content.

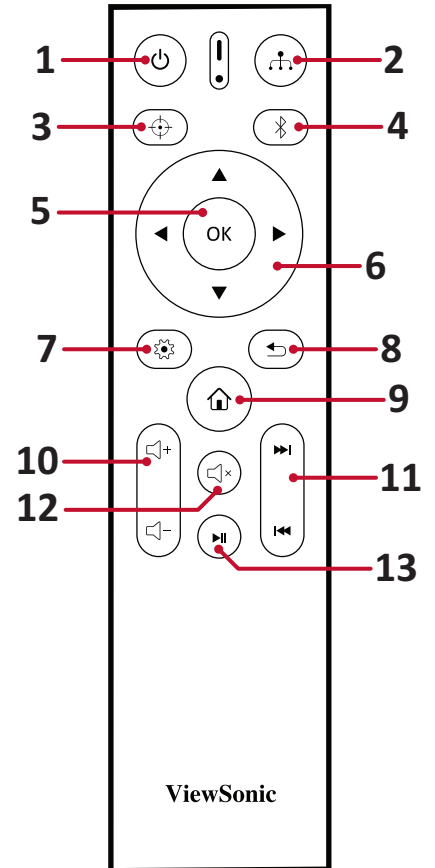

Remote Control - Receiver Range

To ensure proper function of the remote control follow the steps below:

1. The remote control must be held at an angle within 30° perpendicular to the projector's IR remote control sensor(s).
2. The distance between the remote control and the sensor(s) should not exceed 8 m (26 ft.)

NOTE: Refer to the illustration for the location of the infrared (IR) remote control sensor(s).

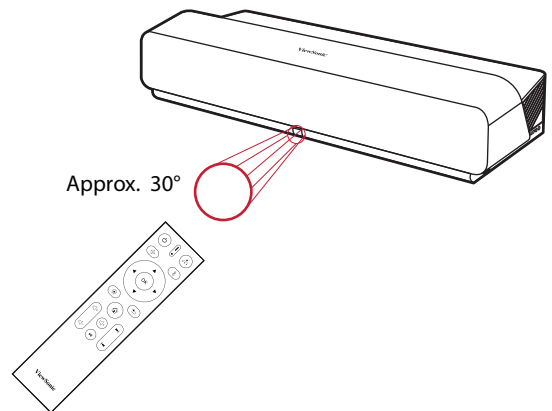

Remote Control - Replacing the Batteries

1. Remove the battery cover from the bottom of the remote control by pressing the finger grip and sliding it across.
2. Remove any existing batteries (if necessary) and install two AAA batteries.

NOTE: Observe the battery's polarities as indicated.

3. Replace the battery cover by aligning it with the base and pushing it back into position.

NOTE:

- Avoid leaving the remote control and batteries in excessive heat or a humid environment.
- Replace only with the same or equivalent type recommended by the battery manufacturer.
- If the batteries are drained or if you will not be using the remote control for an extended period of time, remove the batteries to avoid damage to the remote control.
- Dispose of the used batteries according to the manufacturer's instructions and local environment regulations for your region.

> Initial Setup

This section provides detailed instructions for the initial set up your projector.

Choosing a Location - Projection Orientation

Personal preference and room layout will decide the installation location. Consider the following:

- Size and position of your screen.
- Location of a suitable power outlet.
- Location and distance between the projector and other equipment.

The projector is designed to be installed in one of the following locations:

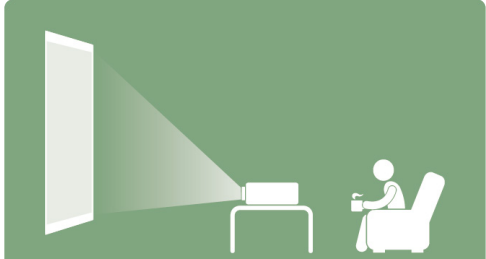
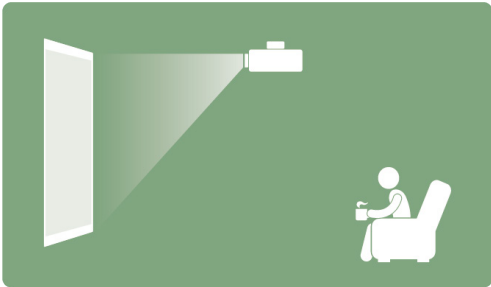
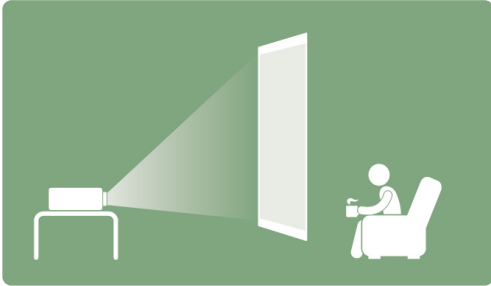
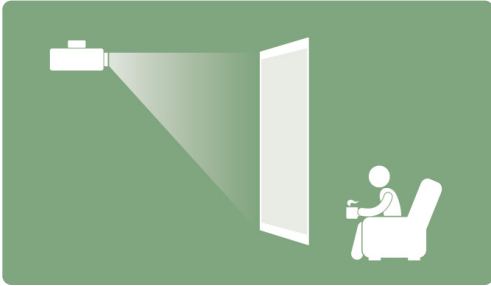
Location	
<p>Front Table</p> <p>The projector is placed near the floor in front of the screen.</p>	
<p>Front Ceiling</p> <p>The projector is suspended upside-down from the ceiling in front of the screen.</p>	
<p>Rear Table¹</p> <p>The projector is placed near the floor behind the screen.</p>	
<p>Rear Ceiling¹</p> <p>The projector is suspended upside-down from the ceiling behind the screen.</p>	

¹ A rear projection screen is required.

Projection Dimensions

- 16:9 Image on a 16:9 Screen

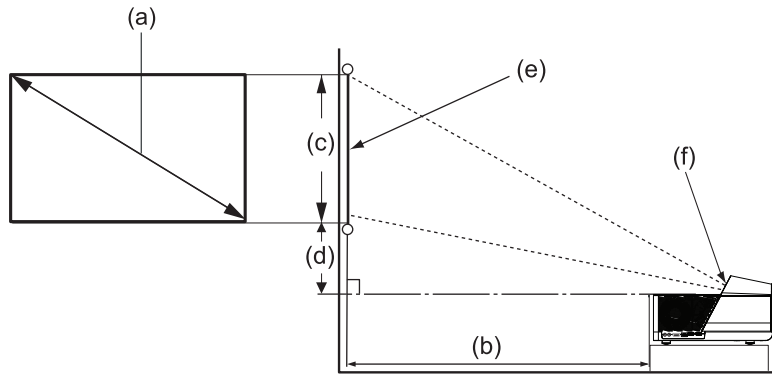

NOTE:

- (e) = Screen
- (f) = Center of Lens
- The distance from the center of the lens to the rear of the projector is 17.35 cm (6.83”).

16:9 Image on a 16:9 Screen

(a) Screen Size		(b) Projection Distance		(c) Image Height		(d) Vertical Offset	
in.	mm	in.	mm	in.	mm	in.	mm
60	1524	6.26	159	29.42	747	2.94	75
70	1778	8.41	214	34.32	872	3.43	87
80	2032	10.59	269	39.22	996	3.92	100
90	2286	12.78	325	44.12	1121	4.41	112
100	2540	14.92	379	49.03	1245	4.9	125
120	3048	19.33	491	58.83	1494	5.88	149
130	3302	21.48	546	64.73	1619	6.37	162
150	3810	25.85	657	73.54	1868	7.35	187

NOTE:

- These figures are for reference purposes only. Please refer to the actual projector for the precise dimensions.
- To learn more about setting up your desired image size, see page 36.

CAUTION: Allow at least 50 cm (20”) of clearance around the projector for proper ventilation and to prevent overheating.

Mounting the Projector

NOTE: If you buy a third party mount, please use the correct screw size. Screw size can vary depending on the thickness of the mounting plate.

1. To ensure the most secure installation, please use a ViewSonic® wall or ceiling mount.
2. Ensure the screws used to attach the mount to the projector meet the following specifications:
 - Screw type: M6 x 10
 - Maximum Screw Length: 10 mm

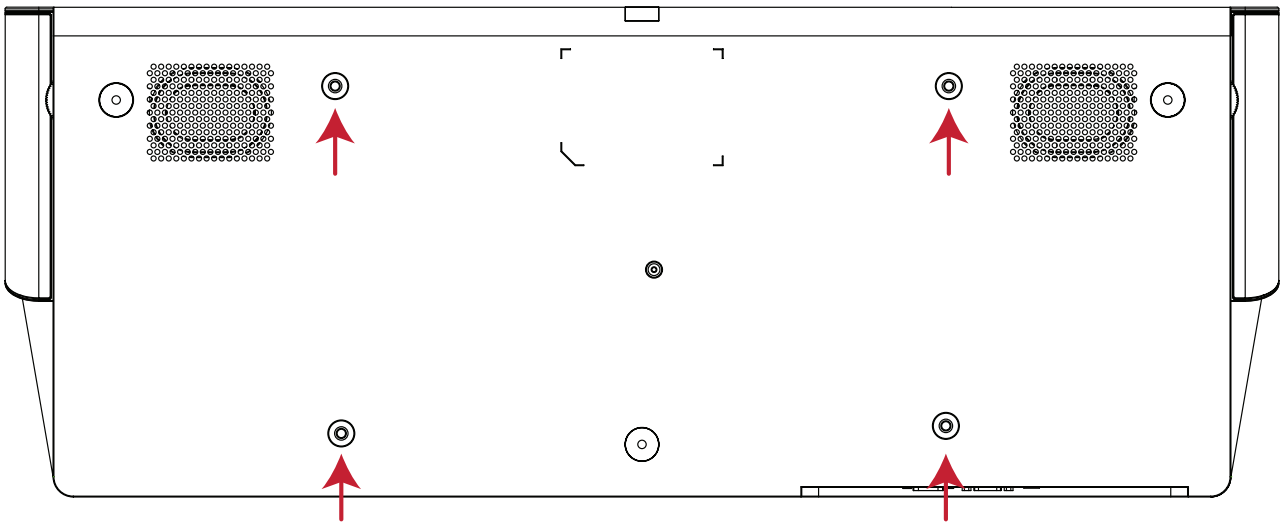

CAUTION:

- Avoid installing the projector near a heat source or air conditioner.
- Keep at least a 10 cm (3.9 in.) gap between the ceiling and the bottom of the projector.

> Making Connections

This section guides you on how to connect the projector with other equipment.

Connecting to Power

1. Connect the power cord to the AC IN jack at the rear of the projector.
2. Plug the power cord into a power outlet.

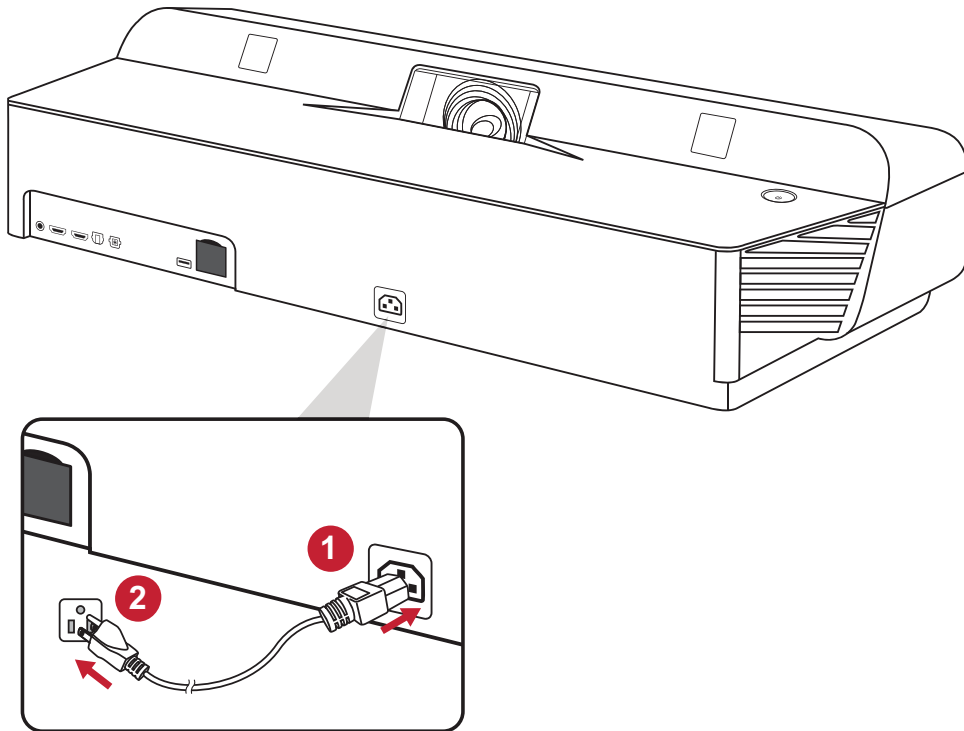

NOTE: When installing the projector, incorporate a readily accessible disconnect device in the fixed wiring, or connect the power plug to an easily accessible outlet near the unit. If a fault should occur during operation of the projector, use the disconnect device to switch off the power supply, or disconnect the power plug.

Connecting to External Devices

HDMI Connection

Connect one end of an HDMI cable to the HDMI port of your video device. Then connect the other end of the cable to the **HDMI 1/2/3** port (each support HDCP 2.0/HDMI 2.2) of your projector.

NOTE: iPhone/iPad users will need to use an additional adapter.

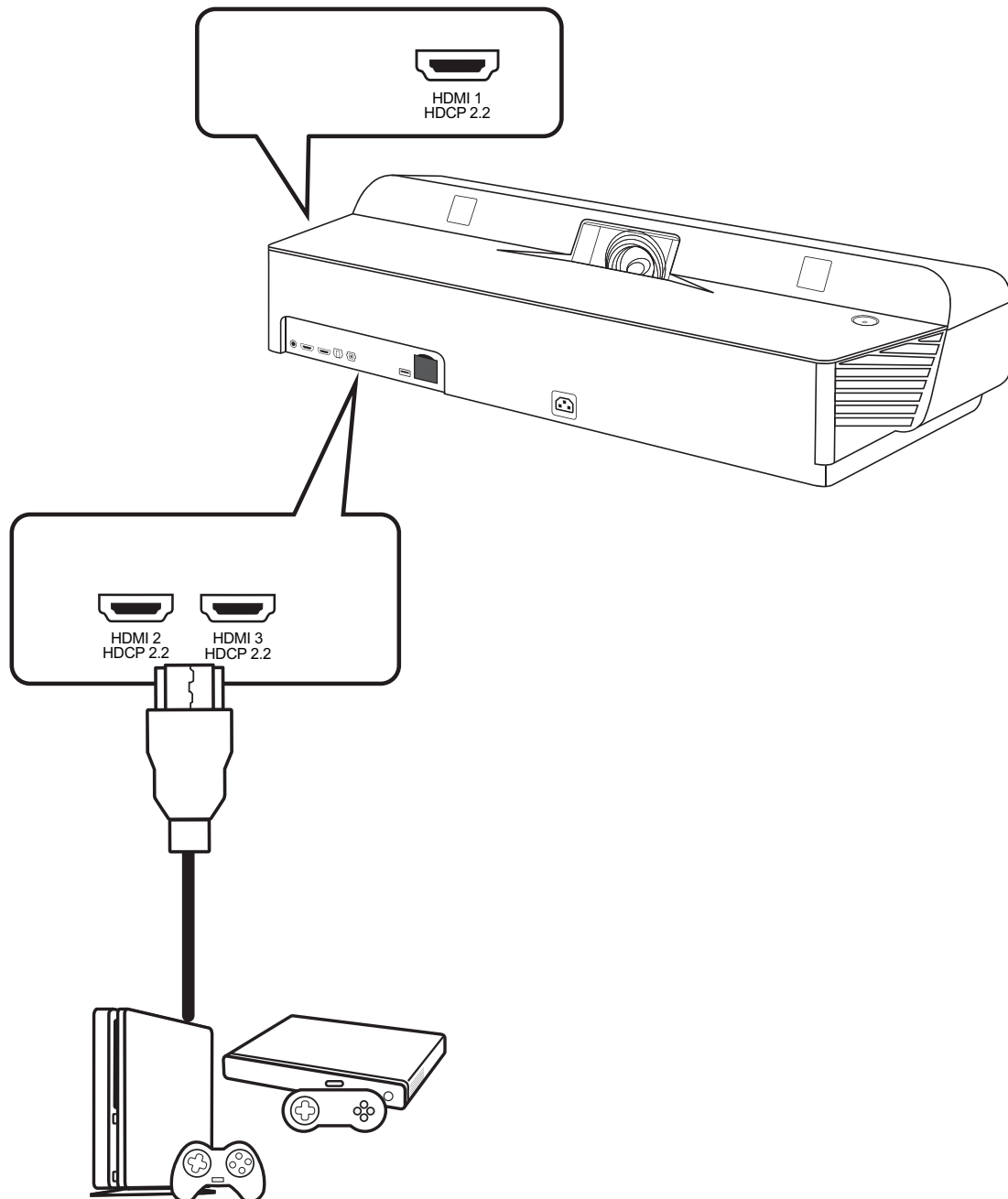

Audio Connection

You can connect to various external sound delivery devices via the **Audio Out**, **Audio In**, **Subwoofer Out**, and **S/PDIF** ports.

- To play music with **Audio In**: select **Bluetooth > Bluetooth Speaker**
- To use **Subwoofer Out**: select **Settings > Advanced Setting > harman/kardon > Internal Speaker > Enable**
- To play music with **Audio Out**: select **Settings > Advanced Setting > harman/kardon > Internal Speaker > Disable**

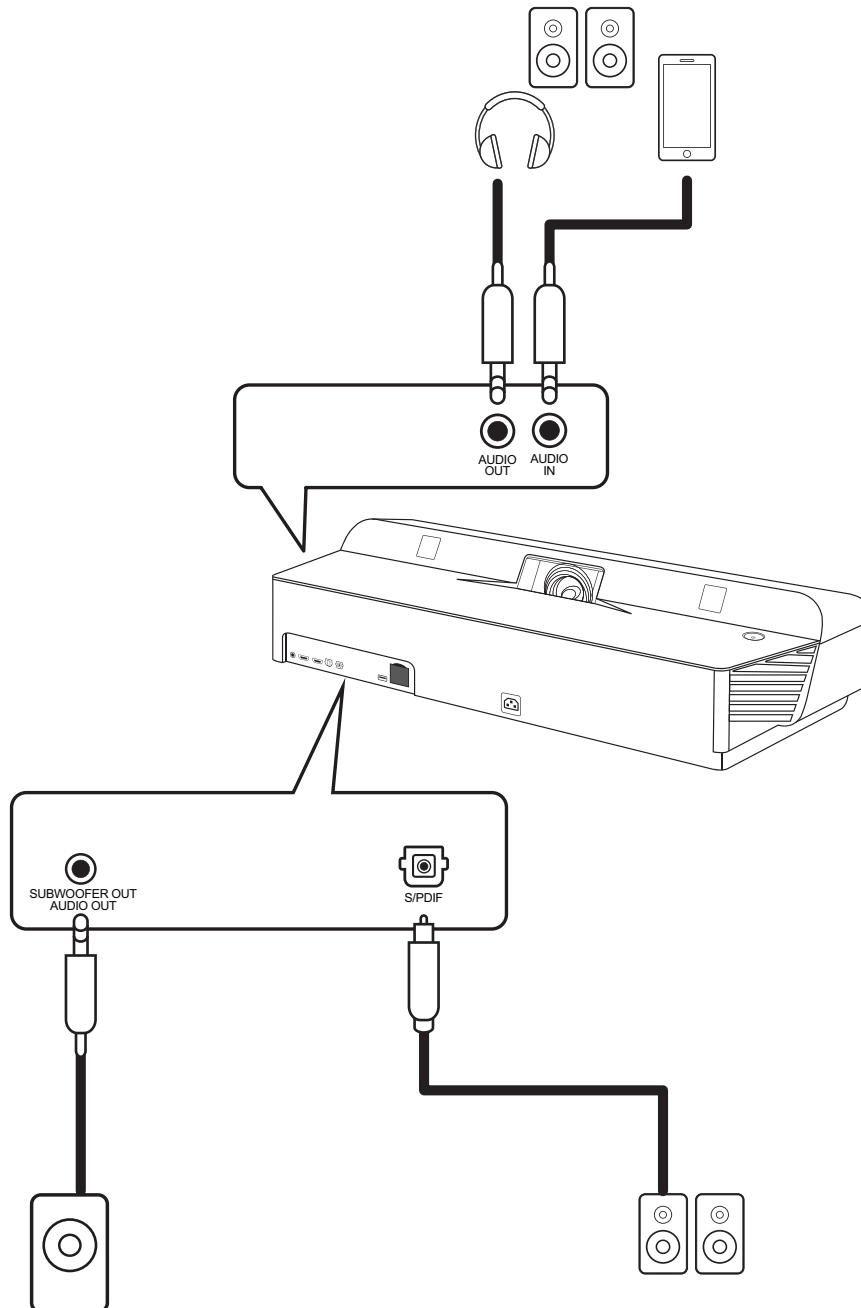

NOTE: Audio In is available for Bluetooth input only.

USB and Network Connection

Just like any PC, it is easy to connect various USB devices, dongles, and networking devices.

USB-C Connection

Connect one end of a USB Type-C cable to the USB-C port of your device. Then connect the other end of the cable to the USB-C port of your projector.

NOTE: Ensure your USB Type-C device can support video transmission.

USB Type-A Connection

Connect a keyboard, a mouse, dongles, storage devices, etc. to the projector's USB Type-A port. To learn more about managing storage, (e.g., USB Flash Drive, content, etc.) see page 58.

Network Connection

Plug the network cable into the **LAN** port, or insert the Wi-Fi dongle for a wireless connection.

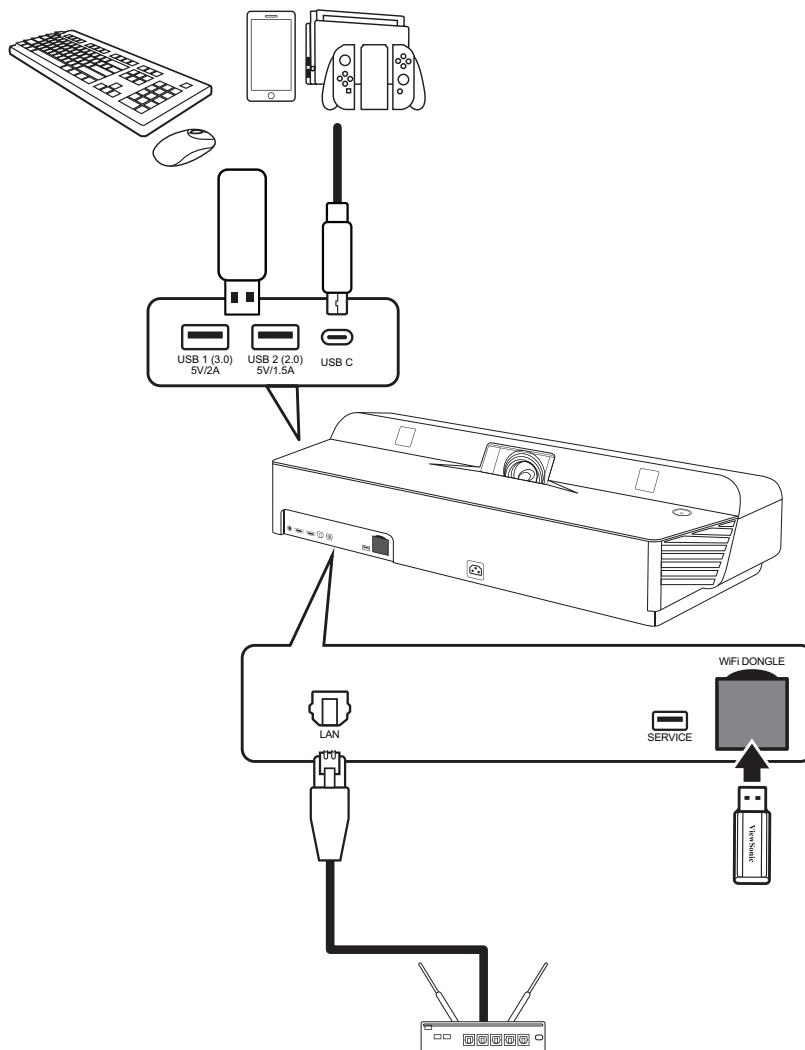

Wireless Screen Mirroring

Screen Mirroring provides a 5GHz Wi-Fi connection for users to mirror the screen on their personal device.

NOTE: Ensure your device is connected to the same network as the projector.

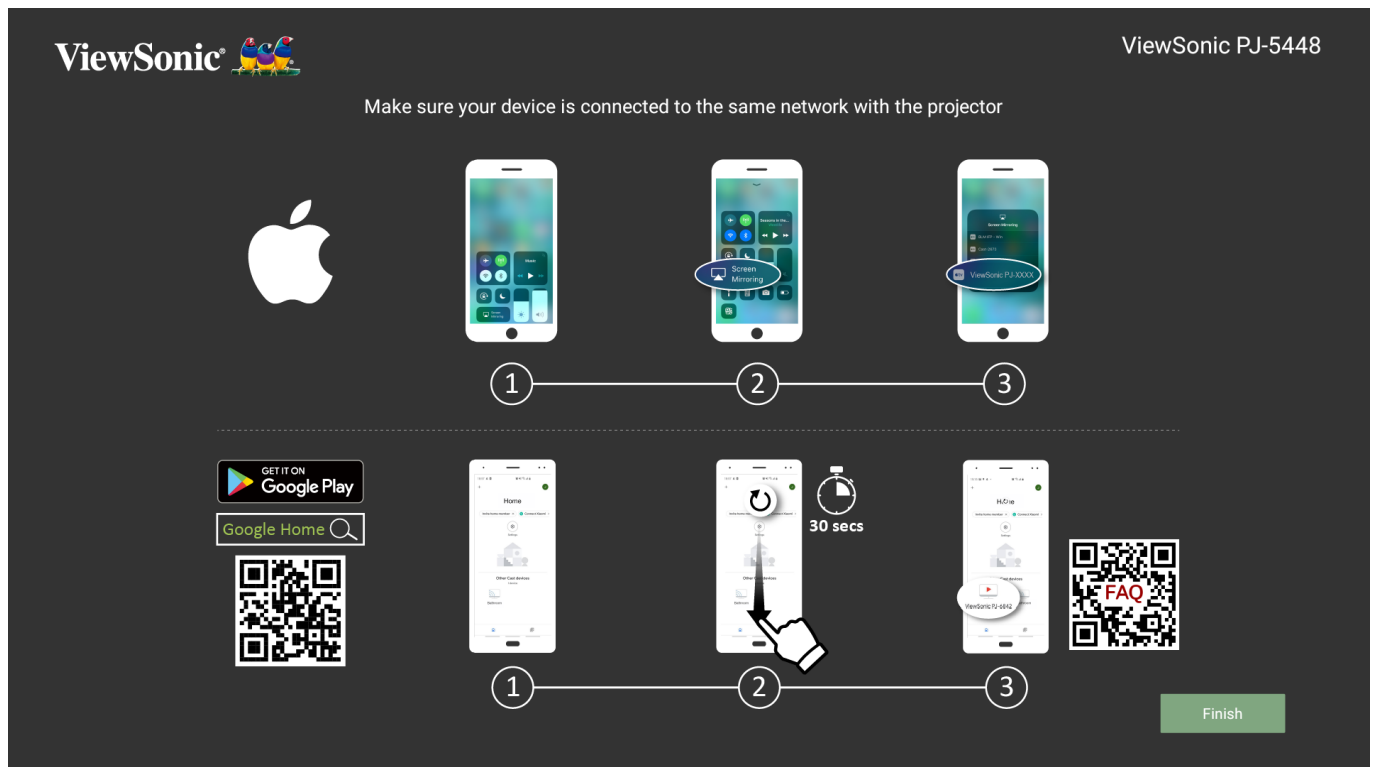

For iOS:

1. Access the drop down control menu.
2. Select the “Screen Mirroring” icon.
3. Choose “ViewSonic PJ-XXXX”.

For Android:

1. Download and install the “Google Home” application and open it.
2. Pull-to-refresh the app and wait for 30 seconds.
3. “ViewSonic PJ-XXXX” will now be visible, select it.

NOTE: Some Android devices support direct “Casting”. If your device does, go to the Casting feature and choose “ViewSonic PJ-XXX” from the list of available devices. You can also scan the FAQ QR code and follow the steps to directly cast your Android device.

Connecting to Networks

Wi-Fi Connection

To connect to a Wi-Fi network:

1. Insert the Wi-Fi dongle into the projector's Wi-Fi dongle socket.

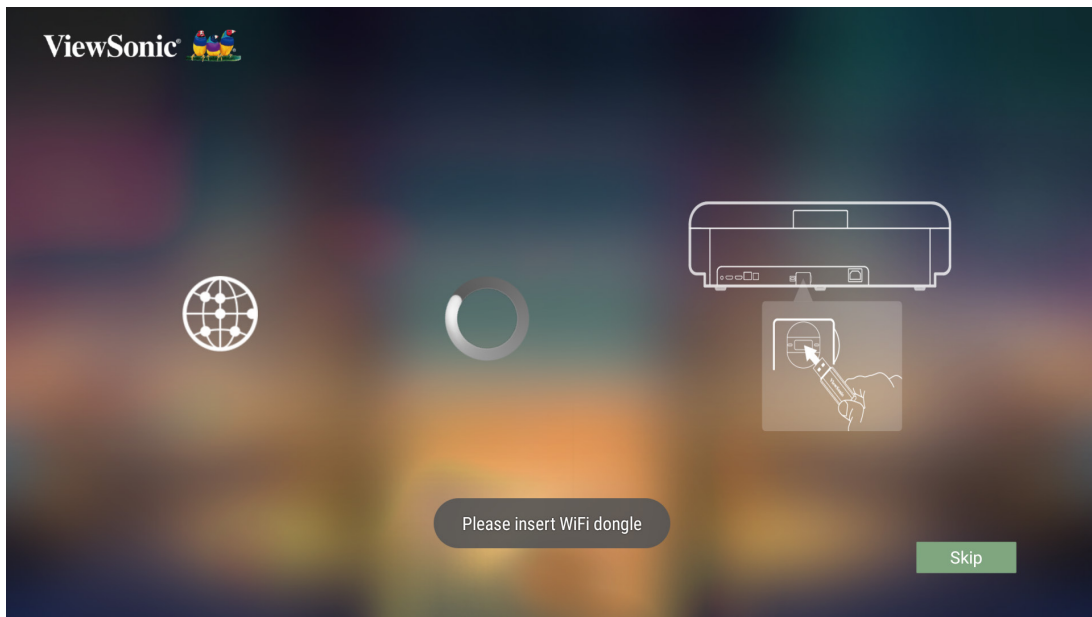

2. Go to: **Home > Settings > Network Settings > Wi-Fi**

3. Press **Left** or **Right** on the remote control to select **Enable**.



4. Available Wi-Fi networks will then be displayed. Select one of the available Wi-Fi networks.



5. If you connect to a secure Wi-Fi network, you must enter the password when prompted.

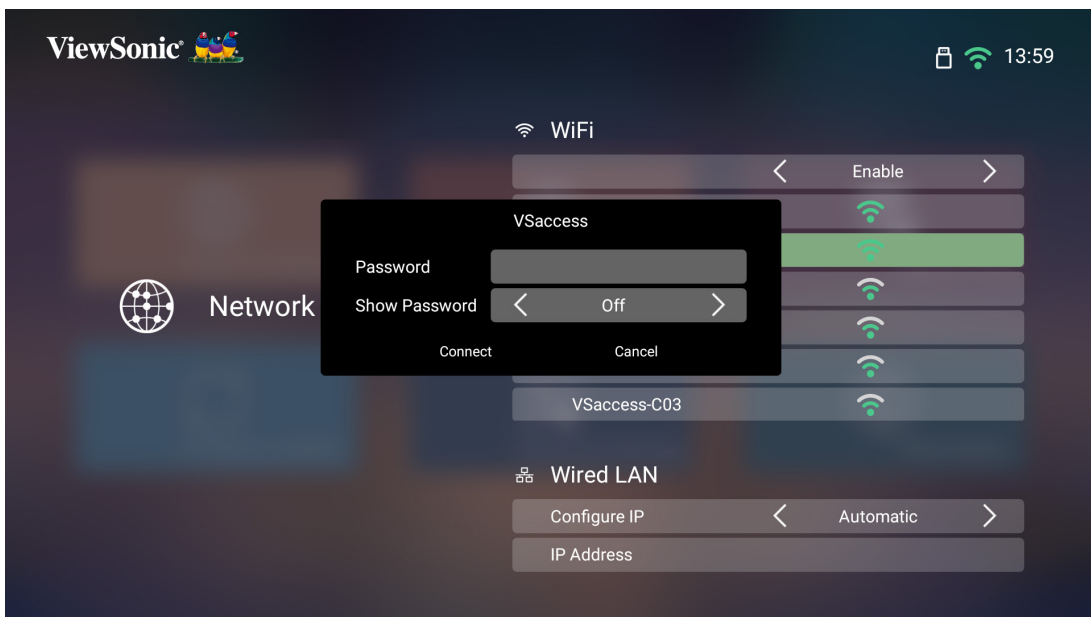

Custom SSID

1. Ensure the Wi-Fi dongle is plugged into the projector's Wi-Fi dongle socket.
2. Go to: **Home > Settings > Network Settings > Wi-Fi**
3. Press **Left** or **Right** on the remote control to select **Enable**.
4. From the available Wi-Fi networks list select **Others** and press **OK** on the remote control.



5. Enter the SSID and select the security level.



6. Enter the password when prompted.



NOTE: It is recommended to let the system configure the network settings automatically by choosing Automatic for Configure IP.

Wired LAN Connection

You can easily connect to wired Internet networks and customize the connection as well.

1. Plug the RJ45 cable into the **LAN** port of the projector, then ensure the other end is plugged into your wired Internet source.
2. Go to: **Home > Settings > Network Settings > Wired LAN Control**



3. You can Configure the IP automatically or manually. Choosing **Manual** will allow access to **IP Address, Subnet Mask, Default Gateway, and DNS Server.**

NOTE: It is recommended to let the system configure the network settings automatically by choosing **Automatic** for **Configure IP.**

Bluetooth Connection

Bluetooth Speaker

The projector is equipped with Bluetooth that allows the user to connect their device wirelessly for audio playback.

To connect and pair your device:

1. Go to: **Home > Bluetooth.**
2. Use the **Left** and **Right** directional buttons on the remote control to select **Bluetooth Speaker** or **Bluetooth Pairing**. Then press **OK** on the remote control.

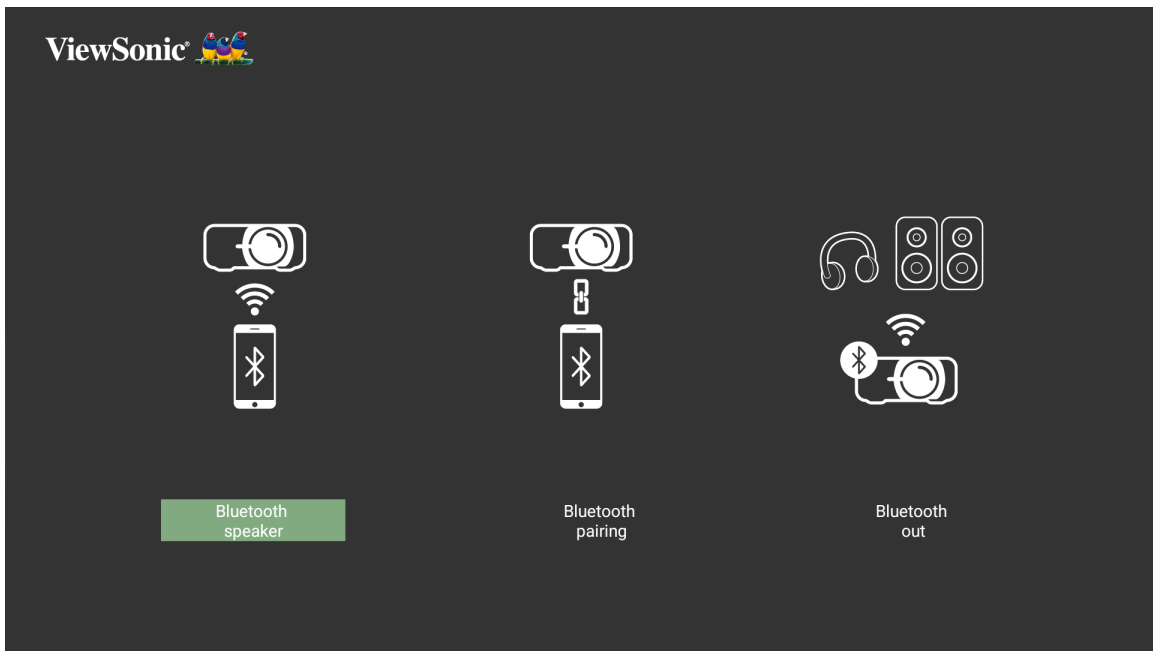

3. When the below dialogue box appears, select **Yes** and press **OK** on the remote control to enter Bluetooth mode.

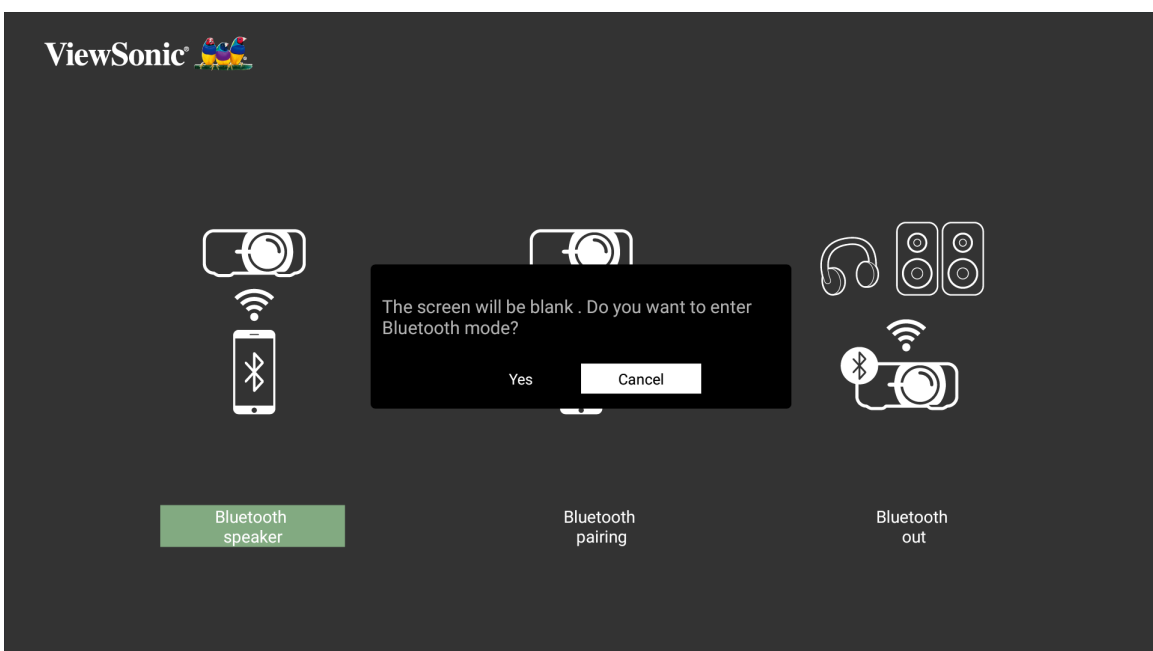

4. A sound effect will be audible upon entering pairing mode.
5. Upon successful connection, another sound effect will be audible.

NOTE:

- Once paired, if both the projector and your device are powered on they will automatically connect via Bluetooth.
- The projector's name will be labeled as "X1000-4K".
- Only the Power and Return buttons can exit Bluetooth mode.

Bluetooth Out

Connect the projector to external headphones or speakers that support Bluetooth.

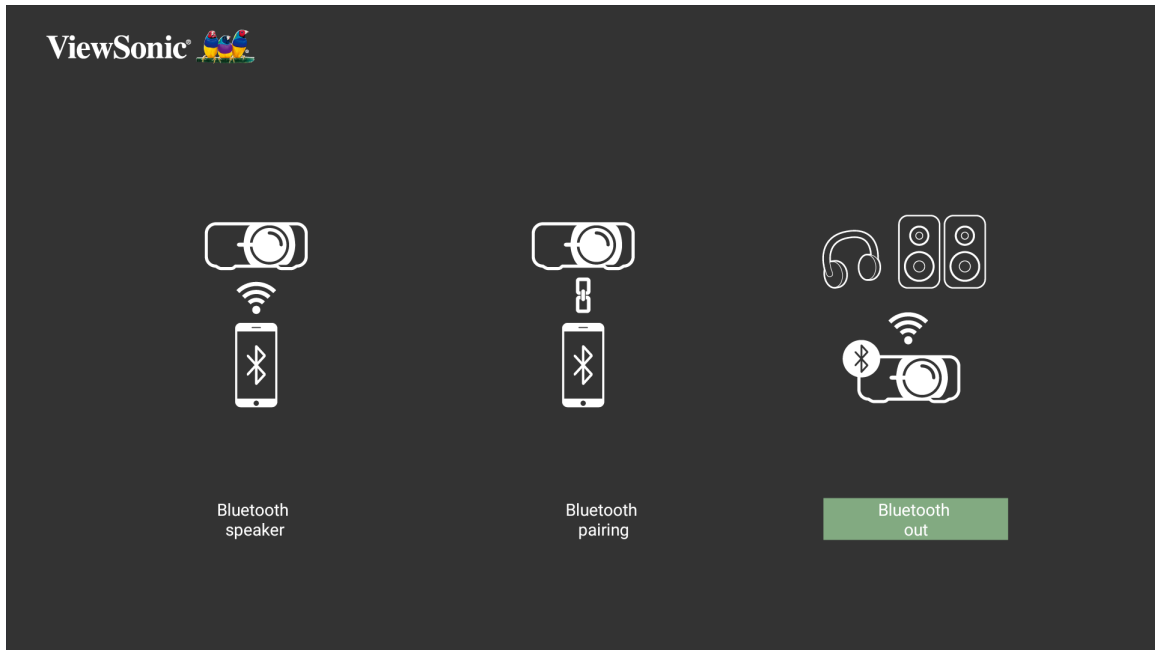

To connect and pair your device:

1. Go to: **Home > Bluetooth.**
2. Use the **Left** and **Right** directional buttons on the remote control to select the **Bluetooth Out** option.

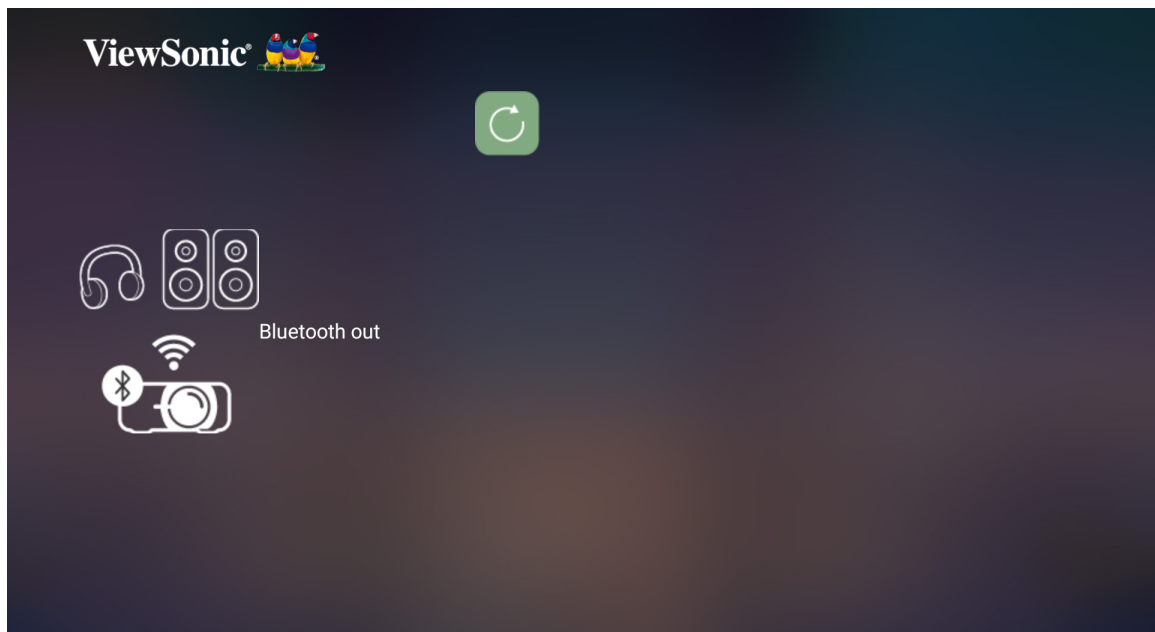

3. The projector will search for nearby Bluetooth devices. Select your device from the list and press **OK** on the remote control.

> Using the Projector

Starting Up the Projector

1. Ensure the projector's power cord is properly connected to a power outlet.
2. Press the **Power** button to turn on the projector.

NOTE: The Status LED will be blue during startup.

First Time Activation

If the projector is activated for the first time, you will need to select your Preferred Language, Projection Orientation, Network Settings, and Source Input. Follow the on-screen instructions using the **OK** and **Up/Down/Left/Right** buttons on the remote control. When the Finish screen appears, this indicates the projector is ready to use.

Image Focus

Select the **Focus** button and press **Right** or **Left** to adjust the image until it is clear.



Preferred Language

Select the desired language and press **OK** to confirm the selection.



Projection Orientation

Select the preferred projection orientation and press **OK** to confirm the selection.
For more information, see page 33.



Network Settings

Select one of the available options. For more information, see page 24.



Source Input

Quickly access the **Source Input** menu by pressing the **Down** button on the remote control when at the **Home Screen**. Additionally, you can press the **Source** button on the remote control.

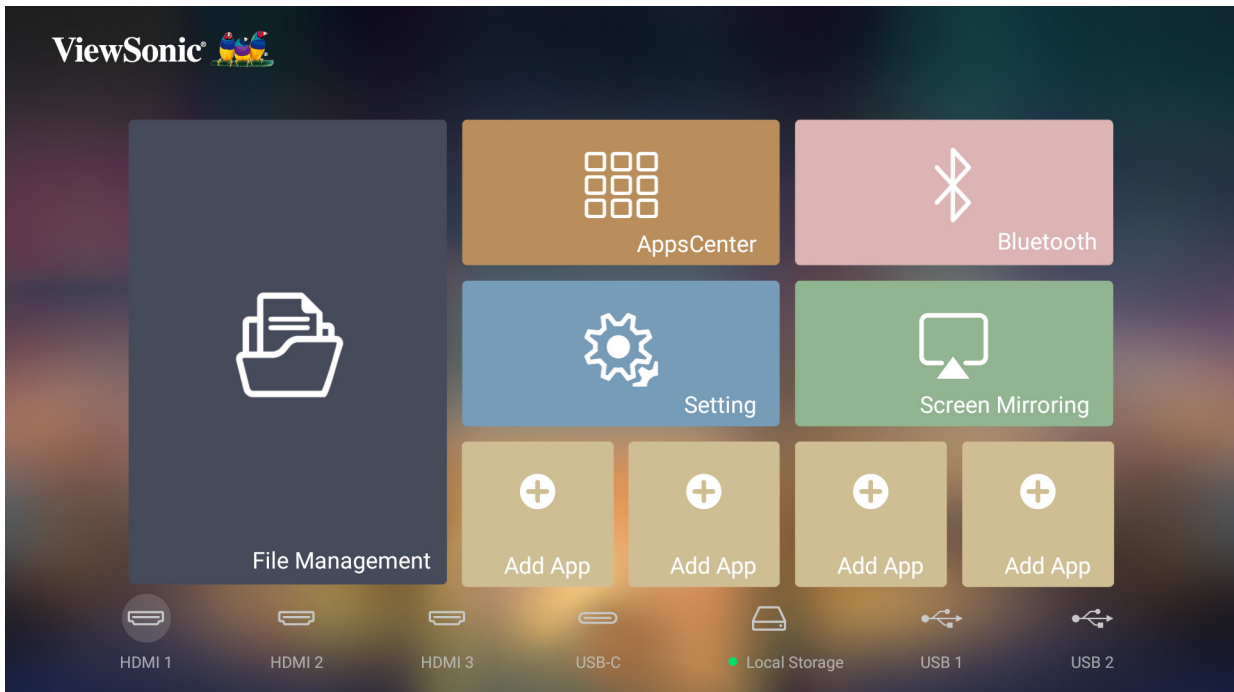

Selecting an Input Source

The projector can be connected to multiple devices at the same time. However, it can only display one full screen at a time.

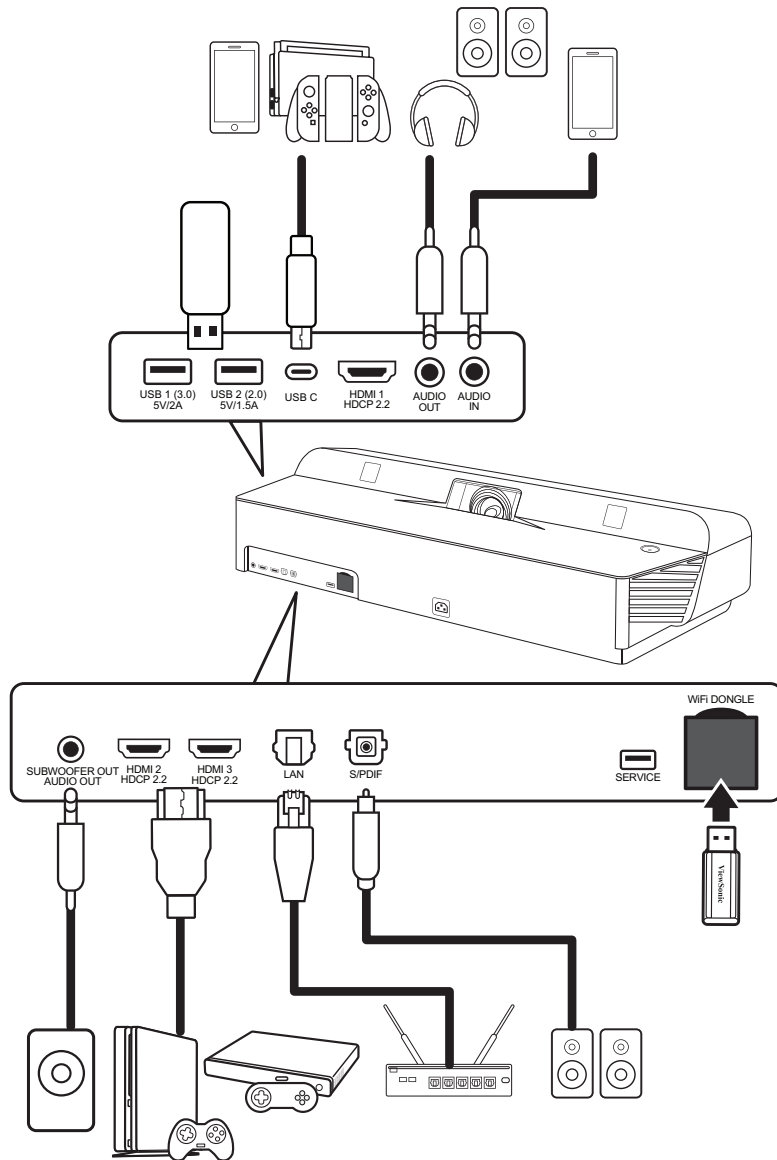

The projector will automatically search for input sources. If multiple sources are connected, press the **Source** button on the remote control to select the desired input, or press the **Down** button when at the **Home Screen** until the source list is displayed.

NOTE: Ensure the connected sources are also turned on.

Adjusting the Projected Image

Adjusting the Projector's Height and Projection Angle

The projector is equipped with two (2) adjuster feet. Adjusting the feet will change the projector's height and the vertical projection angle.

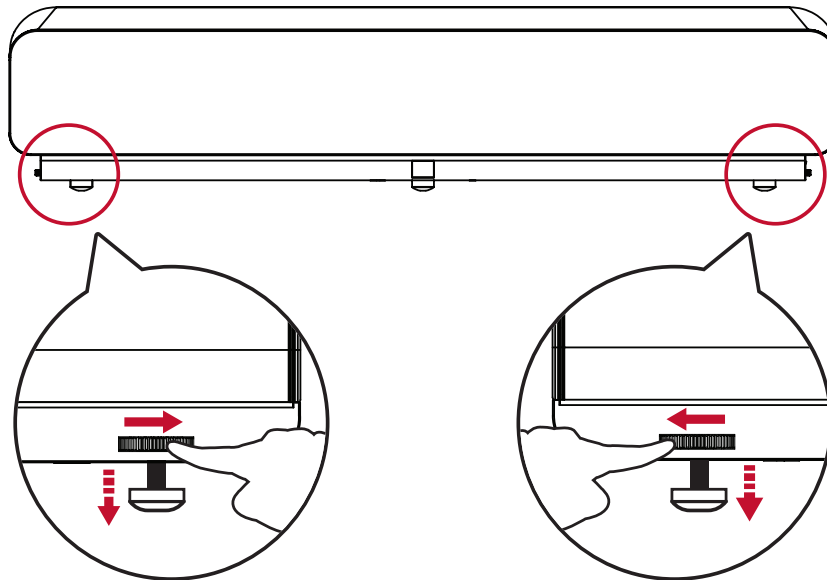

Setting Up the Desired Image Size

The included Distance Card can be used to determine the desired image size.

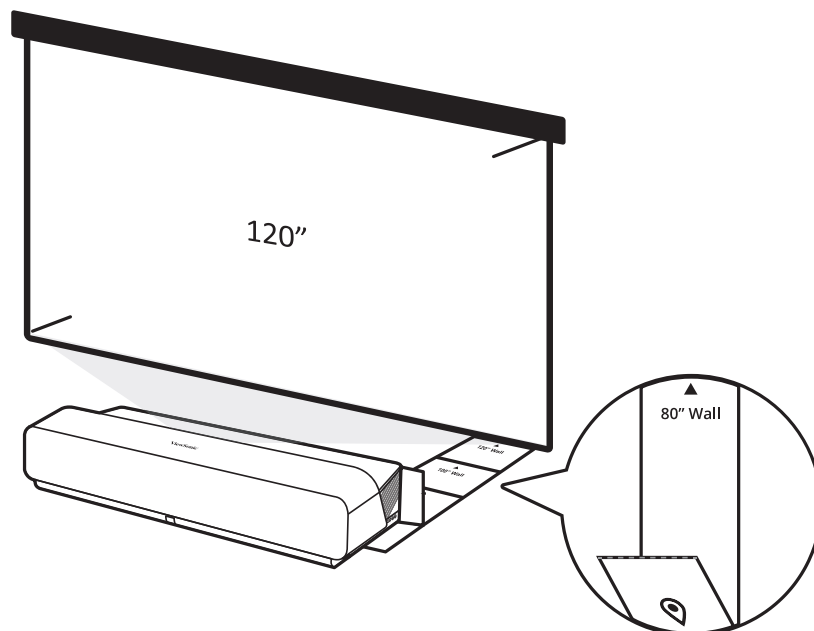

Fine-Tuning the Image Clarity

You can improve the clarity of the image by pressing the **Focus** button, then using the **Left** and **Right** buttons on the remote control.

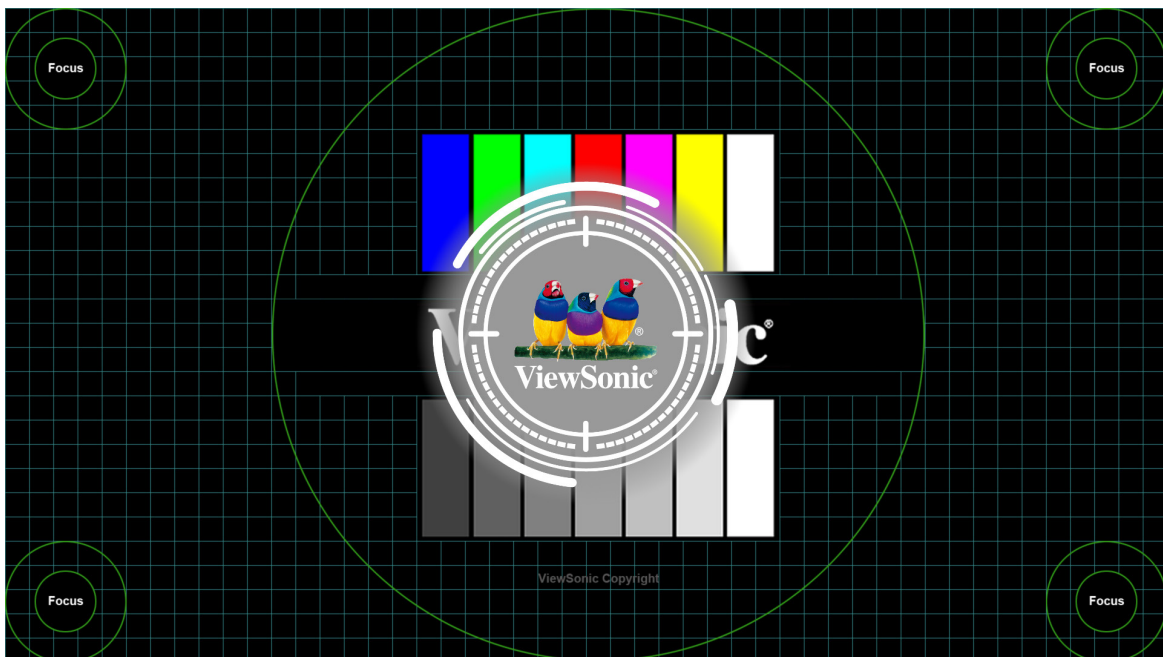
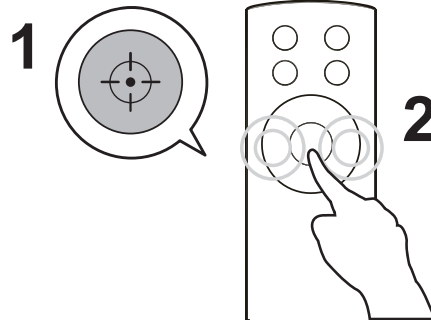
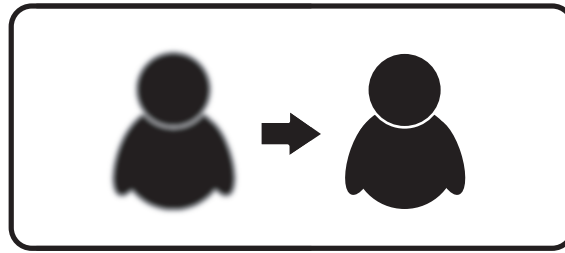

Shutting Down the Projector

1. Press the **Power** button on the projector or remote control and the following message will appear:



2. Press the **Up/Down** buttons on the remote control to select **Turn Off** and press **OK** on the remote control.
3. The Status LED will turn solid red once turned off.

NOTE: When pressing **Power** on the remote control, you can choose from four (4) options: **Turn Off**, **Restart**, **Bluetooth**, and **Turn light source Off**.

Input Source Selected - On-Screen Display (OSD) Tree

After your input source is selected, you can adjust the **Image Setting** and **Advanced** menus.

Main Menu	Sub-menu	Menu Option		
Image Setting	Color Mode	Brightest		
		TV		
		Movie		
		Gaming		
		User 1		
		User 2		
		TV-HDR		
		Movie-HDR		
	Wall Color	Off		
		Pink		
		Yellow		
		Blue		
	Brightness	(-/+ , 0~50)		
	Contrast	(-/+ , 0~100)		
	Color Temp	6500K		
		7500K		
		9300K		
		User	Red Gain	(-/+ , 0~199)
			Green Gain	(-/+ , 0~199)
			Blue Gain	(-/+ , 0~199)
			Red Offset	(-/+ , 0~199)
			Green Offset	(-/+ , 0~199)
			Blue Offset	(-/+ , 0~199)
Tint	(-/+ , -50~50)			
Saturation	(-/+ , 0~100)			
Sharpness	(-/+ , 0~50)			

Main Menu	Sub-menu	Menu Option		
Image Setting	Gamma	1.8		
		2.0		
		2.2		
		2.35		
		2.5		
		sRGB		
		Cubic		
		HDR		
	Color Management	Primary Color	Red	
			Green	
			Blue	
			Cyan	
			Magenta	
			Yellow	
		Hue	(-/+ , -50~50)	
		Saturation	(-/+ , 0~100)	
	Gain	(-/+ , 0~100)		
	Light Source Level	Full		
		Eco		
		Dynamic Black 1		
		Dynamic Black 2		
	Test Pattern	OK		
	Reset Current Color Settings	OK		

Main Menu	Sub-menu	Menu Option		
Advanced	Aspect Ratio	Auto		
		4:3		
		16:9		
		16:10		
		Native		
	HDR	Auto		
		SDR		
	EOTF	Low		
		Mid		
		High		
	Frame Interpolation	Low		
		Mid		
		High		
		Off		
	HDMI Range	Auto		
		Full		
		Limited		
	3D Settings	3D Sync		Auto
				Disable
				Frame Sequential
Frame Packing				
Top-Bottom				
Side-by-Side				
3D Sync Invert		Disable		
		Invert		

Main Menu	Sub-menu	Menu Option		
Advanced	harman/kardon	Audio Mode	Movie	
			Music	
			User	
		100Hz		
		500Hz		
		1500Hz		
		5000Hz		
		10000Hz		
		Audio Volume	(-/+ , 0~50)	
		Mute	Enable	
			Disable	
		S/PDIF	Enable	
			Disable	
	Light Source Level	Full		
		Eco		
		Dynamic 1		
		Dynamic 2		
	Information	Source		
		Resolution		
		3D Format		
HDR/HLG				

Image Setting Menu

To access the **Image Setting** menu:

1. Press **Setting** on the remote control.

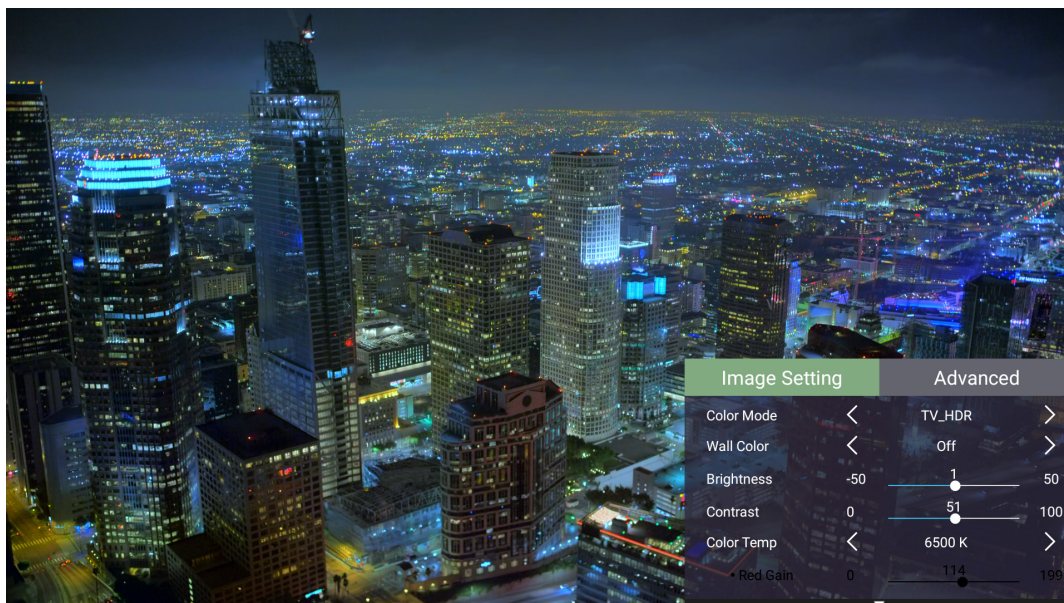



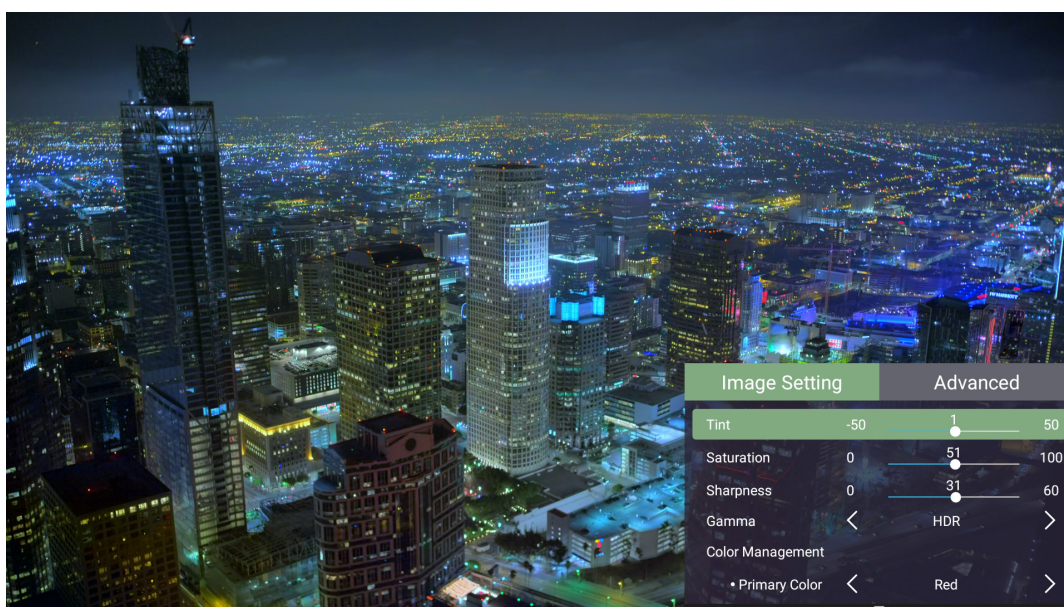

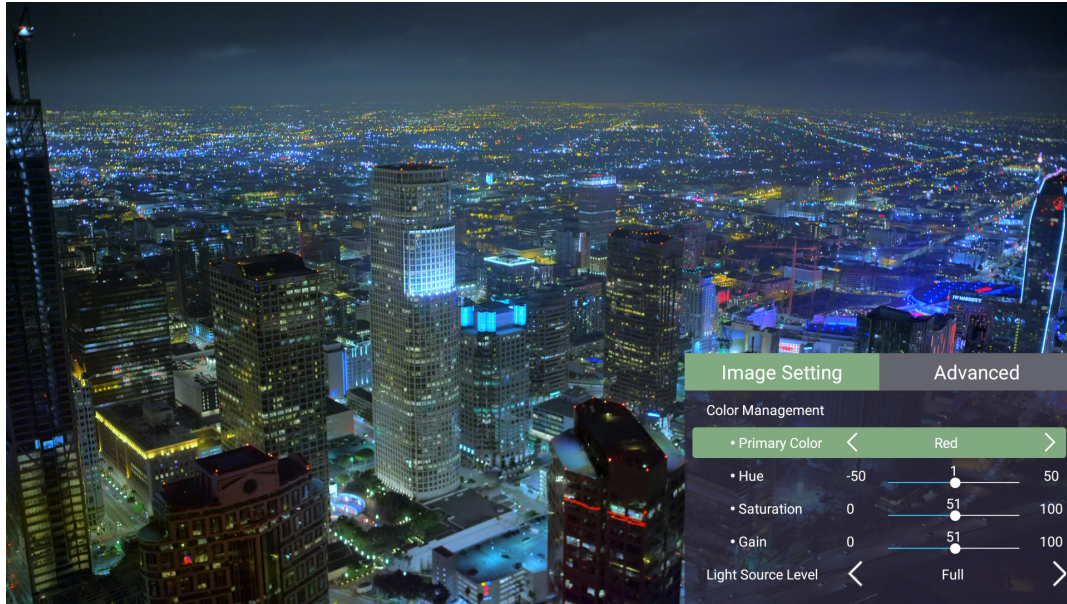

2. Use the **Up/Down** buttons to select a menu.



3. Then use the **Left/Right** buttons to enter the sub-menu(s) and/or adjust the settings.



4. Press the **Return** button to go to the previous menu or exit.

Menu Option	Description
Color Mode	<p>The projector is preset with several predefined picture modes so that you can choose one to suit your operating environment and input signal.</p> <p><u>Brightest</u> Maximizes the brightness of the projected image. This mode is suitable for environments where extra-high brightness is required, i.e. well-lit rooms.</p> <p><u>TV</u> Optimized for viewing sports in well-lit environments.</p> <p><u>Gaming</u> Designed for playing video games.</p> <p><u>Movie</u> Appropriate for colorful movies, video clips from digital cameras, or DVs through the PC input. Best for low-light environments.</p> <p><u>User 1/User 2</u> Recalls the customized user settings.</p> <p><u>TV-HDR / Movie-HDR</u> Change to HDR Picture Mode when an HDR input source is detected.</p>
Brightness	<p>The higher the value, the brighter the image. Lower values will result in a darker image.</p> <div style="display: flex; justify-content: space-around; align-items: flex-end;"> <div style="text-align: center;">  <p>-30</p> </div> <div style="text-align: center;">  <p>50</p> </div> <div style="text-align: center;">  <p>+80</p> </div> </div>
Contrast	<p>Use this to set the peak white level after you have previously adjusted the Brightness setting to suit your selected input and viewing environment.</p> <div style="display: flex; justify-content: space-around; align-items: flex-end;"> <div style="text-align: center;">  <p>-30</p> </div> <div style="text-align: center;">  <p>0</p> </div> <div style="text-align: center;">  <p>+40</p> </div> </div>

Menu Option	Description
Color Temp	Select the color temperature setting. <ul style="list-style-type: none"> • 6500K: Maintains normal white coloring. • 7500K: A higher, cooler color temperature than 6500K. • 9300K: The highest color temperature; makes the image appear the most bluish-white. • User Color: Adjust red, green, and blue values as desired.
Tint	The higher the value, the more greenish the picture becomes. The lower the value, the more reddish the picture becomes.
Saturation	Refers to the amount of that color in a video picture. Lower settings produce less saturated colors; in fact, a setting of "0" removes that color from the image entirely. If the saturation is too high, that color will be overpowering and unrealistic.
Sharpness	A high value results in a sharper picture; a low value softens the picture.
Gamma	Reflects the relationship between input source and picture brightness.

Menu Option	Description
Color Management	<p>Only in permanent installations with controlled lighting levels such as: boardrooms, lecture halls, or home theaters should Color Management be considered.</p> <div data-bbox="676 331 1246 869" data-label="Diagram"> </div> <p>Color Management provides fine color control adjustment to allow for more accurate color reproduction, should you require it.</p> <p>If you have purchased a test disc, which contains various color test patterns and can be used to test the color presentation on monitors, TVs, projectors, etc., you can project any image from the disc on the screen and enter the Color Management menu to make adjustments.</p>
Light Source Level	Select the suitable power consumption of the LED.
Test Pattern	Test the color presentation of the projector.
Reset Current Color Settings	Return current color settings to their default values.

Advanced Setting Menu

To access the **Advanced** menu:

1. Press **Setting** on the remote control.

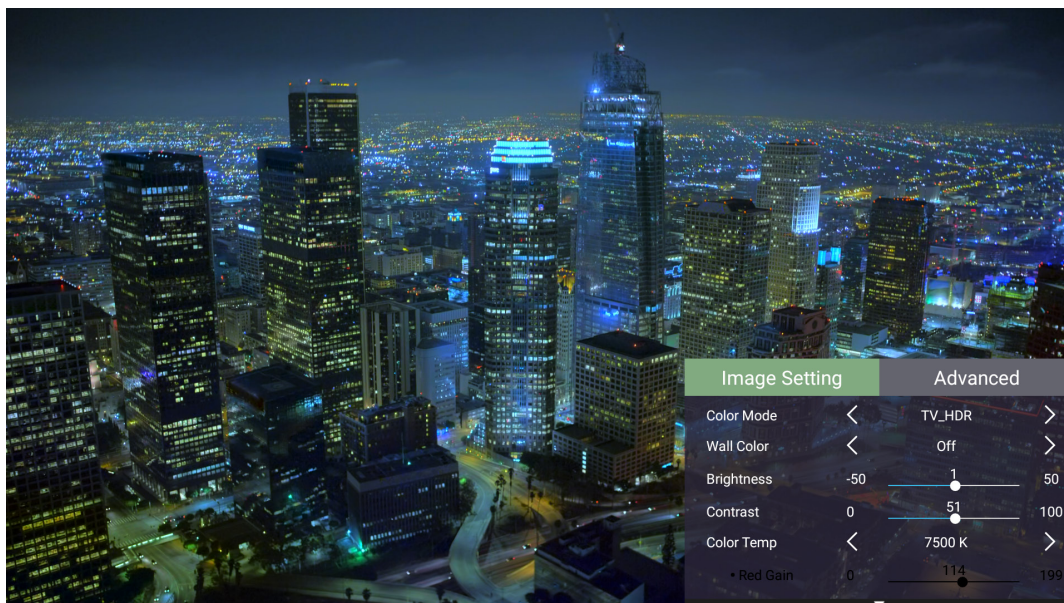

2. Press the **Right** button to access the **Advanced** menu.

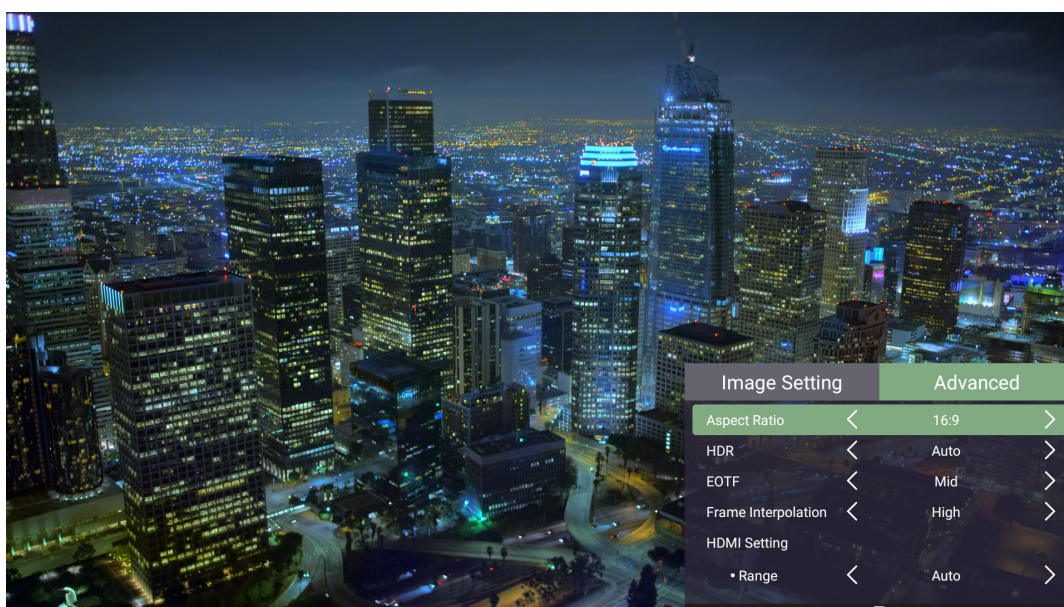

3. Use the **Up/Down** buttons to select a menu.

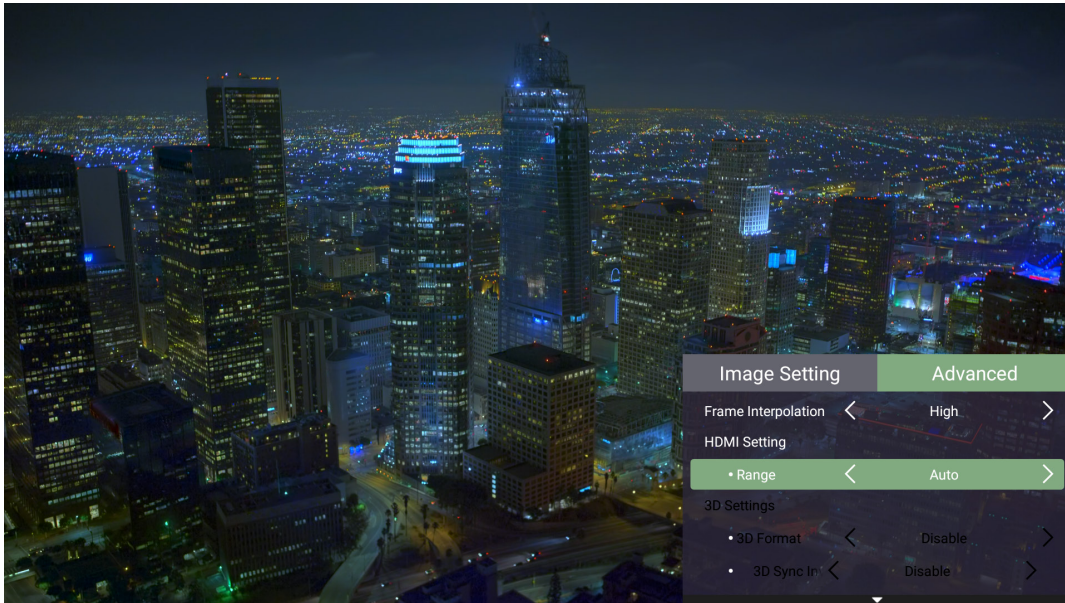

4. Then use the **Left/Right** buttons to enter the sub-menu(s) and/or adjust the settings.

5. Press the **Return** button to go to the previous menu or exit.

Menu Option	Description
Aspect Ratio	<p>The Aspect Ratio is the ratio of the image width to the image height. With the advent of digital signal processing, digital display devices, like this projector, can dynamically stretch and scale the image output to a different aspect than that of the image input signal.</p> <p>NOTE: Only supports HDMI/USB-C (video) signal input.</p> <p><u>Auto</u> Scales an image proportionally to fit the projector's native resolution in its horizontal width. This is suitable for the incoming image which is neither 4:3 nor 16:9 and you want to make the most use of the screen without altering the image's aspect ratio.</p> <p><u>4:3</u> Scales an image so that it is displayed in the center of the screen with a 4:3 aspect ratio. This is most suitable for 4:3 images like computer monitors, standard definition TV, and 4:3 aspect DVD movies, as it displays them without aspect alteration.</p> <p><u>16:9</u> Scales an image so that it is displayed in the center of the screen with a 16:9 aspect ratio. This is most suitable for images which are already in a 16:9 aspect, like high definition TV.</p> <p><u>16:10</u> Scales an image so that it is displayed in the center of the screen with a 16:10 aspect ratio. This is most suitable for images which are already in a 16:10 aspect.</p>

Menu Option	Description
Aspect Ratio	<p><u>Native</u></p> <p>Projects the image as its original resolution and resizes it to fit within the display area. For input signals with lower resolutions, the projected image will be displayed in its original size.</p>
HDR	<p>The projector supports HDR imaging. It can automatically detect the dynamic range of the source from the HDMI 1/2/3 ports, and optimize settings to reproduce contents under a wide range of light conditions.</p>
EOTF	<p>Automatically adjusts the brightness levels of your image according to the input source. You can also manually select a brightness level to display better picture quality.</p> <p>NOTE: This function is not available when SDR is selected in the HDR menu.</p>
Frame Interpolation	<p>Smooths the picture quality of high speed moving objects. This is especially for users who enjoy fast paced sporting events.</p>
HDMI Settings	<p><u>Range</u></p> <p>Select a suitable color range according to the color range setting of the connected output device.</p> <ul style="list-style-type: none"> • Full: Sets the color range from 0~255. • Limited: Sets the color range from 15~235 • Auto: Sets the projector to detect the range of the input signal automatically.
3D Settings	<p>Enables you to enjoy 3D movies, videos, and sporting events in a more realistic way by presenting the depth of the images while wearing 3D glasses. For Blu Ray 3D.</p> <p><u>3D Sync</u></p> <p>Adjust and choose from: Auto, Disable, Frame Sequential, Frame Packing, Top-Bottom, Side-by-Side.</p> <p><u>3D Sync Invert</u></p> <p>Allows for correction if the 3D image depth is inversed.</p>
harman/kardon	<p>Adjust the audio settings.</p>
Information	<p>Shows Input Source, Resolution, 3D format, and HDR.</p>

> Operating the Projector

This section will introduce the **Home Screen** and its menus.

Home Screen

The **Home Screen** is displayed every time you start the projector. To navigate the **Home Screen**, simply use the directional buttons on the remote control. You can return to the main **Home Screen** at any time by pressing the **Home** button on the remote control, regardless of what page you are on.

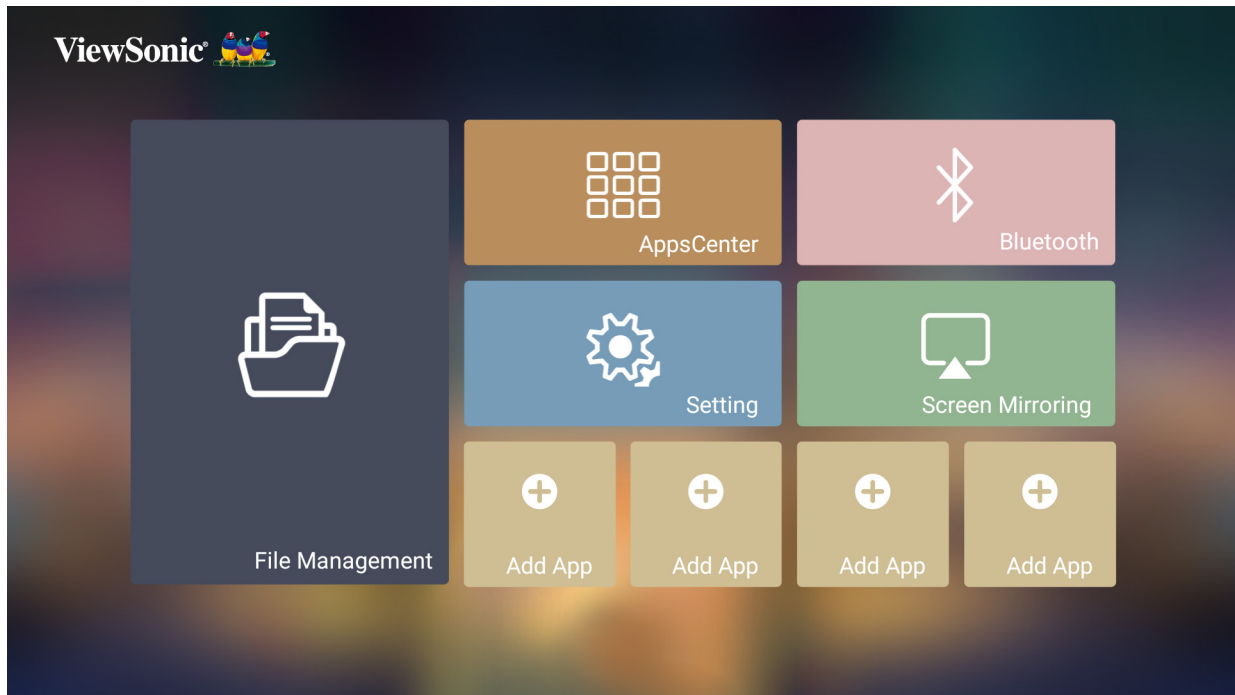

Menu	Description
File Management	Provides a user interface to manage files and folders.
Apps Center	Access and view all the applications you have installed.
Bluetooth	Select the appropriate Bluetooth mode.
Setting	Manage various categories such as: Network settings, Basic and Advanced settings, Date & Time, Firmware update, and System Information.
Screen Mirroring	Mirror your personal device's screen through the projector.
Add App	Select your favorite Apps and add them to the Home Screen .

Home Screen - On-Screen Display (OSD) Menu Tree

Main Menu	Sub-menu	Menu Option		
File Management				
Apps Center				
Bluetooth				
Settings	Network Settings	Wi-Fi	Disable	
			Enable	SSID:
				Configure IP
				IP Address
				Subnet Mask
				Default Gateway
				DNS Server
		Others		
		Wired LAN	Configure IP	Automatic
				Manual
			IP Address	xxx.xxx.xxx.xxx
			Subnet Mask	xxx.xxx.xxx.xxx
			Default Gateway	xxx.xxx.xxx.xxx
	DNS Server	xxx.xxx.xxx.xxx		

Main Menu	Sub-menu	Menu Option		
Settings	Basic Settings	Language	English	
			French	
			German	
			Italian	
			Spanish	
			Russian	
			繁體中文	
			簡體中文	
			日本語	
			韓語	
			Swedish	
			Dutch	
			Turkish	
			Czech	
			Portuguese	
			Thai	
			Polish	
			Finnish	
			Arabic	
			Indonesian	
		Hindi		
		Vietnam		
		Greek		
		Projector Projection	Front Table	
			Front Ceiling	
			Rear Table	
			Rear Ceiling	
		Keystone	Manual	
Focus	OK			
Eye Protection	Disable			
	Enable			
Test Pattern	OK			

Main Menu	Sub-menu	Menu Option		
Settings	Date & Time	Automatic Date & Time	Disable	
			Enable	
		Date		
		Time		
		Time Zone		
	Time Format	12 hours		
		24 hours		
	Firmware Upgrade	Software Update Online		
		Software Update by USB		
		OTA Reminder	Disable	
			Enable	
	Software Version			
	Advanced Settings	Power On Source	Home	
			HDMI 1	
			HDMI 2	
			HDMI 3	
			USB-C	
Auto Power On		CEC	Disable	
	Enable			

Main Menu	Sub-menu	Menu Option		
Settings	Advanced Settings	Smart Energy	Auto Power Off	Disable
				10 minutes
				20 minutes
				30 minutes
			Sleep Timer	Disable
				30 minutes
				1 hour
				2 hours
		3 hours		
		4 hours		
		8 hours		
		Power Saving	Enable	
			Disable	
		harman/kardon	Audio Mode	Movie
				Music
				User
	100Hz			
	500Hz			
	1500Hz			
	5000Hz			
	10000Hz			
	Volume		(-/+ , 0~50)	
	Mute		Disable	
			Enable	
	Internal Speaker		Disable	
			Enable	
	S/PDIF		Disable	
		Enable		
	Light Source Level	Full		
		Eco		
		Dynamic Black 1		
		Dynamic Black 2		

Main Menu	Sub-menu	Menu Option	
Settings	Advanced Settings	High Altitude Mode	Disable
			Enable
		Reset Settings	OK
			Cancel
		Reset To Factory Default	OK
			Cancel
	Information	Light Source Hours	
		System Version	
		Memory Information	
		Network Mac Address	
		Wi-Fi Mac Address	
Serial Number			
Screen Mirroring			
Add App			
Add App			
Add App			
Add App			

Menu Operations

File Management

Easily manage files and folders.

1. Select: **Home > File Management.**

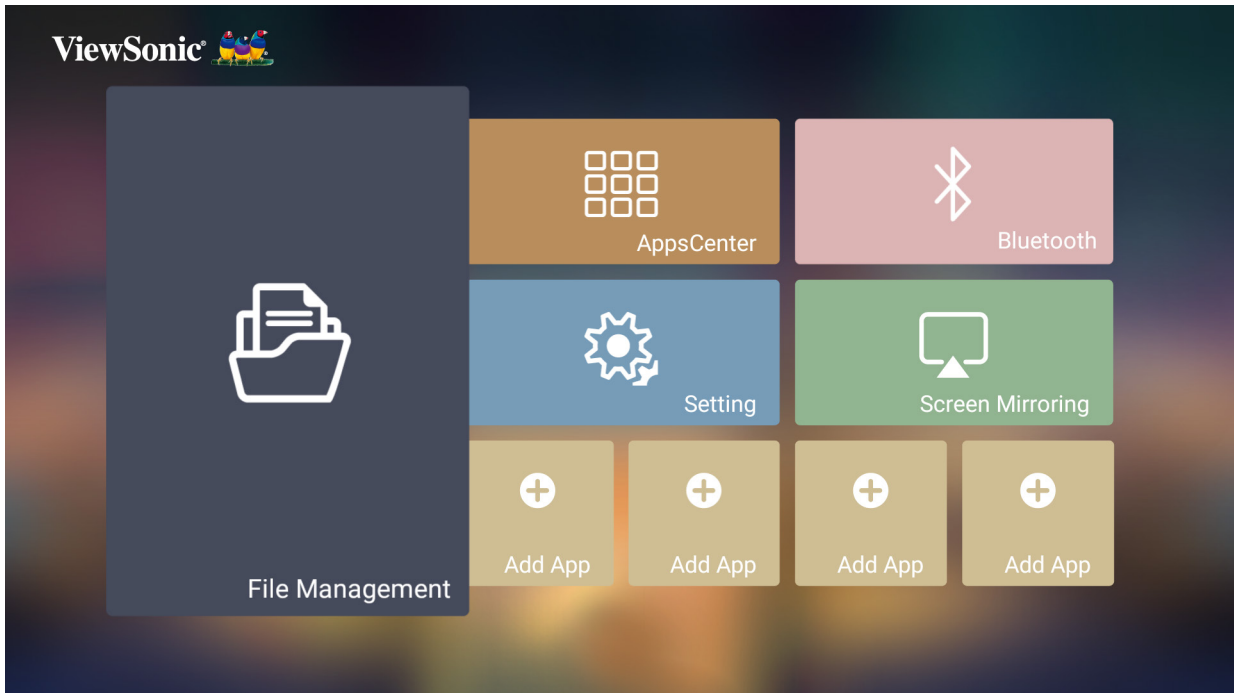

2. Select a device on the source list: USB, Local Storage, etc. Use the direction buttons to select the desired file. Then press **OK** on the remote control to open the selected file.

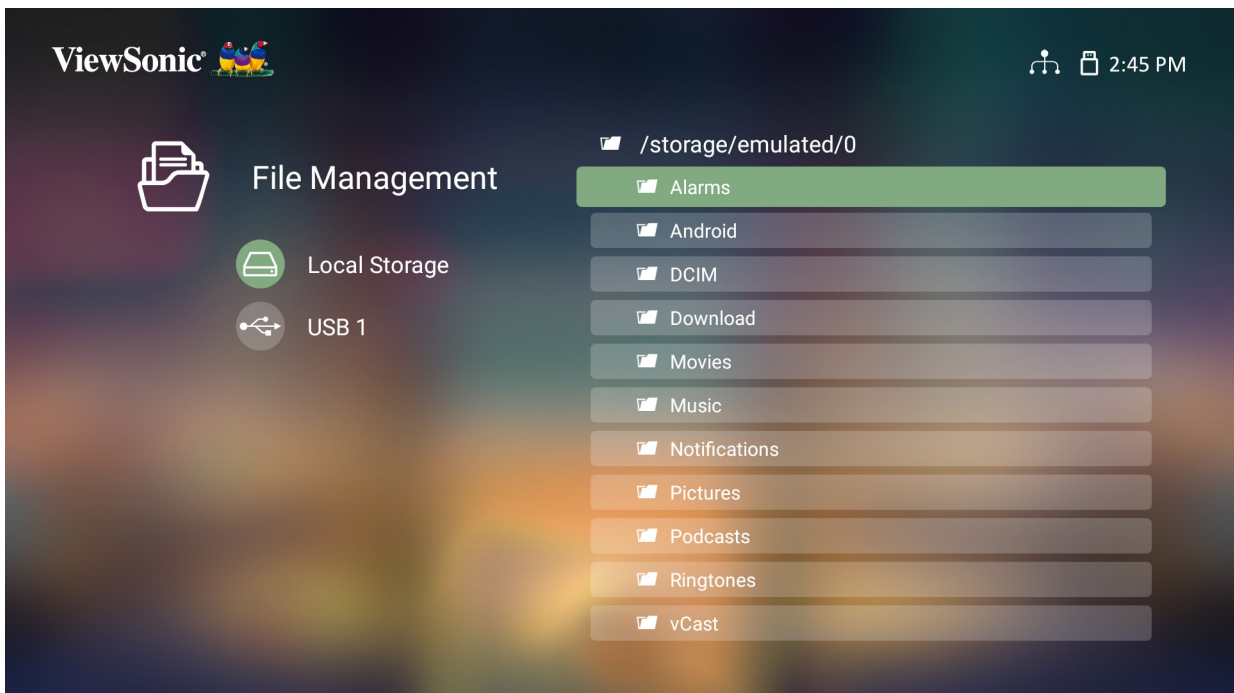

3. Press the **Return** button to go to a previous a level.

NOTE: Press the **Home** button on the remote control to return to the **Home Screen** at anytime.

How to Edit a File

1. While in **File Management**, press and hold the **OK** button for three (3) seconds.
2. A check box will appear at the front of each file. Use the direction buttons and press **OK** to select one or more files.

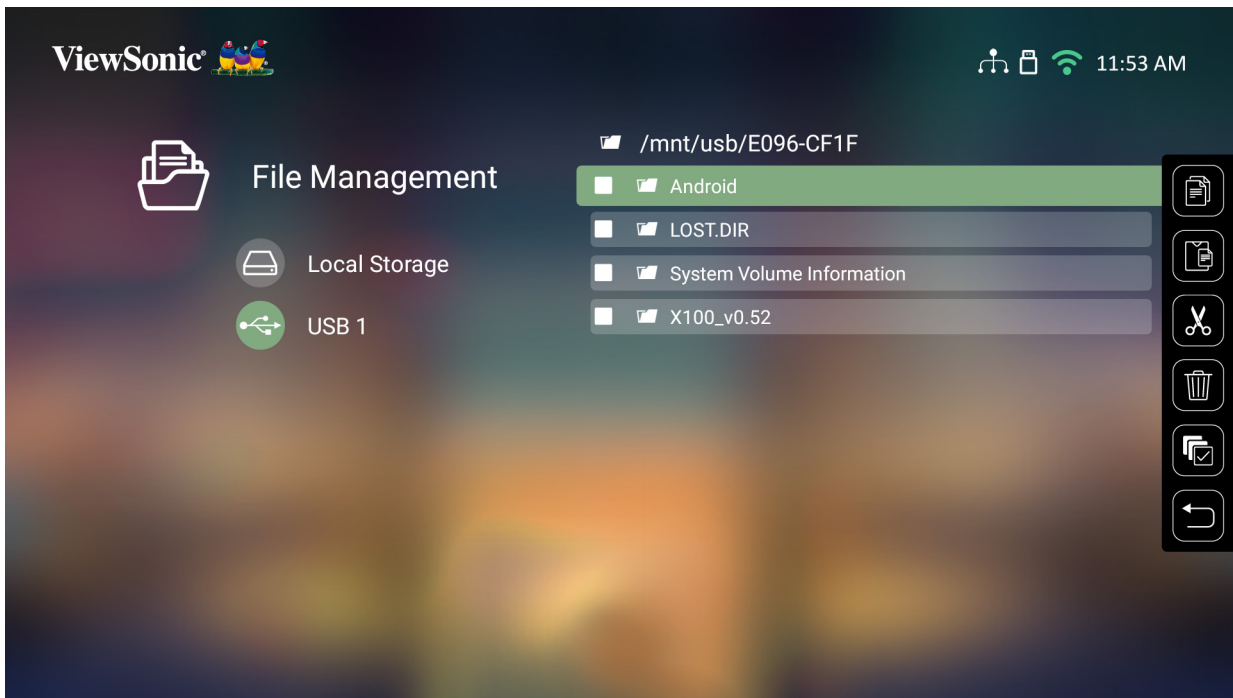



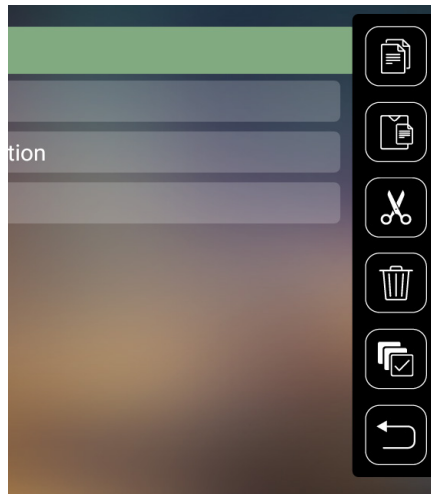



















3. By pressing the **Right** button, Copy, Paste, Cut, Delete, Select All, and Return boxes will be displayed.



4. Select your desired action and press **OK** to execute.
5. If you are Copying or Cutting, select your destination folder to complete the process.

How to Use Control Bar Buttons

The Control Bar buttons will appear on screen if a video, music, or photo file are selected to be opened.

Picture		Video		Music	
	Back		Back		Back
	Play		Rewind		Play
	Next		Play		Pause
	Zoom in		Pause		Next
	Zoom out		Fast Forward		Shuffle
	Rotate (left)		Next		Repeat All
	Rotate (right)				Repeat One
					Play List
					Information

Tips for Using USB

When using USB for reading and/or storage please keep in mind the following:

1. Some USB storage devices may not be compatible.
2. If you use an USB extension cable, the USB device may not recognize the USB.
3. Only use USB storage devices formatted with Windows FAT32 or NTFS file system.
4. Larger files will need extra time to load.
5. Data on USB storage devices may be damaged or lost. Back up important files.

Supported File Formats

Supported Office formats:

	Item	Indicators
Document viewing function	doc/docx	Able to open and read documents in doc/docx
	xls/xlsx	Able to open and read documents in xls/xlsx
	ppt/pptx	Able to open and read documents in ppt/pptx
	Pdf	Able to open and read documents in pdf
Supporting Interface Language	Supporting Interface 44 languages	English, Simplified Chinese, Chinese (TW), Chinese (HK), Spanish (LA), French (EU), PT (EU), PT (BR), German, Russian, Italian, Swedish, Spanish (EU), Korean, Arabic, Farsi, Serbian, Bosnian, Macedonian, Bulgarian, Ukrainian, Greek, Norwegian, Danish, Czech, Hungarian, Slovak, Polish, Romanian, Finnish, Estonian, Latvian, Lithuanian, British English, Slovenian, Croatian, Turkish, Vietnamese, Bahasa Indonesia, Dutch, Malay, Thai, Hindi, Hebrew, Burmese, Catalan.

Supported Multimedia formats:

Extension	Codec	
.xvid	Video	Xvid, H.264, H.265
.avi	Audio	MP3
.mp4 .m4v .mov	Video	H.264, H.265/MPEG 4
.mkv	Video	H.264, H.265
.ts .trp .tp .mts .m2ts	Video	H.264, H.265, MPEG2
.vob	Audio	MP3
	Video	MPEG1, MPEG2
.mpg	Audio	DVD-LPCM
	Video	MPEG1

NOTE: The AAC audio format is not supported.

Supported Photo formats:

Format	Type	Maximum Resolution
.jpg/.jpeg	Progressive JPEG	7680 x 4320
	Baseline JPEG	7680 x 4320
.bmp		9600 x 6400
.png		7680 x 4320

Supported External Connected Device formats:

Device	Support Size (Max. Size)	NTFS Format		FAT32 Format		exFAT	
		Read	Write	Read	Write	Read	Write
USB Memory Stick	256 GB	V	N/A	V	V	N/A	N/A
USB HDD	2 TB	V	N/A	V	V	N/A	N/A

NOTE:

- Windows 10 built-in format tool only supports FAT32 format up to 32 GB.
- Firmware upgrade only supports FAT32 format.

Apps Center

View, launch, and uninstall Apps.

1. To view your Apps, select: **Home > Apps Center**.

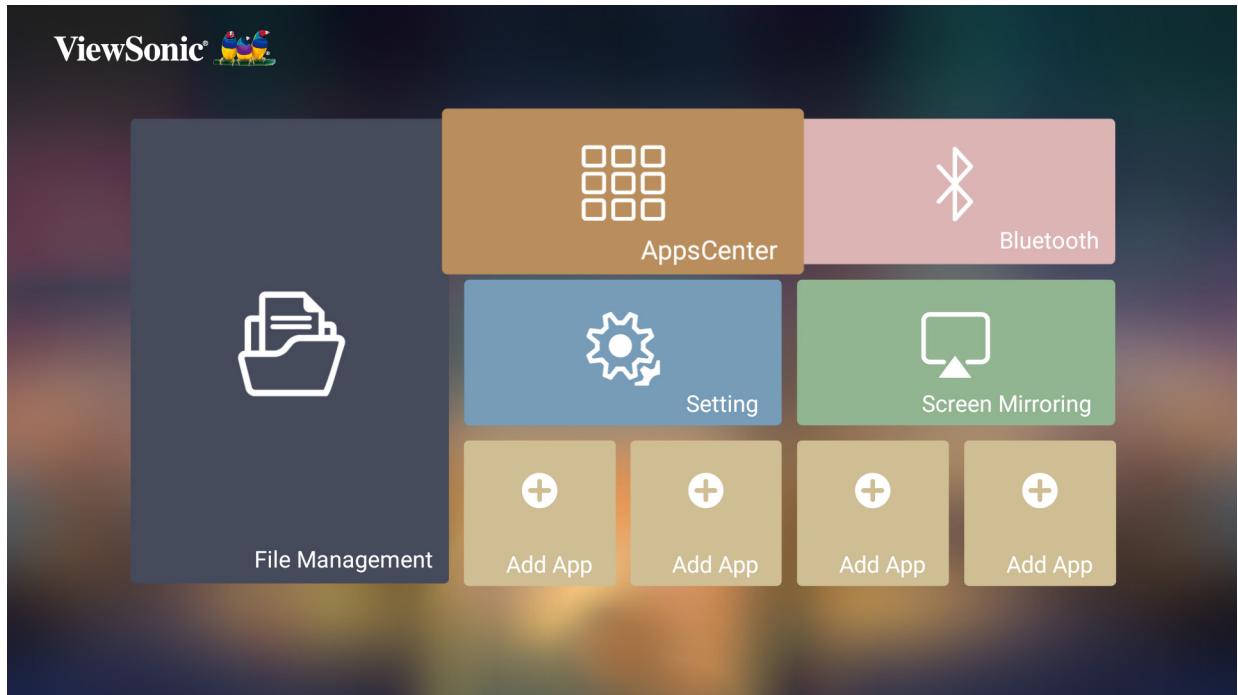

2. Use the direction buttons to select the desired App. Then press **OK** on the remote control to launch the App.

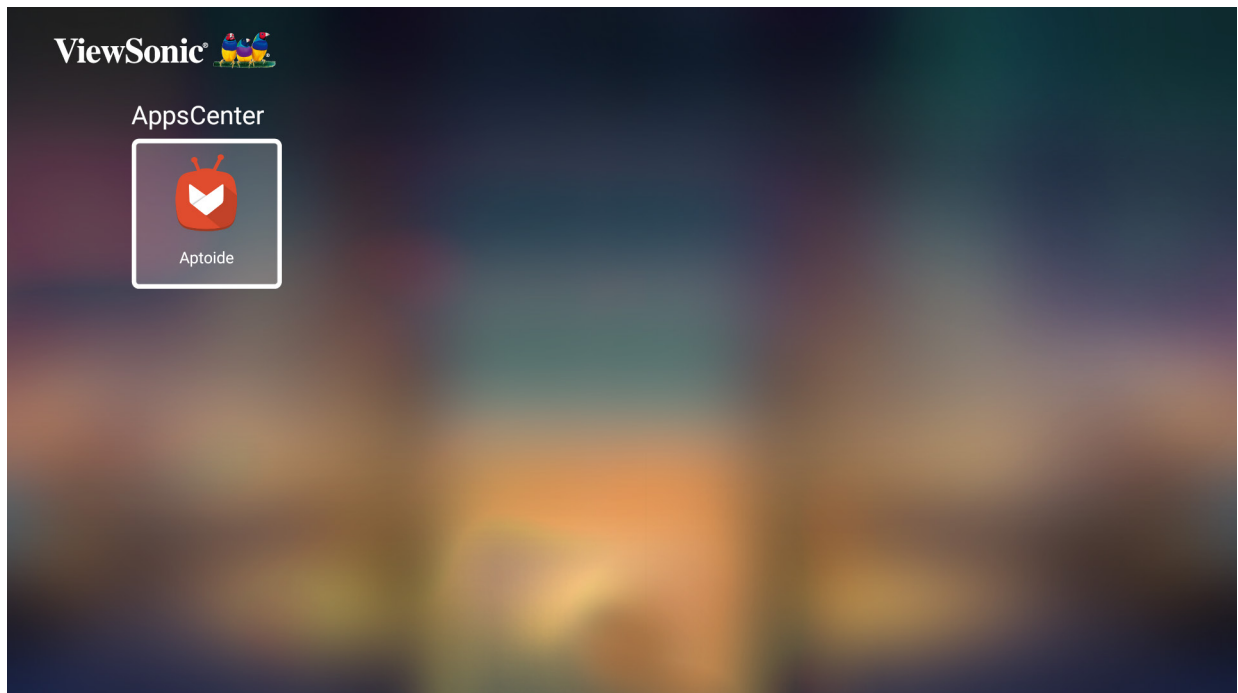

NOTE: Press the **Home** button on the remote control to return to the **Home Screen** at anytime.

To Uninstall Apps

1. Open the **Apps Center** by selecting: **Home > Apps Center**.
2. Use the directional buttons to select the desired App.
3. Press and hold **OK** on the remote control for three (3) seconds. The below dialogue box will appear:

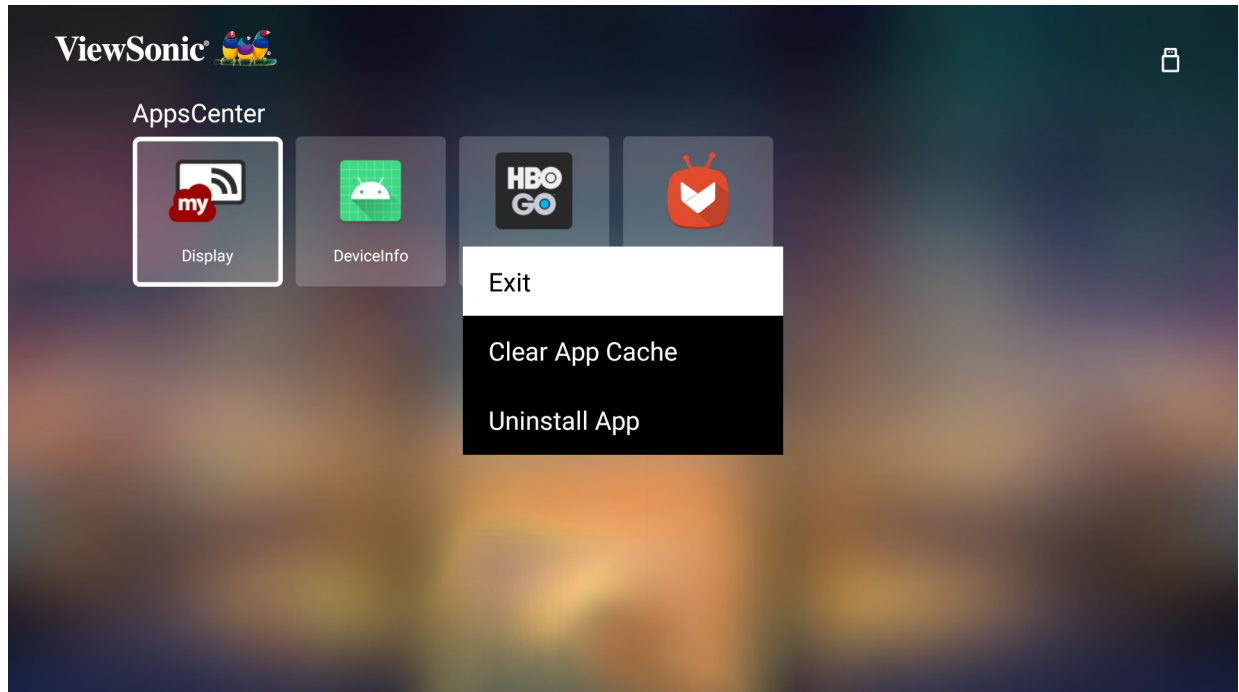

4. Select **OK** to uninstall the App.

NOTE: Press the **Home** button on the remote control to return to the **Home Screen** at anytime.

Bluetooth

The projector is equipped with Bluetooth that allows the user to connect their device wirelessly for audio playback. For more information, see page 29.

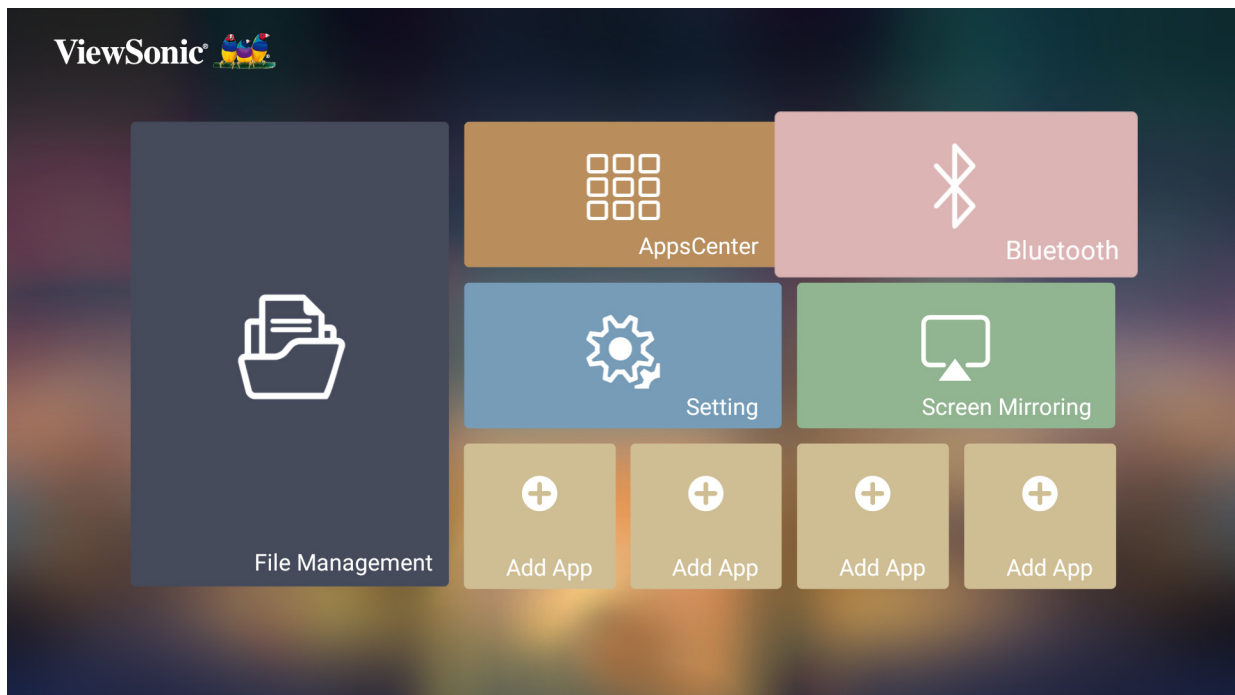

Setting

Under **Setting** you can adjust Network, Basic, and Advanced Settings, Date & Time, Firmware Update, and view Information.

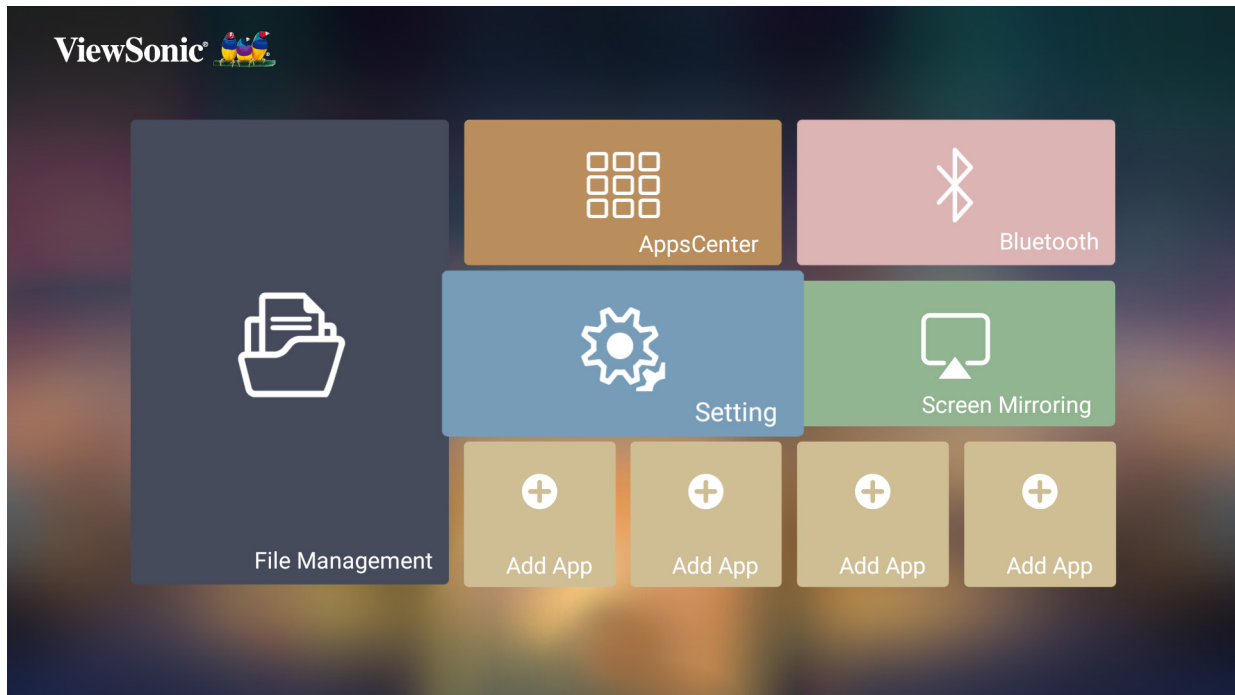

Network Settings

1. Select: **Home > Setting > Network Settings.**

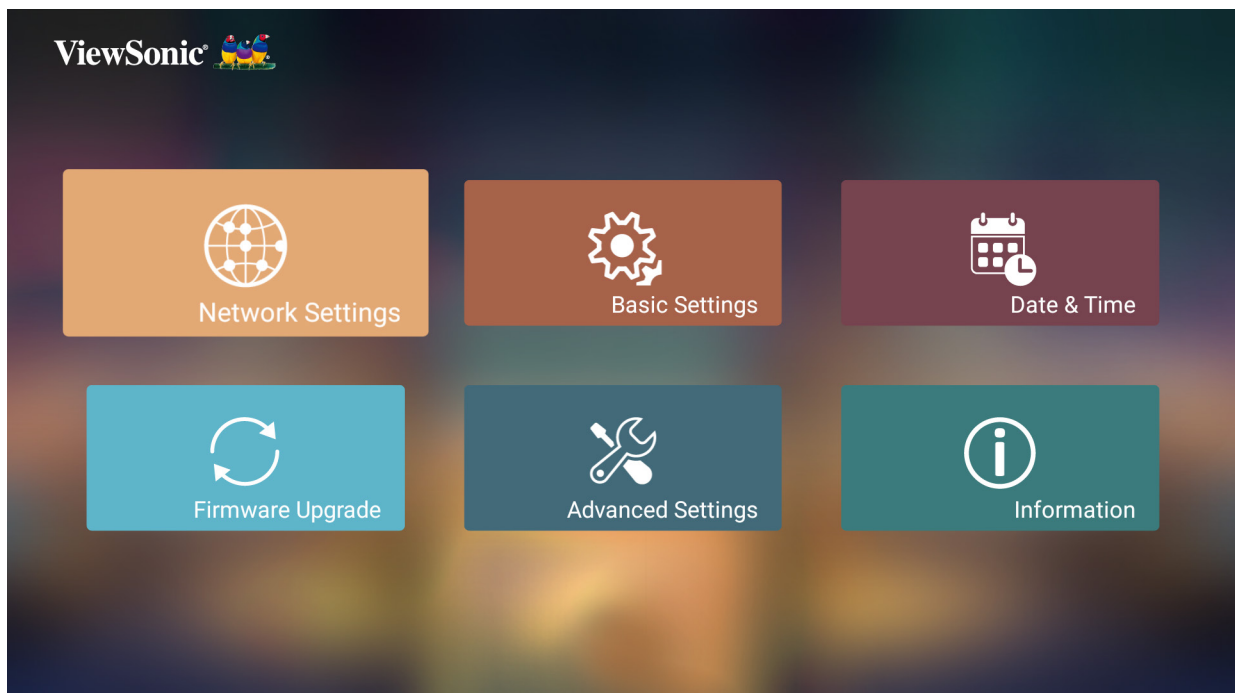

2. Choose from one of the available options: Wi-Fi or Wired LAN.



3. To setup a Wireless or Wired LAN Connection, see “Connecting to Networks” on page 24.

Basic Settings

1. Select: **Home** > **Setting** > **Basic Settings**.

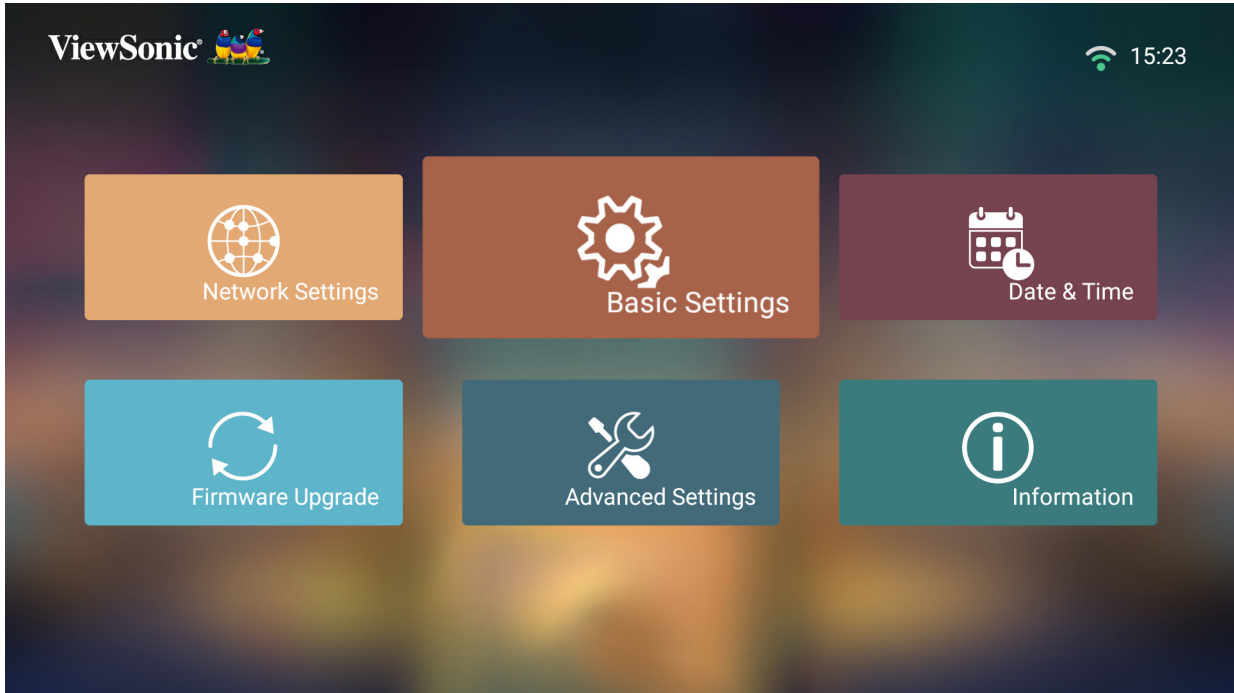

2. Use the **Up** and **Down** buttons to select the desired option and press **OK**. Then use the **Left** and **Right** buttons to make adjustments or selections.

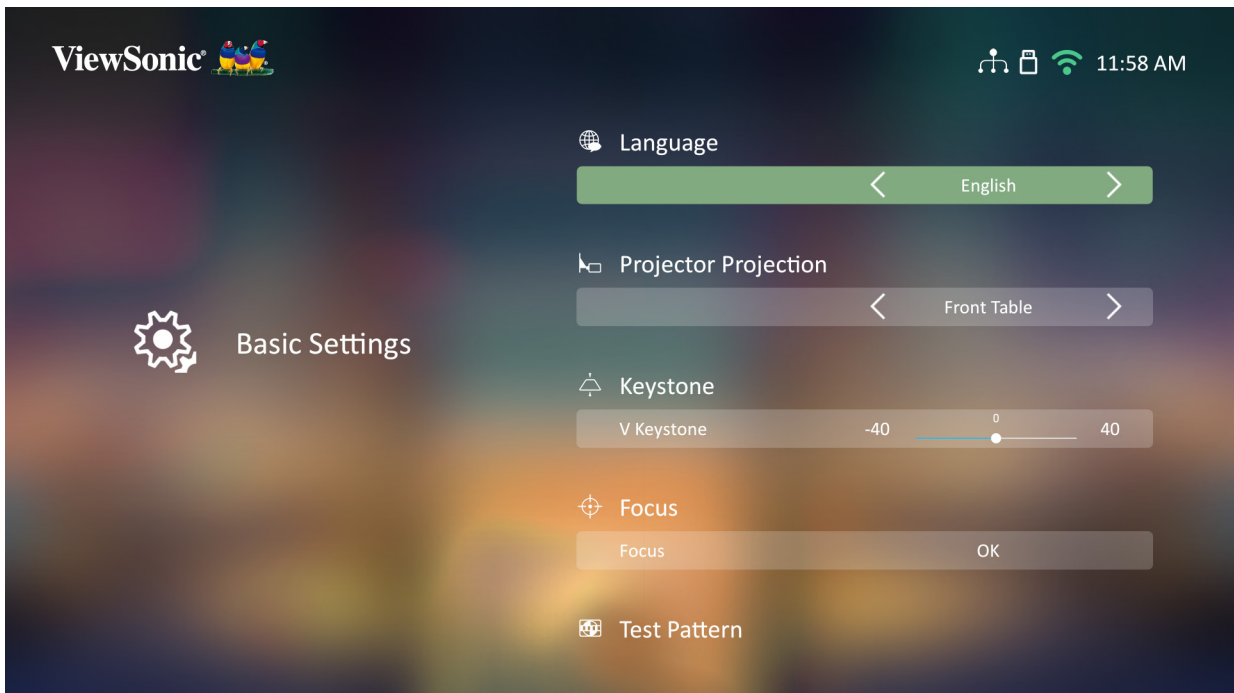

3. To return to a previous menu press the **Return** button.

Menu	Description
Language	Select your desired language.
Projector Position	Select the preferred projection position.
Keystone	Adjust trapezoidal screen image distortion. Keystone can be adjusted manually from -14 to 14.
Focus	Adjust the focus of the screen image. Use the Directional buttons on the remote control to adjust the focus.
Eye Protection	To protect eyes from the direct light of the projector, when an object gets close to the lens, a sensor will detect it and automatically turn off the light. NOTE: When the Eye Protection feature is activated, press any button on the remote control to cancel it.
Test Pattern	Test the color presentation of the projector and/or adjust the focus of the projected image.

Date & Time

Adjust Date, Time, Time Zone, and Time Format.

NOTE: The time is displayed in the top-right corner after connecting to the Internet.

1. Select: **Home > Setting > Date & Time.**

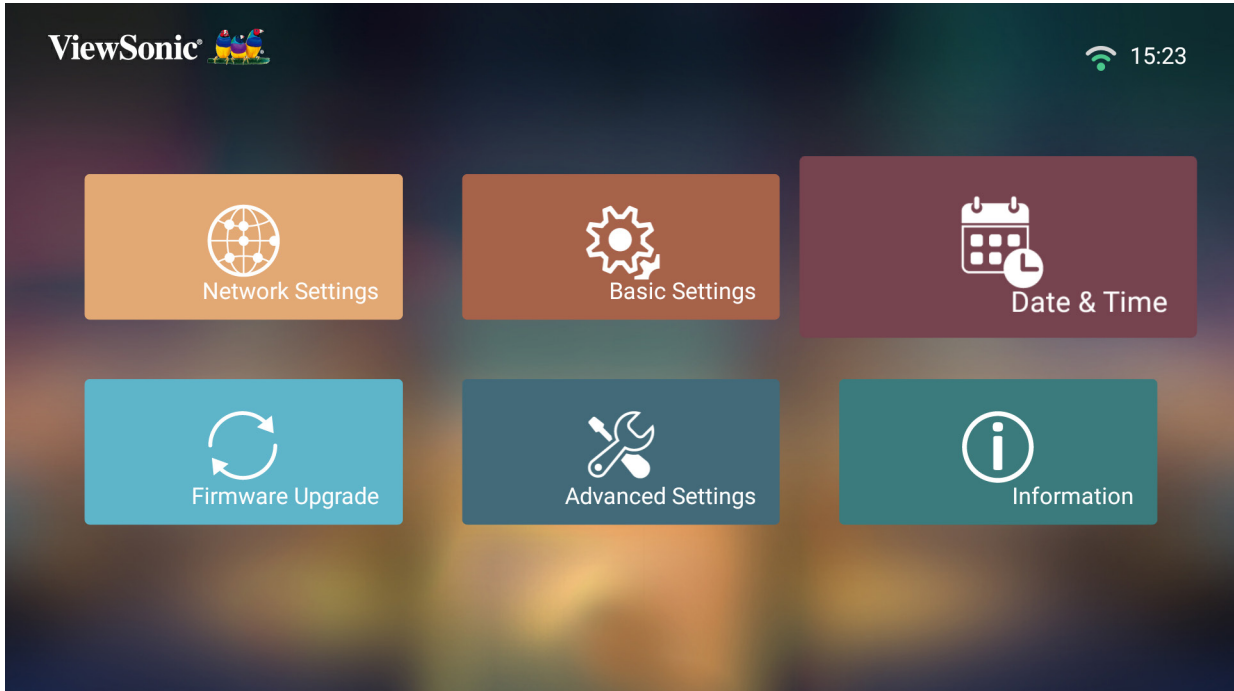

2. Use the **Up** and **Down** buttons to select the desired option and press **OK**. Then use the **Left** and **Right** buttons to make adjustments or selections.

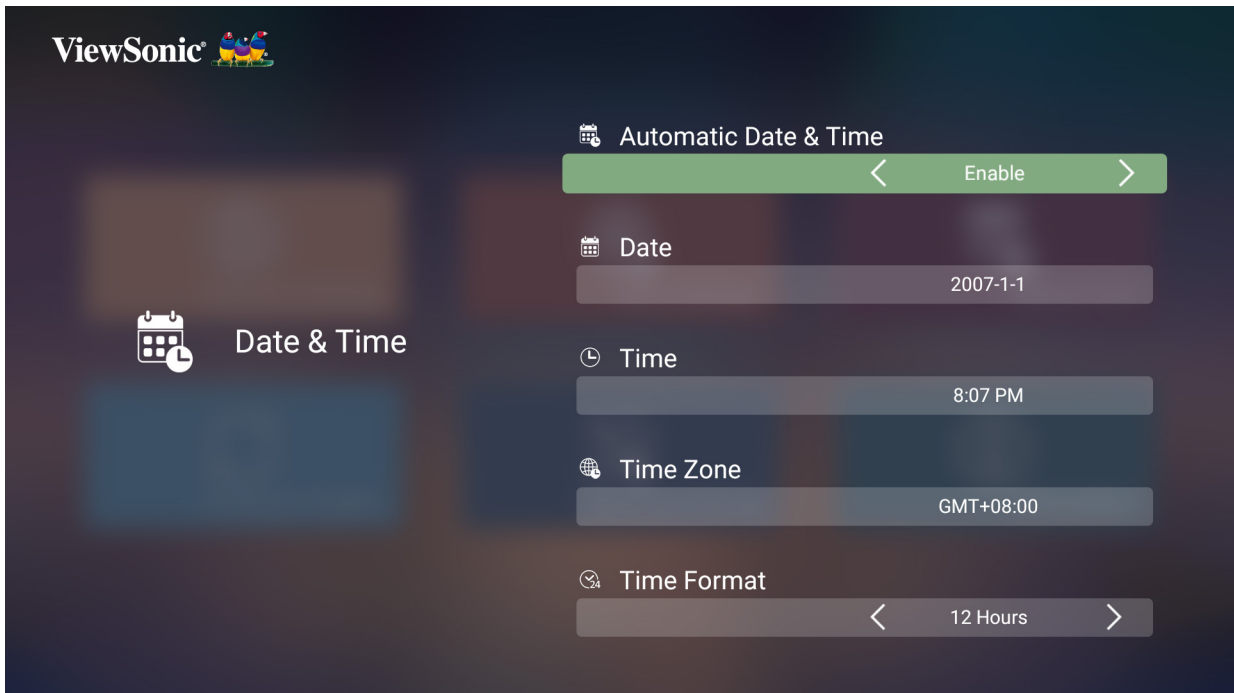

Menu	Description
Automatic Date & Time	<p>Users can synchronize the date and time automatically after connecting to the Internet.</p> <p><u>Enable</u> Turn on synchronization.</p> <p><u>Disable</u> Turn off synchronization.</p>
Time Zone	Select your desired location.
Time Format	<p>Select a different display time format.</p> <p><u>12 Hours</u> 12-hour clock.</p> <p><u>24 Hours</u> 24-hour clock.</p>

Firmware Upgrade

Users can update the firmware by internet or USB, and check the version number.

NOTE: Do not unplug the power cord, USB, or disconnect from the Internet during the upgrading process.

1. Before entering the **Firmware Upgrade** menu, ensure the projector is connected to the Internet.
2. To enter the menu, select: **Home > Setting > Firmware Upgrade**.

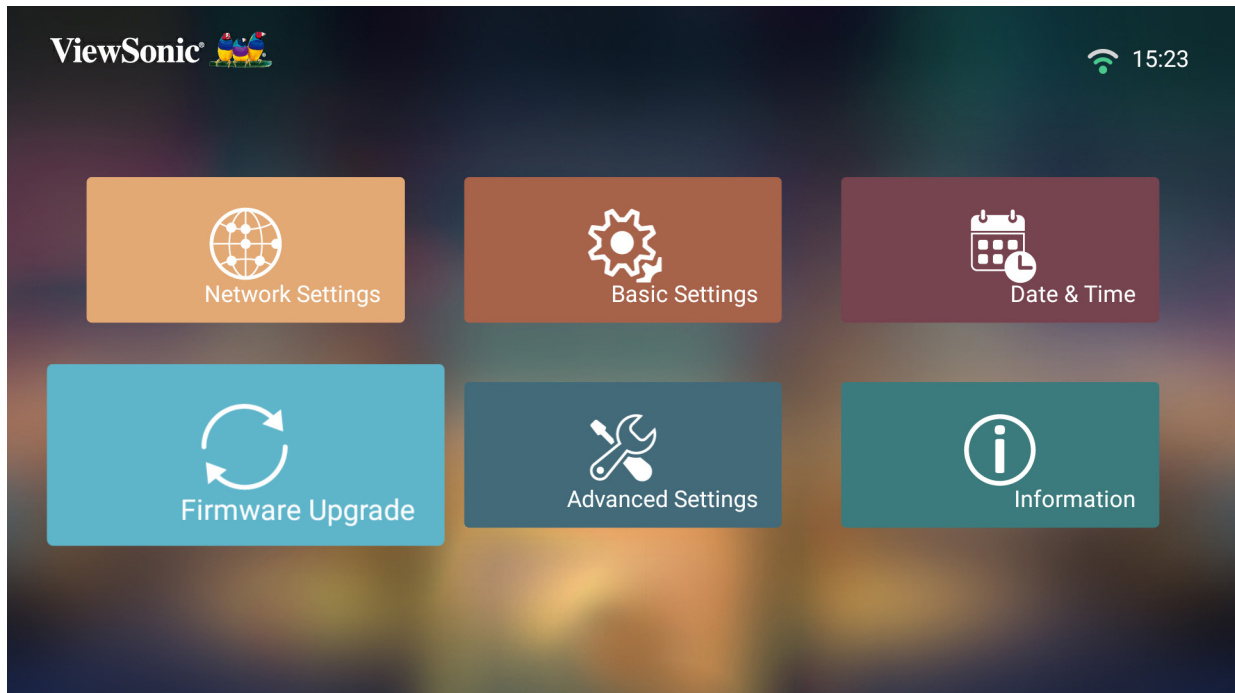

Firmware Update Online

1. Go to: **Home > Setting > Firmware Upgrade > Software Update Online**.



2. Select **Enter** by pressing **OK** on the remote control.
3. The system will check the ViewSonic website (OTA) and display the below dialog message if there is new Firmware.



4. After selecting **Yes**, a progress bar will appear as the update process begins.

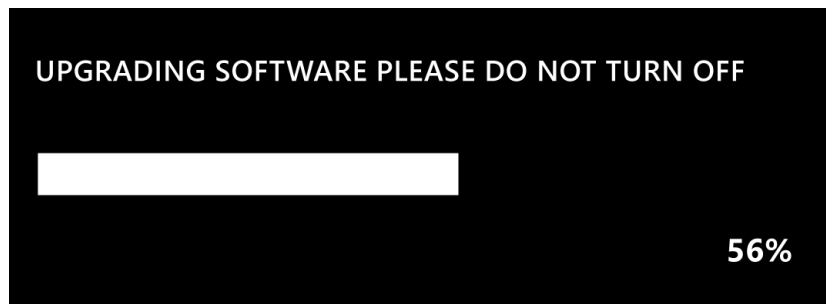

5. After reaching 100% the projector will restart and the screen will turn to black for a few minutes. The whole process will take about 10 minutes.
6. After updating the Firmware, it will take a few minutes to restart the projector.

Firmware Update by USB with FAT32 Format

NOTE: NTFS format, read only.

1. Download the latest version from the ViewSonic website and copy the file to a USB device.
2. Plug the USB into the projector, then go to: **Home > Setting > Firmware Upgrade > Software Update By USB.**
3. Select **Enter** by pressing **OK** on the remote control.
4. The system will detect the Firmware version and display the above dialog message.
5. After selecting **Yes**, a progress bar will appear as the update process begins.
6. After reaching 100% the projector will restart and the screen will turn black for a few minutes. The whole process will take about 10 minutes.
7. After updating the Firmware, it will take a few minutes to restart the projector.

Advanced Settings

1. Select: **Home** > **Setting** > **Advanced Settings**.

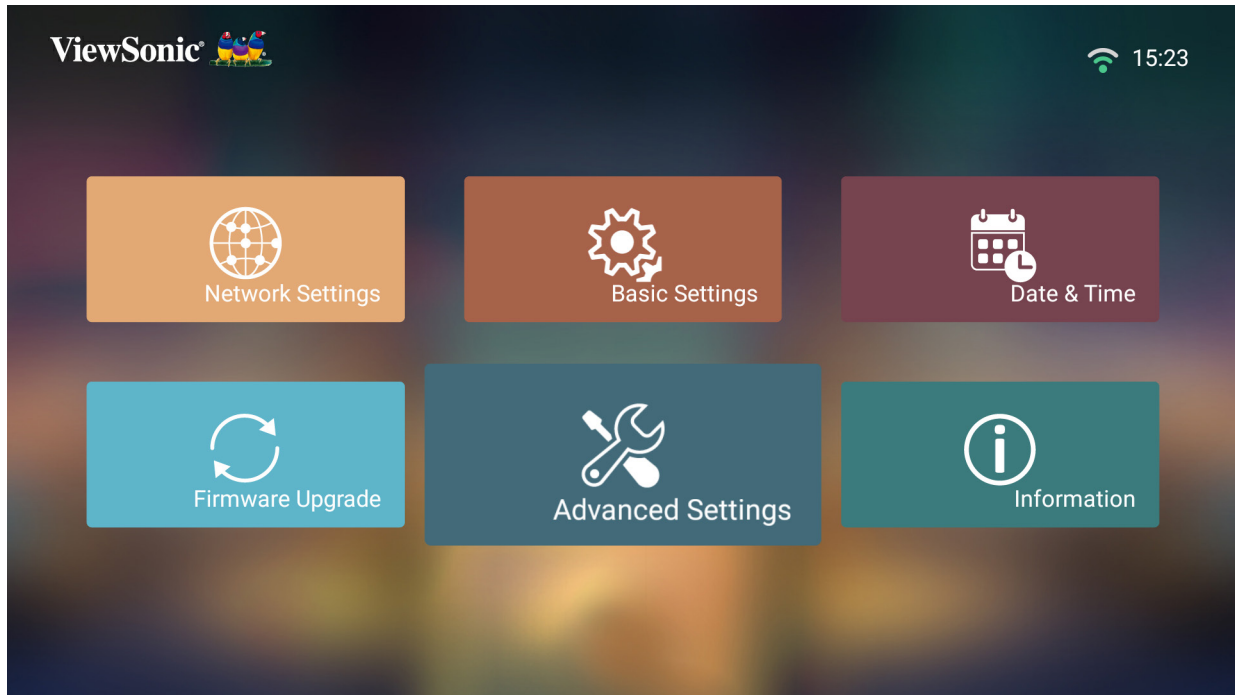

2. Use the **Up** and **Down** buttons to select the desired option and press **OK**. Then use the **Left** and **Right** buttons to make adjustments or selections.

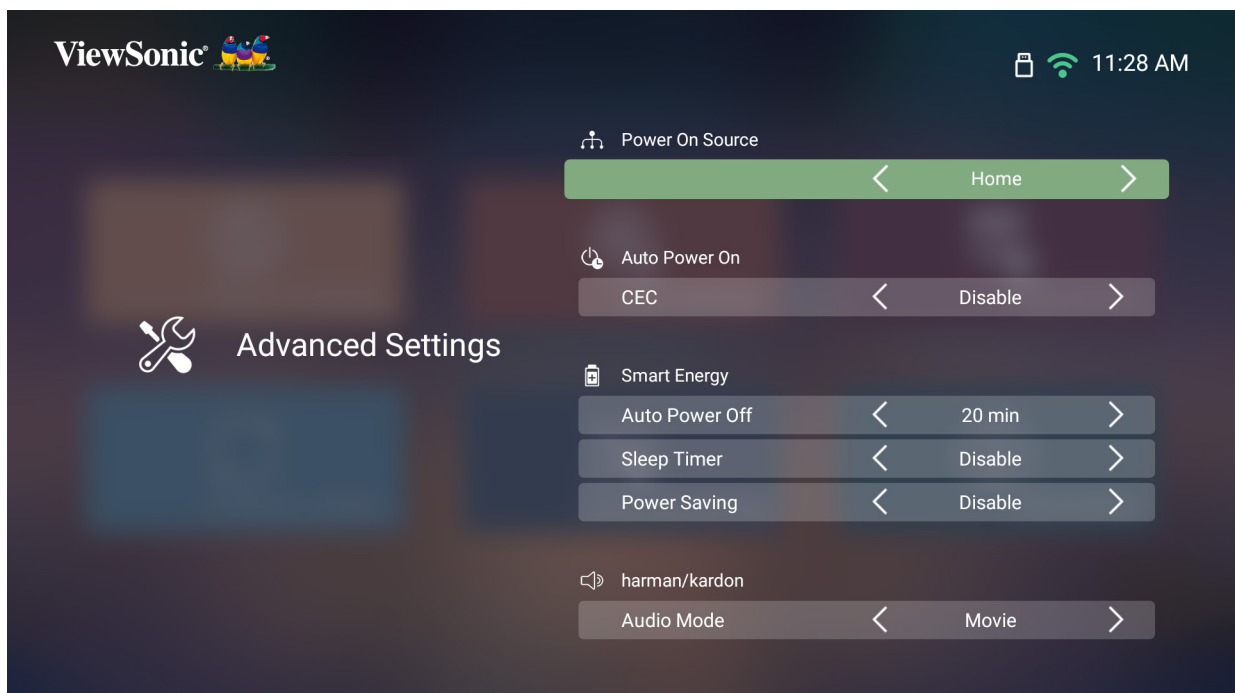

3. To return to a previous menu press the **Return** button.

Menu	Description
Power On Source	Allows the user to enter the desired source directly after turning on the projector.
Auto Power On	<p><u>CEC</u> This projector supports CEC (Consumer Electronics Control) function for synchronized power on/off operation via HDMI connection. That is, if a device that also supports CEC function is connected to the HDMI input of the projector, when the projector's power is turned off, the power of the connected device will also be turned off automatically. When the power of the connected device is turned on, the projector's power will be turned on automatically.</p> <p>NOTE: Ensure both the projector's and the connected device's CEC function are turned on. If the projector does not automatically power on, please turn off the projector first, then it will work.</p>
Smart Energy	<p><u>Auto Power Off</u> The projector can turn off automatically after a set period of time once no input source is detected.</p> <p><u>Sleep Timer</u> Turn off automatically after a set period of time.</p> <p><u>Power Saving</u> Lower power consumption if no input source is detected after five (5) minutes.</p>

Menu	Description
<p>harmon/kardon</p>	<p><u>Audio Mode</u></p> <ul style="list-style-type: none"> • Movie: Default audio mode. • Music: Tuned for music playback. • User: Allows the user to customize the audio equalizer. <p>NOTE: In Custom mode, 100Hz, 500Hz, 1500Hz, 5000Hz, and 10000Hz can be selected.</p>  <p><u>Audio Volume</u> Adjust the volume from 0 to 50.</p> <p><u>Mute</u> Mute or unmute the volume.</p> <p><u>Internal Speaker</u> Switch between internal speaker or audio out. <u>Enable:</u> Activate the Subwoofer Out port. <u>Disable:</u> Activate the Audio Out port.</p> <p><u>S/PDIF</u> Select for audio output via the S/PDIF port.</p>

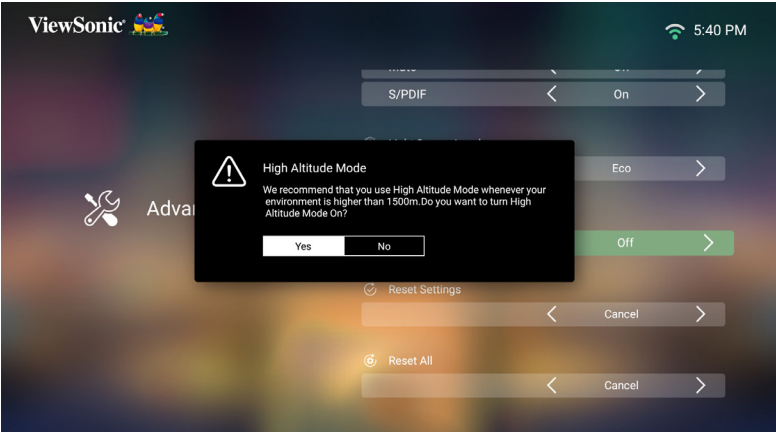
Menu	Description
Light Source Level	<p>Select the suitable power consumption of the LED.</p> <p>Full 100%</p> <p>Eco 70%</p> <p><u>Dynamic Black 1</u> See more dark scene details according to the brightness level of different scenes in the input content.</p> <p><u>Dynamic Black 2</u> High contrast performance according to the brightness level of different scenes in the input content.</p>
High Altitude Mode	<p>It is recommended that you use High Altitude Mode when your environment is between 1,500-3,000 m above sea level, and a temperature between 5°C-25°C.</p>  <p>NOTE: If you use this projector under other extreme conditions excluding the above, it may display auto shut-down symptoms, which is designed to protect your projector from over-heating. In cases like this, you should switch to High Altitude Mode to solve these symptoms. However, this is not to state that this projector can operate under any and all harsh or extreme conditions.</p>

Menu	Description
Reset Settings	Reset the Settings to default. NOTE: Language, High Altitude Mode, Projector Position, Network Settings, All installed Apps in the Apps Center, Add App, Bluetooth, V Keystone, and Light Source Hours will remain unchanged.
Reset to Factory Default	Factory reset. NOTE: Light Source Hours will remain unchanged.

Information

1. Select: **Home** > **Setting** > **Information**.

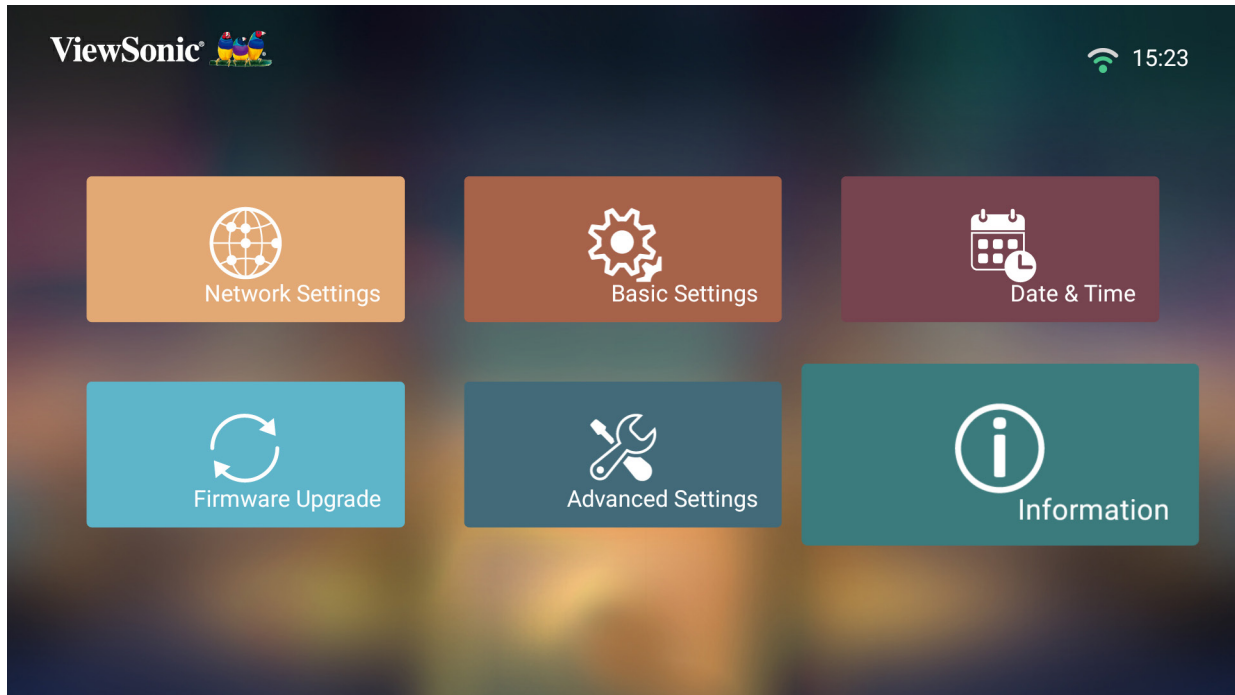

2. View system status and information.



NOTE: Press the **Home** button on the remote control to return to the **Home Screen** at anytime.

Screen Mirroring

Mirror your personal device's screen. To setup wireless Screen Mirroring, see page 23.

NOTE: Ensure your device is connected to the same network as the projector.

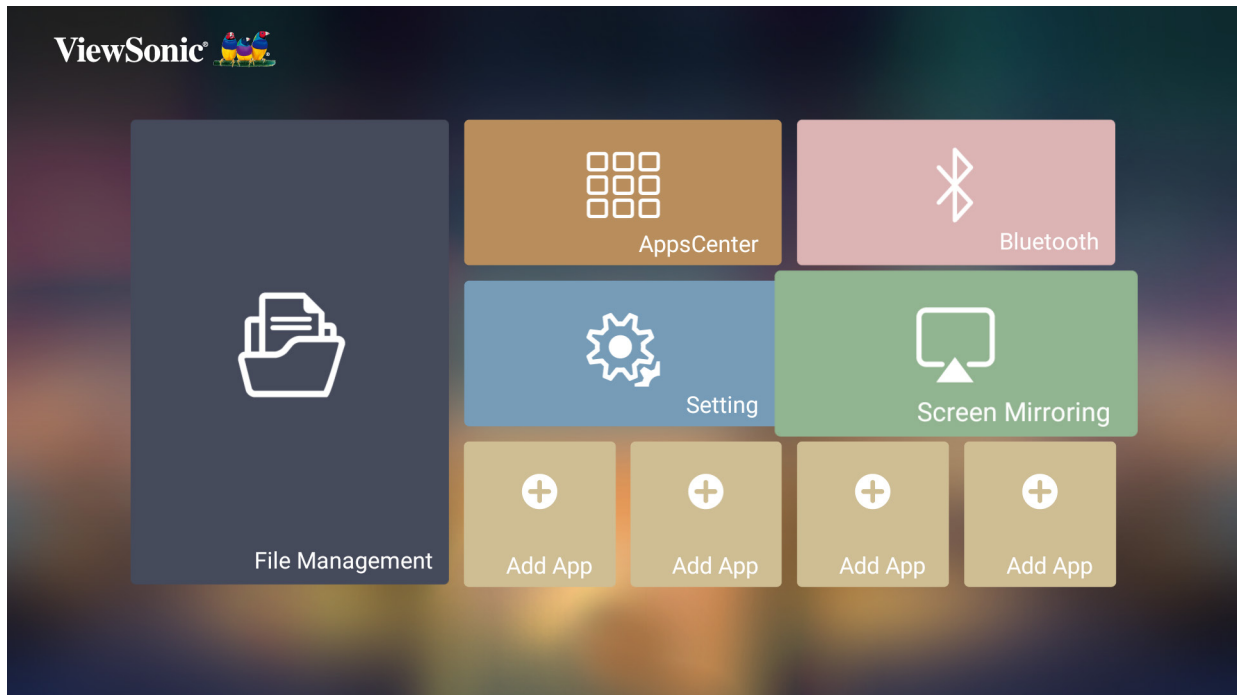

Adding Apps

Add your favorite Apps to the **Home Screen**.

1. From the **Home Screen**, select **Add App** and then press **OK** on the remote control.

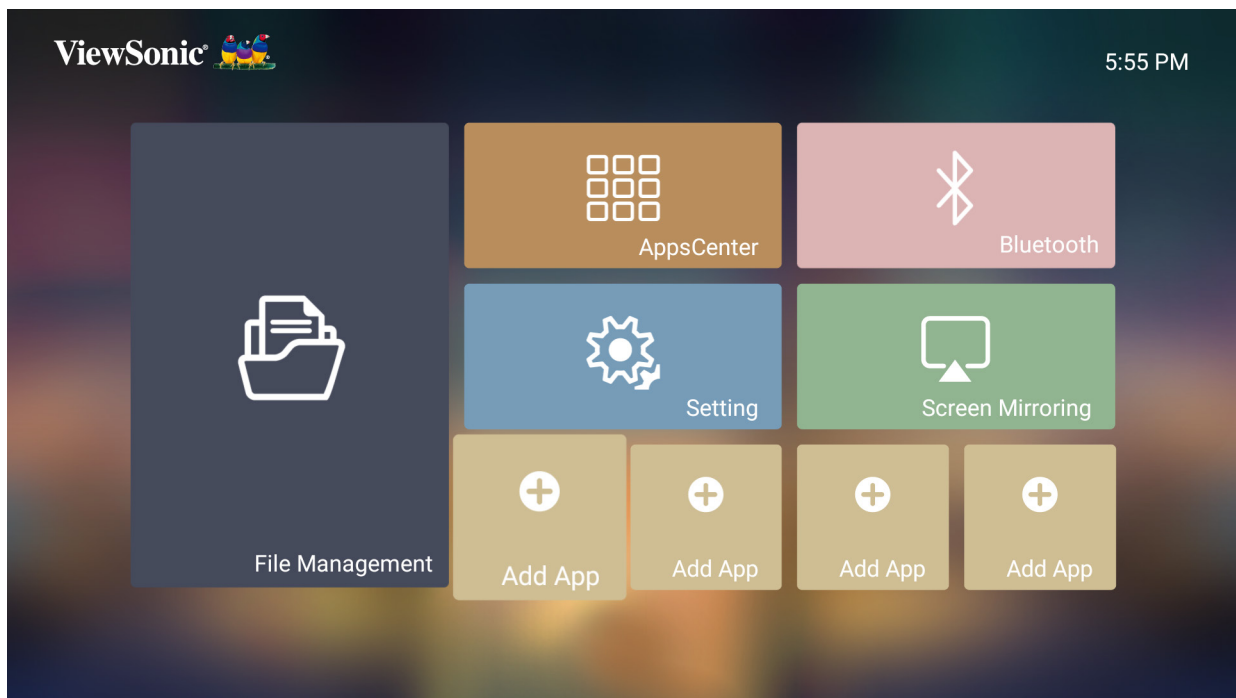

2. Use the directional buttons to select the desired App and press **OK**.

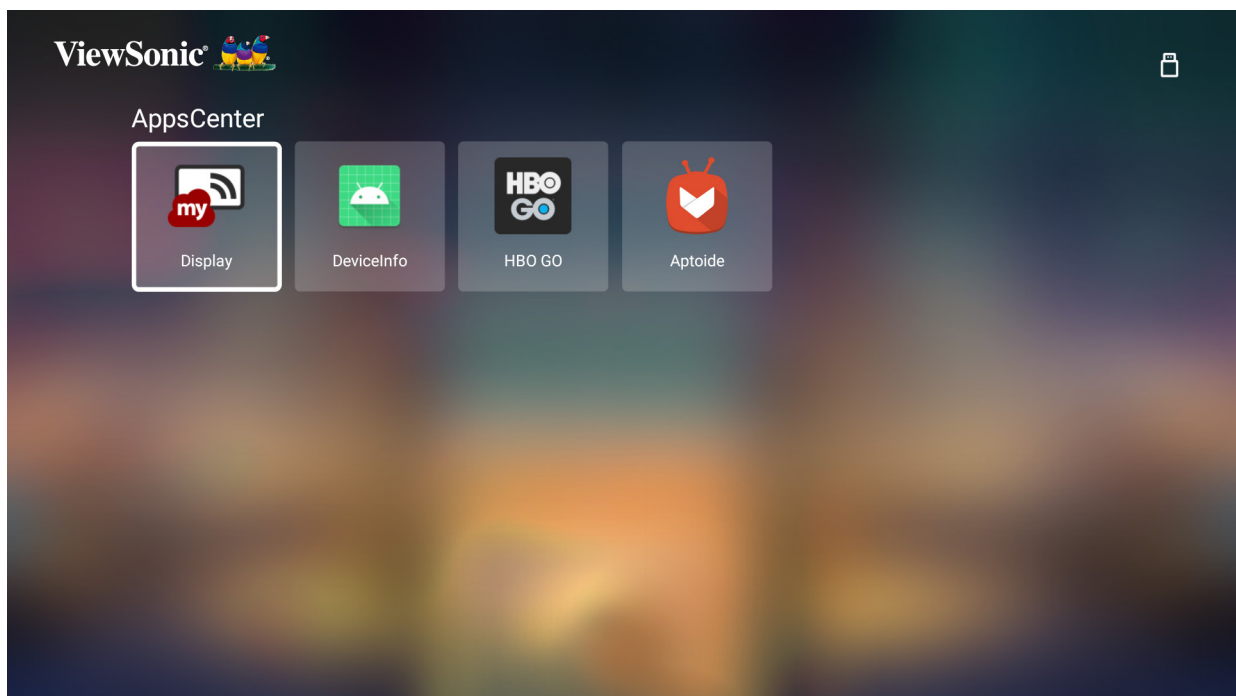

3. Now your favorite App will appear on the **Home Screen**.

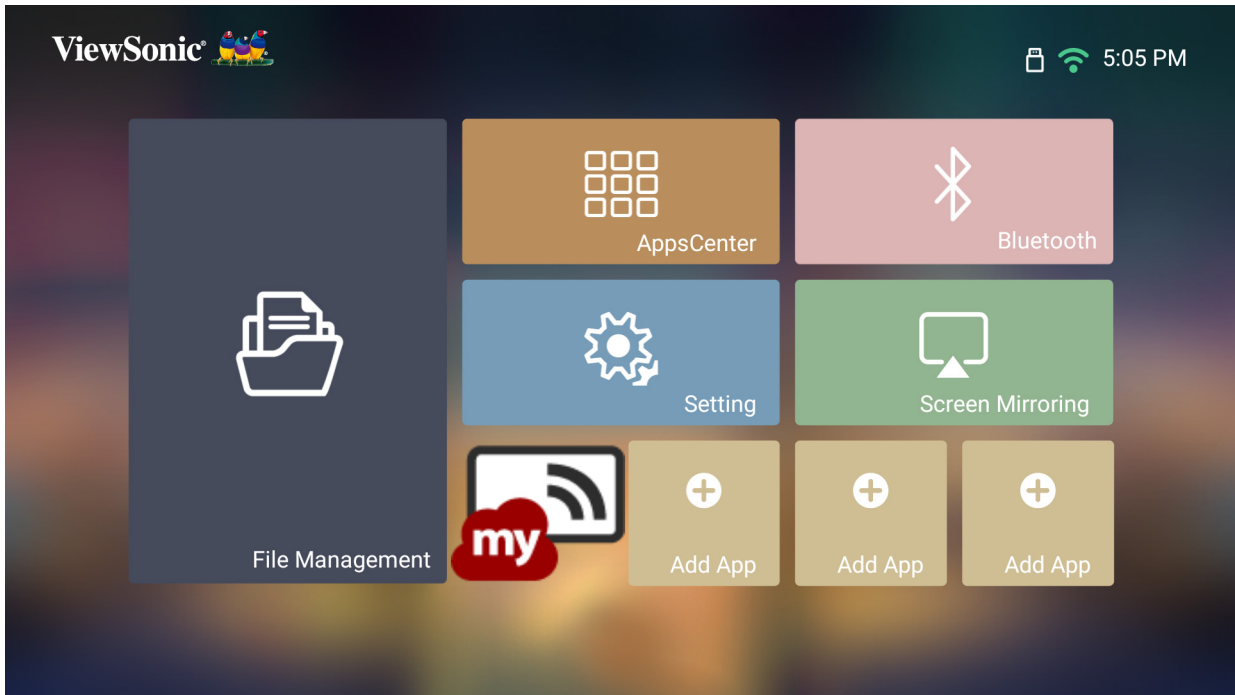

Delete Apps From the Home Screen

1. From the **Home Screen**, select the App you want to delete and press and hold **OK** for three (3) seconds.
2. The message, “Do you want to Delete this application from My Favorites?” will appear.

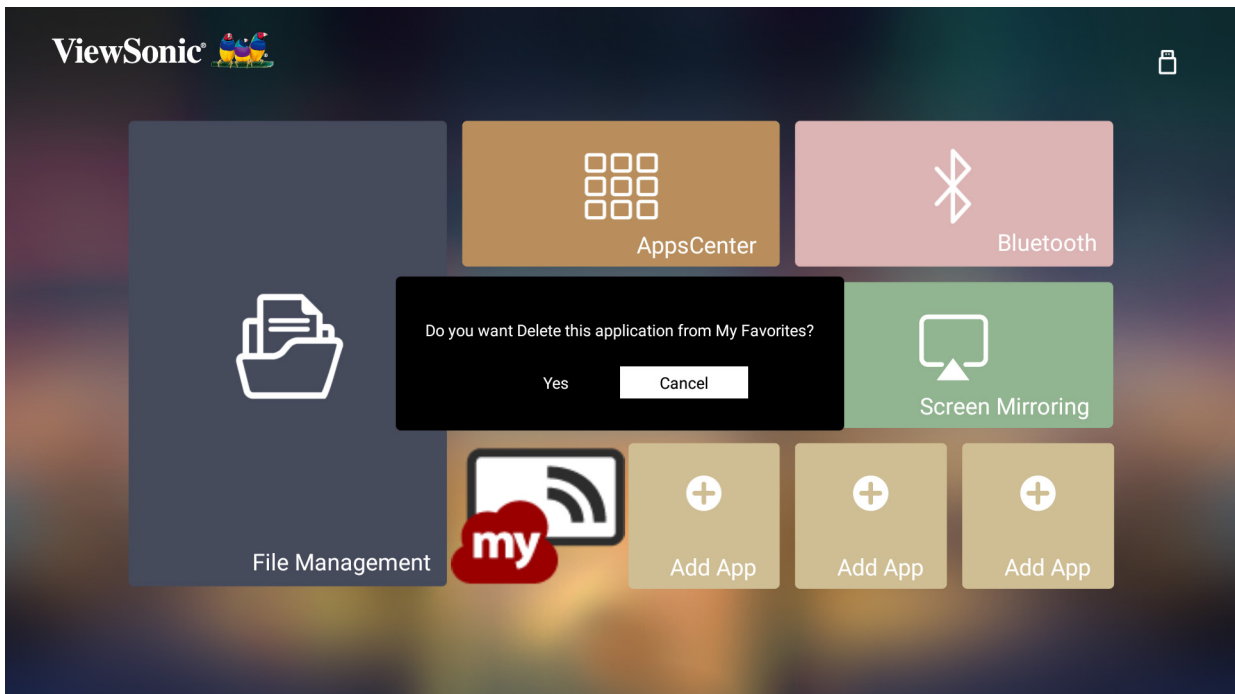

3. Select **Yes**, and press **OK** to delete the App.

> Appendix

Specifications

Item	Category	Specifications
Projector	Type	0.47" 4K-UHD, LED
	Display Size	60"~150"
	Throw Distance	0.159 m~0.657 m (100"@0.379 m)
	Lens	F=1.91, f=2.51 mm
	Optical Zoom	Fixed
	Lamp Type	RGBB LED
	Light Source Life (Normal)	up to 30,000 hours
	Display Color	1.07 Billion Colors
	Keystone	-/+ 14 (Vertical)
Input Signal	HDMI	f _n : 15K~135kHz, f _v :23~120Hz,
Resolution	Native	3840 x 2160
	Support	VGA (640 x 480) to 4K (3840 x 2160)
Local Storage	Total	16 GB
	Available	12 GB
Input	Audio In (3.5 mm)	1
	HDMI	3 (HDMI 2.0, HDCP 1.4/2.2)
	USB Type-C	1
	USB Type-A	3 (USB 3.0 Reader x 1; USB 2.0 Reader x 2)
	RJ45 Input	1
	Wi-Fi Input	1 (5G)
Output	Audio Out (3.5 mm)	2
	Subwoofer	1 (shared with Audio Out)
	S/PDIF	1
	Speaker	20W Cube x 2
	USB Type-A (Power)	3 (USB 3.0, 5V/2A; USB 2.0, 5V/900mA; USB 2.0, 5V/900mA [for Wi-Fi dongle])
Power Adapter ¹	Input Voltage	DC IN 100-240V, 50/60 Hz (auto switch)
Operating Conditions	Temperature	0°C to 35°C (32°F to 95°F)
	Humidity	0% to 90% (non-condensing)
Dimensions	Physical (W x H x D)	757 x 169 x 291 mm (29.8" x 6.65" x 11.46")
Weight	Physical	9.44 kg (20.79 lbs)
Power Consumption	On	200W (Typical)
	Off	< 0.5W (Standby)

¹ Please use the power adapter from ViewSonic® or an authorized source only.

Projector Dimensions

757 mm (W) x 169 mm (H) x 291 mm(D)

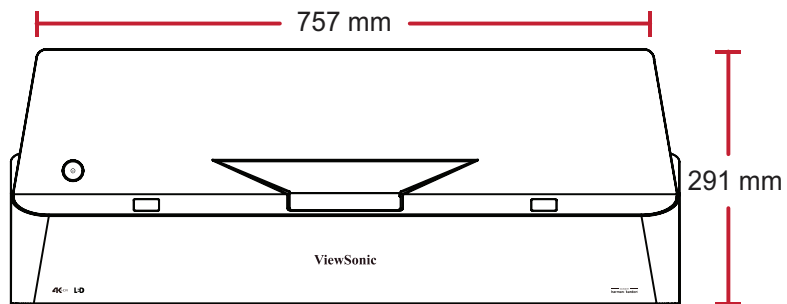
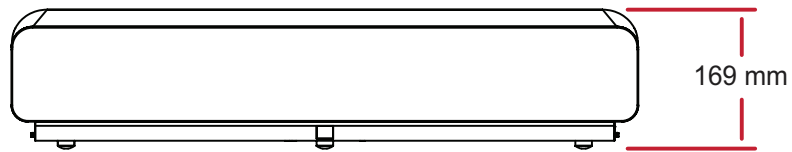

Timing Chart

HDMI/USB C Video Timing

Timing	Resolution (dots)	Refresh Rate (Hz)
SDTV (480i)	720 x 480	60
SDTV (480p)	720 x 480	60
SDTV (576i)	720 x 576	50
SDTV (576p)	720 x 576	50
HDTV (720p)	1280 x 720	50 / 60
HDTV (1080P)	1920 x 1080	24 / 25 / 30 / 50 / 60
HDTV (1080i)	1920 x 1080	50 / 60
UHDTV (4K)	3840x2160	24 / 25 / 30 / 50 / 60
VGA	640 x 480	59 / 67 / 72 / 75 / 85
720 x 400	720 x 400	70
SVGA	800 x 600	56 / 60 / 72 / 75 / 85 / 120
832x624	832x624	75
XGA	1024 x 768	60 / 70 / 75 / 85
1024x576	1024x576	60
XGA+	1152 x 864	75
1152x870	1152x870	75
WXGA	1280 x 768	60 / 75 / 85
WXGA	1280 x 800	60 / 75 / 85
SVGA	1280 x 1024	60 / 75 / 85
1280 x 720	1280 x 720	120
1280 x 960	1280 x 960	60 / 85
HD	1360 x 768	60
WXGA+	1440 x 900	60 / 75 / 85
1400X1050	1400X1050	60
1600x1200	1600x1200	60
WSXGA+	1680x1050	60
WUXGA	1920 x 1200	60

HDMI/USB C PC Timing

Resolution	Refresh Rate (Hz)	Horizontal Frequency (KHz)	Dot Clock Frequency (MHz)
640 x 480	59.940	31.469	25.175
	72.809	37.861	31.500
	75	37.500	31.500
	85.008	43.269	36
	119.518	61.910	52.500
720 x 400	70.087	31.469	28.3221
800 x 600	56.250	35.156	36
	60.317	37.879	40
	72.188	48.077	50
	75	46.875	49.500
	85.061	53.674	56.250
	119.854	77.425	83
1024 x 768	60.004	48.363	65
	70.069	56.476	75
	75.029	60.023	78.750
	84.997	68.667	94.500
	119.804	98.958	137.750
1152 x 864	75	67.500	108
1280 x 768	60	47.396	68.25
	59.870	47.776	79.5
	74.893	60.289	102.25
	84.837	68.633	117.50
1280 x 800	59.810	49.702	83.500
	74.934	62.795	106.500
	84.880	71.554	122.500
1280 x 1024	60.020	60	108
	75.025	79.976	135
	85.024	91.146	157.500
1360 x 768	60.015	47.712	85.500
1366 x 768	60.015	47.712	85.500
1400 x 1050	59.978	65.317	121.750

Resolution	Refresh Rate (Hz)	Horizontal Frequency (KHz)	Dot Clock Frequency (MHz)
1440 x 900	60	55.469	88.75
	59.887	55.935	106.500
	74.984	70.635	136.75
	84.842	80.430	157
1600 x 1200	60	75	162
1680 x 1050	59.883	64.674	119
	59.954	65.290	146.250
1920 x 1200	59.950	74.038	154
3840 x 2160	30	67.5	297
3840 x 2160	60	135	594

3D Support Timing

HDMI 3D (BlueRay 3D with info frame)				
Signal	Resolution (dots)	Aspect Ratio	Refresh Rate (Hz)	Support
Frame Packing				
1080p	1920 x 1080	16:9	23.98/24	Yes
720p	1280 x 720	16:9	50/59.94/60	Yes
Side by Side				
1080i	1920 x 1080	16:9	50/59.94/60	Yes
Top and Bottom				
1080p	1920 x 1080	16:9	23.98/24	Yes
720p	1280 x 720	16:9	50/59.94/60	Yes

3D (HDMI/USB C) Manual Setting				
Signal	Resolution (dots)	Aspect Ratio	Refresh Rate (Hz)	Support
SVGA	800 x 600	4:3	60*/120**	Yes
XGA	1024 x 768	4:3	60*/120**	Yes
HD	1280 x 720	16:9	60*/120**	Yes
WXGA	1280 x 800	16:9	60*/120**	Yes
HDTV (1080p)	1920 x 1080	16:9	60	Yes
NOTE:				
* 60Hz signals are supported for side by side, top and bottom, and frame sequential.				
** 120Hz signals are supported for frame sequential only.				

IR Control Table

Function	Address		Code	Inverse
	Byte 1	Byte 2	Byte 3	Byte 4
Up	83	F4	0B	F4
Down	83	F4	0C	F3
Left	83	F4	0E	F1
Right	83	F4	0F	F0
Mute	83	F4	14	EB
Ok	83	F4	15	EA
Home	83	F4	16	E9
Play/Pause	83	F4	1A	E5
Exit	83	F4	28	D7
Menu/Setting	83	F4	30	CF
Source	83	F4	40	BF
Power On/Off	83	F4	17	E8
Focus	83	F4	92	6D
Bluetooth	83	F4	A2	5D
Previous	83	F4	A7	58
Next	83	F4	A8	57
Volume +	83	F4	82	7D
Volume -	83	F4	83	7C

Glossary

This section describes the standard glossary of terms used in all projector models. All terms are listed in alphabetical order.

NOTE: Some terms may not be applicable to your projector.

A Aspect Ratio

Refers to the ratio of the image width to the image height.

B Brightest Mode

Maximizes the brightness of the projected image. This mode is ideal for environments where extra-high brightness is required, such as using the projector in well lit rooms.

Brightness

Adjusts brightness levels of the screen image

C CEC (Consumer Electronics Control)

Synchronizes power on/off operation via HDMI connection. That is, if a device that also supports CEC function is connected to the HDMI input of the projector, when the projector's power is turned off, the power of the connected device will also be turned off automatically. When the power of the connected device is turned on, the projector's power will be turned on automatically.

Color

Adjusts the color saturation.

Color Temp

Allows users to select specific color temperature settings to further customize their viewing experience.

Contrast

Adjusts the difference between the image background (black level) and the foreground (white level).

D Dynamic Black

This feature gives more depth to your image by smoothly adjusting the light and signal output to create a stunning high contrast ratio. Bright scenes appear crisp and clear, while dark scenes remain detailed with deep blacks and exceptional light and shade detail.

F Focus

Improve the clarity of the projected image.

G Gamma

Allows the user to manually select the greyscale curve of the projector.

H HDMI Range

Allows the user to select HDMI greyscale range between 0~255 (full range) , 16~235 (limited range) or Auto by the signal type detected.

HDR (High-Dynamic Range)

Keeps the brightness level and enhances details on the dark level.

High Altitude Mode

Optional mode for users who live in an environment between 1,500 m and 3,000 m above sea level, and the temperature is between 5° C and 25° C. Activating it will improve projector cooling and performance.

I Information

Displays the timing mode (video signal input) and the serial number.

Input Select

Toggles between the various input options that are available for the projector.

K Keystone
The distortion of an image caused by projecting it onto an angled surface.

L Light Source Level
Use Normal or Eco mode to adjust the brightness level and power consumption.

M Movie Mode
A Picture Mode appropriate for playing colorful movies, video clips from digital cameras, or DVs through the PC input. Best for a low light environment.

S Sharpness
Adjusts the picture quality.

Troubleshooting

This section describes some common problems that you may experience when using the projector.

Problem or Issue	Possible Solutions
The projector does not turn on	<ul style="list-style-type: none">• Ensure the power cord is properly attached to the projector and to the power outlet.• If the cooling process has not completed, please wait until it has finished then try to turn on the projector again.• If the above does not work, try another power outlet or another electrical device with the same power outlet.
There is no picture	<ul style="list-style-type: none">• Ensure the video source cable is connected properly, and that the video source is turned on.• If the input source is not selected automatically, select the correct source with the Source key on either the projector or the remote control.
The image is blurred	<ul style="list-style-type: none">• Adjusting focus with the remote control will help correctly focus the projection lens.• Ensure the projector and screen are aligned properly. If necessary, adjust the height of the projector as well as the projection angle and direction.
The remote control does not work	<ul style="list-style-type: none">• Ensure there are no obstacles between the remote control and projector; and that they are within 8 m (26 ft) of each other.• The batteries may be out of power, please check and replace if necessary.

Maintenance

General Precautions

- Make sure the projector is turned off and the power cable is unplugged from the power outlet.
- Never remove any parts from the projector. Contact ViewSonic® or a reseller when any part of the projector needs replacing.
- Never spray or pour any liquid directly onto the case.
- Handle the projector with care, as a darker-colored projector, if scuffed, may show marks more clearly than a lighter-colored projector.

Cleaning the Lens

- Use a canister of compressed air to remove dust.
- If the lens is still not clean, use lens-cleaning paper or moisten a soft cloth with lens cleaner and gently wipe the surface.

CAUTION: Never rub the lens with abrasive materials.

Cleaning the Case

- Use a soft, lint-free, dry cloth to remove dirt or dust.
- If the case is still not clean, apply a small amount of non-ammonia, non-alcohol based, mild non-abrasive detergent onto a clean, soft, lint-free cloth, then wipe the surface.

CAUTION: Never use wax, alcohol, benzene, thinner, or other chemical detergents.

Storing the Projector

If you intend to store the projector for an extended period of time:

- Ensure the temperature and humidity of the storage area are within the recommend range.
- Retract the adjuster foot completely.
- Remove the batteries from the remote control.
- Pack the projector in its original packaging or equivalent.

Disclaimer

- ViewSonic® does not recommend the use of any ammonia or alcohol-based cleaners on the lens or case. Some chemical cleaners have been reported to damage the lens and/or case of the projector.
- ViewSonic® will not be liable for damage resulting from use of any ammonia or alcohol-based cleaners.

LED Indicators

Light	Status and Description
	
Power	
Red	Stand-by mode (5 sec.) (< 0.5W)
Blue	Powering up
Blue	Normal operation
Green	Bluetooth Mode

> Regulatory and Service Information

Compliance Information

This section addresses all connected requirements and statements regarding regulations. Confirmed corresponding applications shall refer to nameplate labels and relevant markings on the unit.

FCC Compliance Statement

This device complies with part 15 of FCC Rules. Operation is subject to the following two conditions: (1) this device may not cause harmful interference, and (2) this device must accept any interference received, including interference that may cause undesired operation. This equipment has been tested and found to comply with the limits for a Class B digital device, pursuant to part 15 of the FCC Rules.

These limits are designed to provide reasonable protection against harmful interference in a residential installation. This equipment generates, uses, and can radiate radio frequency energy, and if not installed and used in accordance with the instructions, may cause harmful interference to radio communications. However, there is no guarantee that interference will not occur in a particular installation. If this equipment does cause harmful interference to radio or television reception, which can be determined by turning the equipment off and on, the user is encouraged to try to correct the interference by one or more of the following measures:

- Reorient or relocate the receiving antenna.
- Increase the separation between the equipment and receiver.
- Connect the equipment into an outlet on a circuit different from that to which the receiver is connected.
- Consult the dealer or an experienced radio/TV technician for help.

Warning: You are cautioned that changes or modifications not expressly approved by the party responsible for compliance could void your authority to operate the equipment.

Industry Canada Statement

CAN ICES-003(B) / NMB-003(B)

This device complies with Industry Canada licence-exempt RSS standard(s).
Operation is subject to the following two conditions:

- (1) This device may not cause interference, and
- (2) This device must accept any interference, including interference that may cause undesired operation of the device.

This device complies with RSS 210 of Industry Canada. This Class B device meets all the requirements of the Canadian interference-causing equipment regulations.

Under Industry Canada regulations, this radio transmitter may only operate using an antenna of a type and maximum (or lesser) gain approved for the transmitter by Industry Canada. To reduce potential radio interference to other users, the antenna type and its gain should be so chosen that the equivalent isotropically radiated power (e.i.r.p.) is not more than that necessary for successful

Antenna Type : Dipole, Gain : 4.35 dBi (2.4 GHz)

CE Conformity for European Countries

CE The device complies with the EMC Directive 2014/30/EU and Low Voltage Directive 2014/35/EU. and Radio Equipment Directive 2014/53/EU.

The following information is only for EU-member states:

The mark shown to the right is in compliance with the Waste Electrical and Electronic Equipment Directive 2012/19/EU (WEEE). The mark indicates the requirement NOT to dispose of the equipment as unsorted municipal waste, but use the return and collection systems according to local law.



Declaration of RoHS2 Compliance

This product has been designed and manufactured in compliance with Directive 2011/65/EU of the European Parliament and the Council on restriction of the use of certain hazardous substances in electrical and electronic equipment (RoHS2 Directive) and is deemed to comply with the maximum concentration values issued by the European Technical Adaptation Committee (TAC) as shown below:

Substance	Proposed Maximum Concentration	Actual Concentration
Lead (Pb)	0.1%	< 0.1%
Mercury (Hg)	0.1%	< 0.1%
Cadmium (Cd)	0.01%	< 0.01%
Hexavalent Chromium (Cr6 ⁺)	0.1%	< 0.1%
Polybrominated biphenyls (PBB)	0.1%	< 0.1%
Polybrominated diphenyl ethers (PBDE)	0.1%	< 0.1%
Bis (2-ethylhexyl) phthalate (DEHP)	0.1%	< 0.1%
Butyl benzyl phthalate (BBP)	0.1%	< 0.1%
Dibutyl phthalate (DBP)	0.1%	< 0.1%
Diisobutyl phthalate (DIBP)	0.1%	< 0.1%

Certain components of products as stated above are exempted under the Annex III of the RoHS2 Directives as noted below. Examples of exempted components are:

- Mercury in cold cathode fluorescent lamps and external electrode fluorescent lamps (CCFL and EEFL) for special purposes not exceeding (per lamp):
 - » Short length (500 mm): maximum 3.5 mg per lamp.
 - » Medium length (> 500 mm and 1,500 mm): maximum 5 mg per lamp.
 - » Long length (> 1,500 mm): maximum 13 mg per lamp.
- Lead in glass of cathode ray tubes.
- Lead in glass of fluorescent tubes not exceeding 0.2% by weight.
- Lead as an alloying element in aluminum containing up to 0.4% lead by weight.
- Copper alloy containing up to 4% lead by weight.
- Lead in high melting temperature type solders (i.e. lead-based alloys containing 85% by weight or more lead).
- Electrical and electronic components containing lead in a glass or ceramic other than dielectric ceramic in capacitors, e.g. piezoelectronic devices, or in a glass or ceramic matrix compound.

Indian Restriction of Hazardous Substances

Restriction on Hazardous Substances statement (India). This product complies with the “India E-waste Rule 2011” and prohibits use of lead, mercury, hexavalent chromium, polybrominated biphenyls or polybrominated diphenyl ethers in concentrations exceeding 0.1 weight % and 0.01 weight % for cadmium, except for the exemptions set in Schedule 2 of the Rule.

Product Disposal at End of Product Life

ViewSonic® respects the environment and is committed to working and living green. Thank you for being part of Smarter, Greener Computing. Please visit the ViewSonic® website to learn more.

USA & Canada:

<http://www.viewsonic.com/company/green/recycle-program/>

Europe:

<http://www.viewsoniceurope.com/eu/support/call-desk/>

Taiwan:

<https://recycle.epa.gov.tw/>

Copyright Information

Copyright© ViewSonic® Corporation, 2021. All rights reserved.

Macintosh and Power Macintosh are registered trademarks of Apple Inc.

Microsoft, Windows, and the Windows logo are registered trademarks of Microsoft Corporation in the United States and other countries.

ViewSonic®, the three birds logo, OnView, ViewMatch, and ViewMeter are registered trademarks of ViewSonic® Corporation.

VESA is a registered trademark of the Video Electronics Standards Association. DPMS, DisplayPort, and DDC are trademarks of VESA.

ENERGY STAR® is a registered trademark of the U.S. Environmental Protection Agency (EPA).

As an ENERGY STAR® partner, ViewSonic® Corporation has determined that this product meets the ENERGY STAR® guidelines for energy efficiency.

Disclaimer: ViewSonic® Corporation shall not be liable for technical or editorial errors or omissions contained herein; nor for incidental or consequential damages resulting from furnishing this material, or the performance or use of this product.

In the interest of continuing product improvement, ViewSonic® Corporation reserves the right to change product specifications without notice. Information in this document may change without notice.

No part of this document may be copied, reproduced, or transmitted by any means, for any purpose without prior written permission from ViewSonic® Corporation.

Customer Service

For technical support or product service, see the table below or contact your reseller.

NOTE: You will need the product's serial number.

Country/ Region	Website	Country/ Region	Website
Asia Pacific & Africa			
Australia	www.viewsonic.com/au/	Bangladesh	www.viewsonic.com/bd/
中国 (China)	www.viewsonic.com.cn	香港 (繁體中文)	www.viewsonic.com/hk/
Hong Kong (English)	www.viewsonic.com/hk-en/	India	www.viewsonic.com/in/
Indonesia	www.viewsonic.com/id/	Israel	www.viewsonic.com/il/
日本 (Japan)	www.viewsonic.com/jp/	Korea	www.viewsonic.com/kr/
Malaysia	www.viewsonic.com/my/	Middle East	www.viewsonic.com/me/
Myanmar	www.viewsonic.com/mm/	Nepal	www.viewsonic.com/np/
New Zealand	www.viewsonic.com/nz/	Pakistan	www.viewsonic.com/pk/
Philippines	www.viewsonic.com/ph/	Singapore	www.viewsonic.com/sg/
臺灣 (Taiwan)	www.viewsonic.com/tw/	ประเทศไทย	www.viewsonic.com/th/
Việt Nam	www.viewsonic.com/vn/	South Africa & Mauritius	www.viewsonic.com/za/
Americas			
United States	www.viewsonic.com/us	Canada	www.viewsonic.com/us
Latin America	www.viewsonic.com/la		
Europe			
Europe	www.viewsonic.com/eu/	France	www.viewsonic.com/fr/
Deutschland	www.viewsonic.com/de/	Қазақстан	www.viewsonic.com/kz/
Россия	www.viewsonic.com/ru/	España	www.viewsonic.com/es/
Türkiye	www.viewsonic.com/tr/	Україна	www.viewsonic.com/ua/
United Kingdom	www.viewsonic.com/uk/		

Limited Warranty

ViewSonic® Projector

What the warranty covers:

ViewSonic® warrants its products to be free from defects in material and workmanship, under normal use, during the warranty period. If a product proves to be defective in material or workmanship during the warranty period, ViewSonic® will, at its sole option, repair or replace the product with a like product. Replacement product or parts may include remanufactured or refurbished parts or components.

Limited Three (3) year General Warranty:

Subject to the more limited one (1) year warranty set out below, North and South America: Three (3) years warranty for all parts excluding the lamp, three (3) years for labor, and one (1) year for the original lamp from the date of the first consumer purchase.

Other regions or countries: Please check with your local dealer or local ViewSonic® office for the warranty information.

Limited One (1) year Heavy Usage Warranty:

Under heavy usage settings, where a projector's use includes more than fourteen (14) hours average daily usage, North and South America: One (1) year warranty for all parts excluding the lamp, one (1) year for labor, and ninety (90) days for the original lamp from the date of the first consumer purchase; Europe: One (1) year warranty for all parts excluding the lamp, one (1) year for labor, and ninety (90) days for the original lamp from the date of the first consumer purchase. Other regions or countries: Please check with your local dealer or local ViewSonic® office for the warranty information. Lamp warranty subject to terms and conditions, verification and approval. Applies to manufacturer's installed lamp only. All accessory lamps purchased separately are warranted for 90 days.

Who the warranty protects:

This warranty is valid only for the first consumer purchaser.

What the warranty does not cover:

1. Any product on which the serial number has been defaced, modified, or removed.
2. Damage, deterioration, or malfunction resulting from:
 - » Accident, misuse, neglect, fire, water, lightning, or other acts of nature, unauthorized product modification, or failure to follow instructions supplied with the product.
 - » Operation outside of product specifications.
 - » Operation of the product for other than the normal intended use or not under normal conditions.
 - » Repair or attempted repair by anyone not authorized by ViewSonic®.
 - » Any damage of the product due to shipment.
 - » Removal or installation of the product.
 - » Causes external to the product, such as electric power fluctuations or failure.
 - » Use of supplies or parts not meeting Viewsonic's specifications.
 - » Normal wear and tear.
 - » Any other cause which does not relate to a product defect.
3. Removal, installation, and set-up service charges.

How to get service:

1. For information about receiving service under warranty, contact ViewSonic® Customer Support (Please refer to the "Customer Support" page). You will need to provide your product's serial number.
2. To obtain warranted service, you will be required to provide: (a) the original dated sales slip, (b) your name, (c) your address, (d) a description of the problem, and (e) the serial number of the product.
3. Take or ship the product, freight prepaid, in the original container to an authorized ViewSonic® service center or ViewSonic®.
4. For additional information or the name of the nearest ViewSonic® service center, contact ViewSonic®.

Limitation of implied warranties:

There are no warranties, express or implied, which extend beyond the description contained herein including the implied warranty of merchantability and fitness for a particular purpose.

Exclusion of damages:

ViewSonic's liability is limited to the cost of repair or replacement of the product. ViewSonic® shall not be liable for:

1. Damage to other property caused by any defects in the product, damages based upon inconvenience, loss of use of the product, loss of time, loss of profits, loss of business opportunity, loss of goodwill, interference with business relationships, or other commercial loss, even if advised of the possibility of such damages.
2. Any other damages, whether incidental, consequential or otherwise.
3. Any claim against the customer by any other party.

Effect of state law:

This warranty gives you specific legal rights, and you may also have other rights which vary from local authority. Some local governments do not allow limitations on implied warranties and/or do not allow the exclusion of incidental or consequential damages, so the above limitations and exclusions may not apply to you.

Sales outside the U.S.A. and Canada:

For warranty information and service on ViewSonic® products sold outside of the U.S.A. and Canada, contact ViewSonic® or your local ViewSonic® dealer.

The warranty period for this product in mainland China (Hong Kong, Macao, and Taiwan Excluded) is subject to the terms and conditions of the Maintenance Guarantee Card.

For users in Europe and Russia, full details of warranty provided can be found at: <http://www.viewsonic.com/eu/> under "Support/Warranty Information".

Mexico Limited Warranty

ViewSonic® Projector

What the warranty covers:

ViewSonic® warrants its products to be free from defects in material and workmanship, under normal use, during the warranty period. If a product proves to be defective in material or workmanship during the warranty period, ViewSonic® will, at its sole option, repair or replace the product with a like product. Replacement product or parts may include remanufactured or refurbished parts or components & accessories.

How long the warranty is effective:

3 years for all parts excluding the lamp, 3 years for labor, 1 year for the original lamp from the date of the first consumer purchase.

Lamp warranty subject to terms and conditions, verification and approval. Applies to manufacturer's installed lamp only.

All accessory lamps purchased separately are warranted for 90 days.

Who the warranty protects:

This warranty is valid only for the first consumer purchaser.

What the warranty excludes and does not cover:

1. Any product on which the serial number has been defaced, modified or removed.
2. Damage, deterioration, or malfunction resulting from:
 - » Accident, misuse, neglect, fire, water, lightning, or other acts of nature, unauthorized product modification, unauthorized attempted repair, or failure to follow instructions supplied with the product.
 - » Any damage of the product due to shipment.
 - » Causes external to the product, such as electrical power fluctuations or failure.
 - » Use of supplies or parts not meeting ViewSonic®'s specifications.
 - » Normal wear and tear.
 - » Any other cause which does not relate to a product defect.
3. Any product exhibiting a condition commonly known as "image burn-in" which results when a static image is displayed on the product for an extended period of time.
4. Removal, installation, insurance, and set-up service charges.

How to get service:

For information about receiving service under warranty, contact ViewSonic® Customer Support (Please refer to the attached “Customer Service” page). You will need to provide your product’s serial number, so please record the product information in the space provided below on your purchase for your future use. Please retain your receipt of proof of purchase to support your warranty claim.

For Your Records

Product Name: _____ Model Number: _____

Document Number: _____ Serial Number: _____

Purchase Date: _____ Extended Warranty Purchase? _____ (Y/N)

If so, what date does warranty expire? _____

1. To obtain warranty service, you will be required to provide (a) the original dated sales slip, (b) your name, (c) your address, (d) a description of the problem, and (e) the serial number of the product.
2. Take or ship the product, in the original container packaging, to an authorized ViewSonic® service center.
3. Round trip transportation costs for in-warranty products will be paid by ViewSonic®.

Limitation of implied warranties:

There are no warranties, express or implied, which extend beyond the description contained herein including the implied warranty of merchantability and fitness for a particular purpose.

Exclusion of damages:

ViewSonic®’s liability is limited to the cost of repair or replacement of the product. ViewSonic® shall not be liable for:

1. Damage to other property caused by any defects in the product, damages based upon inconvenience, loss of use of the product, loss of time, loss of profits, loss of business opportunity, loss of goodwill, interference with business relationships, or other commercial loss, even if advised of the possibility of such damages.
2. Any other damages, whether incidental, consequential or otherwise.
3. Any claim against the customer by any other party.
4. Repair or attempted repair by anyone not authorized by ViewSonic®.

Contact Information for Sales & Authorized Service (Centro Autorizado de Servicio) within Mexico:	
Name, address, of manufacturer and importers: México, Av. de la Palma #8 Piso 2 Despacho 203, Corporativo Interpalmas, Col. San Fernando Huixquilucan, Estado de México Tel: (55) 3605-1099 http://www.viewsonic.com/la/soporte/index.htm	
NÚMERO GRATIS DE ASISTENCIA TÉCNICA PARA TODO MÉXICO: 001.866.823.2004	
Hermosillo: Distribuciones y Servicios Computacionales SA de CV. Calle Juárez 284 local 2 Col. Bugambilias C.P: 83140 Tel: 01-66-22-14-9005 E-Mail: disc2@hmo.megared.net.mx	Villahermosa: Compumantenimientos Garantizados, S.A. de C.V. AV. GREGORIO MENDEZ #1504 COL, FLORIDA C.P. 86040 Tel: 01 (993) 3 52 00 47 / 3522074 / 3 52 20 09 E-Mail: compumantenimientos@prodigy.net.mx
Puebla, Pue. (Matriz): RENTA Y DATOS, S.A. DE C.V. Domicilio: 29 SUR 721 COL. LA PAZ 72160 PUEBLA, PUE. Tel: 01(52).222.891.55.77 CON 10 LINEAS E-Mail: datos@puebla.megared.net.mx	Veracruz, Ver.: CONEXION Y DESARROLLO, S.A DE C.V. Av. Americas # 419 ENTRE PINZÓN Y ALVARADO Fracc. Reforma C.P. 91919 Tel: 01-22-91-00-31-67 E-Mail: gacosta@qplus.com.mx
Chihuahua: Soluciones Globales en Computación C. Magisterio # 3321 Col. Magisterial Chihuahua, Chih. Tel: 4136954 E-Mail: Cefeo@soluglobales.com	Cuernavaca: Compusupport de Cuernavaca SA de CV Francisco Leyva # 178 Col. Miguel Hidalgo C.P. 62040, Cuernavaca Morelos Tel: 01 777 3180579 / 01 777 3124014 E-Mail: aquevedo@compusupportcva.com
Distrito Federal: QPLUS, S.A. de C.V. Av. Coyoacán 931 Col. Del Valle 03100, México, D.F. Tel: 01(52)55-50-00-27-35 E-Mail : gacosta@qplus.com.mx	Guadalajara, Jal.: SERVICRECE, S.A. de C.V. Av. Niños Héroes # 2281 Col. Arcos Sur, Sector Juárez 44170, Guadalajara, Jalisco Tel: 01(52)33-36-15-15-43 E-Mail: mmiranda@servicrece.com
Guerrero Acapulco: GS Computación (Grupo Sesicomp) Progreso #6-A, Colo Centro 39300 Acapulco, Guerrero Tel: 744-48-32627	Monterrey: Global Product Services Mar Caribe # 1987, Esquina con Golfo Pérsico Fracc. Bernardo Reyes, CP 64280 Monterrey N.L. México Tel: 8129-5103 E-Mail: aydeem@gps1.com.mx
MERIDA: ELECTROSER Av Reforma No. 403Gx39 y 41 Mérida, Yucatán, México CP97000 Tel: (52) 999-925-1916 E-Mail: rrrb@sureste.com	Oaxaca, Oax.: CENTRO DE DISTRIBUCION Y SERVICIO, S.A. de C.V. Murguía # 708 P.A., Col. Centro, 68000, Oaxaca Tel: 01(52)95-15-15-22-22 Fax: 01(52)95-15-13-67-00 E-Mail: gpotai2001@hotmail.com
Tijuana: STD Av Ferrocarril Sonora #3780 L-C Col 20 de Noviembre Tijuana, Mexico	FOR USA SUPPORT: ViewSonic® Corporation 381 Brea Canyon Road, Walnut, CA. 91789 USA Tel: 800-688-6688 E-Mail: http://www.viewsonic.com



ViewSonic®
See the difference®