

WISENET

PUBLIC VIEW MONITOR

SMT-1030PV

SMT-2730PV

SMT-3230PV



Hanwha Techwin

SAFETY INSTRUCTIONS

1. WARNING

To reduce the risk of fire or electric shock, do not expose this product to rain or moisture.

Do not insert any metallic object through the ventilation grills or other openings on the equipment.

Apparatus shall not be exposed to dripping or splashing and that no objects filled with liquids, such as vases, shall be placed on the apparatus.

To prevent injury, this apparatus must be securely attached to the Wall/ceiling in accordance with the installation instructions.

2. CAUTION

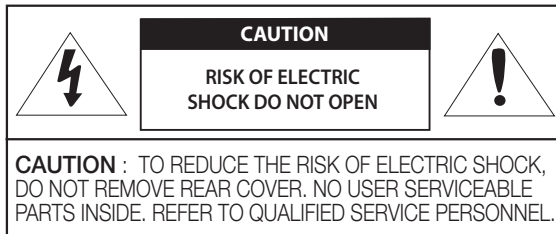

3. EXPLANATION OF GRAPHICAL SYMBOLS



The lightning flash with arrowhead symbol, within an equilateral triangle, is intended to alert the user to the presence of “dangerous voltage: within the product’s enclosure that may be of sufficient magnitude to constitute a risk of electric shock to persons.



The exclamation point within an equilateral triangle is intended to alert the user to the presence of important operating and maintenance (servicing) instructions in the literature accompanying the product.

CAUTION

RISK OF EXPLOSION IF BATTERY IS REPLACED BY AN INCORRECT TYPE.
DISPOSE OF USED BATTERIES ACCORDING TO THE INSTRUCTIONS.

ATTENTION

IL Y A RISQUE D'EXPLOSION SI LA BATTERIE EST REMPLACÉE PAR UNE BATTERIE DE TYPE INCORRECT.
METTRE AU REBUT LES BATTERIES USAGÉES CONFORMÉMENT AUX INSTRUCTIONS.

※ Select an installation site that can hold at least 4 times the monitor weight.

CONTENTS

OVERVIEW

4

- 4 Package Contents
- 5 Names and functions of each part
- 9 Remote control

MENU SETTINGS

10

- 10 OSD Menu setting
- 16 Camera setup

NETWORK CONNECTION AND SETUP & WEBVIEWER

17

- 17 Connecting the PVM Directly to Local Area Networking
- 18 Connecting the PVM Directly to a DHCP Based DSL/Cable Modem
- 19 Using Device Manager
- 19 Automatically searching camera
- 19 Configuring IP address
- 21 Manually registering camera
- 22 Automatically configuring IP
- 22 Port Range Forward (Port Mapping) Setup
- 24 Connecting to the Camera from a Shared Local PC
- 24 Connecting to the Camera from a Remote PC via the Internet
- 24 Connecting to the Camera
- 26 Password setting
- 26 Login
- 26 Camera Web Viewer Setup

SETUP SCREEN

27

- 27 Setup
- 27 Creating a text overlay
- 28 Setting slide show
- 30 Setting alarm input

APPENDIX

33

- 33 Mechanical
- 36 Troubleshooting

overview

PACKAGE CONTENTS

Please check the following contents are included in addition to the main unit.

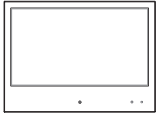

Public View Monitor

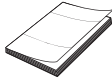

User Manual

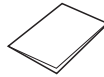

Warranty card



Power Cable

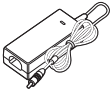

Adapter



Remote Controller



Battery



Terminal Block

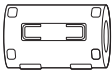

Ferrite Core
(SMT-1030PV only)

NAMES AND FUNCTIONS OF EACH PART

SMT-1030PV(10")

Front

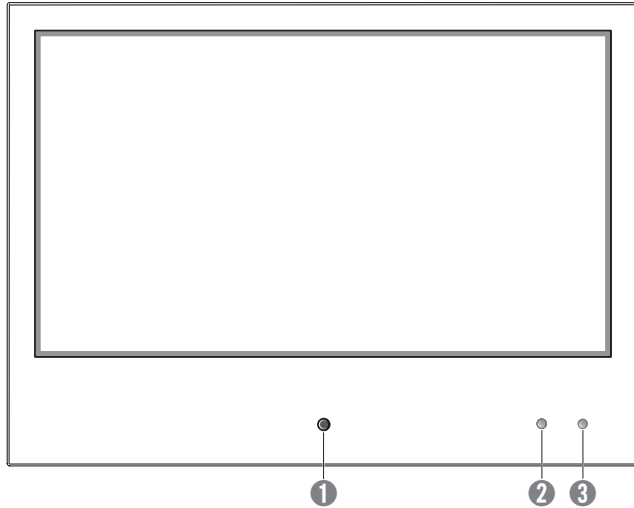

Name		Description of functions
1	Camera Lens	TNB-6030 camera is installed.
2	IR Receiver	Receive IR signal from Remote Controller.
3	LED	Displays the power ON/OFF status. ON – GREEN OFF – RED

overview

Back

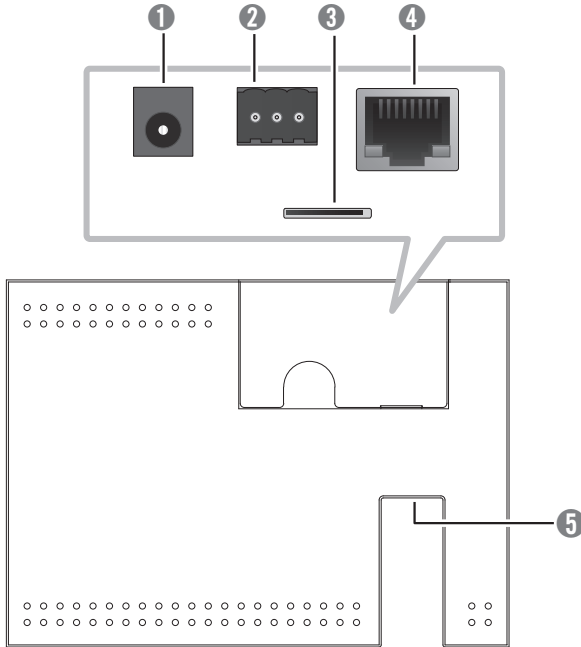

Name		Description of functions
1	DC 12V	This is the power input terminal.
2	ALARM	ALARM signal input / output
3	Micro SD	Compartment for the Micro SD card.
4	PoE	Power of Ethernet(802.3at)
5	RESET	Resets the camera installed in the monitor to its factory default settings. <ul style="list-style-type: none"> ▪ If you forget your password, use the RESET button.



- Wrap the ferrite core provided as an accessory two times around the LAN cable.

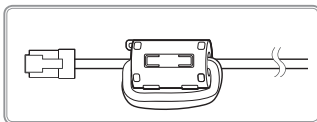

SMT-2730PV(27") / 3230PV(32")

Front

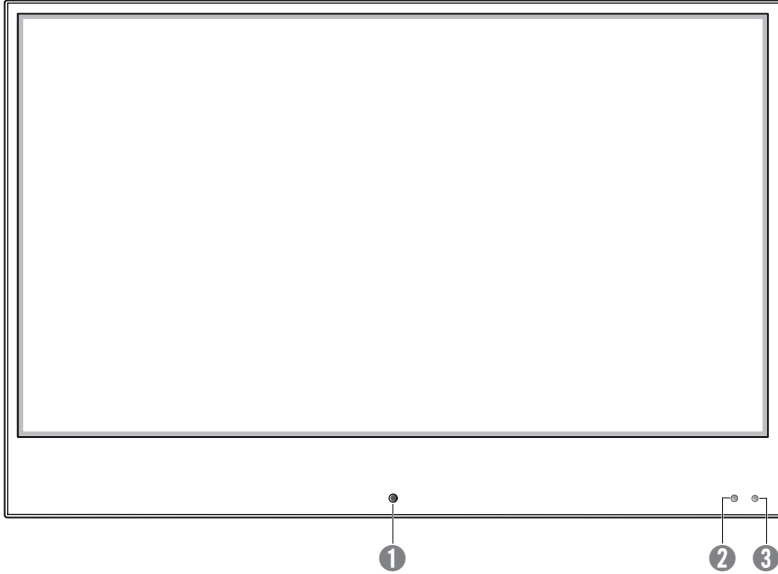

Name		Description of functions
1	Camera Lens	TNB-6031 camera is installed.
2	IR Receiver	Receive IR signal from Remote Controller.
3	LED	Displays the power ON/OFF status. ON – GREEN OFF – RED

Back

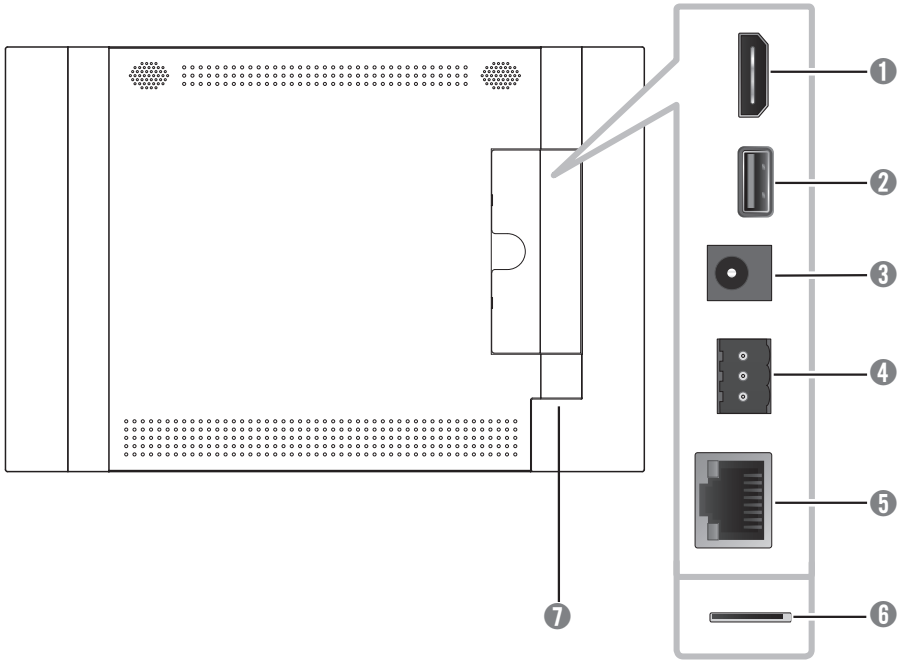

Name		Description of functions
1	HDMI	HDMI input terminal.
2	USB	Connects the USB devices.
3	DC 12V	This is the power input terminal.
4	ALARM	ALARM signal input / output
5	NETWORK	Used to connect the Ethernet cable for network connection.
6	Micro SD	Compartment for the Micro SD card.
7	RESET	Resets the camera installed in the monitor to its factory default settings. <ul style="list-style-type: none"> ■ If you forget your password, use the RESET button.

REMOTE CONTROL

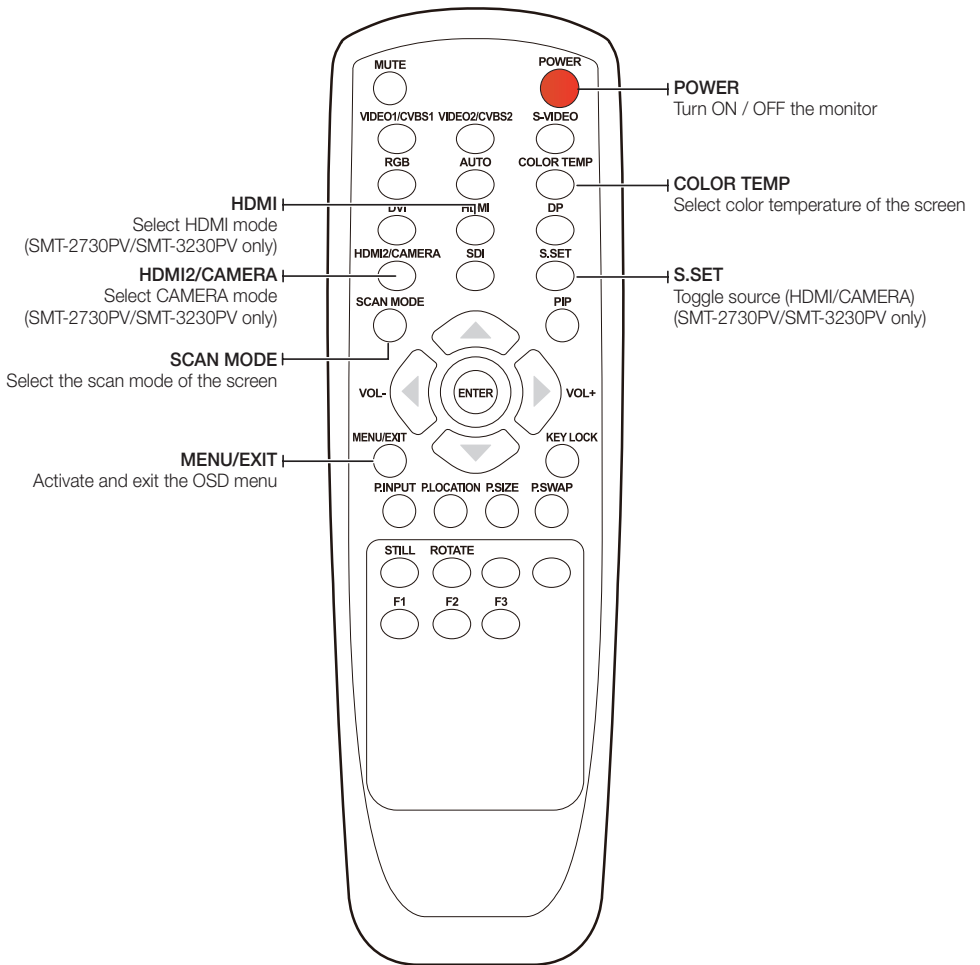



Those buttons without specific description are deprecated buttons.

menu settings

OSD MENU SETTING

MENU STRUCTURE

When user presses the menu key, the first "PICTURE" menu is displayed. Select by "◀" key then two types of menu functions are shown as below.

- PICTURE () : Menu related to PICTURE Function
- OPTION () : Other OSD Menu Status Control and Firmware Update

PICTURE MENU

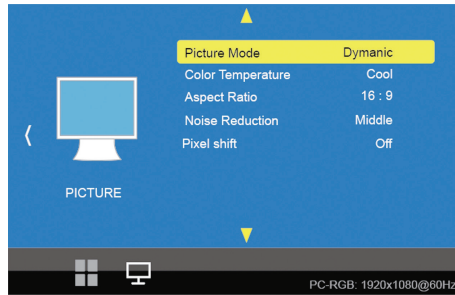

The PICTURE Menu can be selected from the following 5 modes by pressing the ▲ or ▼ key.

functions	Description
Picture Mode	Adjust setting of the picture
Color Temperature	Change color according to the color temperature
Aspect Ratio	Change the aspect ratio
Noise Reduction	Adjust noise attenuation of input signal
Pixel shift	Select auto pixel shift

Picture Mode

Picture Mode can select 4 modes as Mild, Dynamic, Standard and User as shown in the figure below. Press the "◀, ▶" key to change the mode.

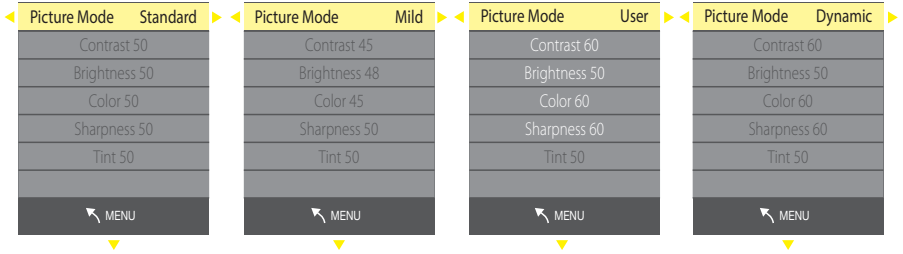

Three of the four modes except for User mode are shipped with fixed values at the time of shipment from the factory.

User mode can be set with "◀, ▶" keys by selecting each item below with "▲, ▼" key only in the User mode.

Contrast	Adjust difference in the color and brightness
Brightness	Adjust the dark and light
Color	Adjust for desired color intensity
Sharpness	Adjust for best clarity of outline detail
Tint	Adjust for natural flesh tones

Color Temperature

Color Temperature can select 4 modes as Cool, Medium, Warm and User as shown in the figure below.

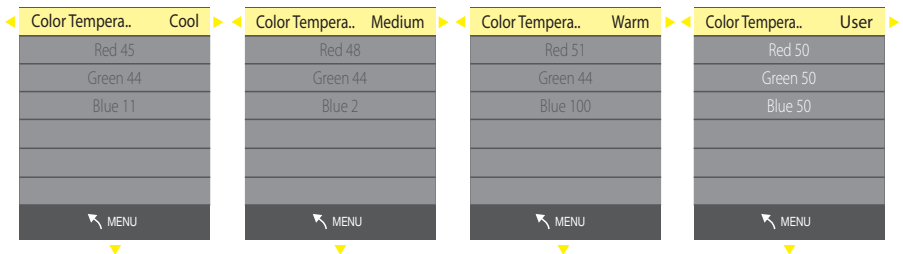

Three modes except User mode are factory shipped with factory default values, and each color item (Red, Green, Blue) is selected with the "▲, ▼" keys in the User mode only.

User settings are available.

menu settings

Aspect Ratio

Aspect Ratio allows user to select the each aspect ratio as shown in the figure below.
(However, activated list is according to the input port and the input resolution.)

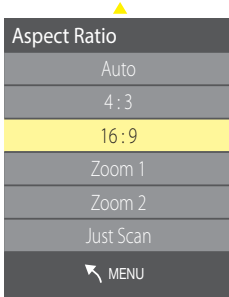

Noise Reduction

Noise Reduction can select 5 modes as Off, Low, Middle, High, Default as shown in the figure below.

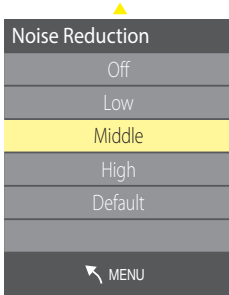

Pixel shift

Select auto pixel shift (On, Off)

OPTION MENU

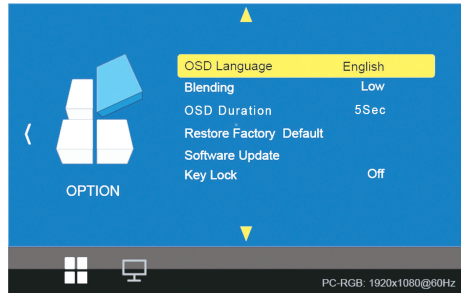

The Option Menu can be selected from the following 7 modes by pressing the ▲ or ▼ key.

functions	Description
OSD Language	Selectable OSD Menu Language
Blending	Adjust blending for OSD Menu and Main window
OSD Duration	Setting Duration time of OSD Menu
Restore Factory Default	Resets the monitor to its factory default settings.
Software Update	Updates the monitor.

menu settings

OSD Language

As shown in the figure below, OSD Language can be selected by “▲, ▼” key.

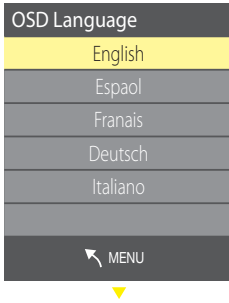

- Press the EXIT button to exit the Setup screen. Then, the language will be changed to the selected language.

Blending

OSD Menu Blending can select 4 modes as Off, Low, Middle, High by pressing the “ENTER” key.

OSD Duration

OSD menu Duration can select 4 modes as 5, 10, 15Sec and Off by pressing the “ENTER” key.

Restore Factory Default

Restore factory default can be selected by pressing the “ENTER” key. Select Yes or No by the “◀, ▶” key.

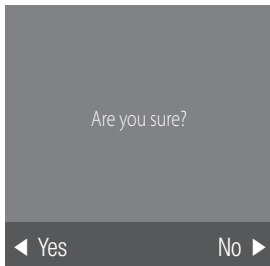

Software Update(Monitor)

Software update default can be selected by pressing the "MENU" key. Select Yes or No by the "◀, ▶" key.

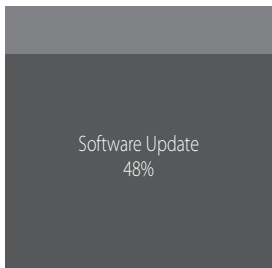
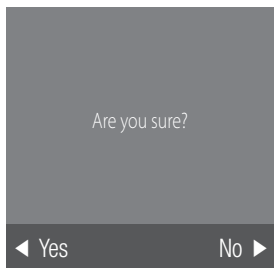

- See below for more information on how to update software for each model:
 - SMT-1030PV: You can update it using a Micro SD card that can be inserted into the Micro SD card port inside the product.
 - SMT-2730PV/SMT-3230PV: You can update it using a USB that can be connected through the external USB port.

menu settings

CAMERA SETUP

Supported video modes

You can use various video modes, and some video modes need to be set up in the camera web viewer.

Live video

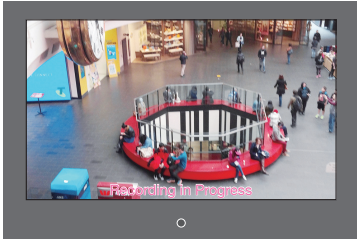

You can watch a live monitoring feed.

Still image

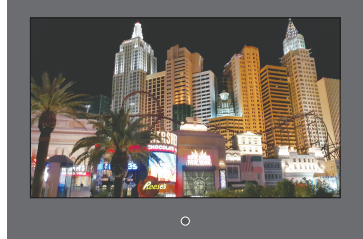

You can see images with Still image.

HDMI input

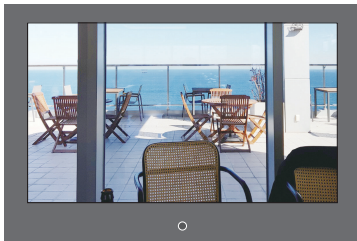

Video is displayed through HDMI input.
(SMT-2730PV/SMT-3230PV only)

Slide show & Live video

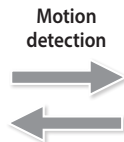
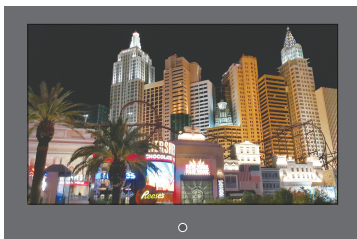

Screen transition
after set Dwell
time

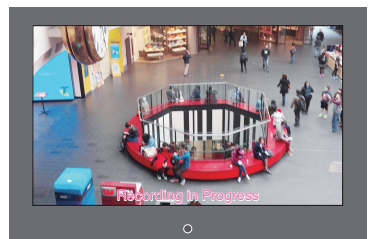

When motion is detected, the screen mode changes from Still image to Live video.



- See the camera manual for more information on recording.

network connection and setup & webviewer

You can set up the network settings according to your network configurations.

CONNECTING THE PVM DIRECTLY TO LOCAL AREA NETWORKING

Connecting to the PVM from a local PC in the LAN

1. Launch an Internet browser on the local PC.
2. Enter the IP address of the PVM in the address bar of the browser.

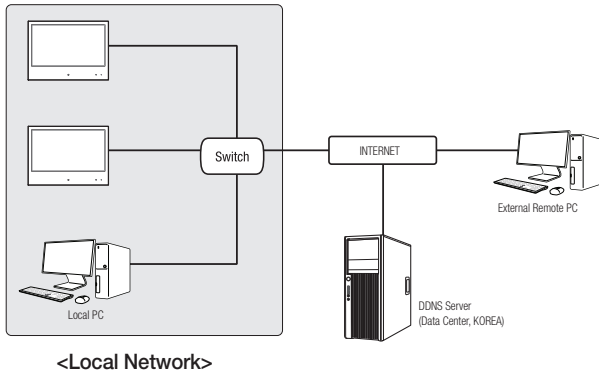

- A remote PC in an external Internet out of the LAN network may not be able to connect to the PVM installed in the intranet if the port-forwarding is not properly set or a firewall is set. In this case, to resolve the problem, contact your network administrator.
- By factory default, the IP address will be assigned from the DHCP server automatically. If there is no DHCP server available, the IP address will be set to 192.168.1.100. To change the IP address, use the Device Manager. For further details on Device Manager use, refer to "**Using Device Manager**". (Page 19)

network connection and setup & webviewer

CONNECTING THE PVM DIRECTLY TO A DHCP BASED DSL/CABLE MODEM

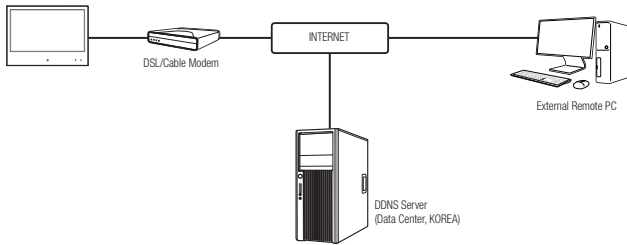

1. Connect the user PC directly with the PVM.
2. Run the Device Manager and change the IP address of the PVM so that you can use the web browser on your desktop to connect to the Internet.
3. Use the Internet browser to connect to the web viewer.
4. Move to **[Setup]** page.
5. Move to **[Network]** – **[DDNS]** and configure the DDNS settings.
6. Move to **[Basic]** – **[IP & Port]**, and set the IP type to **[DHCP]**.
7. Connect the PVM, which was removed from your PC, directly to the modem.
8. Restart the camera.



- For information on how to set DDNS, refer to the online help of Web Viewer.
- For information on how to set the IP format, refer to the online help of Web Viewer.

USING DEVICE MANAGER



- Device manager program can be downloaded from <Technical Guides>-<Online Tool> menu at Hanwha Techwin website (<http://www.hanwha-security.com>).
- More instructions of Device Manager can be found at <Help> menu of the main page.

AUTOMATICALLY SEARCHING CAMERA

If a camera is connected to the same network of the PC where device manager is installed, you can find network camera by using search function.

- Click <Search> at the main page of device manager.
- Check the camera from the list.
 - Check MAC address at the sticker attached to the camera.

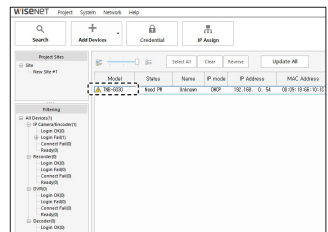

- When searching devices in the Device manager, the result of searching 10" is **TNB-6030**, while the result of searching 27"/32" is **TNB-6031**.

CONFIGURING IP ADDRESS

If you want to change camera network setting, <Login OK> sign must be displayed at <Status>. Click <Authentication> at the main page to log in.

Configuring Static IP

Manually insert and configure IP address & port information.

- Click the camera from the list that you want to change the IP setting.
- Click <IP Assign> at the main page of device manager.
- Select <Assign the following IP address>.
 - IP information of the camera will be displayed as previously set.
- Fill in IP & Port related categories.

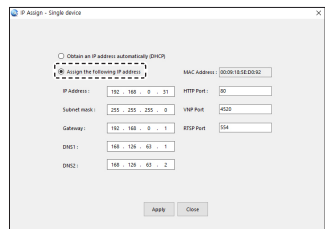

If not using a Broadband Router

For setting <IP Address>, <Subnet Mask>, and <Gateway>, contact your network administrator.

- HTTP Port : Used to access the camera using the Internet browser, defaulted to 80.
- RTSP Port : A port that controls real-time streaming. The initial value is 554.

network connection and setup & webviewer

If using a Broadband Router

- IP Address : Enter an address falling in the IP range provided by the Broadband Router.
ex) 192.168.1.2~254, 192.168.0.2~254, 192.168.XXX.2~254
- Subnet Mask : The <Subnet Mask> of the Broadband Router will be the <Subnet Mask> of the camera.
- Gateway : The <Local IP Address> of the Broadband Router will be the <Gateway> of the camera.

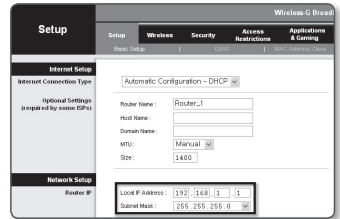

- The settings may differ depending on the connected Broadband Router model. For more information, refer to the user manual of the applicable router.
- For more information about port forwarding of the broadband router, refer to "**Port Range Forward (Port Mapping) Setup**". (Page 22)

If the Broadband Router has more than one camera connected

Configure the IP related settings and the Port related settings distinctly with each other.

ex)

Category		Camera #1	Camera #2
IP related settings	IP Address	192.168.1.100	192.168.1.101
	Subnet Mask	255.255.255.0	255.255.255.0
	Gateway	192.168.1.1	192.168.1.1
Port related settings	HTTP Port	8080	8081
	RTSP Port	554	555



- If the <HTTP Port> is set other than 80, you must provide the <Port> number in the address bar of the Internet browser before you can access the camera.
ex) http://IP address : HTTP Port
http://192.168.1.100:8080

5. Click [Apply] Button.

6. If the success message is displayed, click [OK].

Configuring Dynamic IP

Receive IP address from DHCP

- Example of the Dynamic IP environment
 - If a Broadband Router, with cameras connected, is assigned an IP address by the DHCP server
 - If connecting the camera directly to modem using the DHCP protocols
 - If IPs are assigned by the internal DHCP server via the LAN

1. Click the camera from the list that you want to change the IP setting.
2. Click **<IP Assign>** at the main page of device manager.
3. Select **<Obtain an IP address automatically (DHCP)>**.
4. Click **[Apply]** button.
5. If the success message is displayed, click **[OK]**.

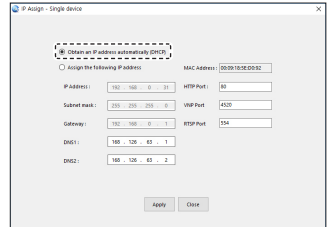

MANUALLY REGISTERING CAMERA

If the camera cannot be found using search function, the camera can be registered remotely by manually inserting IP information, if the camera is connected to external network.

1. Click **<Add Devices>** - **<Manually Add Device>** at the main page of device manager.
2. Insert the range of IP address that you search.
3. Select the **<Model Name>** of the camera that you register, and insert HTTP port, ID, and password.
4. Click **[Register]** button.
5. Check if camera is registered.
 - Check MAC address at the sticker attached to the camera.

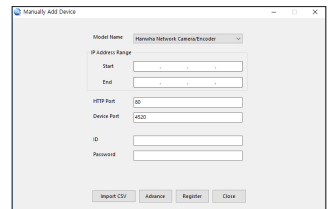

network connection and setup & webviewer

AUTOMATICALLY CONFIGURING IP

1. Click the camera from the list that you want to automatically configure the IP.
2. Click < + > at the main page of device manager.
 - Equipment Setting menu appears.
3. At the menu, click <Auto IP Configure>.
4. Click [Close] button.

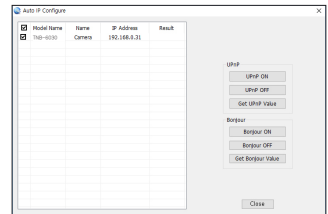

PORT RANGE FORWARD (PORT MAPPING) SETUP

If you have installed a Broadband Router with a camera connected, you must set the port range forwarding on the Broadband Router so that a remote PC can access the camera in it.

Manual Port Range Forwarding

1. From the Setup menu of the Broadband Router, select <Applications & Gaming> - <Port Range Forward>. For setting the port range forward for a third-party Broadband Router, refer to the user guide of that Broadband Router.
2. Select <TCP> and <UDP Port> for each connected camera to the Broadband Router. The number of each port to be configured to the IP router should be set according to the port number designated in <Setup> - <Basic> - <IP & Port> on the camera web viewer.
3. When done, click [Save Settings]. Your settings will be saved.

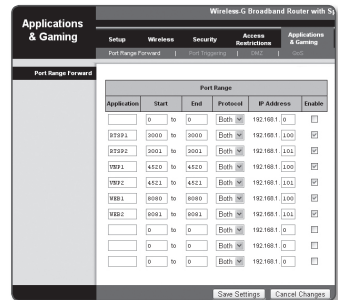

- Port forwarding setting is an example of setting CISCO IP router.
- The settings may differ depending on the connected Broadband Router model. For more information, refer to the user manual of the applicable router.

Setting up Port Range Forward for several network cameras

- You can set a rule of Port Forwarding on the Broadband Router device through its configuration web page.
- A user can change each port using the camera setting screen.

When Camera1 and Camera2 are connected to a router :

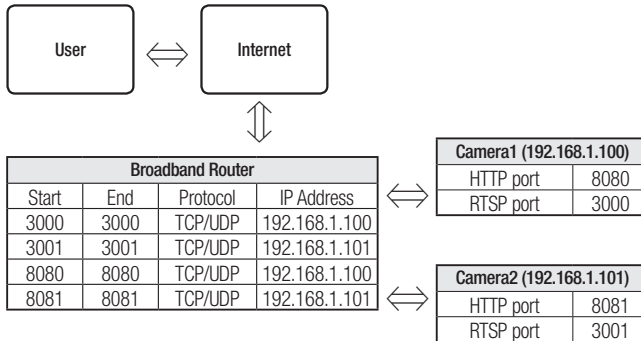

- Port forwarding can be done without additional router setup if the router supports the UPnP (Universal Plug and Play) function.
After connecting the network camera, select the checkbox from the menu <Quick connect> in <Wisenet DDNS> in "Settings -> Network -> DDNS".

network connection and setup & webviewer

CONNECTING TO THE CAMERA FROM A SHARED LOCAL PC

1. Run device manager.
It will scan for connected cameras and display them as a list.
2. Double-click a camera to access.
The Internet browser starts and connects to the camera.



- Access to the camera can also be gained by typing the camera's IP address in the address bar of the Internet browser.

CONNECTING TO THE CAMERA FROM A REMOTE PC VIA THE INTERNET

On a remote computer that is not in the Broadband Router's network cluster is not allowed, users can access cameras within a Broadband Router's network by using the camera's DDNS URL.

1. Before you can access a camera in the Broadband Router network, you should have set the port range forward for the Broadband Router.
2. From the remote PC, launch the Internet browser and type the DDNS URL address of the camera, or the IP address of the Broadband Router in the address bar.
ex) <http://ddns.hanwha-security.com/ID>



- To use Wisenet DDNS, sign up at the Wisenet DDNS homepage (<http://ddns.hanwha-security.com>) and register the product at **[My DDNS]>[Register Product]**.

CONNECTING TO THE CAMERA

Normally, you would

1. Launch the Internet browser.
2. Type the IP address of the camera in the address bar.
ex) • IP address (IPv4) : 192.168.1.100 → <http://192.168.1.100>
- the Login dialog should appear.
• IP address (IPv6) : 2001:230:abcd:ffff:0000:0000:ffff:1111
→ [http://\[2001:230:abcd:ffff:0000:0000:ffff:1111\]](http://[2001:230:abcd:ffff:0000:0000:ffff:1111]) - the Login dialog should appear.

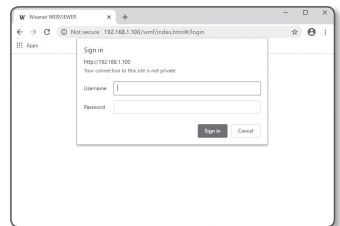

If the HTTP port is other than 80

1. Launch the Internet browser.

Type the IP address and HTTP port number of the camera in the address bar.

ex) IP address : 192.168.1.100:HTTP Port number(8080)

→ <http://192.168.1.100:8080> - the Login dialog should appear.

Using URL

1. Launch the Internet browser.
2. Type the DDNS URL of the camera in the address bar.
ex) URL address : <http://ddns.hanwha-security.com/ID>
- the Login dialog should appear.



- Network connection is disabled in the LAN only environment.

Connecting via UPnP

1. Run the client or operating system in support of the UPnP protocol.
2. Click the camera name for search.
In the Windows operating system, click the camera name searched from the network menu.
 - The login window is displayed.

Connecting via Bonjour

1. Run the client or operating system in support of the Bonjour protocol.
2. Click the camera name for search.
In the Mac operating system, click the camera name searched from the Bonjour tab of Safari.
 - The login window is displayed.

To check the DDNS address

If the camera is connected directly to a DHCP-based cable modem or DSL modem, the IP address will change each time it tries to connect to the ISP (the company you subscribed to).

If this is the case, you will not be informed of the IP address changed by DDNS.

Once you register a dynamic IP-based device with the DDNS server, you can easily check the changed IP when you try to access the device.

To register your device to the <DDNS> server, visit <http://ddns.hanwha-security.com> and register your device first, and then set the Web Viewer's <Network> - <DDNS> to <Wisenet DDNS>, as well as providing <Product ID> that had been used for DDNS registration.

network connection and setup & webviewer

PASSWORD SETTING

When you access the product for the first time, you must register the login password.



- For a new password with 8 to 9 digits, you must use at least 3 of the following: uppercase/lowercase letters, numbers and special characters. For a password with 10 to 15 digits, you must use at least 2 types of those mentioned.
 - Special characters that are allowed: `~!@#$$%^&*()-+=|{}[];?/`

- For higher security, you are not recommended to repeat the same characters or consecutive keyboard inputs for your passwords.
- If you lost your password, you can press the **[RESET]** button to initialize the product. So, don't lose your password by using a memo pad or memorizing it.

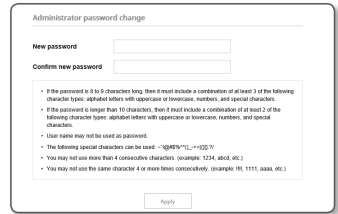

LOGIN

Whenever you access the camera, the login window appears. Enter the User ID and password to access the camera.

- Enter **“admin”** in the **<User name>** input box. The administrator ID, **“admin”**, is fixed and can not be changed.
- Enter the password in the **<Password>** input field.
- Click **[Sign in]**.
If you have logged in successfully, you will see the Live Viewer screen.

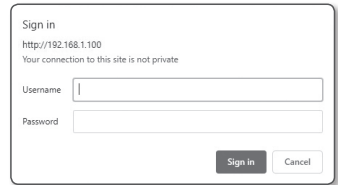

- When you access the camera web viewer, pay special attention to the security by checking whether the image data is encrypted.



- If you check the **“Remember my credentials”** option when your input is done, in future you will be logged in automatically without being prompted to enter the login information.
- You will experience the best video quality if the screen size is 100%. Reducing the ratio may cut the image on the borders.

CAMERA WEB VIEWER SETUP

- Click the **[Setup (⚙️)]** icon.
- The Settings window appears.
- You can configure settings for the camera's basic information, video, audio, network, event, analysis, and system over the network.
- Click **<Help (🔍)>** to view detailed descriptions of each function.

setup screen

SETUP

On the network, you can set up basic information on the camera, video and audio, network, events, people counting, heatmap and system.

1. On the live screen, click the **[Setup (⚙)]** button.
2. The Setup screen appears.



CREATING A TEXT OVERLAY

1. From the Setup menu, select the **<Video & Audio>** tab.
2. Click **<Camera setup>**.

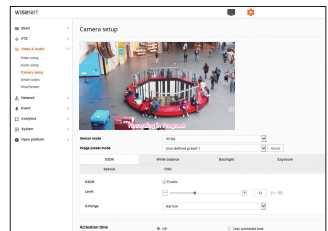

3. Select **<OSD>**.

- The default setting for OSD is "Recording in Progress."

4. Select each item and set it properly.

- OSD Blink : When you check the **<Enable>** box, you will see that the OSD blinks on the Public View Monitor.
- Camera title : It specifies the name of the camera to be displayed on the screen.
Select the **<Enable>** check box to add a camera name.
 - Add : Click the **<Add>** button and you can add a total of 5 lines, 17 characters per line and a total of 85 characters.
 - Preview : Click the **<Preview>** button to check the name of camera that will be displayed on the screen.
- Camera title X, Y : It specifies the position of the camera name on the screen.
- Date & time : Set the time display and date formats on the screen.
- Date & Time X, Y : Specify the position of time display on the screen.
- Weekday overlay : Specify the use of date display date on the screen.
- Size : Sets the size of OSD to small/medium/large.
- Color : Sets the color of the OSD to white/red/blue/green/black/gray.
- Transparency : Sets the transparency of OSD to opaque / low / middle / high.

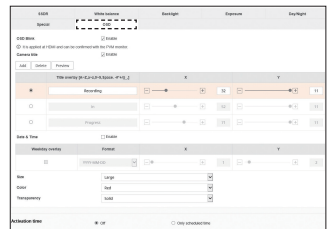

- A position-adjustable item (Camera title, Date & Time) may not be displayed normally if it overlaps with another fixed OSD item.
- Multilingual other than English: Input only in the selected language is available.

SETTING SLIDE SHOW

Setting Micro SD card

1. From the Setup menu, select the **<Event>** tab.
2. Click **<Storage>**.
3. Select **<On>** for the **<Record>** section of Micro SD Card, and click **<Apply>**.
4. Once Status of Micro SD Card is activated, click **<Format>**.
5. Set Image dwell time/Live streaming time.
6. Select an image to upload and click **<Upload>**. Then, file conversion and upload will automatically proceed.
 - File conversion takes about 30 seconds to complete. During the process, do not power off camera or move to another page because doing so will make the process to fail.
7. Once successfully uploaded, the uploaded file name will appear in the image list.
8. Checking the Enable box runs the feature.

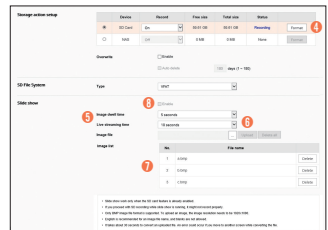
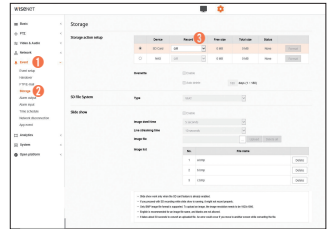

- If you run both Recording and Slide show features of Micro SD card at the same time, the performance of recording might drop.
- Only the encoding of BMP file format and 1920 x 1080 resolution image can be converted.
- Up to 10 images can be uploaded.
- See the camera manual for Micro SD card setup and recommended specifications.

Motion detection setup

1. From the Setup menu, select the **<Event>** tab.
2. Click **<Event setup>**.
3. Check the **<Motion detection>** box.
 - Clicking Motion detection moves you to the Motion detection menu setup screen.
4. Click **<Apply>**.

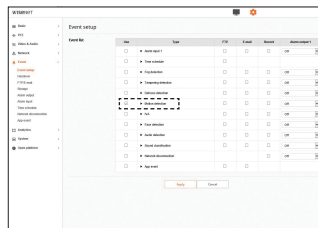

Motion detection menu setup

1. From the Setup menu, select the **<Analytic>** tab.
2. Click **<Motion detection>**.
3. Set the desired detection area/sensitivity and others.
4. If motion is detected, it changes from Still image to Live video.
 - If you enable only Slide show but not Motion detection, only Still image will be shown.

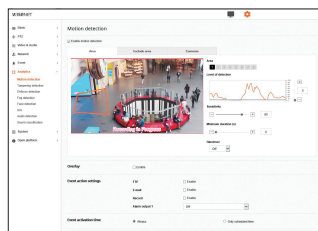

SETTING ALARM INPUT

Connecting to the I/O port box

Connect the Alarm I/O cable to the corresponding port of the port box.

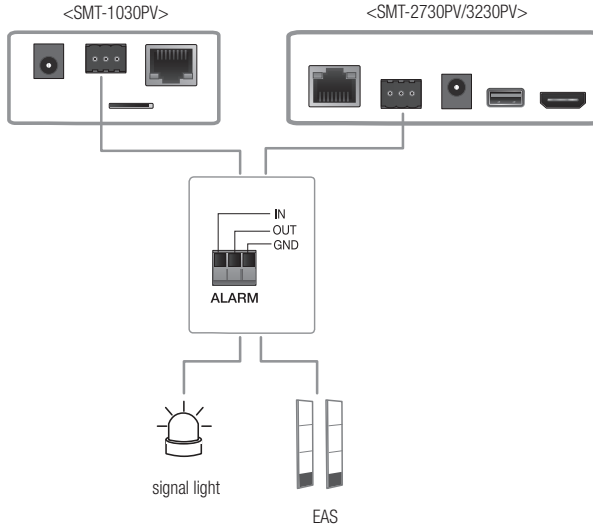

- ALARM-IN : Used to connect the alarm input sensor.
- ALARM-OUT : Used to connect the alarm output signal.
- GND : Common port for alarm in/output signal.



- If devices (e.g., flashing light and siren) that exceed the voltage and current specifications are connected by using the open collector method, it may cause malfunction. Refer to the **"Alarm Out Wiring Diagram"** when connecting devices that exceed the voltage and current specifications.

Alarm In Wiring Diagram

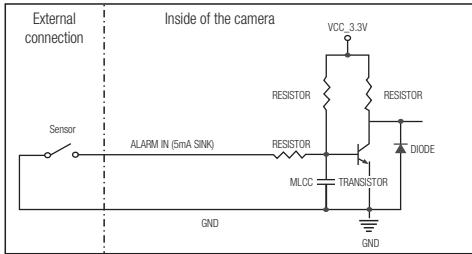

Alarm Out Wiring Diagram

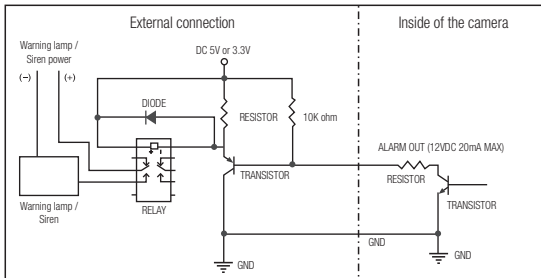

setup screen

Alarm input

You can set the alarm input type, activation time, and operation mode.

1. From the Setup menu, select the **<Event>** tab.
2. Click **<Alarm input>**.
3. Set whether or not to **<Enable>**.
4. Select the type.
 - N.O. (Normal Open) : It is normally open, but if it is closed, an alarm will be triggered.
 - N.C. (Normal Close) : It is normally closed, but if it is open, an alarm will be triggered.

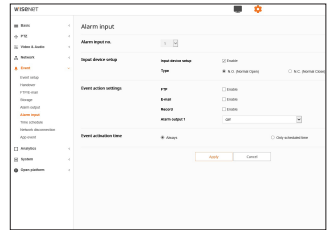

5. Specify the **<Event activation time>**.
 - Always : Always check if an alarm occurs. It activates in operated mode when the alarm occurs.
 - If set to **<Always>**, the activation time cannot be changed.
 - Only scheduled time : Check if an alarm occurs at a specified day of the week for a specified time period. It activates in operated mode when the alarm occurs.
 - [1 min 30 min 1 h] : Sets the time display format on the vertical axis.
 - [Reset] : Reset all settings.
6. Specify an operation that will perform if an alarm occurs.
 - FTP : Specify the use of FTP transfer in the alarm input setup.
 - E-mail : Specify the use of email transfer in the alarm input setup.
 - Record : You can set up the alarm to record to a Micro SD card or an NAS when operating.
 - Alarm output1 : Select whether to set the alarm output if an alarm is incoming, and specify the alarm output time.
7. When done, click **[Apply]**.

MECHANICAL

CABINET

Material : Metal, Finish : Black

DIMENSIONS

SMT-1030PV

unit : mm

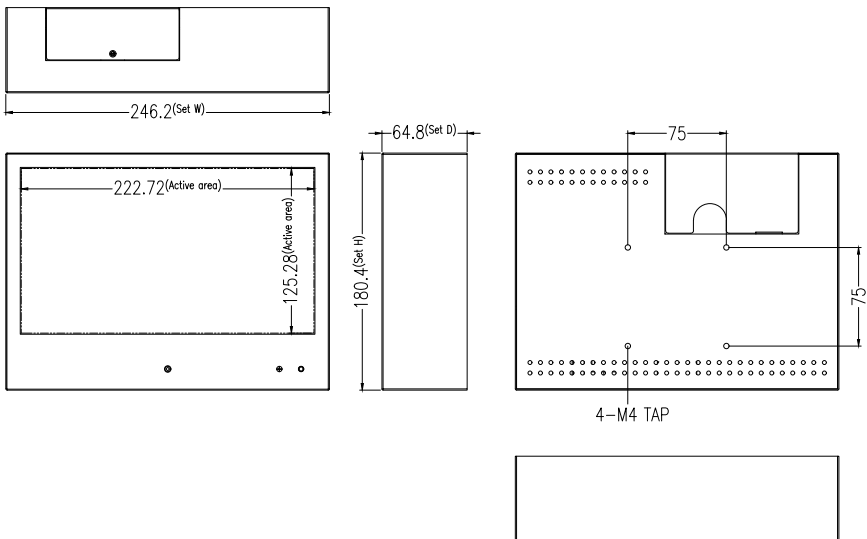

Set Size	246.2 x 180.4 x 64.8mm (9.69 x 7.1 x 2.55inch)
Net Weight	2kg (4.41lbs)
Shipping Weight	3Kg (6.61lbs)
Packing Dimension (W x H x D)	338 x 276 x 153 mm (13.31 x 10.87 x 6.02inch)
VESA Mounting	75 x 75mm (M4 x 10mm)



- Since the use of a screw longer than the standard size may cause a problem, the above recommended screw must be used.

SMT-2730PV

unit : mm

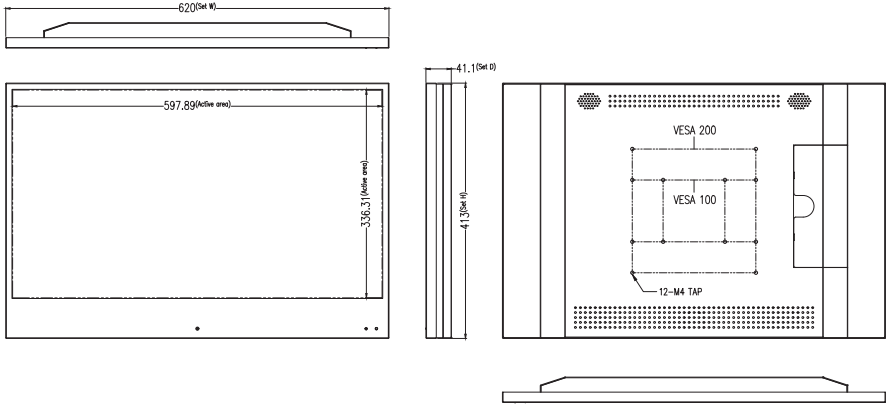

Set Size	620 x 413 x 41.1mm (24.41 x 16.26 x 1.62inch)
Net Weight	8.5kg (18.74lbs)
Shipping Weight	11Kg (24.25lbs)
Packing Dimension (W x H x D)	750 x 551 x 194mm (29.53 x 21.69 x 7.64inch)
VESA Mounting	100 x 100mm / 200 x 100mm / 200 x 200mm (M4 x 10mm)



- Since the use of a screw longer than the standard size may cause a problem, the above recommended screw must be used.

SMT-3230PV

unit : mm

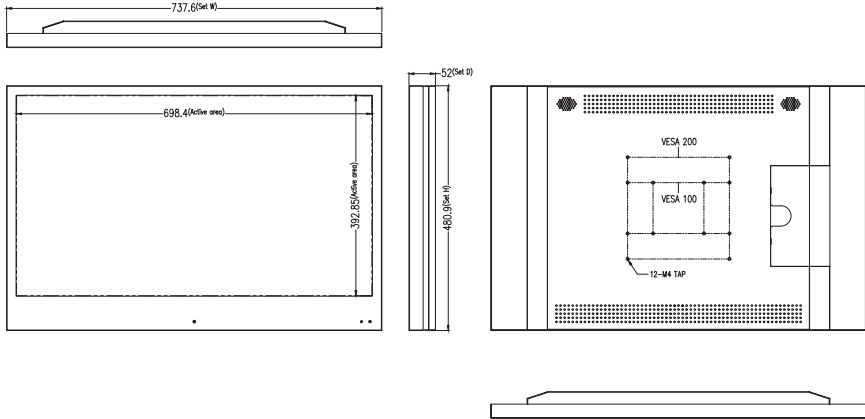

Set Size	737.6 x 480.9 x 52mm (29.04 x 18.93 x 2.05inch)
Net Weight	12.9kg (28.44lbs)
Shipping Weight	16.6Kg (36.60lbs)
Packing Dimension (W x H x D)	891 x 648 x 213mm / 35.08 x 25.51 x 8.39inch
VESA Mounting	100 x 100mm / 200 x 100mm / 200 x 200mm (M4 x 10mm)



- Since the use of a screw longer than the standard size may cause a problem, the above recommended screw must be used.

TROUBLESHOOTING

When the following troubles are occurred, follow the trouble shooting.
Before contacting service center.

Problems and Symptoms	Troubleshooting
The screen doesn't show up	<ul style="list-style-type: none">• Make sure if the power supply is connected property• Turn on the power.• Select the input signal right for the connected port.
The screen is too light or to dark	<ul style="list-style-type: none">• Control the BRIGHTNESS
The screen size is not fit for the PC signal	<ul style="list-style-type: none">• Press the AUTO key among keys in the front. (It is used only in the PC signal)
The screen color shows strange in the PC signal	<ul style="list-style-type: none">• In the FUNCTION menu of OSD menu, perform the AUTO ADJUST.



Hanwha Techwin cares for the environment at all product manufacturing stages, and is taking measures to provide customers with more environmentally friendly products.

The Eco mark represents Hanwha Techwin's devotion to creating environmentally friendly products, and indicates that the product satisfies the EU RoHS Directive.



Correct Disposal of This Product (Waste Electrical & Electronic Equipment)

(Applicable in the European Union and other European countries with separate collection systems)

This marking on the product, accessories or literature indicates that the product and its electronic accessories (e.g. charger, headset, USB cable) should not be disposed of with other household waste at the end of their working life. To prevent possible harm to the environment or human health from uncontrolled waste disposal, please separate these items from other types of waste and recycle them responsibly to promote the sustainable reuse of material resources.

Household users should contact either the retailer where they purchased this product, or their local government office, for details of where and how they can take these items for environmentally safe recycling.

Business users should contact their supplier and check the terms and conditions of the purchase contract. This product and its electronic accessories should not be mixed with other commercial wastes for disposal.



Correct disposal of batteries in this product

(Applicable in the European Union and other European countries with separate battery return systems.)

This marking on the battery, manual or packaging indicates that the batteries in this product should not be disposed of with other household waste at the end of their working life. Where marked, the chemical symbols Hg, Cd or Pb indicate that the battery contains mercury, cadmium or lead above the reference levels in EC Directive 2006/66. If batteries are not properly disposed of, these substances can cause harm to human health or the environment.

To protect natural resources and to promote material reuse, please separate batteries from other types of waste and recycle them through your local, free battery return system.

Head Office

6, Pangyo-ro 319 beon-gil, Bundang-gu, Seongnam-si,
Gyeonggi-do, 463-400 Rep. of KOREA
Tel : +82.70.7147.8753 Fax : +82.31.8018.3740
www.hanwha-security.com

Hanwha Techwin America

500 Frank W. Burr Blvd. Suite 43 Teaneck, NJ 07666
Toll Free +1.877.213.1222 Direct +1.201.325.6920
Fax +1.201.373.0124
www.hanwhasecurity.com

Hanwha Techwin Europe

Heriot House, Heriot Road, Chertsey, Surrey, KT16 9DT, United Kingdom
Tel +44.1372.235663 Fax +44.1932.57.8101
www.hanwha-security.eu

Hanwha Techwin Vietnam Hanoi Office

28th Floor, Handico Building, Pham Hung Street, Me Tri ward,
Nam Tu Liem District, Hanoi City, Vietnam
Tel : +84.91.982.40.88
www.hanwha-security.com
