

Acer LCD Monitor

User Guide

Copyright © 2021. Acer Incorporated.
All Rights Reserved.

Acer LCD Monitor User Guide
Original Issue: 7/2021

Changes may be made periodically to the information in this publication without obligation to notify any person of such revisions or changes. Such changes will be incorporated in new editions of this manual or supplementary documents and publications. This company makes no representations or warranties, either expressed or implied, with respect to the contents hereof and specifically disclaims the implied warranties of merchantability or fitness for a particular purpose.

Record the model number, serial number, purchase date and place of purchase information in the space provided below. The serial number and model number are recorded on the label affixed to your computer. All correspondence concerning your unit should include the serial number, model number and purchase information.

No part of this publication may be reproduced, stored in a retrieval system, or transmitted, in any form or by any means, electronically, mechanically, by photocopy, recording or otherwise, without the prior written permission of Acer Incorporated.

Acer LCD Monitor User Guide

Model number: _____
Serial number: _____
Date of purchase: _____
Place of purchase: _____

Acer and the Acer logo are registered trademarks of Acer Incorporated. Other companies' product names or trademarks are used herein for identification purposes only and belong to their respective companies.

Information for your safety and comrt

Safety instructions

Read these instructions carefully. Keep this document for future reference. Follow all warnings and instructions marked on the product.

Special notes on LCD monitors

The following are normal with the LCD monitor and do not indicate a problem.

- Due to the nature of the fluorescent light, the screen may flicker during initial use. Turn off the power switch and then turn it on again to make sure the flicker disappears.
- You may find slightly uneven brightness on the screen depending on the desktop pattern you use.
- The LCD screen has 99.99% or more effective pixels. It may include blemishes of 0.01% or less such as a missing pixel or pixel lit all the time.
- Due to the nature of the LCD screen, an afterimage of the previous screen may remain after switching the image, when the same image is displayed for hours. In this case, the screen is recovered slowly by changing the image or turning off the power switch for a few hours.

Cleaning your monitor

Please carefully follow these guidelines when cleaning the monitor:

- Always unplug the monitor before cleaning.
- Use a soft cloth to wipe the screen and cabinet front and sides.

Accessibility

Be sure that the power outlet you plug the power cord into is easily accessible and located as close to the equipment operator as possible. When you need to disconnect power from the equipment, be sure to unplug the power cord from the electrical outlet.

Safe listening

To protect your hearing, follow these instructions.

- Gradually increase the volume until you can hear it clearly and comfortably and without distortion.
- After setting the volume level, do not increase it after your ears have adjusted.
- Limit the amount of time listening to music at high volume.
- Avoid turning up the volume to block out noisy surroundings.
- Turn the volume down if you can't hear people speaking near you.

Warnings

- Do not use this product near water.
- Do not place this product on an unstable cart, stand or table. If the product falls, it could be seriously damaged.
- Slots and openings are provided for ventilation to ensure reliable operation of the product

and to protect it from overheating. These openings must not be blocked or covered. The openings should never be blocked by placing the product on a bed, sofa, rug or other similar surface. This product should never be placed near or over a radiator or heat register, or in a built-in installation unless proper ventilation is provided.

- Never push objects of any kind into this product through cabinet slots as they may touch dangerous voltage points or short-out parts that could result in a fire or electric shock. Never spill liquid of any kind onto or into the product.
- To avoid damage of internal components and to prevent battery leakage, do not place the product on a vibrating surface.
- Never use it under sporting, exercising, or any vibrating environment which will probably cause unexpected short current or damage internal devices.

Using electrical power

- This product should be operated from the type of power indicated on the marking label. If you are not sure of the type of power available, consult your dealer or local power company.
- Do not allow anything to rest on the power cord. Do not locate this product where people will walk on the cord.
- If an extension cord is used with this product, make sure that the total ampere rating of the equipment plugged into the extension cord does not exceed the extension cord ampere rating. Also, make sure that the total rating of all products plugged into the wall outlet does not exceed the fuse rating.
- Do not overload a power outlet, strip or receptacle by plugging in too many devices. The overall system load must not exceed 80% of the branch circuit rating. If power strips are used, the load should not exceed 80% of the power strip's input rating.
- This product's power cord is equipped with a three-wire grounded plug. The plug only fits in a grounded power outlet. Make sure the power outlet is properly grounded before inserting the power cord plug. Do not insert the plug into a non-grounded power outlet. Contact your electrician for details.
- **The off mode of this product is AC switch off, and standby mode is DC switch off**

Warning!

The grounding pin is a safety feature. Using a power outlet that is not properly grounded may result in electric shock and/or injury.

Note:

The grounding pin also provides good protection from unexpected noise produced by other nearby electrical devices that may interfere with the performance of this product.

- Use the product only with the supplied power supply cord set. If you need to replace the power cord set, make sure that the new power cord meets the following requirements: detachable type, UL listed/CSA certified, type SPT-2, rated 7 A 125 V minimum, VDE approved or its equivalent, 4.6 meters (15 feet) maximum length.

Product servicing

Do not attempt to service this product yourself, as opening or removing covers may expose you to dangerous voltage points or other risks. Refer all servicing to qualified service personnel.

Unplug this product from the wall outlet and refer servicing to qualified service personnel when:

- the power cord or plug is damaged, cut or frayed
- liquid was spilled into the product
- the product was exposed to rain or water
- the product has been dropped or the case has been damaged
- the product exhibits a distinct change in performance, indicating a need for service
- the product does not operate normally after following the operating instructions

Note:

Adjust only those controls that are covered by the operating instructions, since improper adjustment of other controls may result in damage and will often require extensive work by a qualified technician to restore the product to normal condition.

Potentially explosive environments

Switch off your device in any area with a potentially explosive atmosphere and obey all signs and instructions. Potentially explosive atmospheres include areas where you would normally be advised to turn off your vehicle engine. Sparks in such areas could cause an explosion or fire resulting in bodily injury or even death. Switch off the device near depots, storage and distribution areas; chemical plants; or where blasting operations are in progress. Areas with a potentially explosive atmosphere are often, but not always, marked. They include below deck on boats, chemical transfer or storage facilities, vehicles using liquefied petroleum gas (such as propane or butane), and areas where the air contains chemicals or particles such as grain, dust or metal powders.

Additional safety information

Your device and its enhancements may contain small parts. Keep them out of the reach of small children.

IT Equipment Recycling Information

Acer is strongly committed to environmental protection and views recycling, in the form of salvaging and disposal of used equipment, as one of the company's top priorities in minimizing the burden placed on the environment.

We at Acer are very conscious of the environmental effects of our business and strive to identify and provide the best working procedures to reduce the environmental impact of our products.

For more information and help when recycling, please go to this website:

<https://www.acer-group.com/sustainability/en/our-products-environment.html>

Visit www.acer-group.com for further information on the features and benefits of our other products.

Disposal instructions



Do not throw this electronic device into the trash when discarding. To minimize pollution and ensure utmost protection of the global environment, please recycle. For more information on the Waste from Electrical and Electronics Equipment (WEEE) regulations, visit <https://www.acer-group.com/sustainability/en/our-products-environment.html>

LCD pixel statement

The LCD unit is produced with high-precision manufacturing techniques. Nevertheless, some pixels may occasionally misfire or appear as black or red dots. This has no effect on the recorded image and does not constitute a malfunction.

Power management statement should be as below.

- Activate display's Sleep mode within 5 minutes of user inactivity.
- Wake the monitor when it is in Active Off mode, move the mouse or press any keyboard key.

Tips and information for comfortable use

Computer users may complain of eyestrain and headaches after prolonged use. Users are also at risk of physical injury after long hours of working in front of a computer. Long work periods, bad posture, poor work habits, stress, inadequate working conditions, personal health and other factors greatly increase the risk of physical injury.

Incorrect computer usage may lead to carpal tunnel syndrome, tendonitis, tenosynovitis or other musculoskeletal disorders. The following symptoms may appear in the hands, wrists, arms, shoulders, neck or back:

- numbness, or a burning or tingling sensation
- aching, soreness or tenderness
- pain, swelling or throbbing
- stiffness or tightness
- coldness or weakness

If you have these symptoms, or any other recurring or persistent discomfort and/or pain related to computer use, consult a physician immediately and inform your company's health and safety department.

The following section provides tips for more comfortable computer use.

Finding your comfort zone

Find your comfort zone by adjusting the viewing angle of the monitor, using a footrest, or raising your sitting height to achieve maximum comfort. Observe the following tips:

- refrain from staying too long in one fixed posture
- avoid slouching forward and/or leaning backward
- stand up and walk around regularly to remove the strain on your leg muscles

Taking care of your vision

Long viewing hours, wearing incorrect glasses or contact lenses, glare, excessive room lighting, poorly focused screens, very small typefaces and low-contrast displays could stress your eyes. The following sections provide suggestions on how to reduce eyestrain.

Eyes

- Rest your eyes frequently.
- Give your eyes regular breaks by looking away from the monitor and focusing on a distant point.
- Blink frequently to keep your eyes from drying out.

Display

- Keep your display clean.
- Keep your head at a higher level than the top edge of the display so your eyes point downward when looking at the middle of the display.
- Adjust the display brightness and/or contrast to a comfortable level for enhanced text readability and graphics clarity.
- Eliminate glare and reflections by:
 - placing your display in such a way that the side faces the window or any light source
 - minimizing room light by using drapes, shades or blinds
 - using a task light
 - changing the display's viewing angle
 - using a glare-reduction filter
 - using a display visor, such as a piece of cardboard extended from the display's top front edge
- Avoid adjusting your display to an awkward viewing angle.
- Avoid looking at bright light sources, such as open windows, for extended periods of time.

Developing good work habits

Develop the following work habits to make your computer use more relaxing and productive:

- Take short breaks regularly and often.
- Perform some stretching exercises.
- Breathe fresh air as often as possible.
- Exercise regularly and maintain a healthy body.



Acer Incorporated
8F, 88, Sec. 1, Xintai 5th Rd., Xizhi
New Taipei City 221, Taiwan

Declaration of Conformity

We,

Acer Incorporated

8F, 88, Sec. 1, Xintai 5th Rd., Xizhi, New Taipei City 221, Taiwan

And,

Acer Italy s.r.l.

Viale delle Industrie 1/A, 20020 Arese (MI), Italy

Tel: +39-02-939-921 ,Fax: +39-02 9399-2913

www.acer.it

Product:	LCD Monitor
Trade Name:	Acer
Model Number:	CG437K
SKU Number:	CG437K xxxxxx; (“x” = 0~9, a ~ z, A ~ Z, or blank)

We, Acer Incorporated, hereby declare under our sole responsibility that the product described above is in conformity with the relevant Union harmonization legislations as below Directive and following harmonized standards and/or other relevant standards have been applied:

EMC Directive: 2014/30/EU

<input checked="" type="checkbox"/> EN 55032:2012/AC:2013 Class B	<input checked="" type="checkbox"/> EN 55035:2017
<input checked="" type="checkbox"/> EN 55032:2015+AC 2016 Class B	<input checked="" type="checkbox"/> EN 61000-3-3:2013
<input checked="" type="checkbox"/> EN 61000-3-2:2014 Class D	

LVD Directive: 2014/35/EU

<input checked="" type="checkbox"/> EN 62368-1: 2014+A11:2017

RoHS Directive: 2011/65/EU

<input checked="" type="checkbox"/> EN 50581:2012

ErP Directive: 2009/125/EC

<input checked="" type="checkbox"/> Regulation (EU) 2019/2021;EN50564:2011;EN62087
--

Year to begin affixing CE marking: 2021.

RU Jan / Sr. Manager
Acer Incorporated (Taipei, Taiwan)

Aug.30,2021

Date



Acer America Corporation
333 West San Carlos St., San Jose
Suite 1500
CA 95110, U. S. A.
Tel : 254-298-4000
Fax : 254-298-4147
www.acer.com



Federal Communications Commission Supplier's Declaration of Conformity

This device complies with Part 15 of the FCC Rules. Operation is subject to the following two conditions: (1) this device may not cause harmful interference, and (2) this device must accept any interference received, including interference that may cause undesired operation.

The following local Manufacturer /Importer is responsible for this declaration:

Product:	LCD Monitor
Model Number:	CG437K
SKU Number:	CG437K xxxxxx ("x" = 0~9, a ~ z,A ~ Z, or blank)
Name of Responsible Party:	Acer America Corporation
Address of Responsible Party:	333 West San Carlos St. Suite 1500 San Jose, CA 95110 U. S. A.
Contact Person:	Acer Representative
Phone No.:	254-298-4000
Fax No.:	254-298-4147

Table of Contents

Information for your safety and comrt	ii
Safety instructions.....	ii
Special notes on LCD monitors	ii
Cleaning your monitor	ii
Accessibility	ii
Safe listening	ii
Warnings	ii
Using electrical power	iii
Product servicing	iii
Potentially explosive environments	iv
Additional safety information.....	iv
IT Equipment Recycling Information	iv
Disposal instructions	iv
LCD pixel statement.....	v
Tips and information for comfortable use.....	v
Finding your comfort zone.....	v
Taking care of your vision.....	v
Developing good work habits	vi
Unpacking	1
Monitor introduction	2
Connecting the cables	3
Connecting the adapter and AC Power cord.....	6
Power saving	7
Display Data Channel (DDC).....	8
Standard timing table	10
Remote Controller	11
Using the Shortcut Menu	12
Main page	12
Hot key A (default: Modes)	12
Hot key B (default: Brightness).....	13
Hot key C (Selecting the input).....	13
Main Menu.....	13
Troubleshooting	29
HDMI/DP/USB Mode (Optional).....	29

Unpacking

Please check that the following items are present when you unpack the box, and save the packing materials in case you need to ship or transport the monitor in the future.

LCD monitor

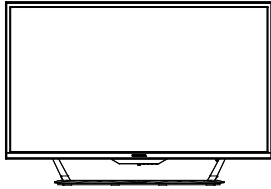

Quick start guide



DP Cable
(Optional)

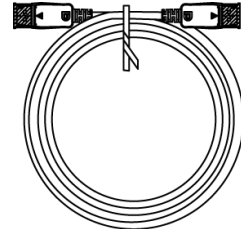

USB cable
(Optional)

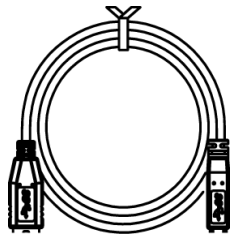

HDMI cable
(Optional)

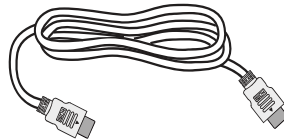

AC Power cord

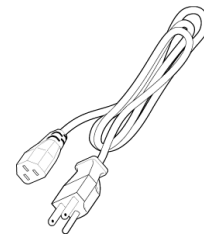

Type C-C cable (Optional)

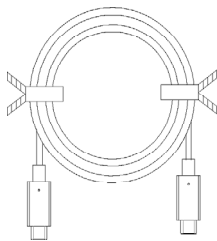

Remote Control (Optional)



LED lamp belt-30cm LED
lights strip
(2pcs, Optional)



LED lamp belt-40cm LED
lights strip
(2pcs, Optional)



LED Module cable
(Optional)

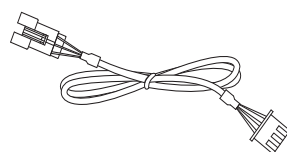

Batteries (1PAA, Optional)





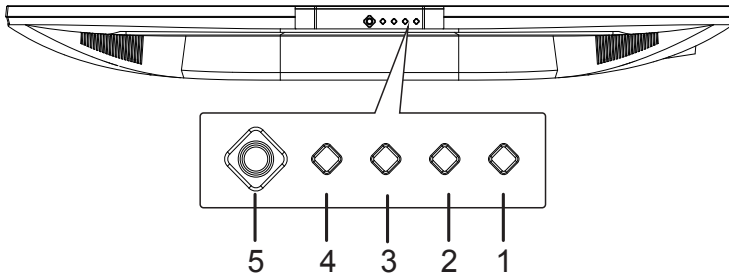

Monitor introduction

User Controls



External controls

-
- | | | |
|-------|---|--|
| 1 |  | Power button turns the monitor on/off. Blue indicates power on. In the power saving mode, the blue power saving lamp and the breathing lamp can be setting according to the LED Control, another OSD Locked mode is a blue breathing lamp. |
| <hr/> | | |
| 2 |  | a. Press to view Hot Key Menu, Press again to enter hotkey 1 function (default is Modes, user can redefine).
b. When the Main Menu is active, press this key to view the basic information for your monitor and current input or reset the custom color settings to the factory defaults. |
| <hr/> | | |
| 3 |  | a. Press to view Hot Key Menu. Press again to enter hotkey 2 function (default is Brightness, user can redefine).
b. When the Main Menu is active, press this button to select Modes menu. |
| <hr/> | | |
| 4 |  | a. Press to view Hot Key Menu. Press again to enter Input select function.
b. When the Main Menu is active, this button will quit the OSD. |
| <hr/> | | |
| 5 |  | a. Press to view Hot Key Menu. Press again to enter Main Menu page.
b. The single toggle button on the backside of the Display bezel operates like a joystick. To move the cursor, simply toggle the button in four directions. Press the button to select desired option. Red indicates operable. Gray indicates inoperable. |
-

Transmitting the 4K 144Hz signal via one HDMI 2.1/ DP 1.4 port requires DSC (Display Stream Compression) functionality.

Connecting the cables

To install the monitor on your host system, please follow the steps below:

1. Turn off your computer and unplug your computer's power cord.
2. Connect the signal cable to the HDMI (optional) and /or DP (optional) input socket of the monitor, and the HDMI (optional) and /or DP (optional) output socket of the graphics card on the computer.
3. USB Type-C Cable (Optional, USB Type-C input models only) Connect one end of the USB Type-C cable (optional) to your computer and connect the other end to your electric devices.(power supplier 5V>/3A, 9V>/3A, 15V>/2A, 20V>/1.5A)
4. Connect the USB Cable(Optional)
Connect the USB cable to port for fast charge.(power supplier BC1.2 >/1.5A)
Connect the USB cable to port.
5. Optional: Connect one end of the LED Module cable to your computer and connect the other end to the LED lamp belt.
6. Insert the monitor power cable into the power port at the back of the monitor.
7. Plug the power cords of your computer and your monitor into a nearby electrical outlet.

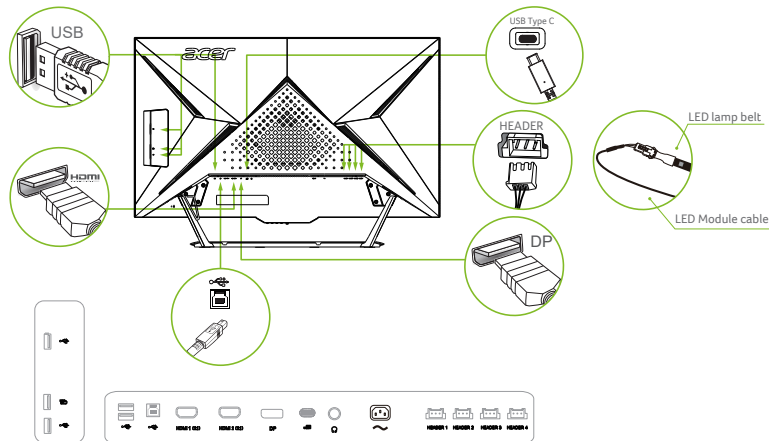

Note:

- Audio output is only for audio output model. Please check user manual for more instruction.
- About the LED lamp belt connection:
When you want to connect the LED lamp belt, remove the silicone pad first.
When you do not need to connect the LED lamp belt, be sure to install the silicone pad back.

LED Light Strip:

1. The placement of the light strips is up to the user's discretion, but Acer suggests attaching them to the back of the monitor, with the two 30 cm strips on the short sides and the two 40 cm strips on the top for best ambient effect.



2. Please search the APP name “RGB Light Sense” as key word to download the software from Acer website(<https://www.acer.com>).
3. Please connect USB Cable/ LED Module cable+ LED lamp belt to enable RGB light sense.
4. Basic control: 9 different lighting effect modes.
 - (1)Static
 - (2)Breathing
 - (3)Filling
 - (4)Motion Point
 - (5)Shifting
 - (6)Spectrum
 - (7)Star
 - (8)Wave
 - (9)Zoom
5. Music sync: Light pattern and colors change depending on the music being played

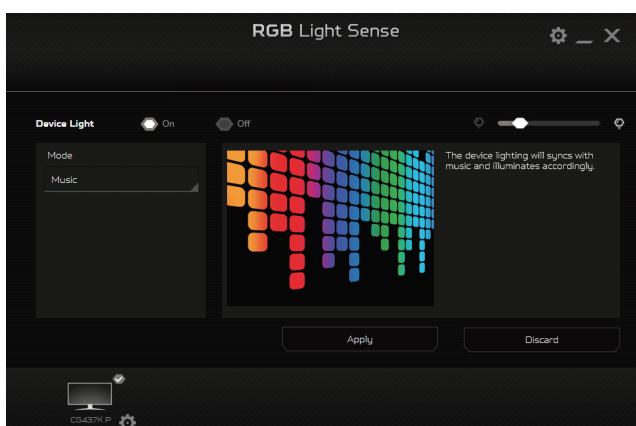

6. Screen sync: Colors change according to the colors shown on screen

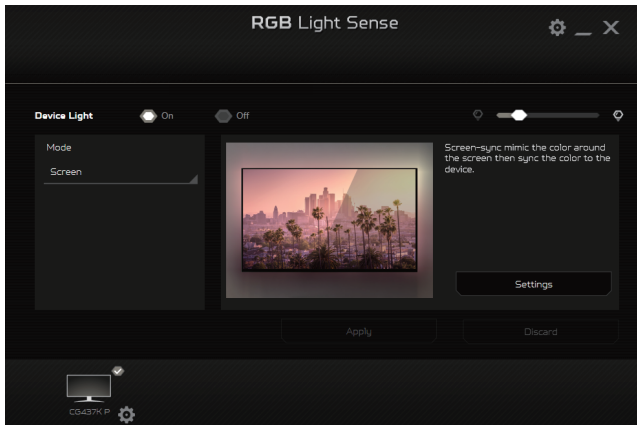

7. Game sync: Lighting effects based on dynamic game events

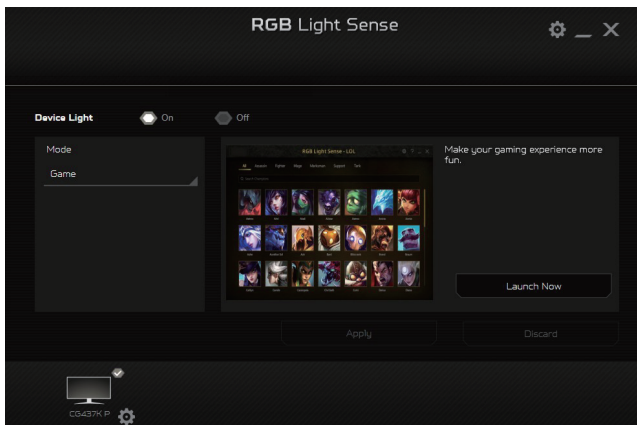

Connecting the adapter and AC Power cord

- Check first to make sure that the power cord you use is the correct type required for your area.
- The monitor has a universal power supply that allows operation in either 100/120 V AC or 220/240 V AC voltage area. No user-adjustment is required.
- Plug one end of the AC power cord to the Adapter, and plug the other end into an AC outlet.
- For units using 120 V AC:
 - Use a UL-listed cord set, type SVT wire and plug rated 10 A/125 V.
- For units using 220/240 V AC:
 - Use a cord set consisting of H05VV-F cord and plug rated 10 A/250 V. The cord set should have the appropriate safety approvals for the country in which the equipment will be installed.

Power saving

The monitor will be driven into "Power Saving" mode by the control signal from the display controller, as indicated by the blue-color power LED.

State	LED Light
ON	Blue (Static, Breathing, Off) by LED Control Setting
Power Saving Mode	Blue (Static or Breathing) by LED Control Setting

The power saving states will be kept until a control signal has been detected or the keyboard or mouse is activated. The recovery time from Active OFF state back to ON state is around 3 seconds.



Note:

LED Control:

Standby Mode: Control the effect of the LED under normal display (Default is Mode B).

Mode A	Fixed LED brightness is 50%.
Mode B	Breathing effect, the brightness range is 0% ~ 50%. (Brightness from 0% to 50% takes 3 seconds) (Brightness from 50% to 0% takes 3 seconds)

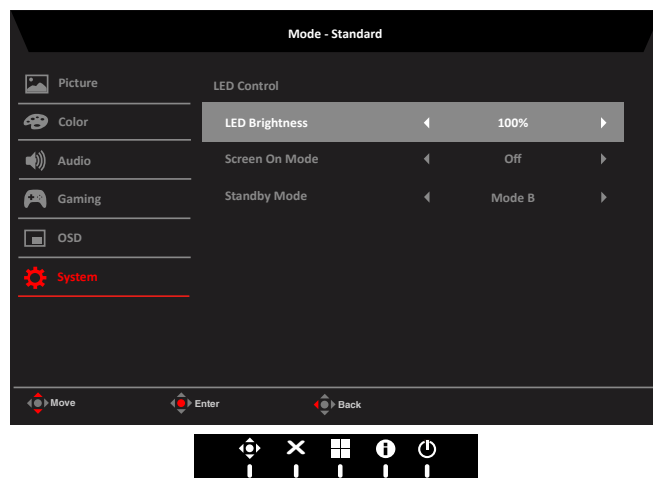

Display Data Channel (DDC)

To make installation easier, so long as your system supports the DDC protocol, the monitor is able to plug-and-play. The DDC is a communication protocol through which the monitor automatically informs the host system about its capabilities; for example, supported resolutions and corresponding timing. The monitor supports the DDC2B standard.

20-pin color display signal cable

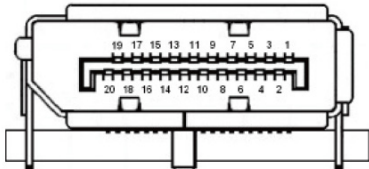

PIN No.	Description	PIN No.	Description
1	ML_Lane 0+	2	GND
3	ML_Lane 0-	4	ML_Lane 1+
5	GND	6	ML_Lane 1-
7	ML_Lane 2+	8	GND
9	ML_Lane 2-	10	ML_Lane 3+
11	GND	12	ML_Lane 3-
13	KONFIG1	14	CONFIG2
15	AUX CH+	16	GND
17	AUX CH-	18	Hot Plug
19	Return	20	DP_PWR

19-pin color display signal cable

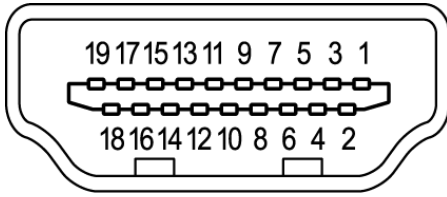

PIN No.	Description	PIN No.	Description
1	TMDS Data2+	2	TMDS Data2 Shield
3	TMDS Data2-	4	TMDS Data1+
5	TMDS Data1 Shield	6	TMDS Data1-
7	TMDS Data0+	8	TMDS Data0 Shield
9	TMDS Data0-	10	TMDS Clock+
11	TMDS Clock Shield	12	TMDS Clock-
13	CEC	14	Reserved (N.C. on device)
15	SCL	16	SDA
17	DDC/CEC Ground	18	+5V Power
19	Hot Plug Detect		

24-pin USB Type C cable

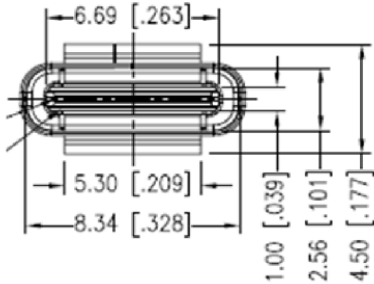

PIN No.	Description	PIN No.	Description
A1	GND	B12	GND
A2	SSTXp1	B11	SSTXp1
A3	SSTXn1	B10	SSTXn1
A4	VBUS	B9	VBUS
A5	CC1	B8	CC1
A6	Dp1	B7	Dp1
A7	Dn1	B6	Dn1
A8	SBU1	B5	SBU1
A9	VBUS	B4	VBUS
A10	SSTXn2	B3	SSTXn2
A11	SSTXp2	B2	SSTXp2
A12	GND	B1	GND

Standard timing table

VESA MODE			
MODE	Resolution		
1	VGA	640x480	60Hz
2	SVGA	800x600	56Hz
3	SVGA	800x600	60Hz
4	XGA	1024x768	60Hz
5	SXGA	1280x1024	60Hz
6	VESA	1280x720	60Hz
7	WXGA	1280x800	60Hz
8	WXGA+	1440x900	60Hz
9	WXGA+	1680x1050	60Hz
10	UXGA	1920x1080	60Hz
11	UHD	3840x2160	30Hz
12	UHD	3840x2160	60Hz
13	UHD	3840x2160	120Hz
14	UHD	3840x2160	144Hz * recommend resolution

Note:

- HDMI1 (2.1): Support max timing resolution (3840x2160-144Hz).
- HDMI2 (2.1): Support max timing resolution (3840x2160-144Hz)..
- DP(1.4):: Support max timing resolution (3840x2160-144Hz),
- DP ALT: Support max timing resolution (3840x2160-144Hz).
- Need to use VESA certified DP 1.4/HDMI 2.1 cables.

Remote Controller

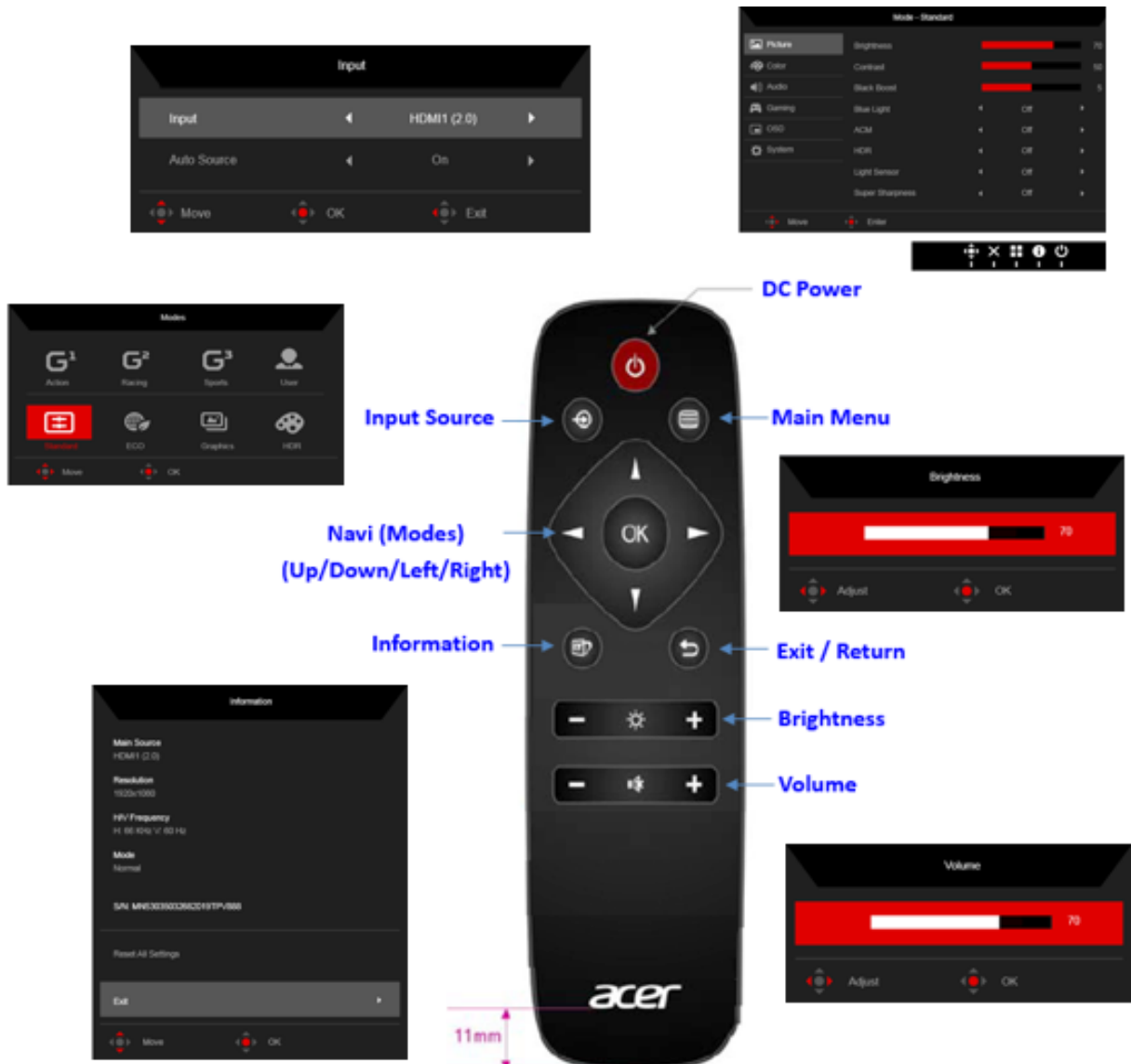

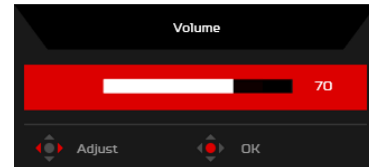
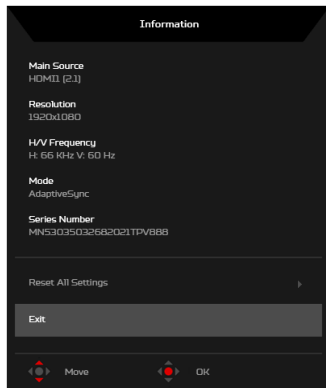
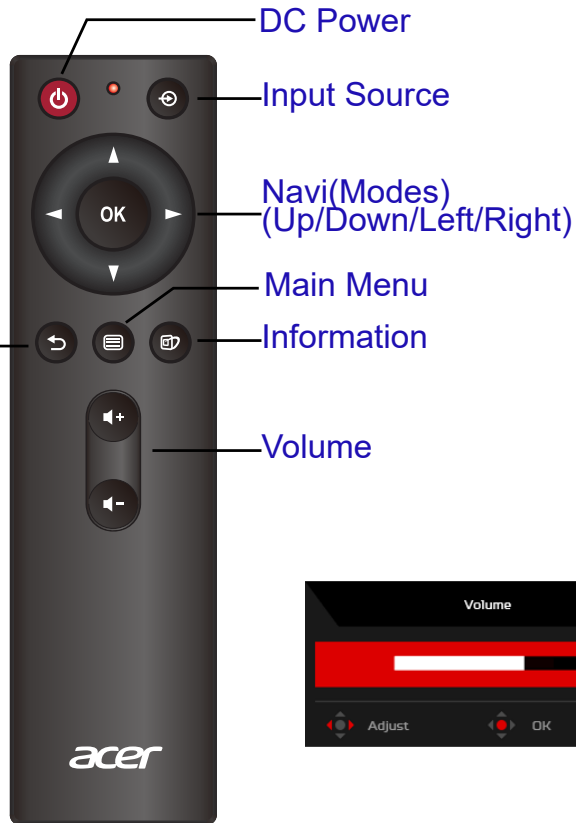
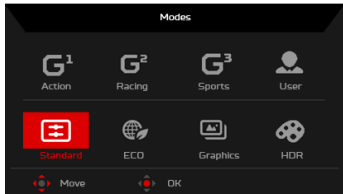
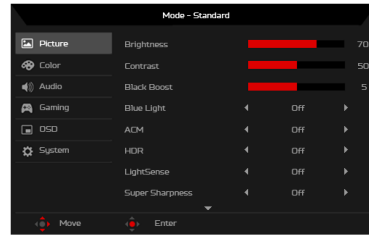
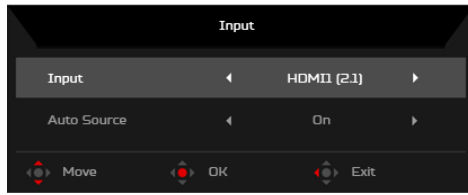

Note: (Saving Mode, Input Not Supported and Cable Not Connected) status press Input hot key can show Input hot key menu, other function hot key is unavailable.

Using the Shortcut Menu

The following content is for general reference only. Actual product specifications may vary. The OSD (On Screen Display) can be used to adjust the settings of your LCD monitor. Press the key to open the OSD. You can use the OSD to adjust the picture quality, OSD position and general settings. For advanced settings, please refer to following page:

Main page

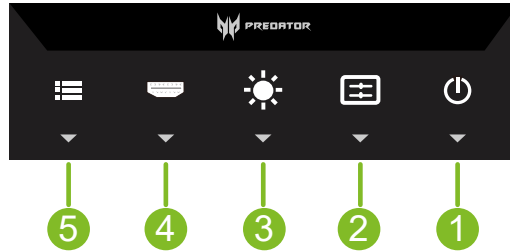

- 1. DC Power:**
Power on/off the monitor
- 2. Hot Key A:**
User Define(Default is Modes Hot Key)
- 3. Hot Key B:**
User Define(Default is Brightness)
- 4. Hot Key C:**
Input Switch Hot Key
- 5. Navi Key:**
Main Menu Hot Key

Hot key A (default: Modes)

To choose game mode (G1, G2, G3) which user-defined profile to use or scenario mode (User, Standard, ECO, Graphics, HDR)

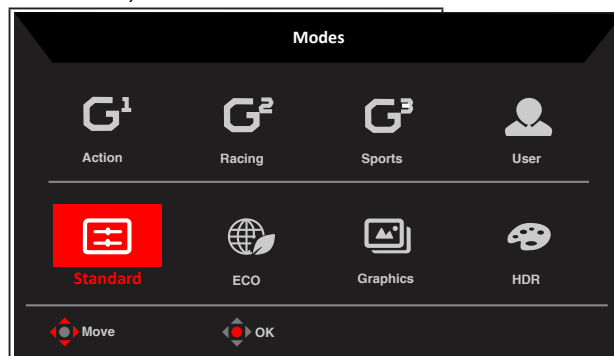

Hot key B (default: Brightness)

Open the Brightness control and select your preferred brightness setting. When you are done, press the joystick to quit current page and store.

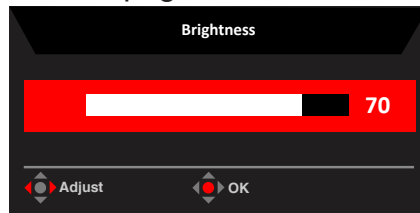









Hot key C (Selecting the input)

Open the Input control and select HDMI1 (2.1), HDMI2 (2.1), DP, DP ALT or Auto Source. When you are done, press the joystick to exit current page and store.



Main Menu

1. Press the **Navi Key** to open the OSD.
2. Toggle the joystick  to the up  or down  to select Picture from the OSD. Then toggle to the right to navigate to the element you wish to adjust and press the joystick to enter it.
3. Toggle the joystick  to the left  or right  to adjust the sliding scales.
4. Information Hot Key : Show Monitor Information and Reset control function.
5. Modes Hot Key : To change Modes Hot Key menu.
6. Exit Hot Key  to exit current page and store.

Picture

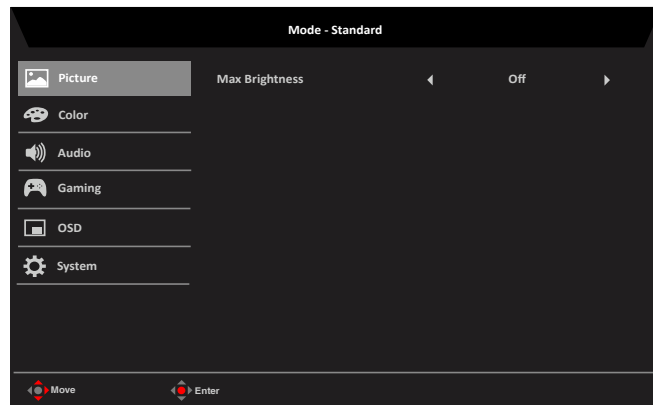
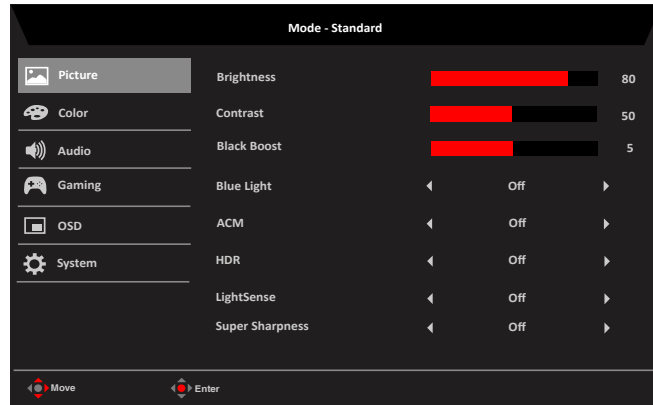



1. **Brightness:** Adjust the brightness from 0 to 100.

 **Note:** Adjusts the balance between light and dark shades.
 Default Brightness will vary depending on the sales area.
2. **Contrast:** Adjust the contrast from 0 to 100.

 **Note:** Sets the degree of difference between light and dark areas.
3. **Black Boost:** Adjust the Black Boost from 0 to 10. Enhances shadows by increasing the brightness without changing lighter shades.

 **Note:** If the image is very bright or has few shadow areas, adjusting this setting may not result in any noticeable changes to the image.
4. **Blue Light:** Filters out blue light to protect your eyes by adjusting how much blue light is shown -- Off, 80%, 70%, 60%, or 50%.

 **Note:** Higher values allow more blue light through. For the best protection select a lower value. When “Blue Light” is on, Brightness & Contrast will show each level of “Blue Light” value.
5. **ACM:** Turn ACM on or off.

 **Note:** Set to “On”, will be based on the current screen to dynamic contrast

adjustment.

- HDR:** Can control (off / Auto / HDR-1000) the default is off, set to auto will automatically detect and deal with HDR signal.



Note:

- When HDR=Auto or HDR-1000, the Modes will also be automatically set to “HDR”.
- When HDR=Auto, some parameters: (ACM, Gamma, Contrast, Blue Light, Black Boost...) functions is gray out and disable, and if you change other adjustable parameters, the “Modes” will not jump to “User” Mode.

- LightSense:** Light Sensor can choose: (Off, Level 1, Level 2 and Level 3), Off is default, Level 3 brightness automatically adjust the maximum range, Level 2 brightness automatically adjust the range is moderate, Level 1 brightness automatically adjust the minimum range.



Note:

The following conditions the Light Sensor auto gray out and unavailable.

After the following functions are enabled, the LightSense is grayed out and disabled.						
Modes	HDR					
Color Space	sRGB	Rec.709	HDR	EBU	DCI	SMPT-E-C
After the LightSense is started, the following functions will be grayed out and disabled.						
Function	ACM	Brightness	Low Blue Light	VRB		

- Super Sharpness:** Turn the Super Sharpness On or Off. Super Sharpness technology can simulate high-resolution images by boosting the pixel density of the original source to make images sharper and clearer.
- Max Brightness:** The default is Off, select On to compensate for higher brightness.

Color

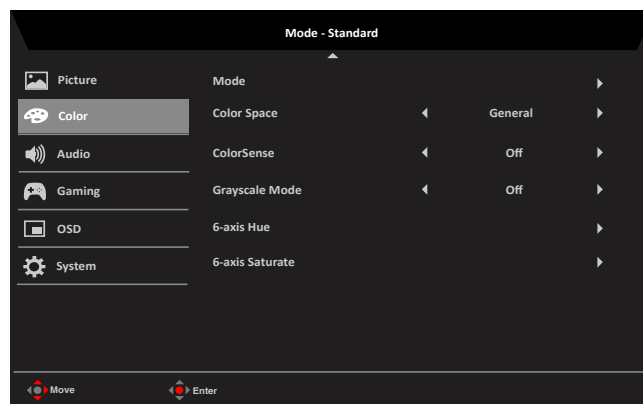
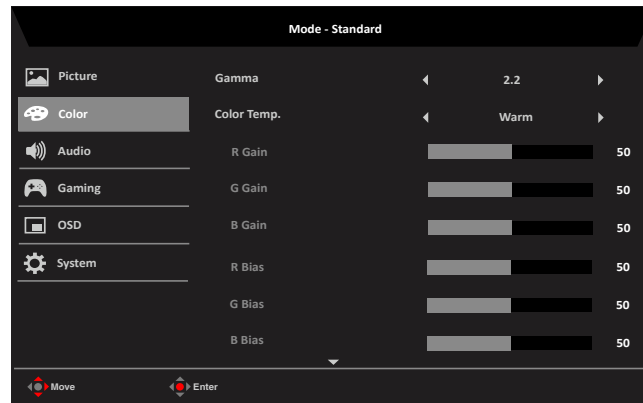

1. **Gamma:** allows you to adjust the luminance tone. The default value is 2.2 (standard value for windows). Adjust range are 1.8, 2.0, 2.2, 2.4 or 2.6.
2. **Color temperature:** You can choose color temperature as Warm, Normal, Cool, Blue light or User.
 - **Warm:** Increases the color temperature. The screen appears warmer with a red/yellow tint. This is the default preset mode.
 - **Normal:** Loads the monitor's normal color settings.
 - **Cool:** Decreases the color temperature. The screen appears cooler with a blue tint.
 - **Bluelight:** Decreases the level of blue light emitted from the screen to make viewing more comfortable for your eyes.
 - **User:** Allows you to manually adjust the color settings.
3. **Modes:** Open Modes Hot Key Menu. Detail rules please refer Modes Spec.

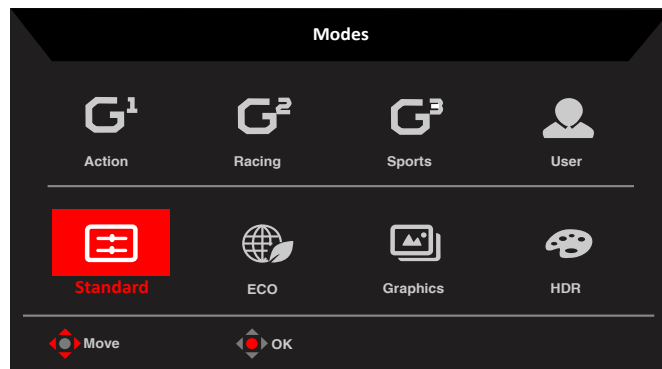

- **Action:** For better color matching representation with the Action game or movie, Users can modify some parameters and save them by themselves.
- **Racing:** For better color matching representation with the Racing game or movie, Users can modify some parameters and save them by themselves.
- **Sports:** For better color matching representation with the Sports game or movie, Users can modify some parameters and save them by themselves.
- **User:** Applies a combination of picture settings defined by users.
- **Standard:** For basic PC application (Default Setting).
- **ECO:** For saving electricity with low power consumption by providing minimum brightness for all running programs.
- **Graphics:** For better color matching representation with the graphics.
- **HDR:** For better color matching representation with the high dynamic lighting rendering (HDR).



Note: In HDR mode, some function item is gray out and parameters are fixed not open to modify:

1. The signal content is SDR, the brightness can to adjustment, but content is HDR the brightness is fixed at 100 and gray out.
2. Users can adjustment (Brightness (SDR), Aim Point, Over Drive, Refresh Rate Num and Super Sharpness).
3. If to adjust the parameter or be saved the Modes will not jump to User mode.
4. 6-axis (Hue & Saturate) are gray out and can't adjustment.

4. **Color Space:** You can choose sRGB, Rec.709, EBU, DCI, SMPTE-C and General.



Note: Color Space = HDR to correspond Modes is HDR, Other Color Space the Modes=Standard.

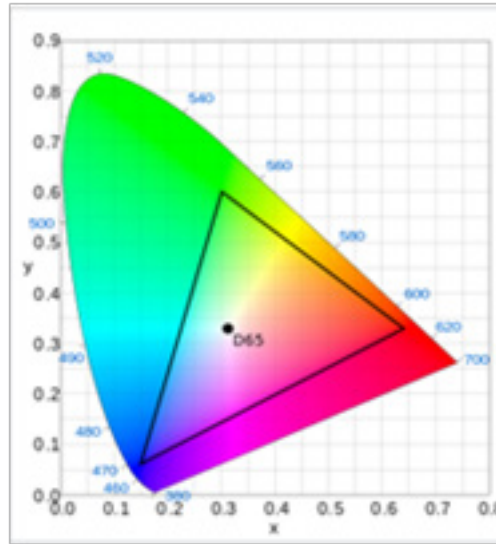
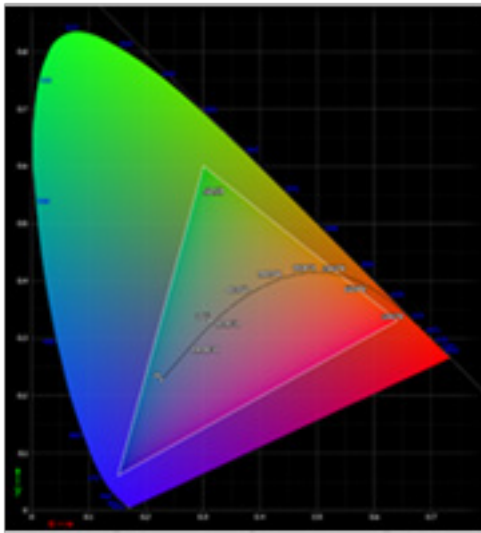

- CIE 1931 positive and negative error of 0.05, ("HDR" according to current Panel to fine-tune).
- Color Space = HDR, the Modes = HDR, Picture page HDR = Auto.
- Modes = (Action, Racing, Sports, Standard, ECO, Graphic, User) is selected; the color space is auto set to "General".
- Color Space = (sRGB/Rec.709/HDR/EBU/DCI/SMPTE-C), If to adjust the parameter the Modes will not jump to User mode, but the Color Space = "General" except.
- Color Space = (sRGB/Rec.709/HDR/EBU/DCI/SMPTE-C), 6-Axis Hue & Saturate is gray out and unavailable.
- Color Space = (sRGB/Rec.709/HDR/EBU/DCI/SMPTE-C), Grayscale Mode is gray out and unavailable.
- Color Space = (sRGB/Rec.709/HDR/EBU/DCI/SMPTE-C), (Light & Color) Sensor are gray out and unavailable.

5. ColorSense: Automatically adjust color temperature smoothly.



Note:

- ColorSense is On, Factory Menu can check the CT (Color Temp) Value.
- Mode = HDR, does not support the ColorSense.
- Color Space = (sRGB/Rec.709/HDR/EBU/DCI/SMPTE-C), does not support the ColorSense.
- ColorSense is on, the Modes is User, the (Contrast, Color Temp, Low Blue Light, 6 axis Hue, 6 axis Saturate, Grayscale Mode) functions are gray out and

After the following functions are enabled, the ColorSense is grayed out and disabled.						
Modes	HDR					
Color Space	sRGB	Rec.709	HDR	EBU	DCI	SMPTE-C
After the ColorSense is started, the following functions will be grayed out and disabled.						
Function	Contrast	Color Temp.	Low Blue Light	6-axis Hue	6-axis Saturate	Grayscale Mode

6. Grayscale Mode: Select grayscale mode “On” or “Off”.

- **On:** Color only black and white effect.
- **Off:** Normal color effect.

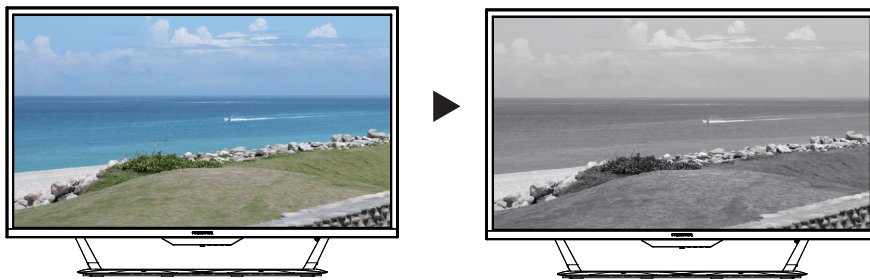

7. 6-axis Hue: Adjust the Red Hue, Green Hue, Blue Hue, Yellow Hue, Magenta Hue , Cyan Hue or Reset.

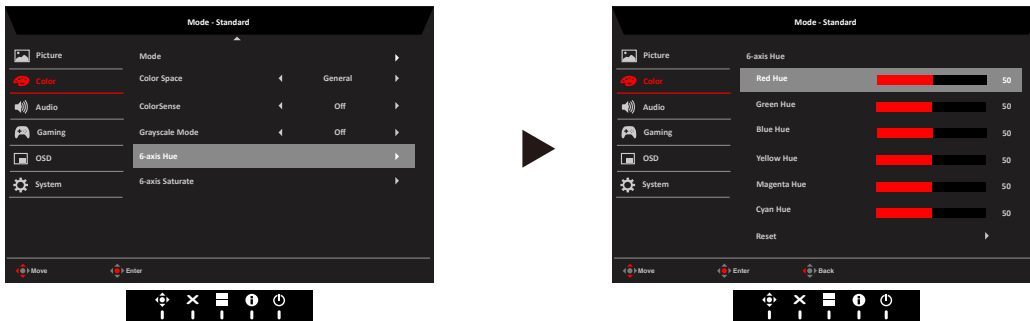

8. 6-axis Saturate: Adjust the Red Saturate, Green Saturate, Blue Saturate, Yellow Saturate, Magenta Saturate, Cyan Saturation or Reset.

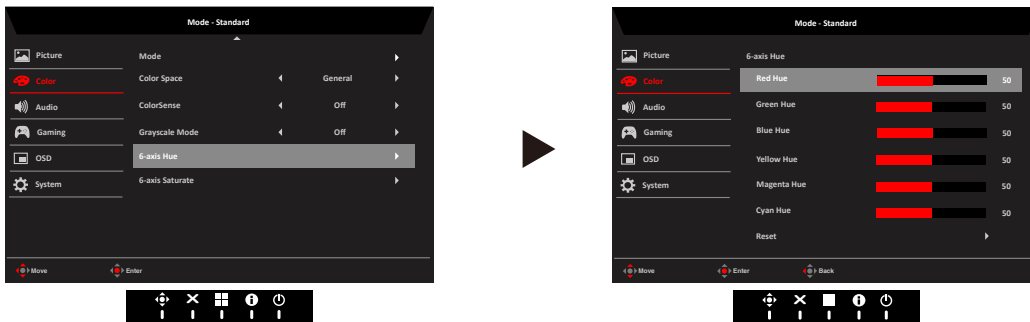

Audio

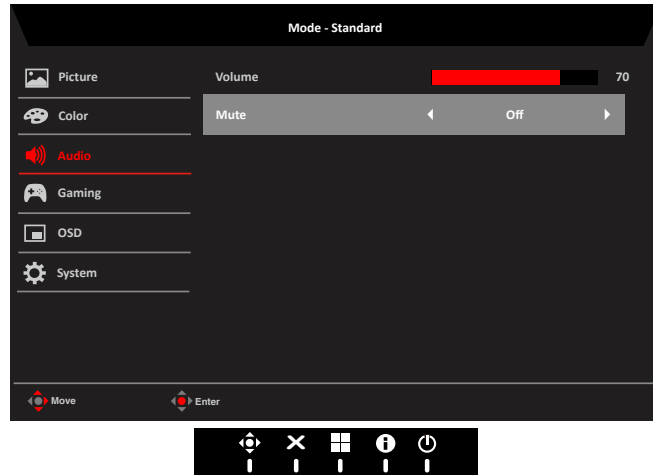

1. **Volume:** Adjust the volume
2. **Mute:** Control the monitor to mute, default is off.

Gaming

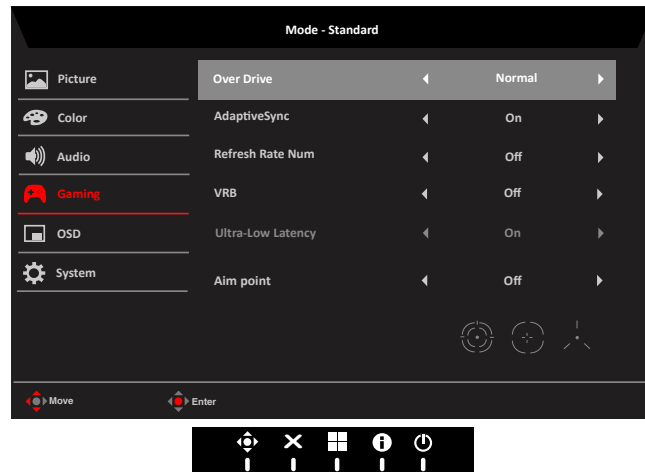

1. **Over Driver:** Select Off, Normal, or Extreme.
2. **AdaptiveSync:** To control support AdaptiveSync or not, default is On.
3. **Refresh Rate Num:** Display the panel's current refresh rate on the screen.
4. **VRB:** To choose whether to support dynamic picture more clean control, default is Off.



Note:

- If AdaptiveSync is "ON", then the Over Drive selection is set to "Normal" automatically.
- If AdaptiveSync is "OFF", then the user can set Over Drive to either one of the three settings including: (a) Extreme (b) Normal (c) Off.
- G-Sync Compatible only support DP (AdaptiveSync).



Note:

- HDR setting = (Auto or HDR-1000) is not support VRB.
- VRB function does not affect the (Logo, Aim Point, Message and Input Icon)

brightness.

- VRB set "Normal or Extreme", when to turn on AdaptiveSync, will auto set VRB is "Off".
- VRB set "Normal or Extreme", when to adjustment (Brightness, Blue Light, ACM), will auto set VRB is "Off".
- VRB setting "Normal or Extreme", when detection of Input Timing <75Hz, will auto off the VRB and gray out to disable.
- VRB = (Normal or Extreme), because the IC control dynamic picture is cleaner, so the overall Brightness will be dark, "Extreme" will be darker than "Normal".

5. **Ultra-Low Latency:** Set to On to speed up the processing time of the display switching process.



Note:

- Ultra-Low Latency is support only Wide Mode = "Full".
- Ultra-Low Latency is not support video interlace mode.
- Ultra-Low Latency is not supports V-Frequency below 48Hz.
- Ultra-Low Latency is not supports resolutions below 800x600.
- AdaptiveSync is "Off", Ultra-Low Latency can control "On" or "Off".
- AdaptiveSync is "On", Ultra-Low Latency is automatically setting to "On" and gray out.

6. **Aim point:** Show an Aim point on the screen for shooting games.



Note: If hot key menu or main menu is trigger the "Aim point" temporarily closed.

OSD

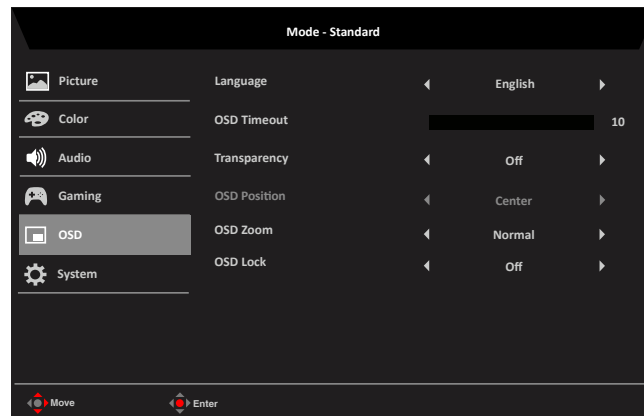

1. **Language:** Set the OSD menu language.
2. **OSD timeout:** Adjust the delay before turning off the OSD menu.
3. **Transparency:** Select the transparency when using gaming mode. The transparency can be 0% (OFF), 20%, 40%, 60%, or 80%.
4. **OSD Position:** The OSD position default is Center, and the display position can be changed to (Top Left, Top Right, Bottom Right, Bottom Left, and Center) OSD Position only support OSD Zoom is X2.

5. **OSD Zoom:** OSD Zoom default is "Normal", choose "X 2" to zoom OSD.
6. **OSD Lock:** To choose OSD lock On/Off.



Note:

OSD Locked:

- Set the OSD Lock to "On" by the OSD option and press "Enter" to execute the All Key lock function.
- The "OSD Locked" message will be displayed in the middle of the screen.
- LED lights will follow standby mode (Mode B) effect, refer the LED Control function.
- Press any Key screen to prompt "OSD Locked" message (Remote controller direction and OK can shows).

OSD Unlocked:

- In normal display condition to press the "Navi Key" in the middle of more than 3 seconds to trigger "OSD Unlock" (Remote controller only has the (arrow and OK) Keys can be released).
- The "OSD Unlock" message will be displayed in the middle of the screen.
- LED lights will be restored to blue light, please refer the LED Control function.

System

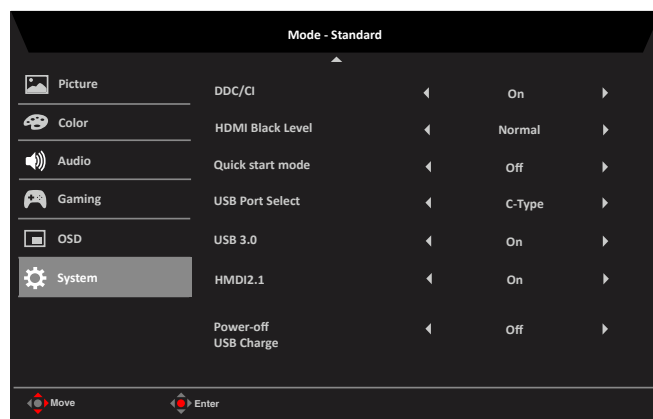
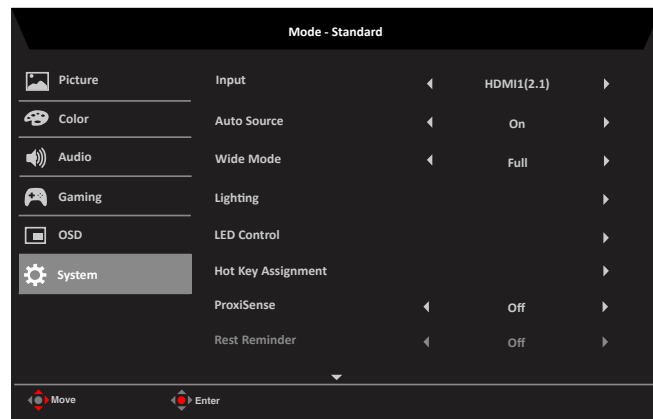

7. **Input:** Select the source from HDMI1 (2.1), HDMI2 (2.1), DP and DP ALT.



Note: If this cannot be woken up from the sleep mode, you can press INPUT

KEY on the remote control or press 2, 3 or 4 to wake up this interface.

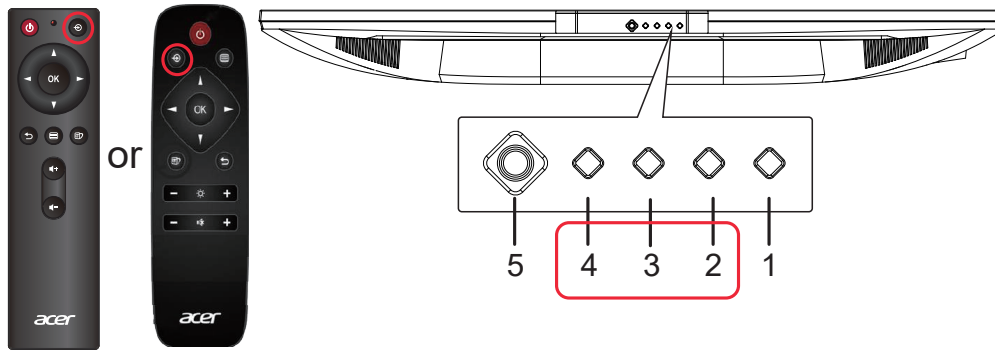

8. **Auto Source:** The default is “On”, can support auto search for signal source in order.



Note: Surround application must set Auto Source is “Off”.

9. **Wide Mode:** You can select which screen aspect you are using. The options are Full, Aspect, 1:1.

10. **Lighting:** Ambient light, choose to follow a favorite to many functions.

- **Lighting Switch:** Lighting main switch, default is "Enable".
- **Lighting Style:** 9 kinds of style choice.

Static	Fixed lights are not flashing (Default).
Breathing	Lighting breathing effect.
Filling	Light up the Lighting in sequence (one-way back and forth).
Motion Point	Lighting is fully lit and moves back and forth in sequence.
Shifting	Lights up from the left to the right and disappears to the right.
Spectrum	Transform spectral effects of different colors.
Star	Starlight flashing effect.
Wave	The color light effect of moving left and right.
Zoom	Lights from the middle to the sides and then disappears in the middle.



Note: The (Spectrum or Wave) is not support Lighting Color.

- **Lighting Color:** Manually select the lighting color.

Red	Red light, in the Lighting Style can support all style.
Green	Green light, in the Lighting Style can support all style.
Blue	Blue light, in the Lighting Style can support all style .
Yellow	Yellow light, in the Lighting Style can support all style.
Magenta	Magenta light, in the Lighting Style can support all style.
Cyan	Cyan light, in the Lighting Style can support all style(Default).



Note: Lighting Style is (Spectrum or Wave) the Lighting Color is gray out and unavailable.

- **Lighting Brightness:**

To control the lighting brightness Auto, 1~10 mapping 0x00~0xFF. (Default is 5).

1-10 : Control the lighting brightness 1~10 mapping 0x00~0xFF (Refer the LED Table).

Auto : If select Lighting brightness “Auto” => LED brightness will depend on light sensor.



Note: When Lighting Brightness is set to Auto, regardless of whether LightSense is turned on, it will detect the current ambient brightness and change the Lighting Brightness.

• **Lighting Health:**

Off : Default is Off, Lighting will be return to previous lighting style

Warm: LED Style = Static, LED Color = Warm, LED Brightness = 80.

Normal: LED Style = Static, LED Color = Normal, LED Brightness = 80.

Cool: LED Style = Static, LED Color = Cool, LED Brightness = 80.



Note:

- When user select to: (Warm, Normal, Cool), (Lighting Style, Lighting Color, Lighting Brightness) is gray out and unavailable.
- When user select to: (Warm, Normal, Cool), the current environment brightness > 50 nits, then the Lighting will auto turn off, if <=50nits, the Lighting will auto turn on after 3~5 seconds.
- Control Zone: There are 5 sets of independently control lighting switches, Default is “All”.
- **Lighting AC/DC On Effects:**



Note:

- AC/DC on will first display the water blue Move the light effect left and right.
- Predator after the Predator Logo disappears, the water blue move light effect will be cleared and display the current setting effect.
- Quick Start Mode is “On” not support water blue Move the light effect left and right Effects.

11. LED Control: Controls the brightness of the Power key LED.



- **LED Brightness:** The default is 100% and there are 4 brightness options. (100%, 50%, 30%, 0%)

- **Screen On Mode:** Control the effect of the LED under normal display (Default is Off).

Off	LED brightness follow user setting (100%~0%).
Mode A	Fixed LED brightness is 100% (Default).
Mode B	Breathing effect, the brightness range is 30% ~ 100%. (Brightness from 30% to 100% takes 2.5 seconds) (Brightness from 100% to 30% takes 1 seconds)
Mode C	Fixed LED brightness is 0%

- **Standby Mode:** Control the effect of the LED under normal display (Default is Mode B).

Mode A	Fixed LED brightness is 50%.
Mode B	Breathing effect, the brightness range is 0% ~ 50%. (Brightness from 0% to 50% takes 3 seconds) (Brightness from 50% to 0% takes 3 seconds)

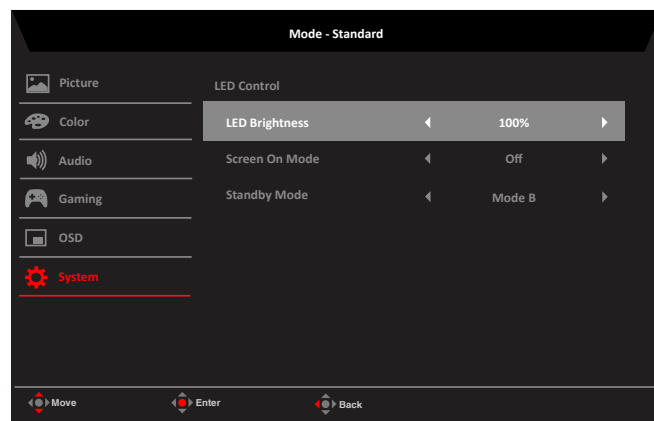

12. **Hot key Assignment:** Select the function of shortcut key 1 or shortcut keys2:(Modes, Brightness, Volume, Gamma, Contrast, Blue Light, Over Drive,VRB).



Note: Hot Key 1 and Hot Key 2 can't repeat the same function.

13. **ProxiSense:** ProxiSense works on principle of transmission and reception of harmless "infrared" signals in order to detect user-presence.



Note:

- The ProxiSense is set to (Range 1 to Range 3), tolerance is (+/-) 20 cm and ACM is off.
- Three status (No signal, no cable connection and out of range) does not support ProxiSense.
- The ProxiSense controls the PWM to 50% (current OSD Brightness parameter) or into the power saving state, and then press any key to restore the PWM to the normal value.
- Power The detection range of the Sensor is in the middle, the upper and lower angles are ignored.

14. **Rest Reminder:** ProxiSense is set Range1~Range3 then Rest Reminder can be control (Off ~ 100Mins), Rest Reminder default is Off.



Note:

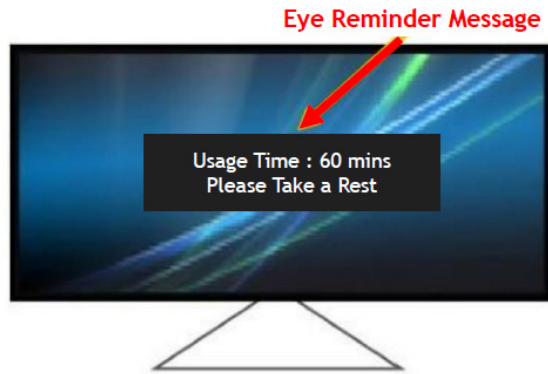

15. **DDC/CI:** Allows the monitor settings to be set through the software on the PC.



Note:

- DDC/CI, short for Display Data Channel/Command Interface, which allows monitor controls to be sent via software.
 - Widget tools must settings the DDC/CI to "On" can to work properly.
16. **HDMI Black level:** Select to set HDMI black level.
17. **Quick Start Mode:** Select Off or On. Turn on to speed up boot speed.
18. **USB Port Select:** Default is C-Type, Can select the USB Port from B-Type and C-Type.
19. **USB 3.0:** Default is "On". It can control determine the USB bandwidth. When USB 3.0 = "Off", DP ALT support to 3840x2160-144Hz. When USB 3.0 = "On", DP ALT support timing by source.
20. **HMDI2.1:** Default is "On. HDMI1 & 2 Resolution can support 3840x2160-144Hz. HDMI2.1 = Off, HDMI1 & 2 Resolution can support 3840x2160-60Hz.
21. **Power-off USB charge:** Turn On or Off. On: DC off/Saving mode can to electrify for USB port. Off: DC off/Saving mode can't to electrify for USB port.



Note: Power-off USB charge is set to off by default. Therefore, the sleep mode cannot be resumed under the USB Type-C input. The user needs to change the Power-off USB to on.

Save Setting to...(User mode only)

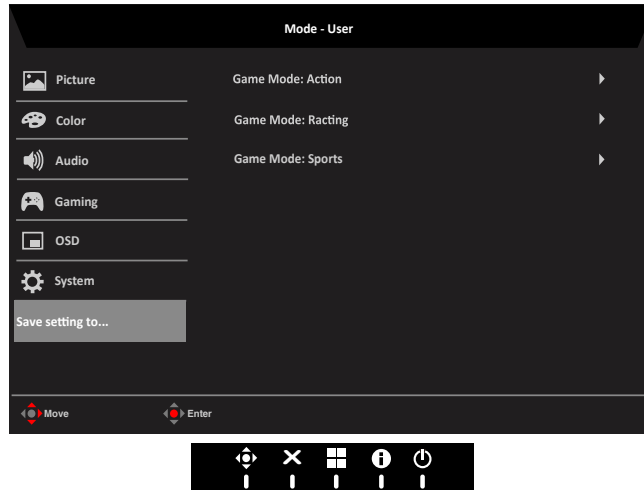

1. Press the MENU key to open the OSD.
2. Toggle the joystick to the up or down to select "Save Setting to..." from the OSD. Then toggle to the right to navigate to the element you wish to adjust and press the joystick to enter it.
3. Save Setting to Game mode: There are three user-defined profiles available. When you have decided what settings suit you, save them and system will be able to recall the settings in the future when you turn on gaming mode .

Information

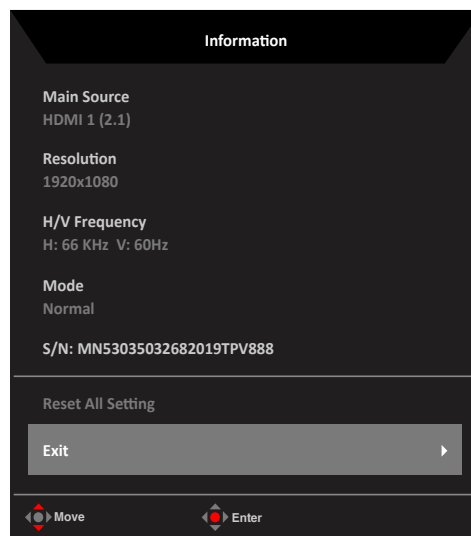

1. "Mode" to display the current state (Normal/AdaptiveSync /SDR/HDR).
2. It will show the SN information (per to the information from the EDID) at the "Information" page.
3. When the information icon is selected, it will show information directly without pressing the "Menu" key again.

Troubleshooting

Before sending your LCD monitor for servicing, please check the troubleshooting list below to see if you can self-diagnose the problem.

HDMI/DP/USB Mode (Optional)

Problem	LED status	Remedy
No picture visible	Blue	Using the OSD menu, adjust brightness and contrast to maximum or reset to their default setting.
	Off	Check the power switch. Check if the AC power cord is properly connected to the monitor.
	Blue and Breathing	Check if the video signal cable is properly connected at the back of monitor. Check if the computer system is switched on and in power saving/standby mode. OSD Locked: If OSD Lock is on, the LED status set Blue and Breathing.

Note: Acer monitor is purposed for video and visual display of information obtained from electronic devices.

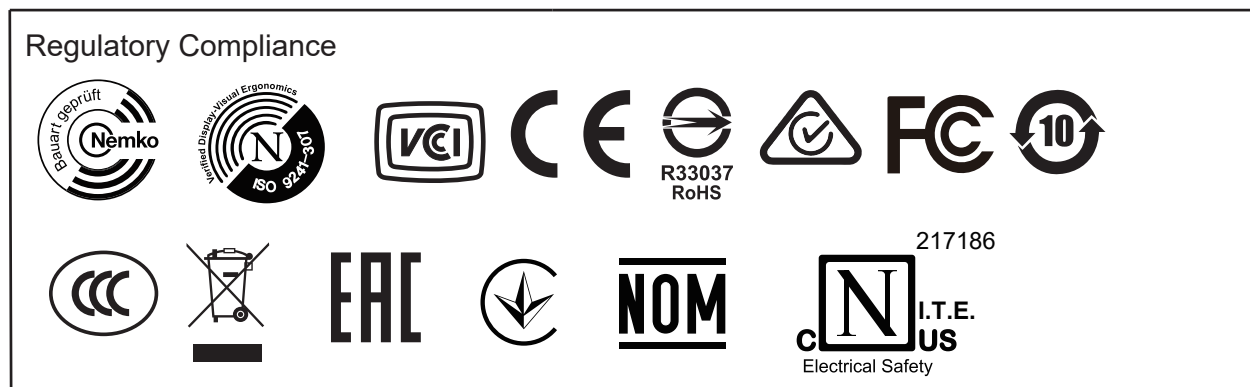

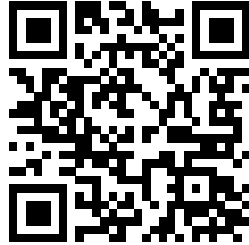

Product Information for EU Energy