



Cisco Webex Desk Camera User Guide

First Published: 2021-02-15

Americas Headquarters

Cisco Systems, Inc.
170 West Tasman Drive
San Jose, CA 95134-1706
USA
<http://www.cisco.com>
Tel: 408 526-4000
800 553-NETS (6387)
Fax: 408 527-0883

THE SPECIFICATIONS AND INFORMATION REGARDING THE PRODUCTS IN THIS MANUAL ARE SUBJECT TO CHANGE WITHOUT NOTICE. ALL STATEMENTS, INFORMATION, AND RECOMMENDATIONS IN THIS MANUAL ARE BELIEVED TO BE ACCURATE BUT ARE PRESENTED WITHOUT WARRANTY OF ANY KIND, EXPRESS OR IMPLIED. USERS MUST TAKE FULL RESPONSIBILITY FOR THEIR APPLICATION OF ANY PRODUCTS.

THE SOFTWARE LICENSE AND LIMITED WARRANTY FOR THE ACCOMPANYING PRODUCT ARE SET FORTH IN THE INFORMATION PACKET THAT SHIPPED WITH THE PRODUCT AND ARE INCORPORATED HEREIN BY THIS REFERENCE. IF YOU ARE UNABLE TO LOCATE THE SOFTWARE LICENSE OR LIMITED WARRANTY, CONTACT YOUR CISCO REPRESENTATIVE FOR A COPY.

The following information is for FCC compliance of Class A devices: This equipment has been tested and found to comply with the limits for a Class A digital device, pursuant to part 15 of the FCC rules. These limits are designed to provide reasonable protection against harmful interference when the equipment is operated in a commercial environment. This equipment generates, uses, and can radiate radio-frequency energy and, if not installed and used in accordance with the instruction manual, may cause harmful interference to radio communications. Operation of this equipment in a residential area is likely to cause harmful interference, in which case users will be required to correct the interference at their own expense.

The following information is for FCC compliance of Class B devices: This equipment has been tested and found to comply with the limits for a Class B digital device, pursuant to part 15 of the FCC rules. These limits are designed to provide reasonable protection against harmful interference in a residential installation. This equipment generates, uses and can radiate radio frequency energy and, if not installed and used in accordance with the instructions, may cause harmful interference to radio communications. However, there is no guarantee that interference will not occur in a particular installation. If the equipment causes interference to radio or television reception, which can be determined by turning the equipment off and on, users are encouraged to try to correct the interference by using one or more of the following measures:

- Reorient or relocate the receiving antenna.
- Increase the separation between the equipment and receiver.
- Connect the equipment into an outlet on a circuit different from that to which the receiver is connected.
- Consult the dealer or an experienced radio/TV technician for help.

Modifications to this product not authorized by Cisco could void the FCC approval and negate your authority to operate the product.

The Cisco implementation of TCP header compression is an adaptation of a program developed by the University of California, Berkeley (UCB) as part of UCB's public domain version of the UNIX operating system. All rights reserved. Copyright © 1981, Regents of the University of California.

NOTWITHSTANDING ANY OTHER WARRANTY HEREIN, ALL DOCUMENT FILES AND SOFTWARE OF THESE SUPPLIERS ARE PROVIDED "AS IS" WITH ALL FAULTS. CISCO AND THE ABOVE-NAMED SUPPLIERS DISCLAIM ALL WARRANTIES, EXPRESSED OR IMPLIED, INCLUDING, WITHOUT LIMITATION, THOSE OF MERCHANTABILITY, FITNESS FOR A PARTICULAR PURPOSE AND NON-INFRINGEMENT OR ARISING FROM A COURSE OF DEALING, USAGE, OR TRADE PRACTICE.

IN NO EVENT SHALL CISCO OR ITS SUPPLIERS BE LIABLE FOR ANY INDIRECT, SPECIAL, CONSEQUENTIAL, OR INCIDENTAL DAMAGES, INCLUDING, WITHOUT LIMITATION, LOST PROFITS OR LOSS OR DAMAGE TO DATA ARISING OUT OF THE USE OR INABILITY TO USE THIS MANUAL, EVEN IF CISCO OR ITS SUPPLIERS HAVE BEEN ADVISED OF THE POSSIBILITY OF SUCH DAMAGES.

Any Internet Protocol (IP) addresses and phone numbers used in this document are not intended to be actual addresses and phone numbers. Any examples, command display output, network topology diagrams, and other figures included in the document are shown for illustrative purposes only. Any use of actual IP addresses or phone numbers in illustrative content is unintentional and coincidental.

All printed copies and duplicate soft copies of this document are considered uncontrolled. See the current online version for the latest version.

Cisco has more than 200 offices worldwide. Addresses and phone numbers are listed on the Cisco website at www.cisco.com/go/offices.

Cisco and the Cisco logo are trademarks or registered trademarks of Cisco and/or its affiliates in the U.S. and other countries. To view a list of Cisco trademarks, go to this URL: <https://www.cisco.com/c/en/us/about/legal/trademarks.html>. Third-party trademarks mentioned are the property of their respective owners. The use of the word partner does not imply a partnership relationship between Cisco and any other company. (1721R)

© 2021 Cisco Systems, Inc. All rights reserved.



CONTENTS

CHAPTER 1

Your Camera 1

- About the Cisco Webex Desk Camera 1
- Camera Hardware 2
- Additional Help and Information 4
- Cisco One-Year Limited Hardware Warranty Terms 4

CHAPTER 2

Set Up Your Camera 5

- Setup Overview 5
- Best Practices 5
- Connect Your Camera 6
- System Requirements of the Camera App 8
- Install the Cisco Webex Desk Camera App 9

CHAPTER 3

Use Your Camera with Webex Apps 11

- Use Your Camera with Cisco Webex Meetings 11
- Use Your Camera with Webex 12
- Set Your Camera as the Default Video Device for Webex 12
- Set the Microphone on Your Camera as the Default Microphone for Webex 13

CHAPTER 4

Use Your Camera with the Camera App 15

- Record a Video 15
- Take a Snapshot 16
- Configure the Video Image Settings 16
- Flip the Video Image 19
- Use Digital Zoom 19
- Mute the Microphones 20

Adjust the Microphone Volume 20
 Specify the Media File Directory 21

CHAPTER 5

Maintain Your Camera 23

Firmware Upgrade 23
 Upgrade the Camera Firmware with the Camera App 23
 Upgrade the Camera Firmware on Cisco Accessory Hub 24
 Reset the Camera Settings 25
 Update the Camera App 26
 View Camera Information 27
 Camera Logs 27
 Collect Logs with the Camera App 27
 Collect Camera Logs with Cisco Accessory Hub 28
 Collect Camera Logs with Webex 28
 Collect Camera Logs with Webex Meetings 29
 Troubleshoot Your Camera 29
 My Computer Doesn't Recognize the Camera 30
 I Can't See My Preview on Webex or Webex Meetings 31
 Webex or Webex Meetings Can't Connect to the Camera 31
 Video Quality is Poor 32
 Accessory Hub Can't Detect the Camera 32

CHAPTER 6

Product Safety and Security 35

Safety and Performance Information 35
 External Devices 35
 UL Warning 35
 Product Label 36
 Compliance Statements 36
 Compliance Statements for the European Union 36
 CE Marking 36
 Compliance Information for Japan 36
 FCC Compliance Statements 36
 FCC Part 15.19 Statement 36
 FCC Part 15.21 Statement 36

FCC Receivers and Class B Digital Statement **37**
Cisco Product Security Overview **37**
Important Online Information **37**



CHAPTER 1

Your Camera

- [About the Cisco Webex Desk Camera](#), on page 1
- [Camera Hardware](#), on page 2
- [Additional Help and Information](#), on page 4
- [Cisco One-Year Limited Hardware Warranty Terms](#), on page 4

About the Cisco Webex Desk Camera

Figure 1: Cisco Webex Desk Camera



The Cisco Webex Desk Camera is a USB web camera for video conferencing, video streaming, and video recording. The camera provides up to 4K Ultra HD video and high-definition audio.

With multiple options for resolution and frame rate, the camera meets the use cases with Webex, Webex Meetings, Cisco Jabber, and all popular third-party video conferencing and video streaming apps. The autofocus, face detection, and 10x digital zoom enhance your video experience for meeting and video streaming.

The camera has a privacy shutter. You can use it to turn off the video stream and block the camera lens when the device isn't in use.

The camera has two Omni Directional Microphones with noise-canceling features, providing audio input for calls, meetings, and recordings.

The camera supports Windows Hello for secure login to your system.

The adjustable clip with a tripod screw thread offers mounting flexibility on a laptop, an external display, a tripod, or a desk stand in various open office spaces, huddle rooms, and home offices. The two USB cables shipped with the camera allow easy connection to computers or devices with fully functional USB-A or USB-C ports.

The Cisco Webex Desk Camera app works with the camera and allows you to record videos, take snapshots, customize the camera settings, and upgrade the firmware.

For more technical specifications, see [Cisco Webex Desk Camera Data Sheet](#).

Camera Hardware

The figures below show the front, back, and bottom of the camera. Use this information to familiarize yourself with the hardware features before you use your camera.

Figure 2: Cisco Webex Desk Camera front view

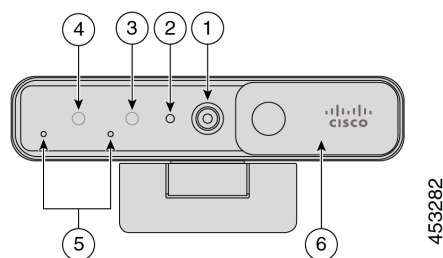

Table 1: Hardware Components on the Front

Component	Description
1. RGB camera	Supports video stream and static snapshots.
2. LED indicator	Indicates the camera status: <ul style="list-style-type: none"> • Solid green for 1.5 seconds: camera is booting. • Solid green: RGB camera is in use. • Off: RGB camera is in standby mode or the shutter is closed.
3. IR camera	Supports Windows Hello via the IR sensor.
4. IR LED	Indicates the IR camera status: <ul style="list-style-type: none"> • Flash red: The IR camera is in use by Windows Hello. • Off: The IR camera is not in sue.
5. Microphones	The audio input channel of the camera. You can mute the audio or adjust the input volume from the Cisco Webex Desk Camera app.

Component	Description
6. Shutter	Turns the video stream on or off and blocks the camera lens when closed to protect privacy.

Figure 3: Cisco Webex Desk Camera back view

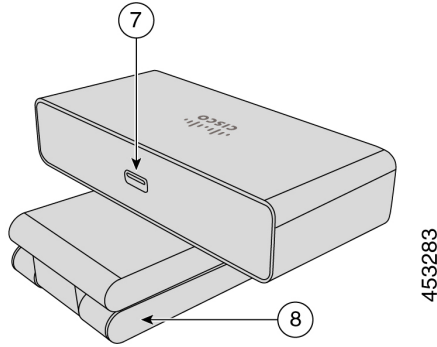

Table 2: Hardware Components at the Back

Component	Description
7. USB-C port	The USB cable plugs into this port to connect the camera to a computer.
8. Camera base and clip	Supports multiple mounting options on flat surfaces or on top of displays. The adjustable hinges provides flexible angles.

Figure 4: Cisco Webex Desk Camera bottom view

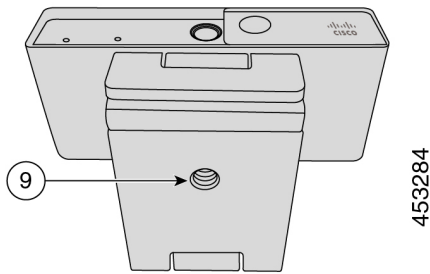

Table 3: Hardware Component at Bottom

Component	Description
9. Tripod screw thread	Use the 1/4"-20 screw thread to mount the camera to a tripod.

Additional Help and Information

The Cisco website (<https://www.cisco.com>) contains more information about the camera.

- For release notes, quick reference guide, and user guide, go to <https://www.cisco.com/c/en/us/support/collaboration-endpoints/webex-desk-camera/model.html#%7Etab-documents>.
- For Help articles, go to <https://cisco.com/go/webexcamhelp>.

Cisco One-Year Limited Hardware Warranty Terms

Special terms apply to your hardware warranty and services that you can use during the warranty period.

Your formal Warranty Statement, including the warranties and license agreements applicable to Cisco software, is available on Cisco.com at this URL: <https://www.cisco.com/go/hwwarranty>.



CHAPTER 2

Set Up Your Camera

- [Setup Overview](#), on page 5
- [Best Practices](#), on page 5
- [Connect Your Camera](#), on page 6
- [System Requirements of the Camera App](#), on page 8
- [Install the Cisco Webex Desk Camera App](#), on page 9

Setup Overview

Connect your Cisco Webex Desk Camera to your computer so that you can use it with the video conferencing and video streaming apps.

Install the Cisco Webex Desk Camera app to record videos, take snapshots, configure the camera settings, and maintain your camera.

Related Topics

- [Connect Your Camera](#), on page 6
- [System Requirements of the Camera App](#), on page 8
- [Install the Cisco Webex Desk Camera App](#), on page 9

Best Practices

Keep these limitations in mind when you set up and use your Cisco Webex Desk Camera.

- Your device needs a dry and well-ventilated space. Cisco Webex Desk Camera operates at 32° to 104°F (0° to 40°C).
- Don't expose the device to water or liquids as they could damage your camera.
- Keep the USB drivers on your computer up to date.
- Make sure the USB port that you connect your camera to provides both power delivery and data transfer.
- Use the camera in appropriate lighting. A bright backlighting or front lighting may cause underexposure or overexposure on your video image. If you can't change the lighting, then you manually adjust the brightness with the Cisco Webex Desk Camera app.

- The privacy shutter on your camera turns the video stream on and off. Slide the shutter right or left to turn the video stream on and off, instead of disconnecting and reconnecting your camera.
- When using your camera with an app on your computer, close the other applications that may use the camera at the same time. Your camera supports one application on Windows, and more than one application on Mac OS at a time.
- The camera has an IR sensor for Windows Hello. Don't block the sensor.
- Gently wipe your camera with a dry and soft cloth on the surface and the front panel. Rough materials may scratch the front panel and affect image clarity.

Connect Your Camera

Your camera gets power from the computer through the USB cable. It's shipped with a USB-A and a USB-C cable. Use the cable that fits the USB port on your computer.

You can mount your camera on your computer, on a display screen, on a desk stand or on a tripod, and participate in a video call or meeting.

Procedure

- Step 1** Open the camera clip.

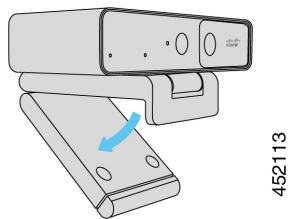

- Step 2** Adjust the camera.

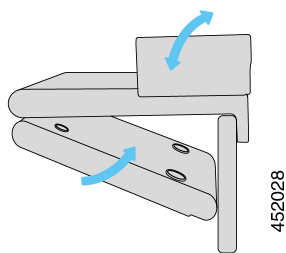

- a) Place your camera on the top edge of your computer display and close the clip until the camera is steady. Refer to the bottom arrow of the previous figure.
- b) Lift the back end of the camera to adjust the angle. Refer to the top arrow of the previous figure.

- Step 3** Connect your camera to your computer with one of the provided USB cables.

Figure 5: Connection for the Camera Mounted on a Computer

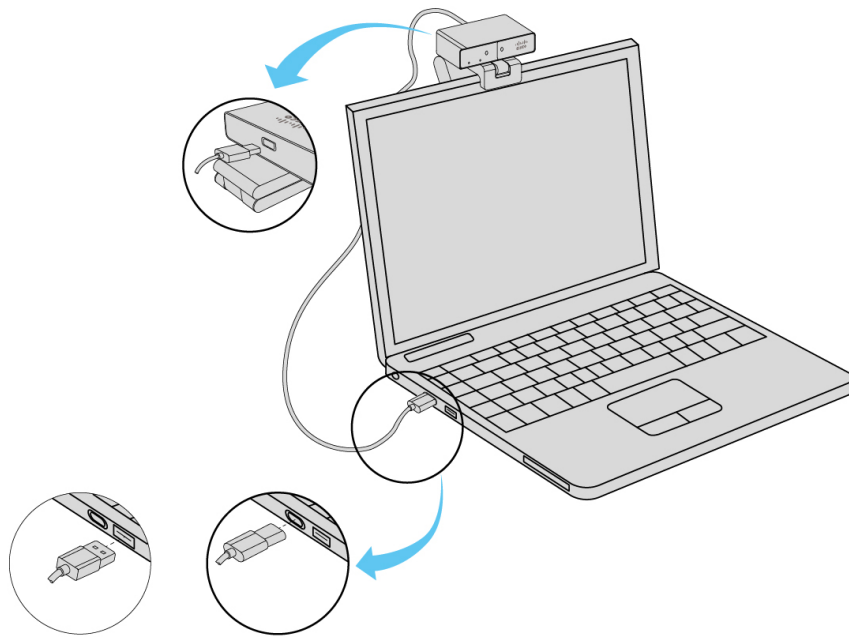

452114

Figure 6: Connection for the Camera Mounted on a Display Screen

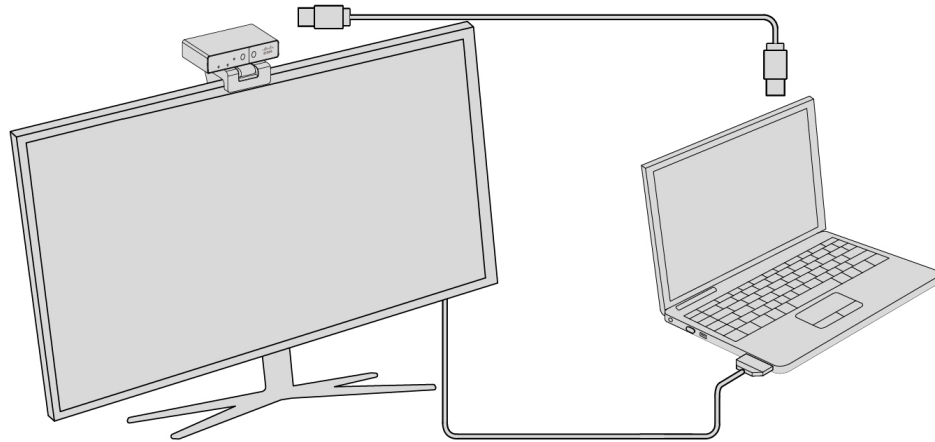

454028

You can also mount your camera on a tripod, as needed. If you have a separate tripod, refer to its manual for information about how to mount your camera on the tripod.

Figure 7: Mount the Camera on a Tripod

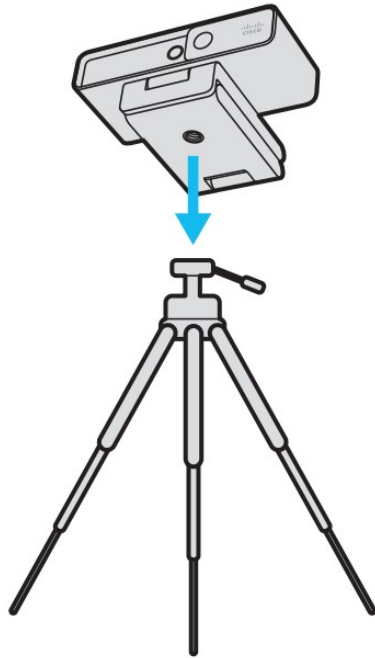

Related Topics

- [Install the Cisco Webex Desk Camera App](#), on page 9
- [Upgrade the Camera Firmware with the Camera App](#), on page 23

System Requirements of the Camera App

The following list shows the computer system requirements for using the Cisco Webex Desk Camera app. You should confirm that your computer meets or exceeds these requirements before you install the camera app.

- Minimum operating system requirements:
 - Windows 10 with Universal C Runtime
 - Mac OS X 10.12
- CPU: i5@2.4 GHz / i7@1.9 GHz Intel processor, or a processor with the equivalent processing capabilities
- RAM: 8 GB or more
- Hard drive space for media file storage
- USB 2.0 port (4K resolutions require a USB 3.0 or USB-C port.)

Related Topics

- [Install the Cisco Webex Desk Camera App](#), on page 9

[Update the Camera App](#), on page 26

Install the Cisco Webex Desk Camera App

The Cisco Webex Desk Camera is designed to function out of the box with the default settings. You can customize the settings with the Cisco Webex Desk Camera app to meet your network or video image requirements.

Before you begin

The Cisco Webex Desk Camera app supports Windows and Mac OS. Make sure that your computer meets or exceeds the minimum requirements. For the system requirements, see [System Requirements of the Camera App](#), on page 8.

Procedure

Step 1 Download the app installer for your computer operating system. Do any of the following actions:

- Go to [Cisco Accessory Hub](#) and download the installation file from **Accessory**

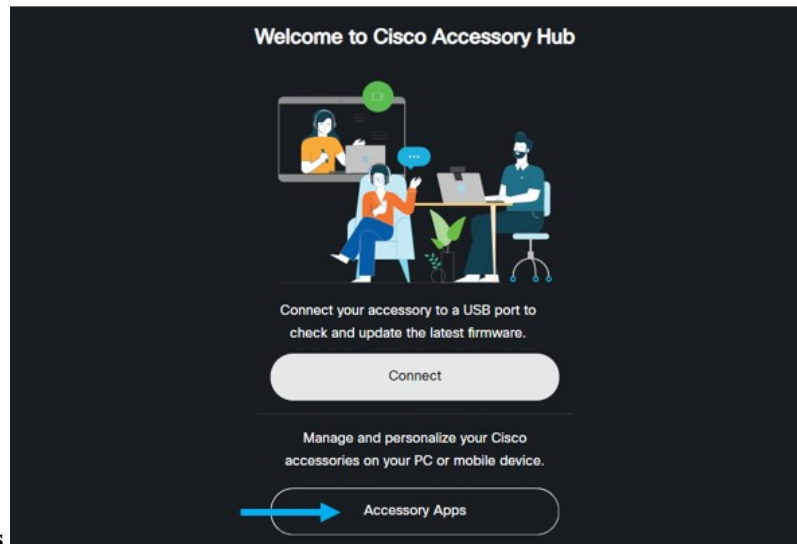

Apps.

Select the version compatible with your operating system to download.

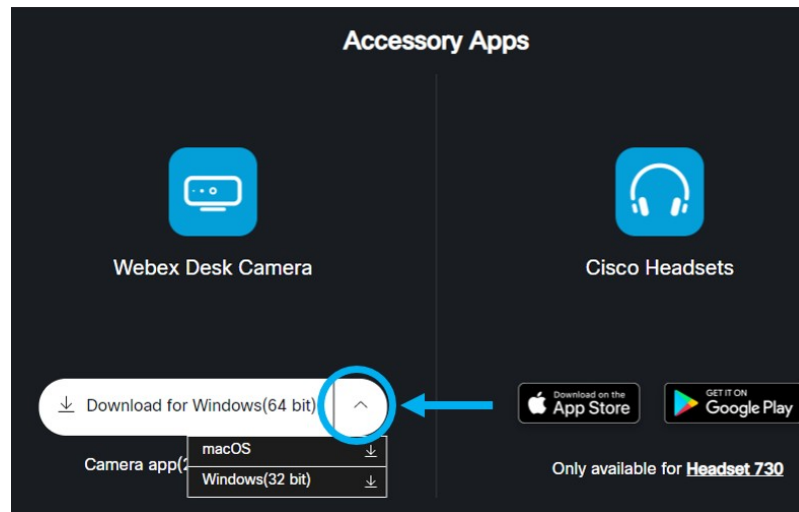

- Go to [Cisco Software Download](#) and download the latest version that is compatible with your operating system. Login is required for downloading.

Step 2 Double-click the executable file to start the installation.

Step 3 Follow the onscreen instructions to complete the installation.

Related Topics

[Update the Camera App](#), on page 26

[Use Your Camera with the Camera App](#), on page 15



CHAPTER 3

Use Your Camera with Webex Apps

- [Use Your Camera with Cisco Webex Meetings](#), on page 11
- [Use Your Camera with Webex](#), on page 12
- [Set Your Camera as the Default Video Device for Webex](#), on page 12
- [Set the Microphone on Your Camera as the Default Microphone for Webex](#), on page 13





Use Your Camera with Cisco Webex Meetings

You can use your camera with Cisco Webex Meetings for video sessions so that other participants can see you. You can select your camera either before you join a meeting or during a meeting.

Before you begin

- Close any apps that may use your camera.
- Connect your camera to your computer.

Procedure

- Step 1** Choose your camera as the video input device.
- a) Click the dropdown arrow on the  **Stop video** or  **Start video** button.
 - b) Choose **Cisco Webex Desk Camera**.
- Step 2** Choose your camera as the audio input device.
- a) Click the dropdown arrow on the  **Mute** or  **Unmute** button.
 - b) Choose **Microphone (Cisco Webex Desk Camera)**.

Related Topics

- [Use Your Camera with Webex](#), on page 12
- [Specify the Media File Directory](#), on page 21

Use Your Camera with Webex

If you use Webex, you can use your camera to collaborate with your coworkers and colleagues.

Before you begin

- Close any apps that may use your camera.
- Connect your camera to your computer.

Procedure

- Step 1** Click .
- Step 2** Click **Camera** from the **Settings** window.
- Step 3** Choose **Cisco Webex Desk Camera** from the **Camera** dropdown list.
- Step 4** (Optional) Click **Change Virtual Background** and choose a blurred or virtual background to use.
- Step 5** Go to the **Speaker and Microphone** tab on the **Settings** window.
- Step 6** Choose **Microphone (Cisco Webex Desk Camera)** from the **Microphone** dropdown list.
-

Related Topics

- [Use Your Camera with Cisco Webex Meetings](#), on page 11
- [Specify the Media File Directory](#), on page 21

Set Your Camera as the Default Video Device for Webex

You can configure Webex to use your Cisco Webex Desk Camera as the default camera for video calls or meetings.

Before you begin

Connect your camera to your computer.

Procedure

- Step 1** Click your profile picture and choose **Settings > Video**.
- Step 2** Choose **Cisco Webex Desk Camera** from the **Camera** dropdown list.
- Step 3** (Optional) Click **Change Virtual Background** and choose a blurred or virtual background to use.
- Step 4** Click **Save**.
-

Related Topics

- [Set the Microphone on Your Camera as the Default Microphone for Webex](#), on page 13

[Use Your Camera with Webex](#), on page 12

Set the Microphone on Your Camera as the Default Microphone for Webex

You can configure your Webex to use the microphone on your camera as the default audio input device for calls and meetings.

Before you begin

Connect your camera to your computer.

Procedure

- Step 1** Click your profile picture and choose **Settings > Audio**.
- Step 2** Choose **Microphone (Cisco Webex Desk Camera)** from the **Microphone** dropdown list.
- Step 3** (Optional) Adjust the input level by dragging the **Volume** slider left or right.
- Step 4** Click **Save**.

Related Topics

[Use Your Camera with Webex](#), on page 12

[Set the Microphone on Your Camera as the Default Microphone for Webex](#), on page 13



CHAPTER 4

Use Your Camera with the Camera App

- [Record a Video](#), on page 15
- [Take a Snapshot](#), on page 16
- [Configure the Video Image Settings](#), on page 16
- [Flip the Video Image](#), on page 19
- [Use Digital Zoom](#), on page 19
- [Mute the Microphones](#), on page 20
- [Adjust the Microphone Volume](#), on page 20
- [Specify the Media File Directory](#), on page 21





Record a Video

You can record videos of on-site events or meetings with the Cisco Webex Desk Camera app. The recordings are saved as AVI files in the **Media** folder.



Note If you close the shutter, the recording stops.

Procedure

- Step 1** Open the Cisco Webex Desk Camera app.
- Step 2** Click  **Record** to start recording.
- Step 3** Click  **Pause** to pause recording.
- Step 4** Click  **Resume** to continue recording.
- Step 5** Click  **Stop** to stop recording.
- Step 6** Click  to view your recording files in the media folder.

Related Topics



[Install the Cisco Webex Desk Camera App](#), on page 9

- [Specify the Media File Directory](#), on page 21
- [Take a Snapshot](#), on page 16
- [Configure the Video Image Settings](#), on page 16
- [Flip the Video Image](#), on page 19
- [Use Digital Zoom](#), on page 19

Take a Snapshot

Use the Snapshot feature on the Cisco Webex Desk Camera app to save static images. The captures are saved as BMP files in the **Media** folder.

Procedure

- Step 1** Open the Cisco Webex Desk Camera app.
- Step 2** If needed, adjust the settings to optimize the image.
For information about the camera configuration, see [Configure the Video Image Settings, on page 16](#).
- Step 3** Below the video frame, click  **Snapshot** to take a picture from the live video.
- Step 4** Click  to view the pictures you take.

Related Topics

- [Install the Cisco Webex Desk Camera App](#), on page 9
- [Specify the Media File Directory](#), on page 21
- [Record a Video](#), on page 15
- [Configure the Video Image Settings](#), on page 16
- [Flip the Video Image](#), on page 19
- [Use Digital Zoom](#), on page 19

Configure the Video Image Settings

The Cisco Webex Desk Camera is designed to function out of the box. You can also adjust the video image settings to meet your network or video image requirements.



- Note** Because of the limitations of Mac OS, the camera settings are reset to the default if you reconnect the camera with the camera app closed. Keep the camera app open to persist your customization when you reconnect the camera.
-

Before you begin

Install the Cisco Webex Desk Camera app on your computer.

Procedure

Step 1 Open the Cisco Webex Desk Camera app.

Step 2 Configure the parameters on the **Basic** and **Advanced** tab as you need.

The following table describes the video image parameters available on the **Basic** tab.

Table 4. Video Image Settings on the Basic Tab

Parameter	Description
Resolution	<p>Choose a resolution for the video recordings and static pictures you take with the camera.</p> <p>A higher resolution rate provides a higher image clarity, consumes more network bandwidth, and requires more storage to save the recorded videos and snapshots.</p> <p>Choose the resolution that suits your network and computer.</p> <p>Default: 1280x720</p> <p>Options:</p> <ul style="list-style-type: none"> • 4096x2160 (USB 3.0 required) • 3840x2160 (USB 3.0 required) • 1920x1080 • 1280x720 • 864x480 • 640x360 • 512x288 • 448x240 • 320x180 • 256x144
Frame rate	<p>Choose a frame rate from the drop-down list.</p> <p>The frame rate is measured with frames per second (fps). A higher frame rate provides a smoother video display, consumes more network bandwidth, and requires more storage to save the recorded video files.</p> <p>Choose the frame rate that suits your network and computer. The available options vary with the resolution that you specified and the USB port specification on your computer.</p> <p>Default: 30</p> <p>Options for USB 3.0: 15, 30, 60</p> <p>Options for USB 2.0: 5, 10, 15, 30</p>

Parameter	Description
Field of view	<p>The field of view determines the width of the view that you can see from the camera. The higher degree you set, the wider the image.</p> <p>Default: 81</p> <p>Options: 65, 70, 75, 81</p>
Brightness	<p>Adjust the brightness of the camera image to suit the available light.</p> <p>Drag the slider left to decrease the brightness or right to increase the brightness.</p> <p>The camera uses facial detection when it sets the correct auto exposure. But if your place is brightly backlit or front lit, then it may under or overexpose your image. Adjust the Brightness setting if you are silhouetted or overexposed in a video call.</p>

The following table describes the video image parameters available on the **Advanced** tab.

Table 5: Video Image Settings on the Advanced Tab

Parameter	Description
Auto focus	<p>Enables or disables automatic focus.</p> <p>In autofocus mode, the camera adjusts the lens to focus on the subject within the camera view.</p> <p>If the autofocus mode is turned off, you can manually adjust the focus. Drag the slider left to make the lense focus closer, and right to focus further.</p> <p>Default: On</p>
Auto white balance	<p>Enables or disables automatic white balance.</p> <p>When auto mode is on, the camera examines the lighting condition and determines the colors to render the image.</p> <p>When the auto mode is off, you can use the slider to adjust the white balance manually and get your intended image colors.</p> <p>Default: On</p>
Contrast	<p>If necessary, adjust the contrast value to improve the image clarity.</p> <p>Drag the slider left to decrease image contrast or right to increase contrast.</p>
Sharpness	<p>Adjusts the sharpness level. A proper sharpness level renders the image details clearly. Drag the slider left to smooth the image or right to sharpen the image.</p>

Parameter	Description
Manual anti-flicker	<p>Some artificial lighting, like fluorescent lights, causes flickers in video images. By default, the camera automatically detects the flickering light in the environment and minimizes the flickering impact on image quality.</p> <p>If the default auto mode doesn't eliminate the flickers, toggle the switch on and try with the available options to optimize the image quality.</p> <p>Default: Off</p> <p>Options for manual mode: 50 Hz, 60 Hz</p>

Related Topics

[Reset the Camera Settings](#), on page 25

Flip the Video Image

Flip the image if you need your video image to be in a horizontally reversed view.

The setting works on video recordings and snapshots as well.

Procedure

-
- Step 1** Open the Cisco Webex Desk Camera app.
 - Step 2** Click  at the top-right corner of the video frame.

Related Topics

[Install the Cisco Webex Desk Camera App](#), on page 9

Use Digital Zoom

Use digital zoom when you need a closer look at a person or item. When zoomed in, you can use the onscreen arrow tool to navigate around the image.

Procedure

-
- Step 1** Open the Cisco Webex Desk Camera app.
 - Step 2** Hover the mouse over the video frame.
 - Step 3** Click the + or - on the zoom bar to zoom in or out of the image.
 - Step 4** Use the arrows on the video frame to navigate around the image.
-

Related Topics

[Install the Cisco Webex Desk Camera App](#), on page 9



Mute the Microphones

By default, your camera microphones are **On**. Mute your microphones if you don't want the meeting participants to hear you.

When the microphones are muted, recordings taken with your camera are silent.

If you use your camera with a meeting application, make sure that you select Cisco Webex Desk Camera as the audio channel on the meeting app settings.

Procedure

-
- Step 1** Open the Cisco Webex Desk Camera app.
 - Step 2** Below the live video frame, click  **Mute**.
 - Step 3** To resume the audio, click  **Unmute**.

Related Topics

[Install the Cisco Webex Desk Camera App](#), on page 9

[Adjust the Microphone Volume](#), on page 20

Adjust the Microphone Volume

Adjust your microphone volume if you sound too loud or too quiet during a meeting. You can't adjust the volume when muted.

Procedure

-
- Step 1** Open the Cisco Webex Desk Camera app.
 - Step 2** Click the downward arrow (∨) on the  **Mute** button.
 - Step 3** On the **Microphone gain** window, move the **Input volume** slider left to decrease or right to increase the volume.

Related Topics

[Install the Cisco Webex Desk Camera App](#), on page 9

[Mute the Microphones](#), on page 20

Specify the Media File Directory

You can specify a location on your local drive to save your pictures and recordings. By default, media files are saved to the **Media** folder on your local drive at

```
...\Users\<user_ID>\Documentation\Cisco Camera\Media
```

Procedure

- Step 1** Open the Cisco Webex Desk Camera app.
 - Step 2** On the **Advanced** tab, click **Change** under **Media file location**.
 - Step 3** Choose the desired folder and click **Select Folder**.
-

Related Topics

- [Record a Video](#), on page 15
- [Take a Snapshot](#), on page 16
- [Install the Cisco Webex Desk Camera App](#), on page 9



CHAPTER 5

Maintain Your Camera

- [Firmware Upgrade, on page 23](#)
- [Reset the Camera Settings, on page 25](#)
- [Update the Camera App, on page 26](#)
- [View Camera Information, on page 27](#)
- [Camera Logs, on page 27](#)
- [Troubleshoot Your Camera, on page 29](#)

Firmware Upgrade

You can upgrade the camera firmware from:

- **Cisco Accessory Hub**
Upgrade the camera either online or with a local firmware file.
- **Cisco Webex Desk Camera App**
Upgrade the camera with a local firmware file.

Upgrade the Camera Firmware with the Camera App

The Cisco Webex Desk Camera app allows you to download the latest firmware and upgrade the camera with the downloaded firmware file on your local drive. Keep the camera firmware up to date to get the latest features.

Before you begin

Close any apps that may use your camera.

Procedure

- Step 1** Open the Cisco Webex Desk Camera app.
- Step 2** Click **Cisco Webex Desk Camera > Camera information** from the menu bar.
- Step 3** Click **Download firmware** to download and save the latest firmware to your local drive.

If your current firmware is up to date, the **Download firmware** button is inactive.

You can also download the firmware from [Cisco Software Download](#). Login is required for downloading.

Step 4 On the **Basic** tab, click **Select file** under **Firmware upgrade**.

Step 5 Choose the firmware file on your local drive.

If you upload a wrong firmware file, click **Remove** to remove it and then upload the right file.

Step 6 Click **Upgrade** to start the upgrade.

Note Keep your camera connected to your computer during the upgrade.

Step 7 When the upgrade completes, wait a minute for your camera to reboot.

Related Topics

[Install the Cisco Webex Desk Camera App](#), on page 9

[Upgrade the Camera Firmware on Cisco Accessory Hub](#), on page 24

[View Camera Information](#), on page 27

Upgrade the Camera Firmware on Cisco Accessory Hub

The Cisco Accessory Hub enables you to upgrade the camera firmware through your Google Chrome web browser. The tool automatically checks your camera model and current firmware version, and gives you the option to upgrade your camera if there is a newer version available. You can also upgrade your camera with a local firmware file using Cisco Accessory Hub.



Note You can only use Cisco Accessory Hub with Google Chrome version 68 and later.

Before you begin

Close any apps that may use your camera.

Procedure

Step 1 Connect your camera to your computer.

Step 2 Go to [Cisco Accessory Hub](#) in your web browser.

Step 3 Click **Connect**.

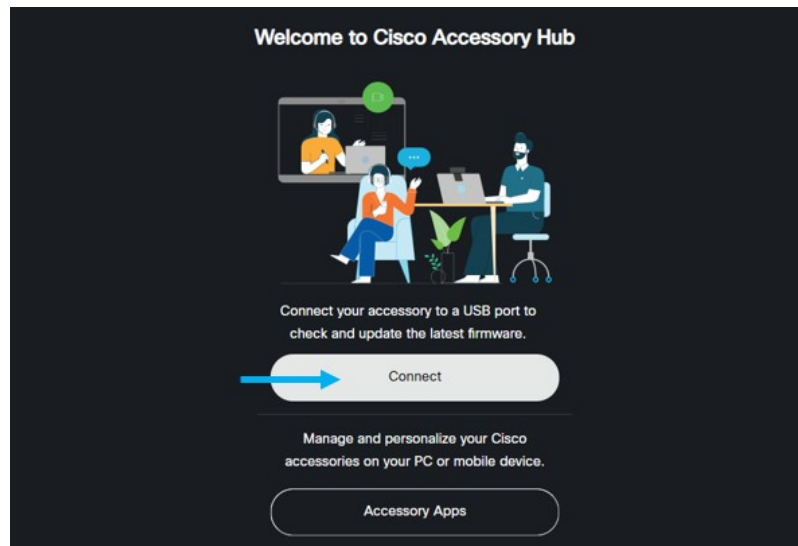

Step 4 Select **Cisco Webex Desk Camera** from the prompted device list and click **Connect**.

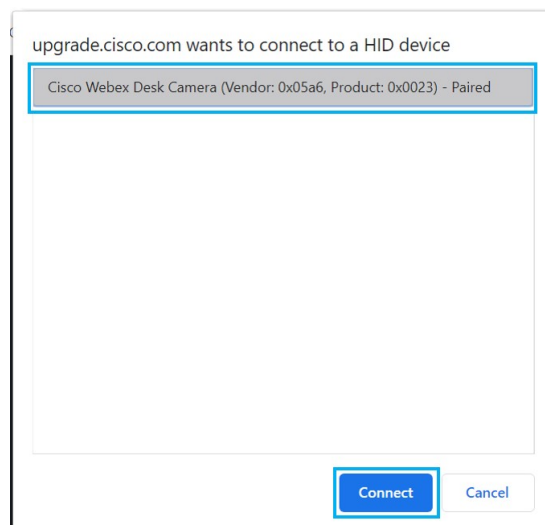

Step 5 Follow the onscreen instructions.

Note Keep your camera connected to your computer during the upgrade.

Step 6 When the upgrade completes, wait a minute for your camera to reboot.

Related Topics

[Upgrade the Camera Firmware with the Camera App](#), on page 23

Reset the Camera Settings

Perform a factory reset if you want to return the camera to the original settings. This can resolve some technical issues.



Note Keep your camera connected to your computer during the reset.

Procedure

Step 1 Open the Cisco Webex Desk Camera app.

Step 2 Click **Reset settings**.

Related Topics

[Install the Cisco Webex Desk Camera App](#), on page 9

[Mute the Microphones](#), on page 20

Update the Camera App

When an app update is available, the **Update** button displays in the upper-right corner of the app.

You can view the current app version from **Cisco Webex Desk Camera > About Cisco Webex Desk Camera** on the menu bar.



Note The update installation closes the application.

Procedure

Step 1 Click the **Update** button.

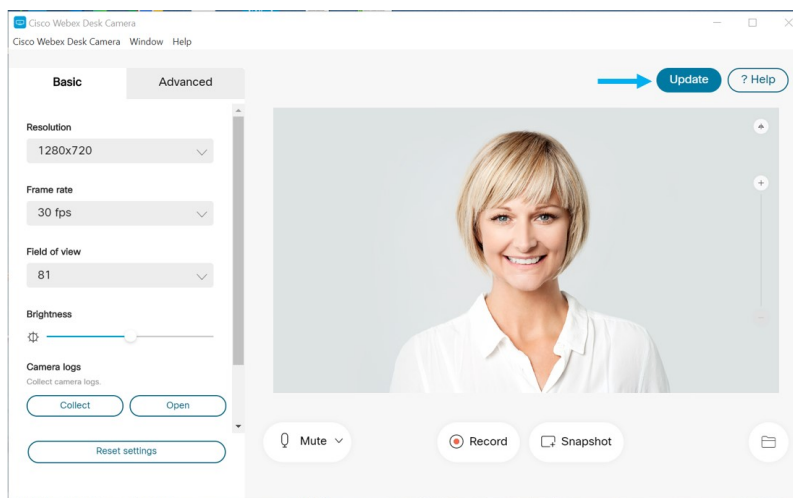

Step 2 Download the latest installer file to your local drive.

Step 3 Double-click the executable file to start the installation.

- Step 4** Follow the onscreen instructions to complete the installation.
-

View Camera Information

Access the Camera information screen to read information about your camera, including the firmware version, the serial number, and the USB cables.

Administrators may ask for this information when they troubleshoot an issue.

Procedure

- Step 1** Open the Cisco Webex Desk Camera app.
- Step 2** Click **Cisco Webex Desk Camera** from the menu bar.
- Step 3** Click **Camera information**.
-

Related Topics

- [Install the Cisco Webex Desk Camera App](#), on page 9
- [Upgrade the Camera Firmware with the Camera App](#), on page 23
- [Upgrade the Camera Firmware on Cisco Accessory Hub](#), on page 24

Camera Logs

You can use the camera logs to diagnose and troubleshoot issues with the camera such as dropped frame rates or poor video quality.

There are several ways you can capture the camera logs:

- Collect camera logs with the Cisco Webex Desk Camera app.
- Get camera logs with the Cisco Accessory Hub at <https://upgrade.cisco.com/accessories>.
- Send camera logs with Webex or Webex Meetings.

Related Topics

- [Collect Logs with the Camera App](#), on page 27
- [Collect Camera Logs with Webex](#), on page 28
- [Collect Camera Logs with Webex Meetings](#), on page 29
- [Collect Camera Logs with Cisco Accessory Hub](#), on page 28

Collect Logs with the Camera App

Collect the camera logs if you encounter problems with your camera or the camera app. The collected log files are saved as compressed files at the following locations:

- For Windows:

C:\Users\

- For Mac OS:

Macintosh HD:\Users\

Procedure

- Step 1** Open the Cisco Webex Desk Camera app.
- Step 2** On the **Basic** tab, locate **Camera logs**.
- Step 3** Click **Collect** to start logs collection.
- Step 4** Click **Open** to open the directory where the log files are saved.

Related Topics

- [Install the Cisco Webex Desk Camera App](#), on page 9
- [Collect Camera Logs with Webex](#), on page 28
- [Collect Camera Logs with Webex Meetings](#), on page 29
- [Collect Camera Logs with Cisco Accessory Hub](#), on page 28

Collect Camera Logs with Cisco Accessory Hub

If you encounter issues when using your camera, use the Cisco Accessory Hub to get camera logs for troubleshooting. The camera logs are saved to the download directory specified in your web browser.



Note You can only use Cisco Accessory Hub with Google Chrome version 68 and later.

Procedure

- Step 1** Connect your camera to your computer.
- Step 2** Go to <https://upgrade.cisco.com/accessories> in your web browser.
- Step 3** Follow the onscreen instructions until the camera serial number and firmware version display.
- Step 4** Click **Get camera logs** at the bottom.

Related Topics

- [Collect Logs with the Camera App](#), on page 27
- [Collect Camera Logs with Webex](#), on page 28
- [Collect Camera Logs with Webex Meetings](#), on page 29

Collect Camera Logs with Webex

If you encounter issues when using your camera with Webex, you can use the **Send logs** feature within Webex to capture camera logs for troubleshooting.

The logs saved at:

- For Windows:

```
C:\Users\<user_ID>\AppData\Local\CiscoSpark\Accessories\current_log.txt
```

- For Mac OS:

```
/Users/<user_ID>/Library/Logs/SparkMacDesktop/current_log.txt
```

Procedure

- Step 1** Click your profile picture.
 - Step 2** Choose **Help > Send logs**.
-

Related Topics

- [Collect Logs with the Camera App](#), on page 27
- [Collect Camera Logs with Webex Meetings](#), on page 29
- [Collect Camera Logs with Cisco Accessory Hub](#), on page 28

Collect Camera Logs with Webex Meetings

If you encounter issues when using your camera with Webex Meetings, use the **Send Problem Report** feature within Webex Meetings to capture camera logs for troubleshooting.

Procedure

- Step 1** Click **Help > Send Problem Report**.
 - Step 2** Choose a problem type and the meeting or session where you are having issues.
 - Step 3** Provide some details by adding a description.
 - Step 4** Click **Send Report**.
-

Related Topics

- [Collect Logs with the Camera App](#), on page 27
- [Collect Camera Logs with Webex](#), on page 28
- [Collect Camera Logs with Cisco Accessory Hub](#), on page 28

Troubleshoot Your Camera

The following sections provide troubleshooting information for common camera-related issues. Use this information to troubleshoot your camera before you contact Cisco technical support.

My Computer Doesn't Recognize the Camera

Problem

You can't see Cisco Webex Desk Camera in the camera list of your conferencing app. The camera doesn't display in the camera, audio, or video device list in Device Manager (Windows) or Hardware (Mac OS).

Solution

- Check if the USB connection is loose or disconnected. Dirt and debris can build up in the USB port so check if the port is blocked.
- Unplug your camera from your computer and reconnect it.
- Try a different USB port. Make sure that the USB port is fully functional. The camera doesn't support USB ports that only deliver power.
- Confirm that the USB cable or the connector isn't damaged. Try a different USB cable.
- If your camera is connected to a USB adapter, make sure the USB port of the adapter provides both power delivery and data transfer.
- Check if the USB drivers on your computer are up to date. Update them if there's a new version available.
- If you are using a computer with Mac OS, make sure that the Cisco Webex Desk Camera app is allowed to use the camera and the microphone. Do the following actions to configure the settings:
 1. Go to **Apple** menu > **System Preferences** > **Security & Privacy** > **Privacy**.
 2. Enable **Cisco Webex Desk Camera** on the **Camera** and **Microphone** panels respectively.
- If you connect the camera to the Thunderbolt port on a Lenovo computer, keep the port driver updated. Go to Lenovo Support for the driver update.



Note Frame rate drop occurs when using the camera on the Thunderbolt port.

- Restart your computer.

Related Topics

[Camera Logs](#), on page 27

[I Can't See My Preview on Webex or Webex Meetings](#), on page 31

[Accessory Hub Can't Detect the Camera](#), on page 32

[Webex or Webex Meetings Can't Connect to the Camera](#), on page 31

[Video Quality is Poor](#), on page 32

I Can't See My Preview on Webex or Webex Meetings

Problem

The camera is connected and is configured correctly, but the video doesn't preview on Webex or Webex Meetings.

Solution

- Close any other applications that are using the camera. Then, go to Webex or Webex Meetings and do the following actions:
 1. Select another camera in the camera list. For example, select the system integrated camera.
 2. Select Cisco Webex Desk Camera again.
- Slide the privacy shutter to the far right side to open it.
- Disconnect and reconnect your camera.

Related Topics

[Camera Logs](#), on page 27

[Accessory Hub Can't Detect the Camera](#), on page 32

[Webex or Webex Meetings Can't Connect to the Camera](#), on page 31

[My Computer Doesn't Recognize the Camera](#), on page 30

[Video Quality is Poor](#), on page 32

Webex or Webex Meetings Can't Connect to the Camera

Problem

When the camera shutter is closed during a Webex meeting, the preview frame of Webex or Webex Meetings shows the message "Can't connect to the camera".

Solution

If you want to stop your video during Webex meetings, use the **Stop video** button on Webex or Webex Meetings, instead of closing the shutter. This helps to avoid the error message.

Related Topics

[Camera Logs](#), on page 27

[I Can't See My Preview on Webex or Webex Meetings](#), on page 31

[Accessory Hub Can't Detect the Camera](#), on page 32

[My Computer Doesn't Recognize the Camera](#), on page 30

[Video Quality is Poor](#), on page 32

Video Quality is Poor

Problem

Your video quality that the meeting participants see is poor or subpar.

Solution

- Check if the lens gets dirty. Clean it with a soft cloth.
- Check your self-view image quality on the meeting app or on the camera app.
 - If the self view looks good, then the problem may be with the network bandwidth. Work with your network service provider to test your network performance and enhance the bandwidth.

The network bandwidth determines the video resolution in Webex meetings or calls. If the bandwidth allows, the default resolution is 720P@30fps for Webex or Webex Meetings, and 1080P@30fps for Webex Room devices.

- If the quality of your self view looks bad, then adjust the resolution in the Cisco Webex Desk Camera app.

For information on how to adjust video resolution, see [Configure the Video Image Settings, on page 16](#).

Related Topics

[Camera Logs](#), on page 27

[I Can't See My Preview on Webex or Webex Meetings](#), on page 31

[Accessory Hub Can't Detect the Camera](#), on page 32

[Webex or Webex Meetings Can't Connect to the Camera](#), on page 31

[My Computer Doesn't Recognize the Camera](#), on page 30

Accessory Hub Can't Detect the Camera

Problem

Cisco Accessory Hub doesn't detect the camera.

Solution

- Check your Google Chrome version and update it to version 86 or later. Earlier versions aren't supported.
- Enable **Experimental Web Platform features** on Chrome. Follow these steps:
 1. Enter **chrome://flags/** in your Chrome browser window.
 2. Scroll down and locate **Experimental Web Platform features**, and enable it.
 3. Restart Chrome.

Related Topics

[Camera Logs](#), on page 27

[I Can't See My Preview on Webex or Webex Meetings](#), on page 31
[Webex or Webex Meetings Can't Connect to the Camera](#), on page 31
[My Computer Doesn't Recognize the Camera](#), on page 30
[Video Quality is Poor](#), on page 32



CHAPTER 6

Product Safety and Security

- [Safety and Performance Information, on page 35](#)
- [Compliance Statements, on page 36](#)
- [Cisco Product Security Overview, on page 37](#)
- [Important Online Information, on page 37](#)

Safety and Performance Information

External Devices

We recommend that you use good-quality external devices that are shielded against unwanted radio frequency (RF) and audio frequency (AF) signals. External devices include headsets, cables, and connectors.

Depending on the quality of these devices and their proximity to other devices, such as mobile phones or two-way radios, some audio noise may still occur. In these cases, we recommend that you take one or more of these actions:

- Move the external device away from the source of the RF or AF signals.
- Route the external device cables away from the source of the RF or AF signals.
- Use shielded cables for the external device, or use cables with a better shield and connector.
- Shorten the length of the external device cable.
- Apply ferrites or other such devices on the cables for the external device.

Cisco cannot guarantee the performance of external devices, cables, and connectors.



Caution

In European Union countries, use only external speakers, microphones, and headsets that are fully compliant with the EMC Directive [89/336/EC].

UL Warning

The LAN/Ethernet cable or other cables attached to the device should not be extended outside of the building.

The device is an accessory and uses with UL Listed product Cisco Webex Desk Hub, please contact Cisco for further information.

If you use the device with an external monitor, then the monitor should not exceed 6.84Kg or you risk an injury.

Product Label

The product label is located on the camera clip surface.

Compliance Statements

Compliance Statements for the European Union

CE Marking

The following CE mark is affixed to the equipment and packaging.



Compliance Information for Japan

VCCI Compliance for Class B Equipment



FCC Compliance Statements

The Federal Communications Commission requires compliance statements for the following:

FCC Part 15.19 Statement

This device complies with part 15 of the FCC Rules. Operation is subject to the following two conditions: (1) This device may not cause harmful interference, and (2) this device must accept any interference received, including interference that may cause undesired operation.

FCC Part 15.21 Statement

Changes or modifications not expressly approved by the party responsible for compliance could void the user's authority to operate the equipment.

FCC Receivers and Class B Digital Statement

This product has been tested and complies with the specifications for a Class B digital device, pursuant to Part 15 of the FCC Rules. These limits are designed to provide reasonable protection against harmful interference in a residential installation. This equipment generates, uses, and can radiate radio frequency energy and, if not installed and used according to the instructions, may cause harmful interference to radio communications. However, there is no guarantee that interference will not occur in a particular installation.

If this equipment does cause harmful interference to radio or television reception, which is found by turning the equipment off and on, the user is encouraged to try to correct the interference by one or more of the following measures:

- Reorient or relocate the receiving antenna
- Increase the separation between the equipment or devices
- Connect the equipment to an outlet other than the receiver's
- Consult a dealer or an experienced radio/TV technician for assistance

Cisco Product Security Overview

This product contains cryptographic features and is subject to U.S. and local country laws that govern import, export, transfer, and use. Delivery of Cisco cryptographic products does not imply third-party authority to import, export, distribute, or use encryption. Importers, exporters, distributors, and users are responsible for compliance with U.S. and local country laws. By using this product, you agree to comply with applicable laws and regulations. If you are unable to comply with U.S. and local laws, return this product immediately.

Further information regarding U.S. export regulations can be found at <https://www.bis.doc.gov/policiesandregulations/ear/index.htm>.

Important Online Information

End User License Agreement

The End User License Agreement (EULA) is located here: <https://www.cisco.com/go/eula>

Regulatory Compliance and Safety Information

Regulatory Compliance and Safety Information (RCSI) is located here:

https://www.cisco.com/c/dam/en/us/td/docs/voice_ip_comm/cuipph/webex/Deskcamera/RCSI/RCSI-0162.pdf

