



# User Guide

## **SUMMARY**

This guide provides information about components, computer setup, backing up, and more.

# Legal information

© Copyright 2020 HP Development Company, L.P.

AMD is a trademark of Advanced Micro Devices, Inc. Intel and Xeon are trademarks of Intel Corporation or its subsidiaries in the U.S. and/or other countries. Linux® is the registered trademark of Linus Torvalds in the U.S. and other countries. Microsoft and Windows are either registered trademarks or trademarks of Microsoft Corporation in the United States and/or other countries. NVIDIA is a trademark or registered trademark of NVIDIA Corporation in the U.S. and other countries. Red Hat Enterprise Linux is a registered trademark of Red Hat, Inc. in the United States and other countries. USB Type-C® is a registered trademark of USB Implementers Forum. DisplayPort™ and the DisplayPort™ logo are trademarks owned by the Video Electronics Standards Association (VESA) in the United States and other countries.

The information contained herein is subject to change without notice. The only warranties for HP products and services are set forth in the express warranty statements accompanying such products and services. Nothing herein should be construed as constituting an additional warranty. HP shall not be liable for technical or editorial errors or omissions contained herein.

First Edition: September 2020

Part number: M07789-001

## Product notice

This guide describes features that are common to most products. Some features may not be available on your computer.

Not all features are available in all editions or versions of Windows. Systems may require upgraded and/or separately purchased hardware, drivers, software or BIOS update to take full advantage of Windows functionality. See <http://www.microsoft.com>.

To access the latest user guides, go to <http://www.hp.com/support>, and follow the instructions to find your product. Then select **Manuals**.

## Software terms

By installing, copying, downloading, or otherwise using any software product preinstalled on this computer, you agree to be bound by the terms of the HP End User License Agreement (EULA). If you do not accept these license terms, your sole remedy is to return the entire unused product (hardware and software) within 14 days for a full refund subject to the refund policy of your seller.

For any further information or to request a full refund of the price of the computer, please contact your seller.

---

# Safety warning notice





Reduce the possibility of heat-related injuries or of overheating the computer by following the practices described.

- 
- ⚠ WARNING!** To reduce the possibility of heat-related injuries or of overheating the computer, do not place the computer directly on your lap or obstruct the computer air vents. Use the computer only on a hard, flat surface. Do not allow another hard surface, such as an adjoining optional printer, or a soft surface, such as pillows or rugs or clothing, to block airflow. Also, do not allow the AC adapter to come into contact with the skin or a soft surface, such as pillows or rugs or clothing, during operation. The computer and the AC adapter comply with the user-accessible surface temperature limits defined by applicable safety standards.
-

---

# About this guide

This guide provides basic information for using and upgrading this product.

- 
-  **WARNING!** Indicates a hazardous situation that, if not avoided, **could** result in serious injury or death.
  -  **CAUTION:** Indicates a hazardous situation that, if not avoided, **could** result in minor or moderate injury.
  -  **IMPORTANT:** Indicates information considered important but not hazard-related (for example, messages related to property damage). Warns the user that failure to follow a procedure exactly as described could result in loss of data or in damage to hardware or software. Also contains essential information to explain a concept or to complete a task.
  -  **NOTE:** Contains additional information to emphasize or supplement important points of the main text.
  -  **TIP:** Provides helpful hints for completing a task.
-

---

# Table of contents

<b>1 Locating HP resources</b>	<b>1</b>
Product information	1
Support	1
Product documentation	2
Product diagnostics	2
Product updates	3
<b>2 Computer features</b>	<b>4</b>
Desktop front components	4
Desktop rear components	5
Tower front components	5
Tower rear components	6
Product specifications	7
<b>3 Setting up the computer</b>	<b>9</b>
Ensuring proper ventilation	9
Setup procedures	10
Adding monitors	10
Finding supported graphics cards	11
Planning for additional monitors	11
Matching graphics cards to monitor connectors	12
Identifying monitor connection requirements	13
Connecting and configuring monitors	13
Using a third-party graphics configuration utility	14
Customizing the monitor (Windows)	15
Installing optional components	15
Security	15
Product recycling	15
<b>4 Backing up, restoring, and recovering</b>	<b>16</b>
Backing up information and creating recovery media	16
Using Windows tools for backing up	16
Using the HP Cloud Recovery Download Tool to create recovery media (select products only)	16
Restoring and recovering your system	16
Creating a system restore	17
Restoring and recovery methods	17
Recovering using HP Recovery media	17
Changing the computer boot order	17
Using HP Sure Recover (select products only)	18

<b>5 Setting up Linux .....</b>	<b>19</b>
Linux-ready systems .....	19
Setting up Red Hat Enterprise Linux (RHEL) .....	19
Setting up SUSE Linux Enterprise Desktop (SLED) .....	19
Setting up Ubuntu .....	20
Open source graphics drivers .....	20
Proprietary graphics drivers .....	20
<b>6 Updating the computer .....</b>	<b>21</b>
Updating the BIOS .....	21
Determining the current BIOS version .....	21
Upgrading the BIOS .....	21
Upgrading device drivers .....	22
<b>7 Maintenance, diagnostics, and minor troubleshooting .....</b>	<b>23</b>
Turning off the computer .....	23
If you encounter issues .....	23
For more information .....	23
Visual inspection .....	23
At startup .....	23
During operation .....	24
Customer Self Repair .....	25
Blink or beep codes: interpreting POST diagnostic lights and audible codes .....	25
Basic troubleshooting .....	25
HP Support .....	25
Online support .....	26
Customer support for computers .....	26
Advisories or bulletins and notices .....	26
Product Change Notifications .....	26
Calling support .....	26
Locating warranty information .....	27
<b>8 Using HP PC Hardware Diagnostics .....</b>	<b>28</b>
Using HP PC Hardware Diagnostics Windows (select products only) .....	28
Using an HP PC Hardware Diagnostics Windows hardware failure ID code .....	28
Accessing HP PC Hardware Diagnostics Windows .....	28
Accessing HP PC Hardware Diagnostics Windows from the Start menu .....	28
Accessing HP PC Hardware Diagnostics Windows from Support Assistant .....	28
Downloading HP PC Hardware Diagnostics Windows .....	29
Downloading the latest HP PC Hardware Diagnostics Windows version from HP .....	29
Downloading the HP PC Hardware Diagnostics Windows from the Microsoft Store .....	29
Downloading HP Hardware Diagnostics Windows by product name or number (select products only) .....	29
Installing HP PC Hardware Diagnostics Windows .....	30
Using HP PC Hardware Diagnostics UEFI .....	30
Using an HP PC Hardware Diagnostics UEFI hardware failure ID code .....	30
Starting HP PC Hardware Diagnostics UEFI .....	30
Downloading HP PC Hardware Diagnostics UEFI to a USB flash drive .....	31
Downloading the latest HP PC Hardware Diagnostics UEFI version .....	31

Downloading HP PC Hardware Diagnostics UEFI by product name or number (select products only) .....	31
Using Remote HP PC Hardware Diagnostics UEFI settings (select products only) .....	31
Downloading Remote HP PC Hardware Diagnostics UEFI .....	31
Downloading the latest Remote HP PC Hardware Diagnostics UEFI version .....	32
Downloading Remote HP PC Hardware Diagnostics UEFI by product name or number .....	32
Customizing Remote HP PC Hardware Diagnostics UEFI settings .....	32
<b>9 Computer operating guidelines, routine care, and shipping preparation .....</b>	<b>33</b>
Operating guidelines and routine care .....	33
Cleaning your computer .....	33
Removing dirt and debris from your computer .....	34
Cleaning your computer with a disinfectant .....	34
Shipping preparation .....	35
<b>10 Electrostatic discharge .....</b>	<b>36</b>
<b>11 Accessibility .....</b>	<b>37</b>
HP and accessibility .....	37
Finding the technology tools you need .....	37
The HP commitment .....	37
International Association of Accessibility Professionals (IAAP) .....	38
Finding the best assistive technology .....	38
Assessing your needs .....	38
Accessibility for HP products .....	38
Standards and legislation .....	39
Standards .....	39
Mandate 376 – EN 301 549 .....	39
Web Content Accessibility Guidelines (WCAG) .....	39
Legislation and regulations .....	40
Useful accessibility resources and links .....	40
Organizations .....	40
Educational institutions .....	41
Other disability resources .....	41
HP links .....	41
Contacting support .....	41
<b>Index .....</b>	<b>42</b>





# 1 Locating HP resources

Read this chapter to learn about where to find additional HP resources.

## Product information

To locate resources that provide product details, how-to information, and more, use this table.

**Table 1-1 Where to find product information**

Topic	Location
Technical specifications	To find the QuickSpecs for your product, go to <a href="http://www.hp.com/go/quickspecs">http://www.hp.com/go/quickspecs</a> , and then click the link. Click <b>Search all QuickSpecs</b> , type your model name in the search box, and then click <b>Go</b> .
<i>Regulatory, Safety, and Environmental Notices</i>	See the <i>Regulatory, Safety, and Environmental Notices</i> for product regulatory information. You can also see the Agency/Environmental label.  To access this guide:  ▲ Type <b>HP Documentation</b> in the taskbar search box, and then select <b>HP Documentation</b> .
System board	A diagram of the system board is located on the inside of the chassis. Additional information is located in the computer <i>Maintenance and Service Guide</i> on the web at <a href="http://www.hp.com/support">http://www.hp.com/support</a> . Follow the instructions to find your product, and then select <b>Manuals</b> .
Serial number, Agency/Environmental, and operating system labels	The serial number, Agency/Environmental, and operating system labels might be on the bottom of the computer, on the rear panel of the computer, or under the service door.

## Support

To locate resources that provide support and warranty information, use this table.

**Table 1-2 Where to find support information**

Topic	Location
Product support	For HP support, go to <a href="http://www.hp.com/support">http://www.hp.com/support</a> .  Here you can access the following types of support: <ul style="list-style-type: none"><li>● Online chat with an HP technician</li><li>● Support telephone numbers</li><li>● HP service center locations</li></ul>
Warranty information	To access this document:  ▲ Type <b>HP Documentation</b> in the taskbar search box, and then select <b>HP Documentation</b> .  – or –

**Table 1-2 Where to find support information (continued)**

Topic	Location
	<p>▲ Go to <a href="http://www.hp.com/go/orderdocuments">http://www.hp.com/go/orderdocuments</a>.</p> <p><b>IMPORTANT:</b> You must be connected to the internet to access the latest version of the warranty.</p> <p>You can find your HP Limited Warranty located with the user guides on your product. The warranty might be on a CD or DVD provided in the box. In some countries or regions, HP might provide a printed warranty in the box. For countries or regions where the warranty is not provided in printed format, you can request a copy from <a href="http://www.hp.com/go/orderdocuments">http://www.hp.com/go/orderdocuments</a>. For products purchased in Asia Pacific, you can write to HP at POD, PO Box 161, Kitchener Road Post Office, Singapore 912006. Include your name, phone number, address, and product name.</p>

## Product documentation

To locate resources that provide product documentation, use this table.

**Table 1-3 Where to find product documentation**

Topic	Location
HP user documentation, white papers, and third-party documentation	User documentation is located on your hard drive. Type <b>HP Documentation</b> in the taskbar search box, and then select <b>HP Documentation</b> . For the latest online documentation, go to <a href="http://www.hp.com/support">http://www.hp.com/support</a> and follow the instructions to find your product. Then select <b>Manuals</b> . The documentation includes this user guide and the <i>Maintenance and Service Guide</i> .
Product notifications	Subscriber's Choice is an HP program that allows you to sign up to receive driver and software alerts, proactive change notifications (PCNs), the HP newsletter, customer advisories, and more. Sign up at <a href="https://h41369.www4.hp.com/">https://h41369.www4.hp.com/</a> .
Technical specifications	The Product Bulletin application contains QuickSpecs for HP computers. QuickSpecs include information about the operating system, power supply, memory, processor, and many other system components. To access the QuickSpecs, go to <a href="http://www.hp.com/go/quickspecs/">http://www.hp.com/go/quickspecs/</a> .
Bulletins and Notices	To find advisories, bulletins, and notices: <ol style="list-style-type: none"><li>1. Go to <a href="http://www.hp.com/support">http://www.hp.com/support</a>.</li><li>2. Follow the instructions to find your product.</li><li>3. Select <b>Advisories</b> or <b>Bulletins and Notices</b>.</li></ol>

## Product diagnostics

To locate resources that provide product diagnostics tools, use this table.

**Table 1-4 Where to find diagnostics tools**

Topic	Location
Diagnostics tools	For additional information, see the computer <i>Maintenance and Service Guide</i> at <a href="http://www.hp.com/support">http://www.hp.com/support</a> . Follow the instructions to find your product, and then select <b>Manuals</b> .
Audible beep and light code definitions	See the computer <i>Maintenance and Service Guide</i> at <a href="http://www.hp.com/support">http://www.hp.com/support</a> . Follow the instructions to find your product, and then select <b>Manuals</b> .

**Table 1-4 Where to find diagnostics tools (continued)**

Topic	Location
POST error codes	See the computer <i>Maintenance and Service Guide</i> at <a href="http://www.hp.com/support">http://www.hp.com/support</a> . Follow the instructions to find your product, and then select <b>Manuals</b> .

## Product updates

To locate resources that provide product updates, use this table.

**Table 1-5 Where to find product updates**

Topic	Location
Driver and BIOS updates	Go to <a href="http://www.hp.com/support">http://www.hp.com/support</a> and select <b>Software and Drivers</b> to verify that you have the latest drivers for the computer.
Operating systems	For information about Windows® operating systems, go to <a href="http://www.support.microsoft.com">http://www.support.microsoft.com</a> .

## 2 Computer features

This chapter provides you with an overview of your computer's features.

### Desktop front components

To identify the front panel components, use this illustration and table.



**NOTE:** Your computer model might look slightly different from the illustration in this section.

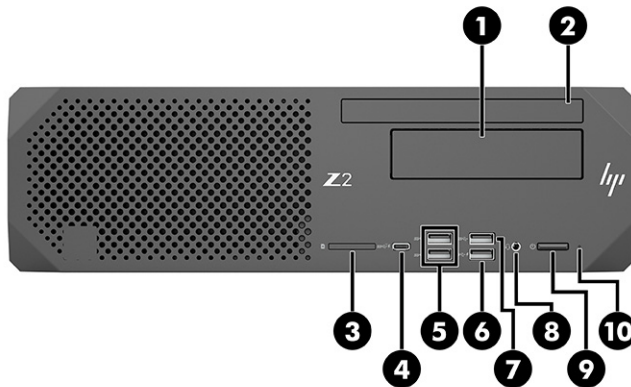

**Table 2-1** Front desktop components and their descriptions

Item	Icon	Component	Item	Icon	Component
1		3.5 in drive bay (optional)	6		USB SuperSpeed Plus port with HP Sleep and Charge (optional)
2		Optical drive (optional)	7		USB SuperSpeed port
3		Memory card reader (optional)	8		Audio-out (headphone)/Audio-in (microphone) combo jack
4		USB Type-C® SuperSpeed Plus port with HP Sleep and Charge (optional)	9		Power button
5		USB SuperSpeed Plus ports (2) (optional)	10		HDD activity





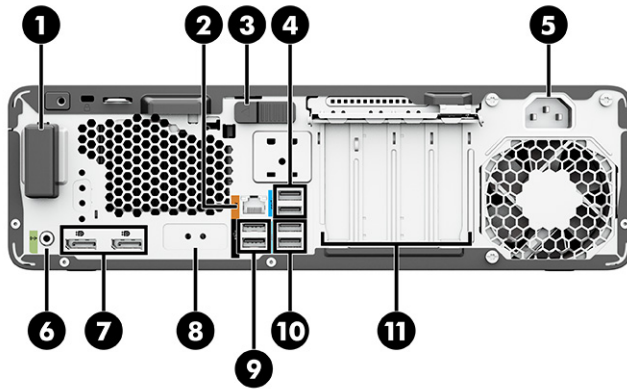

## Desktop rear components

To identify the rear panel components, use this illustration and table.

 **NOTE:** Your computer model might look slightly different from the illustration in this section.



**Table 2-2** Rear desktop components and their descriptions

Item	Icon	Component	Item	Icon	Component
1		Antenna cover	7		DisplayPort™ (DP) connectors (2)
2		RJ-45 (network) jack	8		Serial port (optional)
3		Access panel release latch	9		USB ports (2)
4		USB SuperSpeed port	10		USB SuperSpeed Plus ports (2)
5		Power connector	11		Expansion slot covers (4)
6		Audio line-out connector (green)			

**NOTE:** The labels for the rear panel connectors use industry-standard icons and colors.

**NOTE:** The DP ports are not supported when the system is configured with Intel® Xeon® E3-12x0 v5 processors. For all other processors, these DP ports are disabled by default when a discrete graphics card is installed.

**NOTE:** Simultaneous use of integrated Intel HD graphics and discrete graphics cards to drive more than two monitors can be enabled using Computer Setup. However, HP recommends using only discrete graphics cards when attaching three or more monitors.

## Tower front components

To identify the front panel components, use this illustration and table.



**NOTE:** Your computer model might look slightly different from the illustration in this section.

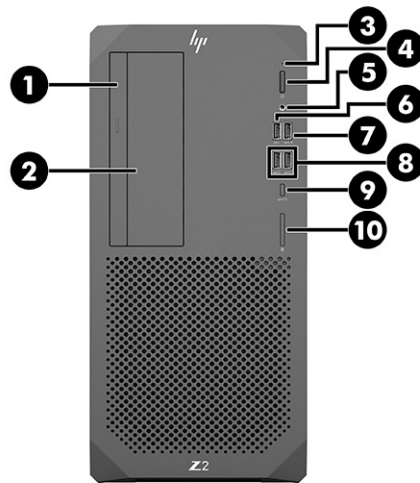

**Table 2-3** Front tower components and their descriptions

Item	Icon	Component	Item	Icon	Component
1		Optical drive (optional)	6		USB SuperSpeed port
2		3.5 in drive bay (optional)	7		USB SuperSpeed Plus port with HP Sleep and Charge (optional)
3		HDD activity	8		USB SuperSpeed Plus ports (2) (optional)
4		Power button	9		USB Type-C SuperSpeed Plus port with HP Sleep and Charge (optional)
5		Audio-out (headphone)/Audio-in (microphone) combo jack	10		Memory card reader (optional)

## Tower rear components

To identify the rear panel components, use this illustration and table.



**NOTE:** Your computer model might look slightly different from the illustration in this section.

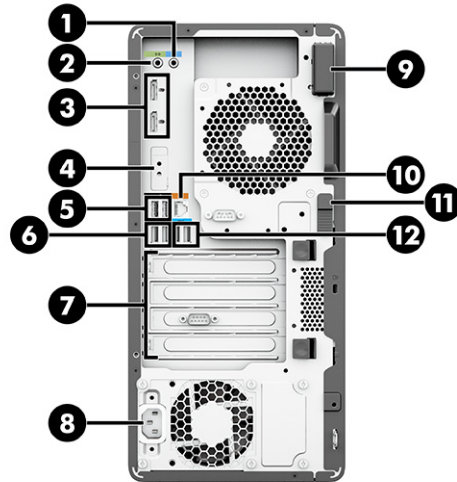

**Table 2-4** Tower rear components and their descriptions

Item	Icon	Component	Item	Icon	Component
1		Audio line-in connector (blue)	7		Expansion slot covers (4)
2		Audio line-out connector (green)	8		Power connector
3		DisplayPort™ (DP) connectors (2)	9		Antenna cover
4		Serial port (optional)	10		RJ-45 (network) jack
5		USB ports (2)	11		Access panel release latch
6		USB SuperSpeed Plus ports (2)	12		USB SuperSpeed port

**NOTE:** The labels for the rear panel connectors use industry-standard icons and colors.

**NOTE:** The DP ports are not supported when the system is configured with Intel® Xeon® E3-12x0 v5 processors. For all other processors, these DP ports are disabled by default when a discrete graphics card is installed.

**NOTE:** Simultaneous use of integrated Intel HD graphics and discrete graphics cards to drive more than two monitors can be enabled using Computer Setup. However, HP recommends using only discrete graphics cards when attaching three or more monitors.

## Product specifications

Read this section to learn where to find the technical specifications about your computer.

To find the QuickSpecs for your product, go to <http://www.hp.com/go/quickspecs>, and then click the link. Click **Search all QuickSpecs**, type your model name in the search box, and then click **Go**.

– or –

Go to <http://www.hp.com/support>, and follow the instructions to find your product. Select **Product Information**, and then select your computer specifications.



---

## 3 Setting up the computer

This chapter describes how to set up your computer.

### Ensuring proper ventilation

Proper ventilation for the system is important for computer operation. Follow these guidelines.

- Operate the computer on a sturdy, level surface.
- Provide at least 15.24 cm (6.00 in) of clearance at the front and back of the computer. (This distance is the *minimum* for all computer models.)

---

 **NOTE:** Your computer might look slightly different from the illustration in this section.

---

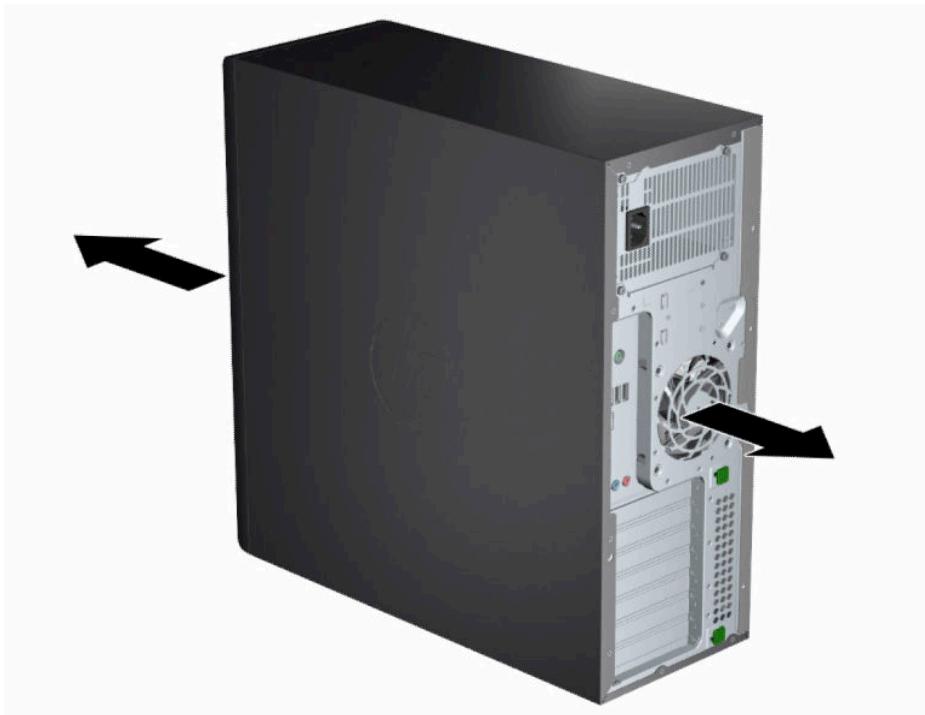

- Ensure that the ambient air temperature is within specified limits. To locate specifications for your computer, see [Product specifications on page 7](#).
- For cabinet installation, ensure adequate cabinet ventilation and ensure that the ambient temperature within the cabinet does not exceed specified limits.

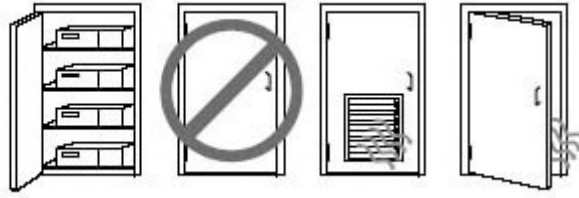

- Never restrict the incoming or outgoing airflow of the computer by blocking any vents or air intakes.

## Setup procedures

Read this section to learn how to set up your computer.

**⚠ WARNING!** To reduce the risk of electric shock:

- Plug the power cord into an AC outlet that is easily accessible at all times.
- If the power cord has a 3-pin attachment plug, plug the cord into a grounded (earthed) 3-pin outlet.

**📝 NOTE:** If your computer has more than 1100 W power supply, it might require more than the typical office power can supply and might require you to check your site infrastructure for wall connector compatibility. For details, see the *Site Preparation Guide* at <http://www.hp.com/support>. Follow the instructions to find your product, and then select **Manuals**.

To set up the computer:

1. Connect the mouse, keyboard, and power cord to the computer (1).
2. Connect the monitor to the computer (2).
3. Connect other peripheral components (such as a printer) according to the instructions included with the device.
4. Connect a network cable to the computer and to a network router or LAN device.
5. Plug the computer power cord and monitor power cord into an AC outlet (3).

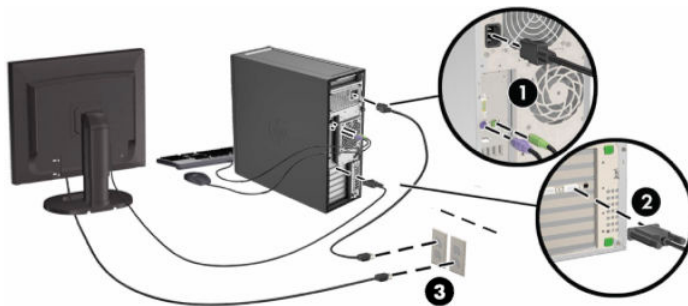

## Adding monitors

This section describes how to add monitors to your computer.

## Finding supported graphics cards

Learn about where to find graphics cards that are supported for your computer.

To find information about graphics cards that are supported for your computer:

1. Go to <http://www.hp.com/go/quickspecs>.
2. Select **Search active QuickSpecs**, and then select **Desktops & Workstations**.
3. Choose your model to view the specifications.
4. Click the link for **Technical Specifications-Graphics** to display expanded technical information for supported graphics cards, including the number of monitors that the card supports, connectors, power consumption, drivers, and other details.



---

**NOTE:** Not all graphics cards are compatible with all video transceivers and adapters. See the graphics card documentation for specific details.

---

## Planning for additional monitors

Read this section to learn what you need to know before adding monitors to your computer.

All graphics cards provided with HP Z-series computers support two simultaneous-display monitors (see [Connecting and configuring monitors on page 13](#)). Cards that support more than two monitors are available. The process for adding monitors depends on your graphics cards and the type and number of monitors you add.

Use this process to plan for adding more monitors.

1. Assess your monitor needs.
  - Determine how many monitors you require.
  - Determine the kind of graphics performance you want.
  - Note the type of graphics connector used by each monitor. HP provides graphics cards with DisplayPort (DP) and DVI-D interfaces, but you can use adapters and third-party cards to interface to other graphics formats, including DVI-I, HDMI, or VGA.



---

**TIP:** Some adapters for older hardware might cost more than others. You might want compare the cost of acquiring adapters with the cost of getting a newer monitor that doesn't need adapters.

---

2. Determine whether you need additional graphics cards.
  - Consult the graphics card documentation to determine how many monitors you can connect to the card.

You might need to acquire adapters to match the card output to the monitor connector. See [Matching graphics cards to monitor connectors on page 12](#).
  - If necessary, plan to acquire a new graphics card to support additional monitors.



---

**IMPORTANT:** Newer generations of graphics cards support only digital output protocols. Traditional analog outputs (VGA, DVI-A, or DVI-I connected to a DVI-A monitor) can be connected only by using an active adapter.

---

 **NOTE:** Monitors with resolutions above 1920 x 1200 pixels at 60 Hz require a graphics card with either Dual Link DVI (DL-DVI) or DisplayPort output. To get native resolution with DVI, you must use a DL-DVI cable, not standard DVI-I or DVI-D cables.

HP computers do not support all graphics cards. Be sure that a new graphics card is supported before purchasing it. See [Finding supported graphics cards on page 11](#).

Some graphics cards support multiple monitors by multiplexing the monitor signal across multiple outputs. This setup might reduce graphics performance. Consult the graphics card documentation, or look up information about the card according to the procedure in [Finding supported graphics cards on page 11](#).

Be sure that the card outputs match the input required by the monitors. (See [Identifying monitor connection requirements on page 13](#))

The different models of HP Z-series computers have different limits on the mechanical size, data speed, and power available for additional graphics cards. See the QuickSpecs for expansion card slot identification to be sure that a new graphics card will work for your computer. To access the QuickSpecs, go to <http://www.hp.com/go/quickspecs/>.

3. If you want to add a new graphics card or cards:
  - a. Determine which supported graphics card best fits your needs in terms of number of monitors, compatibility with the monitors you plan to use, and performance.
  - b. Be sure that you have the correct drivers for the card. For HP-qualified drivers, go to <http://www.hp.com/support>, select **Software and drivers**, and then follow the on-screen instructions.
  - c. Install the graphics card according to the video instructions for your computer at <http://www.hp.com/go/sml>.
  - d. Configure the monitor. For details, see Windows® Help, or go to <http://www.microsoft.com>.

For monitor setup in Linux®, you can often use the settings tool for the graphics cards (for example, NVIDIA® nvidia-settings). In some recent Linux releases, you must modify the window manager system (for example, Gnome 3) preferences.

 **TIP:** To simplify troubleshooting possible problems, enable the first monitor, and be sure that it works properly before you enable the next monitor.



## Matching graphics cards to monitor connectors

The following table describes monitor configuration scenarios. See the illustration that most closely matches your computer.

**Table 3-1 Graphics cards and monitor connectors**

Graphics card interface connector	Monitor connector						
	VGA	DVI	Dual Link DVI	DisplayPort (DP)	HDMI	Mini DisplayPort (mDP)	USB Type-C
 DisplayPort-to-VGA adapter (sold separately)		DP-to-DVI adapter	DP-to-DL DVI adapter	DP cable	DP-to-HDMI adapter	DP-to-mDP cable	N/A

**Table 3-1 Graphics cards and monitor connectors (continued)**

Graphics card interface connector	Monitor connector						
	VGA	DVI	Dual Link DVI	DisplayPort (DP)	HDMI	Mini DisplayPort (mDP)	USB Type-C
<b>Mini DisplayPort</b> 	mDP-to-VGA adapter (sold separately)	mDP-to-DVI adapter	N/A	mDP-to-mDP adapter	mDP-to-HDMI adapter	mDP-to-mDP cable	N/A
<b>HDMI</b> 	HDMI-to-VGA adapter	HDMI-to-DVI adapter/cable	N/A	N/A	HDMI cable	N/A	N/A
<b>USB Type-C*</b> 	USB Type-C-to-VGA adapter	N/A	N/A	USB Type-C-to-DP adapter	USB Type-C-to-HDMI adapter	N/A	USB Type-C cable

\*For the USB Type-C port that your computer supports, see [Computer features on page 4](#).

 **NOTE:** HP graphics cards typically do not include monitor cable adapters.

DisplayPort connections have the highest performance; VGA connections have the lowest.

## Identifying monitor connection requirements

Be sure that you meet these requirements before connecting monitors to your computer.

If the graphics card has four DisplayPort connectors, you can connect a monitor to each connector. Use the proper adapters, if required. See [Matching graphics cards to monitor connectors on page 12](#) for more information about the different graphics cards.

MultiStream Transport (MST) is a method used to connect multiple monitors to a single DisplayPort connector.

Although many NVIDIA graphics cards provide more than four monitor outputs, you can use only four at a time. To connect to multiple ports simultaneously, you can use MST.

AMD® graphics cards support all available monitor outputs. The maximum number of displays depends on the particular graphics card. Consult documentation for the graphics card and monitor for additional details.

 **NOTE:** MST-capable displays or an MST-capable hub must be used to connect displays together in an MST configuration. Consult documentation for the graphics card and monitor for additional details.

## Connecting and configuring monitors

Read this section to learn how to connect and configure monitors.

---

 **NOTE:** The supported graphics cards typically allow at least two monitors, as shown in this section; some supported cards allow more monitors. See the graphics card documentation for details.

 **NOTE:** Your computer might look slightly different from the illustration in this section.

---

1. Connect the monitor cable adapters (if required) to the computer, and then connect the appropriate monitor cables to the adapters or directly to the graphics card.



2. Connect the other ends of the monitor cables to the monitors.

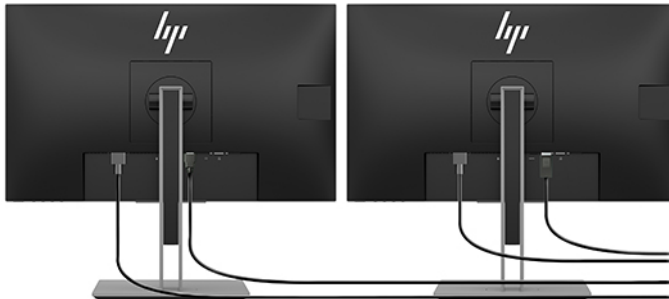

3. Connect one end of the monitor power cord to the monitor and the other end to an AC outlet.
4. Configure the monitor. For details, see Windows Help or go to <http://www.microsoft.com>.

For monitor setup in Linux, you can often use the settings tool for the graphics cards (for example, NVIDIA `nvidia-settings`). In some recent Linux releases, you must modify the window manager system (for example, Gnome 3) preferences.

## Using a third-party graphics configuration utility

Third-party graphics cards might include a monitor configuration utility. Upon installation, this utility is integrated into the operating system. You can select the utility and use it to configure multiple monitors with your computer.

See your graphics card documentation for details.

---

 **NOTE:** Some third-party configuration utilities require that you enable the monitors in Windows before using the configuration tool. See your graphics card documentation for more information, and for graphics card drivers, go to <http://www.hp.com/support>.

---

## Customizing the monitor (Windows)

You can manually select or change the monitor model, refresh rates, screen resolution, color settings, font sizes, and power management settings

To change display settings:

1. Select the **Start** button, select **Settings**, select **System**, and then select **Display**.

– or –

2. Right-click anywhere on the desktop, and then select **Display settings**.

For more information about customizing your monitor display, see the following resources:

Right-click anywhere on the desktop, and then select **Display settings**

- Online documentation provided with the graphics controller utility
- Documentation included with your monitor

## Installing optional components

Depending on the computer model, you can install additional components (such as memory, hard drives, optical drives, PCIe cards, or a second processor) on your computer.

- To view component installation videos, go to <http://www.hp.com/go/sml>.
- For installation guidelines and technical information, see the *Maintenance and Service Guide* for your computer at <http://www.hp.com/support>. Follow the instructions to find your product, and then select **Manuals**.

## Security

Some HP computers have a lock on the side access panel. The key for this lock is shipped attached to the back panel of the computer chassis.

Additional security features reduce the risk of theft and alert you when there has been a chassis intrusion. For information about additional hardware and software security features available for your system, see *Maintenance and Service Guide* for your computer at <http://www.hp.com/support>. Follow the instructions to find your product, and then select **Manuals**.

## Product recycling

HP encourages customers to recycle used electronic hardware, HP original print cartridges, and rechargeable batteries.

For information about recycling HP components or products, go to <http://www.hp.com/go/recycle>

---

## 4 Backing up, restoring, and recovering

You can use Windows tools or HP software to back up your information, create a restore point, reset your computer, create recovery media, or restore your computer to its factory state. Performing these standard procedures can return your computer to a working state faster.

---

 **IMPORTANT:** If you will be performing recovery procedures on a tablet, the tablet battery must be at least 70% charged before you start the recovery process.

 **IMPORTANT:** For a tablet with a detachable keyboard, connect the tablet to the keyboard base before beginning any recovery process.

---

### Backing up information and creating recovery media

These methods of creating recovery media and backups are available on select products only.

#### Using Windows tools for backing up

HP recommends that you back up your information immediately after initial setup. You can do this task either using Windows Backup locally with an external USB drive or using online tools.

---

 **IMPORTANT:** Windows is the only option that allows you to back up your personal information. Schedule regular backups to avoid information loss.

 **NOTE:** If computer storage is 32 GB or less, Microsoft System Restore is disabled by default.

---

#### Using the HP Cloud Recovery Download Tool to create recovery media (select products only)

You can use the HP Cloud Recovery Download Tool to create HP Recovery media on a bootable USB flash drive.

For details:

▲ Go to <http://www.hp.com/support>, search for HP Cloud Recovery, and then select the result that matches the type of computer that you have.

---

 **NOTE:** If you cannot create recovery media yourself, contact support to obtain recovery discs. Go to <http://www.hp.com/support>, select your country or region, and then follow the on-screen instructions.

 **IMPORTANT:** HP recommends that you follow the [Restoring and recovery methods on page 17](#) to restore your computer before you obtain and use the HP recovery discs. Using a recent backup can return your machine to a working state sooner than using the HP recovery discs. After the system is restored, reinstalling all the operating system software released since your initial purchase can be a lengthy process.

---

### Restoring and recovering your system

You have several tools available to recover your system both within and outside of Windows if the desktop cannot load.



HP recommends that you attempt to restore your system using the [Restoring and recovery methods on page 17](#).

## Creating a system restore

System Restore is available in Windows. The System Restore software can automatically or manually create restore points, or snapshots, of the system files and settings on the computer at a particular point.

When you use System Restore, it returns your computer to its state at the time you made the restore point. Your personal files and documents should not be affected.

## Restoring and recovery methods

After you run the first method, test to see whether the issue still exists before you proceed to the next method, which might now be unnecessary.

1. Run a Microsoft System Restore.
2. Run Reset this PC.
3. Recover using HP Recovery media. For more information, see [Recovering using HP Recovery media on page 17](#).

For more information about the first two methods, see the Get Help app:

Select the **Start** button, select the **Get Help** app, and then enter the task you want to perform.

---

 **NOTE:** You must be connected to the internet to access the Get Help app.

---

## Recovering using HP Recovery media

You can use HP Recovery media to recover the original operating system and software programs that were installed at the factory. On select products, it can be created on a bootable USB flash drive using the HP Cloud Recovery Download Tool.

For details, see [Using the HP Cloud Recovery Download Tool to create recovery media \(select products only\) on page 16](#).

---

 **NOTE:** If you cannot create recovery media yourself, contact support to obtain recovery discs. Go to <http://www.hp.com/support>, select your country or region, and then follow the on-screen instructions.

---

To recover your system:

- ▲ Insert the HP Recovery media, and then restart the computer.

---

 **NOTE:** HP recommends that you follow the [Restoring and recovery methods on page 17](#) to restore your computer before you obtain and use the HP recovery discs. Using a recent backup can return your machine to a working state sooner than using the HP recovery discs. After the system is restored, reinstalling all the operating system software released since your initial purchase can be a lengthy process.

---

## Changing the computer boot order

If your computer does not restart using the HP Recovery media, you can change the computer boot order, the order of devices listed in BIOS for startup information. You can select an optical drive or a USB flash drive, depending on the location of your HP Recovery media.

---

 **IMPORTANT:** For a tablet with a detachable keyboard, connect the tablet to the keyboard base before beginning these steps.

---

To change the boot order:

1. Insert the HP Recovery media.
2. Access the system **Startup** menu.
  - For computers or tablets with keyboards attached, turn on or restart the computer or tablet, quickly press **esc**, and then press **f9** for boot options.
  - For tablets without keyboards, turn on or restart the tablet, quickly press and hold the volume up button, and then select **f9**.

– or –

Turn on or restart the tablet, quickly press and hold the volume down button, and then select **f9**.
3. Select the optical drive or USB flash drive from which you want to boot, and then follow the on-screen instructions.

## Using HP Sure Recover (select products only)

Select computer models are configured with HP Sure Recover, a PC OS recovery solution built into the hardware and software. HP Sure Recover can fully restore the HP OS image without installed recovery software.

Using HP Sure Recover, an administrator or user can restore the system and install:

- Latest version of the operating system
- Platform-specific device drivers
- Software applications, in the case of a custom image

To access the latest documentation for HP Sure Recover, go to <http://www.hp.com/support>. Follow the on-screen instructions to find your product and locate your documentation.

---

# 5 Setting up Linux

This chapter describes how to set up and restore the Linux operating system.

 **IMPORTANT:** Do not add optional hardware or third-party devices to the computer until the operating system is successfully installed. Adding hardware might cause errors and prevent the operating system from installing correctly.

 **NOTE:** After you set up the operating system, be sure that the latest BIOS, drivers, and software updates are installed. See [Updating the computer on page 21](#).

---

## Linux-ready systems

The Linux-ready option provides a system with a minimally functional OS preload (for example, FreeDOS). It is intended for situations where the customer will install an OS when the system arrives. The option does not include a license for any operating system.

The Linux-ready option does not include the Linux operating system, which you must supply. Commercial Linux distributions are available for purchase from vendors such as Red Hat® and SUSE. A variety of other Linux distributions are available for free (for example, Ubuntu). To view HP-evaluated configurations and operating systems, go to [http://www.hp.com/support/linux\\_hardware\\_matrix](http://www.hp.com/support/linux_hardware_matrix).

## Setting up Red Hat Enterprise Linux (RHEL)

Various versions of RHEL are certified and supported by Red Hat on HP computers.

For details of RHEL support for a particular platform, see the *Linux Hardware Matrix for HP Workstations* at [http://www.hp.com/support/linux\\_hardware\\_matrix](http://www.hp.com/support/linux_hardware_matrix).

For information about Red Hat certifications on HP computers, go to <https://access.redhat.com/ecosystem>, select **Certified Hardware**, and then follow the on-screen instructions.

Additionally, if HP has tested and packaged selected third-party proprietary drivers compatible with Red Hat Enterprise Linux installations on your HP Workstation, then you can obtain them directly from <http://www.hp.com/support> as described in [Proprietary graphics drivers on page 20](#).

## Setting up SUSE Linux Enterprise Desktop (SLED)

Various versions of SLED are certified and supported by SUSE on HP computers.

For more information, go to the SUSE certification bulletin search page at <https://www.suse.com/yessearch/Search.jsp>.

Additionally, if HP has tested and packaged selected third-party proprietary drivers compatible with SUSE Linux Enterprise Desktop installations on your HP Workstation, then you can obtain them directly from <http://www.hp.com/support> as described in [Proprietary graphics drivers on page 20](#).

# Setting up Ubuntu

Various versions of Ubuntu are certified and supported by Canonical on HP computers.

For more information, go to the Ubuntu Desktop certified hardware search page at <http://www.ubuntu.com/certification/desktop> and search for your computer product. Ubuntu is available at no cost from <http://www.ubuntu.com>.

## Open source graphics drivers

Most distributions of the Linux operating system support graphics hardware through combinations of software technologies built into the kernel and higher-level graphics applications such as display servers (Xorg, Wayland) and display managers (Gnome, KDE).

Graphics hardware behavior depends upon setup by the running kernel and timing information obtained by attached display hardware. When the kernel cannot correctly calibrate its initialization of graphics hardware to available display hardware, the results can yield distorted or blank display screens.

The HP-provided Linux driver disc for Ubuntu relies on the same mechanisms to satisfy dependencies during installation. So the same internet access is needed, as well as capability to elevate from the current user session to administrator privileges.

Interaction with open source graphics drivers can occur during:

- Graphical interactive installation sessions from downloaded Linux distribution media.
- Use of Linux installations not supplemented with vendor-proprietary graphics drivers.

In cases of unusable display screens, HP recommends that the **nomodeset** option be added to the kernel boot parameters to suppress mode-setting driver behavior and prioritize the use of alternate compatible display drivers. You can usually edit the persistent inclusion of this parameter (in cases of the grub family of boot loaders) into kernel boot parameters in configuration files usually found in: **/etc/default/grub**. See your distribution's documentation for boot loader settings parameters.

## Proprietary graphics drivers

Read this section to learn about proprietary graphics drivers.

Most HP computers can be ordered with graphics cards that have been through extensive verification by HP. For a list of supported cards, see *Linux Hardware Matrix for HP Workstations* at [http://www.hp.com/support/linux\\_hardware\\_matrix](http://www.hp.com/support/linux_hardware_matrix).



---

**NOTE:** Not all graphics cards are supported on every computer. Limitations generally occur for cards that consume large amounts of power in lower-power computers.

---

HP supports third-party proprietary graphics drivers. For drivers that have been tested, go to <http://www.hp.com/support>, and follow the on-screen instructions to find your product and locate the documentation.

These proprietary drivers are not a standard part of the RHEL, SLED, or Ubuntu distributions because they are not open source. Driver revisions more recent than those at the HP support website are supported directly by the vendor.

---

## 6 Updating the computer

HP is constantly working to improve your total computer experience. To ensure that the computer uses the latest enhancements, HP recommends that you install the latest BIOS, driver, and software updates on a regular basis.

After successfully starting the computer for the first time, follow these guidelines to be sure that the computer is up to date:

- Be sure that you have the latest system BIOS version loaded. See [Updating the BIOS on page 21](#).
- Be sure that you have the latest drivers for your system. See [Upgrading device drivers on page 22](#).
- Become familiar with your available HP resources. See [Online support on page 26](#).
- Consider a subscription to Driver Alerts at <https://h41369.www4.hp.com/alerts-signup.php>.

### Updating the BIOS

For optimum performance, determine the BIOS version on the computer, and upgrade it if necessary.

#### Determining the current BIOS version

This section describes how to determine the current BIOS version.

To determine the current BIOS version:

1. Press **esc** during startup.
2. Press **f10** to enter Computer Setup (F10).
3. Select **Main**, and then select **System Information**. Note the Computer System BIOS version.



**NOTE:** For procedures for upgrading the BIOS as well as the Computer Setup (F10) BIOS Menu settings, see the *Maintenance and Service Guide* at <http://www.hp.com/support>. Follow the instructions to find your product, and then select **Manuals**.

#### Upgrading the BIOS

Follow these instructions to find and download the latest available BIOS version, which includes the latest enhancements.

1. Go to <http://www.hp.com/support> and select your product.
2. Select **Software and Drivers** and follow the instructions to locate the latest BIOS version available for the computer.
3. Compare the BIOS version on your computer to the BIOS versions on the website (see [Determining the current BIOS version on page 21](#)). If the BIOS version on the website is the same as the version on your system, no further action is required.

4. If the BIOS version on the website is a version later than the one on your system, download the appropriate version for the computer. Follow the instructions in the release notes to complete the installation.

## Upgrading device drivers

To learn how to upgrade device drivers, read this section.

If you install a peripheral device (such as a printer, display adapter, or network adapter), confirm that you have the latest device drivers loaded. If you purchased your device through HP, go to the HP website to download the latest drivers for your device. These drivers have been tested to ensure the best compatibility between your device and your HP computer.

If you did not purchase your device from HP, HP recommends that you go to the HP website first to see if your device and its drivers have been tested for HP computer compatibility. If no driver is available, go to the device manufacturer's website to download the latest drivers.

To upgrade device drivers:

1. Go to <http://www.hp.com/support> and select your product.
2. Follow the instructions to find the latest drivers available for the computer.

If a required driver is not found, see the website of the manufacturer of the peripheral device.

---

# 7 Maintenance, diagnostics, and minor troubleshooting

This section provides information about maintenance, diagnostics, and minor troubleshooting.

## Turning off the computer

To properly turn off the computer, shut down the operating system software.

---

 **IMPORTANT:** Holding down the power button to shut off the computer can cause loss of user data and might damage the storage device. If the system becomes unstable and no other alternative is available, give the system sufficient time to wake completely after you restart the computer. This might take several minutes, especially on larger-capacity or solid-state devices.

---

▲ Select the **Start** button, select the **Power** button, and then select **Shut down**.

## If you encounter issues

To diagnose and resolve issues, HP recommends a sequential troubleshooting approach.

- Visual inspection
- Blink or beep codes
- Basic troubleshooting, including HP PC Hardware Diagnostics
- HP support
- System restore and recovery

These troubleshooting strategies are explained in the following sections.

## For more information

For more troubleshooting information, read this section.

You can find more troubleshooting information in the comprehensive *Maintenance and Service Guide* (English only) available at <http://www.hp.com/support>. Follow the instructions to find your product, and then select **Manuals**.

## Visual inspection

If you encounter a problem with the computer, monitor, or software, the following general suggestions might help you isolate and focus on the problem before taking further action.

## At startup

This section outlines what to check if your computer does not start.

- Verify that the computer is plugged into a functional AC outlet.
- Remove all optical discs and USB flash drives before starting the computer.
- Verify that the computer is on and the power light is on.
- If you have installed an operating system other than the factory-installed operating system, confirm that it is supported on your system by going to <http://www.hp.com/go/quickspecs>.
- Verify that the display panel is lit.
- If you have an optional external monitor:
  - Verify that the monitor is plugged into a functional AC outlet.
  - Verify that the monitor power light is on.
  - If the monitor is dim, turn up the brightness and contrast controls.

## During operation

This section outlines various items to check if your computer has problems while you are using it.

- Beeps and blinking lights on the computer are error codes that can help you diagnose problems. For more information about interpreting these codes, see the *Diagnostic light and audible (beep) codes* section in the *Maintenance and Service Guide* for your computer.
- Press and hold any key. If the system beeps, your keyboard is operating correctly.
- Check all cables for loose or incorrect connections.
- Wake the computer by pressing the power button or any key on the keyboard. If the system remains in standby, shut down the system by pressing and holding the power button for at least 4 seconds. Then press the power button again to restart the system.

If the system does not shut down, unplug the power cord, wait a few seconds, and then plug it in again. If the system does not restart, press the power button.

- Be sure that all required device drivers are installed. For example, if you connect a printer, you must install a printer driver.
- If you are working on a network, use another cable to plug your computer into the network connection. If you still cannot connect, there might be a problem with the network plug.
- If you recently added new hardware, remove the hardware to see whether the computer functions properly.
- If you recently installed new software, uninstall the software to see whether the computer functions properly.
- If the display panel on an all-in-one computer is blank, open the computer and be sure that both ends of the cable between the system board and the display panel are connected. If you are using a graphics card, verify that the card is properly installed.
- Upgrade the BIOS. A new release of the BIOS might support new features or fix your problem.
- For more detailed information, see the troubleshooting chapter in the *Maintenance and Service Guide* at <http://www.hp.com/support>. Follow the instructions to find your product, and then select **Manuals**.



## Customer Self Repair

Under the Customer Self Repair program, you can order a replacement part and install the part without on-site HP technical assistance.

Customer Self Repair might be required for some components. For more information, go to <http://www.hp.com/go/selfrepair> and select your product.



---

**NOTE:** Some components are not eligible for Customer Self Repair and must be returned to HP for service. Call support for further instructions before attempting to remove or repair these components.

---

## Blink or beep codes: interpreting POST diagnostic lights and audible codes

If the power light on the computer is flashing or if you hear beeps, see the *Maintenance and Service Guide* (English only) for interpretation and recommended action.

## Basic troubleshooting

For basic troubleshooting tips, read this section.



---

**WARNING!** When the computer is plugged into an AC power source, voltage is always applied to the system board. To reduce the risk of personal injury from electric shock, hot surfaces, or both, be sure to disconnect the power cord from the wall outlet and allow the internal system components to cool before you touch them.

---

If you have problems with the computer, try the appropriate solutions as described in the previous sections and summarized here to try to isolate the exact problem before you call for technical support.

- If the screen is blank, plug the monitor into a different video port on the computer if one is available, or replace the monitor with a monitor that you know is functioning properly.
- If your monitor is connected with a cable adapter (for example, DP-to-DVI adapter), replace the adapter with one that you know is functioning properly.
- If you are working on a network:
  - Use a different network cable to connect your computer to the network.
  - Connect a different computer with a different cable to the network.

If your problem is not resolved, the network jack on your computer or the network wall jack might be faulty.

- If you recently added new hardware, remove the hardware.
- If you recently installed new software, uninstall the software.
- If a USB storage device is connected to the computer, disconnect the device.
- If the computer will turn on but the operating system will not start, run the preboot diagnostics utility, HP PC Hardware Diagnostics. See [Using HP PC Hardware Diagnostics on page 28](#).

## HP Support

This section outlines the different ways to contact HP support.

## Online support

Online support resources include web-based troubleshooting tools, technical knowledge databases, driver and patch downloads, online communities, and product change notification services.

The following websites are also available to you:

- <http://www.hp.com>—Provides useful product information.
- <http://www.hp.com/support>—Provides the latest online documentation, worldwide technical support, and access to software and drivers for computers.

## Customer support for computers

To look for different types of troubleshooting topics, follow these steps.

1. Go to <http://www.hp.com/support>.
2. Search for your product.
3. Select **Troubleshooting**.
4. Select the problem that you are troubleshooting.

## Advisories or bulletins and notices

Go to the HP Support site to find advisories or bulletins and notices.

1. Go to <http://www.hp.com/support>.
2. Select your product.
3. Select **Advisories** or **Bulletins and Notices**.
4. Select an item to view.

## Product Change Notifications

Product Change Notifications (PCNs) are proactive notifications for product changes occurring within a 30- to 60-day window of the effective date of the change in the manufacturing process.

PCNs give you advance notice of changes to your product, such as an updated BIOS version that you might decide to download before the product change is required. To view a list of PCNs, go to the **Bulletins and Notices** page for your product.

## Calling support

At times, you might encounter an issue that requires support. Before you call support, take these actions to prepare.

- Have the computer readily accessible.
- Write down the computer serial number, product number, model name, and model number and have them in front of you. This information is provided on labels. The labels might be on the bottom of the computer, on the rear panel of the computer, or under the service door.
- Note any applicable error messages.
- Note any add-on options.
- Note the operating system.

- Note any third-party hardware or software.
- Note the details of any blinking lights on the front of the computer (tower and desktop configurations) or on the side of the computer (all-in-one configurations).
- Note the applications that you were using when you encountered the problem.

---

 **NOTE:** When you call in for service or support, you might be asked for the product number of the computer (for example: PS988AV). If the computer has a product number, it is usually located next to the 10- or 12-digit serial number of the computer.

---

For a support phone number, go to <http://www.hp.com/support>, select **Contact Support**, and then follow the on-screen instructions.

## Locating warranty information

If you did not receive a printed warranty with your computer, you can locate warranty information in other ways.

1. Select the **Start** button, select **Help and Support**, and then select **HP Documentation**.

– or –

2. Go to <http://www.hp.com/go/orderdocuments>.

---

 **IMPORTANT:** You must be connected to the internet to access the latest version of the warranty.

---

HP Care Pack Services offer upgraded service levels to extend and expand a standard product warranty.

---

 **NOTE:** For sales information and warranty upgrades (HP Care Packs), call your local authorized service provider or dealer.

---

---

# 8 Using HP PC Hardware Diagnostics

You can use the HP PC Hardware Diagnostics utility to determine whether your computer hardware is running properly. The three versions are HP PC Hardware Diagnostics Windows, HP PC Hardware Diagnostics UEFI (Unified Extensible Firmware Interface), and (for select products only) Remote HP PC Hardware Diagnostics UEFI, a firmware feature.

## Using HP PC Hardware Diagnostics Windows (select products only)

HP PC Hardware Diagnostics Windows is a Windows-based utility that allows you to run diagnostic tests to determine whether the computer hardware is functioning properly. The tool runs within the Windows operating system to diagnose hardware failures.

If HP PC Hardware Diagnostics Windows is not installed on your computer, first you must download and install it. To download HP PC Hardware Diagnostics Windows, see [Downloading HP PC Hardware Diagnostics Windows on page 29](#).

## Using an HP PC Hardware Diagnostics Windows hardware failure ID code

When HP PC Hardware Diagnostics Windows detects a failure that requires hardware replacement, a 24-digit Failure ID code is generated.

- ▲ Depending on the instructions on the screen, choose one of these options:
  - If failure ID link is displayed, select the link and follow the on-screen instructions.
  - If instructions for calling support are displayed. Follow those instructions.

## Accessing HP PC Hardware Diagnostics Windows

After HP PC Hardware Diagnostics Windows is installed, you can access it from the Start menu or HP Support Assistant.

### Accessing HP PC Hardware Diagnostics Windows from the Start menu

After HP PC Hardware Diagnostics Windows is installed, follow these steps to access it.

1. Select the **Start** button.
2. Right-click **HP PC Hardware Diagnostics for Windows**, select **More**, and then select **Run as administrator**.
3. When the tool opens, select the type of diagnostic test that you want to run, and then follow the on-screen instructions.



**NOTE:** To stop a diagnostic test, select **Cancel**.

---

### Accessing HP PC Hardware Diagnostics Windows from Support Assistant

After HP PC Hardware Diagnostics Windows is installed, follow these steps to access it from HP Support Assistant.

1. Type `support` in the taskbar search box, and then select the **HP Support Assistant** app.  
– or –  
Select the question mark icon in the taskbar.
2. Select **Troubleshooting and fixes**.
3. Select **Diagnostics**, and then select **HP PC Hardware Diagnostics Windows**.
4. When the tool opens, select the type of diagnostic test that you want to run, and then follow the on-screen instructions.

---

 **NOTE:** To stop a diagnostic test, select **Cancel**.

---

## Downloading HP PC Hardware Diagnostics Windows

The HP PC Hardware Diagnostics Windows downloading instructions are provided in English only. You must use a Windows computer to download this tool because only .exe files are provided.

### Downloading the latest HP PC Hardware Diagnostics Windows version from HP

To download HP PC Hardware Diagnostics Windows from HP, follow these steps.

1. Go to <http://www.hp.com/go/techcenter/pcdiags>. The HP PC Diagnostics home page is displayed.
2. Select **Download HP Diagnostics Windows**, and then select a location on your computer or a USB flash drive.

The tool downloads to the selected location.

### Downloading the HP PC Hardware Diagnostics Windows from the Microsoft Store

You can download the HP PC Hardware Diagnostics Windows from the Microsoft Store.

1. Select the Microsoft Store app on your desktop or enter `Microsoft Store` in the taskbar search box.
2. Enter `HP PC Hardware Diagnostics Windows` in the **Microsoft Store** search box.
3. Follow the on-screen directions.

The tool downloads to the selected location.

### Downloading HP Hardware Diagnostics Windows by product name or number (select products only)

You can download HP PC Hardware Diagnostics Windows by product name or number.

---

 **NOTE:** For some products, you might have to download the software to a USB flash drive by using the product name or number.

---

1. Go to <http://www.hp.com/support>.
2. Select **Software and Drivers**, select your type of product, and then enter the product name or number in the search box that is displayed.
3. In the **Diagnostics** section, select **Download**, and then follow the on-screen instructions to select the specific Windows diagnostics version to be downloaded to your computer or USB flash drive.

The tool downloads to the selected location.

## Installing HP PC Hardware Diagnostics Windows

To install HP PC Hardware Diagnostics Windows, navigate to the folder on your computer or the USB flash drive where the .exe file downloaded, double-click the .exe file, and then follow the on-screen instructions.

## Using HP PC Hardware Diagnostics UEFI

HP PC Hardware Diagnostics UEFI (Unified Extensible Firmware Interface) allows you to run diagnostic tests to determine whether the computer hardware is functioning properly. The tool runs outside the operating system so that it can isolate hardware failures from issues that are caused by the operating system or other software components.

---

 **NOTE:** For Windows 10 S computers, you must use a Windows computer and a USB flash drive to download and create the HP UEFI support environment because only .exe files are provided. For more information, see [Downloading HP PC Hardware Diagnostics UEFI to a USB flash drive on page 31](#).

---

If your PC does not start in Windows, you can use HP PC Hardware Diagnostics UEFI to diagnose hardware issues.

## Using an HP PC Hardware Diagnostics UEFI hardware failure ID code

When HP PC Hardware Diagnostics UEFI detects a failure that requires hardware replacement, a 24-digit Failure ID code is generated.

For assistance in solving the problem:

- ▲ Select **Contact HP**, accept the HP privacy disclaimer, and then use a mobile device to scan the Failure ID code that appears on the next screen. The HP Customer Support - Service Center page appears with your Failure ID and product number automatically filled in. Follow the on-screen instructions.

– or –

Contact support, and provide the Failure ID code.

---

 **NOTE:** To start diagnostics on a convertible computer, your computer must be in notebook mode, and you must use the attached keyboard.

 **NOTE:** If you need to stop a diagnostic test, press `esc`.

---

## Starting HP PC Hardware Diagnostics UEFI

To start HP PC Hardware Diagnostics UEFI, follow this procedure.

1. Turn on or restart the computer, and quickly press `esc`.
2. Press `f2`.

The BIOS searches three places for the diagnostic tools, in the following order:

- a. Connected USB flash drive

---

 **NOTE:** To download the HP PC Hardware Diagnostics UEFI tool to a USB flash drive, see [Downloading the latest HP PC Hardware Diagnostics UEFI version on page 31](#).

---

- b. Hard drive
  - c. BIOS
3. When the diagnostic tool opens, select a language, select the type of diagnostic test you want to run, and then follow the on-screen instructions.

## Downloading HP PC Hardware Diagnostics UEFI to a USB flash drive

Downloading HP PC Hardware Diagnostics UEFI to a USB flash drive can be useful in some situations.

- HP PC Hardware Diagnostics UEFI is not included in the preinstallation image.
- HP PC Hardware Diagnostics UEFI is not included in the HP Tool partition.
- The hard drive is damaged.



---

**NOTE:** The HP PC Hardware Diagnostics UEFI downloading instructions are provided in English only, and you must use a Windows computer to download and create the HP UEFI support environment because only .exe files are provided.

---

## Downloading the latest HP PC Hardware Diagnostics UEFI version

To download the latest HP PC Hardware Diagnostics UEFI version to a USB flash drive, follow this procedure.

1. Go to <http://www.hp.com/go/techcenter/pcdiags>. The HP PC Diagnostics home page is displayed.
2. Select **Download HP Diagnostics UEFI**, and then select **Run**.

## Downloading HP PC Hardware Diagnostics UEFI by product name or number (select products only)

You can download HP PC Hardware Diagnostics UEFI by product name or number (select products only) to a USB flash drive.



---

**NOTE:** For some products, you might have to download the software to a USB flash drive by using the product name or number.

---

1. Go to <http://www.hp.com/support>.
2. Enter the product name or number, select your computer, and then select your operating system.
3. In the **Diagnostics** section, follow the on-screen instructions to select and download the specific UEFI Diagnostics version for your computer.

## Using Remote HP PC Hardware Diagnostics UEFI settings (select products only)

Remote HP PC Hardware Diagnostics UEFI is a firmware (BIOS) feature that downloads HP PC Hardware Diagnostics UEFI to your computer. It can then execute the diagnostics on your computer, and it might upload results to a preconfigured server.

For more information about Remote HP PC Hardware Diagnostics UEFI, go to <http://www.hp.com/go/techcenter/pcdiags>, and then select **Find out more**.

## Downloading Remote HP PC Hardware Diagnostics UEFI

HP Remote PC Hardware Diagnostics UEFI is also available as a SoftPaq that you can download to a server.

## Downloading the latest Remote HP PC Hardware Diagnostics UEFI version

You can download the latest HP PC Hardware Diagnostics UEFI version to a USB flash drive.

1. Go to <http://www.hp.com/go/techcenter/pcdiags>. The HP PC Diagnostics home page is displayed.
2. Select **Download Remote Diagnostics**, and then select **Run**.

## Downloading Remote HP PC Hardware Diagnostics UEFI by product name or number

You can download HP Remote PC Hardware Diagnostics UEFI by product name or number.



**NOTE:** For some products, you might have to download the software by using the product name or number.

1. Go to <http://www.hp.com/support>.
2. Select **Software and Drivers**, select your type of product, enter the product name or number in the search box that is displayed, select your computer, and then select your operating system.
3. In the **Diagnostics** section, follow the on-screen instructions to select and download the **Remote UEFI** version for the product.

## Customizing Remote HP PC Hardware Diagnostics UEFI settings

Using the Remote HP PC Hardware Diagnostics setting in Computer Setup (BIOS), you can perform several customizations.

- Set a schedule for running diagnostics unattended. You can also start diagnostics immediately in interactive mode by selecting **Execute Remote HP PC Hardware Diagnostics**.
- Set the location for downloading the diagnostic tools. This feature provides access to the tools from the HP website or from a server that has been preconfigured for use. Your computer does not require the traditional local storage (such as a hard drive or USB flash drive) to run remote diagnostics.
- Set a location for storing the test results. You can also set the user name and password that you use for uploads.
- Display status information about the diagnostics run previously.

To customize Remote HP PC Hardware Diagnostics UEFI settings, follow these steps:

1. Turn on or restart the computer, and when the HP logo appears, press **f10** to enter Computer Setup.
2. Select **Advanced**, and then select **Settings**.
3. Make your customization selections.
4. Select **Main**, and then **Save Changes and Exit** to save your settings.

Your changes take effect when the computer restarts.



---

# 9 Computer operating guidelines, routine care, and shipping preparation

Follow these guidelines to ensure the best performance and useful life of your computer.

## Operating guidelines and routine care

HP has developed guidelines to help you properly set up and care for the computer and monitor.

- Keep the computer away from excessive moisture, direct sunlight, and extreme heat and cold.
- Operate the computer on a sturdy, level surface. Leave a 10.2 cm (4 inch) clearance on all vented sides of the computer and above the monitor to permit the required airflow.
- Never restrict the airflow into the computer by blocking any vents or air intakes. Do not place the keyboard, with the keyboard feet down, directly against the front of the desktop unit because this also restricts airflow.
- Never operate the computer with the access panel or any of the expansion card slot covers removed.
- Do not stack computers on top of each other or place computers so near each other that they are subject to each other's recirculated or preheated air.
- To operate a computer within a separate enclosure, intake and exhaust ventilation must be provided on the enclosure, and the previous operating guidelines still apply.
- Keep liquids away from the computer and keyboard.
- Never cover the ventilation slots on the monitor with any type of material.
- Install or enable power management functions of the operating system or other software, including sleep states.
- Turn off the computer before you do either of the following tasks:
  - Wipe the exterior of the computer with a soft, damp cloth as needed. Cleaning products might discolor or damage the finish. See [Removing dirt and debris from your computer on page 34](#) for the recommended steps to clean the high-touch, external surfaces on your computer. After you remove the dirt and debris, you can also clean the surfaces with a disinfectant. See [Cleaning your computer with a disinfectant on page 34](#) for guidelines to help prevent the spread of harmful bacteria and viruses.
  - Occasionally clean the air vents on all vented sides of the computer. Lint, dust, and other foreign matter can block the vents and limit the airflow.

## Cleaning your computer

Cleaning your computer regularly removes dirt and debris so that your device continues to operate at its best. Use the following information to safely clean the external surfaces of your computer.

## Removing dirt and debris from your computer

Here are the recommended steps to clean dirt and debris from your computer.

1. Wear disposable gloves made of latex (or nitrile gloves, if you are latex-sensitive) when cleaning the surfaces.
2. Turn off your device and unplug the power cord and other connected external devices. Remove any installed batteries from items such as wireless keyboards.

---

 **CAUTION:** To prevent electric shock or damage to components, never clean a product while it is turned on or plugged in.

---

3. Moisten a microfiber cloth with water. The cloth should be moist, but not dripping wet.

 **IMPORTANT:** To avoid damaging the surface, avoid abrasive cloths, towels, and paper towels.

---

4. Wipe the exterior of the product gently with the moistened cloth.

 **IMPORTANT:** Keep liquids away from the product. Avoid getting moisture in any openings. If liquid makes its way inside your HP product, it can cause damage to the product. Do not spray liquids directly on the product. Do not use aerosol sprays, solvents, abrasives, or cleaners containing hydrogen peroxide or bleach that might damage the finish.

---

5. Start with the display (if applicable). Wipe carefully in one direction, and move from the top of the display to the bottom. Finish with any flexible cables, like power cord, keyboard cable, and USB cables.
6. Be sure that surfaces have completely air-dried before turning the device on after cleaning.
7. Discard the gloves after each cleaning. Clean your hands immediately after you remove the gloves.

See [Cleaning your computer with a disinfectant on page 34](#) for recommended steps to clean the high-touch, external surfaces on your computer to help prevent the spread of harmful bacteria and viruses.

## Cleaning your computer with a disinfectant

The World Health Organization (WHO) recommends cleaning surfaces, followed by disinfection, as a best practice for preventing the spread of viral respiratory illnesses and harmful bacteria.

After cleaning the external surfaces of your computer using the steps in [Removing dirt and debris from your computer on page 34](#), you might also choose to clean the surfaces with a disinfectant. A disinfectant that is within HP's cleaning guidelines is an alcohol solution consisting of 70% isopropyl alcohol and 30% water. This solution is also known as rubbing alcohol and is sold in most stores.

Follow these steps when disinfecting high-touch, external surfaces on your computer:

1. Wear disposable gloves made of latex (or nitrile gloves, if you are latex-sensitive) when cleaning the surfaces.
2. Turn off your device and unplug the power cord and other connected external devices. Remove any installed batteries from items such as wireless keyboards.

---

 **CAUTION:** To prevent electric shock or damage to components, never clean a product while it is turned on or plugged in.

---

3. Moisten a microfiber cloth with a mixture of 70% isopropyl alcohol and 30% water. The cloth should be moist, but not dripping wet.

---

 **CAUTION:** Do not use any of the following chemicals or any solutions that contain them, including spray-based surface cleaners: bleach, peroxides (including hydrogen peroxide), acetone, ammonia, ethyl alcohol, methylene chloride, or any petroleum-based materials, such as gasoline, paint thinner, benzene, or toluene.

 **IMPORTANT:** To avoid damaging the surface, avoid abrasive cloths, towels, and paper towels.

---

4. Wipe the exterior of the product gently with the moistened cloth.

 **IMPORTANT:** Keep liquids away from the product. Avoid getting moisture in any openings. If liquid makes its way inside your HP product, it can cause damage to the product. Do not spray liquids directly on the product. Do not use aerosol sprays, solvents, abrasives, or cleaners containing hydrogen peroxide or bleach that might damage the finish.

---

5. Start with the display (if applicable). Wipe carefully in one direction, and move from the top of the display to the bottom. Finish with any flexible cables, like power cord, keyboard cable, and USB cables.
6. Be sure that surfaces have completely air-dried before turning the device on after cleaning.
7. Discard the gloves after each cleaning. Clean your hands immediately after you remove the gloves.

## Shipping preparation

If you have to ship your computer, follow these tips to keep your equipment safe.

1. Back up the hard drive files to an external storage device. Be sure that the backup media is not exposed to electrical or magnetic impulses while stored or in transit.

 **NOTE:** The hard drive locks automatically when the system power is turned off.

---

2. Remove and store all removable media.
3. Turn off the computer and external devices.
4. Disconnect the power cord from the AC outlet, and then from the computer.
5. Disconnect the system components and external devices from their power sources and then from the computer.

 **NOTE:** Be sure that all boards are seated properly and secured in the board slots before shipping the computer.

---

6. Pack the system components and external devices in their original packing boxes or similar packaging with sufficient packing material to protect them.

---

# 10 Electrostatic discharge

Electrostatic discharge is the release of static electricity when two objects come into contact—for example, the shock you receive when you walk across the carpet and touch a metal door knob.

A discharge of static electricity from fingers or other electrostatic conductors may damage electronic components.

---

 **IMPORTANT:** To prevent damage to the computer, damage to a drive, or loss of information, observe these precautions:

- If removal or installation instructions direct you to unplug the computer, first be sure that it is properly grounded.
  - Keep components in their electrostatic-safe containers until you are ready to install them.
  - Avoid touching pins, leads, and circuitry. Handle electronic components as little as possible.
  - Use nonmagnetic tools.
  - Before handling components, discharge static electricity by touching an unpainted metal surface.
  - If you remove a component, place it in an electrostatic-safe container.
-

---

# 11 Accessibility

HP's goal is to design, produce, and market products, services, and information that everyone everywhere can use, either on a stand-alone basis or with appropriate third-party assistive technology (AT) devices or applications.

## HP and accessibility

Because HP works to weave diversity, inclusion, and work/life into the fabric of the company, it is reflected in everything HP does. HP strives to create an inclusive environment focused on connecting people to the power of technology throughout the world.

## Finding the technology tools you need

Technology can unleash your human potential. Assistive technology removes barriers and helps you create independence at home, at work, and in the community. Assistive technology helps increase, maintain, and improve the functional capabilities of electronic and information technology.

For more information, see [Finding the best assistive technology on page 38](#).

## The HP commitment

HP is committed to providing products and services that are accessible for people with disabilities. This commitment supports the company's diversity objectives and helps ensure that the benefits of technology are available to all.

The HP accessibility goal is to design, produce, and market products and services that can be effectively used by everyone, including people with disabilities, either on a stand-alone basis or with appropriate assistive devices.

To achieve that goal, this Accessibility Policy establishes seven key objectives to guide HP actions. All HP managers and employees are expected to support these objectives and their implementation in accordance with their roles and responsibilities:

- Raise the level of awareness of accessibility issues within HP, and provide employees with the training they need to design, produce, market, and deliver accessible products and services.
- Develop accessibility guidelines for products and services, and hold product development groups accountable for implementing these guidelines where competitively, technically, and economically feasible.
- Involve people with disabilities in the development of accessibility guidelines and in the design and testing of products and services.
- Document accessibility features, and make information about HP products and services publicly available in an accessible form.
- Establish relationships with leading assistive technology and solution providers.
- Support internal and external research and development that improves assistive technology relevant to HP products and services.

- Support and contribute to industry standards and guidelines for accessibility.

## International Association of Accessibility Professionals (IAAP)

IAAP is a not-for-profit association focused on advancing the accessibility profession through networking, education, and certification. The objective is to help accessibility professionals develop and advance their careers and to better enable organizations to integrate accessibility into their products and infrastructure.

As a founding member, HP joined to participate with other organizations to advance the field of accessibility. This commitment supports HP's accessibility goal of designing, producing, and marketing products and services that people with disabilities can effectively use.

IAAP will make the profession strong by globally connecting individuals, students, and organizations to learn from one another. If you are interested in learning more, go to <http://www.accessibilityassociation.org> to join the online community, sign up for newsletters, and learn about membership options.

## Finding the best assistive technology

Everyone, including people with disabilities or age-related limitations, should be able to communicate, express themselves, and connect with the world using technology. HP is committed to increasing accessibility awareness within HP and with our customers and partners.

Whether it's large fonts that are easy on the eyes, voice recognition that lets you give your hands a rest, or any other assistive technology to help with your specific situation—a variety of assistive technologies make HP products easier to use. How do you choose?

## Assessing your needs

Technology can unleash your potential. Assistive technology removes barriers and helps you create independence at home, at work, and in the community. Assistive technology (AT) helps increase, maintain, and improve the functional capabilities of electronic and information technology.

You can choose from many AT products. Your AT assessment should allow you to evaluate several products, answer your questions, and facilitate your selection of the best solution for your situation. You will find that professionals qualified to do AT assessments come from many fields, including those licensed or certified in physical therapy, occupational therapy, speech/language pathology, and other areas of expertise. Others, while not certified or licensed, can also provide evaluation information. You will want to ask about the individual's experience, expertise, and fees to determine if they are appropriate for your needs.

## Accessibility for HP products

These links provide information about accessibility features and assistive technology, if applicable, included in various HP products. These resources will help you select the specific assistive technology features and products most appropriate for your situation.

- [HP Elite x3—Accessibility Options \(Windows 10 Mobile\)](#)
- [HP PCs—Windows 7 Accessibility Options](#)
- [HP PCs—Windows 8 Accessibility Options](#)
- [HP PC's—Windows 10 Accessibility Options](#)
- [HP Slate 7 Tablets—Enabling Accessibility Features on Your HP Tablet \(Android 4.1/Jelly Bean\)](#)
- [HP SlateBook PCs—Enabling Accessibility Features \(Android 4.3,4.2/Jelly Bean\)](#)
- [HP Chromebook PCs—Enabling Accessibility Features on Your HP Chromebook or Chromebox \(Chrome OS\)](#)

- [HP Shopping—peripherals for HP products](#)

If you need additional support with the accessibility features on your HP product, see [Contacting support on page 41](#).

Additional links to external partners and suppliers that may provide additional assistance:

- [Microsoft Accessibility information \(Windows 7, Windows 8, Windows 10, Microsoft Office\)](#)
- [Google Products accessibility information \(Android, Chrome, Google Apps\)](#)
- [Assistive Technologies sorted by impairment type](#)
- [Assistive Technology Industry Association \(ATIA\)](#)

## Standards and legislation

Countries worldwide are enacting regulations to improve access to products and services for persons with disabilities. These regulations are historically applicable to telecommunications products and services, PCs and printers with certain communications and video playback features, their associated user documentation, and their customer support.

### Standards

The US Access Board created Section 508 of the Federal Acquisition Regulation (FAR) standards to address access to information and communication technology (ICT) for people with physical, sensory, or cognitive disabilities.

The standards contain technical criteria specific to various types of technologies, as well as performance-based requirements which focus on functional capabilities of covered products. Specific criteria cover software applications and operating systems, web-based information and applications, computers, telecommunications products, video and multimedia, and self-contained closed products.

### Mandate 376 – EN 301 549

The European Union created the EN 301 549 standard within Mandate 376 as an online toolkit for public procurement of ICT products. The standard specifies the accessibility requirements applicable to ICT products and services, with a description of the test procedures and evaluation methodology for each requirement.

### Web Content Accessibility Guidelines (WCAG)

Web Content Accessibility Guidelines (WCAG) from the W3C's Web Accessibility Initiative (WAI) helps web designers and developers create sites that better meet the needs of people with disabilities or age-related limitations.

WCAG advances accessibility across the full range of web content (text, images, audio, and video) and web applications. WCAG can be precisely tested, is easy to understand and use, and allows web developers flexibility for innovation. WCAG 2.0 has also been approved as [ISO/IEC 40500:2012](#).

WCAG specifically addresses barriers to accessing the web experienced by people with visual, auditory, physical, cognitive, and neurological disabilities, and by older web users with accessibility needs. WCAG 2.0 provides characteristics of accessible content:

- **Perceivable** (for instance, by addressing text alternatives for images, captions for audio, adaptability of presentation, and color contrast)

- **Operable** (by addressing keyboard access, color contrast, timing of input, seizure avoidance, and navigability)
- **Understandable** (by addressing readability, predictability, and input assistance)
- **Robust** (for instance, by addressing compatibility with assistive technologies)

## Legislation and regulations

Accessibility of IT and information has become an area of increasing legislative importance. These links provide information about key legislation, regulations, and standards.

- [United States](#)
- [Canada](#)
- [Europe](#)
- [Australia](#)
- [Worldwide](#)

## Useful accessibility resources and links

These organizations, institutions, and resources might be good sources of information about disabilities and age-related limitations.



---

**NOTE:** This is not an exhaustive list. These organizations are provided for informational purposes only. HP assumes no responsibility for information or contacts you encounter on the Internet. Listing on this page does not imply endorsement by HP.

---

## Organizations

These organizations are a few of the many that provide information about disabilities and age-related limitations.

- American Association of People with Disabilities (AAPD)
- The Association of Assistive Technology Act Programs (ATAP)
- Hearing Loss Association of America (HLAA)
- Information Technology Technical Assistance and Training Center (ITTATC)
- Lighthouse International
- National Association of the Deaf
- National Federation of the Blind
- Rehabilitation Engineering & Assistive Technology Society of North America (RESNA)
- Telecommunications for the Deaf and Hard of Hearing, Inc. (TDI)
- W3C Web Accessibility Initiative (WAI)



## Educational institutions

Many educational institutions, including these examples, provide information about disabilities and age-related limitations.

- California State University, Northridge, Center on Disabilities (CSUN)
- University of Wisconsin - Madison, Trace Center
- University of Minnesota computer accommodations program

## Other disability resources

Many resources, including these examples, provide information about disabilities and age-related limitations.

- ADA (Americans with Disabilities Act) Technical Assistance Program
- ILO Global Business and Disability network
- EnableMart
- European Disability Forum
- Job Accommodation Network
- Microsoft Enable

## HP links

These HP-specific links provide information that relates to disabilities and age-related limitations.

[Our contact webform](#)

[HP comfort and safety guide](#)

[HP public sector sales](#)

## Contacting support

HP offers technical support and assistance with accessibility options for customers with disabilities.



**NOTE:** Support is in English only.

---

- Customers who are deaf or hard of hearing who have questions about technical support or accessibility of HP products:
  - Use TRS/VRS/WebCapTel to call (877) 656-7058 Monday through Friday, 6 a.m. to 9 p.m. Mountain Time.
- Customers with other disabilities or age-related limitations who have questions about technical support or accessibility of HP products, choose one of the following options:
  - Call (888) 259-5707 Monday through Friday, 6 a.m. to 9 p.m. Mountain Time.
  - Complete the [Contact form for people with disabilities or age-related limitations](#).

# Index

- A**
  - access panel release latch, identifying..... 7
  - accessibility..... 37
  - accessibility needs assessment..... 38
  - antenna cover, identifying..... 5, 7
  - assistive technology (AT)
    - finding..... 38
    - purpose..... 37
  - AT (assistive technology)
    - finding..... 38
    - purpose..... 37
  - audio line-in connector (blue), identifying..... 7
  - audio line-out connector (green), identifying..... 5, 7
  - audio-out (headphone)/audio-in (microphone) combo jack, identifying..... 4, 6
- B**
  - backup, creating..... 16
  - backups..... 16
  - BIOS
    - determining version..... 21
    - updating..... 21
    - upgrading..... 21
  - blink or beep codes..... 25
  - boot order, changing..... 17
- C**
  - caring for your computer..... 33
  - cleaning your computer..... 33
    - disinfecting..... 34
    - removing dirt and debris..... 34
  - components
    - front..... 4, 5
    - rear..... 5, 6
  - computer features..... 4
  - computer operating guidelines..... 33
  - computer setup..... 9
    - adding monitors..... 11
    - connecting monitors..... 10
    - product recycling..... 15
    - security..... 15
    - setup procedures..... 10
  - computer, diagnostics..... 23
  - computer, maintenance..... 23
  - computer, troubleshooting..... 23
  - computer, updating..... 21
  - connectors
    - power..... 5, 7
  - Customer Self Repair..... 25
  - customer support, accessibility..... 41
- D**
  - diagnostics..... 2
  - DisplayPort connector, identifying.. 5, 7
  - documentation..... 2
  - drive bay, identifying..... 4, 6
- E**
  - electrostatic discharge..... 36
  - expansion slot cover, identifying. 5, 7
- G**
  - graphics cards, supported..... 11
  - graphics cards, types..... 12
- H**
  - hard drive activity light, identifying... .. 4, 6
  - HP Assistive Policy..... 37
  - HP driver disc
    - Ubuntu setup..... 20
  - HP PC Hardware Diagnostics UEFI
    - downloading..... 31
    - starting..... 30
    - using..... 30
  - HP PC Hardware Diagnostics Windows
    - accessing..... 28
    - downloading..... 29
    - installing..... 30
    - using..... 28
  - HP Recovery media
    - recovery..... 17
  - HP resources..... 1
  - HP Sure Recover..... 18
- I**
  - International Association of Accessibility Professionals..... 38
- J**
  - jacks
    - audio-out (headphone)/audio-in (microphone)..... 4, 6
    - network..... 5, 7
    - RJ-45 (network)..... 5, 7
- L**
  - links
    - contact information for HP US.. 26
    - HP Customer Self Repair..... 25
    - Linux Hardware Matrix for HP computers..... 19
    - Red Hat Certification..... 19
    - SUSE certification bulletin search page..... 19
    - Ubuntu..... 20
  - Linux
    - proprietary graphics drivers..... 20
    - RHEL..... 19
    - setup..... 19
    - solutions..... 19
  - Linux-ready systems
    - creating a disc..... 19
    - Linux versions..... 19
- M**
  - monitors
    - connecting..... 13

connection requirements.....	13
customizing the monitor.....	15
graphics cards.....	12
monitor setup.....	15
supported graphics cards.....	11
third-party graphics cards.....	14
<b>N</b>	
network jack, identifying.....	5, 7
<b>O</b>	
optical drive, identifying.....	4, 6
<b>P</b>	
ports	
USB .....	5, 7
USB SuperSpeed .....	4-7
USB SuperSpeed Plus .....	4, 6
USB SuperSpeed Plus with HP Sleep and Charge.....	4
USB Type-C SuperSpeed Plus with HP Sleep and Charge.....	4, 6
power button, identifying.....	4, 6
power connector	
identifying.....	5, 7
product change notifications.....	26
product information.....	1
proper ventilation, ensuring.....	9
<b>R</b>	
recovery.....	16
discs.....	17
media.....	17
USB flash drive.....	17
recovery media.....	16
creating using HP Cloud Recovery Download Tool.....	16
creating using Windows tools...	16
Remote HP PC Hardware Diagnostics UEFI settings	
customizing.....	32
using.....	31
resources, accessibility.....	40
restoring.....	16
RHEL	
Linux.....	19
setup.....	19
RJ-45 (network) jack, identifying.	5, 7
<b>S</b>	
Section 508 accessibility standards...	39
setup	
Linux.....	19
RHEL.....	19
SLED.....	19
Ubuntu.....	20
shipping preparation.....	35
SLED	
setup.....	19
slots	
memory card reader.....	4, 6
microSD memory card reader.	4, 6
specifications, product.....	7
standards and legislation, accessibility.....	39
SuperSpeed Plus ports	
USB .....	5, 7
support	
advisories.....	26
bulletins.....	26
computers.....	26
contacting.....	26
general resources.....	1
HP resources.....	1
HP Support.....	25
online.....	26
system restore.....	17
system restore point, creating.....	16
<b>T</b>	
technical support.....	25
troubleshooting.....	23
at startup.....	23
Customer Self Repair.....	25
during operation.....	24
visual inspection.....	23
turning off computer.....	23
<b>U</b>	
Ubuntu	
HP driver disc.....	20
setup.....	20
updates.....	3
updating the computer.....	21
upgrading device drivers.....	22
URLs	
contact information for HP US..	26
HP Customer Self Repair.....	25
Linux Hardware Matrix for HP computers.....	19
Red Hat Certification.....	19
SUSE certification bulletin search page.....	19
Ubuntu.....	20
USB port, identifying.....	5, 7
USB SuperSpeed Plus port with HP Sleep and Charge, identifying.	4, 6
USB SuperSpeed Plus ports , identifying.....	4, 6
USB SuperSpeed Plus ports, identifying.....	5, 7
USB SuperSpeed port, identifying	4-7
USB Type-C SuperSpeed Plus port with HP Sleep and Charge, identifying.....	4, 6
<b>V</b>	
ventilation guidelines.....	33
<b>W</b>	
warranty information.....	27
Windows	
backup.....	16
recovery media.....	16
system restore point.....	16
Windows tools, using.....	16