



RAZER BLACKSHARK V2 PRO

MASTER GUIDE

If esports is your calling, answer it with our best vocal clarity headset—fitted with titanium-coated drivers and a pro-grade headset mic. Powered by Razer HyperSpeed wireless technology, it's time to get tournament-ready with this triple threat of amazing audio, mic clarity and sound isolation.

CONTENTS

1. WHAT'S INSIDE / WHAT'S NEEDED.....	3
2. LET'S GET YOU COVERED.....	5
3. TECHNICAL SPECIFICATIONS.....	6
4. GETTING STARTED.....	7
5. USING YOUR HEADSET.....	11
6. CONFIGURING YOUR RAZER BLACKSHARK V2 PRO.....	14
7. SAFETY AND MAINTENANCE.....	28
8. LEGALESE.....	29

1. WHAT'S INSIDE / WHAT'S NEEDED

WHAT'S INSIDE

- Razer BlackShark V2 Pro

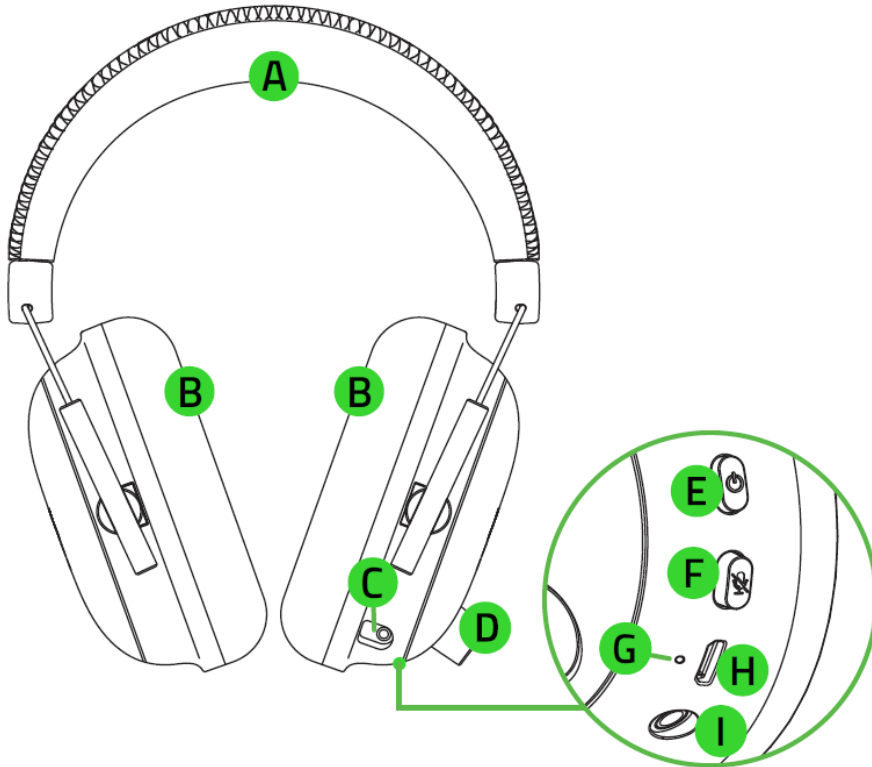

- A. Adjustable padded headband
- B. Ultra-soft breathable memory foam ear cushions
- C. Microphone jack
- D. Volume knob
- E. Power button
- F. Mic mute button
- G. Status indicator
- H. Charging port
- I. 3.5 mm audio + mic jack

- Removable Razer™ HyperClear Supercardioid Mic

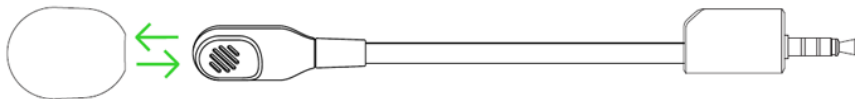

- USB wireless transceiver



- Charging cable

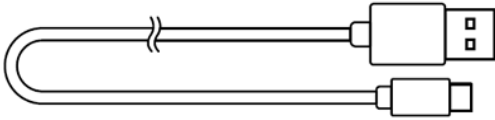

- 3.5 mm combo cable

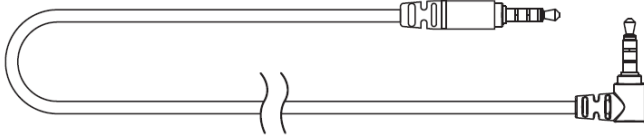

- Important Product Information Guide

WHAT'S NEEDED

PRODUCT REQUIREMENTS

- [Wireless] PC with a free USB port
- [Wired] Devices with 3.5 mm combo jack*

RAZER SYNAPSE REQUIREMENTS

- Windows® 10 64-bit (or higher)
- Internet connection for software installation

**Compatible with PC / Mac / Switch / PS4 / Xbox One (Xbox One Stereo Adapter may be required, purchased separately).*

2. LET'S GET YOU COVERED

You've got a great device in your hands, complete with a 2-year limited warranty coverage. Now maximize its potential and score exclusive Razer benefits by registering at razerid.razer.com

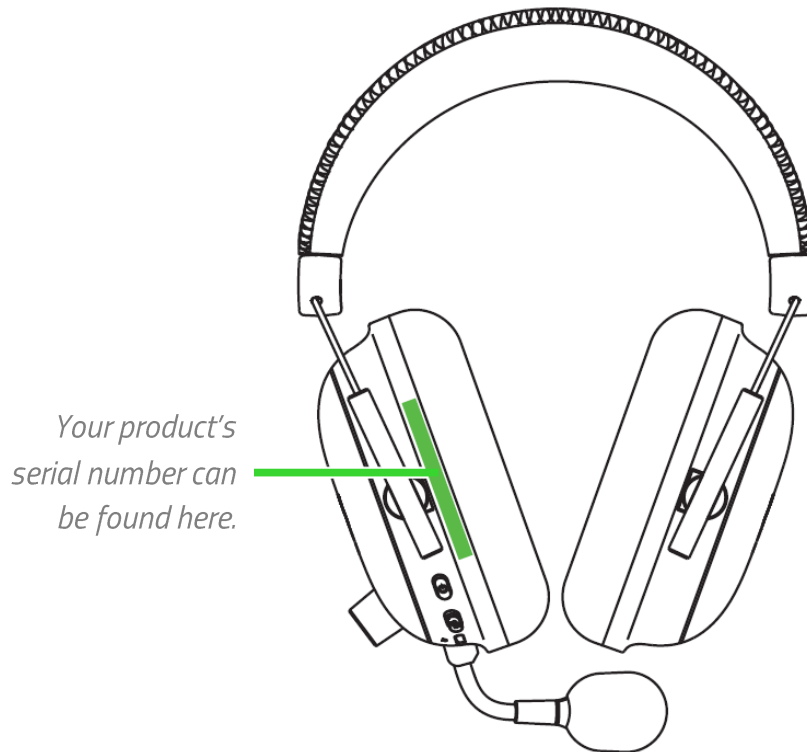

Got a question? Ask the Razer Support Team at support.razer.com

3. TECHNICAL SPECIFICATIONS

HEADPHONES

- Frequency response: 12 Hz – 28 kHz
- Impedance: 32 Ω @ 1 kHz
- Sensitivity (@1 kHz): 100 dB SPL/mW, 1KHz
- Drivers: Customized Dynamic 50 mm Driver
- Inner ear cup diameter: 65 mm x 40 mm / 2.56 in x 1.57 in
- Connection type: Wireless 2.4GHz and 3.5 mm
- Oval ear cushions: Breathable memory foam cushions

MICROPHONE

- Frequency response: 100 Hz – 10 kHz
- Signal-to-noise ratio: \geq 60 dB
- Sensitivity (@1 kHz): -42 ± 3 dB
- Pick-up pattern: Unidirectional

4. GETTING STARTED

CHARGING YOUR HEADSET

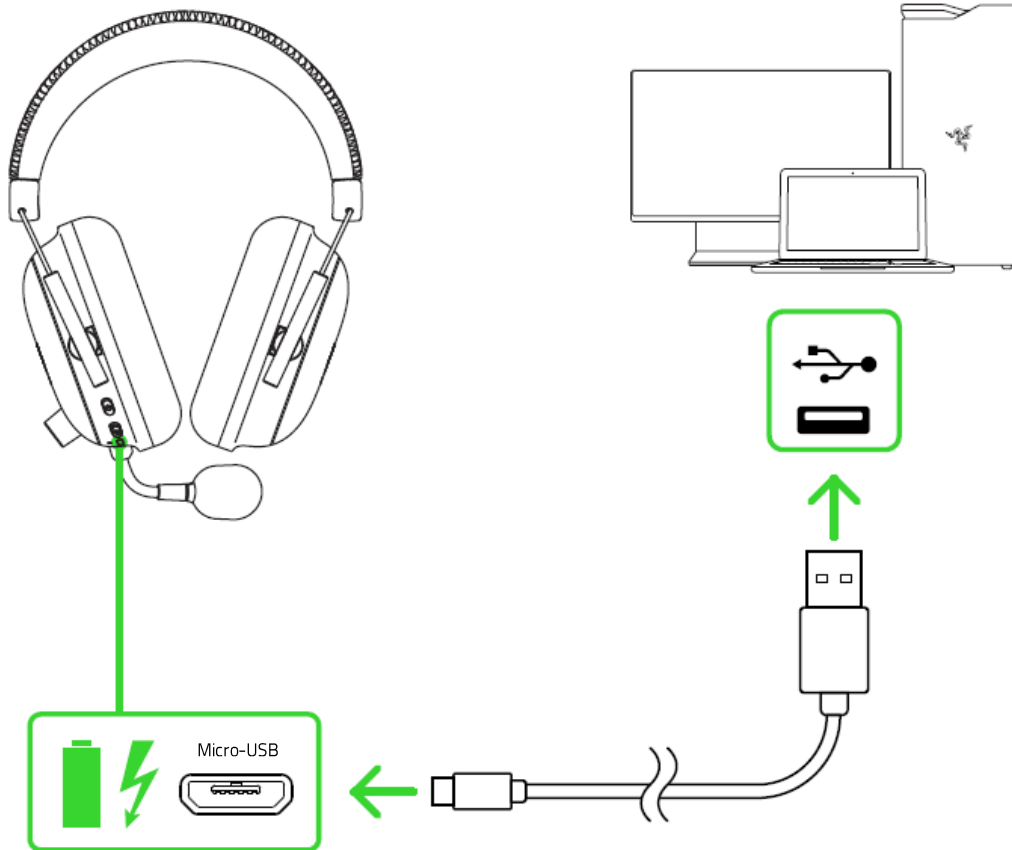

Connect your Razer BlackShark V2 Pro to a powered USB port using the charging cable.





For best results, please fully charge your headset before using it for the first time. A depleted unit will fully charge in about 3 hours.

STATUS INDICATOR BEHAVIORS

When plugged in

Indicator	Battery Status
Blinking green 	Charging
Static green 	Fully charged

When unplugged

Indicator	Sound	Battery Status
Static red 	Warning tone	Low (30%)
Blinking red 	Warning tone	Critical (10%)

CONNECTING YOUR HEADSET

A. TO YOUR PC VIA USB PORT

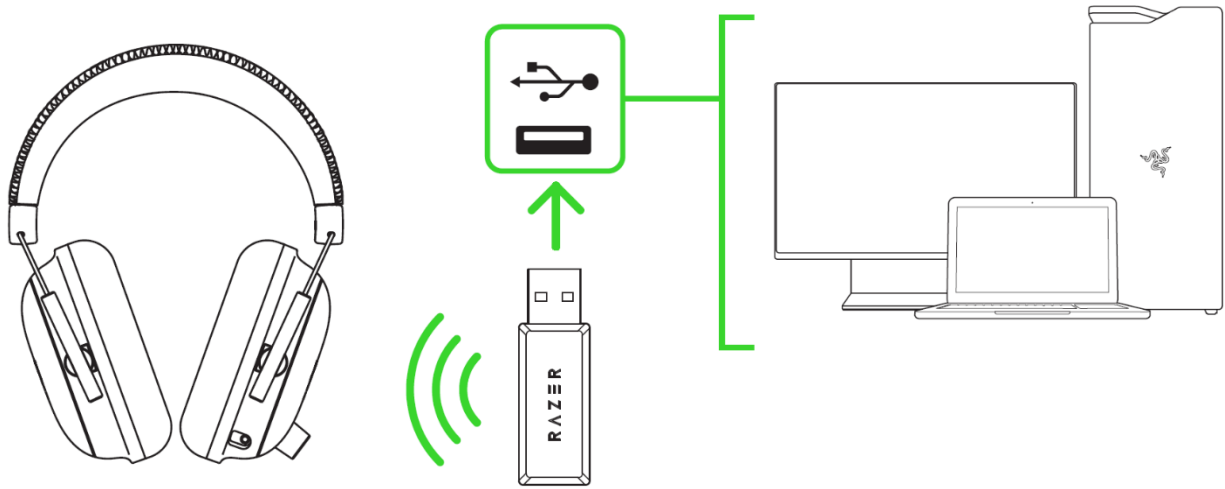

1. Plug the USB wireless transceiver to your PC.

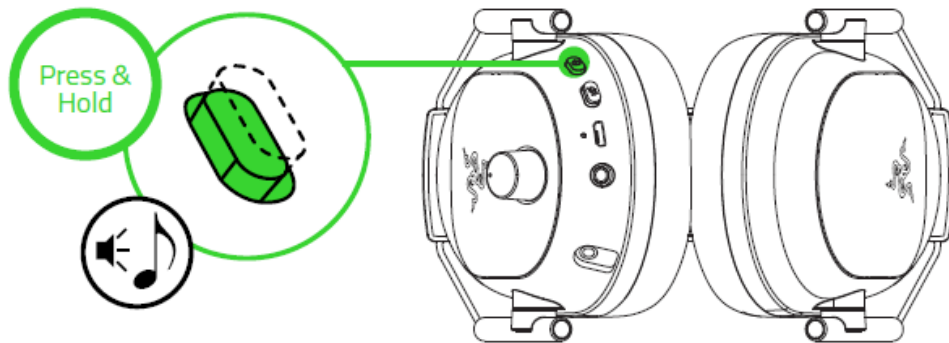

2. Press and hold the power button until the status indicator is lit, or until you hear a tone.



3. Wait until the status indicator briefly becomes static blue indicating that the headset is now connected to the USB wireless transceiver.

Indicator	Status
Blinking blue 	Pairing
Static blue 	Connected

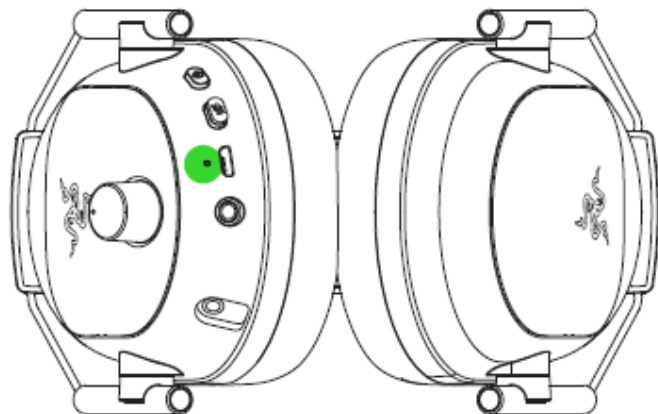

4. On your PC, right-click on the sound icon on the system tray, and then select **Open Sound settings**.

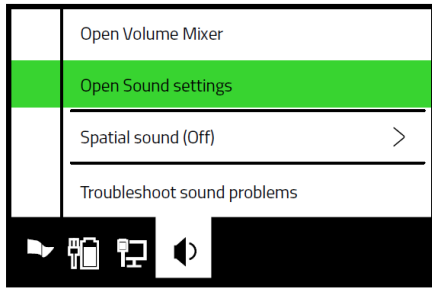

5. On the Sound window, set the **Razer BlackShark V2 Pro** as the default Output and Input device.

Sounds

Output

Choose your output device

Razer BlackShark V2 Pro



Input

Choose your input device

Razer BlackShark V2 Pro

Your headset is now ready to use.

B. TO OTHER DEVICES VIA USB PORT

Plug the USB wireless transceiver* to your device and make sure your Razer BlackShark V2 Pro is the default input and output audio device.

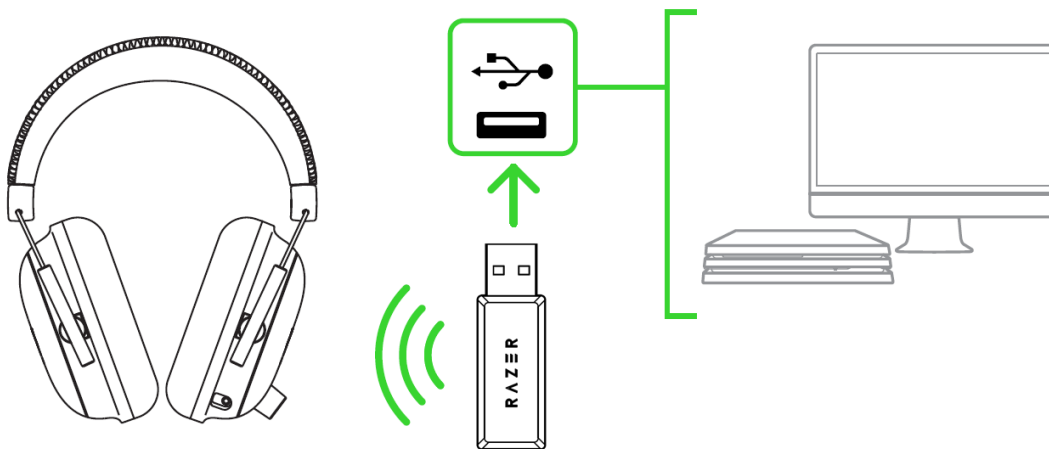

**Compatible with PC / Mac / Switch / PS4.*

C. TO DEVICES VIA 3.5MM AUDIO + MIC JACK

If your device has a 3.5mm audio + mic combined jack, simply plug the 3.5mm combo cable from your headset to your device's audio jack.

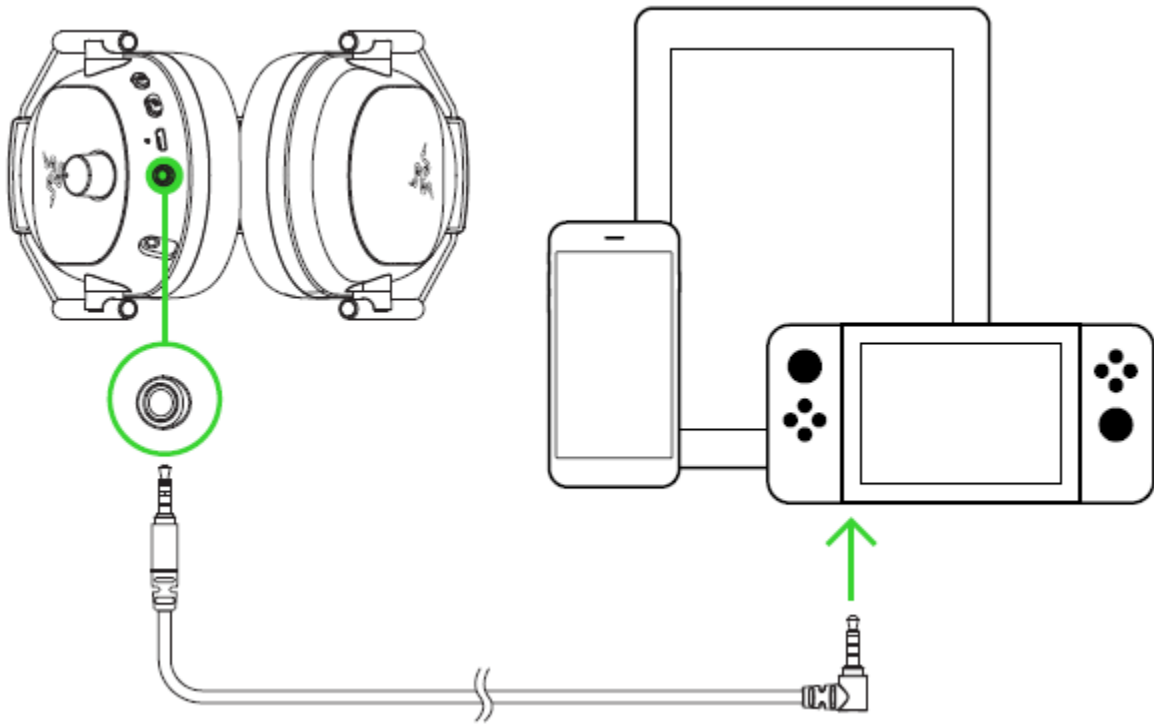

5. USING YOUR HEADSET

POWER BUTTON FUNCTIONS

- **Power ON/OFF.** Power on or off your headset by holding the power button for at least 3 seconds or until you hear 2 short beeps.
- **Play / Pause a track.** While powered on, press the power button to play or pause the current track.
- **Next track.** While powered on, double press the power button to go to the next track.
- **Previous track.** While powered on, triple press the power button to go to the previous track.

ADJUSTING THE VOLUME

Rotate the volume knob as shown to increase or decrease the volume.

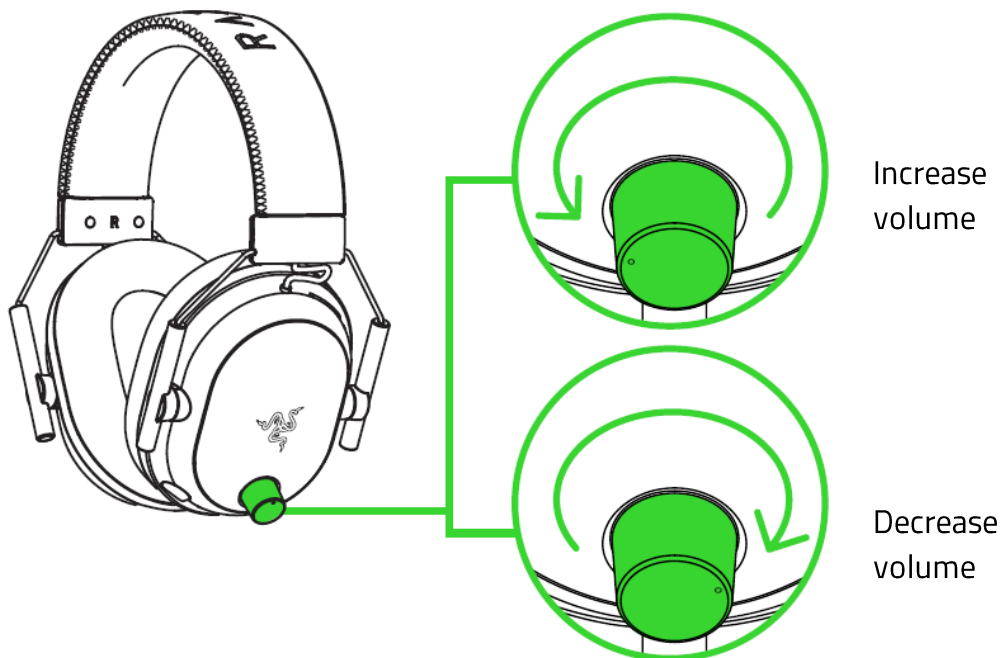

USING THE RAZER™ HYPERCLEAR SUPERCARDIOID MIC

Plug the Razer™ HyperClear Supercardioid Mic to the headphone and bend until it is parallel to your mouth. Make sure the mic diaphragm is in front and the air vent is facing away from your mouth.

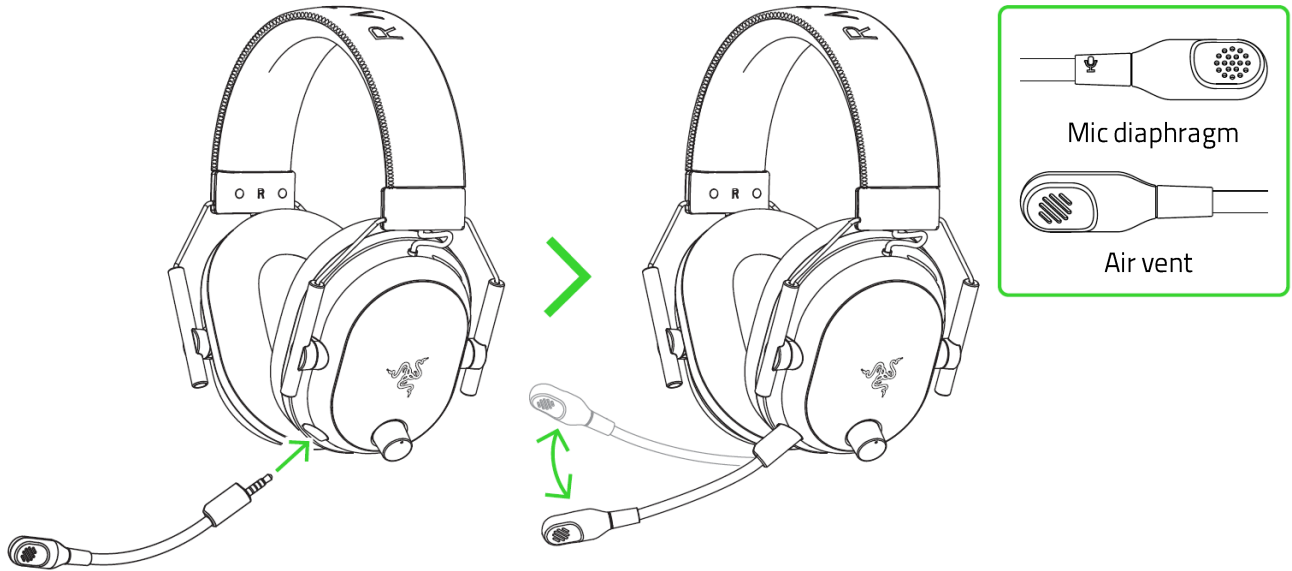

MUTING / UNMUTING THE MICROPHONE

Press the mic mute button to mute or unmute the microphone.

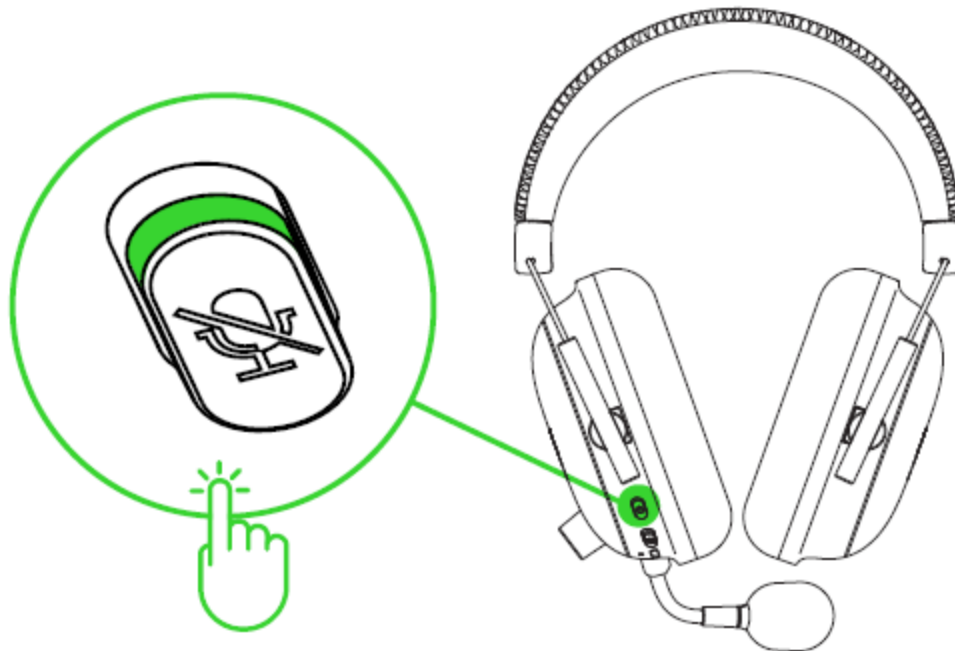

EXTENDING YOUR HEADSET'S LIFESPAN

We recommend stretching the headset gently apart before placing them over your head to minimize headband stress. However, please avoid overstretching the headset beyond its technical limits.

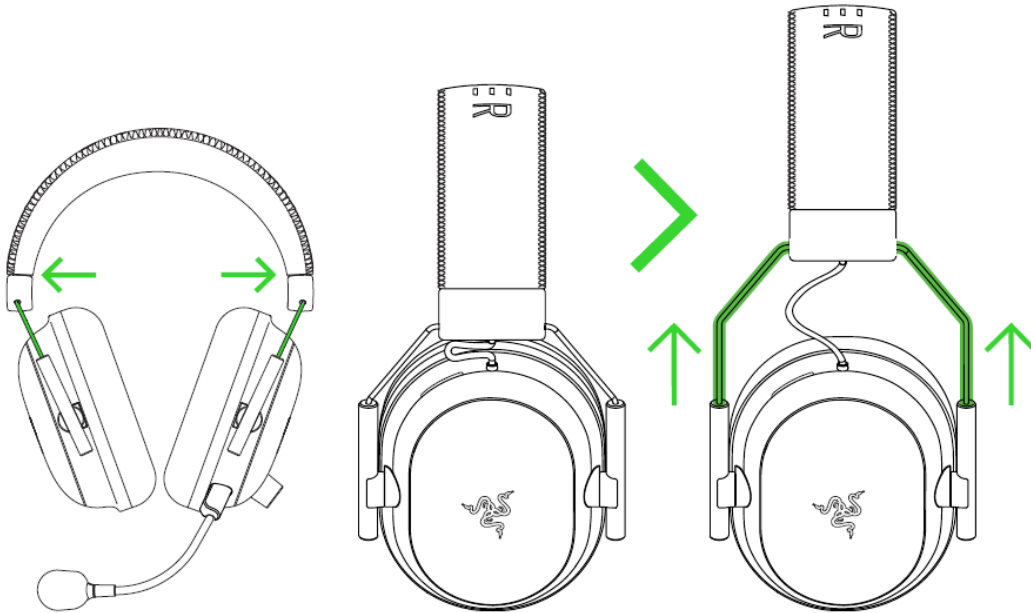

ACTIVATE THX SPATIAL AUDIO

Unleash the full potential of your Razer BlackShark V2 Pro by enabling 360° positional audio for a natural and lifelike experience through Razer Synapse.



6. CONFIGURING YOUR RAZER BLACKSHARK V2 PRO

- i** *Internet connection is required for installation, updates and cloud-based features. Registering for a Razer ID account is recommended, but optional. All listed features are subject to change based on the current software version, connected device(s), and supported apps and software.*

SYNAPSE TAB

The Synapse tab is your default tab when you first launch Razer Synapse. This tab allows you to navigate the Dashboard subtab.

Dashboard

The Dashboard subtab is an overview of your Razer Synapse where you can access all your Razer devices, modules, and online services.

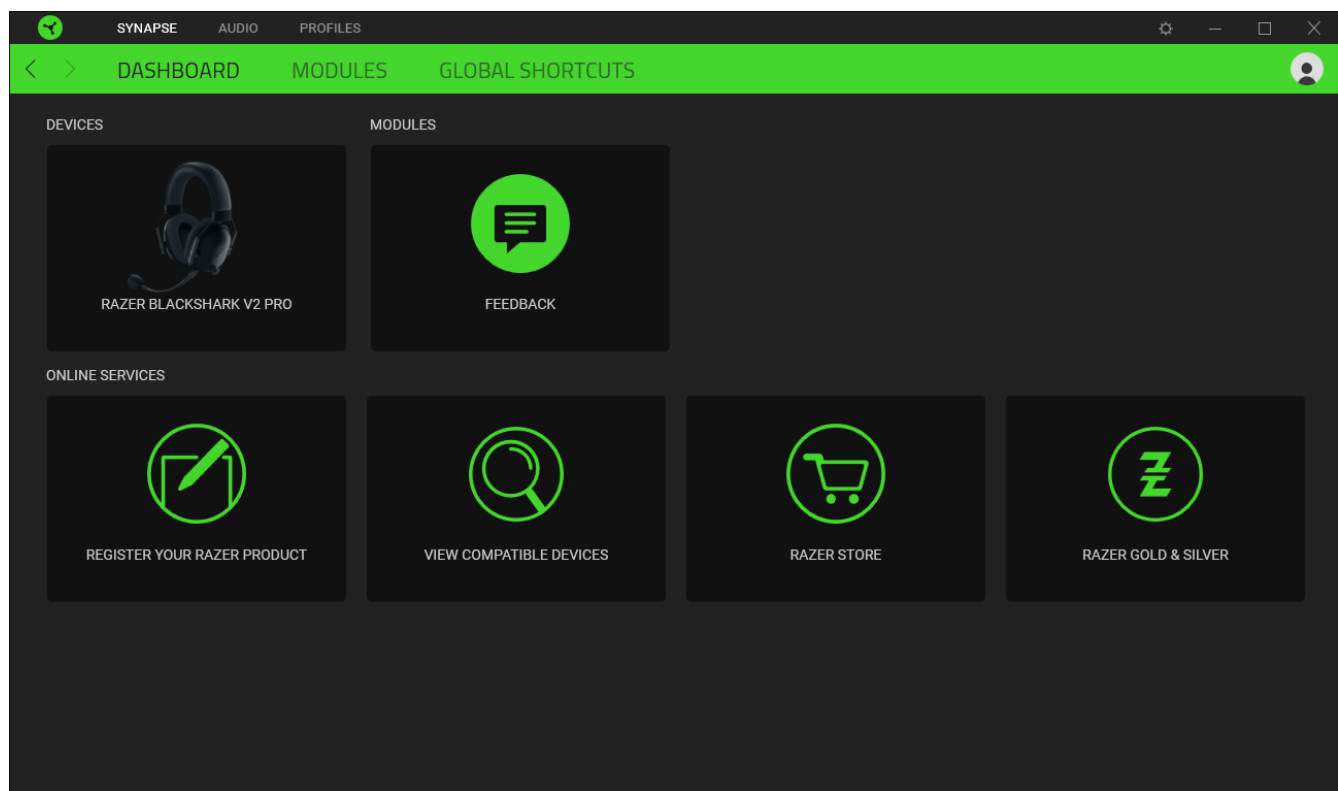

Modules

The Modules subtab displays all installed and available modules for installation.

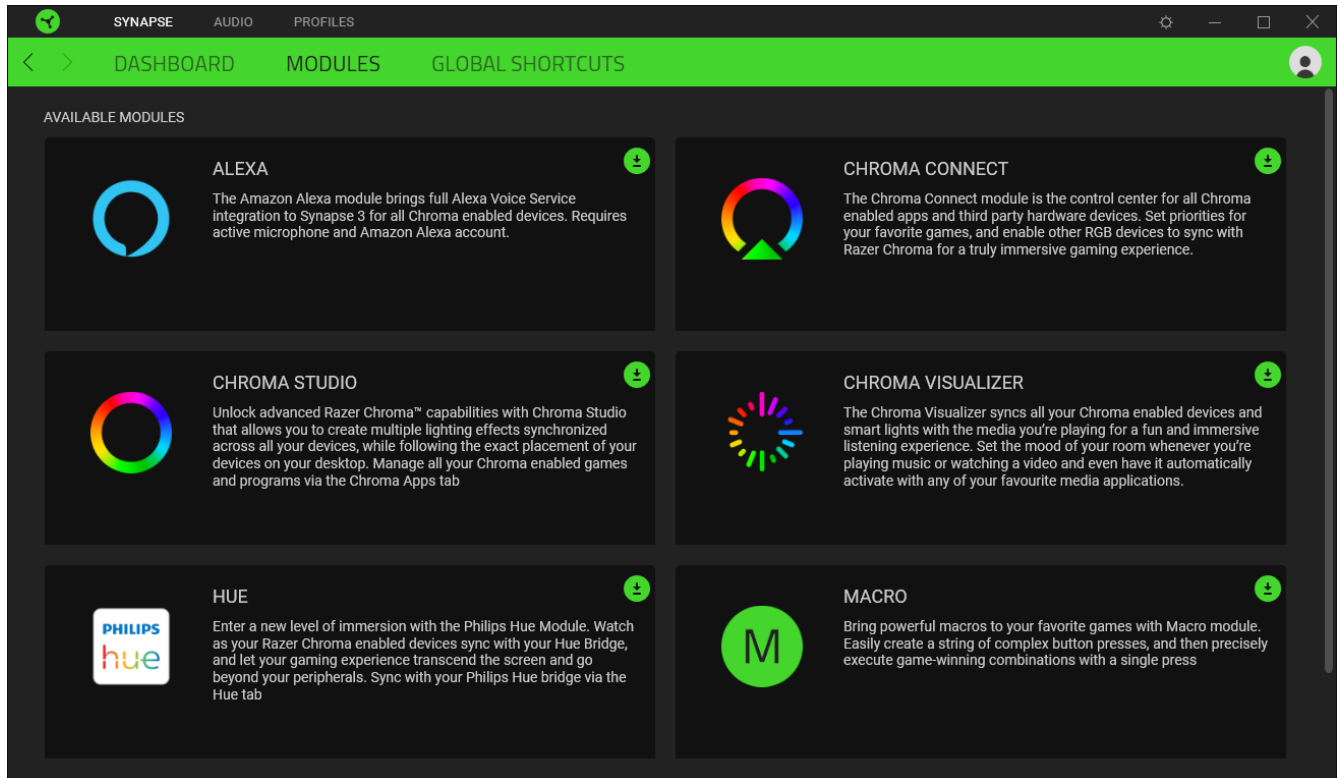

Global Shortcuts

Bind operations or Razer Synapse functions to custom key-combinations from any Razer Synapse-enabled device inputs which apply across all device profiles. [Learn more about Profiles](#)

 *Only Razer Synapse-enabled device inputs will be recognized.*

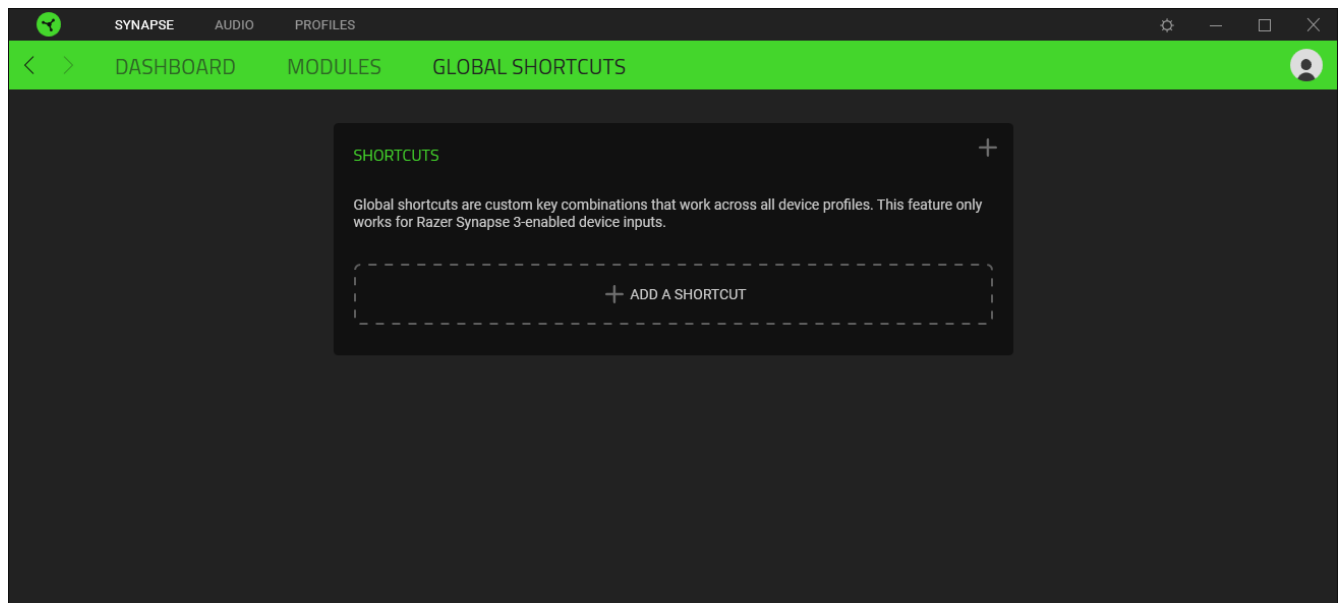

AUDIO TAB

 *Make sure to select THX Spatial Audio as your default playback or output device from the Sound icon on the system tray.*

The Audio tab is the main tab for your Razer BlackShark V2 Pro. From here, you can customize your device's settings to unleash its full potential. Changes made under this tab are automatically saved to your system and cloud storage.

Sound

The Sound subtab is for adjusting the overall system volume or individual volume of all active applications, changing the default fallback device, and accessing Windows Sound properties.

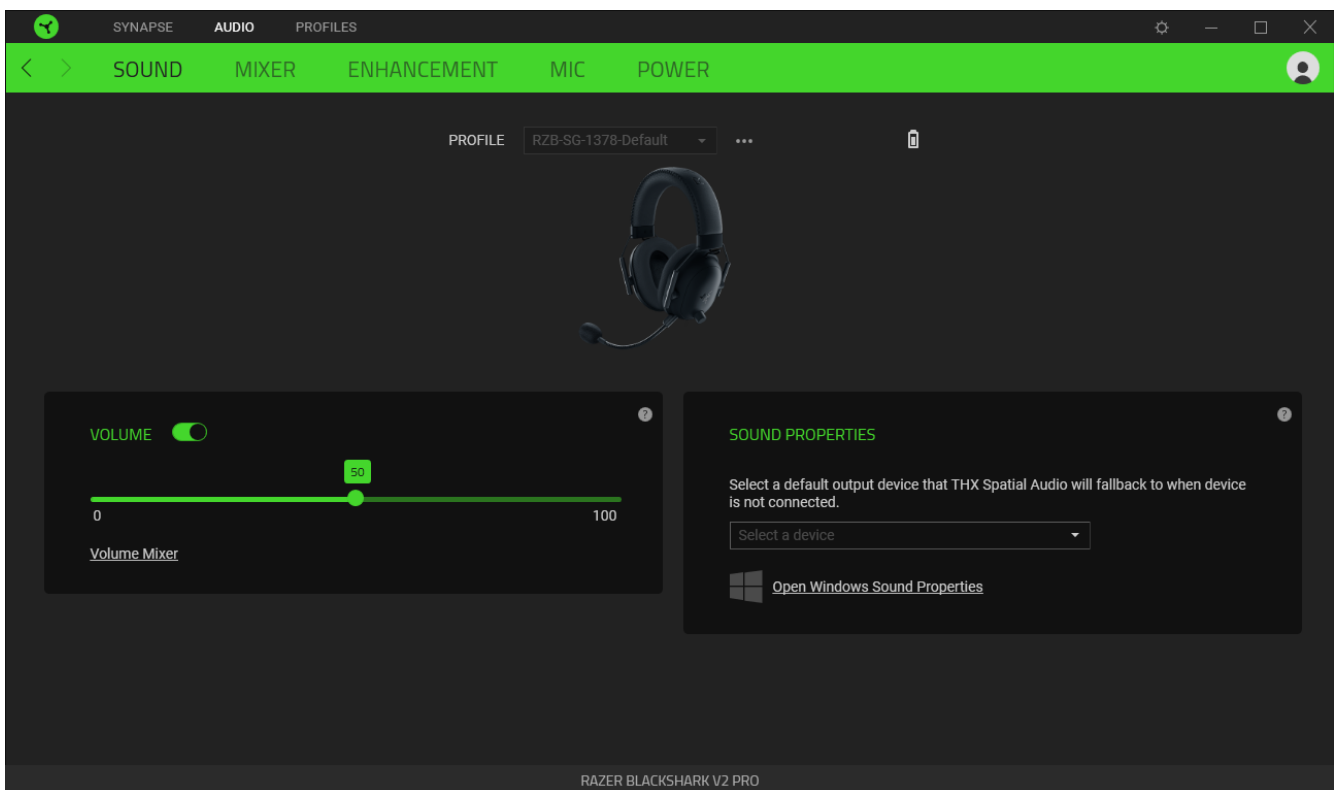

Profile

Profile is a data storage for keeping all your Razer peripheral's settings. By default, the profile name is based on your system's name. To add, rename, duplicate, or delete a profile, simply press the Miscellaneous button (●●●).

Volume

Adjust the audio volume of the device. You may also access the Windows volume mixer of the current playback device where you can proportionally adjust the overall volume of the system or individually adjust the volume of each active application.

Sound Properties

Set a default output device that the THX Spatial Audio will use when the Razer BlackShark V2 Pro is not connected. You may also click on the [Windows Sound Properties](#) link to manage the sound settings of your system such as modifying the playback and recording device settings, sound scheme and default communications activity.

Mixer

The Mixer subtab allows you to enable or disable the THX Spatial Audio and its settings, as well as calibrate the audio positioning of all virtual speakers of the active spatial audio mode.

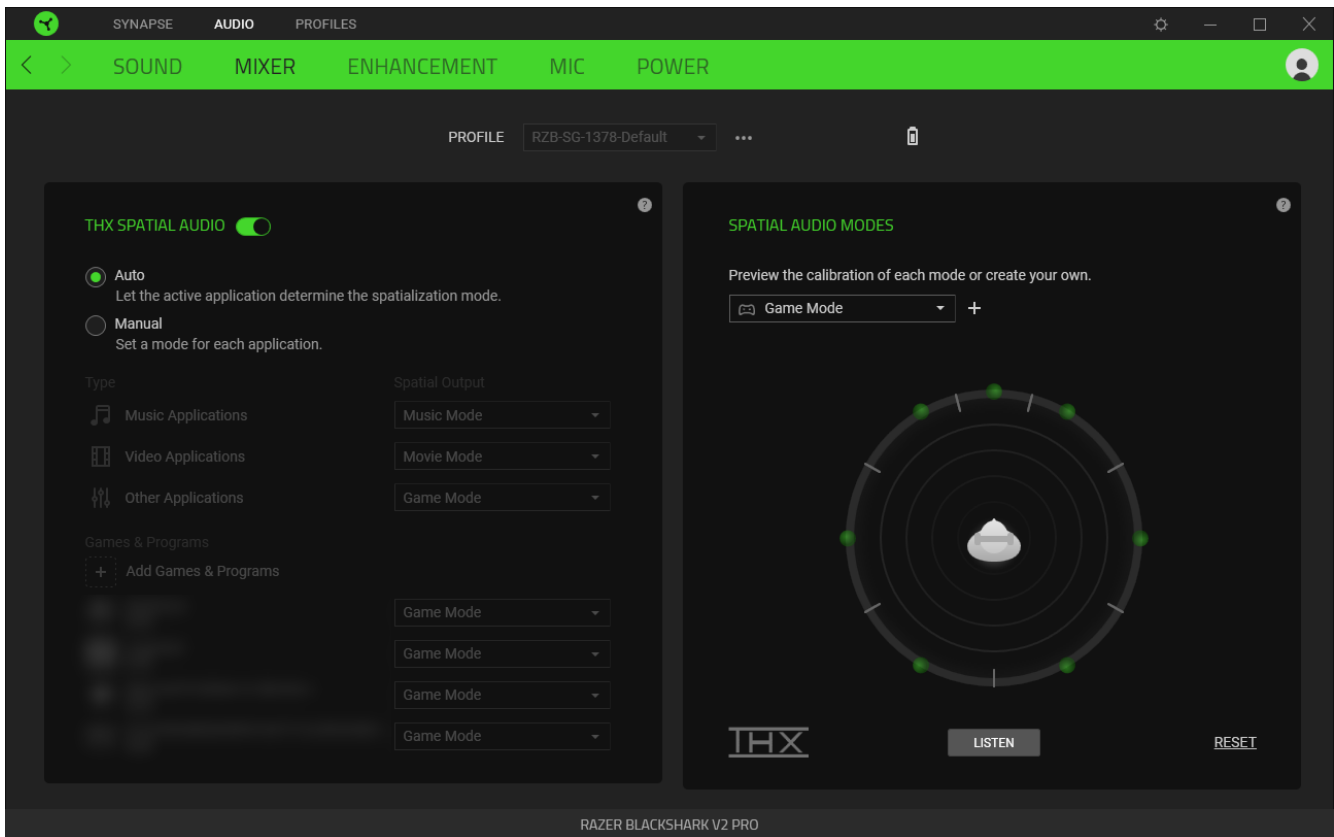

THX Spatial Audio

THX Spatial Audio technology is an advanced positional audio solution that delivers a heightened, immersive experience as you game.

Toggle this setting to enable or disable THX Spatial Audio and its settings. By default, this is set to Auto where all applications will use the recommended output setting. Using Manual will allow you to assign preferred spatial audio modes to specific application types and/or applications.

Spatial Audio Modes

Preview the calibration of each available spatial audio mode preset using the Listen button. Changing the position of any virtual speaker (in any preset mode) will automatically create a Custom Mode. Alternatively, you may also click on the Add button (+) to create a new Custom Mode.

On any Custom Mode, click on the miscellaneous button (●●●) to rename, duplicate, or delete the selected custom mode. To revert the current mode to its original settings, click on the Reset button.

Enhancement

The Enhancement subtab is for customizing the incoming audio settings and frequency response of your audio system.

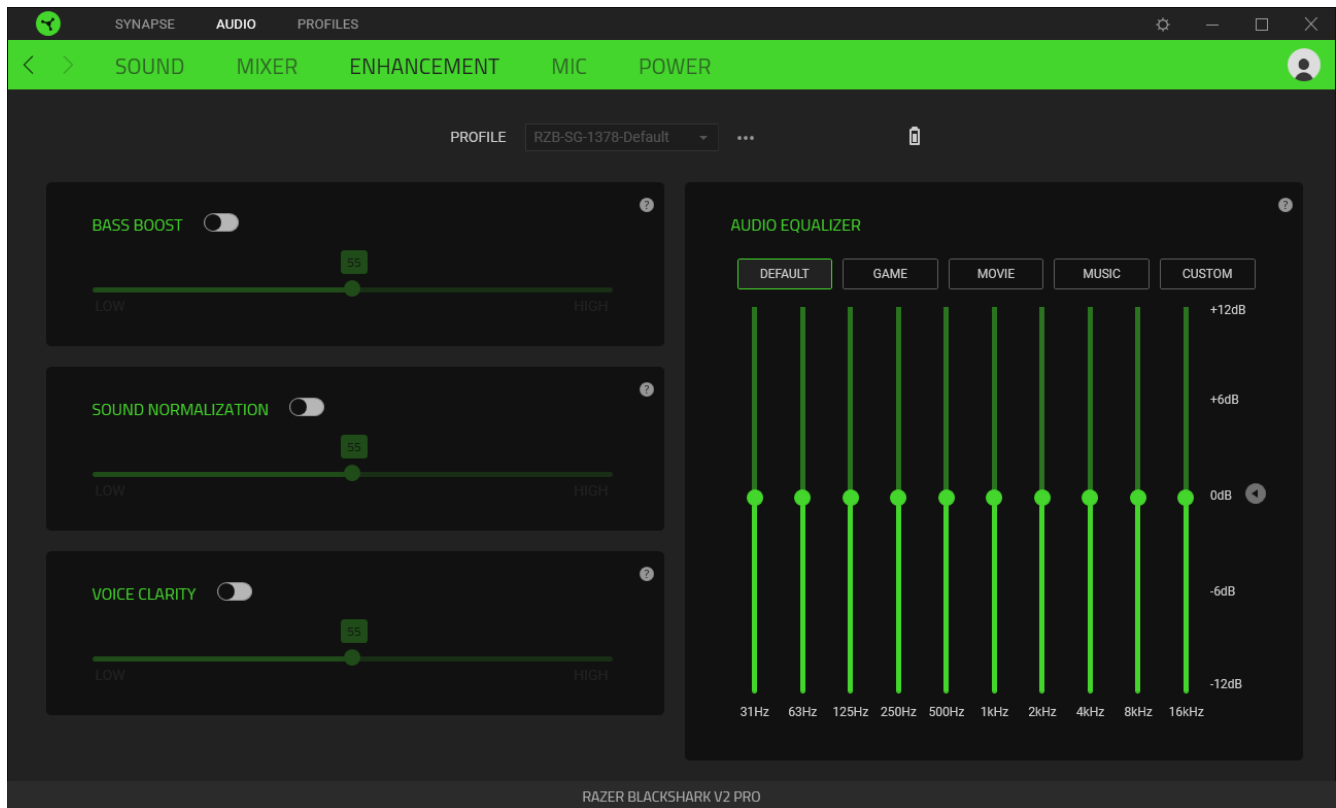

Bass Boost

Enhances the low frequency response to improve the bass output of your headset

Sound Normalization

Reduces the loudest audio received to avoid sudden and unpleasant increase in volume from effects such as shouting or explosions.

Voice Clarity

Enhances the quality of incoming voice conversations by filtering the sound to improve its clarity and volume.

Audio Equalizer

Select any of the available equalizer presets created for the best audio experience designed for balance, gaming immersion, movie viewing, or enjoying your favorite music. Manually adjusting any equalizer preset will automatically set it to Custom.

Mic

The Mic subtab enables you to change the settings for all outgoing mic audio.

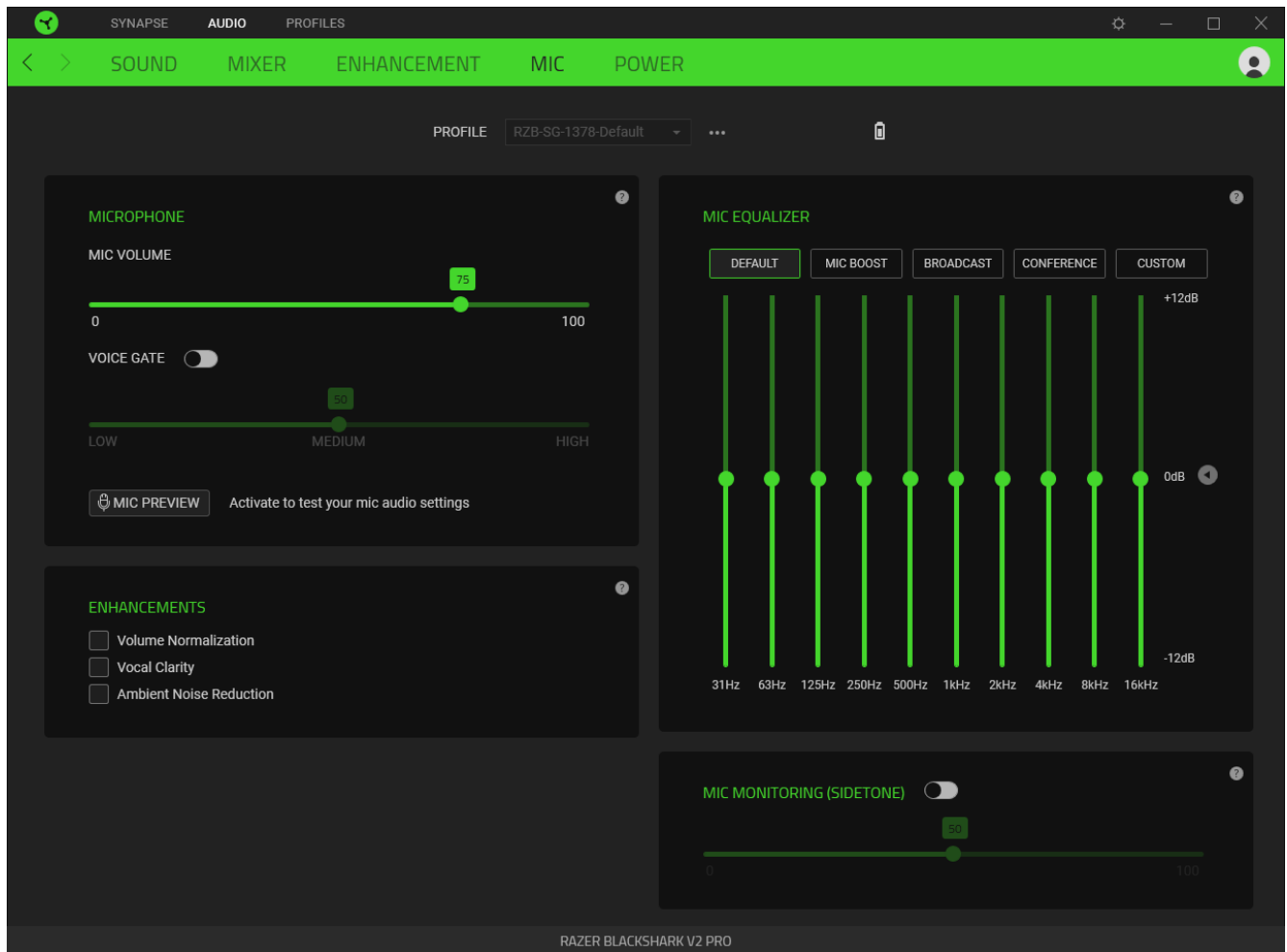

Microphone

Control the mic volume and amount of mic input for a clearer mic audio.

Mic Volume

Adjust the microphone input or mute the mic.

Voice Gate

Control the amount of mic input so that it cuts out background noises and isolates your voice. Any sound that registers below the threshold will be muted.

Enhancements

Improve the quality of the microphone by enabling any of the listed features below:

- **Volume Normalization.** Reduces the variation of loudness.
- **Ambient Noise Reduction.** Decreases environmental noise.
- **Vocal Clarity.** Emphasizes the voice frequency.

Mic Equalizer

Select any of the available mic equalizer presets which best fits your mic needs. Manually adjusting any equalizer preset will automatically set it as a Custom preset.

Mic Monitoring (Sidetone)

Enable this setting to monitor the microphone's raw audio input through the headset with an additional option to increase or decrease the audio monitoring volume.

Power

The Power subtab allows you to manage your device's energy consumption by setting it to power off when it has been idle for a certain amount of time.

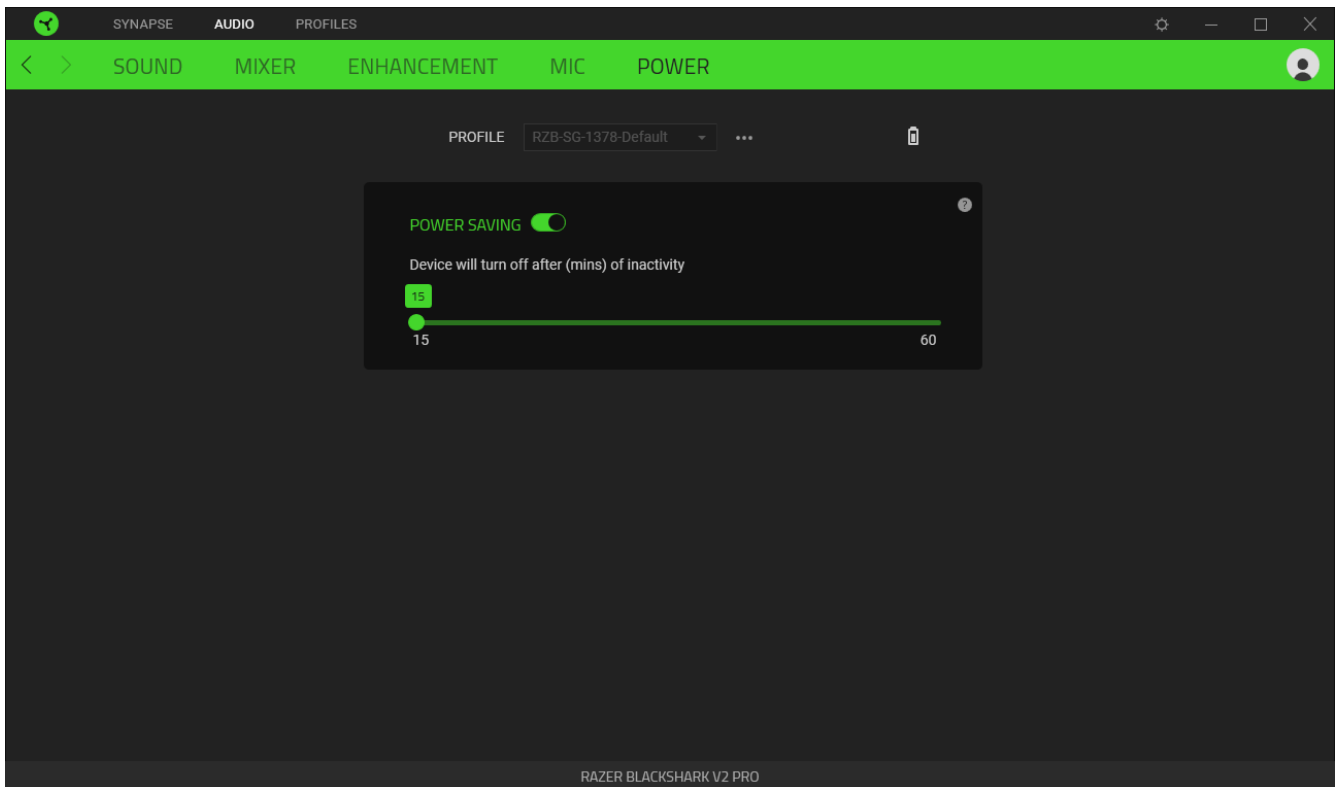





PROFILES TAB

The Profiles tab is a convenient way of managing all your profiles and linking them to your games and applications.

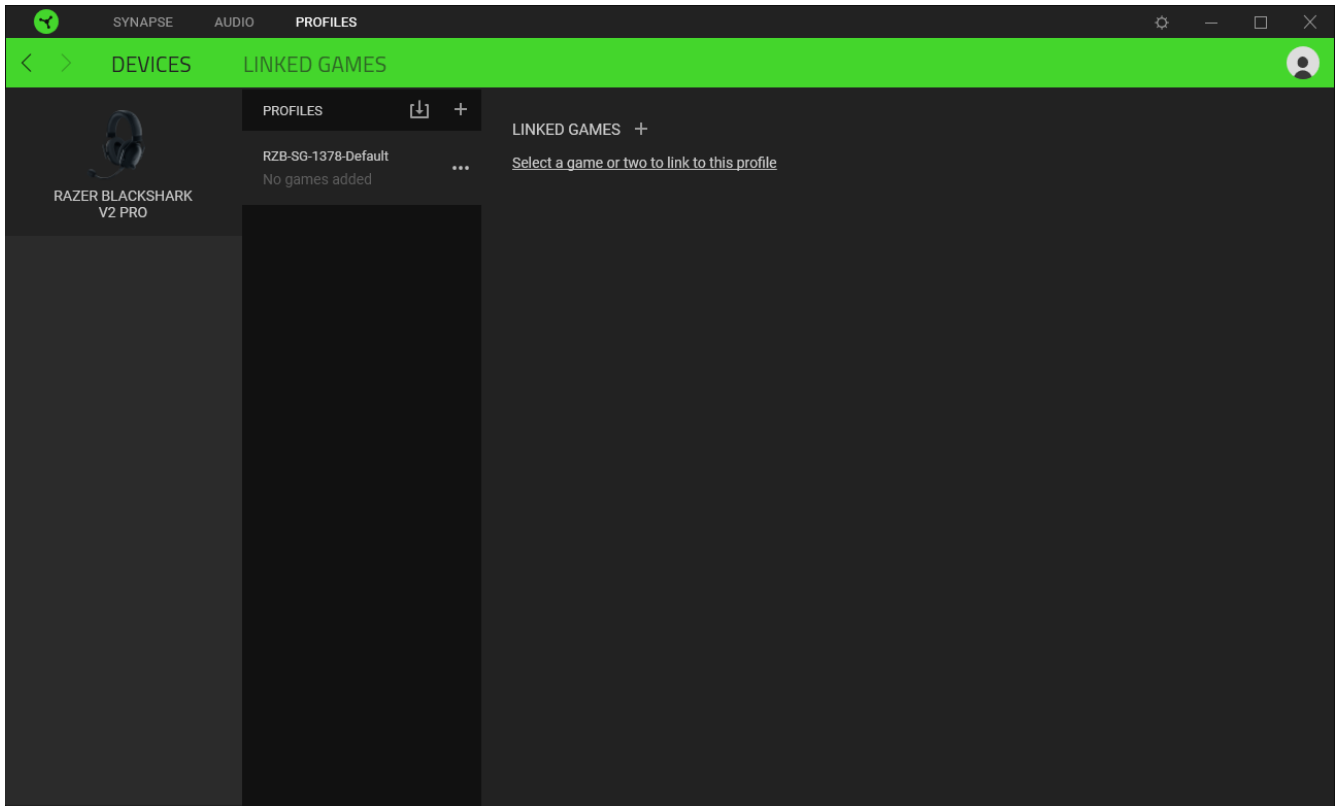
Devices

View which games are linked to each device's profiles or which Chroma Effect is linked to specific games using the Devices subtab.



You can import Profiles from your computer or from the cloud through the import button () or create new profiles within the selected device using the add button (). To rename, duplicate, export, or delete a profile, simply press the Miscellaneous button (). Each profile can be set to automatically activate when you run an application using the Linked Games option.

Linked Games

The Linked Games subtab gives you the flexibility to add games, view devices that are linked to games, or search for added games. You can also sort games based on alphabetical order, last played, or most played. Added games will still be listed here even if it is not linked to a Razer device.

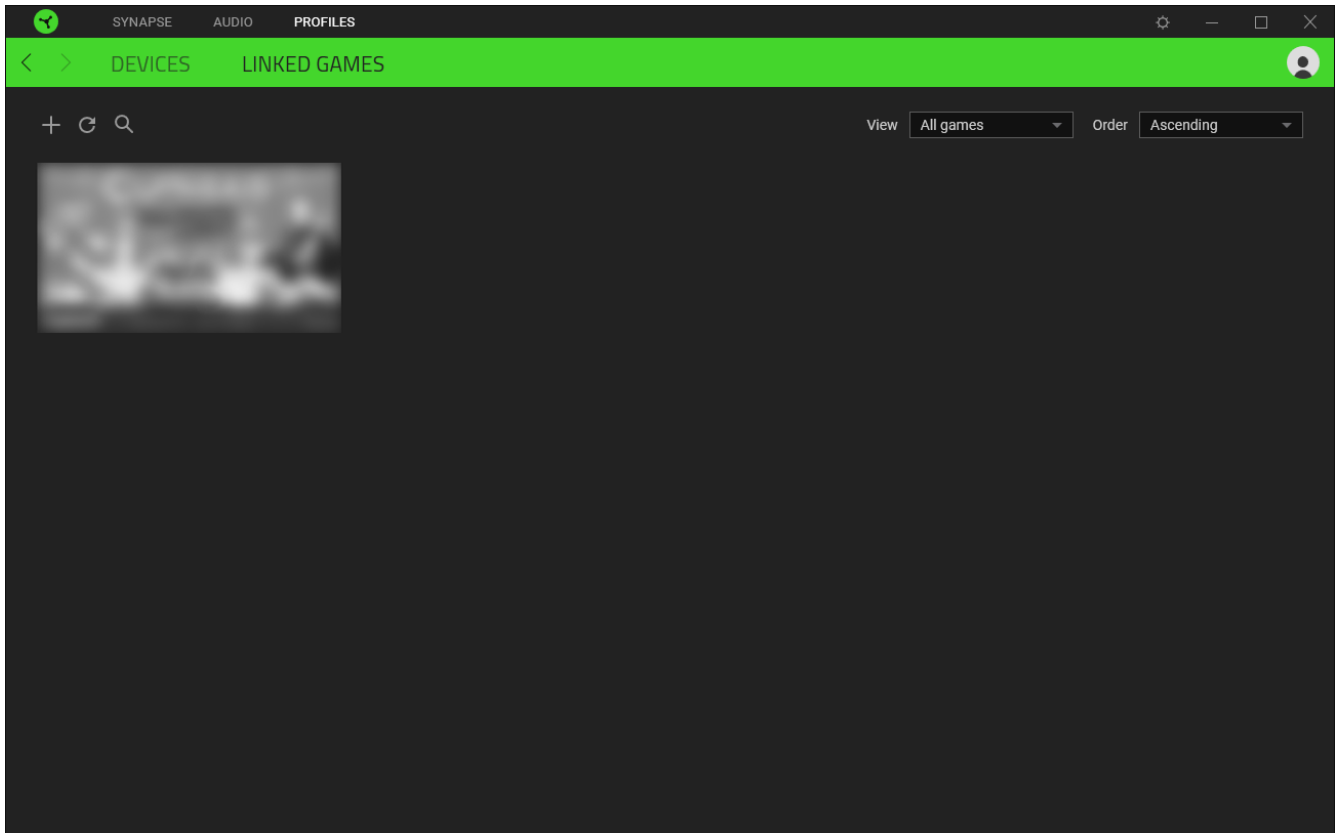

To link games to connected Razer devices or Chroma Effects, simply click on any game from the list, and then click **Select a device and its profile to launch automatically during gameplay** to select the Razer device or Chroma Effect it will link with. Once linked, you may click on the Miscellaneous button (●●●) of the corresponding Chroma Effect or device to select a specific Chroma Effect or profile.

SETTINGS WINDOW

The Settings window, accessible by clicking the (⚙️) button on Razer Synapse, enables you to configure the startup behavior and display language of Razer Synapse, view the master guides of each connected Razer device, or perform factory reset on any connected Razer device.

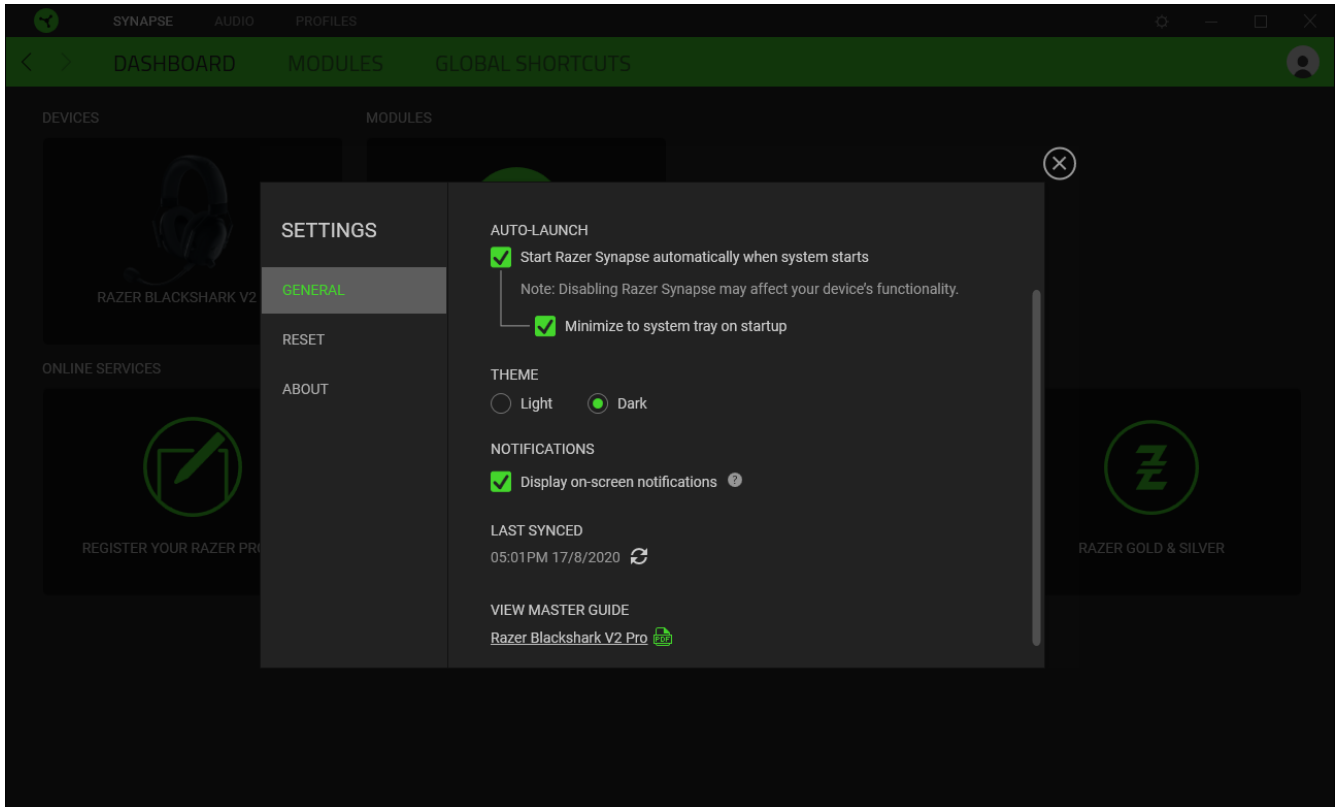

General tab

The default tab of the Settings window. The General tab enables you to change the software's display language, start-up behavior, display theme, and on-screen notifications display. You may also manually sync your profiles to the cloud (↻) or view the master guide of all connected Razer devices and installed modules.

Reset tab

The Reset tab allows you to perform a factory reset on all connected Razer devices with on-board memory and/or reset Razer Synapse tutorials to acquaint yourself again with Razer Synapse's new features on its next launch.

 *By resetting a Razer device, all profiles stored on the selected device's on-board memory will be erased.*

About tab

The About tab displays brief software information, copyright statement and provides relevant links for its terms of use. You may also use this tab to check for software updates, or as a quick access to Razer's social communities.

7. SAFETY AND MAINTENANCE

SAFETY GUIDELINES

In order to achieve maximum safety while using your Razer BlackShark V2 Pro, we suggest that you adopt the following guidelines:

Should you have trouble operating the device properly and troubleshooting does not work, unplug the device and contact the Razer hotline or go to support.razer.com for assistance.

Do not take apart the device (doing so will void your warranty) and do not attempt to operate it under abnormal current loads.

Keep the device away from liquid, humidity or moisture. Operate the device only within the specific temperature range of 0°C (32°F) to 40°C (104°F). Should the temperature exceed this range, unplug and/or switch off the device in order to let the temperature stabilize to an optimal level.

The device isolates external ambient sounds even at low volumes, resulting in lowered awareness of your external surroundings. Please remove the device when engaging in any activities that requires active awareness of your surroundings.

Listening to excessively loud volumes over extended periods of time can damage your hearing. Furthermore, legislation of certain countries permits a maximum sound level of 86db to affect your hearing for 8 hours a day. We therefore recommend that you reduce the volume to a comfortable level when listening for prolonged periods of time. Please, take good care of your hearing.

MAINTENANCE AND USE

The Razer BlackShark V2 Pro requires minimum maintenance to keep it in optimum condition. Once a month we recommend you power off or unplug the device from the computer (if applicable) and clean it using a soft cloth or cotton swab to prevent dirt buildup. Do not use soap or harsh cleaning agents.

BATTERY WARNING

The Razer BlackShark V2 Pro contains a Li-ion rechargeable battery. In general, the life expectancy of such batteries is dependent upon usage. If you suspect that the Li-ion rechargeable battery inside the Razer BlackShark V2 Pro may be drained (has a low charge), try charging it.

Caution: Do not open, mutilate, or expose to conducting materials (metal), moisture, liquid, fire, or heat. Doing so may cause batteries to leak or explode, resulting in personal injury. Battery life varies with usage.

8. LEGALESE

COPYRIGHT AND INTELLECTUAL PROPERTY INFORMATION

©2020 Razer Inc. All rights reserved. Razer, the triple-headed snake logo, Razer logo, and “For Gamers. By Gamers.” are trademarks or registered trademarks of Razer Inc. and/or affiliated companies in the United States or other countries. All other trademarks are the property of their respective owners.

THX and the THX logo are trademarks of THX Ltd., registered in the U.S. and other countries.

Windows and the Windows logo are trademarks or registered trademarks of the Microsoft group of companies.

Razer Inc. (“Razer”) may have copyright, trademarks, trade secrets, patents, patent applications, or other intellectual property rights (whether registered or unregistered) concerning the product in this guide. Furnishing of this guide does not give you a license to any such copyright, trademark, patent or other intellectual property right. The Razer BlackShark V2 Pro (the “Product”) may differ from pictures whether on packaging or otherwise. Razer assumes no responsibility for such differences or for any errors that may appear. Information contained herein is subject to change without notice.

LIMITED PRODUCT WARRANTY

For the latest and current terms of the Limited Product Warranty, please visit [razer.com/warranty](https://www.razer.com/warranty).

LIMITATION OF LIABILITY

Razer shall in no event be liable for any lost profits, loss of information or data, special, incidental, indirect, punitive or consequential or incidental damages, arising in any way out of distribution of, sale of, resale of, use of, or inability to use the Product. In no event shall Razer’s liability exceed the retail purchase price of the Product.

GENERAL

These terms shall be governed by and construed under the laws of the jurisdiction in which the Product was purchased. If any term herein is held to be invalid or unenforceable, then such term (in so far as it is invalid or unenforceable) shall be given no effect and deemed to be excluded without invalidating any of the remaining terms. Razer reserves the right to amend any term at any time without notice.