

CS6080

Companion Scanner

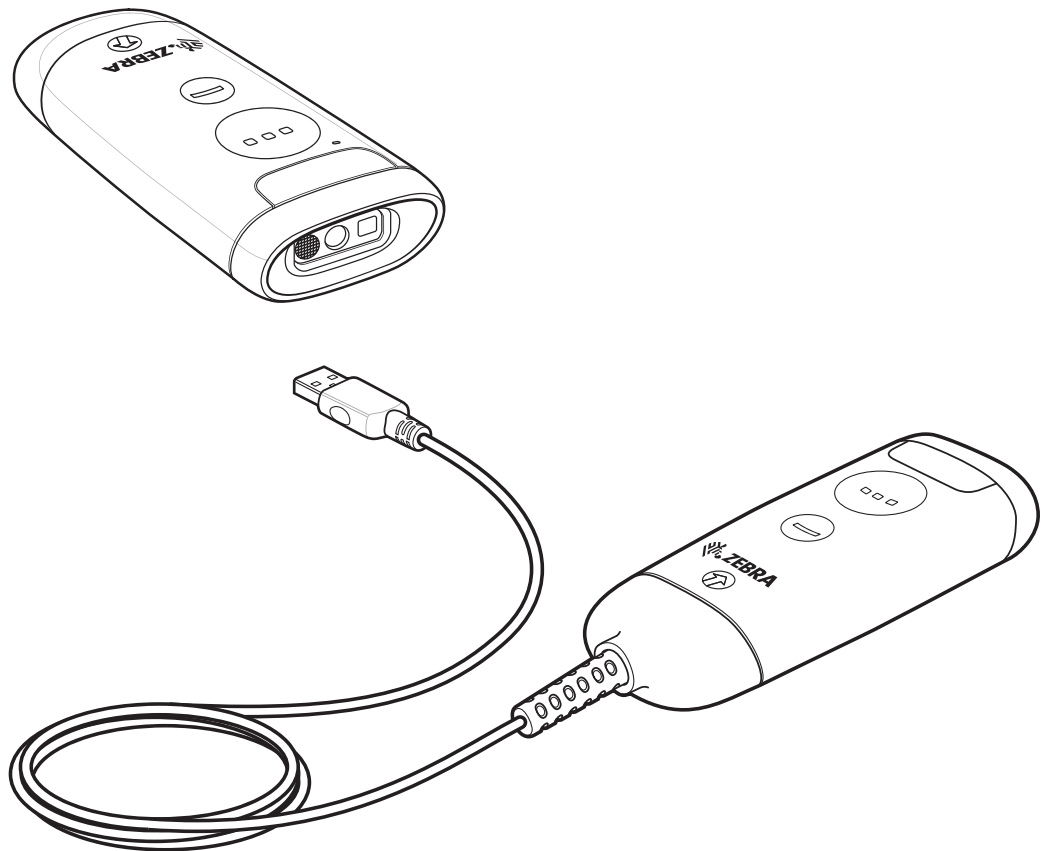

Product Reference Guide



ZEBRA

ZEBRA and the stylized Zebra head are trademarks of Zebra Technologies Corporation, registered in many jurisdictions worldwide. All other trademarks are the property of their respective owners.
© 2023 Zebra Technologies Corporation and/or its affiliates. All rights reserved.

Information in this document is subject to change without notice. The software described in this document is furnished under a license agreement or nondisclosure agreement. The software may be used or copied only in accordance with the terms of those agreements.

For further information regarding legal and proprietary statements, please go to:

SOFTWARE: zebra.com/linkoslegal

COPYRIGHTS: zebra.com/copyright

WARRANTY: zebra.com/warranty

PATENT: jp.zebra.com

END USER LICENSE AGREEMENT: zebra.com/eula

Terms of Use

Proprietary Statement

This manual contains proprietary information of Zebra Technologies Corporation and its subsidiaries (“Zebra Technologies”). It is intended solely for the information and use of parties operating and maintaining the equipment described herein. Such proprietary information may not be used, reproduced, or disclosed to any other parties for any other purpose without the express, written permission of Zebra Technologies.

Product Improvements

Continuous improvement of products is a policy of Zebra Technologies. All specifications and designs are subject to change without notice.

Liability Disclaimer

Zebra Technologies takes steps to ensure that its published Engineering specifications and manuals are correct; however, errors do occur. Zebra Technologies reserves the right to correct any such errors and disclaims liability resulting therefrom.

Limitation of Liability

In no event shall Zebra Technologies or anyone else involved in the creation, production, or delivery of the accompanying product (including hardware and software) be liable for any damages whatsoever (including, without limitation, consequential damages including loss of business profits, business interruption, or loss of business information) arising out of the use of, the results of use of, or inability to use such product, even if Zebra Technologies has been advised of the possibility of such damages. Some jurisdictions do not allow the exclusion or limitation of incidental or consequential damages, so the above limitation or exclusion may not apply to you.

Publication Date

April 19, 2023

Contents

About This Document	21
Introduction	21
Configurations	21
Scanners	21
Accessories	22
Kits.....	23
Chapter Descriptions.....	23
Notational Conventions	24
Icon Conventions	25
Service Information	26
Feedback	26
Getting Started	27
Introduction	27
Features	28
Cordless Front View	28
Corded Front View.....	28
Bottom View	29
Unpacking the Scanner.....	29
Installing the Battery.....	29
Inserting the Battery	29
Removing the Battery	30
Installing the Corded USB Converter Cable.....	30
Inserting the USB Cable	30
Removing the USB Cable.....	30
Charging.....	31
Charging via Cradle.....	31
Connecting Cradle Cable	32
Charging via Charging Pad	33
Charging Spare Batteries	34
Charging Temperature	34

Button Actions	35
123Scan and Software Tools.....	36
Introduction	36
123Scan.....	36
Communication with 123Scan	37
123Scan Requirements	37
123Scan Information	37
Scanner SDK, Other Software Tools, and Videos.....	38
Data Capture	39
Introduction	39
Beeper and LED Indications	39
Digital Scanner Indications	39
LED Indicators.....	41
Other LED Indicators.....	43
Scanning	46
Hand-Held Scanning	46
Hands-Free Scanning.....	46
Aiming with Digital Scanner.....	48
Decode Ranges	49
Maintenance, Troubleshooting, and Technical Specifications	50
Introduction	50
Maintenance.....	50
Known Harmful Ingredients	50
Approved Cleaners for Standard CS6080 Digital Scanners and Cradles	51
Approved Disinfectant Cleaners for Healthcare Configurations of the CS6080 Digital Scanners and Cradles	51
Cleaning the Digital Scanner	52
Troubleshooting	53
Dump Scanner Parameters	56
Send Versions	56
Report Software Version	56
Serial Number	57
Manufacturing Information	57
Technical Specifications.....	58
Duty Cycle.....	61

User Preferences	63
Introduction	63
Scanning Sequence Examples	64
Errors While Scanning	64
User Preferences Parameter Defaults	64
Parameters.....	67
Default Parameters.....	67
Parameter Barcode Scanning	68
Beep After Good Decode	68
Direct Decode Indicator	69
Beeper Volume	70
Beeper Tone	71
Beeper Duration	72
Suppress Power Up Beeps	72
Decode Pager Motor	73
Decode Pager Motor Duration	73
Night Mode	75
Night Mode Trigger	75
Night Mode Toggle.....	76
Night Mode Silence Beeper Radio Indications	77
Night Mode Silence Beeper Low Battery Indication	78
Night Mode Silence Beeper Parameter Programming Indications	79
Scan Button Sensitivity.....	81
Programmable Button Sensitivity	81
Haptic Feedback (Vibrate) on Button Touch	82
Click on Button Touch	83
ADF Rule Selection	84
Scan Button ADF Rule Selection	86
Programmable Button ADF Rule Selection.....	87
Hands-Free ADF Rule Selection.....	88
Lamp Mode.....	89
Lamp Mode Control.....	89
Low Power Mode.....	90
Time Delay to Low Power Mode.....	91
Timeout to Low Power Mode from Auto Aim	93
Battery Preservation Mode	94
Hand-Held Trigger Mode	95
Hands-Free Mode.....	97
Hand-Held Decode Aiming Pattern	97
Hands-Free Decode Aiming Pattern.....	98
Picklist Mode	100
Virtual Tether.....	101

Configuring the Alarm on the Scanner	101
Audio Virtual Tether Alarm on Scanner	102
LED Virtual Tether Alarm.....	103
Illumination Virtual Tether Alarm	103
Haptics Virtual Tether Alarm.....	104
Configuring the Alarm on Cradle	104
Distance	105
Delay Before Virtual Alarm Activates.....	105
Virtual Tether Alarm Duration	105
Stopping the Alarm.....	106
Defeat Virtual Tether Alarm	106
Pause Virtual Tether Alarm Duration.....	107
Virtual Tether Alarm Considerations	107
Continuous Barcode Read	109
Unique Barcode Reporting	109
Decode Session Timeout	110
Hands-free Decode Session Timeout.....	111
Timeout Between Decodes, Same Symbol	112
Timeout Between Decodes, Different Symbols	112
Triggered Timeout, Same Symbol.....	113
Mobile Phone/Display Mode	114
PDF Prioritization.....	115
PDF Prioritization Timeout.....	116
Decoding Illumination	116
Illumination Brightness Hand-Held	117
Illumination Brightness Hands-Free	118
Low Light Scene Detection	119
Scene Detect Sensitivity	120
Motion Tolerance (Hand-Held Trigger Modes Only).....	121
Product ID (PID) Type	122
Product ID (PID) Value	122
ECLevel	123
Add an Enter Key	123
Transmit Code ID Character.....	123
Prefix/Suffix Values	124
Scan Data Transmission Format	125
FN1 Substitution Values	127
Transmit “No Read” Message	128
Unsolicited Heartbeat Interval	129
securPharm Decoding	130
securPharm Output Formatting	131
Sample GS1 Format	131

Contents

Sample IFA Format	132
securPharm Output Formatting Barcodes.....	133
Programmable Button for Single Press	134
Programmable Button for Double Press	135
Radio Communications.....	136
Introduction	136
Setting Parameters	136
Scanning Sequence Examples.....	136
Errors While Scanning.....	137
Radio Communications Parameter Defaults	137
Wireless Beeper Definitions	138
Radio Communication Host Types.....	138
Bluetooth Classic vs. Low Energy Bluetooth	138
Cradle	139
Human Interface Device (HID) Keyboard Emulation	140
Simple Serial Interface (SSI)	141
Serial Port Profile (SPP)	142
Bluetooth Technology Profile Support.....	143
Central/Peripheral Set Up.....	143
Central.....	143
Peripheral.....	143
Bluetooth Friendly Name.....	143
Discoverable Mode	144
Wi-Fi Friendly Mode.....	144
Notes	144
Wi-Fi Friendly Channel Exclusion.....	145
Wi-Fi Channel Exclusion	145
Radio Output Power.....	147
Link Supervision Timeout	148
Bluetooth Radio State	149
HID Host Parameters	150
Apple iOS Virtual Keyboard Toggle	150
HID Keyboard Keystroke Delay	151
HID CAPS Lock Override	151
HID Ignore Unknown Characters.....	152
Emulate Keypad	152
Fast HID Keyboard	153
Quick Keypad Emulation	153
HID Keyboard FN1 Substitution	154
HID Function Key Mapping.....	154

Simulated Caps Lock.....	155
Convert Case.....	155
Auto-Reconnect Feature.....	156
Auto-Reconnect Option.....	157
Reconnect Attempt Beep Feedback.....	158
Reconnect Attempt Interval.....	158
Sleep Between Attempts.....	160
Number of Retry Attempts.....	161
Out of Range Indicator.....	162
Beep on Insertion.....	162
Beep on <BEL>.....	163
Digital Scanner(s) To Cradle Support.....	164
Pairing.....	164
Pairing Modes.....	164
Pairing Methods.....	165
Press Trigger Twice to Re-connect.....	165
Toggle Pairing.....	166
Pairing Barcode Format Using the Scan-To-Connect (STC) Utility.....	166
Connection Maintenance Interval.....	167
Considerations.....	167
AutoConfig (Scanner Cloning Through Cradle).....	169
Cradle Configuration.....	169
Batch Mode.....	170
Modes of Operation.....	170
Persistent Batch Storage.....	173
Page Button.....	174
Page Options.....	175
Page Mode.....	175
Page State Timeout.....	175
Cradle Bluetooth Operation Mode.....	176
Bluetooth Security.....	177
Bluetooth Security Levels.....	177
Save Bluetooth Connection Information.....	178
FIPS Mode.....	179
Bluetooth Radio, Linking, and Batch Operation.....	180
Setting Up an iOS or Android Product To Work With The Digital Scanner.....	180
HID Keyboard Emulation.....	180
Imaging Preferences.....	181
Introduction.....	181
Scanning Sequence Examples.....	182
Errors While Scanning.....	182

Imaging Preferences Parameter Defaults	182
Imaging Preferences	183
Operational Modes	183
Decode Mode	183
Snapshot Mode	183
Video Mode	184
Image Capture Illumination.....	185
Image Capture Autoexposure.....	185
Fixed Exposure.....	186
Fixed Gain	186
Gain/Exposure Priority for Snapshot Mode	187
Snapshot Mode Timeout	188
Snapshot Aiming Pattern.....	189
Silence Operational Mode Changes.....	189
Image Cropping	190
Crop to Pixel Addresses	190
Image Size (Number of Pixels).....	191
Image Brightness (Target White).....	192
JPEG Image Options	193
JPEG Target File Size	193
JPEG Quality and Size Value	194
Image Enhancement	194
Image File Format Selector	195
Image Rotation	196
Bits Per Pixel	196
Signature Capture	197
Output File Format	197
Signature Capture File Format Selector	198
Signature Capture Bits Per Pixel	199
Signature Capture Width	200
Signature Capture Height	200
Signature Capture JPEG Quality	200
Video Mode Format Selector.....	201
Video View Finder (Corded Mode Only)	201
Video View Finder Image Size	202
Video Subsampling.....	203
USB Interface	204
Introduction	204
Connecting a USB Interface.....	204
USB Parameter Defaults.....	206

USB Host Parameters	207
USB Device Type	207
Symbol Native API (SNAPI) Status Handshaking	208
USB Keystroke Delay	209
USB CAPS Lock Override	209
USB Ignore Unknown Characters	210
USB Convert Unknown to Code 39	210
USB Polling Interval.....	211
USB Fast HID	213
Emulate Keypad	213
Emulate Keypad with Leading Zero.....	214
Quick Keypad Emulation	214
USB Keyboard FN 1 Substitution	215
Function Key Mapping.....	215
Simulated Caps Lock.....	216
Convert Case.....	216
USB Static CDC	217
Optional USB Parameters.....	218
TGCS (IBM) USB Direct I/O Beep.....	218
TGCS (IBM) USB Beep Directive	218
TGCS (IBM) USB Barcode Configuration Directive.....	219
IBM Specification Version.....	219
ASCII Character Sets for USB	220
SSI Interface	221
Introduction	221
Communications	221
SSI Transactions.....	222
General Data Transactions.....	222
ACK/NAK Handshaking	222
Transfer of Decode Data	224
ACK/NAK Enabled and Unpacketed ASCII Data	224
ACK/NAK Disabled and Packeted DECODE_DATA.....	224
ACK/NAK Disabled and Unpacketed ASCII Data	225
Communication Summary.....	225
ACK/NAK Option	225
Serial Response Time-out.....	225
Retries	225
Response Time-out, ACK/NAK Handshake	225
Errors.....	225
Things to Remember When Using SSI Communication	226

Encapsulation of RSM Commands/Responses over SSI	226
Command Structure	226
Response Structure	227
Example Transaction	227
Command from Host to Query Packet Size Supported by Device	227
Response from Device with Packet Size Information	227
Command from Host to Retrieve Diagnostic Information	227
Response from Device with Diagnostic Information	228
Simple Serial Interface Default Parameters	229
SSI Host Parameters	230
Software Handshaking	230
Decode Data Packet Format	231
Host Serial Response Time-out	232
Host Character Time-out	233
Multipacket Option	234
Interpacket Delay	235
Event Reporting	236
Decode Event	236
Boot Up Event	237
Parameter Event	237
Symbologies	238
Introduction	238
Scanning Sequence Examples	238
Errors While Scanning	238
Symbology Parameter Defaults	239
Enable/Disable All Code Types	244
UPC/EAN	244
Enable/Disable UPC-A	244
Enable/Disable UPC-E	245
Enable/Disable UPC-E1	245
Enable/Disable EAN-8/JAN-8	246
Enable/Disable EAN-13/JAN-13	246
Enable/Disable Bookland EAN	247
Decode UPC/EAN/JAN Supplementals	247
User-Programmable Supplementals	251
UPC/EAN/JAN Supplemental Redundancy	251
UPC/EAN/JAN Supplemental AIM ID Format	252
Transmit UPC-A Check Digit	253
Transmit UPC-E Check Digit	253
Transmit UPC-E1 Check Digit	254

Contents

Transmit EAN-8 Check Digit.....	254
Transmit EAN-13 Check Digit.....	255
Transmit Code 39 Start/Stop Characters	255
UPC-A Preamble	256
UPC-E Preamble	257
UPC-E1 Preamble	258
Convert UPC-E to UPC-A.....	259
Convert UPC-E1 to UPC-A.....	259
EAN-8/JAN-8 Extend.....	260
Bookland ISBN Format.....	260
UCC Coupon Extended Code	261
Coupon Report	262
ISSN EAN.....	262
UPC Reduced Quiet Zone	263
Code 128.....	263
Enable/Disable Code 128.....	263
Set Lengths for Code 128.....	264
Enable/Disable GS1-128 (formerly UCC/EAN-128)	266
Enable/Disable ISBT 128	266
ISBT Concatenation	267
Check ISBT Table	268
ISBT Concatenation Redundancy	268
Code 128 Security Level	270
Code 128 Reduced Quiet Zone.....	271
Code 128 <FNC4>	271
Code 39.....	272
Enable/Disable Code 39.....	272
Enable/Disable Trioptic Code 39	272
Convert Code 39 to Code 32.....	273
Code 32 Prefix.....	273
Set Lengths for Code 39.....	274
Code 39 Check Digit Verification.....	275
Transmit Code 39 Check Digit.....	275
Code 39 Full ASCII Conversion.....	276
Code 39 Security Level	277
Code 39 Reduced Quiet Zone.....	278
Code 93.....	278
Enable/Disable Code 93.....	278
Set Lengths for Code 93.....	279
Code 11.....	280
Code 11	280

Contents

Set Lengths for Code 11.....	280
Code 11 Check Digit Verification.....	282
Transmit Code 11 Check Digits.....	283
Interleaved 2 of 5 (ITF).....	284
Enable/Disable Interleaved 2 of 5.....	284
Set Lengths for Interleaved 2 of 5.....	284
I 2 of 5 Check Digit Verification.....	286
Transmit I 2 of 5 Check Digit.....	286
Convert I 2 of 5 to EAN-13.....	287
Febraban.....	287
I 2 of 5 Security Level.....	288
I 2 of 5 Reduced Quiet Zone.....	289
Discrete 2 of 5 (DTF).....	290
Enable/Disable Discrete 2 of 5.....	290
Set Lengths for Discrete 2 of 5.....	290
Codabar (NW - 7).....	292
Enable/Disable Codabar.....	292
Set Lengths for Codabar.....	292
CLSI Editing.....	294
NOTIS Editing.....	294
Codabar Security Level.....	295
Codabar Upper or Lower Case Start/Stop Characters Detection.....	296
Codabar Mod 16 Check Digit Verification.....	296
Transmit Codabar Check Digit.....	297
MSI.....	297
Enable/Disable MSI.....	297
Set Lengths for MSI.....	298
MSI Check Digits.....	299
Transmit MSI Check Digit(s).....	300
MSI Check Digit Algorithm.....	300
MSI Reduced Quiet Zone.....	301
Chinese 2 of 5.....	301
Enable/Disable Chinese 2 of 5.....	301
Matrix 2 of 5.....	302
Enable/Disable Matrix 2 of 5.....	302
Set Lengths for Matrix 2 of 5.....	302
Matrix 2 of 5 Check Digit.....	303
Transmit Matrix 2 of 5 Check Digit.....	304
Korean 3 of 5.....	304

Enable/Disable Korean 3 of 5	304
Inverse 1D	305
GS1 DataBar	306
GS1 DataBar Limited	306
GS1 DataBar Expanded, GS1 DataBar Expanded Stacked	307
Convert GS1 DataBar to UPC/EAN	307
GS1 DataBar Limited Margin Check	308
GS1 DataBar Security Level	309
Composite	310
Composite CC-C	310
Composite CC-A/B	310
Composite TLC-39	311
Composite Inverse	311
UPC Composite Mode	312
Composite Beep Mode	313
GS1-128 Emulation Mode for UCC/EAN Composite Codes	313
2D Symbologies	314
Enable/Disable PDF417	314
Enable/Disable MicroPDF417	314
Code 128 Emulation	315
Data Matrix	316
GS1 Data Matrix	316
Data Matrix Inverse	317
Decode Mirror Images (Data Matrix Only)	318
Maxicode	319
QR Code	319
Weblink QR	320
GS1 QR	320
MicroQR	321
Aztec	321
Aztec Inverse	322
Han Xin	323
Han Xin Inverse	323
Grid Matrix	324
Grid Matrix Inverse	324
Grid Matrix Mirror	325
DotCode	326
DotCode Inverse	326
DotCode Mirrored	327
DotCode Prioritize	327
Postal Codes	328

US Postnet	328
US Planet	328
Transmit US Postal Check Digit	329
UK Postal.....	329
Transmit UK Postal Check Digit	330
Japan Postal.....	330
Australia Post	331
Australia Post Format	332
Netherlands KIX Code.....	333
USPS 4CB/One Code/Intelligent Mail	333
UPU FICS Postal.....	334
Mailmark	334
Symbology-Specific Security Levels	335
Redundancy Level.....	335
Redundancy Level 1	335
Redundancy Level 2	335
Redundancy Level 3	335
Redundancy Level 4	336
Security Level	337
1D Quiet Zone Level.....	338
Intercharacter Gap Size.....	339
Report Version	339
Macro PDF Features.....	340
Flush Macro Buffer	340
Abort Macro PDF Entry	340
Data Formatting: ADF, MDF, Preferred Symbol	341
Introduction	341
Advanced Data Formatting (ADF).....	341
Multicode Data Formatting.....	341
MDF in Hands-Free Mode	341
MDF Best Practices	343
Preferred Symbol	344
Data Parsing (UDI Scan+, Label Parse+ and Blood Bag Parse+)	344
Scan a UDI Label using UDI Scan+	344
Scan a GS1 Label using Label Parse+.....	345
Scan a Blood Bag Label using Blood Bag Parse+	345
OCR Programming	346
Introduction	346
Setting Parameters	346

Scanning Sequence Examples.....	347
Errors While Scanning.....	347
OCR Parameter Defaults	347
OCR Programming Parameters.....	348
OCR-A	348
OCR-A Variant.....	349
OCR-B	350
OCR-B Variant.....	351
MICR E13B.....	355
US Currency Serial Number	356
OCR Orientation	356
OCR Lines	358
OCR Minimum Characters	358
OCR Maximum Characters	359
OCR Subset	359
OCR Quiet Zone.....	360
OCR Template.....	360
Required Digit (9).....	361
Required Alpha (A).....	361
Optional Alphanumeric (1)	361
Optional Alpha (2)	362
Alpha or Digit (3)	362
Any Including Space & Reject (4)	362
Any except Space & Reject (5)	363
Optional Digit (7)	363
Digit or Fill (8).....	363
Alpha or Fill (F).....	364
Optional Space ()	364
Optional Small Special (.).....	364
Other Template Operators	364
Repeat Previous (R).....	368
Multiple Templates	369
Template Examples	369
OCR Check Digit Modulus.....	369
OCR Check Digit Multiplier	370
OCR Check Digit Validation	372
None.....	372
Product Add Left to Right.....	372
Product Add Right to Left.....	373
Digit Add Left to Right	373
Digit Add Right to Left	374
Product Add Right to Left Simple Remainder	374
Digit Add Right To Left Simple Remainder	375
Health Industry - HIBCC43.....	375

Inverse OCR.....	377
OCR Redundancy	378
Standard Parameter Defaults	379
Country Codes.....	390
Introduction	390
USB, BT HID Country Keyboard Types (Country Codes).....	391
Country Code Pages	406
Introduction	406
Country Code Page Defaults	406
Country Code Page Barcodes	410
CKJ Decode Control	420
Introduction	420
CJK Control Parameters	421
Unicode Output Control	421
CJK Output Method to Windows Host	422
Non-CJK UTF Barcode Output.....	425
Country Keyboard Type Missing Characters	425
Unicode/CJK Decode Setup with Windows Host.....	427
Setting Up the Windows Registry Table for Unicode Universal Output.....	427
Adding CJK IME on Windows.....	427
Selecting the Simplified Chinese Input Method on the Host.....	428
Selecting the Traditional Chinese Input Method on the Host	428
Programming Reference.....	430
Symbol Code Identifiers	430
AIM Code Identifiers.....	431
Sample Barcodes	436
UPC/EAN	436
UPC-A, 100%	436
UPC-A with 2-digit Add-on.....	436
UPC-A with 5-digit Add-on.....	436
UPC-E	437
UPC-E with 2-digit Add-on.....	437

Contents

UPC-E with 5-digit Add-on.....	438
EAN-8	438
EAN-13, 100%.....	438
EAN-13 with 2-digit Add-on	438
EAN-13 with 5-digit Add-on	439
Code 128.....	439
GS1-128	439
Code 39.....	439
Code 93.....	440
Code 11 with 2 Check Digits	440
Interleaved 2 of 5	440
MSI with 2 Check Digits	440
Chinese 2 of 5	441
Matrix 2 of 5	441
Korean 3 of 5.....	441
GS1 DataBar.....	442
GS1 DataBar Omnidirectional (formerly GS1 DataBar-14)	442
GS1 DataBar Truncated	442
GS1 DataBar Stacked	442
GS1 DataBar Stacked Omnidirectional	443
GS1 DataBar Limited.....	443
GS1 DataBar Expanded	444
GS1 DataBar Expanded Stacked	444
2D Symbolologies	444
PDF417	444
Data Matrix	445
GS1 Data Matrix	446
Maxicode	446
QR Code.....	446
GS1 QR	447
MicroQR	447
Aztec.....	447
Grid Matrix	448
Han Xin	448
Postal Codes.....	448
US Postnet	448
UK Postal.....	448
Japan Postal.....	449
Australian Post	449
OCR	450
OCR-A	450

OCR-B	450
MICR E13B.....	450
US Currency	450
Numeric Barcodes	451
Cancel	451
Numeric Barcodes.....	451
Alphanumeric Barcodes.....	453
Cancel	453
Alphanumeric Barcodes	453
ASCII Character Sets	470
Communication Protocol Functionality	480
Functionality Supported via Communication (Cable) Interface	480
Functionality Supported via Radio Communication	481
Signature Capture Code	482
Introduction	482
Code Structure	482
Signature Capture Area	482
CapCode Pattern Structure	483
Start / Stop Patterns.....	483
Dimensions	484
Data Format	484
Additional Capabilities.....	485
Signature Boxes.....	485
Non-Parameter Attributes	486
Introduction	486
Attributes	486
Model Number	486
Serial Number.....	486
Date of Manufacture	486
Date of First Programming	487
Configuration Filename	487
Beeper/LED	488

Contents

Parameter Defaults.....	489
Beep on Next Bootup	489
Reboot	489
Host Trigger Session	489
Firmware Version	490
Scankit Version.....	490
ScanSpeed Analytics.....	490
ScanSpeed Analytics.....	491
Introduction	491
Histogram Decode Information	491
Image of Slowest Decoded Barcode.....	495
Upgrading Over Bluetooth Without A Cradle	498
Introduction	498
Upgrading Without a Cradle.....	498
Troubleshooting	499
Index.....	500

About This Document

Introduction

This guide provides information about using the CS6080 Zebra product and accessories, if applicable.



IMPORTANT: If you have a problem with your equipment, contact Zebra Global Customer Support for your region. Contact information is available at: www.zebra.com/support.

Configurations

For additional information regarding the latest available configurations, check Solutions Pathway.

Scanners

This guide covers the following configurations:

Part Number	Description
CS6080-SR40004VZWW	CS6080 Cordless: Companion Scanner, Inductive, Area Imager, Standard Range, Midnight Black, Vibration Motor
CS6080-SR40004VMWW	CS6080 Cordless: Companion Scanner, Inductive, Area Imager, Standard Range, Midnight Black, Vibration Motor, MFi
CS6080-SR40004VZK	CS6080 Cordless: Companion Scanner, Inductive, Area Imager, Standard Range, Midnight Black, Vibration Motor - India, Korea, Japan Only
CS6080-SR40004VZCN	CS6080 Cordless: Companion Scanner, Inductive, Area Imager, Standard Range, Midnight Black, Vibration Motor - China Only
CS6080-SRK0004VZWW	CS6080 Coded: Companion Scanner, Area Imager, Standard Range, Midnight Black, Vibration Motor
CS6080-SRK0004VZK	CS6080 Coded: Companion Scanner, Area Imager, Standard Range, Midnight Black, Vibration Motor - India, Korea, Japan Only
CS6080-SRK0004VZCN	CS6080 Coded: Companion Scanner, Area Imager, Standard Range, Midnight Black, Vibration Motor - China Only
CS6080-HC4F00BVZWW	CS6080: Cordless: Companion Scanner, Inductive, Area Imager, Healthcare, FIPS, HC White, Vibration Motor
CS6080-HC4F00BVMWW	CS6080: Cordless: Companion Scanner, Inductive, Area Imager, Healthcare, FIPS, HC White, Vibration Motor, MFi

About This Document

Part Number	Description
CS6080-HC4F00BVZK	CS6080: Cordless: Companion Scanner, Inductive, Area Imager, Healthcare, FIPS, HC White, Vibration Motor - India, Korea, Japan Only
CS6080-HC4F00BVZCN	CS6080 Cordless: Companion Scanner, Inductive, Area Imager, Healthcare, FIPS, HC White, Vibration Motor - China Only
CS6080-HCKF00BVZWW	CS6080: Corded: Companion Scanner, Area Imager, Healthcare, FIPS, HC White, Vibration Motor
CS6080-HCKF00BVZK	CS6080: Corded: Companion Scanner, Area Imager, Healthcare, FIPS, HC White, Vibration Motor - India, Korea, Japan Only
CS6080-HCKF00BVZCN	CS6080 Corded: Companion Scanner, Area Imager, Healthcare, HC White, Vibration Motor - China Only

Accessories

This guide covers the following configurations:

Part Number	Description
BTRY-CS60EAB0E-04	Spare Battery, CS6080-SR
BTRY-CS60EAB0E-04K	Spare Battery, CS6080-SR - India, Korea, Japan Only
BTRY-CS60EABHE-0B	Spare Battery, CS6080-HC
BTRY-CS60EABHE-0BK	Spare Battery, CS6080-HC - India, Korea, Japan Only
CR6080-SC100F4WW	CS6080 Cordless: Standard Cradle, Inductive, Bluetooth, Midnight Black - 1 Slot for Scanner and 1 Slot for Spare Battery. USB-C Cradle Cable CBL-CS6-S07-04 Sold Separately.
CR6080-SC100F4CN	CS6080 Cordless: Standard Cradle, Inductive, Bluetooth, Midnight Black - 1 Slot for Scanner and 1 Slot for Spare Battery.USB-C Cradle Cable CBL-CS6-S07-04 Sold Separately. China Only.
CR6080-PC100FBWW	CS6080 Cordless: Presentation Cradle, Inductive, Bluetooth, Healthcare White. USB-C Cradle Cable CBL-CS6-S07-0B Sold Separately.
CR6080-PC100FBCN	CS6080 Cordless: Presentation Cradle, Inductive, Bluetooth, Healthcare White. USB-C Cradle Cable CBL-CS6-S07-0B Sold Separately. China Only.
CR6080-SA40004WW	CS6080 Cordless: 4-Slot Device Cradle Adapter Cup, Inductive, Midnight Black
CR6080-BA40004WW	CS6080 Cordless: 4-Slot Battery Cradle Adapter Cup, Inductive, Midnight Black
CVTR-U70060C-04	7 ft (2.1m) Corded USB Converter - CS6080-SR (Midnight Black)
CVTR-U70060C-0B	7 ft (2.1m) Corded USB Converter - CS6080-HC (HC White)
LNYS-000060W-04	Lanyard, Retractor, Silicon Sleeve - CS6080 Cordless (Midnight Black)
CUP-GS0060C-04	Gooseneck Cup - CS6080-SR Corded (Midnight Black)
CUP-GS0060C-0B	Gooseneck Cup - CS6080-HC Corded (HC White)
STND-GS0060C-04	Gooseneck Intellistand - CS6080-SR Corded (Midnight Black)
STND-GS0060C-0B	Gooseneck Intellistand - CS6080-HC Corded (HC White)
STND-WS0060C-04	Gooseneck Intellistand, Weighted - CS6080-SR Corded (Midnight Black)

About This Document

Part Number	Description
STND-WS0060C-0B	Gooseneck Intellistand, Weighted - CS6080-HC Corded (HC White)
CBL-CS6-S07-04	CS6080 Cordless Cradle Cable: USB-C (Cradle) to USB-A (Host) Cable; 7ft. (2.1m), Straight - Midnight Black
CBL-CS6-S07-0B	CS6080 Cordless Cradle Cable: USB-C (Cradle) to USB-A (Host) Cable; 7ft. (2.1m), Straight - HC White

Kits

This guide covers the following configurations:

Part Number	Description
CR6080-SC400F4WW	CS6080 Cordless: 4-Slot Device ShareCradle, Inductive, Midnight Black. Includes Power Supply and DC line cord. 3-wire grounded country specific AC line cord sold separately.
CR6080-BC40004WW	CS6080 Cordless: 4-Slot Battery ShareCradle, Inductive, Midnight Black. Includes Power Supply and DC line cord. 3-wire grounded country specific AC line cord sold separately.
CS6080-SR400004SVW	CS6080-SR Black Cordless Standard Cradle KIT: CS6080-SR40004VZWW Scanner, CR6080-SC100F4WW Cradle, CBL-CS6-S07-04 USB-C Cable
CS6080-SR40000KSVW	CS6080-SR Black Corded (with Stand) KIT: CS6080-SRK0004VZWW Scanner, STND-GS0060C-04 Stand
CS6080-SR40000TZVW	CS6080-SR Black Cordless (with Lanyard) KIT: CS6080-SR40004VZWW Scanner, LNYD-000060W-04 Lanyard
CS6080-SR40000TSVW	CS6080-SR Black Cordless Standard Cradle (with Lanyard) KIT: CS6080-SR40004VZWW Scanner, CR6080-SC100F4WW Cradle, LNYD-000060W-04 Lanyard, CBL-CS6-S07-04 USB-C Cable
CS6080-HCB00004P1W	CS6080-HC White Cordless FIPS Presentation Cradle KIT: CS6080-HC4F00BVZWW Scanner, CR6080-PC100FBWW Cradle, CBL-CS6-S07-0B USB-C Cable
CS6080-HCB0000KSVW	CS6080-HC White Corded FIPS (with Stand) KIT: CS6080-HCKF00BVZWW Scanner, STND-GS0060C-0B Stand
CS6080-HCB0000TZVW	CS6080-HC White Cordless FIPS (with Lanyard) KIT: CS6080-HC4F00BVZWW Scanner, LNYD-000060W-04 Lanyard
CS6080-HCB0000TP1W	CS6080-HC White Cordless FIPS Presentation Cradle (with Lanyard) KIT: CS6080-HC4F00BVZWW Scanner, CR6080-PC100FBWW Cradle, LNYD-000060W-04 Lanyard, CBL-CS6-S07-0B USB-C Cable

Chapter Descriptions

Topics covered in this guide are as follows:

- Getting Started provides a product overview, unpacking instructions, and cable connection information.
- 123Scan and Software Tools describes the Zebra software tools available for customizing scanner operation.
- Data Capture provides beeper and LED definitions, techniques involved in scanning barcodes, general instructions and tips about scanning, and decode ranges.

About This Document

- Maintenance, Troubleshooting, and Technical Specifications provides suggested scanner maintenance, troubleshooting, technical specifications, and signal descriptions (pinouts).
- Radio Communications provides information about the modes of operation and features available for wireless communication. This chapter also includes programming barcodes to configure the scanner.
- User Preferences describes each user preference feature and provides programming barcodes for selecting these features.
- Imaging Preferences describes imaging preference features and provides programming barcodes for selecting these features.
- USB Interface describes how to set up the scanner with a USB host.
- SSI Interface describes the system requirements of the Simple Serial Interface (SSI), which provides a communications link between Zebra decoders and a serial host.
- Symbologies describes all symbology features and provides programming barcodes for selecting these features for the scanner.
- Data Formatting: ADF, MDF, Preferred Symbol briefly describes the Zebra features available for customizing scanner operation.
- OCR Programming describes how to set up the scanner for OCR programming.
- Standard Parameter Defaults provides a table of all host devices and miscellaneous scanner defaults.
- Country Codes provides barcodes for programming the country keyboard type for the USB keyboard (HID) device.
- Country Code Pages provides barcodes for selecting code pages for the country keyboard type.
- CKJ Decode Control describes control parameters for Unicode/CJK (Chinese, Japanese, Korean) barcode decode through USB HID Keyboard Emulation mode.
- Programming Reference provides a table of AIM code identifiers, ASCII character conversions, and keyboard maps.
- Sample Barcodes includes sample barcodes of various code types.
- Numeric Barcodes includes the numeric barcodes to scan for parameters requiring specific numeric values.
- Alphanumeric Barcodes includes the alphanumeric barcodes to scan for parameters requiring specific alphanumeric values.
- ASCII Character Sets provides ASCII character value tables.
- Communication Protocol Functionality lists supported scanner functionality by communication protocol.
- Signature Capture Code describes CapCode, a special pattern that encloses a signature area on a document and allows the scanner to capture a signature.
- Non-Parameter Attributes defines non-parameter attributes.
- ScanSpeed Analytics describes the Zebra ScanSpeed Analytics software that allows the identification of barcodes that slow down processes.
- Upgrading Over Bluetooth Without A Cradle provides information about performing upgrades on the scanner without a cradle, using 123Scan.

Notational Conventions

The following conventions are used in this document:

- **Bold** text is used to highlight the following:

About This Document

- Dialog box, window and screen names
- Drop-down list and list box names
- Check box and radio button names
- Icons on a screen
- Key names on a keypad
- Button names on a screen.
- Bullets (•) indicate:
 - Action items
 - Lists of alternatives
 - Lists of required steps that are not necessarily sequential.
- Sequential lists (e.g., those that describe step-by-step procedures) appear as numbered lists.
- Throughout the programming barcode menus, asterisks (*) are used to denote default parameter settings.



* Indicates Default — * Baud Rate 9600 — Feature/Option

Icon Conventions

The documentation set is designed to give the reader more visual clues. The following graphic icons are used throughout the documentation set. These icons and their associated meanings are described below.



NOTE: The text here indicates information that is supplemental for the user to know and that is not required to complete a task.



IMPORTANT: The text here indicates information that is important for the user to know.



CAUTION—EYE INJURY: Wear protective eyewear when performing certain tasks.



CAUTION—PRODUCT DAMAGE: If the precaution is not taken, the product could be damaged.



CAUTION: If the precaution is not heeded, the user could receive minor or moderate injury.



CAUTION—HOT SURFACE: Touching this area could result in burns.



CAUTION—ESD: Observe proper electrostatic safety precautions.



CAUTION—ELECTRIC SHOCK: Disconnect the printer power before performing certain procedures to avoid the risk of electric shock.



WARNING: If danger is not avoided, the user CAN be seriously injured or killed.



DANGER! If danger is not avoided, the user WILL be seriously injured or killed.



NOTE: This is an icon for wired networking notes.



NOTE: This is an icon for wireless networking notes.

Service Information

If you have a problem with your equipment, contact Zebra Global Customer Support for your region. Contact information is available at www.zebra.com/support.

When contacting support, please have the following information available:

- Serial number of the unit
- Model number or product name
- Software/firmware type or version number

Zebra responds to calls by email, telephone or fax within the time limits set forth in support agreements.

If your problem cannot be solved by Zebra Customer Support, you may need to return your equipment for servicing and will be given specific directions. Zebra is not responsible for any damages incurred during shipment if the approved shipping container is not used. Shipping the units improperly can possibly void the warranty.

If you purchased your Zebra business product from a Zebra business partner, contact that business partner for support.

Feedback

If you have comments, questions, or suggestions about this guide, send an email to EVM-techdocs@zebra.com.

Getting Started

Introduction

Introducing the CS6080 Companion Scanner, featuring a groundbreaking design that easily converts between corded and cordless operation, hand-held and hands-free, as your needs change. As a cordless scanner, the CS6080 is small enough to tuck in a pocket and offers the latest mobile technology including contactless charging. As a corded scanner, the CS6080 offers compact scanning for spaces with limited real-estate. Whether you purchase a corded or cordless model up front, you can change modes at any time for superior investment protection. And you get Zebra's industry-leading scanning performance and our unique DataCapture DNA and industry-preferred management tools that make it easier than ever to integrate, deploy and manage your scanners.

This guide provides basic instructions for setting up, programming, and using CS6080 scanners. The scanner is available in the following versions:

- CS6080-SR: Standard Range
- CS6080-HC: Healthcare



NOTE: This guide applies to all scanner configurations, including cordless, corded, standard range and healthcare unless specifically indicated.

Features

Cordless Front View

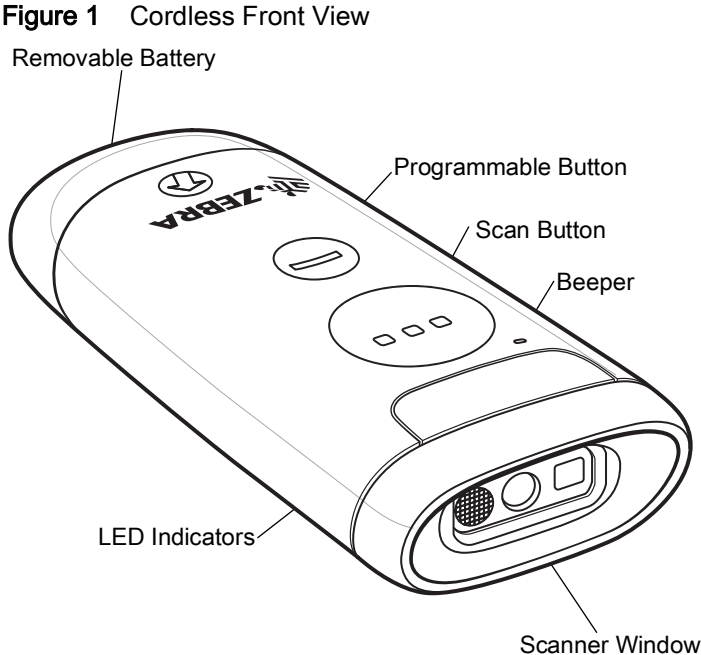

Corded Front View

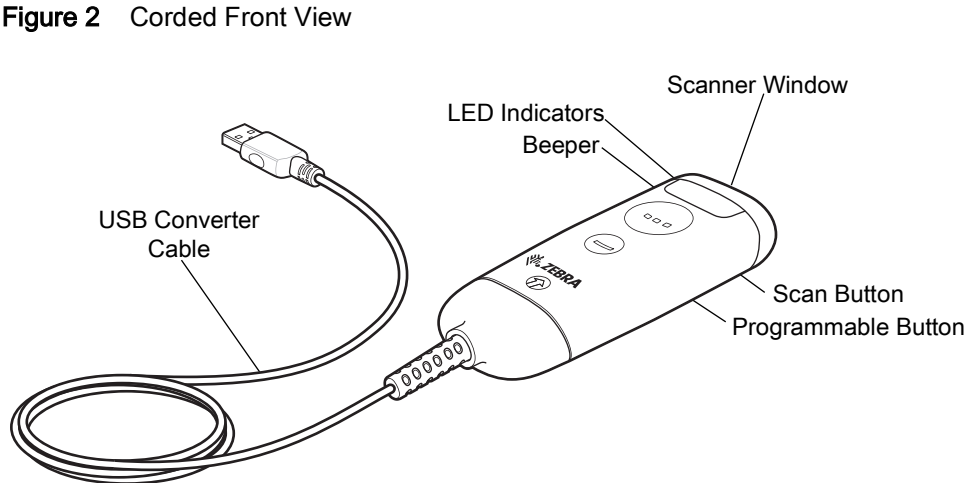

Bottom View

Figure 3 Bottom View

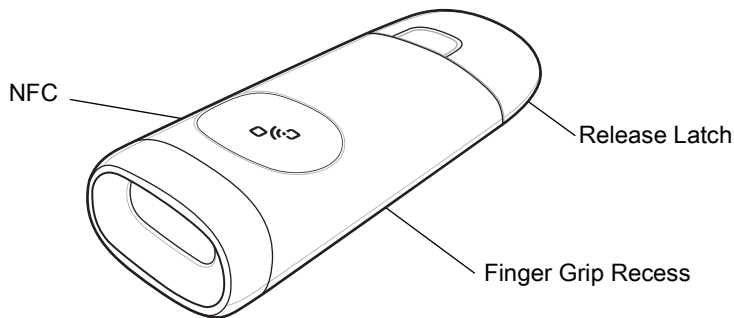

Unpacking the Scanner

Carefully remove all protective material from the scanner and save the shipping container for later storage and shipping. Verify that you received the following equipment:

- CS6080
- Lithium-Polymer battery (cordless) or USB Converter Cable (corded)
- Quick Start Guide.

Inspect the equipment. If any equipment is missing or damaged, contact support. See [Service Information on page 26](#) for contact information.

Installing the Battery

Use the battery to charge the cordless scanner.

Inserting the Battery

1. Insert the battery into the scanner.

Figure 4 Inserting the Battery

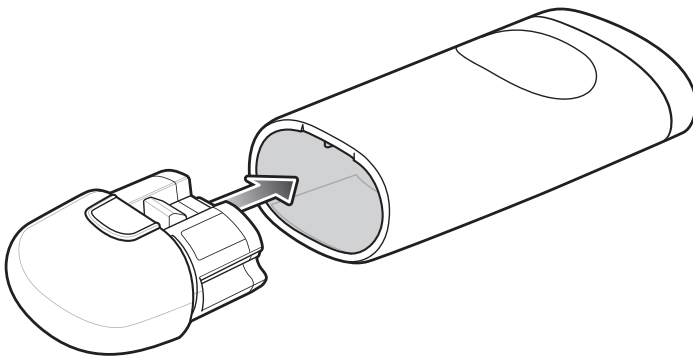

2. Press the battery into the scanner until the battery snaps into place.



NOTE: If you purchased a corded configuration, using the corded USB Converter Cable and want to convert to a cordless configuration, using a battery, remove the corded USB Converter Cable prior to step 1.

Removing the Battery

To remove the battery, press the release and pull the battery away from the scanner.

Figure 5 Removing the Battery

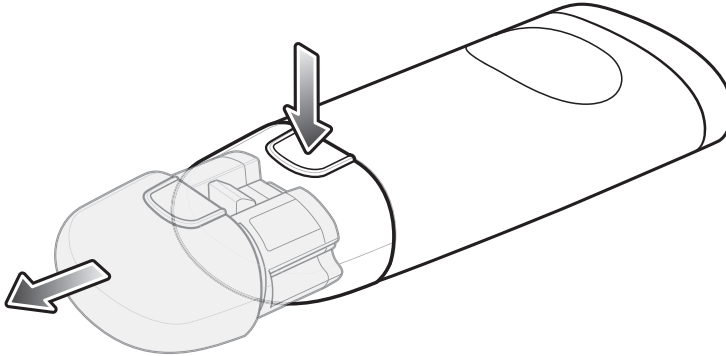

Installing the Corded USB Converter Cable

Use the USB Converter Cable to connect the corded scanner to a host.

Inserting the USB Cable

1. Insert the corded USB Converter Cable into the scanner.
2. Connect the other end of the corded USB Converter Cable to a USB port on the host PC.



NOTE: If you purchased a cordless configuration, using a battery and want to convert to a corded configuration, using the corded USB Converter Cable, remove the battery prior to step 1.

Figure 6 Inserting the USB Cable

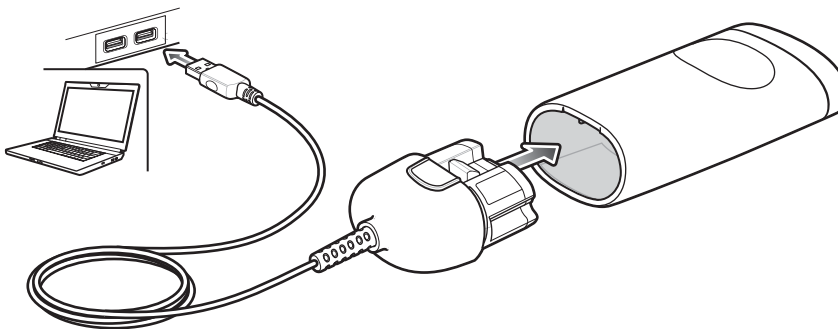

Removing the USB Cable

To remove the corded USB Converter Cable, press the release and pull the cable away from the scanner.

Figure 7 Removing the USB Cable

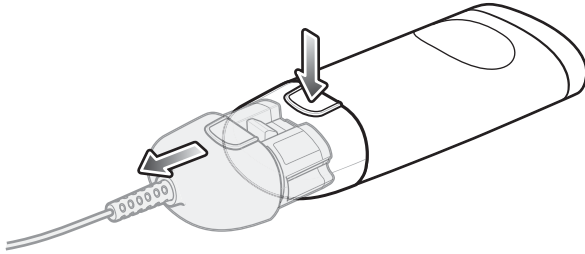

Charging

Use a cradle or charging pad to charge the cordless scanner and use the battery charger or cradle to charge spare batteries.

Charging via Cradle



NOTE: Only applies to cordless configurations.

1. Connect the cable to the cradle with the USB-C connector.
2. Connect the other end of the cable to a USB port on the host PC, or to a USB power adapter plugged into an AC outlet with the USB-A connector.
3. Insert the CS6080 into a scanner slot to begin charging.
 - In the Standard cradle, insert the scanner upright with the battery side first.
 - In the Healthcare Presentation cradle, insert the scanner upside down with the scanner window first.

Figure 8 Charging via Cradle

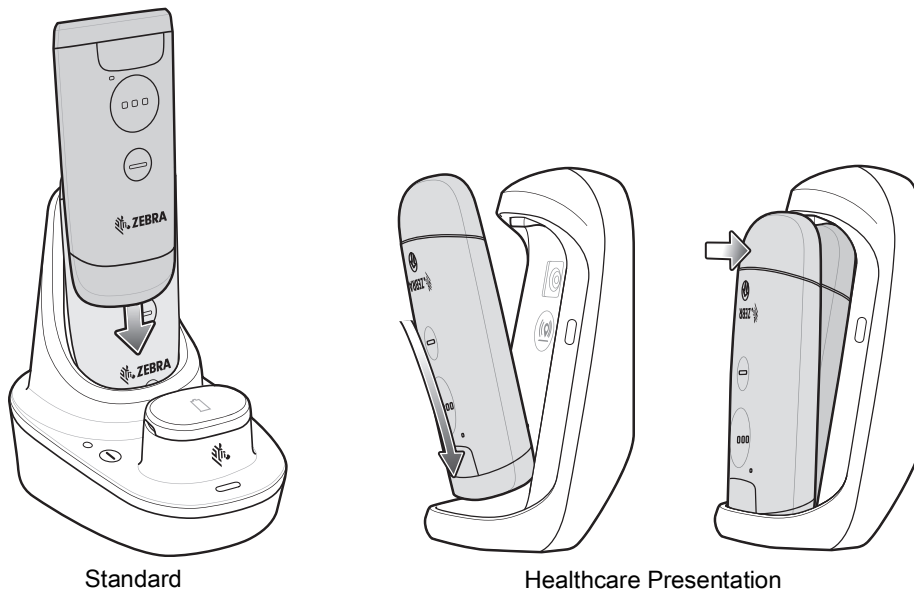

Standard

Healthcare Presentation

Figure 9 4-Slot Device Charging Cradle

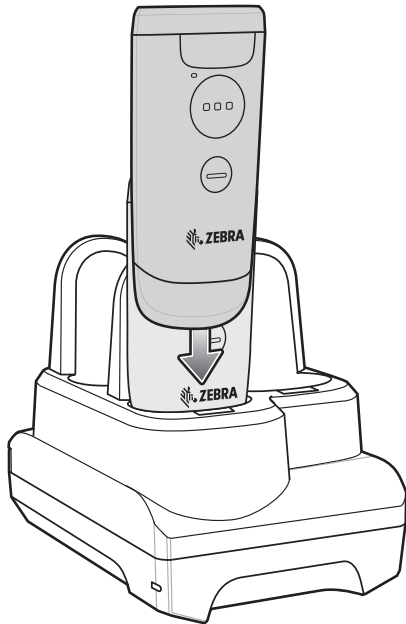

The CS6080 begins charging. The charge status LEDs light to indicate progress. See [Beeper and LED Indications on page 39](#) for more information.

Connecting Cradle Cable

Figure 10 Standard Cradle Cable

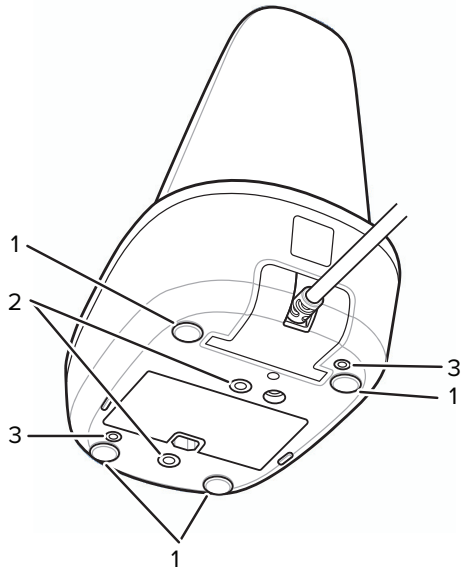

1	Mounting Feet (4)
2	Mounting Hole (2) M4x5
3	Mounting Hole (2) M3x5

Figure 11 Healthcare Presentation Cradle Cable

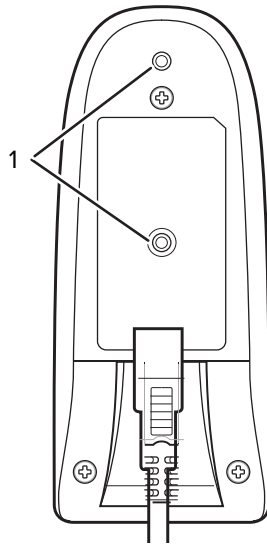

1	Mounting Holes (2) M4x5
---	----------------------------

Charging via Charging Pad



NOTE: Only applies to cordless configurations.

1. Follow the third party instructions for connecting your charging pad to power.
2. Place the scanner on the charging pad with the buttons facing up.

The battery charging indicator LED on the scanner lights to show the charging status.



NOTE: The CS6080 is only compatible with Qi type charging pads and charging times cannot be guaranteed when using third party accessories.

Figure 12 Charging via Charging Pad

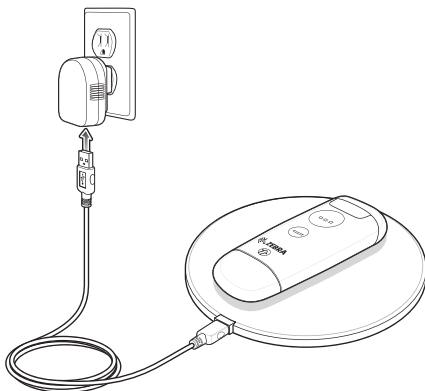

Charging Spare Batteries

1. Connect the cable to the cradle with the USB-C connector.
2. Connect the other end of the cable to a USB port on the host PC, or to a USB power adapter plugged into an AC outlet with the USB-A connector.
3. Remove the spare battery slot cap.
4. Insert the battery into the spare battery slot to begin charging. The charge LED on the cradle lights to show the charging status.

Figure 13 Charging Spare Batteries

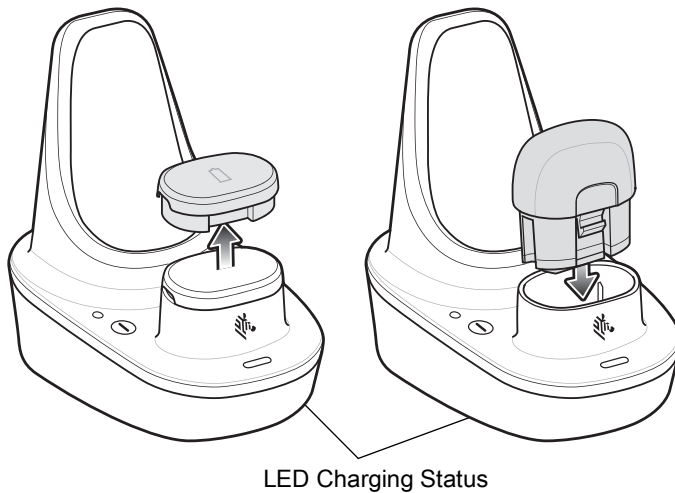
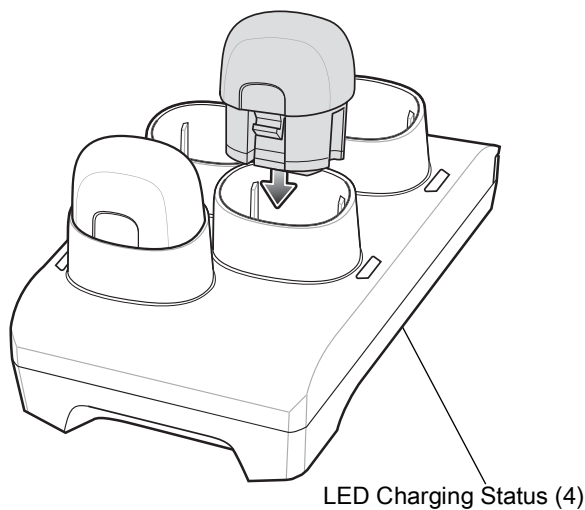

Figure 14 4-Slot Battery Charging Cradle



Charging Temperature

Charge batteries in temperatures from 0°C to 40°C (32°F to 104°F). Charging is halted at temperatures above 40°C.

The scanner or accessory indicates when charging is disabled due to abnormal temperatures via its LED and/or battery icon (see [Table 2 on page 39](#)).

Button Actions

To actuate the buttons, apply a finite force to the button recess.

For subsequent button actuations, remove force, and then re-apply force.

Table 1 Button Actions

Action	Description
Scan Button (...)	
Single press	Trigger
Double press	Issue connection to last known address if disconnected/if connected in HID mode to an Apple device, will send show/hide keypad
Hold for 3 seconds	Battery status
Hold until beam goes off plus 5 seconds longer	Night mode
Programmable Button (-)	
Single press (not in cradle) default*	Show/hide keypad
Single press option 2	Programmable trigger
Single press option 3	Toggle lamp mode (cordless only)
Single press in cradle	Toggle lamp mode (cordless only)
Double press	Drop Bluetooth connection

123Scan and Software Tools

Introduction

This chapter briefly describes the Zebra software tools available for customizing scanner operation.

123Scan

123Scan is a software tool that simplifies scanner setup and more.

Intuitive enough for first time users, the 123Scan wizard guides users through a streamlined setup process. Settings are saved in a configuration file that can be printed as a single programming barcode for scanning, emailed to a smart phone for scanning from its screen, or downloaded to the scanner using a USB cable.

Through 123Scan a user can:

- Configure a scanner using a wizard.
 - Program the following scanner settings.
 - Speaker tone / volume settings.
 - Enable / disable symbologies.
 - Communication settings.
 - Modify data before transmission to a host using:
 - Advanced Data Formatting (ADF) - Scan one barcode per trigger press.
 - Multicode Data Formatting (MDF) - Scan many barcodes in one trigger press (select scanners).
 - Preferred Symbol - Single out one barcode on label of many (select scanners).
- Load parameter settings to a scanner via the following.
 - Barcode scanning.
 - Scan a paper barcode.
 - Scan a barcode from a PC screen.
 - Scan a barcode from a smart phone screen.
 - Download over a USB cable.
 - Load settings to one scanner.
 - Stage up to 10 scanners simultaneously (Powered USB Hub recommended with 0.5 amp / port).
- Validate scanner setup.

- View scanned data within the utility's **Data** view screen.
- Capture an image and save to a PC within the utility's **Data** view screen.
- Review settings using the Parameter Report.
- Clone settings from an already deployed scanner from the **Start** screen.
- Upgrade scanner firmware.
 - Load settings to one scanner.
 - Stage up to 10 scanners simultaneously (Powered USB Hub recommended with 0.5 amp / port).
- View statistics such as:
 - Asset tracking information.
 - Time and usage information.
 - Barcodes scanned by symbology.
 - Battery diagnostics (select scanners).
- Generate the following reports.
 - Barcode Report - Programming barcode, included parameter settings, and supported scanner models.
 - Parameter Report - Parameters programmed within a configuration file.
 - Inventory Report - Scanner asset tracking information.
 - Validation Report - Scanned data from the **Data** view.
 - Statistics Report - All statistics retrieved from the scanner.

For more information go to: www.zebra.com/123Scan.

Communication with 123Scan

Use a USB cable or Bluetooth connection to connect the scanner to a Windows host computer running 123Scan.

123Scan Requirements

- Host computer running Windows XP, 7, 8, and 10
- Scanner
- USB cable or Bluetooth connection.

123Scan Information

For more information on 123Scan, go to: www.zebra.com/123Scan.

For a 1 minute tour of 123Scan, go to: www.zebra.com/ScannerHowToVideos.

To see a list of all of our software tools, go to: www.zebra.com/scannersoftware.

Scanner SDK, Other Software Tools, and Videos

Tackle all your scanner programming needs with our diversified set of software tools. Whether you need to simply stage a device, or develop a fully featured application with image and data capture as well as asset management, these tools help you every step of the way.

To download any of the following free tools, go to: www.zebra.com/scannersoftware.

- 123Scan configuration utility
- SDKs
 - Scanner SDK for Windows (connection through Bluetooth, USB cable to scanner and USB cable to cradle)
 - Scanner SDK for Linux (connection through USB cable to scanner and USB cable to cradle)
 - Scanner SDK for Android (Bluetooth connection only)
- Drivers (connection through Bluetooth, USB cable to scanner and USB cable to cradle)
 - OPOS driver
 - JPOS driver
 - USB CDC driver
 - TWAIN driver
- Scanner Management Service (SMS) for Remote Management (connection through USB cable to scanner and USB cable to cradle)
 - Windows
 - Linux
- How-To-Videos



NOTE: For a list of SDK supported scanner functionality by communication protocol, see [Communication Protocol Functionality on page 480](#).

Data Capture

Introduction

This chapter provides beeper and LED definitions, techniques involved in scanning barcodes, general instructions and tips about scanning, and decode ranges.

Beeper and LED Indications

The digital scanner issues different beep sequences/patterns and an LED display to indicate status. [Table 2](#) defines beep sequences/patterns and LED displays which occur during both normal scanning and while programming the digital scanner.

Digital Scanner Indications

Table 2 Digital Scanner Beeper and LED Indications

Beeper Sequence	LED	Indication
Standard Use		
Low/medium/high beeps	Green	Power up.
Scanning		
None	Green solid	Presentation Mode on.
None	No LED; green LED is turned off	Presentation Mode off.
Medium beep (or as configured)	Green flash	A barcode was successfully decoded. (See Other LED Indicators on page 43 for programming beeper sounds.)
Four long low beeps	Red	A transmission error was detected in a scanned symbol. The data is ignored. This occurs if a unit is not properly configured. Check option setting.
Five long low beeps	Red	Conversion or format error.
None	Red (fast blink) on trigger press	Scanner is disabled by a host command to the scanner.
Wireless Operation		
Low, high, low, high	Red	Out of batch storage memory, unable to store new barcode.
Radio Indications		

Table 2 Digital Scanner Beeper and LED Indications (Continued)

Beeper Sequence	LED	Indication
Low	None	Scanner inserted into a cradle (may be disabled).
Low, high	Blue	Bluetooth connection established.
High, low	Red	Bluetooth disconnection event.
Long low, long high	Red	Bluetooth page timeout; remote device is out of range/not powered.
Long low, long high, long low, long high	Red	Bluetooth connection attempt was rejected by remote device.
None	Blue (blink)	Bluetooth attempting reconnection.
Five high	Blue (blink)	Enable Beep on Reconnect Attempt (default is disable).
Six high	Blue (fast/fast/slow)	Paging state indication.
Parameter Programming		
Long low/long high beeps	Red	Input error, incorrect barcode or Cancel scanned, wrong entry, incorrect barcode programming sequence; remain in program mode.
High/low beeps	Green	Keyboard parameter selected. Enter value using barcode keypad.
High/low/high/low beeps	Green	Successful program exit with change in the parameter setting.
ADF Programming		
High/low beeps	Green	Number expected. Enter another digit. Add leading zeros to the front if necessary.
Low/low beeps	Green	Alpha expected. Enter another alphabetic character or scan the End of Message barcode.
High/high beeps	Green blinking	ADF criteria or action is expected. Enter another criteria or action or scan the Save Rule barcode.
High/low/low beeps	Green	All criteria or actions cleared for current rule, continue entering rule.
High/low/high/low beeps	Green (turns off blinking)	Rule saved. Rule entry mode exited.
Long low/long high beeps	Red	Rule error. Entry error, wrong barcode scanned, or criteria/action list is too long for a rule. Re-enter criteria or action.
Low beep	Green	Deleted last saved rule. The current rule is left intact.
Low/high/high beeps	Green	All rules deleted.
Long low/long high/long low/long high beeps	Red	Out of rule memory. Erase some existing rules, then try to save rule again.
Long low/long high/long low beeps	Green (turns off blinking)	Cancel rule entry. Rule entry mode exited because of an error or the user asked to exit rule entry.

Cradle LED Indications

Table 3 Cradle LED Indications

LED	Indication
Standard Use	
Green (stays on)	Power Up
Green (slow blinking)	Not enough voltage to charge the scanner (for resolution, see Troubleshooting on page 53)
Radio Indications	
Blue (off, then on)	Bluetooth connection established
Blue	Page button
Blue (fast/fast/slow)	Page issued
Maintenance Indications	
Red (stays on)	Enter boot loader
Red blinking	Firmware installation

[Table 4](#) lists the conditions in which the specified host controls the System Indicator LED.

Table 4 Host Controlled Cradle LED Indications

LED	Indication
123Scan	
Green (slow blinking)	Scanner connected to 123Scan
Red (fast blinking)	File being transferred to the scanner (parameters and firmware)
Red (slow blinking)	Firmware activated on the scanner; loaded into memory
Green (solid)	Programming completed successfully (parameters and firmware)
Red (solid)	Error State
SMS	
Blinking Red (Both scanner and cradle)	Loading the SMS package to scanner

LED Indicators

Table 5 LED Indicators

Action	Description
Decode Indicator LED	
Successful decode	Green
On error	Red
Battery Indicator LED	
When in cradle and charging is complete	Solid Green
When in cradle and charging is in progress	Blinking Amber

Table 5 LED Indicators

Action	Description
When in cradle and there is a charging error	Fast Blinking Amber
When used in hand-held mode and the Scan Button (...) is pressed for 3 seconds - Full Battery	Solid Green
When used in hand-held mode and the Scan Button (...) is pressed for 3 seconds - Mid Charge	Solid Amber
When used in hand-held mode and the Scan Button (...) is pressed - Low Battery	Solid Red
Bluetooth Indicator LED	
While actively pairing	Blinking Blue
Connected	Solid Blue
Bluetooth Error	Steady Red for 2 seconds

Other LED Indicators

Table 6 Other LED Indicators

Action	Beeper Sequence	System/Decode LED	Description
Standard Use			
Bootup	Low, Medium, High	Green	Power Up
Decode	As configured	Green	A barcode symbol was decoded
Hands-free Mode (Presentation On)	None	Green (stays on)	Presentation mode on
Hand-held Mode	None	Green (stays off)	Presentation mode off
TRANSMIT_ERROR	4x Low	Red	Transmission error
CONVERT_ERROR	5x Low	Red	Conversion or format error
Image Capture			
SNAPSHOT_START	Low	Blinking green	Snapshot mode started
SNAPSHOT_COMPLETE	Low	Default Green LED mode based upon Hand-held / Hands-free mode state	Snapshot mode completed
SNAPSHOT_TIMEOUT	High, Low	Default Green mode based upon Hand-held / Hands-free Mode state	Snapshot mode timed out
Parameter Programming			
ENTRY_ERROR	Low, High	Red	Input error: incorrect barcode, programming sequence, or Cancel scanned.
NUMBER_EXPECTED	High, Low	Green	Number expected. Enter value using numeric barcodes.
PARAM_ENTERED	High, Low, High, Low	Green	Successful program exit with change in parameter setting.
ADF Programming			
NUMBER_EXPECTED	High, Low	Green	Enter another digit. Add leading zeros to the front if necessary.
ALPHA_EXPECTED	Low, Low	Green	Enter another alphabetic character or scan the End of Message barcode.
CRIT_ACT_EXPECTED	High, High	Blinking Green	ADF criteria or action is expected. Enter another criterion or action, or scan the Save Rule barcode.
RULE_SAVED	High, Low, High, Low	Green (turns off blinking)	Rule saved. Rule entry mode exited.

Table 6 Other LED Indicators

Action	Beeper Sequence	System/Decode LED	Description
CRIT_ACT_CLEARED	High, Low, Low	Green	All criteria or actions cleared for current rule, continue entering rule.
LAST_RULE_DELETED	Low	Green	Delete last saved rule. The current rule is left intact.
ALL_RULES_DELETED	Low, High, High	Green	All rules are deleted.
OUT_OF_RULE_MEM	Low, High, Low, High	Red	Out of rule memory. Erase some existing rules, then try to save rule again.
CANCEL_RULE_ENTRY	Low, High, Low	Green (turns off blinking)	Cancel rule entry. Rule entry mode exited because of an error or the user asked to exit rule entry.
RULE_ERROR	Low, High	Red	Entry error, wrong barcode scanned, or criteria/action list is too long for a rule. Re-enter criterion or action.
Macro PDF			
MPDF_BUFFERED	2x Low	None	MPDF sequence buffered.
MPDF_FILE_ID_ERROR	2x Long Low	None	File ID error. A barcode not in the current MPDF sequence was scanned.
MPDF_OUT_OF_MEMORY	3x Long Low	None	Out of memory. There is not enough buffer space to store the current MPDF symbol.
MPDF_BAD_SYMBOLGY	4x Long Low	None	Bad symbology. Scanned a 1D or 2D barcode in a MPDF sequence, a duplicate MPDF label, a label in an incorrect order, or trying to transmit an empty or illegal MPDF field.
MPDF_FLUSH_BUFFER	5x Long Low	None	Flushing MPDF buffer.
MPDF_ABORT	Fast Warble	None	Aborting MPDF sequence.
MPDF_FLUSH_NO_DATA	Low, High	Red	Flushing an already empty MPDF buffer.
Wireless Operation			
OUT_OF_MEMORY	Low, High, Low, High	Red	Out of batch storage memory, unable to store new barcode.

Table 6 Other LED Indicators

Action	Beeper Sequence	System/Decode LED	Description
Maintenance Indications			
Enter Bootloader	High, High	Steady Red	
Firmware Installation	None	Blinking Red	

If a cordless scanner is connected using FIPS, when the trigger is pressed the System LED is Amber until the session ends (trigger release, session timeout, or successful decode).

Scanning



NOTE: The scanner emits a white illumination with a green aim dot.

Hand-Held Scanning

1. Aim the digital scanner at a barcode and press the trigger to decode.
2. Press the trigger until the digital scanner beeps, indicating the barcode is successfully decoded. For more information on beeper and LED definitions, see [Beeper and LED Indications on page 39](#)

Figure 15 Scanning in Hand-Held Mode.



Hands-Free Scanning

The scanner is in hands-free (presentation) mode when it sits in the CR6080-PC cradle. During idle conditions the scanner operates in object detection mode, where it automatically wakes up to decode a barcode presented in the field of view. In object detection mode it is normal for the illumination LEDs to be dimly lit.

To scan:

1. Ensure all connections are secure (see appropriate host chapter).
2. Present the barcode in the scanner field of view.
3. Upon successful decode, the scanner beeps and the LED flashes green. (For more information about beeper and LED definitions, [Beeper and LED Indications on page 39](#)).

Figure 16 Corded Scanning in Hands-Free Mode

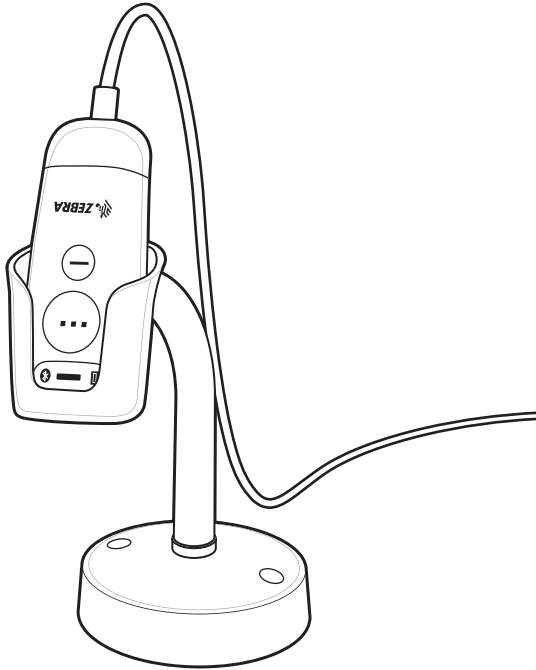
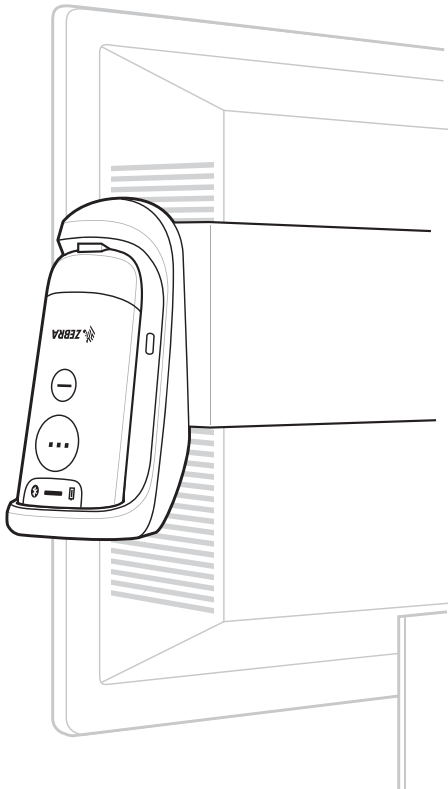

Figure 17 Cordless Scanning in Hands-Free Mode



Aiming with Digital Scanner

When scanning, the digital scanner projects a green LED dot which allows positioning the barcode within its field of view. See [Decode Ranges on page 49](#) for the proper distance to achieve between the digital scanner and a barcode.

Figure 18 *Aiming Dot*



The digital scanner turns on its white illumination LEDs to illuminate the target barcode.

To scan a barcode, center the symbol.

Figure 19 *Scanning Orientation with Aiming Dot*

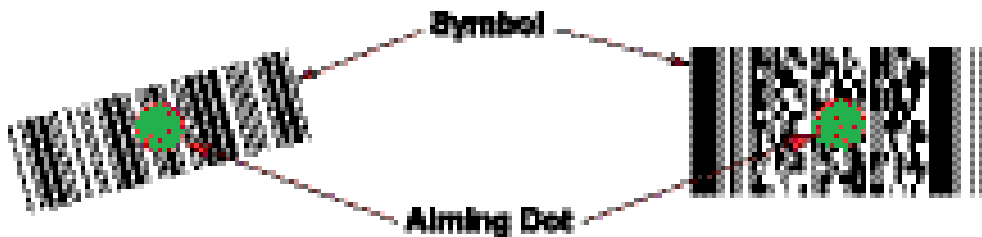

The digital scanner can also read a barcode presented within the aiming dot not centered. The top examples in [Figure 20 on page 48](#) show acceptable aiming options, while the bottom examples can not be decoded.

Figure 20 *Acceptable and Incorrect Aiming*

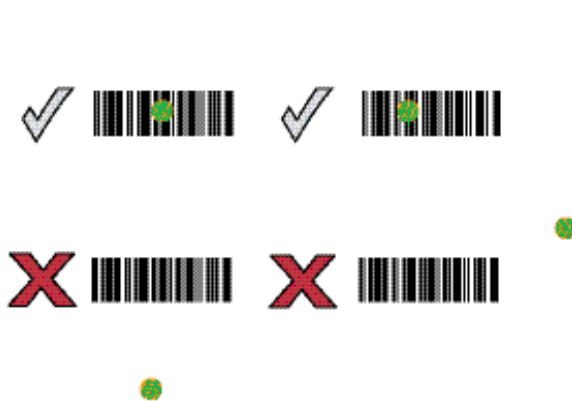

The aiming dot is smaller when the digital scanner is closer to the symbol and larger when it is farther from the symbol. Scan symbols with smaller bars or elements (mil size) closer to the digital scanner, and those with larger bars or elements (mil size) farther from the digital scanner.

The digital scanner beeps to indicate that it successfully decoded the barcode. For more information on beeper and LED definitions, see [Table 2 on page 39](#).

Decode Ranges

Table 7 CS6080 Decode Ranges

Barcode Type	Symbol Density	CS6080-SR & CS6080-HC Typical Working Ranges	
		Near	Far
Code 39	5.0 mil	2.4 in/6.1 cm	9.5 in/24.1 cm
	20.0 mil	2.5 in/6.3 cm	26.0 in/66.0 cm
Code 128	5.0 mil	2.8 in/7.1 cm	9.0 in/22.9 cm
100% UPC	13.0 mil	1.8 in/4.6 cm	19.5 in/49.5 cm
PDF 417	6.67 mil	2.4 in/6.1 cm	8.0 in/20.3 cm
Data Matrix	10.0 mil	2.9 in/7.4 cm	8.5 in/21.5 cm
QR Code	15.0 mil	1.2 in/3.0 cm	11.5 in/29.2 cm
	20.0 mil	1.2 in/3.0 cm	14.0 in/35.6 cm

Maintenance, Troubleshooting, and Technical Specifications

Introduction

This chapter provides suggested digital scanner maintenance, troubleshooting, technical specifications, and signal descriptions (pin-outs).

Maintenance



IMPORTANT: Use pre-moistened wipes and do not allow liquid cleaner to pool.

¹Ensure the following items are addressed when using sodium hypochlorite (bleach) based cleaners:

- For scanner only. Do not use on cradle.
- Always follow the manufacturer's recommended instructions: use gloves during application and remove the residue afterwards with a damp cloth to avoid prolonged skin contact while handling the scanner.
- Due to the powerful oxidizing nature of sodium hypochlorite, the metal surfaces, including electrical contacts on the scanner, are prone to oxidation (corrosion) when exposed to this chemical in the liquid form (including wipes) and should be avoided. In the event that these type of disinfectants come in contact with metal on the scanner, prompt removal with a dampened cloth after the cleaning step is critical.



IMPORTANT: To avoid damage to the device, use only approved cleaning and disinfecting agents listed below. The use of non-approved cleaning or disinfecting agents may void the warranty.

Known Harmful Ingredients

The following chemicals are known to damage the plastics on Zebra scanners and should not come in contact with the device:

- Acetone
- Ammonia solutions
- Aqueous or alcoholic alkaline solutions
- Aromatic and chlorinated hydrocarbons
- Benzene
- Carbolic acid
- Compounds of amines or ammonia

- Ethanolamine
- Ethers
- Ketones
- TB-lysoform
- Toluene
- Trichloroethylene.

Approved Cleaners for Standard CS6080 Digital Scanners and Cradles

- Isopropyl alcohol 70% (including wipes)
- 10% Bleach (Sodium Hypochlorite 0.55%) and water solution ¹ (see Important note above)
- 3% Hydrogen Peroxide and 97% water solution
- Mild dish soap

Approved Disinfectant Cleaners for Healthcare Configurations of the CS6080 Digital Scanners and Cradles



IMPORTANT: * = Scanner only. Do not use on cradle.

Only use cleaning agents from the following list, following the manufacturer's instructions:

- 3% Hydrogen Peroxide and 97% Water solution
- 10% Bleach (Sodium Hypochlorite 0.55%) and 90% Water Solution
- 91% Isopropyl Alcohol and 9% Water Solution
- Azowipe
- Clorox Dispatch Hospital Cleaner Disinfectant Towels with Bleach
- Clorox Formula 409 Glass and Surface Cleaner
- Clorox Healthcare Bleach Germicidal Wipes
- Clorox Healthcare Hydrogen Peroxide Wipes
- Clorox Healthcare Multi-Surface Quat Alcohol Wipes
- Diversey D10 Concentrate Detergent Sanitizer
- Diversey Dimension 256 Neutral Disinfectant Cleaner
- Diversey Oxivir Tb Wipes
- Diversey Virex II 256 One-Step Disinfectant Cleaner
- Metrex CaviCide
- Metrex CaviCide1
- Medipal Alcohol Wipes
- Metrex CaviWipes
- Metrex CaviWipes1
- PDI Easy Screen® Cleaning Wipe

- PDI Sani-Cloth AF3 Germicidal Disposable Wipe
- PDI Sani-Cloth Bleach Germicidal Disposable Wipe
- PDI Sani-Cloth HB Sani-Germicidal Disposable Wipe
- PDI Sani-Cloth Plus Germicidal Disposable Cloth
- PDI Super Sani-Cloth Germicidal Wipe
- Progressive Products Wipes Plus
- Sani Professional Disinfecting Multi-Surface Wipes
- Sani-Hands® Instant Hand Sanitizing Wipes
- SC Johnson Windex Original Glass Cleaner with Ammonia-D
- Sterets Alcowipe
- Steris Coverage Plus Germicidal Surface Wipes
- Veridien Viraguard

Cleaning the Digital Scanner

Routinely cleaning the exit window is required. A dirty window may affect scanning accuracy. Do not allow any abrasive material to touch the window.

To clean the scanner:

1. Dampen a soft cloth with one of the approved cleaning agents listed above or use pre-moistened wipes.
2. Gently wipe all surfaces, including the front, back, sides, top and bottom. Never apply liquid directly to the scanner. Be careful not to let liquid pool around the scanner window, trigger, cable connector or any other area on the device.
3. Be sure to clean the trigger and in between the trigger and the housing (use a cotton-tipped applicator to reach tight or inaccessible areas).
4. Do not spray water or other cleaning liquids directly into the exit window.
5. Wipe the scanner exit window with a lens tissue or other material suitable for cleaning optical material such as eyeglasses.
6. Immediately dry the scanner window after cleaning with a soft non-abrasive cloth to prevent streaking.
7. Allow the unit to air dry before use.
8. Scanner connectors:
 - a. Dip the cotton portion of a cotton-tipped applicator in isopropyl alcohol.
 - b. Rub the cotton portion of the cotton-tipped applicator back-and-forth across the connector on the Zebra scanner at least 3 times. Do not leave any cotton residue on the connector.
 - c. Use the cotton-tipped applicator dipped in alcohol to remove any grease and dirt near the connector area.
 - d. Use a dry cotton tipped applicator and rub the cotton portion of the cotton-tipped applicator back-and-forth across the connectors at least 3 times. Do not leave any cotton residue on the connectors.

Troubleshooting

Table 8 Troubleshooting

Problem	Possible Causes	Possible Solutions
The aiming dot does not appear when pressing the trigger.	No power to the digital scanner.	If the configuration requires a power supply, re-connect the power supply.
	Incorrect host interface cable is used.	Connect the correct host interface cable.
	Interface/power cables are loose.	Re-connect cables.
	Digital scanner is disabled.	For USB IBM hand-held, IBM table-top, and OPOS modes, enable the digital scanner via the host interface. Otherwise, see the technical person in charge of scanning.
	Aiming pattern is disabled.	Enable the aiming pattern. See Hand-Held Decode Aiming Pattern on page 97 .
Digital scanner emits aiming dot, but does not decode the barcode.	Digital scanner is not programmed for the correct barcode type.	Program the digital scanner to read that type of barcode. See Symbologies on page 238 .
	Barcode symbol is unreadable.	Scan test symbols of the same barcode type to determine if the barcode is defaced.
	The aiming dot is not correctly placed on the symbol.	Move the symbol so that the aiming dot is within the field of view (see Aiming with Digital Scanner on page 48).
	Distance between digital scanner and barcode is incorrect.	Move the scanner closer to or further from the barcode. See Decode Ranges on page 49 .

Table 8 Troubleshooting (Continued)

Problem	Possible Causes	Possible Solutions
Digital scanner decodes barcode, but does not transmit the data to the host.	Digital scanner is not programmed for the correct host type.	Scan the appropriate host type programming barcode. See the chapter corresponding to the host type.
	Interface cable is loose.	Re-connect the cable.
	Cradle is not programmed for the correct host type.	Check digital scanner host parameters or edit options.
	Digital scanner is not paired to host connected interface.	Pair digital scanner to the cradle by scanning the PAIR barcode on the cradle.
	Cradle has lost connection to the host.	In this exact order: disconnect power supply; disconnect host cable; wait three seconds; reconnect host cable; reconnect power supply; reestablish pairing.
	If the digital scanner emits four long low beeps, a transmission error occurred. This occurs if a unit is not properly configured or connected to the wrong host type.	Set the scanner's communication parameters to match the host's setting.
	If the digital scanner emits 5 low beeps, a conversion or format error occurred.	Configure the digital scanner's conversion parameters properly.
Imager comes on, but scanner does not decode the barcode.	If the digital scanner emits low/high/low beeps, it detected an invalid ADF rule.	Program the correct ADF rules. Refer to the Advanced Data Formatting Programmer Guide.
	Scanner is not programmed correctly.	Ensure the scanner is programmed to read the type of barcode being scanned.
	Barcode may be defaced.	Ensure the symbol is not defaced. Scan other barcodes of the same barcode type.
Host displays scanned data incorrectly.	Scanner is not the proper distance from the barcode.	Move scanner closer to or further from barcode.
	Digital scanner is not programmed to work with the host.	Scan the appropriate host type programming barcode. Program the proper editing options (e.g., UPC-E to UPC-A Conversion).
Digital scanner emits short low/short medium/short high beep sequence (power-up beep sequence) more than once.	The USB bus may put the digital scanner in a state where power to the scanner is cycled on and off more than once.	Normal during host reset.
Digital scanner emits 4 short high beeps during decode attempt.	Digital scanner has not completed USB initialization.	Wait several seconds and scan again.
Digital scanner emits low/high beeps during programming.	Input error, incorrect barcode or Cancel barcode was scanned.	Scan the correct numeric barcodes within range for the parameter programmed.

Table 8 Troubleshooting (Continued)

Problem	Possible Causes	Possible Solutions
Digital scanner emits low/high/low/high beeps during programming.	Out of host parameter storage space.	Scan Default Parameters on page 67 .
	Out of memory for ADF rules.	Reduce the number of ADF rules or the number of steps in the ADF rules.
	During programming, indicates out of ADF parameter storage space.	Erase all rules and re-program with shorter rules.
Digital scanner emits low/high/low beeps.	ADF transmit error.	Refer to the Advanced Data Formatting Guide for information.
	Invalid ADF rule is detected.	Refer to the Advanced Data Formatting Guide for information.
Digital scanner emits a power-up beep after changing USB host type.	The USB bus re-established power to the digital scanner.	Normal when changing USB host type.
Digital scanner emits frequent beeps.	No power to the scanner.	Check the system power. If the configuration requires a power supply, re-connect the power supply.
	Incorrect host interface cable is used.	Verify that the correct host interface cable is used. If not, connect the correct host interface cable.
	Interface/power cables are loose.	Check for loose cable connections and re-connect cables.
Digital scanner emits five long low beeps after a barcode is decoded.	Conversion or format error was detected. The scanner conversion parameters are not properly configured.	Ensure the scanner conversion parameters are properly configured.
	Conversion or format error was detected. An ADF rule was set up with characters that can't be sent for the host selected.	Change the ADF rule, or change to a host that can support the ADF rule.
	Conversion or format error was detected. A barcode was scanned with characters that can't be sent for that host.	Change the barcode, or change to a host that can support the barcode.
Digital scanner emits long beeps for 5 seconds when scanning a barcode.	Memory is full.	Download barcode data to the host and clear the memory.
Digital scanner LED blinks even if the pairing request was canceled from remote iOS/Android™ device.	If pass key entry is canceled from the tablet/phone, the digital scanner remains in the pass key entry mode for 30 seconds before timing out.	To exit pass key entry mode scan Cancel or scan any other barcode.
Scanner battery LED turns solid red for a few seconds.	Battery is not charged.	Charge the battery. See Charging on page 31 .

Table 8 Troubleshooting (Continued)

Problem	Possible Causes	Possible Solutions
Bluetooth LED turns off.	Scanner is out of range.	Move closer to the host and press any button to re-pair with the host.
Digital scanner does not fully charge.	Scanner is not properly seated on the cradle or Qi wireless charging pad.	Ensure the scanner is properly seated in the cradle or properly placed on a Qi wireless charging pad.
The cradle LED is green but slow blinking.	Not enough voltage to charge the scanner.	Unplug the cradle, ensure the proper cable is used and that the hub is able to supply power to all devices.



NOTE: If after performing these checks the digital scanner still experiences problems, contact the distributor or call support.

Dump Scanner Parameters

To debug a scanner issue, scan the following barcode with the scanner connected in USB HID keyboard mode to Microsoft® Windows Notepad or Wordpad. This outputs all the scanner's asset tracking information and parameter settings to a text document.

See the parameter numbers in [Standard Parameter Defaults on page 379](#) to interpret the parameter/attribute numbers in the output.



NOTE: Use 123Scan if available as an alternative to using this feature. 123Scan is the preferable method for outputting scanner information.

For proper formatting, it may be necessary to first scan [<DATA> <SUFFIX 1> \(1\) on page 126](#).

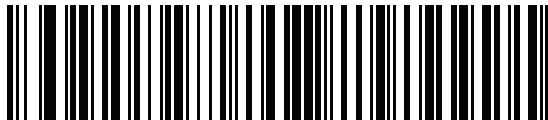

Dump Scanner Parameters

Send Versions

Report Software Version

Scan the following barcode to send the version of software installed in the scanner.



Report Software Version

Serial Number

Scan the following barcode to send the scanner serial number to the host.



Serial Number

Manufacturing Information

Scan the following barcode to send the scanner manufacturing information to the host.

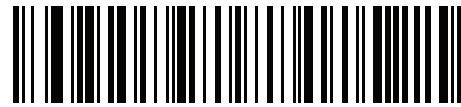

Manufacturing Information

Technical Specifications



NOTE: Operating current specifications are subject to change.

Table 9 Technical Specifications

Item	Description										
Physical Characteristics											
Dimensions - CS6080-SR CS6080-SR Scanner Standard Cradle	.9 in H x 1.8 in W x 4.3 in D / 2.3cm H x 4.6 cm W x 10.9 cm D 4.5 in H x 3.1 in W x 4.2 in D / 11.3 cm H x 7.8 cm W x 10.7 cm D										
Dimensions - CS6080-HC CS6080-HC Scanner Presentation Cradle	.9 in H x 1.8 in W x 4.3 in D / 2.3 cm H x 4.6 cm W x 10.9 cm D 3.5 in H x 2.1 in W x 2.4 in D / 9.0 cm H x 5.3 cm W x 6.1 cm D										
Weight - CS6080-SR Corded Cordless Standard Cradle	2.0 oz / 56.0 g 2.9 oz / 83 g 4.9 oz / 138.0 g										
Weight - CS6080-HC Corded Cordless Presentation Cradle	2.0 oz / 58 g 3.1 oz / 87 g 3.4 oz / 96 g										
Input Voltage Range Scanner and cradle	4.5 to 5.5 VDC Host Powered; 4.5 to 5.5 VDC External Power Supply										
Current	<table border="0"> <thead> <tr> <th>Mode</th> <th>Typ</th> </tr> </thead> <tbody> <tr> <td>Operating @ Nominal = 5V</td> <td>400</td> </tr> <tr> <td>Idle @ Nominal = 5V</td> <td>90</td> </tr> <tr> <td>Cradle, Standard USB</td> <td>450</td> </tr> <tr> <td>Cradle, BC1.2 USB</td> <td>600</td> </tr> </tbody> </table>	Mode	Typ	Operating @ Nominal = 5V	400	Idle @ Nominal = 5V	90	Cradle, Standard USB	450	Cradle, BC1.2 USB	600
Mode	Typ										
Operating @ Nominal = 5V	400										
Idle @ Nominal = 5V	90										
Cradle, Standard USB	450										
Cradle, BC1.2 USB	600										
Available Colors	Midnight Black (CS6080-SR), Healthcare White (CS6080-HC)										
Supported Host Interfaces	USB										
Keyboard Support	Supports over 90 international keyboards										
FIPS Security Certification	CS6080-HC: Certified Compliant with FIPS 140-2										
User Indicators	Direct Decode Indicator Good Decode LEDs Beeper (adjustable tone and volume) Haptic feedback on decode Capacitive trigger with haptic and audible feedback Dedicated Battery Gauge Dedicated Bluetooth LED										
Performance Characteristics											
Motion Tolerance (hand-held)	Up to 20 in. / 51 cm, per second for 13 mil UPC in optimized mode.										

Table 9 Technical Specifications (Continued)

Item	Description
Light Source	Aiming Pattern: Circular 525nm true green LED
Illumination	1 Warm White LED
Imager Field of View	44.5° horizontal, 33.5° vertical nominal
Image Sensor	1,280 x 960 pixels
Minimum Print Contrast	20% minimum reflective difference
Skew Tolerance	+/- 60°
Pitch Tolerance	+/- 60°
Roll Tolerance	0° - 360°
Minimum Element Resolution	Code 39 - 5.0 mil
User Environment	
Operating Temperature	32° to 122°F / 0° to 50°C
Storage Temperature	-40° to 158°F / -40° to 70°C
Humidity	5% to 95% RH, non-condensing
Drop Specification (Scanner)	Designed to withstand multiple drops @ 5 ft./1.5 m to concrete
Tumble Specification (Scanner)	Designed to withstand 250 tumbles in 1.5 ft./0.5 m tumbler Note: 1 tumble = 0.5 cycle
Ambient Light Immunity	0 to 10037 Foot Candles/0 to 108,000 Lux
Environmental Sealing	Scanner rated IP65
Electrostatic Discharge (ESD)	+/-15kV Air discharge, +/-8kV Direct, +/-8kV Indirect
Radio Specifications	
Bluetooth Radio	Standard Bluetooth Version 5.0 with BLE: Class 1 330 ft. (100m) and Class 2 33 ft. (10m), Serial Port and HID Profiles
Adjustable Bluetooth Power	Output power adjustable down to negative 10 dBm in 8 Steps
Battery	
Battery Capacity/Type	735 mAh Lithium Polymer battery
Scans Per Battery Charge	13,000 scans
Operating Time Per Full Charge	18 hours
Battery Charge Time (from empty)	
CS6080-SR: Standard USB	Full charge: 6 hours
CS6080-SR: BC1.2 USB	Full charge: 3 hours
CS6080-HC: Standard USB	Full charge: 8 hours
CS6080-HC: BC1.2 USB	Full charge: 6 hours
Accessories	
Cordless Accessories	Standard cradle, presentation cradle, spare battery, 4-slot scanner ShareCradle, 4-slot battery ShareCradle, lanyard
Corded Accessories	Gooseneck Intellistand (weighted and standard), cup, corded USB converter

Table 9 Technical Specifications (Continued)

Item	Description
Symbol Decode Capability	
1D	Base 32 (Italian Pharma), Codabar/NW7, Code, 11, Code 39, Code 93, Code 128, GS1 DataBar, I 2 of 5, Korean 3 of 5, MSI Plessey, UPC/EAN.
2D	Aztec, Composite Codes, DataMatrix, DotCode, Han Xin, MaxiCode, PDF417, MicroPDF417, Postal Codes, QR Code, Micro QR, TLC-39, SecurPharm
OCR	OCR-A, OCR-B, MICR, US Currency
Utilities and Management	
123Scan	Programs scanner parameters, upgrades firmware, provides scanned barcode data and prints reports. See 123Scan and Software Tools on page 36 .
Symbol Scanner SDK	Generates a fully-featured scanner application, including documentation, drivers, test utilities and sample source code. www.zebra.com/ScannerSDKforWindows
Scanner Management Service (SMS)	Remotely manages your Zebra scanner and queries its asset information. www.zebra.com/sms
Decode Ranges (Typical)*	See Decode Ranges on page 49 .

Duty Cycle

The plot shown in [Figure 21](#) indicates the maximum allowed duty cycle changes with ambient temperature in Level Trigger Mode.

Figure 21 Level Trigger Mode

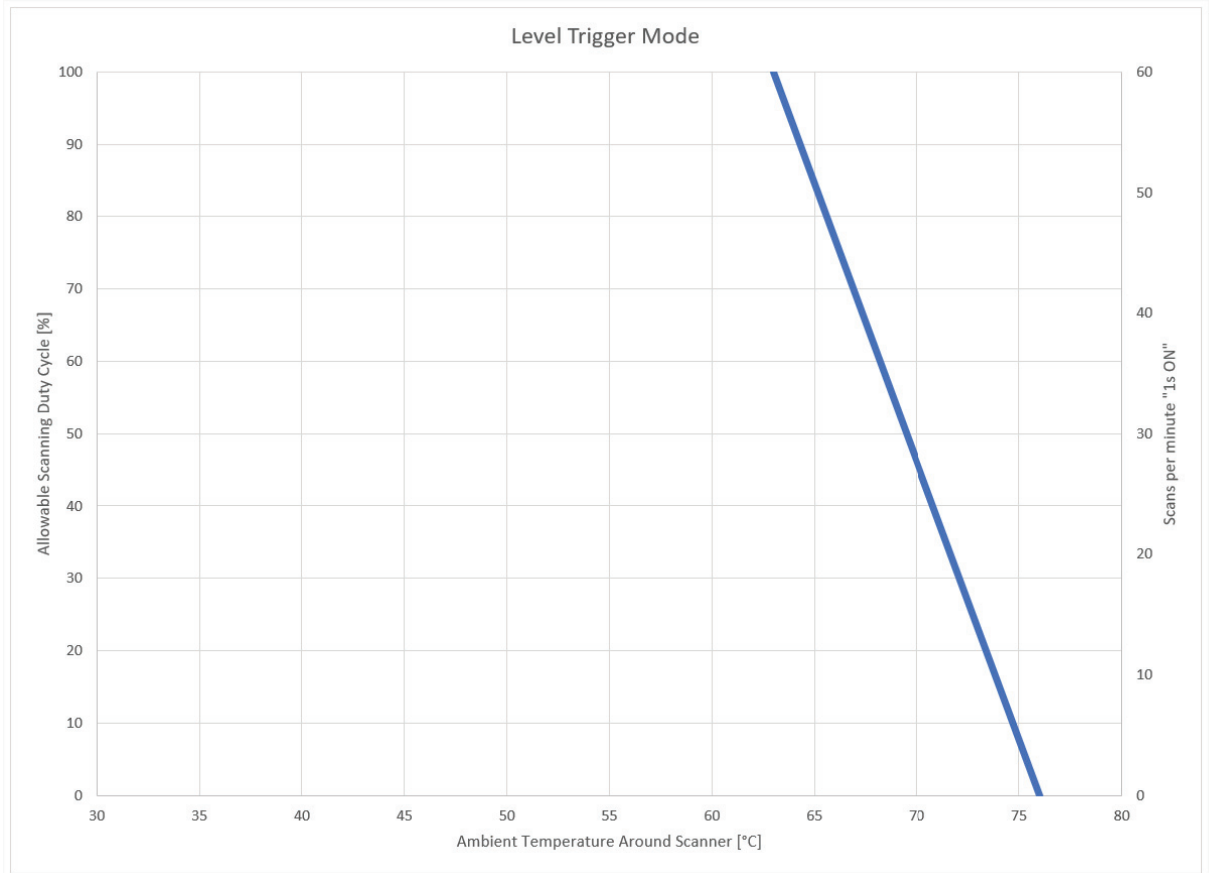

The plot shown in [Figure 22](#) indicates the maximum allowed duty cycle changes with ambient temperature in Scene Detection Mode.

Figure 22 Scene Detection Mode

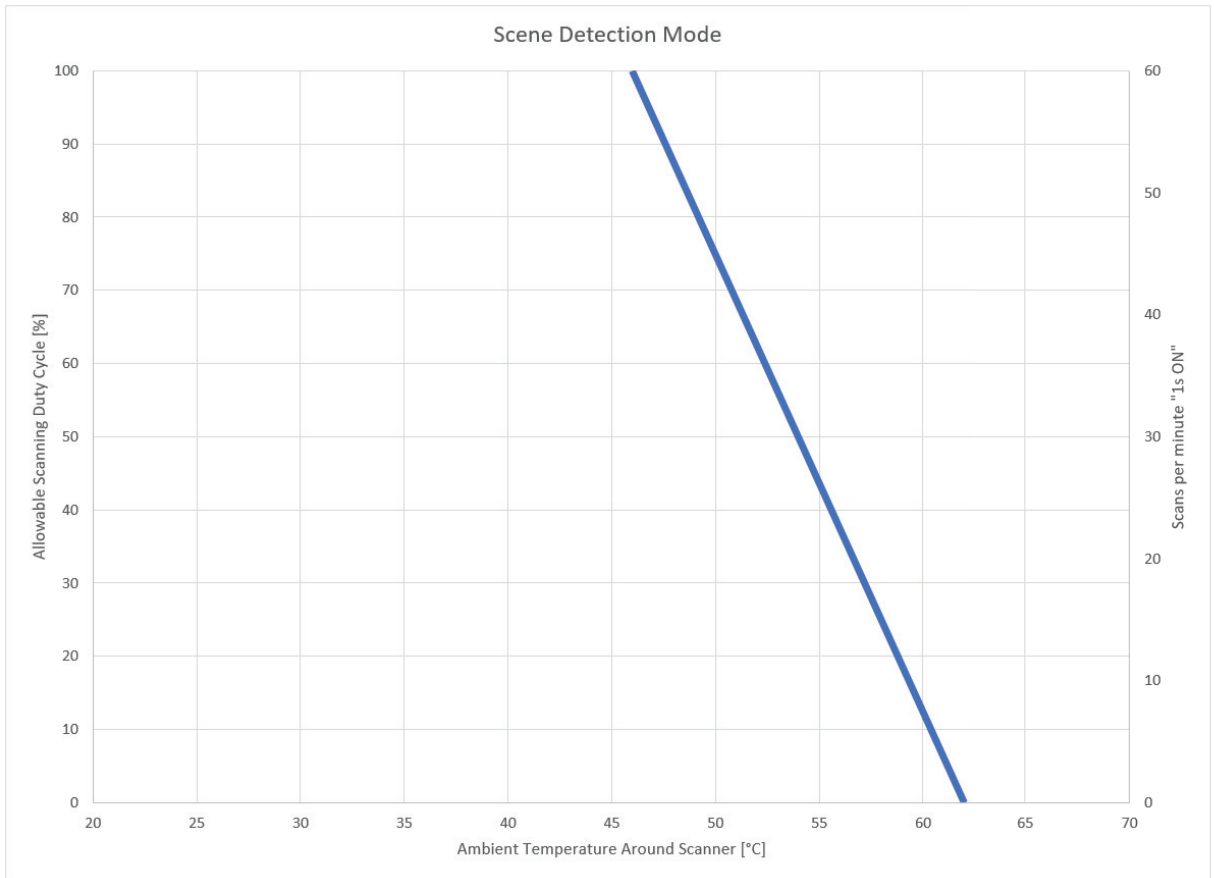

Scanning Sequence Examples

In most cases, scanning one barcode sets the parameter value. For example, to set the beeper tone to high, scan the **High Frequency** (beeper tone) barcode listed under [Beeper Tone on page 71](#). The digital scanner issues a fast warble beep and the LED turns green, signifying a successful parameter entry.

Other parameters, such as **Serial Response Time-Out** or **Data Transmission Formats**, require scanning several barcodes. See these parameter descriptions for this procedure.

Errors While Scanning

Unless otherwise specified, to correct an error during a scanning sequence, just re-scan the correct parameter.

User Preferences Parameter Defaults

[Table 10](#) lists defaults for user preferences parameters. To change the default values:

- Scan the appropriate barcodes in this guide. These new values replace the standard default values in memory. To recall the default parameter values, see [Default Parameters on page 67](#).
- Configure the digital scanner using the 123Scan configuration program (see [123Scan and Software Tools on page 36](#)).



See [Standard Parameter Defaults on page 379](#) for all user preferences, hosts, symbologies, and miscellaneous default parameters.

Table 10 User Preferences Parameter Defaults

Parameter	Parameter Number ¹	SSI Number ²	Default	Page Number
User Preferences				
Set Default Parameter			Restore Defaults	67
Parameter Barcode Scanning	236	ECh	Enable	68
Beep After Good Decode	56	38h	Enable	68
Direct Decode Indicator	859	F2h 5Bh	Disable	69
Beeper Volume	140	8Ch	High	70
Beeper Tone	145	91h	Medium	71
Beeper Duration	628	F1h 74h	Medium	72
Suppress Power Up Beeps	721	F1h D1h	Do Not Suppress	72
Decode Pager Motor	613	F1h 65h	Enable	73
Decode Pager Motor Duration	626	F1h 72h	150 msec	73
Night Mode Trigger	1215	F8h 04h BFh	Disable	75
Night Mode Toggle	N/A	N/A	N/A	76
Night Mode Silence Beeper Radio Indications	2262	F8h 08h D6	Enable Always	77
¹ Parameter number decimal values are used for programming via RSM commands. ² SSI number hex values are used for programming via SSI commands.				

User Preferences

Table 10 User Preferences Parameter Defaults (Continued)

Parameter	Parameter Number ¹	SSI Number ²	Default	Page Number
Night Mode Silence Beeper Low Battery Indication	2263	F8h 08h D7	Enable Always	78
Night Mode Silence Beeper Parameter Programming Indications	2264	F8h 08h D8	Enable Always	79
Scan Button Sensitivity	2133	F8 08 55	Normal Touch	81
Programmable Button Sensitivity	2134	F8 08 56	Normal Touch	81
Haptic Feedback (Vibrate) on Button Touch	1251	F8h 04h E3h	Enable	82
Click on Button Touch	1252	F8h 04h E4h	Enable	83
Scan Button ADF Rule Selection	2070	SSI # F8h 08h 16h	No Action	86
Programmable Button ADF Rule Selection	2071	(SSI # F8h 08h 17h)	No Action	87
Hands-Free ADF Rule Selection	2072	(SSI # F8h 08h 18h)	No Action	88
Lamp Mode Control	1711	F8h 06h AFh	Disable (SR configurations) Enable Lamp Mode without Scanning (HC configurations)	89
Lamp Mode Timeout	1712	F8h 06h B0h	5 Minutes	90
Low Power Mode	128	80h	Enable	90
Time Delay to Low Power Mode	146	92h	1 sec	91
Timeout to Low Power Mode from Auto Aim (Applies to cordless configurations only)	729	F1h D9h	15 sec	93
Battery Preservation Mode (Applies to cordless configurations only)	1765	F8h 06h E5h	Enable	94
Hand-Held Trigger Mode	138	8Ah	Level	95
Hands-Free Mode	630	F1h 76h	Enable	97
Hand-Held Decode Aiming Pattern	306	F0h 32h	Enable	97
Hands-Free (Presentation) Decode Aiming Pattern	590	F1h 4Eh	Disable Hands-Free Decode Aiming Pattern	98
Picklist Mode	402	F0h 92h	Disabled Always	100
Virtual Tether Alarm Configuration	2053	F8h 08h 05h	Disable	101
Delay Before Virtual Tether Alarm Activates	2054	F8h 08h 06h	30 Seconds	105
Virtual Tether Alarm Duration	2055	F8h 08h 07h	5 Minutes	105
Defeat Virtual Tether Alarm	2119	F8h 08h 47h	Pause Alarm on Scan Button	106
Pause Virtual Tether Alarm Duration	2120	F8h 08h 48h	30 Seconds	107
Continuous Barcode Read	649	F1h 89h	Disable	109

¹ Parameter number decimal values are used for programming via RSM commands.

² SSI number hex values are used for programming via SSI commands.

Table 10 User Preferences Parameter Defaults (Continued)

Parameter	Parameter Number ¹	SSI Number ²	Default	Page Number
Unique Barcode Reporting	723	F1h D3h	Enable	109
Decode Session Timeout	136	88h	9.9 sec	110
Hands-Free Decode Session Timeout	400	F0h 90h	15	111
Timeout Between Decodes, Same Symbol	137	89h	0.5 sec	112
Timeout Between Decodes, Different Symbols	144	90h	0.1 sec	112
Triggered Timeout, Same Symbol	724	F1 D4	Disable	113
Mobile Phone/Display Mode	716	F1h CCh	Normal	114
PDF Prioritization	719	F1h CFh	Disable	115
PDF Prioritization Timeout	720	F1h D0h	200 ms	116
Decoding Illumination	298	F0h 2Ah	Enable	116
Illumination Brightness - Hand-Held	669	F1h 9Dh	High	117
Illumination Brightness - Hands-Free	2118	F8h 08h 46h	Medium	118
Low Light Scene Detection	810	F2h 2Ah	No Low Light Scene Detection	119
Scene Detect Sensitivity	1943	F8h 97h	Low	120
Motion Tolerance (Hand-Held Trigger Mode Only)	858	F2h 5Ah	Less Motion Tolerance	121
Product ID (PID) Type	1281	F8h 05h 01h	Host Type Unique	122
Product ID (PID) Value	1725	F8h 06h BDh	0	122
ECLevel	1710	F8h 06h AEh	0	123
Miscellaneous Options				
Add an Enter Key	N/A	N/A	N/A	123
Transmit Code ID Character	45	2Dh	None	123
Prefix Value	99, 105	63h, 69h	7013 <CR><LF>	124
Suffix 1 Value	98, 104	62h, 68h	7013 <CR><LF>	124
Suffix 2 Value	100, 106	64h, 6Ah		
Scan Data Transmission Format	235	EBh	Data As Is	125
FN1 Substitution Values	103, 109	67h, 6Dh	7013 <CR><LF>	127
Transmit "No Read" Message	94	5Eh	Disable	128
Unsolicited Heartbeat Interval	1118	F8h 04h 5Eh	Disable	129
securPharm Decoding	1752	F8h 06h D8h	Disable	130
securPharm Output Formatting	1753	F8h 06h D9h	No Formatting	131
Programmable Button for Single Press	2060	F8h 08h 0Ch	Apple Show/Hide Keypad	134
Programmable Button for Double Press	2103	F8h 08h 37h	No Action	135

¹ Parameter number decimal values are used for programming via RSM commands.

² SSI number hex values are used for programming via SSI commands.

Parameters

Default Parameters

The digital scanner can be reset to two types of defaults: factory defaults or custom defaults. Scan the appropriate barcode below to reset the digital scanner to its default settings and/or set the digital scanner current settings as the custom default.

- **Restore Defaults** - Resets all default parameters as follows:
 - If custom default values were configured (see **Write to Custom Defaults**), the custom default values are set for all parameters each time the **Restore Defaults** barcode below is scanned.
 - If no custom default values were configured, the factory default values are set for all parameters each time the **Restore Defaults** barcode below is scanned. (For factory default values, see [Standard Parameter Defaults](#).)
- **Set Factory Defaults** - Scan the **Set Factory Defaults** barcode below to eliminate all custom default values and set the digital scanner to factory default values (For factory default values, see [Standard Parameter Defaults](#)).
- **Write to Custom Defaults** - Custom default parameters can be configured to set unique default values for all parameters. After changing all parameters to the desired default values, scan the **Write to Custom Defaults** barcode below to configure custom defaults.



* Restore Defaults



Set Factory Defaults



Write to Custom Defaults

Parameter Barcode Scanning

Parameter # 236 (SSI # ECh)

To disable the decoding of parameter barcodes, including the **Set Defaults** parameter barcodes, scan the **Disable Parameter Scanning** barcode below. To enable decoding of parameter barcode, scan **Enable Parameter Scanning**.



* Enable Parameter Barcode Scanning
(1)



Disable Parameter Barcode Scanning
(0)

Beep After Good Decode

Parameter # 56 (SSI # 38h)

Scan a barcode below to select whether or not the digital scanner beeps after a good decode. If selecting **Do Not Beep After Good Decode**, the beeper still operates during parameter menu scanning and to indicate error conditions.



* Beep After Good Decode (Enable)
(1)

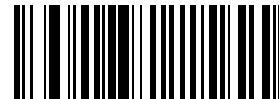

Do Not Beep After Good Decode (Disable)
(0)

Direct Decode Indicator

Parameter # 859 (SSI # F2h 5Bh)

This feature is only supported in Auto Aim and Standard (Level) trigger modes. Scan a barcode below to select optional blinking of the illumination on a successful decode

- **Disable Direct Decode Indicator** - illumination does not blink on a successful decode.
- **1 Blink** - illumination blinks once upon a successful decode.
- **2 Blinks** - illumination blinks twice upon a successful decode.



* Disable Direct Decode Indicator
(0)

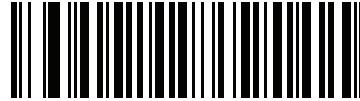

1 Blink
(1)

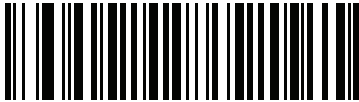

2 Blinks
(2)

Beeper Volume

Parameter # 140 (SSI # 8Ch)

To select a beeper volume, scan the **Low Volume**, **Medium Volume**, or **High Volume** barcode.



Low Volume
(2)



Medium Volume
(1)



*** High Volume**
(0)

Beeper Tone

Parameter # 145 (SSI # 91h)

To select a beeper tone, scan one of the following barcodes.

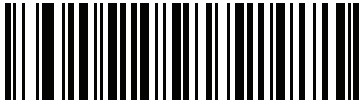

**Off
(3)**

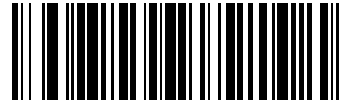

**Low Tone
(2)**

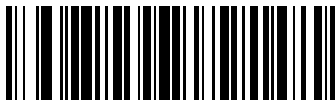

*** Medium Tone
(1)**



**High Tone
(0)**



**Medium to High Tone (2-tone)
(4)**

Beeper Duration

Parameter # 628 (SSI # F1h 74h)

To select the duration for the beeper, scan one of the following barcodes.

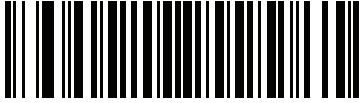

Short
(0)

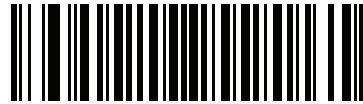

* Medium
(1)

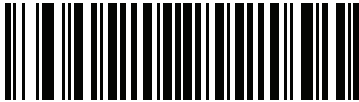

Long
(2)

Suppress Power Up Beeps

Parameter # 721 (SSI # F1h D1h)

Scan a barcode below to select whether or not to suppress the digital scanner power-up beeps.



* Do Not Suppress Power Up Beeps
(0)



Suppress Power Up Beeps
(1)

Decode Pager Motor

Parameter # 613 (SSI # F1h 65h)

The scanner includes a pager motor which, when enabled, vibrates the scanner for a period of time when a successful decode occurs.

Scan a barcode below to enable or disable the pager motor. If enabled, scan the appropriate barcode to set the period of time in which to vibrate the scanner (see [Decode Pager Motor Duration](#) below).

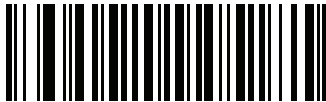

**Pager Motor Disable
(0)**



*** Pager Motor Enable
(1)**

Decode Pager Motor Duration

Parameter # 626 (SSI # F1h 72h)

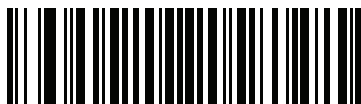

*** 150 msec
(15)**



**200 msec
(20)**

Decode Pager Motor Duration (continued)



250 msec
(25)



300 msec
(30)

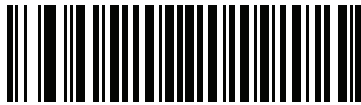

400 msec
(40)



500 msec
(50)

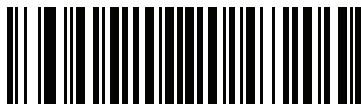

600 msec
(60)



750 msec
(75)

Night Mode

Parameter # 1215 (SSI # F8h 04h BFh)

The Night Mode feature allows the user to easily switch to a quiet mode in order to use the pager motor with the beeper off.



NOTE: Do not use Lamp Mode, Night Mode, and Low Light Assist together.

Enter and exit Night Mode in one of two ways:

- Scan [Enable Night Mode Trigger \(1\) on page 76](#) and use the trigger to toggle between entering and exiting Night Mode.
- Scan the [Toggle Night Mode on page 76](#) to enter or exit Night Mode, regardless of the state of the **Night Mode Trigger** parameter.

Entering Night Mode:

- Enables **Decode Pager Motor**
- Disables **Beep After Good Decode**.
- Disables **Beep on Insertion**.
- Disables the page beep if the [Page Button on page 174](#) is enabled (the LED and vibrate features remain enabled).
- Disables the Bluetooth disconnect beep.
- Vibrates the pager motor.

Exiting Night Mode:

- Returns the scanner to the previously programmed states for the parameter changes above. For example, if **Beep After Good Decode** was enabled before entering Night Mode, it returns to enabled upon exiting night mode.
- Sounds two short beeps.

In Night Mode:

- Scanning the pairing barcode activates the pager motor instead of the warble beep and, on pairing connection, the pager motor re-activates.
- Scanning a default parameter barcode exits Night Mode.
- Removing the scanner battery exits Night Mode.
- If the scanner loses power due to a dead battery or **Battery Off** is scanned, the scanner exits Night Mode on the next power up and resumes normal operation.

For scanners that do not use a pager motor (non-HC units), scanning any Night Mode or pager motor parameters sounds an error beep.

Night Mode Trigger

Enable this to use the trigger to toggle between entering and exiting Night Mode. To toggle, point the scanner away from a barcode, press the trigger until the beam goes off, and then continue pressing the trigger for an additional 5 seconds. Note that pressing the trigger an additional 5 seconds after decoding a barcode has no affect.

When entering Night Mode, the pager motor vibrates. When exiting Night Mode, the scanner emits two short beeps.



**Enable Night Mode Trigger
(1)**

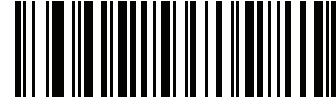

*** Disable Night Mode Trigger
(0)**

Night Mode Toggle

To toggle between entering and exiting Night Mode without using the trigger, scan this barcode. This functions regardless of the state of the **Night Mode Trigger** parameter.

When scanning this barcode, the pager motor vibrates when entering Night Mode, and the scanner emits two short beeps when exiting Night Mode.



Toggle Night Mode

Night Mode Silence Beeper Radio Indications

Parameter # 2262 (SSI # F8h 08h D6)

Scan a barcode below to enable or disable this feature.



Disable Always
(0)



*** Enable Always**
(1)



Disable in Night Mode
(2)

When **Disable in Night Mode** or **Disable Always** is active, the following radio beeper indications are silenced:

Radio Indication Name	Beeper Sequence	Radio Indication
Bluetooth page timeout	Long low/long high	Remote device is out of range/not powered.
Bluetooth connection attempt	Long low/long high/long low/long high	Bluetooth connection attempt is rejected by remote device.

Night Mode Silence Beeper Low Battery Indication

Parameter # 2263 (SSI # F8h 08h D7)

This parameter enables or disables the Night Mode Silence Beeper Low Battery Indication feature.

When **Disable in Night Mode** or **Disable Always** is active, the low battery (on the trigger release) beeper indication of four short high beeps is silenced.



Disable Always
(0)



*** Enable Always**
(1)



Disable in Night Mode
(2)

Night Mode Silence Beeper Parameter Programming Indications

Parameter # 2264 (SSI # F8h 08h D8)

This parameter enables silencing the beep that occurs when the scanner is being programmed if the parameter is set to **Disable in Night Mode** or **Disable Always**.



Disable Always
(0)



*** Enable Always**
(1)



Disable in Night Mode
(2)

User Preferences

When **Disable in Night Mode** or **Disable Always** is active, the following parameter barcode programming beeper indications are silenced:

Parameter Programming Indication Name	Beeper Sequence	Parameter Programming Indication
Input error	Long low/long high	Incorrect bar code or Cancel scanned, wrong entry, incorrect bar code programming sequence; remain in program mode
Keyboard parameter selected	High/low	Enter value using bar code keypad.
Successful programming	High/low/high/low	Successful program exited with change in the parameter setting.
ADF Programming		
Number expected	High/low	Enter another digit. Add leading zeros to the front, if necessary.
Alpha expected	Low/low	Enter another alphabetic character or scan the End of Message bar code.
ADF criteria/action expected	High/high	Enter another criteria or action or scan the Save Rule bar code.
ADF criteria/action cleared	High/low/low	All criteria or actions cleared for current rule, continuing entering rule.
Rule saved	High/low/high/low	Rule successfully saved and rule entry mode exited.
Rule error	Long low/long high	Entry error, wrong bar code scanned, or criteria/action list is too long for a rule. Re-enter criteria or action.
Deleted last saved rule	Low	Deletes the last saved rule but the current rule is left intact.
All rules deleted	Long/high/high	All rules entered are deleted.
Out of memory	Long low/long high/ long low/long high	Out of ADF memory. Erase some existing rules, then try to erase the rule again.
Cancel rule entry	Long low/long high/long low	Rule entry mode exited because of an error or the user asked to exit rule entry.

Scan Button Sensitivity

Parameter # 2133 (SSI # F8 08 55)

To adjust the force required to activate the Scan Button, scan one of the barcodes below.



* Normal Touch
(0)



Light Touch
(1)

Programmable Button Sensitivity

Parameter # 2134 (SSI # F8 08 56)

To adjust the force required to activate the Programmable Button, scan one of the barcodes below.



* Normal Touch
(0)



Light Touch
(1)

Haptic Feedback (Vibrate) on Button Touch

Parameter # 1251 (SSI # F8h 04h E3h)

The scanner provides haptic feedback which, when enabled, vibrates the scanner upon a button touch. Scan one of the following barcodes to enable or disable this parameter.



*** Enable Haptic Feedback (Vibrate) on Button Touch
(1)**



**Disable Haptic Feedback (Vibrate) on Button Touch
(0)**

Click on Button Touch

Parameter # 1252 (SSI # F8h 04h E4)

Scan one of the following barcodes to enable or disable a click upon a button touch.



*** Enable Click on Button Touch
(1)**







**Disable Click on Button Touch
(0)**

ADF Rule Selection

ADF Rule Selection allows for different ADF rules to be applied to decode data depending on how the data is scanned. On the CS6080 scanner, data can be scanned using the Scan Button, the Programmable Button or in Presentation Mode.

Within ADF a formatting rule can be assigned a Rule Set Flag number from 1 to 4 in its criteria list.

Rule Set Flag 1 	Rule Set Flag 2 	Rule Set Flag 3 	Rule Set Flag 4 
--	--	--	--

For example, an ADF rule can implement as follows:

Criteria	Actions
When a barcode: <ul style="list-style-type: none"> • Is length 5, and • Starts with the letter P and • Code 128 code type, and • Rule Set Flag 1 is enabled  	Then format the decode data this way: <ul style="list-style-type: none"> • Send X • Send first 5 characters of barcode • Send Enter key

The ADF Rule Selection setting can be used automatically set or clear one of the Rule Set Flags when the reading of decode data occurs with one of the following triggering sources:

- Programmable Button
- Scan Button
- Hands-Free

The following options are available for the ADF Rule Selection setting: (= Set Flag, = Clear Flag)

When the reading of decode data occurs, then the four Rule Set Flags in ADF are changed as in the following table (except when No Action is selected):

ADF Rule Selection	Rule Set Flag 1	Rule Set Flag 2	Rule Set Flag 3	Rule Set Flag 4
No Action (default)	No Change	No Change	No Change	No Change
Use Rule 1	<input checked="" type="checkbox"/> Set	<input type="checkbox"/> Cleared	<input type="checkbox"/> Cleared	<input type="checkbox"/> Cleared
Use Rule 2	<input type="checkbox"/> Cleared	<input checked="" type="checkbox"/> Set	<input type="checkbox"/> Cleared	<input type="checkbox"/> Cleared
Use Rule 3	<input type="checkbox"/> Cleared	<input type="checkbox"/> Cleared	<input checked="" type="checkbox"/> Set	<input type="checkbox"/> Cleared
Use Rule 4	<input type="checkbox"/> Cleared	<input type="checkbox"/> Cleared	<input type="checkbox"/> Cleared	<input checked="" type="checkbox"/> Set
Use Generic Rules	<input type="checkbox"/> Cleared	<input type="checkbox"/> Cleared	<input type="checkbox"/> Cleared	<input type="checkbox"/> Cleared

When ADF processes the decode data, then the criteria for each rule is checked, rules that do not specify a Rule Set Flag number always apply. Rules that specify a Rule Set Flag number apply based on the ADF Rule Selection setting for the trigger source.

For example if the ADF Rule Selection settings have the following values:

Programmable Button	Use Rule 1
Scan Button	Use Rule 2
Hands-free	Use Rule 3

When a barcode is scanned with:

- The Programmable Button pressed, then Rule Set Flag 1 is set and the others are cleared.
- The Scan Button pressed, then the Rule Set Flag 2 is set and the others are cleared
- Hands-free, then all Rule Set Flags are cleared.

After the Rule Set Flags are adjusted, then the ADF engine processes the decode data. ADF goes down the rule list for the first rule that applies. The rules tagged with a Rule Set number are enabled or disabled based on the ADF Rule Selection settings.



NOTE: If **No Action** is selected then the state of the Rule Selection Flags from the last decode remain enabled.

When programming ADF rules using ADF Rule Selection, be sure to have rules corresponding to Rule Sets 1 to 4 at the top of the rule list, otherwise a generic rule applies before a rule set based rule is applied.

Scan Button ADF Rule Selection

Parameter #2070 (SSI # F8h 08h 16h)



* No Action
(0)



Use Rule 1
(1)



Use Rule 2
(2)



Use Rule 3
(3)



Use Rule 4
(4)



Use Generic Rules
(0xff)

Programmable Button ADF Rule Selection

Parameter #2071 (SSI # F8h 08h 17h)



* No Action
(0)



Use Rule 1
(1)



Use Rule 2
(2)



Use Rule 3
(3)



Use Rule 4
(4)



Use Generic Rules
(0xff)

Hands-Free ADF Rule Selection

Parameter #2072 (SSI # F8h 08h 18h)



* No Action
(0)



Use Rule 1
(1)



Use Rule 2
(2)



Use Rule 3
(3)



Use Rule 4
(4)



Use Generic Rules
(0xff)

Lamp Mode



NOTE: Lamp Mode applies to the healthcare cradle and scanner in scan stand only.

Disable Hands-Free Mode (see [Hands-Free Mode on page 97](#)) and Enable Lamp Mode with Scanning for on demand Presentation Mode with Timeout when scanner is in a cradle or scan stand.

Lamp Mode uses the scanner to illuminate the workspace around the scanner by providing continuous illumination on demand. Lamp Mode may be enabled or disabled. Once enabled, Lamp Mode is activated or deactivated by pressing the Programmable Button on the scanner. Lamp Mode may be enabled with the option to allow barcode scanning, or not.

Lamp Mode Control

Parameter #1711 (SSI # F8h 06h AFh)

This parameter enables or disables the Lamp Mode feature.



NOTE: The default value for Healthcare configurations of the scanner is **Enable Lamp Mode without Scanning**.

The default value for SR configurations of the scanner is **Disable Lamp Mode**.

Do not use Lamp Mode, Night Mode, and Low Light Assist together.



Enable Lamp Mode with Scanning
(1)

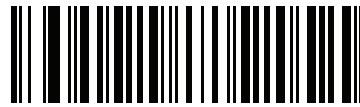

* Enable Lamp Mode without Scanning
(2)
(default for HC models)



* Disable Lamp Mode
(0)
(default for SR models)

Lamp Mode Timeout

Parameter #1712 (SSI # F8h 06h B0h)

This parameter controls how long the lamp remains on for when Lamp Mode is enabled.



1 Minute
(1)



* 5 Minutes
(5)

Low Power Mode

Parameter # 128 (SSI # 80h)



NOTE: Applies to cordless configurations only.

This parameter determines whether or not the digital scanner enters low power mode after a decode attempt.

If disabled, power remains on after each decode attempt.



Disable Low Power Mode
(0)



* Enable Low Power Mode
(1)

Time Delay to Low Power Mode

Parameter # 146 (SSI # 92h)



NOTE: This parameter only applies when Low Power Mode is enabled.

This parameter sets the time the digital scanner remains active before entering low power mode. The digital scanner wakes upon trigger press or when the host attempts to communicate with the digital scanner.

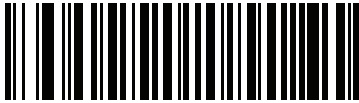

100 msec
(65)

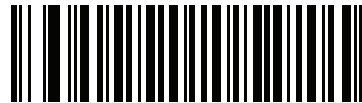

500 msec
(69)



* 1 Sec
(17)

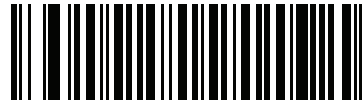

2 sec
(18)



3 sec
(19)

Time Delay to Low Power Mode (continued)



4 sec
(20)



5 sec
(21)

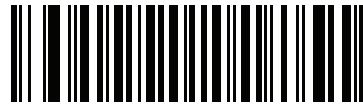

10 sec
(26)



15 sec
(27)

Timeout to Low Power Mode from Auto Aim

Parameter # 729 (SSI # F1 D9)

This parameter sets the time the scanner remains in auto aim before entering Low Power Mode.



Disabled
(0)



5 sec
(5)

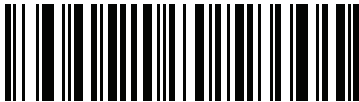

* 15 sec
(11)



30 sec
(13)



1 minute
(17)

Battery Preservation Mode

Parameter # 1765 (SSI # F8h 06h E5h)



NOTE: This parameter only applies to cordless operation.

Battery Preservation Mode preserves the battery charge when the digital scanner is not being used for an extended period of time.

- Scan **Enable Battery Preservation Mode** to internally disconnect the battery from the digital scanner when the digital scanner is unused and not being charged for five hours¹. In this mode the scanner completely turns off. This preserves the battery charge as there is no current drain on the battery and significantly extends battery shelf life. To exit Battery Preservation Mode² and return to normal operation either press the digital scanner trigger or return to charging. The digital scanner cannot scan until the wake up process is complete³. This takes a few seconds. The amount of time before the battery disconnects from the scanner can be set via **Battery Preservation Timeout Value** below.



NOTE: ¹Five hours is the default timeout value but can be changed via **Battery Preservation Timeout Value**.

²Low Power Mode (90) must be enabled for Battery Preservation Mode to take effect.

³When asleep in Battery Preservation Mode, the digital scanner cannot be accessed for remote management.

To return back to normal operation, insert the scanner back into the cradle to complete the wake up process.

- Scan **Disable Battery Preservation Mode** to keep the battery connected to the digital scanner at all times. This prevents the battery from being disconnected from the scanner after hours of sitting idle (no scanning) and not charging. When Battery Preservation Mode is disabled, substantial battery shelf life improvements are not gained as compared to when Battery Preservation Mode is enabled.
- Scan **Battery Preservation Timeout** followed by 3 digits in [Numeric Barcodes on page 451](#) to select a different battery preservation timeout value (the default for battery preservation timeout is five hours). For example, if the preservation timeout value should be 12 hours, scan **Battery Preservation Timeout** below, then scan **0**, **1**, and **2**. To correct an error or change the selection, scan [Numeric Barcodes on page 451](#).



* Enable Battery Preservation Mode
(5)



Disable Battery Preservation Mode
(0)



Battery Preservation Timeout Value

Hand-Held Trigger Mode

Parameter # 138 (SSI # 8Ah)

Select one of the following trigger modes for the digital scanner.

- **Standard (Level)** - A trigger press activates decode processing. Decode processing continues until the barcode decodes, you release the trigger, or the [Decode Session Timeout on page 110](#) occurs.
- **Presentation (Blink)** - The digital scanner activates decode processing when it detects a barcode in its field of view. After a period of non-use, the digital scanner enters a low power mode, in which the LEDs turn off until the digital scanner senses motion.
- **Auto Aim** - This trigger mode projects the aiming dot when you lift the digital scanner. A trigger press activates decode processing. After 5 seconds of inactivity the aiming dot shuts off.



* Level (Standard)
(0)

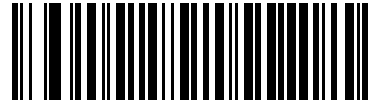

Presentation (Blink)
(7)



Auto Aim
(9)

Hands-Free Mode

Parameter # 630 (SSI # F1h 76h)

In hands-free mode, when you place the CS6080 in the presentation cradle, it automatically triggers when presented with a barcode. Lifting the digital scanner causes it to behave according to the setting of the [Hand-Held Trigger Mode on page 95](#).

If you select **Disable Hands-Free Mode**, the digital scanner behaves according to the setting of the [Hand-Held Trigger Mode on page 95](#) regardless of whether the CS6080 is in the presentation cradle.



* Enable Hands-Free Mode
(1)



Disable Hands-Free Mode
(0)

Hand-Held Decode Aiming Pattern

Parameter # 306 (SSI # F0h 32h)

Select **Enable Hand-Held Decode Aiming Pattern** to project the aiming dot during barcode capture, **Disable Hand-Held Decode Aiming Pattern** to turn the aiming dot off, or **Enable Hand-Held Decode Aiming Pattern on PDF** to project the aiming dot when the digital scanner detects a 2D barcode.



NOTE: With [Picklist Mode on page 100](#) enabled, the decode aiming dot flashes even when the **Hand-Held Decode Aiming Pattern** is disabled.



* Enable Hand-Held Decode Aiming Pattern
(2)



Disable Hand-Held Decode Aiming Pattern
(0)

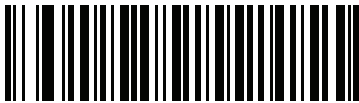

Enable Hand-Held Decode Aiming Pattern on PDF
(3)

Hands-Free Decode Aiming Pattern

Parameter # 590 (SSI # F1h 4Eh)

Select **Enable Hands-Free Decode Aiming Pattern** to project the aiming dot during barcode capture, **Disable Hands-Free Decode Aiming Pattern** to turn the aiming dot off, or **Enable Hands-Free Decode Aiming Pattern on PDF** to project the aiming dot when the digital scanner detects a 2D barcode.



NOTE: With [Picklist Mode on page 100](#) enabled, the decode aiming dot flashes even when the **Decode Aiming Pattern** is disabled.



Enable Hands-Free Decode Aiming Pattern
(1)



* Disable Hands-Free Decode Aiming Pattern
(0)



Enable Hands-Free Decode Aiming Pattern on PDF
(2)

Picklist Mode

Parameter # 402 (SSI # F0h 92h)

Scan one of the following barcodes to select a Picklist Mode. In this mode, you can pick out and decode a barcode from a group of barcodes that are printed close together by placing the aiming pattern on the barcode you want to decode.



NOTE: Enabling Picklist Mode overrides the Disable Decode Aiming Pattern options. You can not disable the decode aiming pattern when Picklist Mode is enabled.

Enabling Picklist Mode can slow decode speed and hinder the ability to decode longer barcodes.

- Enable Picklist Mode Always - Picklist Mode is always enabled.
- Enable Picklist Mode in Hand-held Mode - Picklist Mode is enabled when the scanner is out of hands-free mode and disabled when the scanner is in presentation mode.
- Enable Picklist Mode in Hands-free Mode - Picklist Mode is enabled when the scanner is in hands-free mode only.
- Disable Picklist Mode Always - Picklist Mode is always disabled.

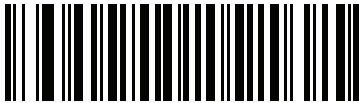

Enable Picklist Mode Always
(2)



Enable Picklist Mode in Hand-held Mode
(1)

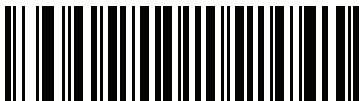

Enable Picklist Mode in Hands-free Mode
(3)



*** Disable Picklist Mode Always**
(0)

Virtual Tether

Virtual Tether feature allows the scanner, cradle or host application to alert users when Bluetooth connection is lost. It works by independently controlling the scanner's illumination, audio, haptics, audio and visual as well as visual LED alarm only options.

To adjust the range of the scanner and cradle connection, change the radio power (high, medium, low). See Radio Output Power on [Radio Output Power on page 147](#).

Configuring the Alarm on the Scanner

Parameter # 2053 (SSI # F8h 08h 05h)

The Virtual Tether alarm on the scanner includes audio, LED, illumination, and haptic which Each alarm type can be enabled or disabled using the barcodes in this section. This allows for creation of custom alarms. This feature is disabled by default.



* Disable Virtual Tether Alarm
(0)



Enable Virtual Tether Alarm
(1)

Audio Virtual Tether Alarm on Scanner

Parameter # 2246 (SSI # F8h 08h C6h)

Scan the barcodes below to disable or enable the Audio Virtual Tether Alarm on the scanner.



NOTE: To disable the audio alarm on the scanner and cradle when the scanner is in Night Mode, configure the audio alarm on the scanner to **Enable Audio Virtual Tether Alarm Except in Night Mode**.



Disable Audio Virtual Tether Alarm
(0)



Enable Audio Virtual Tether Alarm
(Plays in Night Mode)
(1)



* Enable Audio Virtual Tether Alarm
Except in Night Mode
(see [Night Mode on page 75](#))
(2)



NOTE: If Audio Alarm is enabled, it plays at a high volume.

LED Virtual Tether Alarm

Parameter # 2247 (SSI # F8h 08h C7h)

Scan the barcodes below to disable or enable this feature. When enabled, the scanner LEDs blink green and red.



Disable LED Virtual Tether Alarm
(0)



* Enable LED Virtual Tether Alarm
(1)

Illumination Virtual Tether Alarm

Parameter # 2248 (SSI # F8h 08h C8h)

Scan the barcodes below to disable or enable this feature.



Disable Illumination Virtual Tether Alarm
(0)



* Enable Illumination Virtual Tether Alarm
(1)

Haptics Virtual Tether Alarm

Parameter # 2249 (SSI # F8h 08h C9h)



Disable Haptics Virtual Tether Alarm
(0)



* Enable Haptics Virtual Tether Alarm
(1)

Configuring the Alarm on Cradle

Parameter # 2124 (SSI # F8h 08h 4Ch)

Scan the barcodes below to disable or enable this feature on the cradle. When enabled, the cradle LEDs blink green and red and the audio alarm sounds (this may be disabled).



* Disable Virtual Tether Alarm on the Cradle
(0)



Enable Audio and Visual Virtual
Tether Alarm on the Cradle
(1)



Enable Visual Virtual Tether Alarm
on the Cradle (No Beeper)
(2)

Distance

To adjust the range of the scanner and cradle connection, change the radio power to high, medium, or low (see [Radio Output Power on page 147](#)).

Delay Before Virtual Alarm Activates

Parameter # 2054 (SSI # F8h 08h 06h)

When the device is out of range, it holds off on sounding the Virtual Tether alarm to provide an opportunity to re-establish a connection (5 - 99 seconds). The default is 30 seconds.



NOTE: Ensure that this setting is not too short in order to avoid the following:

- If the cradle resets, it causes the scanner to activate the Virtual Tether alarm.
- Noisy RF environments can lead to frequent, momentary disconnect/reconnect sequences.

To set a timeout:

1. Scan the **Delay Before Alarm Activates** barcode.
2. Scan two barcodes from [Numeric Barcodes](#) that correspond to the desired timeout duration. Enter a leading zero for single digit numbers (for example, for an alarm to start after 5 seconds, scan the 0 barcode and then the 5 barcode).

To correct an error or change the selection, scan [Cancel on page 451](#).



Delay Before Alarm Activates

Virtual Tether Alarm Duration

Parameter # 2055 (SSI # F8h 08h 07h)

Set up the amount of time for the Alarm to play in minutes (1 - 99 minutes). The default is 5 minutes.

To set a timeout:

1. Scan the **Alarm Duration** barcode.

2. Scan two barcodes from [Numeric Barcodes](#) that correspond to the desired alarm duration. Enter a leading zero for single digit numbers (for example, for an alarm to start after 5 minutes, scan the 0 barcode and then the 5 barcode). The value of zero sets the duration to **Infinite**.

To correct an error or change the selection, scan [Cancel on page 451](#).



Alarm Duration

Stopping the Alarm

The alarm stops once the connection is established, the timeout period expires or the scanner's battery is drained.



NOTE: Any connection stops the alarm. The scanner does not need to connect to the same cradle.

Defeat Virtual Tether Alarm

Parameter # 2119 (SSI # F8h 08h 47h)

The cradle Page Button is used to defeat or pause the alarm.



**Do Not Defeat Alarm
(0)**



*** Pause Alarm on Scan/Page Button
(1)**



**Stop Alarm on Scan/Page Button
(2)**

Pause Virtual Tether Alarm Duration

Parameter # 2120 (SSI # F8h 08h 48h)

Pressing the Scan Button on the scanner pauses the alarm for a programmable number of seconds (1 - 99 seconds). The default is **30 Seconds**.

To set a timeout:

1. Scan the **Pause Virtual Tether Alarm Duration** barcode.
2. Scan two barcodes from [Numeric Barcodes](#) that correspond to the desired alarm duration. Enter a leading zero for single digit numbers (for example, for an alarm to start after 5 seconds, scan the 0 barcode and then the 5 barcode).

To correct an error or change the selection, scan [Cancel on page 451](#).



Pause Virtual Tether Alarm Duration

Virtual Tether Alarm Considerations

Causes for the alarm to activate include:

- The device goes out of range.
- If the cradle does not have power, the scanner sounds an alarm. Includes USB suspend of the cradle.
- Removing the battery from the scanner causes the cradle to sound the alarm.
- If Virtual Tether is enabled and a power outage occurs that causes multiple cradles or Bluetooth hosts to lose power, it activates alarms on the scanners paired to them. To stop the alarm:
 - A scan button press can be configured to defeat the alarm (see [Defeat Virtual Tether Alarm on page 106](#) for details).

OR

- Unpower the scanners by removing the battery.
- Connect the scanner to another device.
- Press the Scan Button (must be configured to Stop Alarm on Scan Button).

Causes for the alarm to not activate:

- The scanner and cradle need to have an existing connection before an alarm activates. No alarm on power up.
- If the scanner is connected to another cradle/host by insertion or by scanning the pairing barcode.
- If another scanner connects to the cradle and causes the original scanner to disconnect.
- If scanner is charging (including on a Qi pad) the alarm does not activate as in this case the scanner is not lost.
- If any of the batch modes are enabled or if auto-reconnect is not set to reconnect immediately.

User Preferences

- Virtual Tether does not apply to hosts that do not support the auto-reconnect feature such as HID Bluetooth Low Energy (Discoverable) and SPP BT Classic (Discoverable).
- Alarm is not activated if the disconnection occurs due to firmware update or configuration via 123Scan or SMS.

Cause for Visual Virtual Alarm only

- If the scanner disconnects from the cradle due to the Battery Preservation feature activating, the cradle only plays the visual portion of the virtual tether alarm if enabled.

Continuous Barcode Read

Parameter # 649 (SSI # F1h 89h)

Enable this to report every barcode while the trigger is pressed.



NOTE: Zebra strongly recommends enabling [Picklist Mode on page 100](#) with this feature. Disabling Picklist Mode can cause accidental decodes when more than one barcode is in the digital scanner's field of view.



* Disable Continuous Barcode Read
(0)



Enable Continuous Barcode Read
(1)

Unique Barcode Reporting

Parameter # 723 (SSI # F1h D3h)

Enable this to report only unique barcodes while the trigger is pressed. This option only applies when **Continuous Barcode Read** is enabled.



Disable Continuous Barcode Read Uniqueness
(0)



* Enable Continuous Barcode Read Uniqueness
(1)

Decode Session Timeout

Parameter # 136 (SSI # 88h)

This parameter sets the maximum time decode processing continues during a scan attempt. It is programmable in 0.1 second increments from 0.5 to 9.9 seconds. The default timeout is 9.9 seconds.

To set a Decode Session Timeout, scan the barcode below. Next, scan two numeric barcodes from [Numeric Barcodes on page 451](#) that correspond to the desired on time. Enter a leading zero for single digit numbers. For example, to set a Decode Session Timeout of 0.5 seconds, scan the barcode below, then scan the 0 and 5 barcodes. To correct an error or change the selection, scan [Cancel on page 451](#).



Decode Session Timeout

Hands-free Decode Session Timeout

Parameter # 400 (SSI # F0h 90h)

This parameter is the hands-free compliment to the **Decode Session Timeout**. It configures the minimum and maximum decode processing time during a hands-free scan attempt. It only applies to the hands-free trigger mode or when a scanner is placed in the Presentation cradle (CR6080-PC).

The minimum decode processing time is defined as the time in which the scanner stops decoding when an object is removed or left stationary in the imaging field of view.

The maximum decode processing time is defined as the time in which the scanner stops decoding when an object is left in and is moving in the field of view.

Both the maximum and minimum times are configured using a single setting. The relationship of this setting is as follows:

Setting Value	Minimum Time	Maximum Time
$X < 25$	250 ms	$X * 100$ ms
$X \geq 25$	$X * 10$ ms	$X * 100$ ms

For example, a setting value of 100 results in the scanner turning off approximately 1 second after an object is removed from the field of view or 10 seconds while an object is in the field of view moving.

The default value of the setting is 15 which results in a Minimum time of 250 ms and Maximum time of 1.5 seconds.

Adjust this setting based on your requirements. For example, when doing PDF prioritization, this parameter should be set to a value where the maximum time is above the PDF prioritization timeout.



Hands-free Decode Session Timeout

Timeout Between Decodes, Same Symbol

Parameter # 137 (SSI # 89h)

Use this option in Continuous Barcode Read mode to prevent the beeper from continuously beeping when a symbol is left in the digital scanner field of view. The barcode must be out of the field of view for the timeout period before the digital scanner reads the same consecutive symbol. It is programmable in 0.1 second increments from 0.0 to 9.9 seconds. The default interval is 0.5 seconds.

To select the timeout between decodes for the same symbol, scan the barcode below, then scan two numeric barcodes from [Numeric Barcodes on page 451](#) that correspond to the desired interval, in 0.1 second increments.



Timeout Between Decodes, Same Symbol

Timeout Between Decodes, Different Symbols

Parameter # 144 (SSI # 90h)

Use this option in presentation mode or Continuous Barcode Read to control the time the digital scanner is inactive between decoding different symbols. It is programmable in 0.1 second increments from 0.1 to 9.9 seconds. The default is 0.1 seconds.

To select the timeout between decodes for different symbols, scan the barcode below, then scan two numeric barcodes from [Numeric Barcodes on page 451](#) that correspond to the desired interval, in 0.1 second increments.



NOTE: Timeout Between Decodes, Different Symbols cannot be greater than or equal to the Decode Session Timeout.



Timeout Between Decodes, Different Symbols

Triggered Timeout, Same Symbol

Parameter # 724 (SSI # F1 D4)

Scan **Enable Triggered Timeout, Same Symbol** below to apply **Timeout Between Decodes, Same Symbol** (parameter #137 on page 112) in hand-held trigger mode. Subsequent scans of **Enable Triggered Timeout, Same Symbol** are ignored until **Timeout Between Decodes, Same Symbol** expires.



NOTE: 1.This feature does not apply to Timeout Between Decodes, Different Symbols.

2.Timeout Between Decodes, Same Symbol should not be greater than or equal to the Time Delay to Low Power Mode (parameter #146 on page 91).

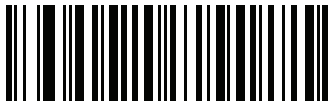

Enable Triggered Timeout, Same Symbol

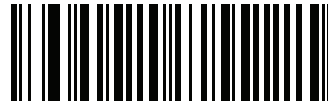

* Disable Triggered Timeout, Same Symbol

Mobile Phone/Display Mode

Parameter # 716 (SSI # F1h CCh)

This mode improves barcode reading performance off mobile phones and electronic displays. Select Enhanced in hand-held, hands-free, or both modes, or select Normal Mobile Phone/Display Mode.



* Normal Mobile Phone/Display Mode
(0)

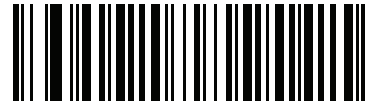

Enhanced in Hand-Held Mode
(1)



Enhanced in Hands-Free Mode
(2)

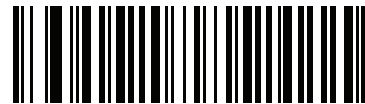

Enhanced in Both Modes
(3)

PDF Prioritization

Parameter # 719 (SSI # F1h CFh)

Enable this feature to delay decoding a 1D barcode (Code 128) by the value specified in [PDF Prioritization Timeout](#). During that time the digital scanner attempts to decode a PDF417 symbol (e.g., on a US driver's license), and if successful, reports this only. If it does not decode (can not find) a PDF417 symbol, it reports the 1D symbol after the timeout. The 1D symbol must be in the device field of view for the digital scanner to report it. This parameter does not affect decoding other symbologies.



NOTE: The 1D Code 128 barcode lengths include the following:

- 7 to 10 characters
- 14 to 22 characters
- 27 to 28 characters

In addition, a Code 39 barcode with the following lengths are considered to potentially be part of a US driver's license:

- 8 characters
- 12 characters.

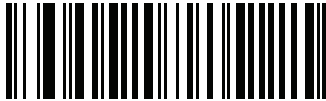

* Disable PDF Prioritization
(0)



Enable PDF Prioritization
(1)

PDF Prioritization Timeout

Parameter # 720 (SSI # F1h D0h)

- ✓ Hands-free [Decode Session Timeout on page 110](#) should be set to a longer duration than Prioritization Timeout when configured.

When [PDF Prioritization](#) is enabled, this timeout specifies how long the digital scanner attempts to decode a PDF417 symbol before reporting the 1D barcode in the field of view.

Scan the following barcode, then scan four digits from [Numeric Barcodes on page 451](#) that specify the timeout in milliseconds. For example, to enter 400 ms, scan the following barcode, then scan 0400. The range is 0 to 5000 ms, and the default is 200 ms.



PDF Prioritization Timeout

Decoding Illumination

Parameter # 298 (SSI # F0h 2Ah)

Selecting **Enable Decoding Illumination** causes the digital scanner to flash illumination to aid decoding. Select **Disable Decoding Illumination** to prevent the digital scanner from using decoding illumination.

Enabling illumination usually results in superior images. The effectiveness of the illumination decreases as the distance to the target increases.



* Enable Decoding Illumination
(1)



Disable Decoding Illumination
(0)

Illumination Brightness Hand-Held

Parameter # 669 (SSI # F1h 9Dh)

Scan one of the following barcodes to set the illumination brightness used during an active decode session. This only applies in hand-held mode (not in presentation mode).



NOTE: Selecting a lower brightness level can affect decode performance.



Low Illumination Brightness for Hand-Held
(0)



Medium Illumination Brightness for Hand-Held
(3)



* High Illumination Brightness for Hand-Held
(7)

Illumination Brightness Hands-Free

Parameter # 2118 (SSI # F8h 08h 46h)

Scan one of the following barcodes to set the illumination brightness used when the scanner is in Presentation Mode. This does not apply in hand-held mode.



NOTE: Selecting a lower brightness level can affect decode performance.



Low Illumination Brightness for Hands-Free
(0)



* Medium Illumination Brightness for Hands-Free
(3)



High Illumination Brightness for Hands-Free
(7)

Low Light Scene Detection

Parameter # 810 (SSI # F2h 2Ah)

Scan one of the following barcodes to allow the scanner to detect motion in dim to dark illumination environments when in presentation mode:

- **No Low Light Scene Detection** - The scanner attempts to detect motion as best it can with the aim pattern and illumination turned off when the scanner is idle.
- **Aiming Pattern Low Light Assist Scene Detection** - Illumination is off, but the aim pattern is on when the scanner is idle to assist in scene detection.
- **Dim Illumination Low Light Assist Scene Detection** - The aim pattern is off, but illumination is on at a dim level to assist in scene detection.



NOTE: Do not use Lamp Mode, Night Mode, and Low Light Assist together.



* No Low Light Assist Scene Detection
(0)



Aiming Pattern Low Light Assist Scene Detection
(1)



Dim Illumination Low Light Assist Scene Detection
(2)

Scene Detect Sensitivity

Parameter # 1943 (SSI # F8h 97h)

This parameter sets the illumination range sensitivity when motion is detected.



* Low
(10)



Medium
(128)



High
(190)

Motion Tolerance (Hand-Held Trigger Modes Only)

Parameter # 858 (SSI # F2h 5Ah)

Less Motion Tolerance provides optimal decoding performance on 1D barcodes.

To increase motion tolerance and speed decoding when scanning a series of 1D barcodes in rapid progression, scan **More Motion Tolerance**.

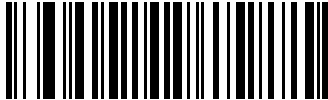

* Less Motion Tolerance
(0)

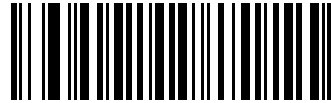

More Motion Tolerance
(1)

Product ID (PID) Type

Parameter # 1281

SSI # F8h 05h 01h

Scan one of the following bar codes to define the PID value reported in USB enumeration.

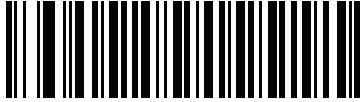

* Host Type Unique
(0)

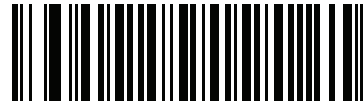

Product Unique
(1)



IBM Unique
(2)

Product ID (PID) Value

Parameter # 1725

SSI # F8h 06h BDh

To set a Product ID value, scan **Set PID Value**, and then scan four numeric bar codes in [Numeric Barcodes on page 451](#) that correspond to the value. Enter a leading zero for single digit numbers. To correct an error, or change a selection, scan [Cancel on page 451](#). The range is (0,1600-1649).



NOTE: This parameter is applicable to customers using a Firmware Flash Update per the Toshiba Global Commerce Solutions (TGCS) Universal Serial Bus OEM Point-of-Sale Device Interface.



Set PID Value

ECLevel

Parameter # 1710

SSI # F8h 06h AEh

To set an ECLevel value, scan **Set ECLevel**, and then scan five numeric bar codes in [Numeric Barcodes on page 451](#) that correspond to the desired level. Enter a leading zero for single digit numbers. To correct an error, or change a selection, scan [Cancel on page 451](#).



NOTE: This parameter is applicable to customers using a Firmware Flash Update per the Toshiba Global Commerce Solutions (TGCS) Universal Serial Bus OEM Point-of-Sale Device Interface. It allows a customer to define an ECLevel value in order to manage and control Flash Update operations on the 4690 operating system.

Contact the Zebra Customer Support Center online at: www.zebra.com/support for more information.

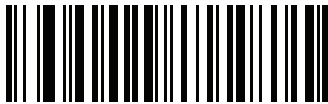

Set ECLevel

Add an Enter Key

To add an Enter key (carriage return/line feed) after scanned data, scan the following barcode. To program other prefixes and/or suffixes, see [Prefix/Suffix Values on page 124](#).

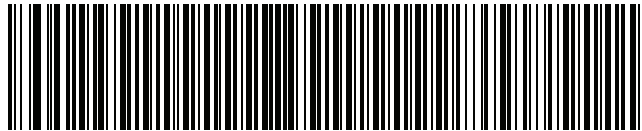

Add Enter Key (Carriage Return/Line Feed)

Transmit Code ID Character

Parameter # 45 (SSI # 2Dh)

A Code ID character identifies the code type of a scanned barcode. This is useful when decoding more than one code type. In addition to any single character prefix already selected, the Code ID character is inserted between the prefix and the decoded symbol.

Select no Code ID character, a Symbol Code ID character, or an AIM Code ID character. For Code ID characters, see [Programming Reference on page 430](#).



NOTE: If you enable Symbol Code ID Character or AIM Code ID Character, and enable [Transmit "No Read" Message on page 128](#), the digital scanner appends the code ID for Code 39 to the NR message.

Transmit Code ID Character (continued)



Symbol Code ID Character
(2)



AIM Code ID Character
(1)



* None
(0)

Prefix/Suffix Values

Key Category Parameter # P = 99, S1 = 98, S2 = 100 (SSI # P = 63h, S1 = 62h, S2 = 64h)

Decimal Value Parameter # P = 105, S1 = 104, S2 = 106 (SSI # P = 69h, S1 = 68h, S2 = 6Ah)

You can append a prefix and/or one or two suffixes to scan data for use in data editing. To set a value for a prefix or suffix, scan a four-digit number (i.e., four barcodes from [Numeric Barcodes on page 451](#)) that corresponds to that value. See [ASCII Character Sets on page 470](#) for the four-digit codes.

When using host commands to set the prefix or suffix, set the key category parameter to 1, then set the 3-digit decimal value. See [ASCII Character Sets on page 470](#) for the four-digit codes.

The default prefix and suffix value is 7013 <CR><LF> (the Enter key). To correct an error or change a selection, scan [Cancel on page 451](#).



NOTE: To use Prefix/Suffix values, first set the [Scan Data Transmission Format on page 125](#).

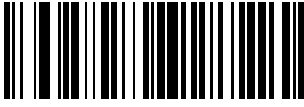

Scan Prefix
(7)

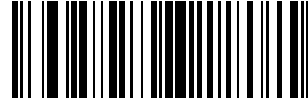

Scan Suffix 1
(6)



Scan Suffix 2
(8)

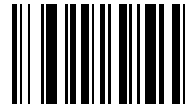

Data Format Cancel

Scan Data Transmission Format

Parameter # 235 (SSI # EBh)

To change the scan data format, scan one of the following eight barcodes corresponding to the desired format.



NOTE: If using this parameter do not use ADF rules to set the prefix/suffix.

To set values for the prefix and/or suffix, see [Prefix/Suffix Values on page 124](#).



* Data As Is
(0)



<DATA> <SUFFIX 1>
(1)



<DATA> <SUFFIX 2>
(2)



<DATA> <SUFFIX 1> <SUFFIX 2>
(3)



<PREFIX> <DATA >
(4)

Scan Data Transmission Format (continued)



<PREFIX> <DATA> <SUFFIX 1>
(5)



<PREFIX> <DATA> <SUFFIX 2>
(6)



<PREFIX> <DATA> <SUFFIX 1> <SUFFIX 2>
(7)

FN1 Substitution Values

Key Category Parameter # 103 (SSI # 67h)

Decimal Value Parameter # 109 (SSI # 6Dh)

The wedge and USB HID keyboard hosts support a FN1 Substitution feature. Enabling this substitutes any FN1 character (0x1b) in an EAN128 barcode with a value. This value defaults to 7013 (Enter Key).

When using host commands to set the FN1 substitution value, set the key category parameter to 1, then set the 3-digit keystroke value. See the ASCII Character Set table for the current host interface for the desired value.

To select a FN1 substitution value via barcode menus:

1. Scan the barcode below.



Set FN1 Substitution Value

2. Locate the keystroke desired for FN1 Substitution in the ASCII Character Set table for the current host interface. Enter the 4-digit ASCII Value by scanning each digit in [Numeric Barcodes on page 451](#).

To correct an error or change the selection, scan **Cancel**.

To enable FN1 substitution for USB HID keyboard, scan the **Enable FN1 Substitution** barcode on page 215.

Transmit “No Read” Message

Parameter # 94 (SSI # 5Eh)

Scan a barcode below to select whether or not to transmit a No Read message. Enable this to transmit the characters NR when a successful decode does not occur before trigger release or the **Decode Session Timeout** expires. See [Decode Session Timeout on page 110](#). Disable this to send nothing to the host if a symbol does not decode.



NOTE: If you enable **Transmit No Read**, and also enable Symbol Code ID Character or AIM Code ID Character for [Transmit Code ID Character on page 123](#), the digital scanner appends the code ID for Code 39 to the NR message.



**Enable No Read
(1)**



*** Disable No Read
(0)**

Unsolicited Heartbeat Interval

Parameter # 1118 (SSI # F8h 04h 5Eh)

The imager supports sending **Unsolicited Heartbeat Messages** to assist in diagnostics. To enable this feature and set the desired unsolicited heartbeat interval, scan one of the time interval barcodes below, or scan **Set Another Interval** followed by four numeric barcodes from [Numeric Barcodes](#) (scan sequential numbers that correspond to the desired number of seconds).

Scan **Disable Unsolicited Heartbeat Interval** to turn off the feature.

The heartbeat event is sent as decode data (with no decode beep) in the form of:

MOTEVTHB:nnn

where nnn is a three-digit sequence number starting at 001 and wrapping after 100.

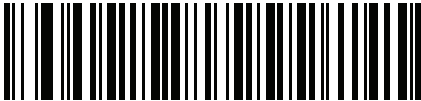

10 seconds
(10)



1 minute
(60)



Set Another Interval



* Disable Unsolicited Heartbeat Interval
(0)

securPharm Decoding

Parameter # 1752 (SSI # F8h 06h D8h)

securPharm decoding implements the IFA and GS1 Coding System for the European pharmaceutical industry. securPharm code is used to prevent pharmaceutical counterfeiting.

When this feature is enabled, if a GS1 symbol is decoded and includes any aspects of the Application Identifier associated with the securPharm GS1 specifications, the entire GS1 symbol is processed as a securPharm symbol. For this reason, it is expected that under certain circumstances, a GS1 barcodes that is a securPharm symbol may not be processed properly; if the GS1 symbol is not created as per the specification. The output cannot be guaranteed as valid.

Although the GS1-128 type and the GS1 DataBar family are not specifically indicated in the IFA specification, they are supported.

The securPharm output is in XML format and can include the product number, serial number, lot number, expiration and Date of Manufacturing. The XML tags can be arranged in any order. Tags that are not in the barcode are omitted. For example:

```
<content dfi="value_dfi">
<Daten_1>value_Daten_1</Daten_1>
<Daten_2>value_Daten_2</Daten_2>
<Daten_n>value_Daten_n</Daten_n>
</content>
```

Where:

value_dfi = IFA or GS1

Daten_1 to Daten_n is the production number, serial number, etc.

Scan a barcode below to enable or disable the ability to process pharmaceutical type barcodes.



* Disable securPharm Decoding
(0)



Enable securPharm Decoding
(1)

securPharm Output Formatting

Parameter # 1753 (SSI # F8h 06h D9h)



NOTE: securPharm Output Formatting is effective only when [securPharm Decoding on page 130](#) is enabled. securPharm Output Formatting parameter options represent bit positions. Therefore, any combination of formatting can be used.

When you scan a securPharm Output Formatting barcode, the securPharm output is formatted in a number of ways.

Sample GS1 Format

Product Number: GTINData Identifier DI Data Format Identifier: GS1

Data Carrier <i>FNC1</i> 04150123456782 101A234B5 <i>FNC1</i> 1717231 211234567890123456	
--	---

> Scanned Barcode >

```
<content dfi="GS1">
<gtin>04150123456782</gtin>
<lot>1A234B5</lot>
<exp>151231</exp>
<sn>1234567890123456</sn>
```

Sample GS1 Output - Feature Disabled

The output has no format:

```
0104150123456782101A234B517151231211234567890123456
```

Sample GS1 Output - No Formatting (0)

The output is a single line of characters:

```
<content
dfi="GS1"><gtin>04150123456782</gtin><lot>1A234B5</lot><exp>151231</exp><sn>1234567890123
456</sn></content>
```

Sample GS1 Output - Insert Tab (1)

The output is a single line of characters with a tab inserted in the XML body:

```
<content
dfi="GS1">[tab]<gtin>04150123456782</gtin>[tab]<lot>1A234B5</lot>[tab]<exp>151231</exp>[tab]<sn>123
4567890123456</sn></content>
```

Sample GS1 Output - Insert New Line (2)

The output consists of multiple lines of characters with a new line character at the end of each line.

```
<content dfi="GS1">
<gtin>04150123456782</gtin>
<lot>1A234B5</lot>
<exp>151231</exp>
<sn>1234567890123456</sn>
</content>
```

Sample GS1 Output - Insert Tab and New Line (3)

The output consists of multiple lines of characters with tabs and a new line character at the end of each line.

```
<content dfi="GS1">
[tab]<gtin>04150123456782</gtin>
[tab]<lot>1A234B5</lot>
[tab]<exp>151231</exp>
[tab]<sn>1234567890123456</sn>
</content>
```

Sample IFA Format

Product Number: PPNData Identifier DI Data Format Identifier: IFA

Data Carrier

Mac069N11123456782Gs

1T1A234B5*Gs*

D151231*Gs*

S1234567890123456



> Scanned Barcode >

```
<content dfi="IFA">
  <ppn>111234567842</ppn>
  <lot>1A234B5</lot>
  <sn>1234567890123456</sn>
</content>
```

Sample GS1 Output - Feature Disabled

The output has no format:

```
[ ]>069N1112345678421T1A234B5S1234567890123456
```

Sample GS1 Output - No Formatting (0)

The output is a single line of characters:

```
<content
dfi="IFA"><ppn>111234567842</ppn><lot>1A234B5</lot><sn>1234567890123456</sn></content>
```

Sample GS1 Output - Insert Tab (1)

The output is a single line of characters with a tab inserted in the XML body:

```
<content
dfi="IFA">[tab]<ppn>111234567842</ppn>[tab]<lot>1A234B5</lot>[tab]<sn>1234567890123456</sn></con
tent>
```

Sample GS1 Output - Insert New Line (2)

The output consists of multiple lines of characters with a new line character at the end of each line.

```
<content dfi="IFA">
<ppn>111234567842</ppn>
<lot>1A234B5</lot>
<sn>1234567890123456</sn>
</content>
```

Sample GS1 Output - Insert Tab and New Line (3)

The output consists of multiple lines of characters with tabs and a new line character at the end of each line.

```
<content dfi="IFA">  
[tab]<ppn>111234567842</ppn>  
[tab]<lot>1A234B5</lot>  
[tab]<sn>1234567890123456</sn>  
</content>
```

securPharm Output Formatting Barcodes

Scan a barcode below to format the securPharm output.



*** No Formatting
(0)**



**Insert Tab
(1)**



**Insert New Line
(2)**



**Insert Tab and New Line
(3)**

Programmable Button for Single Press

Parameter # 2060 (SSI # F8h 08h 0Ch)

The Programmable Button can be configured for the following options:

- **Apple Show/Hide Keypad** - If connecting to Apple devices in HID Keyboard Mode, a press of the Programmable Button (-) shows or hides the keypad.



NOTE: Apple features must be enabled for the show/hide keyboard feature to work (see [Apple iOS Virtual Keyboard Toggle on page 150](#)).

- **Second Trigger** - The Programmable Button (-) acts as a second trigger to scan parameters and decode data.
- **Lamp Mode** - The Programmable Button (-) activates Lamp Mode (for more information, see [Lamp Mode on page 89](#)).

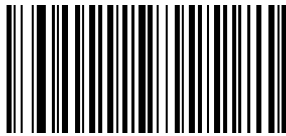

* Apple Show/Hide Keypad
(0)

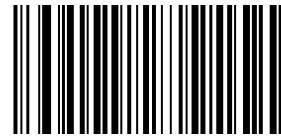

Second Trigger
(1)

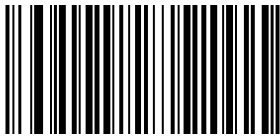

Lamp Mode
(2)

Programmable Button for Double Press

Parameter # 2103 (SSI # F8h 08h 37h)

The CS6080 can be programmed to drop the Bluetooth connection on a double press of the Programmable Button.



NOTE: The double press of the Scan Button issues Bluetooth connection to the last know device.



*** No Action
(0)**



**Drop Bluetooth Connection
(1)**

Radio Communications

Introduction

This chapter provides information about the modes of operation and features available for wireless communication between the CS6080 cordless digital scanners, cradles and hosts. The chapter also includes the parameters necessary to configure the digital scanner.

The digital scanner ships with the settings shown in the [Radio Communication Default Table on page 137](#) (also see [Standard Parameter Defaults](#) for all defaults). If the default values suit requirements, programming is not necessary.

Setting Parameters

To set feature values, scan a single barcode or a short barcode sequence. The settings are stored in non-volatile memory and are preserved even when the scanner powers down.



NOTE: Most computer monitors allow scanning barcodes directly on the screen. When scanning from the screen, be sure to set the document magnification to a level where you can see the barcode clearly, and bars and/or spaces do not merge.

If not using the default host, select the host type (see each host chapter for specific host information) after the power-up beeps sound. This is only necessary upon the first power-up when connected to a new host.

To return all features to default values, scan a barcode in [Default Parameters on page 67](#). Throughout the programming barcode menus, asterisks (*) indicate default values.

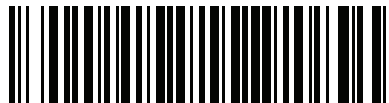

* Indicates default * Enable Parameter (1) Feature/option
Option value

Scanning Sequence Examples

In most cases, scanning one barcode sets the parameter value. For example, to enable Wi-Fi Friendly Mode, scan the **Enable Wi-Fi Friendly Mode** barcode listed under [Wi-Fi Friendly Mode on page 144](#). The scanner issues a fast warble beep and the LED turns green, signifying a successful parameter entry.

Other parameters, such as **Bluetooth Friendly Name**, require scanning several barcodes. See the parameter descriptions for this procedure.

Errors While Scanning

Unless otherwise specified, to correct an error during a scanning sequence, just re-scan the correct parameter.

Radio Communications Parameter Defaults

[Table 11](#) lists the defaults for radio communication parameters. Change these values in one of two ways:

- Scan the appropriate barcodes in this chapter. The new value replaces the standard default value in memory. To recall default parameter values, see [Default Parameters on page 67](#).
- Configure the scanner using the 123Scan configuration program. See [123Scan and Software Tools](#).



NOTE: See [Standard Parameter Defaults](#) for all user preference, host, symbology, and miscellaneous default parameters.

Table 11 Radio Communication Default Table

Parameter	Parameter Number	SSI Number	Default	Page Number
Radio Communications Host Types	N/A	N/A	Cradle Host	138
Bluetooth Friendly Name	607	F1h 5Fh	n/a	144
Discoverable Mode	610	F1h 62h	General	144
Wi-Fi Friendly Mode	1299	F8h 05h 77h	Disable	144
Wi-Fi Friendly Channel Exclusion	N/A	N/A	Use All Channels	145
Radio Output Power	1324	F8h 05h 2Ch	High	147
Link Supervision Timeout	1698	F8h 06h A2h	5 sec	148
Bluetooth Radio State	1354	F8h 05h 4Ah	On	149
Apple iOS Virtual Keyboard Toggle	1114	F8h 04h 5Ah	Disable	150
HID Keyboard Keystroke Delay	N/A	N/A	No Delay (0 msec)	151
HID CAPS Lock Override	N/A	N/A	Do Not Override (Disable)	151
HID Ignore Unknown Characters	N/A	N/A	Send Barcodes with Unknown Characters	152
Emulate Keypad	N/A	N/A	Enable	152
Fast HID Keyboard	1361	F8h 05h 51h	Enable	153
Quick Keypad Emulation	1362	F8h 05h 52h	Enable	153
HID Keyboard FN1 Substitution	N/A	N/A	Disable	154
HID Function Key Mapping	N/A	N/A	Disable	154
Simulated Caps Lock	N/A	N/A	Disable	155
Convert Case	N/A	N/A	No Case Conversion	155
Auto-Reconnect Option	604	F1h 5Ch	Auto-Reconnect Immediately	157
Reconnect Attempt Beep Feedback	559	F1h 2Fh	Disable	158

Table 11 Radio Communication Default Table (Continued)

Parameter	Parameter Number	SSI Number	Default	Page Number
Reconnect Attempt Interval	558	F1h 2Eh	30 sec	158
Sleep Between Attempts	1778	F8h 06h F2h	Sleep for 1 Minute	160
Number of Retry Attempts	1779	F8h 06h F3h	Do Not Retry	161
Beep on Insertion	288	20h	Enable	162
Beep on <BEL>	150	96	Enable	163
Pairing Modes	542	F1h 1Eh	Unlocked	164
Pairing on Contacts	545	F1h 21h	Enable	165
Toggle Pairing	1322	F8h 05h 2Ah	Disable	166
Connection Maintenance Interval	N/A	N/A	15 Minutes	167
AutoConfig (Scanner Cloning Through Cradle)	2139	F8 08 5B	Disable	169
Batch Mode	544	F1h 20h	Normal (Do Not Batch Data)	169
Persistent Batch Storage	1399	F8h 05h 77h	Disable	173
Page Button	746	F1h EAh	Enable	174
Page Mode	1364	F8h 05h 54h	Page Simple	175
Page Stage Timeout	1365	F8h 05h 55h	30 Seconds	175
Cradle Bluetooth Operation Mode	1355	F8h 05h 4Bh	Bluetooth Classic Only	176
Bluetooth Security Levels	1393	F8h 05h 71h	Low	177
Save Bluetooth Connection Information	1743	F8h 06h CFh	Enable	178
FIPS Mode	736	F1h E0h	Disable	179

Wireless Beeper Definitions

When the digital scanner scans the pairing barcode it issues various beep sequences indicating successful or unsuccessful operations. See [Beeper and LED Indications on page 39](#) for all beep sequences and LED displays including those which occur during pairing operations.

Radio Communication Host Types

To set up the digital scanner for communication with a cradle, or to use standard Bluetooth profiles, scan the appropriate host type barcode below.

Bluetooth Classic vs. Low Energy Bluetooth

Low Energy (LE) Bluetooth has a smaller RF footprint which significantly improves Wi-Fi co-existence. However, LE Bluetooth is up to 7 times slower than Classic Bluetooth (0.27 Mbps versus 0.7-2.1 Mbps), so data intensive activities such as firmware update can take significantly longer.

Cradle

Select this host type when connecting a scanner to a communication cradle.



NOTE: The scanner automatically tries to reconnect to a remote device when a disconnection occurs that is due to the radio losing communication. See [Auto-Reconnect Feature on page 156](#) for more information.

To establish a connection (for initial setup only):

1. Scan the **Cradle-Bluetooth Classic** or **Cradle-Low Energy** barcode.
2. Scan the pairing barcode on the cradle or place the scanner in the cradle.

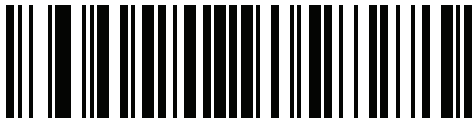

Cradle Bluetooth Classic

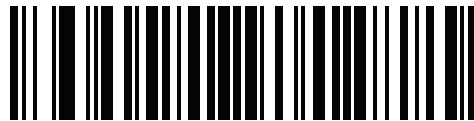

Cradle Bluetooth Low Energy

Human Interface Device (HID) Keyboard Emulation

Select this host type when connecting to a PC/tablet/phone emulating a Bluetooth keyboard.

- **HID Bluetooth Classic** - Enables the host and scanner to communicate using the HID Keyboard Profile over Bluetooth Classic radio. The scanner(s) is discoverable (Peripheral Mode) and also supports Central Mode.

To establish a connection (initial setup only):

1. Scan the **HID Bluetooth Classic** barcode.
2. Connect to Central Mode or Peripheral Mode.
 - Central Mode - Scan a pairing barcode with the host device's MAC address.
 - Peripheral Mode - From the host, discover Bluetooth devices and select your scanner from the discovered device list.

- **HID Bluetooth Low Energy (Discoverable)** - Enables the host to establish a HID Keyboard Profile connection with the scanner over Bluetooth Low Energy radio. The scanner(s) is discoverable (Peripheral Mode).

To establish a connection (initial setup only):

3. Scan the **HID Bluetooth Low Energy (Discoverable)** barcode.
4. From the host discover Bluetooth devices and select your scanner from the discovered device list.

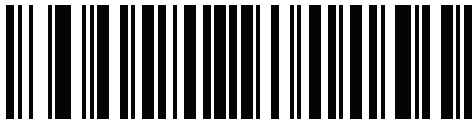

HID Bluetooth Classic

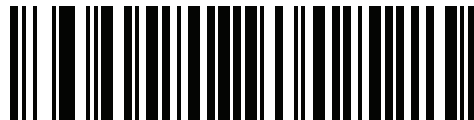

HID Bluetooth Low Energy (Discoverable)

Simple Serial Interface (SSI)

Select this host type when connecting to a Zebra mobile device or PC/tablet/phone running a Zebra scanner SDK app.

- **SSI BT Classic (Non-discoverable)** - Enables communication with Zebra mobile computers. It enables the scanner(s) to establish a connection with the host over Bluetooth Classic radio. The scanner is NOT in discoverable (Central Mode).

To establish a connection (initial setup only):

1. Scan the **SSI BT Classic (Non-discoverable)** barcode.
2. Scan a pairing barcode with the host device's MAC address.



NOTE: Additional steps may be necessary depending on host's Bluetooth stack.

- **SSI BT Classic (Discoverable)** - Enables communication with Scanner SDK for Android generated apps. It enables the host to establish a connection with the scanner over Bluetooth Classic radio. The scanner is in discoverable (Peripheral Mode).

To establish a connection (initial setup only):

3. Scan the **SSI BT Classic (Discoverable)** barcode.
 4. From the host, discover Bluetooth devices and select your scanner from your discovered device list.
- **SSI BT LE** - Enables communication with apps generated using the Zebra's Scanner SDKs for iOS and Android. It enables the host to establish a connection with the scanner over a Bluetooth Low Energy radio. The scanner is in discoverable (Peripheral Mode) and also supports Central Mode.
 - Free Demonstration App - Download Scanner Control App for iOS from the App Store.
 - Free Demonstration App - Download Scanner Control App for Android from the Google Play Store.
 - **SSI BT with MFi (iOS Support)** - Enables communication with Scanner SDK for iOS generated apps. This enables an Apple device and scanner to communicate over Bluetooth Classic radio. The scanner is discoverable (Peripheral Mode) and also supports Central Mode.
 - Free Demonstration App - Download Scanner Control App for iOS from the App Store.

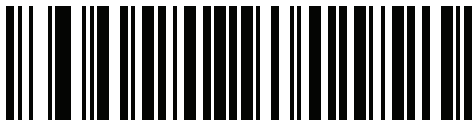

SSI BT Classic (Non-Discoverable)



SSI BT Classic (Discoverable)

Simple Serial Interface (continued)

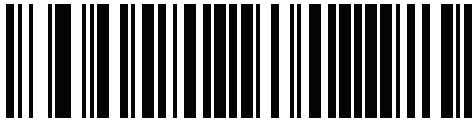

SSI BT LE



SSI BT with MFi (iOS Support)

Serial Port Profile (SPP)

Select this host type when connecting to a PC/tablet/phone using a Bluetooth serial connection.

- **SPP BT Classic (Non-Discoverable)** - Enables the scanner to establish a Serial Port Profile (SPP) connection with the host over Bluetooth Classic radio. The scanner is NOT discoverable (Central Mode).

To establish a connection (initial setup only):

1. Scan the **SPP BT Classic (Non-discoverable)** barcode.
2. Scan a pairing barcode with the MAC address of the host device.

- **SPP BT Classic (Discoverable)** - Enables the host to establish a Serial Port Profile (SPP) connection with the scanner over Bluetooth Classic radio. The scanner is discoverable (Peripheral Mode).

To establish a connection (initial setup only):

3. Scan the **SPP BT Classic (Discoverable)** barcode.
4. From the host, discover Bluetooth devices and select your scanner from the discovered device list.

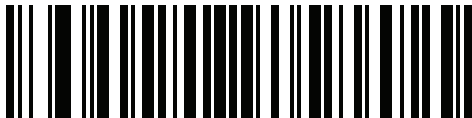

SPP BT Classic (Non-Discoverable)



SPP BT Classic (Discoverable)

Bluetooth Technology Profile Support

With Bluetooth Technology Profile Support, the cradle is not required for wireless communication. The digital scanner communicates directly to the host using Bluetooth technology. The digital scanner supports the standard Bluetooth Serial Port Profile (SPP) and HID Profiles which enable the digital scanner to communicate with other Bluetooth devices that support these profiles.

- SPP - the digital scanner connects to the PC/host via Bluetooth and performs like there is a serial connection.
- HID - the digital scanner connects to the PC/host via Bluetooth and performs like a keyboard.

Central/Peripheral Set Up

The digital scanner can be set up as a Central or Peripheral. When the digital scanner is set up as a Peripheral, it is discoverable and connectible to other devices. When the digital scanner is set up as a Central, the Bluetooth address of the remote device to which a connection is requested is required. A pairing barcode with the remote device address must be created and scanned to attempt a connection to the remote device. See the [Pairing Barcode Format Using the Scan-To-Connect \(STC\) Utility on page 166](#) for information about creating a pairing barcode.

Central

When the digital scanner is set up as a Central (SPP), it initiates the radio connection to a Peripheral device. Initiating the connection is done by scanning a pairing barcode for the remote device (see [Pairing Barcode Format Using the Scan-To-Connect \(STC\) Utility on page 166](#)).

Peripheral

When the digital scanner is set up as a Peripheral device (SPP), the digital scanner accepts an incoming connection request from a remote device.



NOTE: The number of digital scanners is dependent on the host capability.

Bluetooth Friendly Name

Parameter # 607 (SSI # F1h 5Fh)

You can set a meaningful name for the digital scanner that appears in the application during device discovery. The default name is the digital scanner name followed by its serial number, e.g., **CS6080123456789ABCDEF**. Scanning **Set Defaults** reverts the digital scanner to this name; use custom defaults to maintain the user-programmed name through a **Set Defaults** operation.

To set a new Bluetooth Friendly Name, scan the following barcode, then scan up to 23 characters from [Alphanumeric Barcodes on page 453](#). If the name contains less than 23 characters, Then scan **End of Message** in the Advanced Data Formatting Guide.



NOTE: If your application allows you to set a device name, this takes precedence over the Bluetooth Friendly Name.



Bluetooth Friendly Name

Discoverable Mode

Parameter # 610 (SSI # F1h 62h)

Select a discoverable mode based on the device initiating discovery:

- Select **General Discoverable Mode** when initiating connection from a PC.
- Select **Limited Discoverable Mode** when initiating connection from a mobile device (e.g., Q), and the device does not appear in General Discoverable Mode. Note that it can take longer to discover the device in this mode.

The device remains in Limited Discoverable Mode for 30 seconds, and green LEDs flash while in this mode. It is then non-discoverable. To re-active Limited Discoverable Mode, press the trigger.



* General Discoverable Mode
(0)



Limited Discoverable Mode
(1)

Wi-Fi Friendly Mode

Scanners configured for Wi-Fi friendly mode behave as follows:

- The scanner remains in sniff mode, and exits sniff mode only during firmware update.
- If any Wi-Fi channel is excluded from the hopping sequence, AFH turns off.
- Scanner (and cradle) avoid the selected Wi-Fi channels after establishing connection.

Notes

- If using this feature, configure all scanners in the area for Wi-Fi friendly mode.
- By default, no Wi-Fi channels are excluded.

- Since Bluetooth requires a minimum of 20 channels when Wi-Fi channels 1, 6, and 11 are excluded, a smaller number of channels are cut from the hopping sequence.
- Updating Wi-Fi friendly settings before Bluetooth connection is recommended.

Scan a barcode below to enable or disable **Wi-Fi Friendly Mode**, then see [Wi-Fi Friendly Channel Exclusion](#) to select any channels to exclude.

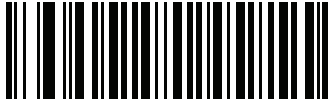

* **Disable Wi-Fi Friendly Mode**

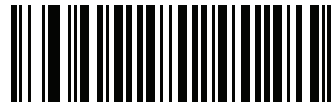

Enable Wi-Fi Friendly Mode

Wi-Fi Friendly Channel Exclusion

Wi-Fi Channel Exclusion

Select the channels to exclude:

- **Exclude Wi-Fi channel 1:** Bluetooth channels 0-21 are excluded from hopping sequence (2402-2423 MHz).
- **Exclude Wi-Fi channel 6:** Bluetooth channels 25-46 are excluded from hopping sequence (2427 - 2448 MHz).
- **Exclude Wi-Fi channel 11:** Bluetooth channels 50-71 are excluded from hopping sequence (2452 - 2473 MHz).
- **Exclude Wi-Fi channel 1, 6 and 11:** Bluetooth channels 2-19 (2404-2421 MHz), 26-45 (2428 - 2447 MHz) and 51-69 (2453 - 2471 MHz) are excluded from hopping sequence.
- **Exclude Wi-Fi channels 1 and 6:** Bluetooth channels 0-21 (2402-2423 MHz) and 25-46 (2427 - 2448 MHz) are excluded from hopping sequence.
- **Exclude Wi-Fi channels 1 and 11:** Bluetooth channels 0-21 (2402-2423 MHz) and 50-71 (2452 - 2473 MHz) are excluded from hopping sequence.
- **Exclude Wi-Fi channel 6 and 11:** Bluetooth channels 25-46 (2427 - 2448 MHz) and 50-71 (2452 - 2473 MHz) are excluded from hopping sequence.

Wi-Fi Friendly Channel Exclusion (continued)



* Use All Channels (Standard AFH)

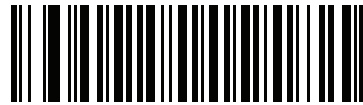

Exclude Wi-Fi Channel 1

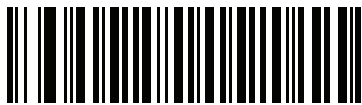

Exclude Wi-Fi Channel 6

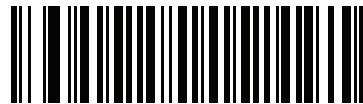

Exclude Wi-Fi Channel 11

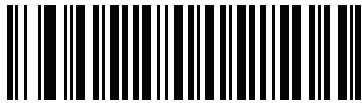

Exclude Wi-Fi Channels 1, 6, and 11



Exclude Wi-Fi Channels 1 and 6

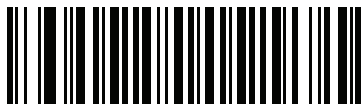

Exclude Wi-Fi Channels 1 and 11



Exclude Wi-Fi Channels 6 and 11

Radio Output Power

Parameter # 1324 (SSI # F8h 05h 2Ch)

The CS6080 uses a Bluetooth Class 1 qualified and Class 2 capable radio. Optionally, reduce the radio output power to restrict the transmission range and reduce the effect of the radio on neighboring wireless systems.



NOTE: Bluetooth stack resets on power change and the device loses connection.

Scan a barcode to select the desired power mode.

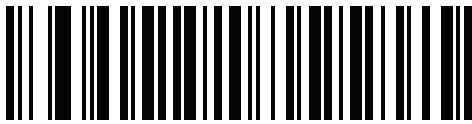

* High Power Setting
(0)

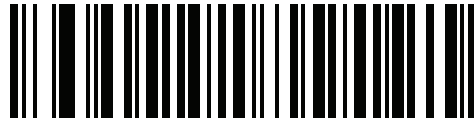

Medium Power Setting
(1)

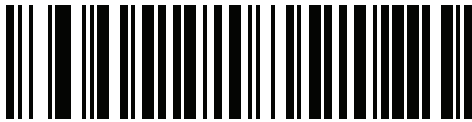

Low Power Setting
(2)



Very Low Power Setting
(3)



NOTE: With Very Low Power Setting the scanner may repeatedly connect/disconnect from the remote device. Increase [Link Supervision Timeout on page 148](#) or increase Radio Power Setting if you are seeing this issue.

Link Supervision Timeout

Parameter # 1698 (SSI # F8h 06h A2h)

Link supervision timeout controls how quickly the scanner senses that the Bluetooth radio lost connection to the remote device. A lower value helps prevent data loss at the edge of the operating range while a larger value helps prevent disconnects due to the remote device not responding in time. If you are experiencing occasional disconnects and the scanner is able to reconnect, increase the link supervision timeout value.



NOTE: The scanner only controls Link Supervision Timeout in Central Mode.

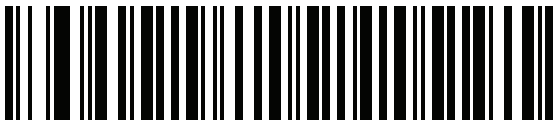

.5 Seconds

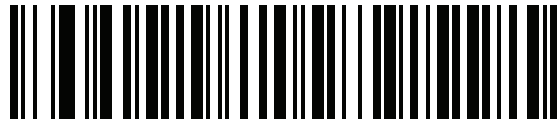

2 Seconds

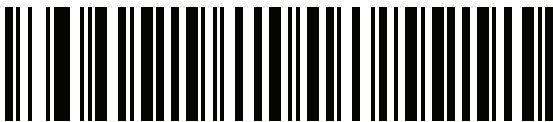

* 5 Seconds

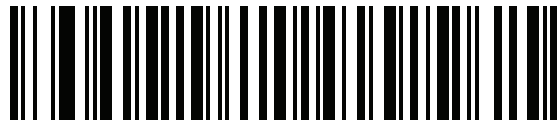

10 Seconds

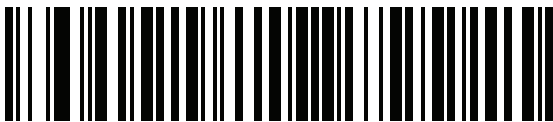

20 Seconds

Bluetooth Radio State

Parameter # 1354 (SSI # F8h 05h 4Ah)



NOTE: The radio on/off parameters are for both scanner and cradle. If the scanner is NOT connected to the cradle, the scanner's radio will turn off. If the scanner is connected to the cradle, both the scanner and cradle radios will be turned off. If the cradle radio is turned off, the only options to turn the cradle radio back on is via host command or using Parameter Batch Mode.

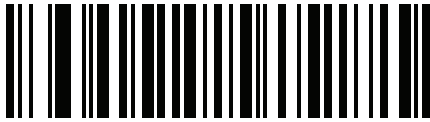

Bluetooth Radio Off

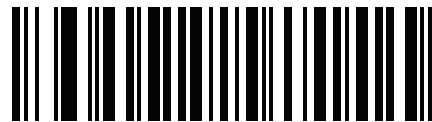

* Bluetooth Radio On

HID Host Parameters

The digital scanner supports virtual keyboard emulation for the Apple iOS, and keyboard emulation over the Bluetooth HID profile. In this mode the digital scanner can interact with Bluetooth enabled hosts supporting the HID profile as a Bluetooth keyboard. Scanned data is transmitted to the host as keystrokes.

Apple iOS Virtual Keyboard Toggle

Parameter # 1114 (SSI # F8h 04h 5Ah)

This option works with Apple iOS devices to enable the opening and closing of the iOS virtual keyboard by double-pressing the Scan Button or single-pressing the Programmable button, depending on the setting.



NOTE: When this feature is enabled, the digital scanner may be incompatible with non-Apple iOS devices. Enable this feature before connecting an Apple Device to use.



* Disable
(0)

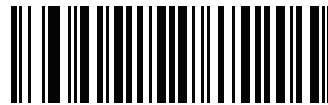

Enable
(1)

HID Keyboard Keystroke Delay

This parameter sets the delay, in milliseconds, between emulated keystrokes. Scan a barcode below to increase the delay when the HID host requires a slower transmission of data.



*** No Delay (0 msec)**



Medium Delay (20 msec)



Long Delay (40 msec)

HID CAPS Lock Override

When enabled, the case of the data is preserved regardless of the state of the caps lock key. This setting is always enabled for the “Japanese, Windows (ASCII)” keyboard type and can not be disabled.



*** Do Not Override Caps Lock Key
(Disable)**



**Override Caps Lock Key
(Enable)**

HID Ignore Unknown Characters

This option applies only to the HID Keyboard Emulation device and IBM device. Unknown characters are characters the host does not recognize. When **Send Barcodes With Unknown Characters** is selected, all barcode data is sent except for unknown characters, and no error beeps sound. When **Do Not Send Barcodes With Unknown Characters** is selected, barcode data is sent up to the first unknown character, then the digital scanner issues an error beep.



* **Send Barcodes With Unknown Characters**
(Enable)



Do Not Send Barcodes With Unknown Characters
(Disable)

Emulate Keypad

When enabled, all characters are sent as ASCII sequences over the numeric keypad. For example, ASCII A is sent as "ALT make" 0 6 5 "ALT Break."



Disable Keypad Emulation



* **Enable Keypad Emulation**

Fast HID Keyboard

Parameter # 1361 (SSI # F8h 05h 51h)

This option transmits Bluetooth HID keyboard data at a faster rate.

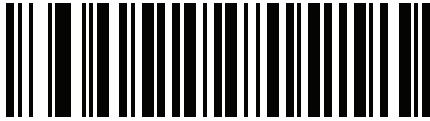

Fast HID Disable

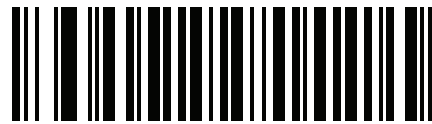

* Fast HID Enable

Quick Keypad Emulation

Parameter # 1362 (SSI # F8h 05h 52h)



NOTE: This option applies only to a HID Keyboard Emulation Device which has **Emulate Keypad** enabled (see [Emulate Keypad on page 152](#)).

This parameter enables a quicker method of keypad emulation where ASCII sequences are only sent for ASCII characters not found on the keyboard.

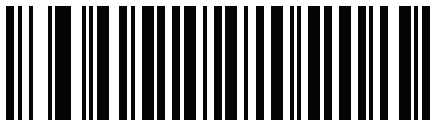

Quick Keypad Emulation Disable



* Quick Keypad Emulation Enable

HID Keyboard FN1 Substitution

When enabled, this parameter allows replacement of any FN1 character in an EAN128 barcode with a Key Category and value chosen by the user. See [FN1 Substitution Values on page 127](#) to set the Key Category and Key Value.



* Disable Keyboard FN1 Substitution



Enable Keyboard FN1 Substitution

HID Function Key Mapping

ASCII values under 32 are normally sent as control-key sequences. When this parameter is enabled, the keys in bold are sent in place of the standard key mapping (see [Table 30 on page 470](#)).

Table entries that do not have a bold entry remain the same whether or not this parameter is enabled.



* Disable Function Key Mapping



Enable Function Key Mapping

Simulated Caps Lock

When enabled, the digital scanner inverts upper and lower case characters on the digital scanner barcode as if the Caps Lock state is enabled on the keyboard. This inversion is done regardless of the current state of the keyboard Caps Lock state.



* Disable Simulated Caps Lock



Enable Simulated Caps Lock

Convert Case

When enabled, the digital scanner converts all barcode data to the selected case.



* No Case Conversion



Convert All to Upper Case



Convert All to Lower Case

Auto-Reconnect Feature

When in SPP Central, Cradle Host Mode, and Bluetooth Keyboard Emulation, the digital scanner automatically tries to reconnect to a remote device when a disconnection occurs that is due to the radio losing communication. This can happen if the digital scanner goes out of range with the remote device, or if the remote device powers down. The digital scanner tries to reconnect for the period of time specified by the Reconnect Attempt Interval setting. During that time the green LED continues to blink.

If the auto-reconnect process fails due to page time-outs, the digital scanner sounds a page timeout beep (long low/long high) and enters low power mode. The auto-reconnect process can be re-started by pressing the digital scanner trigger.

If the auto-reconnect process fails because the remote device rejects the connection attempt, the digital scanner sounds a connection reject beep sequence (see [Wireless Beeper Definitions on page 138](#)) and deletes the remote pairing address. If this happens, a pairing barcode must be scanned to attempt a new connection to the remote device.



NOTE: If a barcode is scanned while the auto-reconnect sequence is in process, a transmission error beep sequence sounds and the data is not transmitted to the host. After a connection is reestablished, normal scanning operation returns. For error beep sequence definitions, see [Beeper and LED Indications on page 39](#).

The digital scanner has memory available for storing a remote Bluetooth address for each Central Mode (SPP, Cradle). When switching between these modes, the digital scanner automatically tries to reconnect to the last device it was connected to in that mode.



NOTE: Switching between Bluetooth host types by scanning a host type barcode ([page 138](#)) causes the radio to be reset. Scanning is disabled during this time. It takes several seconds for the digital scanner to re-initialize the radio at which time scanning is enabled.

Auto-Reconnect Option

Parameter # 604 (SSI # F1h 5Ch)

In Bluetooth Keyboard Emulation (HID) mode, SPP Central, and Cradle Host Mode, select a re-connect option for when the digital scanner loses its connection with a remote device:

- **Auto-Reconnect on Barcode Data:** The digital scanner auto-reconnects when you scan a barcode. With this option, a delay can occur when transmitting the first characters. The digital scanner sounds a decode beep upon barcode scan, followed by a connection, a page timeout, a rejection beep, or a transmission error beep. Select this option to optimize battery life on the digital scanner and mobile device. Note that auto-reconnect does not occur on rejection and cable unplug commands.
- **Auto-Reconnect Immediately:** When the digital scanner loses connection, it attempts to reconnect. If a page timeout occurs, the digital scanner attempts reconnect on a trigger press. Select this option if the digital scanner battery life is not an issue and you do not want a delay to occur when the first barcode is transmitted. Note that auto-reconnect does not occur on rejection and cable unplug commands.
- **Disable Auto-Reconnect:** When the digital scanner loses connection, you must re-establish it manually.



Auto-Reconnect on Barcode Data
(1)

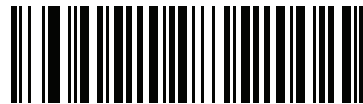

* Auto-Reconnect Immediately
(2)

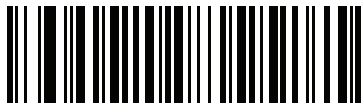

Disable Auto-Reconnect
(0)

Reconnect Attempt Beep Feedback

Parameter # 559 (SSI # F1h 2Fh)

When a digital scanner disconnects as it goes out of range, it immediately attempts to reconnect. While the digital scanner attempts to reconnect, the green LED continues to blink. If the auto-reconnect process fails, the digital scanner emits a page timeout beep (long low/long high) and stops blinking the LED. The process can be restarted by pressing the trigger.

The Beep on Reconnect Attempt feature is disabled by default. When enabled, the digital scanner emits 5 short high beeps every 5 seconds while the re-connection attempt is in progress. Scan a barcode below to enable or disable Beep on Reconnect Attempt.



* Disable Beep on Reconnect Attempt
(0)



Enable Beep on Reconnect Attempt
(1)

Reconnect Attempt Interval

Parameter # 558 (SSI # F1h 2Eh)

When a digital scanner disconnects, it immediately attempts to reconnect for the default time interval of 30 seconds. This time interval can be changed to one of the options below.

To set the Reconnect Attempt Interval, scan one of the barcodes below.



* Attempt to Reconnect for 30 Seconds
(6)



Attempt to Reconnect for 1 Minute
(12)

Reconnect Attempt Interval (continued)



Attempt to Reconnect for 1.5 Minutes
(18)



Attempt to Reconnect for 2 Minutes
(24)



Attempt to Reconnect for 5 Minutes
(60)



Attempt to Reconnect for 30 Minutes
(360)



Attempt to Reconnect for 1 Hour
(720)



Attempt to Reconnect Indefinitely
(0)

Sleep Between Attempts

Parameter # 1778 (SSI # F8h 06h F2h)

Scan a barcode below to reduce potential Wi-Fi interference and extend scanner battery life by allowing the scanner to go to sleep (low power mode) for the time indicated between reconnect attempts.



NOTE: This feature only works when low power mode is enabled on the scanner and when the scanner is not charging in the cradle.



Sleep for 30 Seconds
(30)



* Sleep for 1 Minute
(60)



Sleep for 2 Minutes
(120)



Sleep for 5 Minutes
(300)



Sleep for 30 Minutes
(1800)



Sleep for 1 Hour
(3600)

Number of Retry Attempts

Parameter # 1779 (SSI # F8h 06h F3h)

Scan a barcode below to control how many reconnect and associated sleep attempts to execute. After the number of retries is reached, the scanner no longer attempts to reconnect to the host.



NOTE: After the retry period expires, if the trigger is pressed, the scanner restarts the auto-reconnect and sleep sequence.



*** Do Not Retry
(0)**



**Retry 5 Times
(5)**



**Retry 10 Times
(10)**



**Retry 20 Times
(20)**



**Retry 40 Times
(40)**

Out of Range Indicator

An out of range indicator can be set by scanning [Enable Beep on Reconnect Attempt \(1\)](#) on page 158 and extending the time using the [Reconnect Attempt Interval](#) on page 158.

For example, with Beep on Reconnect Attempt disabled while the digital scanner loses radio connection when it is taken out of range, the digital scanner attempts to reconnect silently during the time interval set by scanning a Reconnect Attempt Interval.

When Beep on Reconnect Attempt is enabled, the digital scanner emits 5 high beeps every 5 seconds while the re-connection attempt is in progress. If the Reconnect Attempt Interval is adjusted to a longer period of time, such as 30 minutes, the digital scanner emits 5 high beeps every 5 seconds for 30 minutes providing an out of range indicator.

Beep on Insertion

Parameter # 288 (SSI # 20h)

When a digital scanner is inserted into a cradle and detects power, it emits a short low beep. This feature is enabled by default.

To enable or disable beeping on insertion, scan the appropriate barcode below.



*** Enable Beep on Insertion
(1)**



**Disable Beep on Insertion
(0)**

Beep on <BEL>

Parameter # 150 (SSI # 96h)



NOTE: This parameter only applies to Bluetooth SPP (Serial Port Profile) and USB CDC Host.

If you enable this parameter, the digital scanner issues a beep when it detects a <BEL> character. <BEL> indicates an illegal entry or other important event.

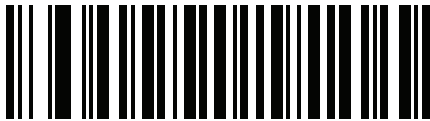

* Beep on <BEL> Enable

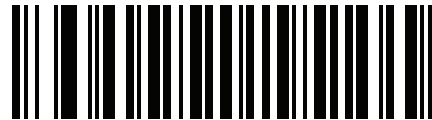

Beep on <BEL> Disable

Digital Scanner(s) To Cradle Support

Pairing

Pairing is the process by which a digital scanner initiates communication with a cradle.

To pair the digital scanner with the cradle, scan the pairing barcode. A high/low/high/low beep sequence indicates that the pairing barcode was decoded. When a connection between the cradle and digital scanner is established, a low/high beep sounds.



- NOTE:**
1. The pairing barcode that connects the digital scanner to a cradle is unique to each cradle.
 2. Do not scan data or parameters until pairing completes.
 3. Only when the digital scanner is paired to the cradle, it automatically tries to reconnect to a remote device when a disconnection occurs that is due to the radio losing communication. For more information see [Auto-Reconnect Feature on page 156](#).

Pairing Modes

Parameter # 542 (SSI # F1h 1Eh)

When operating with the cradle, two modes of pairing are supported:

- **Locked Pairing Mode** - When a cradle is paired (connected) to the digital scanner, any attempt to connect a different digital scanner, by either scanning the **PAIR** barcode on the cradle or by inserting it into the cradle with the pairing on contacts feature enabled ([page 165](#)), is rejected. The currently connected digital scanner(s) maintain connection. In this mode, you must set a [Connection Maintenance Interval on page 167](#).
- **Unlocked Pairing Mode** - Pair (connect) a new digital scanner to a cradle at any time by either scanning the **PAIR** barcode on the cradle or by inserting it into the cradle with the pairing on contacts feature enabled. This unpairs the previous digital scanner from the cradle.

To set the cradle pairing mode, scan the appropriate barcode below.



* Unlocked Pairing Mode
(0)



Locked Pairing Mode
(1)

Lock Override

Lock Override overrides a locked digital scanner base pairing and connects a new digital scanner. To use **Lock Override**, scan the barcode below, followed by the pairing barcode on the cradle.



Lock Override

Pairing Methods

Parameter # 545 (SSI # F1h 21h)

There are two pairing methods. The default method allows the digital scanner and cradle to pair (connect) when the pairing barcode on the cradle is scanned. A second method pairs the digital scanner and cradle when the digital scanner is inserted in the cradle. To enable this feature, scan **Enable Pair On Contacts** below. With this feature enabled it is not necessary to scan the pairing barcode on the cradle. If the pairing is successful, a low/high connection beep sequence sounds a few seconds after the digital scanner is placed in the cradle. See [Wireless Beeper Definitions on page 138](#) for other beep sequences.

To enable or disable pairing on contacts, scan the appropriate barcode below.



* Enable Pair On Contacts
(1)



Disable Pair on Contacts
(0)

Press Trigger Twice to Re-connect



IMPORTANT: This feature only applies to hosts capable of a commanded connection; SPP Peripheral and HID BLE hosts do not support this feature.

Upon a double trigger press, the scanner attempts to connect to the last known address. This feature differs from auto-reconnect (see [Auto-Reconnect Feature on page 156](#)) in that the scanner attempts connection only once and keeps the address even on commanded disconnect. The last known address is only cleared upon a reject or with a new successful connection. The address persists over scanner reboot.



NOTE: This feature does not interfere with a double trigger press to open/close an iOS keypad in HID mode.

Unpairing



NOTE: When unpairing the digital scanner the host may issue a connection back to the scanner after scanner disconnects.

Unpair the digital scanner from the cradle or PC/host to make the cradle available for pairing with another digital scanner. Scan the barcode below to disconnect the digital scanner from its cradle/PC host.



Unpairing

Toggle Pairing

Parameter # 1322 (SSI # F8h 05h 2Ah)

If the scanner is configured for Toggle Pairing, scanning the Toggle Pairing barcode a second time will unpair the scanner.

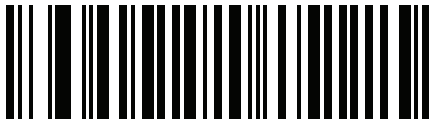

* Toggle Pairing Disable



Toggle Pairing Enable

Pairing Barcode Format Using the Scan-To-Connect (STC) Utility

Use the STC utility to create a pairing barcode in one step by connecting the Zebra Bluetooth scanner to a phone, tablet, or PC by scanning an STC barcode.

The STC utility is available as a standalone utility. Supported operating systems include Windows and Android.

For more information, go to www.zebra.com/scantoconnect. Source code is also available for easy app integration.

Connection Maintenance Interval



NOTE: The Connection Maintenance Interval only applies in locked pairing mode (see [page 164](#)).

When a digital scanner disconnects from a cradle due to a Link Supervision Timeout, the digital scanner immediately attempts to reconnect to the cradle for 30 seconds. If the auto-reconnect process fails, it can be restarted by pressing the digital scanner trigger.

To guarantee that a disconnected digital scanner can reconnect when it comes back in range, the cradle reserves the connection for that digital scanner for a period of time defined by the Connection Maintenance Interval. If the cradle is supporting the maximum three digital scanners and one digital scanner disconnects, a fourth digital scanner cannot pair to the cradle during this interval. To connect another digital scanner: either wait until the connection maintenance interval expires then scan the **PAIR** barcode on the cradle with the new digital scanner; or, scan **Lock Override** ([page 165](#)) with the new digital scanner then scan the **PAIR** barcode on the cradle.



NOTE: The cradle stores the remote pairing address of each digital scanner in memory regardless of the digital scanner condition (e.g., discharged battery). When you want to change the digital scanners paired to the cradle, unpair each digital scanner currently connected to the cradle by scanning the **Unpairing** barcode prior and reconnect each appropriate digital scanner by scanning the **PAIR** barcode on the cradle.

Considerations

The system administrator determines the Connection Maintenance Interval. A shorter interval allows new users to gain access to abandoned connections more quickly, but causes problems if users leave the work area for extended periods. A longer interval allows existing users to leave the work area for longer periods of time, but ties up the system for new users.

To avoid this conflict, users who are going off-shift can scan the unpair barcode on [page 166](#) to ignore the Connection Maintenance Interval and make the connection immediately available.

To set the Connection Maintenance Interval, scan one of the barcodes below.



* Set Interval to 15 Minutes
(0)



Set Interval to 30 Minutes
(1)

Connection Maintenance Interval (continued)



Set Interval to 60 Minutes
(2)



Set Interval to 2 Hours
(3)



Set Interval to 4 Hours
(4)



Set Interval to 8 Hours
(5)



Set Interval to 24 Hours
(6)



Set Interval to Forever
(7)

AutoConfig (Scanner Cloning Through Cradle)

Parameter # 2139 (SSI # F8 08 5B)

This parameter controls scanner cloning through the cradle. When enabled, the cradle's stored scanner parameters are transmitted to the CS6080 upon pairing to the cradle, configuring the CS6080 with updated parameters. This allows the scanner to be automatically configured for a new host application, use case, or workflow. This feature is disabled by default.



* Disable
(0)



Enable
(1)

The cradle's configuration of the scanner is limited to the following scanner parameters:

- All Symbologies Parameters (see [Radio Communications on page 136](#))
- Advanced Data Formatting rules (see [Advanced Data Formatting \(ADF\) on page 341](#))
- Night Mode Trigger (see [Night Mode Trigger on page 75](#))
- Lamp Mode Control and Timeout (see [Lamp Mode Control on page 89](#) and [Lamp Mode Timeout on page 90](#))
- securPharm Decoding and Output Formatting (see [securPharm Decoding on page 130](#) and [securPharm Output Formatting on page 131](#))
- Multicode Rules (see [Multicode Data Formatting on page 341](#))
- Data Parsing (UDI, Blood Bag, GS1 Label) rules (see [Data Parsing \(UDI Scan+, Label Parse+ and Blood Bag Parse+\) on page 344](#))
- Picklist Mode (see [Picklist Mode on page 100](#))
- Reconnect Attempt Beep Feedback (see [Reconnect Attempt Beep Feedback on page 158](#)).



NOTE: When AutoConfig (Scanner Cloning Through Cradle) is enabled, scanning is disabled for up to 3 to 5 seconds while the configuration is being uploaded to the scanner. The blue LED will blink during this period.

Any pre-programmed scanner settings listed above are temporarily overwritten during connection once AutoConfig (Scanner Cloning Through Cradle) is performed by pairing the scanner and cradle.

Cradle Configuration

The cradle can be configured using one of the following methods:

- 123Scan

- Parameter barcodes



NOTE: The scanner must be paired to the cradle when performing parameter barcode scanning for it to persist and be loaded in the future AutoConfig (Scanner Cloning Through Cradle) sessions.

- A Zebra scanner SDK generated application.
- SMS

Batch Mode

Parameter # 544 (SSI # F1h 20h)



IMPORTANT: Batch mode does not apply to SPP Peripheral Mode.

The digital scanner supports five versions of batch mode. When the digital scanner is configured for any of the batch modes, it attempts to store barcode data (not parameter barcodes) until transmission is initialized, or the maximum number of barcodes are stored. When a barcode is saved successfully, a good decode beep sounds and the LED flashes green. If the digital scanner is unable to store a new barcode, a low/high/low/high out of memory beep sounds. (See page 39 for all beeper and LED definitions.)

In all modes, calculate the amount of data (number of barcodes) the digital scanner can store as follows:

$$\text{Number of storable barcodes} = 30,720 \text{ bytes of memory} / (\text{number of characters in the barcode} + 3).$$



NOTE: If the batch mode selection is changed while there is batched data, the new batch mode takes effect only after all the previously batched data is sent.

Modes of Operation

- **Normal (default)** - Do not batch data. The digital scanner attempts to transmit every scanned barcode.
- **Out of Range Batch Mode** - The digital scanner starts storing barcode data when it loses its connection to a remote device (for example, when a user holding the digital scanner walks out of range). Data transmission is triggered by reestablishing the connection with the remote device (for example, when a user holding the digital scanner walks back into range).



NOTE: Do not use Out of Range Batch Mode together with the [Auto-Reconnect Feature on page 156](#). Decode data scanned will be batched and will not cause the scanner to reconnect.

- **Standard Batch Mode** - The digital scanner starts storing barcode data after **Enter Batch Mode** is scanned. Data transmission is triggered by scanning **Send Batch Data**.



NOTE: Transmission is halted if the connection to the remote device is lost.

- **Cradle Contact Batch Mode** - The digital scanner starts storing barcode data when **Enter Batch Mode** is scanned. Data transmission is triggered by insertion of the digital scanner into the cradle.



NOTE: If the digital scanner is removed from the cradle during batch data transfer, transmission halts until the digital scanner is re-inserted in the cradle.

- **Cable Batch Mode** - Use scanner with a battery to store data to non-volatile memory. Data will be sent out when the scanner is connected to the PC via USB cable. The value for the barcode is 5.



NOTE: FIPS mode must be disabled and persistent batch mode must be enabled for the feature to work.

- **Parameter Batch Mode** - When **Parameter Batch Mode** is entered and no connection to the cradle exists, the scanner begins storing parameter barcode data intended for the cradle. Parameter barcode transmission is triggered by insertion of the scanner into the cradle. Parameter Batch Mode is exited upon the end of the transmission. Alternatively, parameter barcode batching may be cancelled prior to insertion of the scanner into the cradle by scanning **Exit Parameter Batch Mode**.

Parameter Batch Mode may be used when the cradle and/or scanner is configured with its radio turned off or connected to a non-cradle device.

In all modes, transmissions are halted if the digital scanner is moved out of range. The digital scanner resumes when it is back in range. If a barcode is scanned while batch data is transmitted it is appended to the end of the batched data; parameter barcodes are not stored.



* Normal
(00h)



Out of Range Batch Mode
(01h)



Standard Batch Mode
(02h)



Cradle Contact Batch Mode
(03h)



Enter Batch Mode

Batch Mode (continued)



Send Batch Data



Cable Batch Mode

(5)



Enter Parameter Batch Mode



Exit Parameter Batch Mode

Persistent Batch Storage

Parameter #1399 (F8h 05h 77h)

When the scanner is configured for Persistent Batch Storage, batch data is stored in non-volatile memory and preserved even when the digital scanner is powered down. This parameter is Disabled by default.



NOTE: Frequently storing batch data with this setting *Enabled* will shorten the life of the non-volatile memory.

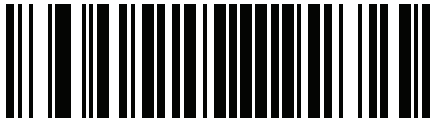

* Persistent Batch Disable
(0)

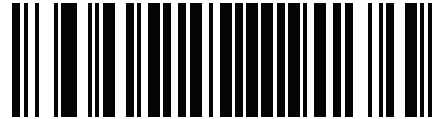

Persistent Batch Enable
(1)

Page Button

Parameter # 746 (SSI # F1h EAh)

The cradle offers a page button. The page button is a sensor that when touched, causes paired scanners to emit a beeping sequence. The default is Enable **Page Button**.

1. Place your finger over the button sensor .
2. Press down for approximately 1 second.
3. The cradle LED will turn blue when the scanner is out of the cradle. The paired scanner will beep, blink, and vibrate. If multiple scanners are paired to the cradle, all the scanners will beep, blink, and vibrate.
4. Repeat as necessary.



NOTE: Scanners out of radio range will not beep when paged. See [Technical Specifications on page 58](#) for detailed radio range information.

Scan one of the following barcodes to enable or disable this feature.



Disable Page Button
(0)

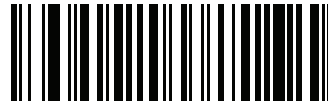

* Enable Page Button
(1)

Page Options

To select a page option, select one of the barcodes below.

Page Mode

Parameter # 1364 (SSI # F8h 05h 54h)

- **Page State** - In this mode, the cradle sends a page state request to each scanner. It remains in Page State indication until every scanner sends an acknowledgment.

The scanner enters Page State when the LED indicator is blinking blue and the vibrator and beeper is activated. When the trigger is pressed, or the scanner is inserted into the cradle, or the requested timeout (default is 30 sec) is reached, the scanner sends the acknowledgment to the cradle and returns to its normal state.

- **Page Simple** - In this mode, the cradle sends a page indication request to each scanner, and returns to idle state. Each scanner issues a single Page State indication.

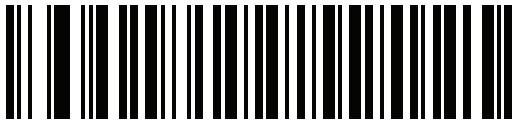

Page State

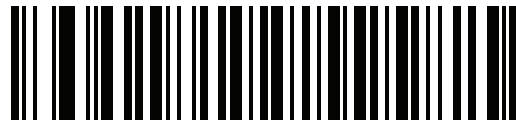

* Page Simple

Page State Timeout

Parameter # 1365 (SSI # F8h 05h 55h)

Page timeout is programmable in 1 second increments from 1 to 99 seconds. The default timeout is 30 seconds.



NOTE: Page State Timeout only applies to Page State Mode.

To set a page timeout:

1. Scan the **Page Timeout** barcode below.

2. Scan two numeric barcodes from [Numeric Barcodes on page 451](#) that correspond to the desired timeout duration. Enter a leading zero for single digit numbers (for example, for a 5 second page timeout, scan the 0 barcode and then the 5 barcode). To correct an error or change the selection, scan [Cancel on page 451](#).

The Page State Timeout default is 30 seconds.

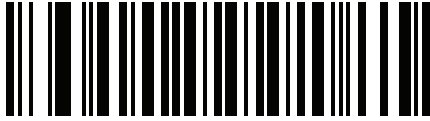

Page Timeout

Cradle Bluetooth Operation Mode

Parameter # 1355 (SSI # F8h 05h 4Bh)

Set up cradle to accept only **Bluetooth Classic** both **Bluetooth Classic and Low Energy** connections or **Low Energy Only** connections.



NOTE: All **Bluetooth Classic** connections must be terminated before the setting can change to **Low Energy Only**. All **Low Energy** connections must be terminated before setting can change to **Bluetooth Classic Only**.

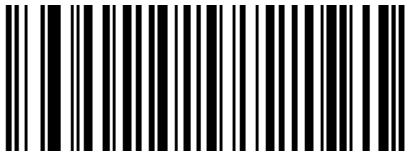

* Bluetooth Classic Only

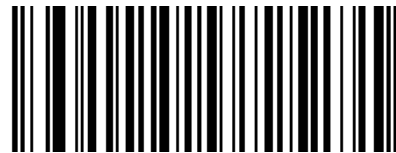

Bluetooth Classic and Low Energy

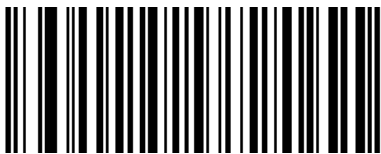

Low Energy Only

Bluetooth Security

The digital scanner supports Bluetooth Authentication. Authentication can be requested by either the remote device or the digital scanner.



NOTE: A remote device can still request Authentication.

Bluetooth Security Levels

Parameter # 1393 (SSI # F8h 05h 71h)

For more information on Bluetooth security, see Chapter 3 of the Guide to Bluetooth Security:

<https://nvlpubs.nist.gov/nistpubs/SpecialPublications/NIST.SP.800-121r2.pdf>



NOTE: Data sent over Bluetooth is encrypted in all security modes.

- **Low Bluetooth Security (default)** - The low security setting is designed for ease of connection with most devices and minimal user interaction. Uses "Just Works" secure and simple pairing method with no man in the middle protection. Provides level 2 security (as per Guide to Bluetooth Security).
- **Medium Bluetooth Security** - The medium security setting requires a passkey for the initial connection to pair scanner to remote host (unless using NFC OOB). Uses "Passkey Entry" secure and simple pairing method with man in the middle protection. Provides level 3 security (as per Guide to Bluetooth Security).
- **High Bluetooth Security** - The high security setting requires "Secure Connections" (AES-128) between scanner and remote host. Scanning in of a passkey is required (unless using NFC OOB). Scanner only supports high security when configured for Bluetooth Low Energy host. Provides level 4 security (as per Guide to Bluetooth Security).



NOTE: When using medium or high security setting:

- If connecting to a cradle, place scanner in the cradle for initial pairing.
- If connecting to host supporting OOB pairing over NFC, use tap to pair method.
- If connecting to a host that does not support OOB pairing over NFC, passkey entry is required.

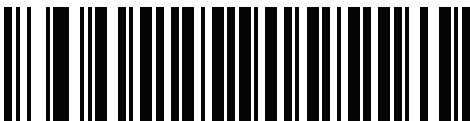

* Low Bluetooth Security

Bluetooth Security Levels (continued)

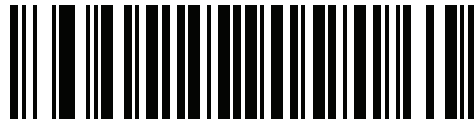

Medium Bluetooth Security

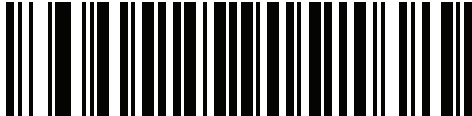

High Bluetooth Security

Save Bluetooth Connection Information

Parameter # 1743 (F8h 06h CFh)

Scan a bar code below to enable or disable the digital scanner's ability to save Bluetooth connection information.



NOTE: Depending on the auto-reconnect settings, the scanner reconnects when going out of range and other conditions where connection is lost, but auto-reconnect is desired.

- **Enable (default)** - The scanner saves the last connection and attempts to reconnect after battery swap (power cycle) if it is set to auto-reconnect. See [Auto-Reconnect Feature on page 156](#).
- **Disable** - The scanner does not save the last connection to permanent memory and does not reconnect after battery swap (power cycle).



* Save Bluetooth Connection Information
(Enable)



Save Bluetooth Connection Information
(Disable)

FIPS Mode

Parameter # 736 (SSI # F1h E0h)

The Federal Information Processing Standard (FIPS) 140-2 is a U.S. government computer security standard used to accredit cryptographic modules. FIPS enabled scanners and cradles offer this secure mode of operation.

To enable the FIPS mode of operation (disabled by default), scan the **Enable FIPS** barcode. The scanner attempts to establish a secure session with the cradle to which it is connected. On success, the scanner lights an amber LED on every trigger press to signal that all data will be transmitted over Bluetooth in a secure fashion. On failure, the scanner will sound transmission failure error message on every attempt to transmit data.

To disable the FIPS mode, scan the **Disable FIPS** barcode at any time.



Enable FIPS
(1)



*** Disable FIPS**
(0)

Bluetooth Radio, Linking, and Batch Operation

The CS6080 digital scanner has a Bluetooth Class 1 qualified and Class 2 capable radio which achieves a range of at least 100 m / 330 ft. (open air, line of sight). The actual range you achieve is influenced by the presence of other radios, shelving and wall materials as well as which cradle is tested. The environments vary widely and often influence radio ranges.

When the digital scanner goes out of communications range to the base, it can be configured for Batch Mode (see [This parameter controls scanner cloning through the cradle. When enabled, the cradle's stored scanner parameters are transmitted to the CS6080 upon pairing to the cradle, configuring the CS6080 with updated parameters. This allows the scanner to be automatically configured for a new host application, use case, or workflow. This feature is disabled by default. on page 169](#)). The digital scanner has sufficient onboard memory to store 500 barcodes of typical size (UPC/EAN).

Setting Up an iOS or Android Product To Work With The Digital Scanner

Perform the following steps on each device to establish a link.

HID Keyboard Emulation

1. On the CS6080, scan [Human Interface Device \(HID\) Keyboard Emulation on page 140](#).
2. On an iOS/iPad/iPhone, select **Settings > General > Bluetooth** and turn Bluetooth On. Choose the CS6080 digital scanner from the list of discovered devices. A link should be established allowing scanning into any application with keyboard entry.
3. On an Android/ET1/Droid, select **Settings > Wireless & networks > Bluetooth** (to turn Bluetooth on, if not already on). Select Bluetooth Settings and choose the CS6080 digital scanner from the list of discovered devices. (The CS6080 digital scanner normally displays as CS6080 - xxxxxx, where xxxxxx is the serial number.)

Imaging Preferences

Introduction

You can program the digital scanner to perform various functions, or activate different features. This chapter describes imaging preference features and provides programming barcodes for selecting these features.



NOTE: Only the Symbol Native API (SNAPI) with Imaging interface supports image capture. See [Symbol Native API \(SNAPI\) Status Handshaking on page 208](#) to enable this host.

The digital scanner ships with the settings in [Imaging Preferences Parameter Defaults on page 182](#) (also see [Standard Parameter Defaults](#) for all host device and miscellaneous defaults). If the default values suit requirements, programming is not necessary.

To set feature values, scan a single barcode or a short barcode sequence. The settings are stored in non-volatile memory and are preserved even when you power down the digital scanner.



NOTE: Most computer monitors allow scanning the barcodes directly on the screen. When scanning from the screen, be sure to set the document magnification to a level where you can see the barcode clearly, and bars and/or spaces are not merging.

To return all features to default values, scan [* Restore Defaults on page 67](#). Throughout the programming barcode menus, asterisks (*) indicate default values.



Scanning Sequence Examples

In most cases scanning one barcode sets the parameter value. For example, to disable image capture illumination, scan the **Disable Image Capture Illumination** barcode under [Image Capture Illumination on page 185](#). The digital scanner issues a fast warble beep and the LED turns green, signifying a successful parameter entry.

Other parameters require scanning several barcodes. See these parameter descriptions for this procedure.

Errors While Scanning

Unless otherwise specified, to correct an error during a scanning sequence, just re-scan the correct parameter.

Imaging Preferences Parameter Defaults

[Table 12](#) lists the defaults for imaging preferences parameters. To change the default values, scan the appropriate barcodes in this guide. These new values replace the standard default values in memory. To recall the default parameter values, scan * [Restore Defaults on page 67](#).



NOTE: See [Standard Parameter Defaults](#) for all user preferences, hosts, symbologies, and miscellaneous default parameters.

Table 12 Imaging Preferences Parameter Defaults

Parameter	Parameter Number	SSI Number	Default	Page Number
Imaging Preferences				
Operational Modes	N/A	N/A	N/A	183
Image Capture Illumination	361	F0h 69h	Enable	185
Image Capture Autoexposure	360	F0h 68h	Enable	185
Fixed Exposure	567	F4h F1h 37h	100	186
Fixed Gain	568	F1h 38h	50	186
Gain / Exposure Priority for Snapshot Mode	562	F1h 32h	Autodetect	187
Snapshot Mode Timeout	323	F0h 43h	0 (30 seconds)	188
Snapshot Aiming Pattern	300	F0h 2Ch	Enable	189
Silence Operational Mode Changes	1293	F8h 05h 0Dh	Disable (do not silence)	189
Image Cropping	301	F0h 2Dh	Disable	190
Crop to Pixel Addresses	315 316 317 318	F4h F0h 3Bh F4h F0h 3Ch F4h F0h 3Dh F4h F0h 3Eh	0 top 0 left 959 bottom 1279 right	190
Image Size (Number of Pixels)	302	F0h 2Eh	Full	191
Image Brightness (Target White)	390	F0h 86h	180	192
JPEG Image Options	299	F0h 2Bh	Quality	193

Table 12 Imaging Preferences Parameter Defaults (Continued)

Parameter	Parameter Number	SSI Number	Default	Page Number
JPEG Target File Size	561	F1h 31h	160 kB	193
JPEG Quality and Size Value	305	F0h 31h	65	194
Image Enhancement	564	F1h 34h	Low (1)	194
Image File Format Selector	304	F0h 30h	JPEG	195
Image Rotation	665	F1h 99h	0	196
Bits per Pixel (BPP)	303	F0h 2Fh	8 BPP	196
Signature Capture	93	5Dh	Disable	197
Signature Capture Image File Format Selector	313	F0h 39h	JPEG	198
Signature Capture Bits per Pixel (BPP)	314	F0h 3Ah	8 BPP	199
Signature Capture Width	366	F4h F0h 6Eh	400	200
Signature Capture Height	367	F4h F0h 6Fh	100	200
Signature Capture JPEG Quality	421	F0h A5h	65	200
Video Mode Format Selector	916	F2h 94h	JPEG	201
Video View Finder	324	F0h 44h	Disable	201
Video View Finder Image Size	329	F0h 49h	1700 Bytes	202
Video Subsampling	667	F1h 9Bh	1/4 Resolution	203

Imaging Preferences

The parameters in this chapter control image capture characteristics. Image capture occurs in all modes of operation, including decode and snapshot.

Operational Modes

The digital scanner has three modes of operation:

- Decode Mode
- Snapshot Mode
- Video Mode.

Decode Mode

By default, when you press the trigger the digital scanner attempts to locate and decode enabled barcodes within its field of view. The digital scanner remains in this mode until it decodes a barcode or you release the trigger.

Snapshot Mode

Use Snapshot Mode to capture a high-quality image and transmit it to the host. To temporarily enter this mode scan the **Snapshot Mode** barcode. While in this mode the digital scanner blinks the green LED at 1-second intervals to indicate it is not in standard operating (decode) mode.

In Snapshot Mode, the digital scanner turns on its aiming pattern to highlight the area to capture in the image. The next trigger press instructs the digital scanner to capture a high quality image and transmit it to the host. A short time may pass (less than 2 seconds) between when the trigger is pressed and the image is captured as the digital scanner adjusts to the lighting conditions. Hold the digital scanner steady until the image is captured, denoted by a single beep.

If you do not press the trigger within the Snapshot Mode Timeout period, the digital scanner returns to Decode Mode. Use [Snapshot Mode Timeout on page 188](#) to adjust this timeout period. The default timeout period is 30 seconds.

To disable the aiming pattern during Snapshot Mode, see [Snapshot Aiming Pattern on page 189](#).



Snapshot Mode

Video Mode



NOTE: Applies to corded configurations only.

In this mode the imager behaves as a video camera as long as you press the trigger. Release the trigger to return to Decode Mode. Scan this barcode to temporarily enter Video Capture Mode.



Video Mode

Image Capture Illumination

Parameter # 361 (SSI # F0h 69h)

Selecting **Enable Image Capture Illumination** causes illumination to turn on during every image capture. Disable illumination to prevent the digital scanner from using illumination.

Enabling illumination usually results in superior images. The effectiveness of illumination decreases as the distance to the target increases.



* Enable Image Capture Illumination
(1)



Disable Image Capture Illumination
(0)

Image Capture Autoexposure

Parameter # 360 (SSI # F0h 68h)

Select **Enable Image Capture Autoexposure** to allow the digital scanner to control gain settings and exposure (integration) time to best capture an image for the selected operation mode.

Select **Disable Image Capture Autoexposure** to manually adjust the gain and exposure time (see the following pages). This option is only recommended for advanced users with difficult image capture situations.



* Enable Image Capture Autoexposure
(1)



Disable Image Capture Autoexposure
(0)

Fixed Exposure

Parameter # 567 (SSI # F4h F1h 37h)

Type: Word

Range: 5 to 30,000

This parameter configures the exposure used in manual mode for Snapshot mode.

Each integer value represents 100 μ s worth of exposure. The default value is 100 which results in an exposure setting of 10 ms.

To set the **Fixed Exposure** parameter, scan **Fixed Exposure** followed by four numeric barcodes representing the value. Leading zeros are required. For example, to set a Fixed Exposure value of 99, scan 0, 0, 9, 9. See [Numeric Barcodes](#) for numeric barcodes.



Fixed Exposure
(4 digits)

Fixed Gain

Parameter # 568 (SSI # F1h 38h)

Type: Byte

Range 1 - 100

This parameter configures the gain setting used in manual mode for Snapshot modes.

A value of 1 indicates that gain is not used for image capture. A value of 100 indicates that maximum gain is used for image capture. The default value of this parameter is 50.

To set the **Fixed Gain** parameter, scan **Fixed Gain** below followed by three numeric barcodes representing the value. Leading zeros are required. For example, to set a Fixed Gain value of 99, scan 0, 9, 9. See [Numeric Barcodes](#) for numeric barcodes.



Fixed Gain

Gain/Exposure Priority for Snapshot Mode

Parameter # 562 (SSI # F1h 32h)

This parameter alters the digital scanner gain exposure priority when it acquires an image in Snapshot Mode in auto exposure mode.

- Scan **Low Exposure Priority** to set a mode in which the digital scanner favors higher gain over exposure to capture an image. This results in an image that is less susceptible to motion blur at the expense of noise artifacts. However, for most applications, the amount of noise is acceptable.
- Scan **Low Gain Priority** to set a mode in which the digital scanner favors longer exposure time rather than higher gain to capture an image. This ensures that the image is less noisy and produces fewer artifacts during post processing activities like image enhancement (sharpening). The mode is recommended for fixed mount / fixed object image capture since the image acquired is susceptible to motion blur.
- Scan **Autodetect** (default) to set a mode in which the digital scanner automatically selects Gain Priority or Low Exposure Priority mode for Snapshot Mode. If the digital scanner is in a magnetic reed switch enabled stand (or it is configured in Blink Mode), it uses Low Gain Priority mode. Otherwise, it uses the Low Exposure Priority mode.



Low Gain Priority
(0)



Low Exposure Priority
(1)



* Autodetect
(2)

Snapshot Mode Timeout

Parameter # 323 (SSI # F0h 43h)

This parameter sets the amount of time the imager remains in Snapshot Mode. The imager exits Snapshot Mode when you press the trigger, or when the Snapshot Mode Timeout elapses. To set this timeout value, scan the **Set Snapshot Mode Timeout** barcode, and then scan a barcode from [Numeric Barcodes on page 451](#). The default value is 0 which represents 30 seconds; values increment by 30. For example, 0 = 30 seconds, 1 = 60 seconds, 2 = 90 seconds, etc. The maximum timeout value that can be set on the scanner is 9 = 300 seconds.

To quickly re-set the default timeout to 30 seconds, scan the **30 Seconds** barcode.

If you scan **No Timeout**, the imager remains in Snapshot Mode until you press the trigger.



Set Snapshot Mode Timeout

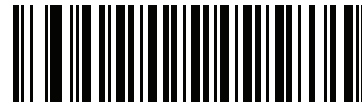

*** 30 Seconds**

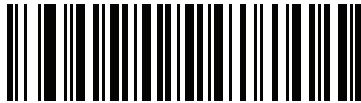

No Timeout

Snapshot Aiming Pattern

Parameter # 300 (SSI # F0h 2Ch)

Select **Enable Snapshot Aiming Pattern** to project the aiming pattern when in Snapshot Mode, or **Disable Snapshot Aiming Pattern** to turn the aiming pattern off.



* **Enable Snapshot Aiming Pattern**
(1)



Disable Snapshot Aiming Pattern
(0)

Silence Operational Mode Changes

Parameter # 1293 (SSI # F8h 05h 0Dh)

Enable this feature to silence the beeper when switching between operational modes (e.g., from Decode Mode to Snapshot Mode).



Silence Operational Mode Changes (Enable)
(1)



* **Do Not Silence Operational Mode Changes (Disable)**
(0)

Image Cropping

Parameter # 301 (SSI # F0h 2Dh)

This parameter crops a captured image. Select **Disable Image Cropping** to present the full 1280 x 960 pixels. Select **Enable Image Cropping** to crop the image to the pixel addresses set in [Crop to Pixel Addresses on page 190](#).



Enable Image Cropping
(1)



* Disable Image Cropping
(Use Full 1280 x 960 Pixels)
(0)

Crop to Pixel Addresses

Parameter # 315 (SSI # F4h F0h 3Bh) (Top)

Parameter # 316 (SSI # F4h F0h 3Ch) (Left)

Parameter # 317 (SSI # F4h F0h 3Dh) (Bottom)

Parameter # 318 (SSI # F4h F0h 3Eh) (Right)

If you selected **Enable Image Cropping**, set the pixel addresses from (0,0) to (1259 x 959) to crop to.

Columns are numbered from 0 to 1279, rows from 0 to 959. Specify four values for Top, Left, Bottom, and Right, where Top and Bottom correspond to row pixel addresses, and Left and Right correspond to column pixel addresses. For example, for a 4 row x 8 column image in the extreme bottom-right section of the image set the following values:

Top = 796, Bottom = 959, Left = 1272, Right = 1279

To set the crop to pixel address, scan each pixel address barcode below followed by four numeric barcodes representing the value. Leading zeros are required. For example, to crop the top pixel address to 3, scan 0, 0, 0, 3. See [Numeric Barcodes](#) for numeric barcodes. The defaults are:

Top = 0, Bottom = 959, Left = 0, Right = 1279



NOTE: The digital scanner has a cropping resolution of 4 pixels. Setting the cropping area to less than 4 pixels (after resolution adjustment, see [Image Size \(Number of Pixels\) on page 191](#)) transfers the entire image.



Top Pixel Address
(0 - 959 Decimal)

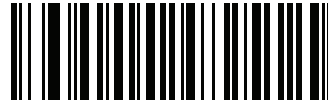

Left Pixel Address
(0 - 1279 Decimal)



Bottom Pixel Address
(0 - 959 Decimal)

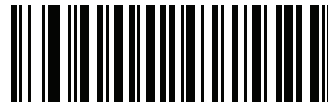

Right Pixel Address
(0 - 1279 Decimal)

Image Size (Number of Pixels)

Parameter # 302 (SSI # F0h 2Eh)

This option alters image resolution before compression. Multiple pixels are combined to one pixel, resulting in a smaller image containing the original content with reduced resolution.

Select one of the following values:

Table 13 Image Sizes

Resolution Value	Uncropped Image Size
Full	1280 x 960
1/2	640 x 480
1/4	320 x 240



* Full Resolution
(0)



1/2 Resolution
(1)



1/4 Resolution
(3)

Image Brightness (Target White)

Parameter # 390 (SSI # F0h 86h)

Type: Byte

Range: 1 - 240

This parameter sets the Target White value used in Snapshot mode when using auto exposure. White and black are defined as 240 decimal and 1, respectively. Setting the value to the factory default of 180 sets the white level of the image to ~180.

To set the Image Brightness parameter, scan **Image Brightness** below followed by three numeric barcodes representing the value. Leading zeros are required. For example, to set an Image Brightness value of 99, scan 0, 9, 9. See [Numeric Barcodes](#) for numeric barcodes.



* 180



Image Brightness
(3 digits)

JPEG Image Options

Parameter # 299 (SSI # F0h 2Bh)

Select an option to optimize JPEG images for either size or for quality. Scan the **JPEG Quality Selector** barcode to enter a quality value; the digital scanner then selects the corresponding image size. Scan the **JPEG Size Selector** barcode to enter a size value; the digital scanner then selects the best image quality.



* JPEG Quality Selector
(1)



JPEG Size Selector
(0)

JPEG Target File Size

Parameter # 561 (SSI # F1h 31h)

Type: Word

Range: 5-350

This parameter defines the target JPEG file size in terms 1 Kilobytes (1024 bytes). The default value is 160 kB which represents 160 Kilobytes.



CAUTION: JPEG compress may take 10 to 15 seconds based on the amount of information in the target image. Scanning * [JPEG Quality Selector \(1\)](#) (default setting) produces a compressed image that is consistent in quality and compression time.

To set the JPEG Target File Size parameter, scan **JPEG Target File Size** below followed by three numeric barcodes representing the value. Leading zeros are required. For example, to set an image file size value of 99, scan 0, 9, 9 in [Numeric Barcodes](#).



JPEG Target File Size
(3 digits)

JPEG Quality and Size Value

JPEG Quality = Parameter # 305 (SSI # F0h 31h)

If you selected **JPEG Quality Selector**, scan the **JPEG Quality Value** barcode followed by 3 barcodes from [Numeric Barcodes](#) corresponding to a value from 5 to 100, where 100 represents the highest quality image.



JPEG Quality Value
(Default: 065)
(5 - 100 Decimal)

Image Enhancement

Parameter # 564 (SSI # F1h 34h)

This parameter configures the digital scanner's Image Enhance feature. This feature uses a combination of edge sharpening and contrast enhancement to produce an image that is visually pleasing.

The levels of image enhancement are:

- Off (0)
- Low (1) - Default
- Med (2)
- High (3).



Off
(0)



*** Low**
(1)

Image Enhancement (continued)



Medium
(2)



High
(3)

Image File Format Selector

Parameter # 304 (SSI # F0h 30h)

Select an image format appropriate for the system (BMP, TIFF, or JPEG). The digital scanner stores captured images in the selected format.



BMP File Format
(3)



*** JPEG File Format**
(1)



TIFF File Format
(04h)

Image Rotation

Parameter # 665 (SSI # F1h 99h)

This parameter controls the rotation of the image by 0, 90, 180, or 270 degrees.



* Rotate 0°
(0)



Rotate 90°
(1)



Rotate 180°
(2)



Rotate 270°
(3)

Bits Per Pixel

Parameter # 303 (SSI # F0h 2Fh)

Select the number of significant bits per pixel (BPP) to use when capturing an image. Select **1 BPP** for a black and white image, **4 BPP** to assign 1 of 16 levels of gray to each pixel, or **8 BPP** to assign 1 of 256 levels of gray to each pixel.



NOTE: The digital scanner ignores these settings for JPEG file formats, which only support **8 BPP**.

The digital scanner ignores 1 BPP for TIFF file formats, which only support **4 BPP** and **8 BPP**. 1 BPP is coerced to 4 BPP for TIFF file formats.



**1 BPP
(0)**



**4 BPP
(1)**



*** 8 BPP
(2)**

Signature Capture

Parameter # 93 (SSI # 5Dh)

A signature capture barcode is a special-purpose symbology which delineates a signature capture area in a document with a machine-readable format. The recognition pattern is variable so it can optionally provide an index to various signatures. The region inside the barcode pattern is considered the signature capture area. See [Signature Capture Code on page 482](#) for more information.

Output File Format

Decoding a signature capture barcode de-skews the signature image and converts the image to a BMP, JPEG, or TIFF file format. The output data includes the file descriptor followed by the formatted signature image.

Table 14 Output Formats

File Descriptor			Signature Image
Output Format (1 byte)	Signature Type (1 byte)	Signature Image Size (4 bytes) (BIG Endian)	
JPEG - 1	1-8	0x00000400	0x00010203....
BMP - 3			
TIFF - 4			

To enable or disable Signature Capture, scan the appropriate barcode below.



**Enable Signature Capture
(1)**



*** Disable Signature Capture
(0)**

Signature Capture File Format Selector

Parameter # 313 (SSI # F0h 39h)

Select a signature file format appropriate for the system (BMP, TIFF, or JPEG). The digital scanner stores captured signatures in the selected format.



**BMP Signature Format
(3)**



*** JPEG Signature Format
(1)**



**TIFF Signature Format
(4)**

Signature Capture Bits Per Pixel

Parameter # 314 (SSI # F0h 3Ah)

Select the number of significant bits per pixel (BPP) to use when capturing a signature. Select **1 BPP** for a black and white image, **4 BPP** to assign 1 of 16 levels of gray to each pixel, or **8 BPP** to assign 1 of 256 levels of gray to each pixel.



NOTE: The digital scanner ignores these settings for JPEG file formats, which only support **8 BPP**.



1 BPP
(0)



4 BPP
(1)



*** 8 BPP**
(2)

Signature Capture Width

Parameter # 366 (SSI # F4h F0h 6Eh)

The aspect ratio of the Signature Capture Width and Signature Capture Height parameters must match that of the signature capture area. For example, a 4 x 1 inch signature capture area would require a 4 to 1 aspect ratio of width to height.

To set the width of the signature capture box, scan the **Signature Capture Width** barcode, followed by 4 barcodes from [Numeric Barcodes](#) corresponding to a value in the range of 016 to 1280 decimal.



Signature Capture Width
(Default: 400)
(016 - 1280 Decimal)

Signature Capture Height

Parameter # 367 (SSI # F4h F0h 6Fh)

To set the height of the signature capture box, scan the **Signature Capture Height** barcode, followed by 3 barcodes from [Numeric Barcodes](#) corresponding to a value in the range of 016 to 960 decimal.



Signature Capture Height (Default: 100)
(016 - 960 Decimal)

Signature Capture JPEG Quality

Parameter # 421 (SSI # F0h A5h)

Scan the **JPEG Quality Value** barcode followed by 3 barcodes from [Numeric Barcodes](#) corresponding to a value from 005 to 100, where 100 represents the highest quality image.



JPEG Quality Value (Default: 065)
(5 - 100 Decimal)

Video Mode Format Selector

Parameter # 916 (SSI # F2h 94h)

When the digital imager scanner is in Video Mode, select whether to send data in BMP or JPEG format.

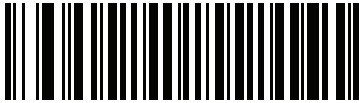

BMP File Format
(3)



*** JPEG File Format**
(1)

Video View Finder (Corded Mode Only)

Parameter # 324 (SSI # F0h 44h)

Scan one of the following barcodes to select whether to project the video view finder while in Snapshot Mode.

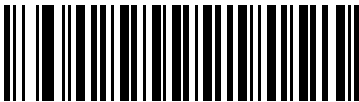

Enable Video View Finder
(1)

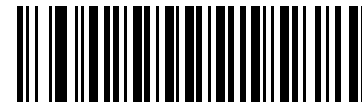

*** Disable Video View Finder**
(0)

Video View Finder Image Size

Parameter # 329 (SSI # F0h 49h)

This parameter sets the number of 100-byte blocks. Values range from 800 to 12,000 bytes. A smaller value transmits more frames per second, while a larger value increases video quality.

Scan the **Video View Finder Image Size** barcode, and then scan three barcodes from [Numeric Barcodes](#) corresponding to the 100-byte value from 800 to 12,000 bytes. For example, to select 1500 bytes, enter 0, 1, 5. To select 900 bytes, enter 0, 0, 9. The default is 1700 bytes.



Video View Finder Image Size

Video Subsampling

Parameter # 667 (SSI # F1h 9Bh)

This option alters video frame resolution before compression. Multiple pixels are combined to one pixel, resulting in smaller video frames containing the original content with reduced resolution.

Scan a barcode below to select the desired video subsampling.

Table 15 Video Subsampling

Resolution Value	Uncropped Image Size
Full	1280 x 800
1/2	640 x 400
1/4	320 x 200

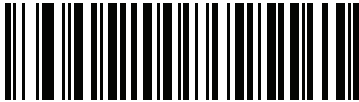

Full Resolution
(0)



1/2 Resolution
(1)



*1/4 Resolution
(3)

USB Interface

Introduction

This chapter provides instructions for programming the scanner to interface with a USB host. The scanner connects directly to a USB host, or a powered USB hub. The USB host can power the scanner.

Throughout the programming barcode menus, default values are indicated with asterisks (*).

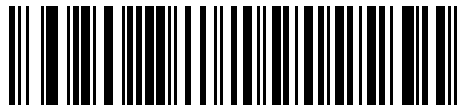

* Indicates Default — * North American Standard USB Keyboard — Feature/Option

Connecting a USB Interface

The scanner connects to USB-capable hosts, including:

- TGCS (IBM) terminals
- Apple™ desktop and notebooks
- Other network computers that support more than one keyboard.

The following operating systems support the scanner through USB:

- Windows 8, 10
- MacOS 8.5 - MacOS 10.6 (Supported via HID Keyboard only)
- IBM 4690 OS
- Linux

The scanner interfaces with USB hosts that support Human Interface Devices (HID).

Figure 23 USB Connection

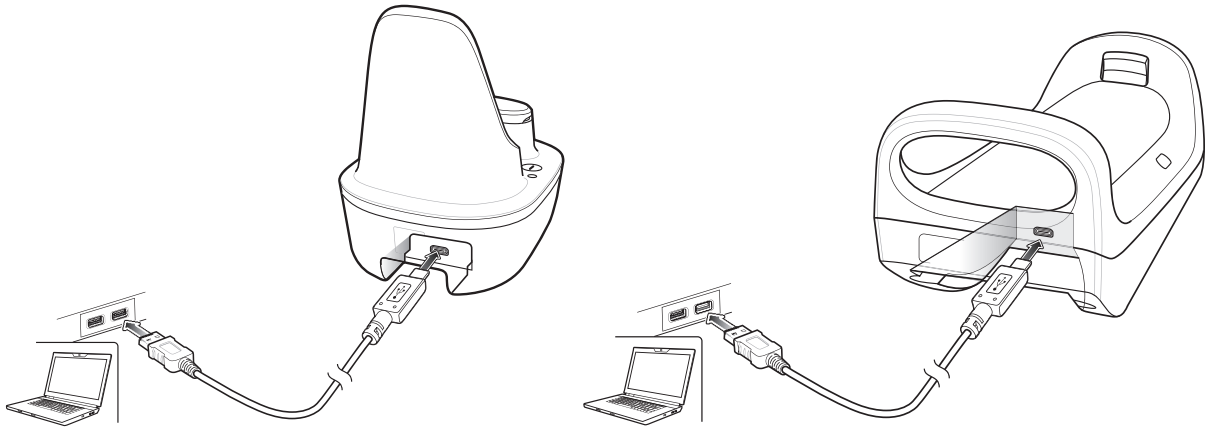

To connect the cradle to a USB host:

1. Attach the modular connector of the USB interface cable to the cable interface port on the digital scanner. See [Connecting Cradle Cable on page 32](#).
2. Plug the series A connector in the USB host or hub, or plug the Plus Power connector in an available port of the IBM SurePOS terminal.
3. Ensure all connections are secure.
4. Pair the digital scanner to the cradle by scanning the barcode on the cradle.
5. Select the USB device type by scanning the appropriate barcode from [USB Device Type on page 207](#).
6. On first installation when using Windows, the software displays a prompt to select or install the *Human Interface Device* driver. To install the Human Interface Device driver provided by Windows, click **Next** through all the choices and click **Finished** on the last choice. The digital scanner powers up during this installation.
7. To modify any other parameter options, scan the appropriate barcodes in this chapter.
8. Connect an external power supply if desired.



NOTE: Interface cables vary depending on configuration. The connectors illustrated in [Figure 23](#) are examples only. The connectors may be different from those illustrated, but the steps to connect the cradle remain the same.

Disconnect the host cables before the power supply, or the digital scanner may not recognize the new host.

If problems occur, see [Troubleshooting on page 53](#).

USB Parameter Defaults

Table 16 lists the defaults for USB host parameters. If any option needs to be changed, scan the appropriate barcode(s) provided in the Parameter Descriptions section beginning on 207.



NOTE: See [Standard Parameter Defaults](#) for all user preferences, hosts, symbologies, and miscellaneous default parameters.

See [Country Codes on page 390](#) for USB Country Keyboard Types (Country Codes).

Table 16 USB Host Default Table

Parameter	Default	Page Number
USB Host Parameters		
USB Device Type	HID Keyboard Emulation	207
Symbol Native API (SNAPI) Status Handshaking	Enable	208
USB Keystroke Delay	No Delay	209
USB CAPS Lock Override	Do Not Override (Disable)	209
USB Ignore Unknown Characters	Send	210
USB Convert Unknown to Code 39	Disable	210
USB Polling Interval	3 msec	211
USB Fast HID	Enable	213
Emulate Keypad	Enable	213
Emulate Keypad with Leading Zero	Enable	214
Quick Keypad Emulation	Enable	214
USB FN1 Substitution	Disable	215
Function Key Mapping	Disable	215
Simulated Caps Lock	Disable	216
Convert Case	No Case Conversion	216
USB Static CDC	Enable	217
TGCS (IBM) USB Direct I/O Beep	Honor	218
TGCS (IBM) USB Beep Directive	Ignore Beep Directive	218
TGCS (IBM) USB Barcode Configuration Directive	Ignore Barcode Configuration Directive	219
IBM Specification Version	Version 2.2	219

USB Host Parameters

USB Device Type

Select the desired USB device type.



NOTE:

When changing USB device types, the scanner automatically restarts. The imager issues a power-up beep sequence.

1. Before scanning [USB CDC Host \(Note 1\) on page 208](#), install the appropriate USB CDC Driver on the host to ensure the scanner does not stall during power up (due to a failure to enumerate USB). Go to www.zebra.com/support, Support & Downloads > Barcode Scanners > USB CDC Driver, select the appropriate Windows platform, and download the appropriate CDC Driver (64 bit or 32 bit).

To recover a stalled scanner:

Install the USB CDC Driver

or

Unplug the USB cable and add power. Connect the scanner via Bluetooth and scan HID Keyboard or another host.

2. Select **IBM Hand-Held USB** to disable data transmission when an IBM register issues a Scan Disable command. Aim, illumination, and decoding is still permitted. Select **OPOS (IBM Hand-held with Full Disable)** to completely shut off the scanner when an IBM register issues a Scan Disable command, including aim, illumination, decoding, and data transmission.
3. Select **USB HID POS** to communicate over a USB cable with Universal Windows Platform (UWP) applications running on Windows 10 devices.



* HID Keyboard Emulation



IBM Table Top USB

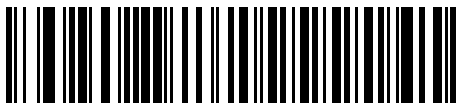

IBM Hand-Held USB



OPOS
(IBM Hand-held with Full Disable)

USB Device Type (continued)



SSI over USB CDC



USB CDC Host
(Note 1)



Symbol Native API (SNAPI) without Imaging Interface



Symbol Native API (SNAPI) with Imaging Interface



USB HID POS
(for Windows 10 devices only)

Symbol Native API (SNAPI) Status Handshaking

After selecting a SNAPI interface as the USB device type, select whether to enable or disable status handshaking.



* Enable SNAPI Status Handshaking



Disable SNAPI Status Handshaking

USB Keystroke Delay

This parameter sets the delay, in milliseconds, between emulated keystrokes. Scan a barcode below to increase the delay when hosts require a slower transmission of data.

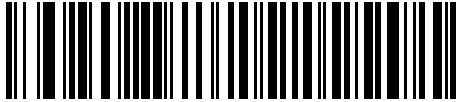

* No Delay



Medium Delay (20 msec)

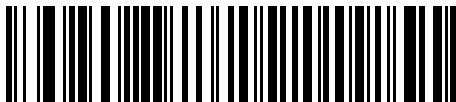

Long Delay (40 msec)

USB CAPS Lock Override

This option applies only to the HID Keyboard Emulation device. When enabled, the case of the data is preserved regardless of the state of the caps lock key. This setting is always enabled for the “Japanese, Windows (ASCII)” keyboard type and can not be disabled.



Override Caps Lock Key
(Enable)



* Do Not Override Caps Lock Key
(Disable)

USB Ignore Unknown Characters

This option applies only to the HID Keyboard Emulation device and IBM device. Unknown characters are characters the host does not recognize. When **Send Barcodes With Unknown Characters** is selected, all barcode data is sent except for unknown characters, and no error beeps sound. When **Do Not Send Barcodes With Unknown Characters** is selected, barcode data is sent up to the first unknown character, then the imaging imager scanner issues an error beep.

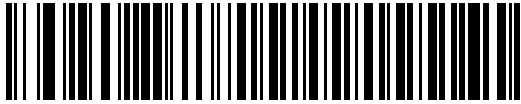

* Send Barcodes with Unknown Characters

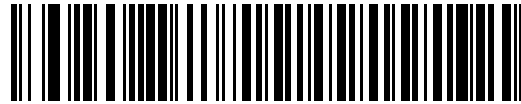

Do Not Send Barcodes with Unknown Characters

USB Convert Unknown to Code 39

This option applies only to the IBM Hand-held, IBM Tabletop, and OPOS devices. Scan a barcode below to enable or disable converting unknown barcode type data to Code 39.



* Disable Convert Unknown to Code 39



Enable Convert Unknown to Code 39

USB Polling Interval

Scan a barcode below to set the polling interval. The polling interval determines the rate at which data can be sent between the scanner and host computer. A lower number indicates a faster data rate



NOTE: When changing USB Device Types, the imaging imager automatically restarts and issues a disconnect-reconnect beep sequence.



IMPORTANT: Ensure your host machine can handle the selected data rate..



1 msec

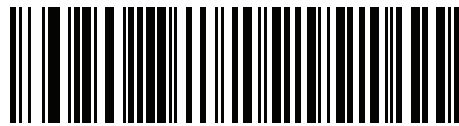

2 msec

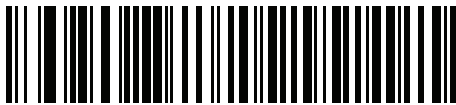

* 3 msec



4 msec

USB Polling Interval (continued)



5 msec



6 msec

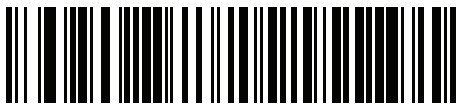

7 msec



8 msec

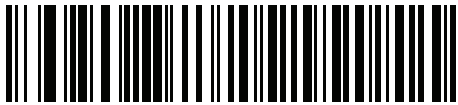

9 msec



10 msec

USB Fast HID

This option transmits USB HID data at a faster rate.

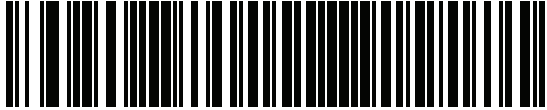

* Enable

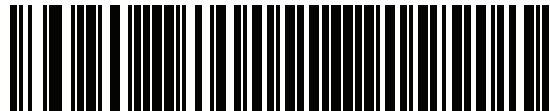

Disable

Emulate Keypad

When enabled, all characters are sent as ASCII sequences over the numeric keypad. For example ASCII A would be sent as “ALT make” 0 6 5 “ALT Break.”



Disable Keypad Emulation

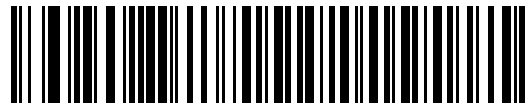

* Enable Keypad Emulation

Emulate Keypad with Leading Zero

Enable this to send character sequences sent over the numeric keypad as ISO characters which have a leading zero. For example ASCII A transmits as “ALT MAKE” 0 0 6 5 “ALT BREAK”.



Disable Keypad Emulation with Leading Zero



* Enable Keypad Emulation with Leading Zero

Quick Keypad Emulation

This option applies only to the HID Keyboard Emulation Device and if Emulate Keypad is enabled. This parameter enables a quicker method of keypad emulation where ASCII sequences are only sent for ASCII characters not found on the keyboard. The default value is **Enable**.

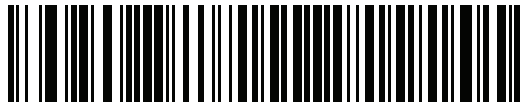

* Enable

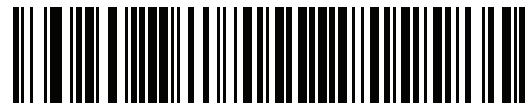

Disable

USB Keyboard FN 1 Substitution

This option applies only to the USB HID Keyboard Emulation device. When enabled, this allows replacement of any FN 1 characters in an EAN 128 barcode with a Key Category and value chosen by the user (see [FN1 Substitution Values on page 127](#) to set the Key Category and Key Value).



Enable FN1 Substitution



* Disable FN1 Substitution

Function Key Mapping

ASCII values under 32 are normally sent as a control-key sequences (see [Table 30 on page 470](#)). When this parameter is enabled, the keys in bold are sent in place of the standard key mapping. Table entries that do not have a bold entry remain the same whether or not this parameter is enabled.

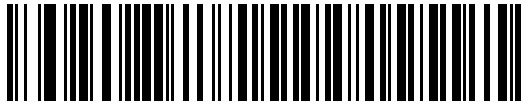

* Disable Function Key Mapping

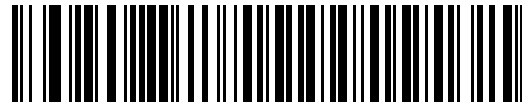

Enable Function Key Mapping

Simulated Caps Lock

When enabled, the imaging imager scanner inverts upper and lower case characters on the imaging imager scanner barcode as if the Caps Lock state is enabled on the keyboard. This inversion is done regardless of the current state of the keyboard Caps Lock state.

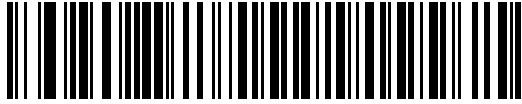

* Disable Simulated Caps Lock

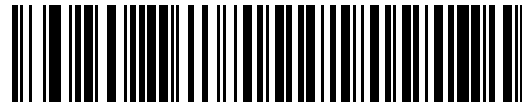

Enable Simulated Caps Lock

Convert Case

When enabled, the imaging imager scanner converts all barcode data to the selected case.

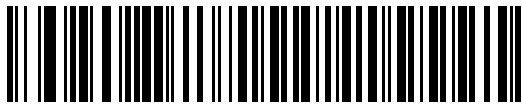

* No Case Conversion



Convert All to Upper Case

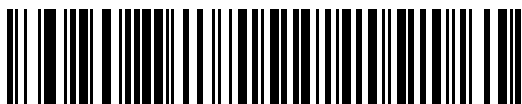

Convert All to Lower Case

USB Static CDC

Parameter # 670

When disabled, each device connected consumes another COM port (first device = COM1, second device = COM2, third device = COM3, etc.)

When enabled, each device connects to the same COM port.

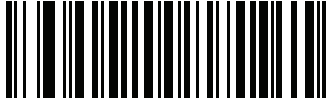

*** Enable USB Static CDC**
(1)



Disable USB Static CDC
(0)

Optional USB Parameters

If you configure the imaging imager scanner and find the settings were not saved, or changed, when the system is restarted scan the barcodes that follow to override USB interface defaults.

Scan a barcode below after setting defaults and before configuring the imaging imager scanner.

TGCS (IBM) USB Direct I/O Beep

Parameter # 1360 (SSI # 550h)

The host can send a direct I/O beep request to the scanner. If you select **Ignore Direct I/O Beep**, the scanner does not sound beeps on this command. All directives are still acknowledged to the USB host as if they were processed.



* Honor Direct IO Beep



Ignore Direct IO Beep

TGCS (IBM) USB Beep Directive

The host can send a beeper configuration request to the scanner. Scan **Ignore Beep Directive** to prevent the scanner from processing the host request. All directives are still acknowledged to the USB host as if they were processed.



Honor Beep Directive



* Ignore Beep Directive

TGCS (IBM) USB Barcode Configuration Directive

The host can enable and disable code types. Scan **Ignore Barcode Configuration Directive** to prevent the scanner from processing the host request. All directives are still acknowledged to the USB host as if they were processed.



Honor Barcode Configuration Directive



* Ignore Barcode Configuration Directive

IBM Specification Version

The IBM USB interface specification version selected defines how code types are reported over the IBM USB interface.

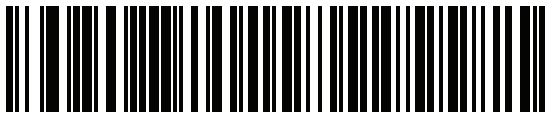

Original Specification

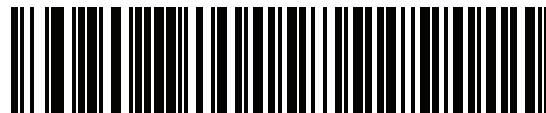

* Version 2.2

ASCII Character Sets for USB

See [ASCII Character Sets](#) for the following:

- ASCII Character Set ([Table 30 on page 470](#))
- ALT Key Character Set ([Table 31 on page 474](#))
- GUI Key Character Set ([Table 32 on page 474](#))
- PF Key Character Set ([Table 33 on page 476](#))
- F Key Character Set ([Table 34 on page 477](#))
- Numeric Character Set ([Table 35 on page 478](#))
- Extended Character Set ([Table 36 on page 478](#)).

SSI Interface

Introduction

This chapter describes the system requirements of the Simple Serial Interface (SSI), which provides a communications link between Zebra decoders (e.g., scan engines, slot scanners, hand-held scanners, two-dimensional scanners, hands-free scanners, and RF base stations) and a serial host. It provides the means for the host to control the decoder or scanner.

Communications

All communication between the digital scanner and host occurs over the hardware interface lines using the SSI protocol. Refer to the Simple Serial Interface Programmer's Guide, p/n 72-40451-xx, for more information on SSI.

The host and the digital scanner exchange messages in packets. A packet is a collection of bytes framed by the proper SSI protocol formatting bytes. The maximum number of bytes per packet that the SSI protocol allows for any transaction is 257 (255 bytes + 2 byte checksum).

Decode data can be sent as ASCII data (unpacketed), or as part of a larger message (packeted), depending on the digital scanner configuration.

SSI performs the following functions for the host device:

- Maintains a bi-directional interface with the digital scanner
- Allows the host to send commands that control the digital scanner
- Passes data from the digital scanner to a host device in SSI packet format or straight decode message.

The working environment of the SSI consists of a digital scanner, a serial cable which attaches to the host device, and in some instances, a power supply.

SSI transmits all decode data including special formatting (e.g., AIM ID). Parameter settings can control the format of the transmitted data.

The digital scanner can also send parameter information, product identification information, or event codes to the host.

All commands sent between the digital scanner and host must use the format described in the SSI Message Formats section. [SSI Transactions on page 222](#) describes the required sequence of messages in specific cases.

Table 17 lists all the SSI opcodes the digital scanner supports. It identifies the SSI partner allowed to send a message of each type. The host transmits opcodes designated type H. The digital scanner transmits type D opcodes, and either partner can transmit Host/Decoder (H/D) types.

Table 17 SSI Commands

Name	Type	Opcode	Description
AIM_OFF	H	0xC4	Deactivate aim pattern.
AIM_ON	H	0xC5	Activate aim pattern.
BEEP	H	0xE6	Sound the beeper.
CAPABILITIES_REPLY	D	0xD4	Reply to CAPABILITIES_REQUEST; contains a list of the capabilities and commands the decoder supports.
CAPABILITIES_REQUEST	H	0xD3	Request capabilities report from the decoder.
CMD_ACK	H/D	0xD0	Positive acknowledgment of received packet.
CMD_NAK	H/D	0xD1	Negative acknowledgment of received packet.
DECODE_DATA	D	0xF3	Decode data in SSI packet format.
EVENT	D	0xF6	Event indicated by associated event code.
LED_OFF	H	0xE8	De-activate LED output.
LED_ON	H	0xE7	Activate LED output.
PARAM_DEFAULTS	H	0xC8	Set parameter default values.
PARAM_REQUEST	H	0xC7	Request values of certain parameters.
PARAM_SEND	H/D	0xC6	Send parameter values.
REPLY_REVISION	D	0xA4	Reply to REQUEST_REVISION contains decoder's software/hardware configuration.
REQUEST_REVISION	H	0xA3	Request the decoder's configuration.
SCAN_DISABLE	H	0xEA	Prevent the operator from scanning barcodes.
SCAN_ENABLE	H	0xE9	Permit barcode scanning.
SLEEP	H	0xEB	Request to place the decoder into low power.
START_DECODE	H	0xE4	Tell decoder to attempt to decode a barcode.
STOP_DECODE	H	0xE5	Tell decoder to abort a decode attempt.
WAKEUP	H	N/A	Wakeup decoder after it has entered low power mode.

For details of the SSI protocol, refer to the Simple Serial Interface Programmer's Guide (72-40451-xx).

SSI Transactions

General Data Transactions

ACK/NAK Handshaking

If you enable ACK/NAK handshaking, all packeted messages must have a CMD_ACK or CMD_NAK response, unless the command description states otherwise. This parameter is enabled by default. Zebra recommends leaving this handshaking enabled to provide feedback to the host. Raw decode data and WAKEUP do not use ACK/NAK handshaking since they are not packeted data.

Following is an example of a problem which can occur if you disable ACK/NAK handshaking:

- The host sends a PARAM_SEND message to the digital scanner to change the baud rate from 9600 to 19200.
- The digital scanner cannot interpret the message.
- The digital scanner does not implement the change the host requested.
- The host assumes that the parameter change occurred and acts accordingly.
- Communication is lost because the change did not occur on both sides.

If you enable ACK/NAK handshaking, the following occurs:

- The host sends a PARAM_SEND message.
- The digital scanner cannot interpret the message.
- The digital scanner CMD_NAKs the message.
- The host resends the message.
- The digital scanner receives the message successfully, responds with CMD_ACK, and implements parameter changes.

Transfer of Decode Data

The Decode Data Packet Format parameter controls how decode data is sent to the host. Set this parameter to send the data in a DECODE_DATA packet. Clear this parameter to transmit the data as raw ASCII data.



NOTE: When transmitting decode data as raw ASCII data, ACK/NAK handshaking does not apply regardless of the state of the ACK/NAK handshaking parameter. ACK/NAK Enabled and Packeted Data

The digital scanner sends a DECODE_DATA message after a successful decode. The digital scanner waits for a programmable time-out for a CMD_ACK response. If it does not receive the response, the digital scanner tries to send two more times before issuing a host transmission error. If the digital scanner receives a CMD_NAK from the host, it may attempt a retry depending on the cause field of the CMD_NAK message.

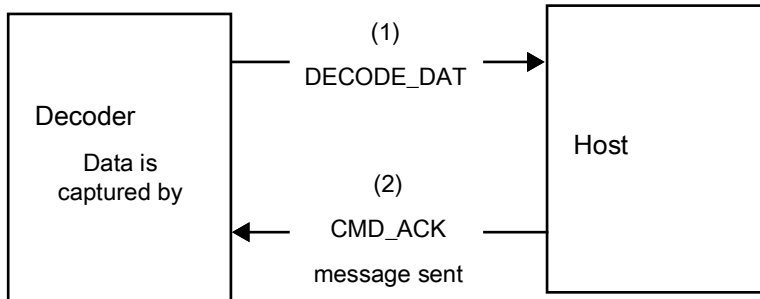

ACK/NAK Enabled and Unpacketed ASCII Data

Even though the ACK/NAK handshaking is enabled, no handshaking occurs because the handshaking applies only to packeted data. In this example the **packeted_decode** parameter is disabled.

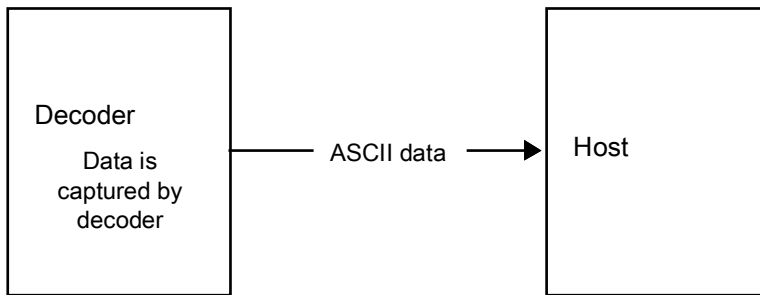

ACK/NAK Disabled and Packeted DECODE_DATA

In this example ACK/NAK does not occur even though **packeted_decode** is enabled because the ACK/NAK handshaking parameter is disabled.

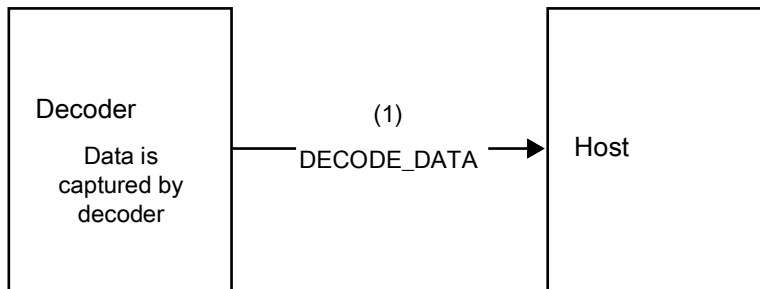

ACK/NAK Disabled and Unpacketed ASCII Data

Data captured by the digital scanner is sent to the host.

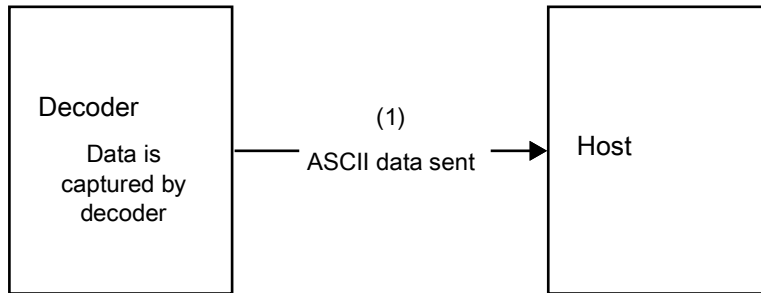

Communication Summary

ACK/NAK Option

Enable or disable ACK/NAK handshaking. This handshaking is enabled by default and Zebra recommends leaving it enabled. Disabling this handshaking can cause communication problems, as handshaking is the only acknowledgment that a message was received, and if it was received correctly. ACK/NAK is not used with unpacketed decode data regardless of whether or not it is enabled.

Serial Response Time-out

The Serial Response Time-out parameter determines how long to wait for a handshaking response before trying again, or aborting any further attempts. Set the same value for both the host and digital scanner.



NOTE: You can temporarily change the Serial Response Time-out when the host takes longer to process an ACK or longer data string. Zebra does not recommend frequent permanent changes due to limited write cycles of non-volatile memory.

Retries

When sending data, the host should resend twice after the initial send if the digital scanner does not respond with an ACK or NAK (if ACK/NAK handshaking is enabled), or response data (e.g., PARAM_SEND, REPLY_REVISION). If the digital scanner replies with a NAK RESEND, the host resends the data. All resent messages must have the resend bit set in the Status byte.

The digital scanner resends data two times after the initial send if the host fails to reply with an ACK or NAK (if ACK/NAK handshaking is enabled).

Response Time-out, ACK/NAK Handshake

If you use PARAM_SEND to change these serial parameters, the ACK response to the PARAM_SEND uses the previous values for these parameters. The new values then take effect for the next transaction.

Errors

The digital scanner issues a communication error when:

- Failure to receive an ACK or NAK after initial transmit and two resends.

Things to Remember When Using SSI Communication

There is a permanent/temporary bit in the PARAM_SEND message. Removing power from the digital scanner discards temporary changes. Permanent changes are written to non-volatile memory. Frequent changes shorten the life of the non-volatile memory.

Encapsulation of RSM Commands/Responses over SSI

The SSI protocol allows the host to send a command that is variable in length up to 255 bytes. Although there is a provision in the protocol to multi-packet commands from the host, the scan engine does not support this. The host must fragment packets using the provisions in the RSM protocol.

Command Structure

Table 18

Byte	7	6	5	4	3	2	1	0
0	Length (not including the checksum)							
1	SSI_MGMT_COMMAND (0x80)							
2	Message Source (4 - Host)							
3	Reserved (0)			Reserved (0)		Reserved (0)	Cont'd packet	Retransmit
4	Payload data (see the following example)							
...								
Length -1								
Length	2's complement checksum (MSB)							
Length +1	2's complement checksum (LSB)							

The expected response in the positive case is SSI_MGMT_COMMAND which may be a multi-packet response. For devices that do not support the SSI_MGMT_COMMAND, the response is the standard SSI_NAK.

Response Structure

Table 13-1

Byte	7	6	5	4	3	2	1	0
0	Length (not including the checksum)							
1	SSI_MGMT_COMMAND (0x80)							
2	Message Source (0 - Decoder)							
3	Reserved (0)			Reserved (0)		Reserved (0)	Cont'd packet	Retransmit
4	Payload data (see the following example)							
...								
Length -1								
Length	2's complement checksum (MSB)							
Length +1	2's complement checksum (LSB)							

Example Transaction

The following example illustrates how to retrieve diagnostic information (Diagnostic Testing and Reporting (Attribute #10061) decimal) from the engine using encapsulation of RSM commands over SSI. Before sending any RSM command, the host must send the RSM Get Packet Size command to query the packet size supported by the device.

Command from Host to Query Packet Size Supported by Device

0A 80 04 00 00 06 20 00 FF FF FD 4E

Where:

- 0A 80 04 00 is encapsulation of RSM commands over SSI command header
- 00 06 20 00 FF FF is RSM Get Packet Size command
- FD 4E is SSI command checksum

Response from Device with Packet Size Information

0C 80 00 00 00 08 20 00 00 F0 00 F0 FD 6C

Where:

- 0C 80 00 00 is encapsulation of RSM command over SSI command header
- 00 08 20 00 00 F0 00 F0 is RSM Get Packet Size response
- FD 6C is SSI response checksum

Command from Host to Retrieve Diagnostic Information

0C 80 04 00 00 08 02 00 27 4D 42 00 FE B0

Where:

- 0C 80 04 00 is encapsulation of RSM commands over SSI command header
- 00 08 02 00 27 4D 42 00 is attribute Get command requesting attribute 10061 decimal
- FE B0 is SSI command checksum

Response from Device with Diagnostic Information

21 80 00 00 00 1D 02 00 27 4D 41 01 42 00 0E 00 00 00 00 01 03 02 03 03 03 04 03 05 03 06 03 FF
FF FC 15

Where:

- 21 80 00 00 00 1D 02 00 27 4D 41 01 42 00 0E 00 00 is encapsulation of RSM responses over SSI command header
- 00 00 01 03 02 03 03 03 04 03 05 03 06 03 is attribute Get response which includes diagnostic report value
- FF FF is attribute Get response, packet termination
- FC 15 is SSI response checksum

Simple Serial Interface Default Parameters

This section describes how to set up the digital scanner with an SSI host. When using SSI, program the digital scanner via barcode menu or SSI hosts commands.

Throughout the programming barcode menus, asterisks (*) indicate default values.

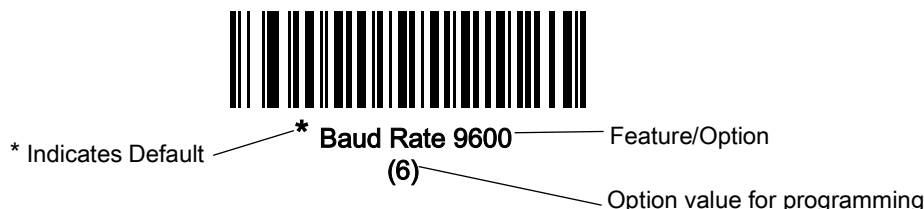

NOTE: Most computer monitors allow scanning the barcodes directly on the screen. When scanning from the screen, be sure to set the document magnification to a level where you can see the barcode clearly, and bars and/or spaces are not merging.

Table 14 lists the defaults for the SSI host. There are two ways to change the default values:

- Scan the appropriate barcodes in this guide. These new values replace the standard default values in memory. To recall the default parameter values, scan the * Restore Defaults barcode on page 67.
- Download data through the device serial port using SSI. Hexadecimal parameter numbers appear in this chapter below the parameter title, and options appear in parenthesis beneath the accompanying barcodes. Refer to the Simple Serial Interface (SSI) Programmer's Guide for detailed instructions for changing parameters using this method.



NOTE: See [Standard Parameter Defaults](#) for all user preferences, hosts, symbologies, and miscellaneous default parameters.

Table 14 SSI Default Table

Parameter	Parameter Number	SSI Number	Default	Page Number
Select SSI Host	N/A	N/A	N/A	230
Software Handshaking	159	9Fh	ACK/NAK	230
Decode Data Packet Format	238	EEh	Send Raw Decode Data	231
Host Serial Response Time-out	155	9Bh	2 sec	232
Host Character Time-out	239	EFh	200 msec	233
Multipacket Option	334	F0h 4Eh	Option 1	234
Interpacket Delay	335	F0h 4Fh	0 ms	235
Event Reporting				
Decode Event	256	F0h 00h	Disable	236
Boot Up Event	258	F0h 02h	Disable	237
Parameter Event	259	F0h 03h	Disable	237



NOTE: SSI interprets Prefix, Suffix1, and Suffix2 values listed in [Table 23 on page 379](#) differently than other interfaces. SSI does not recognize key categories, only the 3-digit decimal value. The default value of 7013 is interpreted as CR only.

SSI Host Parameters

Software Handshaking

Parameter # 159 (SSI # 9Fh)

This parameter offers control of data transmission in addition to the control hardware handshaking offers. Hardware handshaking is always enabled; you cannot disable it.

- **Disable ACK/NAK Handshaking:** When this option is selected, the digital scanner neither generates nor expects ACK/NAK handshaking packets.
- **Enable ACK/NAK Handshaking:** When this option is selected, after transmitting data, the digital scanner expects either an ACK or NAK response from the host. The digital scanner also ACKs or NAKs messages from the host.

The digital scanner waits up to the programmable Host Serial Response Time-out to receive an ACK or NAK. If the digital scanner does not get a response in this time, it resends its data up to two times before discarding the data and declaring a transmit error.



Disable ACK/NAK
(0)



* Enable ACK/NAK
(1)

Decode Data Packet Format

Parameter # 238 (SSI # EEh)

This parameter selects whether to transmit decoded data in raw format (unpacketed), or with the packet format defined by the serial protocol.

Selecting the raw format disables ACK/NAK handshaking for decode data.



*** Send Raw Decode Data
(0)**



**Send Packeted Decode Data
(1)**

Host Serial Response Time-out

Parameter # 155 (SSI # 9Bh)

This parameter specifies how long the digital scanner waits for an ACK or NAK before resending. Also, if the digital scanner wants to send, and the host has already been granted permission to send, the digital scanner waits for the designated time-out before declaring an error.

To set the delay period (options are 2, 5, 7.5, or 9.9 seconds), scan one of the following barcodes.

✓ Other values are available via SSI command.



*** Low - 2 Seconds
(20)**



**Medium - 5 Seconds
(50)**



**High - 7.5 Seconds
(75)**



**Maximum - 9.9 Seconds
(99)**

Host Character Time-out

Parameter # 239 (SSI # EFh)

This parameter determines the maximum time the digital scanner waits between characters transmitted by the host before discarding the received data and declaring an error.

To set the delay period (options are 200, 500, 750, or 990 ms), scan one of the following barcodes.

✓ Other values are available via SSI command.



* Low - 200 ms
(20)



Medium - 500 ms
(50)



High - 750 ms
(75)



Maximum - 990 ms
(99)

Multipacket Option

Parameter # 334 (SSI # F0h 4Eh)

This parameter controls ACK/NAK handshaking for multi-packet transmissions.

- **Multi-Packet Option 1:** The host sends an ACK / NAK for each data packet during a multi-packet transmission.
- **Multi-Packet Option 2:** The digital scanner sends data packets continuously, with no ACK/NAK handshaking to pace the transmission. The host, if overrun, can use hardware handshaking to temporarily delay digital scanner transmissions. At the end of transmission, the digital scanner waits for a CMD_ACK or CMD_NAK.
- **Multi-Packet Option 3:** Option 3 is the same as option 2 with the addition of a programmable interpacket delay.



* Multipacket Option 1
(0)



Multipacket Option 2
(1)



Multipacket Option 3
(2)

Interpacket Delay

Parameter # 335 (SSI # F0h 4Fh)

This parameter specifies the interpacket delay if you selected **Multipacket Option 3**.

To set the delay period (options are 0, 25, 50, 75, or 99 ms), scan one of the following barcodes.

✓ Other values are available via SSI command.



* Minimum - 0 ms
(0)



Low - 25 ms
(25)



Medium - 50 ms
(50)



High - 75 ms
(75)



Maximum - 99 ms
(99)

Event Reporting

The host can request the digital scanner to provide certain information (events) relative to the digital scanner behavior. Enable or disable the events listed in [Table 15](#) and on the following pages by scanning the appropriate barcodes.

Table 15 Event Codes

Event Class	Event	Code Reported
Decode Event	Non parameter decode	0x01
Boot Up Event	System power-up	0x03
Parameter Event	Parameter entry error	0x07
	Parameter stored	0x08
	Defaults set (and parameter event is enabled by default)	0x0A
	Number expected	0x0F

Decode Event

Parameter # 256 (SSI # F0h 00h)

When enabled, the digital scanner generates a message to the host upon a successful barcode decode. When disabled, no notification is sent.

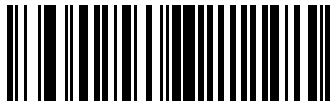

Enable Decode Event
(1)



* Disable Decode Event
(0)

Boot Up Event

Parameter # 258 (SSI # F0h 02h)

When enabled, the digital scanner generates a message to the host whenever power is applied. When disabled, no notification is sent.

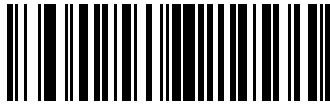

Enable Boot Up Event
(1)



* Disable Boot Up Event
(0)

Parameter Event

Parameter # 259 (SSI # F0h 03h)

When enabled, the digital scanner generates a message to the host when one of the events specified in [Table 15 on page 236](#) occurs. When disabled, no notification is sent.



Enable Parameter Event
(1)

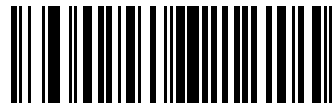

* Disable Parameter Event
(0)

Symbologies

Introduction

This chapter describes symbology features and provides programming barcodes for selecting these features. Before programming, follow the instructions in [Getting Started on page 27](#).

To set feature values, scan a single barcode or a short barcode sequence. The settings are stored in non-volatile memory and are preserved even when the digital scanner powers down.



NOTE: Most computer monitors allow scanning the barcodes directly on the screen. When scanning from the screen, be sure to set the document magnification to a level where you can see the barcode clearly, and bars and/or spaces do not merge.

Select a host type (see each host chapter for specific host information) after the power-up beeps sound. This is only necessary upon the first power-up when connected to a new host.

To return all features to default values, see [User Preferences Parameter Defaults on page 64](#). Throughout the programming barcode menus, asterisks (*) indicate default values.

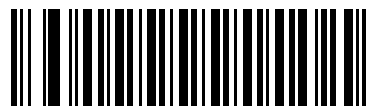

* Indicates Default — * Enable UPC-A — Feature/Option
(1) — Option Value

Scanning Sequence Examples

In most cases, scanning one barcode sets the parameter value. For example, to transmit barcode data without the UPC-A check digit, simply scan the **Do Not Transmit UPC-A Check Digit** barcode under [Transmit UPC-A Check Digit on page 253](#). The digital scanner issues a fast warble beep and the LED turns green, signifying a successful parameter entry.

Other parameters, such as **Set Length(s) for D 2 of 5** require scanning several barcodes. See the individual parameter, such as **Set Length(s) for D 2 of 5**, for this procedure.

Errors While Scanning

Unless otherwise specified, to correct an error during a scanning sequence, just re-scan the correct parameter.

Symbology Parameter Defaults

Table 16 lists the defaults for all symbology parameters. To change the default values, scan the appropriate barcodes in this guide. These new values replace the standard default values in memory. To recall the default parameter values, see [Standard Parameter Defaults on page 379](#).



NOTE: See [Standard Parameter Defaults](#) for all user preferences, hosts, and miscellaneous default parameters.

Table 16 Symbology Parameter Defaults

Parameter	Parameter Number	SSI Number	Default	Page Number
Enable/Disable All Code Types				244
1D Symbologies				
UPC/EAN				
UPC-A	1	01h	Enable	244
UPC-E	2	02h	Enable	245
UPC-E1	12	0Ch	Disable	245
EAN-8/JAN 8	4	04h	Enable	246
EAN-13/JAN 13	3	03h	Enable	246
Bookland EAN	83	53h	Disable	247
Decode UPC/EAN/JAN Supplementals (2 and 5 digits)	16	10h	Ignore	247
User-Programmable Supplementals			000	251
Supplemental 1:	579	F1h 43h		
Supplemental 2:	580	F1h 44h		
UPC/EAN/JAN Supplemental Redundancy	80	50h	10	251
Decode UPC/EAN/JAN Supplemental AIM ID	672	F1h A0h	Combined	252
Transmit UPC-A Check Digit	40	28h	Enable	253
Transmit UPC-E Check Digit	41	29h	Enable	253
Transmit UPC-E1 Check Digit	42	2Ah	Enable	254
Transmit EAN-8 Check Digit	1881	F8 07 59	Transmit	254
Transmit EAN-13 Check Digit	1882	F8 07 5A	Transmit	255
Transmit Code 39 Start/Stop Characters	1900	F8 07 6C	Do Not Transmit	255
UPC-A Preamble	34	22h	System Character	256
UPC-E Preamble	35	23h	System Character	257
UPC-E1 Preamble	36	24h	System Character	258
Convert UPC-E to A	37	25h	Disable	259
Convert UPC-E1 to A	38	26h	Disable	259
EAN-8/JAN-8 Extend	39	27h	Disable	260

Symbologies

Table 16 Symbology Parameter Defaults (Continued)

Parameter	Parameter Number	SSI Number	Default	Page Number
Bookland ISBN Format	576	F1h 40h	ISBN-10	260
UCC Coupon Extended Code	85	55h	Disable	261
Coupon Report	730	F1h DAh	New Coupon Format	262
ISSN EAN	617	F1h 69h	Disable	262
UPC Reduced Quiet Zone	1289	F8h 05h 09h	Disable	263
Code 128				
Code 128	8	08h	Enable	263
Set Length(s) for Code 128	209, 210	D1h, D2h	Any Length	264
GS1-128 (formerly UCC/EAN-128)	14	0Eh	Enable	266
ISBT 128	84	54h	Enable	266
ISBT Concatenation	577	F1h 41h	Disable for SR models Enable for HC models	267
Check ISBT Table	578	F1h 42h	Enable	268
ISBT Concatenation Redundancy	223	DFh	10	268
Code 128 Security Level	751	F1h EFh	Security Level 1	270
Code 128 Reduced Quiet Zone	1208	F8h 04h B8h	Disable	271
Code 128 <FNC4>	1254	F8h 04h E6h	Ignore	271
Code 39				
Code 39	0	00h	Enable	272
Trioptic Code 39	13	0Dh	Disable	272
Convert Code 39 to Code 32 (Italian Pharmacy Code)	86	56h	Disable	273
Code 32 Prefix	231	E7h	Disable	273
Set Length(s) for Code 39	18, 19	12h, 13h	1 to 55	274
Code 39 Check Digit Verification	48	30h	Disable	275
Transmit Code 39 Check Digit	43	2Bh	Disable	275
Code 39 Full ASCII Conversion	17	11h	Disable	276
Code 39 Security Level	750	F1h EEh	Security Level 1	277
Code 39 Reduced Quiet Zone	1209	F8h 04h B9h	Disable	278
Code 93				
Code 93	9	09h	Enable	278
Set Length(s) for Code 93	26, 27	1Ah, 1Bh	1 to 55	279
Code 11				
Code 11	10	0Ah	Disable	280
Set Lengths for Code 11	28, 29	1Ch, 1Dh	4 to 55	280
Code 11 Check Digit Verification	52	34h	Disable	282
Transmit Code 11 Check Digit(s)	47	2Fh	Disable	283

Symbologies

Table 16 Symbology Parameter Defaults (Continued)

Parameter	Parameter Number	SSI Number	Default	Page Number
Interleaved 2 of 5 (ITF)				
Interleaved 2 of 5 (ITF)	6	06h	Enable	284
Set Lengths for I 2 of 5	22, 23	16h, 17h	6 to 55	284
I 2 of 5 Check Digit Verification	49	31h	Disable	286
Transmit I 2 of 5 Check Digit	44	2Ch	Disable	286
Convert I 2 of 5 to EAN 13	82	52h	Disable	287
Febraban	1750	F8h 06h D6h	Disable	287
I 2 of 5 Security Level	1121	F8h 04h 61h	Security Level 1	288
I 2 of 5 Reduced Quiet Zone	1210	F8h 04h BAh	Disable	289
Discrete 2 of 5 (DTF)				
Discrete 2 of 5	5	05h	Disable	290
Set Length(s) for D 2 of 5	20, 21	14h 15h	1 to 55	290
Codabar (NW - 7)				
Codabar	7	07h	Enable	292
Set Lengths for Codabar	24, 25	18h, 19h	4 to 55	292
CLSI Editing	54	36h	Disable	294
NOTIS Editing	55	37h	Disable	294
Codabar Security Level	1776	F8h 06h F0h	Security Level 1	295
Codabar Upper or Lower Case Start/ Stop Characters Detection	855	F2h 57h	Upper Case	296
Codabar Mod 16 Check Digit Verification	1784	F8h 06h F8h	Disable	296
Transmit Codabar Check Digit	704	F1h C0h	Disable	297
MSI				
MSI	11	0Bh	Disable	297
Set Length(s) for MSI	30, 31	1Eh, 1Fh	4 to 55	298
MSI Check Digits	50	32h	One	299
Transmit MSI Check Digit	46	2Eh	Disable	300
MSI Check Digit Algorithm	51	33h	Mod 10/Mod 10	300
MSI Reduced Quiet Zone	1392	F8h 05h 70h	Disable	301
Chinese 2 of 5				
Chinese 2 of 5	408	F0h 98h	Disable	301
Matrix 2 of 5				
Matrix 2 of 5	618	F1h 6Ah	Disable	302
Matrix 2 of 5 Lengths	619 620	F1h 6Bh F1h 6Ch	4 to 55	302
Matrix 2 of 5 Check Digit	622	F1h 6Eh	Disable	303
Transmit Matrix 2 of 5 Check Digit	623	F1h 6Fh	Disable	304

Symbologies

Table 16 Symbology Parameter Defaults (Continued)

Parameter	Parameter Number	SSI Number	Default	Page Number
Korean 3 of 5				
Korean 3 of 5	581	F1h 45h	Disable	304
Inverse 1D	586	F1h 4Ah	Regular	305
GS1 DataBar				
GS1 DataBar Omnidirectional (formerly GS1 DataBar-14), GS1 DataBar Truncated, GS1 DataBar Stacked, GS1 DataBar Stacked Omnidirectional	338	F0h 52h	Enable	306
GS1 DataBar Limited	339	F0h 53h	Enable	306
GS1 DataBar Expanded, GS1 DataBar Expanded Stacked	340	F0h 54h	Enable	307
Convert GS1 DataBar to UPC/EAN	397	F0h 8Dh	Disable	307
GS1 DataBar Limited Margin Check	728	F1h D8h	Level 3	308
GS1 DataBar Security Level	1706	F8h 06h AAh	Level 1	309
Composite				
Composite CC-C	341	F0h 55h	Disable	310
Composite CC-A/B	342	F0h 56h	Disable	310
Composite TLC-39	371	F0h 73h	Disable	311
Composite Inverse	1113	F8h 04h 59h	Regular	311
UPC Composite Mode	344	F0h 58h	UPC Never Linked	312
Composite Beep Mode	398	F0h 8Eh	Beep As Each Code Type is Decoded	313
GS1-128 Emulation Mode for UCC/EAN Composite Codes	427	F0h ABh	Disable	313
2D Symbologies				
PDF417	15	0Fh	Enable	314
MicroPDF417	227	E3h	Disable	314
Code 128 Emulation	123	7Bh	Disable	315
Data Matrix	292	F0h 24h	Enable	316
GS1 Data Matrix	1336	F8h 05h 38h	Disable	316
Data Matrix Inverse	588	F1h 4Ch	Inverse Autodetect	317
Decode Mirror Images (Data Matrix Only)	537	F1h 19h	Auto	318
Maxicode	294	F0h 26h	Disable	319
QR Code	293	F0h 25h	Enable	319
Weblink QR	1947	F7 07 9B	Enable	320
GS1 QR	1343	F8h 05h 3Fh	Enable	320
MicroQR	573	F1h 3Dh	Enable	321
Aztec	574	F1h 3Eh	Enable	321

Table 16 Symbology Parameter Defaults (Continued)

Parameter	Parameter Number	SSI Number	Default	Page Number
Aztec Inverse	589	F1h 4Dh	Inverse Autodetect	322
Han Xin	1167	F8h 04h 8Fh	Disable	323
Han Xin Inverse	1168	F8h 04h 90h	Regular	323
Grid Matrix	1718	F8h 06h B6h	Disable	324
Grid Matrix Inverse	1719	F8h 06h B7h	Regular Only	324
Grid Matrix Mirror	1736	F8h 06h C8h	Regular Only	325
DotCode	1906	F8 07 72h	Disable	326
DotCode Inverse	1907	F8 07 73h	Inverse Autodetect	326
DotCode Mirrored	1908	F8 07 74h	Autodetect	327
DotCode Prioritize	1937	F8 07 91h	Disable	327
Postal Codes				
US Postnet	89	59h	Disable	328
US Planet	90	5Ah	Disable	328
Transmit US Postal Check Digit	95	5Fh	Enable	329
UK Postal	91	5Bh	Disable	329
Transmit UK Postal Check Digit	96	60h	Enable	330
Japan Postal	290	F0h 22h	Disable	330
Australia Post	291	F0h 23h	Disable	331
Australia Post Format	718	F1h CEh	Autodiscriminate	332
Netherlands KIX Code	326	F0h 46h	Disable	333
USPS 4CB/One Code/Intelligent Mail	592	F1h 50h	Disable	333
UPU FICS Postal	611	F1h 63h	Disable	334
Mailmark	1337	F8h 05h 39h	Disable	334
Symbology-Specific Security Levels				
Redundancy Level	78	4Eh	1	335
Security Level	77	4Dh	1	337
1D Quiet Zone Level	1288	F8h 05h 08h	1	338
Intercharacter Gap Size	381	F0h 7Dh	Normal	339
Report Version				339
Macro PDF				
Flush Macro PDF Buffer	N/A	N/A	N/A	340
Abort Macro PDF Entry	N/A	N/A	N/A	340

Enable/Disable All Code Types

To disable all symbologies, scan **Disable All Code Types** below. This is useful when enabling only a few code types.

Scan **Enable All Code Types** turn on (enable) all code types. This is useful when you want to read all codes, or when you want to disable only a few code types.



Disable All Code Types

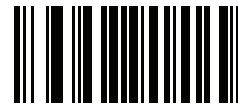

Enable All Code Types

UPC/EAN

Enable/Disable UPC-A

Parameter # 1 (SSI # 01h)

To enable or disable UPC-A, scan the appropriate barcode below.

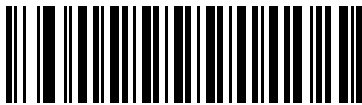

*** Enable UPC-A
(1)**

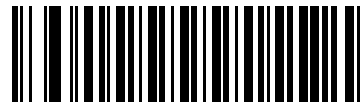

**Disable UPC-A
(0)**

Enable/Disable UPC-E

Parameter # 2 (SSI # 02h)

To enable or disable UPC-E, scan the appropriate barcode below.

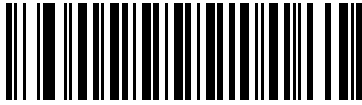

* Enable UPC-E
(1)



Disable UPC-E
(0)

Enable/Disable UPC-E1

Parameter # 12 (SSI # 0Ch)

UPC-E1 is disabled by default.

To enable or disable UPC-E1, scan the appropriate barcode below.



NOTE: UPC-E1 is not a UCC (Uniform Code Council) approved symbology.

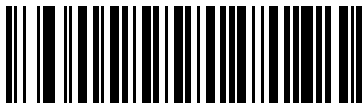

Enable UPC-E1
(1)

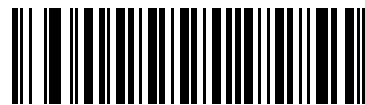

* Disable UPC-E1
(0)

Enable/Disable EAN-8/JAN-8

Parameter # 4 (SSI # 04h)

To enable or disable EAN-8/JAN-8, scan the appropriate barcode below.

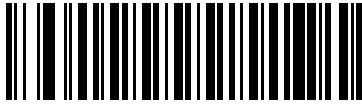

* Enable EAN-8/JAN-8
(1)



Disable EAN-8/JAN-8
(0)

Enable/Disable EAN-13/JAN-13

Parameter # 3 (SSI # 03h)

To enable or disable EAN-13/JAN-13, scan the appropriate barcode below.

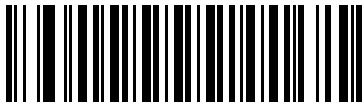

* Enable EAN-13/JAN-13
(1)



Disable EAN-13/JAN-13
(0)

Enable/Disable Bookland EAN

Parameter # 83 (SSI # 53h)

To enable or disable Bookland EAN, scan the appropriate barcode below.

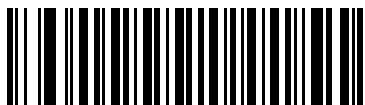

Enable Bookland EAN
(1)



* Disable Bookland EAN
(0)



NOTE: If you enable Bookland EAN, select a [Bookland ISBN Format on page 260](#). Also select either Decode UPC/EAN Supplementals, Autodiscriminate UPC/EAN Supplementals, or Enable 978/979 Supplemental Mode in [Decode UPC/EAN/JAN Supplementals on page 247](#).

Decode UPC/EAN/JAN Supplementals

Parameter # 16 (SSI # 10h)

Supplementals are barcodes appended according to specific format conventions (e.g., UPC A+2, UPC E+2, EAN 13+2). The following options are available:

- If you select **Ignore UPC/EAN with Supplementals**, and the digital scanner is presented with a UPC/EAN plus supplemental symbol, the digital scanner decodes UPC/EAN and ignores the supplemental characters.
- If you select **Decode UPC/EAN with Supplementals**, the digital scanner only decodes UPC/EAN symbols with supplemental characters, and ignores symbols without supplementals.
- If you select **Autodiscriminate UPC/EAN Supplementals**, the digital scanner decodes UPC/EAN symbols with supplemental characters immediately. If the symbol does not have a supplemental, the digital scanner must decode the barcode the number of times set via [UPC/EAN/JAN Supplemental Redundancy on page 251](#) before transmitting its data to confirm that there is no supplemental.
- If you select one of the following **Supplemental Mode** options, the digital scanner immediately transmits EAN-13 barcodes starting with that prefix that have supplemental characters. If the symbol does not have a supplemental, the digital scanner must decode the barcode the number of times set via [UPC/EAN/JAN Supplemental Redundancy on page 251](#) before transmitting its data to confirm that there is no supplemental. The digital scanner transmits UPC/EAN barcodes that do not have that prefix immediately.
 - Enable 378/379 Supplemental Mode
 - Enable 978/979 Supplemental Mode



NOTE: If you select 978/979 Supplemental Mode and are scanning Bookland EAN barcodes, see [Enable/Disable Bookland EAN on page 247](#) to enable Bookland EAN, and select a format using [Bookland ISBN Format on page 260](#).

- Enable 977 Supplemental Mode
- Enable 414/419/434/439 Supplemental Mode
- Enable 491 Supplemental Mode
- **Enable Smart Supplemental Mode** - applies to EAN-13 barcodes starting with any prefix listed previously.
- **Supplemental User-Programmable Type 1** - applies to EAN-13 barcodes starting with a 3-digit user-defined prefix. Set this 3-digit prefix using [User-Programmable Supplementals on page 251](#).
- **Supplemental User-Programmable Type 1 and 2** - applies to EAN-13 barcodes starting with either of two 3-digit user-defined prefixes. Set the 3-digit prefixes using [User-Programmable Supplementals on page 251](#).
- **Smart Supplemental Plus User-Programmable 1** - applies to EAN-13 barcodes starting with any prefix listed previously or the user-defined prefix set using [User-Programmable Supplementals on page 251](#).
- **Smart Supplemental Plus User-Programmable 1 and 2** - applies to EAN-13 barcodes starting with any prefix listed previously or one of the two user-defined prefixes set using [User-Programmable Supplementals on page 251](#).



NOTE: To minimize the risk of invalid data transmission, select either to decode or ignore supplemental characters.

Decode UPC/EAN/JAN Supplementals (continued)

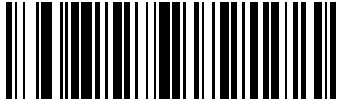

Decode UPC/EAN/JAN Only With Supplementals
(1)



* Ignore Supplementals
(0)



Autodiscriminate UPC/EAN/JAN Supplementals
(2)

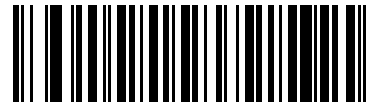

Enable 378/379 Supplemental Mode
(4)



Enable 978/979 Supplemental Mode
(5)



Enable 977 Supplemental Mode
(7)

Decode UPC/EAN/JAN Supplementals (continued)



Enable 414/419/434/439 Supplemental Mode
(6)



Enable 491 Supplemental Mode
(8)



Enable Smart Supplemental Mode
(3)



Supplemental User-Programmable Type 1
(9)



Supplemental User-Programmable Type 1 and 2
(10)



Smart Supplemental Plus User-Programmable 1
(11)



Smart Supplemental Plus User-Programmable 1 and 2
(12)

User-Programmable Supplementals

Supplemental 1: Parameter # 579 (SSI # F1h 43h)

Supplemental 2: Parameter # 580 (SSI # F1h 44h)

If you selected a Supplemental User-Programmable option from [Decode UPC/EAN/JAN Supplementals on page 247](#), select **User-Programmable Supplemental 1** to set the 3-digit prefix. Then select the 3 digits using the numeric barcodes beginning on [451](#). Select **User-Programmable Supplemental 2** to set a second 3-digit prefix. Then select the 3 digits using the numeric barcodes beginning on [451](#). The default is 000 (zeros).



User-Programmable Supplemental 1



User-Programmable Supplemental 2

UPC/EAN/JAN Supplemental Redundancy

Parameter # 80 (SSI # 50h)

If you selected **Autodiscriminate UPC/EAN/JAN Supplementals**, this option adjusts the number of times to decode a symbol without supplementals before transmission. The range is from two to thirty times. Five or above is recommended when decoding a mix of UPC/EAN/JAN symbols with and without supplementals. The default is 10.

Scan the barcode below to set a decode redundancy value. Next, scan two numeric barcodes in [Numeric Barcodes](#). Enter a leading zero for single digit numbers. To correct an error or change a selection, scan [Cancel on page 451](#).



UPC/EAN/JAN Supplemental Redundancy

UPC/EAN/JAN Supplemental AIM ID Format

Parameter # 672 (SSI # F1h A0h)

Select an output format when reporting UPC/EAN/JAN barcodes with Supplementals with [Transmit Code ID Character on page 123](#) set to **AIM Code ID Character**:

- **Separate** - transmit UPC/EAN with supplementals with separate AIM IDs but one transmission, i.e.:
]E<0 or 4><data>]E<1 or 2>[supplemental data]
- **Combined** - transmit UPC/EAN with supplementals with one AIM ID and one transmission, i.e.:
]E3<data+supplemental data>
- **Separate Transmissions** - transmit UPC/EAN with supplementals with separate AIM IDs and separate transmissions, i.e.:
]E<0 or 4><data>
]E<1 or 2>[supplemental data]



Separate
(0)



* Combined
(1)



Separate Transmissions
(2)

Transmit UPC-A Check Digit

Parameter # 40 (SSI # 28h)

The check digit is the last character of the symbol used to verify the integrity of the data. Scan the appropriate barcode below to transmit the barcode data with or without the UPC-A check digit. It is always verified to guarantee the integrity of the data.

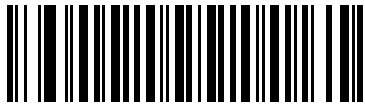

* Transmit UPC-A Check Digit
(1)

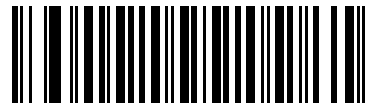

Do Not Transmit UPC-A Check Digit
(0)

Transmit UPC-E Check Digit

Parameter # 41 (SSI # 29h)

The check digit is the last character of the symbol used to verify the integrity of the data. Scan the appropriate barcode below to transmit the barcode data with or without the UPC-E check digit. It is always verified to guarantee the integrity of the data.

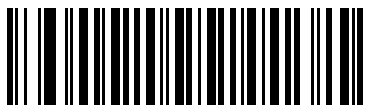

* Transmit UPC-E Check Digit
(1)



Do Not Transmit UPC-E Check Digit
(0)

Transmit UPC-E1 Check Digit

Parameter # 42 (SSI # 2Ah)

The check digit is the last character of the symbol used to verify the integrity of the data. Scan the appropriate barcode below to transmit the barcode data with or without the UPC-E1 check digit. It is always verified to guarantee the integrity of the data.

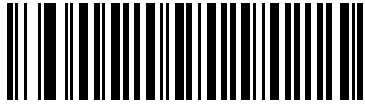

* Transmit UPC-E1 Check Digit
(1)

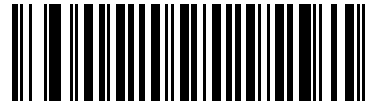

Do Not Transmit UPC-E1 Check Digit
(0)

Transmit EAN-8 Check Digit

Parameter # 1881 (SSI # F8 07 59)

The check digit is the last character of the symbol used to verify the integrity of the data. Scan the appropriate barcode below to transmit the barcode data with or without the EAN-8 Check Digit. It is always verified to guarantee the integrity of the data.



* Transmit EAN-8 Check Digit
(1)



Do Not Transmit EAN-8 Check Digit
(0)

Transmit EAN-13 Check Digit

Parameter # 1882 (SSI # F8 07 5A)

The check digit is the last character of the symbol used to verify the integrity of the data. Scan the appropriate barcode below to transmit the barcode data with or without the EAN-13 Check Digit. It is always verified to guarantee the integrity of the data.



* Transmit EAN-13 Check Digit
(1)



Do Not Transmit EAN-13 Check Digit
(0)

Transmit Code 39 Start/Stop Characters

Parameter # 1900 (SSI # F8 07 6C)

The Code 39 Start/Stop Characters are not normally transmitted along with the barcode data. Scan Transmit Code 39 Start/Stop Characters to have them transmitted with the barcode data.



Transmit Code 39 Start/Stop Characters
(1)



* Do Not Transmit 39 Start/Stop Characters
(0)

UPC-A Preamble

Parameter # 34 (SSI # 22h)

Preamble characters are part of the UPC symbol, and include Country Code and System Character. There are three options for transmitting a UPC-A preamble to the host device: transmit System Character only, transmit System Character and Country Code ("0" for USA), and transmit no preamble. Select the appropriate option to match the host system.

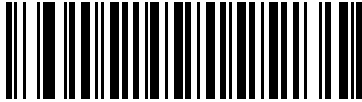

No Preamble (<DATA>)
(0)

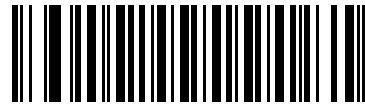

* System Character (<SYSTEM CHARACTER>
<DATA>)
(1)

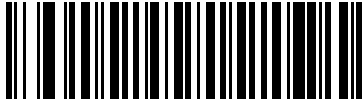

System Character & Country Code
(< COUNTRY CODE> <SYSTEM CHARACTER>
<DATA>)
(2)

UPC-E Preamble

Parameter # 35 (SSI # 23h)

Preamble characters are part of the UPC symbol, and include Country Code and System Character. There are three options for transmitting a UPC-E preamble to the host device: transmit System Character only, transmit System Character and Country Code ("0" for USA), and transmit no preamble. Select the appropriate option to match the host system.



No Preamble (<DATA>
(0)

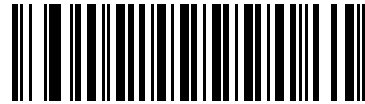

* System Character (<SYSTEM CHARACTER>
<DATA>
(1)

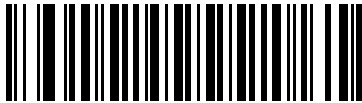

System Character & Country Code
(< COUNTRY CODE> <SYSTEM CHARACTER>
<DATA>
(2)

UPC-E1 Preamble

Parameter # 36 (SSI # 24h)

Preamble characters are part of the UPC symbol, and include Country Code and System Character. There are three options for transmitting a UPC-E1 preamble to the host device: transmit System Character only, transmit System Character and Country Code ("0" for USA), and transmit no preamble. Select the appropriate option to match the host system.



No Preamble (<DATA>)
(0)



* System Character (<SYSTEM CHARACTER> <DATA>)
(1)

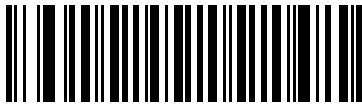

System Character & Country Code
(< COUNTRY CODE> <SYSTEM CHARACTER> <DATA>)
(2)

Convert UPC-E to UPC-A

Parameter # 37 (SSI # 25h)

Enable this to convert UPC-E (zero suppressed) decoded data to UPC-A format before transmission. After conversion, the data follows UPC-A format and is affected by UPC-A programming selections (e.g., Preamble, Check Digit).

Disable this to transmit UPC-E decoded data as UPC-E data, without conversion.

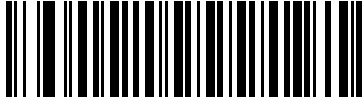

Convert UPC-E to UPC-A (Enable)
(1)

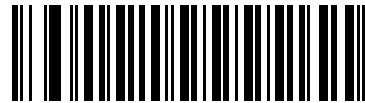

* Do Not Convert UPC-E to UPC-A (Disable)
(0)

Convert UPC-E1 to UPC-A

Parameter # 38 (SSI # 26h)

Enable this to convert UPC-E1 decoded data to UPC-A format before transmission. After conversion, the data follows UPC-A format and is affected by UPC-A programming selections (e.g., Preamble, Check Digit).

Disable this to transmit UPC-E1 decoded data as UPC-E1 data, without conversion.

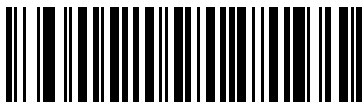

Convert UPC-E1 to UPC-A (Enable)
(1)



* Do Not Convert UPC-E1 to UPC-A (Disable)
(0)

EAN-8/JAN-8 Extend

Parameter # 39 (SSI # 27h)

Enable this parameter to add five leading zeros to decoded EAN-8 symbols to make them compatible in format to EAN-13 symbols. Disable this to transmit EAN-8 symbols as is.

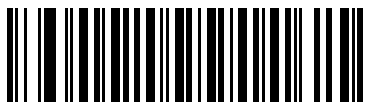

Enable EAN/JAN Zero Extend
(1)



* Disable EAN/JAN Zero Extend
(0)

Bookland ISBN Format

Parameter # 576 (SSI # F1h 40h)

If you enabled Bookland EAN using [Enable/Disable Bookland EAN on page 247](#), select one of the following formats for Bookland data:

- **Bookland ISBN-10** - The digital scanner reports Bookland data starting with 978 in traditional 10-digit format with the special Bookland check digit for backward-compatibility. Data starting with 979 is not considered Bookland in this mode.
- **Bookland ISBN-13** - The digital scanner reports Bookland data (starting with either 978 or 979) as EAN-13 in 13-digit format to meet the 2007 ISBN-13 protocol.



* Bookland ISBN-10
(0)



Bookland ISBN-13
(1)



NOTE: For Bookland EAN to function properly, first enable Bookland EAN using [Enable/Disable Bookland EAN on page 247](#), then select either Decode UPC/EAN Supplementals, Autodiscriminate UPC/EAN Supplementals, or Enable 978/979 Supplemental Mode in [Decode UPC/EAN/JAN Supplementals on page 247](#).

UCC Coupon Extended Code

Parameter # 85 (SSI # 55h)

Enable this parameter to decode UPC-A barcodes starting with digit '5', EAN-13 barcodes starting with digit '99', and UPC-A/GS1-128 Coupon Codes. UPCA, EAN-13, and GS1-128 must be enabled to scan all types of Coupon Codes.

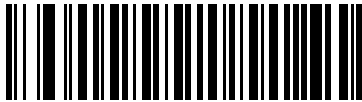

Enable UCC Coupon Extended Code
(1)

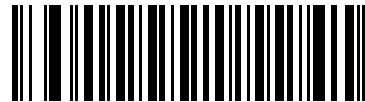

* Disable UCC Coupon Extended Code
(0)



NOTE: See [UPC/EAN/JAN Supplemental Redundancy on page 251](#) to control autodiscrimination of the GS1-128 (right half) of a coupon code.

Coupon Report

Parameter # 730 (SSI # F1h DAh)

Select an option to determine which type of coupon format to support.

- Select **Old Coupon Format** to support UPC-A/GS1-128 and EAN-13/GS1-128.
- Select **New Coupon Format** as an interim format to support UPC-A/GS1-DataBar and EAN-13/GS1-DataBar.
- If you select **Autodiscriminate Format**, the digital scanner supports both **Old Coupon Format** and **New Coupon Format**.



Old Coupon Format
(0)

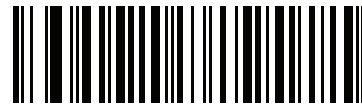

* New Coupon Format
(1)



Autodiscriminate Coupon Format
(2)

ISSN EAN

Parameter # 617 (SSI # F1h 69h)

To enable or disable ISSN EAN, scan the appropriate barcode below.



Enable ISSN EAN
(1)



* Disable ISSN EAN
(0)

UPC Reduced Quiet Zone

Parameter # 1289 (SSI # F8h 05h 09h)

Scan one of the following barcodes to enable or disable decoding UPC barcodes with reduced quiet zones. If you select **Enable**, select a [1D Quiet Zone Level on page 338](#).



Enable UPC Reduced Quiet Zone
(1)



* Disable UPC Reduced Quiet Zone
(0)

Code 128

Enable/Disable Code 128

Parameter # 8 (SSI # 08h)

To enable or disable Code 128, scan the appropriate barcode below.

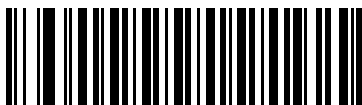

* Enable Code 128
(1)



Disable Code 128
(0)

Set Lengths for Code 128

Parameter # L1 = 209 (SSI # D1h), L2 = 210 (SSI # D2h)

The length of a code refers to the number of characters (i.e., human readable characters), including check digit(s) the code contains. Set lengths for Code 128 to any length, one or two discrete lengths, or lengths within a specific range. The default is Any Length.



NOTE: When setting lengths for different barcode types, enter a leading zero for single digit numbers.

- **One Discrete Length** - Select this option to decode only Code 128 symbols containing a selected length. Select the length using the numeric barcodes in [Numeric Barcodes](#). For example, to decode only Code 128 symbols with 14 characters, scan **Code 128 - One Discrete Length**, then scan **1** followed by **4**. To correct an error or change the selection, scan [Cancel on page 451](#).
- **Two Discrete Lengths** - Select this option to decode only Code 128 symbols containing either of two selected lengths. Select lengths using the numeric barcodes in [Numeric Barcodes](#). For example, to decode only Code 128 symbols containing either 2 or 14 characters, select **Code 128 - Two Discrete Lengths**, then scan **0, 2, 1**, and then **4**. To correct an error or change the selection, scan [Cancel on page 451](#).
- **Length Within Range** - Select this option to decode a Code 128 symbol with a specific length range. Select lengths using numeric barcodes in [Numeric Barcodes](#). For example, to decode Code 128 symbols containing between 4 and 12 characters, first scan **Code 128 - Length Within Range**. Then scan **0, 4, 1**, and **2** (enter a leading zero for single digit numbers). To correct an error or change the selection, scan [Cancel on page 451](#).
- **Any Length (default)**- Select this option to decode Code 128 symbols containing any number of characters within the digital scanner capability.

Set Lengths for Code 128 (continued)

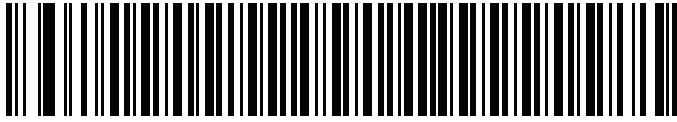

Code 128 - One Discrete Length

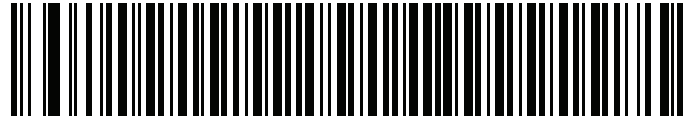

Code 128 - Two Discrete Lengths

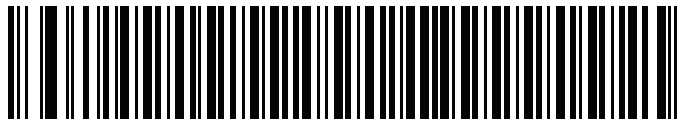

Code 128 - Length Within Range

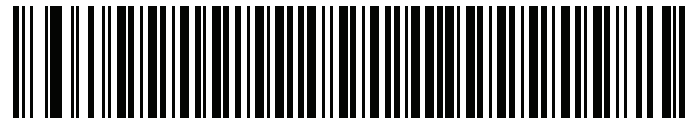

* Code 128 - Any Length

Enable/Disable GS1-128 (formerly UCC/EAN-128)

Parameter # 14 (SSI # 0Eh)

To enable or disable GS1-128, scan the appropriate barcode below.

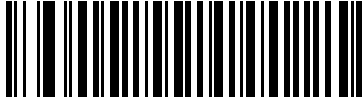

* Enable GS1-128
(1)

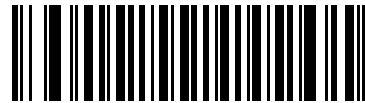

Disable GS1-128
(0)

Enable/Disable ISBT 128

Parameter # 84 (SSI # 54h)

ISBT 128 is a variant of Code 128 used in the blood bank industry. Scan a barcode below to enable or disable ISBT 128. If necessary, the host must perform concatenation of the ISBT data.



* Enable ISBT 128
(1)



Disable ISBT 128
(0)

ISBT Concatenation

Parameter # 577 (SSI # F1h 41h)



NOTE: Disable ISBT Concatenation when using UDI with ICCBBA for blood bag labels (see [Scan a Blood Bag Label using Blood Bag Parse+ on page 345](#)).

Select an option for concatenating pairs of ISBT code types:

- If you select **Disable ISBT Concatenation**, the digital scanner does not concatenate pairs of ISBT codes it encounters.
- If you select **Enable ISBT Concatenation**, there must be two ISBT codes in order for the digital scanner to decode and perform concatenation. The digital scanner does not decode single ISBT symbols.
- If you select **Autodiscriminate ISBT Concatenation**, the digital scanner decodes and concatenates pairs of ISBT codes immediately. If only a single ISBT symbol is present, the digital scanner must decode the symbol the number of times set via [ISBT Concatenation Redundancy on page 268](#) before transmitting its data to confirm that there is no additional ISBT symbol.



NOTE: The default for SR configurations of the scanner is Disable ISBT Concatenation.

The default for Healthcare configurations of the scanner is Enable ISBT Concatenation.

When enabling ISBT Concatenation or Autodiscriminate ISBT Concatenation set Code 128 Security Level to Level 2.

For Autodiscriminate ISBT Concatenation to operate as expected, both ISBT barcodes must be in the field of view at the same time. This may be difficult to achieve in presentation mode.



* Disable ISBT Concatenation
(0)
(default for SR models)



* **Enable ISBT Concatenation**
(1)
(default for HC models)



Autodiscriminate ISBT Concatenation
(2)

Check ISBT Table

Parameter # 578 (SSI # F1h 42h)

The ISBT specification includes a table that lists several types of ISBT barcodes that are commonly used in pairs. If you set **ISBT Concatenation** to **Enable**, enable **Check ISBT Table** to concatenate only those pairs found in this table. Other types of ISBT codes are not concatenated.



* **Enable Check ISBT Table**
(1)



Disable Check ISBT Table
(0)

ISBT Concatenation Redundancy

Parameter # 223 (SSI # DFh)

If you set **ISBT Concatenation** to **Autodiscriminate**, use this parameter to set the number of times the digital scanner must decode an ISBT symbol before determining that there is no additional symbol.

Scan the barcode below, then scan two numeric barcodes in [Numeric Barcodes](#) to set a value between 2 and 20. Enter a leading zero for single digit numbers. To correct an error or change a selection, scan [Cancel on page 451](#). The default is 10.



ISBT Concatenation Redundancy

Code 128 Security Level

Parameter # 751 (SSI # F1h EFh)

Code 128 barcodes are vulnerable to misdecodes, particularly when Code 128 Lengths is set to **Any Length**. The digital scanner offers four levels of decode security for Code 128 barcodes. There is an inverse relationship between security and digital scanner aggressiveness. Increasing the level of security can reduce scanning aggressiveness, so select only the level of security necessary.

- **Code 128 Security Level 0:** This setting allows the digital scanner to operate in its most aggressive state, while providing sufficient security in decoding most in-spec barcodes.
- **Code 128 Security Level 1:** A barcode must be successfully read twice, and satisfy certain safety requirements before being decoded. This default setting eliminates most misdecodes.
- **Code 128 Security Level 2:** Select this option with greater barcode security requirements if **Security Level 1** fails to eliminate misdecodes.
- **Code 128 Security Level 3:** If you selected **Security Level 2**, and misdecodes still occur, select this security level to apply the highest safety requirements. A barcode must be successfully read three times before being decoded.



NOTE: Selecting this option is an extreme measure against mis-decoding severely out-of-spec barcodes. Selecting this level of security significantly impairs the decoding ability of the digital scanner. If this level of security is required, try to improve the quality of the barcodes.

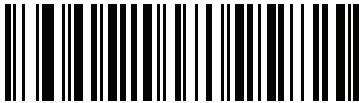

Code 128 Security Level 0
(0)



* Code 128 Security Level 1
(1)



Code 128 Security Level 2
(2)



Code 128 Security Level 3
(3)

Code 128 Reduced Quiet Zone

Parameter # 1208 (SSI # F8h 04h B8h)

Scan one of the following barcodes to enable or disable decoding Code 128 barcodes with reduced quiet zones. If you select **Enable**, select a [1D Quiet Zone Level on page 338](#).



Enable Code 128 Reduced Quiet Zone
(1)



* Disable Code 128 Reduced Quiet Zone
(0)

Code 128 <FNC4>

Parameter # 1254 (SSI # F8h 04h E6h)

This feature applies to Code 128 barcodes with an embedded <FNC4> character. Enable this to strip the <FNC4> character from the decode data. The remaining characters are sent to the host unchanged. When disabled, the <FNC4> character is processed normally as per Code 128 standard.



Honor Code 128 <FNC4>
(1)



* Ignore Code 128 <FNC4>
(0)

Code 39

Enable/Disable Code 39

Parameter # 0 (SSI # 00h)

To enable or disable Code 39, scan the appropriate barcode below.

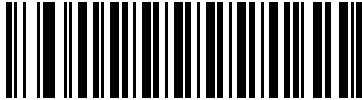

* Enable Code 39
(1)

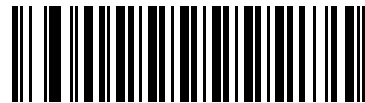

Disable Code 39
(0)

Enable/Disable Trioptic Code 39

Parameter # 13 (SSI # 0Dh)

Trioptic Code 39 is a variant of Code 39 used in the marking of computer tape cartridges. Trioptic Code 39 symbols always contain six characters. To enable or disable Trioptic Code 39, scan the appropriate barcode below.

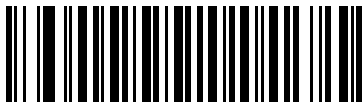

Enable Trioptic Code 39
(1)



* Disable Trioptic Code 39
(0)



NOTE: You cannot enable Trioptic Code 39 and Code 39 Full ASCII simultaneously.

Convert Code 39 to Code 32

Parameter # 86 (SSI # 56h)

Code 32 is a variant of Code 39 used by the Italian pharmaceutical industry. Scan the appropriate barcode below to enable or disable converting Code 39 to Code 32.



NOTE: Code 39 must be enabled for this parameter to function.



Enable Convert Code 39 to Code 32
(1)

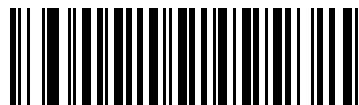

* Disable Convert Code 39 to Code 32
(0)

Code 32 Prefix

Parameter # 231 (SSI # E7h)

Scan the appropriate barcode below to enable or disable adding the prefix character “A” to all Code 32 barcodes.



NOTE: Convert Code 39 to Code 32 must be enabled for this parameter to function.

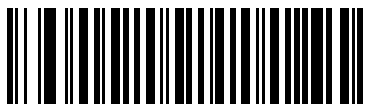

Enable Code 32 Prefix
(1)



* Disable Code 32 Prefix
(0)

Set Lengths for Code 39

Parameter # L1 = 18 (SSI # 12h), L2 = 19 (SSI # 13h)

The length of a code refers to the number of characters (i.e., human readable characters), including check digit(s) the code contains. Set lengths for Code 39 to any length, one or two discrete lengths, or lengths within a specific range. If Code 39 Full ASCII is enabled, **Length Within a Range** or **Any Length** are the preferred options. The default is 1 to 55.



NOTE: When setting lengths for different barcode types, enter a leading zero for single digit numbers.

- **One Discrete Length** - Select this option to decode only Code 39 symbols containing a selected length. Select the length using the numeric barcodes in [Numeric Barcodes](#). For example, to decode only Code 39 symbols with 14 characters, scan **Code 39 - One Discrete Length**, then scan 1 followed by 4. To correct an error or change the selection, scan [Cancel on page 451](#).
- **Two Discrete Lengths** - Select this option to decode only Code 39 symbols containing either of two selected lengths. Select lengths using the numeric barcodes in [Numeric Barcodes](#). For example, to decode only Code 39 symbols containing either 2 or 14 characters, select **Code 39 - Two Discrete Lengths**, then scan 0, 2, 1, and then 4. To correct an error or change the selection, scan [Cancel on page 451](#).
- **Length Within Range** - Select this option to decode a Code 39 symbol with a specific length range. Select lengths using numeric barcodes in [Numeric Barcodes](#). For example, to decode Code 39 symbols containing between 4 and 12 characters, first scan **Code 39 - Length Within Range**. Then scan 0, 4, 1, and 2 (enter a leading zero for single digit numbers). To correct an error or change the selection, scan [Cancel on page 451](#).
- **Any Length** - Select this option to decode Code 39 symbols containing any number of characters within the digital scanner capability.



Code 39 - One Discrete Length



Code 39 - Two Discrete Lengths



* Code 39 - Length Within Range



Code 39 - Any Length

Code 39 Check Digit Verification

Parameter # 48 (SSI # 30h)

Enable this feature to check the integrity of all Code 39 symbols to verify that the data complies with specified check digit algorithm. Only Code 39 symbols which include a modulo 43 check digit are decoded. Enable this feature if the Code 39 symbols contain a Modulo 43 check digit.

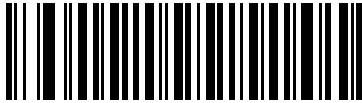

Enable Code 39 Check Digit
(1)

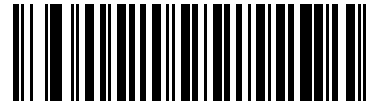

* Disable Code 39 Check Digit
(0)

Transmit Code 39 Check Digit

Parameter # 43 (SSI # 2Bh)

Scan a barcode below to transmit Code 39 data with or without the check digit.

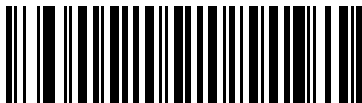

Transmit Code 39 Check Digit (Enable)
(1)



* Do Not Transmit Code 39 Check Digit (Disable)
(0)



NOTE: Code 39 Check Digit Verification must be enabled for this parameter to function.

Code 39 Full ASCII Conversion

Parameter # 17 (SSI # 11h)

Code 39 Full ASCII is a variant of Code 39 which pairs characters to encode the full ASCII character set. To enable or disable Code 39 Full ASCII, scan the appropriate barcode below.

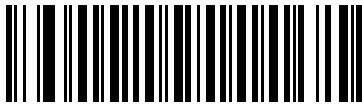

Enable Code 39 Full ASCII
(1)

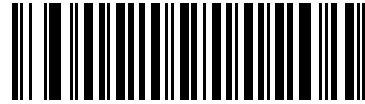

* Disable Code 39 Full ASCII
(0)



NOTE: You cannot enable Trioptic Code 39 and Code 39 Full ASCII simultaneously.

Code 39 Full ASCII to Full ASCII Correlation is host-dependent, and is therefore described in the ASCII Character Set Table for the appropriate interface. See the [ASCII Character Sets for USB on page 220](#).

Code 39 Security Level

Parameter # 750 (SSI # F1h EEh)

The digital scanner offers four levels of decode security for Code 39 barcodes. There is an inverse relationship between security and digital scanner aggressiveness. Increasing the level of security can reduce scanning aggressiveness, so select only the level of security necessary.

- **Code 39 Security Level 0:** This setting allows the digital scanner to operate in its most aggressive state, while providing sufficient security in decoding most in-spec barcodes.
- **Code 39 Security Level 1:** This default setting eliminates most misdecodes.
- **Code 39 Security Level 2:** Select this option with greater barcode security requirements if **Security Level 1** fails to eliminate misdecodes.
- **Code 39 Level 3:** If you selected **Security Level 2**, and misdecodes still occur, select this security level to apply the highest safety requirements.



NOTE: Selecting this option is an extreme measure against mis-decoding severely out-of-spec barcodes. Selecting this level of security significantly impairs the decoding ability of the digital scanner. If this level of security is required, try to improve the quality of the barcodes.



Code 39 Security Level 0
(0)



* Code 39 Security Level 1
(1)



Code 39 Security Level 2
(2)



Code 39 Security Level 3
(3)

Code 39 Reduced Quiet Zone

Parameter # 1209 (SSI # F8h 04h B9h)

Scan one of the following barcodes to enable or disable decoding Code 39 barcodes with reduced quiet zones. If you select **Enable**, select a [1D Quiet Zone Level on page 338](#).



Enable Code 39 Reduced Quiet Zone
(1)



* Disable Code 39 Reduced Quiet Zone
(0)

Code 93

Enable/Disable Code 93

Parameter # 9 (SSI # 09h)

To enable or disable Code 93, scan the appropriate barcode below.

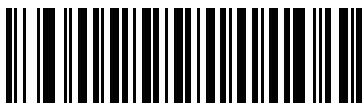

* Enable Code 93
(1)



Disable Code 93
(0)

Set Lengths for Code 93

Parameter # L1 = 26 (SSI # 1Ah), L2 = 27 (SSI # 1Bh)

The length of a code refers to the number of characters (i.e., human readable characters), including check digit(s) the code contains. Set lengths for Code 93 to any length, one or two discrete lengths, or lengths within a specific range. The default is 1 to 55.

- **One Discrete Length** - Select this option to decode only Code 93 symbols containing a selected length. Select the length using the numeric barcodes in [Numeric Barcodes](#). For example, to decode only Code 93 symbols with 14 characters, scan **Code 93 - One Discrete Length**, then scan 1 followed by 4. To correct an error or to change the selection, scan [Cancel on page 451](#).
- **Two Discrete Lengths** - Select this option to decode only Code 93 symbols containing either of two selected lengths. Select lengths using the numeric barcodes in [Numeric Barcodes](#). For example, to decode only Code 93 symbols containing either 2 or 14 characters, select **Code 93 - Two Discrete Lengths**, then scan 0, 2, 1, and then 4. To correct an error or to change the selection, scan [Cancel on page 451](#).
- **Length Within Range** - Select this option to decode a Code 93 symbol with a specific length range. Select lengths using the numeric barcodes in [Numeric Barcodes](#). For example, to decode Code 93 symbols containing between 4 and 12 characters, first scan **Code 93 - Length Within Range**. Then scan 0, 4, 1, and 2 (enter a leading zero for single digit numbers). To correct an error or change the selection, scan [Cancel on page 451](#).
- **Any Length** - Scan this option to decode Code 93 symbols containing any number of characters within the digital scanner capability.



Code 93 - One Discrete Length



Code 93 - Two Discrete Lengths



* Code 93 - Length Within Range



Code 93 - Any Length

Code 11

Code 11

Parameter # 10 (SSI # 0Ah)

To enable or disable Code 11, scan the appropriate barcode below.

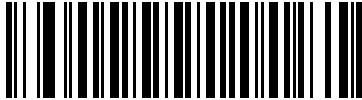

Enable Code 11
(1)

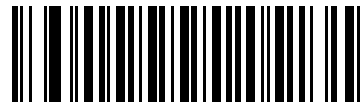

* Disable Code 11
(0)

Set Lengths for Code 11

Parameter # L1 = 28 (SSI # 1Ch), L2 = 29 (SSI # 1Dh)

The length of a code refers to the number of characters (i.e., human readable characters), including check digit(s) the code contains. Set lengths for Code 11 to any length, one or two discrete lengths, or lengths within a specific range. The default is 4 to 55.

- **One Discrete Length** - Select this option to decode only Code 11 symbols containing a selected length. Select the length using the numeric barcodes in [Numeric Barcodes](#). For example, to decode only Code 11 symbols with 14 characters, scan **Code 11 - One Discrete Length**, then scan 1 followed by 4. To correct an error or to change the selection, scan [Cancel on page 451](#).
- **Two Discrete Lengths** - Select this option to decode only Code 11 symbols containing either of two selected lengths. Select lengths using the numeric barcodes in [Numeric Barcodes](#). For example, to decode only Code 11 symbols containing either 2 or 14 characters, select **Code 11 - Two Discrete Lengths**, then scan 0, 2, 1, and then 4. To correct an error or to change the selection, scan [Cancel on page 451](#).
- **Length Within Range** - Select this option to decode a Code 11 symbol with a specific length range. Select lengths using numeric barcodes in [Numeric Barcodes](#). For example, to decode Code 11 symbols containing between 4 and 12 characters, first scan **Code 11 - Length Within Range**. Then scan 0, 4, 1, and 2 (enter a leading zero for single digit numbers). To correct an error or change the selection, scan [Cancel on page 451](#).
- **Any Length** - Scan this option to decode Code 11 symbols containing any number of characters within the digital scanner capability.

Set Lengths for Code 11 (continued)



Code 11 - One Discrete Length



Code 11 - Two Discrete Lengths



* Code 11 - Length Within Range



Code 11 - Any Length

Code 11 Check Digit Verification

Parameter # 52 (SSI # 34h)

This feature allows the digital scanner to check the integrity of all Code 11 symbols to verify that the data complies with the specified check digit algorithm. This selects the check digit mechanism for the decoded Code 11 barcode. The options are to check for one check digit, check for two check digits, or disable the feature.

To enable this feature, scan the barcode below corresponding to the number of check digits encoded in the Code 11 symbols.



* Disable
(0)

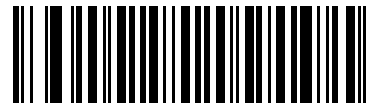

One Check Digit
(1)

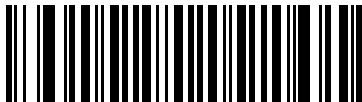

Two Check Digits
(2)

Transmit Code 11 Check Digits

Parameter # 47 (SSI # 2Fh)

This feature selects whether or not to transmit the Code 11 check digit(s).

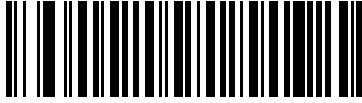

Transmit Code 11 Check Digit(s) (Enable)
(1)

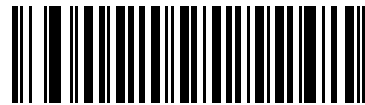

* Do Not Transmit Code 11 Check Digit(s) (Disable)
(0)



NOTE: Code 11 Check Digit Verification must be enabled for this parameter to function.

Interleaved 2 of 5 (ITF)

Enable/Disable Interleaved 2 of 5

Parameter # 6 (SSI # 06h)

To enable or disable Interleaved 2 of 5, scan the appropriate barcode below, and select an Interleaved 2 of 5 length from the following pages.

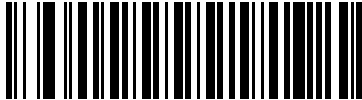

* Enable Interleaved 2 of 5
(1)



Disable Interleaved 2 of 5
(0)

Set Lengths for Interleaved 2 of 5

Parameter # L1 = 22 (SSI # 16h), L2 = 23 (SSI # 17h)

The length of a code refers to the number of characters (i.e., human readable characters), including check digit(s) the code contains. Set lengths for I 2 of 5 to any length, one or two discrete lengths, or lengths within a specific range. The range for Interleaved 2 of 5 lengths is 0 - 80. The default is 6 to 55.

- **One Discrete Length** - Select this option to decode only I 2 of 5 symbols containing a selected length. Select the length using the numeric barcodes in [Numeric Barcodes](#). For example, to decode only I 2 of 5 symbols with 14 characters, scan **I 2 of 5 - One Discrete Length**, then scan **1** followed by **4**. To correct an error or to change the selection, scan [Cancel on page 451](#).
- **Two Discrete Lengths** - Select this option to decode only I 2 of 5 symbols containing either of two selected lengths. Select lengths using the numeric barcodes in [Numeric Barcodes](#). For example, to decode only I 2 of 5 symbols containing either 2 or 14 characters, select **I 2 of 5 - Two Discrete Lengths**, then scan **0, 2, 1**, and then **4**. To correct an error or to change the selection, scan [Cancel on page 451](#).
- **Length Within Range** - Select this option to decode an I 2 of 5 symbol with a specific length range. Select lengths using numeric barcodes in [Numeric Barcodes](#). For example, to decode I 2 of 5 symbols containing between 4 and 12 characters, first scan **I 2 of 5 - Length Within Range**. Then scan **0, 4, 1**, and **2** (enter a leading zero for single digit numbers). To correct an error or change the selection, scan [Cancel on page 451](#).
- **Any Length** - Scan this option to decode I 2 of 5 symbols containing any number of characters within the digital scanner capability.



NOTE: Due to the construction of the I 2 of 5 symbology, it is possible for a scan line covering only a portion of the code to transmit as a complete scan, yielding less data than is encoded in the barcode. To prevent this, select specific lengths (I 2 of 5 - One Discrete Length, Two Discrete Lengths) for I 2 of 5 applications.



I 2 of 5 - One Discrete Length



I 2 of 5 - Two Discrete Lengths



* I 2 of 5 - Length Within Range



I 2 of 5 - Any Length

I 2 of 5 Check Digit Verification

Parameter # 49 (SSI # 31h)

Enable this feature to check the integrity of all I 2 of 5 symbols to verify the data complies with either the specified Uniform Symbology Specification (USS), or the Optical Product Code Council (OPCC) check digit algorithm.



* Disable
(0)



USS Check Digit
(1)



OPCC Check Digit
(2)

Transmit I 2 of 5 Check Digit

Parameter # 44 (SSI # 2Ch)

Scan the appropriate barcode below to transmit I 2 of 5 data with or without the check digit.

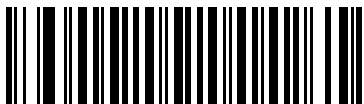

Transmit I 2 of 5 Check Digit (Enable)
(1)



* Do Not Transmit I 2 of 5 Check Digit (Disable)
(0)

Convert I 2 of 5 to EAN-13

Parameter # 82 (SSI # 52h)

Enable this parameter to convert 14-character I 2 of 5 codes to EAN-13, and transmit to the host as EAN-13. To accomplish this, the I 2 of 5 code must be enabled, and the code must have a leading zero and a valid EAN-13 check digit.

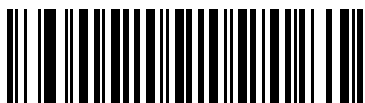

Convert I 2 of 5 to EAN-13 (Enable)
(1)



* Do Not Convert I 2 of 5 to EAN-13 (Disable)
(0)

Febraban

Parameter # 1750 (SSI # F8h 06h D6h)

Febraban is an I 2 of 5 barcode of length 44 that requires special check characters to be inserted in the transmitted data stream. When enabled, the I 2 of 5 internal check digit calculation and transmission is disabled. When disabled, all I 2 of 5 functionality works as usual.

Recommendations for Length Setting

I 2 of 5 Length 1: Larger of the fixed length and the FEBRABAN length (==44).

I 2 of 5 Length 2: Smaller of the fixed length and the FEBRABAN length (==44).



Enable Febraban
(1)



* Disable Febraban
(0)

I 2 of 5 Security Level

Parameter # 1121 (SSI # F8h 04h 61h)

Interleaved 2 of 5 barcodes are vulnerable to misdecodes, particularly when I 2 of 5 Lengths is set to **Any Length**. The digital scanner offers four levels of decode security for Interleaved 2 of 5 barcodes. There is an inverse relationship between security and digital scanner aggressiveness. Increasing the level of security can reduce scanning aggressiveness, so select only the level of security necessary.

- **I 2 of 5 Security Level 0:** This setting allows the digital scanner to operate in its most aggressive state, while providing sufficient security in decoding most in-spec barcodes.
- **I 2 of 5 Security Level 1:** A barcode must be successfully read twice, and satisfy certain safety requirements before being decoded. This default setting eliminates most misdecodes.
- **I 2 of 5 Security Level 2:** Select this option with greater barcode security requirements if **Security Level 1** fails to eliminate misdecodes.
- **I 2 of 5 Security Level 3:** If you selected **Security Level 2**, and misdecodes still occur, select this security level. The highest safety requirements are applied. A barcode must be successfully read three times before being decoded.



NOTE: Selecting this option is an extreme measure against mis-decoding severely out-of-spec barcodes. Selecting this level of security significantly impairs the decoding ability of the digital scanner. If this level of security is required, try to improve the quality of the barcodes.

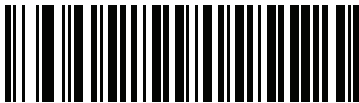

I 2 of 5 Security Level 0
(00h)



* I 2 of 5 Security Level 1
(01h)

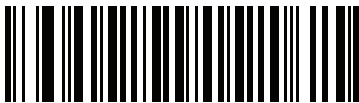

I 2 of 5 Security Level 2
(02h)



I 2 of 5 Security Level 3
(03h)

I 2 of 5 Reduced Quiet Zone

Parameter # 1210 (SSI # F8h 04h BAh)

Scan one of the following barcodes to enable or disable decoding I 2 of 5 barcodes with reduced quiet zones. If you select **Enable**, select a [1D Quiet Zone Level on page 338](#).



Enable I 2 of 5 Reduced Quiet Zone
(1)



* Disable I 2 of 5 Reduced Quiet Zone
(0)

Discrete 2 of 5 (DTF)

Enable/Disable Discrete 2 of 5

Parameter # 5 (SSI # 05h)

To enable or disable Discrete 2 of 5, scan the appropriate barcode below.

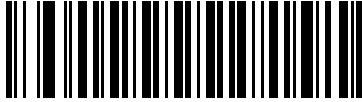

Enable Discrete 2 of 5
(1)



* Disable Discrete 2 of 5
(0)

Set Lengths for Discrete 2 of 5

Parameter # L1 = 20 (SSI # 14h), L2 = 21 (SSI # 15h)

The length of a code refers to the number of characters (i.e., human readable characters), including check digit(s) the code contains. Set lengths for D 2 of 5 to any length, one or two discrete lengths, or lengths within a specific range. The range for Discrete 2 of 5 lengths is 1 - 55.

- **One Discrete Length** - Select this option to decode only D 2 of 5 symbols containing a selected length. Select the length using the numeric barcodes in [Numeric Barcodes](#). For example, to decode only D 2 of 5 symbols with 14 characters, scan **D 2 of 5 - One Discrete Length**, then scan **1** followed by **4**. To correct an error or to change the selection, scan [Cancel on page 451](#).
- **Two Discrete Lengths** - Select this option to decode only D 2 of 5 symbols containing either of two selected lengths. Select lengths using the numeric barcodes in [Numeric Barcodes](#). For example, to decode only D 2 of 5 symbols containing either 2 or 14 characters, select **D 2 of 5 - Two Discrete Lengths**, then scan **0, 2, 1**, and then **4**. To correct an error or to change the selection, scan [Cancel on page 451](#).
- **Length Within Range** - Select this option to decode a D 2 of 5 symbol with a specific length range. Select lengths using numeric barcodes in [Numeric Barcodes](#). For example, to decode D 2 of 5 symbols containing between 4 and 12 characters, first scan **D 2 of 5 - Length Within Range**. Then scan **0, 4, 1**, and **2** (enter a leading zero for single digit numbers). To correct an error or change the selection, scan [Cancel on page 451](#).
- **Any Length** - Scan this option to decode D 2 of 5 symbols containing any number of characters within the digital scanner capability.



NOTE: Due to the construction of the D 2 of 5 symbology, it is possible for a scan line covering only a portion of the code to transmit as a complete scan, yielding less data than is encoded in the barcode. To prevent this, select specific lengths (**D 2 of 5 - One Discrete Length, Two Discrete Lengths**) for D 2 of 5 applications.



D 2 of 5 - One Discrete Length



D 2 of 5 - Two Discrete Lengths



*** D 2 of 5 - Length Within Range**



D 2 of 5 - Any Length

Codabar (NW - 7)

Enable/Disable Codabar

Parameter # 7 (SSI # 07h)

To enable or disable Codabar, scan the appropriate barcode below.

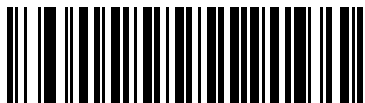

* Enable Codabar
(1)



Disable Codabar
(0)

Set Lengths for Codabar

Parameter # L1 = 24 (SSI # 18h), L2 = 25 (SSI # 19h)

The length of a code refers to the number of characters (i.e., human readable characters), including check digit(s) the code contains. Set lengths for Codabar to any length, one or two discrete lengths, or lengths within a specific range. The default is 4 to 55.

- **One Discrete Length** - Select this option to decode only Codabar symbols containing a selected length. Select the length using the numeric barcodes in [Numeric Barcodes](#). For example, to decode only Codabar symbols with 14 characters, scan **Codabar - One Discrete Length**, then scan 1 followed by 4. To correct an error or to change the selection, scan [Cancel on page 451](#).
- **Two Discrete Lengths** - Select this option to decode only Codabar symbols containing either of two selected lengths. Select lengths using the numeric barcodes in [Numeric Barcodes](#). For example, to decode only Codabar symbols containing either 2 or 14 characters, select **Codabar - Two Discrete Lengths**, then scan 0, 2, 1, and then 4. To correct an error or to change the selection, scan [Cancel on page 451](#).
- **Length Within Range** - Select this option to decode a Codabar symbol with a specific length range. Select lengths using numeric barcodes in [Numeric Barcodes](#). For example, to decode Codabar symbols containing between 4 and 12 characters, first scan **Codabar - Length Within Range**. Then scan 0, 4, 1, and 2 (enter a leading zero for single digit numbers). To correct an error or change the selection, scan [Cancel on page 451](#).
- **Any Length** - Scan this option to decode Codabar symbols containing any number of characters within the digital scanner capability.

Set Lengths for Codabar (continued)



Codabar - One Discrete Length



Codabar - Two Discrete Lengths



* Codabar - Length Within Range



Codabar - Any Length

CLSI Editing

Parameter # 54 (SSI # 36h)

Enable this parameter to strip the start and stop characters and insert a space after the first, fifth, and tenth characters of a 14-character Codabar symbol. Enable this feature if the host system requires this data format.



NOTE: Symbol length does not include start and stop characters.

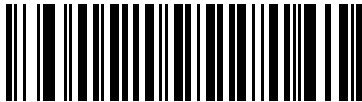

Enable CLSI Editing
(1)

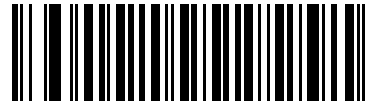

* Disable CLSI Editing
(0)

NOTIS Editing

Parameter # 55 (SSI # 37h)

Enable this parameter to strip the start and stop characters from a decoded Codabar symbol. Enable this feature if the host system requires this data format.

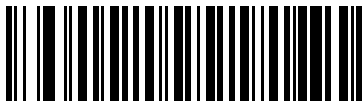

Enable NOTIS Editing
(1)



* Disable NOTIS Editing
(0)

Codabar Security Level

Parameter # 1776 (SSI # F8h 06h F0h)

The scanner offers four levels of decode security for Codabar barcodes. There is an inverse relationship between security and scanner aggressiveness. Increasing the level of security can reduce scanning aggressiveness, so select only the level of security necessary.

- **Codabar Security Level 0:** This setting allows the scanner to operate in its most aggressive state, while providing sufficient security in decoding most in-spec barcodes.
- **Codabar Security Level 1:** This default setting eliminates most misdecodes.
- **Codabar Security Level 2:** Select this option with greater barcode security requirements if **Security Level 1** fails to eliminate misdecodes.
- **Codabar Security Level 3:** If you selected **Security Level 2**, and misdecodes still occur, select this security level to apply the highest safety requirements.



NOTE: Selecting this option is an extreme measure against mis-decoding severely out-of-spec barcodes, and significantly impairs the decoding ability of the imaging scanner. If this level of security is required, try to improve the quality of the barcodes.



Codabar Security Level 0
(0)



* Codabar Security Level 1
(1)



Codabar Security Level 2
(2)



Codabar Security Level 3
(3)

Codabar Upper or Lower Case Start/Stop Characters Detection

Parameter # 855 (SSI # F2h 57h)

Select whether to detect upper case or lower case Codabar start/stop characters.



Lower Case
(1)

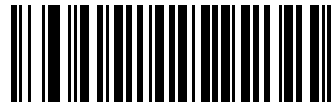

* Upper Case
(0)

Codabar Mod 16 Check Digit Verification

Parameter # 1784

SSI # F8h 06h F8h

Enable this feature to check the Codabar Mod 16 Check Digit to verify that the data complies with the specified check digit algorithm.



Enable Codabar Mod 16 Check Digit
(1)



* Disable Codabar Mod 16 Check Digit
(0)

Transmit Codabar Check Digit

Parameter # 704

SSI # F1h C0h

Scan one of the following barcodes to select whether or not to transmit the Codabar check digit(s).



note: [Codabar Mod 16 Check Digit Verification](#) must be enabled for this parameter to function.



Enable Codabar Check Digit Transmission
(1)



* Disable Codabar Check Digit Transmission
(0)

MSI

Enable/Disable MSI

Parameter # 11 (SSI # 0Bh)

To enable or disable MSI, scan the appropriate barcode below.

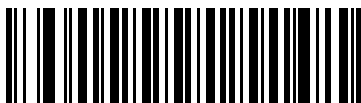

Enable MSI
(1)



* Disable MSI
(0)

Set Lengths for MSI

Parameter # L1 = 30 (SSI # 1Eh), L2 = 31 (SSI # 1Fh)

The length of a code refers to the number of characters (i.e., human readable characters), including check digit(s) the code contains. Set lengths for MSI to any length, one or two discrete lengths, or lengths within a specific range. The default is 4 to 55.

- **One Discrete Length** - Select this option to decode only MSI symbols containing a selected length. Select the length using the numeric barcodes in [Numeric Barcodes](#). For example, to decode only MSI symbols with 14 characters, scan **MSI - One Discrete Length**, then scan **1** followed by **4**. To correct an error or to change the selection, scan [Cancel on page 451](#).
- **Two Discrete Lengths** - Select this option to decode only MSI symbols containing either of two selected lengths. Select lengths using the numeric barcodes in [Numeric Barcodes](#). For example, to decode only MSI symbols containing either 2 or 14 characters, select **MSI - Two Discrete Lengths**, then scan **0, 2, 1**, and then **4**. To correct an error or to change the selection, scan [Cancel on page 451](#).
- **Length Within Range** - Select this option to decode a MSI symbol with a specific length range. Select lengths using numeric barcodes in [Numeric Barcodes](#). For example, to decode MSI symbols containing between 4 and 12 characters, first scan **MSI - Length Within Range**. Then scan **0, 4, 1**, and **2** (enter a leading zero for single digit numbers). To correct an error or change the selection, scan [Cancel on page 451](#).
- **Any Length** - Scan this option to decode MSI symbols containing any number of characters within the digital scanner capability.



NOTE: Due to the construction of the MSI symbology, it is possible for a scan line covering only a portion of the code to transmit as a complete scan, yielding less data than is encoded in the barcode. To prevent this, select specific lengths (**MSI - One Discrete Length, Two Discrete Lengths**) for MSI applications.

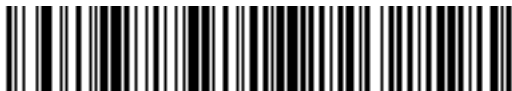

MSI - One Discrete Length



MSI - Two Discrete Lengths

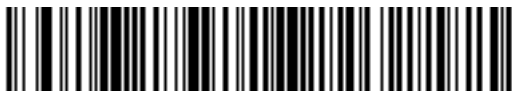

* MSI - Length Within Range



MSI - Any Length

MSI Check Digits

Parameter # 50 (SSI # 32h)

With MSI symbols, one check digit is mandatory and always verified by the reader. The second check digit is optional. If the MSI codes include two check digits, scan the **Two MSI Check Digits** barcode to enable verification of the second check digit.

- 0 - Does not check the MSI check digit; decodes MSI with no check digit.
- 1 - This is for MSI barcodes with one check digit. This is the default.
- 2 - This is for MSI barcodes with two check digits.

See [MSI Check Digit Algorithm on page 300](#) to select second digit algorithms.

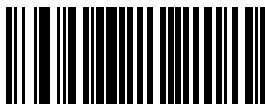

No MSI Check Digit
(0)

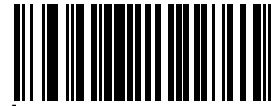

* One MSI Check Digit
(1)

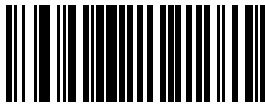

Two MSI Check Digits
(2)

Transmit MSI Check Digit(s)

Parameter # 46 (SSI # 2Eh)

Scan a barcode below to transmit MSI data with or without the check digit.



Transmit MSI Check Digit(s) (Enable)
(1)

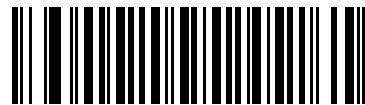

* Do Not Transmit MSI Check Digit(s) (Disable)
(0)

MSI Check Digit Algorithm

Parameter # 51 (SSI # 33h)

Two algorithms are possible for the verification of the second MSI check digit. Select the barcode below corresponding to the algorithm used to encode the check digit.

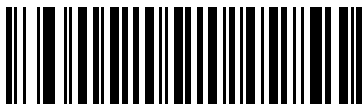

MOD 11/MOD 10
(0)



* MOD 10/MOD 10
(1)

MSI Reduced Quiet Zone

Parameter # 1392 (SSI # F8h 05h 70h)

Scan one of the following barcodes to enable or disable decoding MSI barcodes with reduced quiet zones. If enabled select a [1D Quiet Zone Level on page 338](#).



* Disable MSI Reduced Quiet Zone
(0)



Enable MSI Reduced Quiet Zone
(1)

Chinese 2 of 5

Enable/Disable Chinese 2 of 5

Parameter # 408 (SSI # F0h 98h)

To enable or disable Chinese 2 of 5, scan the appropriate barcode below.

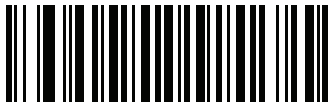

Enable Chinese 2 of 5
(1)

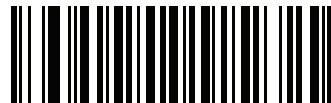

* Disable Chinese 2 of 5
(0)

Matrix 2 of 5

Enable/Disable Matrix 2 of 5

Parameter # 618 (SSI # F1h 6Ah)

To enable or disable Matrix 2 of 5, scan the appropriate barcode below.



Enable Matrix 2 of 5
(1)



* Disable Matrix 2 of 5
(0)

Set Lengths for Matrix 2 of 5

Parameter # L1 = 619 (SSI # F1h 6Bh), L2 = 620 (SSI # F1h 6Ch)

The length of a code refers to the number of characters (i.e., human readable characters), including check digit(s) the code contains. Set lengths for Matrix 2 of 5 to any length, one or two discrete lengths, or lengths within a specific range. The default is **Length Within Range**: 4 to 55.

- **One Discrete Length** - Select this option to decode only Matrix 2 of 5 symbols containing a selected length. Select the length using the numeric barcodes in [Numeric Barcodes](#). For example, to decode only Matrix 2 of 5 symbols with 14 characters, scan **Matrix 2 of 5 - One Discrete Length**, then scan **1** followed by **4**. To correct an error or to change the selection, scan [Cancel on page 451](#).
- **Two Discrete Lengths** - Select this option to decode only Matrix 2 of 5 symbols containing either of two selected lengths. Select lengths using the numeric barcodes in [Numeric Barcodes](#). For example, to decode only Matrix 2 of 5 symbols containing either 2 or 14 characters, select **Matrix 2 of 5 - Two Discrete Lengths**, then scan **0, 2, 1**, and then **4**. To correct an error or to change the selection, scan [Cancel on page 451](#).
- **Length Within Range** - Select this option to decode a Matrix 2 of 5 symbol with a specific length range. Select lengths using the numeric barcodes in [Numeric Barcodes](#). For example, to decode Matrix 2 of 5 symbols containing between 4 and 12 characters, first scan **Matrix 2 of 5 - Length Within Range**. Then scan **0, 4, 1**, and **2** (enter a leading zero for single digit numbers). To correct an error or change the selection, scan [Cancel on page 451](#).
- **Any Length** - Scan this option to decode Matrix 2 of 5 symbols containing any number of characters within the digital scanner capability.

Set Lengths for Matrix 2 of 5 (continued)



Matrix 2 of 5 - One Discrete Length



Matrix 2 of 5 - Two Discrete Lengths



* Matrix 2 of 5 - Length Within Range



Matrix 2 of 5 - Any Length

Matrix 2 of 5 Check Digit

Parameter # 622 (SSI # F1h 6Eh)

The check digit is the last character of the symbol used to verify the integrity of the data. Scan the appropriate barcode below to transmit the barcode data with or without the Matrix 2 of 5 check digit.

Enable Matrix 2 of 5 Check Digit
(1)* Disable Matrix 2 of 5 Check Digit
(0)

Transmit Matrix 2 of 5 Check Digit

Parameter # 623 (SSI # F1h 6Fh)

Scan a barcode below to transmit Matrix 2 of 5 data with or without the check digit.



Transmit Matrix 2 of 5 Check Digit
(1)



* Do Not Transmit Matrix 2 of 5 Check Digit
(0)

Korean 3 of 5

Enable/Disable Korean 3 of 5

Parameter # 581 (SSI # F1h 45h)

To enable or disable Korean 3 of 5, scan the appropriate barcode below.



NOTE: The length for Korean 3 of 5 is fixed at 6.



Enable Korean 3 of 5
(1)



* Disable Korean 3 of 5
(0)

Inverse 1D

Parameter # 586 (SSI # F1h 4Ah)

This parameter sets the 1D inverse decoder setting. Options are:

- **Regular Only** - the digital scanner decodes regular 1D barcodes only.
- **Inverse Only** - the digital scanner decodes inverse 1D barcodes only.
- **Inverse Autodetect** - the digital scanner decodes both regular and inverse 1D barcodes.



NOTE: The Inverse 1D setting may impact Composite or Inverse Composite decoding. See [Composite Inverse](#) on page 311.



* Regular
(0)



Inverse Only
(1)



Inverse Autodetect
(2)

GS1 DataBar

The variants of GS1 DataBar are GS1 DataBar Omnidirectional, GS1 DataBar Truncated, GS1 DataBar Stacked, GS1 DataBar Stacked Omnidirectional, DataBar Expanded, GS1 DataBar Expanded Stacked and DataBar Limited. The limited and expanded versions have stacked variants. Scan the appropriate barcodes to enable or disable each variant of GS1 DataBar.

GS1 DataBar Omnidirectional (formerly GS1 DataBar-14), GS1 DataBar Truncated, GS1 DataBar Stacked, GS1 DataBar Stacked Omnidirectional



NOTE: When GS1 DataBar Omnidirectional is enabled the variants are also enabled.

Parameter # 338 (SSI # F0h 52h)

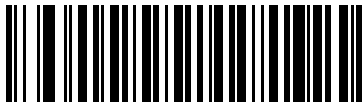

* Enable GS1 DataBar Omnidirectional
(1)

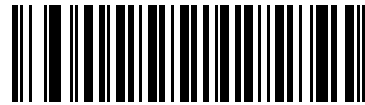

Disable GS1 DataBar Omnidirectional
(0)

GS1 DataBar Limited

Parameter # 339 (SSI # F0h 53h)

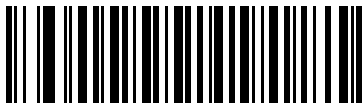

* Enable GS1 DataBar Limited
(1)



Disable GS1 DataBar Limited
(0)

GS1 DataBar Expanded, GS1 DataBar Expanded Stacked



NOTE: When GS1 DataBar Expanded is enabled GS1 DataBar Expanded Stacked is also enabled.

Parameter # 340 (SSI # F0h 54h)

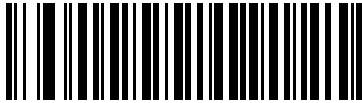

* Enable GS1 DataBar Expanded
(1)

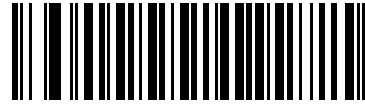

Disable GS1 DataBar Expanded
(0)

Convert GS1 DataBar to UPC/EAN

Parameter # 397 (SSI # F0h, 8Dh)

This parameter only applies to GS1 DataBar Omnidirectional and GS1 DataBar Limited symbols not decoded as part of a Composite symbol. Enable this to strip the leading '010' from DataBar-14 and DataBar Limited symbols encoding a single zero as the first digit, and report the barcode as EAN-13.

For barcodes beginning with two or more zeros but not six zeros, this parameter strips the leading '0100' and reports the barcode as UPC-A. The UPC-A Preamble parameter that transmits the system character and country code applies to converted barcodes. Note that neither the system character nor the check digit can be stripped.

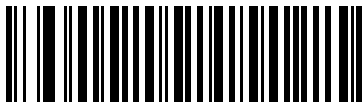

Enable Convert GS1 DataBar to UPC/EAN
(1)



* Disable Convert GS1 DataBar to UPC/EAN
(0)

GS1 DataBar Limited Margin Check

Parameter # 728 (SSI # F1h D8h)

The decoder offers four levels of margin check for GS1 DataBar Limited barcodes. There is an inverse relationship between level of margin check and decoder aggressiveness. Increasing the level of margin check may result in reduced aggressiveness in scanning, so only choose the level of margin check necessary.

- Level 1: No clear margin required. This complies with the original GS1 standard, yet might result in erroneous decoding of the DataBar Limited barcode when scanning some UPC symbols that start with the digits 9 and 7.
- Level 2: Automatic risk detection. This level of security may result in erroneous decoding of DataBar Limited barcodes when scanning some UPC symbols. If a misdecode is detected, the decoder operates in Level 3 or Level 1.
- Level 3: Margin check level reflects newly proposed GS1 standard that requires a 5x trailing clear margin.
- Level 4: Margin check level extends beyond the standard required by GS1. This level of security requires a 5x leading and trailing clear margin.



GS1 DataBar Limited Margin Check Level 1
(1)



GS1 DataBar Limited Margin Check Level 2
(2)



* GS1 DataBar Limited Margin Check Level 3
(3)



GS1 DataBar Limited Margin Check Level 4
(4)

GS1 DataBar Security Level

Parameter # 1706 (SSI # F8h 06h AAh)

The decoder offers four levels of decode security for GS1 DataBar (GS1 DataBar Omnidirectional, GS1 DataBar Limited, GS1 DataBar Expanded) barcodes.

- Security Level 0: This setting allows the digital scanner to operate in its most aggressive state, while providing sufficient security in decoding most in-spec barcodes.
- Security Level 1: This setting eliminates most misdecodes while maintaining reasonable aggressiveness (default).
- Security Level 2: This setting allows greater barcode security requirements if Security Level 1 fails to eliminate misdecodes.
- Security Level 3: This setting applies the highest safety requirements. Select if Security Level 2 was applied and misdecodes still occur.



Security Level 0
(0)

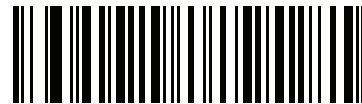

* Security Level 1
(1)



Security Level 2
(2)



Security Level 3
(3)

Composite

Composite CC-C

Parameter # 341 (SSI # F0h 55h)

Scan a barcode below to enable or disable Composite barcodes of type CC-C.



Enable CC-C
(1)

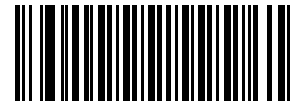

* Disable CC-C
(0)

Composite CC-A/B

Parameter # 342 (SSI # F0h 56h)

Scan a barcode below to enable or disable Composite barcodes of type CC-A/B.



Enable CC-A/B
(1)



* Disable CC-A/B
(0)

Composite TLC-39

Parameter # 371 (SSI # F0h 73h)

Scan a barcode below to enable or disable Composite barcodes of type TLC-39.

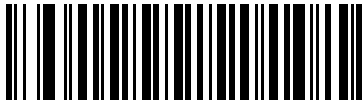

Enable TLC39
(1)

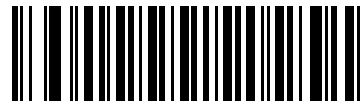

* Disable TLC39
(0)

Composite Inverse

Parameter # 1113 (SSI # F8h 04h 59h)

This parameter sets Composite for either regular decode or inverse decode.

- **Regular Only:** The digital scanner decodes regular Composite barcodes only (default).
- **Inverse Only:** The digital scanner decodes inverse Composite barcodes only. This mode only supports Inverse Composite that has DataBar combined with CCAB. No other 1D/2D combinations. For this parameter to work as expected, [Composite CC-A/B on page 310](#) and corresponding 1D Inverse or 1D Inverse Autodetect (on page 305) and DataBar must be enabled.



NOTE: To decode regular Composite, Inverse Composite must be set to Regular Only and Inverse 1D must be set to **Regular Only** or **Autodetect**.

To decode inverse Composite, Inverse Composite must be set to Inverse Only and Inverse 1D must be set to **Inverse Only** or **Autodetect**.



* Regular Only
(0)



Inverse Only
(1)

UPC Composite Mode

Parameter # 344 (SSI # F0h 58h)

Select an option for linking UPC symbols with a 2D symbol during transmission as if they were one symbol:

- Select **UPC Never Linked** to transmit UPC barcodes regardless of whether a 2D symbol is detected.
- Select **UPC Always Linked** to transmit UPC barcodes and the 2D portion. If 2D is not present, the UPC barcode does not transmit.
- If you select **Autodiscriminate UPC Composites**, the digital scanner determines if there is a 2D portion, then transmits the UPC, as well as the 2D portion if present.



* UPC Never Linked
(0)



UPC Always Linked
(1)



Autodiscriminate UPC Composites
(2)

Composite Beep Mode

Parameter # 398 (SSI # F0h, 8Eh)

To select the number of decode beeps when a composite barcode is decoded, scan the appropriate barcode.

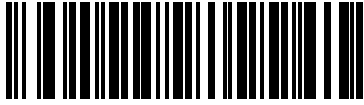

Single Beep after both are decoded
(0)



* Beep as each code type is decoded
(1)

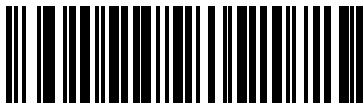

Double Beep after both are decoded
(2)

GS1-128 Emulation Mode for UCC/EAN Composite Codes

Parameter # 427 (SSI # F0h, ABh)

Select whether to enable or disable this mode.



Enable GS1-128 Emulation Mode for
UCC/EAN Composite Codes
(1)



* Disable GS1-128 Emulation Mode for
UCC/EAN Composite Codes
(0)

2D Symbologies

Enable/Disable PDF417

Parameter # 15 (SSI # 0Fh)

To enable or disable PDF417, scan the appropriate barcode below.



* Enable PDF417
(1)



Disable PDF417
(0)

Enable/Disable MicroPDF417

Parameter # 227 (SSI # E3h)

To enable or disable MicroPDF417, scan the appropriate barcode below.



Enable MicroPDF417
(1)



* Disable MicroPDF417
(0)

Code 128 Emulation

Parameter # 123 (SSI # 7Bh)

Enable this parameter to transmit data from certain MicroPDF417 symbols as Code 128. [AIM Code ID Character on page 124](#) must be enabled for this parameter to work.

Enable Code 128 Emulation to transmit these MicroPDF417 symbols with one of the following prefixes:

-]C1if the first codeword is 903-905
-]C2if the first codeword is 908 or 909
-]C0if the first codeword is 910 or 911

Disable Code 128 Emulation to transmit these MicroPDF417 symbols with one of the following prefixes:

-]L3if the first codeword is 903-905
-]L4if the first codeword is 908 or 909
-]L5if the first codeword is 910 or 911

Scan a barcode below to enable or disable Code 128 Emulation.



NOTE: Linked MicroPDF codewords 906, 907, 912, 914, and 915 are not supported. Use GS1 Composites instead.



Enable Code 128 Emulation
(1)



* Disable Code 128 Emulation
(0)

Data Matrix

Parameter # 292 (SSI # F0h, 24h)

To enable or disable Data Matrix, scan the appropriate barcode below.



*** Enable Data Matrix
(1)**



**Disable Data Matrix
(0)**

GS1 Data Matrix

Parameter # 1336 (SSI # F8h 05h 38h)

To enable or disable GS1 Data Matrix, scan the appropriate barcode below.

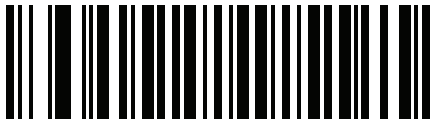

*** Disable GS1 Data Matrix
(0)**

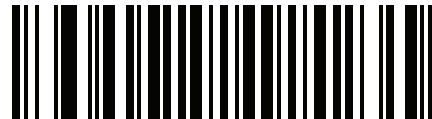

**Enable GS1 Data Matrix
(1)**

Data Matrix Inverse

Parameter # 588 (SSI # F1h 4Ch)

This parameter sets the Data Matrix inverse decoder setting. Options are:

- **Regular Only** - the digital scanner decodes regular Data Matrix barcode only.
- **Inverse Only** - the digital scanner decodes inverse Data Matrix barcode only.
- **Inverse Autodetect** - the digital scanner decodes both regular and inverse Data Matrix barcodes.



Regular
(0)



Inverse Only
(1)



* Inverse Autodetect
(2)

Decode Mirror Images (Data Matrix Only)

Parameter # 537 (SSI # F1h 19h)

Select an option for decoding mirror image Data Matrix barcodes:

- Always - decode only Data Matrix barcodes that are mirror images
- Never - do not decode Data Matrix barcodes that are mirror images
- Auto - decode both mirrored and unmirrored Data Matrix barcodes.



Never
(0)



Always
(1)



*** Auto**
(2)

Maxicode

Parameter # 294 (SSI # F0h, 26h)

To enable or disable Maxicode, scan the appropriate barcode below.



Enable Maxicode
(1)



* Disable Maxicode
(0)

QR Code

Parameter # 293 (SSI # F0h, 25h)



NOTE: Inverse QR barcodes decode if **QR Code** is enabled.

To enable or disable QR Code, scan the appropriate barcode below.



* Enable QR Code
(1)



Disable QR Code
(0)

Weblink QR

Parameter # 1947 (SSI # F7 07 9B)

Scanner will decode QR codes with web link only if parameter is enabled. To enable or disable Weblink QR, scan the appropriate barcode below.



* Enable Weblink QR Code
(1)



Disable Weblink QR Code
(0)

GS1 QR

Parameter # 1343 (SSI # F8h 05h 3Fh)

To enable or disable GS1 QR, scan the appropriate barcode below.



Disable GS1 QR
(0)



* Enable GS1 QR
(1)

MicroQR

Parameter # 573 (SSI # F1h 3Dh)

To enable or disable MicroQR, scan the appropriate barcode below.



* Enable MicroQR
(1)



Disable MicroQR
(0)

Aztec

Parameter # 574 (SSI # F1h 3Eh)

To enable or disable Aztec, scan the appropriate barcode below.



* Enable Aztec
(1)



Disable Aztec
(0)

Aztec Inverse

Parameter # 589 (SSI # F1h 4Dh)

This parameter sets the Aztec inverse decoder setting. Options are:

- **Regular Only** - the digital scanner decodes regular Aztec barcodes only.
- **Inverse Only** - the digital scanner decodes inverse Aztec barcodes only.
- **Inverse Autodetect** - the digital scanner decodes both regular and inverse Aztec barcodes.



Regular
(0)



Inverse Only
(1)



* Inverse Autodetect
(2)

Han Xin

Parameter # 1167 (SSI # F8h 04h 8Fh)

To enable or disable Han Xin, scan the appropriate barcode below.



Enable Han Xin
(1)



* Disable Han Xin
(0)

Han Xin Inverse

Parameter # 1168 (SSI # F8h 04h 90h)

Select a Han Xin inverse decoder setting:

- **Regular Only** - the decoder decodes Han Xin barcodes with normal reflectance only.
- **Inverse Only** - the decoder decodes Han Xin barcodes with inverse reflectance only.
- **Inverse Autodetect** - the decoder decodes both regular and inverse Han Xin barcodes.

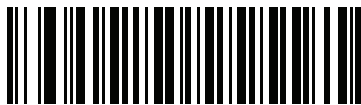

* Regular
(0)



Inverse Only
(1)



Inverse Autodetect
(2)

Grid Matrix

Parameter # 1718 (SSI # F8h 06h B6h)

Scan one of the following barcodes to enable or disable Grid Matrix.



Enable
(1)

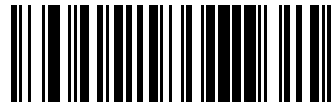

*** Disable**
(0)

Grid Matrix Inverse

Parameter # 1719 (SSI # F8h 06h B7h)

Scan one of the following barcodes to select a Grid Matrix inverse decoder setting:

- **Regular Only** - The scanner decodes regular Grid Matrix barcode only.
- **Inverse Only** - The scanner decodes inverse Grid Matrix barcodes only.
- **Autodiscriminate** - The scanner decodes both regular and inverse Grid Matrix barcodes.



*** Regular Only**
(0)



Inverse Only
(1)



Autodiscriminate
(2)

Grid Matrix Mirror

Parameter # 1736 (SSI # F8h 06h C8h)

Scan one of the following barcodes to select a Grid Matrix mirror decoder setting:

- **Regular Only** - The scanner decodes regular Grid Matrix barcodes only.
- **Mirrored Only** - The scanner decodes mirrored Grid Matrix barcodes only.
- **Auto-discriminate** - The scanner decodes both regular and mirrored Grid Matrix barcodes.



* Regular Only
(0)



Mirrored Only
(1)



Autodiscriminate
(2)

DotCode

Parameter # 1906 (SSI # F8 07 72h)

Scan one of the following barcodes to enable or disable DotCode.



* Disable DotCode
(0)

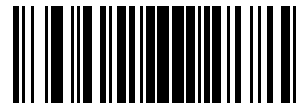

Enable DotCode
(1)

DotCode Inverse

Parameter # 1907 (SSI # F8 07 73h)

Scan one of the following barcodes to select a DotCode Inverse decoder setting. Setting options are:

- **Regular Only** - Decoder decodes DotCode barcodes with normal reflectance only.
- **Inverse Only** - Decoder decodes DotCode barcodes with inverse reflectance only.
- **Inverse Autodetect** - Decoder decodes both regular and inverse DotCode barcodes.



Regular Only
(0)

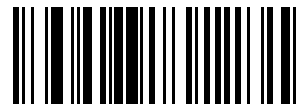

Inverse Only
(1)

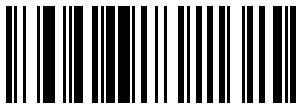

* Inverse Autodetect
(2)

DotCode Mirrored

Parameter # 1908 (SSI # F8 07 74h)

Scan one of the following barcodes to select a DotCode Mirror decoder setting:

- **Non-Mirrored Only** - Digital scanner decodes non-mirrored DotCode barcodes only.
- **Mirrored Only** - Digital scanner decodes mirrored DotCode barcodes only.
- **Autodetect** - Digital scanner decodes both mirrored and non-mirrored DotCode barcodes.

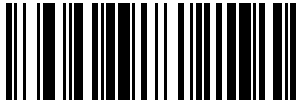

Never
(0)

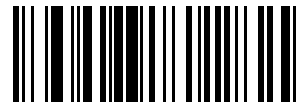

Always
(1)



*** Autodetect**
(2)

DotCode Prioritize

Parameter # 1937 (SSI # F8 07 91h)

Enable DotCode Prioritize to give priority to DotCode decoding as compared to other symbologies.

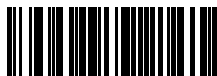

*** Disable**



Enable

Postal Codes

US Postnet

Parameter # 89 (SSI # 59h)

To enable or disable US Postnet, scan the appropriate barcode below.



Enable US Postnet
(1)



* Disable US Postnet
(0)

US Planet

Parameter # 90 (SSI # 5Ah)

To enable or disable US Planet, scan the appropriate barcode below.



Enable US Planet
(1)



* Disable US Planet
(0)

Transmit US Postal Check Digit

Parameter # 95 (SSI # 5Fh)

Select whether to transmit US Postal data, which includes both US Postnet and US Planet, with or without the check digit.

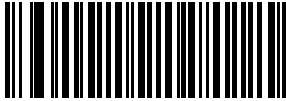

* Transmit US Postal Check Digit
(1)

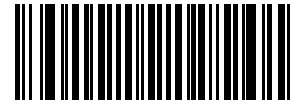

Do Not Transmit US Postal Check Digit
(0)

UK Postal

Parameter # 91 (SSI # 5Bh)

To enable or disable UK Postal, scan the appropriate barcode below.



Enable UK Postal
(1)

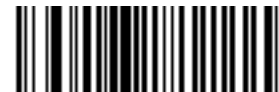

* Disable UK Postal
(0)

Transmit UK Postal Check Digit

Parameter # 96 (SSI # 60h)

Select whether to transmit UK Postal data with or without the check digit.



*** Transmit UK Postal
Check Digit
(1)**



**Do Not Transmit UK Postal Check Digit
(0)**

Japan Postal

Parameter # 290 (SSI # F0h, 22h)

To enable or disable Japan Postal, scan the appropriate barcode below.



**Enable Japan Postal
(1)**



*** Disable Japan Postal
(0)**

Australia Post

Parameter # 291 (SSI # F0h, 23h)

To enable or disable Australia Post, scan the appropriate barcode below.



**Enable Australia Post
(1)**



*** Disable Australia Post
(0)**

Australia Post Format

Parameter # 718 (SSI # F1h, CEh)

To select one of the following formats for Australia Post, scan the appropriate barcode below:

- **Autodiscriminate** (or Smart mode) - Attempt to decode the Customer Information Field using the N and C Encoding Tables.



NOTE: This option increases the risk of misdecodes because the encoded data format does not specify the Encoding Table used for encoding.

- **Raw Format** - Output raw bar patterns as a series of numbers 0 through 3.
- **Alphanumeric Encoding** - Decode the Customer Information Field using the C Encoding Table.
- **Numeric Encoding** - Decode the Customer Information Field using the N Encoding Table.

For more information on Australia Post Encoding Tables, refer to the Australia Post Customer Barcoding Technical Specifications available at www.auspost.com.au.



* Autodiscriminate
(0)



Raw Format
(1)



Alphanumeric Encoding
(2)



Numeric Encoding
(3)

Netherlands KIX Code

Parameter # 326 (SSI # F0h, 46h)

To enable or disable Netherlands KIX Code, scan the appropriate barcode below.



Enable Netherlands KIX Code
(1)



* Disable Netherlands KIX Code
(0)

USPS 4CB/One Code/Intelligent Mail

Parameter # 592 (SSI # F1h 50h)

To enable or disable USPS 4CB/One Code/Intelligent Mail, scan the appropriate barcode below.



Enable USPS 4CB/One Code/Intelligent Mail
(1)



* Disable USPS 4CB/One Code/Intelligent Mail
(0)

UPU FICS Postal

Parameter # 611 (SSI # F1h 63h)

To enable or disable UPU FICS Postal, scan the appropriate barcode below.



Enable UPU FICS Postal
(1)

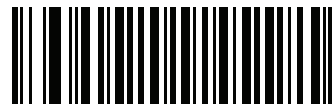

* Disable UPU FICS Postal
(0)

Mailmark

Parameter # 1337 (SSI # F8h 05h 39h)

To enable or disable Mailmark, scan the appropriate barcode below.

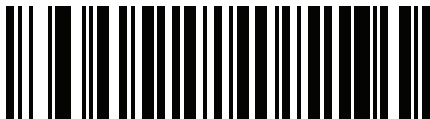

* Disable Mailmark
(0)

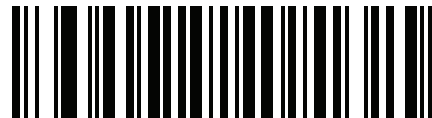

Enable Mailmark
(1)

Symbology-Specific Security Levels

Redundancy Level

Parameter # 78 (SSI # 4Eh)

The digital scanner offers four levels of decode redundancy. Select higher redundancy levels for decreasing levels of barcode quality. As redundancy levels increase, the digital scanner aggressiveness decreases.

Select the redundancy level appropriate for the barcode quality.

Redundancy Level 1

The following code types must be successfully read twice before being decoded:

Table 17 Redundancy Level 1 Codes

Code Type	Code Length
Codabar	8 characters or less
MSI	4 characters or less
D 2 of 5	8 characters or less
I 2 of 5	8 characters or less

Redundancy Level 2

The following code types must be successfully read twice before being decoded:

Table 18 Redundancy Level 2 Codes

Code Type	Code Length
All	All

Redundancy Level 3

Code types other than the following must be successfully read twice before being decoded. The following codes must be read three times:

Table 19 Redundancy Level 3 Codes

Code Type	Code Length
MSI	4 characters or less
D 2 of 5	8 characters or less
I 2 of 5	8 characters or less
Codabar	8 characters or less

Redundancy Level 4

The following code types must be successfully read three times before being decoded:

Table 20 Redundancy Level 4 Codes

Code Type	Code Length
All	All

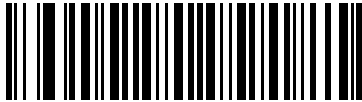

* Redundancy Level 1
(1)

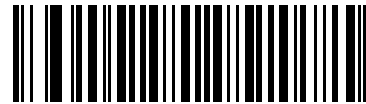

Redundancy Level 2
(2)

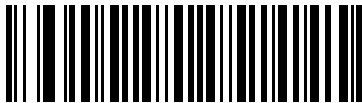

Redundancy Level 3
(3)

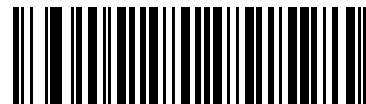

Redundancy Level 4
(4)

Security Level

Parameter # 77 (SSI # 4Dh)

The digital scanner offers four levels of decode security for delta barcodes, which include the Code 128 family, UPC/EAN, and Code 93. Select increasing levels of security for decreasing levels of barcode quality. There is an inverse relationship between security and digital scanner aggressiveness, so choose only that level of security necessary for any given application.

- **Security Level 0:** This setting allows the digital scanner to operate in its most aggressive state, while providing sufficient security in decoding most “in-spec” barcodes.
- **Security Level 1:** This default setting eliminates most misdecodes.
- **Security Level 2:** Select this option if Security level 1 fails to eliminate misdecodes.
- **Security Level 3:** If you selected Security Level 2 and misdecodes still occur, select this security level. Be advised, selecting this option is an extreme measure against mis-decoding severely out of spec barcodes. Selecting this level of security significantly impairs the decoding ability of the digital scanner. If you need this level of security, try to improve the quality of the barcodes.

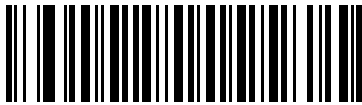

Security Level 0
(0)

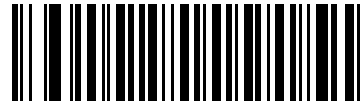

* Security Level 1
(1)

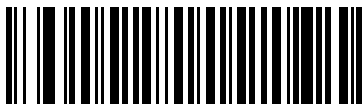

Security Level 2
(2)



Security Level 3
(3)

1D Quiet Zone Level

Parameter # 1288 (SSI # F8h 05h 08h)

This feature sets the level of aggressiveness in decoding barcodes with a reduced quiet zone (the area in front of and at the end of a barcode), and applies to symbologies enabled by a Reduced Quiet Zone parameter. Because higher levels increase the decoding time and risk of misdecodes, Zebra Technologies strongly recommends enabling only the symbologies which require higher quiet zone levels, and leaving Reduced Quiet Zone disabled for all other symbologies. Options are:

- 0 - The digital scanner performs normally in terms of quiet zone.
- 1 - The digital scanner performs more aggressively in terms of quiet zone.
- 2 - The digital scanner only requires one side EB (end of barcode) for decoding.
- 3 - The digital scanner decodes anything in terms of quiet zone or end of barcode.

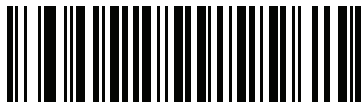

1D Quiet Zone Level 0
(0)

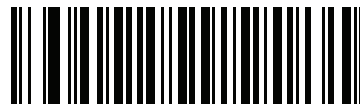

* 1D Quiet Zone Level 1
(1)



1D Quiet Zone Level 2
(2)



1D Quiet Zone Level 3
(3)

Intercharacter Gap Size

Parameter # 381 (SSI # F0h, 7Dh)

The Code 39 and Codabar symbologies have an intercharacter gap that is typically quite small. Due to various barcode-printing technologies, this gap can grow larger than the maximum size allowed, preventing the digital scanner from decoding the symbol. If this problem occurs, scan the **Large Intercharacter Gaps** parameter to tolerate these out-of-specification barcodes.



* Normal Intercharacter Gaps
(06h)



Large Intercharacter Gaps
(0Ah)

Report Version

Scan the barcode below to report the version of software installed in the digital scanner.

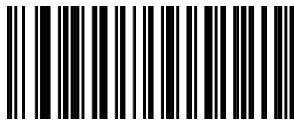

Report Software Version

Macro PDF Features

Macro PDF is a special feature for concatenating multiple PDF symbols into one file. The digital scanner can decode symbols that are encoded with this feature, and can store more than 64 Kb of decoded data stored in up to 50 MacroPDF symbols.



CAUTION: When printing, keep each Macro PDF sequence separate, as each sequence has unique identifiers. Do not mix barcodes from several Macro PDF sequences, even if they encode the same data. When scanning Macro PDF sequences, scan the entire Macro PDF sequence without interruption. If, when scanning a mixed sequence, the digital scanner emits two long low beeps (Low/Low) this indicates an inconsistent file ID or inconsistent symbology error.

Flush Macro Buffer

This flushes the buffer of all decoded Macro PDF data stored to that point, transmits it to the host device, and aborts from Macro PDF mode.



Flush Macro PDF Buffer

Abort Macro PDF Entry

This clears all currently-stored Macro PDF data in the buffer without transmission and aborts from Macro PDF mode.



Abort Macro PDF Entry

Data Formatting: ADF, MDF, Preferred Symbol

Introduction

This chapter briefly describes the Zebra features available for customizing scanner operation.

Advanced Data Formatting (ADF)

Advanced Data Formatting (ADF) is a means of customizing data from before transmission to the host device. Use ADF to edit scan data to suit your host's requirements. With ADF you scan one barcode per trigger pull. ADF is programmed using 123Scan.

To watch a video on Creating an Advanced Data Formatting (ADF) Rule using 123Scan, go to: <http://www.zebra.com/ScannerHowToVideos>

For additional information, refer to the Advanced Data Formatting Programmer Guide.

Multicode Data Formatting

Multicode Data Formatting (MDF) enables a 2D imaging scanner to scan all barcodes on a label with a single trigger pull, and then modify and transmit the data to meet host application requirements. MDF supports programming up to nine unique labels into one scanner. MDF also supports scanning multiple barcodes on opposite sides of a box by holding the trigger.

Programming options include:

- Output all or specific barcodes
- Control the barcode output sequence
- Apply unique multicode data formatting (MDF) to each output barcode
- Discard scanned data if all required barcodes are not present

For more information, refer to the MDF and Preferred Symbol User Guide.

To watch a video on Creating an Multicode Data Formatting (MDF) Rule using 123Scan, go to: <http://www.zebra.com/ScannerHowToVideos>

MDF in Hands-Free Mode

MDF in a hands-free scanning mode may yield multiple unexpected and undesired outputs when a label (most likely on a complex label) passes through the scanner's field of view. This problem happens when the complex label's barcodes can be matched by more than one group (for example, Group 1 represents all barcodes present and Group 2 represent some barcodes present).



NOTE: A similar problem can also occur in the hand-held trigger mode. If multiple MDF rules/groups exist and all the label is not in the field of view when pressing the trigger, the output may vary depending on which MDF rules/groups match.

The problem is demonstrated in [Figure 24](#) and as follows:

1. As the label is moving through the field of view, it is first partially read (some of the barcodes in the field of view in Frame 2).
2. Then, the second decode occurs as it is fully read (all the barcodes in the field of view in Frame 3).
3. This yields two different outputs (instead of the expected single output) from the presentation of a label. This problem is driven by a complex label inadvertently matching two different MDF rules/groups, thereby yielding two outputs.

Figure 24 Scanning Label in a Horizontal Orientation

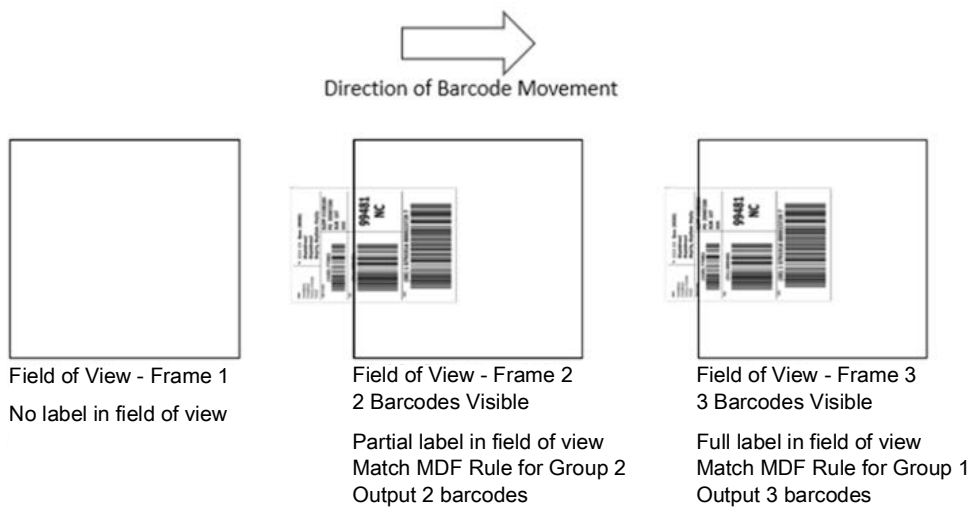

NOTE: To minimize issues associated with MDF hands-free mode, see [MDF Best Practices on page 343](#).

MDF Best Practices

Suggestions to minimize the undesired multiple outputs during the MDF scanning in hands-free mode are as follows:

- Scan barcodes in a vertical orientation (see [Figure 25](#)).

Figure 25 Scanning Label in a Vertical Orientation

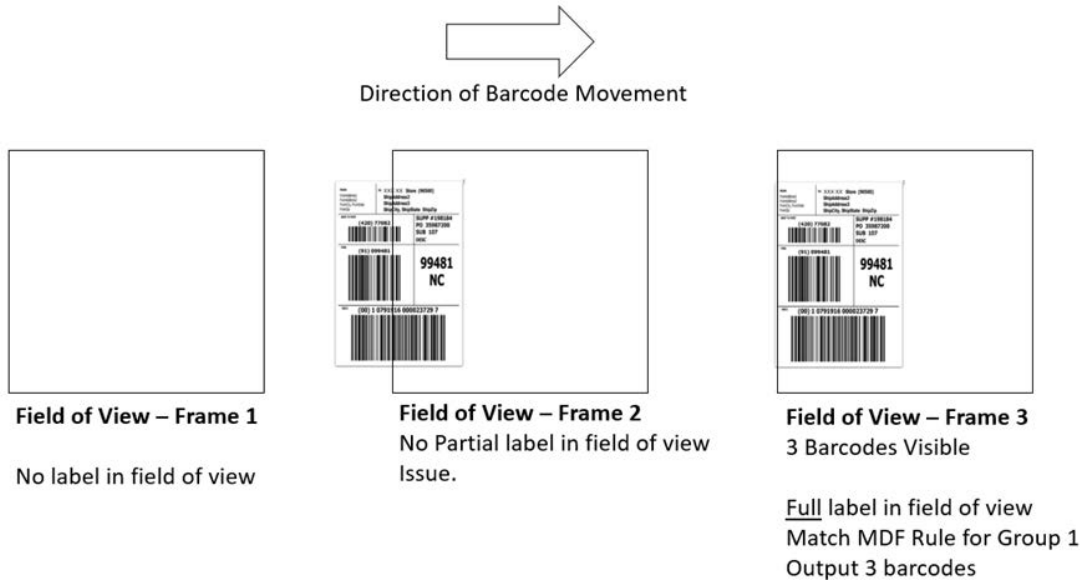

- When creating the MDF programming with multiple groups, the Group 1's pattern match should be the most complicated (hardest to match), which equals to the most number of barcodes and criteria. Then Group 2, 3, and so on should be progressively matched more easily.
- When defining criteria, avoid enabling an output when the pattern is not matched. Set **Output if NO pattern match set** as **Discard bar code** (see [Figure 26](#)).

Figure 26 Figure Match Setting for Output

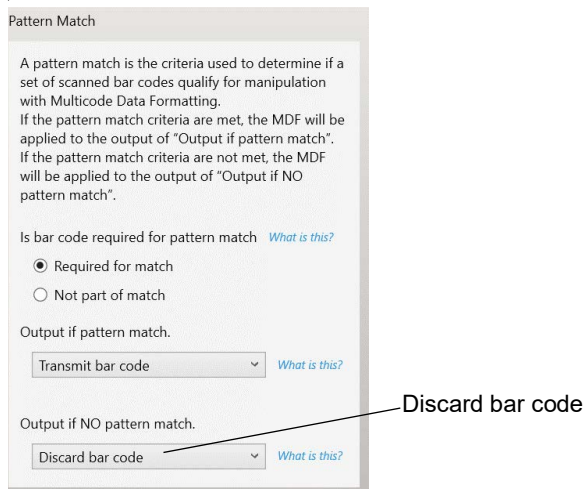

- Select **Discard barcode(s) NOT within the pattern match** in the 123Scan MDF setting. For more details, select **What is this?** located next to this selection.

 Discard scanned bar code(s) NOT within pattern match [What is this?](#)

- To prevent double decodes of the same symbol, increase the **Timeout Between Same Symbols** setting. See [Timeout Between Decodes, Same Symbol on page 112](#) for more details.
- Turn the scanner's aimer on to assist operators in scanning the barcode in a more consistent manner.

Other reasons a label/barcode may not be decoded while in the field of view are as follows:

The label out of focus (too close or too far away). See [Decode Ranges on page 49](#) for correct working range.

Specular reflection (reflection off a shiny surface).

The label is presented at extreme angle to scanner.

Preferred Symbol

Preferred Symbol is a barcode prioritization technique that enables favored decoding of high priority barcode(s). The Preferred Symbol is the only barcode that is decoded and output within the preset Preferred Symbol Timeout. During this time, the scanner attempts to decode the prioritized barcode and reports only this barcode.

For more information, refer to the MDF and Preferred Symbol User Guide.

To program Preferred Symbol via 123Scan, select **123Scan > Configuration Wizard > Symbolologies** screen, and then select **Preferred Symbol** from the drop-down menu. Preferred Symbol programming is saved in the 123Scan configuration file.

Data Parsing (UDI Scan+, Label Parse+ and Blood Bag Parse+)



NOTE: When using UDI with ICCBBA for blood bag labels, disable ISBT Concatenation (see [Scan a Blood Bag Label using Blood Bag Parse+ on page 345](#)).

Data Parsing allows a Zebra scanner to scan a UDI label, GS1 label, or Blood Bags with one or more barcodes encoded with multiple data fields (for example: date of manufacture, expiration date, batch number, GTIN, SSCC) and transmit select data fields and not others, in a specific order to a host application.

Wave the scanner over all the barcodes while holding the trigger and the scanner finds and transmits only the required data fields, even if they are spread across multiple barcodes and on different sides of the container. In addition, the scanner can insert field separators (for example: tab, enter, slash) to automate data entry into a host application.

Programming your scanner is easy using 123Scan's intuitive drag and drop interface. For more information on writing a Data Parsing Rule, see the Data Parsing User Guide.

To watch a video on creating a Data Parsing Rule using 123Scan, go to: www.zebra.com/ScannerHowToVideos.

Scan a UDI Label using UDI Scan+

Government regulatory agencies* have established Unique Device Identification (UDI) standards to identify and monitor the distribution and use of medical devices within healthcare environments. These UDI standards identify medical devices from manufacturing through distribution to patient use - enabling complete traceability of the millions of individual medical devices utilized for patient care. To enable UDI compliance, all medical devices must carry a UDI label to enable Track and Trace from the point of production, during shipment, through the product's use, and disposal.

* United States Food and Drug Administration (FDA), European Commission, International Medical Device Regulatory Forum

Scan a GS1 Label using Label Parse+

The GS1 Organization, an international standards body, has released specifications used worldwide for generating shipping labels. These labels are used when shipping packages (logistics), raw materials, and produce.

Scan a Blood Bag Label using Blood Bag Parse+

The ICCBBA Organization, an international standards body, has released a specification used worldwide for generating blood bag labels. These labels are used when shipping, storing and using blood bags. For more information, go to:

<https://www.iccbba.org/tech-library/iccbba-documents/standards-documents/standard-labeling-blood2>.

OCR Programming

Introduction

This chapter describes how to set up the scanner for OCR programming. The scanner can read 6 to 60 point OCR typeface. It supports font types OCR-A, OCR-B, MICR E13B, and US Currency Serial Number.

OCR is not as secure as a barcode. To decrease OCR misdecodes and speed OCR reading, set an accurate OCR template and character subset, and use a check digit.

All OCR fonts are disabled by default. Enabling OCR could slow barcode decoding. You can enable OCR-A and OCR-B at the same time, but not other combined font types.

Setting Parameters

To set feature values, scan a single barcode or a short barcode sequence. The settings are stored in non-volatile memory and are preserved even when the imager powers down.



NOTE: Most computer monitors allow scanning barcodes directly on the screen. When scanning from the screen, be sure to set the document magnification to a level where you can see the barcode clearly, and bars and/or spaces do not merge.

To return all features to default values, scan the [* Restore Defaults on page 67](#). Throughout the programming barcode menus, asterisks (*) indicate default values.

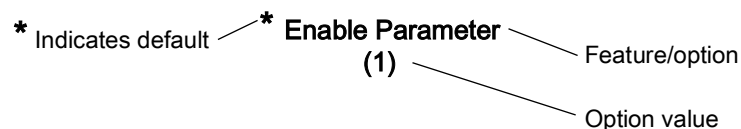
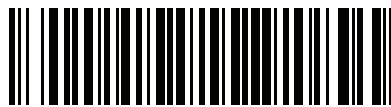

Scanning Sequence Examples

In most cases scanning one barcode sets the parameter value. For example, to enable OCR-B, scan the **Enable OCR-B** barcode under [OCR-B on page 350](#). The scanner issues a fast warble beep and the LED turns green, signifying a successful parameter entry.

Other parameters require scanning several barcodes. See the parameter descriptions for this procedure.

Errors While Scanning

Unless otherwise specified, to correct an error during a scanning sequence, just re-scan the correct parameter.

OCR Parameter Defaults

[Table 21](#) lists the defaults for OCR parameters. Change these values in one of two ways:

- Scan the appropriate barcodes in this chapter. The new value replaces the standard default value in memory. To recall default parameter values, see [User Preferences Parameter Defaults on page 64](#).
- Configure the scanner using the 123Scan configuration program. See [123Scan and Software Tools](#).



NOTE: See [User Preferences](#) for all user preference, host, symbology, and miscellaneous default parameters.

Table 21 OCR Programming Default Table

Parameter	Parameter Number	SSI Number	Default	Page Number
OCR Programming Parameters				
OCR-A	680	F1h A8h	Disable	348
OCR-A Variant	684	F1h ACh	OCR-A Full ASCII	349
OCR-B	681	F1h A9h	Disable	350
OCR-B Variant	685	F1h ADh	OCR-B Full ASCII	351
MICR E13B	682	F1h AAh	Disable	355
US Currency	683	F1h ABh	Disable	356
OCR Orientation	687	F1h AFh	0°	356
OCR Lines	691	F1h B3h	1	358
OCR Minimum Characters	689	F1h B1h	3	358
OCR Maximum Characters	690	F1h B2h	100	359
OCR Subset	686	F1h AEh	Selected font variant	359
OCR Quiet Zone	695	F1h B7h	50	360
OCR Template	547	F1h 23h	99999999	360
OCR Check Digit Modulus	688	F1h B0h	1	369
OCR Check Digit Multiplier	700	F1h BCh	1212121212	370

Table 21 OCR Programming Default Table (Continued)

Parameter	Parameter Number	SSI Number	Default	Page Number
OCR Check Digit Validation	694	F1h B6h	None	372
Inverse OCR	856	F2h 58h	Regular	377
OCR Redundancy	1770	F8h 06h EAh	Level 1	378

OCR Programming Parameters

OCR-A

Parameter # 680 (SSI # F1h A8h)

Scan one of the following barcodes to enable or disable OCR-A.



NOTE: OCR is not as secure as a barcode. To decrease OCR misdecodes and speed OCR reading, set an accurate OCR template and character subset, and use a check digit. See [OCR Subset on page 359](#) and [OCR Template on page 360](#).



Enable OCR-A
(1)



* Disable OCR-A
(0)

OCR-A Variant

Parameter # 684 (SSI # F1 ACh)

The font variant sets a processing algorithm and default character subset for the given font. To choose a variant, scan one of the following barcodes. Select the most appropriate font variant to optimize performance and accuracy.

OCR-A supports the following variants:

- OCR-A Full ASCII

!"#\$()*+,-./0123456789<>ABCDEFGHIJKLMNOPQRSTUVWXYZ^

- OCR-A Reserved 1

\$*+,-./0123456789ABCDEFGHIJKLMNOPQRSTUVWXYZ

- OCR-A Reserved 2

\$*+,-./0123456789<>ABCDEFGHIJKLMNOPQRSTUVWXYZ

- OCR-A Banking

-0123456789<> ƒ ħ ĩ

Special banking characters output as the following representative characters:

ƒ outputs as f

ħ outputs as c

ĩ outputs as h



NOTE: Enable OCR-A before setting this parameter. If disabling OCR-A, set the variant to its default (OCR-A Full ASCII).



* OCR-A Full ASCII
(0)



OCR-A Reserved 1
(1)

OCR-A Variant (continued)

OCR-A Reserved 2
(2)OCR-A Banking
(3)

OCR-B

Parameter # 681 9SSI # F1h A9h)

Scan one of the following barcodes to enable or disable OCR-B.



NOTE: OCR is not as secure as a barcode. To decrease OCR misdecodes and speed OCR reading, set an accurate OCR template and character subset, and use a check digit. See [OCR Subset on page 359](#) and [OCR Template on page 360](#).

Enable OCR-B
(1)* Disable OCR-B
(0)

OCR-B Variant

Parameter # 685 (SSI # F1h ADh)

OCR-B has the following variants. Select the most appropriate font variant to optimize performance and accuracy.

- OCR-B Full ASCII

!#\$%()*+,-./0123456789<>ABCDEFGHIJKLMNOPQRSTUVWXYZ^|ñ

- OCR-B Banking

#+-0123456789<>JNP|

- OCR-B Limited

+,./0123456789<>ACENPSTVX

- OCR-B ISBN 10-Digit Book Numbers

-0123456789>BCEINPSXz

- OCR-B ISBN 10 or 13-Digit Book Numbers

-0123456789>BCEINPSXz

- OCR-B Travel Document Version 1 (TD1) 3-Line ID Cards

-0123456789<ABCDEFGHIJKLMNOPQRSTUVWXYZ

- OCR-B Travel Document Version 2 (TD2) 2-Line ID Cards

-0123456789<ABCDEFGHIJKLMNOPQRSTUVWXYZ

- OCR-B Travel Document 2 or 3-Line ID Cards Auto-Detect

!#\$%()*+,-./0123456789<>ABCDEFGHIJKLMNOPQRSTUVWXYZ^|ñ

- OCR-B Passport

-0123456789<ABCDEFGHIJKLMNOPQRSTUVWXYZñ

- OCR-B Visa Type A

-0123456789<ABCDEFGHIJKLMNOPQRSTUVWXYZ

- OCR-B Visa Type B

-0123456789<ABCDEFGHIJKLMNOPQRSTUVWXYZñ

- OCR-B ICAO Travel Documents

This allows reading either TD1, TD2, Passport, Visa Type A, or Visa Type B without switching between these options. It automatically recognizes the travel document read.

Scanning any ISBN Book Number automatically applies the appropriate ISBN checksum.

To choose a variant, scan one of the barcodes below. Selecting the following OCR-B variants automatically sets the appropriate [OCR Lines on page 358](#). These five variants invoke extensive special algorithms and checking for that particular document type:

VariantOCR Lines Setting

Passport2

TD1 ID Cards3

TD2 ID Cards2

Visa Type A2

Visa Type B2



NOTE: When setting one of the variants above with both OCR-A and OCR-B enabled, the scanner reads the specified travel document but does not read OCR-A. When the OCR-B variant is set back to the default (OCR-B Full ASCII), the scanner reads OCR-A.

Enable OCR-B before setting this parameter. If disabling OCR-B, set the variant to its default (OCR-B Full ASCII).



* OCR-B Full ASCII
(0)



OCR-B Banking
(1)



OCR-B Limited
(2)



OCR-B ISBN 10-Digit Book Numbers
(6)

OCR-B Variant (continued)



OCR-B ISBN 10 or 13-Digit Book Numbers
(7)



OCR-B Travel Document Version 1 (TD1)
3 Line ID Cards
(3)



OCR-B Travel Document Version 2 (TD2)
2-Line ID Cards
(8)

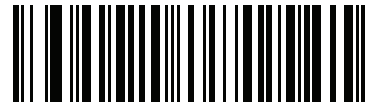

Travel Document 2 or 3-Line ID Cards Auto-Detect
(20)



OCR-B Passport
(4)

OCR-B Variant (continued)



OCR-B Visa Type A
(9)



OCR-B Visa Type B
(10)



OCR-B ICAO Travel Documents
(11)

MICR E13B

Parameter # 682 (SSI # F1h AAh)

Scan one of the following barcodes to enable or disable MICR E13B.

MICR E 13B uses the following characters:

0 1 2 3 4 5 6 7 8 9 t a o d

TOAD characters (Transit, On Us, Amount, and Dash) output as the following representative characters:

t outputs as t

a outputs as a

o outputs as o

d outputs as d



NOTE: OCR is not as secure as a barcode. To decrease OCR misdecodes and speed OCR reading, set an accurate OCR template and character subset, and use a check digit. See [OCR Subset on page 359](#) and [OCR Template on page 360](#).



Enable MICR E13B
(1)



* Disable MICR E13B
(0)

US Currency Serial Number

Parameter # 683 (SSI # F1h ABh)

Scan one of the following barcodes to enable or disable US Currency Serial Number.



NOTE: OCR is not as secure as a barcode. To decrease OCR misdecodes and speed OCR reading, set an accurate OCR template and character subset, and use a check digit. See [OCR Subset on page 359](#) and [OCR Template on page 360](#).

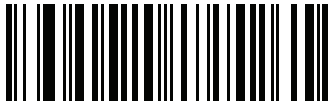

Enable US Currency
(1)

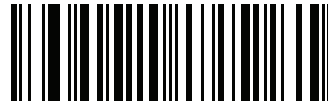

* Disable US Currency
(0)

OCR Orientation

Parameter # 687 (SSI # F1h AFh)

Select one of five options to specify the orientation of the OCR to read:

- 0° to the imaging engine (default)
- 270° clockwise (or 90° counterclockwise) to the imaging engine
- 180° (upside down) to the imaging engine
- 90° clockwise to the imaging engine
- Omnidirectional

Setting an incorrect orientation can cause misdecodes.

OCR Orientation (continued)



* OCR Orientation 0°
(0)



OCR Orientation 270° Clockwise
(1)



OCR Orientation 180° Clockwise
(2)



OCR Orientation 90° Clockwise
(3)



OCR Orientation Omnidirectional
(4)

OCR Lines

Parameter # 691 (SSI # F1h B3h)

To select the number of OCR lines to decode, scan one of the following barcodes. Selecting Visas, TD1, or TD2 ID cards automatically sets the appropriate **OCR Lines**. Also see [OCR-B Variant on page 351](#).



* OCR 1 Line
(1)



OCR 2 Lines
(2)



OCR 3 Lines
(3)

OCR Minimum Characters

Parameter # 689 (SSI # F1h B1h)

To select the minimum number of OCR characters (not including spaces) per line to decode, scan the following barcode, then scan a three-digit number between 003 and 100 using the barcodes in [Numeric Barcodes](#) representing the number of OCR characters to decode. Strings of OCR characters less than the minimum are ignored. The default is 003.



OCR Minimum Characters

OCR Maximum Characters

Parameter # 690 (SSI # F1h B2h)

To select the maximum number of OCR characters (including spaces) per line to decode, scan the following barcode, then scan a three-digit number between 003 and 100 using the barcodes in [Numeric Barcodes](#) representing the number of OCR characters to decode. Strings of OCR characters greater than the maximum are ignored. The default is 100.



OCR Maximum Characters

OCR Subset

Parameter # 686 (SSI # F1h AEh)

Create an OCR subset to define a custom group of characters in place of a preset font variant. For example, if scanning only numbers and the letters A, B, and C, create a subset of just these characters to speed decoding. This applies a designated OCR Subset across all enabled OCR fonts.

To set or modify the OCR font subset:

1. Enable the appropriate OCR font(s).
2. Scan the **OCR Subset** barcode.
3. Scan numbers and letters to form the OCR Subset from [Alphanumeric Barcodes](#).
4. Scan [End of Message on page 459](#).

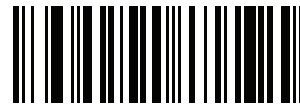

OCR Subset

To cancel an OCR subset, for OCR-A or OCR-B, scan OCR-A variant **Full ASCII**, or OCR-B variant **Full ASCII**.

For MICR E13B or US Currency Serial Number, create a subset which includes all allowed characters in that character set, or scan an option from the [Default Parameters on page 67](#) and re-program the scanner.

OCR Quiet Zone

Parameter # 695 (SSI # F1h B7h)

This option sets the OCR quiet zone. The scanner stops scanning a field when it detects a sufficiently wide blank space. The width of this space is defined by the End of Field option. Used with parsers that tolerate slanted characters, the End of Field count is approximately a count of 8 for a character width. For example, if set to 15, then two character widths are an end of line indicator for the parser. Larger end of field numbers require bigger quiet zones at each end of text line.

To set a quiet zone, scan the following barcode, then scan a two-digit number using the numeric keypad in [Numeric Barcodes](#). The range of the quiet zone is 20 - 99 and the default is 50, indicating a six character width quiet zone.

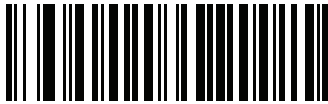

OCR Quiet Zone

OCR Template

Parameter # 547 (SSI # F1h 23h)

This option creates a template for precisely matching scanned OCR characters to a desired input format. Appropriate OCR template needs to be set before using OCR features.

To set or modify the OCR decode template, scan the [OCR Template](#) barcode, and then scan barcodes on the following pages that correspond to numbers and letters to form the template expression. Then scan **End of Message**. The default is **99999999** which accepts OCR strings only containing eight digits.

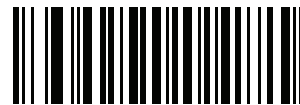

OCR Template



End of Message

Required Digit (9)

Only a numeric character is accepted in this position.

Template	Valid data	Valid data	Invalid data
99999	12987	30517	123AB



9

Required Alpha (A)

Only an alpha character is accepted in this position.

Template	Valid data	Valid data	Invalid data
AAAAA	ABCDE	UVWXY	12FGH



A

Optional Alphanumeric (1)

An alphanumeric character is accepted in this position if present. Optional characters are not allowed as the first character(s) in a field of like characters.

Template	Valid data	Valid data	Invalid data
99991	1234A	12345	1234<



1

Optional Alpha (2)

An alpha character is accepted in this position if present. Optional characters are not allowed as the first character(s) in a field of like characters.

Template	Valid data	Valid data	Invalid data
AAAA2	ABCDE	WXYZ	ABCD6



2

Alpha or Digit (3)

An alphanumeric character is required in this position to validate the incoming data.

Template	Valid data	Valid data	Invalid data
33333	12ABC	WXY34	12AB<



3

Any Including Space & Reject (4)

Any character is accepted in this position, including space and reject. It cannot be the first place in a template. An underscore (_) represents rejects in the output. This is a good selection for troubleshooting.

Template	Valid data	Valid data
99499	12\$34	34 98



4

Any except Space & Reject (5)

Any character is accepted in this position, except a space or reject.

Template	Valid data	Valid data	Invalid data
55999	A.123	*Z456	A BCD



5

Optional Digit (7)

A numeric character is accepted if present. Optional characters are not allowed as the first character(s) in a field of like characters.

Template	Valid data	Valid data	Invalid data
99977	12345	789	789AB



7

Digit or Fill (8)

Any numeric or fill character is accepted in this position.

Template	Valid data	Valid data	Valid data
88899	12345	>>789	<<789



8

Alpha or Fill (F)

Any alpha or fill character is accepted in this position.

Template	Valid data	Valid data	Valid data
AAAFF	ABCXY	LMN>>	ABC<5



F

Optional Space ()

A space is accepted if present. Optional characters are not allowed as the first character(s) in a field of like characters.

Template	Valid data	Valid data	Invalid data
99 99	12 34	1234	67891



Space

Optional Small Special (.)

A special character is accepted if present. Optional characters are not allowed as the first character(s) in a field of like characters. Small special characters are - , and .

Template	Valid data	Valid data	Invalid data
AA.99	MN.35	XY98	XYZ12



.

Other Template Operators

These template operators assist in capturing, delimiting, and formatting scanned OCR data.

Literal String (" and +)

Use either of these delimiting characters surrounding characters from the alphanumeric keyboard in [Alphanumeric Barcodes](#) to define a literal string within a template that must be present in scanned OCR data. There are two characters used to delimit required literal strings; if one of the delimiter characters is present in the desired literal string, use the other delimiter.

Template	Valid data	Invalid data
"35+BC"	35+BC	AB+22



New Line (E)

To create a template of multiple lines, add **E** between the template of each single line.

Template	Valid data	Valid data	Invalid data
999EAAAA	321	987	XYZW
	BCAD	ZXYW	12



String Extract (C)

This operator combined with others defines a string of characters to extract from the scanned data. The string extract is structured as follows:

CbPe

Where:

- C is the string extract operator
- b is the string begin delimiter
- P is the category (one or more numeric or alpha characters) describing the string representation
- e is the string end delimiter

Values for *b* and *e* can be any scannable character. They are included in the output stream.

Template	Incoming data	Output
C>A>	XQ3>ABCDE>	>ABCDE>
	->ATHRUZ>123	>ATHRUZ>
	1ABCZXYZ	No Output



C

Ignore to End of Field (D)

This operator causes all characters after a template to be ignored. Use this as the last character in a template expression. Examples for the template 999D:

Template	Incoming data	Output
999D	123-PED	123
	357298	357
	193	193



D

Skip Until (P1)

This operator skips over characters until a specific character type or a literal string is detected. It can be used in two ways:

P1ct

Where:

- P1 is the Skip Until operator
- c is the type of character that triggers the start of output
- t is one or more template characters

P1"s"t

Where:

- P1 is the Skip Until operator
- "s" is one or more literal string characters (see [Literal String \(" and +\) on page 365](#)) that trigger the start of output
- t is one or more template characters

The trigger character or literal string is included in output from a Skip Until operator, and the first character in the template should accommodate this trigger.

Template	Incoming data	Output
P1"PN"AA9999	123PN9876	PN9876
	PN1234	PN1234
	X-PN3592	PN3592



P



1

Skip Until Not (P0)

This operator skips over characters until a specific character type or a literal string is not matched in the output stream. It can be used in two ways:

`P0ct`

Where:

- `P0` is the Skip Until Not operator
- `c` is the type of character that triggers the start of output
- `t` is one or more template characters

`P0"s"t`

Where:

- `P0` is the Skip Until Not operator
- `"s"` is one or more literal string characters (see [Literal String \(" and +\) on page 365](#)) that trigger the start of output
- `t` is one or more template characters

The trigger character or literal string is not included in output from a Skip Until Not operator.

Template	Incoming data	Output
P0A9999	BPN3456	3456
	PN1234	1234
	5341	No output

Template	Incoming data	Output
P0"PN"9999	PN3456	3456
	5341	No output
	PNPN7654	7654



P



0

Repeat Previous (R)

This operator allows a template character to repeat one or more times, allowing the capture of variable-length scanned data. The following examples capture two required alpha characters followed by one or more required digits:

Template	Incoming data	Output
AA9R	AB3	AB3
	PN12345	PN12345
	32RM52700	No output



R

Scroll Until Match (S)

This operator steps through scanned data one character at a time until the data matches the template.

Template	Incoming data	Output
S99999	AB3	No Output
	PN12345	12345
	32RM52700	52700



S

Multiple Templates

This feature sets up multiple templates for OCR decoding. To do this, follow the procedure described in [OCR Template on page 360](#) (scan the [OCR Template](#) barcode, and then barcodes corresponding to numbers and letters to form the template expression, and then **End of Message**) for each template in the multiple template string, using a capital letter **X** as a separator between templates.

For example, set the [OCR Template](#) as **99999XAAAAA** to decode OCR strings of either **12345** or **ABCDE**.

Template Examples

Following are sample templates with descriptions of valid data for each definition.

Field Definition Description

"M"99977 M followed by three digits and two optional digits.

"X"997777"X" X followed by two digits, four optional digits, and an X.

9959775599 Two digits followed by any character, a digit, two optional digits, any two characters, and two digits.

A55"- "999"- "99 A letter followed by two characters, a dash, three digits, a dash, and two digits.

33A" . "99 Two alphanumeric characters followed by a letter, a period, and two digits.

999992991 Five digits followed by an optional alpha, two digits, and an optional alphanumeric.

"PN98" Literal field - **PN98**

OCR Check Digit Modulus

Parameter # 688 (SSI # F1h B0h)

The check digit is the last digit (in the right-most position) in an OCR string and improves the accuracy of the collected data. This option sets OCR module check digit calculation. The calculation is performed on incoming data to determine this check digit, based on the numeric weight of the alpha and numeric characters. See [OCR Check Digit Multiplier on page 370](#). If the incoming data does not match the check digit, the data is considered corrupt.

The selected check digit option does not take effect until you set [OCR Check Digit Validation on page 372](#).

To choose the Check Digit Modulus, such as 10 for Modulus 10, scan the following barcode, and then scan a three-digit number from 001 to 099 representing the check digit using the numeric keypad in [Numeric Barcodes](#). The default is 1.



OCR Check Digit

OCR Check Digit Multiplier

Parameter # 700 (SSI # F1h BCh)

This option sets OCR check digit multipliers for character positions. For check digit validation, each character in scanned data has an assigned weight to use in calculating the check digit. The scanner OCR ships with the following weight equivalents:

0 = 0	A = 10	K = 20	U = 30
1 = 1	B = 11	L = 21	V = 31
2 = 2	C = 12	M = 22	W = 32
3 = 3	D = 13	N = 23	X = 33
4 = 4	E = 14	O = 24	Y = 34
5 = 5	F = 15	P = 25	Z = 35
6 = 6	G = 16	Q = 26	Space = 0
7 = 7	H = 17	R = 27	
8 = 8	I = 18	S = 28	
9 = 9	J = 19	T = 29	

All other characters are equivalent to one (1).

You can define the multiplier string if it is different from the default.

121212121212 (default)

123456789A (for ISBN, Product Add Right to Left. See [OCR Check Digit Validation on page 372](#))

For example:

ISBN	0	2	0	1	1	8	3	9	9	4
Multiplier	10	9	8	7	6	5	4	3	2	1
Product	0	18	0	7	6	40	12	27	18	4
Product add	0+	18+	0+	7+	6+	40+	12+	27+	18+	4= 132

ISBN uses Modulus 11 for the check digit. In this case, 132 is divisible by 11, so it passes the check digit.

To set the check digit multiplier, scan the following barcode, and then scan numbers and letters to form the multiplier string from [Alphanumeric Barcodes](#). Then scan [End of Message on page 459](#).



OCR Check Digit Multiplier

OCR Check Digit Validation

Parameter # 694 (SSI # F1h B6h)

Use the following options to protect against scanning errors by applying a check digit validation scheme.

None

No check digit validation, indicating no check digit is applied. This is the default.



* No Check Digit
(0)

Product Add Left to Right

Each character in the scanned data is assigned a numeric value (see [OCR Check Digit Multiplier on page 370](#)). Each digit representing a character in the scanned data is multiplied by its corresponding digit in the multiplier, and the sum of these products is computed. The check digit passes if this sum modulo Check Digit Modulus is zero.

Example:

Scanned data numeric value is 132456 (check digit is 6)

Check digit multiplier string is 123456

Digit	1	3	2	4	5	6	
Multiplier	1	2	3	4	5	6	
Product	1	6	6	16	25	36	
Product add	1+	6+	6+	16+	25+	36=	90

The Check Digit Modulus is 10. It passes because 90 is divisible by 10 (the remainder is zero).



Product Add Left to Right
(3)

Product Add Right to Left

Each character in the scanned data is assigned a numeric value (see [OCR Check Digit Multiplier on page 370](#)). The check digit multiplier is reversed in order. Each value representing a character in the scanned data is multiplied by its corresponding digit in the reversed multiplier, resulting in a product for each character in the scanned data. The sum of these products is computed. The check digit passes if this sum modulo Check Digit Modulus is zero.

Example:

Scanned data numeric value is 132459 (check digit is 9)

Check digit multiplier string is 123456

Digit	1	3	2	4	5	9	
Multiplier	6	5	4	3	2	1	
Product	6	15	8	12	10	9	
Product add	6+	15+	8+	12+	10+	9=	60

The Check Digit Modulus is 10. It passes because 60 is divisible by 10 (the remainder is 0).

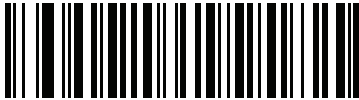

Product Add Right to Left
(1)

Digit Add Left to Right

Each character in the scanned data is assigned a numeric value (see [OCR Check Digit Multiplier on page 370](#)). Each value representing a character in the scanned data is multiplied by its corresponding digit in the multiplier, resulting in a product for each character in the scanned data. The sum of each individual digit in all of the products is then calculated. The check digit passes if this sum modulo Check Digit Modulus is zero.

Example:

Scanned data numeric value is 132456 (check digit is 6)

Check digit multiplier string is 123456

Digit	1	3	2	4	5	6	
Multiplier	1	2	3	4	5	6	
Product	1	6	6	16	25	36	
Digit add	1+	6+	6+	1+6+	2+5+	3+6=	36

The Check Digit Modulus is 12. It passes because 36 is divisible by 12 (the remainder is 0).



**Digit Add Left to Right
(4)**

Digit Add Right to Left

Each character in the scanned data is assigned a numeric value (see [OCR Check Digit Multiplier on page 370](#)). The check digit multiplier is reversed in order. Each value representing a character in the scanned data is multiplied by its corresponding digit in the reversed multiplier, resulting in a product for each character in the scanned data. The sum of each individual digit in all of the products is then calculated. The check digit passes if this sum modulo Check Digit Modulus is zero.

Example:

Scanned data numeric value is 132456 (check digit is 6)

Check digit multiplier string is 123456

Digit	1	3	2	4	5	6	
Multiplier	6	5	4	3	2	1	
Product	6	15	8	12	10	6	
Digit add	6+	1+5+	8+	1+2+	1+0+	6=	30

The Check Digit Modulus is 10. It passes because 30 is divisible by 10 (the remainder is 0).



**Digit Add Right to Left
(2)**

Product Add Right to Left Simple Remainder

Each character in the scanned data is assigned a numeric value (see [OCR Check Digit Multiplier on page 370](#)). The check digit multiplier is reversed in order. Each value representing a character in the scanned data is multiplied by its corresponding digit in the reversed multiplier, resulting in a product for each character in the scanned data. The sum of these products **except for the check digit's product** is computed. The check digit passes if this sum modulo Check Digit Modulus is equal to the check digit's product.

Example:

Scanned data numeric value is 122456 (check digit is 6)

Check digit multiplier string is 123456

Digit	1	2	2	4	5	6
Multiplier	6	5	4	3	2	1

Product	6	10	8	12	10	6
Product add	6+	10+	8+	12+	10=	46 6

The Check Digit Modulus is 10. It passes because 46 divided by 10 leaves a remainder of 6.



**Product Add Right to Left Simple Remainder
(5)**

Digit Add Right To Left Simple Remainder

Each character in the scanned data is assigned a numeric value (see [OCR Check Digit Multiplier on page 370](#)). The check digit multiplier is reversed in order. Each value representing a character in the scanned data is multiplied by its corresponding digit in the reversed multiplier, resulting in a product for each character in the scanned data. The sum of each individual digit in all of the products **except for the check digit's product** is then calculated. The check digit passes if this sum modulo Check Digit Modulus is equal to the check digit's product.

Example:

Scanned data numeric value is 122459 (check digit is 6)

Check digit multiplier string is 123456

Digit	1	2	2	4	5	9
Multiplier	6	5	4	3	2	1
Product	6	10	8	12	10	9
Digit add	6+	1+0+	8+	1+2+	1+0=	19 9

The Check Digit Modulus is 10. It passes because 19 divided by 10 leaves a remainder of 9.



**Digit Add Right to Left Simple Remainder
(6)**

Health Industry - HIBCC43

This is the health industry module 43 check digit standard. The check digit is the modulus 43 sum of all the character values in a given message, and is printed as the last character in a given message.

Example:

Supplier Labeling Data Structure: + A 1 2 3 B J C 5 D 6 E 7 1

Sum of values: $41+10+1+2+3+11+19+12+5+13+6+14+7+1 = 145$

Divide 145 by 43. The quotient is 3 with a remainder of 16. The check digit is the character corresponding to the value of the remainder (see [Table 22](#)), which in this example is 16, or **G**. The complete Supplier Labeling Data Structure, including the check digit, therefore is:

A 1 2 3 B J C 5 D 6 E 7 1 G

Table 22 Table of Numeric Value Assignments for Computing HIBC LIC Data Format Check Digit

0 = 0	9 = 9	I = 18	R = 27	- = 36
1 = 1	A = 10	J = 19	S = 28	. = 37
2 = 2	B = 11	K = 20	T = 29	Space = 38
3 = 3	C = 12	L = 21	U = 30	\$ = 39
4 = 4	D = 13	M = 22	V = 31	/ = 40
5 = 5	E = 14	N = 23	W = 32	+ = 41
6 = 6	F = 15	O = 24	X = 33	% = 42
7 = 7	G = 16	P = 25	Y = 34	
8 = 8	H = 17	Q = 26	Z = 35	



Health Industry - HIBCC43
(9)

Inverse OCR

Parameter # 856 (SSI # F2h 58h)

Inverse OCR is white or light words on a black or dark background. Select an option for decoding inverse OCR:

- **Regular Only** - Decode regular OCR (black on white) strings only.
- **Inverse Only** - Decode inverse OCR (white on black) strings only.
- **Autodiscriminate** - Decode both regular and inverse OCR strings.



* Regular Only
(0)



Inverse Only
(1)



Autodiscriminate
(2)

OCR Redundancy

Parameter # 1770 (SSI # F8h 06h EAh)

This option adjusts the number of times to decode an OCR text string before transmission. There are three levels of OCR decode redundancy. There is an inverse relationship between the redundancy level and OCR decoding aggressiveness. Increasing the level of the redundancy can reduce OCR scanning aggressiveness, so select only the level of redundancy necessary.

- **OCR Redundancy Level 1:** This default setting allows the digital scanner to operate in its most aggressive state while providing sufficient accuracy in decoding most in-spec OCR text strings.
- **OCR Redundancy Level 2:** This setting eliminates most misdecodes while maintaining reasonable aggressiveness.
- **OCR Redundancy Level 3:** Select this option with greater redundancy requirements if OCR Redundancy Level 2 fails to eliminate misdecodes.



* OCR Redundancy Level 1
(1)



OCR Redundancy Level 2
(2)



OCR Redundancy Level 3
(3)

Standard Parameter Defaults

Table 23 Standard Parameter Defaults

Parameter	Parameter Number	SSI Number	Default	Page Number
Dump Scanner Parameters	N/A	N/A	N/A	56
Report Software Version	N/A	N/A	N/A	56
Serial Number	N/A	N/A	N/A	57
Manufacturing Information	N/A	N/A	N/A	57
User Preferences				
Set Default Parameter	N/A	N/A	Restore Defaults	67
Parameter Barcode Scanning	236	ECh	Enable	68
Beep After Good Decode	56	38h	Enable	68
Direct Decode Indicator	859	F2h 5Bh	Disable	69
Beeper Volume	140	8Ch	High	70
Beeper Tone	145	91h	Medium	71
Beeper Duration	628	F1h 74h	Medium	72
Suppress Power Up Beeps	721	F1h D1h	Do Not Suppress	72
Decode Pager Motor	613	F1h 65h	Enable	73
Decode Pager Motor Duration	626	F1h 72h	150 msec	73
Night Mode Trigger	1215	F8h 04h BFh	Disable	75
Night Mode Toggle	N/A	N/A	N/A	76
Night Mode Silence Beeper Radio Indications	2262	F8h 08h D6	Enable Always	77
Night Mode Silence Beeper Low Battery Indication	2263	F8h 08h D7	Enable Always	78
Night Mode Silence Beeper Parameter Programming Indications	2264	F8h 08h D8	Enable Always	78
Scan Button Sensitivity	2133	F8 08 55	Normal Touch	81
Programmable Buttton Sesityivity	2134	F8 08 56	Normal Touch	81
Haptic Feedback (Vibrate) on Button Touch	1251	F8h 04h E3h	Enable	82
Click on Button Touch	1252	F8h 04h E4h	Enable	83
Scan Button ADF Rule Selection	2070	F8h 08h 16h	No Action	86
Programmable Button ADF Rule Selection	2071	F8h 08h 17h	No Action	87

Standard Parameter Defaults

Table 23 Standard Parameter Defaults

Parameter	Parameter Number	SSI Number	Default	Page Number
Hands-Free ADF Rule Selection	2072	F8h 08h 18h	No Action	88
Lamp Mode Control	1711	F8h 06h AFh	Disable - for SR Models Enable Lamp Mode without Scanning - for HC models	89
Lamp Mode Timeout	1712	F8h 06h B0h	5 Minutes	90
Low Power Mode	128	80h	Enable	90
Time Delay to Low Power Mode	146	92h	1 sec	91
Timeout to Low Power Mode from Auto Aim (Applies to cordless configurations only)	729	F1h D9h	15 sec	93
Battery Preservation Mode (Applies to cordless configurations only)	1765	F8h 06h E5h	Enable	94
Hand-Held Trigger Mode	138	8Ah	Level	95
Hands-Free Mode	630	F1h 76h	Enable	97
Hand-Held Decode Aiming Pattern	306	F0h 32h	Enable	97
Hands-Free (Presentation) Decode Aiming Pattern	590	F1h 4Eh	Disable Hands-Free Decode Aiming Pattern	98
Picklist Mode	402	F0h 92h	Disabled Always	100
Virtual Tether Alarm Configuration	2053	F8h 08h 05h	Disable	101
Delay Before Virtual Tether Alarm Activates	2054	F8h 08h 06h	30 Seconds	105
Virtual Tether Alarm Duration	2055	F8h 08h 07h	5 Minutes	105
Defeat Virtual Tether Alarm	2119	F8h 08h 47h	Pause Alarm on Scan Button	106
Pause Virtual Tether Alarm Duration	2120	F8h 08h 48h	30 Seconds	107
Continuous Barcode Read	649	F1h 89h	Disable	109
Unique Barcode Reporting	723	F1h D3h	Enable	109
Decode Session Timeout	136	88h	9.9 sec	110
Hands-Free Decode Session Timeout	400	F0h 90h	15	111
Timeout Between Decodes, Same Symbol	137	89h	0.5 sec	112
Timeout Between Decodes, Different Symbols	144	90h	0.1 sec	112
Triggered Timeout, Same Symbol	724	F1 D4	Disable	113
Mobile Phone/Display Mode	716	F1h CCh	Normal	114
PDF Prioritization	719	F1h CFh	Disable	115
PDF Prioritization Timeout	720	F1h D0h	200 ms	116
Decoding Illumination	298	F0h 2Ah	Enable	116
Illumination Brightness Hand-Held	669	F1h 9Dh	High	117
Illumination Brightness Hands-Free	2118	F8h 08h 46h	Medium	118

Standard Parameter Defaults

Table 23 Standard Parameter Defaults

Parameter	Parameter Number	SSI Number	Default	Page Number
Low Light Scene Detection	810	F2h 2Ah	No Low Light Assist Scene Detection	119
Scene Detect Sensitivity	1943	F8h 97h	Low	120
Motion Tolerance (Hand-Held Trigger Mode Only)	858	F2h 5Ah	Less Motion Tolerance	121
Product ID (PID) Type	1281	F8h 05h 01h	Host Type Unique	122
Product ID (PID) Value	1725	F8h 06h BDh	0	122
ECLevel	1710	F8h 06h AEh	0	123
Add an Enter Key	N/A	N/A	N/A	123
Transmit Code ID Character	45	2Dh	None	123
Prefix Value	99, 105	63h, 69h	7013 <CR><LF>	124
Suffix 1 Value	98, 104	62h, 68h	7013 <CR><LF>	124
Suffix 2 Value	100, 106	64h, 6Ah		
Scan Data Transmission Format	235	EBh	Data as is	125
FN1 Substitution Values	103, 109	67h, 6Dh	7013 <CR><LF>	127
Transmit "No Read" Message	94	5Eh	Disable	128
Unsolicited Heartbeat Interval	1118	F8h 04h 5Eh	Disable	129
securPharm	1752	F8h 06h D8h	Disable	130
securPharm Output Formatting	1753	F8h 06h D9h	No Formatting	131
Programmable Button for Single Press	2060	F8h 08h 0Ch	Apple Show/Hide Keypad	134
Programmable Button for Double Press	2103	F8h 08h 37h	No Action	135
Radio Communications				
Radio Communications Host Types	N/A	N/A	Cradle Host	138
Bluetooth Friendly Name	607	F1h 5Fh	n/a	143
Discoverable Mode	610	F1h 62h	General	144
Wi-Fi Friendly Mode	1299	F8h 05h 77h	Disable	144
Wi-Fi Friendly Channel Exclusion	N/A	N/A	Use All Channels	145
Radio Output Power	1324	F8h 05h 2Ch	High	147
Link Supervision Timeout	1698	F8h 06h A2h	5 sec	148
Bluetooth Radio State	1354	F8h 05h 4Ah	On	149
HID Features for Apple iOS	1114	F8h 04h 5Ah	Disable	150
HID Keyboard Keystroke Delay	N/A	N/A	No Delay (0 msec)	151
HID CAPS Lock Override	N/A	N/A	Do Not Override (Disable)	151
HID Ignore Unknown Characters	N/A	N/A	Send Barcodes with Unknown Characters	152

Standard Parameter Defaults

Table 23 Standard Parameter Defaults

Parameter	Parameter Number	SSI Number	Default	Page Number
Emulate Keypad	N/A	N/A	Enable	152
Fast HID Keyboard	1361	F8h 05h 51h	Enable	153
Quick Keypad Emulation	1362	F8h 05h 52h	Enable	153
HID Keyboard FN1 Substitution	N/A	N/A	Disable	154
HID Function Key Mapping	N/A	N/A	Disable	154
Simulated Caps Lock	N/A	N/A	Disable	155
Convert Case	N/A	N/A	No Case Conversion	155
Auto-Reconnect Option	604	F1h 5Ch	Auto-Reconnect Immediately	156
Reconnect Attempt Beep Feedback	559	F1h 2Fh	Disable	158
Reconnect Attempt Interval	558	F1h 2Eh	30 sec	158
Sleep Between Attempts	1778	F8h 06h F2h	Sleep for 1 Minute	160
Number of Retry Attempts	1779	F8h 06h F3h	Do Not Retry	161
Beep on Insertion	288	20h	Enable	162
Beep on <BEL>	150	96	Enable	163
Pairing Modes	542	F1h 1Eh	Unlocked	164
Pairing on Contacts	545	F1h 21h	Enable	165
Toggle Pairing	1322	F8h 05h 2Ah	Disable	166
Connection Maintenance Interval	N/A	N/A	15 Minutes	167
AutoConfig (Scanner Cloning Through Cradle)	2139	F8 08 5B	Disable	169
Batch Mode	544	F1h 20h	Normal (Do Not Batch Data)	169
Persistent Batch Storage	1399	F8h 05h 77h	Disable	173
Page Button	746	F1h EAh	Enable	174
Page Mode	1364	F8h 05h 54h	Page Simple	175
Page Stage Timeout	1365	F8h 05h 55h	30 Seconds	175
Cradle Bluetooth Operation Mode	1355	F8h 05h 4Bh	Bluetooth Classic Only	176
Bluetooth Security Levels	1393	F8h 05h 71h	Low	177
Save Bluetooth Connection Information	1743	F8h 06h CFh	Enable	178
FIPS Mode	736	F1h E0h	Disable	179
Imaging Preferences				
Operational Modes	N/A	N/A	N/A	183
Image Capture Illumination	361	F0h 69h	Enable	185
Image Capture Autoexposure	360	F0h 68h	Enable	185
Fixed Exposure	567	F4h F1h 37h	100	186
Fixed Gain	568	F1h 38h	50	186

Standard Parameter Defaults

Table 23 Standard Parameter Defaults

Parameter	Parameter Number	SSI Number	Default	Page Number
Gain / Exposure Priority for Snapshot Mode	562	F1h 32h	Autodetect	187
Snapshot Mode Timeout	323	F0h 43h	0 (30 seconds)	188
Snapshot Aiming Pattern	300	F0h 2Ch	Enable	189
Silence Operational Mode Changes	1293	F8h 05h 0Dh	Disable (do not silence)	189
Image Cropping	301	F0h 2Dh	Disable	190
Crop to Pixel Addresses	315 316 317 318	F4h F0h 3Bh F4h F0h 3Ch F4h F0h 3Dh F4h F0h 3Eh	0 top 0 left 959 bottom 1279 right	190
Image Size (Number of Pixels)	302	F0h 2Eh	Full	191
Image Brightness (Target White)	390	F0h 86h	180	192
JPEG Image Options	299	F0h 2Bh	Quality	193
JPEG Target File Size	561	F1h 31h	160 kB	193
JPEG Quality and Size Value	305	F0h 31h	65	194
Image Enhancement	564	F1h 34h	Low (1)	194
Image File Format Selector	304	F0h 30h	JPEG	195
Image Rotation	665	F1h 99h	0	196
Bits per Pixel (BPP)	303	F0h 2Fh	8 BPP	196
Signature Capture	93	5Dh	Disable	197
Signature Capture Image File Format Selector	313	F0h 39h	JPEG	198
Signature Capture Bits per Pixel (BPP)	314	F0h 3Ah	8 BPP	199
Signature Capture Width	366	F4h F0h 6Eh	400	200
Signature Capture Height	367	F4h F0h 6Fh	100	200
Signature Capture JPEG Quality	421	F0h A5h	65	200
Video Mode Format Selector	916	F2h 94h	JPEG	201
Video View Finder	324	F0h 44h	Disable	201
Video View Finder Image Size	329	F0h 49h	1700 Bytes	202
Video Subsampling	667	F1h 9Bh	1/4 Resolution	203
USB Host Parameters				
USB Device Type	N/A	N/A	HID Keyboard Emulation	207
Symbol Native API (SNAPI) Status Handshaking	N/A	N/A	Enable	208
USB Keystroke Delay	N/A	N/A	No Delay	209
USB CAPS Lock Override	N/A	N/A	Disable	209
USB Ignore Unknown Characters	N/A	N/A	Send	210
USB Convert Unknown to Code 39	N/A	N/A	Disable	210

Standard Parameter Defaults

Table 23 Standard Parameter Defaults

Parameter	Parameter Number	SSI Number	Default	Page Number
USB Polling Interval	N/A	N/A	3 msec	211
USB Fast HID	N/A	N/A	Enable	213
Emulate Keypad	N/A	N/A	Enable	213
Emulate Keypad with Leading Zero	N/A	N/A	Enable	214
Quick Keypad Emulation	N/A	N/A	Enable	214
USB FN1 Substitution	N/A	N/A	Disable	215
Function Key Mapping	N/A	N/A	Disable	215
Simulated Caps Lock	N/A	N/A	Disable	216
Convert Case	N/A	N/A	No Case Conversion	216
USB Static CDC	N/A	N/A	Enable	217
TGCS (IBM) USB Direct I/O Beep	1360	550h	Honor	218
TGCS (IBM) USB Beep Directive	N/A	N/A	Ignore Beep Directive	218
TGCS (IBM) USB Barcode Configuration Directive	N/A	N/A	Ignore Barcode Configuration Directive	219
IBM Specification Version	N/A	N/A	Version 2.2	219
SSI				
Select SSI Host	N/A	N/A	N/A	230
Software Handshaking	159	9Fh	ACK/NAK	230
Decode Data Packet Format	238	EEh	Send Raw Decode Data	231
Host Serial Response Time-out	155	9Bh	2 sec	232
Host Character Time-out	239	EFh	200 msec	233
Multipacket Option	334	F0h 4Eh	Option 1	234
Interpacket Delay	335	F0h 4Fh	0 ms	235
Event Reporting				
Decode Event	256	F0h 00h	Disable	236
Boot Up Event	258	F0h 02h	Disable	237
Parameter Event	259	F0h 03h	Disable	237
Symbologies				
Enable/Disable All Code Types				244
UPC/EAN				
UPC-A	1	01h	Enable	244
UPC-E	2	02h	Enable	245
UPC-E1	12	0Ch	Disable	245
EAN-8/JAN 8	4	04h	Enable	246
EAN-13/JAN 13	3	03h	Enable	246
Bookland EAN	83	53h	Disable	247

Standard Parameter Defaults

Table 23 Standard Parameter Defaults

Parameter	Parameter Number	SSI Number	Default	Page Number
Decode UPC/EAN/JAN Supplementals (2 and 5 digits)	16	10h	Ignore	247
User-Programmable Supplementals			000	251
Supplemental 1:	579	F1h 43h		
Supplemental 2:	580	F1h 44h		
UPC/EAN/JAN Supplemental Redundancy	80	50h	10	251
Decode UPC/EAN/JAN Supplemental AIM ID	672	F1h A0h	Combined	252
Transmit UPC-A Check Digit	40	28h	Enable	253
Transmit UPC-E Check Digit	41	29h	Enable	253
Transmit UPC-E1 Check Digit	42	2Ah	Enable	254
Transmit EAN-8 Check Digit	1881	F8 07 59	Transmit	254
Transmit EAN-13 Check Digit	1882	F8 07 5A	Transmit	255
Transmit Code 39 Start/Stop Characters	1900	F8 07 6C	Do Not Transmit	255
UPC-A Preamble	34	22h	System Character	256
UPC-E Preamble	35	23h	System Character	257
UPC-E1 Preamble	36	24h	System Character	258
Convert UPC-E to A	37	25h	Disable	259
Convert UPC-E1 to A	38	26h	Disable	259
EAN-8/JAN-8 Extend	39	27h	Disable	260
Bookland ISBN Format	576	F1h 40h	ISBN-10	260
UCC Coupon Extended Code	85	55h	Disable	261
Coupon Report	730	F1h DAh	New Coupon Format	262
ISSN EAN	617	F1h 69h	Disable	262
UPC Reduced Quiet Zone	1289	F8h 05h 09h	Disable	263
Code 128				
Code 128	8	08h	Enable	263
Set Length(s) for Code 128	209, 210	D1h, D2h	Any Length	264
GS1-128 (formerly UCC/EAN-128)	14	0Eh	Enable	266
ISBT 128	84	54h	Enable	266
ISBT Concatenation	577	F1h 41h	Disable for SR models Enable for HC models	267
Check ISBT Table	578	F1h 42h	Enable	268
ISBT Concatenation Redundancy	223	DFh	10	268
Code 128 Security Level	751	F1h EFh	Security Level 1	270
Code 128 Reduced Quiet Zone	1208	F8h 04h B8h	Disable	271
Code 128 <FNC4>	1254	F8h 04h E6h	Ignore	271
Code 39				

Standard Parameter Defaults

Table 23 Standard Parameter Defaults

Parameter	Parameter Number	SSI Number	Default	Page Number
Code 39	0	00h	Enable	272
Trioptic Code 39	13	0Dh	Disable	272
Convert Code 39 to Code 32 (Italian Pharmacy Code)	86	56h	Disable	273
Code 32 Prefix	231	E7h	Disable	273
Set Length(s) for Code 39	18, 19	12h, 13h	1 to 55	274
Code 39 Check Digit Verification	48	30h	Disable	275
Transmit Code 39 Check Digit	43	2Bh	Disable	275
Code 39 Full ASCII Conversion	17	11h	Disable	276
Code 39 Security Level	750	F1h EEh	Security Level 1	277
Code 39 Reduced Quiet Zone	1209	F8h 04h B9h	Disable	278
Code 93				
Code 93	9	09h	Enable	278
Set Length(s) for Code 93	26, 27	1Ah, 1Bh	1 to 55	279
Code 11				
Code 11	10	0Ah	Disable	280
Set Lengths for Code 11	28, 29	1Ch, 1Dh	4 to 55	280
Code 11 Check Digit Verification	52	34h	Disable	282
Transmit Code 11 Check Digit(s)	47	2Fh	Disable	283
Interleaved 2 of 5 (ITF)				
Interleaved 2 of 5 (ITF)	6	06h	Enable	284
Set Lengths for I 2 of 5	22, 23	16h, 17h	6 to 55	284
I 2 of 5 Check Digit Verification	49	31h	Disable	286
Transmit I 2 of 5 Check Digit	44	2Ch	Disable	286
Convert I 2 of 5 to EAN 13	82	52h	Disable	287
Febraban	1750	F8h 06h D6h	Disable	287
I 2 of 5 Security Level	1121	F8h 04h 61h	Security Level 1	288
I 2 of 5 Reduced Quiet Zone	1210	F8h 04h BAh	Disable	289
Discrete 2 of 5 (DTF)				
Discrete 2 of 5	5	05h	Disable	290
Set Length(s) for D 2 of 5	20, 21	14h 15h	1 to 55	290
Codabar (NW - 7)				
Codabar	7	07h	Enable	292
Set Lengths for Codabar	24, 25	18h, 19h	4 to 55	292
CLSI Editing	54	36h	Disable	294
NOTIS Editing	55	37h	Disable	294

Standard Parameter Defaults

Table 23 Standard Parameter Defaults

Parameter	Parameter Number	SSI Number	Default	Page Number
Codabar Security Level	1776	F8h 06h F0h	Security Level 1	295
Codabar Upper or Lower Case Start/Stop Characters Detection	855	F2h 57h	Upper Case	296
Codabar Mod 16 Check Digit Verification	1784	F8h 06h F8h	Disable	296
Transmit Codabar Check Digit	704	F1h C0h	Disable	297
MSI				
MSI	11	0Bh	Disable	297
Set Length(s) for MSI	30, 31	1Eh, 1Fh	4 to 55	298
MSI Check Digits	50	32h	One	299
Transmit MSI Check Digit	46	2Eh	Disable	300
MSI Check Digit Algorithm	51	33h	Mod 10/Mod 10	300
MSI Reduced Quiet Zone	1392	F8h 05h 70h	Disable	301
Chinese 2 of 5				
Chinese 2 of 5	408	F0h 98h	Disable	301
Matrix 2 of 5				
Matrix 2 of 5	618	F1h 6Ah	Disable	302
Matrix 2 of 5 Lengths	619 620	F1h 6Bh F1h 6Ch	4-55	302
Matrix 2 of 5 Check Digit	622	F1h 6Eh	Disable	303
Transmit Matrix 2 of 5 Check Digit	623	F1h 6Fh	Disable	304
Korean 3 of 5				
Korean 3 of 5	581	F1h 45h	Disable	304
Inverse 1D	586	F1h 4Ah	Regular	305
GS1 DataBar				
GS1 DataBar Omnidirectional (formerly GS1 DataBar-14), GS1 DataBar Truncated, GS1 DataBar Stacked, GS1 DataBar Stacked Omnidirectional	338	F0h 52h	Enable	306
GS1 DataBar Limited	339	F0h 53h	Enable	306
GS1 DataBar Expanded, GS1 DataBar Expanded Stacked	340	F0h 54h	Enable	307
Convert GS1 DataBar to UPC/EAN	397	F0h 8Dh	Disable	307
GS1 DataBar Limited Margin Check	728	F1h D8h	Level 3	308
GS1 DataBar Security Level	1706	F8h 06h AAh	Level 1	309
Composite				
Composite CC-C	341	F0h 55h	Disable	310
Composite CC-A/B	342	F0h 56h	Disable	310

Standard Parameter Defaults

Table 23 Standard Parameter Defaults

Parameter	Parameter Number	SSI Number	Default	Page Number
Composite TLC-39	371	F0h 73h	Disable	311
Composite Inverse	1113	F8h 04h 59h	Regular	311
UPC Composite Mode	344	F0h 58h	UPC Never Linked	312
Composite Beep Mode	398	F0h 8Eh	Beep As Each Code Type is Decoded	313
GS1-128 Emulation Mode for UCC/EAN Composite Codes	427	F0h ABh	Disable	313
2D Symbolgies				
PDF417	15	0Fh	Enable	314
MicroPDF417	227	E3h	Disable	314
Code 128 Emulation	123	7Bh	Disable	315
Data Matrix	292	F0h 24h	Enable	316
GS1 Data Matrix	1336	F8h 05h 38h	Disable	316
Data Matrix Inverse	588	F1h 4Ch	Inverse Autodetect	317
Decode Mirror Images (Data Matrix Only)	537	F1h 19h	Auto	318
Maxicode	294	F0h 26h	Disable	319
QR Code	293	F0h 25h	Enable	319
Weblink QR	1947	F7 07 9B	Enable	320
GS1 QR	1343	F8h 05h 3Fh	Enable	320
MicroQR	573	F1h 3Dh	Enable	321
Aztec	574	F1h 3Eh	Enable	321
Aztec Inverse	589	F1h 4Dh	Inverse Autodetect	322
Han Xin	1167	F8h 04h 8Fh	Disable	323
Han Xin Inverse	1168	F8h 04h 90h	Regular	323
Grid Matrix	1718	F8h 06h B6h	Disable	324
Grid Matrix Inverse	1719	F8h 06h B7h	Regular Only	324
Grid Matrix Mirror	1736	F8h 06h C8h	Regular Only	325
DotCode	1906	F8 07 72h	Disable	326
DotCode Inverse	1907	F8 07 73h	Inverse Autodetect	326
DotCode Mirrored	1908	F8 07 74h	Autodetect	327
DotCode Prioritize	1937	F8 07 91h	Disable	327
Postal Codes				
US Postnet	89	59h	Disable	328
US Planet	90	5Ah	Disable	328
Transmit US Postal Check Digit	95	5Fh	Enable	329
UK Postal	91	5Bh	Disable	329
Transmit UK Postal Check Digit	96	60h	Enable	330

Table 23 Standard Parameter Defaults

Parameter	Parameter Number	SSI Number	Default	Page Number
Japan Postal	290	F0h 22h	Disable	330
Australia Post	291	F0h 23h	Disable	331
Australia Post Format	718	F1h CEh	Autodiscriminate	332
Netherlands KIX Code	326	F0h 46h	Disable	333
USPS 4CB/One Code/Intelligent Mail	592	F1h 50h	Disable	333
UPU FICS Postal	611	F1h 63h	Disable	334
Mailmark	1337	F8h 05h 08h	Disable	334
Symbology-Specific Security Levels				
Redundancy Level	78	4Eh	1	335
Security Level	77	4Dh	1	337
1D Quiet Zone Level	1288	F8h 05h 08h	1	338
Intercharacter Gap Size	381	F0h 7Dh	Normal	339
Report Version				339
Macro PDF				
Flush Macro PDF Buffer	N/A	N/A	N/A	340
Abort Macro PDF Entry	N/A	N/A	N/A	340
OCR Programming Parameters				
OCR-A	680	F1h A8h	Disable	348
OCR-A Variant	684	F1h ACh	OCR-A Full ASCII	349
OCR-B	681	F1h A9h	Disable	350
OCR-B Variant	685	F1h ADh	OCR-B Full ASCII	351
MICR E13B	682	F1h AAh	Disable	355
US Currency	683	F1h ABh	Disable	356
OCR Orientation	687	F1h AFh	0°	356
OCR Lines	691	F1h B3h	1	358
OCR Minimum Characters	689	F1h B1h	3	358
OCR Maximum Characters	690	F1h B2h	100	359
OCR Subset	686	F1h AEh	Selected font variant	359
OCR Quiet Zone	695	F1h B7h	50	360
OCR Template	547	F1h 23h	99999999	360
OCR Check Digit Modulus	688	F1h B0h	1	369
OCR Check Digit Multiplier	700	F1h BCh	121212121212	370
OCR Check Digit Validation	694	F1h B6h	None	372
Inverse OCR	856	F2h 58h	Regular	377
OCR Redundancy	1770	F8h 06h EAh	Level 1	378

Country Codes

Introduction

This chapter provides instructions for programming the keyboard to interface with a USB or BT HID. The host powers the scanner. For host setup information, see [USB Interface](#).



NOTE: Mobile device keyboards are English only.

To select a code page for the country keyboard type, see [Country Code Page Barcodes](#).

Throughout the programming barcode menus, default values are indicated with asterisks (*).

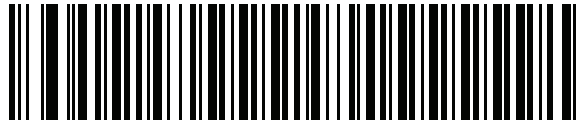

* Indicates Default — * US English (North American) — Feature/Option

USB, BT HID Country Keyboard Types (Country Codes)

Scan the barcode corresponding to the keyboard type. For a USB host, this setting applies only to the USB Keyboard (HID) device. If the keyboard type is not listed, see [Emulate Keypad on page 213](#) for the USB HID host.



NOTE: When changing USB country keyboard types the digital scanner automatically resets and issues the standard startup beep sequences.



NOTE: For best results when using international keyboards, enable [Quick Keypad Emulation on page 214](#).



IMPORTANT: 1. Some country keyboard barcode types are specific to certain Windows Operating Systems (i.e., XP, and Win 7 or higher). Barcodes requiring a specific Windows OS are noted so in their barcode captions.

2. Use the **French International** barcode for Belgian French keyboards.

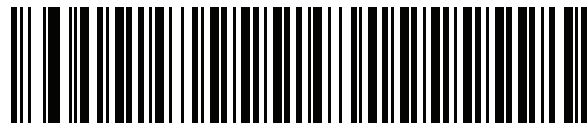

* US English (North American)



US English (Mac)



Albanian



Arabic (101)



Arabic (102)

Country Codes (Continued)

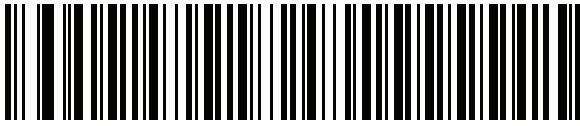

Arabic (102) AZERTY

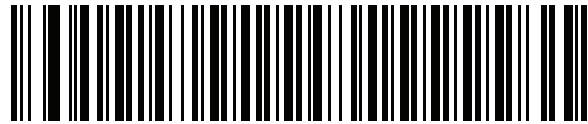

Azeri (Latin)

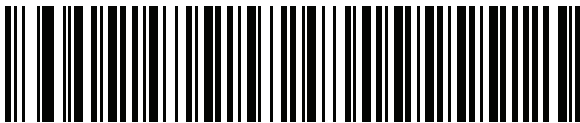

Azeri (Cyrillic)

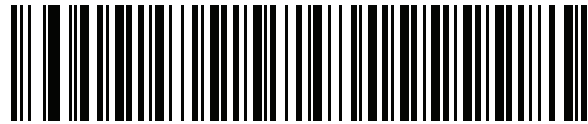

Belarusian

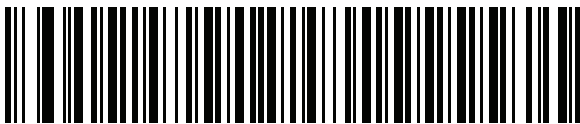

Bosnian (Latin)

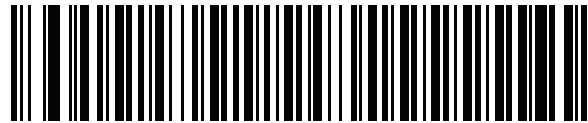

Bosnian (Cyrillic)



Bulgarian (Latin)

Country Codes (Continued)

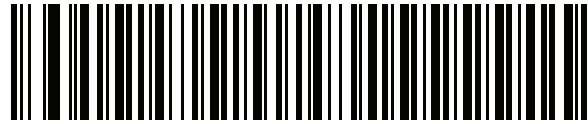

**Bulgarian Cyrillic (Typewriter)
(Bulgarian -Windows XP
Typewriter - Win 7 or higher)**

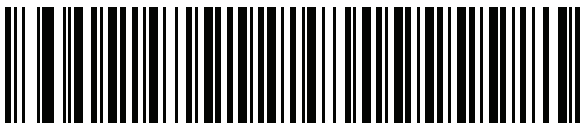

Canadian French Win7

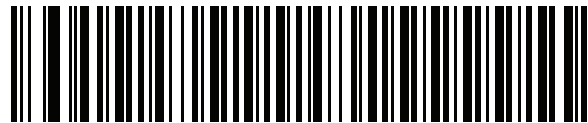

Canadian French (Legacy)

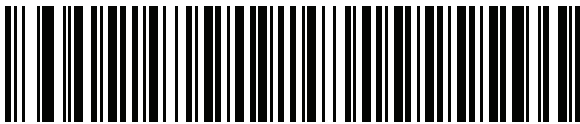

Canadian Multilingual Standard

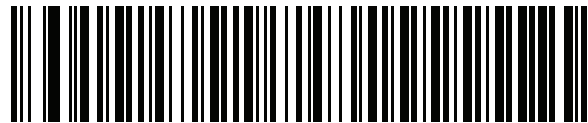

Chinese (ASCII)

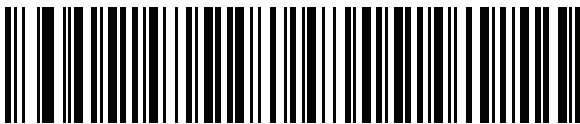

Chinese (Simplified)*

Country Codes (Continued)

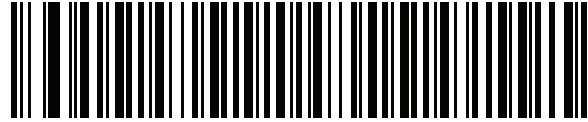

Chinese (Traditional)*

*For CJK keyboard types, see [CJK Decode Control on page 420](#).

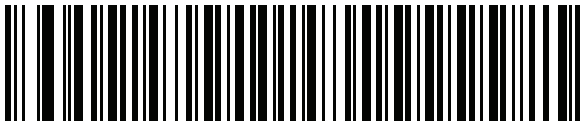

Croatian



Czech



Czech (Programmer)



Czech (QWERTY)



Danish



Dutch (Netherlands)

Country Codes (Continued)

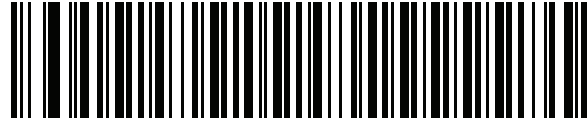

Estonian

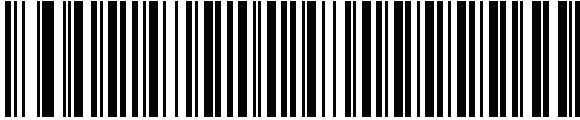

Faeroese

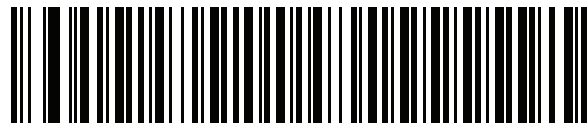

Finnish

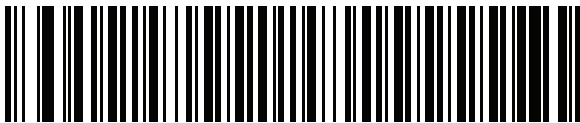

French (France)



French International
(Belgian French)



French (Canada) 95/98

Country Codes (Continued)

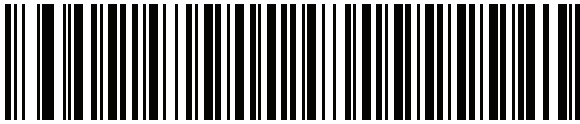

French (Canada) 2000/XP*

*Note that there is also a country code barcode for [Canadian Multilingual Standard on page 393](#). Be sure to select the appropriate barcode for your host system.

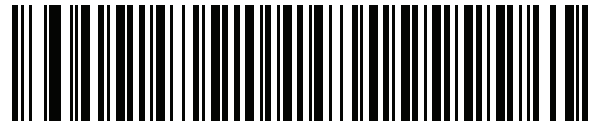

Galician



German

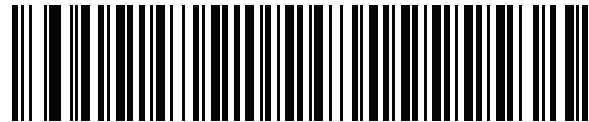

Greek Latin

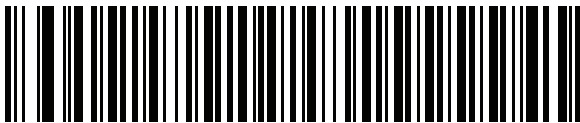

Greek (220) Latin

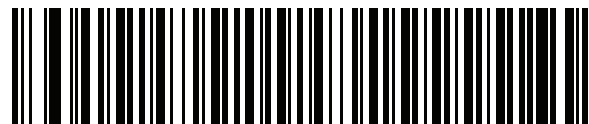

Greek (319) Latin

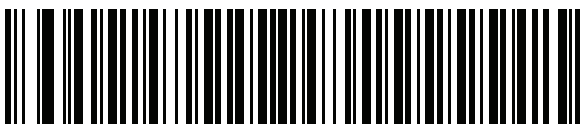

Greek

Country Codes (Continued)

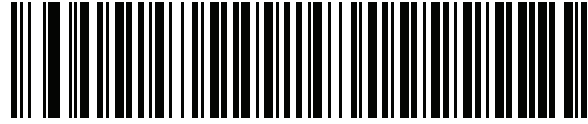

Greek (220)



Greek (319)

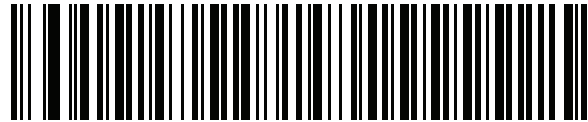

Greek Polytonic

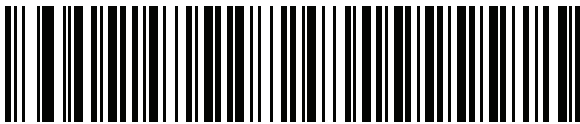

Hebrew Israel

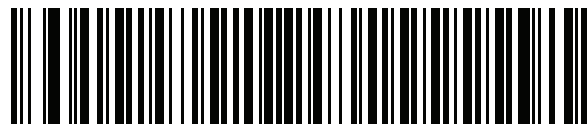

Hungarian

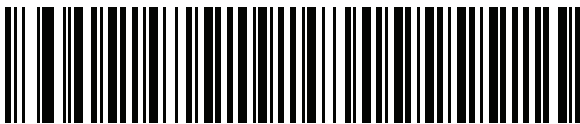

Hungarian_101KEY



Icelandic

Country Codes (Continued)

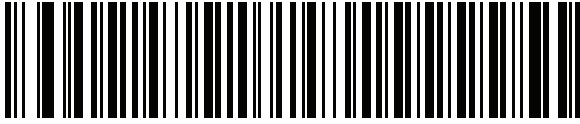

Irish

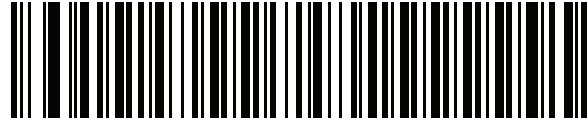

Italian

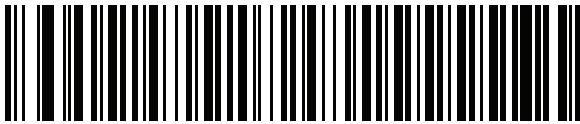

Italian (142)

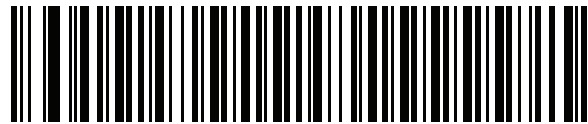

Japanese (ASCII)



Japanese (SHIFT-JIS)*

*For CJK keyboard types, see [CJK Decode Control on page 420](#).

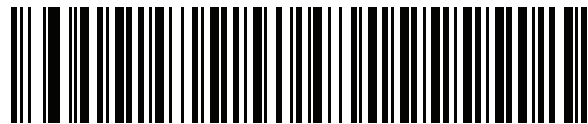

Kazakh



Korean (ASCII)

Country Codes (Continued)



Korean (Hangul)*

*For CJK keyboard types, see [CJK Decode Control on page 420](#).

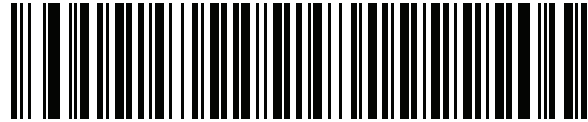

Kyrgyz



Latin American



Latvian



Latvian (QWERTY)



Lithuanian



Lithuanian (IBM)

Country Codes (Continued)

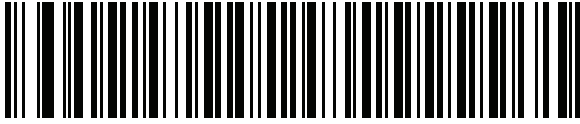

Macedonian (FYROM)

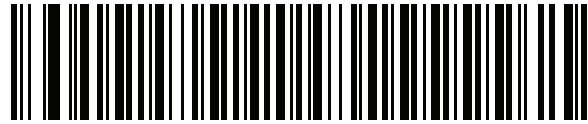

Maltese_47KEY

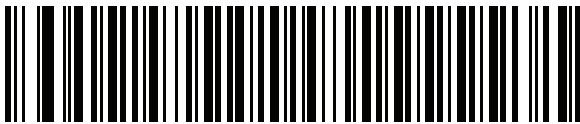

Mongolian

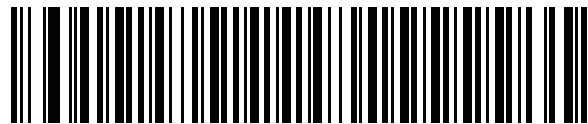

Norwegian

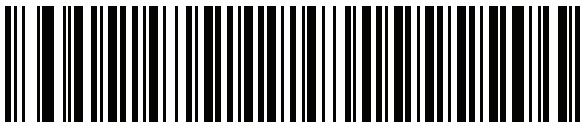

Polish (214)



Polish (Programmer)



Portuguese (Brazil)
(Windows XP)

Country Codes (Continued)

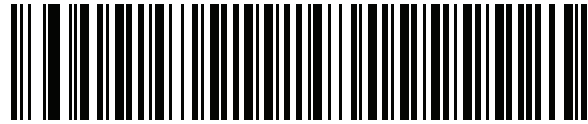

Portuguese (Brazilian ABNT)

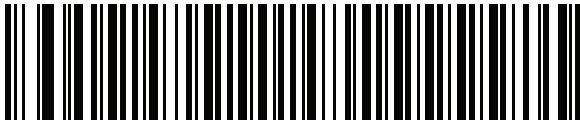

Portuguese (Brazilian ABNT2)



Portuguese (Portugal)

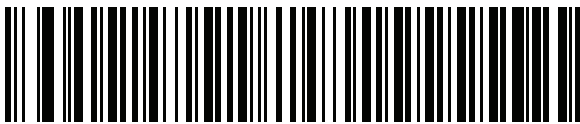

Romanian
(Windows XP)



Romanian (Legacy)
(Win 7 or higher)



Romanian (Standard)
(Win 7 or higher)

Country Codes (Continued)

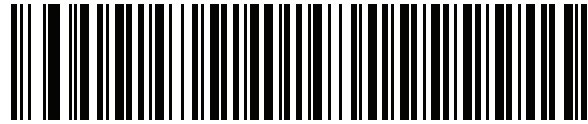

Romanian (Programmer)
(Win 7 or higher)

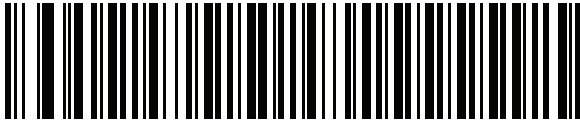

Russian

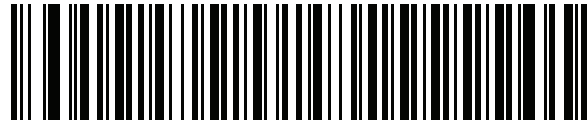

Russian (Typewriter)



Serbian (Latin)



Serbian (Cyrillic)



Slovak

Country Codes (Continued)

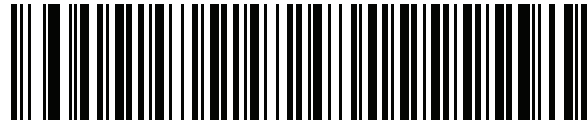

Slovak (QWERTY)

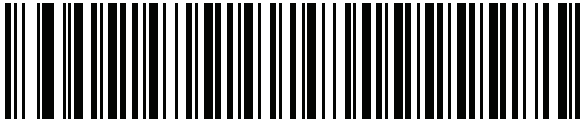

Slovenian

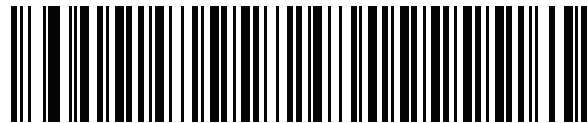

Spanish



Spanish (Variation)



Swedish

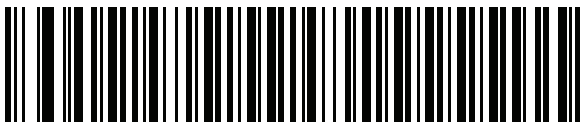

Swiss French



Swiss German

Country Codes (Continued)

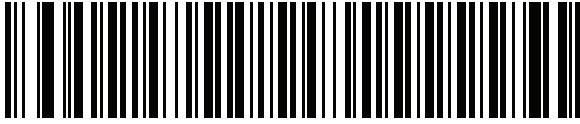

Tatar

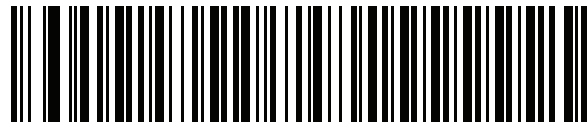

Thai (Kedmanee)

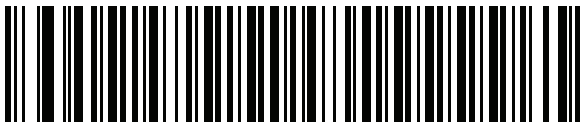

Turkish F



Turkish Q



UK English



Ukrainian



US Dvorak

Country Codes (Continued)



US Dvorak Left

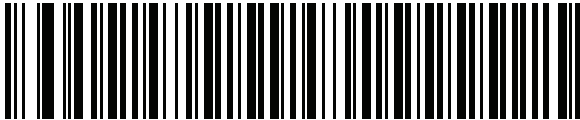

US Dvorak Right

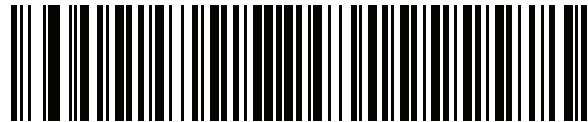

US International



Uzbek



Vietnamese

Country Code Pages

Introduction

This chapter provides barcodes for selecting code pages for the country keyboard type selected in [Country Codes](#). If the default code page in [Table 24](#) is appropriate for your selected country keyboard type, you do not need to scan a country code page barcode.



NOTE: ADF rules can also specify a code page based on the symbology and other ADF criteria. Refer to the Advanced Data Formatting Programmer Guide.

Country Code Page Defaults

[Table 24](#) lists the code page default for each country keyboard.

Table 24 Country Code Page Defaults

Country Keyboard	Code Page Default
US English (North American)	Windows 1252
US English (Mac)	Mac CP10000
Albanian	Windows 1250
Arabic 101	Windows 1256
Arabic 102	Windows 1256
Arabic 102 AZERTY	Windows 1256
Azeri Latin	Windows 1254
Azeri Cyrillic	Windows 1251
Belarusian	Windows 1251
Bosnian Latin	Windows 1250
Bosnian Cyrillic	Windows 1251
Bulgarian Latin	Windows 1250
Bulgarian Cyrillic	Windows 1251
Canadian French Win7	Windows 1252
Canadian French (Legacy)	Windows 1252
Canadian Multilingual	Windows 1252
Croatian	Windows 1250

Table 24 Country Code Page Defaults

Country Keyboard	Code Page Default
Chinese ASCII	Windows 1252
Chinese (Simplified)	Windows 936, GBK
Chinese (Traditional)	Windows 950, Big5
Czech	Windows 1250
Czech Programmers	Windows 1250
Czech QWERTY	Windows 1250
Danish	Windows 1252
Dutch Netherland	Windows 1252
Estonian	Windows 1257
Faeroese	Windows 1252
Finnish	Windows 1252
French (France)	Windows 1252
French (Canada) 95/98	Windows 1252
French (Canada) 2000/XP	Windows 1252
French International (Belgian French)	Windows 1252
Galician	Windows 1252
German	Windows 1252
Greek Latin	Windows 1252
Greek220 Latin	Windows 1253
Greek319 Latin	Windows 1252
Greek	Windows 1253
Greek220	Windows 1253
Greek319	Windows 1253
Greek Polytonic	Windows 1253
Hebrew Israel	Windows 1255
Hungarian	Windows 1250
Hungarian_101KEY	Windows 1250
Icelandic	Windows 1252
Irish	Windows 1252
Italian	Windows 1252
Italian_142	Windows 1252
Japanese ASCII	Windows 1252
Japanese (Shift-JIS)	Windows 932, Shift-JIS
Kazakh	Windows 1251
Korean ASCII	Windows 1252
Korean (Hangul)	Windows 949, Hangul
Kyrgyz Cyrillic	Windows 1251

Table 24 Country Code Page Defaults

Country Keyboard	Code Page Default
Latin America	Windows 1252
Latvian	Windows 1257
Latvian QWERTY	Windows 1257
Lithuanian	Windows 1257
Lithuanian_IBM	Windows 1257
Macedonian -FYROM	Windows 1251
Maltese_47KEY	Windows 1252
Mongolian-Cyrillic	Windows 1251
Norwegian	Windows 1252
Polish_214	Windows 1250
Polish Programmer	Windows 1250
Portuguese Brazil	Windows 1252
Portuguese Brazilian ABNT	Windows 1252
Portuguese Brazilian ABNT2	Windows 1252
Portuguese Portugal	Windows 1252
Romanian	Windows 1250
Romanian Legacy	Windows 1250
Romanian Standard	Windows 1250
Romanian Programmer	Windows 1250
Russian	Windows 1251
Russian Typewriter	Windows 1251
Serbian Latin	Windows 1250
Serbian Cyrillic	Windows 1251
Slovak	Windows 1250
Slovak QWERTY	Windows 1250
Slovenian	Windows 1250
Spanish	Windows 1252
Spanish Variation	Windows 1252
Swedish	Windows 1252
Swiss French	Windows 1252
Swiss German	Windows 1252
Tatar	Windows 1251
Thai-Kedmanee	Windows 874
Turkish F	Windows 1254
Turkish Q	Windows 1254
Ukrainian	Windows 1251
United Kingdom	Windows 1252

Table 24 Country Code Page Defaults

Country Keyboard	Code Page Default
United States	Windows 1252
US Dvorak	Windows 1252
US Dvorak Left Hand	Windows 1252
US Dvorak Right Hand	Windows 1252
US International	Windows 1252
Uzbek Cyrillic	Windows 1251
Vietnamese	Windows 1258

Country Code Page Barcodes

Scan the barcode corresponding to the country keyboard code page.



Windows 1250
Latin 2, Central European

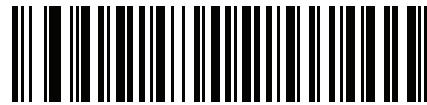

Windows 1251
Cyrillic, Slavic

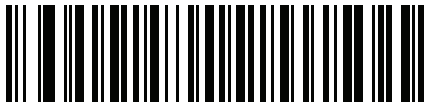

Windows 1252
Latin 1, Western European

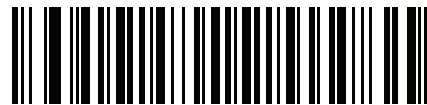

Windows 1253
Greek

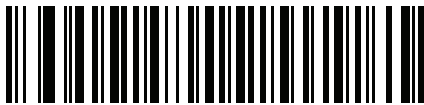

Windows 1254
Latin 5, Turkish

Country Code Page Barcodes (Continued)



Windows 1255
Hebrew

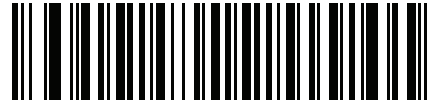

Windows 1256
Arabic

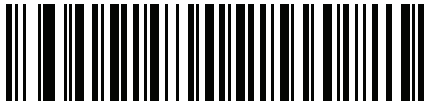

Windows 1257
Baltic

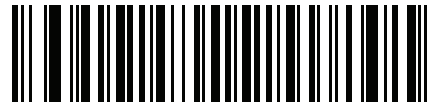

Windows 1258
Vietnamese



Windows 874
Thai

Country Code Page Barcodes (Continued)



Windows 20866
Cyrillic KOI8-R

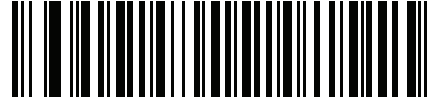

Windows 932
Japanese Shift-JIS

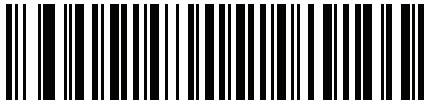

Windows 936
Simplified Chinese GBK

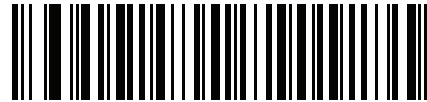

Windows 54936
Simplified Chinese GB18030

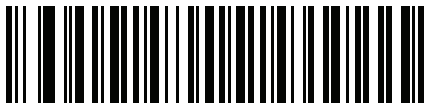

Windows 949
Korean Hangul

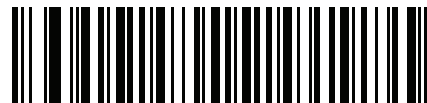

Windows 950
Traditional Chinese Big5

Country Code Page Barcodes (Continued)



MS-DOS 437
Latin US

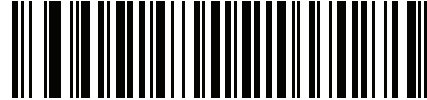

MS-DOS 737
Greek

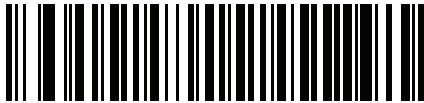

MS-DOS 775
Baltic

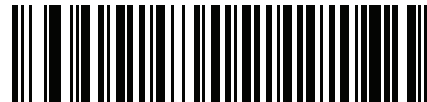

MS-DOS 850
Latin 1

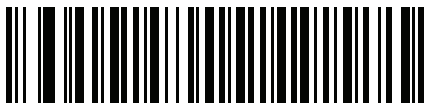

MS-DOS 852
Latin 2

Country Code Page Barcodes (Continued)



MS-DOS 855
Cyrillic

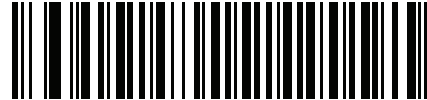

MS-DOS 857
Turkish

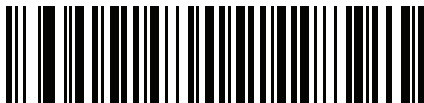

MS-DOS 860
Portuguese

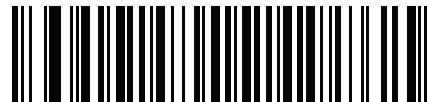

MS-DOS 861
Icelandic



MS-DOS 862
Hebrew

Country Code Page Barcodes (Continued)



MS-DOS 863
French Canada

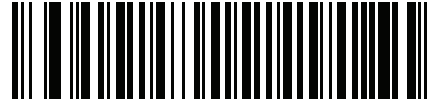

MS-DOS 865
Nordic

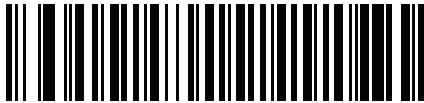

MS-DOS 866
Cyrillic

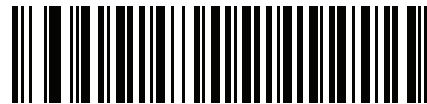

MS-DOS 869
Greek 2

Country Code Page Barcodes (Continued)



ISO 8859-1
Latin 1, Western European

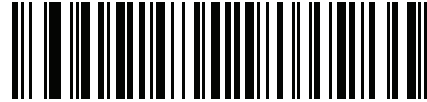

ISO 8859-2
Latin 2, Central European

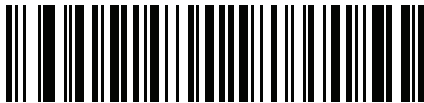

ISO 8859-3
Latin 3, South European

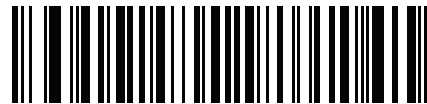

ISO 8859-4
Latin 4, North European

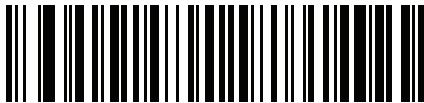

ISO 8859-5
Cyrillic

Country Code Page Barcodes (Continued)



ISO 8859-6
Arabic

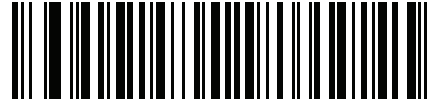

ISO 8859-7
Greek

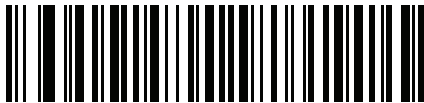

ISO 8859-8
Hebrew

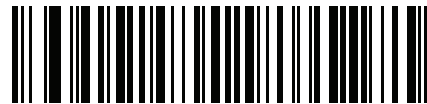

ISO 8859-9
Latin 5, Turkish



ISO 8859-10
Latin 6, Nordic

Country Code Page Barcodes (Continued)



ISO 8859-11
Thai



ISO 8859-13
Latin 7, Baltic



ISO 8859-14
Latin 8, Celtic

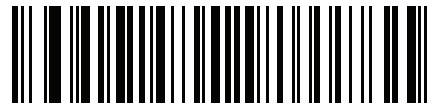

ISO 8859-15
Latin 9

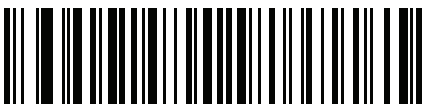

ISO 8859-16
Latin 10, South-Eastern European

Country Code Page Barcodes (Continued)



UTF-8

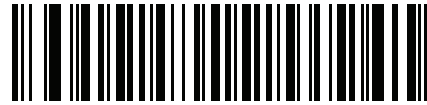

UTF-16LE
UTF-16 Little Endian

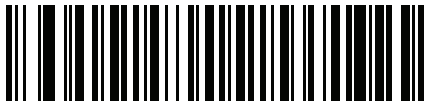

UTF-16BE
UTF-16 Big Endian

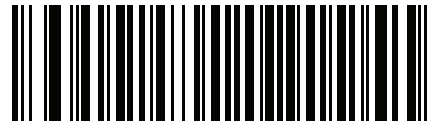

Mac CP10000
Roman

CKJ Decode Control

Introduction

This appendix describes control parameters for CJK (Chinese, Japanese, Korean) barcode decode through USB HID Keyboard Emulation mode.



NOTE: Because ADF does not support CJK character processing, there is no format manipulation for CJK output.

CJK Control Parameters

Unicode Output Control

Parameter # 973

For a Unicode encoded CJK barcode, select one of the following options for unicode output:

- **Universal Output to Unicode and MBCS Application** - This default method applies to Unicode and MBCS expected applications, such as MS Word and Notepad on a Windows host.



NOTE: To support Unicode universal output, set up the registry table for the Windows host. See [Unicode/CJK Decode Setup with Windows Host on page 427](#).

- **Output to Unicode Application Only** - This method applies only to Unicode expected applications, such as MS Word and WordPad, but not Notepad.



* Universal Output
(0)

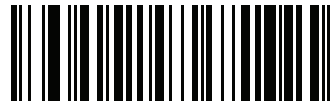

Unicode Application Only
(1)

CJK Output Method to Windows Host

Parameter # 972

For a national standard encoded CJK barcode, select one of the following options for CJK output to a Windows host:

- **Universal CJK Output** - This is the default universal CJK output method for US English IME or Chinese/Japanese/Korean ASCII IME on a Windows host. This method converts CJK characters to Unicode and emulates the characters when transmitting to the host. Use the [Unicode Output Control](#) parameter to control Unicode output.



NOTE: To support universal CJK output, set up the registry table for the Windows host. See [Unicode/CJK Decode Setup with Windows Host on page 427](#).

- **Other options for CJK output** - With the following methods, the scanner sends the CJK character hexadecimal internal code (Nei Ma) value to host, or converts the CJK character to Unicode and sends the hexadecimal Unicode value to host. When using these methods, the Windows host must select the corresponding IME to accept the CJK character. See [Unicode/CJK Decode Setup with Windows Host on page 427](#).
 - **Japanese Unicode Output**
 - **Simplified Chinese GBK Code Output**
 - **Simplified Chinese Unicode Output**
 - **Korean Unicode Code Output**
 - **Traditional Chinese Big5 Code Output** (Windows XP)
 - **Traditional Chinese Big5 Code Output** (Windows 7)
 - **Traditional Chinese Unicode Code Output** (Windows XP)
 - **Traditional Chinese Unicode Code Output** (Windows 7)



NOTE: The Unicode emulate output method depends on the host system (Windows XP or Windows 7).



* Universal CJK Output
(0)



Japanese Unicode Output
(34)

(for Japanese Unicode Output, select Simplified Chinese Unicode IME on the Windows host)

CJK Output Method to Windows Host (continued)



Chinese (Simplified) GBK Output
(1)



Chinese (Simplified) Unicode Output
(2)

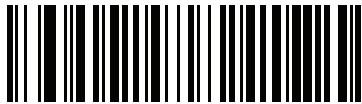

Korean Unicode Output
(50)

(for Korean Unicode Output, select Simplified Chinese Unicode
IME on the Windows host)



Chinese (Traditional) Big5 Output (Windows XP)
(17)



Chinese (Traditional) Big5 Output (Windows 7)
(19)

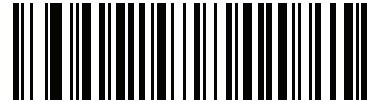

Chinese (Traditional) Unicode Output (Windows XP)
(18)



Chinese (Traditional) Unicode Output (Windows 7)
(20)

Non-CJK UTF Barcode Output

Parameter # 960

Some country keyboard type layouts contain characters that do not exist in the default code page (see [Country Keyboard Type Missing Characters on page 425](#)). Although the default code page can not encode these characters in a barcode, they can be encoded in the UTF-8 barcode. Scan this parameter barcode to output the Unicode values by emulation mode.



NOTE: Use this special country keyboard type to decode the non-CJK UTF-8 barcode. After decoding, re-configure the scanner to use the original country keyboard type.

Use US English IME on Windows. See [Unicode Output Control on page 421](#).

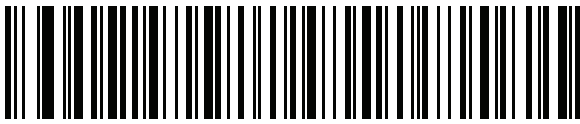

Non-CJK UTF-8 Emulation Output

Country Keyboard Type Missing Characters

Country keyboard type: **Tatar, Uzbek, Mongolian, Kyrgyz, Kazakh and Azeri**

Default code page: CP1251

Missing characters:

Table 25 Country keyboard type: Tatar, Uzbek, Mongolian, Kyrgyz, Kazakh and Azeri

ƒ	F
χ	Χ
κ	Κ
h	h
ϑ	Θ
ϑ	Θ
γ	Υ
Ғ	Ғ
Ж	Ж
?	
Ғ	Ғ
Ү	Ү
К	К
ч	Ч
к	К

Country keyboard type: **Romanian (Standard)**

Default code page: CP1250

Missing characters:

Table 26 Country Keyboard Type: Romanian (Standard)

ș	Ș
ț	Ț

Country keyboard type: **Portuguese-Brazilian (ABNT), Portuguese-Brazilian (ABNT2)**

Default code page: CP1252

Missing character: **Ꞥ**

Country keyboard type: **Azeri-Latin**

Default code page: CP1254

Missing characters: ə, Ə

Unicode/CJK Decode Setup with Windows Host

This section describes how to set up CJK decode with a Windows host.

Setting Up the Windows Registry Table for Unicode Universal Output

To support the Unicode universal output method, set up the Windows host registry table as follows:

1. Select **Start > Run > regedt32** to start the registry editor.
2. Under **HKEY_Current_User\Control Panel\Input Method**, set **EnableHexNumpad** to **1** as follows:

```
[HKEY_CURRENT_USER\Control Panel\Input Method]
```

```
"EnableHexNumpad"="1"
```

If this key does not exist, add it as type **REG_SZ** (string value).

3. Reboot the computer to implement the registry change.

Adding CJK IME on Windows

To add the desired CJK input language:

1. Click **Start > Control Panel**.
2. If the Control Panel opens in category view, select **Switch to Classic View** in the top left corner.
3. Select **Regional and Language Options**.
4. Click the **Language** tab.
5. Under **Supplemental Language Support**, select the **Install Files for East Asian Languages** check box if not already selected, and click **Apply**. This may require a Windows installation CD to install the required files. This step ensures that the East Asian Languages (CJK) are available.
6. Under **Text Services and Input Language**, click **Details**.
7. Under **Installed Services**, click **Add**.
8. In the **Add Input Language** dialog box, choose the CJK input language and keyboard layout or Input Method Editor (IME) to add.
9. Click **OK** twice. The language indicator appears in the system tray (at bottom right corner of the desktop by default). To switch between input languages (keyboard languages) select the language indicator in the system tray.
10. Select the language indicator in the system tray to select the desired country keyboard type.
11. Verify that the characters displayed on each country's keyboard appear.

Selecting the Simplified Chinese Input Method on the Host

To select the Simplified Chinese input method:

- Select Unicode/GBK input on Windows XP: **Chinese (Simplified) - NeiMa**, then click the input bar to select **Unicode** or **GBK NeiMa** input.



Or



- Select Unicode/GBK input on Windows7: **Chinese (Simplified) - Microsoft Pinyin New Experience Input Style**, then select **Tool Menu > Secondary Inputs > Unicode Input** or **GB Code Input**.

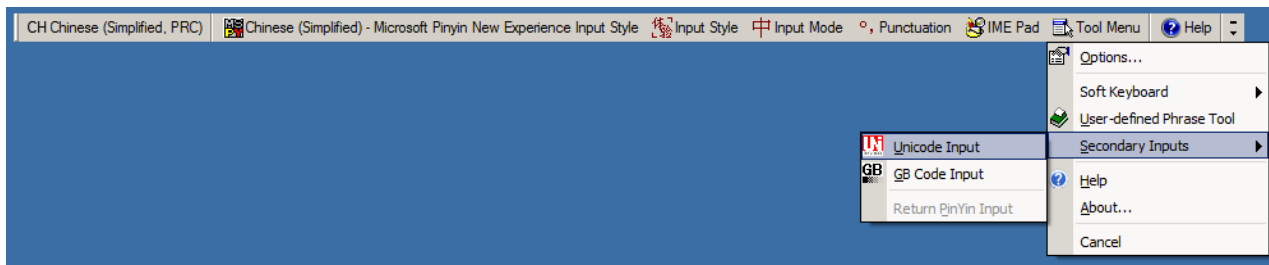

Selecting the Traditional Chinese Input Method on the Host

To select the Traditional Chinese input method:

- Select Unicode input on Windows XP: **Chinese (Traditional) - Unicode**

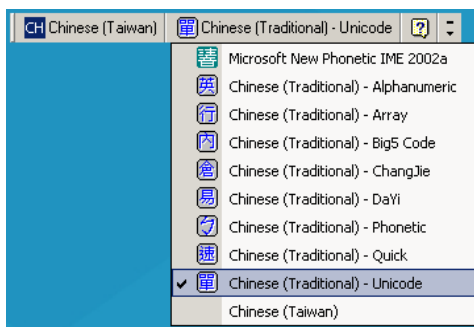

- Select Big5 input on Windows XP: **Chinese (Traditional) - Big5 Code**

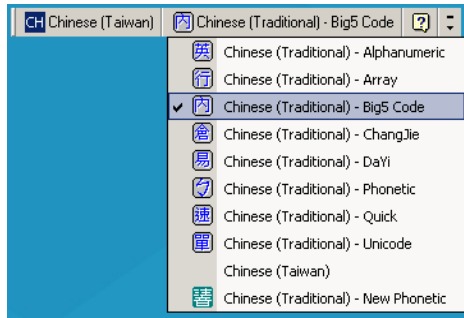

- Select Unicode/Big5 input on Windows 7: **Chinese (Traditional) - New Quick**. This option support both Unicode and Big5 input.



Programming Reference

Symbol Code Identifiers

Table 27 Symbol Code Characters

Code Character	Code Type
A	UPC-A, UPC-E, UPC-E1, EAN-8, EAN-13
B	Code 39, Code 32
C	Codabar
D	Code 128, ISBT 128, ISBT 128 Concatenated
E	Code 93
F	Interleaved 2 of 5
G	Discrete 2 of 5, or Discrete 2 of 5 IATA
H	Code 11
J	MSI
K	GS1-128
L	Bookland EAN
M	Trioptic Code 39
N	Coupon Code
R	GS1 DataBar Family
S	Matrix 2 of 5
T	UCC Composite, TLC 39
U	Chinese 2 of 5
V	Korean 3 of 5
X	ISSN EAN, PDF417, Macro PDF417, Micro PDF417
z	Aztec, Aztec Rune
P00	Data Matrix
P01	QR Code, MicroQR
P02	Maxicode
P03	US Postnet

Table 27 Symbol Code Characters (Continued)

Code Character	Code Type
P04	US Planet
P05	Japan Postal
P06	UK Postal
P08	Netherlands KIX Code
P09	Australia Post
P0A	USPS 4CB/One Code/Intelligent Mail
P0B	UPU FICS Postal
P0C	Mailmark
P0D	Grid Matrix, Grid Matrix Inverse, Grid Matrix Mirror
P0G	GS1 DM
P0H	Han Xin
P0Q	GS1 QR
P0X	Signature Capture

AIM Code Identifiers

Each AIM Code Identifier contains the three-character string **jcm** where:

j=Flag Character (ASCII 93)

c=Code Character (see [Table 28](#))

m=Modifier Character (see [Table 29](#))

Table 28 Aim Code Characters

Code Character	Code Type
A	Code 39, Code 39 Full ASCII, Code 32
C	Code 128, ISBT 128, ISBT 128 Concatenated, GS1-128, Coupon (Code 128 portion)
d	Data Matrix
d2	GS1 Data Matrix
E	UPC/EAN, Coupon (UPC portion)
e	GS1 DataBar Family
F	Codabar
G	Code 93
H	Code 11
h	Han Xin
I	Interleaved 2 of 5
L	PDF417, Macro PDF417, Micro PDF417
L2	TLC 39
M	MSI
Q	QR Code, MicroQR

Table 28 Aim Code Characters (Continued)

Code Character	Code Type
Q3	GS1 QR
S	Discrete 2 of 5, IATA 2 of 5
U	Maxicode
z	Aztec, Aztec Rune
X	Bookland EAN, ISSN EAN, Trioptic Code 39, Chinese 2 of 5, Matrix 2 of 5, Korean 3 of 5, US Postnet, US Planet, UK Postal, Japan Postal, Australia Post, Netherlands KIX Code, USPS 4CB/One Code/ Intelligent Mail, UPU FICS Postal, Signature Capture
X0	Mailmark
]g	Grid Matrix, Grid Matrix Inverse, Grid Matrix Mirror

The modifier character is the sum of the applicable option values based on [Table 29](#).

Table 29 Modifier Characters

Code Type	Option Value	Option
Code 39	0	No check character or Full ASCII processing.
	1	Reader has checked one check character.
	3	Reader has checked and stripped check character.
	4	Reader has performed Full ASCII character conversion.
	5	Reader has performed Full ASCII character conversion and checked one check character.
	7	Reader has performed Full ASCII character conversion and checked and stripped check character.
	Example: A Full ASCII barcode with check character W, A+I+MI+DW , is transmitted as]A7AIMID where 7 = (3+4).	
Trioptic Code 39	0	No option specified at this time. Always transmit 0.
	Example: A Trioptic barcode 412356 is transmitted as]X0412356	
Code 128	0	Standard data packet, no Function code 1 in first symbol position.
	1	Function code 1 in first symbol character position.
	2	Function code 1 in second symbol character position.
	Example: A Code (EAN) 128 barcode with Function 1 character ^{FNC1} in the first position, AIMID is transmitted as]C1AIMID	
I 2 of 5	0	No check digit processing.
	1	Reader has validated check digit.
	3	Reader has validated and stripped check digit.
	Example: An I 2 of 5 barcode without check digit, 4123, is transmitted as]I04123	
Codabar	0	No check digit processing.
	1	Reader has checked check digit.
	3	Reader has stripped check digit before transmission.
	Example: A Codabar barcode without check digit, 4123, is transmitted as]F04123	

Table 29 Modifier Characters (Continued)

Code Type	Option Value	Option
Code 93	0	No options specified at this time. Always transmit 0.
	Example: A Code 93 barcode 012345678905 is transmitted as JG00 12345678905	
MSI	0	Check digits are sent.
	1	No check digit is sent.
	Example: An MSI barcode 4123, with a single check digit checked, is transmitted as JM1 4123	
D 2 of 5	0	No options specified at this time. Always transmit 0.
	Example: A D 2 of 5 barcode 4123, is transmitted as JS0 4123	
UPC/EAN	0	Standard data packet in full EAN format, i.e. 13 digits for UPC-A, UPC-E, and EAN-13 (not including supplemental data).
	1	Two digit supplemental data only.
	2	Five digit supplemental data only.
	3	Combined data packet comprising 13 digits from EAN-13, UPC-A or UPC-E symbol and 2 or 5 digits from supplemental symbol.
	4	EAN-8 data packet.
	Example: A UPC-A barcode 012345678905 is transmitted as JE00 12345678905	
Bookland EAN	0	No options specified at this time. Always transmit 0.
	Example: A Bookland EAN barcode 123456789X is transmitted as JX0 123456789X	
ISSN EAN	0	No options specified at this time. Always transmit 0.
	Example: An ISSN EAN barcode 123456789X is transmitted as JX0 123456789X	
Code 11	0	Single check digit
	1	Two check digits
	3	Check characters validated but not transmitted.
GS1 DataBar Family		No option specified at this time. Always transmit 0. GS1 DataBar Omnidirectional and GS1 DataBar Limited transmit with an Application Identifier "01". Note: In GS1-128 emulation mode, GS1 DataBar is transmitted using Code 128 rules (i.e., J C1).
	Example: A GS1 DataBar Omnidirectional barcode 0110012345678902 is transmitted as Je00 110012345678902.	

Table 29 Modifier Characters (Continued)

Code Type	Option Value	Option
EAN.UCC Composites (GS1 DataBar, GS1-128, 2D portion of UPC composite)		Native mode transmission. Note: UPC portion of composite is transmitted using UPC rules.
	0	Standard data packet.
	1	Data packet containing the data following an encoded symbol separator character.
	2	Data packet containing the data following an escape mechanism character. The data packet does not support the ECI protocol.
	3	Data packet containing the data following an escape mechanism character. The data packet supports the ECI protocol.
		GS1-128 emulation Note: UPC portion of composite is transmitted using UPC rules.
	1	Data packet is a GS1-128 symbol (i.e., data is preceded with JJC1).
PDF417, Micro PDF417	0	Reader set to conform to protocol defined in 1994 PDF417 symbology specifications. Note: When this option is transmitted, the receiver cannot reliably determine whether ECIs have been invoked or whether data byte 92 _{DEC} has been doubled in transmission.
	1	Reader set to follow the ECI protocol (Extended Channel Interpretation). All data characters 92 _{DEC} are doubled.
	2	Reader set for Basic Channel operation (no escape character transmission protocol). Data characters 92 _{DEC} are not doubled. Note: When decoders are set to this mode, unbuffered Macro symbols and symbols requiring the decoder to convey ECI escape sequences cannot be transmitted.
	3	The barcode contains a GS1-128 symbol, and the first codeword is 903-907, 912, 914, 915.
	4	The barcode contains a GS1-128 symbol, and the first codeword is in the range 908-909.
	5	The barcode contains a GS1-128 symbol, and the first codeword is in the range 910-911.
	Example: A PDF417 barcode ABCD, with no transmission protocol enabled, is transmitted as]L2ABCD.	
Data Matrix	0	ECC 000-140, not supported.
	1	ECC 200.
	2	ECC 200, FNC1 in first or fifth position.
	3	ECC 200, FNC1 in second or sixth position.
	4	ECC 200, ECI protocol implemented.
	5	ECC 200, FNC1 in first or fifth position, ECI protocol implemented.
	6	ECC 200, FNC1 in second or sixth position, ECI protocol implemented.
GS1 Data Matrix	2	ECC 200, FNC1 in first or fifth position.

Table 29 Modifier Characters (Continued)

Code Type	Option Value	Option
MaxiCode	0	Symbol in Mode 4 or 5.
	1	Symbol in Mode 2 or 3.
	2	Symbol in Mode 4 or 5, ECI protocol implemented.
	3	Symbol in Mode 2 or 3, ECI protocol implemented in secondary message.
QR Code	0	Model 1 symbol.
	1	Model 2 / MicroQR symbol, ECI protocol not implemented.
	2	Model 2 symbol, ECI protocol implemented.
	3	Model 2 symbol, ECI protocol not implemented, FNC1 implied in first position.
	4	Model 2 symbol, ECI protocol implemented, FNC1 implied in first position.
	5	Model 2 symbol, ECI protocol not implemented, FNC1 implied in second position.
	6	Model 2 symbol, ECI protocol implemented, FNC1 implied in second position.
GS1 QR	3	Model 2 symbol, ECI protocol not implemented, FNC1 implied in first position.
Aztec	0	Aztec symbol.
	C	Aztec Rune symbol.
Han Xin	0	Generic data, no special features are set. The transmitted data does not follow the AIM ECI protocol.
	1	ECI protocol enabled. There is at least one ECI mode encoded. Transmitted data must follow the AIM ECI protocol.
Grid Matrix, Grid Matrix Inverse, Grid Matrix Mirror	0	No options specified at this time. Always transmit 0.
Mailmark	0	No option specified at this time. Always transmit 0.

Sample Barcodes

UPC/EAN

UPC-A, 100%



UPC-A with 2-digit Add-on



UPC-A with 5-digit Add-on



UPC-E



UPC-E with 2-digit Add-on



UPC/EAN (continued)

UPC-E with 5-digit Add-on



EAN-8

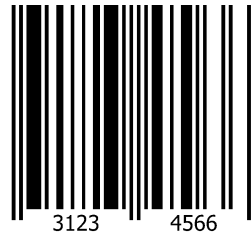

EAN-13, 100%



EAN-13 with 2-digit Add-on

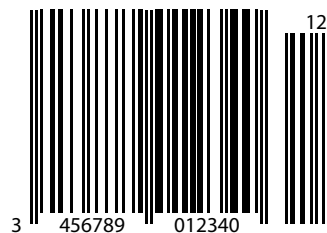

EAN-13 with 5-digit Add-on



Code 128



GS1-128



Code 39



Code 93

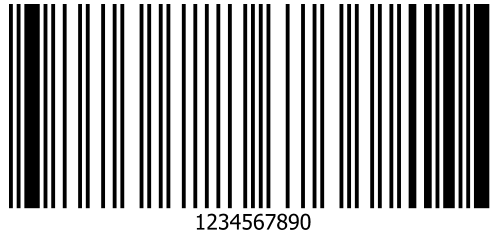

Code 11 with 2 Check Digits



Interleaved 2 of 5



MSI with 2 Check Digits



NOTE: MSI must be enabled to read the following barcode (see [MSI on page 297](#)).



Chinese 2 of 5



NOTE: Chinese 2 of 5 must be enabled to read the following barcode (see [MSI on page 297](#)).

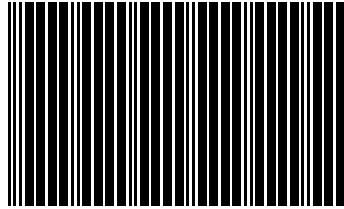

45454545454

Matrix 2 of 5



NOTE: Matrix 2 of 5 must be enabled to read the following barcode (see [Matrix 2 of 5 on page 302](#)).



223344

Korean 3 of 5



NOTE: Korean 3 of 5 must be enabled to read the following barcode (see [Korean 3 of 5 on page 441](#)).



1400230

GS1 DataBar

GS1 DataBar Omnidirectional (formerly GS1 DataBar-14)



7612341562341

GS1 DataBar Truncated

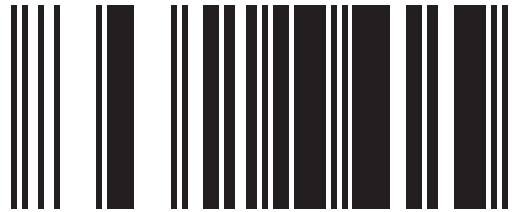

(01)0061414199996

GS1 DataBar Stacked



GS1 DataBar Stacked Omnidirectional



GS1 DataBar Limited



GS1 DataBar (continued)

GS1 DataBar Expanded



GS1 DataBar Expanded Stacked



2D Symbologies

PDF417

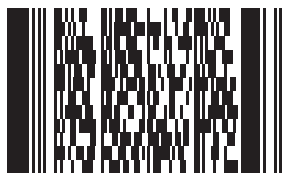

Data Matrix



2D Symbologies (continued)

GS1 Data Matrix



NOTE: GS1 Data Matrix must be enabled to read the following barcode (see [GS1 Data Matrix on page 446](#)).



Maxicode



NOTE: Maxicode must be enabled to read the following barcode (see [Maxicode on page 446](#)).

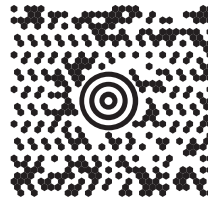

QR Code



2D Symbologies (continued)

GS1 QR



NOTE: GS1 QR must be enabled to read the following barcode (see [GS1 QR on page 447](#)).



MicroQR



Aztec

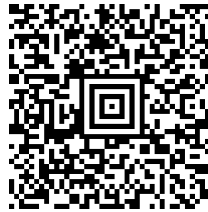

0123456789ABCDEFGHIJKLMNOPQRSTUVWXYZ0123456789ABCDEFGHIJKLMNOPQRSTUVWXYZ
01234567890123456789ABCDEFGHIJKLMNOPQRSTUVWXYZ0123456789ABCDEFGHIJKLMNOPQRSTUVWXYZ
STUVWXYZ0123456789

2D Symbologies (continued)

Grid Matrix



NOTE: Grid Matrix must be enabled to read the following barcode (see [Grid Matrix on page 448](#)).

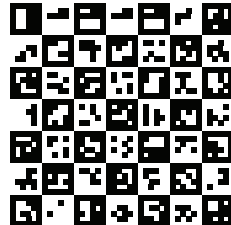

Han Xin



NOTE: Han Xin must be enabled to read the following barcode (see [Han Xin on page 448](#)).

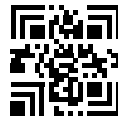

Postal Codes

US Postnet



NOTE: US Postnet must be enabled to read the following barcode (see [US Postnet on page 448](#)).



UK Postal



NOTE: UK Postal must be enabled to read the following barcode (see [UK Postal on page 448](#)).



Postal Codes (continued)

Japan Postal



NOTE: Japan Postal must be enabled to read the following barcode (see [Japan Postal on page 449](#)).



Australian Post



NOTE: Australia must be enabled to read the following barcode (see [Australian Post on page 449](#)).



OCR



NOTE: OCR must be enabled to read the following barcodes (see [OCR Programming Parameters on page 348](#)).

OCR-A

WFSGH67890

OCR-B

12345ABMKP

MICR E13B

⑆0 1 2 3 ⑆ 4 5 6 ⑆ 7 8 9 0 ⑆

US Currency

F 01840626 D

Numeric Barcodes

Cancel

To correct an error or change a selection, scan the barcode below.



Cancel

Numeric Barcodes

For parameters requiring specific numeric values, scan the appropriately numbered barcode(s).

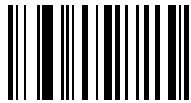

0



1



2

Numeric Barcodes



3



4



5



6

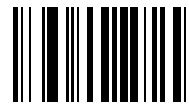

7



8

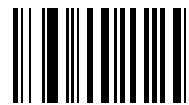

9

Alphanumeric Barcodes

Cancel

To correct an error or change a selection, scan the barcode below.



Cancel

Alphanumeric Barcodes



Space



#



\$

Alphanumeric Barcodes (continued)

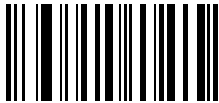

*

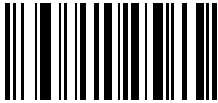

%

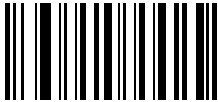

+



-



.



/

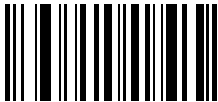

!

Alphanumeric Barcodes (continued)



“

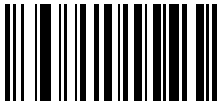

&

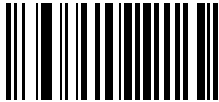

'

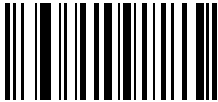

(



)

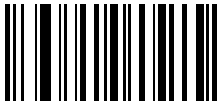

:

Alphanumeric Barcodes (continued)



;



<



=

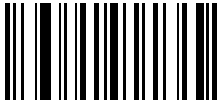

>



?

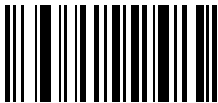

@

Alphanumeric Barcodes (continued)



[



\

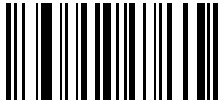

]

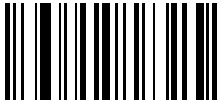

^



-

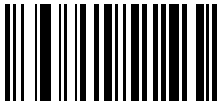

,

Alphanumeric Barcodes (continued)



NOTE: The barcodes that follow should not be confused with those on the numeric keypad.

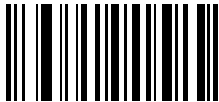

1

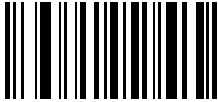

0



2



3



4

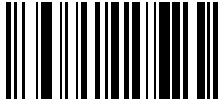

5

Alphanumeric Barcodes (continued)



6

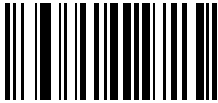

7



8

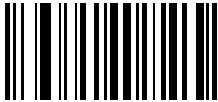

9



End of Message



Cancel

Alphanumeric Barcodes (continued)



A

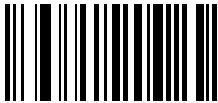

B

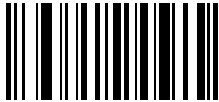

C

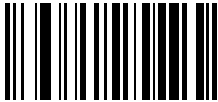

D



E



F

Alphanumeric Barcodes (continued)

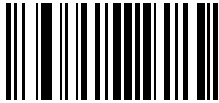

G

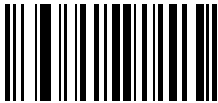

H



I



J



K



L

Alphanumeric Barcodes (continued)



M

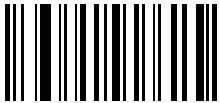

N

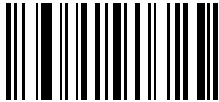

O



P



Q



R

Alphanumeric Barcodes (continued)



S



T

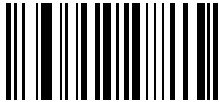

U



V

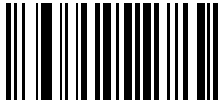

W



X

Alphanumeric Barcodes (continued)



Y

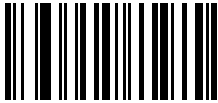

Z

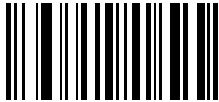

a

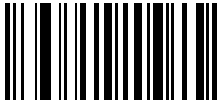

b



c

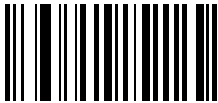

d

Alphanumeric Barcodes (continued)

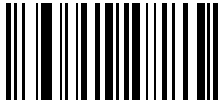

e

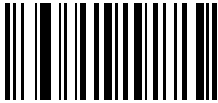

f



g

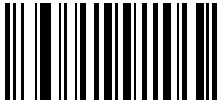

h



i



j

Alphanumeric Barcodes (continued)



k

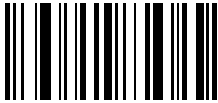

l

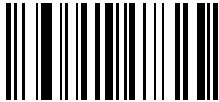

m

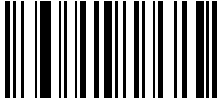

n



o



p

Alphanumeric Barcodes (continued)

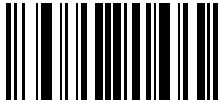

q

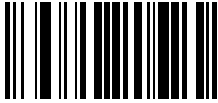

r

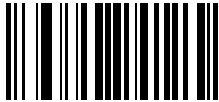

s

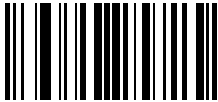

t

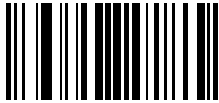

u

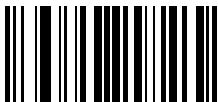

v

Alphanumeric Barcodes (continued)

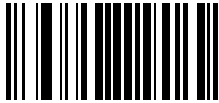

w

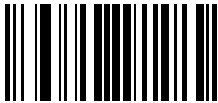

x

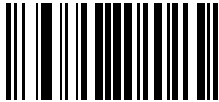

y



z

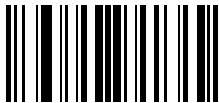

{

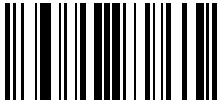

|

Alphanumeric Barcodes (continued)

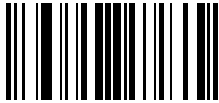

}

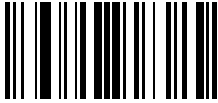

~

ASCII Character Sets

Table 30 ASCII Character Set

ASCII Value (Prefix/Suffix)	Full ASCII Code 39 Encode Char	Keystroke
1000	%U	CTRL 2
1001	\$A	CTRL A
1002	\$B	CTRL B
1003	\$C	CTRL C
1004	\$D	CTRL D
1005	\$E	CTRL E
1006	\$F	CTRL F
1007	\$G	CTRL G
1008	\$H	CTRL H/ BACKSPACE ¹
1009	\$I	CTRL I/ HORIZONTAL TAB ¹
1010	\$J	CTRL J
1011	\$K	CTRL K
1012	\$L	CTRL L
1013	\$M	CTRL M/ ENTER ¹
1014	\$N	CTRL N
1015	\$O	CTRL O
1016	\$P	CTRL P
1017	\$Q	CTRL Q
1018	\$R	CTRL R
1019	\$S	CTRL S
1020	\$T	CTRL T
1021	\$U	CTRL U
1022	\$V	CTRL V

The keystroke in bold transmits only if you enabled Function Key Mapping. Otherwise, the unbold keystroke transmits.

ASCII Character Sets

Table 30 ASCII Character Set (Continued)

ASCII Value (Prefix/Suffix)	Full ASCII Code 39 Encode Char	Keystroke
1023	\$W	CTRL W
1024	\$X	CTRL X
1025	\$Y	CTRL Y
1026	\$Z	CTRL Z
1027	%A	CTRL [
1028	%B	CTRL \
1029	%C	CTRL]
1030	%D	CTRL 6
1031	%E	CTRL -
1032	Space	Space
1033	/A	!
1034	/B	"
1035	/C	#
1036	/D	\$
1037	/E	%
1038	/F	&
1039	/G	'
1040	/H	(
1041	/I)
1042	/J	*
1043	/K	+
1044	/L	,
1045	-	-
1046	.	.
1047	/o	/
1048	0	0
1049	1	1
1050	2	2
1051	3	3
1052	4	4
1053	5	5
1054	6	6
1055	7	7
1056	8	8
1057	9	9

The keystroke in bold transmits only if you enabled Function Key Mapping. Otherwise, the unbold keystroke transmits.

ASCII Character Sets

Table 30 ASCII Character Set (Continued)

ASCII Value (Prefix/Suffix)	Full ASCII Code 39 Encode Char	Keystroke
1058	/Z	:
1059	%F	;
1060	%G	<
1061	%H	=
1062	%I	>
1063	%J	?
1064	%V	@
1065	A	A
1066	B	B
1067	C	C
1068	D	D
1069	E	E
1070	F	F
1071	G	G
1072	H	H
1073	I	I
1074	J	J
1075	K	K
1076	L	L
1077	M	M
1078	N	N
1079	O	O
1080	P	P
1081	Q	Q
1082	R	R
1083	S	S
1084	T	T
1085	U	U
1086	V	V
1087	W	W
1088	X	X
1089	Y	Y
1090	Z	Z
1091	%K	[
1092	%L	\

The keystroke in bold transmits only if you enabled Function Key Mapping. Otherwise, the unbold keystroke transmits.

Table 30 ASCII Character Set (Continued)

ASCII Value (Prefix/Suffix)	Full ASCII Code 39 Encode Char	Keystroke
1093	%M]
1094	%N	^
1095	%O	_
1096	%W	'
1097	+A	a
1098	+B	b
1099	+C	c
1100	+D	d
1101	+E	e
1102	+F	f
1103	+G	g
1104	+H	h
1105	+I	i
1106	+J	j
1107	+K	k
1108	+L	l
1109	+M	m
1110	+N	n
1111	+O	o
1112	+P	p
1113	+Q	q
1114	+R	r
1115	+S	s
1116	+T	t
1117	+U	u
1118	+V	v
1119	+W	w
1120	+X	x
1121	+Y	y
1122	+Z	z
1123	%P	{
1124	%Q	
1125	%R	}
1126	%S	~
1127		Undefined

The keystroke in bold transmits only if you enabled Function Key Mapping. Otherwise, the unbold keystroke transmits.

Table 31 ALT Key Character Set

ALT Keys	Keystroke
2064	ALT 2
2065	ALT A
2066	ALT B
2067	ALT C
2068	ALT D
2069	ALT E
2070	ALT F
2071	ALT G
2072	ALT H
2073	ALT I
2074	ALT J
2075	ALT K
2076	ALT L
2077	ALT M
2078	ALT N
2079	ALT O
2080	ALT P
2081	ALT Q
2082	ALT R
2083	ALT S
2084	ALT T
2085	ALT U
2086	ALT V
2087	ALT W
2088	ALT X
2089	ALT Y
2090	ALT Z

Table 32 GUI Key Character Set

GUI Key	Keystroke
3000	Right Control Key
3048	GUI 0
3049	GUI 1
3050	GUI 2

Note: GUI Shift Keys - The Apple [™] iMac keyboard has an apple key on either side of the space bar. Windows-based systems have a GUI key to the left of the left ALT key, and to the right of the right ALT key.

Table 32 GUI Key Character Set (Continued)

GUI Key	Keystroke
3051	GUI 3
3052	GUI 4
3053	GUI 5
3054	GUI 6
3055	GUI 7
3056	GUI 8
3057	GUI 9
3065	GUI A
3066	GUI B
3067	GUI C
3068	GUI D
3069	GUI E
3070	GUI F
3071	GUI G
3072	GUI H
3073	GUI I
3074	GUI J
3075	GUI K
3076	GUI L
3077	GUI M
3078	GUI N
3079	GUI O
3080	GUI P
3081	GUI Q
3082	GUI R
3083	GUI S
3084	GUI T
3085	GUI U
3086	GUI V
3087	GUI W
3088	GUI X
3089	GUI Y
3090	GUI Z

Note: GUI Shift Keys - The Apple™ iMac keyboard has an apple key on either side of the space bar. Windows-based systems have a GUI key to the left of the left ALT key, and to the right of the right ALT key.

Table 33 PF Key Character Set

PF Keys	Keystroke
4001	PF 1
4002	PF 2
4003	PF 3
4004	PF 4
4005	PF 5
4006	PF 6
4007	PF 7
4008	PF 8
4009	PF 9
4010	PF 10
4011	PF 11
4012	PF 12
4013	PF 13
4014	PF 14
4015	PF 15
4016	PF 16

Table 34 F key Character Set

F Keys	Keystroke
5001	F 1
5002	F 2
5003	F 3
5004	F 4
5005	F 5
5006	F 6
5007	F 7
5008	F 8
5009	F 9
5010	F 10
5011	F 11
5012	F 12
5013	F 13
5014	F 14
5015	F 15
5016	F 16
5017	F 17
5018	F 18
5019	F 19
5020	F 20
5021	F 21
5022	F 22
5023	F 23
5024	F 24

Table 35 Numeric Key Character Set

Numeric Keypad	Keystroke
6042	*
6043	+
6044	Undefined
6045	-
6046	.
6047	/
6048	0
6049	1
6050	2
6051	3
6052	4
6053	5
6054	6
6055	7
6056	8
6057	9
6058	Enter
6059	Num Lock

Table 36 Extended Key Character Set

Extended Keypad	Keystroke
7001	Break
7002	Delete
7003	Pg Up
7004	End
7005	Pg Dn
7006	Pause
7007	Scroll Lock
7008	Backspace
7009	Tab
7010	Print Screen
7011	Insert
7012	Home
7013	Enter
7014	Escape

Table 36 Extended Key Character Set (Continued)

Extended Keypad	Keystroke
7015	Up Arrow
7016	Dn Arrow
7017	Left Arrow
7018	Right Arrow

Communication Protocol Functionality

Functionality Supported via Communication (Cable) Interface

Table 37 lists supported scanner functionality by communication protocol.

Table 37 Communication Interface Functionality

Communication Interfaces	Functionality		
	Data Transmission	Remote Management	Image and Video Transmission
USB			
HID Keyboard Emulation	Supported	Not Available	Not Available
CDC COM Port Emulation	Supported	Not Available	Not Available
SSI over CDC COM Port Emulation	Supported	Supported	Supported
IBM Table-Top USB	Supported	Supported	Not Available
IBM Hand-Held USB	Supported	Supported	Not Available
USB OPOS Hand-Held	Supported	Supported	Not Available
Symbol Native API (SNAPI) without Imaging Interface	Supported	Supported	Not Available
Symbol Native API (SNAPI) with Imaging Interface	Supported	Supported	Supported

Functionality Supported via Radio Communication

Table 38 Communication Interface Functionality

Communication Interfaces	Scanner Functionality
Simple Serial Interface (SSI)	SSI BT Classic (Non-discoverable) SSI BT Classic (Discoverable) SSI BT Low Energy SSI BT with MFi (iOS Support)
HID (Keyboard Emulation)	HID BT Classic HID BT LE (Discoverable)
Serial Port Profile (SPP)	SPP BT Classic (Non-discoverable) SPP BT Classic (Discoverable)

Signature Capture Code

Introduction

CapCode, a signature capture code, is a special pattern that encloses a signature area on a document and allows a scanner to capture a signature.

There are several accepted patterns that allow automatic identification of different signatures on the same form. For example, on the federal tax return 1040 form there are three signature areas, one each for two joint filers, and one for a professional preparer. By using different patterns, a program can correctly identify all three, so they can be captured in any sequence and still be identified correctly.

Code Structure

Signature Capture Area

A CapCode is printed as two identical patterns on either side of a signature capture box, as shown in [Figure 27 on page 482](#). Each pattern extends the full height of the signature capture box.

The box is optional, so you can omit it, replace it with a single baseline, or print a baseline with an "X" on top of it towards the left, as is customarily done in the US to indicate a request for signature. However, if an "X" or other markings are added in the signature box area, these are captured with the signature.

Figure 27 CapCode



CapCode Pattern Structure

A CapCode pattern structure consists of a start pattern followed by a separator space, a signature capture box, a second separator space, and then a stop pattern. Assuming that X is the dimension of the thinnest element, the start and stop patterns each contains $9X$ total width in 4 bars and 3 spaces. A $7X$ quiet zone is required to the left and to the right of the CapCode pattern.

Figure 28 CapCode Structure

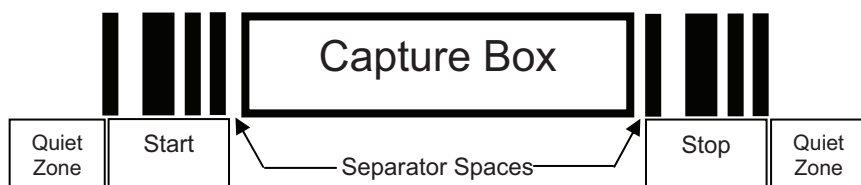

The separator spaces on either side of the signature capture box can be between $1X$ and $3X$ wide.

Start / Stop Patterns

Table 39 lists the accepted start / stop patterns. The bar and space widths are expressed as multiples of X . You must use the same pattern on either side of a signature capture box. The type value is reported with the captured signature to indicate the purpose of the signature captured.

Table 39 Start/Stop Pattern Definitions

Bar/Space Patterns							Type
B	S	B	S	B	S	B	
1	1	2	2	1	1	1	2
1	2	2	1	1	1	1	5
2	1	1	2	1	1	1	7
2	2	1	1	1	1	1	8
3	1	1	1	1	1	1	9

Table 40 lists selectable parameters used to generate the image of the captured signature.

Table 40 User Defined CapCode Parameters

Parameter	Defined
Width	Number of pixels
Height	Number of pixels
Format	JPEG, BMP, TIFF
JPEG quality	1 (most compression) to 100 (best quality)
Bits Per Pixel (not applicable to JPEG format)	1 (2 levels)
	4 (16 levels)
	8 (256 levels)

BMP format does not use compression, JPEG and TIFF formats do.

Dimensions

The size of the signature capture box is determined by the height and separation of the start and stop patterns. The line width of the signature capture box is insignificant.

The thinnest element width, referred to here as X, is nominally 10 mils (1 mil = 0.0254 mm). Select this as an exact multiple of the pixel pitch of the printer used. For example, when using a 203 DPI (dots-per-inch) printer and printing 2 dots per module, the resulting X dimension is 9.85 mils.

Data Format

The decoder output is formatted according to [Table 41](#). Zebra decoders allow different user options to output or inhibit barcode type. Selecting "Symbol ID" as the barcode type for output identifies the CapCode with letter "i".

Table 41 Data Format

File Format (1 byte)	Type (1 byte)	Image Size (4 bytes, BIG Endian)	Image Data
JPEG - 1 BMP - 3 TIFF - 4	See Table 39 on page 483 , last column		(Same bytes as in a data file)

Additional Capabilities

Regardless of how the signature is captured, the output signature image is de-skewed and right-side up.

A scanner that captures signatures automatically determines whether it is scanning a signature or a barcode. You can disable the signature capturing capability in a decoder.

Signature Boxes

Figure 29 illustrates the five acceptable signature boxes:

Figure 29 Acceptable Signature Boxes

Type 2:



Type 5:



Type 7:



Type 8:



Type 9:



Non-Parameter Attributes

Introduction

This appendix defines non-parameter attributes.

Attributes

Model Number

Attribute #533

Model number of the scanner. This electronic output matches the printout on the physical device label, for example **CS6080-SR0F007ZZWW**.

Type	S
Size (Bytes)	18
User Mode Access	R
Values	Variable

Serial Number

Attribute #534

Unique serial number assigned in the manufacturing facility. This electronic output matches the printout on the physical device label, for example **M1J26F45V**.

Type	S
Size (Bytes)	16
User Mode Access	R
Values	Variable

Date of Manufacture

Attribute #535

Date of device manufacture assigned in the manufacturing facility. This electronic output matches the printout on the physical device label, for example **30APR14** (which reads the 30th of April 2014).

Type	S
Size (Bytes)	7
User Mode Access	R
Values	Variable

Date of First Programming

Attribute #614

Date of first electronic programming represents the first time settings were electronically loaded to the scanner either by 123Scan or via SMS, for example **18MAY14** (which reads the 18th of May 2014).

Type	S
Size (Bytes)	7
User Mode Access	R
Values	Variable

Configuration Filename

Attribute #616

The name assigned to the configuration settings loaded electronically to the device either by 123Scan or via SMS.



NOTE: Scanning the Set Defaults barcode automatically changes the configuration filename to factory defaults.

To indicate the configuration settings loaded to the device were changed, the configuration filename changes to *Modified* upon scanning any parameter barcode.

Type	S
Size (Bytes)	17
User Mode Access	RW
Values	Variable

Beeper/LED**Attribute #6000**

Activates the beeper and/or LED.

Type	X
Size (Bytes)	N/A
User Mode Access	W

Values:

Beep / LED Action	Value
1 high short beep	0
2 high short beeps	1
3 high short beeps	2
4 high short beeps	3
5 high short beeps	4
1 low short beep	5
2 low short beeps	6
3 low short beeps	7
4 low short beeps	8
5 low short beeps	9
1 high long beep	10
2 high long beeps	11
3 high long beeps	12
4 high long beeps	13
5 high long beeps	14
1 low long beep	15
2 low long beeps	16
3 low long beeps	17
4 low long beeps	18
5 low long beeps	19
Fast warble beep	20
Slow warble beep	21
High-low beep	22
Low-high beep	23
High-low-high beep	24
Low-high-low beep	25
High-high-low-low beep	26
Green LED off	42

Green LED on	43
Red LED on	47
Red LED off	48

Parameter Defaults

Attribute #6001

This attribute restores all parameters to their factory defaults.

Type	X
Size (Bytes)	N/A
User Mode Access	W
Values	0 = Restore Defaults 1 = Restore Factory Defaults 2 = Write Custom Defaults

Beep on Next Bootup

Attribute #6003

This attribute configures (enables or disables) beep on next boot up of scanner.

Type	X
Size (Bytes)	N/A
User Mode Access	W
Values	0 = Disable beep on next bootup 1 = Enable beep on next bootup

Reboot

Attribute #6004

This attribute initiates a device reboot.

Type	X
Size (Bytes)	N/A
User Mode Access	W
Values	N/A

Host Trigger Session

Attribute #6005

This attribute triggers a decode session similar to manually depressing the scanner trigger button.

Type	X
Size (Bytes)	N/A

User Mode Access	W
Values	1 = Start Host Trigger Session 0 = Stop Host Trigger Session

Firmware Version

Attribute #20004

The scanner's operating system version. For example, **NBRFMAAC** or **PAAAABS00-007-R03D0**.

Type	S
Size (Bytes)	Variable
User Mode Access	R
Values	Variable

Scankit Version

Attribute #20008

Identifies the 1D decode algorithms resident on the device, for example **SKIT4.33T02**.

Type	S
Size (Bytes)	Variable
User Mode Access	R
Values	Variable

ScanSpeed Analytics

Identifies problematic barcodes to speed up scanning processes.

Zebra ScanSpeed Analytics software allows you to visually identify barcodes that slow down processing and impact efficiency. Over time, the software collects data that you can use to eliminate poor performing barcodes from inventory. For more information go to www.zebra.com/scanspeedanalytics.

ScanSpeed Analytics

Introduction

This appendix describes the Zebra ScanSpeed Analytics software that allows the identification of barcodes that slow down processes. Over time, the collected data can be used to eliminate poor performing barcodes from inventory. When scanners capture and read data faster, processes run faster.

For more information go to www.zebra.com/scanspeedanalytics.

Histogram Decode Information

Within the scanner, each barcode symbology has a series of RSM attributes ([Table 42 on page 492](#)) to access its statistic information: Decode Count; Minimum Decode Time; Slowest Decode Time; Average Decode Time; Slowest Decode Data; and, ScanSpeed Histogram.

ScanSpeed Histogram is an array of eight items of double WORD (4 bytes). Each bin holds the count of decoded barcodes per range of decode time. For example, the range of Bin1 decode times is from 0 ms to 75 ms. All the Bin time ranges are show below:

Bin1<=75ms

Bin2<=110ms

Bin3<=170ms

Bin4<=300ms

Bin5<=600ms

Bin6<=1000ms

Bin7<=1500ms

Bin8>1500ms

123Scan displays this histogram data in its Statistics tab shown in [Figure 30](#).

Figure 30 123Scan Statistics Tab - Histogram Data

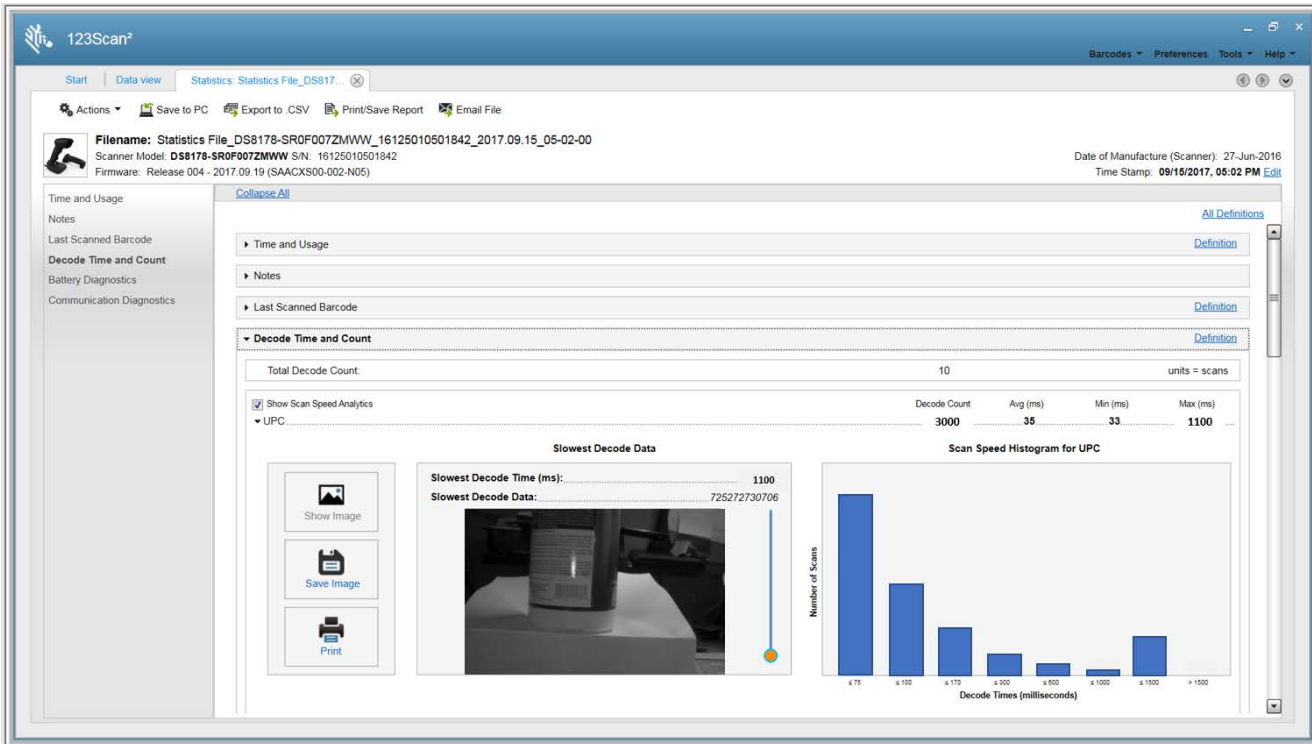

Table 42 Attributes Numbers of Barcode Symbology Statistic Information

Barcode Name	Decode Count		Minimum Decode Time	Slowest Decode Time (Max Decode Time)	Average Decode Time	Slowest Decode Data	ScanSpeed Histogram
	Decimal Value	Hex Value (Shown in Little Endian Format)					
UPC	15421	0x3D, 0x3C	15424	15425	15426	15707	15706
EAN/JAN	15428	0x44, 0x3C	15431	15432	15433	15709	15708
2 of 5	15449	0x59, 0x3C	15452	15453	15454	15715	15714
Codabar	15456	0x60, 0x3C	15459	15460	15461	15717	15716
Code 11	15477	0x75, 0x3C	15480	15481	15482	15723	15722
Code 128	15442	0x52, 0x3C	15445	15446	15447	15713	15712
Code 39	15435	0x4B, 0x3C	15438	15439	15440	15711	15710
Code 93	15463	0x67, 0x3C	15466	15467	15468	15719	15718

Table 42 Attributes Numbers of Barcode Symbology Statistic Information (Continued)

Barcode Name	Decode Count		Minimum Decode Time	Slowest Decode Time (Max Decode Time)	Average Decode Time	Slowest Decode Data	ScanSpeed Histogram
	Decimal Value	Hex Value (Shown in Little Endian Format)					
Composite	15519	0x9F, 0x3C	15522	15523	15524	15735	15734
GS1 DataBar	15512	0x98, 0x3C	15515	15516	15517	15733	15732
MSI	15470	0x6E, 0x3C	15473	15474	15475	15721	15720
Datamatrix	15491	0x83, 0x3C	15494	15495	15496	15727	15726
PDF	15484	0x7C, 0x3C	15487	15488	15489	15725	15724
Postal Codes	15505	0x91, 0x3C	15508	15509	15510	15731	15730
QR	15498	0x8A, 0x3C	15501	15502	15503	15729	15728
Aztec	15533	0xAD, 0x3C	15536	15537	15538	15739	15738
OCR	15526	0xA6, 0x3C	15529	15530	15531	15737	15736
Maxicode	15659	0x2B, 0x3D	15662	15663	15664	15755	15754
GS1-Datamatrix	15673	0x39, 0x3D	15676	15677	15678	15747	15746
GS1-QR Code	15680	0x40, 0x3D	15683	15684	15685	15749	15748
Coupon	15666	0x32, 0x3D	15669	15670	15671	15757	15756
Other 1D	15540	0xB4, 0x3C	15543	15544	15545	15741	15740
Other 2D	15547	0xBB, 0x3C	15550	15551	15552	15743	15742
Other	15554	0xC2, 0x3C	15557	15558	15559	15745	15744
Unused Statistic ID	19999	0x1F, 0x4E	19999	19999	19999	19999	19999

Example

The UPC data below is taken from the first row of **Table 42** above.

UPC DECODE COUNT

Attribute #:15421

Type:DWORD (4 bytes)

Description:Returns the UPC barcode decode count, including all variants (UPC-A, UPC-E, UPC-E1, etc.).

UPC MINIMUM DECODE TIME

Attribute #:15424

Type:DWORD (4 bytes)

Description:Returns the Minimum Decode Time in milliseconds of all UPC barcode decodes.

UPC SLOWEST DECODE TIME

Attribute #:15425

Type:DWORD (4 bytes)

Description:Returns the Slowest Decode Time in milliseconds of all UPC barcode decodes.

UPC AVERAGE DECODE TIME

Attribute #:15426

Type:DWORD (4 bytes)

Description:Returns the Average Decode Time in milliseconds of all UPC barcode decodes.

UPC SLOWEST DECODE DATA

Attribute #:15707

Type:Array of BYTE (25 bytes)

Description:Returns the UPC barcode data with the Slowest Decode Time.

UPC SCAN SPEED HISTOGRAM

Attribute #:15706

Type:Array of DWORD (32 bytes)

Description:Returns the UPC barcode ScanSpeed Histogram.

Image of Slowest Decoded Barcode

The user can configure the scanner to store the image(s) of the slowest decoded barcode.

Table 43 RSM Attributes to Store/Retrieve Image of Slowest Decoded Barcode

Attribute #	Type	Property	Default Value	Description
1755	Array of WORD	RW	<p>Default format = {0x1F, 0x4E}</p> <p>0x1F, 0x4E No image retained Barcode name = Unused Statistic ID Decimal value = 19999 see last row in Table 42 on page 492)</p> <p>0x3D, 0x3C Image retained for UPC Decimal value = 15421</p> <p>Sample image retained for UPC only = {0x3D, 0x3C}</p>	<p>Attribute 1755 is named List of Stored Images.</p> <p>This attribute defines which image, by symbology, of the slowest decoded barcode will be stored in the scanner.</p> <p>One symbology image can be stored in the scanner.</p> <p>Note: {0x1F, 0x4E} = a 1 WORD value which is in little-endian format.</p>
1756	WORD	RW	0	<p>Attribute 1756 is named Threshold To Store Slowest Decode Barcode Image.</p> <p>This attribute defines the threshold above which the scanner stores the image of the slowest decoded barcode.</p> <p>Specify a Histogram Bin value (0, 1, 2, 3, 4, 5, 6 or 7).</p> <p>The purpose of setting up this threshold is to reduce the barcode image storage frequency.</p> <p>0 - No threshold check (default value) 1 - Specifies the decode time threshold as Histogram Bin 1 value of 75 ms</p> <p>Similarly, the other Histogram Bins specify the corresponding threshold time as follows:</p> <p>Bin 1 <= 75ms Bin 2 <= 110ms Bin 3 <= 170ms Bin 4 <= 300ms Bin 5 <= 600ms Bin 6 <= 1000ms Bin 7 <= 1500ms</p>

Table 43 RSM Attributes to Store/Retrieve Image of Slowest Decoded Barcode (Continued)

Attribute #	Type	Property	Default Value	Description
6036	WORD	WO	N/A	<p>Attribute 6036 is named Retrieve Slowest Decoded Barcode Image.</p> <p>The image must be retrieved using the SNAPi communication protocol.</p> <p>This attribute allows you to retrieve from the scanner a single image, by symbology, of the slowest decoded data.</p> <p>For example, to retrieve the slowest decoded barcode image for a UPC symbology, enter its hex value, 0x3D, 0x3C (decimal value 15421), using a SET command.</p> <p>See Table 42 on page 492 for symbology hex and decimal values.</p>

Upgrading Over Bluetooth Without A Cradle

Introduction

This appendix provides information about performing upgrades on the scanner without a cradle, using 123Scan.

Upgrading Without a Cradle



NOTE: To accomplish this your PC must support Bluetooth communication.

To upgrade a CS6080 scanner using 123Scan without a cradle:

1. From the 123Scan **Start** screen, select **Update Scanner Firmware**.
2. From the **No scanner was found!** dialog box, select **click here** to pair over Bluetooth.

Figure 31 Pair Over Bluetooth Dialog

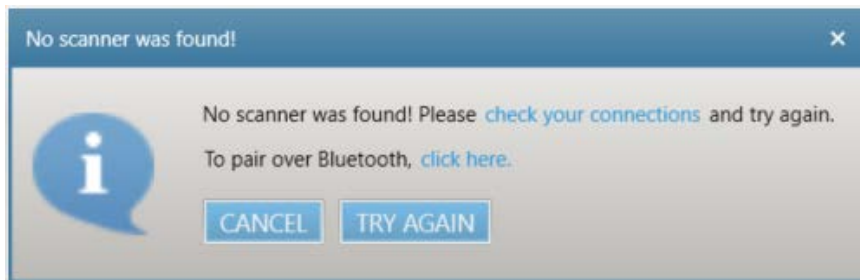

3. Scan the pairing barcode that displays to enable Bluetooth communication between the scanner and the host PC. Once paired (can take 15 seconds), 123Scan guides the user through the remaining steps.



NOTE: The pairing barcode in [Figure](#) is a sample and not for scanning. Scan the actual pairing barcode that displays in 123Scan.

Figure 32 Pairing Barcode



Troubleshooting

Table 44 Troubleshooting

Problem	Possible Causes	Possible Solutions
The Pair over Bluetooth dialog box Figure 31 on page 498 does not display.	Scanner and/or cradle with a USB cable is connected to the PC.	Remove the USB cable connected to the PC from the scanner and/or cradle. Re-select Update Scanner Firmware from the 123Scan Start screen.
Pairing barcode does not work correctly.	Scanner was already paired directly to the PC using the Windows pairing process.	Select the Bluetooth icon in the PC tray and remove the scanner from the Bluetooth connection.
Windows displays the Add a device pop up window (see Figure 33 on page 499).	N/A	This is a Windows display message that cannot be suppressed. Do not tap the Add a device window and continue to follow the 123Scan prompts to complete the process.

Figure 33 Add a device Window

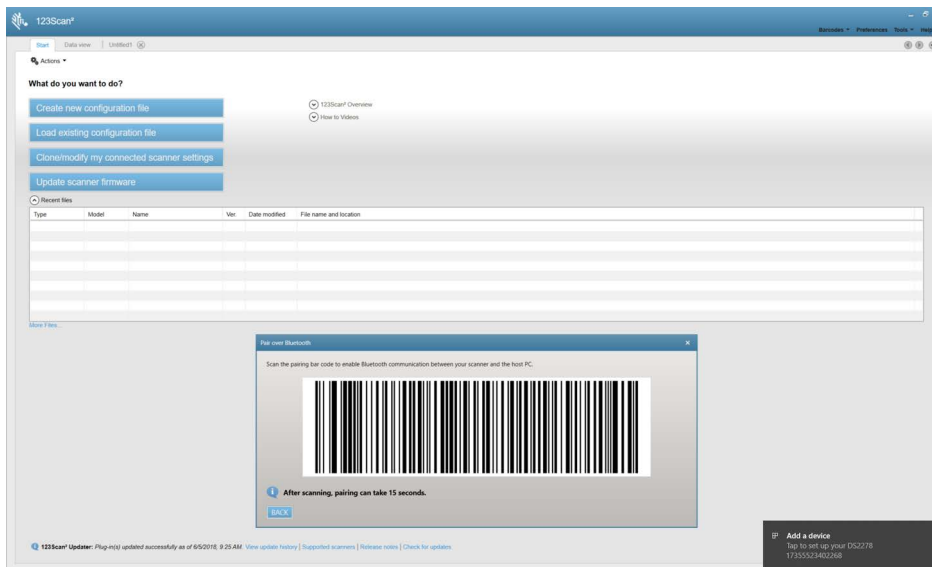

Index

Numerics

123Scan	36
requirements	37
2D bar codes	
aztec	321
aztec inverse	322
code 128 emulation	315
data matrix	316
data matrix inverse	317
grid matrix	324
grid matrix inverse	324
grid matrix mirror	325
han xin	323
han xin inverse	323
maxicode	319
microPDF417	314
microQR	321
PDF417	314
QR code	319, 320

A

ADF	341
invalid rule	55
programming indicators	40
transmit error	55
advanced data formatting	40, 55, 341
aiming options	
enabling	98
hand-held decode aiming pattern	98
orientation	48
snapshot aiming pattern	189
snapshot mode timeout	188
attributes, non-parameter	
beep on next bootup	489
configuration filename	487
date of first programming	487
date of manufacture	486
firmware version	490
host trigger session	489
model number	486

parameter defaults	489
reboot	489
scankit version	490
scanspeed analytics	490
serial number	486
autoexposure	185
auto-reconnect	164, 167
aztec bar codes	
sample	447

B

bar code defaults	
imaging preferences	182
radio communications	137
USB	206
user preferences	64
bar codes	
Australia post	331
Australia post format	332
autoexposure	185
aztec	321
aztec inverse	322
batch mode	170, 172
battery preservation mode	94
beep after good decode	68
beep on insertion	162
beeper duration	72
beeper tone	71
beeper volume	70
bits per pixel	196, 199
Bluetooth friendly name	143
Bluetooth technology support	150
bookland EAN	247
bookland ISBN	260
cancel	453
Chinese 2 of 5	301
codabar	292
codabar CLSI editing	294
codabar lengths	292
codabar NOTIS editing	294
codabar security level	295

Table of Contents

codabar start and stop characters	296	fixed gain	186
code 11	280	flush macro buffer/abort macro PDF entry	340
code 11 check digit verification	282	FN1 substitution values	127
code 11 lengths	280	gain and exposure priority for snapshot mode	187
code 128	263	grid matrix	324
code 128 emulation	315	grid matrix inverse	324
code 128 lengths	264	grid matrix mirror	325
code 128 reduced quiet zone	271	GS1 databar bar codes	306
code 128 security level	270	GS1 databar expanded	307
code 32 prefix	273	GS1 databar limited	306
code 39	272	GS1 databar limited margin check	308
code 39 check digit verification	275	GS1 databar security level	309
code 39 full ASCII	276	GS1 databar-14	306
code 39 lengths	274	GS1-128	266
code 39 reduced quiet zone	278	GS1-128 emulation mode	313
code 39 security level	277	han xin	323
code 39 transmit check digit	275	han xin inverse	323
code 93	278	hand-held decode aiming pattern	98
code 93 lengths	279	hands-free mode	97
composite beep mode	313	I 2 of 5 check digit verification	286
composite CC-A/B	310	I 2 of 5 convert to EAN-13	287
composite CC-C	310	I 2 of 5 reduced quiet zone	289
composite inverse	311	I 2 of 5 security level	288
composite TLC-39	311	I 2 of 5 transmit check digit	286
continuous bar code read	109	illumination	116
convert code 39 to code 32	273	illumination brightness	117, 118
convert GS1 databar to UPC/EAN	307	image brightness (target white)	192
convert UPC-E to UPC-A	259	image cropping	190
convert UPC-E1 to UPC-A	259	image enhancement	194
country code page defaults	406	image file format	195, 198
country code pages	410	image resolution	191
country codes	391	image rotation	196
crop to address	190	intercharacter gap size	339
data matrix	316	interleaved 2 of 5	284
data matrix inverse	317	convert to EAN-13	287, 288
decode mirror images	318	interleaved 2 of 5 lengths	284
decode pager motor	73	inverse 1D	305
decode pager motor duration	73	ISBT 128	266
decode session timeout	110, 111	ISBT concatenation	267, 268
disable all code types	244	ISBT concatenation redundancy	268
discrete 2 of 5	290	ISSN EAN	262
discrete 2 of 5 lengths	290	Japan postal	330
dump scanner parameters	56	JPEG image options	193
EAN zero extend	260	JPEG quality and size	194
EAN-13/JAN-13	246	JPEG target file size	193
EAN-8/JAN-8	246	Korean 3 of 5	304
eclevel	123	lamp mode	
enable all code types	244	lamp mode control	89
enter	123	lamp mode timeout	90
event reporting		lock override	165
boot up event	237	low light scene detection	119
decode event	236	low power mode	90
parameter event	237	manufacturing information	57
febraban	287	matrix 2 of 5	302
fixed exposure	186	matrix 2 of 5 check digit	303

Table of Contents

matrix 2 of 5 lengths	302	classic bluetooth and low energy	176
maxicode	319	connection maintenance interval	167
microPDF417	314	convert case	155
microQR	321	cradle bluetooth	139
mobile phone/display mode	114	discoverable mode	144
motion tolerance	121	emulate keypad	152
MSI	297	fast HID keyboard	153
MSI check digit algorithm	300	HID bluetooth	140
MSI lengths	298	HID caps lock override	151
MSI reduced quiet zone	301	HID function key mapping	154
MSI transmit check digit	300	HID ignore unknown characters	152
Netherlands KIX code	333	HID keyboard FN1 sub	154
night mode trigger	75	HID keyboard keystroke delay	151
number of retry attempts	161	link supervision timeout	148
numeric bar codes	453	lock override	165
OCR		output power	147
check digit	369	page	174
check digit multiplier	370	page mode	175
check digit validation	372	page state timeout	175
default table	347	pairing methods	165
inverse OCR	377	persistent batch storage	173
lines	358	quick keypad emulation	153
maximum characters	359	SSI	141
MICR E13B	355	SSP	142
minimum character	358	toggle pairing	166
OCR-A	348	unpairing	166
OCR-A variant	349	wi-fi friendly channel exclusion	145
OCR-B	350	wi-fi friendly mode	144
OCR-B variant	351	reconnect attempt interval	158
orientation	356	redundancy level	335
parameters	348	report version	339
quiet zone	360	scan data options	125
redundancy	378	securePharm	130
subset	359	securePharm output formatting	131
template	360	security level	337
US currency serial number	356	send versions	56
pager motor	73	serial number	57
parameter scanning	68	set defaults	67
PDF prioritization	115	signature capture	197
PDF prioritization timeout	116	signature capture height	200
PDF417	314	signature capture JPEG quality	200
picklist mode	100	signature capture width	200
pid type	122	silence operational mode changes	189
pid value	122	sleep between reconnect attempts	160
postal	328	snapshot aiming pattern	189
prefix/suffix values	124	snapshot mode timeout	188
QR code	319, 320	software version	56
quiet zone level	338	SSI	
radio		baud rate	230
batch mode	170	data packet format	231
beep on	163	host character timeout	233
beep on insertion	162	host RTS line state	231
bluetooth friendly name	143	host serial response time-out	232
bluetooth radio state	149	interpacket delay	235
bluetooth security	177	multipacket option	234

Table of Contents

Chinese 2 of 5 bar codes	301	composite bar codes	
sample	441	beep mode	313
CJK	420	composite CC-A/B	310
cleaning the devices		composite CC-C	310
approved disinfectant cleaners for healthcare devices	51	composite inverse	311
.	51	composite TLC-39	311
approved for standard devices	51	GS1-128 emulation mode	313
how to	52	UPC composite mode	312
known harmful ingredients	50	country code page defaults	406
codabar bar codes	292	country code pages	410
CLSI editing	294	country codes	391
lengths	292	cradle indicators	41
NOTIS editing	294	cradle indicators (host controlled)	41
security level	295	cropping	190
start and stop characters	296		
code 11 bar codes	280	D	
check digit verification	282	data matrix bar codes	316
lengths	280	sample	446, 447, 448, 449, 450
sample	440	decode ranges	
transmit check digit	283	CS6080-hc	49
code 128 bar codes	263	CS6080-sr	49
GS1-128	266	default parameters	
ISBT 128	266	imaging preferences	182
ISBT concatenation	267, 268	OCR	347
ISBT concatenation redundancy	268	radio communications	137
lengths	264	restoring	67
reduced quiet zone	271	SSI	229
sample	439	symbolologies	239
security level	270	USB	206
code 128 barcodes		user preferences	64
fnc4	271	discrete 2 of 5 bar codes	290
code 128 emulation bar codes	315	lengths	290
code 39 bar codes	272		
check digit verification	275	E	
code 32 prefix	273	ecllevel	123
code 39	272	encryption	177
code 39 security Level	277	error indications	
convert code 39 to code 32	273	ADF	55
full ASCII	276	format	55
lengths	274	input	54
reduced quiet zone	278	miscellaneous scanner options	137
sample	439	unknown characters	210
transmit check digit	275	exposure options	
trioptic	272	autoexposure	185
code 93 bar codes	278	fixed exposure	186
lengths	279	fixed gain	186
sample	440	gain and exposure priority for snapshot mode	187
code ID character	123	illumination	116
code identifiers			
AIM code IDs	431	F	
modifier characters	432	firmware	
Symbol	430	flash update	122, 123
communication protocol			
cable interface	480		
radio	481		

Table of Contents

fixed exposure	186
fixed gain	186

G

gain and exposure priority for snapshot mode	187
grid matrix bar codes	
sample	448
gs1 data matrix bar codes	
sample	446
GS1 databar	306
GS1 databar bar codes	
convert GS1 databar to UPC/EAN	307
GS1 databar expanded	307
GS1 databar limited	306
GS1 databar limited margin check	308
GS1 databar security level	309
GS1 databar-14	306
sample	442
GS1 QR bar codes	
sample	447

H

han xin bar codes	
sample	448
HID Profile	143
host types	
USB	207

I

illumination	116
brightness	117, 118
low light scene detection	119
image brightness (target white)	192
image cropping	190
image enhancement	194
image options	
bits per pixel	196
cropping	190
file formats	195, 198
image brightness (target white)	192
image enhancement	194
image resolution	191
image rotation	196
JPEG image options	193
JPEG size/quality	194
JPEG target file size	193
image resolution	191
imaging preferences	
defaults	182
interleaved 2 of 5 bar codes	284
check digit verification	286
convert to EAN-13	287

febraban	287
lengths	284
reduced quiet zone	289
sample	440
security level	288
transmit check digit	286

J

JPEG image options	193
size/quality	194
JPEG target file size	193

K

keyboard types (country codes)	
Albanian	391
Arabic (101)	391
Arabic (102)	391
Arabic (102) Azerty	392
Azeri (Cyrillic)	392
Azeri (Latin)	392
Belarusian	392
Bosnian (Cyrillic)	392
Bosnian (Latin)	392
Bulgarian (Latin)	392
Bulgarian Cyrillic (Typewriter)	393
Canadian French (Legacy)	393
Canadian French Win7	393
Canadian Multilingual Standard	393
Chinese (ASCII)	393
Croatian	394
Czech	394
Czech (Programmer)	394
Czech (QWERTY)	394
Danish	394
Dutch (Netherlands)	394
Estonian	395
Faeroese	395
Finnish	395
French (Canada) 2000/XP	396
French (Canada) 95/98	395
French (France)	395
French International	395
Galician	396
German	396
Greek	396
Greek (220) Latin	396
Greek (319) Latin	396
Greek 220	397
Greek 319	397
Greek Latin	396
Greek Polytonic	397
Hebrew Israel	397
Hungarian	397

Table of Contents

Hungarian_101KEY	397		
Irish	398		
Islandic	397		
Italian	398		
Italian (142)	398		
Japanese (ASCII)	398		
Kazakh	398		
Korean (ASCII)	398, 399		
Kyrgyz	399		
Latin American	399		
Latvian	399		
Latvian (QWERTY)	399		
Lithuanian	399		
Lithuanian (IBM)	399		
Macedonian (FYROM)	400		
Maltese_47KEY	400		
Mongolian	400		
Norwegian	400		
Polish (214)	400		
Polish (Programmer)	400		
Portuguese (Brazil)	400		
Portuguese (Brazilian ABNT)	401		
Portuguese (Brazilian ABNT2)	401		
Portuguese (Portugal)	401		
Romanian	401		
Romanian (Legacy)	401		
Romanian (Programmer)	402		
Romanian (Standard)	401		
Russian	402		
Russian (Typewriter)	402		
Serbian (Cyrillic)	402		
Serbian (Latin)	402		
Slovak	402		
Slovak (QWERTY)	403		
Slovenian	403		
Spanish	403		
Spanish (Variation)	403		
Swedish	403		
Swiss French	403		
Swiss German	403		
Tatar	404		
Thai (Kedmanee)	404		
Turkish F	404		
Turkish Q	404		
UK English	404		
Ukrainian	404		
US Dvorak	404		
US Dvorak Left	405		
US Dvorak Right	405		
US English	391		
US International	405		
Uzbek	405		
Vietnamese	405		
Korean 3 of 5 bar codes	304		
sample	441		
		L	
		LED indicators	
		ADF programming	40
		cradle	41
		cradle, host controlled	41
		parameter programming	40
		radio	39
		scanning	39
		standard	39
		wireless	39
		lithium-ion battery	29
		lock override	165
		locked pairing mode	
		barcodes	
		radio pairing modes	164
		connection maintenance interval	167
		low power mode	156
		M	
		macro PDF	340
		flush buffer/abort PDF entry	340
		maintenance	
		approved cleaners for standard devices	51
		approved disinfectant cleaners for healthcare devices	51
		how to clean the devices	52
		known harmful ingredients	50
		matrix 2 of 5 bar codes	302
		check digit	303
		lengths	302
		sample	441
		transmit check digit	304
		maxicode bar codes	319
		sample	446
		MDF	341
		microPDF417 bar codes	314
		microQR code bar codes	
		sample	447
		MSI bar codes	297
		check digit algorithm	300
		lengths	298
		reduced quiet zone	301
		sample	440
		transmit check digit	300
		MSI barcodes	
		check digits	299
		multicode data formatting	341
		N	
		non-parameter attributes	486, 491
		beep on next bootup	489
		configuration filename	487

Table of Contents

supplemental redundancy	251
supplementals	247
UCC coupon extended code	261
UPC-A	244
UPC-A preamble	256
UPC-E	245
UPC-E preamble	257
UPC-E1	245
UPC-E1 preamble	258
UPC/EAN/JAN bar codes	
samples	436
USB connection	204
USB defaults	206
USB parameters	207
user preferences	
defaults	64
user preferences bar codes	
batch mode	170, 172
beep on insertion	162
night mode trigger	75
persistent batch storage	173
V	
version	
bar codes	56
video	
image size	202
subsampling	203
W	
wi-fi friendly mode	
channel exclusion	145
notes	144
wireless indicators	39

