

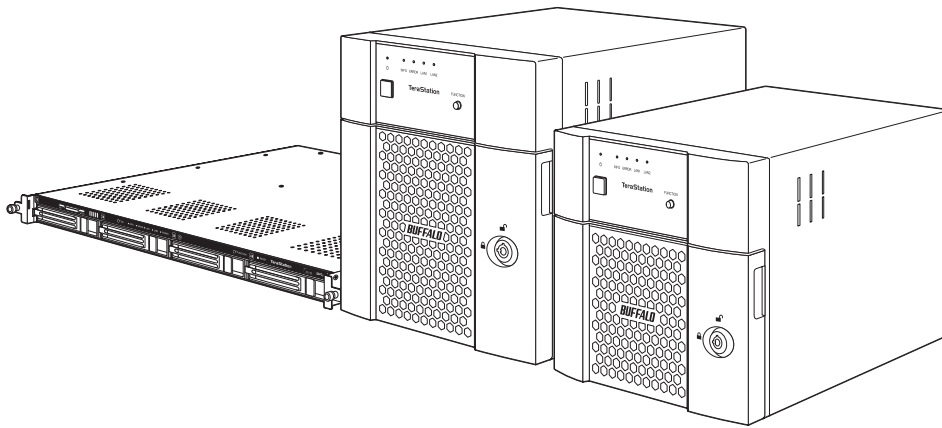

Network Attached Storage

TeraStation 3010, 3020

User Manual



Please make sure to read this manual before using and follow the procedures. If you have any inquiries about the product, contact the number on the warranty statement or the packing box. Do not discard the included documents, the warranty statement, or the packing box.

Americas: www.buffaloamericas.com

Europe: www.buffalo-technology.com

Asia Pacific: www.buffalo-asia.com

35021138-24

June 2020

Notice

Regulatory Compliance Information

For Customers in the United States

This device complies with Part 15 of the FCC Rules. Operation is subject to the following two conditions: (1) this device may not cause harmful interference, and (2) this device must accept any interference received, including interference that may cause undesired operation.

Note: This equipment has been tested and found to comply with the limits for a Class A digital device, pursuant to part 15 of the FCC Rules. These limits are designed to provide reasonable protection against harmful interference when the equipment is operated in a commercial environment. This equipment generates, uses, and can radiate radio frequency energy and, if not installed and used in accordance with the instruction manual, may cause harmful interference to radio communications. Operation of this equipment in a residential area is likely to cause harmful interference in which case the user will be required to correct the interference at his own expense.

For Customers in Europe

Warning: This is a class A product. In a domestic environment this product may be cause radio interference in which case the user may be required to take adequate measures.

This product may cause interference if used in residential areas. Such use must be avoided unless the user takes special measures to reduce electromagnetic emissions to prevent interference to the reception of radio and television broadcasts.

Environmental Information



- The equipment that you have purchased has required the extraction and use of natural resources for its production.
- The equipment may contain hazardous substances that could impact health and the environment.
- In order to prevent the dissemination of those substances into the environment, and to relieve pressure on natural resources, we encourage you to seek out an appropriate take-back program. Take-back programs will reuse or recycle materials of any end-of-life equipment in a responsible way.
- Products with the crossed-out wheeled-bin symbol above should not be recycled. Instead, seek out a take-back program as mentioned.
- If you need more information on the collection, reuse, and recycling of our end-of-life products, please contact your local or regional waste administration.

For Customers in Taiwan





BSMI

警告使用者：

此為甲類資訊技術設備，於居住環境中使用時，可能會造成射頻擾動，在此種情況下，使用者會被要求採取某些適當的對策。

Warning Symbols and Graphical Icons on the Product

Warning symbols are used on the product for safety operation and prevention of injury to you and damage to the unit. The following explains the meanings of symbols used on the product.

	This symbol indicates important warnings or cautions for operation and maintenance. Additional information will follow this symbol.
	This symbol indicates the presence of an alternating current.
	This symbol indicates that the rack-mounted equipment should not be used for a shelf or a work space.
	This symbol indicates danger of hazardous high voltage.

Safety Precautions

Before using your device, basic safety instructions should always be followed.

- (1) Read these instructions.
- (2) Keep these instructions.
- (3) Heed all warnings and follow all instructions.
- (4) The socket-outlet shall be installed near the equipment and shall be easily accessible.
- (5) Only use the cables and accessories that are included in the package. Don't use other accessories or cables unless specifically instructed to in the documentation. Also, do not use USB cables that are 3 meters or longer to connect USB devices.
- (6) The device can only be used in a fixed location, such as a telecommunication center or a dedicated computer room. When you install the device, ensure that the protective earthing connection of the socket-outlet is verified by a technician.

Translation to Norwegian:

Utstyr som er koplet til beskyttelsesjord via nettplugg og/eller via annet jordtilkoplede utstyr – og er tilkoplede et kabel-TV nett, kan forårsake brannfare. For å unngå dette skal det ved tilkopling av utstyret til kabel-TV nettet installeres en galvanisk isolator mellom utstyret og kabel-TV nettet.

Translation to Swedish:

Utrustning som är kopplad till skyddsjord via jordat vägguttag och/eller via annan utrustning och samtidigt är kopplad till kabel-TV nät kan i vissa fall medföra risk för brand. För att undvika detta skall vid anslutning av utrustningen till kabel-TV nät galvanisk isolator finnas mellan utrustningen och kabel-TV nätet.

Table Of Contents

Notice	1
Regulatory Compliance Information.....	1
Warning Symbols and Graphical Icons on the Product.....	2
Safety Precautions	2
Chapter 1 Getting Started	11
Diagrams.....	11
TS3010 Series TeraStations	11
TS3020 Series TeraStations	14
Turning the TeraStation On and Off.....	16
Re-Inserting Drives	19
Creating a USB Initialization Drive	19
Chapter 2 Configuration	20
Configuring Settings via Setup Wizard	20
Opening Setup Wizard	20
Opening Settings	21
Checking the Device Information from Dashboard	23
Chapter 3 File Sharing	24
Configuring Shared Folders	24
Adding a Shared Folder.....	24
Recycle Bin.....	26
Read-Only Shares.....	26

Hidden Shares	27
Configuring Users	27
Adding a User	27
Importing User Information.....	30
Adding a Group	30
Configuring Access Restrictions for Shared Folders	33
Local Users and Groups	33
Active Directory	35
Configuring Access Restrictions for Subfolders	38
Enabling Subfolders' Access Restrictions	38
Restoring Owner and Permission Settings	40
If a Shared Folder Cannot Be Accessed.....	42

Chapter 4 Storage Management **44**

RAID Modes	44
Working with RAID Arrays	45
Using JBOD	45
Changing RAID Mode	46
Shutting Down the TeraStation Automatically If an Error Occurs.....	47
Configuring Actions for If a Drive Used for the RAID Array Has Not Been Detected	49
Configuring a Hot Spare.....	52
Expanding RAID Capacity Without Deleting Data	53
RAID Scanning.....	57
Configuring Low Drive Space Alerts	58
Adding an External Drive	59
Connecting an External Drive	59
Compatibility	59

Dismounting Drives	60
Dismounting Using the Function Button	60
Dismounting from Settings	60
Checking Drives	61
S.M.A.R.T.	62
Displaying S.M.A.R.T. Information	63
Checking the Drive Condition.....	64
Formatting Drives	64
Encrypting Drives.....	65
Erasing Data on the TeraStation Completely	66
Quotas.....	67
Quotas for Users.....	67
Quotas for Groups	67
Size Limits.....	68
Using the TeraStation as an iSCSI Device	71
Introduction	71
Creating an iSCSI Volume	72
Connecting or Disconnecting Volumes.....	74
Using with Multiple Computers	75
Configuring Access Restrictions	75
Expanding Volume Sizes	78
Deleting Volumes.....	79
Advanced Settings.....	80

Chapter 5 Backup **82**

Backing Up Data on the TeraStation.....	82
Backup Modes.....	82
Preparing a Backup Destination.....	84

Configuring a Backup Job	86
If Backing Up from rsync-Compatible Devices to the TeraStation	89
Restoring Backup Data	90
Backup Logs for If Backup Fails	91
Replication.....	93
Preparing a Replication Destination	94
Configuring a Replication Job	96
Synchronizing Between Source and Destination TeraStations Periodically.....	98
Failover	99
Before Configuring Failover.....	100
Usage Restrictions	100
Configuring Failover	101
Switching to the Backup TeraStation Manually.....	103
Reconfiguring After Failover Occurs	104
Synchronizing Between Main and Backup TeraStations Periodically	105
Backing Up Your Mac with Time Machine	107

Chapter 6 Cloud Services and Remote Access..... 113

Synchronizing with Amazon S3	113
Preparing for Amazon S3	113
Uploading Files to Amazon S3.....	115
Synchronizing with Dropbox	119
Configuring a New Job	120
Changing Job Settings	122
Creating a Shared Link (Windows Only).....	126
Using Microsoft Azure for Data Preservation	126
Creating a New Backup Job.....	126
Creating a New Restore Job	131

Changing Job Settings	135
Synchronizing with Microsoft OneDrive	137
Configuring a New Job	137
Changing Job Settings	144
Corrective Actions for in Case of Error	148
WebAccess	149
FTP.....	152

Chapter 7 Advanced Features 154

Antivirus Software	154
Activating Virus Scanning	154
Configuring Security Settings	155
Licenses	157
Connecting Through a Proxy Server	158
Updating Antivirus Pattern Files	159
Configuring Folders as Virus Scanning Targets	160
Configuring Virus Scanning	161
Checking the Log	162
Opening the Online Help	163
Email Notification	163
Sleep Mode	165
Wake-on-LAN	167
UPS (Uninterruptible Power Supply)	168
Port Trunking.....	169
Offline Files for Windows.....	171
Accessing from an NFS Client.....	172
Encrypting Data Transmission	177

Encrypting Settings Data	177
Encrypting FTP Transfer Data	177
SSL Keys	177
SNMP	178
Saving and Applying Settings.....	179
Saving Settings	180
Applying Settings	181
Transferring Another TeraStation's Settings.....	182
Creating a Config File (.nas_config).....	182
Transferring Settings.....	182
Restoring Factory Defaults.....	183
Initializing from Settings	183
Initializing Using the USB Initialization Drive	184
Resetting the Administrator Password	185
Logs	185
Displaying TeraStation's Logs	185
Transferring Logs to the Syslog Server	186
Creating a Shortcut to the Logs in the Shared Folder.....	188
Changing Archive Rules for File Access Logs.....	189
Updating the Firmware.....	191
Updating Manually	191
Updating Automatically	192
Configuring Update Notification	193
Name, Date, Time, and Language	195
Beep Alerts	197
LEDs.....	198
Proxy Server	198

Jumbo Frames	199
Changing the IP Address	201
Mapping IP Address and Hostname	203
Boot Authentication	205
Notes Before Use.....	205
Important Notice	205
Setting Up the Authentication Server on a Windows PC	206
Configuring Boot Authentication on the TeraStation.....	206
If the TeraStation Cannot Be Accessed	208

Chapter 8 Drive Replacement..... 211

LEDs.....	211
Drive Replacement Procedure	212
Using a Redundant RAID Mode or JBOD and TeraStation Is On	212
Using a Redundant RAID Mode or JBOD and TeraStation Is Off	215
Using RAID 0	215
Using a Hot Spare.....	216
Replacing a Non-Malfunctioning Drive.....	216

Chapter 9 Utilities..... 218

NAS Navigator2.....	218
Windows	218
macOS.....	218
NovaBACKUP	218

Chapter 10 Appendix **219**

TeraStation Does Not Work Properly	219
---	------------

Power LED Keeps Blinking	219
Booting the TeraStation in Emergency Mode.....	220
Cleaning the Dustproof Filter	221
Info and Error LEDs	223
Errors.....	223
Status	224
Default Settings	226
Specifications	227

Chapter 1 Getting Started

Diagrams

Depending on the number or type of drives in the unit, the model name will be different. Check the sticker on the packing box for your unit's model name.

TS3010 Series TeraStations

TS3210DN

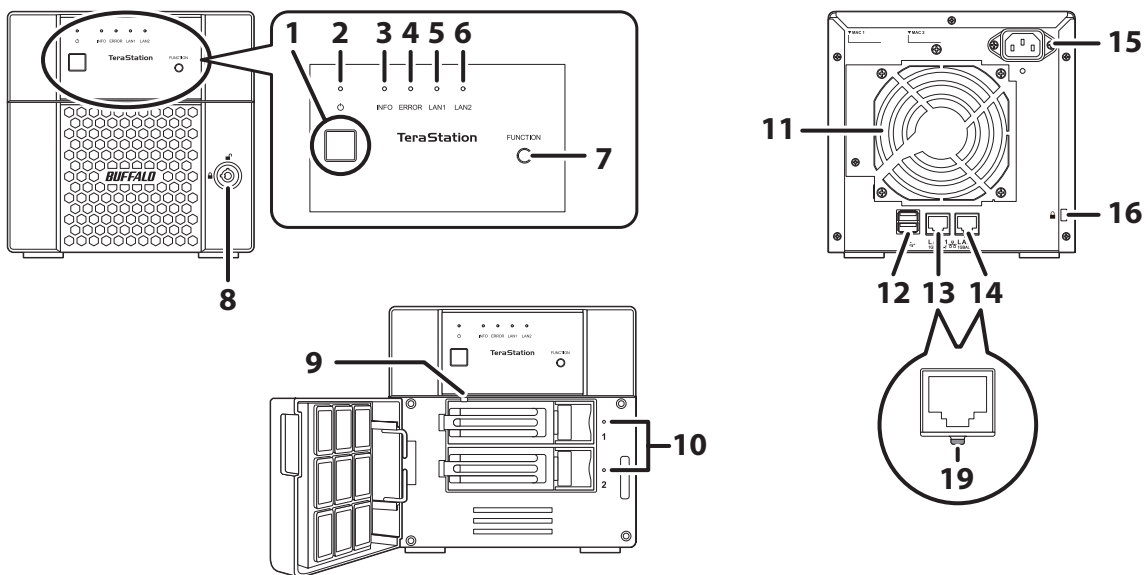

TS3410DN

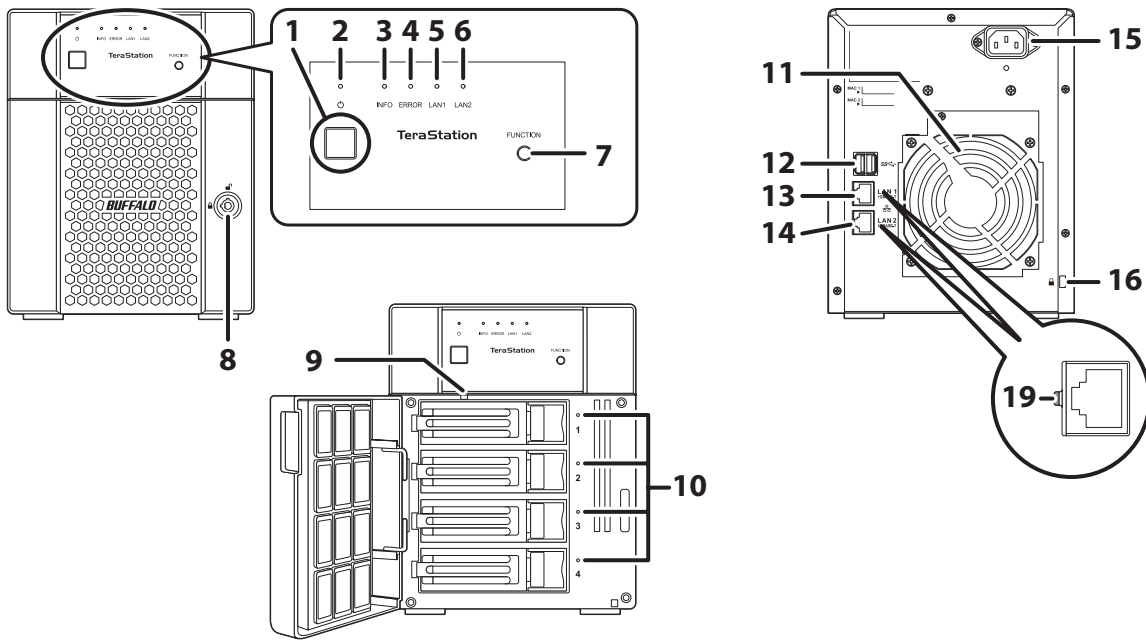

TS3410RN

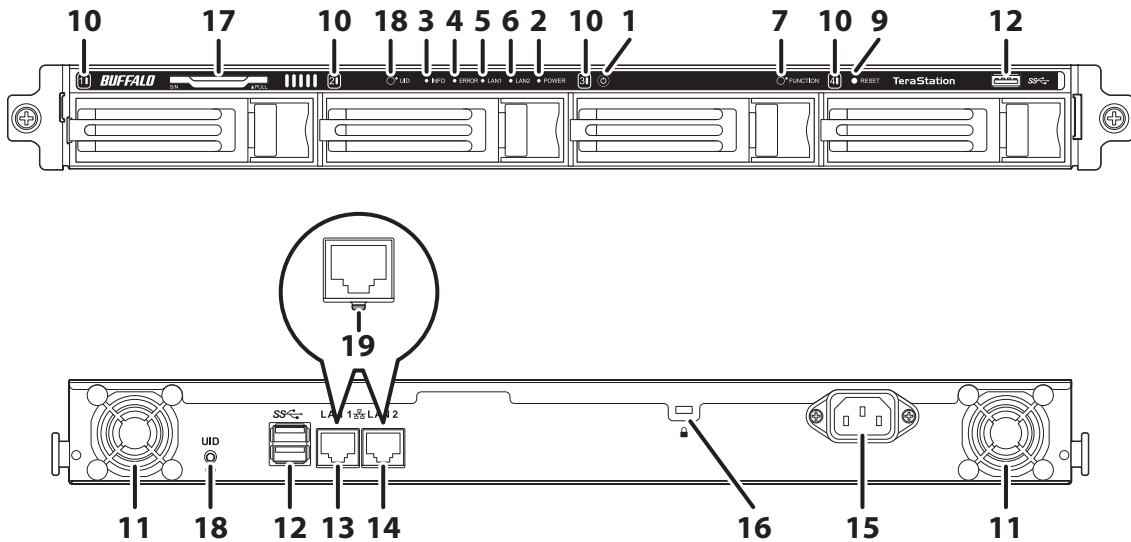

1 Power Button (⏻)

To power on the TeraStation, connect the power cable and wait for 10 seconds, then press the power button. To power off the TeraStation, press and hold down the power button for three seconds. If the TeraStation beeps, pressing and holding this button for a short period will stop the beeping.

2 Power LED

On the TS3210DN and TS3410DN TeraStation models, the LED glows green when the TeraStation is on. On the TS3410RN TeraStation model, the LED glows white when the TeraStation is on.

3 Info LED

If there is a status message, the info LED will light up amber. Check the Settings interface or NAS Navigator2 to see the status message.

4 Error LED

If there is an error, the error LED will light up red. Check the Settings interface or NAS Navigator2 to see the error message.

5 LAN1 LED

When LAN port 1 is connected, this LED glows green and blinks when the connection is experiencing activity.

6 LAN2 LED

When LAN port 2 is connected, this LED glows green and blinks when the connection is experiencing activity.

7 Function Button

Use this button for dismounting USB devices, rebuilding RAID arrays, configuring failover, stopping the TeraStation's beeping, and initializing settings using a USB drive.

8 Drive Lock ( )

Open the front panel with the key to replace drives or access the init button.

9 Init Button

Press and hold down this button to initialize the TeraStation's admin username and password, IP settings, SSL, and service port restriction settings to their factory default values. The effects of this button can be changed in Settings.

10 Status LEDs

Normally, these LEDs blink green when drives are accessed. If a drive fails, its LED will turn red.

11 Fan

Spins to prevent overheating inside. Do not block the fan.

12 USB Port ()

Compatible Buffalo USB drives, USB memory devices, and USB UPS device connections can be connected. USB hubs are not compatible.

13 LAN Port 1 (1GbE, )

Connect an Ethernet cable to use this port for your network. It is available for communicating at max. 1000 Mbps.

14 LAN Port 2 (1GbE, )

Connect an Ethernet cable to use this port for your network. It is available for communicating at max. 1000 Mbps.

15 Power Connector

Use the included power cable to connect to a UPS, surge protector, or outlet.

16 Anti-Theft Security Slot ()

Use this slot to secure your TeraStation with a cable lock (not included).

17 Serial Number

This sticker shows the TeraStation's serial number.

18 UID Button

Press this button to cycle the blue LED on and off.

19 Link LED

Glows green when the TeraStation is connected to a network.

TS3020 Series TeraStations

TS3220DN

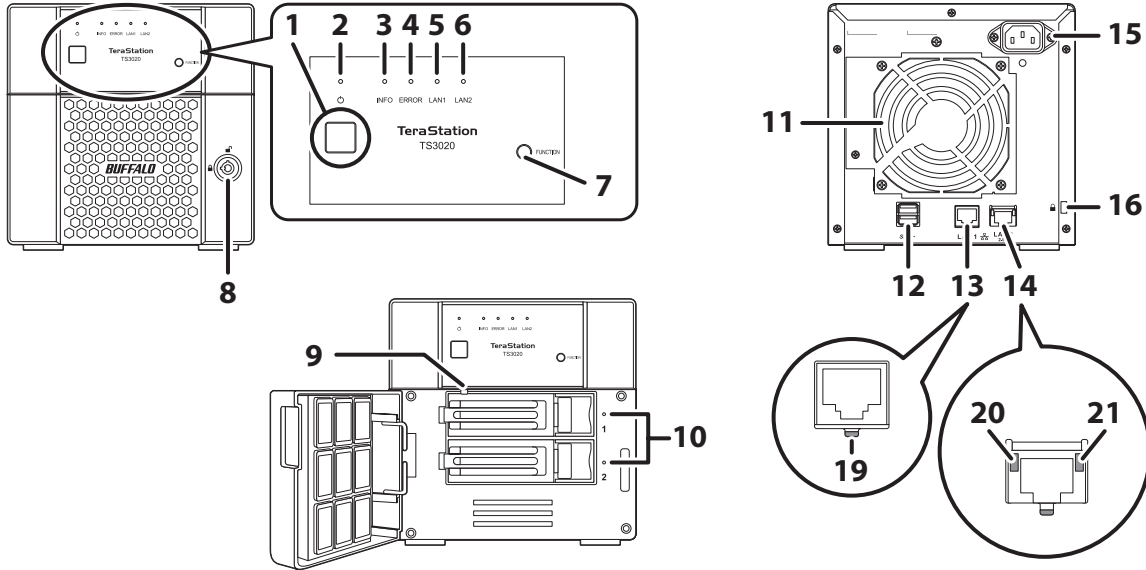

TS3420DN

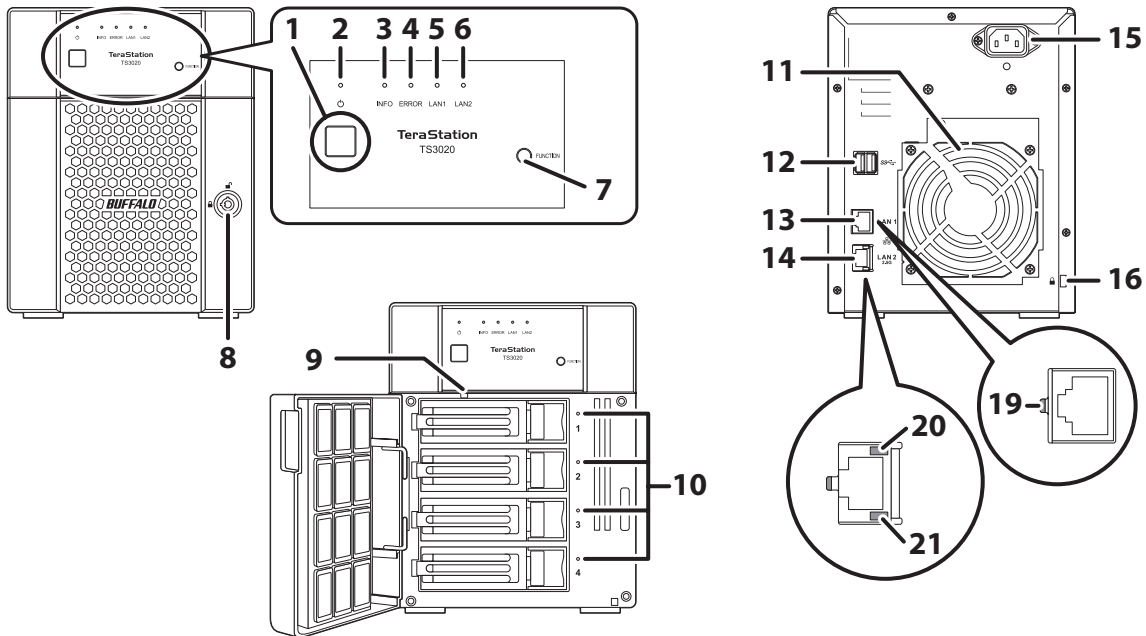

TS3420RN

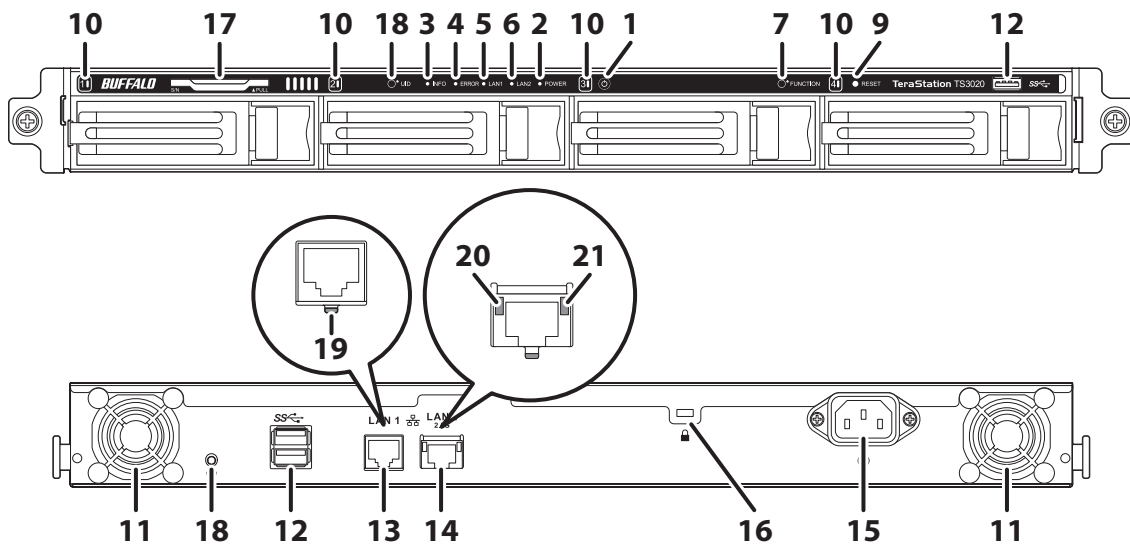

1 Power Button

To power on the TeraStation, connect the power cable and wait for 10 seconds, then press the power button. To power off the TeraStation, press and hold down the power button for three seconds. If the TeraStation beeps, pressing and holding this button for a short period will stop the beeping.

2 Power LED

On the TS3220DN and TS3420DN TeraStation models, the LED glows green when the TeraStation is on. On the TS3420RN TeraStation model, the LED glows white when the TeraStation is on.

3 Info LED

If there is a status message, the info LED will light up amber. Check the Settings interface or NAS Navigator2 to see the status message.

4 Error LED

If there is an error, the error LED will light up red. Check the Settings interface or NAS Navigator2 to see the error message.

5 LAN1 LED

When LAN port 1 is connected, this LED glows green and blinks when the connection is experiencing activity.

6 LAN2 LED

When LAN port 2 is connected, this LED glows green and blinks when the connection is experiencing activity.

7 Function Button

Use this button for dismounting USB devices, rebuilding RAID arrays, configuring failover, stopping the TeraStation's beeping, and initializing settings using a USB drive.

8 Drive Lock

Open the front panel with the key to replace drives or access the init button.

9 Init Button

Press and hold down this button with something pointed to initialize the TeraStation's admin username and password, IP settings, SSL, and service port restriction settings to their factory default values. The effects of this button can be changed in Settings.

10 Status LEDs

Normally, these LEDs blink green when drives are accessed. If a drive fails, its LED will turn red.

11 Fan

Spins to prevent overheating inside. Do not block the fan.

12 USB Port

Compatible Buffalo USB drives, USB memory devices, and USB UPS device connections can be connected. USB hubs are not compatible.

13 LAN Port 1 (1GbE)

Connect an Ethernet cable to use this port for your network. It is available for communicating at max. 1000 Mbps.

14 LAN Port 2 (2.5GbE)

Connect an Ethernet cable to use this port for your network. It is available for communicating at max. 2.5 Gbps if using the included Ethernet or category 6A cable.

Note: To communicate at up to 2.5 Gbps, all network devices must be compatible with 2.5GbE.

15 Power Connector

Use the included power cable to connect to a UPS, surge protector, or outlet.

16 Anti-Theft Security Slot

Use this slot to secure your TeraStation with a cable lock (not included).

17 Serial Number

This sticker shows the TeraStation's serial number.

18 UID Button

Press this button to cycle the blue LED on and off.

19 Link/Act LED

Glow green when the TeraStation is connected to a network and blinks when the connection is experiencing activity.

20 Link/Act LED

Glow amber when the TeraStation is connected to a network at 100 Mbps or 2.5 Gbps and blinks when the connection is experiencing activity.

21 Link/Act LED

Glow green when the TeraStation is connected to a network at 1000 Mbps and blinks when the connection is experiencing activity.

Turning the TeraStation On and Off

Note: Do not disconnect or reconnect the internal drives while turning on or off the TeraStation.

Press the power button on the TeraStation to turn it on.

To turn off the TeraStation, press and hold down the power button for three seconds. Don't unplug the power cable without powering the TeraStation off first.

You can also shut down or restart the TeraStation remotely from Settings using the procedure below.

- 1 Double-click the NAS Navigator2 icon () to start NAS Navigator2.

- 2 Right-click your TeraStation's icon and select *Open Settings*. For macOS, select the TeraStation's icon while holding down the control key, then select *Open Settings*.

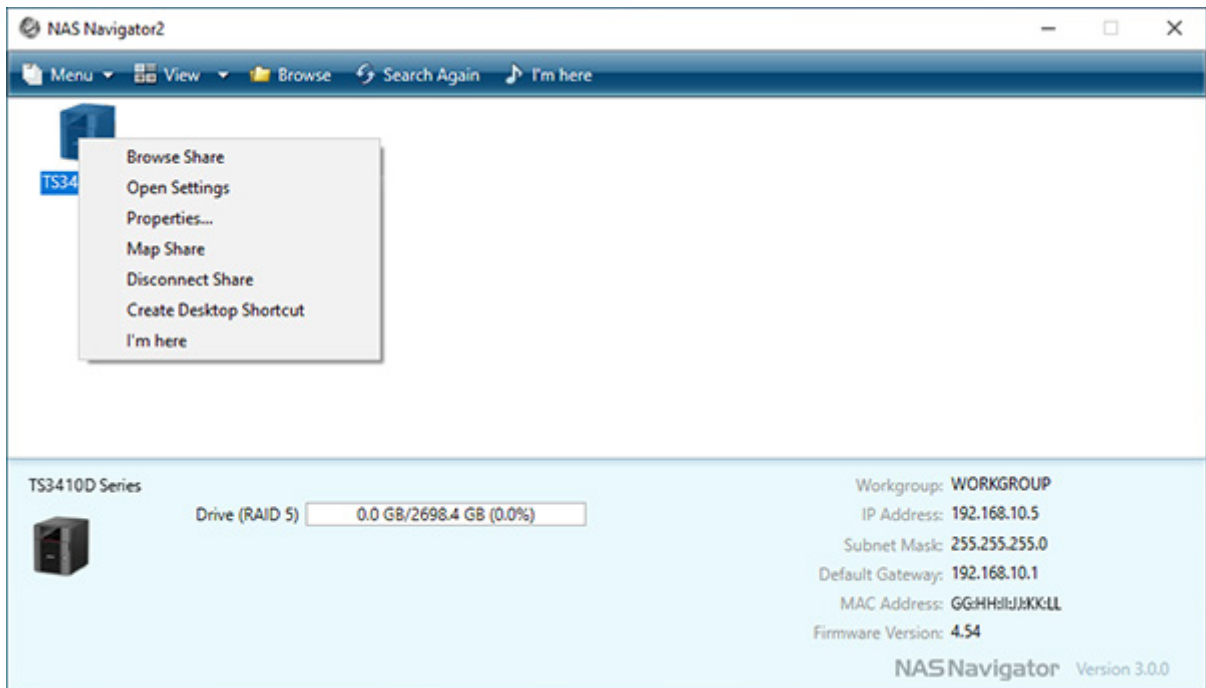

- 3 Enter the username and password, then click **OK**.

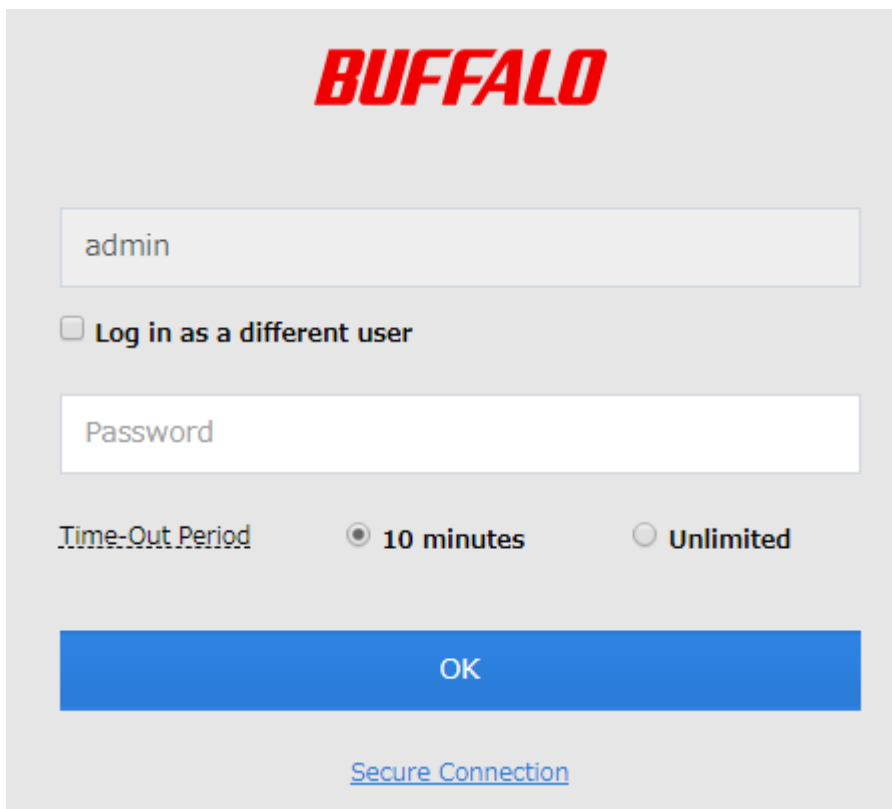

Note: The default username and password are "admin" and "password".

4 Settings will open.

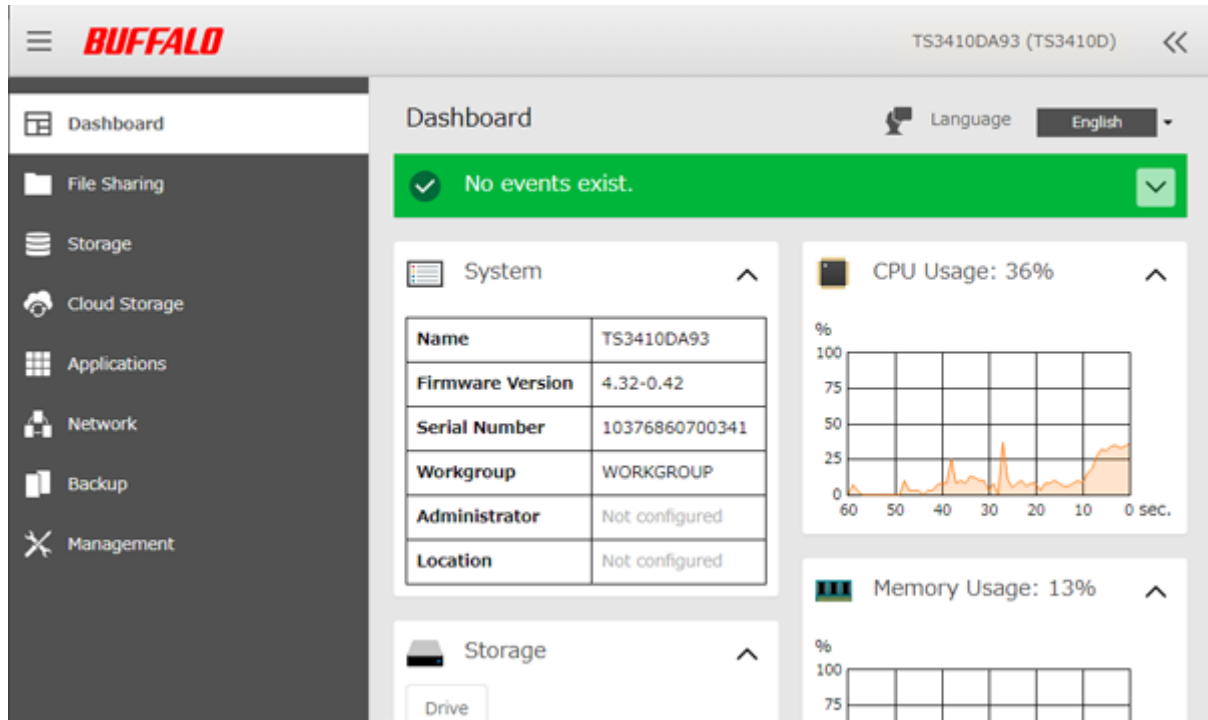

5 Click  at the top-right of Settings and choose *Shut Down*.

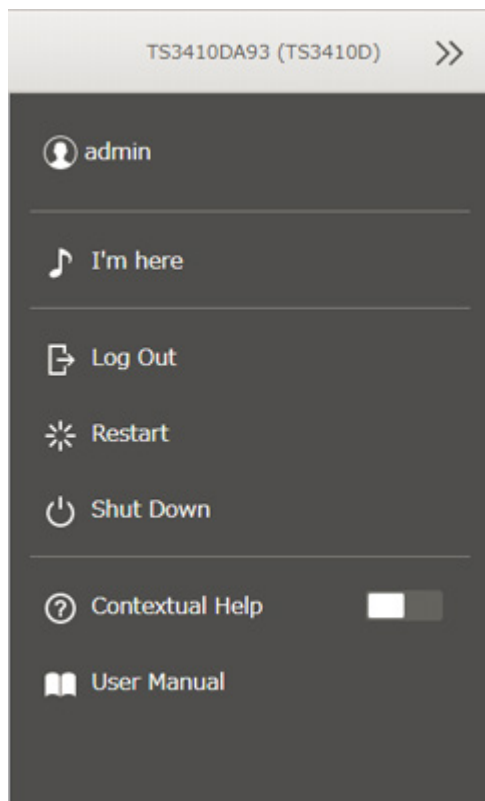

6 Click Yes.

7 The “Confirm Operation” screen will open. Enter the confirmation number, then click *OK*.

When the power LED turns off, the shutdown process is completed.

Re-Inserting Drives

If the E14 or E16 error appears on the Dashboard in Settings and NAS Navigator2 after initial bootup, follow the procedure below to re-insert the internal drives.

- 1** Turn off the TeraStation.
- 2** Open the front cover with the included key.
- 3** Push a drive's unlock button and swing the lock mechanism out.
- 4** Pull out the drive cartridge and remove it from the TeraStation.
- 5** Insert the drive back into the same slot with the lock mechanism remaining open.

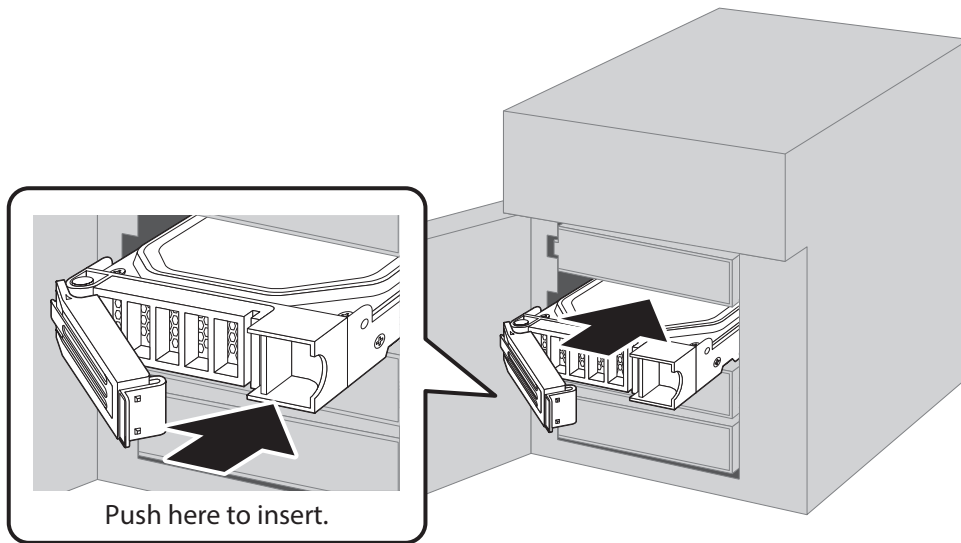

- 6** Swing the lock back down until it clicks into place.
- 7** Repeat steps 3–6 for all other installed drives.
- 8** Once every drive has been re-inserted, close the front cover.
- 9** Press the power button on the TeraStation.
- 10** Make sure any error messages have cleared from the LCD panel.

The drives are now inserted properly.

Creating a USB Initialization Drive

We recommend creating a USB initialization drive as soon as possible. This USB drive can be used to initialize the TeraStation's settings to its factory default values or recover the system if your TeraStation encounters an error that prevents the unit from booting. For the detailed procedure, refer to the ["Creating a USB Initialization Drive"](#) subsection in chapter 7.

Chapter 2 Configuration

Configure and manage your TeraStation using the Settings interface, accessible from a browser window. Open the interface using the appropriate procedure below or type the TeraStation's IP address into the URL field of your browser.

Note: Microsoft Edge, Firefox, Google Chrome, Internet Explorer 9 or later, and Safari 9 or later are supported. If you have difficulty viewing Settings, check the following:

- If there are a large number of registered users, groups, or shared folders, use another browser instead of Internet Explorer.
- If you have a proxy server enabled in the browser settings, configure the exception settings for Settings or disable the proxy server.
- With Internet Explorer, set security to *Local intranet*. On Windows Server operating systems, higher-level security is configured by default. Set the security to a lower level temporarily.

Configuring Settings via Setup Wizard

When you access Settings for the first time, or after initializing the TeraStation's settings, the setup wizard will automatically appear to help you configure several TeraStation settings, such as RAID mode and proxy server settings.

An example screen of the setup wizard is displayed below. Step through the wizard to configure any desired settings. If there is any setting you would like to configure later, click *Skip* to move to the next setup wizard screen, or click *Cancel* to exit the wizard.

Example of Setup Wizard Screen

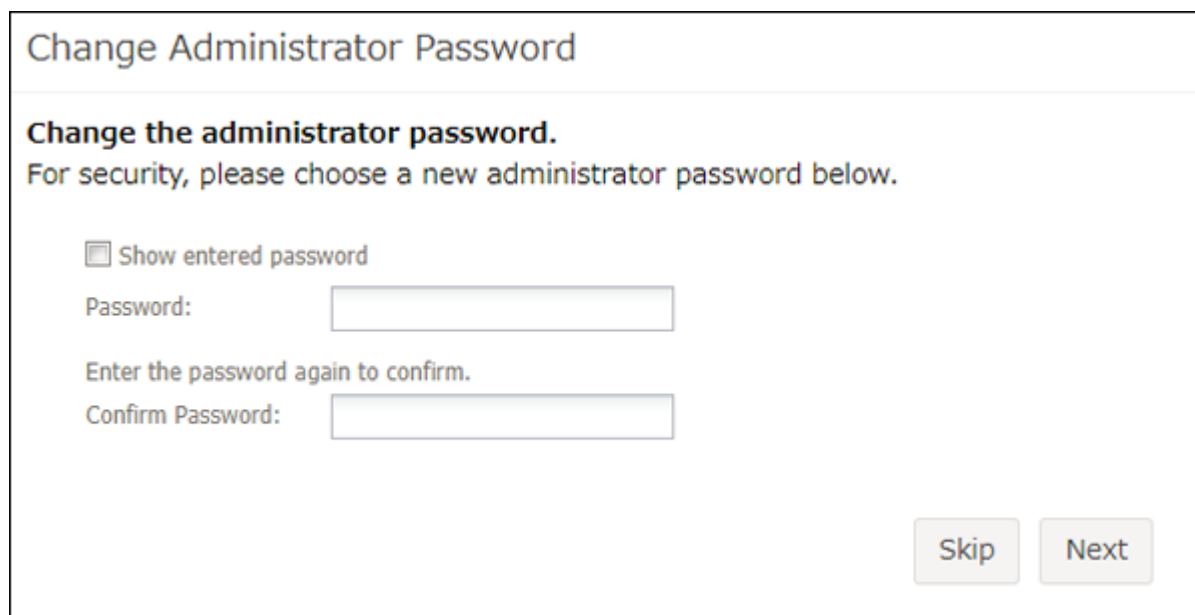

The screenshot shows a web-based setup wizard titled "Change Administrator Password". The main heading is "Change the administrator password." followed by the instruction "For security, please choose a new administrator password below." There is a checkbox labeled "Show entered password" which is currently unchecked. Below this are two text input fields: the first is labeled "Password:" and the second is labeled "Confirm Password:". At the bottom right of the form are two buttons: "Skip" and "Next".

Opening Setup Wizard

You may run the setup wizard even after the initial setup or initialization. To launch the setup wizard again, follow the procedure below.

- 1 From Settings, click *Management*.

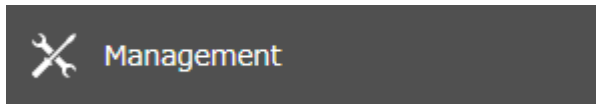

- 2 Click the settings icon (⚙️) to the right of "Restore/Erase".



- 3 Click *Execute Wizard*.

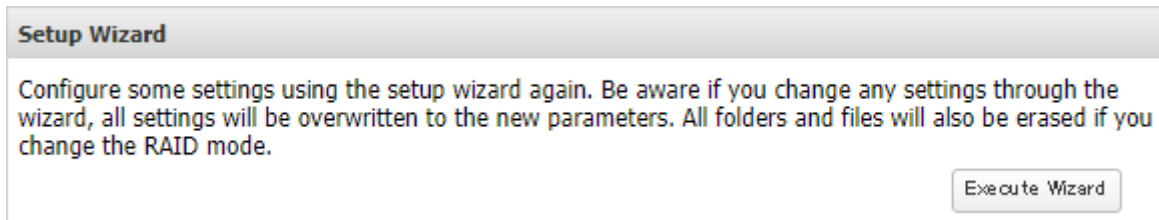

- 4 The "Confirm Operation" screen will open. Enter the confirmation number, then click *OK*.

- 5 Follow the procedure on the screen and finish the setup wizard.

Opening Settings

- 1 Double-click the NAS Navigator2 icon (🖱️) to start NAS Navigator2.
- 2 Right-click your TeraStation's icon and select *Open Settings*. For macOS, select the TeraStation's icon while holding down the control key, then select *Open Settings*.

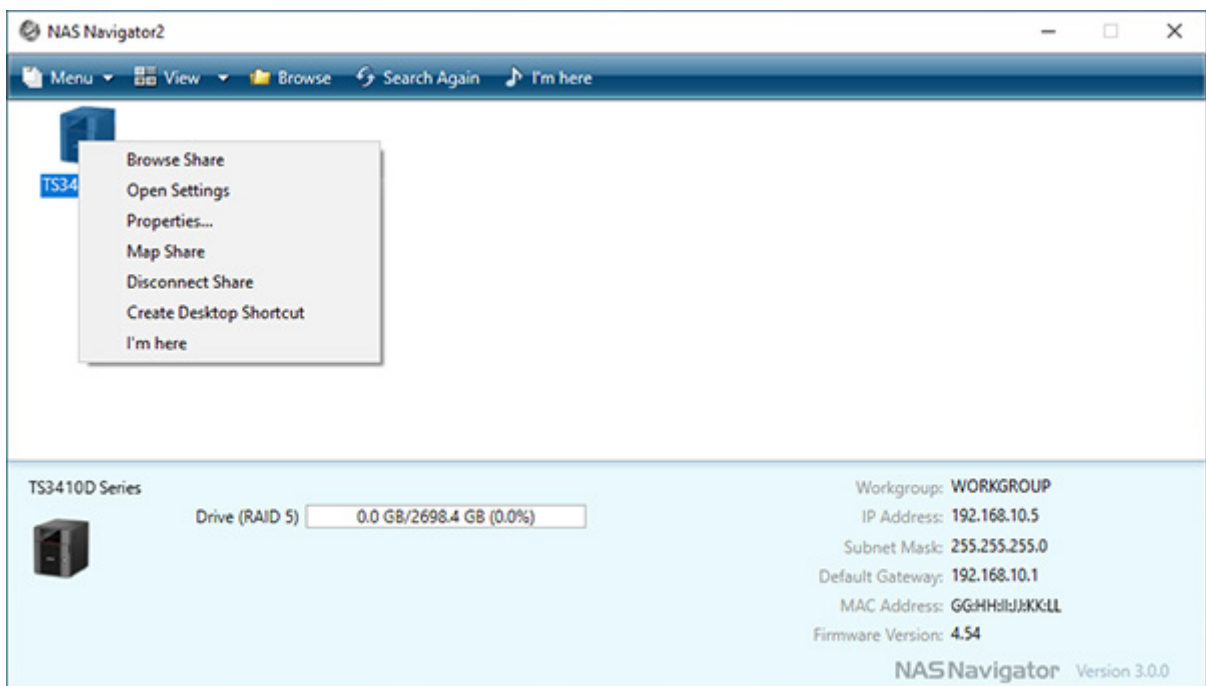

3 Enter the username and password, then click *OK*.

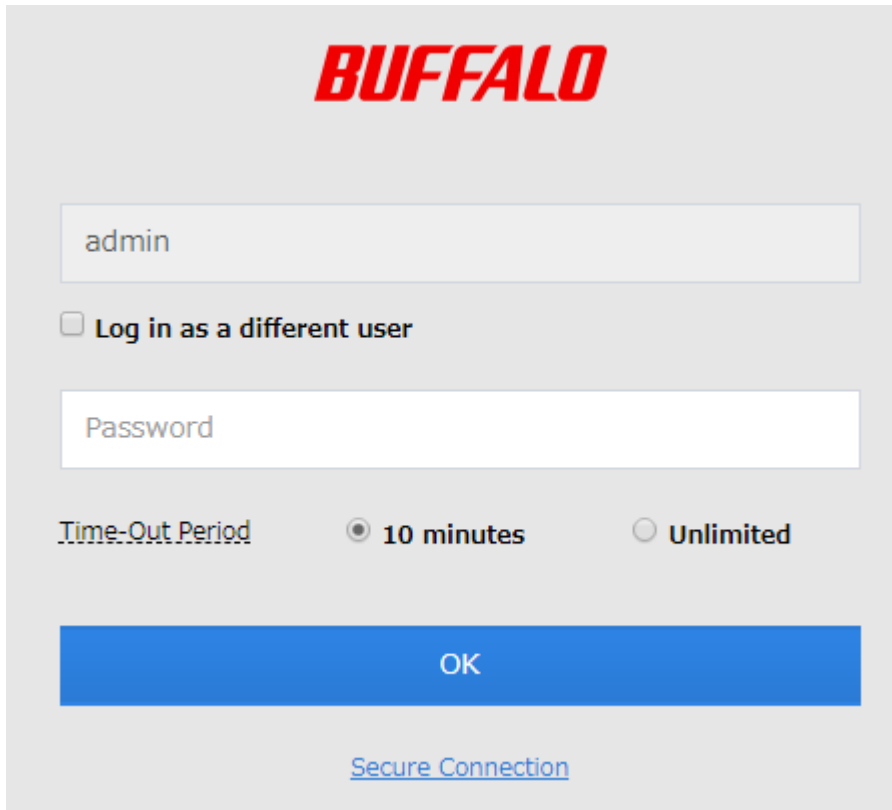

Notes:

- If the time-out period is set to "10 minutes", you will be logged out of Settings after 10 minutes of inactivity.
- Click *Secure Connection* to log in using an encrypted connection.

4 Settings will open.

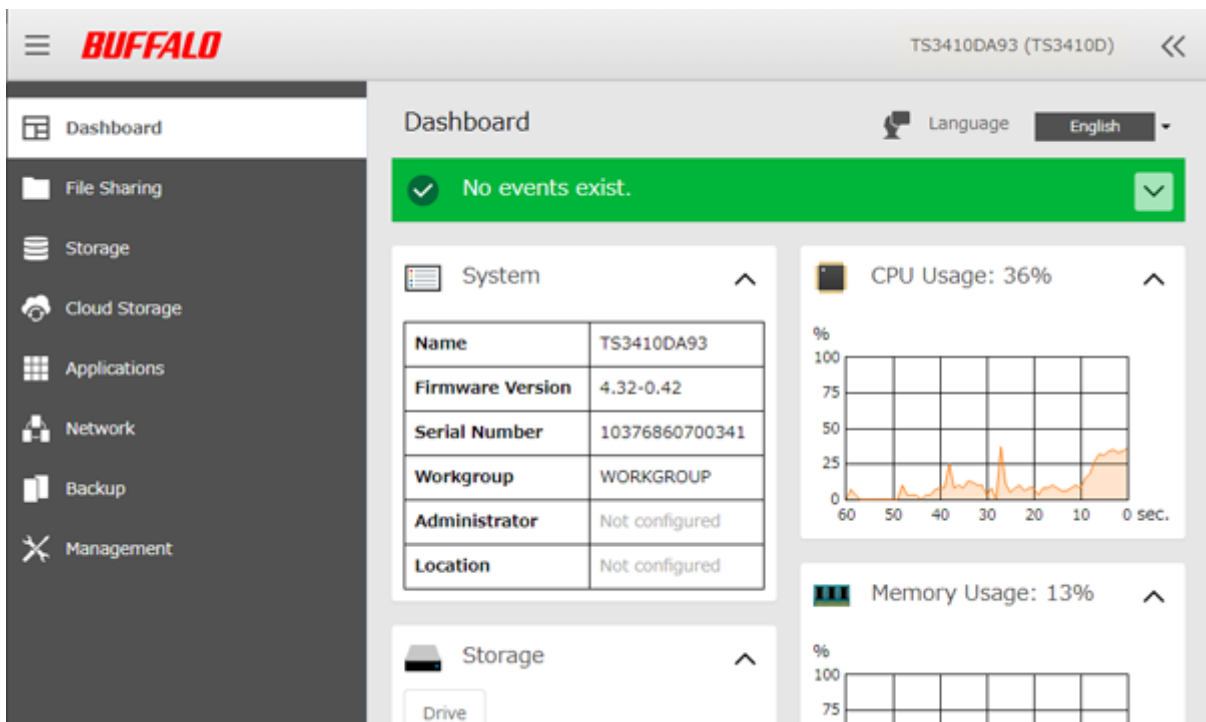

Notes:

- Username/Password Combinations:

Username	Password	Settings Available
admin (default)	password (default)	All
guest	blank	System information (read-only)
Your username	Your password	If a user is assigned as an administrator, all settings are available. If assigned to another group, only system information (read-only) is available.

- Click  at the top-right of Settings and choose *I'm here* to have the TeraStation beep so it can be located easily.

Checking the Device Information from Dashboard

When opening the Settings interface, the Dashboard page will appear first. Dashboard will show the following device information:

- Notices, such as information events and errors
- System information, such as hostname, firmware version, IP address, etc.
- Drive information, such as used space of internal drives, LVM volumes, iSCSI volumes, etc.
- CPU and system memory usage
- Network information, such as IP address, link speed, sent and received rates, etc.

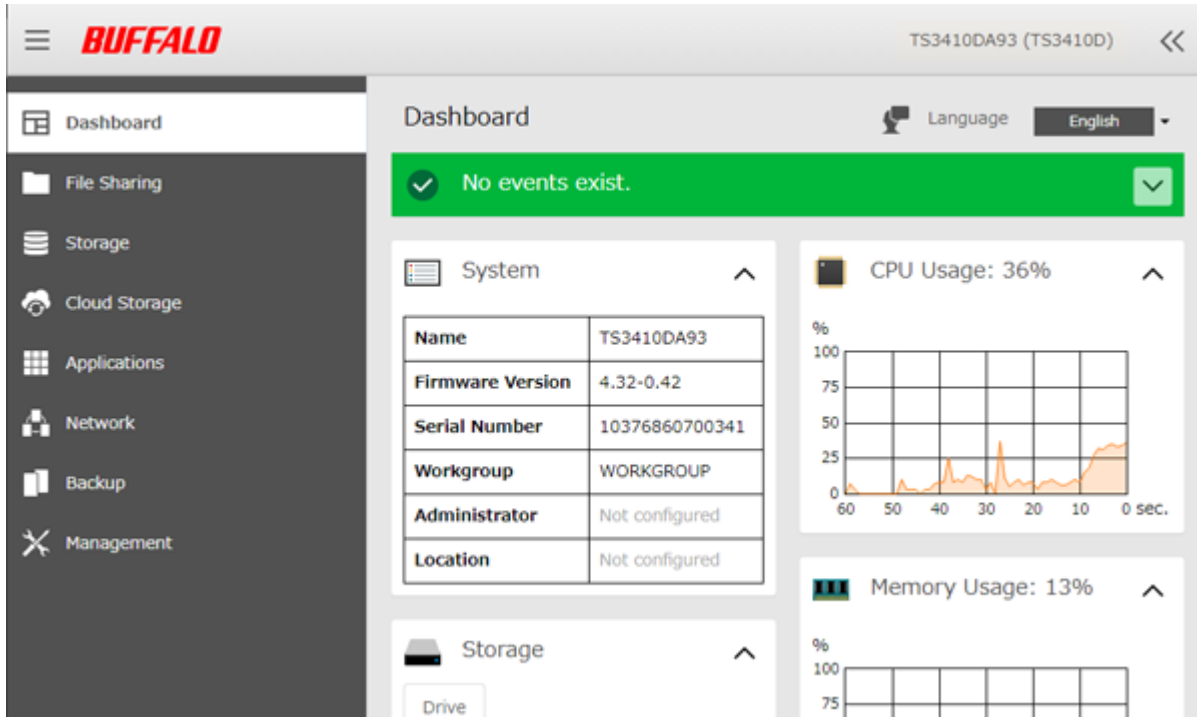

The screenshot displays the Buffalo TeraStation Dashboard for device TS3410DA93 (TS3410D). The interface includes a navigation menu on the left with options like Dashboard, File Sharing, Storage, Cloud Storage, Applications, Network, Backup, and Management. The main content area shows a 'No events exist.' notification, a 'System' section with a table of device details, and two performance charts: 'CPU Usage: 36%' and 'Memory Usage: 13%'. The system table contains the following data:

Name	TS3410DA93
Firmware Version	4.32-0.42
Serial Number	10376860700341
Workgroup	WORKGROUP
Administrator	Not configured
Location	Not configured

Notes:

- If the number of files on the TeraStation increases, it will also increase the memory usage of the TeraStation. This memory usage will decrease after a certain period of time passes. To reduce the memory usage immediately, try the following operations:
 - Restarting the TeraStation.
 - Dismounting the USB drive.
- If there is not enough free space on the TeraStation, it may cause abnormal system behavior. Make sure that there is always at least 1 GB or more of free space on the TeraStation.

Chapter 3 File Sharing

Configuring Shared Folders

Adding a Shared Folder

1 From Settings, click *File Sharing*.

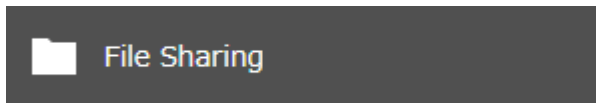

2 Click the settings icon (⚙️) to the right of "Folder Setup".

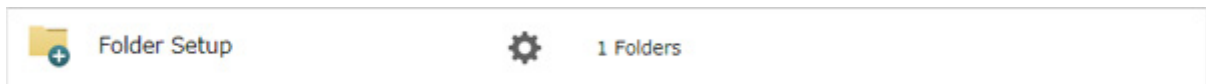

3 Click *Create Folder*.

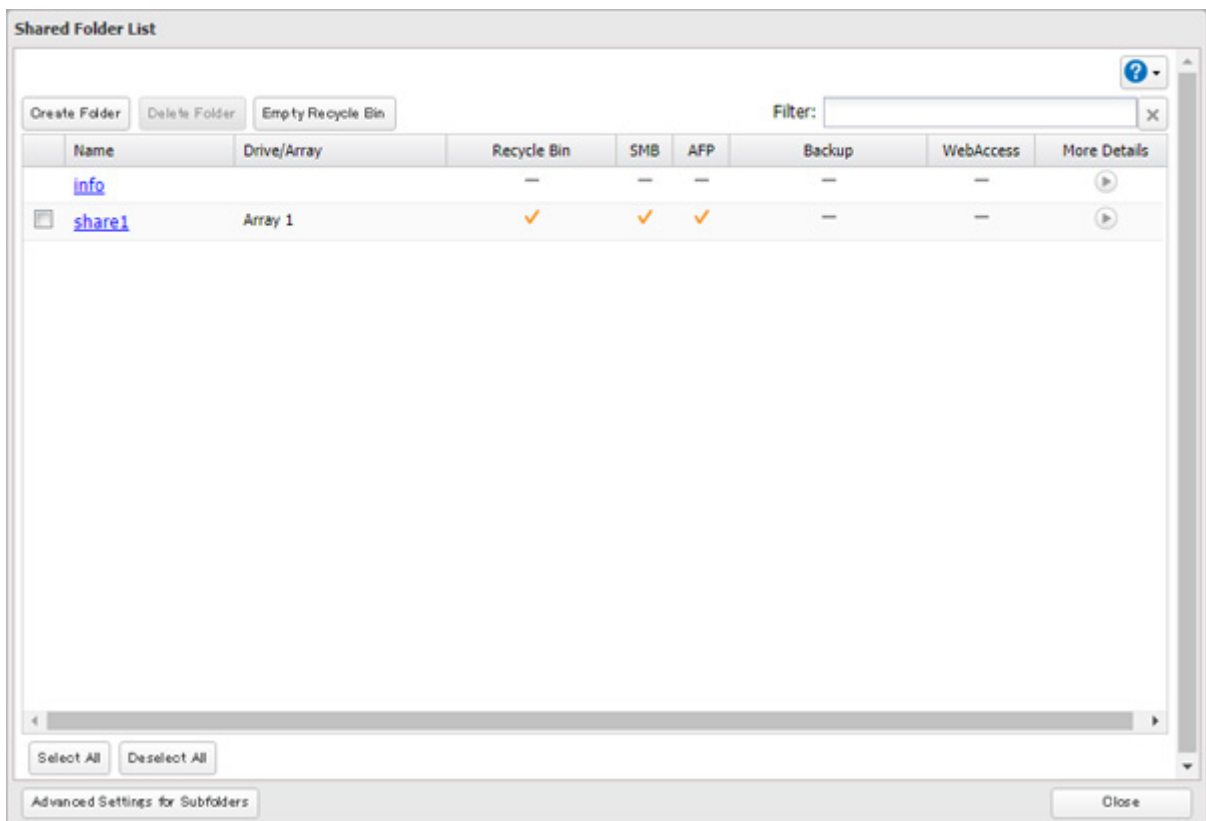

4 Configure the desired settings, then click *OK*.

Shared Folder Settings

*Required ?

Basic Option 1 Option 2 Access Restrictions

Copy Settings from: []

Name * : []

Drive/Array: Drive 1 []

Recycle Bin: Enable Disable

LAN Protocol Support: SMB (Windows/Mac) AFP (Mac)

FTP Backup

SFTP WebAccess

NFS

— NFS Path _____

OK Cancel

Notes:

- Names may contain up to 27 alphanumeric characters, hyphens (-), and underscores (_). Multibyte characters are supported. The first character should not be a symbol.
- When you click the *Option 1* tab, you can enter the folder description. Descriptions may contain up to 75 alphanumeric characters, hyphens (-), underscores (_), and spaces. Multibyte characters are supported. The first character should not be a space.
- You may create up to 400 shared folders.
- If the names of shared folders accessed via AFP and FTP connections contain multibyte characters, configure the client language in *Management > Name/Time/Language* to match the characters. If the setting and display language do not match, the shared folder name will not be displayed correctly.
- The following characters are handled differently by macOS and Windows devices. Avoid using these characters when sharing data between macOS and Windows devices:
— ~ // — ç £ ↵
- Windows does not support some characters that macOS and the TeraStation allow. If you create a filename on a macOS device using any of the following symbols, it will not display correctly on a Windows computer. You may

2 Click the *Option 2* tab and change the “Attribute” option to “Read only”, then click *OK*.

Read-only shares and HFS Plus-formatted USB drives will have “(Read Only)” added to comments in File Explorer.

Notes:

- Configure the share attribute only through Settings. Configuring folder attributes through Windows is not supported and may cause unexpected behavior.
- To set a read-only share or USB drive to another attribute, follow the procedure above and change the attribute in step 2 from “Read only” to the appropriate attribute.

Hidden Shares

If a shared folder becomes hidden, it will not be displayed under Network, and only certain users will be allowed to access it. To hide a shared SMB folder, follow the procedure below.

1 From Settings, navigate to *File Sharing > Folder Setup* and choose a shared folder to make hidden.

2 Click the *Option 2* tab and select the “Hidden share (SMB only)” checkbox, then click *OK*.

Notes:

- If protocols other than “SMB (Windows/Mac)” or “Backup” under “LAN Protocol Support” on the *Basic* tab are enabled, the hidden shares option will be grayed out and cannot be selected.
- Configure hidden share attributes only through Settings. Configuring them through Windows is not supported and may cause unexpected behavior.

To access a hidden folder, open File Explorer in your computer and enter “\\TeraStation name\shared folder name\$” into the address bar. For example, if the TeraStation name is “TSXXX001” and the shared folder name is “share”, enter “\\TSXXX001\share\$” to open it.

Configuring Users

Adding a User

Note: The TeraStation can register a maximum 300 of users, which include the default users “admin” and “guest”.

1 From Settings, click *File Sharing*.

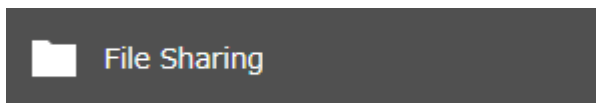

2 Click the settings icon () to the right of “Users”.



3 Click *Create User*.

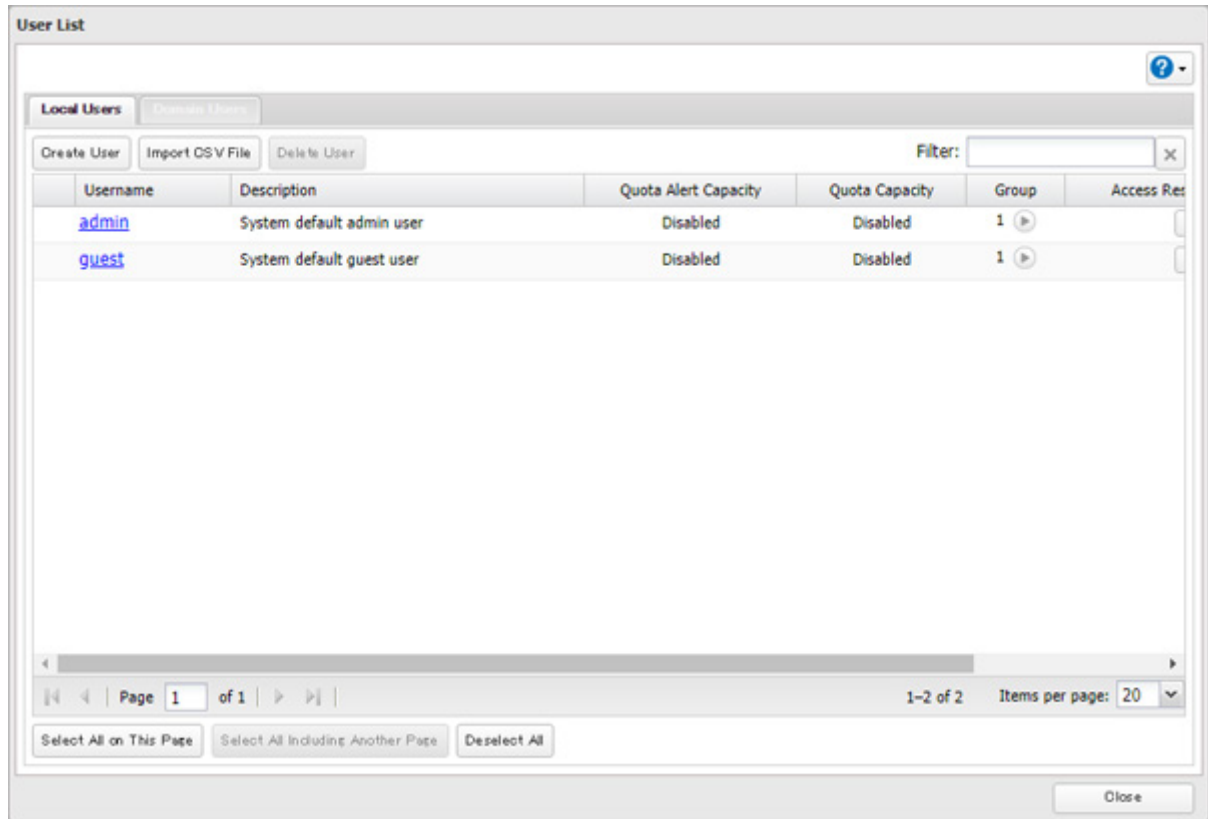

4 Enter the desired settings, then click *OK*.

Notes:

- Usernames may contain up to 128 alphanumeric characters, hyphens (-), underscores (_), periods (.), and the symbols ! # & @ \$ * ^ %. The first character should not be a symbol.
- The user ID should be a number from 1000 to 1999. Each user ID should be unique. If this field is left blank, a user ID is assigned automatically.
- Do not duplicate user IDs, group IDs, usernames, or group names. Each should be distinct and unique.
- User descriptions may contain up to 75 alphanumeric characters, hyphens (-), underscores (_), and spaces. Multibyte characters are supported. The first character should not be a symbol or space.
- Passwords may contain up to 20 alphanumeric characters, hyphens (-), underscores (_), spaces, commas (,), periods (.), semicolons (;), tildes (~), and the symbols @ ! \$ & * + = ? [^ } { \. The first character should not be a symbol unless it is an underscore.
- Use the same username and password for both Windows and the TeraStation or you may be unable to access shared folders.
- Do not use a name already in use as a group; do not use any of the following words as a username as these words are reserved for internal use by the TeraStation: _lldpd, adm, admin, administrator, admins, all, apache, avahi, avahi-autoipd, backup, bin, crontab, daemon, dialout, dip, disk, ftp, ftpuser, fuse, gnats, guest, guests, halt, hdusers, irc, kmem, libuuid, list, lp, mail, man, messagebus, mysql, netdev, news, nobody, nogroup, none, ntp, openldap, operator, plugdev, proftpd, proxy, puppet, root, rpc, rpcuser, sambashare, sasl, shadow, shutdown, snmp, splx, src, ssh, sshd, staff, statd, sudo, sync, syslog, tmhttpd, tty, users, utmp, uucp, winbindd_priv, www, www-data

Importing User Information

You can import users in *File Sharing > Users* by clicking *Import CSV File*.

An example format for user data: Username (required), password (required), and user description (optional).

Example 1: Importing usernames, passwords, and comments

```
username1,password1,comment1
```

```
username2,password2,comment2
```

```
username3,password3,comment3
```

Example 2: Importing usernames and passwords

```
username1,password1,
```

```
username2,password2,
```

```
username3,password3,
```

Guidelines:

- Use commas (,) as separators. Do not put spaces before or after commas. If you don't want user descriptions, use a comma after the password at the end.
- If a line is in an incorrect format, the username entered on that line will not be registered.
- If an unavailable name is used by a user or if the username already exists, an error will occur and cancel the import process. User whose usernames were entered during or after the error occurs will not be imported.
- Do not use commas (,) in the username, password, or user description.

Note: Imported users are added to the "hdusers" group automatically.

Adding a Group

- 1 From Settings, click *File Sharing*.

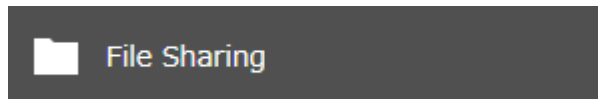

- 2 Click the settings icon (⚙️) to the right of "Groups".



3 Click *Add Group*.

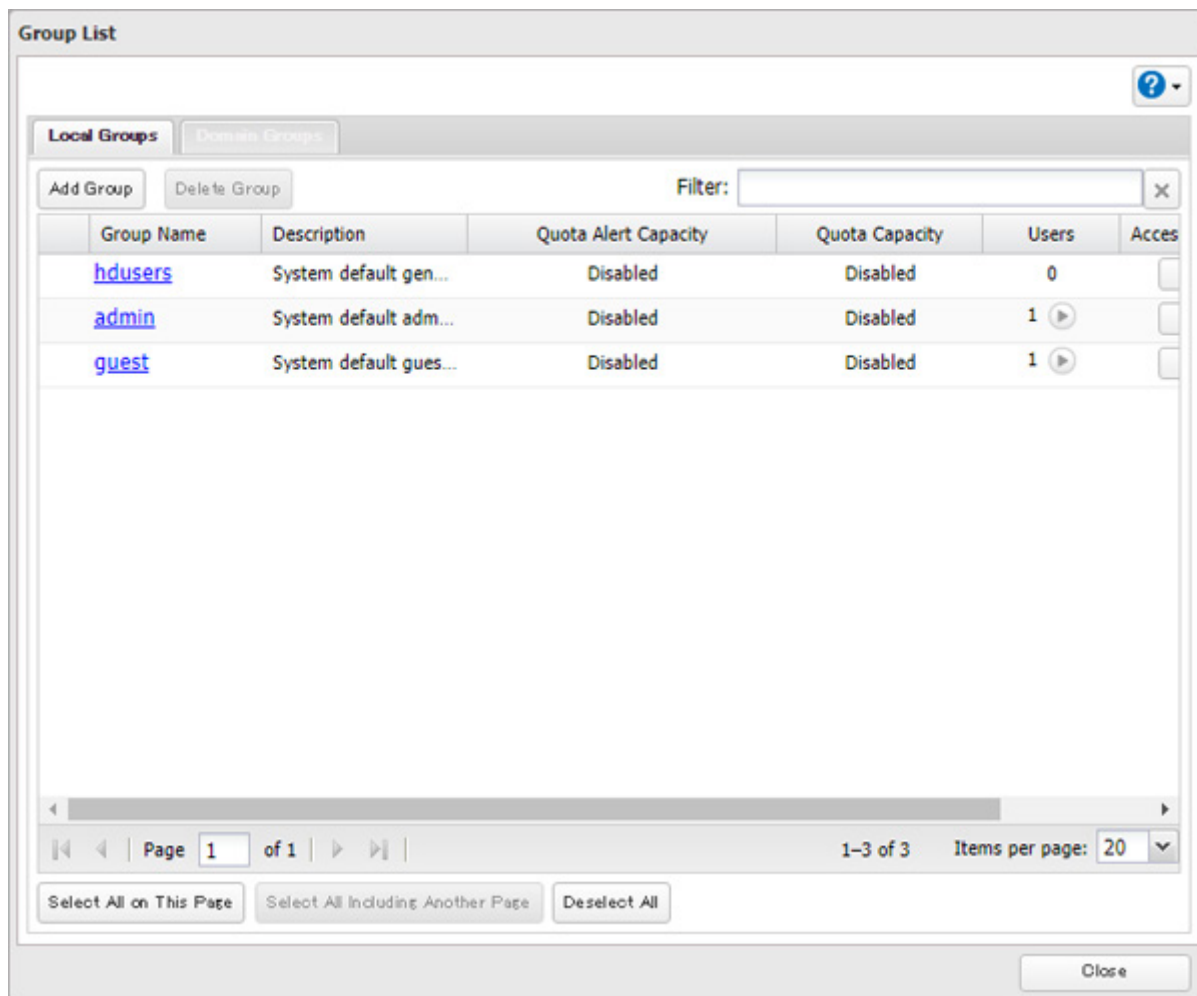

4 Enter the desired settings, then click *OK*.

Group Settings

Group Name: *

Group ID:
Enter a number between 1000 and 1999.

Group Privileges:
General users

Select a recipient for group notifications:

User (with email address configured)
Disabled

Email address

Description:

Quota:

Enable (Units: GB)
Quota Alert Capacity: 1
Quota Capacity: 1

Disable

Filter:

Username
<input type="checkbox"/> admin
<input type="checkbox"/> user01

Select All Deselect All

OK Cancel

Notes:

- Group names may contain up to 20 alphanumeric characters, hyphens (-), underscores (_), and periods (.). The first character should not be a symbol.
- Group descriptions may contain up to 75 alphanumeric characters, hyphens (-), underscores (_), and spaces. Multibyte characters are supported. The first character should not be a symbol or space.
- If the group ID field is left blank, a group ID is automatically assigned. Use numbers between 1000 and 1999 to set a group ID manually. Don't use duplicate group IDs.
- You may register up to 300 groups with the TeraStation.
- If you are logged in as an administrator, you can change any setting, including other users' passwords. If you are logged in as a member of the power users group, you can create and edit shared folders, users, and groups. If you are logged in as a member of the general users group, you can change only your own password.
- Do not use a name in use as a user; do not use any of the following words as a group name as these words are reserved for internal use by the TeraStation: _lldpd, adm, admin, administrator, admins, all, apache, avahi, avahi-autoipd, backup, bin, crontab, daemon, dialout, dip, disk, ftp, ftpuser, fuse, gnats, guest, guests, halt, hdusers, irc, kmem, libuuid, list, lp, mail, man, messagebus, mysql, netdev, news, nobody, nogroup, none, ntp, openldap, operator, plugdev, proftpd, proxy, puppet, root, rpc, rpcuser, sambashare, sasl, shadow, shutdown, snmp, splx, src, ssh, sshd, staff, statd, sudo, sync, syslog, tmhttpd, tty, users, utmp, uucp, winbindd_priv, www, www-data

Configuring Access Restrictions for Shared Folders

You may restrict access for specific shared folders, including external USB drives.

Notes:

- Configure access restrictions only through Settings. Configuring access restrictions through Windows is not supported and may cause unexpected behavior.
- Shared folders with limited access can still be used as backup destinations.
- If you grant both read-only and read and write access to the users or groups, the attributes will become as below:

	Group with read and write access	Group with read-only access	Group with no access
User with read and write access	R/W	R	R/W
User with read-only access	R	R	R
User with no access	R/W	R	-

R/W: Read and write, R: Read-only, -: No access

- If you change access restrictions for a user or group while they are accessing files, unexpected behavior may occur.

Local Users and Groups

- 1 From Settings, click *File Sharing*.

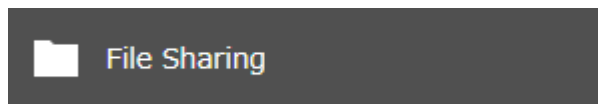

- 2 Click the settings icon () to the right of "Folder Setup".



3 Click the shared folder that you want to set access restrictions for.

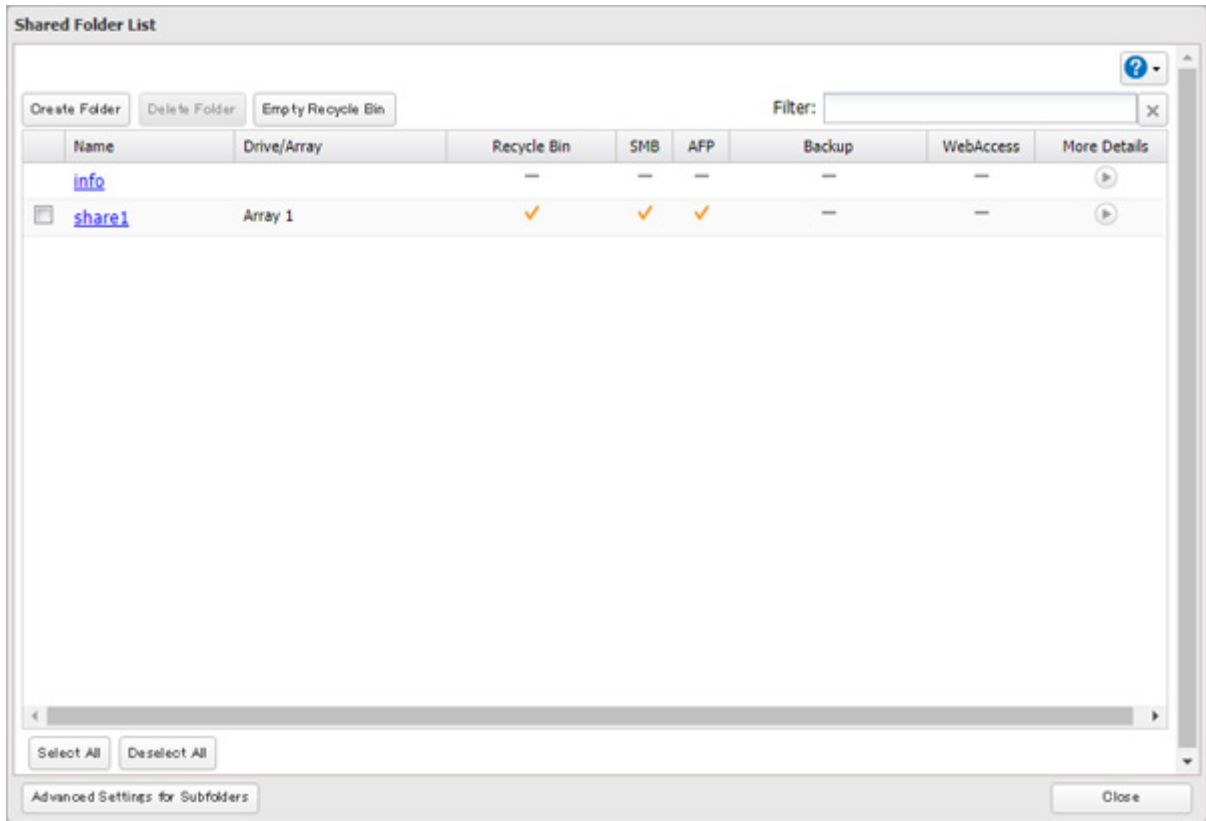

4 Click the *Access Restrictions* tab.

5 Enable “Access Restrictions for Shared Folders”.

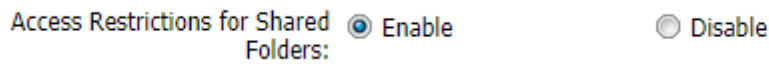

6 Select the level of access for the user or group.

WR : Read and write **R** : Read-only : No access

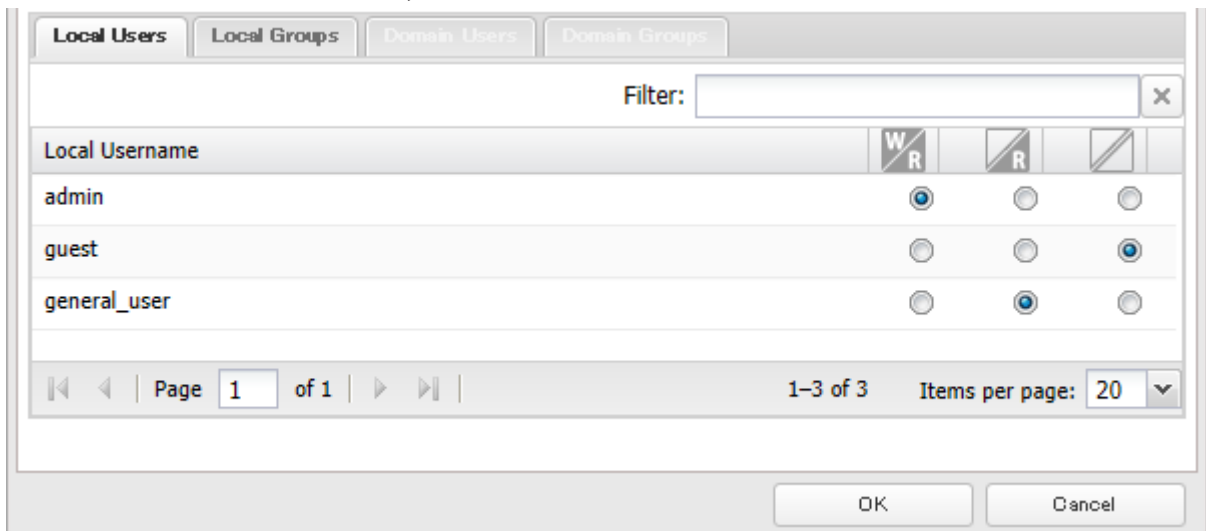

7 Click *OK*.

Notes:

- The example above shows access restrictions by users. To restrict access by group, click the *Local Groups* tab and select group permissions.
- For an access-restricted shared folder, if you change the access restrictions of all users and groups from read and write or read-only to access prohibited from the user or group list page in Settings, that shared folder can only be accessed by admin users and groups.

Active Directory

If there is an Active Directory environment, the TeraStation will use account information from the Active Directory domain controller to set access restrictions for TeraStation's shared folders. There is no need to perform individual account management for the TeraStation. If multiple TeraStations are installed on the network, the account information is centrally managed in Active Directory, greatly reducing the operations required for installation and management.

Notes:

- If usernames or group names from Active Directory include multibyte characters, you will not be able to configure access restrictions for them.
- The TeraStation supports a domain environment with a maximum of 10,000 users and groups.

1 From Settings, click *Network*.



2 Click the settings icon () to the right of "Workgroup/Domain".

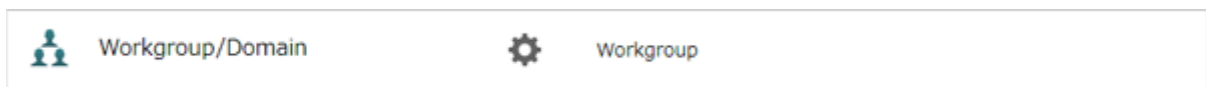

3 Click *Edit*.

4 Select "Active Directory", then click *Next*.

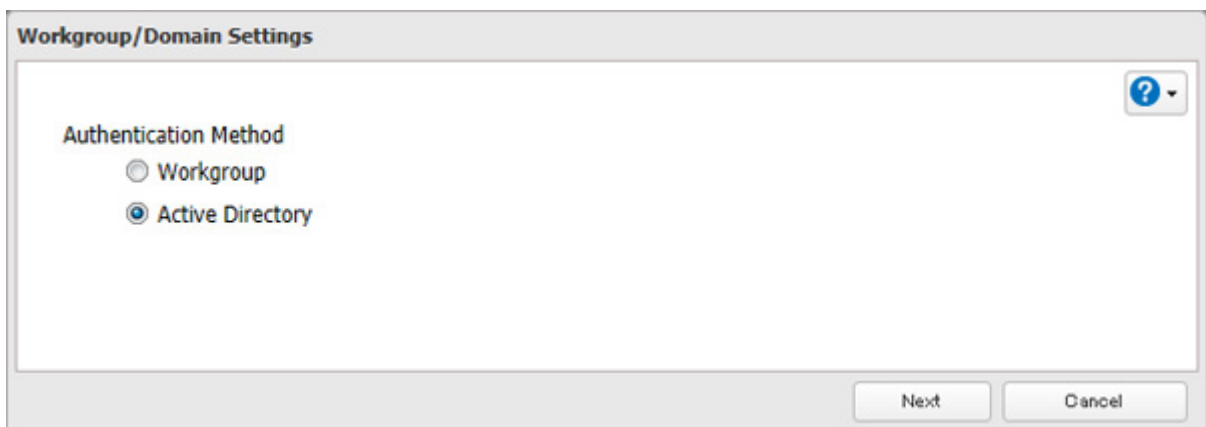

- 5** Enter the domain controller information and click *Search*. The domain controller on the same network will be detected and required settings will be entered into each field automatically. Alternatively, you can also manually enter the settings.

Active Directory Domain Settings

*Required ?

Detect Domain Controller : Search
(IP Address, DNS Name, or Computer Name)

NetBIOS Name * :

DNS Name * :

Domain Controller Name * :
(Computer Name)

Administrator Name * :

Administrator Password * :

WINS Server IP Address:

Configure domain controller as an NTP server

OK Cancel

- 6** If there is a difference of more than five minutes between the TeraStation's clock and the domain controller's clock, joining the domain or authenticating domain users and groups may fail. For best results, select "Configure domain controller as an NTP server" if the domain controller can function as the NTP server.

- 7** Click *OK*.

- 8** Click the settings icon () to the right of "Folder Setup".

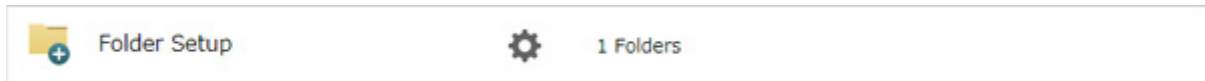

9 Click the shared folder that you want to set access restrictions for.

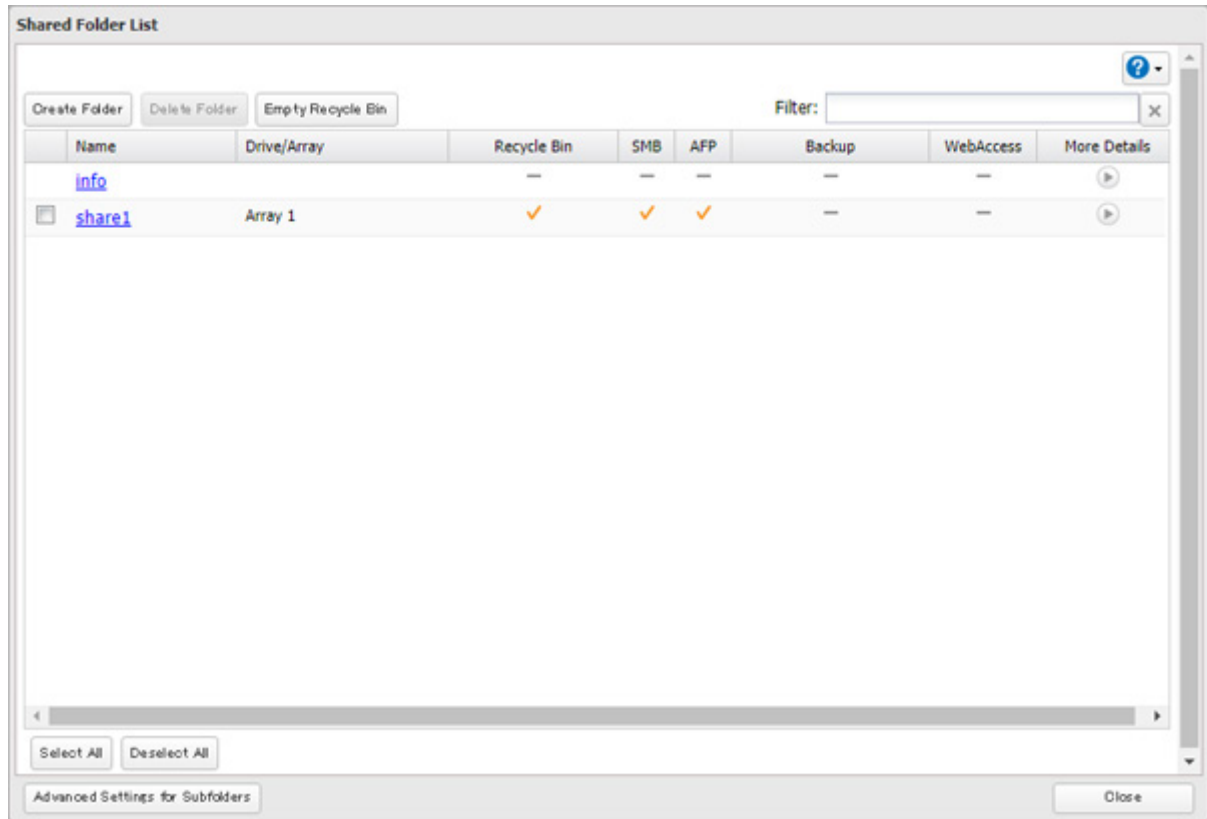

10 Click the *Access Restrictions* tab.

11 Enable “Access Restrictions for Shared Folders”.

Access Restrictions for Shared Folders: Enable Disable

12 Select the level of access for the user or group.

W/**R** : Read and write **R** : Read-only : No access

13 Click *OK*.

Notes:

- To have the TeraStation join an Active Directory domain, configure it to use a DNS server that can resolve names for the Active Directory domain.
- After building an Active Directory domain, the administrator password for joining the domain must be changed at least once, or joining the Active Directory domain will fail.
- The DNS name and NetBIOS name of Active Directory domains should be identical.
- If the TeraStation is a member server of an Active Directory domain, you cannot connect as a guest user via AFP.
- If your TeraStation is a member server in an Active Directory domain and you change the authentication method to “Workgroup”, the account on the domain controller will not be deleted automatically.
- If FTP is enabled, local and domain group access restrictions from the AD network do not work. Use user access restrictions instead.
- For an access-restricted shared folder, if you change the access restrictions of all users and groups from read and write or read-only to access prohibited from the user or group list page in Settings, that shared folder can only be accessed by admin users and groups.
- If you allow read and write or read-only access for most users, group access restrictions are recommended.

- Depending on the domain controller’s policy settings, the domain controller may force the TeraStation to leave the Active Directory domain. If this occurs, the TeraStation will lose the domain users and groups so if you have configured access restrictions using domain accounts, these users will no longer be able to access shared folders. In such a case, change the policy settings on the domain controller or let the TeraStation join the Active Directory domain again.

Configuring Access Restrictions for Subfolders

You may restrict access to subfolders in shared folders by configuring access permissions from your computer using Windows File Explorer.

Notes:

- Depending on the environment, the function may not work properly when enabled. We recommend verifying the functionality before using.
- Access permissions configuring from File Explorer is available for up to 18 files and 24 folders. This number of available access permissions may vary if access permissions are inherited from the parent object. The number of available access permissions are not many so using group access permissions is recommended if the permission level is the same to the multiple users; it will save spending the number of available access permissions.

Enabling Subfolders’ Access Restrictions

- 1 From Settings, click *File Sharing*.

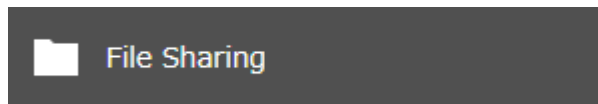

- 2 Click the settings icon () to the right of “Folder Setup”.

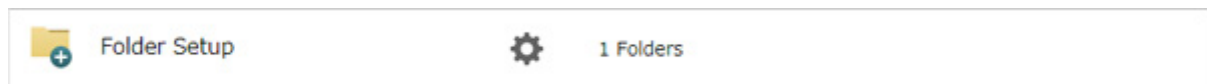

3 Click the shared folder that you want to set access restrictions for.

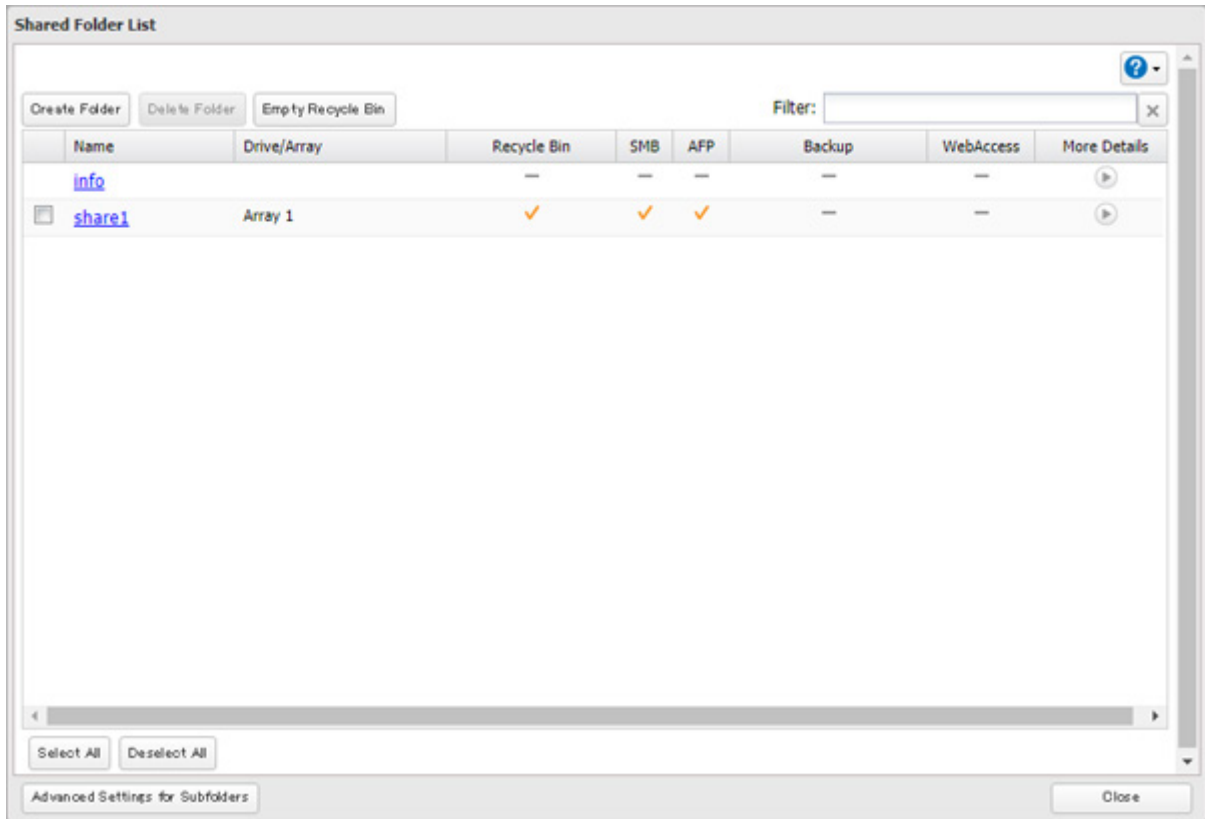

4 Clear all checkboxes for “LAN Protocol Support” other than “SMB (Windows/Mac)”, “Backup”, and “NFS”.

5 Click the *Option 2* tab.

6 Enable “Access Restrictions for Subfolders”.

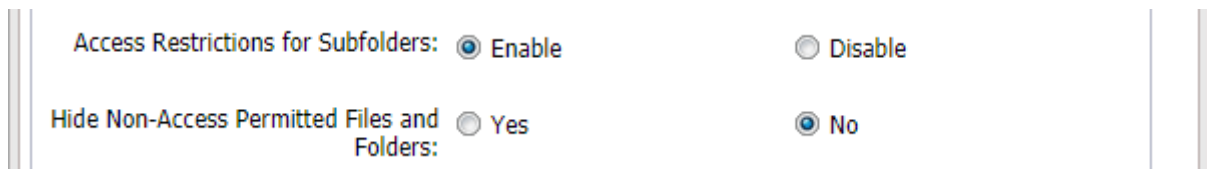

Note: If “Hide Non-Access Permitted Files and Folders” is enabled, non-access permitted sub-files and folders will not be displayed in shared folders.

7 Click *OK*.

Enabling subfolders’ access restrictions finished. Next, configure access permissions for each user or group to files and folders in subfolders from File Explorer.

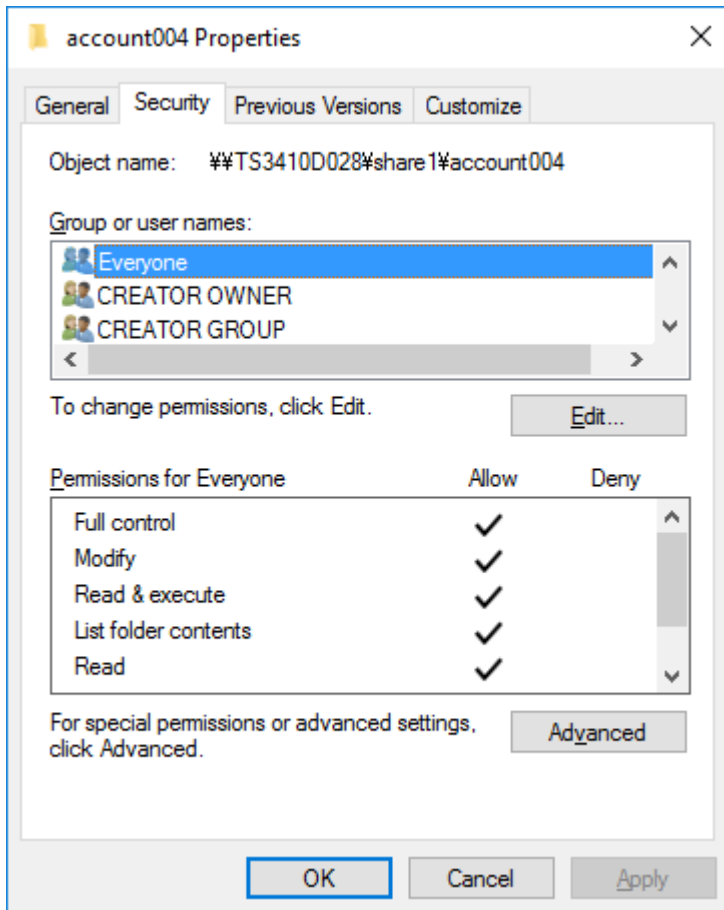

You may also configure access permissions for domain users and groups. You should have the TeraStation join your Active Directory domain before configuring access permissions from File Explorer.

Notes:

- If enabling subfolders' access restrictions for a USB drive, the drive should be formatted using XFS or ext3.
- The UID and GID of domain accounts should be updated before using the subfolders' access restrictions if the TeraStation joined the AD network while running a firmware version earlier than 3.00 and has since updated to version 3.00 or later. To update the UID and GID, navigate to *File Sharing > SMB > Edit* in Settings and click *Update*.
- To back up or replicate files to backup or replication destinations with access permission settings of files and folders in subfolders unchanged, make sure that the same workgroup name, user IDs, and group IDs are configured between backup or replication sources and destinations.
- If you clear the "Read & execute" checkbox under "Allow" (as shown on the image above) and disable the subfolders' access restrictions, these users and groups will have read and write permission.
- If the TeraStation's settings have been initialized but you configure the same UID and GID for new users and groups, access permissions to files and folders in subfolders may be inherited.

Restoring Owner and Permission Settings

If you changed the owner to an unexpected user or accidentally lost permissions to a specific folder, restore them by following the procedure below.

- 1 From Settings, click *File Sharing*.

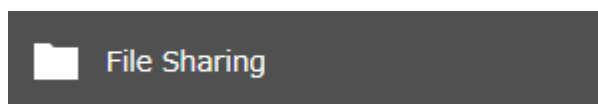

2 Click the settings icon () to the right of "Folder Setup".

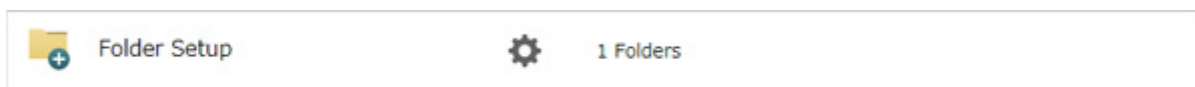

3 Click *Advanced Settings for Subfolders*.

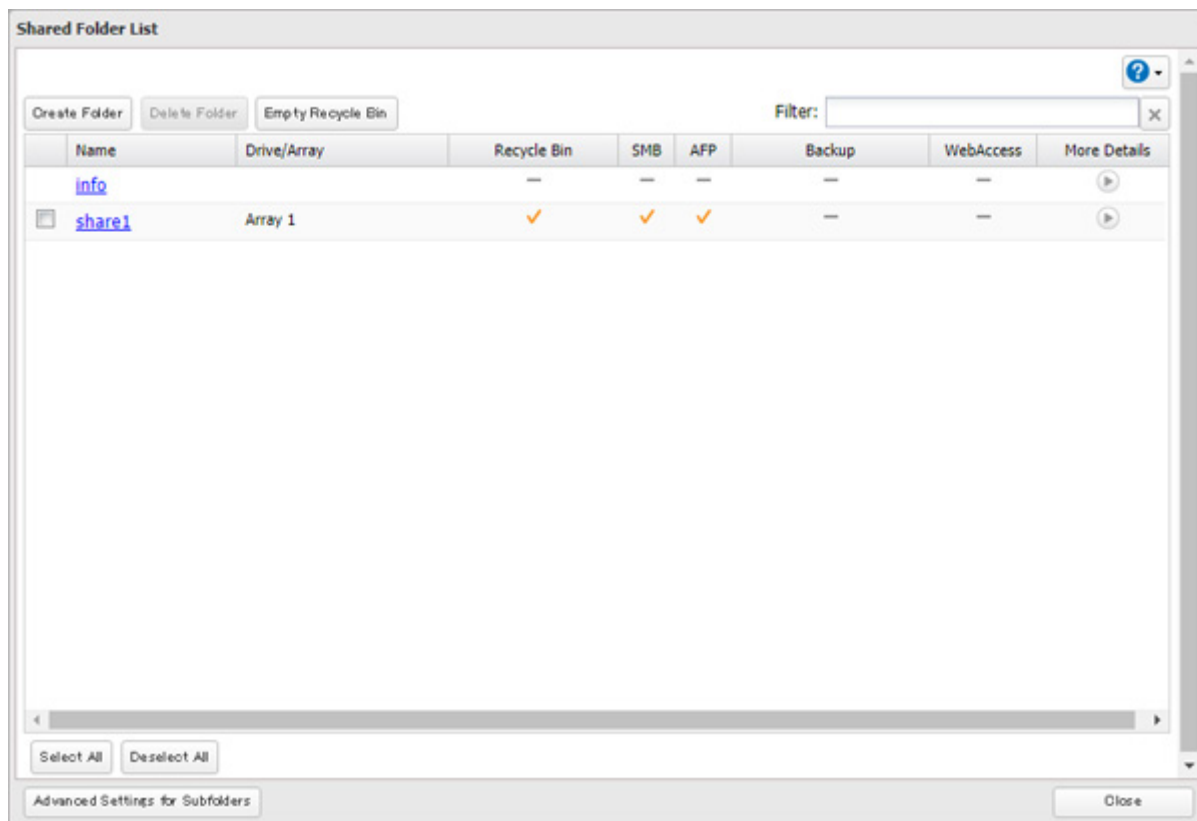

4 Select a folder to restore permissions from the tree.

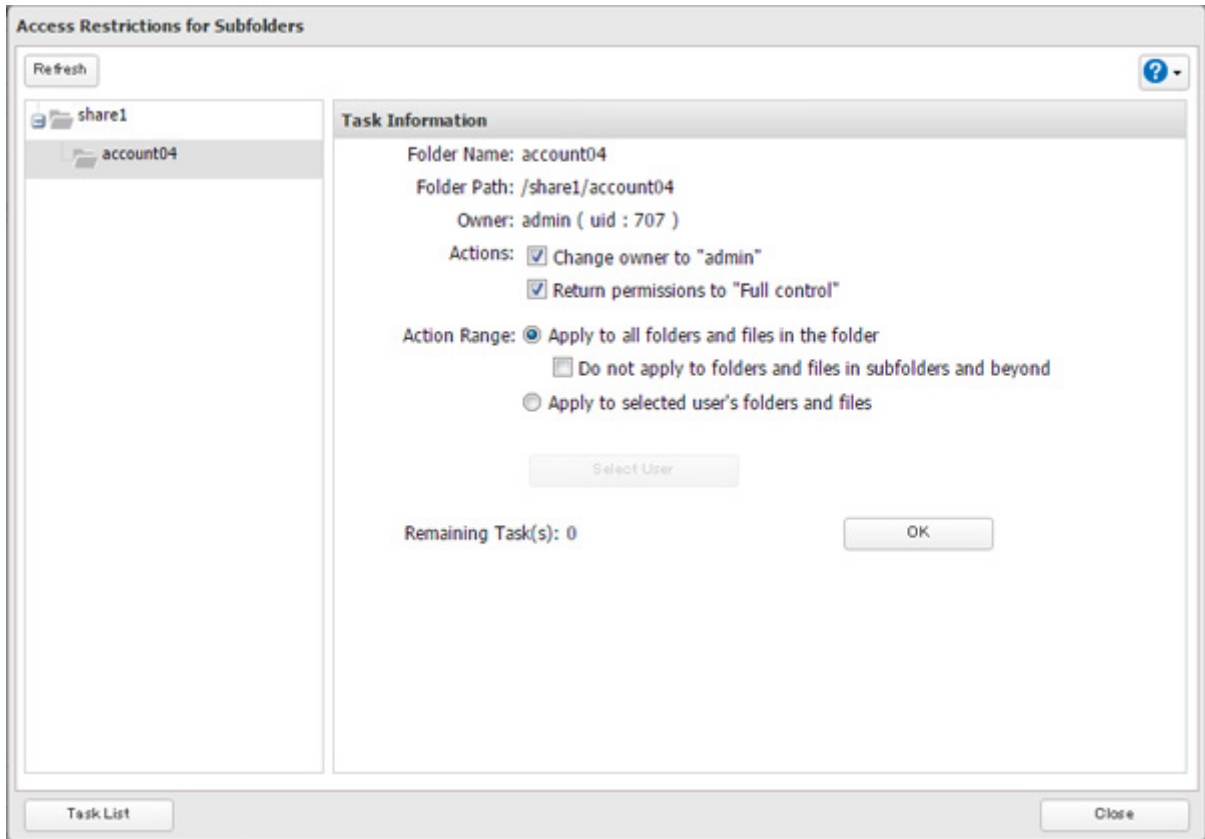

Note: If you select a root shared folder from the tree, the action will not be run to the recycle bin. To run the action, select the recycle bin instead.

5 Select the actions and action range to run, then click *OK*.

6 The “Confirm Operation” screen will open. Enter the confirmation number, then click *OK*.

If a Shared Folder Cannot Be Accessed

Due to the security reasons, you may be unable to access shared folders from computers running certain Windows versions. In such a case, try either of the following corrective actions:

- Adding a Windows credential
- Configuring the TeraStation to allow you to enter a Windows credential when a shared folder cannot be accessed

Follow the procedure below to change the TeraStation settings so you can enter a Windows credential.

1 From Settings, click *File Sharing*.

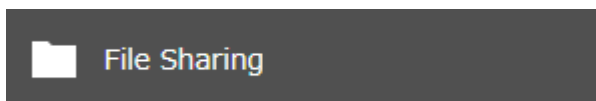

2 Click the settings icon () to the right of “SMB”.

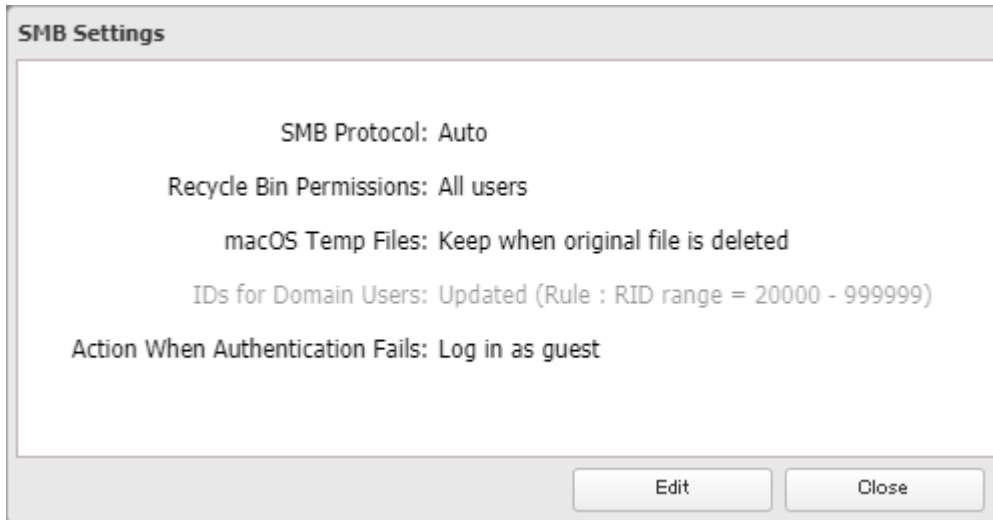
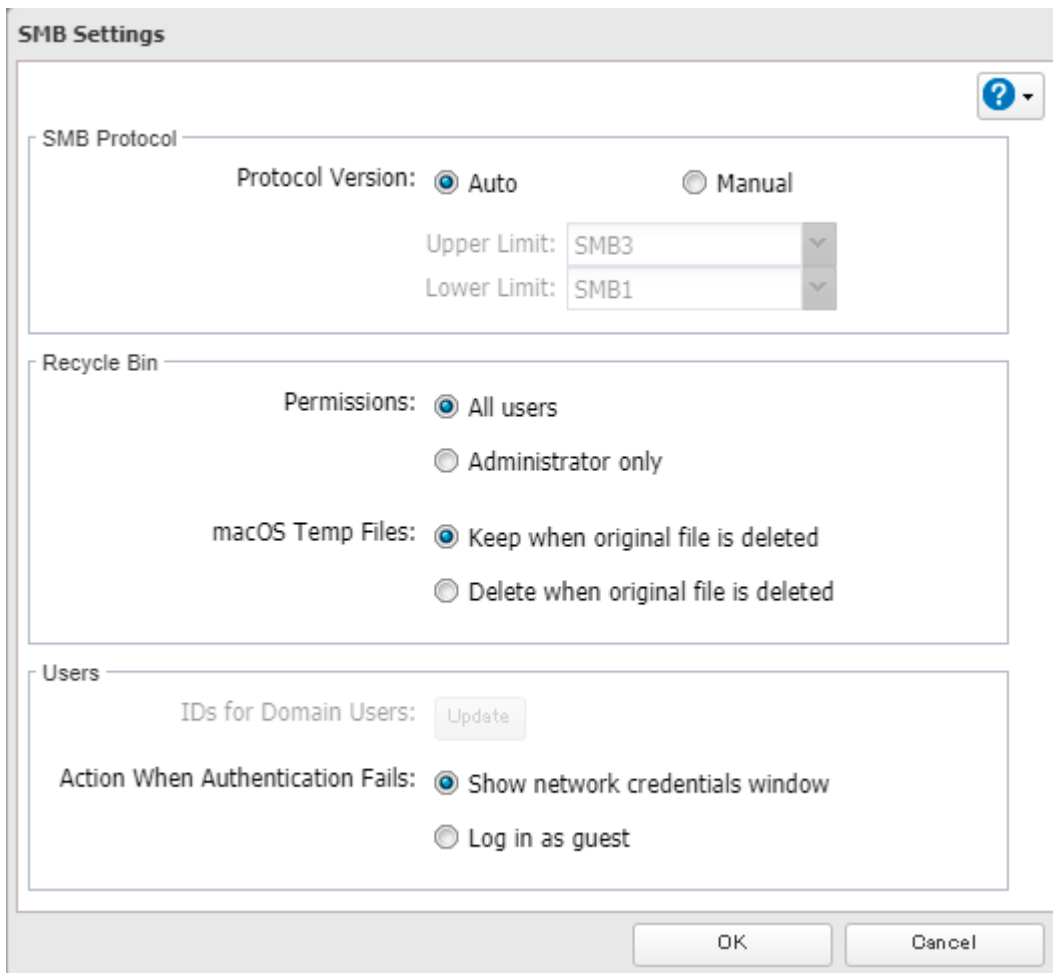

3 Click *Edit*.**4** Under "Users", change the "Action When Authentication Fails" to "Show network credentials window".**5** Click *OK*.

The settings will be changed. The window to enter a username and password will be displayed next time you access a shared folder but fails.

Chapter 4 Storage Management

RAID Modes

The TeraStation supports many types of RAID. The type of RAID arrays available for use depends on how many drives are installed on your TeraStation.

Notes:

- If you change the RAID mode, all data on the array is deleted. This is true for every procedure in this chapter. Always back up any important data before performing actions that affect your RAID array.
- Some RAID arrays allow you to change the RAID mode without losing data by adding drives. To change a RAID mode by adding drives to the existing array, refer to the [“Expanding RAID Capacity Without Deleting Data”](#) section below.
- Drive capacity is displayed in Settings in actual gigabytes. The Properties window in Windows may show GiB instead, which will be a smaller number.
- If the TeraStation is restarted or shut down while changing the RAID mode, the message that appears on the Dashboard in Settings and NAS Navigator2 will change from I46 or I47 to I18.
- RAID 5, 6, and 10 are only available for TeraStation models that allow three or more drives to be inserted. Please check Settings on your model before changing the RAID mode.

RAID 6

RAID 6 arrays are available for TeraStations with four drives. RAID 6 combines four or more drives into a single array. The usable space is equal to the sum of the capacity of all drives minus the capacity of two drives. For example, if four drives are combined into a RAID 6 array, the usable space is the sum of the capacity of two drives. If two drives in the array become damaged, you can recover data by replacing them. If three or more drives become damaged, then all data in the array will be lost.

RAID 5

RAID 5 arrays are available for TeraStations with three or more drives. RAID 5 combines three or more drives into a single array. The usable space is equal to the sum of the capacity of the drives minus the capacity of one drive. For example, if four drives are combined into a RAID 5 array, the usable space is the sum of three drives. If one drive in the array becomes damaged, you can recover data by replacing the damaged drive. If two or more drives become damaged at the same time, then all data in the array will be lost.

RAID 10

RAID 10 arrays are available for TeraStations with four drives. In this mode, mirrored pairs of drives in RAID 1 arrays are combined into a RAID 0 array. The usable space is equal to the capacity of the smallest drive multiplied by the number of drives divided by two.

RAID 1

Combines two or more drives into a mirrored array. The usable space is equal to the capacity of a single drive. Identical data is written to each drive. If a drive becomes damaged, data can be recovered by replacing the damaged drive. As long as one drive in the array remains undamaged, all data in the array can be recovered.

RAID 0

Combines two or more drives into a single array. The usable space is equal to the total capacity of all drives in the array. This simple RAID mode offers faster performance than RAID modes that include parity. If a single drive in the array becomes damaged, then all data in the array will be lost.

JBOD

This mode uses the drives inside the TeraStation as individual drives. The usable space is equal to the total capacity of all drives on the TeraStation. If any of the drives become damaged, then all data on that drive will be lost.

Working with RAID Arrays

To change RAID settings, navigate to *Storage > RAID* in Settings.

Using JBOD

With JBOD, each drive on the TeraStation is addressed separately. To put drives from an array into JBOD, follow the procedure below.

- 1 From Settings, click *Storage*.



- 2 Click the settings icon () to the right of "RAID".



3 Click the array to delete.

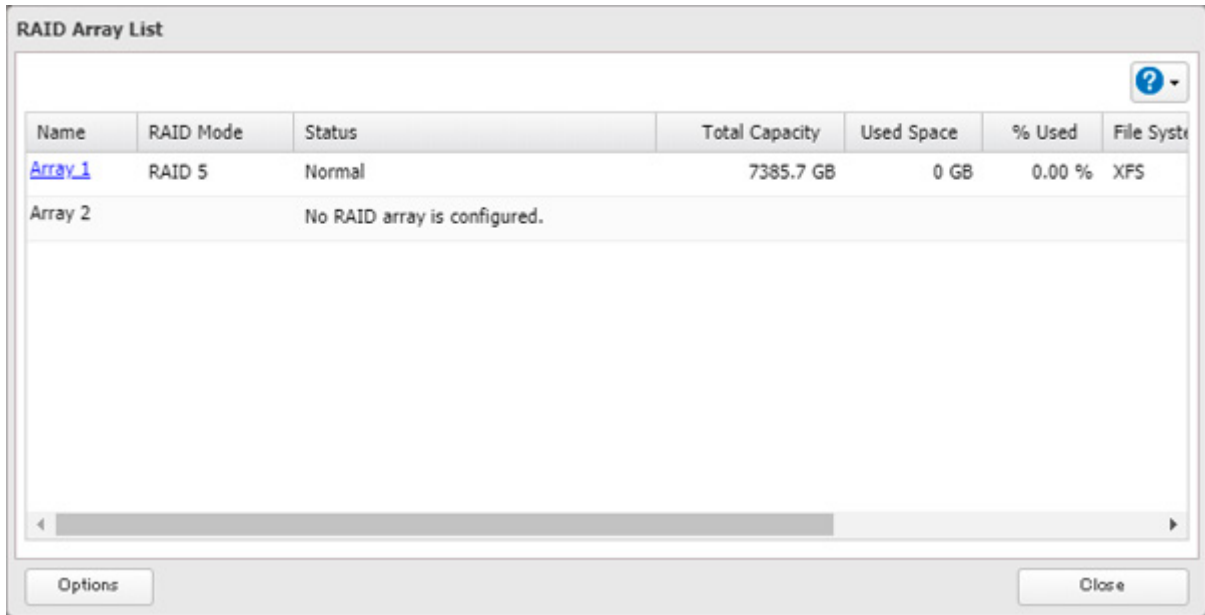

4 Click *Delete RAID Array*.

5 The “Confirm Operation” screen will open. Enter the confirmation number, then click *OK*.

6 Click *OK* when completed. Next, create a shared folder by referring to the [“Adding a Shared Folder”](#) section in chapter 3.

Changing RAID Mode

To change the RAID mode, first put the drives into JBOD by referring to the [“Using JBOD”](#) section above. Then, follow the procedure below.

1 From Settings, click *Storage*.



2 Click the settings icon (⚙️) to the right of “RAID”.

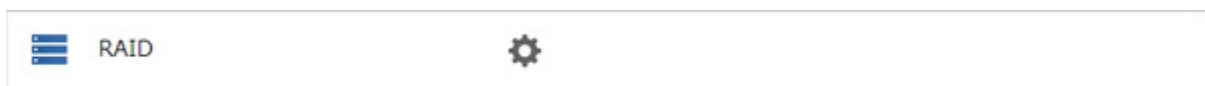

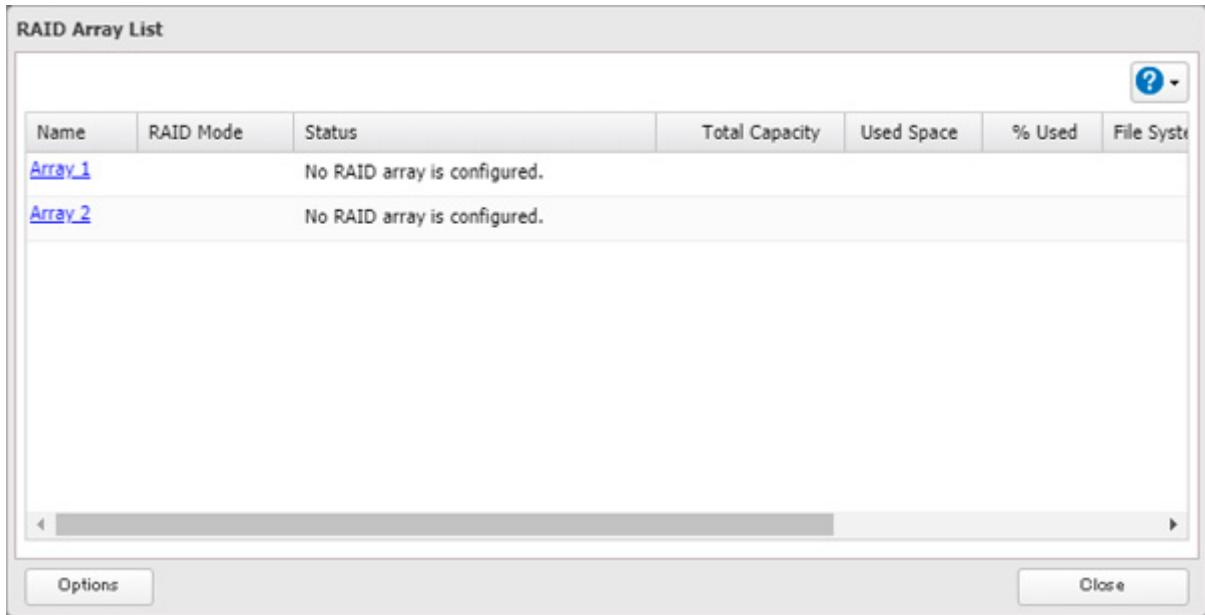
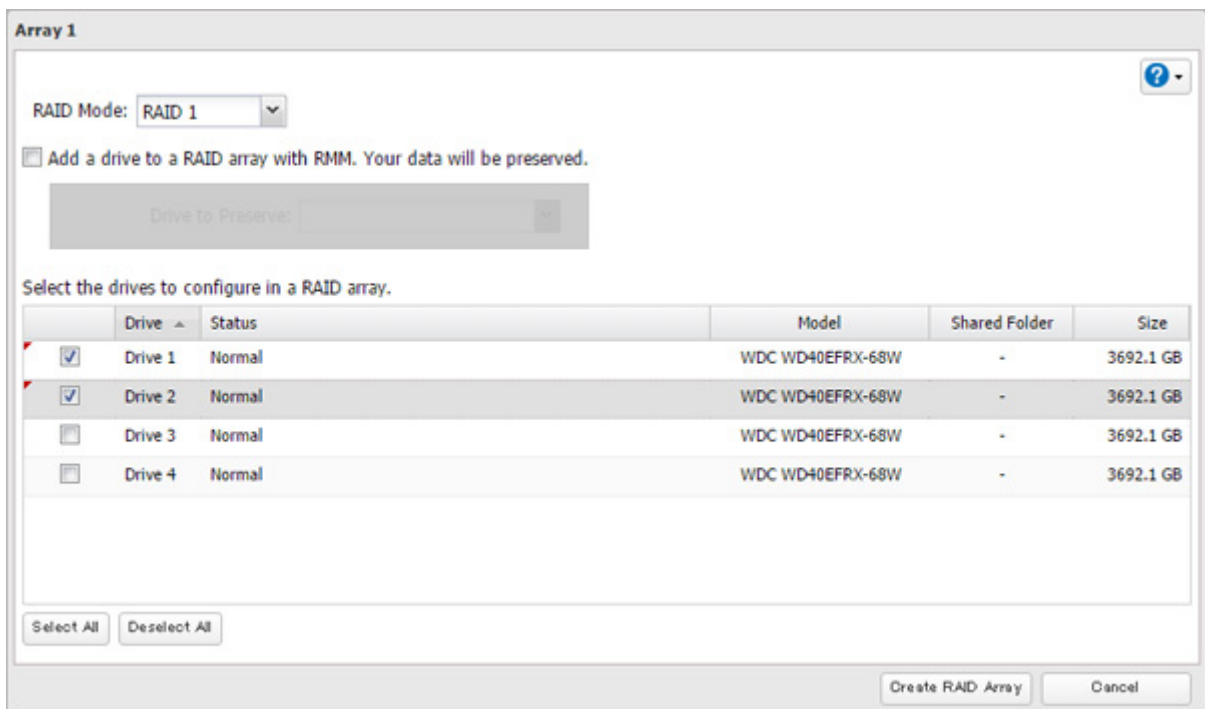
3 Choose a RAID array.**4** Select a RAID mode and the drives to be used, then click *Create RAID Array*.**5** The “Confirm Operation” screen will open. Enter the confirmation number, then click *OK*.**6** Click *OK* when completed. Next, create a shared folder by referring to the [“Adding a Shared Folder”](#) section in chapter 3.

Shutting Down the TeraStation Automatically If an Error Occurs

This function will shut down the TeraStation automatically if an error occurs on a drive that is used in a redundant RAID array. To configure auto shutdown, follow the procedure below.

1 From Settings, click *Storage*.



2 Click the settings icon (⚙️) to the right of "RAID".



3 Click *Options*.

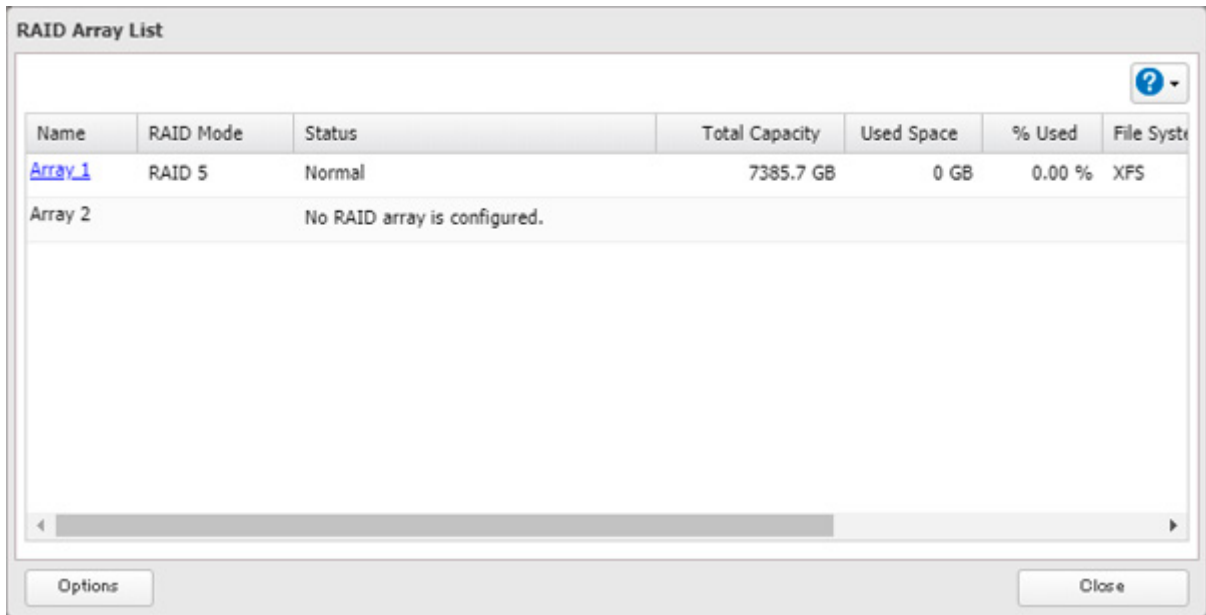

4 Click *Edit*.

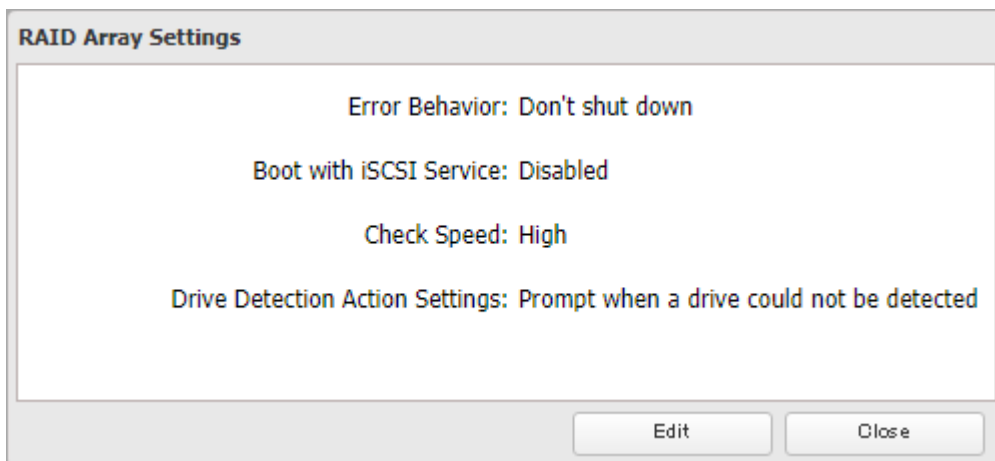

- 5** Change the “Error Behavior” option to “Shut down” and click *OK*.

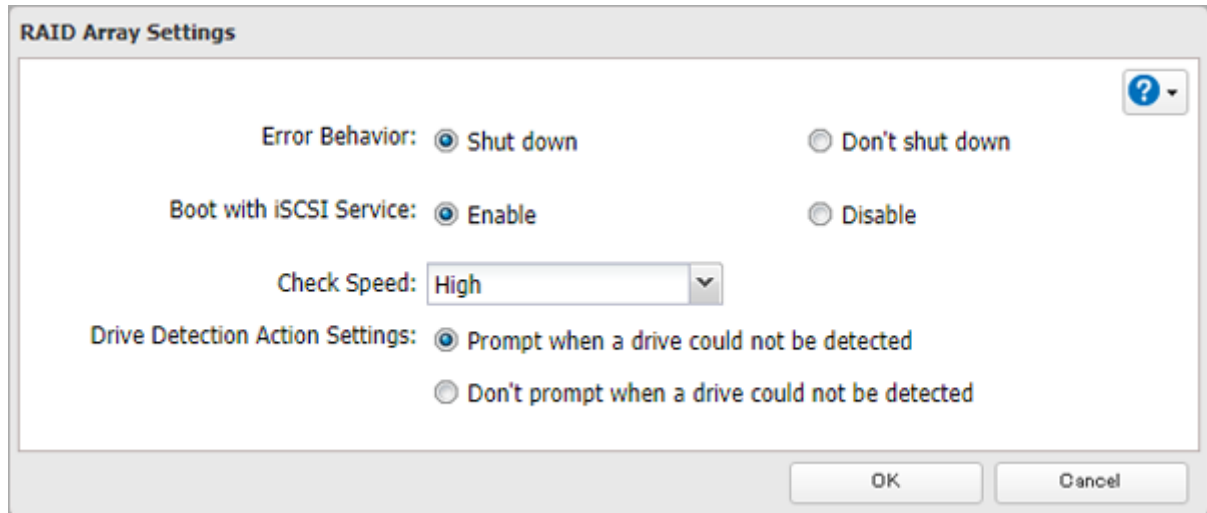

Configuring Actions for If a Drive Used for the RAID Array Has Not Been Detected

The TeraStation can configure actions for if a drive used for the RAID array cannot be mounted when booting.

Displaying or Hiding the Confirmation Screen

Configure to display or hide the confirmation screen for selecting actions for if a drive used for the RAID array cannot be mounted when booting. It is configured to display the confirmation screen by default. To hide the screen, follow the procedure below.

- 1** From Settings, click *Storage*.



- 2** Click the settings icon (⚙️) to the right of “RAID”.

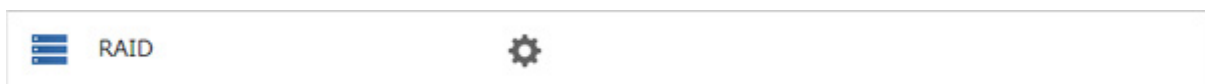

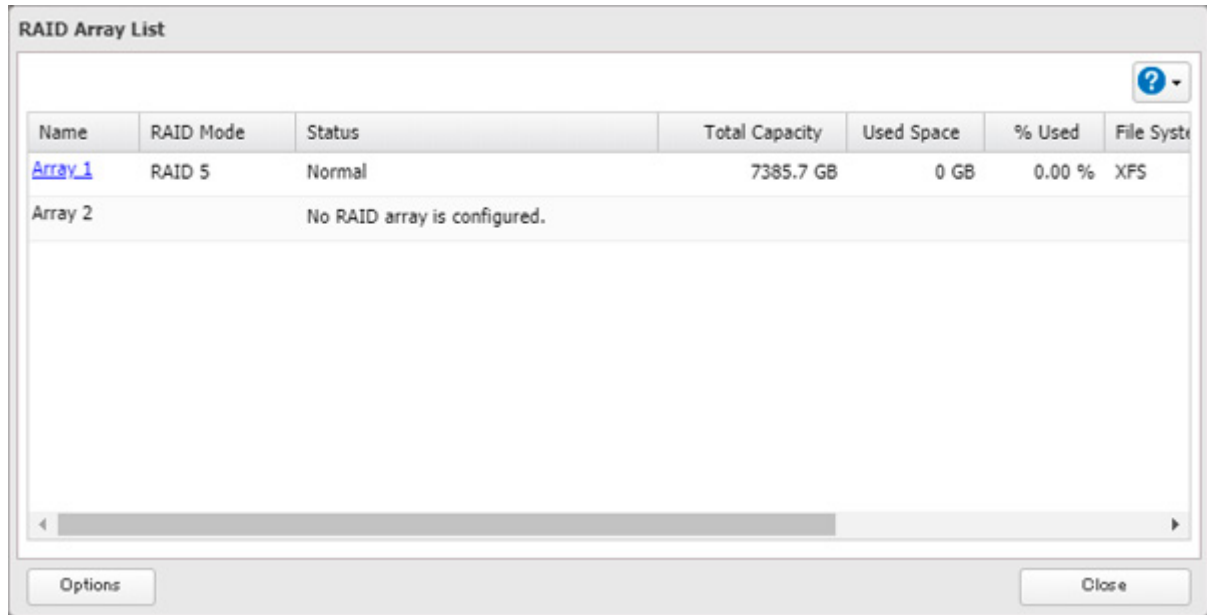
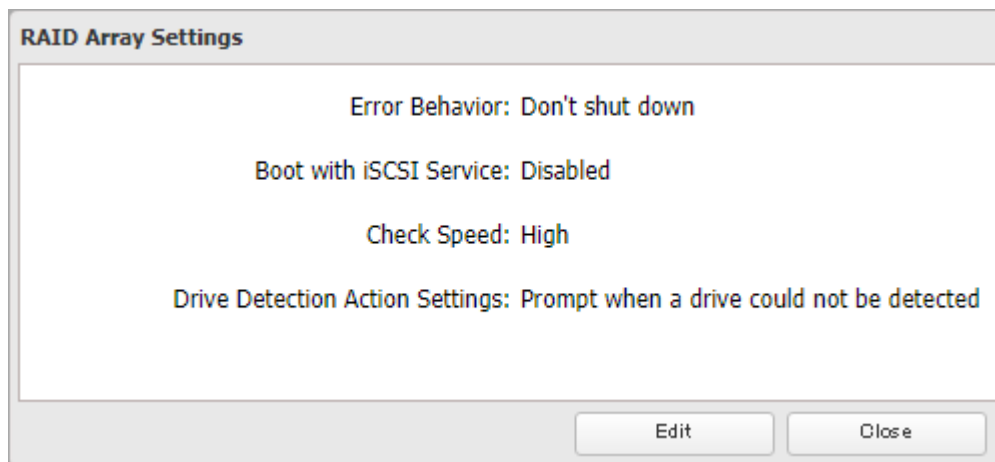
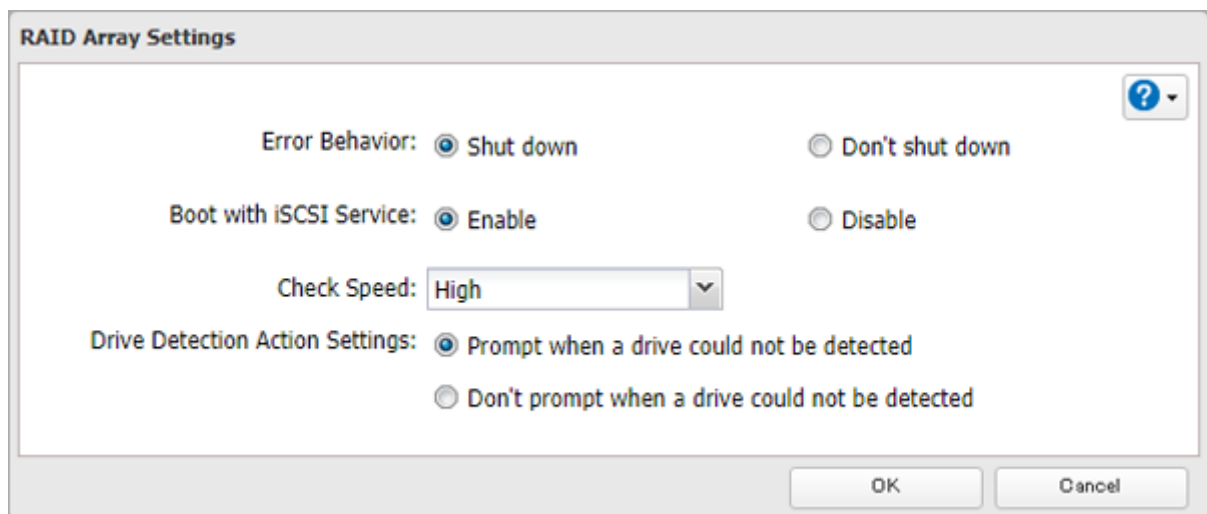
3 Click *Options*.**4** Click *Edit*.**5** Change the "Drive Detection Action Settings" option to "Don't prompt when a drive could not be detected" and click *OK*.

When the confirmation screen is hidden, an undetected drive will automatically be dismounted from the TeraStation and the TeraStation will be in degraded mode if a redundant RAID mode is configured. If RAID 0 is configured, the

RAID array will be corrupted so that data will be lost. It is recommended to proceed without changing settings that make the confirmation screen appear.

Selecting the Action on the Confirmation Screen

When the confirmation screen is displayed, the following screen will appear after logging in to Settings if the drive used for the RAID array could not be mounted. Select the action to run when the screen appears.

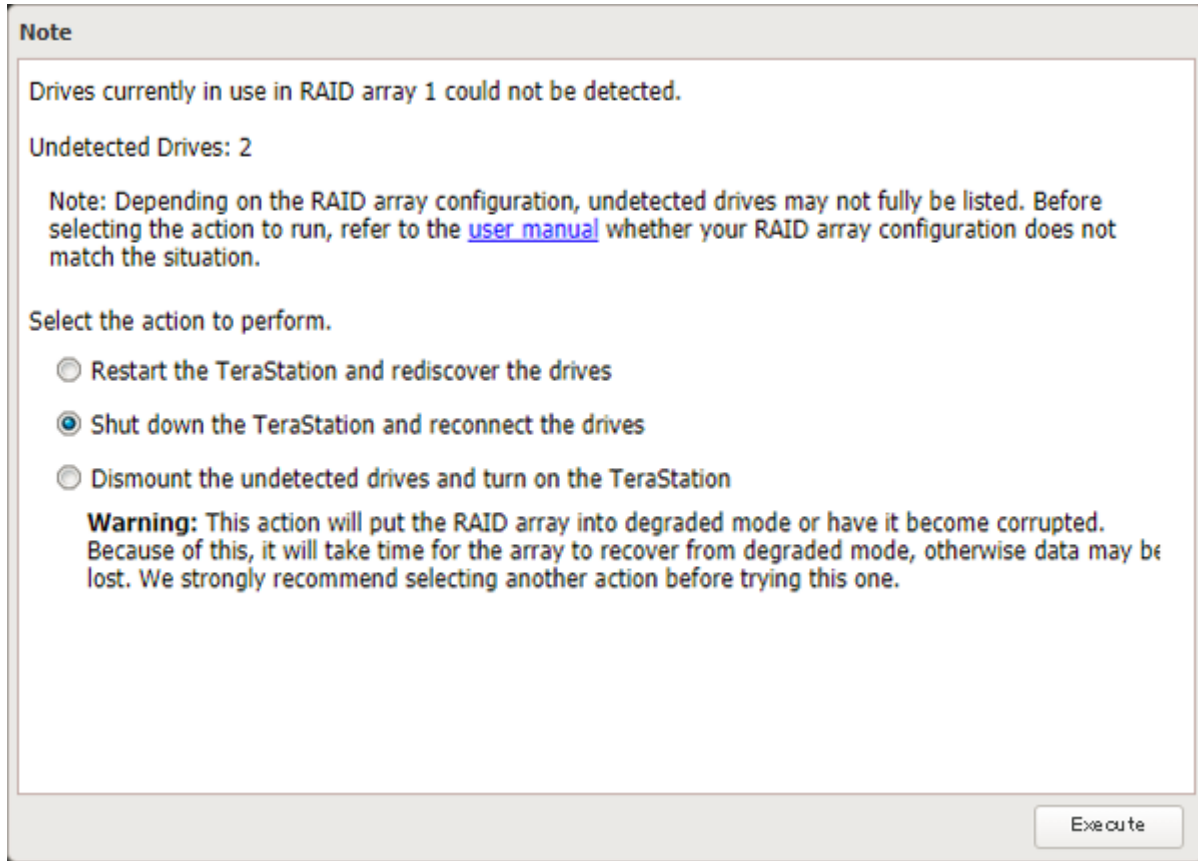

Conditions and Corrective Actions If Undetected Drives Aren't Displayed Properly

Even when you configure the NAS to show the confirmation screen if a drive being used for the RAID array cannot be mounted, undetected drives will not be displayed under the following conditions. If you are using any of the RAID array configurations below, follow the corrective action.

Conditions	Corrective Actions
RAID 10 has been configured.	<ol style="list-style-type: none"> 1 Refer to the “Selecting the Action on the Confirmation Screen” section above on how to access the confirmation screen. 2 Select “Shut down the TeraStation and reconnect the drives” and click <i>Execute</i>. 3 After the TeraStation shuts down, confirm that all drives have been inserted properly. 4 Press the power button to power on the TeraStation. 5 Log in to Settings and make sure the confirmation screen doesn't appear.
Multiple arrays have been configured.	

Configuring a Hot Spare

If you have a hot spare configured and an array fails, the TeraStation immediately switches over to the hot spare. To use a hot spare, you need a RAID 1 or RAID 5 array and an extra drive that's not part of an array.

Notes:

- All data on the hot spare drive is deleted when it is configured as a hot spare and again when it changes from a spare to a drive in the array.
- A hot spare cannot be configured for TeraStation models with only two drives included.

1 From Settings, click *Storage*.



2 Click the settings icon (⚙️) to the right of "RAID".



3 Choose a RAID array.

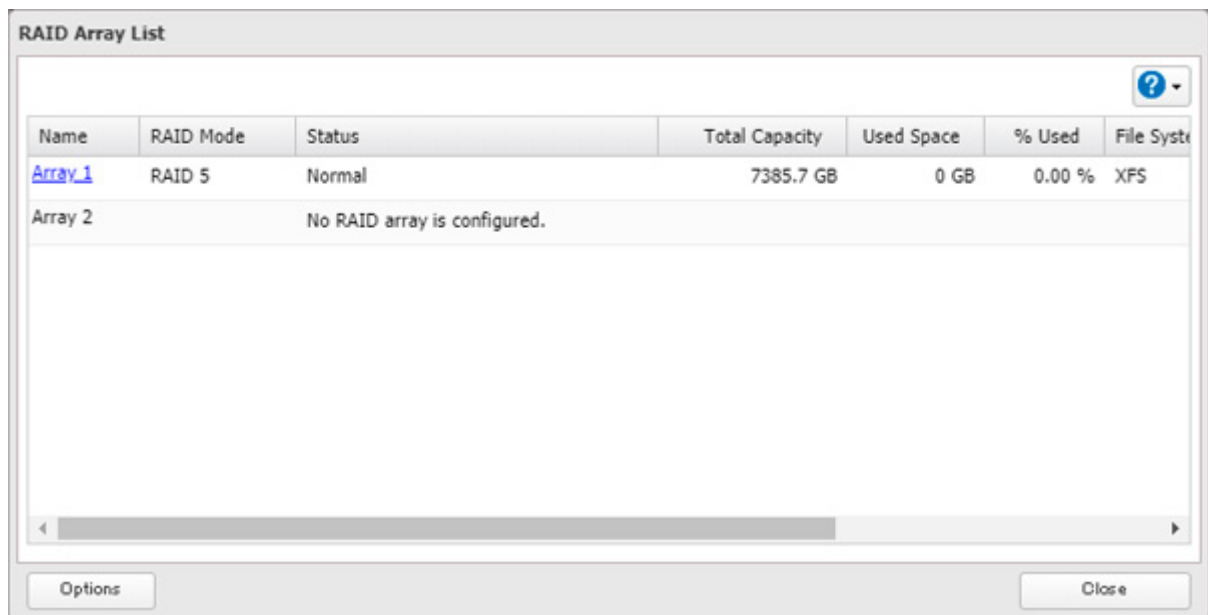

4 Click *Set as a hot spare*.

Array 1

Current RAID Mode: RAID 1

New RAID Mode: RAID 1

Change at least one setting.

Select the drive to add to a RAID array.

Drive	Status	Model	Shared Folder	Size	Spare Drive
<input checked="" type="checkbox"/> Drive 1	Array 1 / Normal	WDC WD40EFRX-68W	-	3694 GB	-
<input checked="" type="checkbox"/> Drive 2	Array 1 / Normal	WDC WD40EFRX-68W	-	3694 GB	-
<input type="checkbox"/> Drive 3	Normal	WDC WD40EFRX-68W	-	3692.1 GB	Set as a hot spare
<input type="checkbox"/> Drive 4	Normal	WDC WD40EFRX-68W	-	3692.1 GB	Set as a hot spare

Select All Deselect All

Delete RAID Array Change RAID Array Cancel

5 Click Yes.**6** The “Confirm Operation” screen will open. Enter the confirmation number, then click *OK*.**7** Click *OK* when completed.

Note: To turn the hot spare back to a normal drive, choose *Set as a normal drive*.

Expanding RAID Capacity Without Deleting Data

You can create or expand a RAID array without erasing data on the drive by using RMM (RAID Mode Manager). If using a TeraStation model whose drives are not fully installed into the slots, such as the TS3410DN TeraStation model with two drives included, follow the procedure to add a new drive first. Otherwise, refer to the procedures in this section to configure the RAID array. The following examples use the case of the TS3410DN TeraStation model.

Adding a Drive

The procedure for adding a new drive will vary depending on your device.

1 Open the front cover with the included key.**2** Push the drive’s unlock button for the empty slot and swing the lock mechanism out.**3** Pull out the drive cartridge and remove it from the TeraStation.**4** Insert the new drive (sold separately) into the empty slot with the lock mechanism remaining open and swing the lock back down until it clicks into place.**5** Close the front cover.**6** When the drive is recognized, the status LED will flash red and the I32 message will appear on the Dashboard in Settings and NAS Navigator2.

7 From Settings, click *Storage*.



8 Click the settings icon () to the right of “Drives”.



9 Select the inserted new drive and click *Format Drive*.

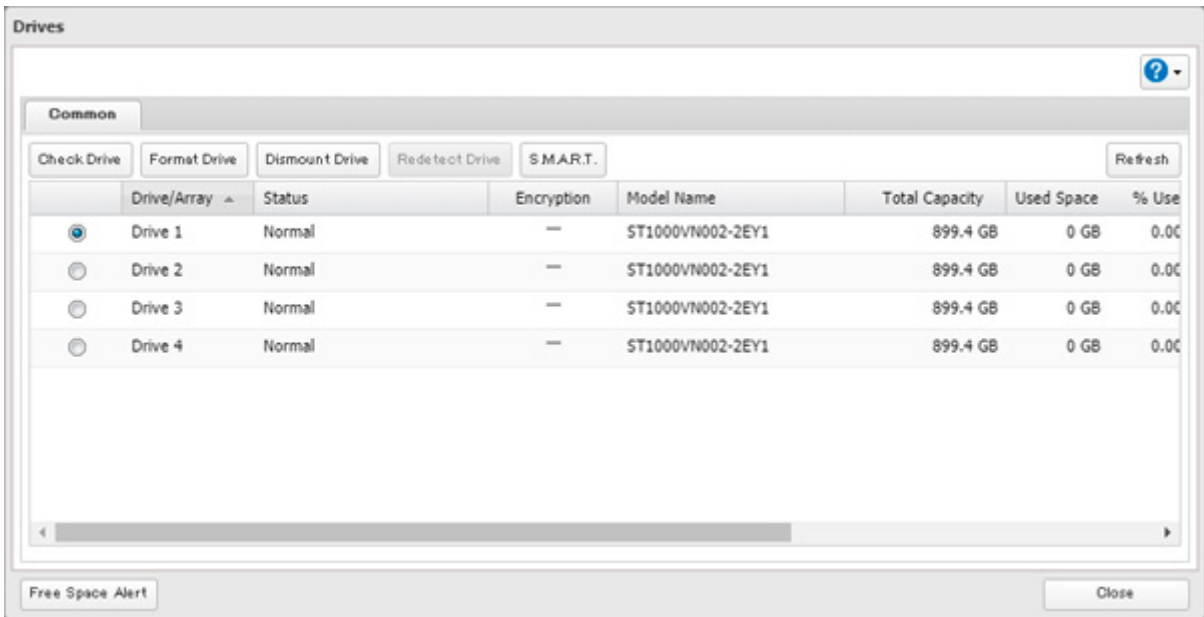

10 Select a format type and click *Format*.

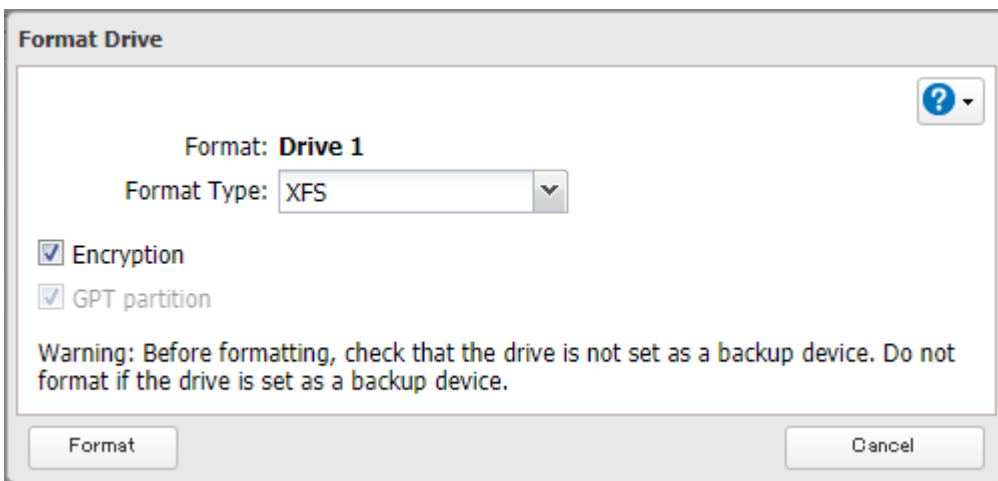

11 The “Confirm Operation” screen will open. Enter the confirmation number, then click *OK*.

12 Click *OK* when completed.

Drives Are Currently in JBOD

If the drives are currently in JBOD (not in a RAID array), you may change it to a RAID 1 array. To create the RAID 1 array using RMM, you must have at least two drives available in JBOD.

1 From Settings, click *Storage*.



2 Click the settings icon (⚙️) to the right of "RAID".



3 Choose a RAID array.

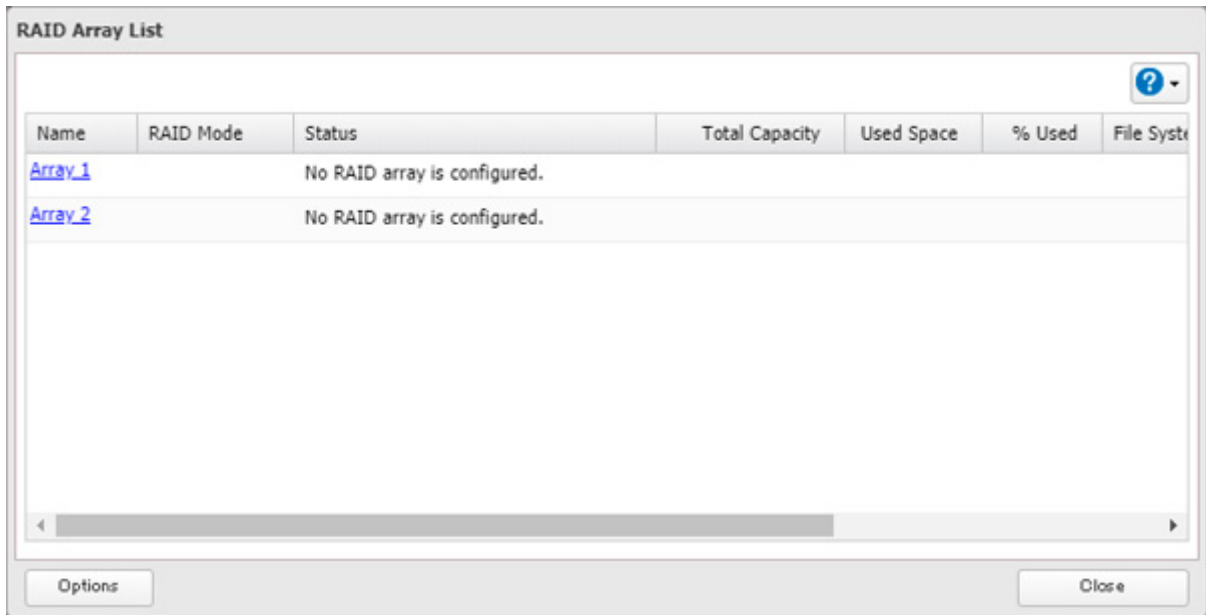

4 Set the RAID mode to "RAID 1".

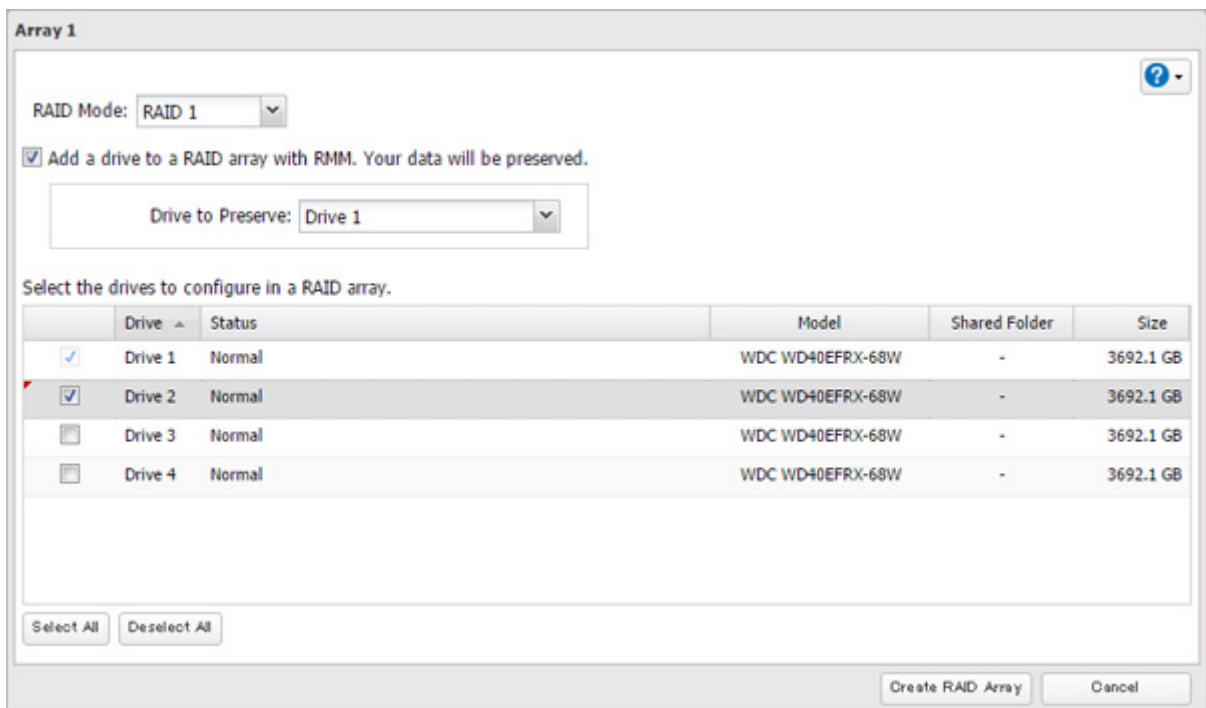

5 Select the "Add a drive to a RAID array with RMM. Your data will be preserved." checkbox.

- 6 Select the drive whose data will be saved from the drop-down list.
- 7 Select the drive to add to the RAID array.
- 8 Click *Create RAID Array*.
- 9 The “Confirm Operation” screen will open. Enter the confirmation number, then click *OK*.
- 10 Click *OK* when completed.

Drives Are Currently in RAID 1 or RAID 5

If the drives are currently in a RAID 1 or RAID 5 array, you can use RMM to add drives to the RAID array, then change the RAID mode.

Note: RMM can be used to expand an array by only one drive per operation. To expand by two or more drives, RMM must be activated multiple times. For example, if you want to create a RAID 6 array by adding two drives, change the RAID mode to RAID 5 first using one drive, then change it to RAID 6 using another drive.

- 1 From Settings, click *Storage*.



- 2 Click the settings icon () to the right of “RAID”.



- 3 Choose a RAID array.

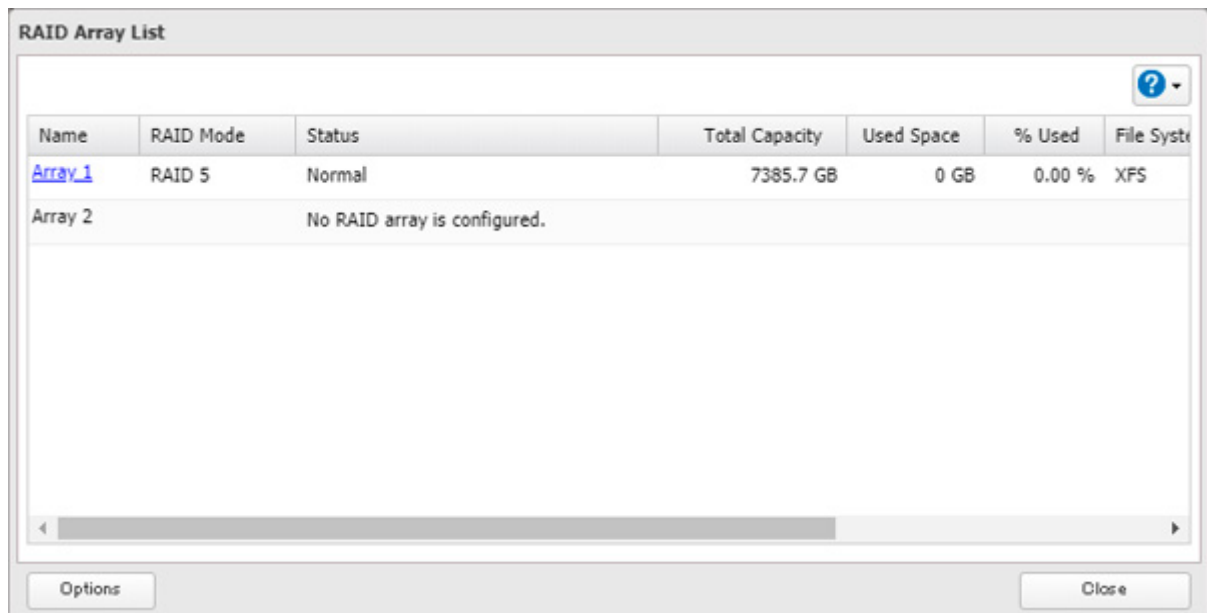

- 4** Select one drive to add to the RAID array. If changing the RAID mode, choose the desired mode for the array from the drop-down list. Otherwise, keep the current RAID mode as is.

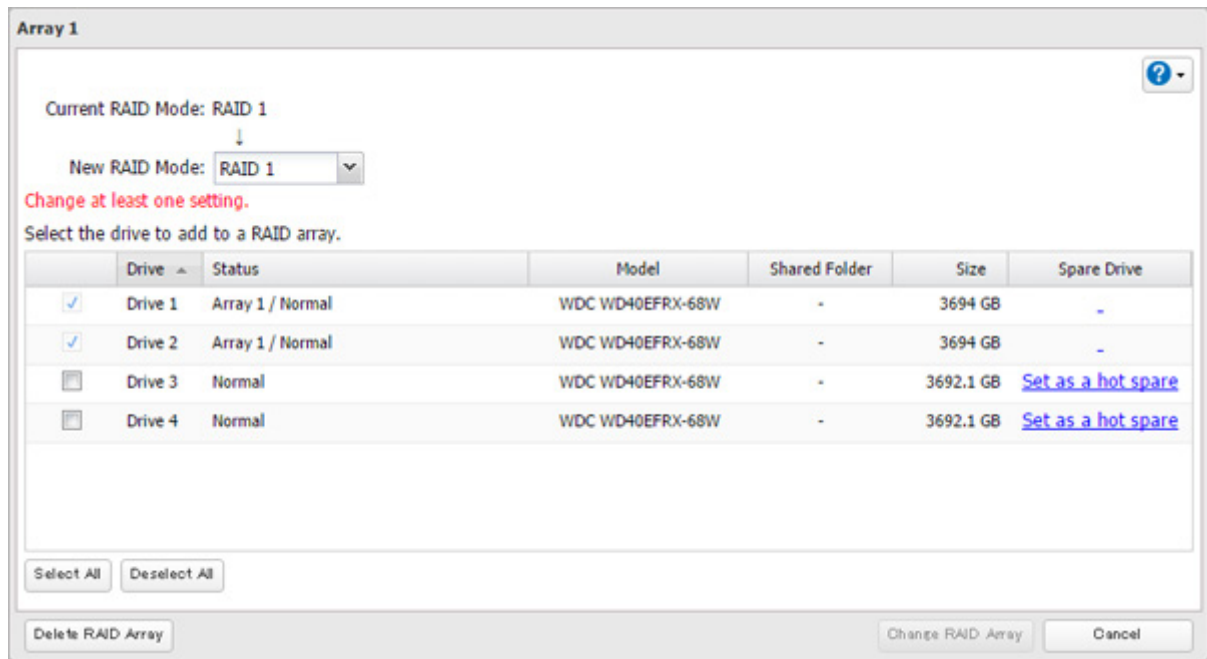

- 5** Click *Change RAID Array*.
- 6** The “Confirm Operation” screen will open. Enter the confirmation number, then click *OK*.
- 7** Click *OK* when completed.

RAID Scanning

A RAID scan checks your RAID array for bad sectors and if it finds any, it automatically repairs them. Arrays other than RAID 0 are supported. For best results, run a RAID scan regularly.

- 1** From Settings, click *Storage*.



- 2** Move the RAID scanning switch to the  position to enable RAID scanning.

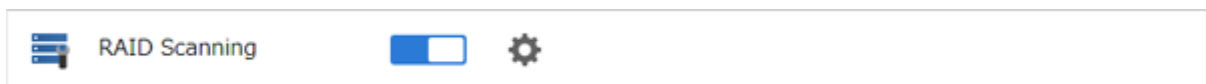

- 3** Click the settings icon () to the right of “RAID Scanning”.

- 4** Click *Edit*.

5 Select when to run the scan and click *OK*.

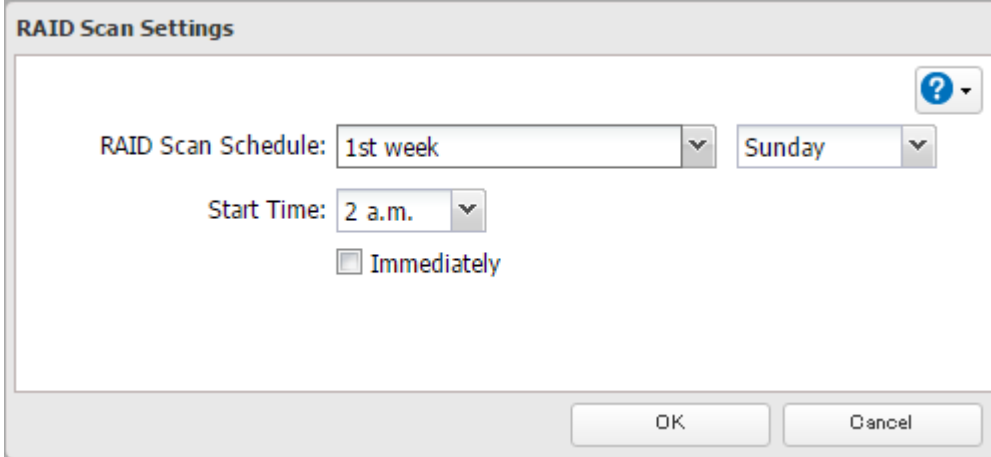

The image shows a dialog box titled "RAID Scan Settings". It contains the following elements:

- A help icon (question mark in a blue circle) in the top right corner.
- A label "RAID Scan Schedule:" followed by two dropdown menus. The first dropdown is set to "1st week" and the second is set to "Sunday".
- A label "Start Time:" followed by a dropdown menu set to "2 a.m.". Below this is a checkbox labeled "Immediately", which is currently unchecked.
- At the bottom of the dialog are two buttons: "OK" and "Cancel".

Notes:

- Select the "Immediately" checkbox to run a RAID scan immediately.
- To stop a RAID scan, click *Cancel RAID Scan*.

Configuring Low Drive Space Alerts

You can configure the TeraStation to notify you when it is running low on free space, either by having a message displayed on the Dashboard in Settings or having the TeraStation send you an email notification. This function is applicable to internal drives, RAID arrays, and NAS volumes on the TeraStation.

Note: If you have configured low drive space alerts and created iSCSI volumes on the LVM-enabled area, the I65 message will appear on the Dashboard in Settings and NAS Navigator2.

1 From Settings, click *Storage*.



2 Click the settings icon () to the right of "Drives".

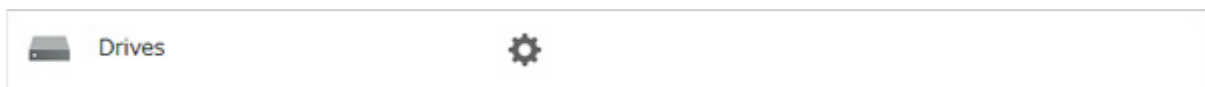

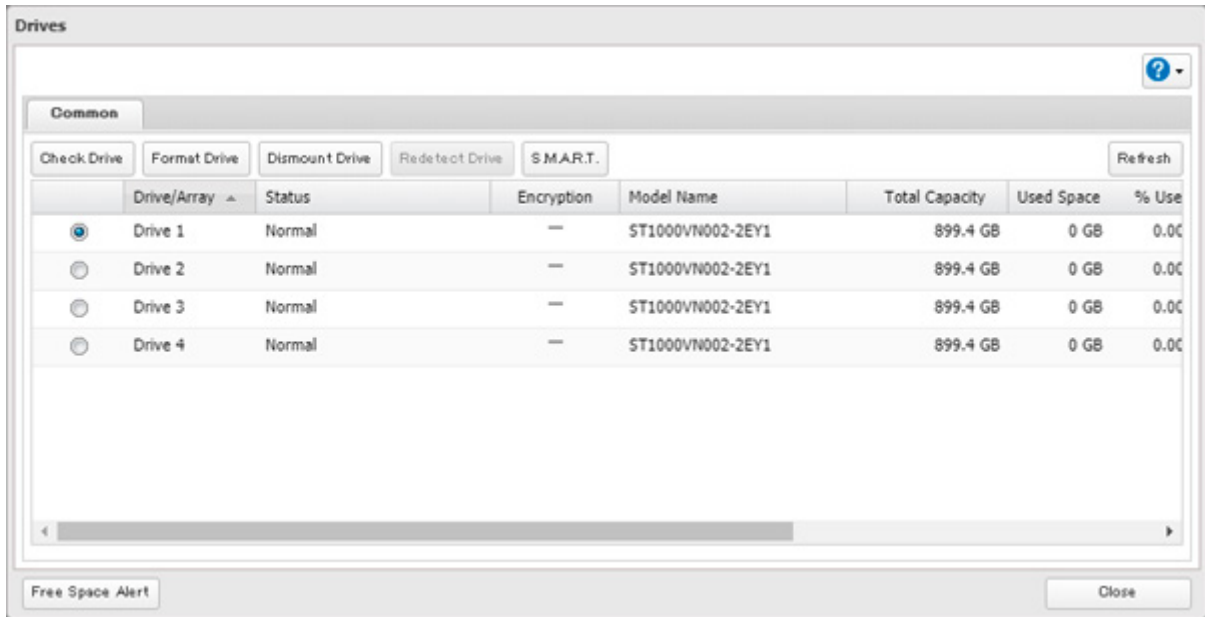
3 Click *Free Space Alert*.**4** Change the “Free Space Alert” option to “Enable” and enter the threshold value, then click *OK*. If the percentage of remaining free space on the TeraStation decreases past the threshold percentage, a notification will appear on the Dashboard in Settings.

The free space alert will be enabled. To configure free space alert email notifications, refer to the [“Email Notification”](#) section in chapter 7.

Adding an External Drive

Connecting an External Drive

Your TeraStation features USB ports (the number of available ports will depend on your model), and you can connect external drives to these ports. Once connected, they appear as shared folders on the TeraStation. Formatted drives are detected automatically. Unformatted drives should be formatted in Settings.

After a USB drive is recognized, the TeraStation adds “usbdisk x” to the shared folder list, where “x” is the USB port to which the drive is connected.

Compatibility

Supported file systems for external USB drives are below:

File Systems	Recommended Situation
XFS	Connecting to another Buffalo NAS device.
Ext3	Connecting to another Buffalo NAS device that is a TS-X or older model.
NTFS*	Connecting to Windows computers. The NTFS-formatted drive can use many more functions of the operating system than an exFAT drive.
HFS Plus*,**	Connecting to macOS computers. The HFS Plus-formatted drive can use many more functions of the operating system than an exFAT drive.
exFAT†	Connecting to both Windows and macOS computers.
FAT32	Connecting to both Windows and macOS computers.

*This cannot be formatted from Settings.

**This is read-only from the TeraStation. Files on the USB drive can be copied to the TeraStation.

Make sure only one device is connected to a USB port on the TeraStation. Note that only the first partition of a connected USB drive is mounted. Additional partitions are not recognized.

Notes:

- If your USB 3.0 drive is not reconfigured after rebooting the TeraStation, unplug and reconnect it.
- When copying a file that is over 100 MB to a FAT32-formatted USB drive using File Explorer, an error message may appear. In such a case, use an FTP or SFTP connection to copy the file.
- When copying files from a shared folder to a FAT32-formatted USB drive, the progress bar may not be displayed or the file copying may fail. Using a file system other than FAT32 is recommended for the USB drive.
- After connecting an RDX drive to the TeraStation, click *Redetect Drive* anytime.

Dismounting Drives

If the TeraStation is powered on, dismount drives (internal and external) before unplugging them. You may dismount external drives using the function button, or dismount any drive from Settings. If the TeraStation is off, then all drives are already dismounted and may be unplugged safely.

Notes:

- Do not dismount internal drives while a RAID array is rebuilding or RMM is being configured. If you do, data on the drives may be lost.
- To dismount an RDX cartridge from an RDX dock, first perform the dismount process either using the function button or from Settings, then press the eject button on the dock to disconnect the cartridge.

Dismounting Using the Function Button

When you press the function button, the TeraStation will beep once. Press and hold down the button until the TeraStation beeps again and the button starts blinking blue. It will take about six seconds. When the function button stops blinking and returns to glowing, the dismount is finished. You may now unplug any USB drives safely. After 60 seconds, the function button will go out and any drives that have not yet been unplugged will be remounted.

Dismounting from Settings

- 1 From Settings, click *Storage*.



- 2** Click *Drives* to dismount an internal drive or *USB Drives* to dismount an external drive.

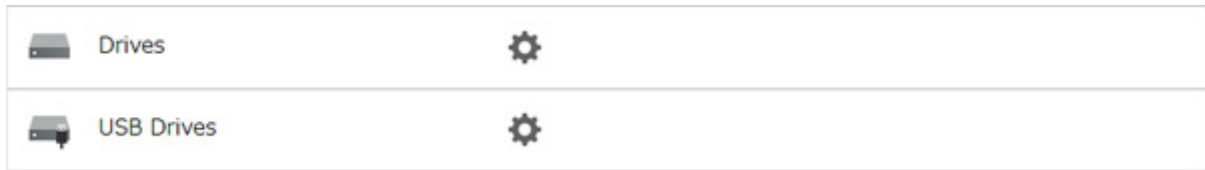

- 3** Select the drive to dismount and click *Dismount Drive*.

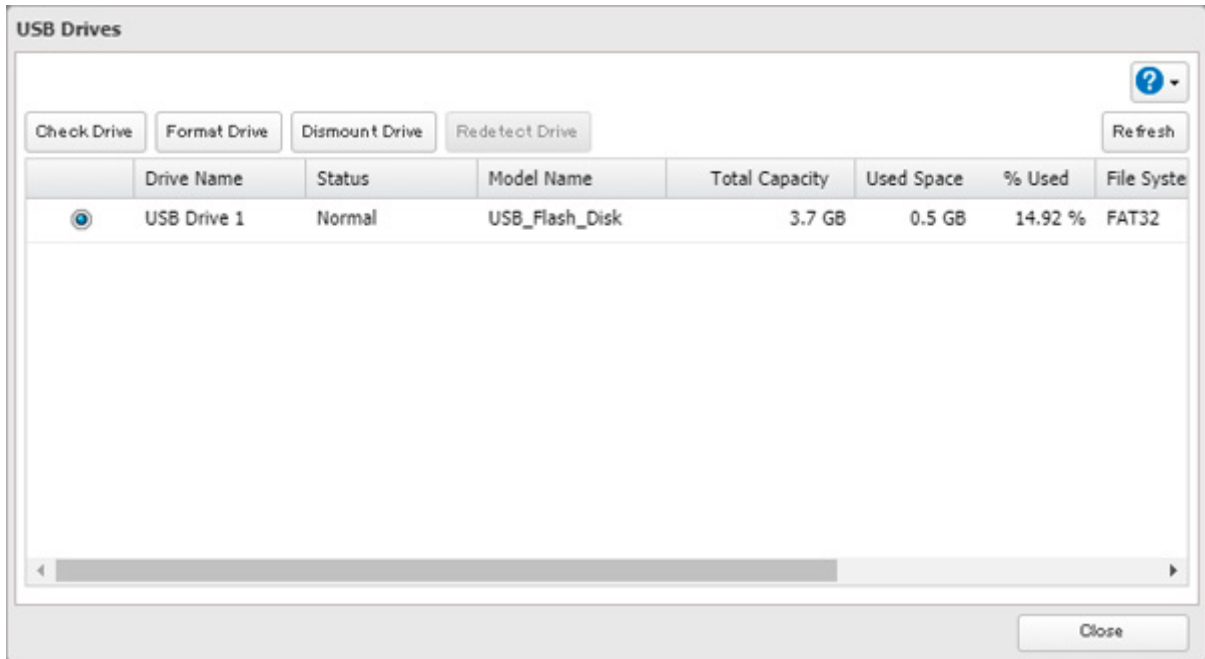

- 4** The “Confirm Operation” screen will open. Enter the confirmation number, then click *OK*.
- 5** When the dismounting process is completed, it is safe to unplug the drive. Disconnect the drive from the TeraStation.

Note: To remount the drive, unplug it and then plug it back in.

Checking Drives

A drive check tests the data on a drive on the TeraStation or one that is connected via USB for integrity. Errors are fixed automatically. With large drives, a drive check may run for many hours. Shared folders cannot be accessed during a drive check. Do not turn off the TeraStation until the drive check is finished. Use the procedure below to run a drive check.

- 1** From Settings, click *Storage*.



- 2 Click *Drives* to check an internal drive or *USB Drives* to check an external drive.



- 3 Select the drive or array to test, then click *Check Drive*.

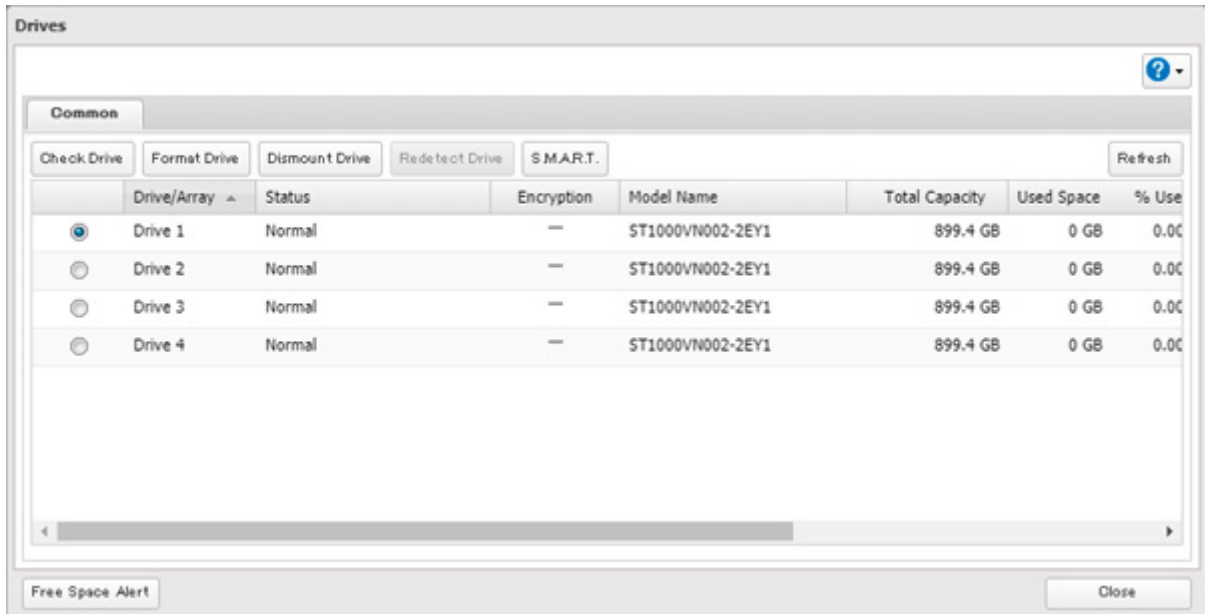

- 4 Click *Check*. You have the option of deleting information files from macOS during the check if desired.

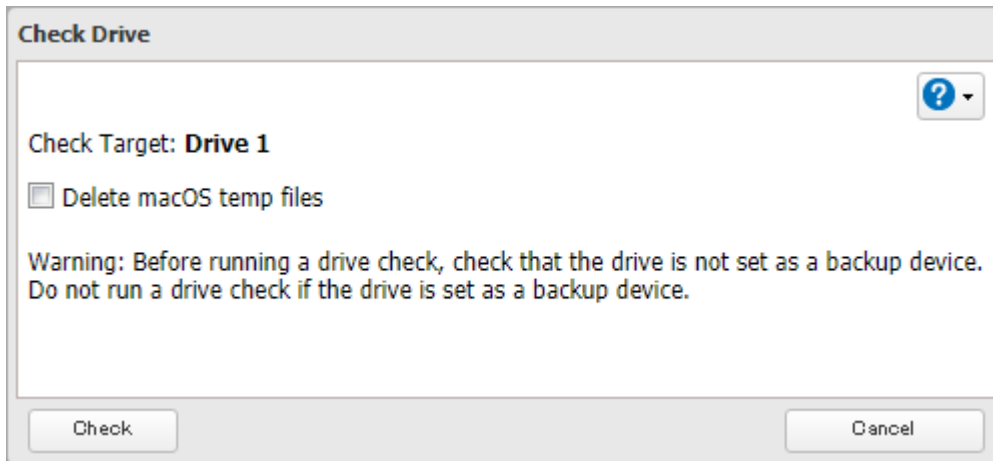

S.M.A.R.T.

S.M.A.R.T. (Self-Monitoring, Analysis, and Reporting Technology) monitors internal drives to detect and report various indicators of reliability, in the hope of anticipating failures. If S.M.A.R.T. informs you of impending drive failure, you may choose to replace the drive to avoid outages and possible data loss. Follow the procedure below to check S.M.A.R.T. information for the TeraStation's internal drives.

Note: S.M.A.R.T. information is only available for internal drives.

Displaying S.M.A.R.T. Information

1 From Settings, click *Storage*.



2 Click the settings icon (⚙️) to the right of "Drives".



3 Select a drive to check and click *S.M.A.R.T.*

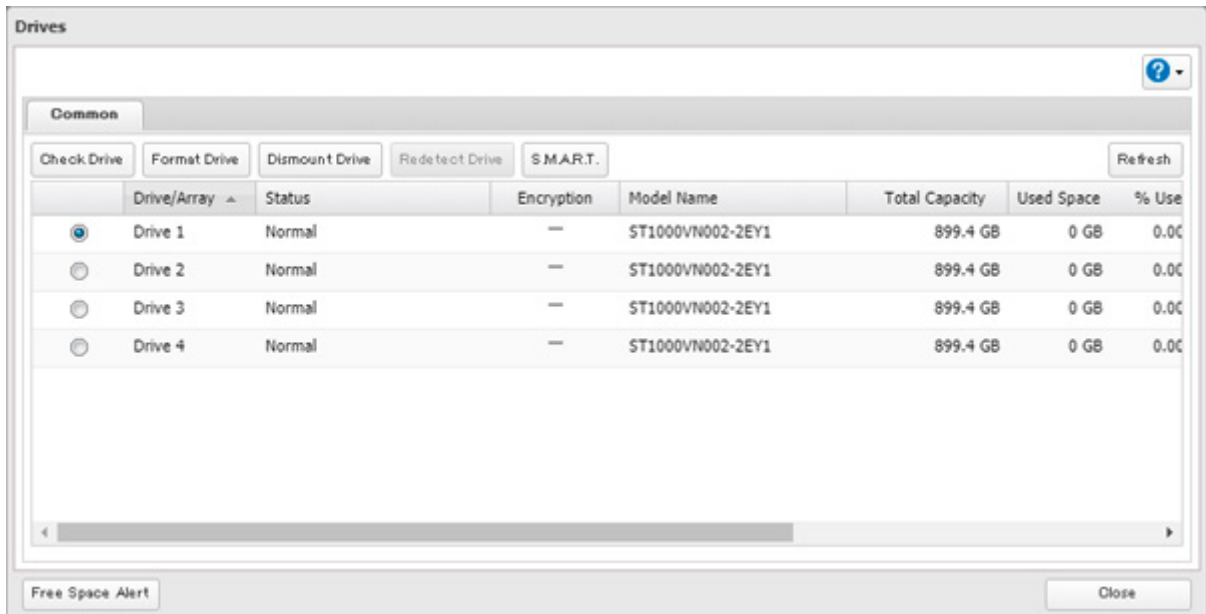

- 4** The S.M.A.R.T. information for the drive will be displayed. Different information may be displayed depending on the brand of drives on your TeraStation. Critical attributes are displayed in bold.

S.M.A.R.T.

Drive 1

Model: ST1000VN000-1HJ162 Serial Number: W513BYVB
 Capacity: 1,000,204,886,016 bytes [1.00 TB] Firmware Version: SC60

Filter: X

ID	Attribute	Status	Current Value	Worst Value	Threshold Value	Raw Value
1	Raw_Read_Error_Rate	OK	117	100	6	123486608
3	Spin_Up_Time	OK	96	96	0	0
4	Start_Stop_Count	OK	100	100	20	147
5	Reallocated_Sector_Ct	OK	100	100	10	0
7	Seek_Error_Rate	OK	71	60	30	13087519
9	Power_On_Hours	OK	96	96	0	3742
10	Spin_Retry_Count	OK	100	100	97	0
12	Power_Cycle_Count	OK	100	100	20	147
184	End-to-End_Error	OK	100	100	99	0
187	Reported_Uncorrect	OK	100	100	0	0
188	Command_Timeout	OK	100	100	0	0

Close

Checking the Drive Condition

Attributes with the worst value that is equal to or less than the threshold value may be significant. If an attribute reports a failure, or has had one in the past, it will be displayed in the status column. In such a case, replacing that drive is recommended.

Formatting Drives

Note: Under some circumstances, data deleted when a drive is formatted can be recovered. To ensure that data is “gone forever”, a format might not be sufficient. Refer to the [“Erasing Data on the TeraStation Completely”](#) section below.

- 1** From Settings, click *Storage*.



- 2** Click *Drives* to format an internal drive or *USB Drives* to format an external drive.

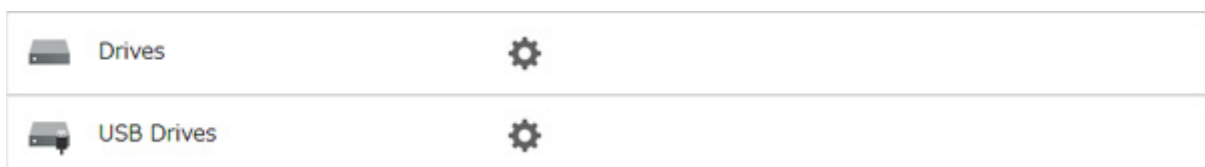

3 Select the drive or array to format, then click *Format Drive*.

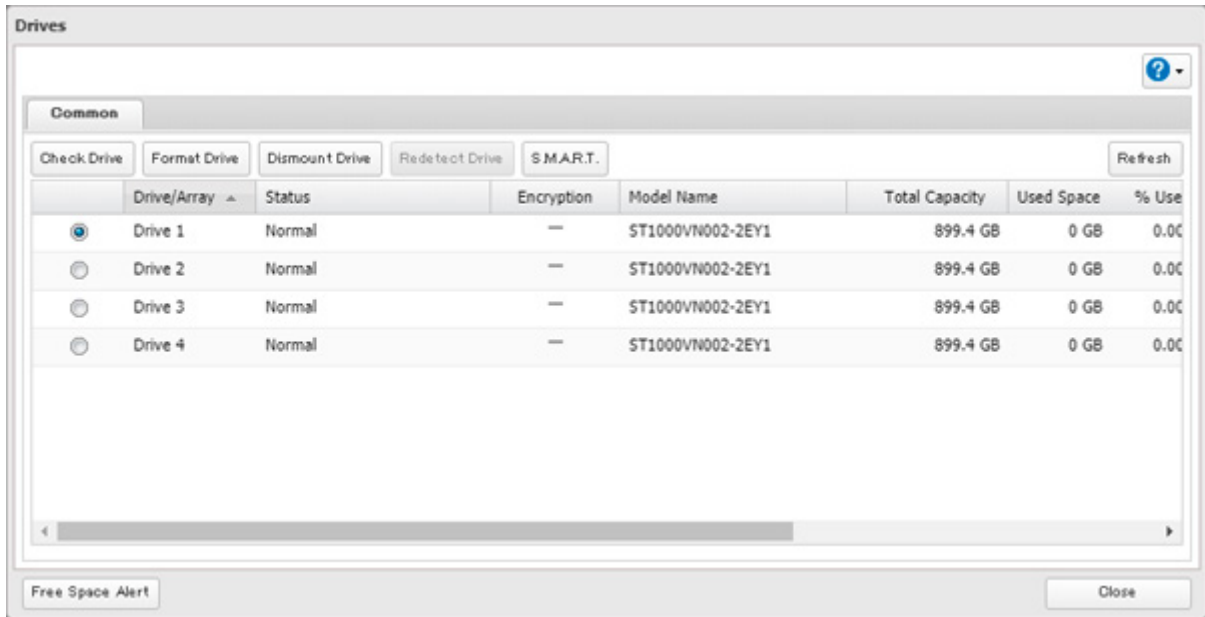

4 Select a format type, then click *Format*.

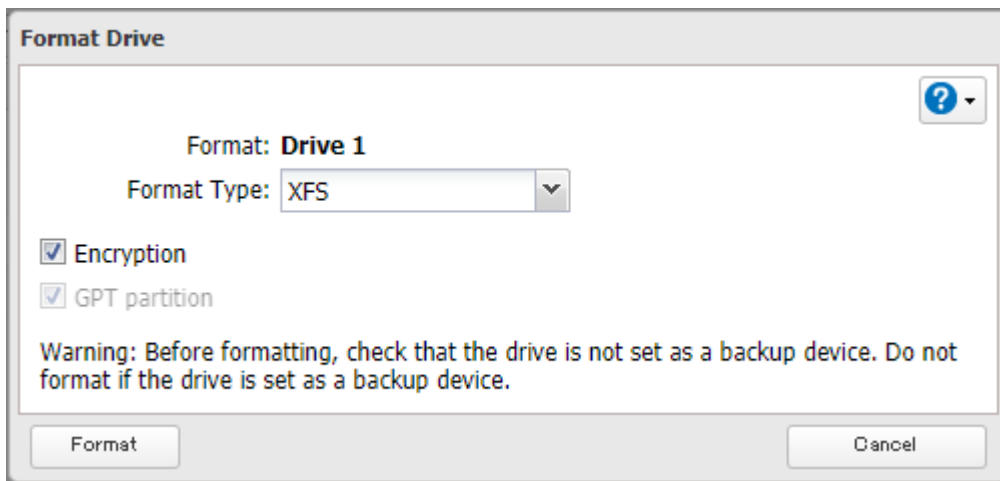

5 The “Confirm Operation” screen will open. Enter the confirmation number, then click *OK*.

6 Depending on the size and the formatted file system of your drive, the format may take several minutes or several hours to complete. The I20 message for drives or the I28 message for USB drives will appear on the Dashboard in Settings and NAS Navigator2 until the format is completed. Click *OK* when completed.

Notes:

- Do not turn off or disconnect power to the TeraStation while formatting a drive.
- For drives that are 2.2 TB or larger, make sure that the “GPT partition” checkbox is selected.

Encrypting Drives

Internal drives (and arrays) can be encrypted with 256-bit AES during formatting. Encrypted drives and arrays are then readable only from that specific TeraStation. To decrypt a drive or array, clear the “Encryption” checkbox and format it again.

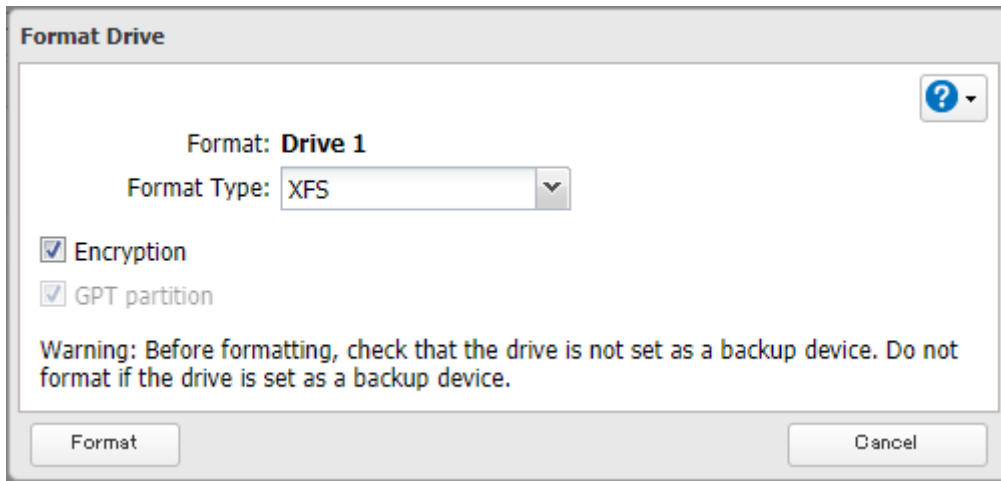

Erasing Data on the TeraStation Completely

Under some circumstances, data from formatted drives can be recovered. The drive erasure process in this section does a much more thorough job of erasing data. This procedure is recommended for removing all data from a drive in a way that makes it nearly impossible to recover with current tools. The TeraStation will then be in the following state:

- All drives in JBOD
- An empty shared folder on each drive
- All settings returned to their default values
- All logs deleted

If you remove a drive and then erase all data on the TeraStation, the Dashboard in Settings and NAS Navigator2 will display the E22 error and the number of the removed drive. You can still use the TeraStation.

Follow the procedure below to completely and permanently erase all data from your TeraStation.

- 1 From Settings, click *Management*.

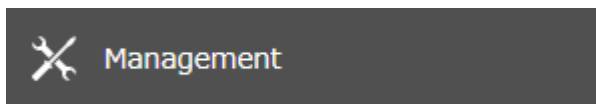

- 2 Click the settings icon (⚙️) to the right of "Restore/Erase".



- 3 Click *Erase TeraStation*.

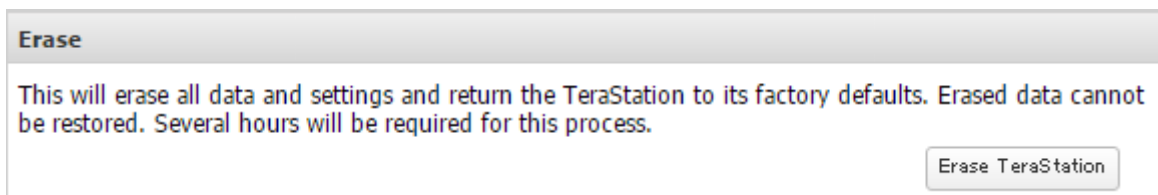

- 4 The "Confirm Operation" screen will open. Enter the confirmation number, then click *OK*.

- 5 All data on the TeraStation will be permanently erased.

Quotas

You can set a quota for each user or group as well as a threshold alert where you will receive an email notification if the space used exceeds the configured threshold. To configure email notifications for the quota, refer to the [“Email Notification”](#) section in chapter 7.

Notes:

- When using quotas, disable the recycle bin or empty the trash folder often. The limited space includes the space used for trash.
- Quotas apply per drive or per array. If a quota is set to 1 GB, each array or drive can use a maximum of 1 GB.
- Quotas cannot be set for external drives connected to the TeraStation.
- If both user and group quotas are configured for a user, the most restrictive quota will always apply.
- When joined to a domain, only local users and groups will be able to set quotas. Domain users and groups will be able to configure access restrictions for shares but cannot set quotas.

Quotas for Users

Follow this procedure to limit the shared folder space available for a user.

- 1 From Settings, click *File Sharing*.

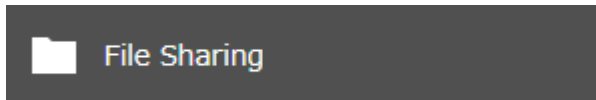

- 2 Click the settings icon () to the right of “Users”.

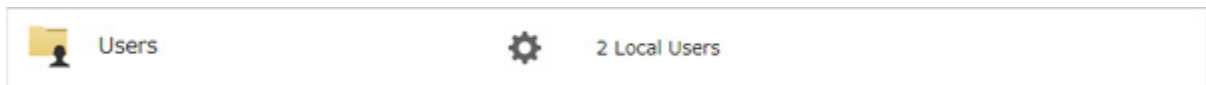

- 3 Select the user that will be given a quota and click *Edit*. If you want to set a quota for a new user, create a user by referring to the [“Adding a User”](#) section in chapter 3.

- 4 Enable quotas, choose the alert and the maximum amount of space the user will be allowed to use, and click *OK*.

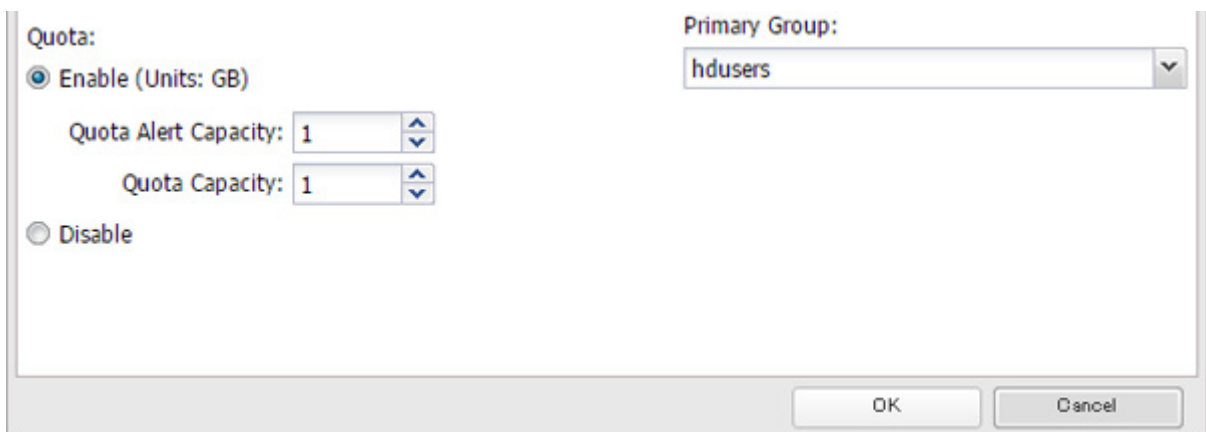

Note: If you change the primary group, restart the TeraStation to apply the quota settings.

Quotas for Groups

Follow the procedure below to limit the space for shared folders that each group can use.

- 1 From Settings, click *File Sharing*.

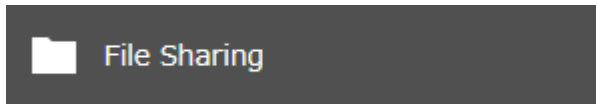

- 2 Click the settings icon () to the right of "Groups".

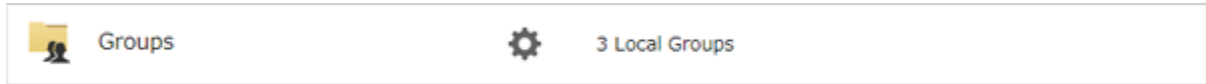

- 3 Select the group that will be given a quota and click *Edit*. If you want to set a quota for a new group, create a group by referring to the ["Adding a Group"](#) section in chapter 3.

- 4 Enable quotas, choose the alert and the maximum amount of space the group will be allowed to use, and click *OK*.



- 5 Click *Close*.

- 6 Click the settings icon () to the right of "Users".

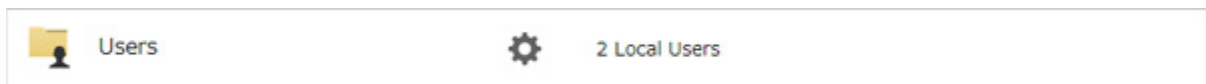

- 7 Select the user that will inherit the group quota settings and click *Edit*. If you want to add a new user to a group with a quota, create a user by referring to the ["Adding a User"](#) section in chapter 3.

- 8 Select the group's checkbox to join and change the user's primary group to the group with the quota, then click *OK*.

- 9 Click *Close*.

- 10 Click  at the top-right of Settings and select *Restart*.

Size Limits

If LVM is enabled, volumes can be created with maximum size limits.

Notes:

- When creating an LVM volume, all data in the area where you specified for the LVM volume will be erased. Before changing any settings, back up any important data.

- Do not use any of the following words for the name of a volume as these words are reserved for internal use by the TeraStation: array x, authtest, disk x, global, homes, info, lost+found, lp, mediacartridge x, msdfs_root, mt-daapd, printers, ram, spool, usbdisk x. Any instances of "x" denote a number (for example: array1 or disk3)

1 From Settings, click *Storage*.



2 Click the settings icon () to the right of "LVM".



3 Select the drive or array where the volume will be located and click *Enable LVM*.

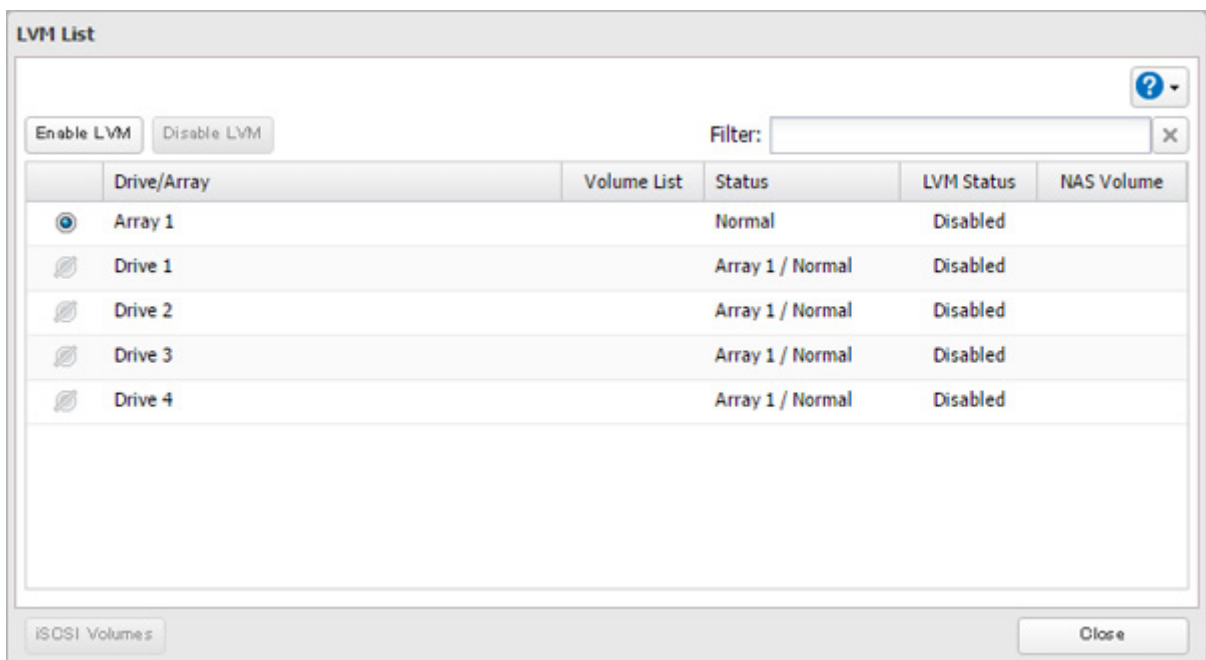

4 The "Confirm Operation" screen will open. Enter the confirmation number, then click *OK*.

5 Click *OK*.

6 Click *Edit* under “NAS Volume”.

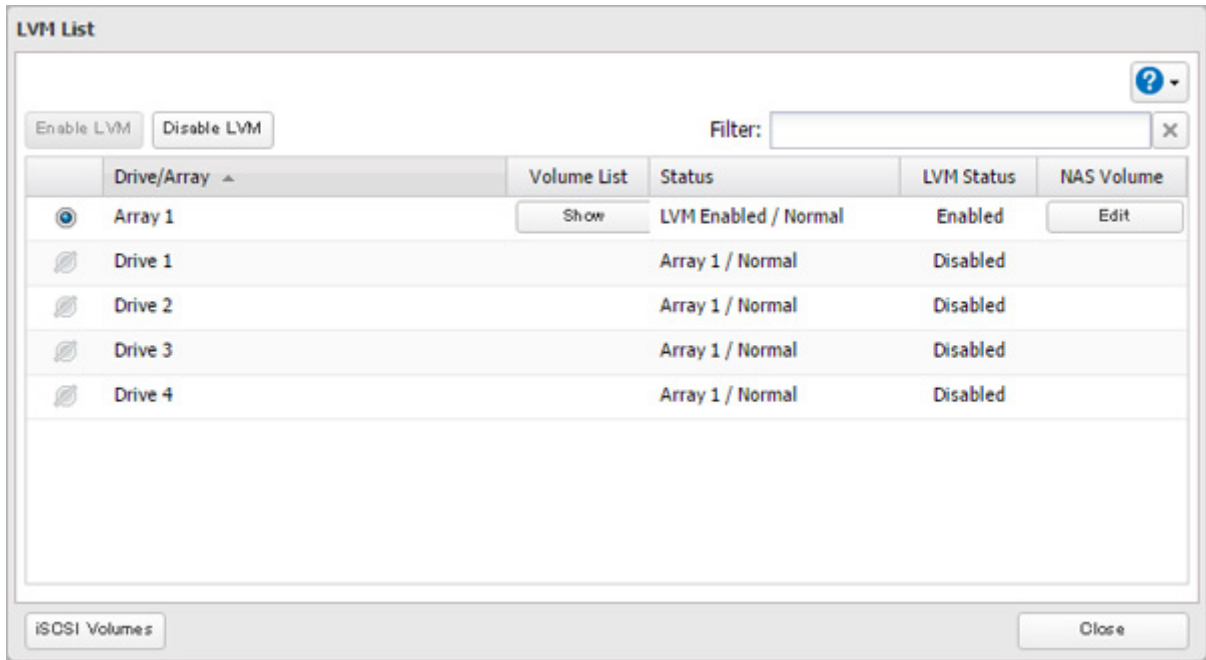

7 Click *Create Volume*.

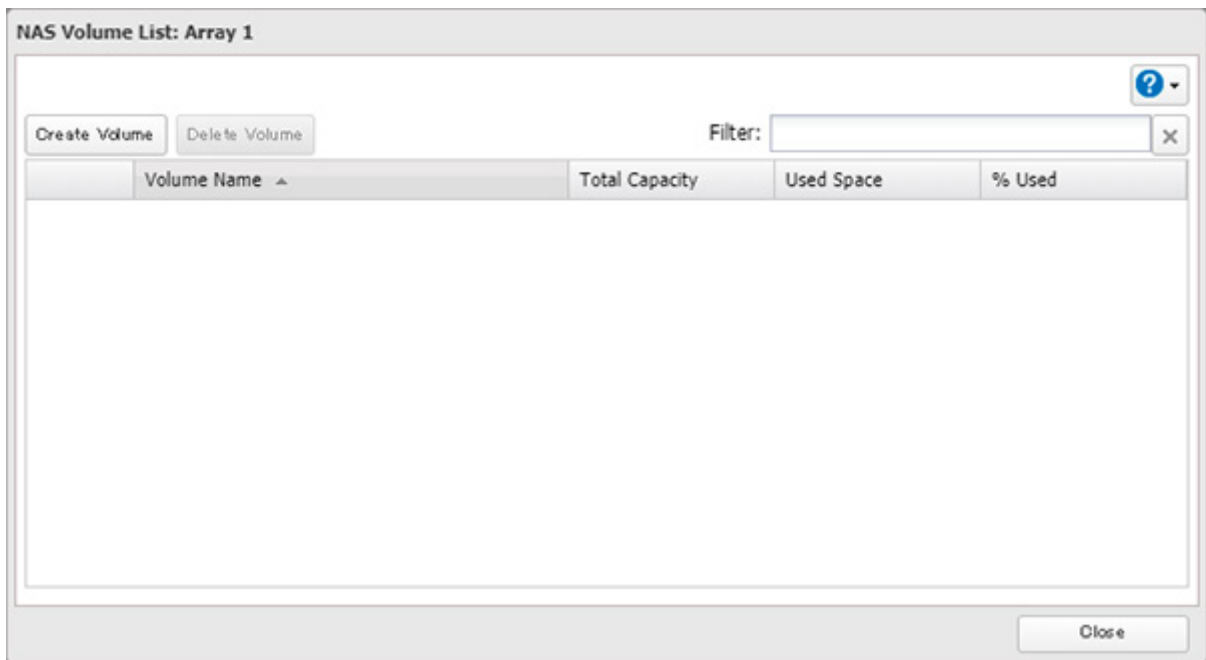

8 Configure the desired settings, then click *OK*.

9 Click *OK*.

10 Click *Close*, then click *Close* again.

11 Navigate to *File Sharing > Folder Setup*.

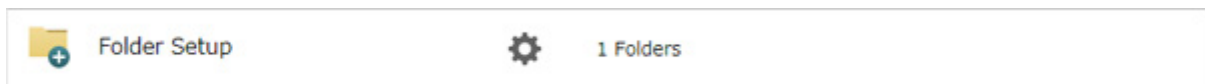

12 Click *Create Folder*.

13 Configure the settings.

14 Select the volume that you created for "Drive/Array" on the *Basic* tab and click *OK*.

Notes:

- If you click *Show* under "Volume List", the volumes will be listed on the screen and you can see if these volumes are being used as iSCSI or NAS.
- If an LVM volume could not be mounted, try restarting the TeraStation. If an issue still exists, delete and recreate the LVM volume. Deleting the LVM volume will erase data on the volume.

Using the TeraStation as an iSCSI Device

Introduction

iSCSI is a protocol for carrying SCSI commands over IP networks. Unlike traditional SAN protocols such as Fibre Channel, which requires special-purpose cabling, iSCSI can be run over long distances using existing network infrastructure. Normal Windows formatting such as NTFS is supported.

Differences Between NAS and iSCSI

With iSCSI, the TeraStation is connected to a single computer, such as a server. Other computers on the network access files on the TeraStation through the computer it's connected to. The TeraStation can be used as a local drive from Windows Server. Features of Windows Server such as Active Directory can be used normally.

As a NAS, the TeraStation is a server, and computers (including other servers) on the network can access shared folders on it directly. A separate server is not required, and features such as backup are built-in.

Network Configuration

Use gigabit or faster network equipment with iSCSI. For best results, a dedicated network for iSCSI is recommended, separate from the regular network. By default, the IP address of the TeraStation is automatically assigned from a DHCP server. However, in this case, if you turn off and restart the TeraStation, the IP address may be changed and the volumes on the TeraStation may not be accessible. To avoid changing the IP address unexpectedly, using a static IP address for the TeraStation is recommended.

Connection Tool

The Microsoft iSCSI Software Initiator is already installed on your computer. You don't need to download and install it.

Creating an iSCSI Volume

To use the TeraStation as an iSCSI drive, create a volume first. Configure the TeraStation as described below.

Notes:

- If the volume settings are changed, all data on the volume will be erased. Before changing any settings, back up any important data.
- The TeraStation can have up to 255 volumes, but we recommend creating no more than 32. Exceeding this volume amount may cause irreparable damage to the unit.
- Do not use any of the following words for the name of a volume as these words are reserved for internal use by the TeraStation: array *x*, authtest, disk *x*, global, homes, info, lost+found, lp, mediacartridge *x*, msdfs_root, mt-daapd, printers, ram, spool, usbdisk *x*. Any instances of “*x*” denote a number (for example: array1 or disk3)

1 From Settings, click *Storage*.



2 Move the iSCSI switch to the  position to enable iSCSI.

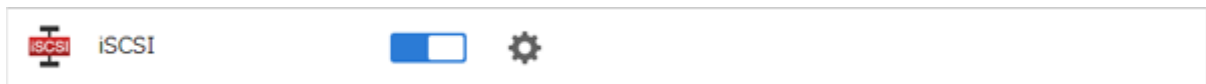

3 Click the settings icon () to the right of “iSCSI”.

4 Click *Create Volume*.

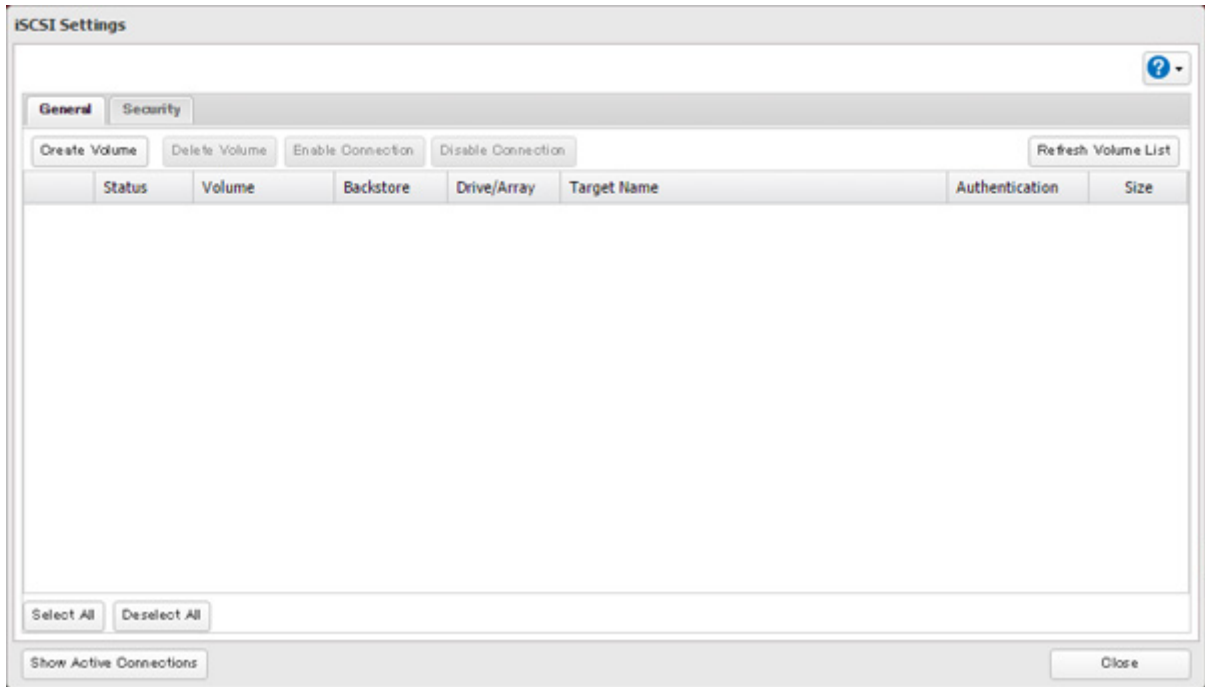

5 Enter a volume name, volume description, drive or array where a volume will be created, and volume size. Click *OK* when completed.

If you enabled LVM for the target drive or array, or selected “File I/O” for the “Backstore” option, the volume size that you specify here can be changed later. To change the volume size, refer to the [“Expanding Volume Sizes”](#) section below.

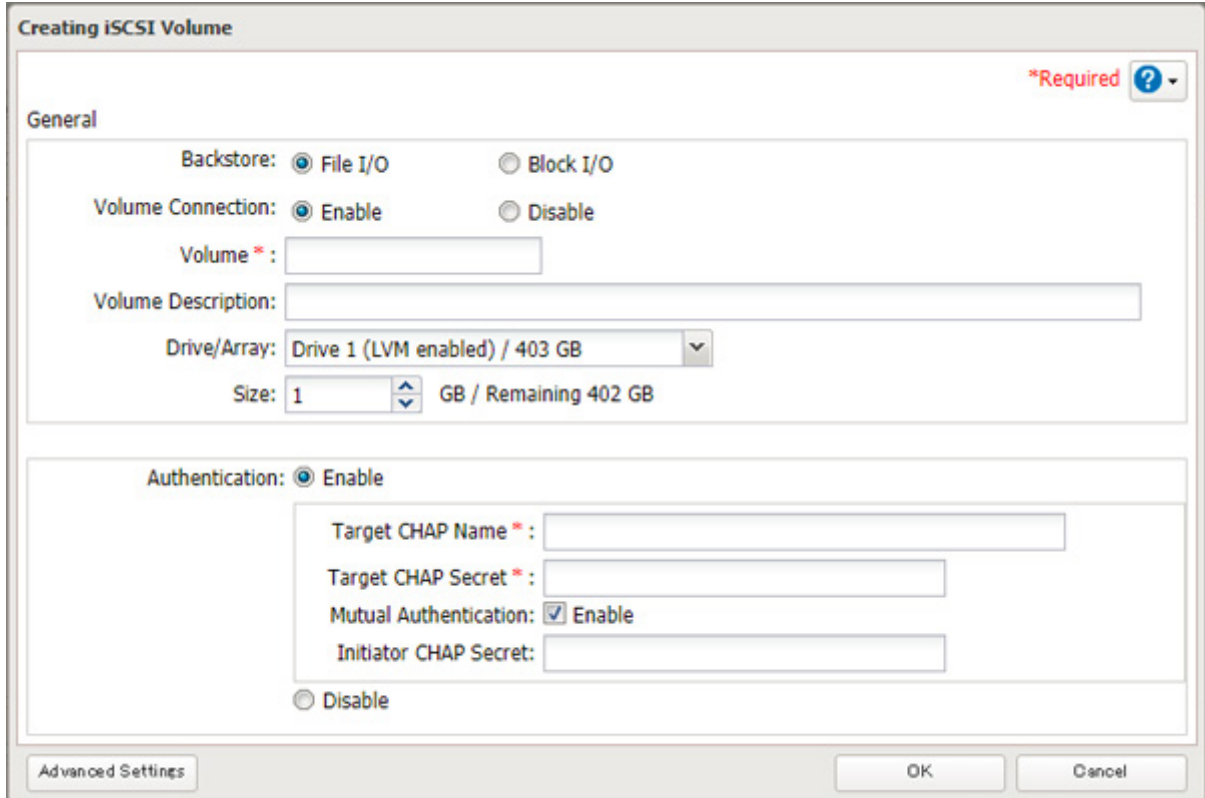

6 Click *OK*, then click *OK* again.

Notes:

- If you click *Disable Connection* for the selected volume in *Storage > iSCSI* in Settings, the selected iSCSI volume can no longer be accessed. If you click *Enable Connection*, the volume will become accessible from the iSCSI initiator software.
- If you selected “Block I/O” for the “Backstore” option, write cache (WCE) cannot be configured from the “Advanced Settings” page.

Connecting or Disconnecting Volumes

Connecting Volumes

To connect a volume, follow the procedure below.

Note: Do not shut down the TeraStation while connecting to an iSCSI volume. It may cause unexpected data erasure. Make sure all connections are disconnected before shutdown.

- 1 From Windows, navigate to *Control Panel > System and Security > Administrative Tools > iSCSI Initiator*.
- 2 Enter the IP address of the TeraStation into the “Target” field and click *Quick Connect*.

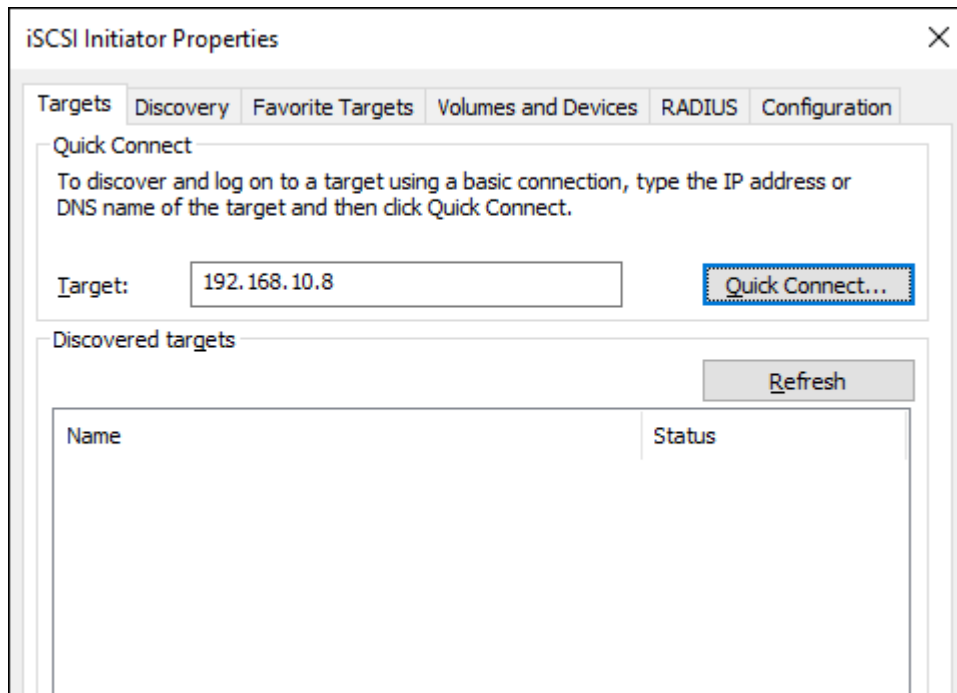

- 3 Confirm if the connection is established and click *Done*.

Formatting Volumes

If using the connected volume for the first time, the volume should be formatted to be used as a local drive. Follow the procedure below for formatting.

- 1 From Windows, navigate to *Control Panel > System and Security > Administrative Tools > Computer Management*.
- 2 Click *Disk Management*.
When the “Initialize Disk” screen appears, click *OK* without changing any settings.
- 3 Right-click the drive volume that shows the status “Unallocated” and click *New Simple Volume* from the displayed menu. Follow the screen to finish formatting.

When the formatting process is completed, the drive will be visible as an icon in Computer or This PC and can be used as a normal drive on the computer.

Disconnecting a Volume

- 1** From Windows, navigate to *Control Panel > System and Security > Administrative Tools > iSCSI Initiator*. The status of the connecting volume will be displayed as “Connected” under “Discovered targets”.
- 2** Select a volume to disconnect and click *Disconnect*.
- 3** Click *Yes*.
- 4** When the volume status is displayed as “Inactive”, the disconnection was carried out properly.

Using with Multiple Computers

If the TeraStation is divided into multiple volumes (or drives), it can be used with multiple computers. However, it is not recommended to access a single volume or drive from multiple computers at the same time for security reasons. When using the TeraStation as an iSCSI device, it should only connect to a single initiator unless the computer running the initiator also has clustering enabled and configured on its operating system. To avoid using multiple initiators for access, enable mutual authentication.

Checking Whether iSCSI Volume Is Connected

To check whether an iSCSI volume is connected, navigate to *Storage > iSCSI*. Current volumes will be listed. If “Connected” is displayed under “Status”, the volume is currently connected to the client.

Configuring Access Restrictions

A CHAP name and secret can be configured for the entire iSCSI volume or each existing volume. Access restrictions can be configured so that entering a target CHAP name and secret is required for each connection.

The TeraStation can perform mutual authentication (two-way authentication). Dual passwords ensure that only authorized client computers can access the volume on the TeraStation.

Follow the procedure below to enable access restrictions.

Configuring Access Restrictions for the Entire TeraStation

- 1** From Settings, click *Storage*.



- 2** Click the settings icon (⚙️) to the right of “iSCSI”.

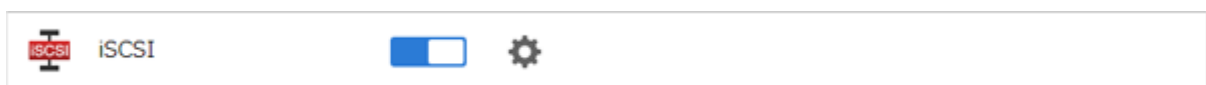

- 3** Click the *Security* tab.

4 Click *Edit* under “Access Control (Target Discovery)”.



5 Enable authentication, enter the target CHAP name and secret, and click *OK*.

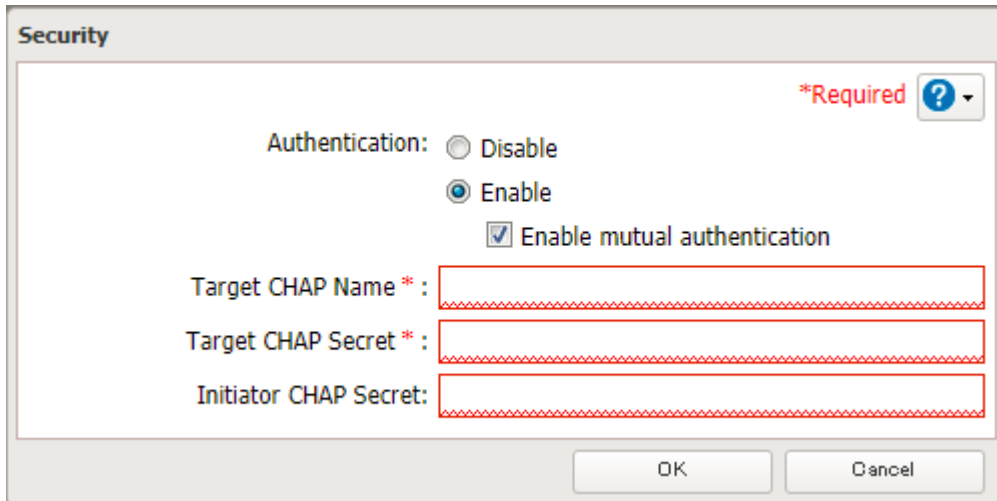

Note: To enable mutual authentication in addition to target CHAP name and secret authentication, select the “Enable mutual authentication” checkbox and enter the initiator CHAP secret.

To search or connect the volume which has mutual authentication enabled from Microsoft iSCSI Initiator, initiator CHAP secret settings should be configured.

6 Click *OK* when completed.

Connecting Volumes on the Access-Restricted TeraStation

If access restrictions are configured for the entire iSCSI volume, that volume will not be detected by Microsoft iSCSI Initiator. To connect that volume, the target CHAP name and secret should be authenticated.

1 Open the Microsoft iSCSI Initiator.

2 Register the initiator CHAP secret to your computer first. If you didn’t enable mutual authentication, skip this step.

Click *CHAP* on the *Configuration* tab. Enter the configured initiator CHAP secret into the “Initiator CHAP secret” field and click *OK*.

3 From the *Discovery* tab, click *Discover Portal*.

4 Enter the TeraStation’s IP address into the “IP address or DNS name” field and click *Advanced*.

5 Select the “Enable CHAP log on” checkbox and enter the target CHAP name into the “Name” field and the target CHAP secret into the “Target secret” field.

If mutual authentication is enabled, select the “Perform mutual authentication” checkbox.

6 Click *OK*, then click *OK* again.

- 7 The iSCSI volumes on the TeraStation will be listed under “Discovered targets” on the *Targets* tab. Select the desired volume to connect and click *Connect*.
- 8 Click *OK*.
- 9 When the status of the selected volume is displayed as “Connected”, the connection is established properly.

Configuring Access Restrictions for Individual Volumes

If access restrictions are configured for a volume, that volume cannot be accessed unless the target CHAP name and secret are authenticated.

- 1 From Settings, click *Storage*.



- 2 Click the settings icon () to the right of “iSCSI”.



- 3 Click the volume to enable access restrictions.
- 4 Enable authentication, enter the target CHAP name and secret, and click *OK*.

 A dialog box titled "Editing iSCSI Volume" with a grey border. In the top right corner, there is a red asterisk followed by the word "Required" and a blue question mark icon. The dialog is divided into two main sections. The first section, labeled "General", contains the following fields: "Backstore: File I/O", "Volume Connection:" with radio buttons for "Enable" (selected) and "Disable", "Volume: volume", "Volume Description:" with an empty text box, "Drive/Array: Drive 1 / 403 GB", "Size: 10 GB + 0" (with a spinner box) "GB = 10 GB / Remaining 393 GB", and "Target Name: iqn.2004-08.jp.buffalo.e2abb504f2fd.volume". The second section, labeled "Authentication:", contains radio buttons for "Enable" (selected) and "Disable". Under "Enable", there are four text input fields: "Target CHAP Name *:", "Target CHAP Secret *:", "Mutual Authentication:" with a checked checkbox and the word "Enable", and "Initiator CHAP Secret:". At the bottom of the dialog, there is a button labeled "Advanced Settings" on the left, and "OK" and "Cancel" buttons on the right.

Note: To enable mutual authentication, select the “Enable” checkbox to the right of “Mutual Authentication” and enter the initiator CHAP secret.

- 5 Click *OK* when completed.

Connecting to Individual Volumes That Are Access-Restricted

- 1** Open the Microsoft iSCSI Initiator.
- 2** Register the initiator CHAP secret to your computer first. If you didn't enable mutual authentication, skip this step.
Click *CHAP* on the *Configuration* tab. Enter the configured initiator CHAP secret into the "Initiator CHAP secret" field and click *OK*.
- 3** From the *Discovery* tab, click *Discover Portal*.
- 4** Enter the TeraStation's IP address into the "IP address or DNS name" field and click *OK*.
- 5** The iSCSI volumes on the TeraStation will be listed under "Discovered targets" on the *Targets* tab. Select the desired volume to connect and click *Connect*.
- 6** Click *Advanced*.
- 7** Select the "Enable CHAP log on" checkbox and enter the target CHAP name into the "Name" field and the target CHAP secret into the "Target secret" field.
If mutual authentication is enabled, select the "Perform mutual authentication" checkbox.
- 8** Click *OK*, then click *OK* again.
- 9** When the status of the selected volume is displayed as "Connected", the connection is established properly.

Expanding Volume Sizes

The volume size of the existing volumes can be expanded after they are created.

Notes:

- Expanding the volume size may erase all data on the volume depending on the formatting type. Backing up the data before expanding the volume size is recommended.
- To expand the volume size, the volume should have "File I/O" selected for the "Backstore" option, or the volume needs to have been created on a drive or array with LVM enabled.

- 1** From Settings, click *Storage*.



- 2** Click the settings icon () to the right of "iSCSI".

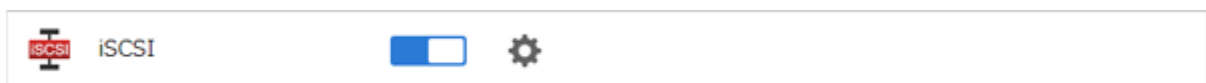

- 3** Select the volume to expand.

4 Enter the desired volume size to add and click *OK*.

5 Click *OK*.

Deleting Volumes

To delete an existing volume, follow the procedure below.

Note: Deleting a volume will erase all data on the volume. Back up the data before deleting the volume.

1 From Settings, click *Storage*.



2 Click the settings icon (⚙️) to the right of "iSCSI".



3 Select the volume to delete and click *Delete Volume*.

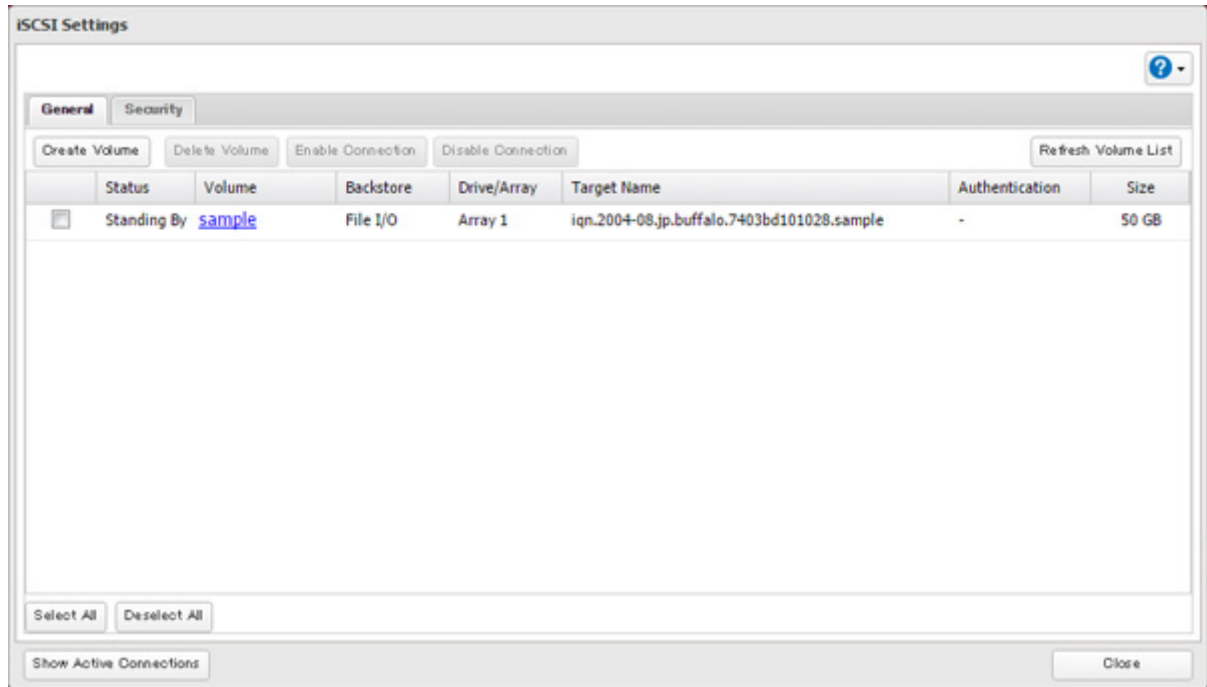

4 Confirm that the volume is correctly selected on the screen and click *OK*.

5 The “Confirm Operation” screen will open. Enter the confirmation number, then click *OK*.

6 Click *OK*.

Advanced Settings

You can configure the following advanced parameters for each iSCSI volume.

Advanced Parameter	Description
HeaderDigest	Controls the HeaderDigest usage by the iSCSI target portal group endpoint.
DataDigest	Controls the DataDigest usage by the iSCSI target portal group (TPG) endpoint.
MaxConnections	Controls the usage of Multiple Connections per Session (MC/S). Initiator and target negotiate the maximum number of connections requested and/or acceptable.
InitialR2T	Turns on or off the default use of R2T (Ready to Transfer) for unidirectional and the output part of bidirectional commands.
ImmediateData	Indicates whether the initiator and target have agreed to support immediate data on this session.
MaxRecvDataSegmentLength	Maximum data segment length in bytes the initiator and target can receive in an iSCSI Protocol Data Unit (PDU).
MaxXmitDataSegmentLength	Maximum data segment length in bytes that can be sent.
MaxBurstLength	Maximum iSCSI data payload in a Data-In or a solicited Data-Out iSCSI sequence, in bytes.
FirstBurstLength	Maximum amount in bytes of unsolicited data an iSCSI initiator can send to the target during the execution of a single SCSI command.
MaxOutstandingR2T	The R2T PDUs that can be in transition before an acknowledge PDU is received.
QueuedCommands	Maximum number of commands queued to any session of this target.
File I/O Write Sync	Synchronous file I/O provides reliability but slower performance. Asynchronous writes are faster, but buffered data will be lost if a power outage occurs.

Advanced Parameter	Description
Write Cache (WCE)	Increases performance. This cannot be used when block I/O is selected.
LUN	Number used to identify a local unit.

Chapter 5 Backup

Backing Up Data on the TeraStation

You can back up the TeraStation folders to another shared folder on the same TeraStation, a connected USB drive, or a shared folder on another Buffalo NAS device, either on the same network or on another network.

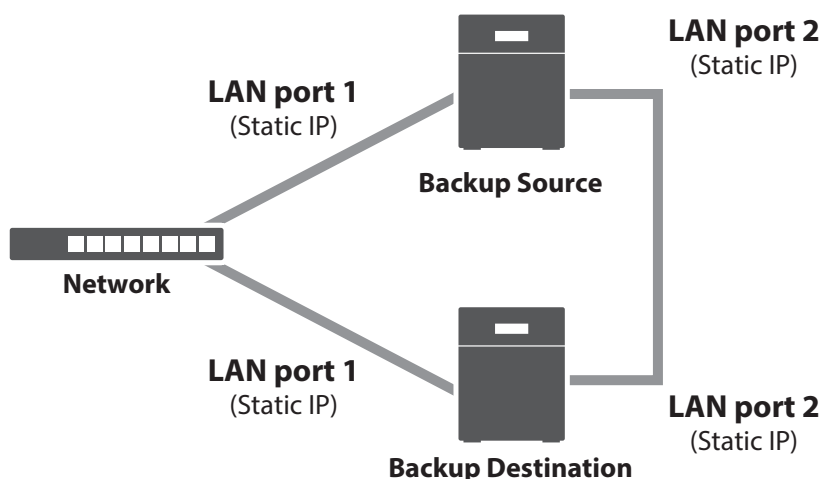

Backup Modes

The following types of backup are available from this TeraStation. To restore data from backup, refer to the [“Restoring Backup Data”](#) section below.

Full Backup

All files in the source will be backed up to the destination. You can specify how many backup versions to keep from 1–400, or select “Unlimited” to keep all backups until the drive is full. If you specify a number of backup versions, the backup destination folder should be on the same TeraStation or on an external USB drive attached to that TeraStation.

The backup data will be stored in the folder whose name will be the backup date and time.

- **Folders available as backup sources:**

- Shared folder on the backup source TeraStation (excluding the “info” folder)^{*1}
- USB drive connected to the backup source TeraStation
- Shared folder on another Buffalo NAS device^{*2}
- Shared folder on another rsync-compatible device

- **Folders available as backup destinations:**

- Shared folder on the backup source TeraStation (excluding the “info” folder)^{*2}
- USB drive connected to the backup source TeraStation^{*2,3}
- Shared folder on another Buffalo NAS device^{*2,3,4}
- Shared folder on another rsync-compatible device

^{*1} You can select up to the second level of folders. However, if the folder name of a second level folder contains “@”, that folder may not appear as the target folder.

*2 The folder should have the “Backup” checkbox selected under “LAN Protocol Support” on the shared folder settings.

*3 If the “Inherit subfolders' access restrictions” option is selected when creating a backup job, use XFS or ext3 file systems.

*4 If the “Inherit subfolders' access restrictions” option is selected when creating a backup job, the device should be a Buffalo NAS device whose subfolders' access restrictions is available.

Overwrite (Incremental)

The first backup job runs like a full backup. As each subsequent backup job runs, only files that have been changed since the last full backup will be backed up, but any files deleted from the backup source folder will also remain in the backup destination folder. The folder structure in the backup destination folder will be the same as the backup source folder.

- **Folders available as backup sources:**
 - Shared folder on the backup source TeraStation (excluding the “info” folder)*¹
 - USB drive connected to the backup source TeraStation
 - Shared folder on another Buffalo NAS device*²
 - Shared folder on another rsync-compatible device
- **Folders available as backup destinations:**
 - Shared folder on the backup source TeraStation (excluding the “info” folder)*²
 - USB drive connected to the backup source TeraStation*^{2,3}
 - Shared folder on another Buffalo NAS device*^{2,3,4}
 - Shared folder on another rsync-compatible device

*1 You can select up to the second level of folders. However, if the folder name of a second level folder contains “@”, that folder may not appear as the target folder.

*2 The folder should have the “Backup” checkbox selected under “LAN Protocol Support” on the shared folder settings.

*3 If the “Inherit subfolders' access restrictions” option is selected when creating a backup job, use XFS or ext3 file systems.

*4 If the “Inherit subfolders' access restrictions” option is selected when creating a backup job, the device should be a Buffalo NAS device whose subfolders' access restrictions is available.

Overwrite (Differential)

The first backup job runs like a full backup. As each subsequent backup job runs, only files that have been changed since the last full backup will be backed up, and any files deleted from the backup source folder will also be deleted from the backup destination folder. The backup destination folder will always remain the same size as the backup source folder, and the folder structure in the backup destination folder will be the same as the backup source folder.

- **Folders available as backup sources:**
 - Shared folder on the backup source TeraStation (excluding the “info” folder)*¹
 - USB drive connected to the backup source TeraStation
 - Shared folder on another Buffalo NAS device*²
 - Shared folder on another rsync-compatible device
- **Folders available as backup destinations:**
 - Shared folder on the backup source TeraStation (excluding the “info” folder)*²
 - USB drive connected to the backup source TeraStation*^{2,3}
 - Shared folder on another Buffalo NAS device*^{2,3,4}
 - Shared folder on another rsync-compatible device

*1 You can select up to the second level of folders. However, if the folder name of a second level folder contains “@”, that folder may not appear as the target folder.

*2 The folder should have the “Backup” checkbox selected under “LAN Protocol Support” on the shared folder settings.

*3 If the “Inherit subfolders' access restrictions” option is selected when creating a backup job, use XFS or ext3 file systems.

*4 If the “Inherit subfolders' access restrictions” option is selected when creating a backup job, the device should be a Buffalo NAS device whose subfolders' access restrictions is available.

Management Backup

Each time a backup is executed, management information is stored, and only files that have changed are backed up. Data is retrieved from the previous backup file for files that were not changed, which can help reduce the space used for backup and also for referencing status at a particular point in time (for data snapshot applications). You can specify how many backup versions to keep from 1–400, or select “Unlimited” to keep all backups until the drive is full. If using an external USB drive as the backup destination, do not use folders from drives formatted with FAT. The backup data will be stored in the folder whose name will be the backup date and time, and the destination folder will be set to read-only.

- **Folders available as backup sources:**

- Shared folder on the backup source TeraStation (excluding the “info” folder)*
- USB drive connected to the backup source TeraStation
- Shared folder on another Buffalo NAS device**
- Shared folder on another rsync-compatible device

- **Folders available as backup destinations:**

- Shared folder on the backup source TeraStation (excluding the “info” folder)
- USB drive connected to the backup source TeraStation

*You can select up to the second level of folders. However, if the folder name of a second level folder contains “@”, that folder may not appear as the target folder.

**The folder should have the “Backup” checkbox selected under “LAN Protocol Support” on the shared folder settings.

Note: For the destination folder, do not use a folder that has already been used as a target folder for another backup job. If you wish to use a folder that currently contains backup data as the destination folder for another backup job, format the folder first, or delete all data in the destination folder and change the folder attribute to read and write before configuring the folder as the destination folder.

Preparing a Backup Destination

Configure a shared folder on a Buffalo NAS device or connected USB drive as a backup destination. The following procedure explains using another shared folder on the TeraStation as a backup destination. The procedure may vary depending on which Buffalo NAS device is selected as a destination. If using a USB drive as a backup destination, make sure its attribute is set to read and write. To change a read-only USB drive's attribute to read and write, refer to the “[Read-Only Shares](#)” section in chapter 3.

If you would like to back up data from multiple backup sources, we recommend not using the same backup destination, as data in the backup destination may be overwritten by subsequent backup jobs. If you must back up data from multiple backup sources to the same backup destination, using management backup is recommended for precise version control.

Note: If you want to set this TeraStation as the backup destination for an rsync-compatible device, refer to the “[If Backing Up from rsync-Compatible Devices to the TeraStation](#)” section instead of following the procedure below.

- 1 From Settings, click *File Sharing*.

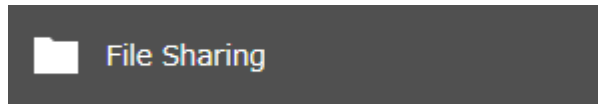

- 2 Click the settings icon () to the right of "Folder Setup".

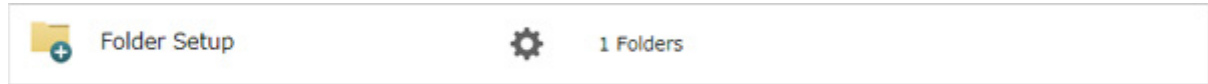

- 3 Choose the folder to be set as a backup destination.

- 4 Under "LAN Protocol Support", select the "Backup" checkbox on the *Basic* tab.



- 5 Click *OK* and proceed to the next step to create a backup device access key.

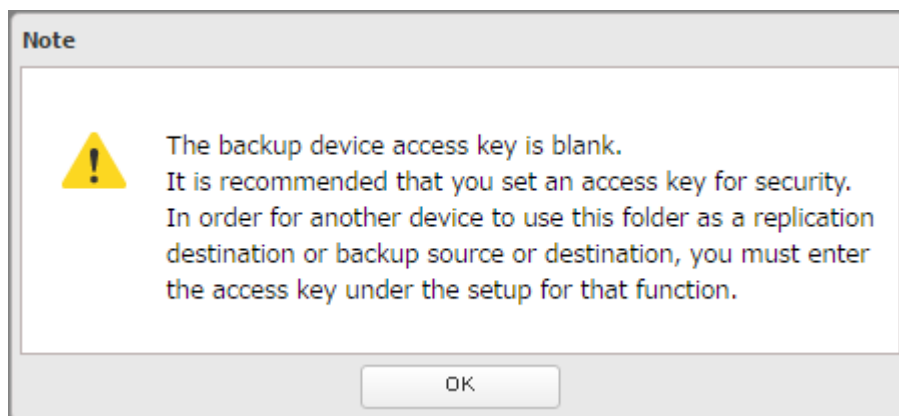

- 6 Enter the desired characters into the backup device access key field and click *OK*.



Note: You may leave this field blank if you do not want a backup device access key, but for security reasons we highly recommend entering one for the shared folder. If a backup device access key is configured for the shared folder, that folder will not show up as a target for the backup source or destination when configuring a backup job on another Buffalo NAS device unless it's entered. You may create multiple folders using different backup device access keys for backup and replication, but only one access key can be used on the TeraStation. Folders that are configured with a different access key cannot be used.

A backup destination has been created.

Notes:

- If you want to back up to a Buffalo NAS device on another network, follow the procedure below to add the Buffalo NAS device so it can be used as a backup destination.
 - (1) Create a new backup job by referring to the "[Configuring a Backup Job](#)" section below.
 - (2) On the screen that allows you to select a shared folder, click *List of Servers*.
 - (3) Click *Add*; select the "Add Buffalo NAS device" option, enter the IP address or hostname of the destination Buffalo NAS device, then click *OK*.

- (4) Click *Close* when completed.
 - (5) Click *Refresh* and make sure the desired Buffalo NAS device has been added to the list.
- If you want to back up to an rsync-compatible device, follow the procedure below to add the rsync-compatible device so it can be used as a backup destination.
 - (1) Create a new backup job by referring to the [“Configuring a Backup Job”](#) section below.
 - (2) On the screen that allows you to select a shared folder, click *List of Servers*.
 - (3) Click *Add*; select the “Add rsync-compatible device” option, enter the IP address or hostname of the destination device, then click *OK*. If you want to encrypt the rsync access, enable rsync over SSH and enter the rsync account settings.
 - (4) Click *Close* when completed.
 - (5) Click *Refresh* and make sure the desired rsync-compatible device has been added to the list.

Configuring a Backup Job

You can configure backup jobs by using another shared folder on the Buffalo NAS device or a USB drive connected to the TeraStation as a destination. You can also back up to a Buffalo NAS device on another network as long as the two networks are connected by a VPN or the route is configured properly.

- 1** From Settings, click *Backup*.



- 2** Click the settings icon () to the right of “Backup”.

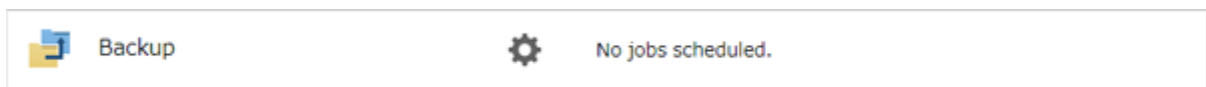

- 3** If you had configured a backup device access key for the backup source folder on another Buffalo NAS device or the backup destination folder, click *Set*. If you hadn't, skip to step 5.

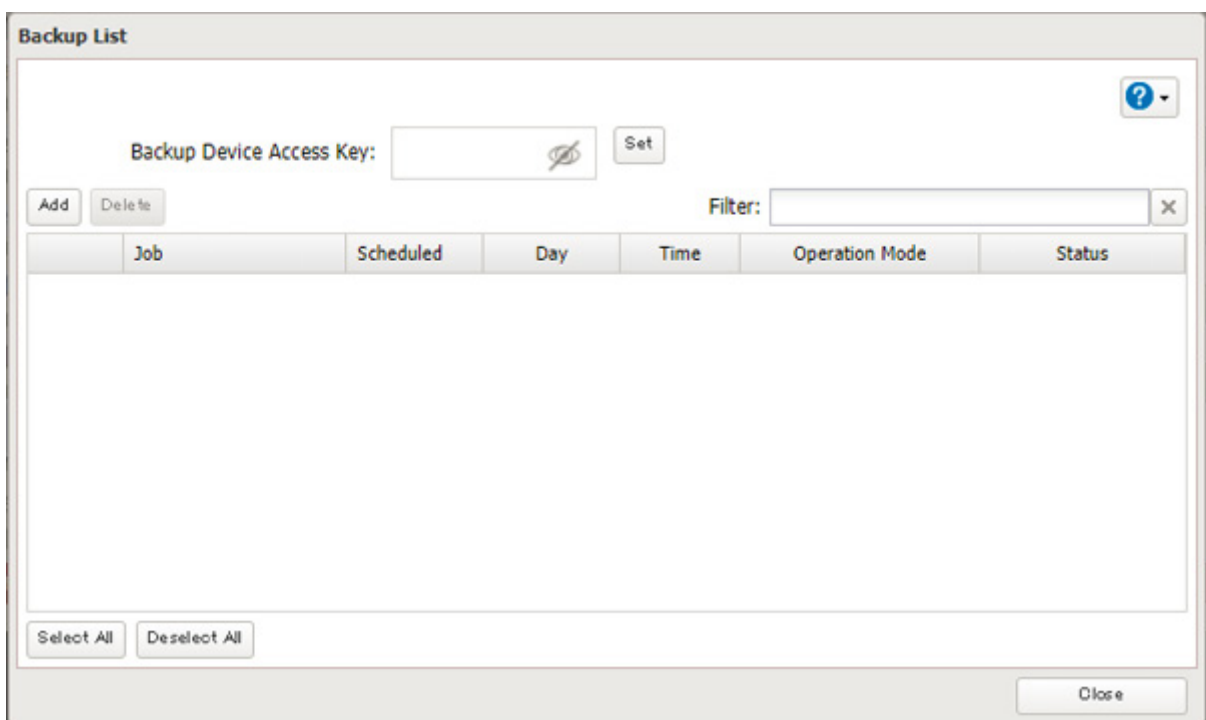

4 Enter the backup device access key and click *OK*.

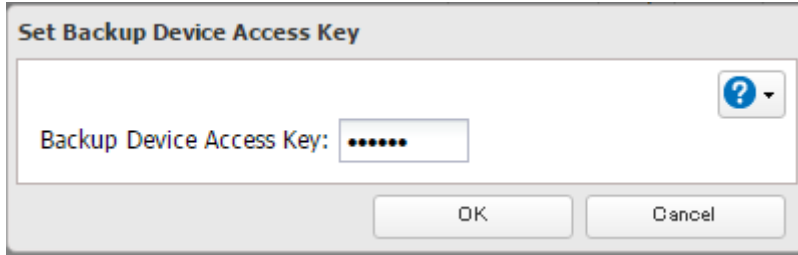

5 Click *Add*.

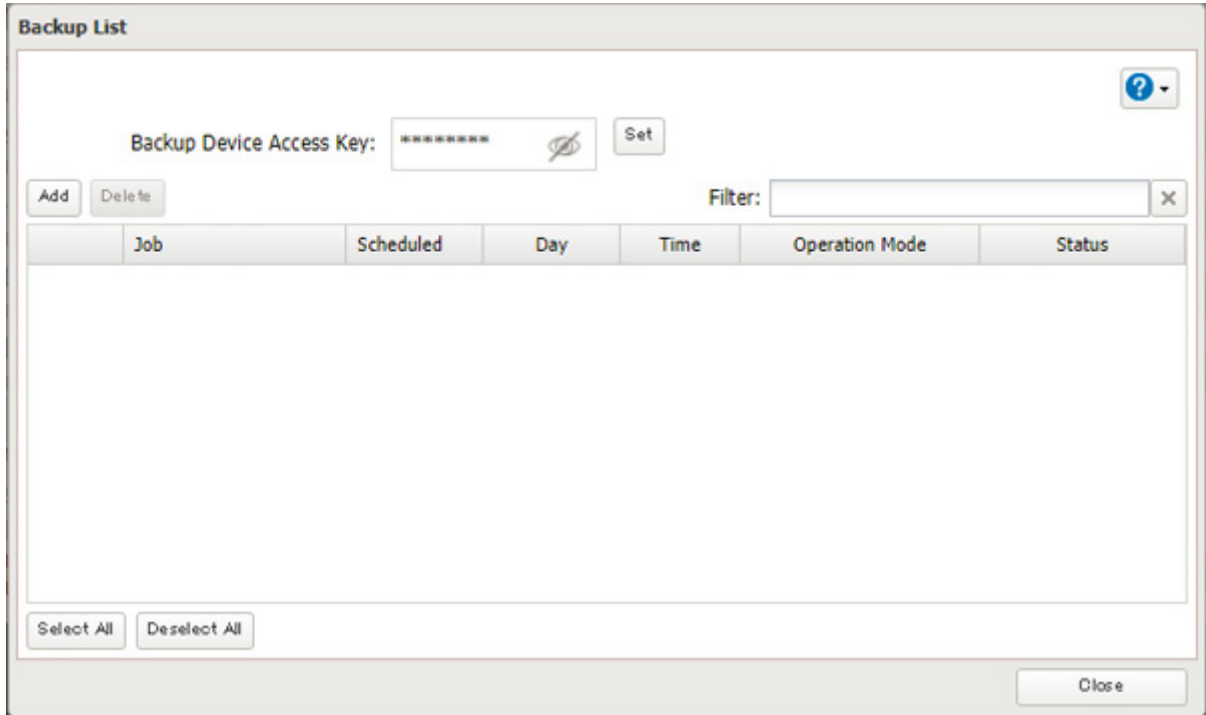

- 6 Select backup settings such as date and time to run, then select a backup mode for the “Operation Mode” drop-down list. Refer to the differences between the backup modes in the “Backup Modes” section above.

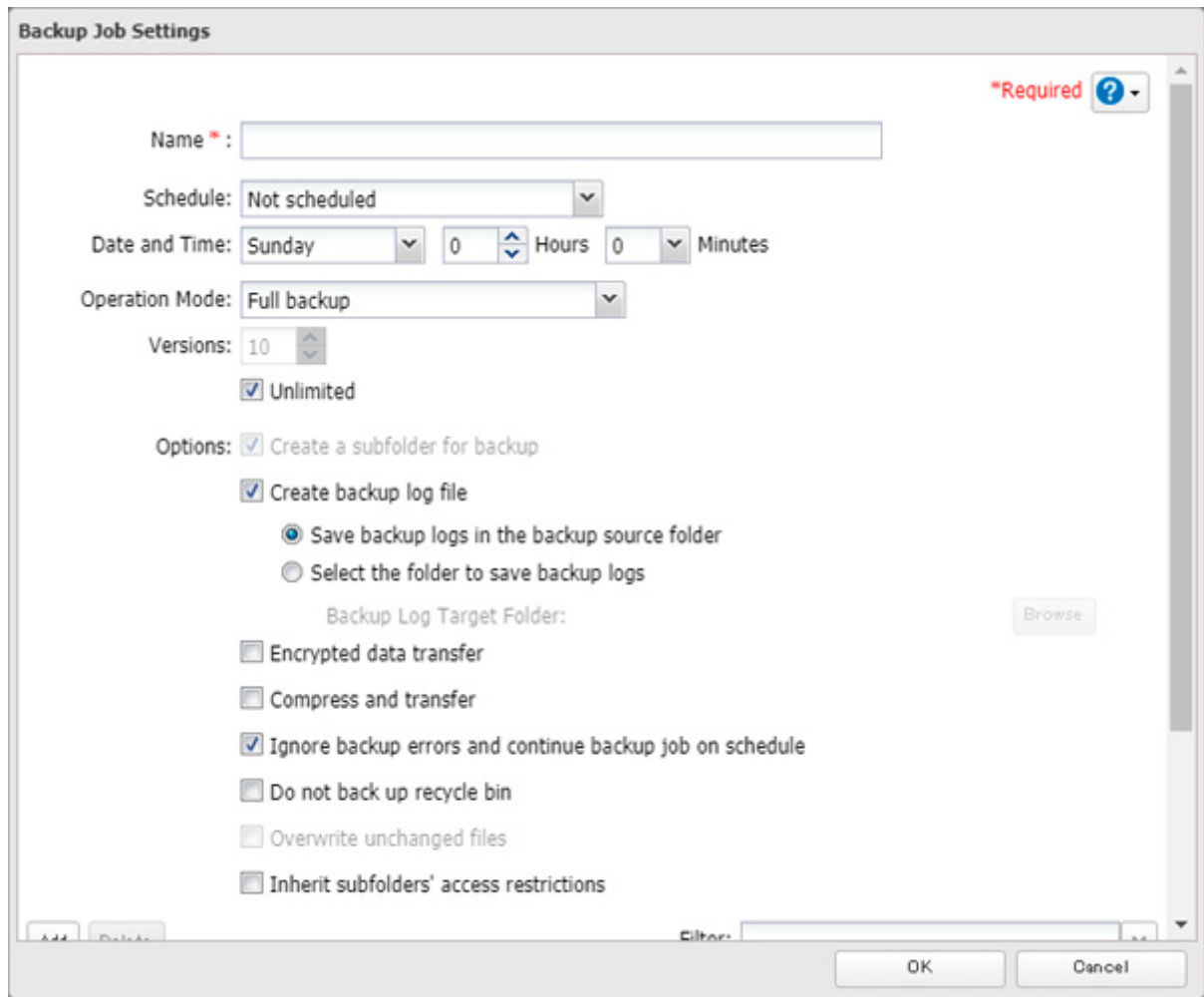

- 7 Click *Add*.

8 Select the shared folder that will be the backup source and destination.

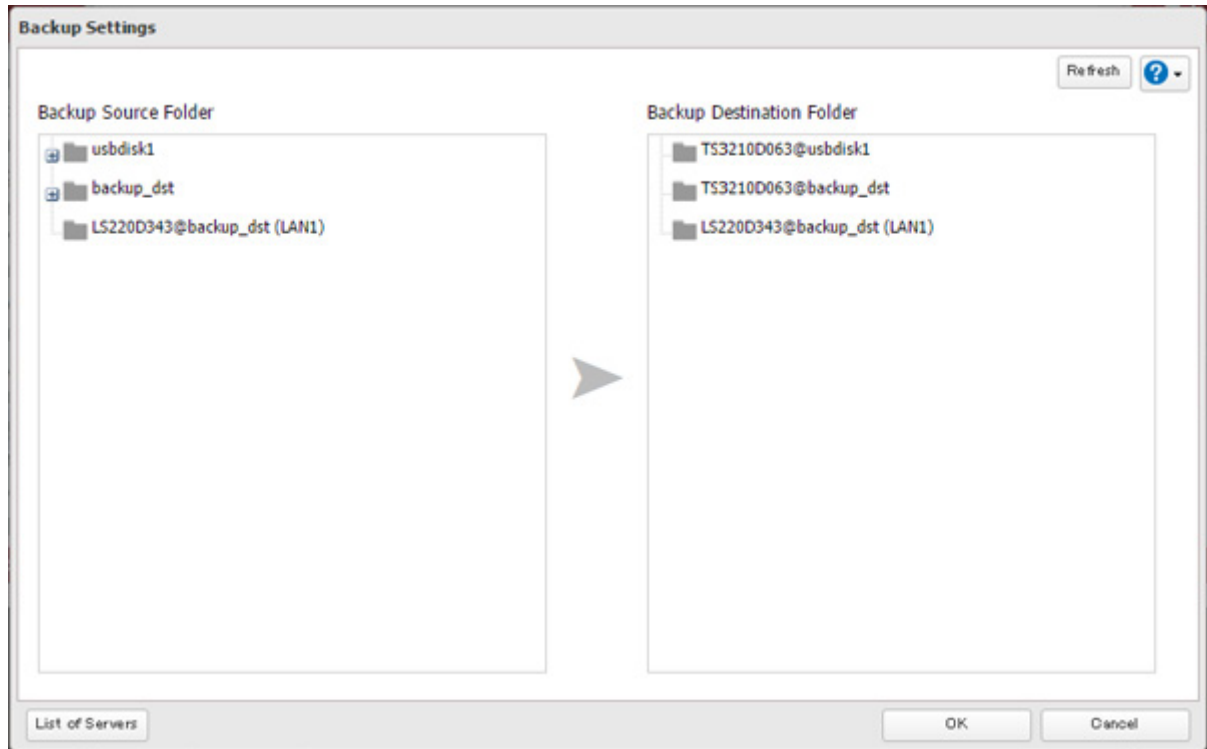

9 Click *OK*, then click *OK* again. The backup job will be added to the backup jobs list.

Notes:

- Up to eight backup jobs can be configured at a time, and twenty-five backup source and destination folder pairs can be used in one backup job.
- To inherit the subfolders' access restriction settings to the backup destination, the backup destination should also support the subfolders' access restrictions. Check it before creating a backup job.
- To back up data between Buffalo NAS devices on a network using jumbo frames, make sure that both devices are configured to use identical (or similar) MTU sizes. If MTU sizes are significantly different, the backup job may not be properly performed. In such a case, select the default MTU size (1500 bytes) for both devices.
- You can also specify a hostname by a fully qualified domain name (FQDN).
- Windows-based TeraStations with multibyte characters in the hostname may not be detected as a backup destination, and folders in these devices cannot be used as backup destination folders.
- Backup data, such as ".DS_Store" files, from macOS may include characters that cannot be read on FAT32-formatted drives in its filename. For best results, reformat the drive before using it as a backup destination.

If Backing Up from rsync-Compatible Devices to the TeraStation

If you want to set an rsync-compatible device as the backup source and back up data on the rsync-compatible device to the TeraStation, you will need to enable rsync access on the TeraStation.

1 From Settings, click *File Sharing*.

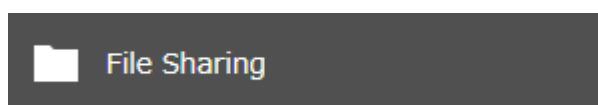

- 2 Click the settings icon () to the right of “rsync”.

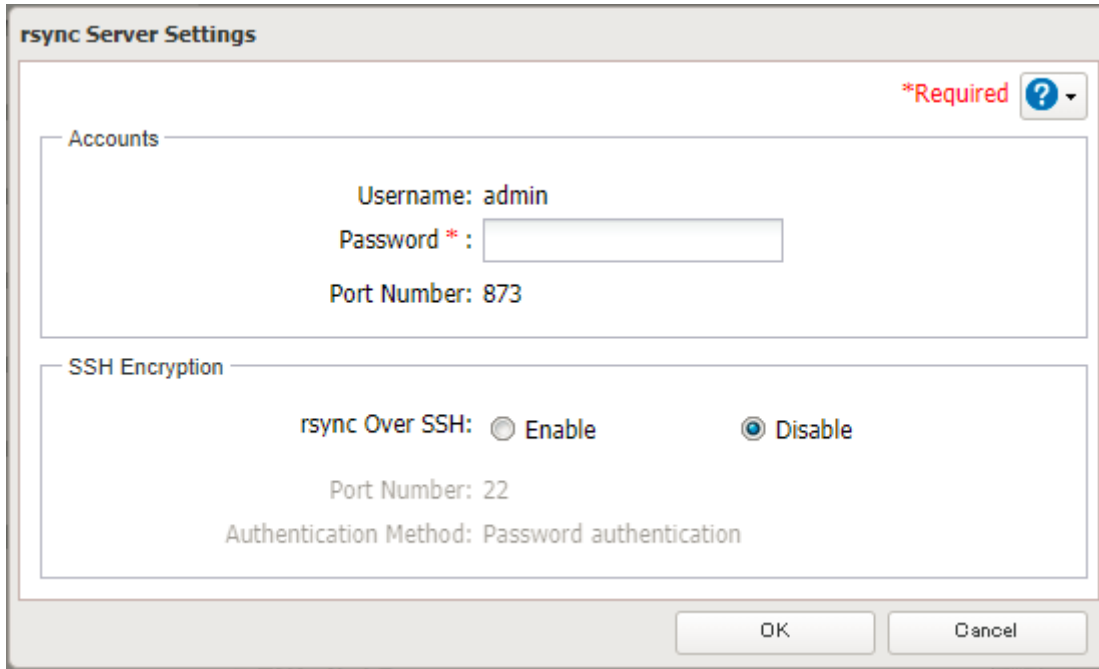

- 3 Enter this TeraStation's admin password into the “Password” field and click OK.

 A dialog box titled 'rsync Server Settings'. It has a red asterisk and a question mark icon in the top right corner. The dialog is divided into two sections: 'Accounts' and 'SSH Encryption'. In the 'Accounts' section, there are fields for 'Username: admin', 'Password *:' (with a red asterisk), and 'Port Number: 873'. In the 'SSH Encryption' section, there are radio buttons for 'rsync Over SSH: Enable' and 'Disable' (which is selected). Below this, there is a 'Port Number: 22' and 'Authentication Method: Password authentication'. At the bottom right, there are 'OK' and 'Cancel' buttons.

Note: If you want to encrypt the rsync access, enable rsync over SSH.

- 4 Move the rsync switch to the  position to enable rsync.



Restoring Backup Data

The procedure for restoring backup data varies depending on the backup mode. Refer to the following subsection corresponding to the backup mode you have used for backup. When restoring backup data, make sure you have enough available space on the TeraStation to accommodate the backup data, otherwise the restore process will fail.

Full and Management Backups

Copy and paste the backed up files from the backup destination folder to a folder which you want to restore.

Overwrite Backups (Incremental and Differential)

Files and folders have already been stored on the desired destination. You can access them by switching the operation to the backup destination TeraStation. Alternatively, you can restore any files or folders by creating a backup job and configuring the backup destination as a backup source and selecting the same backup mode for the “Operation Mode” drop-down list. Please do not use the same folder as the backup destination to restore backup data from multiple backup sources, as this may cause the restored data to get overwritten.

Backup Logs for If Backup Fails

If backup fails, the I54 message appears on the Dashboard in Settings and NAS Navigator2 and the following backup error codes may be displayed in the “Status” field. Read the description and try the respective corrective actions for each error to resolve it.

Code	Description	Corrective Action	Log Example
Code 3	The backup destination USB drive could not be found.	Check that the backup destination USB drive is connected to the TeraStation properly.	rsync error: errors selecting input/output files, dirs (code 3) at main.c(634) [Receiver=3.1.0]
			Can't write to backup destination(target disk is broken?).
Code 5	The backup destination shared folder could not be found.	Check that the Ethernet cable is securely connected and that the hub or other devices on the network are turned on.	rsync error: error starting client-server protocol (code 5) at main.c(1504)
	Authentication failed.	Try adding the rsync-compatible NAS device from the server list again.	@ERROR: auth failed on module
	A registered user does not have permission to run.	Check the settings of the rsync-compatible NAS device.	@ERROR: permission denied
Code 10	The Ethernet cable was disconnected from the backup source TeraStation when the backup job started.	Reconnect the Ethernet cable.	rsync error: error in socket IO (code 10) at clientserver.c(128) [sender=3.1.0pre1]
	A backup destination doesn't support the subfolders' access restrictions.	Select another backup destination or remove the subfolders' access restrictions.	
Code 11	The drive capacity of the backup destination TeraStation became full.	Delete unnecessary files and folders.	rsync error: error in file IO (code 11) at receiver.c(389) [receiver=3.1.0]
	Files larger than 4 GB were backed up to the FAT32-formatted USB drive.	Reduce the file size to 4 GB or less, or change the file system to one other than FAT32. Refer to the “Adding an External Drive” section in chapter 4 for compatible file systems.	rsync: write failed on “filename”: File too large (27)
Code 12	Could not communicate between backup source and destination TeraStations.	Check that the Ethernet cable is securely connected and that the hub or other devices on the network are turned on.	rsync error: error in rsync protocol data stream (code 12) at io.c(515)
	The settings of the TeraStation were changed while the backup job was running.	Do not change the settings while the backup job is running. If changed, the connection is temporarily terminated and the backup job will fail.	

Code	Description	Corrective Action	Log Example
Code 14	There was insufficient memory on the TeraStation so the backup job did not run.	Reduce the number of backup destination files or disable any other functions running at the same time.	ERROR: out of memory in flist_expand
Code 22			rsync error: error in IPC code (code 14) at main.c(655) [receiver=2.6.8]
			rsync: fork failed in do_recv: Cannot allocate memory (12)
Code 20	The connection was disconnected while the backup job was running.	Do not change the settings while the backup job is running. If changed, the connection is temporarily terminated and the backup job will fail.	rsync error: received SIGINT, SIGTERM, or SIGHUP (code 20) at rsync.c(242)
Code 23	Invalid characters were used in the filename or folder name of the backup destinations.	Change the filename or folder name using compatible characters. Available characters are described in the "Adding a Shared Folder" section in chapter 3.	rsync error: some files could not be transferred (code 23) at main.c(702)
	The backup destination files were updated while the backup job was running.	Do not overwrite the backup destination files while the backup job is running. If updated, the backup destination files will not be backed up and the backup job will fail.	
	The TeraStation backed up the data to the FAT32-formatted USB drive, then the capitalization of letters in the filenames or folder names on the backup source TeraStation was changed.	Do not change the capitalization of letters in the filenames and folder names on the backup source TeraStation if the backup destination USB drive is formatted to FAT32. Linux on the TeraStation is case-sensitive but FAT isn't, so files or folders with names that are identical save for the capitalization will not be identified and treated as the same file or folder. To back up properly, using XFS or ext3 is recommended.	
	A file system on the backup destination may be corrupted.	Run a drive check on the backup destination by referring to the "Checking Drives" section in chapter 4.	
Code 24	The backup destination files were updated while the backup job was running.	Do not overwrite the backup destination files while the backup job is running. If updated, the backup destination files will not be backed up and the backup job will fail.	rsync warning: some files vanished before they could be transferred (code 24) at main.c

Code	Description	Corrective Action	Log Example
Code 30	The Ethernet cable was disconnected from the backup source or destination TeraStations while the backup job was running.	Reconnect the Ethernet cable.	rsync error: timeout in data send/receive (code 30) at io.c(195) [sender=3.1.0]
B14	Insufficient TeraStation memory.	Restart the TeraStation and try again.	-
B101	The backup destination TeraStation does not exist.	Check that the backup destination TeraStation is turned on, the Ethernet cables are securely connected, and the hostname of the backup destination TeraStation is not changed.	-
B102		Check that the backup destination folders on the backup destination TeraStation are on the shared folder list and the backup destination folders are configured for backup in Settings.	-
B103	The backup source folders on the backup source TeraStation do not exist.	Check that the backup source folders on the backup source TeraStation are on the shared folder list.	-
B104	The backup destination folders on the backup destination TeraStation do not exist.	Check that the backup destination folders on the backup destination TeraStation are on the shared folder list.	-
B105	The drives were not recognized.	Check that the drives are recognized properly in Settings. If you configure the "usbdisk" folders for the backup source or destinations, check whether these folders are on the shared folder list.	-
B106	The file systems of the USB drive are not supported.	Check that the USB drive is formatted to the compatible file systems. If you configure the management backup in the backup job, FAT format cannot be used for the backup destination.	-
B107	The device files such as "/dev/null" etc. does not exist.	Restart the TeraStation and try again.	-
B108	Credentials to access a shared folder on the rsync-compatible NAS device were not found.	Try adding the rsync-compatible NAS device from the server list again.	-

Replication

Replication copies all data from one shared folder to another shared folder on a different TeraStation. This is an easy way to set up a reliable data protection system in the event your main TeraStation fails. To configure replication, connect an Ethernet cable to the LAN port of each TeraStation and follow the procedure below. For best results, use static IP addresses and a 10GbE port for connecting both replication TeraStations (source and destination).

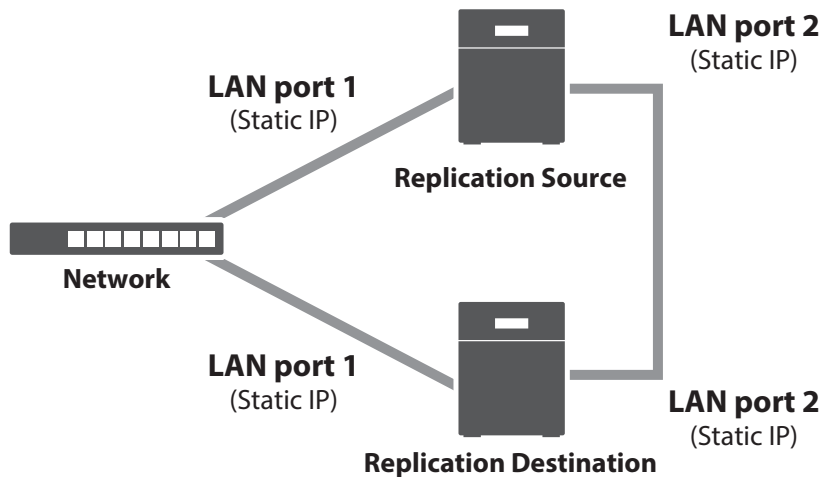

Note: Replication source data is copied to the replication destination folder with a differential overwrite. Any data not on the replication source will be overwritten.

The following describes what can be configured as replication sources and replication destinations.

Folders Available as Replication Sources

- Shared folder on the replication source TeraStation (excluding the “info” folder)^{*1}
- USB drive connected to the replication source TeraStation

Folders Available as Replication Destinations^{*2}

- Shared folder on the replication source TeraStation (excluding the “info” folder)
- USB drive connected to the replication source TeraStation^{*3}
- Shared folder on another Buffalo NAS device^{*4}

^{*1} You can select up to the second level of folders. However, if the folder name of a second level folder contains “@”, that folder may not appear as the target folder.

^{*2} The folder should have the “Backup” checkbox selected under “LAN Protocol Support” on the shared folder settings.

^{*3} If the “Inherit subfolders’ access restrictions” option is selected when creating a replication job, use XFS or ext3 file systems.

^{*4} If the “Inherit subfolders’ access restrictions” option is selected when creating a replication job, the device should be a Buffalo NAS device whose subfolders’ access restrictions is available.

Preparing a Replication Destination

Configure a folder as a replication destination. Follow the procedure below to prepare a Buffalo NAS device as a replication destination.

- 1 From Settings, click *File Sharing*.

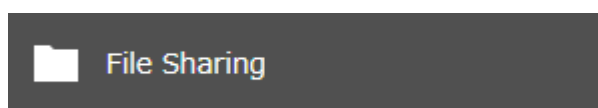

- 2 Click the settings icon () to the right of “Folder Setup”.

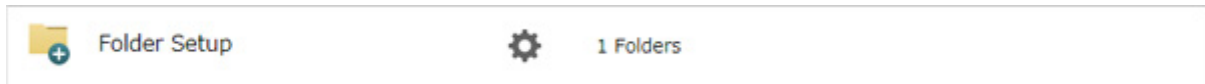

- 3 Choose the folder to be set as a replication destination.

- 4 Under “LAN Protocol Support”, select the “Backup” checkbox on the *Basic* tab.



- 5 Click *OK* and proceed to the next step to create a backup device access key.

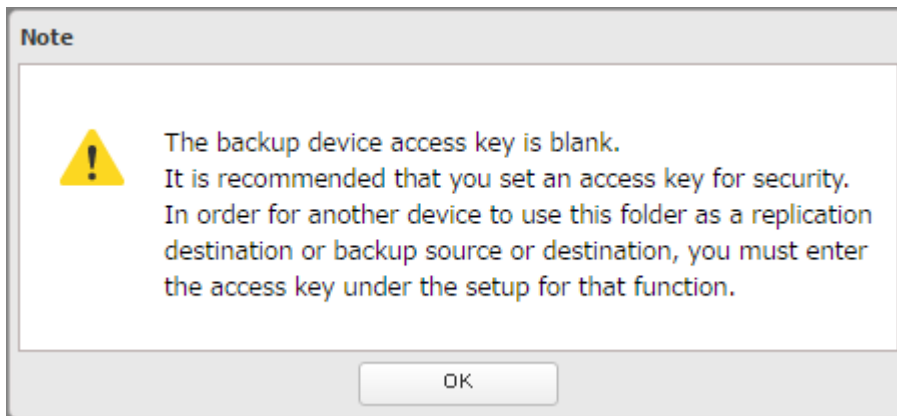

- 6 Enter the desired characters into the backup device access key field and click *OK*.



Note: You may leave this field blank if you do not want a backup device access key, but for security reasons we highly recommend entering one for the shared folder. If a backup device access key is configured for the shared folder, that folder will not show up as the replication destination when configuring a replication job on another Buffalo NAS device unless it's entered. You may create multiple folders using different backup device access keys for backup and replication, but only one access key can be used on the TeraStation. Folders that are configured with a different access key cannot be used.

A replication destination has been created.

Note: If you want to replicate to a Buffalo NAS device on another network, follow the procedure below to add the Buffalo NAS device so it can be used as a replication destination.

- (1) Create a new replication job by referring to the [“Configuring a Replication Job”](#) section below.
- (2) On the screen that allows you to select a shared folder, click *List of Servers*.
- (3) Click *Add*; select the “Add Buffalo NAS device” option, enter the IP address or hostname of the destination Buffalo NAS device, then click *OK*.
- (4) Click *Close* when completed.
- (5) Click *Refresh* and make sure the desired Buffalo NAS device has been added to the list.

Configuring a Replication Job

- 1 From Settings, click *Backup*.



- 2 Click the settings icon (⚙️) to the right of "Replication".



- 3 Click *Edit*.

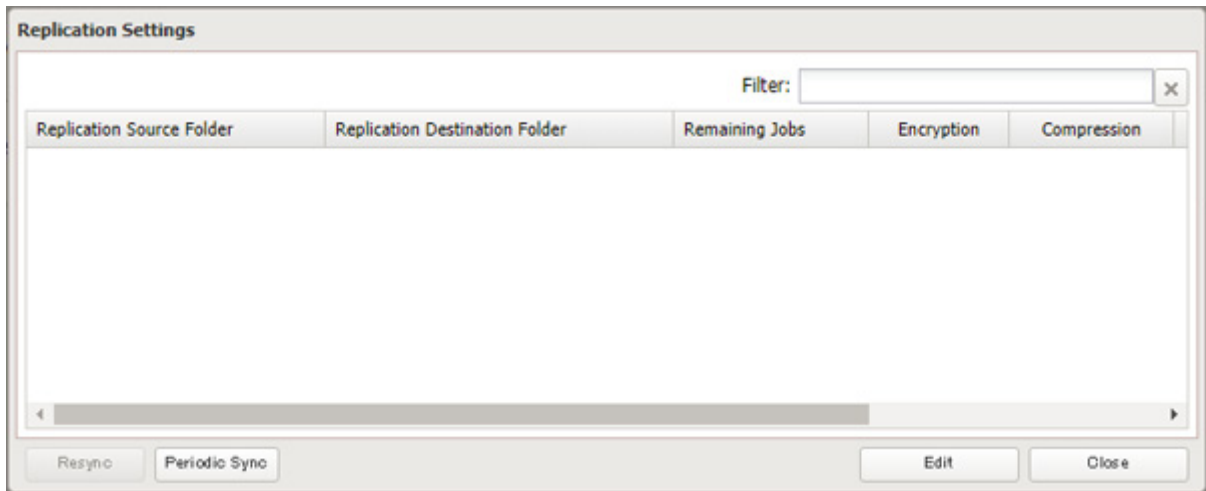

- 4 If you had configured a backup device access key for the replication destination folder, click *Set*. If you hadn't, skip to step 6.

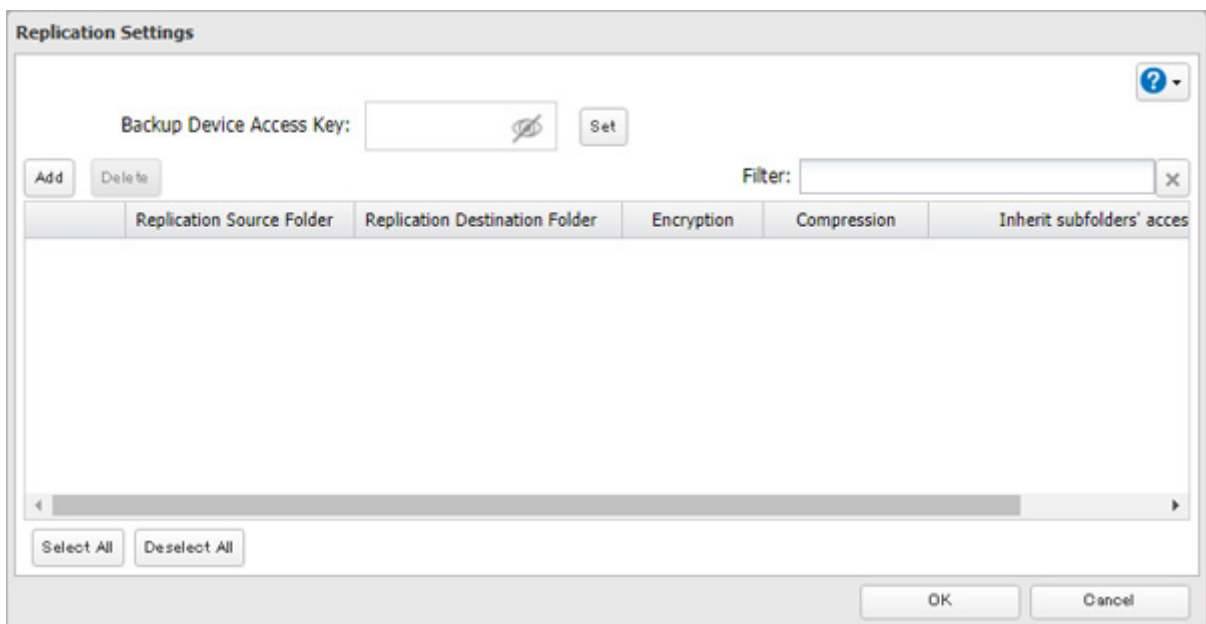

5 Enter the backup device access key and click *OK*.

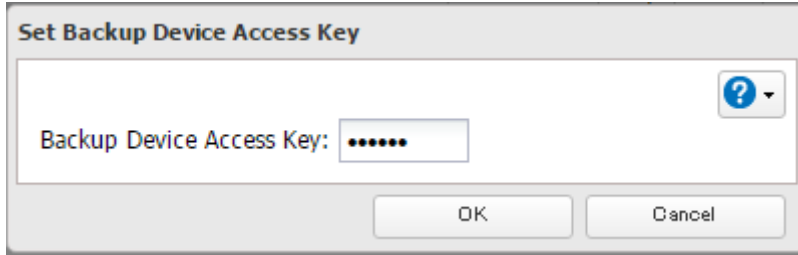

6 Click *Add*.

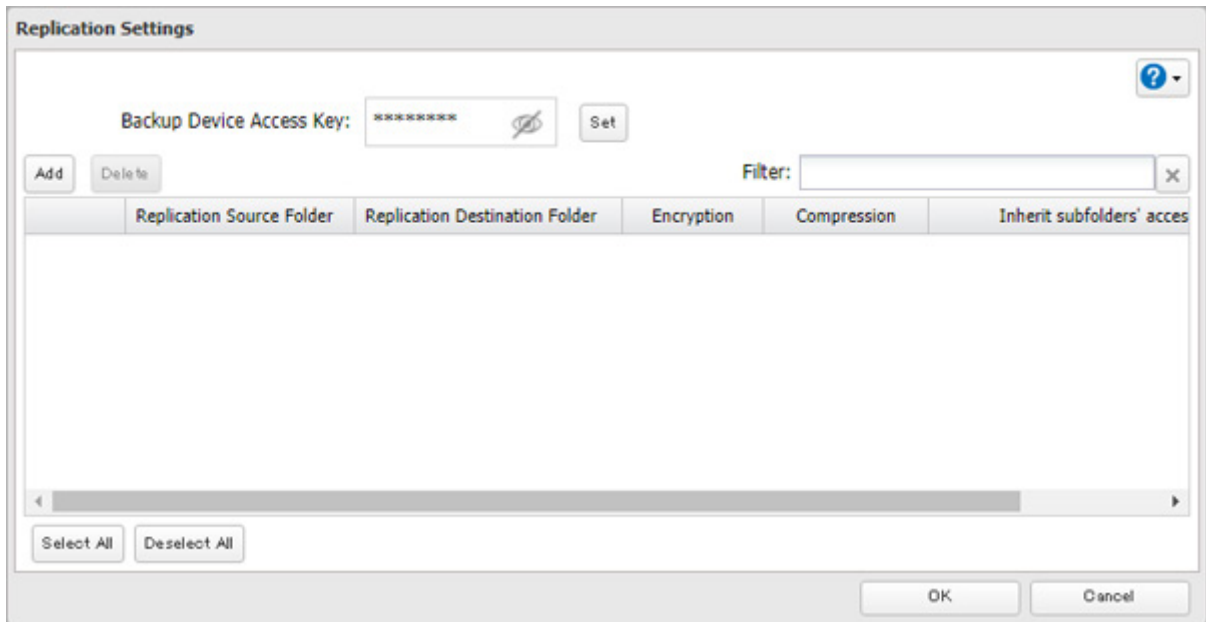

7 Select the shared folder that will be the replication source and destination, then click *OK*.

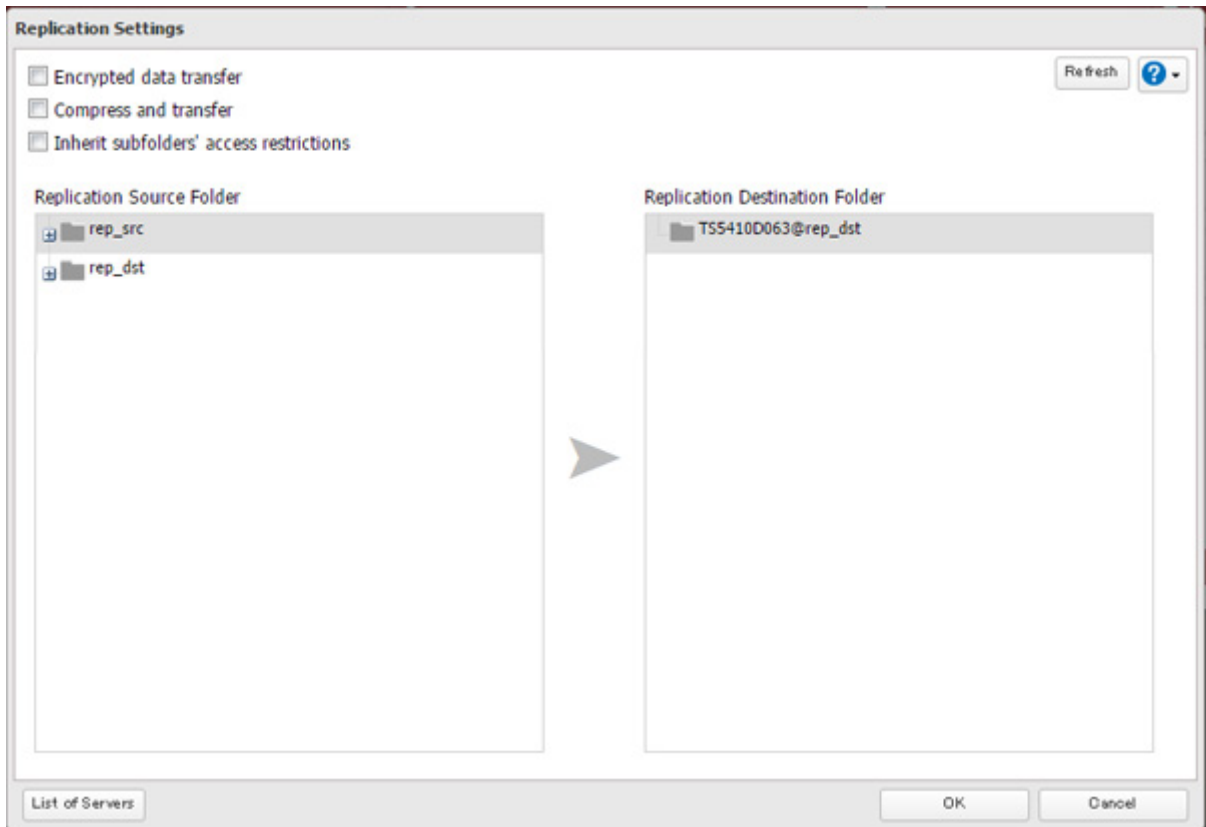

8 Click *OK*, then *Yes*.

Notes:

- During setup, you may choose to encrypt and/or compress replication data. Encrypted data will be transferred securely on the network. Compressed data will ease network loading and is recommended for slow or heavily loaded network connections. Enabling either will increase the CPU load on the source TeraStation so that the transfer speed will become slower, and replication time will be slower than if they are disabled. Encrypted or compressed data will be decrypted or decompressed on the destination TeraStation.
- A maximum of 32 shared folders can be configured for replication.
- Don't use the same TeraStation for both failover and replication, or replication and Time Machine.
- Don't configure replication from one source folder to multiple destination folders.
- If a network problem causes a replication error, unsynced data may be shown as "0" even though replication is incomplete. Click *Resync* to recover from the replication error. All files from the source folder will be copied to the destination folder.

Synchronizing Between Source and Destination TeraStations Periodically

To copy files that are saved via other file sharing protocols such as AFP or FTP to the replication destination regularly, configure "Periodic Sync" in Settings. Follow the procedure below.

1 From Settings, click *Backup*.



2 Click the settings icon () to the right of "Replication".



3 Click *Periodic Sync*.

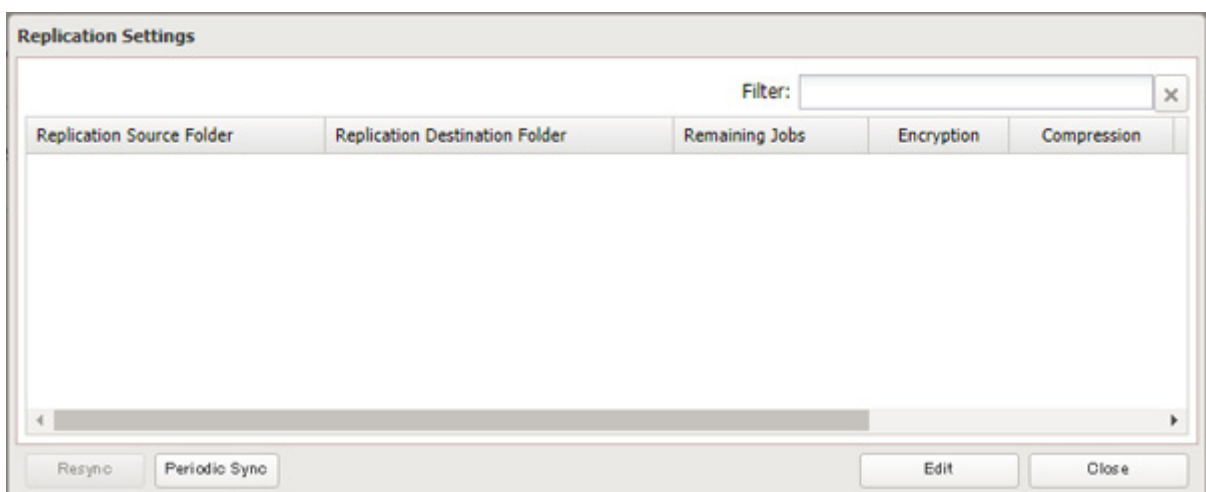

- 4 Select “Daily” or “Weekly” from the “Schedule” drop-down list. If “Daily” is selected, configure the sync period. If “Weekly” is selected, specify the weekdays and the sync period.

- 5 When the configuration is completed, click OK.

Failover

With failover, two TeraStations are connected to the network for redundancy, with one being the main TeraStation and the other being the backup TeraStation. If an issue renders the main TeraStation inaccessible, operation automatically switches to the backup TeraStation.

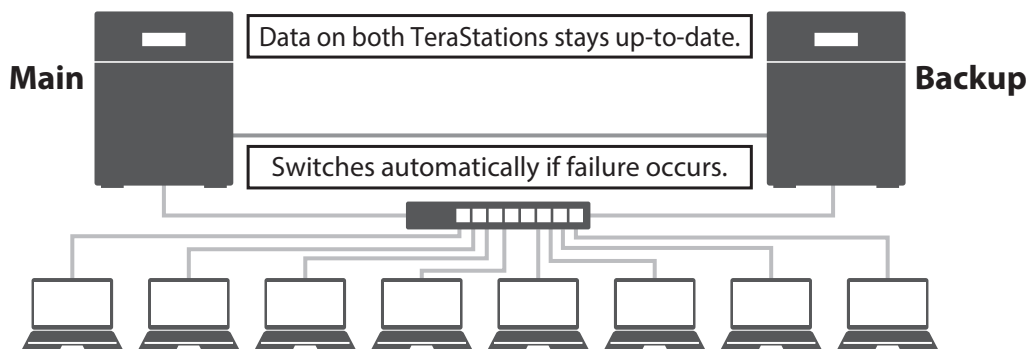

Failover will activate if any of the following occurs:

- **The backup TeraStation cannot detect the main TeraStation within a specified time**

If the backup TeraStation has not received a packet from the main TeraStation within a specified time, the backup TeraStation considers the main TeraStation to have failed. By default, it will try five times and wait 60 seconds. If this is triggered by accident, reconfigure failover from the main TeraStation.

- **Errors**

Failover will occur if any of the following errors occur:

E12 (cooling failure), E14 (cannot mount RAID array), E16* (drive not found), E22* (cannot mount drive), E30* (drive failure)

*This triggers when the drive is configured in JBOD.

Notes:

- Only use identical model and capacity TeraStations for failover. If the capacity of the main TeraStation is larger than that of the backup TeraStation, an I33 replication error will occur.
- All drive bays of a TeraStation should be occupied if it will be used for failover. Failover will not work if a drive is missing from any bay.

Before Configuring Failover

Use the same LAN ports for transferring data and configure both TeraStations with static IP addresses for the purposes of failover.

Using the Same LAN Port for Both File Sharing and Failover

Using this setup, if the main TeraStation fails, the backup TeraStation will replace it completely. The backup TeraStation will be updated over normal network traffic.

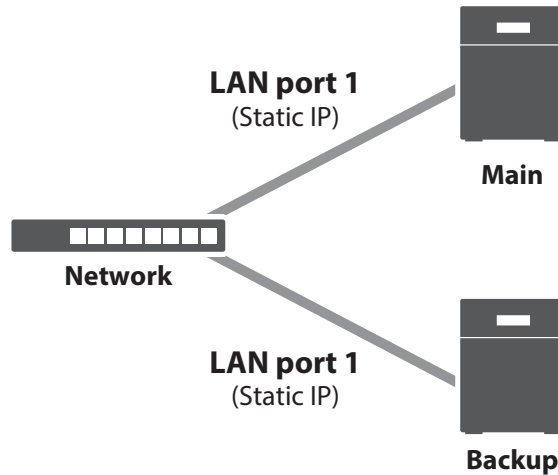

Using Different LAN Ports Between File Sharing and Failover

With this setup, the backup TeraStation and main TeraStation are connected by a second Ethernet cable connecting their LAN port 2. Updating is done over this dedicated network path, so updates are quicker and don't interfere with normal network traffic.

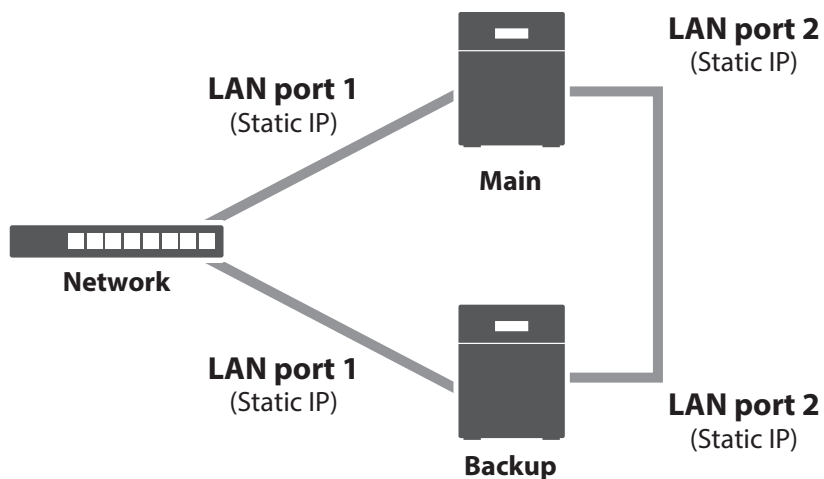

Usage Restrictions

Functional Restrictions

Failover is not available when any of the following functions are enabled:

Replication, sleep mode, encrypted drive volume, LVM volume, iSCSI volume, port trunking, Amazon S3*, Dropbox Sync, Microsoft Azure Storage Sync, Microsoft OneDrive Sync, hot spare, access restrictions by Active Directory domain

*Even if the function is disabled, the settings may remain if the settings were configured beforehand. Initialize all settings before configuring failover.

Setting Restrictions

The following functions will not be available while failover is enabled:

Initializing settings, changing the RAID settings, formatting drives, iSCSI volume, changing the backup TeraStation's settings, turning the TeraStation on and off, updating the firmware

While failover is enabled, shutdown, power-on, and firmware update operations can be made available by temporarily putting the TeraStation into maintenance mode. Maintenance mode can be enabled or disabled at *Backup > Failover* in the main TeraStation's Settings. Click *Maintenance mode* to enable maintenance mode, or click *Cancel maintenance mode* to disable maintenance mode.

To update the firmware while in maintenance mode, the main TeraStation can be updated from Settings, but the backup TeraStation cannot. Download the firmware updater from the [Buffalo website](#) for the backup TeraStation and try updating the firmware on it.

Non-Transferable Settings

The settings below are not copied from the main TeraStation to the backup TeraStation. Make a note of the original settings so that they can be configured manually if a failover error occurs.

IP address, hostname, WebAccess, UPS sync, antivirus*, the backup job settings either if specifying shared folders on the backup TeraStation or USB drives as the backup destination, USB drives' shared folder settings, and low drive space alerts

*The settings configured on the Trend Micro NAS Security settings page will not be copied to the backup TeraStation. The settings configured on the main TeraStation's Settings page will be copied only if the antivirus is activated on the TeraStation.

Using with UPS

Once failover is configured, you cannot set up a UPS for the backup TeraStation. Configure your UPS before configuring failover. UPS recovery can be configured for both the main and backup TeraStations.

Configuring Failover

- 1 From Settings for the main TeraStation, click *Backup*.



- 2 Click the settings icon () to the right of "Failover".

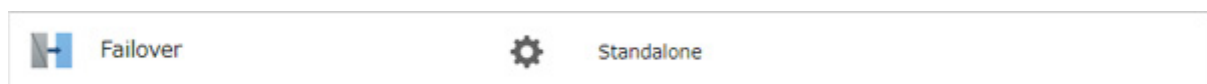

3 Click *Configure Failover*.

Failover

Status: Standalone

Backup Device: Configure Failover

Remaining Jobs: —

IP Settings for File Sharing | Periodic Sync | Advanced Settings

LAN Port:

Virtual IP Address:

Subnet Mask:

Edit Close

4 Select a TeraStation to be the failover backup device and enter its administrator username and password (by default, the username is “admin” and the password is “password”).

Failover Settings

*Required ?

Backup Device Settings: Backup Device: TS3410D355

Administrator Username * :

Administrator Password * :

IP Settings for File Sharing: LAN Port: (LAN1) 192.168.10.38

Virtual IP Address * :

Subnet Mask * : 255.255.255.0

Backup LAN Port: (LAN1) 192.168.10.38

Access Restrictions for Subfolders: Inherit Do not inherit

Use TeraStations of the same model and storage capacity for the main and backup units. Set the MTU size to 1500 bytes for both units.

Continue Close

- 5** Select the LAN port to be used for sharing files and enter a virtual IP address and subnet mask. The LAN port you have selected here will also be used for pinging. If you select the same LAN port as the backup LAN port, the backup TeraStation will replace the main TeraStation even if just a network error occurs.
About virtual IP addresses: A virtual IP address is an IP address that will be used for file sharing while failover is configured. By assigning a different IP address from the one to be assigned to the LAN port, you can access the TeraStation for sharing files, as well as open Settings using the virtual IP address. This IP address will be inherited to the backup TeraStation when failover occurs, so you can access the backup TeraStation even if you don't know the backup TeraStation's static IP address.
 Configure an unused IP address for the virtual IP; make sure it uses the same segment as the main and backup TeraStations.
- 6** Select the LAN port to be used for transferring data via failover.
- 7** Configure whether or not to inherit the settings of subfolders' access restrictions to the backup TeraStation, then click *Continue*.
- 8** If the administrator username and password is correct, the backup TeraStation will beep. Press and hold down the function button on the backup TeraStation to accept the settings from the main TeraStation. When you press the function button, the backup TeraStation will stop beeping.
- 9** Press the function button. When you press the function button, the TeraStation will beep once. Press and hold down the button until the backup TeraStation beeps again.
- 10** The I51 message will appear on the Dashboard in Settings and NAS Navigator2 for both TeraStations. Wait until initialization finishes. Failover is configured after it finishes and the I51 message disappears.

Notes:

- If you want to cancel the failover settings while both the main and backup TeraStations are working properly, click *Force Failover to Stop* on both TeraStations and restart them. After the TeraStations are restarted, make sure that all settings such as IP address and files in the shared folders are correct.
 When you cancel failover settings, attributes of the shared folders on the backup TeraStation will become read-only. Change the attribute settings to the desired options if necessary.
- If replication is configured for more than one folder, initialize the TeraStation before configuring failover.
- The main TeraStation cannot be used as the backup location for Time Machine.
- Do not use the same TeraStation for both failover and replication, or failover and Time Machine.
- If email notification is enabled and failover occurs, navigate to *Management > Email Notification > Edit* in the main TeraStation's Settings and click *OK*.
- MTU size settings for main and backup TeraStations should be 1500 bytes. To change the MTU size, navigate to *Network > IP Address > Edit*, and change the MTU size to "1500" bytes.
- Files whose filenames contain more than 80 alphanumeric characters will not be backed up.
- If the I33 message appears on the Dashboard in Settings and NAS Navigator2, navigate to *Backup > Replication* and click *Resync*.
- The RAID array on the backup TeraStation may be reconfigured and resynchronized as part of the failover configuration process. This is expected behavior and not an error.

Switching to the Backup TeraStation Manually

If "Switch to backup unit manually" is selected on the *Advanced Settings* tab in the main TeraStation's Settings, the backup TeraStation will not replace the main TeraStation if the main TeraStation fails. To manually replace the main TeraStation with the backup TeraStation, you can either:

- Log in to Settings for the backup TeraStation and click *Set as Main Unit*.
- Or, press and hold down the function button on the backup TeraStation.

Note: If the main TeraStation fails but all LAN port connections on the backup TeraStation remain up, you cannot replace the main TeraStation with the backup TeraStation from Settings. In such a case, use the function button instead.

Reconfiguring After Failover Occurs

When the backup TeraStation replaces the main TeraStation, the I49 message may appear on NAS Navigator2. To configure failover again, follow the procedure below using a new TeraStation unit. The following procedure is an example using the replaced backup TeraStation (“main TeraStation”) and the new TeraStation (“backup TeraStation”). If you don’t want to configure failover with the new TeraStation, cancel the failover settings by following steps 1–5 below and restart both TeraStations. The I49 message will disappear.

Note: The following procedure will also work if failover occurs unexpectedly.

1 After failover occurs, log in to Settings for the new main TeraStation.

If you have configured to synchronize with the UPS device connected to the failed TeraStation, the E10 error will be displayed on the main TeraStation. In such a case, follow the procedure below to change the UPS settings on the new main TeraStation. If you hadn’t, skip to the next step.

- a. Disconnect the UPS cable from the failed TeraStation and connect it to the main TeraStation.
- b. Click *Management*.
- c. Click the settings icon () to the right of “Power Management”.
- d. Click *Edit*.
- e. Select “Sync with UPS connected to this TeraStation” and reconfigure the desired UPS settings.
- f. Click *OK* when completed.

2 Click *Backup*.



3 Click the settings icon () to the right of “Failover”.

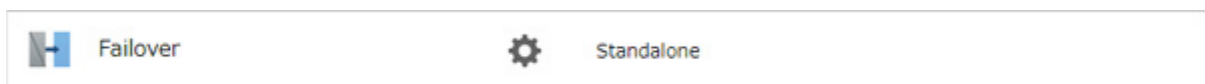

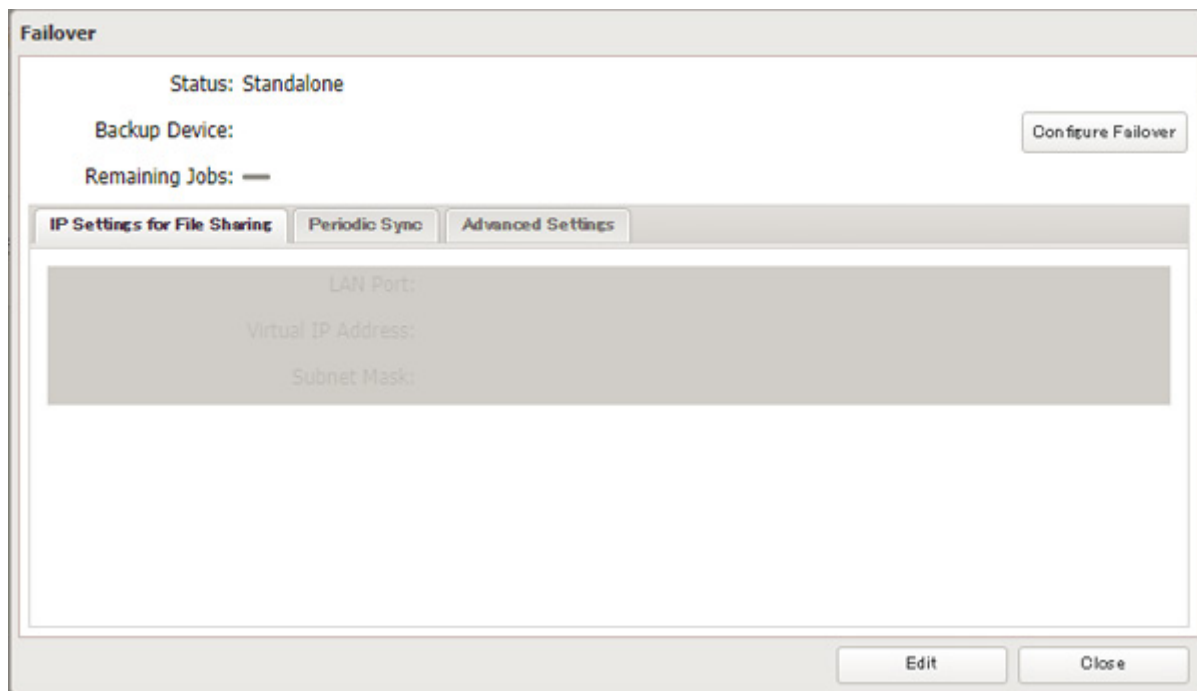
4 Click *Configure Failover*.**5** Click *Force Failover to Stop* to cancel the failover settings.**6** Shut down this main TeraStation.**7** Turn the backup TeraStation on.**8** Log in to Settings for the backup TeraStation, then rename the TeraStation's hostname and configure the IP address so that it has a new static IP address.**9** Power on the main TeraStation. To configure the UPS sync on the backup TeraStation, configure the settings here. Otherwise, skip to the next step.

To synchronize with the UPS device connected to the main TeraStation, follow the procedure below on the backup TeraStation.

- a. Click *Management*.
- b. Click the settings icon () to the right of "Power Management".
- c. Click *Edit*.
- d. Select "Sync with UPS connected to another Buffalo NAS device on the same network" and configure the main TeraStation as a sync source.
- e. Click *OK* when completed.

10 Reconfigure failover by referring to the "[Configuring Failover](#)" section above.

Synchronizing Between Main and Backup TeraStations Periodically

To copy files that are saved via other file sharing protocols such as AFP or FTP to the backup TeraStation regularly, configure "Periodic Sync" in Settings. Follow the procedure below.

1 From Settings for the main TeraStation, click *Backup*.

2 Click the settings icon () to the right of "Failover".

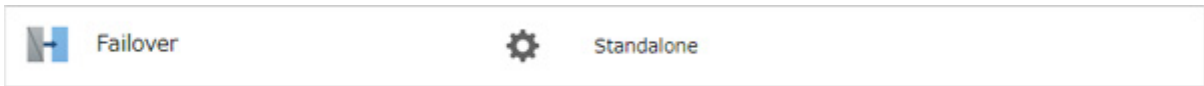

3 Click the *Periodic Sync* tab.

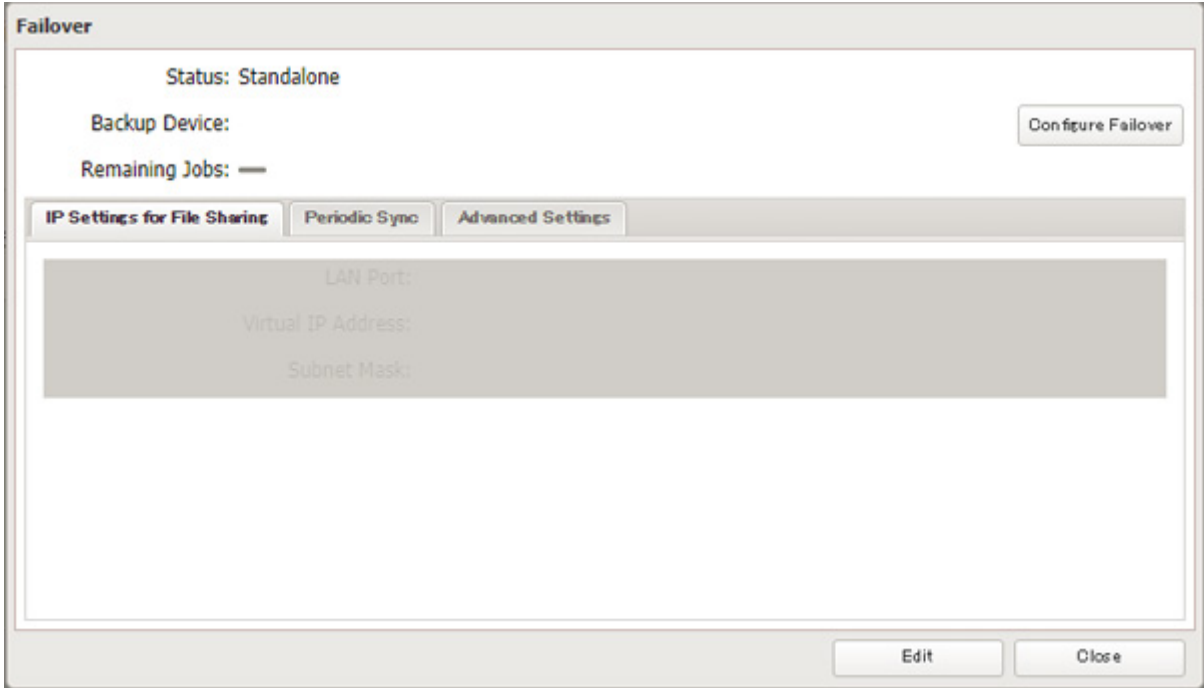

4 Click *Edit*.

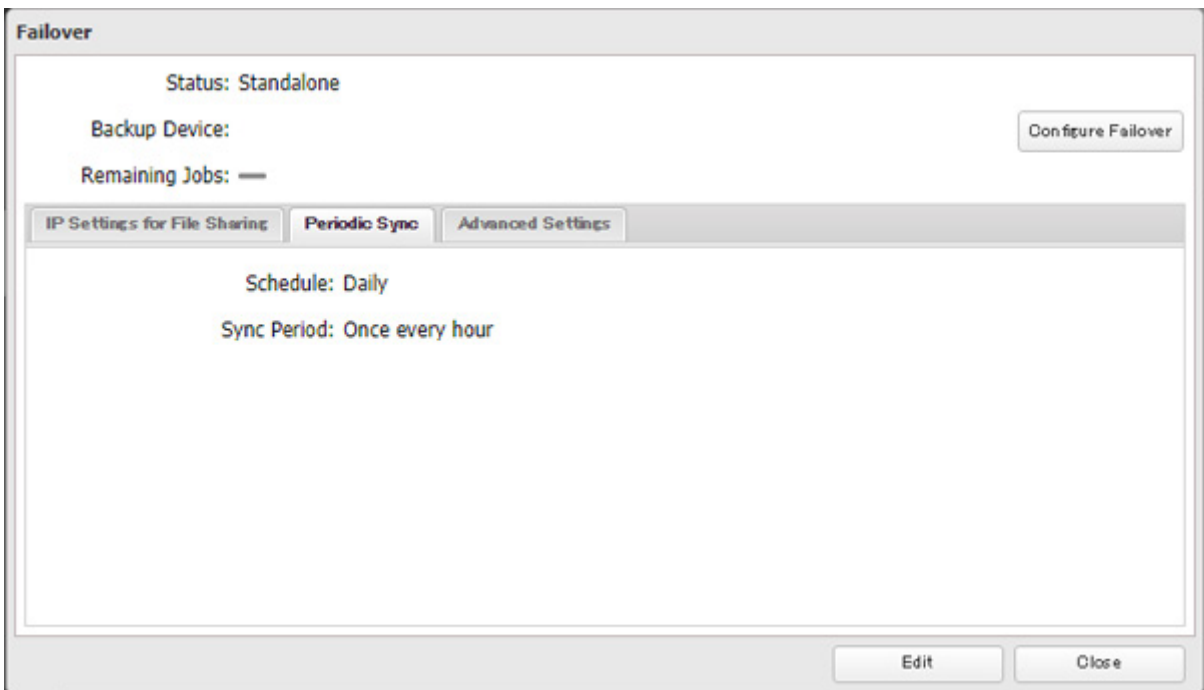

- 5** Select “Daily” or “Weekly” from the “Schedule” drop-down list. If “Daily” is selected, configure the sync period. If “Weekly” is selected, specify the weekdays and the sync period.

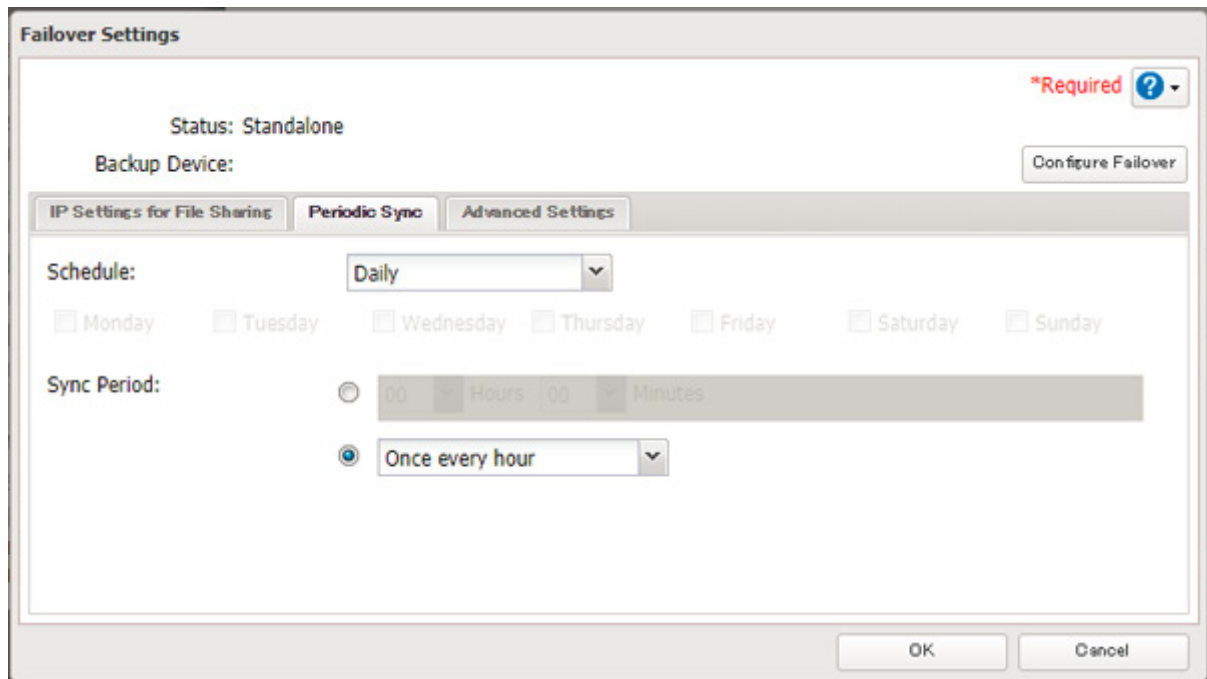

- 6** When the configuration is completed, click *OK*.

Backing Up Your Mac with Time Machine

Time Machine is a backup program included with macOS. Configure your TeraStation as shown below to use Time Machine.

1. Preparing a Shared Folder for Time Machine

- 1** From Settings, click *File Sharing*.

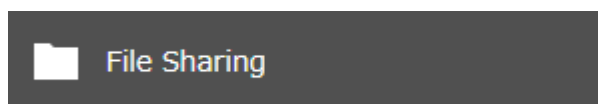

- 2** Move the AFP switch to the  position to enable AFP.

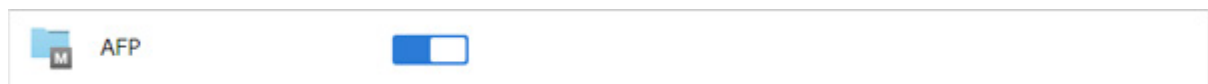

- 3** Click the settings icon () to the right of “Folder Setup”.

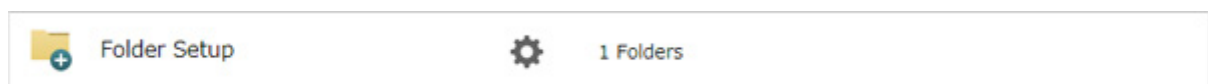

- 4** Choose a shared folder as your backup destination for Time Machine.

- 5** Under “LAN Protocol Support”, select the “AFP (Mac)” checkbox on the *Basic* tab and click *OK*.

- 6** Click *Close*.

2. Configuring a Shared Folder as a Backup Destination

1 From Settings, click *Backup*.



2 Click the settings icon (⚙️) to the right of "Time Machine".



3 Click *Edit*.

4 Click *Browse*.

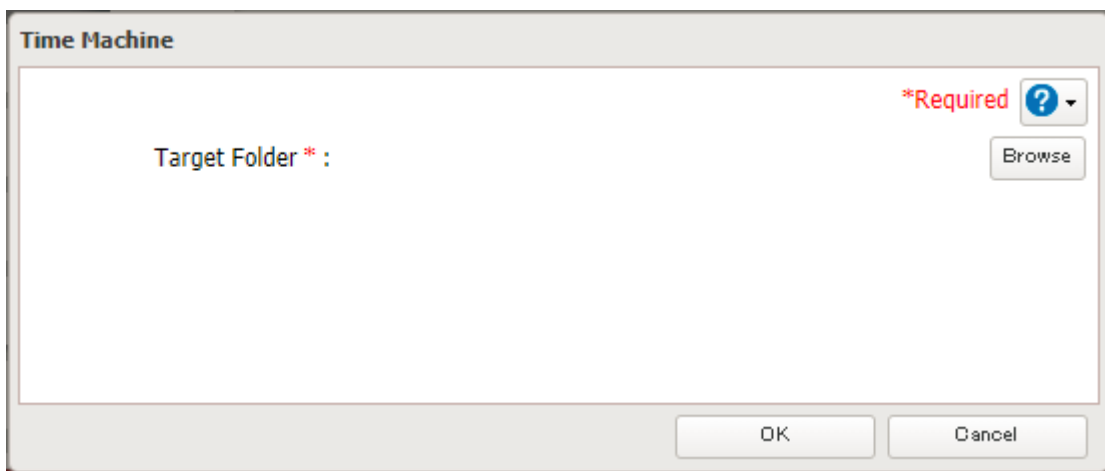

5 Select the shared folder that you enabled AFP for in the previous steps, then click *OK*.

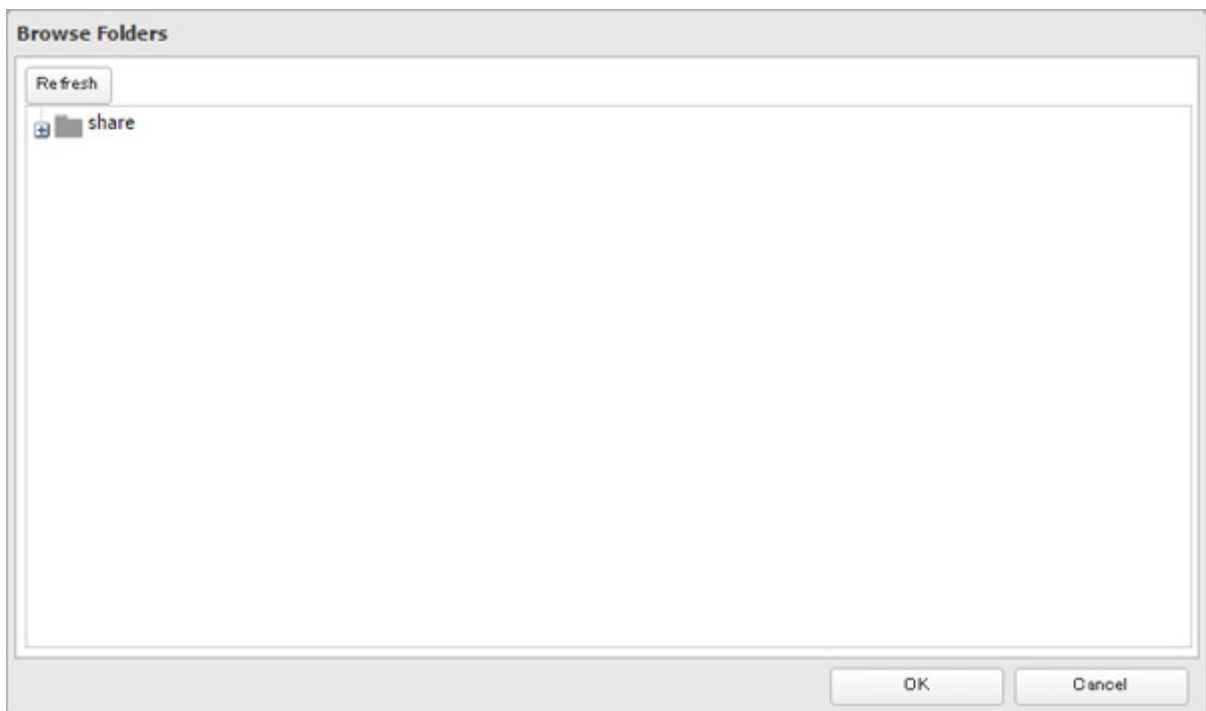

6 Click *OK*, then click *OK* again.

7 Move the Time Machine switch to the  position to enable Time Machine.



3. Configuring Time Machine on macOS

1 From the Apple menu, open *System Preferences*.

2 Click *Time Machine*.

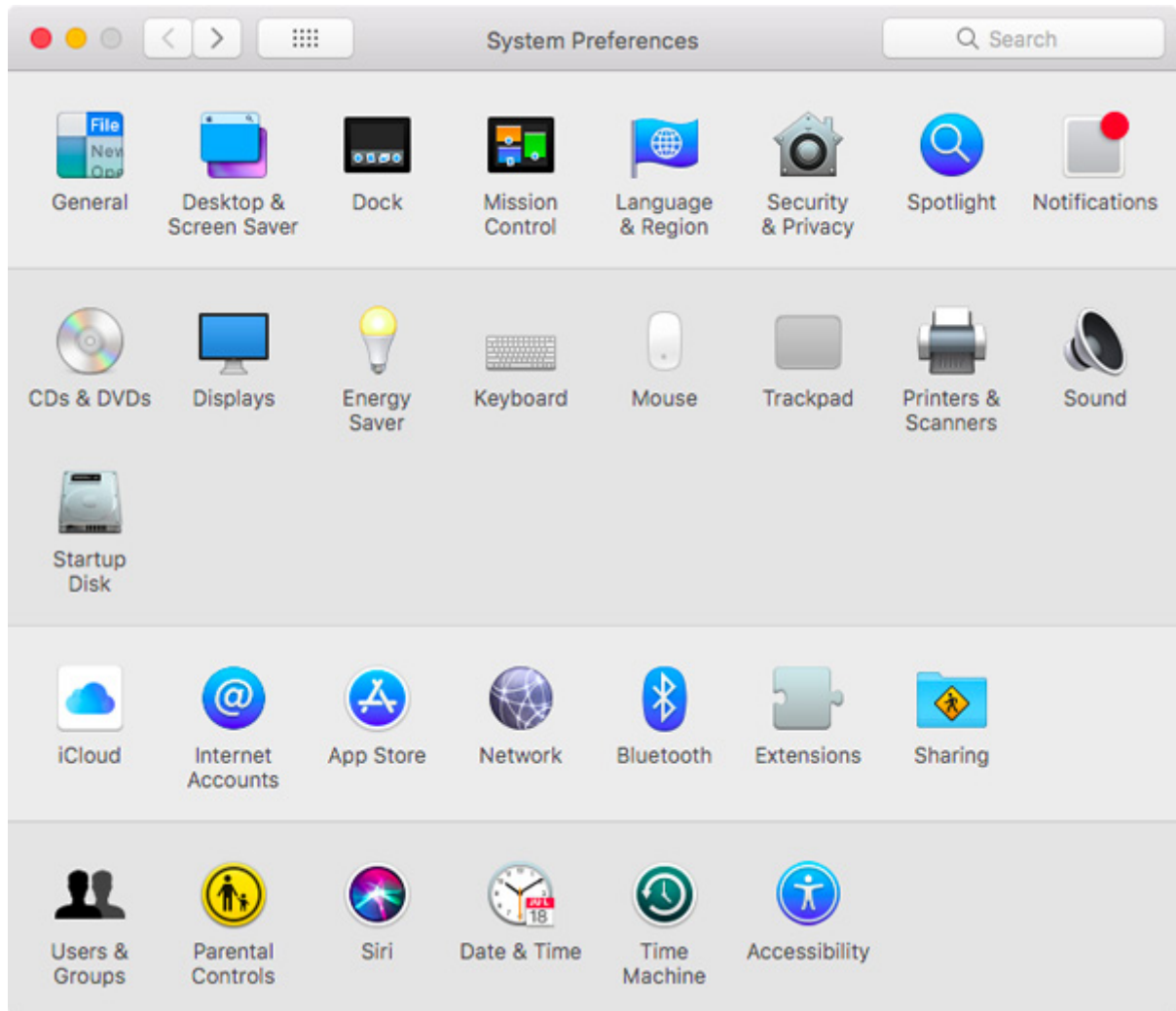

3 Click *Select Backup Disk*.

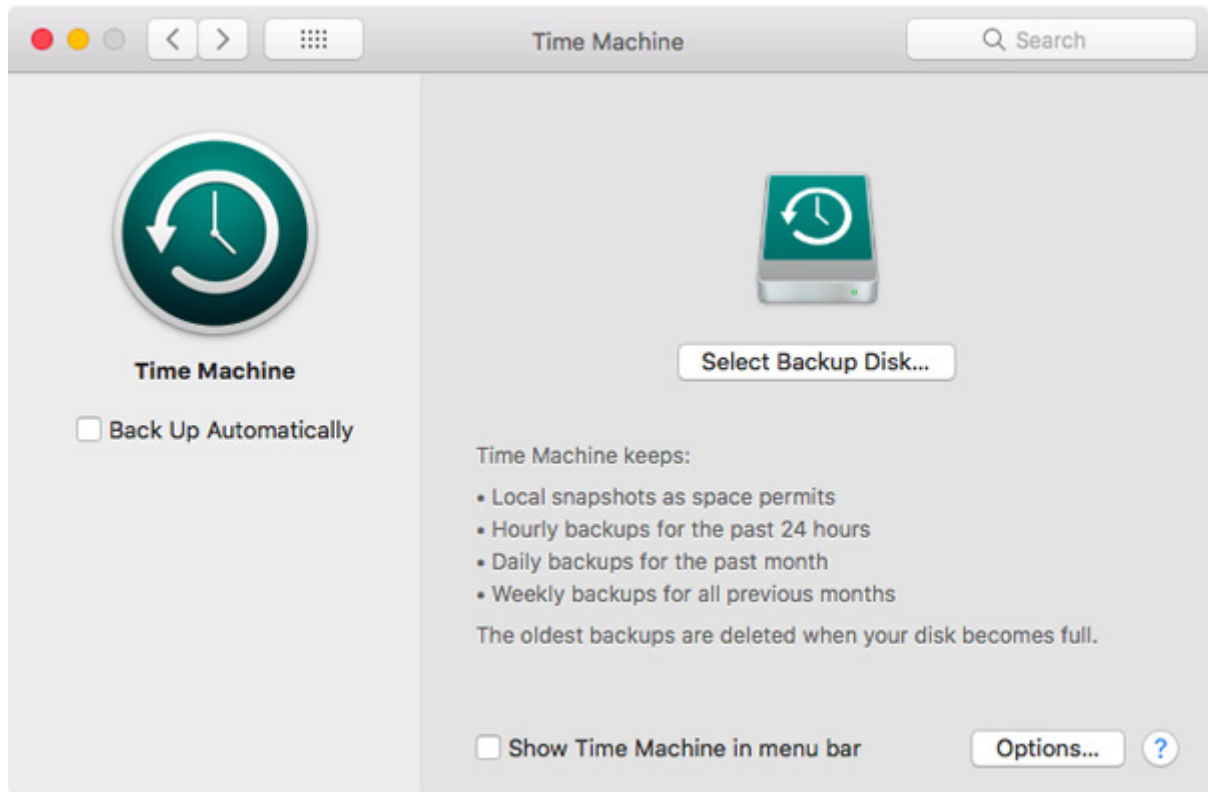

4 Select the shared folder, then click *Use Disk*.

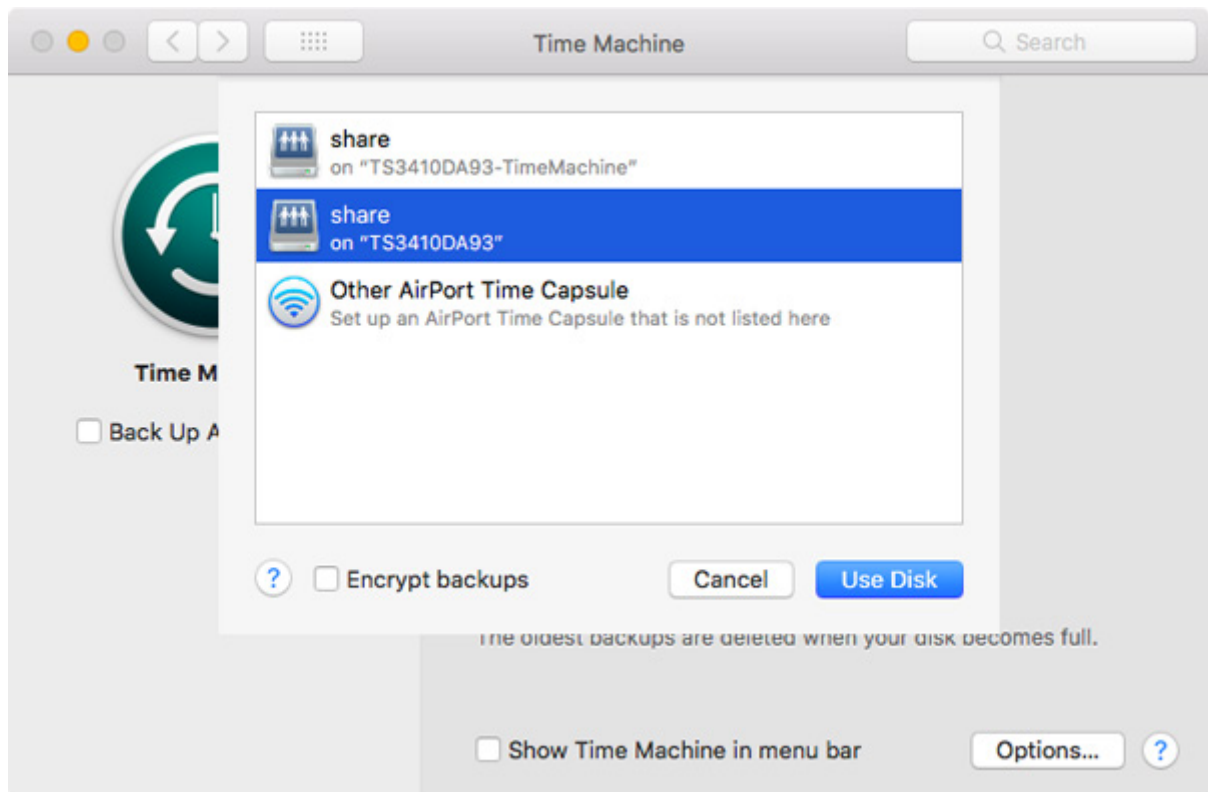

5 Click *Connect*.

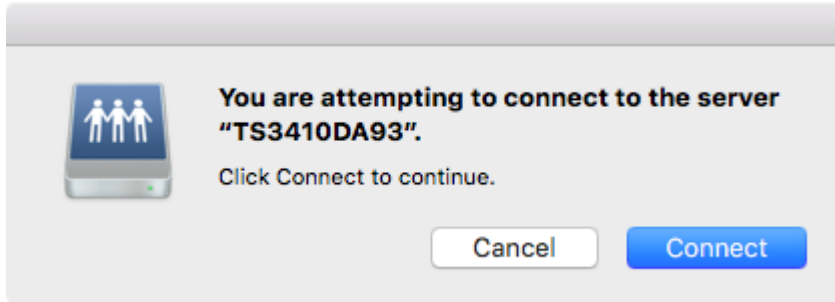

6 Enter a username and password to be used for accessing the shared folder and click *Connect*.

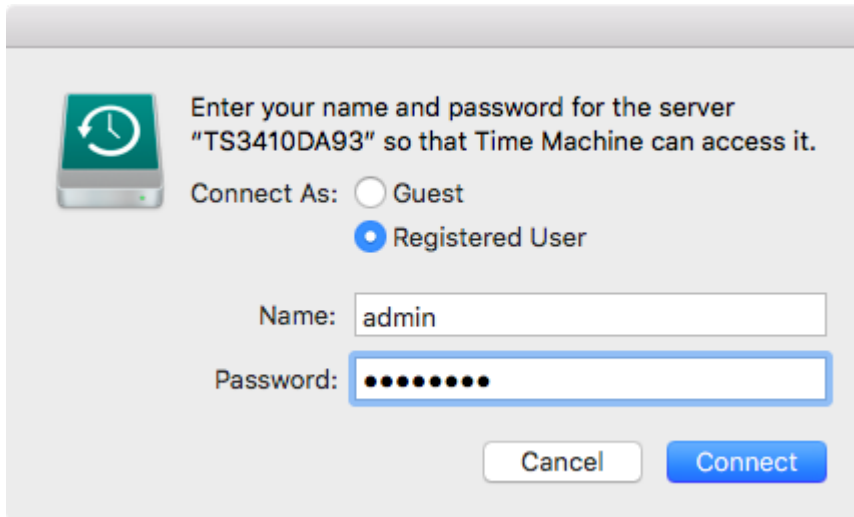

Note: If access restrictions are not configured on the destination share, log in with the administrator account. The default username and password for the administrator account are “admin” and “password”. If access restrictions are configured, log in with an account with write privileges.

7 Time Machine will count down from 120 seconds, then backup will begin.

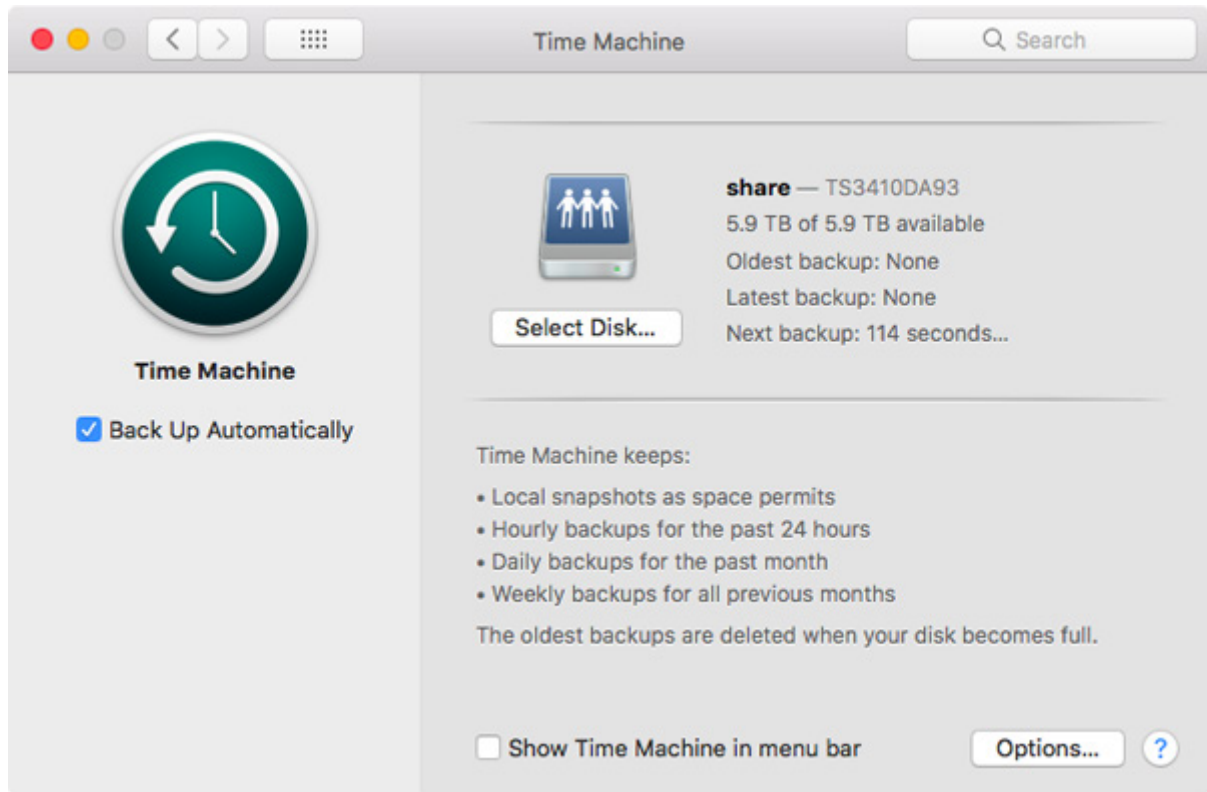

Chapter 6 Cloud Services and Remote Access

Synchronizing with Amazon S3

The TeraStation supports Amazon S3, a fee-based online storage service provided by Amazon, and other cloud storage services that share the Amazon S3 API. Follow the procedure below to configure your TeraStation for use with Amazon S3.

Notes:

- Depending on the services you have purchased, prices for operations and amount of data will vary. To avoid being charged unexpectedly expensive fees, we recommend staying aware of the price structure for data storage and operations and regularly checking how much have been charged.
- Set the TeraStation's time settings to the correct time. Using NTP is recommended. To configure NTP settings on the TeraStation, refer to the ["Name, Date, Time, and Language"](#) section in chapter 7.
- This function doesn't support Amazon S3 Glacier.

Preparing for Amazon S3

1 From Settings, click *Cloud Storage*.

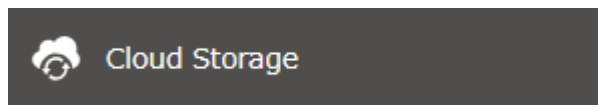

2 Click the settings icon (⚙) to the right of "Amazon S3".



3 Click *Add*.

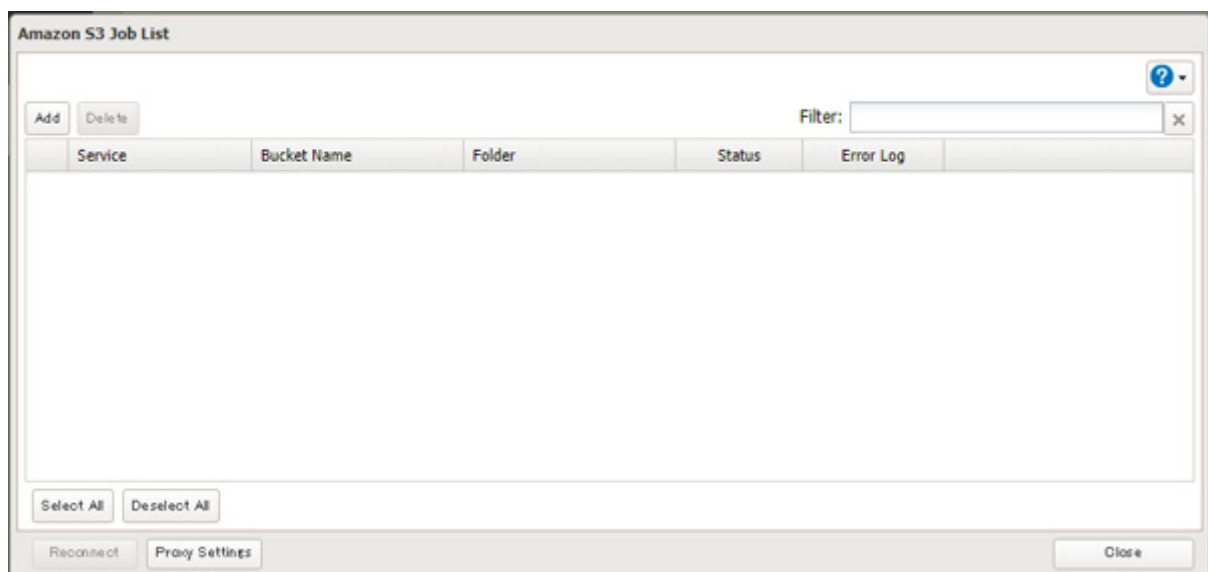

- 4** Select the service name and region name that you have selected when creating the bucket from the drop-down list. Enter the bucket name, access key ID, and secret access key; select the storage class and the connection protocol, then click *OK*.

Amazon S3 Settings

*Required ?

Service: Amazon S3

Target Hostname:

Region Name: Asia Pacific (Tokyo)

Region: ap-northeast-1

Bucket Name * :

Access Key ID * :

Secret Access Key * :

Storage Class: Standard RRS

Connection Protocol: HTTP HTTPS

OK Cancel

- 5** Enter a remote folder name to use with Amazon S3 and click *OK*.

Create Shared Folder

*Required ?

Create a shared folder to use for Amazon S3 on this TeraStation.

Folder Name *

OK Cancel

- 6** Under "LAN Protocol Support", select the "Backup" checkbox on the *Basic* tab.

LAN Protocol Support:

- SMB (Windows/Mac)
- AFP (Mac)
- Backup
- FTP
- SFTP
- WebAccess
- NFS

7 Click *OK*.

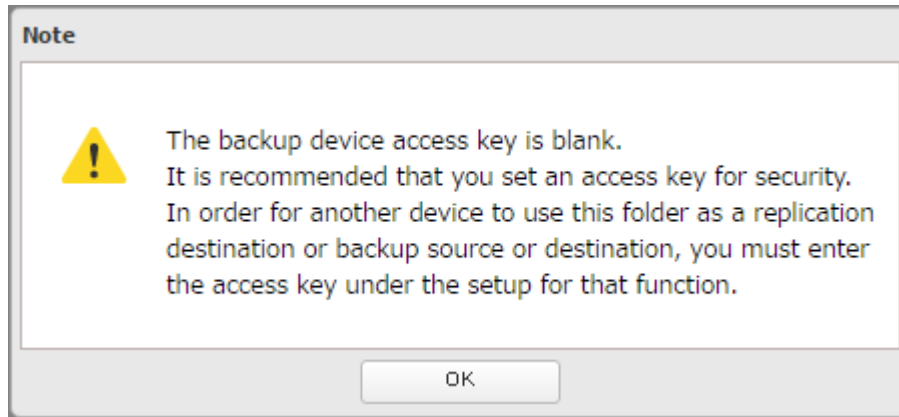

8 Enter the desired characters into the backup device access key field.



9 Configure the desired shared folder settings, then click *OK*.

Notes:

- If a remote folder created through this process is configured to use NFS, it cannot be mounted from an NFS client.
- Files cannot be uploaded to this remote folder using WebAccess.
- If using Amazon S3 through a proxy server, click *Proxy Settings*. From the displayed page, you can select whether to use the configured settings or configure an identical proxy server. If using the identical proxy server, select “New settings” and enter the proxy server name, port number, username, and password. Consult your network administrator for detailed proxy server settings.
- If you enter an incorrect bucket name and then cancel editing the Amazon S3 settings, the incorrect bucket name may still accidentally be registered. If this occurs, start from step 4 above and reconfigure the Amazon S3 settings correctly.
- Do not configure a folder that is created through the procedure above as a replication destination folder.

Uploading Files to Amazon S3

To upload files to Amazon S3 buckets, using a backup job is recommended.

1 From Settings, click *Backup*.



2 Click the settings icon (⚙️) to the right of “Backup”.



3 If you had configured a backup device access key to the remote folder that was created through the [“Preparing for Amazon S3”](#) section above, click *Set*. If you hadn't, skip to step 5.

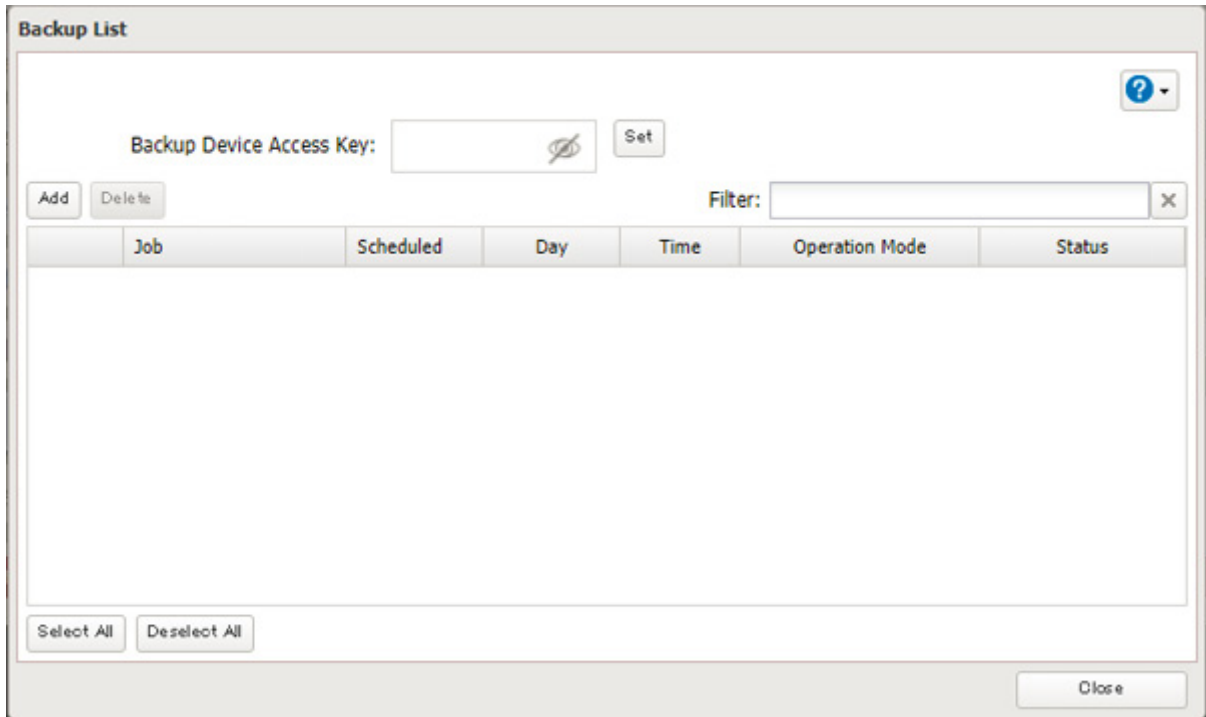

4 Enter the backup device access key and click *OK*.

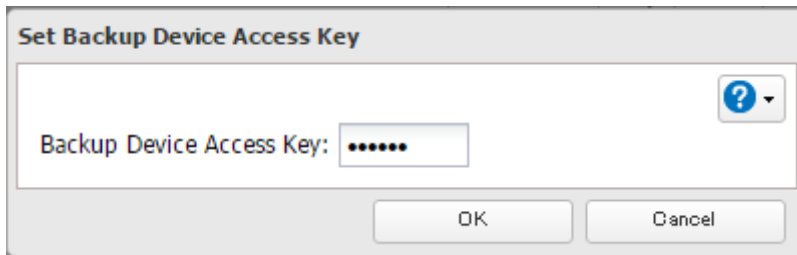

5 Click *Add*.

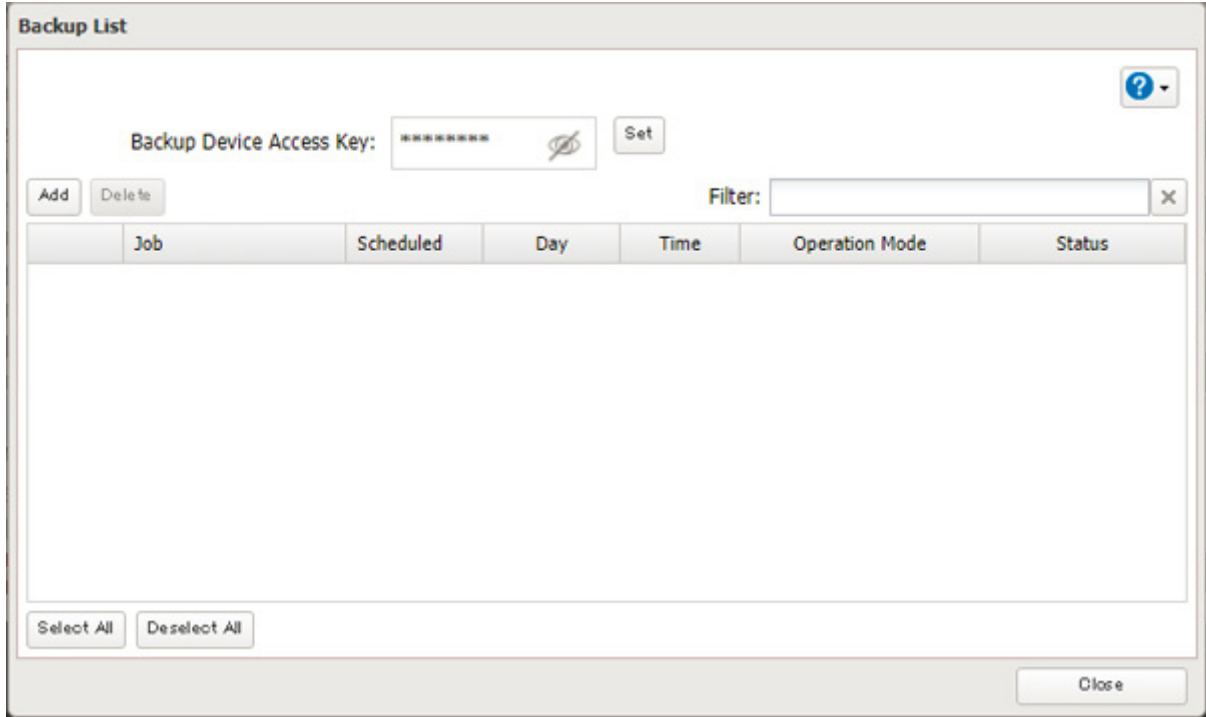

6 Select backup settings such as date and time to run, select a backup mode for the "Operation Mode" drop-down list. It is recommended to configure a job to run periodically. Refer to the differences between the backup modes in the ["Backup Modes"](#) section in chapter 5.

Note: If you create a differential backup job and there are files that only exist in the destination folder, these files will be deleted when the job runs. Make sure that files are not saved when creating a backup job.

The screenshot shows the 'Backup Job Settings' dialog box. It contains the following fields and options:

- Name ***: A text input field.
- Schedule**: A dropdown menu set to 'Not scheduled'.
- Date and Time**: A dropdown menu set to 'Sunday', followed by two spinners for '0' Hours and '0' Minutes.
- Operation Mode**: A dropdown menu set to 'Full backup'.
- Versions**: A spinner set to '10', with a checked checkbox for 'Unlimited'.
- Options**:
 - Create a subfolder for backup
 - Create backup log file
 - Save backup logs in the backup source folder
 - Select the folder to save backup logs
 - Backup Log Target Folder: [Browse]
 - Encrypted data transfer
 - Compress and transfer
 - Ignore backup errors and continue backup job on schedule
 - Do not back up recycle bin
 - Overwrite unchanged files
 - Inherit subfolders' access restrictions

At the bottom, there are 'Add' and 'Delete' buttons on the left, a 'Filter:' label with an input field, and 'OK' and 'Cancel' buttons on the right.

7 Click *Add*.

- 8 Select the shared folder that files will be saved to as a source, and the remote folder created through the [“Preparing for Amazon S3”](#) section above as a destination.

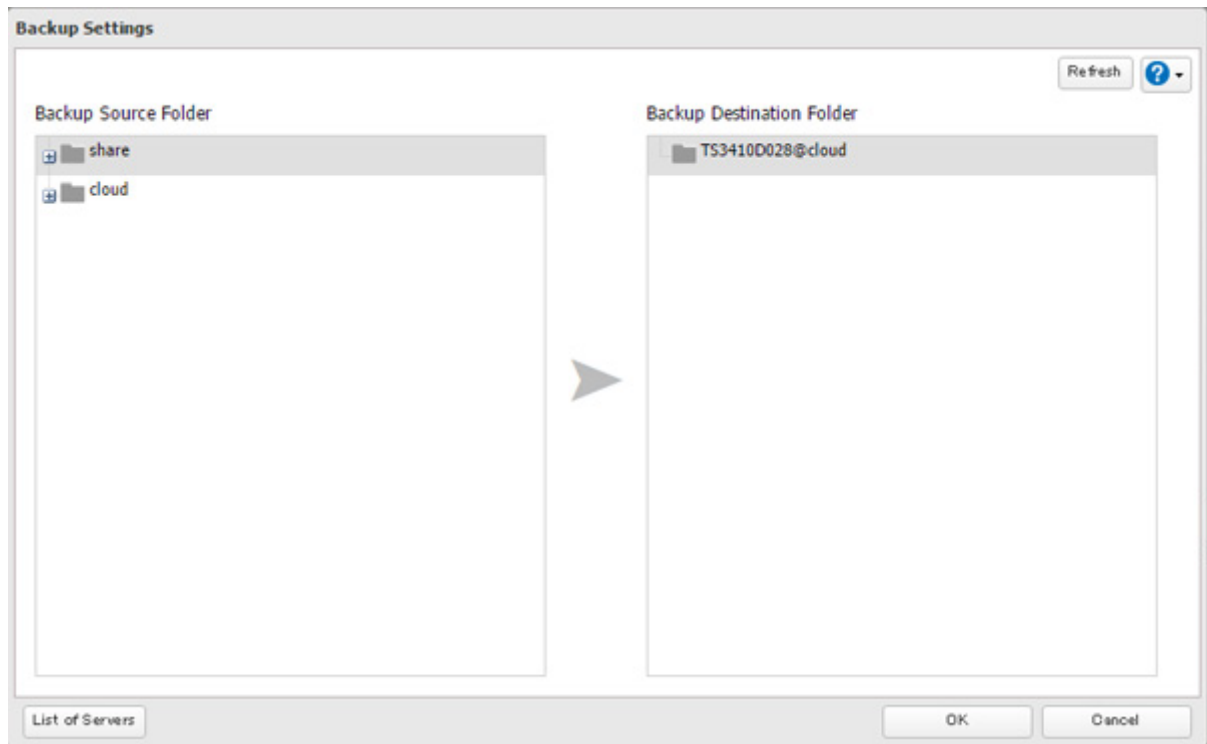

- 9 Click *OK*. The backup job will be added to the backup job list.

Notes:

- To use the service after the network was temporarily disconnected, click *Reconnect*.
- If a file is directly added to the Amazon S3 bucket, the file will not be replicated to the remote folder.
- Do not copy 100,000 or more files to the backup source folder at once. If you do and uploading fails, check the network environment speed and try again with fewer files.
- Be careful with existing files in the remote folder, as files with the same name will be overwritten even if copied files are older.
- If you copy a file to the shared folder using File Explorer or a backup process, the file will also be uploaded sequentially to the Amazon S3 bucket. This second uploading process will start in the background during the first copying process and will not be visible. If the TeraStation is shut down or restarted immediately after copying a file to the shared folder, changing the settings, or disconnecting and reconnecting the Ethernet cable, the file may not be uploaded to the bucket. Try copying the file again if this occurs.
- If you encounter any upload or download errors, click *Error Log*. The log will display the filename and operation during which the error occurred.
- If uploading fails, try copying the file again. If it still fails, click *Reconnect* or set the Amazon S3 switch to off and on again, then restart the function service.
- If accessing or transferring files that total 1 TB or more to the Amazon S3 bucket, make sure there is enough free space on the TeraStation for temporary file caching. For example, when uploading 1 TB of files to the bucket, it is recommended to keep at least 2 TB of free space available.

Synchronizing with Dropbox

The TeraStation supports synchronizing with Dropbox, the online cloud service. Once linked, you can share TeraStation files via Dropbox (or Dropbox files via TeraStation). To link your TeraStation with your Dropbox account, follow the procedure below.

Note: To use Dropbox Sync, you will need a Dropbox account and an available empty Dropbox folder. If you don't have a Dropbox account, or if you need to create a new empty Dropbox folder, refer to the Dropbox website.

Configuring a New Job

1 From Settings, click *Cloud Storage*.

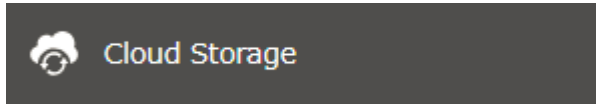

2 Move the Dropbox Sync switch to the  position to enable Dropbox Sync.



3 Click the settings icon () to the right of "Dropbox Sync".



4 Click *Add*.

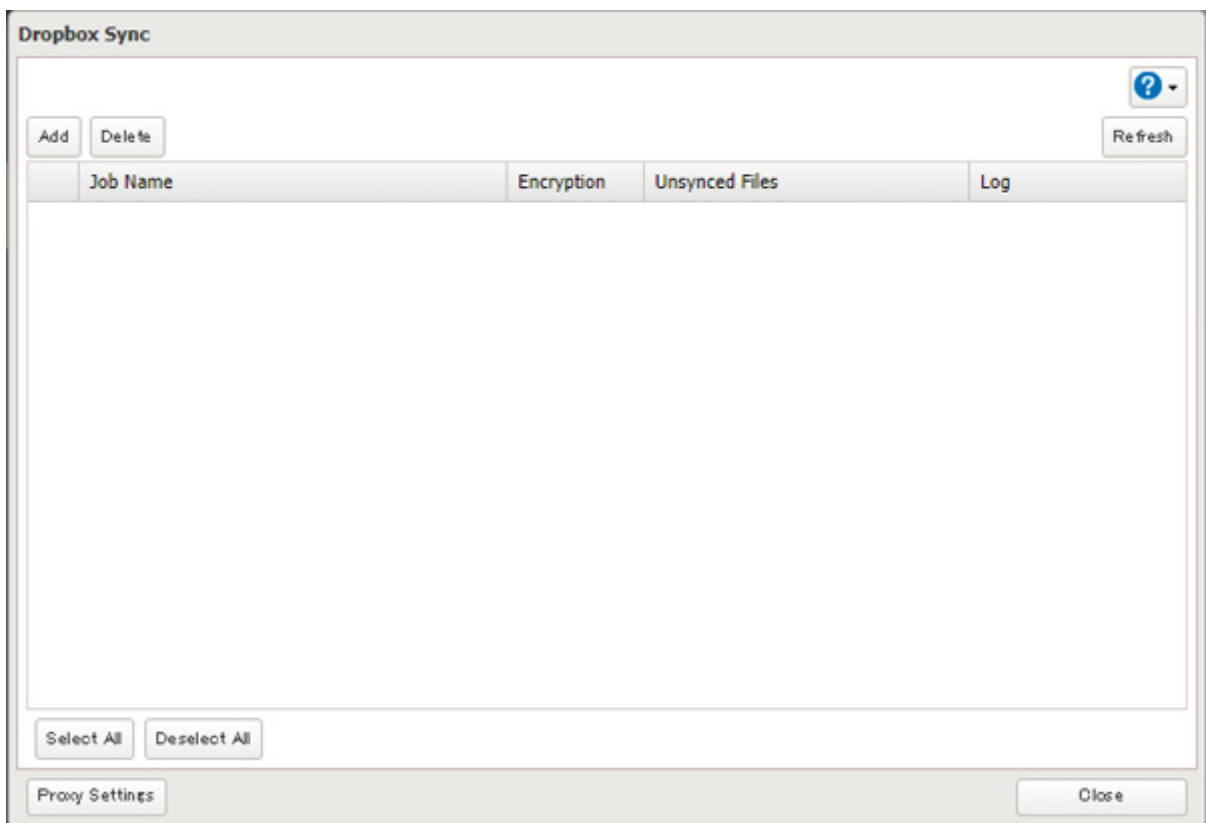

5 Click *View Dropbox Authentication Page*.

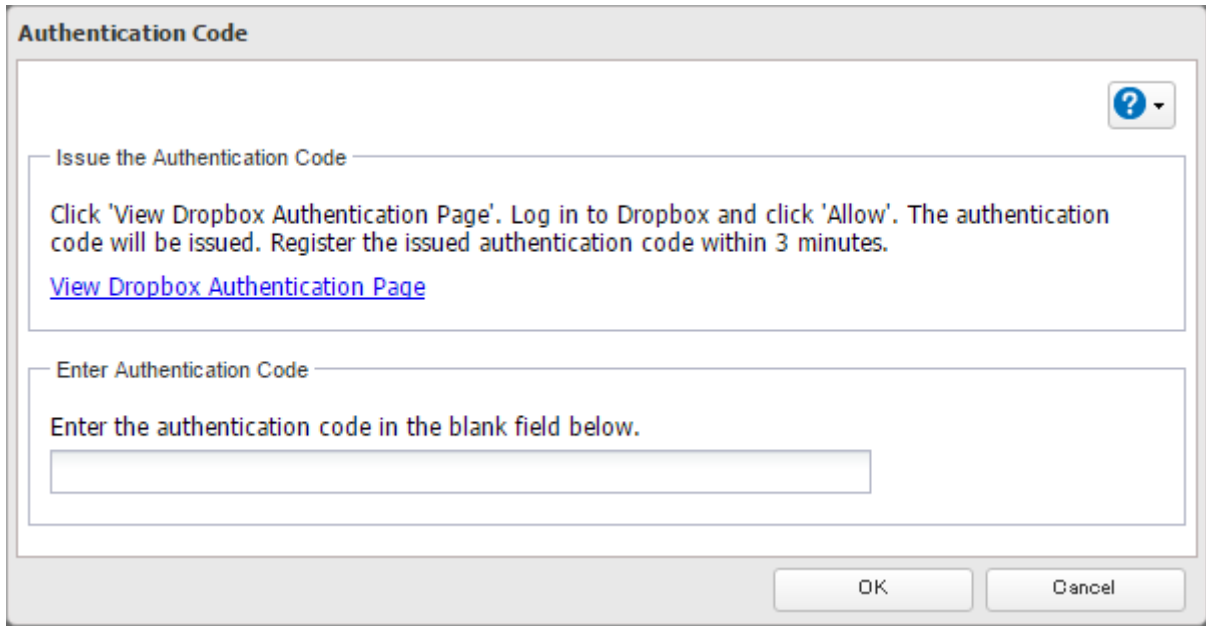

6 The authentication site that is offered by Dropbox will be displayed. Log in to the website with your Dropbox account, then click *Allow*.

7 The authentication code will be displayed. Copy the authentication code and return to Settings. Authentication code reregistration should be finished within three minutes.

8 Paste the authentication code and click *OK*.

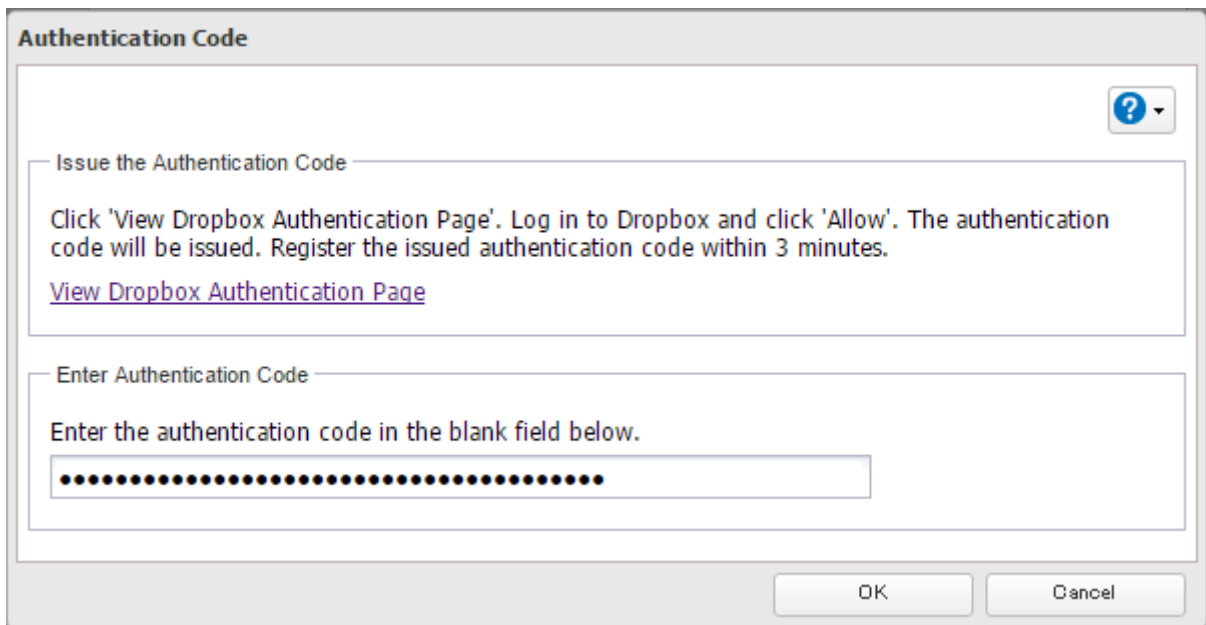

9 Enter the desired job name; select the TeraStation and Dropbox folders, and configure encryption. Click *OK*.

If you enable encryption, you will need to set an encryption password. The password cannot be changed once you configure it. Please take note of the password and keep it secure. If you forget the password, create a new job using the same Dropbox account. The old job can then be deleted.

10 Click *OK*.

Notes:

- Up to eight Dropbox jobs can be configured at a time.
- When encryption is enabled, files uploaded to Dropbox not using Dropbox Sync will not be downloaded to the TeraStation even if the sync direction is configured to “Bidirectional” or “Download only”.
- Refer to the following website for synchronization restrictions between the TeraStation and Dropbox: <https://www.dropbox.com/help/145>
- Folders that are configured for Dropbox Sync cannot be renamed or used for replication.
- Files that are 900 MB or larger cannot be downloaded using Dropbox Sync. However, even if the file size is smaller than 900 MB, downloading may fail when multiple processes are running at the same time.

Changing Job Settings

Follow the procedure below to change any job settings you have already configured.

1 From Settings, click *Cloud Storage*.

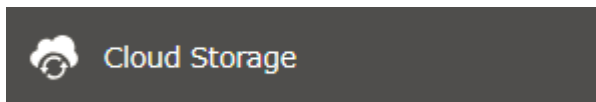

2 Click the settings icon (⚙️) to the right of “Dropbox Sync”.



3 From the job list, click the job whose settings you want to change.

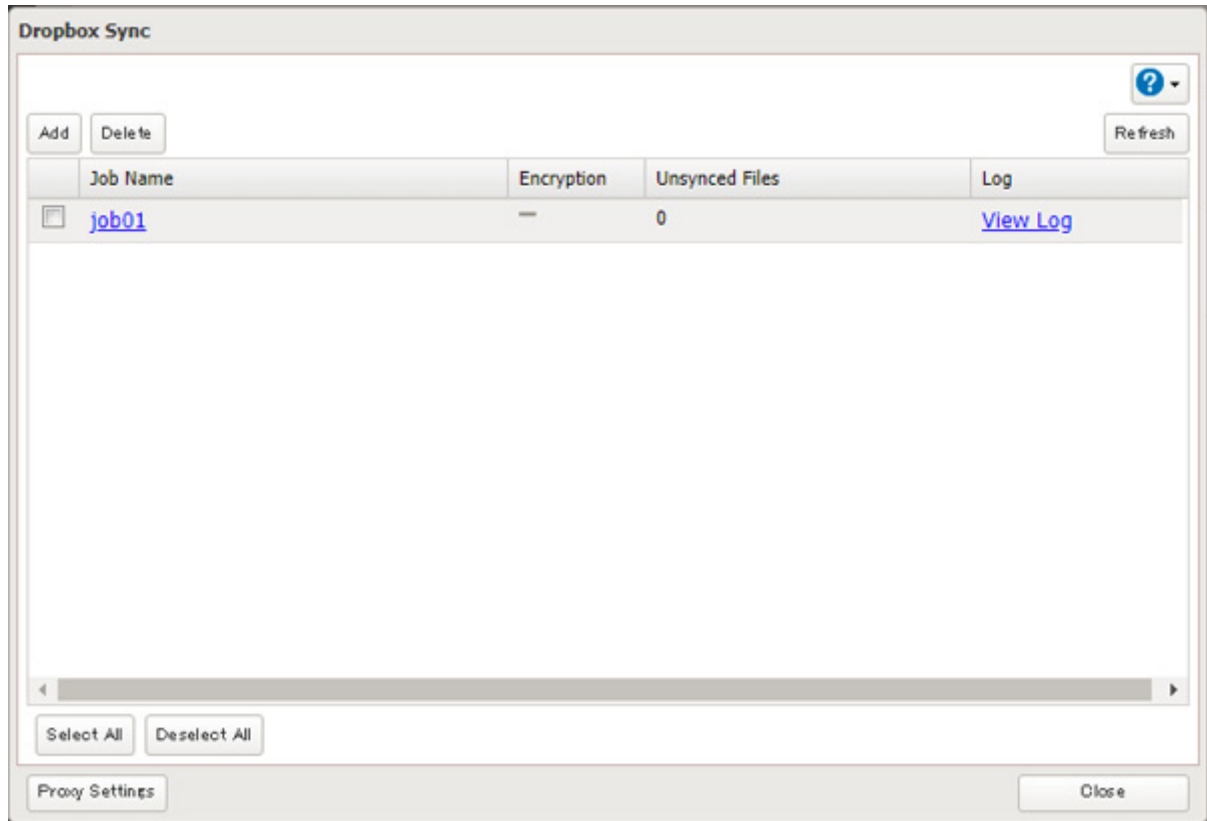

4 Click the *Options* tab.

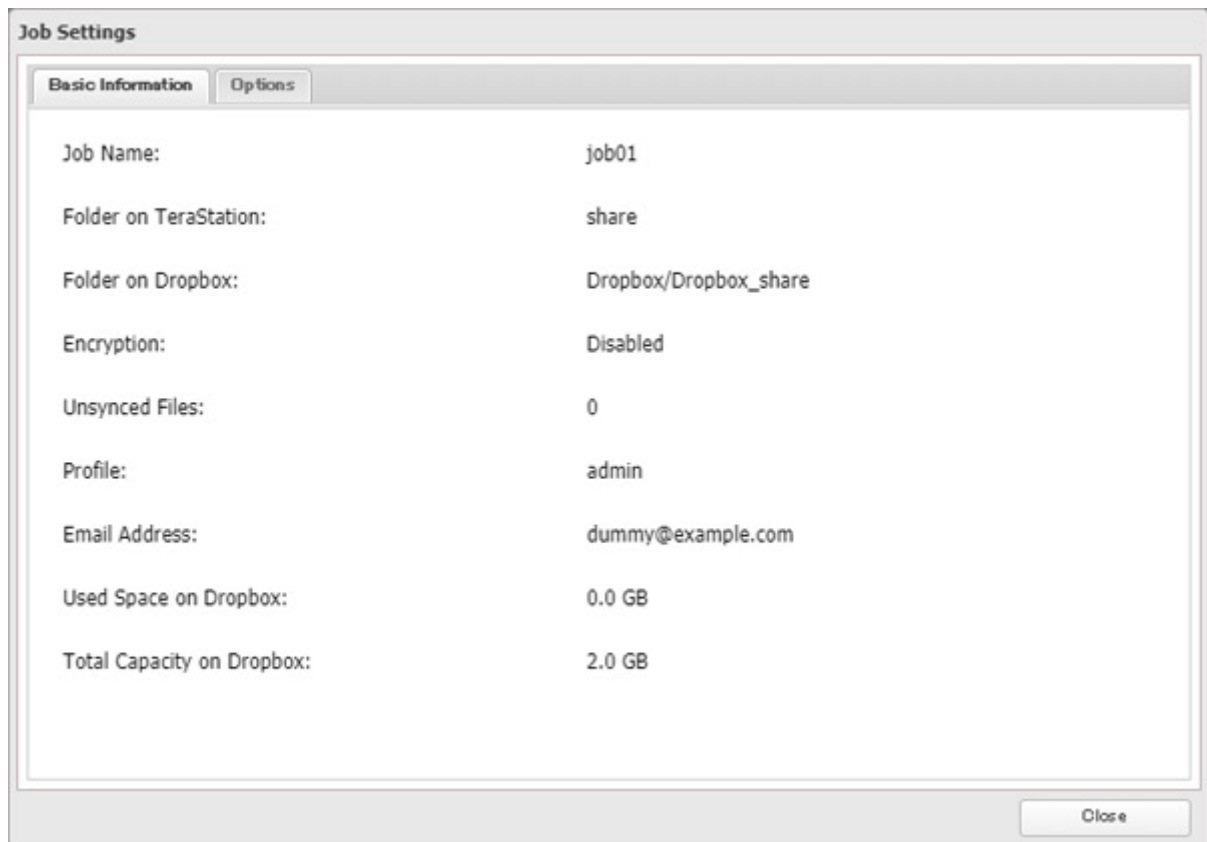

5 Click *Edit*.

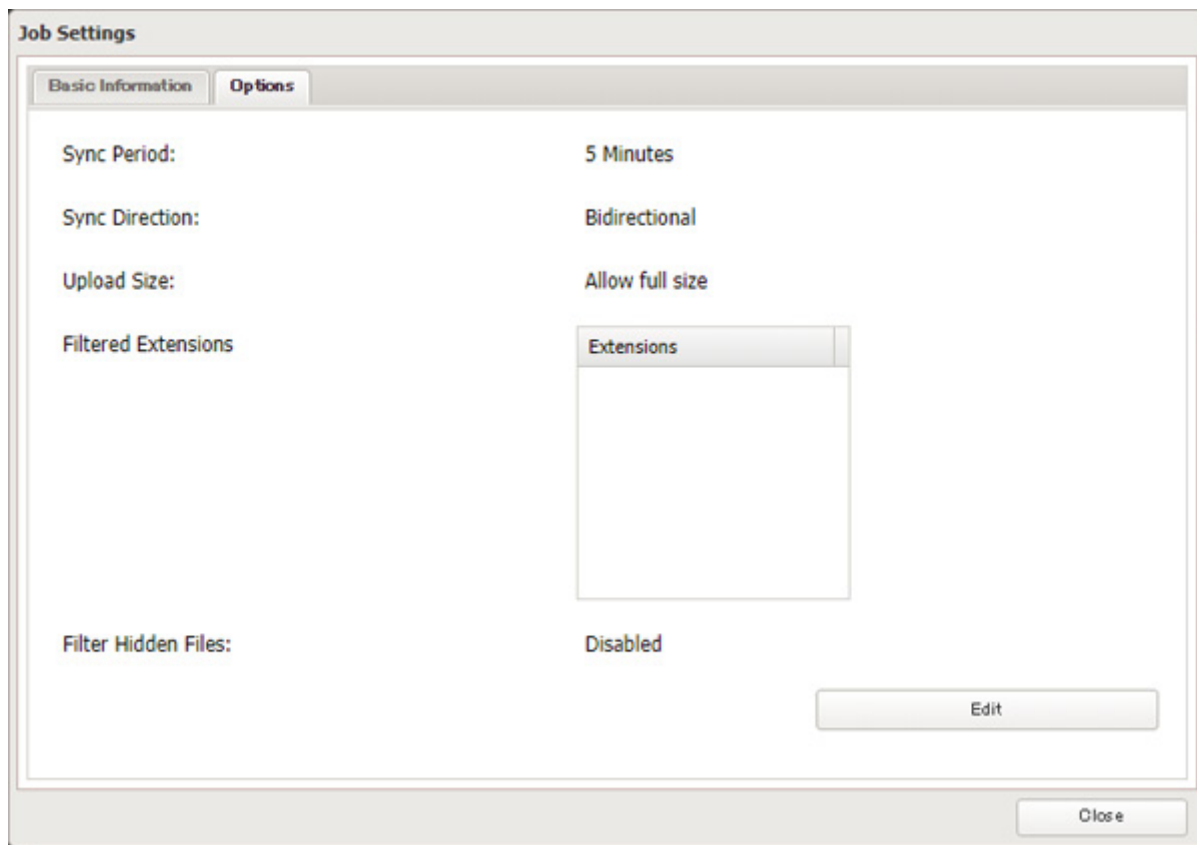

6 Configure the desired settings and click OK.

The screenshot shows the 'Job Settings' dialog box with the following configuration:

- Sync Period:** 5 Minutes
- Sync Direction:** Bidirectional
- Upload Size Limit:** Limit size, Allow full size
- Filtered Extensions:** An empty list box with 'Add' and 'Delete' buttons below it.
- Filter Hidden Files:** Enable, Disable

Notes:

- When specific settings are changed, the changes will not be applied and the files on Dropbox may not be synchronized to the TeraStation. In such a case, delete the target files to be synchronized and upload them to Dropbox again or delete the job and recreate it again. The following are the specific circumstances for when files may not be synchronized:
 - Uploading or downloading fails.
 - File extensions are removed from filtering.
 - The sync direction is changed.
- If using Dropbox through a proxy server, click *Proxy Settings*. From the displayed page, you can select whether to use the configured settings or configure an identical proxy server. If using the identical proxy server, select "New settings" and enter the proxy server name, port number, username, and password. Consult your network administrator for detailed proxy server settings.
- "Hidden files" from the "Filter Hidden Files" option refer to files whose filename starts with a period.
- Regardless of whether file filtering was configured, the following files will not be uploaded to Dropbox:
 - desktop.ini
 - thumbs.db
 - Files whose filename contains the symbols / \ > < : " | ? *
 - Files whose filename ends with either a space or period
 - Files whose filename starts with either ~\$ or .~
 - Files whose filename starts with ~ and have the file extension .tmp

Creating a Shared Link (Windows Only)

Buffalo offers a Windows application, “B-Sync”, that can create shared links for the files stored in the TeraStation folders. You can download the application from the [Buffalo website](#). Refer to the application help for the usage procedure.

Using Microsoft Azure for Data Preservation

The TeraStation supports synchronizing with Microsoft Azure, the online cloud storage service. Once linked, you can back up data on the TeraStation to Azure Storage, or restore data from Azure Storage to the TeraStation.

Microsoft Azure offers multiple types of storage and the TeraStation is compatible with blob storage. There are three types of blobs: block blobs, page blobs, and append blobs. The TeraStation only works with block blobs to store your data.

This feature is meant for situations such as disaster recovery and not a catch-all backup function. After linking the TeraStation and Microsoft Azure, data on the TeraStation will not be bidirectionally synchronized between the TeraStation and an Azure container.

Notes:

- Depending on the services you have purchased, prices for operations and amount of data will vary. To avoid being charged unexpectedly expensive fees, we recommend staying aware of the price structure for data storage and operations and regularly checking how much have been charged.
- To access data that have been backed up to the container, use “Microsoft Azure Storage Explorer”.
- If using Azure Storage through a proxy server, click *Proxy Settings*. From the displayed page, you can select whether to use the configured settings or configure an identical proxy server. If using the identical proxy server, select “New settings” and enter the proxy server name, port number, username, and password. Consult your network administrator for detailed proxy server settings.

To link your TeraStation with a Microsoft Azure Storage account, follow the procedure below.

Creating a New Backup Job

1 From the Azure portal, create your Azure Storage account and a container before proceeding with the procedure.

2 From Settings, click *Cloud Storage*.

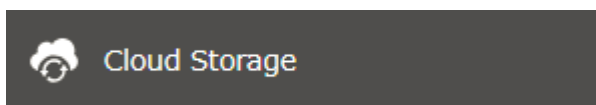

3 Move the Microsoft Azure Storage Sync switch to the  position to enable Microsoft Azure Storage Sync.



4 Click the settings icon () to the right of “Microsoft Azure Storage Sync”.



5 Click *Add*.

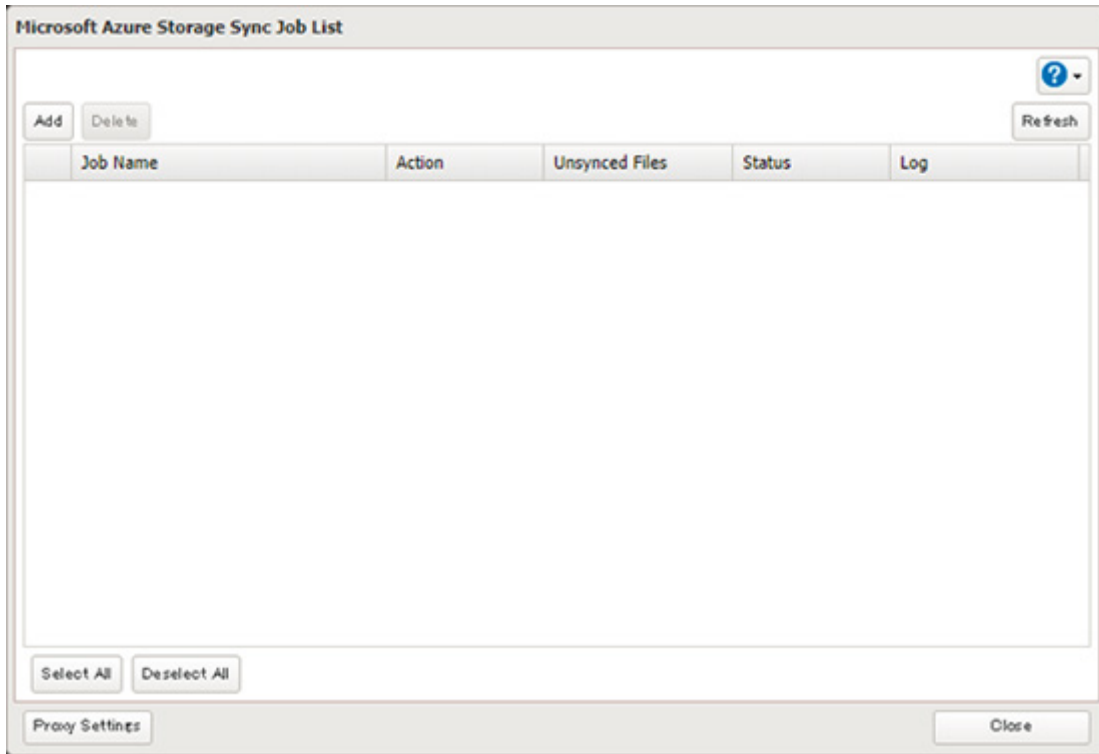

6 The job setup wizard will open. Enter your Azure Storage account name and access key, then click *Next*.

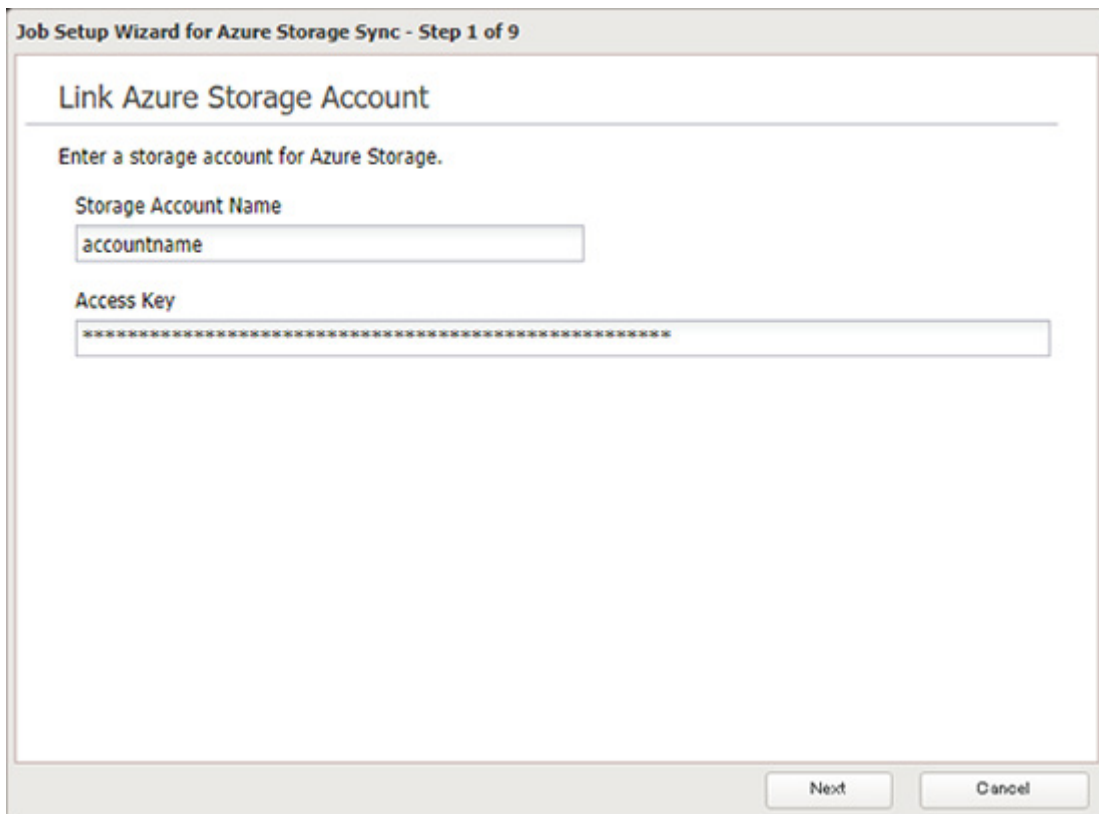

7 Enter the desired job name and click *Next*.

Job Setup Wizard for Azure Storage Sync - Step 2 of 9

Enter a Job Name

Enter a job name to create.

Job Name

Back Next Cancel

8 Select “Backup” and click *Next*.

Job Setup Wizard for Azure Storage Sync - Step 3 of 9

Select Sync Action

Select the sync action for your files.

Backup (TeraStation to Azure Storage)
Back up files from the backup source folder to a container. The first time the backup job runs, it will act as a full backup. Files added to the source are kept in the container in subsequent backups. You can select the action for files deleted from the source on the following page.

Restore (Azure Storage to TeraStation)
Restore files from a container to a shared folder on the TeraStation.

Back Next Cancel

- 9 Select the desired shared folder on the TeraStation as the backup source folder and enter the container name for the backup destination, then click *Next*.

Job Setup Wizard for Azure Storage Sync - Step 4 of 9

Configure Job Pairs

Select the shared folder that contains desired files for backup as the backup source and enter a container name.

Backup Source Folder
backup_src01

Container Name
test5

Back Next Cancel

- 10 Specify the sync period and click *Next*.

Job Setup Wizard for Azure Storage Sync - Step 5 of 9

Configure Sync Period

Select the interval of time between each backup.

Backup Interval
5 Minutes

Back Next Cancel

- 11 Select the desired action to take for files in the container that share the same name as files in the backup source after they are deleted, then click *Next*.

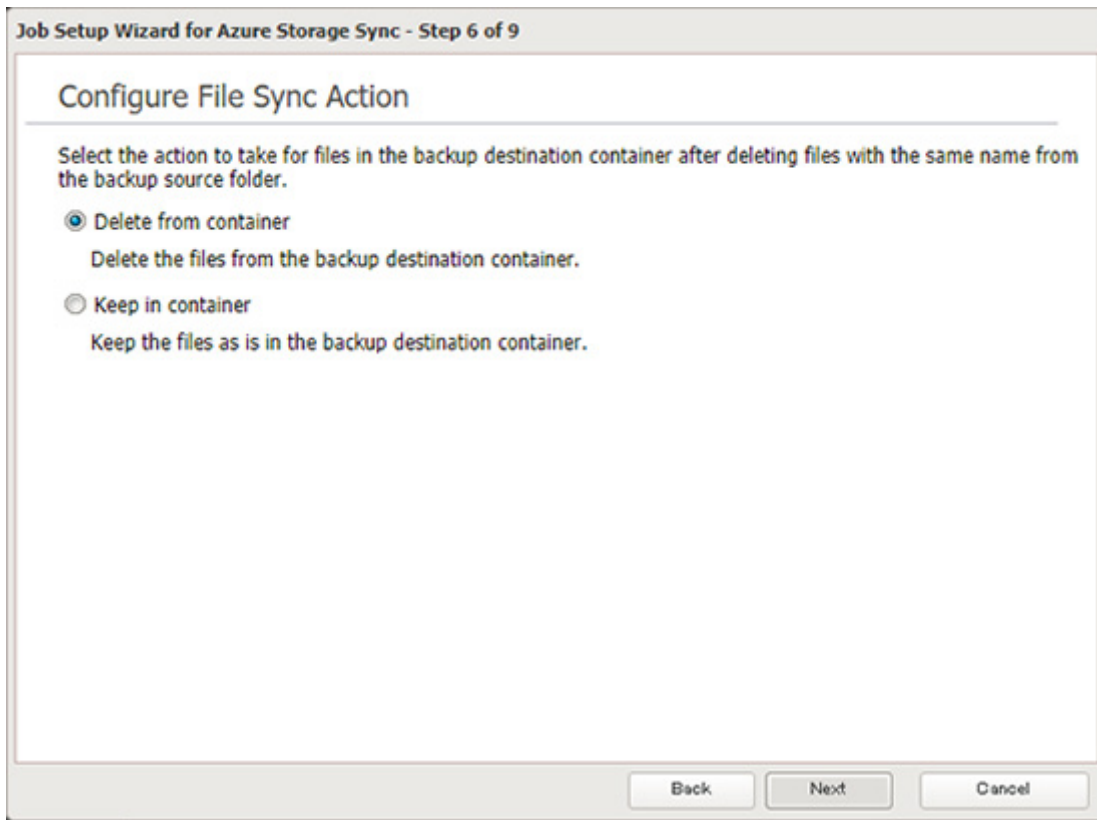

- 12 Configure whether to filter the backup target files. The following screen is available to configure file filtering by file size and whether they're hidden. "Hidden files" refer to files whose filename starts with a period. Configure the desired filtering settings and click *Next*.

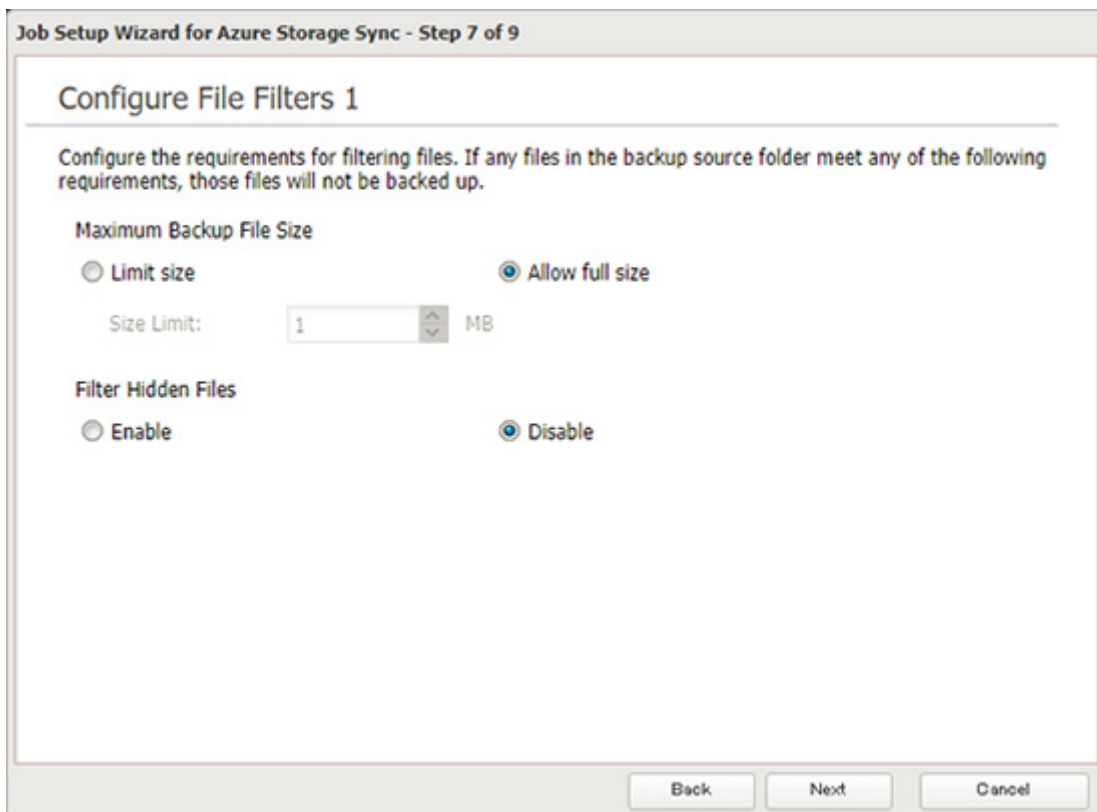

- 13** The following screen is available to configure file filtering by extensions. Configure the desired filtering settings and click *Next*.

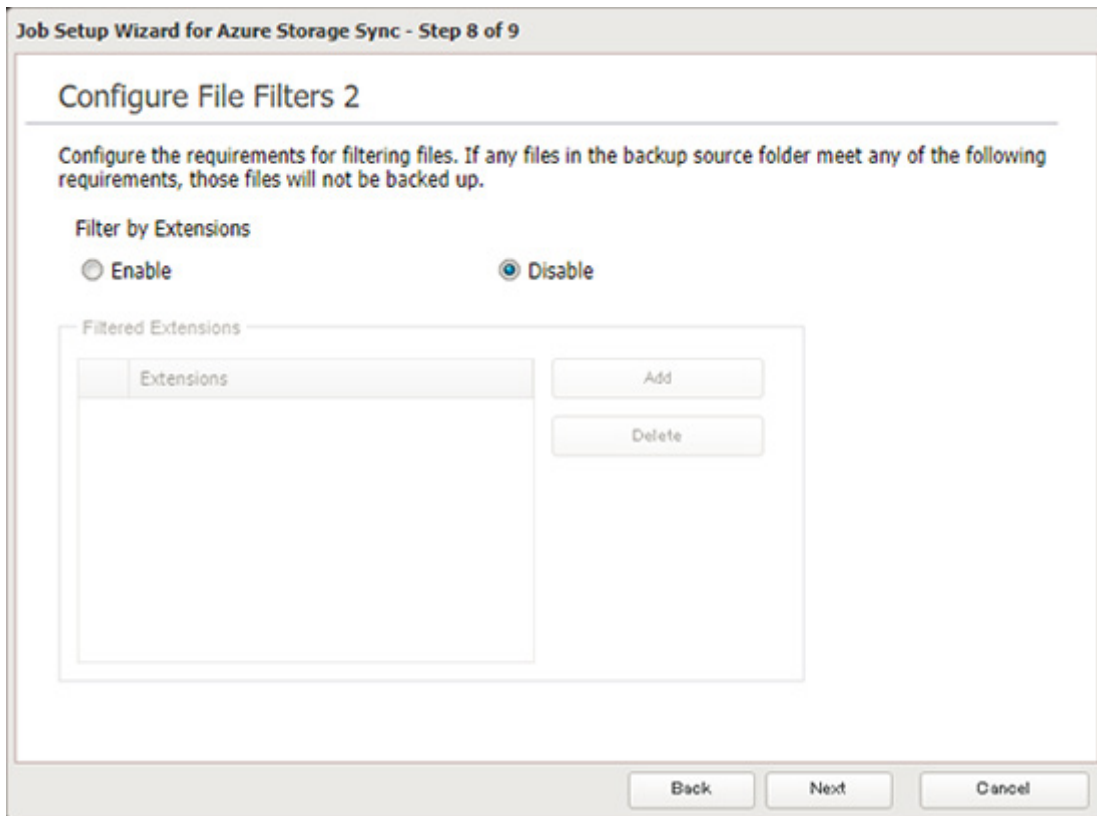

- 14** Confirm that all settings are properly configured and click *OK*.

Notes:

- Regardless of whether file filtering was configured, the following files will not be backed up to an Azure Storage container:
 - desktop.ini
 - thumbs.db
 - Files whose filename contains the symbols / \ > < : " | ? *
 - Files whose filename ends with either a space or period
 - Files whose filename starts with either ~\$ or .~
 - Files whose filename starts with ~ and have the file extension .tmp
- Do not copy files that are 10 GB or larger, and do not copy 100,000 or more files to the backup source folder at once. If you do and backup fails, check the network environment speed and try again with fewer or smaller files.

Creating a New Restore Job

- 1** From the Azure portal, create your Azure Storage account and a container before beginning the following procedure.
- 2** From Settings, click *Cloud Storage*.

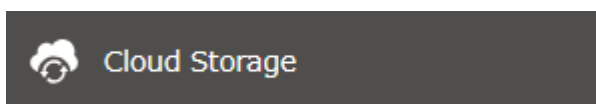

3 Move the Microsoft Azure Storage Sync switch to the  position to enable Microsoft Azure Storage Sync.



4 Click the settings icon () to the right of "Microsoft Azure Storage Sync".



5 Click *Add*.

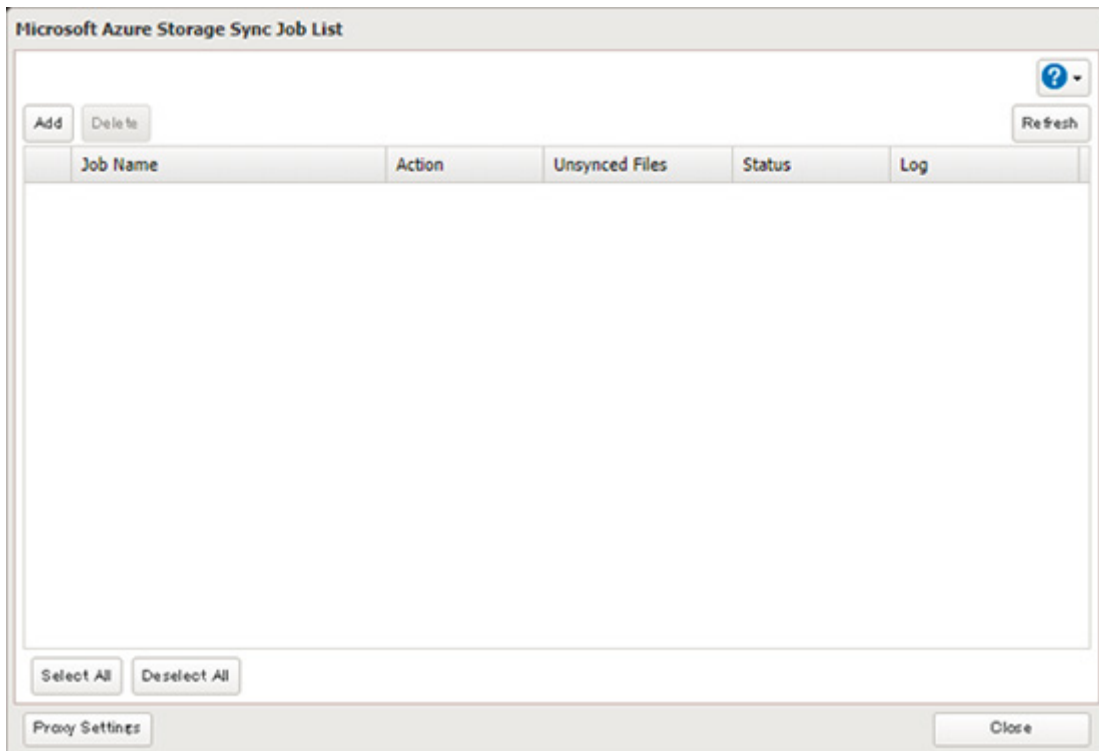

6 The job setup wizard will open. Enter your Azure Storage account name and access key, then click *Next*.

Job Setup Wizard for Azure Storage Sync - Step 1 of 9

Link Azure Storage Account

Enter a storage account for Azure Storage.

Storage Account Name

Access Key

Next Cancel

7 Enter the desired job name and click *Next*.

Job Setup Wizard for Azure Storage Sync - Step 2 of 9

Enter a Job Name

Enter a job name to create.

Job Name

Back Next Cancel

8 Select “Restore” and click *Next*.

Job Setup Wizard for Azure Storage Sync - Step 3 of 9

Select Sync Action

Select the sync action for your files.

Backup (TeraStation to Azure Storage)
Back up files from the backup source folder to a container. The first time the backup job runs, it will act as a full backup. Files added to the source are kept in the container in subsequent backups. You can select the action for files deleted from the source on the following page.

Restore (Azure Storage to TeraStation)
Restore files from a container to a shared folder on the TeraStation.

Back Next Cancel

9 Enter the container name for the restore source and select the desired shared folder on the TeraStation as the restore destination, then click *Next*.

Job Setup Wizard for Azure Storage Sync - Step 4 of 5

Configure Job Pairs

Enter a container name for the restore source and select a shared folder as the restore destination for restored files.

Container Name
test5

Restore Destination Folder
restore_dst01 Create Folder

Folder Level for Restored Files

First level
Files will be restored to the first level of the restored destination folder.

Second level
A folder will automatically be created in the restored destination folder and files will be restored to this folder. This folder name will be the date on which the job was created.

Back Next Cancel

10 Select either to restore data into the first level folder (root folder) or the second level (subfolder) of the restore destination folder, then click *Next*.

11 Confirm that all settings are properly configured and click *OK*.

Note: When deleting a completed restored job, it can be converted to a backup job. If that restore job had been configured to restore to the second level on the shared folder, restored data will automatically move to the first level. If there are files with the same filename in the first level folder, those files will be overwritten.

Changing Job Settings

Follow the procedure below to change any job settings you have already configured.

1 From Settings, click *Cloud Storage*.

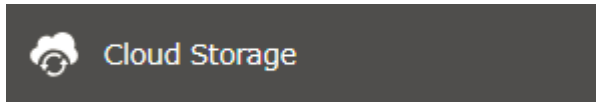

2 Click the settings icon (⚙️) to the right of "Microsoft Azure Storage Sync".



3 From the job list, click the job whose settings you want to change.

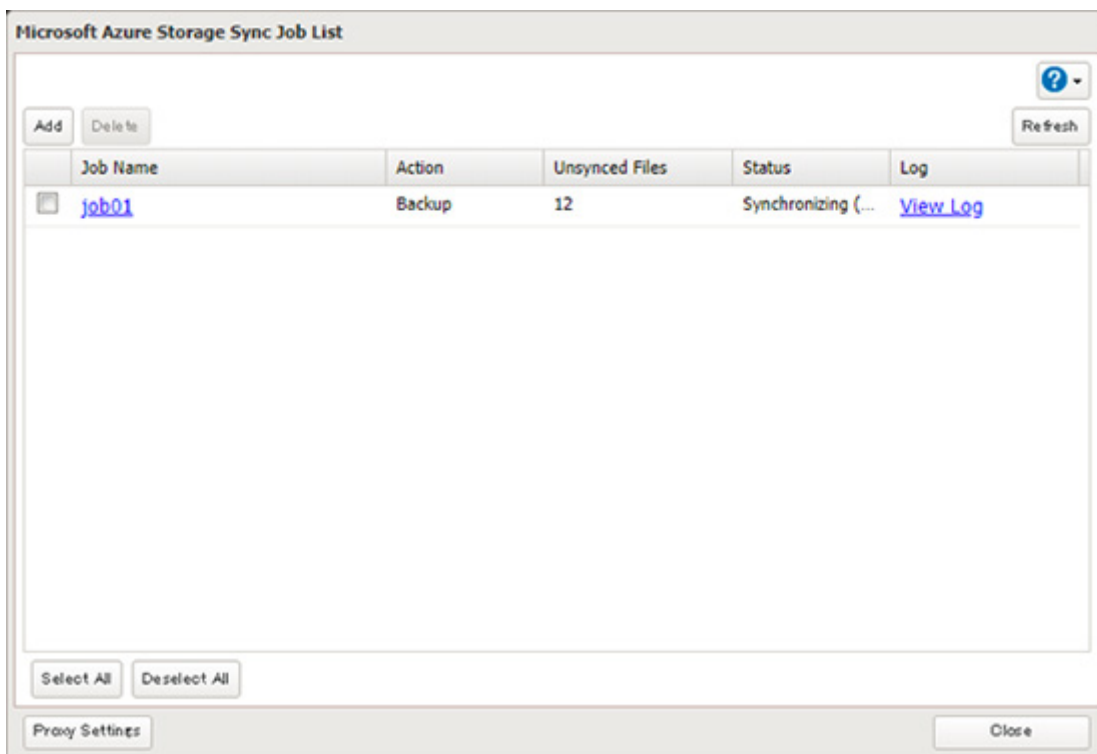

4 Click the *Options* tab.

The screenshot shows a dialog box titled "Job Settings" with two tabs: "Basic" and "Options". The "Options" tab is selected. The dialog contains the following settings:

Storage Account Name:	accountname
Job Name:	job01
Sync Action:	Backup
Files Deleted in Backup Source:	Keep in container
Backup Source Folder:	backup_src01
Container Name:	test5

A "Close" button is located at the bottom right of the dialog.

5 Click *Edit*.

The screenshot shows the same "Job Settings" dialog box with the "Options" tab selected. The settings are:

Backup Interval:	5 Minutes
Maximum Backup File Size:	Allow full size
Filter Hidden Files:	Disabled
Filter by Extensions:	Disabled

An "Edit" button is located at the bottom right of the dialog, and a "Close" button is at the very bottom right.

6 Configure the desired settings and click OK.

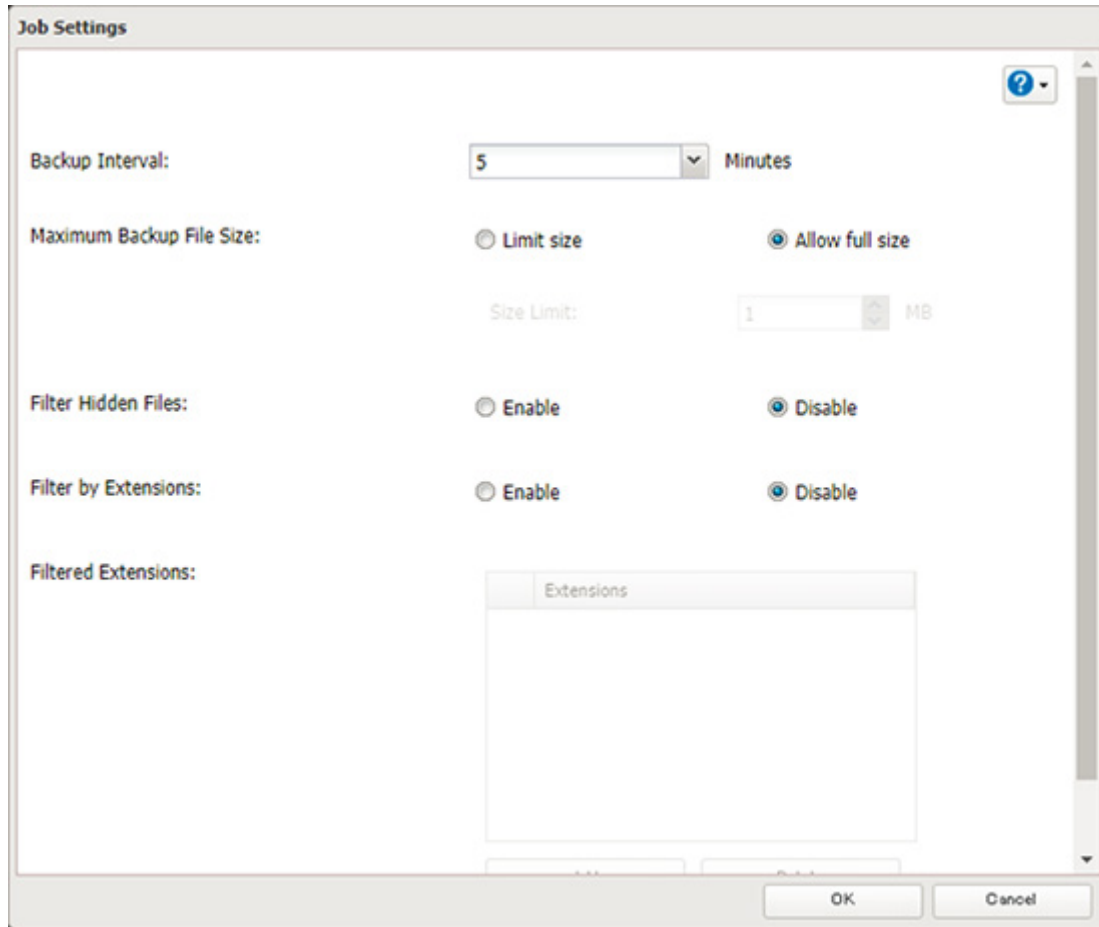

Synchronizing with Microsoft OneDrive

The TeraStation supports synchronizing with Microsoft OneDrive, the online cloud storage. Once linked, you can share the TeraStation files via OneDrive (or OneDrive files via the TeraStation). To link your TeraStation with your Microsoft account, follow the procedure below.

Note: To use Microsoft OneDrive Sync, you need a Microsoft account and an available empty OneDrive folder. If you don't have a Microsoft account, or if you need to create a OneDrive folder, refer to the Microsoft website.

Configuring a New Job

1 From Settings, click *Cloud Storage*.

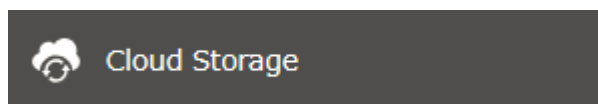

2 Move the OneDrive Sync switch to the  position to enable OneDrive Sync.



3 Click the settings icon () to the right of “Microsoft OneDrive Sync”.



4 Click *Add*.

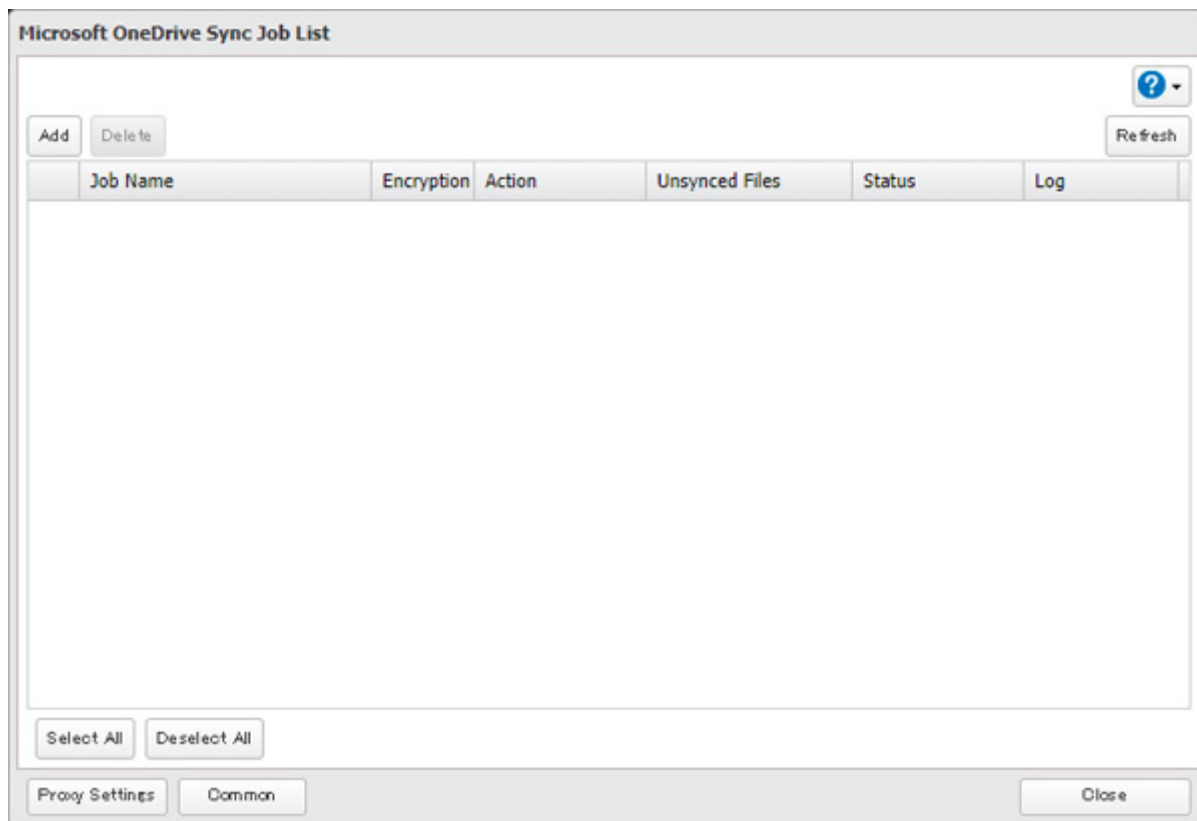

5 The sign-in window will open. Enter the username and password of your Microsoft account, then sign in.

6 Enter the desired job name and click *Next*.

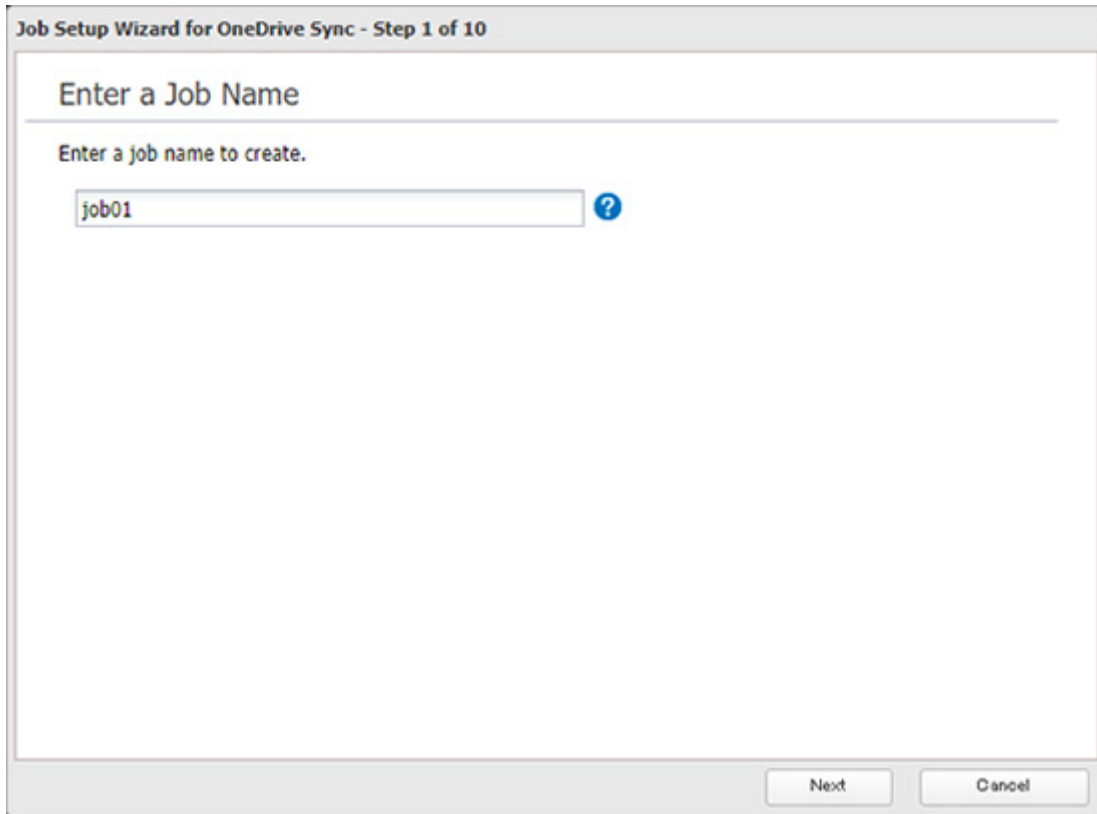

7 Select the sync action and behavior for when files with the same name are already in the target folder. The behavior for when files with the same name already exist will work when the files that have the same name on both the TeraStation and OneDrive are changed. Click *Next* after configuring.

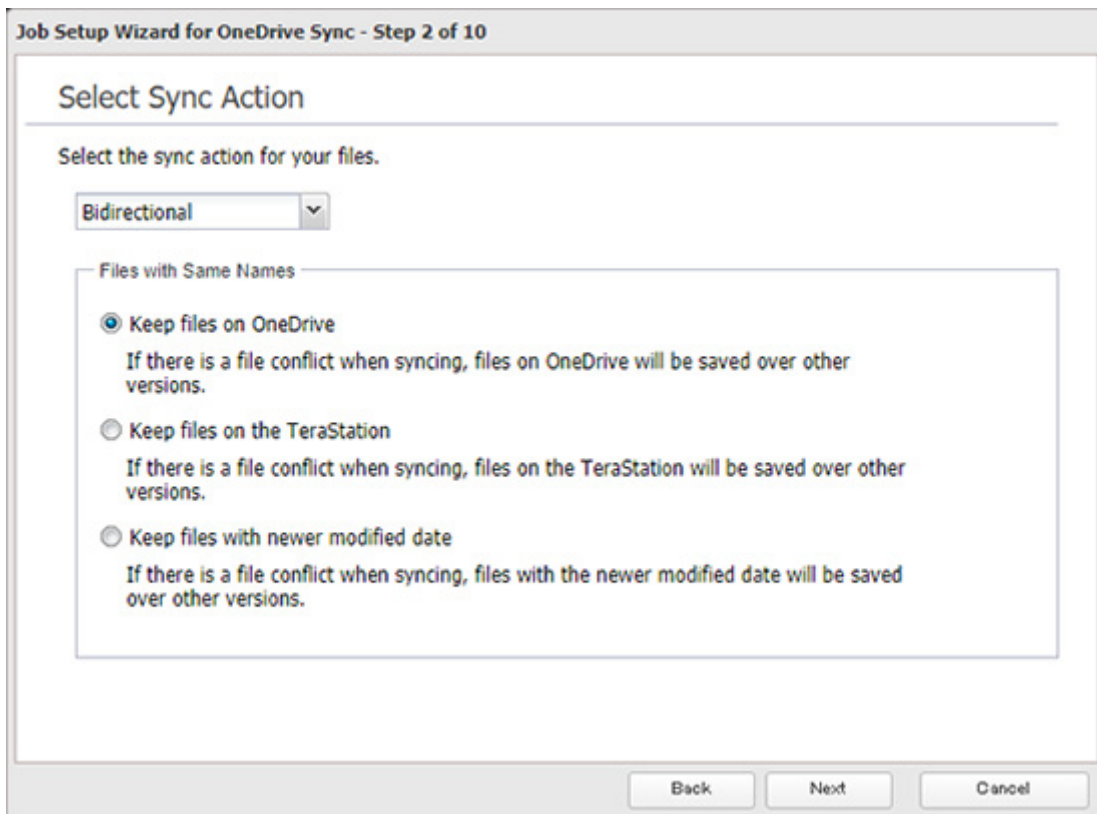

- 8** Select the desired TeraStation and OneDrive folders. If you want to create an empty folder first, click *Browse* under “Folder on TeraStation”, then click *Create Folder* on the selecting folder window that appears. Click *Next* after selecting the folders.

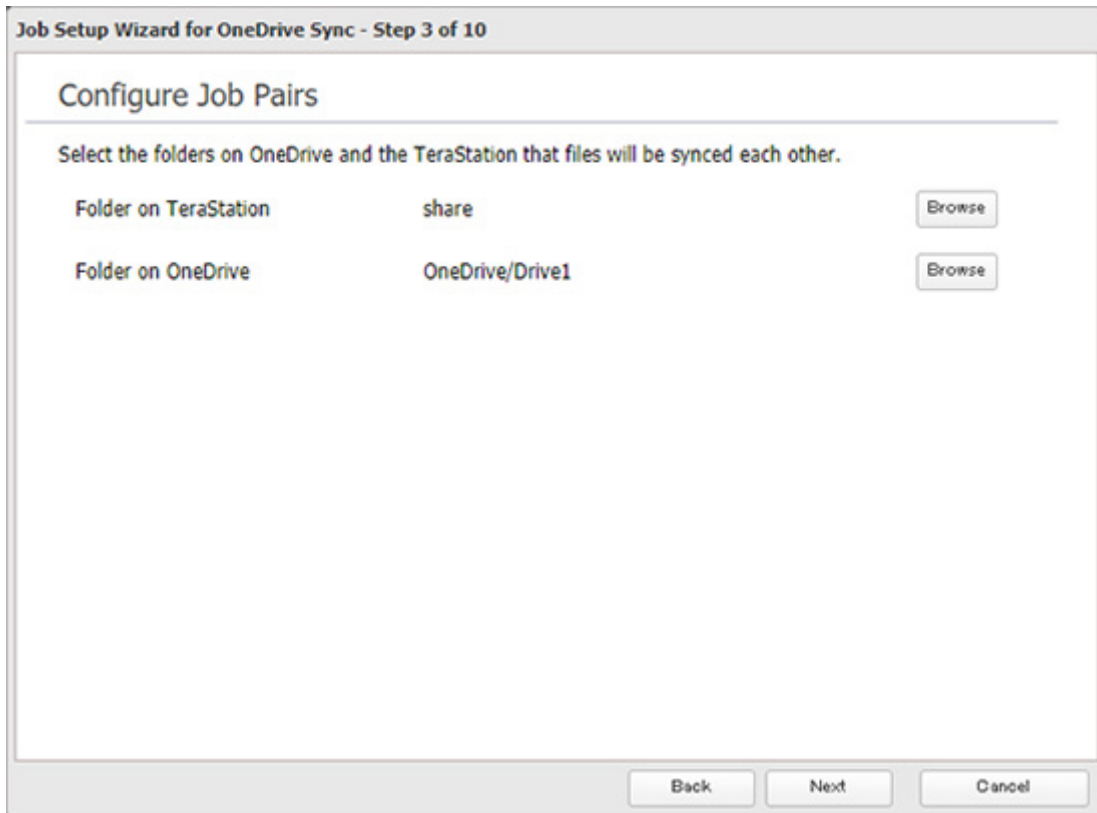

Notes:

- We do not recommend having the “TMNAS” folder or the specified quarantine folder to sync to OneDrive.
- The 6th level and deeper of shared and OneDrive folders cannot be selected.

9 Specify the sync period and click *Next*.

The screenshot shows a window titled "Job Setup Wizard for OneDrive Sync - Step 4 of 10". The main heading is "Configure Sync Period". Below the heading, it says "Select the interval of time between each synchronization." There is a dropdown menu with the number "5" selected, followed by the word "Minutes". At the bottom of the window, there are three buttons: "Back", "Next", and "Cancel".

10 Files will be uploaded during the start and end time of the period configured in step 9 above. If you want to always upload files during the configured sync period, select "Always sync within the sync period" for "Frequency". Click *Next* after configuring.

The screenshot shows a window titled "Job Setup Wizard for OneDrive Sync - Step 5 of 10". The main heading is "Configure Schedule". Below the heading, it says "Configure a schedule for a job. If you select 'Daily' for frequency, specify the start and end time. If you select 'Weekly' for frequency, specify the day of the week and times." There are three dropdown menus: "Frequency" with "Daily" selected, "Start Time" with "01:00" selected, and "End Time" with "05:00" selected. Below these, there is a "Day of Week" section with checkboxes for "Sunday", "Monday", "Tuesday", "Wednesday", "Thursday", "Friday", and "Saturday", all of which are currently unchecked. At the bottom of the window, there are three buttons: "Back", "Next", and "Cancel".

- 11** Select whether to encrypt the files using a password. When encryption is enabled, uploaded files will be archived in zip format and encrypted using the entered encryption password. Click *Next* after selecting.

Job Setup Wizard for OneDrive Sync - Step 6 of 10

Configure Encryption

Enable encryption for the files when uploading to OneDrive.

Enable Disable

Encryption Password
***** ?

Setting an encryption password with 10 or more characters is recommended.
The encryption password cannot be changed once it's configured. Make sure to manage the password carefully after it has been saved.

Back Next Cancel

Note: If the password contains spaces or backslashes (\), decrypting a file on a computer may fail.

- 12** Select whether to check for file consistency. If an inconsistency occurs with a file between the TeraStation and OneDrive, that file will be updated using the latest file version even if it hasn't been changed. Click *Next* after selecting.

Job Setup Wizard for OneDrive Sync - Step 7 of 10

Configure Consistency Check

Enable a consistency check. Files will be compared to a hash value between files on the source and destination folders for uploading/downloading. If there are any inconsistencies between files, the system will try syncing again.

Enable Disable

Back Next Cancel

- 13** Configure whether to filter the target files. The following screen is available to configure file filtering by file sizes and whether they're hidden. The file size filtering will work only for the upload process. The available maximum size is up to 15360 MB (15 GB). "Hidden files" refer to files whose filename starts with a period. Configure the desired filtering settings and click *Next*.

The screenshot shows a dialog box titled "Job Setup Wizard for OneDrive Sync - Step 8 of 10" with the main heading "Configure File Filters 1". Below the heading is a sub-heading "Configure File Filters 1" and a descriptive paragraph: "Configure the requirements for filtering files. If any files in the folder on either the TeraStation or OneDrive meet any of the following requirements, those files will not be synced." The dialog contains two sections: "Filter by File Size" and "Filter Hidden Files". In the "Filter by File Size" section, the "Enable" radio button is selected, and the "Maximum Size" is set to "1" MB. In the "Filter Hidden Files" section, the "Disable" radio button is selected. At the bottom of the dialog are three buttons: "Back", "Next", and "Cancel".

- 14** The following screen is available to configure file filtering by extensions. Configure the desired filtering settings and click *Next*.

The screenshot shows a dialog box titled "Job Setup Wizard for OneDrive Sync - Step 9 of 10" with the main heading "Configure File Filters 2". Below the heading is a sub-heading "Configure File Filters 2" and a descriptive paragraph: "Configure the requirements for filtering files. If any files in the folder on either the TeraStation or OneDrive meet any of the following requirements, those files will not be synced." The dialog contains a section "Filter by Extensions" with the "Enable" radio button selected. Below this is a "Filtered Extensions" section with a list box containing "tmp" and a checkbox next to it. To the right of the list box are "Add" and "Delete" buttons. At the bottom of the dialog are three buttons: "Back", "Next", and "Cancel".

15 Confirm that all settings are properly configured and click *OK*.**Notes:**

- Files whose filename contains the symbols " # % & * / : > < ? \ } { ~ may fail to be synchronized. This symbol limitation is based on "Normalization Form Canonical Composition (NFC)". If synchronization fails, check whether these symbols are not included in the filename.
If you copy files that contain these symbols to a TeraStation folder from macOS, the filenames may be converted to different ones that don't contain these symbols.
- Depending on your network environment, you may fail to download larger files. To prevent this issue, divide a larger file into smaller files or compress the files to a smaller size before uploading them to OneDrive.
- When files are uploaded from the TeraStation folder using OneDrive Sync and then downloaded onto a computer from OneDrive, time stamps for files may be changed to the download date.
- If there are nine or more jobs created, the TeraStation will re-arrange the number of concurrently-running jobs to reduce the load when synchronizing files.
- Do not copy 100,000 or more files to the TeraStation folder at once. If you do and synchronization fails, try again with fewer files.
- 4 or more jobs will make the TeraStation unstable. Especially if you antivirus is enabled, it will use much more system resources than other functions. In such a case, it is recommended to configure only one job.
- If a file's size is zero bytes, a sync error occurs and the file will not be synchronized. The I64 message will appear on the Dashboard in Settings and NAS Navigator2.

Changing Job Settings

Follow the procedure below to change any job settings you have already configured.

- From Settings, click *Cloud Storage*.

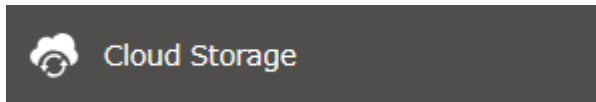

- Click the settings icon () to the right of "Microsoft OneDrive Sync".



3 From the job list, click the job whose settings you want to change.

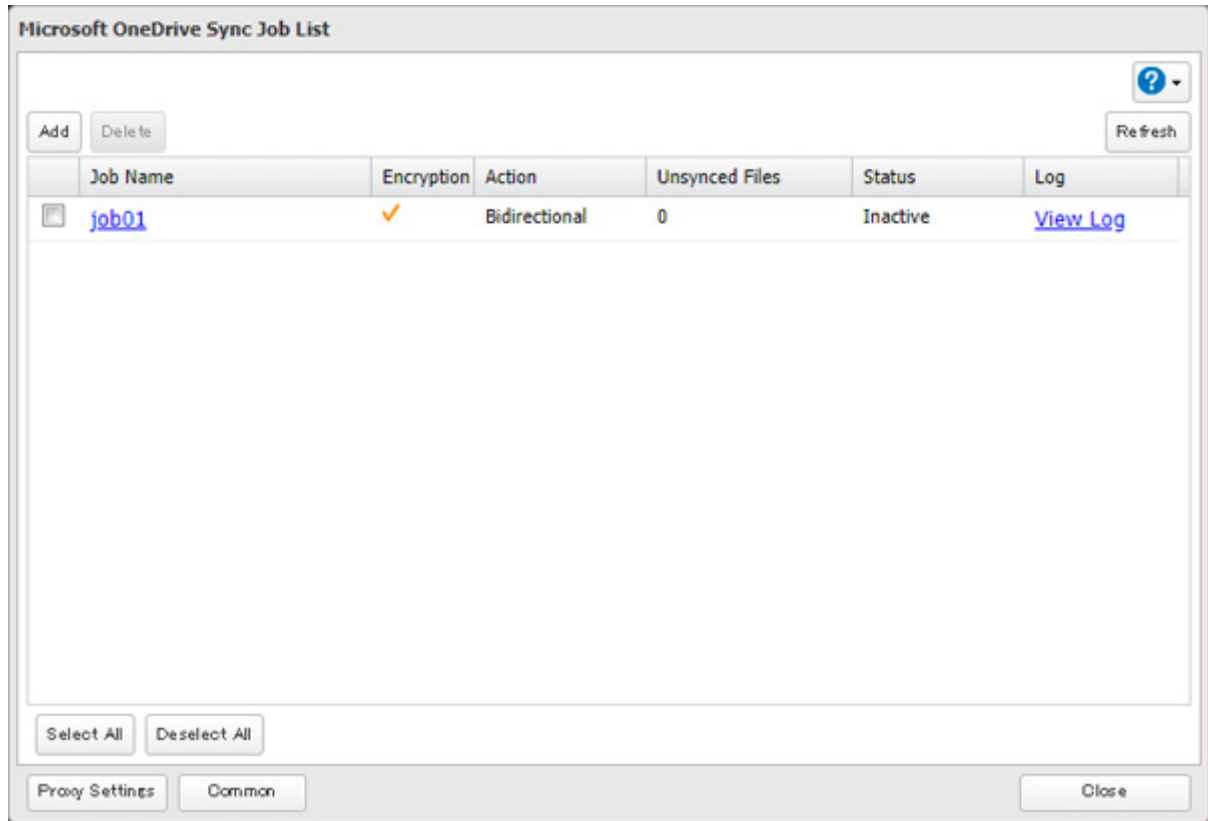

4 Click the *Options* tab.

The image shows a 'Job Settings' dialog box with two tabs: 'Basic' and 'Options'. The 'Options' tab is selected. The dialog contains the following fields and values:

Field	Value
Job Name:	job01
Folder on TeraStation:	share
Folder on OneDrive:	OneDrive/Drive1/
Used Space on OneDrive:	0.0 GB
Total Capacity on OneDrive:	5.0 GB
Account Name:	admin

A 'Close' button is located at the bottom right of the dialog box.

5 Click *Edit*.

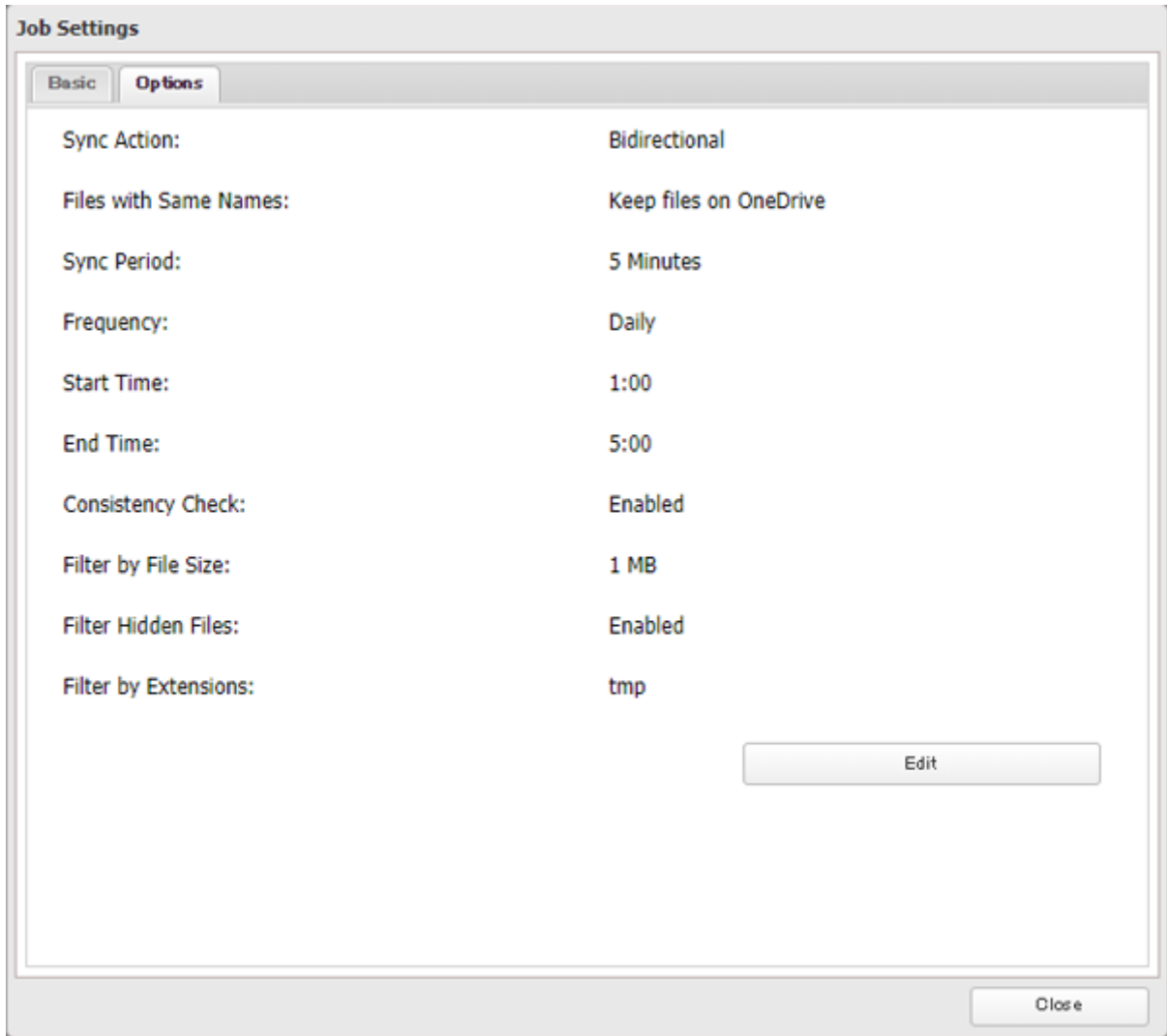

6 Configure the desired settings and click OK.

Corrective Actions for in Case of Error

You may encounter error messages that contain the following error codes; these codes may also appear in the error log as well. If you encounter one of the following error codes, refer to the table below and try the respective corrective action. If the error code is not listed on the table, please refer to the Microsoft website instead: <https://docs.microsoft.com/en-us/onedrive/developer/rest-api/concepts/errors?view=odsp-graph-online>.

Code	Description	Corrective Action
access_denied	Access denied for the requested information.	To link with OneDrive, please consent the request from OneDrive.
server_error	The authentication server encountered a temporary error.	Please try again later.
temporarily_unavailable	The authentication server is too busy.	Please try again later.
authcode_notfound	The authentication server is too busy.	Please wait for about 10 minutes and try again.
auth_server_error	The authentication server encountered a temporary error.	The authentication server will recover within UTC 12:00 midnight–8:45 a.m. (Mon–Fri). Please wait until it recovers.
auth_server_maintenance	The authentication server is currently undergoing maintenance.	Maintenance will finish within UTC 12:00 midnight–8:45 a.m. (Mon–Fri). Please wait until maintenance finishes.

Code	Description	Corrective Action
activityLimitReached	There are too many requests so data could not be synchronized.	Check that the same Microsoft account is used on another TeraStation or Microsoft applications. This error may be resolved by reducing the maximum number of threads per job on the window that appears by navigating to the job list and then clicking <i>Common</i> .
invalidRequest	A zero-byte file was going to be synchronized but failed.	Remove the zero-byte file and try again. If the I64 message persists on the Dashboard in Settings, click the "Clear" button to delete the message.
network_error	Could not register the authentication code.	Check that the network or proxy server settings are correct.
Unexpected error	Unknown error.	Please try again later.

WebAccess

WebAccess is a software utility for accessing the files in the shared folder of your TeraStation from your computer or mobile devices through the Internet. **Be careful when configuring WebAccess. Certain settings can make the files in the shared folder available to anyone on the Internet, without any access restrictions.**

Note: WebAccess supports downloading up to 60,000 files at a time. Attempting to download 60,000 or more files at a time may result in unexpected behavior.

- 1 From Settings, click *File Sharing*.

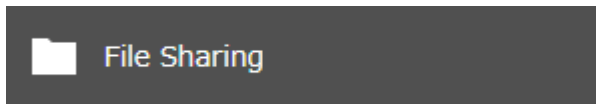

- 2 Click the settings icon () to the right of "WebAccess".



3 Click *Edit*.

WebAccess Settings

HTTPS/SSL Encryption: Disabled

Access via BuffaloNAS.com: Enabled

Server: [redacted]

BuffaloNAS.com Name: [redacted]

BuffaloNAS.com Key: [redacted]

Disabled

Other DNS Service Hostname: [redacted]

UPnP: Enabled

Disabled

External Port: [redacted]

NAS Internal Port: 9000

Exclusive Session: Disabled

Session Timeout: 30 Minutes

WebAccess URL: -

Edit Close

4 Configure the desired settings, then click *OK*.

WebAccess Settings *Required ?

HTTPS/SSL Encryption: Enable Disable

Access via BuffaloNAS.com: Enable

Server:

BuffaloNAS.com Name *: webaxs

BuffaloNAS.com Key *: sY3PYbdZVl0jIOD4q6P-

Generate Random Key

Disable

Other DNS Service Hostname *: [redacted]

UPnP: Enable Disable

External Port *: [redacted]

NAS Internal Port *: 9000

Exclusive Session: Enable Disable

Session Timeout *: 30 Minutes Unlimited

LAN Only OK Cancel

- To use SSL encryption for more secure data transfers, enable “HTTPS/SSL Encryption”.
- You may use the BuffaloNAS.com server as a DNS server, or disable it to use a different DNS server.
- Choose a “BuffaloNAS.com Name” and “BuffaloNAS.com Key” for your WebAccess account. Names and keys may contain between 3 and 20 alphanumeric characters, underscores (_), and hyphens (-).
- If “Exclusive Session” is enabled, multiple users cannot be logged in to WebAccess at the same time. Only the last login will be active.
- Enter a time in minutes (1 to 120, or “Unlimited”) before inactive users are logged out of WebAccess.

5 Move the WebAccess switch to the  position to enable WebAccess.



6 Click the settings icon () to the right of "Folder Setup".

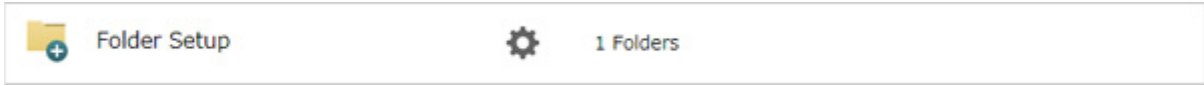

7 Select a shared folder to publish.

Notes:

- For best results, create a new dedicated share for WebAccess.
- When accessing shared folders through WebAccess from a remote location, a username and password may be required for certain operations. For best results, create a user account with permissions on the WebAccess share before using WebAccess.

8 Under "LAN Protocol Support", select the "WebAccess" checkbox on the *Basic* tab.

9 Click the *Option 2* tab.

10 Select the desired WebAccess security level for "WebAccess Permissions".

Allow anonymous: Anyone can access (view) shared folders. (Access restrictions configured for shared folders will not work.)

Allow all groups and users: All groups and users registered on the Buffalo NAS device can use WebAccess. (Access restrictions configured for shared folders will not work.)

Use inherited folder permissions: Users and groups have the same access permissions with WebAccess that they do locally. If access restrictions are not set for the shared folder, then this option will not be shown.

Whether a user or group can access a folder through WebAccess depends on a combination of WebAccess settings and the shared folder's settings.

		Not logged in	Access restrictions for the logged-in users		
			No access	Read-only	Read and write
WebAccess permissions	Allow anonymous	R	R/W	R/W	R/W
	Allow all groups and users	-	R/W	R/W	R/W
	Use inherited folder permissions	-	-	R	R/W

R/W: Read and write, R: Read-only, -: No access

11 Click *OK*.

There are many ways to access WebAccess folders depending on your device:

- Use a web browser on a computer, supported browsers include Microsoft Edge, Firefox, Google Chrome, Internet Explorer 9 or later, Safari 9 or later. Refer to the help guide at the BuffaloNAS.com website after connecting with your BuffaloNAS.com name for more detailed information.
- To access from an iOS device, install the "WebAccess i" application from the App Store. Refer to the help guide for the app for more detailed information.
- To access from an Android device, install the "WebAccess A" application from Google Play. Refer to the help guide for the app for more detailed information.

FTP

By default, the TeraStation's shares are only accessible by users connected to the same network or router as the TeraStation. The optional FTP server allows users outside the local network to access the TeraStation.

Note: FTP is intended for users who already have FTP client software and have experience with it.

- 1 From Settings, click *File Sharing*.

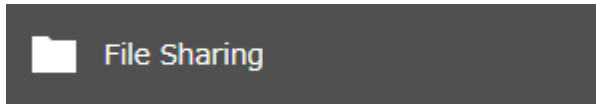

- 2 Move the FTP switch to the  position to enable FTP.



- 3 Click the settings icon () to the right of "Folder Setup".

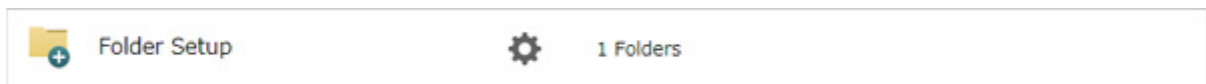

- 4 Choose a folder to enable remote FTP access on.

- 5 Under "LAN Protocol Support", select the "FTP" checkbox on the *Basic* tab; select read-only or read and write for the shared folder's attribute on the *Option 2* tab and click *OK*.

Accessing the TeraStation with an FTP Client

To access the TeraStation via FTP, configure your FTP client software with the following settings:

- Hostname: IP address of the TeraStation
- Username: the TeraStation's username
- Password: the TeraStation's password
- Port: 21

Accessing the TeraStation with an Anonymous User

To allow anonymous access to your FTP share, disable access restrictions. Configure your FTP client software with the following settings for anonymous FTP access:

- Hostname: IP address of the TeraStation
- Username: "Anonymous"
- Password: any character string
- Port: 21

Notes:

- If the TeraStation joins a domain, domain and anonymous users cannot remote access via FTP. Domain users will be able to access remotely using SFTP.
- Shared folders connected by FTP are available from the "/mnt" folder. The examples of default locations are:
 /mnt/array1/share
 /mnt/disk1/share
 /mnt/usbdisk1

- If a file was created or copied using AFP, you may be unable to delete it using an FTP connection. If this occurs, use an SMB or AFP connection instead to delete the file.
- For FTP connections, make sure that the total filename length including the folder path is 250 single-byte characters or less.

Chapter 7 Advanced Features

Antivirus Software

Trend Micro NAS Security can protect your network and data from software viruses, malware, and spyware. Virus scan by Trend Micro NAS Security is available for files in the TeraStation's shared folders, except for the "usbdisk" folder.

To use the Trend Micro NAS Security software, purchase an OP-TSVC license pack (sold separately). If your TeraStation is already running an activated antivirus software, no license registration is necessary.

Notes:

- If LVM is enabled on the TeraStation, the antivirus software may not work properly. For best results, disable LVM before use.
- To use the antivirus software effectively, the TeraStation should be connected to the Internet. The connection can be routed through a proxy server if the appropriate settings are configured in *Administration > Proxy Settings* from the left-side menu of the Trend Micro NAS Security settings page.
- Trend Micro is a trademark of Trend Micro Incorporated.

Activating Virus Scanning

Follow the procedure below to activate virus scanning.

- 1 From Settings, click *Applications*.

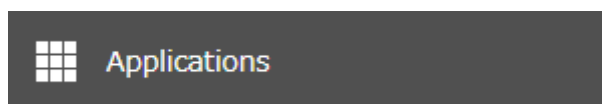

- 2 Move the antivirus switch to the  position to enable antivirus.



A quarantine folder named "TMNAS" is automatically created on the TeraStation. If a virus is detected, it is moved to this folder.

If you want to configure a specific shared folder as a quarantine folder, follow the procedure below.

- 1 Create a new shared folder by referring to the ["Adding a Shared Folder"](#) section in chapter 3.

- 2 From Settings, click *Applications*.

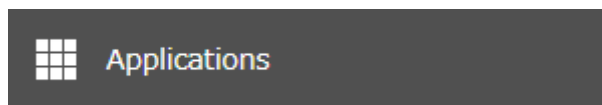

- 3 Click the settings icon () to the right of "Antivirus".

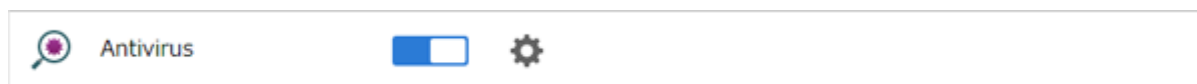

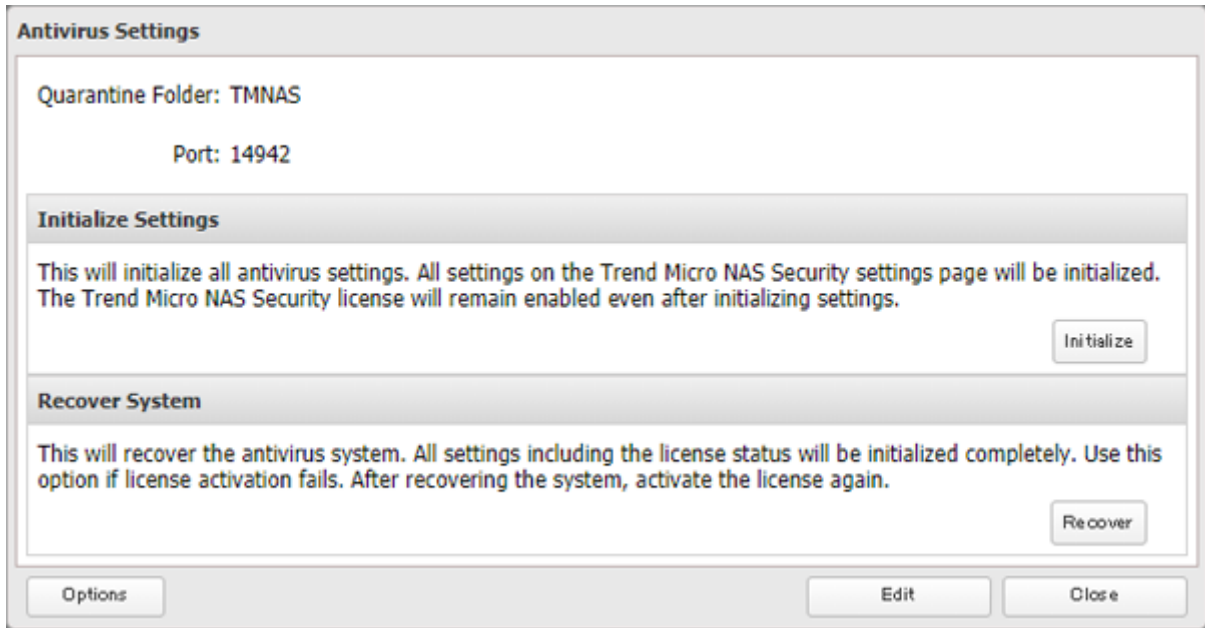
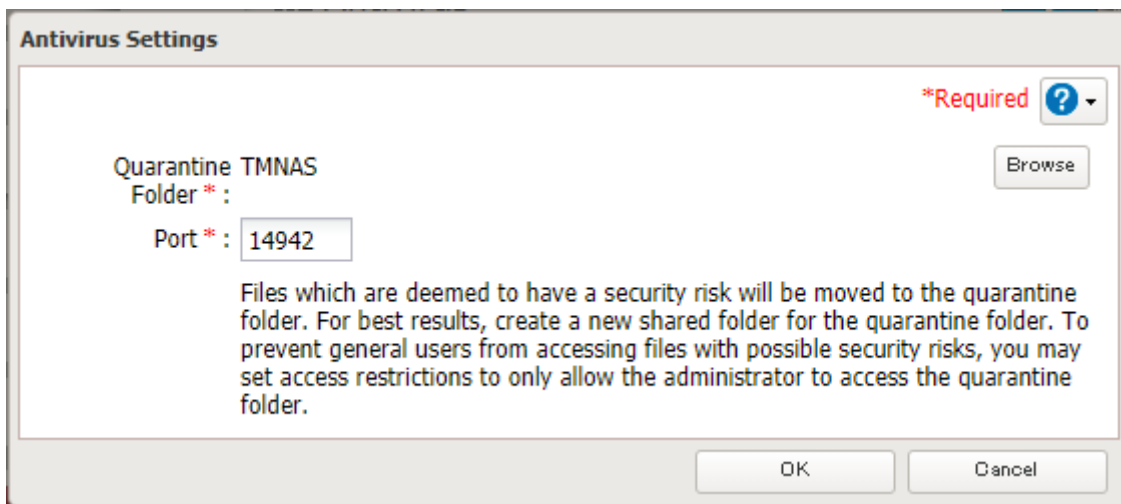
4 Click *Edit*.**5** Click *Browse* and select the quarantine folder.**6** Click *OK*.

Configuring Security Settings

Use the Trend Micro NAS Security settings page to configure security settings such as updating pattern files, configuring scan schedules, and activating or extending the license. To open the settings page, follow the procedure below.

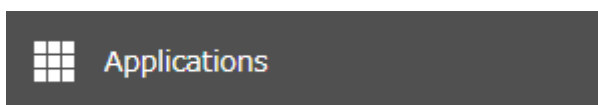
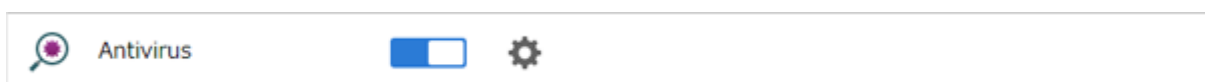
1 From Settings, click *Applications*.**2** Click the settings icon () to the right of "Antivirus".

3 Click *Options*.

Antivirus Settings

Quarantine Folder: TMNAS

Port: 14942

Initialize Settings

This will initialize all antivirus settings. All settings on the Trend Micro NAS Security settings page will be initialized. The Trend Micro NAS Security license will remain enabled even after initializing settings.

Initialize

Recover System

This will recover the antivirus system. All settings including the license status will be initialized completely. Use this option if license activation fails. After recovering the system, activate the license again.

Recover

Options Edit Close

4 Enter your username and password, then click *Log On*.

LOGON

Please type your user name and the password to access the web console.

User name:

Password: Log On

You can log on using the TeraStation's admin account. The default username and password are "admin" and "password".

5 The Trend Micro NAS Security settings page will open.

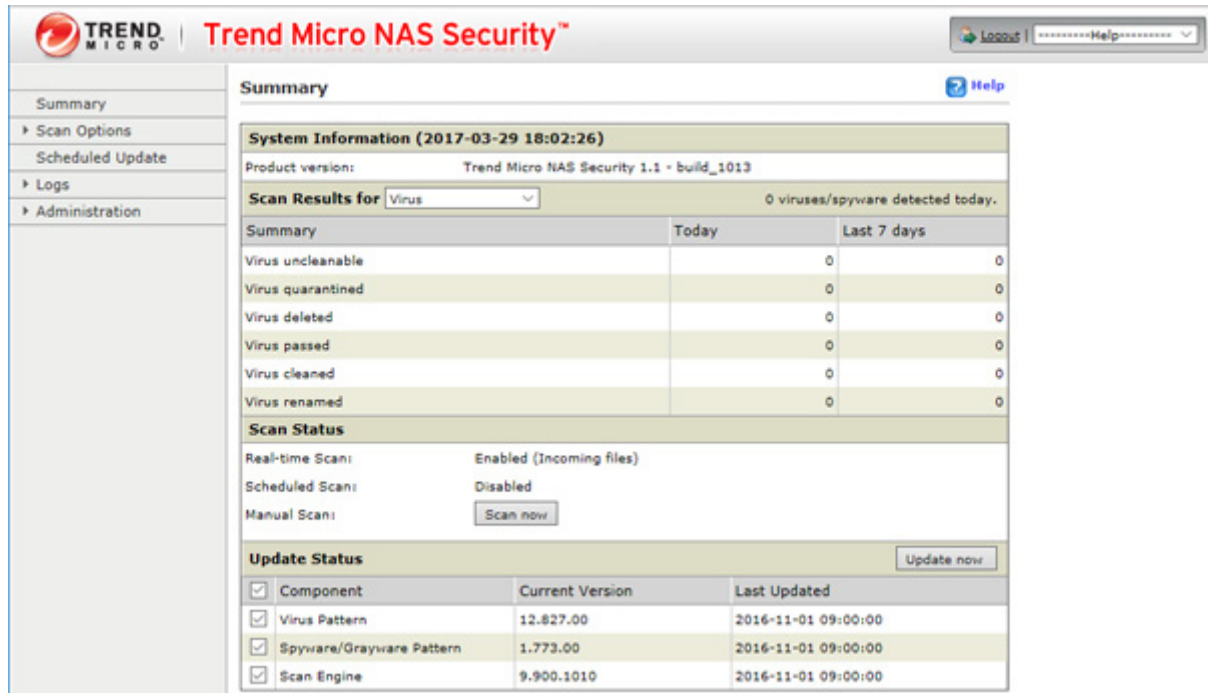

Notes:

- The Trend Micro NAS Security settings page is compatible with IE 6.0 SP2 or later (Windows) and Firefox 1.5 or later (Windows or Mac).
- To change the display language of the Trend Micro NAS Security settings page, change the system language to the desired settings by referring to the [“Name, Date, Time, and Language”](#) section below.

Licenses

If the antivirus software on your TeraStation is not activated or has expired, please purchase an OP-TSVC license pack (sold separately). If your TeraStation includes activated antivirus software, no license registration is required. The total period for antivirus software updates to be available may be extended by up to five years. The example below shows an initial one-year period for updates extended by an additional year.

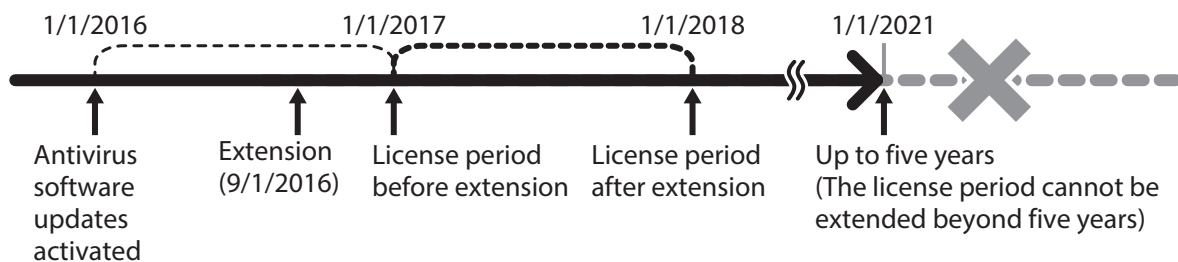

Note: It's not possible to register a serial number that would extend the total license period beyond five years, such as a second three-year license after three years.

- 1 From the left-side menu of the Trend Micro NAS Security settings page, click *Administration > Product License*.

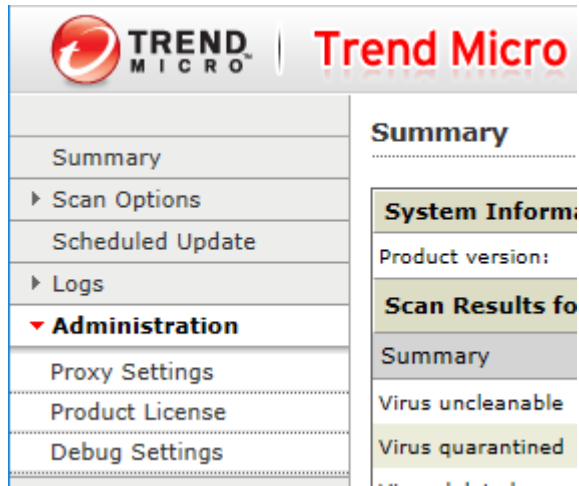

- 2 Enter the serial number from the “Trend Micro NAS Security License Pack Guide”, included in your package. Click *Activate*.

Product License

 **The product has not been activated.**

Product Activation

You must activate your product to enable scanning and security updates.

Serial number: - - - -

(Code format: XXXX-XXXX-XXXX-XXXX-XXXX)

The new license is now registered.

To check the status of the current license, open the Trend Micro NAS Security settings page and navigate to *Administration > Product License* on the left-side menu.

Connecting Through a Proxy Server

If you must pass through a proxy server to connect to the Internet in your network environment, follow this procedure to set the IP address of the proxy server and other settings.

- 1 From the left-side menu of the Trend Micro NAS Security settings page, click *Administration > Proxy Settings*.

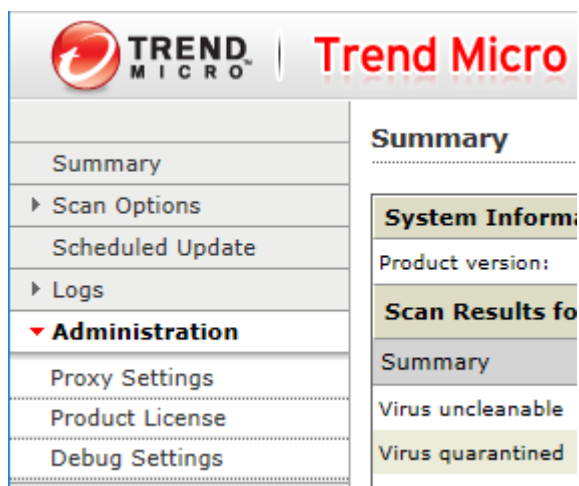

- 2 Select the “Use a proxy server to access the Internet (License update)” checkbox. Enter the IP address and port of the proxy server, then click *Save*.

Proxy Settings ? Help

General | Component Update

Use a proxy server to access the Internet (License update)

Server name or IP address:

Port:

Proxy server authentication

User name:

Password:

The antivirus software is now configured to use a proxy server.

Updating Antivirus Pattern Files

For best results, configure your antivirus software to update the antivirus pattern files automatically as described below.

- 1 From the left-side menu of the Trend Micro NAS Security settings page, choose *Scheduled Updates*.

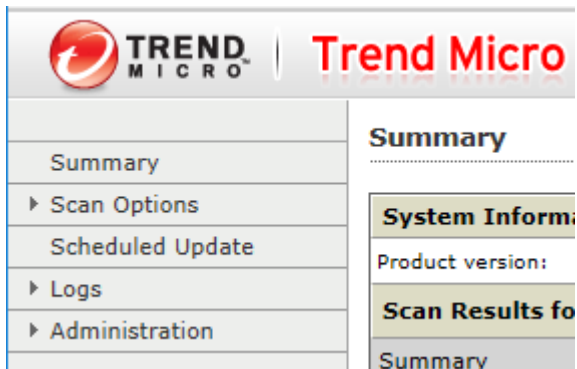

TREND MICRO | Trend Micro

Summary

- Scan Options
- Scheduled Update
- Logs
- Administration

Summary

System Information

Product version:

Scan Results for Summary

- 2 Check “Enable Scheduled Update”.

Scheduled Update

Enable Scheduled Update

Update Frequency

Start time: : (hh:mm)

Repeat interval: Hourly

Daily, update for

- 3** Select a time for updates to begin, an interval for updates, and an amount of time for updates to continue. Select the components to update. Click *Save*.

Scheduled Update

Enable Scheduled Update

Update Frequency

Start time: : (hh:mm)

Repeat interval:

Hourly

Daily, update for

Weekly, every update for:

Components to Update

<input checked="" type="checkbox"/>	Component	Current Version	Last Updated
<input checked="" type="checkbox"/>	Virus Pattern	12.827.00	2016-11-01 09:00:00
<input checked="" type="checkbox"/>	Spyware/Grayware Pattern	1.773.00	2016-11-01 09:00:00
<input checked="" type="checkbox"/>	Scan Engine	9.900.1010	2016-11-01 09:00:00

The antivirus software is now configured to update automatically at the scheduled time. Updates will not be downloaded if the TeraStation is turned off, in standby mode, or disconnected from the Internet.

Configuring Folders as Virus Scanning Targets

By default, all folders on the TeraStation (including attached USB drives) will be scanned. Follow the procedure below to block specific shared folders from being scanned.

- 1** From Settings, click *File Sharing*.

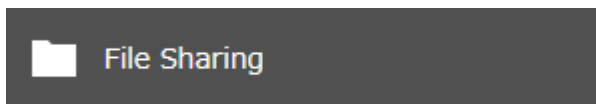

- 2** Click the settings icon (⚙️) to the right of "Folder Setup".

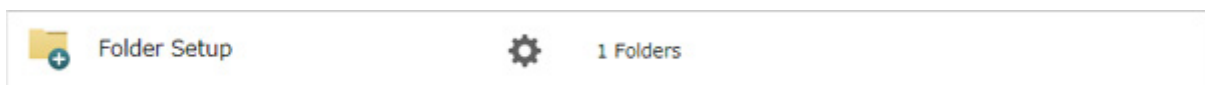

- 3** Click the shared folder that you want to exclude from the scan.

- 4** If the options' checkboxes are selected on the *Option 1* tab, it means the shared folder will be scanned by those scan options. To exclude from the scan, clear the options' checkboxes.

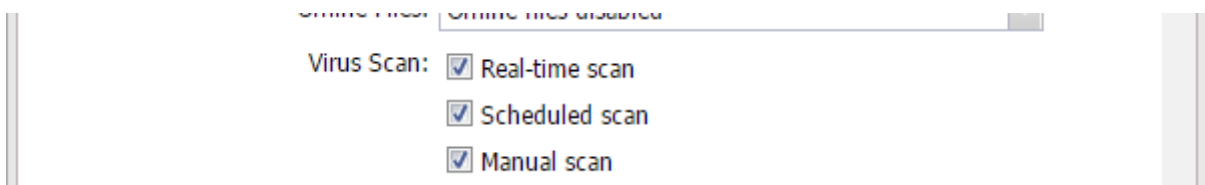

- 5** Click *OK*.

Note: Even if the scan options are selected in the quarantine folder settings, the quarantine folder will be excluded from the virus scan.

Configuring Virus Scanning

Three types of virus scans are available:

- **Real-time scan**

The virus scan runs in the background, scanning every file that you read or write. This is the default type of scanning. Your TeraStation may run slower if real-time scanning is enabled.

- **Scheduled scan**

A scheduled scan is executed at specific regular intervals, such as every Tuesday at 3 a.m.

- **Manual scan**

A manual scan runs once when initiated. Initiate a manual scan as described below.

1 From the left-side menu of the Trend Micro NAS Security settings page, choose *Scan Options > Manual Scan*.

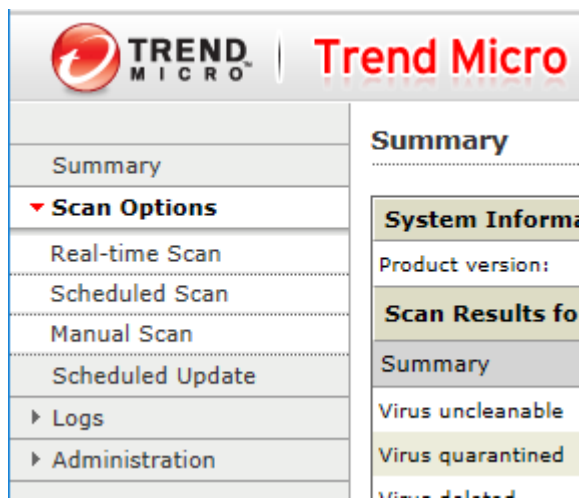

2 Click *Scan now*. This starts the virus scan.

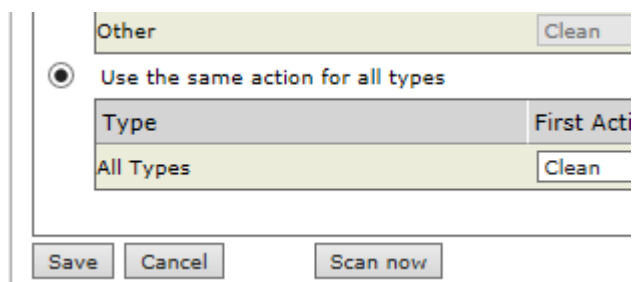

If the scan finds a virus, the user can be notified in two ways:

- The I34 virus alert message is normally shown on the Dashboard in Settings and NAS Navigator2. Once the virus is removed from the quarantine folder, the message is no longer displayed. If the antivirus software is configured to delete viruses from the quarantine folder automatically, then the I34 virus alert message will not be displayed.
- If email notification is enabled in Settings, then the antivirus software notifies the user by email if a virus is found. Enabling email notifications is recommended.

Depending on how many files are on your TeraStation, a virus scan may take several hours. Estimated scanning times are shown below.

10,000 files: ~ 30 minutes

100,000 files: ~ 5 hours

1,000,000 files: ~ 50 hours

Notes:

- If the quarantine folder doesn't have enough space, the infected files may be unable to be moved to the quarantine folder. The Trend Micro NAS security scan log may identify any infected files as quarantined even if the quarantine did not actually occur. In such a case, remove non-essential files from the quarantine folder and try the virus scan again.
- If the infected file is too large, it may be unable to be moved to the quarantine folder. In such a case, check the scan log to see whether the quarantine was successful. If it was not, move the infected file to the quarantine folder manually.

Checking the Log

Follow the procedure below to check the virus scan log.

- 1 From the left-side menu of the Trend Micro NAS Security settings page, choose *Logs*.

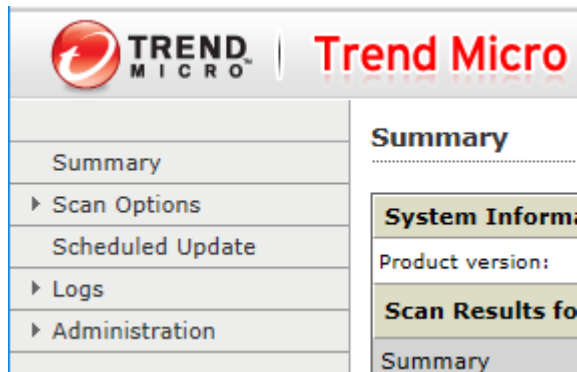

- 2 Click the log item that you want to check.

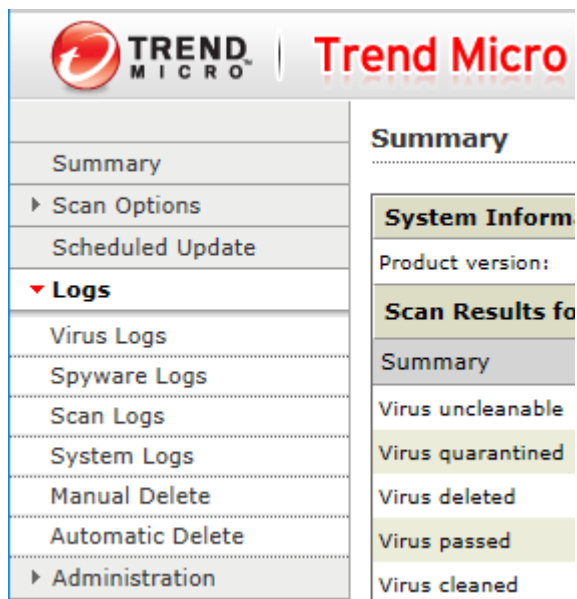

3 Click *Display Log*.**System Logs**

16 log(s) stored from 2017-03-29 17:07:03 to 2017-03-29 18:01:21

Data range:

Start date: 

End date: 

Sort by:

Entries per page: entries

Note: Only the previous 1000 log entries will be retrieved for the specified log range.

This completes the procedure for checking the log.

Opening the Online Help

For more information on the antivirus software, refer to the online help. Follow the procedure below to access the online help.

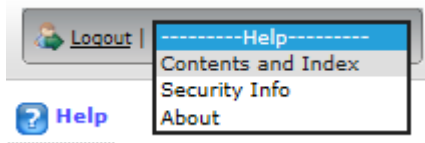

1 From the right-top menu of the Trend Micro NAS Security settings page, choose *Help > Contents and Index*.**2** Online help will open.

Online help is now viewable.

Email Notification

Your TeraStation can send you email reports daily, or when settings are changed or an error occurs. You can configure the events that will trigger notifications from any of the following functions: quotas, drives (internal, external, or RAID array), fan, backup, replication, failover, antivirus, system alert.

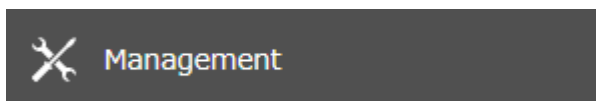
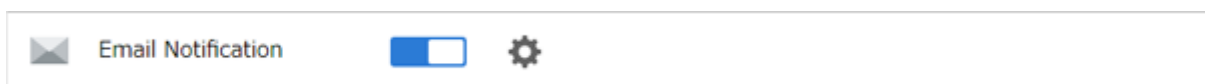
Refer to the contextual help in Settings for more detailed information such as when the notification email will be sent or the differences between the notification categories.

1 From Settings, click *Management*.**2** Move the email notification switch to the  position to enable email notification.**3** Click the settings icon () to the right of "Email Notification".

4 Click *Edit*.

5 Enter your email server settings, notification email's default subject, then configure recipients and the time when email reports will be sent. Click *OK* to save the configured settings and have a test email sent.

If you select an authentication type other than "Disable" from the drop-down list, you can enter the sender email address and credentials of the email server.

Email Notification *Required ?

SMTP Server Address * :

SMTP Port * :

Authentication Type: ▼

Sender Address:

POP3 Server Address:

POP3 Port:

SSL/TLS: ▼

Username:

Password:

Subject * :

Add Delete Select from List

Recipients * :

Name	Recipients	Class

Select All Deselect All

Send Daily Report at: ▼ Hours

OK Cancel

- 6** To change the events of email reports, click *Advanced Report Settings*. On the displayed screen, select or clear the category's checkboxes.

Categories	<input checked="" type="checkbox"/> Daily Report	<input checked="" type="checkbox"/> Info	<input checked="" type="checkbox"/> Notice	<input checked="" type="checkbox"/> Error
Drive Quota			<input checked="" type="checkbox"/>	
User			<input checked="" type="checkbox"/>	
Group			<input checked="" type="checkbox"/>	
Storage	<input checked="" type="checkbox"/>	<input checked="" type="checkbox"/>	<input checked="" type="checkbox"/>	<input checked="" type="checkbox"/>
Internal Drive	<input checked="" type="checkbox"/>	<input checked="" type="checkbox"/>	<input checked="" type="checkbox"/>	<input checked="" type="checkbox"/>
RAID Array	<input checked="" type="checkbox"/>	<input checked="" type="checkbox"/>	<input checked="" type="checkbox"/>	<input checked="" type="checkbox"/>
USB Drive	<input checked="" type="checkbox"/>			<input checked="" type="checkbox"/>
Fan				<input checked="" type="checkbox"/>
Backup		<input checked="" type="checkbox"/>	<input checked="" type="checkbox"/>	
Replication			<input checked="" type="checkbox"/>	
Failover		<input checked="" type="checkbox"/>	<input checked="" type="checkbox"/>	
Virus Scan		<input checked="" type="checkbox"/>	<input checked="" type="checkbox"/>	
System Alert		<input checked="" type="checkbox"/>		

Email notification will be enabled.

Email Notification Categories

Notification emails will be categorized into the following importance levels. You can configure them from the "Report Settings" page.

Levels	Details
Daily Report	Describes the status of the TeraStation in a daily report email.
Info	Sends a notification email if an event occurs. Info reports will contain just information such as capacity information, job starts/completes, etc.
Notice	Sends a notification email if a non-critical error occurs. Notice reports will contain warnings such as something has failed, but the function or unit can continue operating as usual. It is recommended to perform the corrective action for the notice as soon as possible.
Error	Sends a notification email if a critical error occurs. Error reports will describe critical failures that prevented a function or unit from operating properly. It is recommended to perform the corrective action for the error immediately.

Sleep Mode

To save energy, you can specify times to put the TeraStation into sleep (standby) mode, during which the drives and LEDs are turned off.

- 1** From Settings, click *Management*.

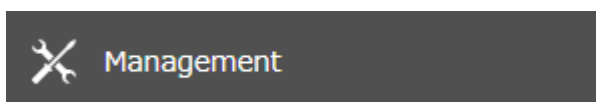

2 Click the settings icon () to the right of “Sleep Timer”.



3 Click *Edit*.

4 Specify the timer interval, wake-up time, and time to enter sleep mode, then click *OK*.

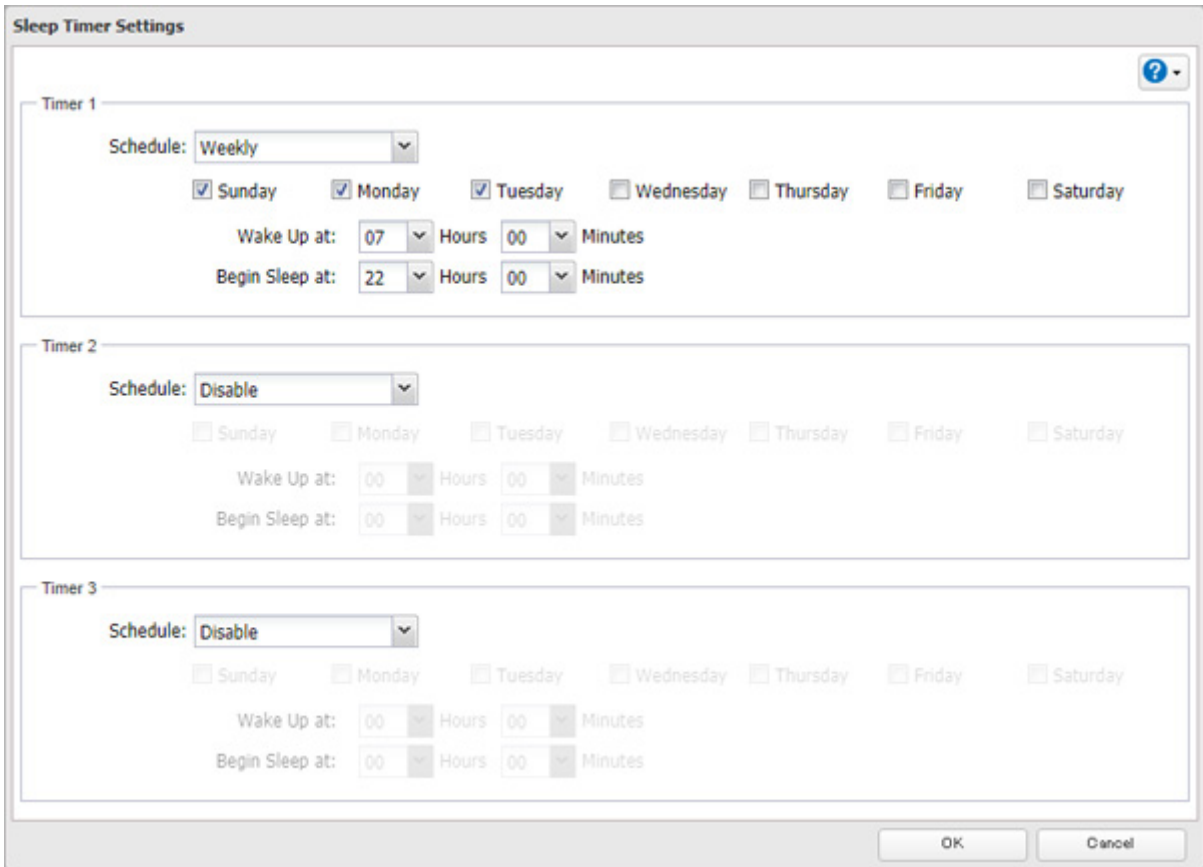

Notes:

- Up to three timers can be set.
- The time to enter sleep mode can be set from 12:00 a.m. to 3:45 a.m. of the next day. The time to wake from sleep mode can be set from 12:00 a.m. to 11:45 p.m. If the time to enter sleep mode is after 12:00 a.m., the wake-up time setting may be from 4:00 a.m. to 11:45 p.m.
- The time to enter sleep mode should not be set to the same time as or earlier than the start time.
- If a timer is scheduled during checking or formatting a drive, running a backup process, or setting a backup job within five minutes of the current time, the TeraStation will not change to standby mode when the configured time is reached.
- If scheduled times in the timer overlap, the operation is performed using the widest time interval.
- Examples of timer settings are shown below:
 - **Example 1:**
 If running at a current time of 10:00 a.m. Wednesday
 Timer 1: Daily 12:00–24:00
 Timer 2: Not used
 Timer 3: Not used
 No operation is performed at 12:00 p.m. and the unit enters sleep mode at 12:00 a.m.

- **Example 2:**

If running at a current time of 10:00 a.m. Wednesday

Timer 1: Daily 9:00–18:00

Timer 2: Wednesday 10:00–20:00

Timer 3: Not used

On days other than Wednesday, normal operation begins at 9:00 a.m. and the unit enters sleep mode at 6:00 p.m. On Wednesday, the unit enters sleep mode at 8:00 p.m.

- **Example 3:**

If running at a current time of 10:00 a.m. Wednesday

Timer 1: Daily 9:00–18:00

Timer 2: Wednesday 10:00–1:00 a.m. of the next day

Timer 3: Not used

On days other than Wednesday, normal operation begins at 9:00 a.m. and the unit enters sleep mode at 6:00 p.m. On Wednesday, normal operation begins at 10:00 a.m. and the unit enters sleep mode at 1:00 a.m. of the next day.

- **Example 4:**

If running at a current time of 10:00 a.m. Wednesday

Timer 1: Daily 9:00–18:00

Timer 2: Wednesday 7:30–22:00

Timer 3: Not used

On days other than Wednesday, normal operation begins at 9:00 a.m. and the unit enters sleep mode at 6:00 p.m. On Wednesday, normal operation begins at 7:30 a.m. and the unit enters sleep mode at 10:00 p.m.

- To wake the TeraStation from sleep mode before the wake-up time, press and hold down the power button for three seconds.

Wake-on-LAN

The TeraStation supports Wake-on-LAN, which allows it to be turned on remotely. The TeraStation will be turned on automatically in the following situations: receiving a Wake-on-LAN packet, recovering from a power outage, disconnecting and reconnecting the power cable.

- 1** From Settings, click *Network*.



- 2** Click the settings icon () to the right of "IP Address".



- 3** Click *Edit*.

4 Enable “Wake-on-LAN”, then click OK.

Wake-on-LAN: Enable
 Disable

Gateway Owner: Assign automatically

Default Gateway Address: 192.168.10.1

DNS Owner: Assign automatically

Primary DNS Server: 192.168.10.1

Secondary DNS Server:

Services Restarted After: 1 seconds

OK Cancel

Wake-on-LAN is now enabled. As long as the TeraStation is connected to a power source and the network, you can turn it on remotely.

Notes:

- After receiving the Wake-on-LAN packet, the TeraStation may take up to five minutes to be ready to use.
- To use Wake-on-LAN, you’ll need Wake-on-LAN software that sends Wake-on-LAN packets. The TeraStation does not include Wake-on-LAN software.
- The TeraStation does not support using Wake-on-LAN and port trunking at the same time. You may use either feature, but not both at the same time.

UPS (Uninterruptible Power Supply)

If a UPS (sold separately) is attached, the TeraStation can be automatically shut down to protect data in the event of a power outage.

Notes:

- If the TeraStation is connected directly to a UPS, select “Sync with UPS connected to this TeraStation”. If a different Buffalo NAS device is connected to the UPS, select “Sync with UPS connected to another Buffalo NAS device on the same network”. After making this selection, enter the IP address of the Buffalo NAS device that will be the sync source into “Other Buffalo NAS’s IP Address”.
- If you don’t want to connect any UPS devices, select “Do not synchronize with UPS” and the operation for if a power supply failure occurred. If “Use last state” at “AC Power Recovery” is selected, the TeraStation will revert to the state before the power supply failure occurred. If “Stay off” is selected, the TeraStation will remain off even after the TeraStation shuts down due to the power supply failure.
- When the TeraStation restarts after an automatic shutdown such as from a power outage or power supply issue, verify that external power has been restored. If the TeraStation is turned on while it is still running on the UPS and external power has not been restored, the automatic shutdown will not be performed, even after the specified time elapses.
- If the power supply from the UPS to the TeraStation stops and restarts when UPS recovery is enabled, the TeraStation will automatically restart.

1 Plug the power cable of the UPS to a wall socket.

2 Connect the power cable of the TeraStation to the UPS.

- 3 Connect the UPS and TeraStation.
- 4 Turn on the UPS, then the TeraStation.
- 5 From Settings, click *Management*.

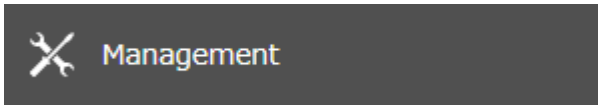

- 6 Click the settings icon () to the right of "Power Management".

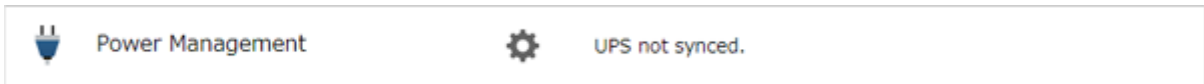

- 7 Click *Edit*.
- 8 Configure the desired settings, then click *OK*.

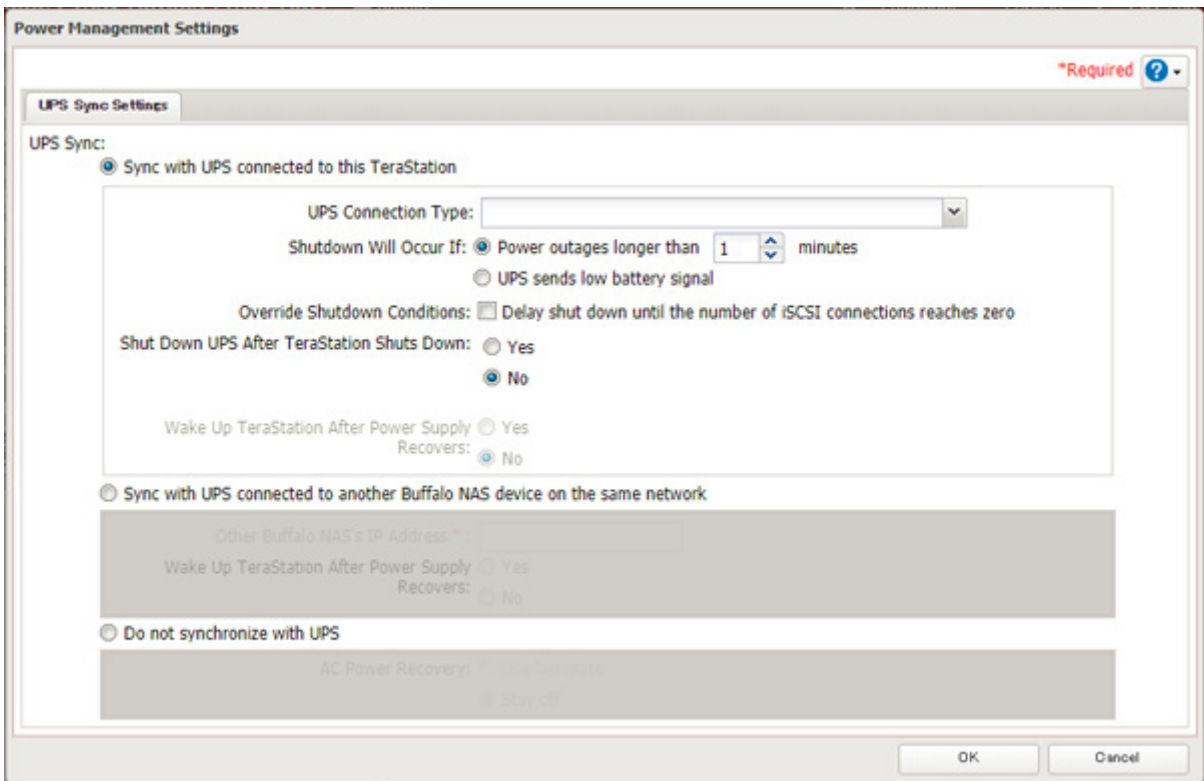

Port Trunking

Two Ethernet cables can be used to establish two separate communication routes, providing LAN port redundancy and improving communication reliability. The use of two Ethernet cables enables access to the TeraStation even if one of the cables becomes disconnected.

The port trunking modes that can be set on the TeraStation are shown below:

Trunking Mode	Characteristics
Active-backup	Only one NIC slave in the bond is active. A different slave becomes active if and only if the active slave fails.

Trunking Mode	Characteristics
Dynamic link aggregation	Creates aggregation groups that share the network speed and duplex settings. Utilizes all slave network interfaces in the active aggregator group according to the 802.3ad specification. Note: To use this mode, a separate intelligent switch that supports IEEE 802.3ad is required. Configure LACP on the switch first.
TLB	The outgoing network packet traffic is distributed according to the current load (relative to the speed) on each network interface slave.
ALB	The incoming and outgoing network packet traffic is distributed according to the current load on each network interface slave. The receive load balancing is achieved by ARP negotiation.

Note: If the TeraStation is being used as an iSCSI drive, disable iSCSI before changing network settings such as port trunking. Navigate to *Storage > iSCSI* in Settings and move the iSCSI switch to the **off** position temporarily.

1 Use an Ethernet cable to connect the hub LAN port and TeraStation LAN port.

Notes:

- Do not connect the second Ethernet cable to the TeraStation yet.
- If using an intelligent switch, configure the LAN ports on the switch first, before connecting to the TeraStation.

2 From Settings, click *Network*.



3 Click the settings icon () to the right of "Port Trunking".

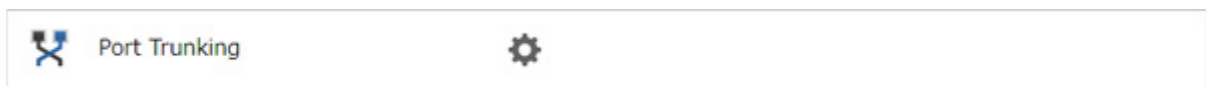

4 Select the LAN port that will be used and choose a port trunking bond, then click the port group.

5 Select the port trunking mode and click *OK*.

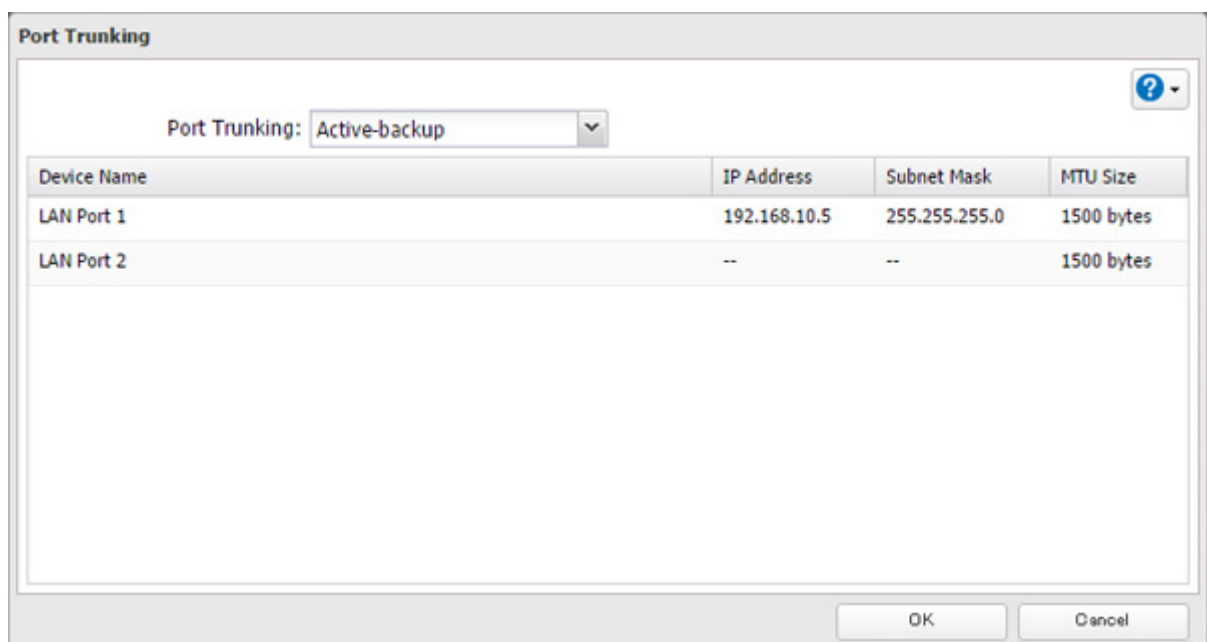

- 6 Click *Save*.
- 7 Connect the hub's LAN port and TeraStation's LAN port using the second LAN cable. If you are using an intelligent switch, connect to the LAN port that was previously configured for port trunking.
- 8 Restart the TeraStation by pressing and holding down the power button for three seconds to power off the TeraStation, then press the power button again to turn the TeraStation on.

Notes:

- If you configure port trunking, make sure to restart the TeraStation after settings are saved. Otherwise, the connection may become unstable.
- If you have selected dynamic link aggregation for the port trunking mode on the TS3020 series TeraStations, the link speed for LAN port 2 will be limited to up to 1000 Mbps. Disable the auto negotiation settings on the connected intelligent switch.
- If you have selected a port trunking mode other than dynamic link aggregation on the TS3020 series TeraStations, the port with the faster link speed will be used for access. You can check the link speed of each port from the Dashboard in Settings.

Offline Files for Windows

The "offline files" feature that is included with many versions of Windows can be used with files on the TeraStation. You will be able to work on files stored on the TeraStation even when your PC is disconnected from the network. When you next connect to the network, the updated files are written and synchronized. Follow the procedure below to configure offline files.

- 1 From Settings, click *File Sharing*.

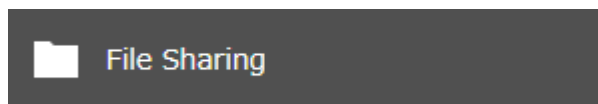

- 2 Click the settings icon () to the right of "Folder Setup".

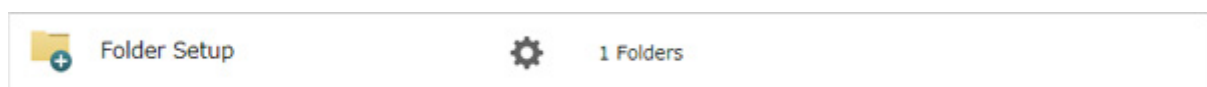

- 3 Click the shared folder for offline files.
- 4 Choose either "Manual caching of documents", "Automatic caching of documents", or "Automatic caching of programs and documents" on the *Option 1* tab, then click *OK*.

Manual caching of documents: User selects files that are cached.

Automatic caching of documents: Opened files can be cached locally for offline use. Previous versions of files that are not synchronized are automatically replaced by the latest versions.

Automatic caching of programs and documents: Opened files can be cached locally for use offline. Previous versions of files and applications executed on the network that are not synchronized are automatically replaced by the latest version of the files and applications.

- 5** From File Explorer, right-click the icon of the shared folder on the TeraStation for which you have set the offline feature, then click *Always available offline*. If the offline file wizard opens, follow the procedure on the screen.

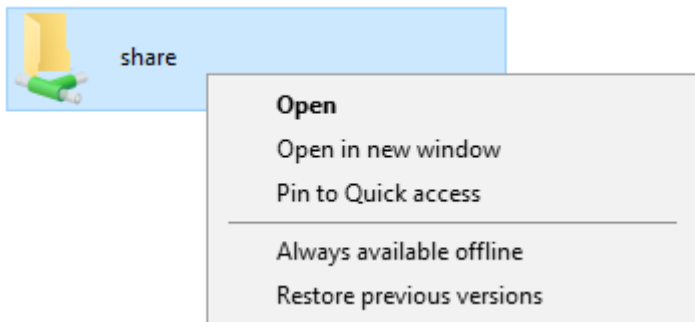

- 6** When the offline settings and synchronization settings are completed, the files and folders set appear as shown:

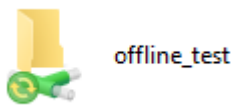

- 7** If the computer is disconnected from the network after synchronization is completed, the offline file function can be used.

Offline files can be accessed by the original Universal Naming Convention (UNC) where the data was saved.

Notes:

- If you cannot access offline files, try the following procedure:
 - (1) Reconnect the computer to the network.
 - (2) From Control Panel, change the view to the icon view and click *Sync Center*. Click *Sync All* to synchronize all offline files.
 - (3) Disconnect the computer from the network and verify that you can access offline files.
- If you have configured the recycle bin for the shared folder, temp files may be created in the recycle bin.

Accessing from an NFS Client

Note: (US customers only) Buffalo's customer support will help configure the NFS settings on your TeraStation, and will support VMware and Windows clients but will not provide support for configuring your Linux or other UNIX clients. There are various types of UNIX and the procedures for configuring NFS with them will vary considerably. For help configuring your NetWare, Linux, or other UNIX clients for NFS support, please consult each client's own documentation and support.

- 1** From Settings, click *File Sharing*.

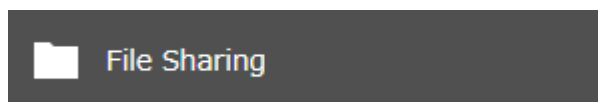

- 2** Click the settings icon (⚙️) to the right of "Folder Setup".

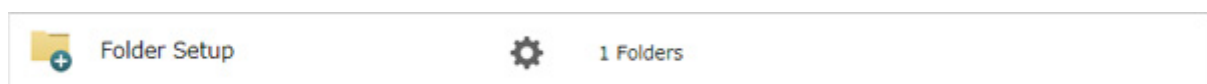

- 3** Choose the shared folder that will be accessible from the NFS client.

4 Under “LAN Protocol Support”, select the “NFS” checkbox on the *Basic* tab and click *OK*.
Note the NFS path. It will be used later for accessing data from an NFS client.

5 Click *Close*.

6 Move the NFS switch to the  position to enable NFS.



7 Click the settings icon () to the right of “NFS”.

8 Click the *Client Settings* tab.

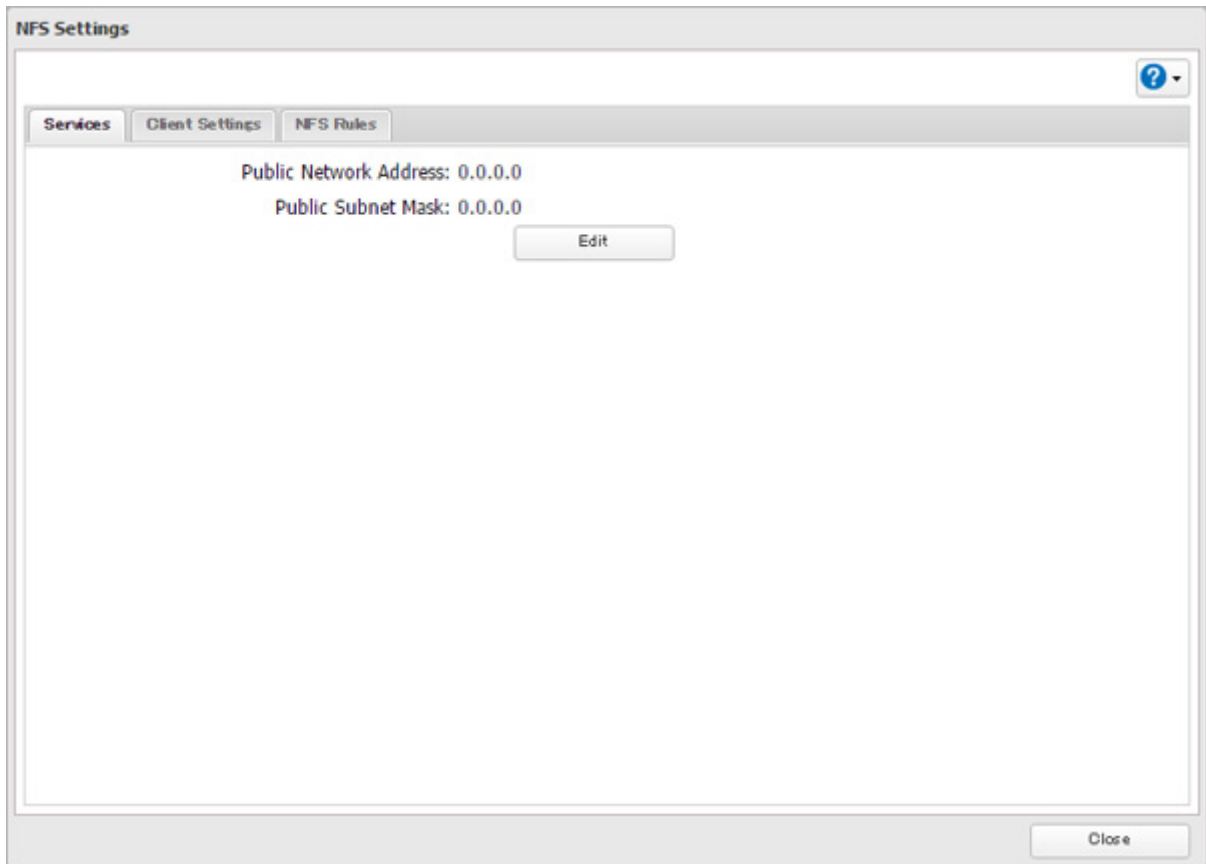

9 Click *Add*.

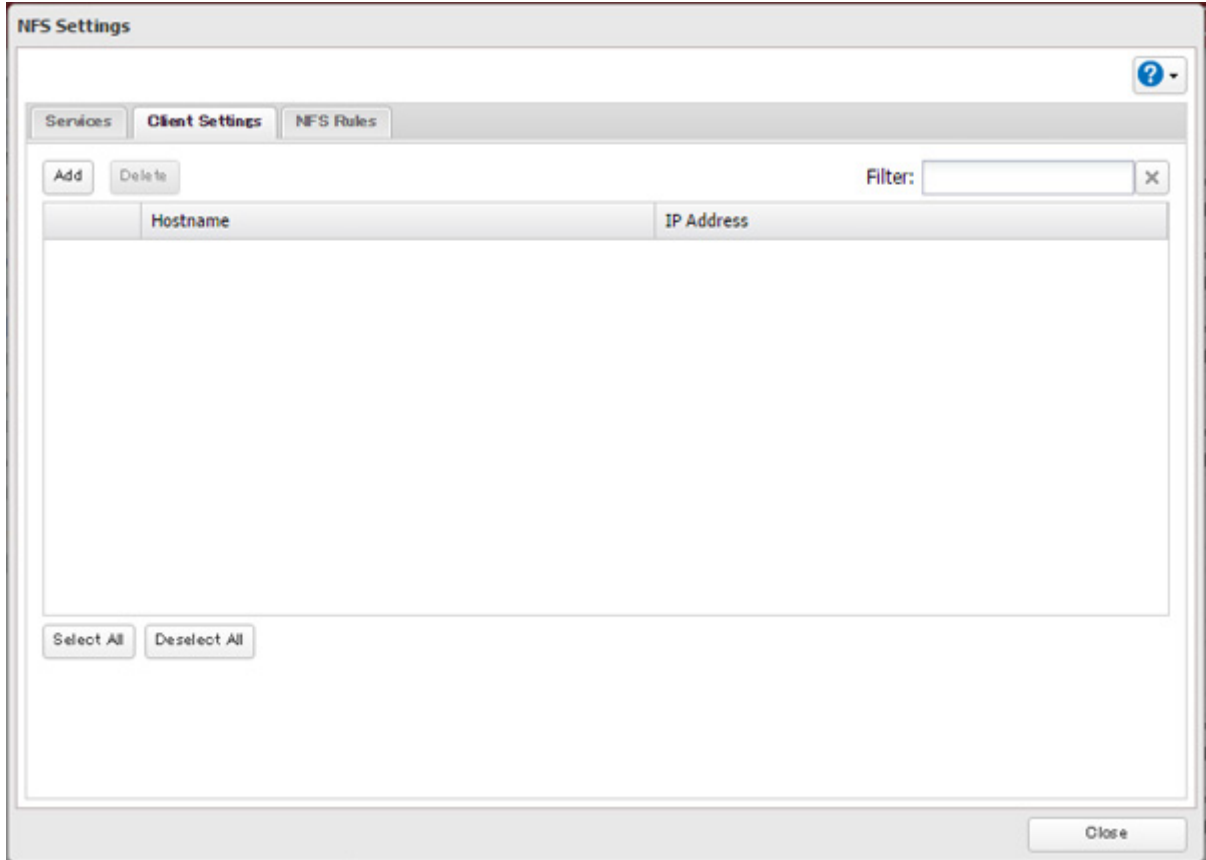

Note: To delete a client, select the checkboxes of the clients from the lists and click *Delete*.

10 Enter the hostname and IP address of the NFS client, then click *OK*. You should add all NFS clients to access the shared folder.

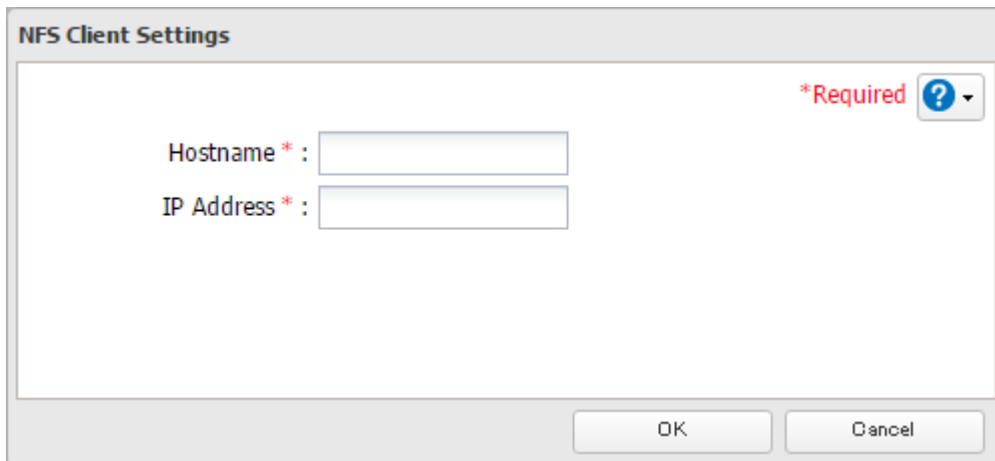

11 Click the *NFS Rules* tab.

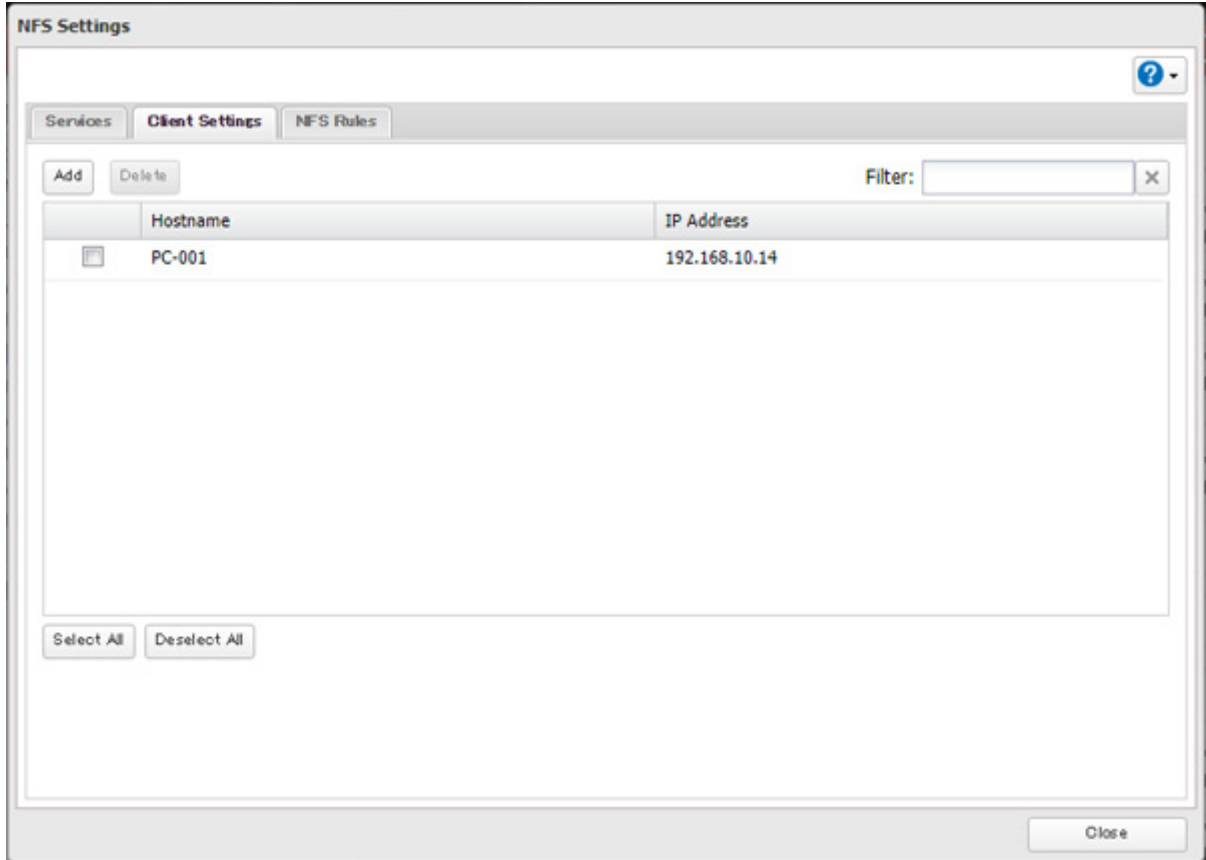

12 Click *Add*.

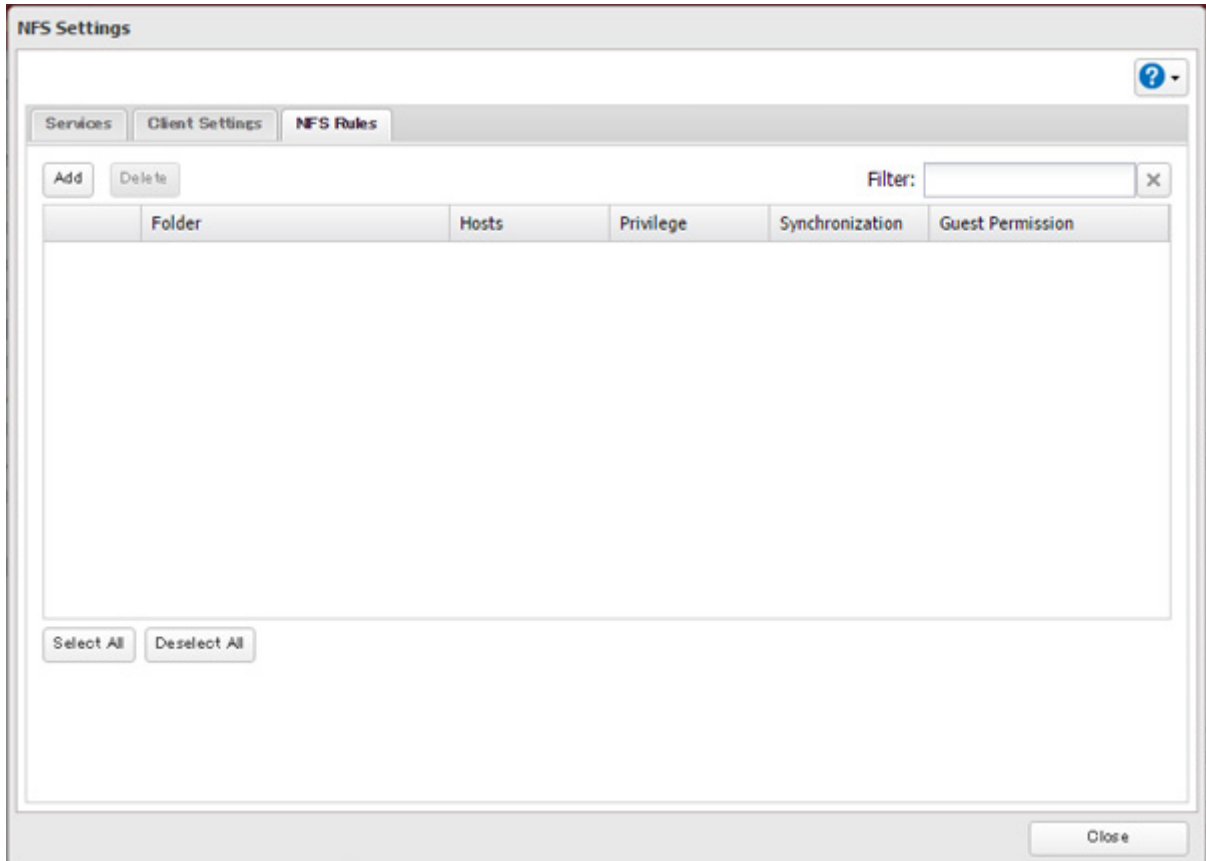

- 13** Choose the folder to restrict access to, and enter the clients that will have restricted access into the “Hosts” field. Clients may be entered by hostname, IP address, or IP address range. Wildcards are supported. Separate multiple entries with commas. You may assign read-only or read and write access to the listed clients. Rules override any settings made from the *Services* tab.

- 14** Click *OK*.

Notes:

- To restrict NFS access to a specific network or client, navigate to *File Sharing > NFS > Services* and click *Edit*. Enter the address of the network. For example, if your local network subnet has a router at 192.168.1.1 and clients with IP addresses in the range from 192.168.1.2 through 192.168.1.48 with subnet mask 255.255.255.0, then the “Public Network Address” would be 192.168.1.0 and the “Public Subnet Mask” would be 255.255.255.0. This would mean that only clients on this local network would be able to access the NFS share. If the default settings are used (0.0.0.0 for both the public network address and the public subnet mask), then access to the NFS share will not be restricted.
- If you configure “Guest Permission” to “Forced” on the screen after navigating to *NFS Rules > Add*, user ID and group ID should be 65534 when the data is written from NFS clients; this is recommended for SMB or other protocols as well. Use “Ignored” if the TeraStation only enables NFS connection.
- Be aware that some NFS clients may be able to access via NFS although the clients do not exist in the allowed NFS client list.

NFS Mount Commands

Enter the mount command to access the shared folder from the NFS client. The mount command depends on your operating system. The examples below assume that IP address of your TeraStation is 192.168.11.10, “/mnt/array1/share” is the desired NFS path, and “/mnt/nas” or drive letter “z” is the mount point.

For Linux:

```
mount -t nfs 192.168.11.10:/mnt/array1/share /mnt/nas
```

For Windows Service for Unix 3.5:

```
mount 192.168.11.10:/mnt/array1/share z:
```

Note: A shared folder whose folder name contains multibyte characters cannot be accessed.

For Solaris 10:

```
mount -F nfs 192.168.11.10:/mnt/array1/share /mnt/nas
```

For macOS:

```
mount -t nfs -o resvport 192.168.11.10:/mnt/array1/share /mnt/nas
```

Encrypting Data Transmission

Encrypting Settings Data

All communication with Settings can use SSL encryption if you access the Settings page by changing “http://” to “https://” in the browser address bar or click *Secure Connection* from the login window. Once you are logged in using the HTTPS connection and wish to disable SSL encryption, click *Normal Connection* from the login window.

Encrypting FTP Transfer Data

You can encrypt passwords using SSH for secure FTP communication. First, open a shared folder’s settings; under “LAN Protocol Support”, select the “SFTP” checkbox on the *Basic* tab and click *OK*. Also, you have to enable the SFTP service by moving the SFTP switch to the **on** position on “File Sharing”.

SSL Keys

SSL keys are used during setup screen operations and FTP communication. SSL (Secure Socket Layer) is a type of encryption system called public key encryption. Generally, SSL is managed by the two files below.

server.crt (SSL Certificates)

The TeraStation sends the file to a computer, and the computer uses it to perform encryption. The TeraStation receives the encrypted data and uses server.key (the private key) to decrypt the data.

In SSL, this key contains the server certificate, and depending on your computer environment, a check may be performed to determine the trustworthiness of the certificate. The server certificate included in the TeraStation’s default settings was created by Buffalo, and in some cases, the security certificate warning message may appear in your browser or another security software. Disregard this message and continue.

Note: Use TLS 1.2 SSL Certificate.

server.key (SSL Private Key)

This file is used as a pair with server.crt (server certificate). This is required for decrypting the data that was encrypted by the server certificate, and this is normally not revealed.

Note: The passphrase for the private key must be removed before importing to the TeraStation.

Updating SSL Key Files

To update a server certificate and a private key for SSL, follow this procedure.

- 1** From Settings, click *Management*.
- 2** Click *SSL*.
- 3** Register “server.key” for “Secret Key” and “server.crt” for “Server Certificate (.crt)”, then click *Import*.

Notes:

- Place the SSL key files (server.key, server.crt) directly below the C root drive. The SSL key files may be unable to be updated if it is placed in folders or paths that contain multibyte characters.
- If Settings cannot be displayed after updating, initialize the TeraStation settings.
- Updating the firmware initializes an SSL key.

SNMP

If SNMP is enabled, you can browse your TeraStation from SNMP-compatible network management software. Examples of frequently-notified traps are described in the [“Relevant Trap List”](#) section below.

- 1 From Settings, click *Network*.



- 2 Click the settings icon () to the right of “SNMP”.



- 3 Click *Edit*.

- 4 Select whether to use SNMP version 2 or version 3.

SNMP Settings *Required 

Use SNMPv2

SNMP Community Name * :

Trap Notify: Enable
 Disable

Trap Settings

Trap Notify Community Name * :

Trap Notify IP Address * :

Use SNMPv3

Username * :

Authentication and Privacy Protocol: SHA / AES

Authentication and Privacy Password * :

Password (Confirm) * :

- 5 Configure the desired settings, then click *OK*.

- 6 Move the SNMP switch to the  position to enable SNMP.



- 7 SNMP has been configured for the TeraStation. For further use, configure your SNMP-compatible network management software using the Buffalo-specific MIB (management information base) file. The MIB file is available from the [Buffalo website](#).

Depending on which SNMP client software you use, the procedure for configuring the software will differ. For more detailed information on configuring the client software, refer to its help or included manual.

Relevant Trap List

Standard Public MIB Traps

Conditions	Trap Name	OID
SNMP service starts.	coldStart	1.3.6.1.6.3.1.1.5.1
SNMP service ends.	nsNotifyShutdown	1.3.6.1.4.1.8072.4.0.2

Private MIB Traps

If any traps are not listed in the following chart, refer to the web page for downloading the private MIB file on the [Buffalo website](#) for more detailed information.

Conditions	Trap Name
Backup fails.	nasBackupStatus
The RAID array is in degraded mode.	nasDiskStatus
An error occurs and an error code has been displayed.	nasErrorOccur
An event occurs and an event code has been displayed.	nasInformationOccur

Saving and Applying Settings

The TeraStation's settings can be saved to a USB drive and applied to another TeraStation of the same series. Use this feature to back up and copy settings to a new TeraStation.

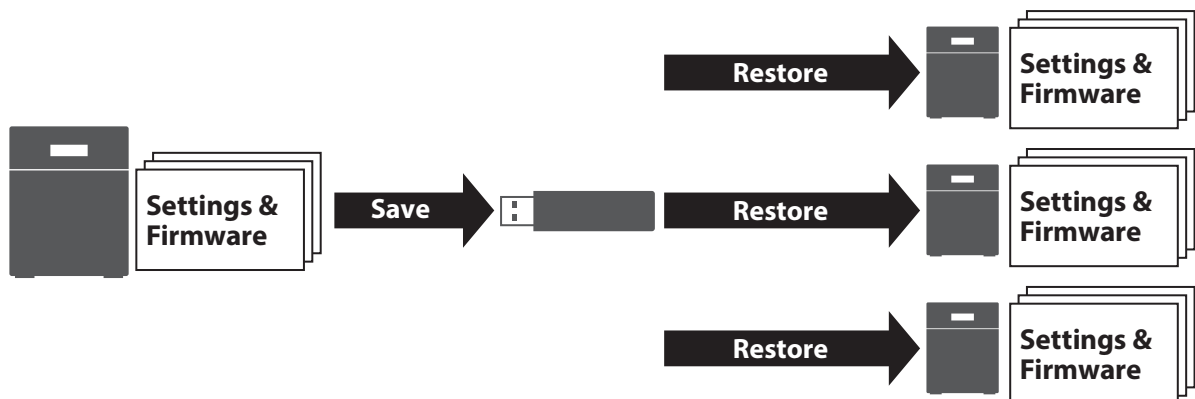

Write down the drive configuration (number of drives, RAID, LVM, etc.) of the TeraStation whose settings were saved. Make sure that any TeraStations that you apply these settings to have the exact same drive configuration before you apply the settings. If the drive configuration is different, you may get unexpected results.

The following settings are not saved or applied:

Category	Settings
File Sharing	Subfolders' access restriction settings in the shared folders
	All settings for USB drives
Storage	All settings in "Drives"
	All settings in "LVM"
	All settings in "iSCSI"
	USB drive information
Cloud Storage	Job settings of Dropbox Sync
	Job settings of Microsoft OneDrive Sync
Network	All settings except for service port restrictions, Wake-on-LAN, and MTU size settings in "IP Address"
	All settings in "Port Trunking"
Backup	All settings in "Failover"
Management	The TeraStation's hostname
	All settings in "Power Management"
	All settings in "SSL"
	Display language in Settings

Saving Settings

1 Insert a 1 GB or larger USB drive (not included) into a USB port on the TeraStation.

Note: All data on the USB drive will be erased!

2 From Settings, click *Management*.

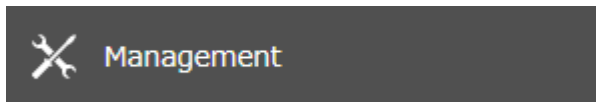

3 Click the settings icon () to the right of "Configuration Management".

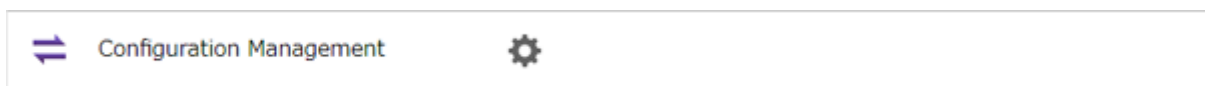

4 Select "Save current configuration to a USB drive".

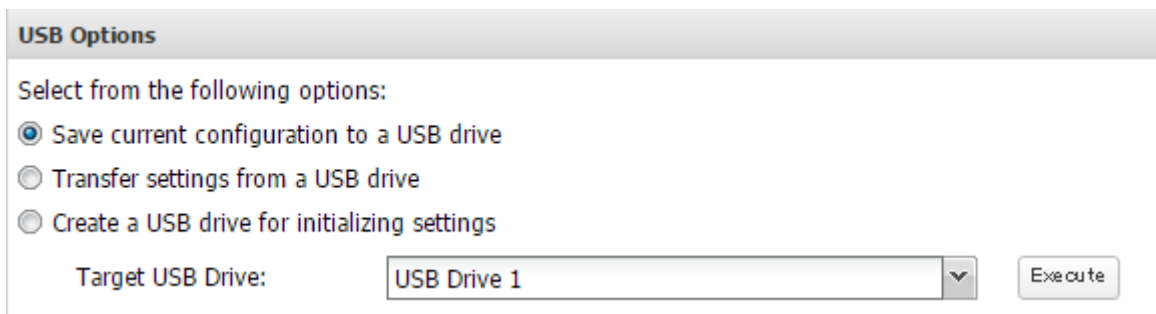

5 From "Target USB Drive", select the USB drive that is connected to the USB port on the TeraStation, then click *Execute*.

6 The "Confirm Operation" screen will open. Enter the confirmation number, then click *OK*.

7 The TeraStation will save the settings. When saving settings is completed, click *OK*.

Troubleshooting:

If the settings are not saved to the USB drive successfully, you may receive an error message such as “The specified operation cannot be executed.”. Verify:

- The USB drive has a capacity of 1 GB or more.
- The USB drive is not write-protected.
- Failover is configured on the TeraStation.

Applying Settings

The saved settings can be applied to a different TeraStation of the same series. If applying settings to another TeraStation, the unit’s current firmware version will be changed to the version used to save the settings.

Notes:

- The saved settings on the TS3010 series TeraStations cannot be applied to the TS3020 series TeraStations and vice versa.
- Since firmware version 4.36, saved settings cannot be applied from a USB drive that contains saved settings from a unit that was running a firmware version earlier than 4.36. In such a case, create the settings restoration USB drive again using a unit running firmware version 4.36 or later.

1 Insert the USB drive with the saved settings into a USB port on the TeraStation.

2 From Settings, click *Management*.

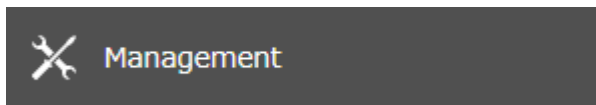

3 Click the settings icon () to the right of “Configuration Management”.



4 Select “Transfer settings from a USB drive”.

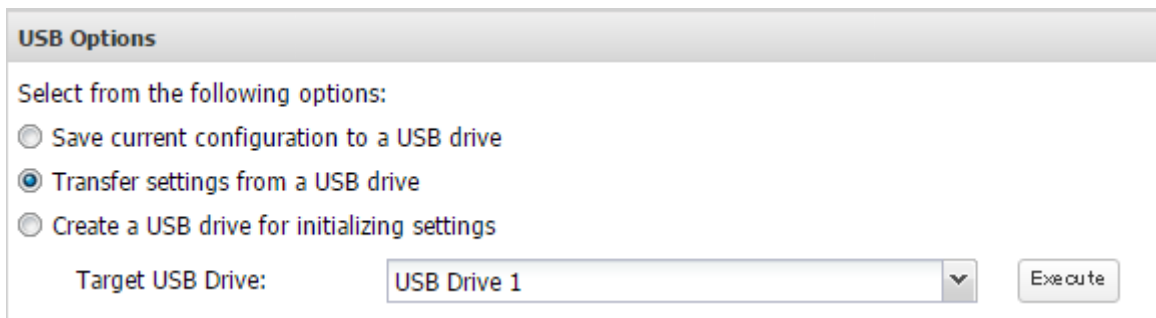

5 From “Target USB Drive”, select the USB drive that is connected to the USB port on the TeraStation, then click *Execute*.

6 The “Confirm Operation” screen will open. Enter the confirmation number, then click *OK*.

7 The TeraStation will apply the settings. When applying settings is completed, click *OK*.

Transferring Another TeraStation's Settings

You can transfer saved settings from another series TeraStation to your TeraStation. The following settings can be transferred:

- Shared folders which are created from "File Sharing" > "Folder Setup"
- Access restrictions
- Users
- Groups

Note: This feature currently supports the following TeraStation series as of August 2019. The latest compatibility information will be on the [Buffalo website](#).

- TS-X series firmware version 1.58 or later
- TS3000 series
- TS4000 series
- TS5000 series
- TS3010 series
- TS3020 series
- TS5010 series

Creating a Config File (.nas config)

Procedure for TS-X Series

To transfer settings from TS-X series TeraStations, it will use the "NS-SHFT" software to create a config file. The NS-SHFT can be downloaded from the [Buffalo website](#).

For the procedure on creating the config file, refer to the NS-SHFT user guide.

Procedure for TeraStations Other Than TS-X Series

Follow the procedure below to create a config file on a TeraStation that is not part of TS-X series TeraStations.

- 1 Refer to the user manual of the TeraStation whose settings will be saved to a USB drive.
- 2 Access the "usbdisk x" shared folder while connecting the USB drive to the TeraStation whose settings were saved in the previous step. The "x" in the folder name represents the USB port number you connected the drive to.
- 3 Copy and paste the .nas_config file to the desired location on your computer.

Transferring Settings

Follow the procedure below to transfer settings from another series TeraStation.

- 1 Before transferring access restrictions with Active Directory domain users, make sure the migration target TeraStations are joined to the same domain controller. To have the unit join the domain network, refer to the procedure on the "[Active Directory](#)" section in chapter 3.
If you didn't configure access restrictions with Active Directory domain users, skip to the next step.

- 2 From Settings, click *Management*.

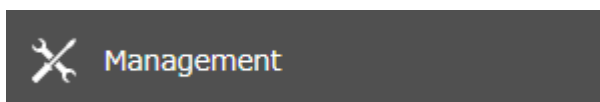

- 3** Click the settings icon () to the right of “Configuration Management”.



- 4** Click *Browse* and choose the config file (.nas_config) that was created with the migration source TeraStation. If the config file was created with a password, enter it into the “Password” field.

Configuration Migration

Migrate another TeraStation's users, groups, shared folders, and access restriction settings. Select the config file (.nas_config) that was saved on the other TeraStation.
 Note: If the migration source TeraStation is configured with Active Directory, this TeraStation should also have the same configuration, or else migration will not work.

For detailed information about compatible products for migration or the procedure to save the config file, refer to the [user manual](#).

Config File (.nas_config):

Password:
(if needed)

- 5** Click *Import*.

- 6** The “Confirm Operation” screen will open. Enter the confirmation number, then click *OK*.

- 7** The TeraStation will transfer the settings. When transferring settings is completed, click *OK*.

Notes:

- If the migration target TeraStation contains shared folders, users, and groups that share the same name as the transferred settings, the existing settings will be overwritten.
- If the migration target TeraStations have already added some shared folders, users, and groups, the transferred settings may exceed the maximum number of allowed shared folders, users, or groups. After migration finishes, open Settings and verify that all settings were properly transferred.

Restoring Factory Defaults

Initializing from Settings

To initialize the TeraStation to its factory defaults from Settings, follow the procedure below.

- 1** From Settings, click *Management*.

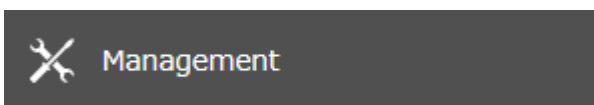

- 2** Click the settings icon () to the right of “Restore/Erase”.

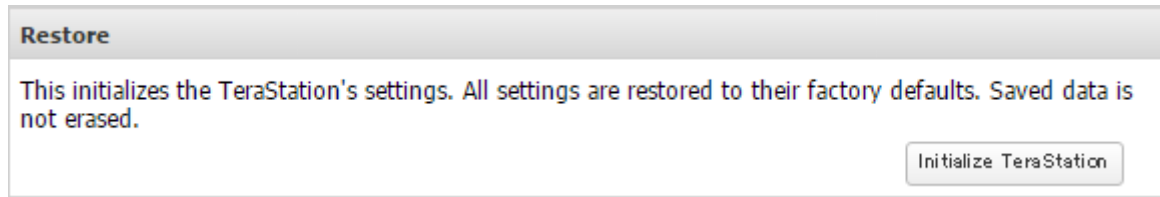

3 Click *Initialize TeraStation*.**4** The “Confirm Operation” screen will open. Enter the confirmation number, then click *OK*.**5** The TeraStation will restore its factory default settings. Close the browser and wait until the initialization is finished.

Initializing Using the USB Initialization Drive

A USB initialization drive will restore the settings on your TeraStation to their factory defaults. You can initialize them without logging in to Settings. Follow the procedure below to create a USB initialization drive.

Notes:

- You can use the USB initialization drive to initialize settings on the same TeraStation unit that created it.
- Normally, making and using a USB initialization drive will not affect data on the TeraStation. However, always back up your data regularly!
- This USB drive can be used to recover the system if your TeraStation doesn't boot at all. In this case, if the data partition is damaged, then all your data will be deleted by the recovery process.

Creating a USB Initialization Drive

1 Insert a 1 GB or larger USB drive (not included) into a USB port on the TeraStation.

Note: All data on the USB drive will be erased!

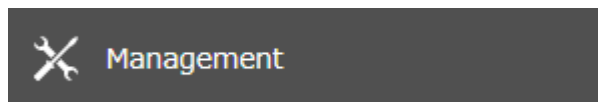
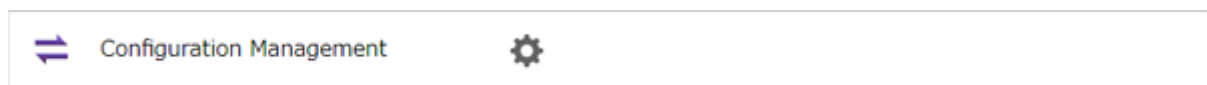
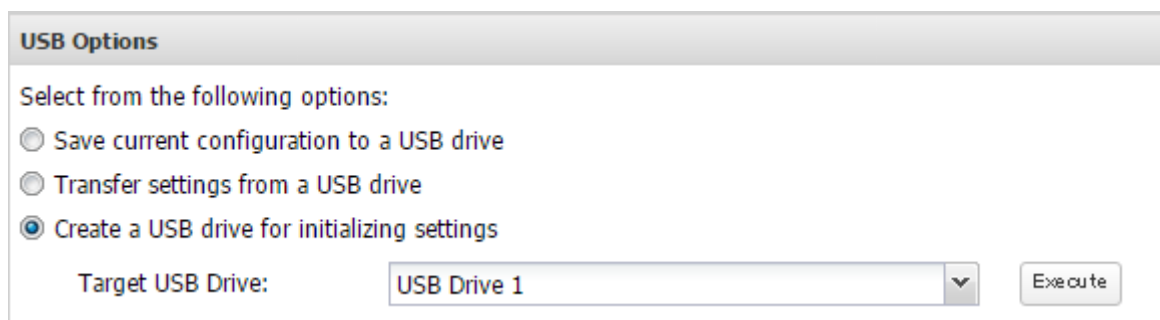
2 From Settings, click *Management*.**3** Click the settings icon (⚙️) to the right of “Configuration Management”.**4** Select “Create a USB drive for initializing settings”.**5** From “Target USB Drive”, select the USB drive that is connected to the USB port on the TeraStation, then click *Execute*.

- 6 The “Confirm Operation” screen will open. Enter the confirmation number, then click *OK*.
- 7 The TeraStation will create the USB initialization drive. This will take about a minute. When creating the USB initialization drive is completed, refresh the browser and log in to Settings again.

Starting Initialization

To initialize the settings on your TeraStation with the USB drive created above, follow the procedure below.

Note: If using the USB initialization drive to initialize, the unit’s current firmware version will be changed to the version used to create the USB initialization drive.

- 1 Turn off the TeraStation by pressing and holding down the power button for three seconds.
- 2 Insert the USB drive into a USB port on the TeraStation. Make sure that no other USB drives are currently connected to any USB ports on the TeraStation.
- 3 Power on the TeraStation while holding down the function button.
- 4 When the info LED glows, press the function button. The I41 message will appear on NAS Navigator2 at this time.
- 5 It will take several minutes for initializing the settings. The TeraStation will restart when it’s finished.

Dismount the USB drive before unplugging it. Refer to the [“Dismounting Drives”](#) section in chapter 4 for the procedure on dismounting drives.

Resetting the Administrator Password

If you forget the admin username or password and cannot log in to Settings, or incorrect network settings are configured and Settings becomes inaccessible, initialize these settings by holding down the init button (refer to the [“Diagrams”](#) section in chapter 1) for 10 seconds. This will typically reset the admin username and password, network configuration, SSL, and security port settings to their factory default values.

This button can be disabled in Settings; to do so, navigate to *Management > Restore/Erase > Edit* under “Init Button Settings”; then select “Keep current admin username and password” and click *OK*.

Logs

Displaying TeraStation’s Logs

Follow the procedure to check the TeraStation’s logs.

- 1 From Settings, click *Management*.

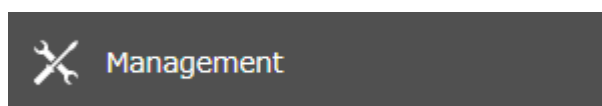

- 2 Click the settings icon () to the right of “Logs”.



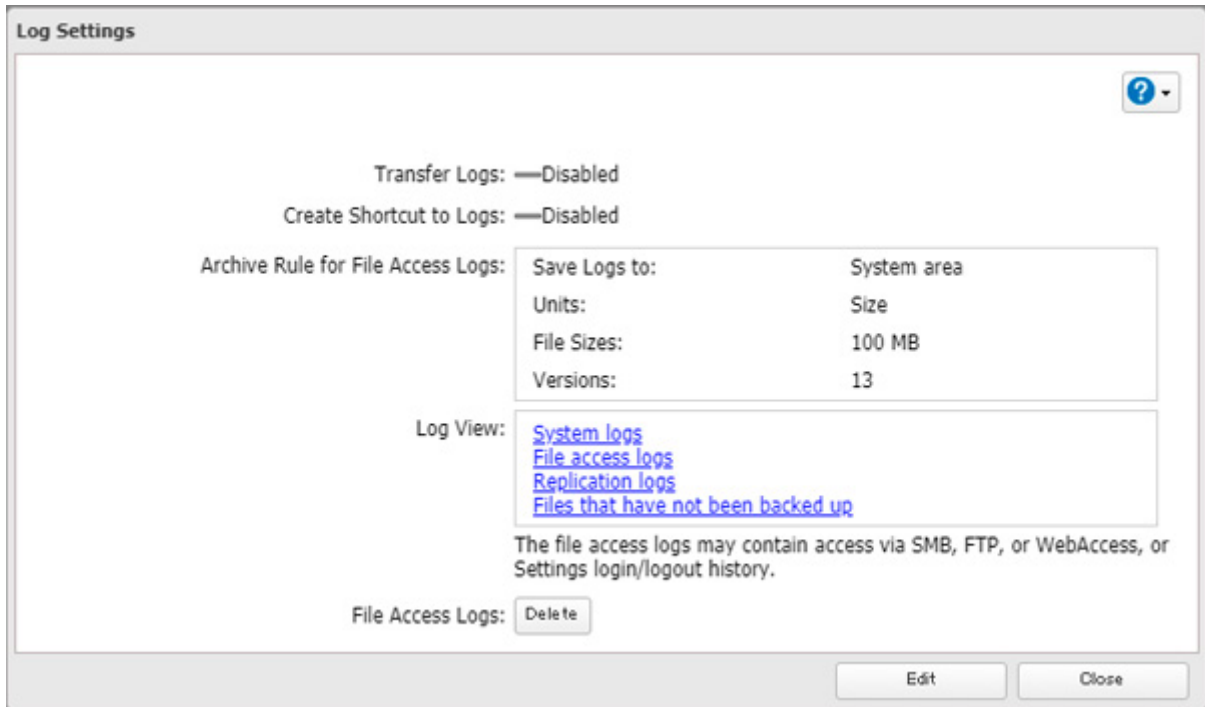

3 Select a log to view.

The file access log stores file access events that occurred on the internal drives. File access on USB drives are not logged.

Note: All logs are encoded in UTF-8 format. To show them correctly, change the software encoding to “UTF-8”.

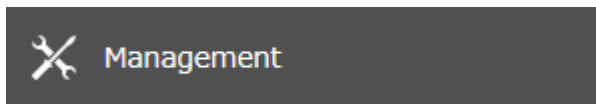
Transferring Logs to the Syslog Server

1 From Settings, click *Management*.**2** Click the settings icon () to the right of “Logs”.

3 Click *Edit*.

Log Settings

Transfer Logs: —Disabled

Create Shortcut to Logs: —Disabled

Archive Rule for File Access Logs:

Save Logs to:	System area
Units:	Size
File Sizes:	100 MB
Versions:	13

Log View:

- [System logs](#)
- [File access logs](#)
- [Replication logs](#)
- [Files that have not been backed up](#)

The file access logs may contain access via SMB, FTP, or WebAccess, or Settings login/logout history.

File Access Logs:

4 Enable “Syslog Transfer”.

Log Settings *Required

Syslog Transfer: Enable

Syslog Server IP Address * :

Logs to Transfer:

- System logs
- File access logs

Disable

Create Shortcut to Logs: Enable

Target Shared Folder * :

Disable

Archive Rule for File Access Logs:

Save Logs to: System area Specified folder

Target Folder * :

Units: Day Week Month Size

File Sizes * : MB

Versions * :

Archive Size: 1300 MB

5 Enter the IP address of the syslog server where you want to transfer the logs to.

6 Select the type of log that you want to transfer from “Logs to Transfer”.

7 Click *OK*.

Creating a Shortcut to the Logs in the Shared Folder

1 From Settings, click *Management*.

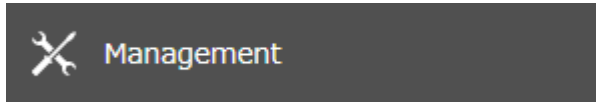

2 Click the settings icon () to the right of “Logs”.

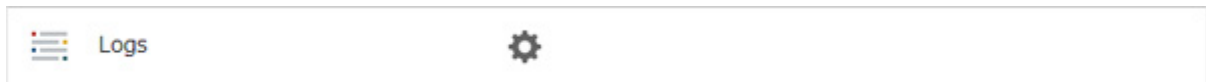

3 Click *Edit*.

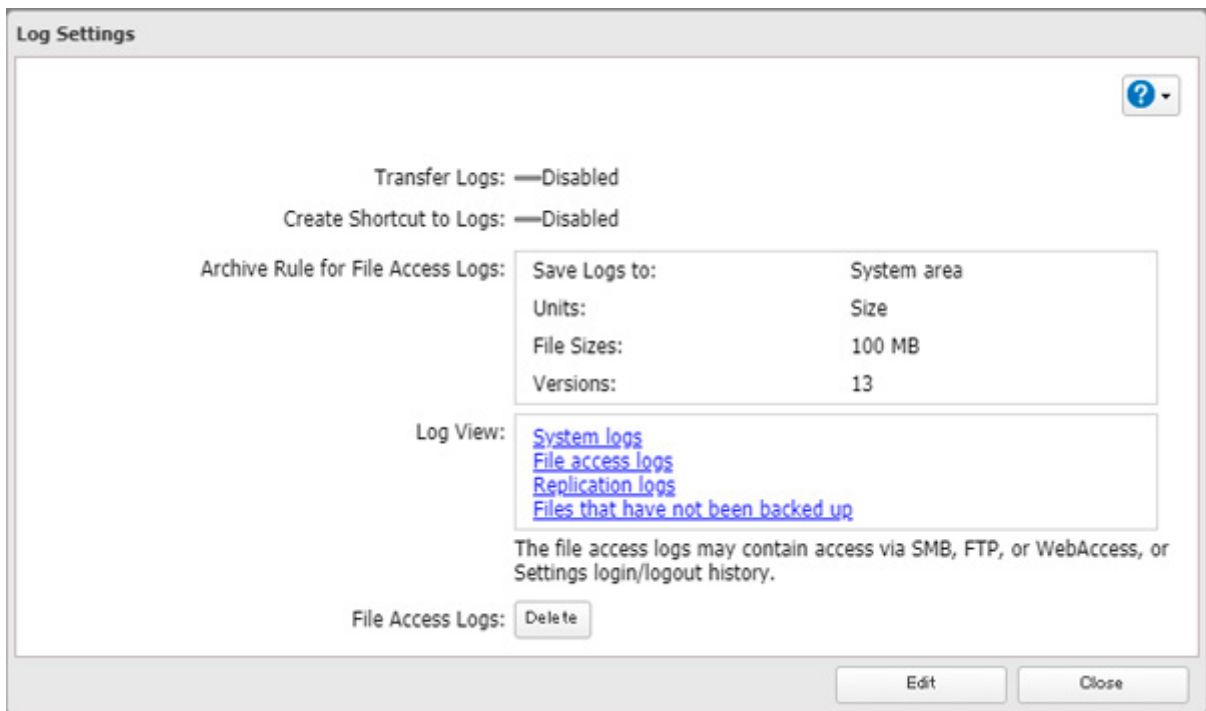

4 Enable “Create Shortcut to Logs”.

Log Settings *Required ?

Syslog Transfer: Enable

Syslog Server IP Address * :

Logs to Transfer: System logs
 File access logs

Disable

Create Shortcut to Logs: Enable

Target Shared Folder * : Browse

Disable

Archive Rule for File Access Logs: Save Logs to: System area Specified folder

Target Folder * : Browse

Units: Day Week Month Size

File Sizes * : MB

Versions * : Archive Size: 1300 MB

OK Cancel

5 Click *Browse* and under “Target Shared Folder”, select the shared folder where the created shortcut will lead. Click *OK*.

In the selected shared folder, a folder named “system_log” will now contain the logs.

Changing Archive Rules for File Access Logs

You can configure how many logs are kept or how long each log will be kept on the TeraStation.

1 From Settings, click *Management*.

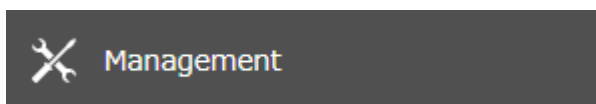

2 Click the settings icon () to the right of “Logs”.



3 Click *Edit*.

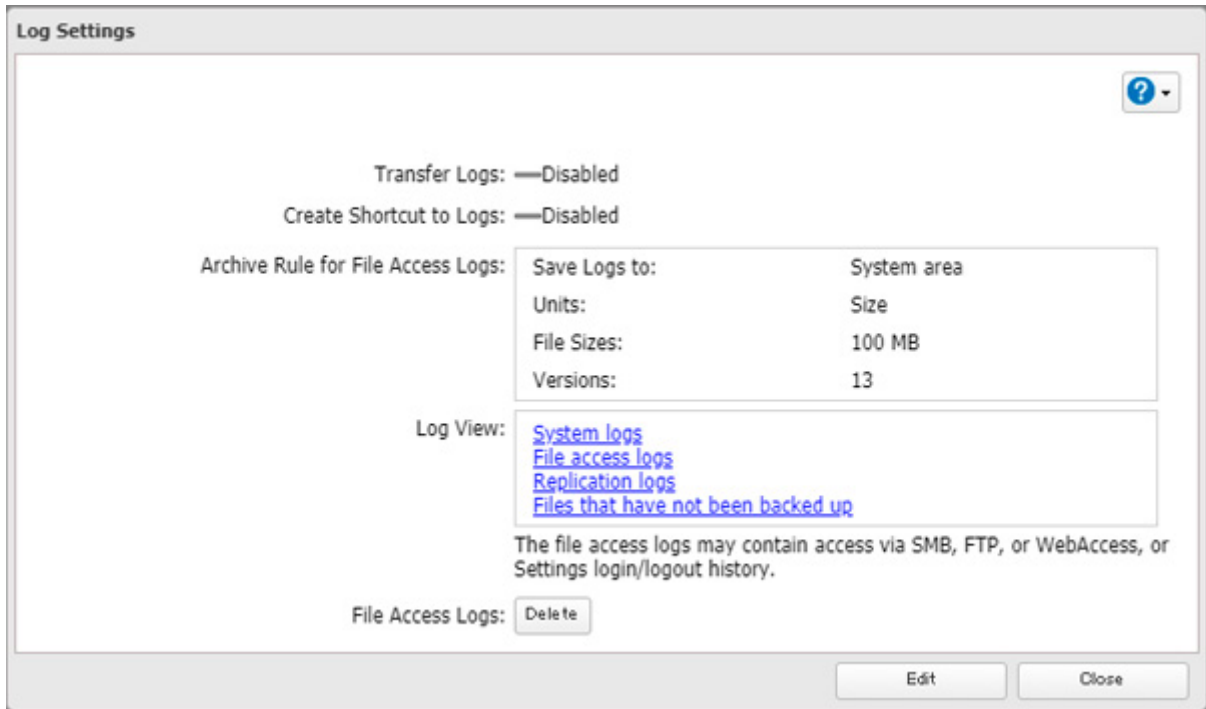

4 Specify the location and select the unit and version to save logs to the right of “Archive Rule for File Access Logs”. For example, if you select “Month” for the unit and enter “7” for the version, the file access logs for the next 7 months will be saved on the TeraStation.

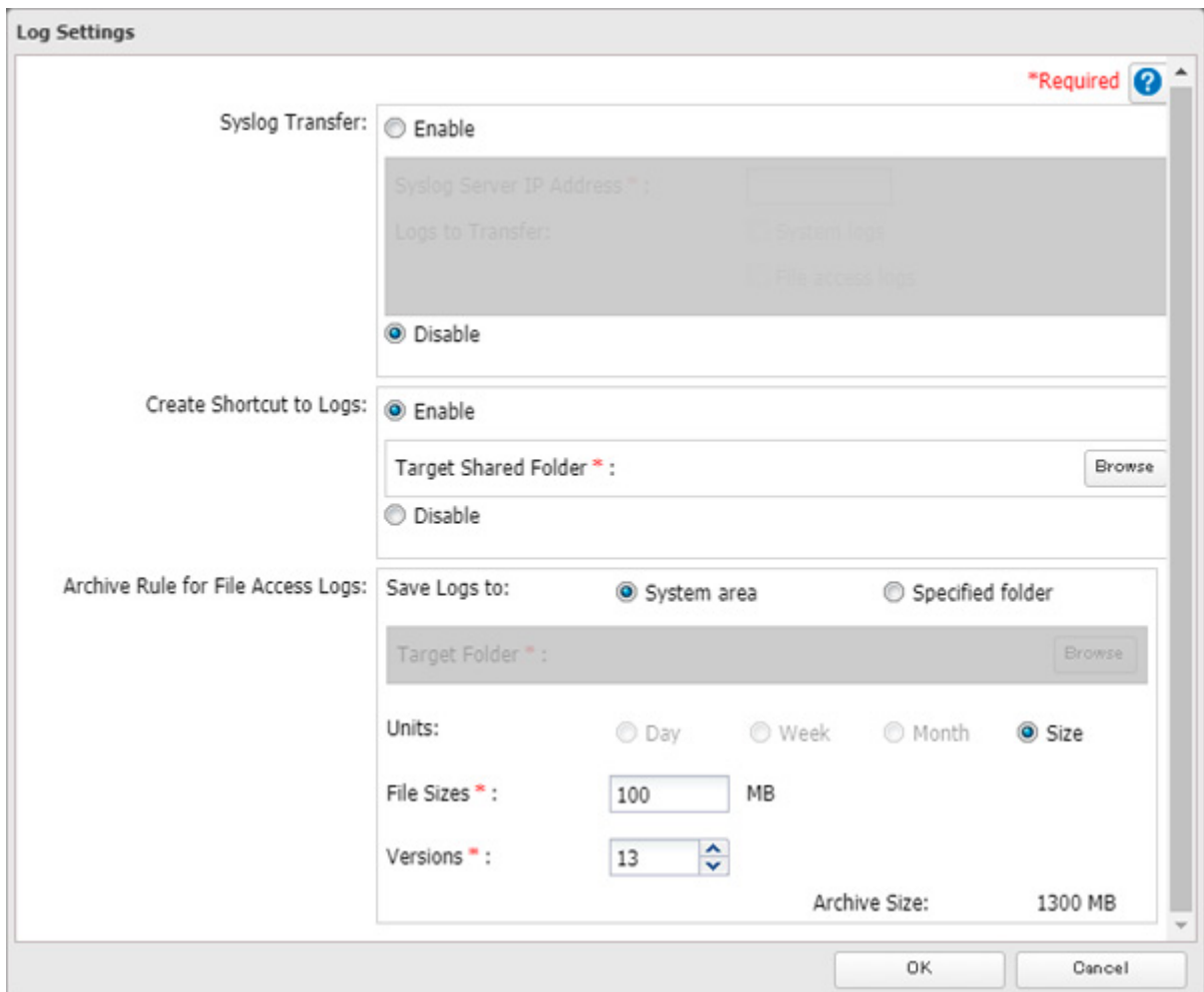

Available duration and capacity to save logs will vary depending on the unit. The following values are available:

- **Log destination is set to the system area**
Unit (Size): 1–100 for file sizes and 1–13 for all versions
- **Log destination is set to a designated folder**
 - Unit (Day): 1–367 for all versions
 - Unit (Week): 1–53 for all versions
 - Unit (Month): 1–13 for all versions
 - Unit (Size): 1–100 for file sizes and 1–13 for all versions

5 Click *OK*.

Notes:

- To delete the saved logs, click *Delete* at the window in step 3.
- If there is not enough space to save logs, the **I70** message will appear on the Dashboard in Settings and NAS Navigator2. If it appears, free up space by deleting the current file access logs. If no free space is made available elsewhere, older logs will automatically be deleted.
- If the shared folder to which logs are saved was created on a drive or RAID array, and that drive or RAID array is later changed using RMM, the log folder will be automatically changed to the system area. The **I72** message will also appear on the Dashboard in Settings and NAS Navigator2.
- You cannot delete a RAID array, format a drive, or change a folder name while file access logs are being saved to the shared folder.

Updating the Firmware

If a new firmware version is available, a message is displayed when the TeraStation boots. You can update the firmware either manually or automatically.

Notes:

- If all drives and RAID arrays on the TeraStation have LVM enabled but no LVM volumes have been created, you will not be able to update the firmware from Settings.
- Settings will not be available while the firmware is updating. Don't try to access Settings from another computer until the update is completed.

Updating Manually

1 From Settings, click *Management*.

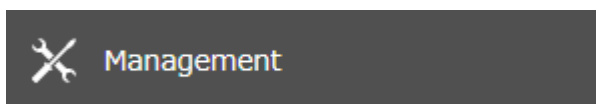

2 Click the settings icon () to the right of "Update".

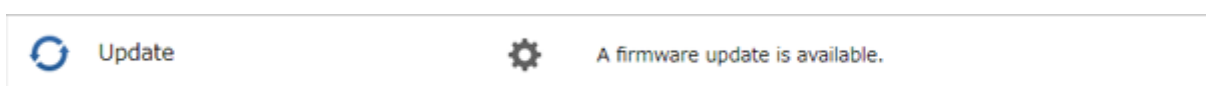

3 Click *Install Update*.

4 The "Confirm Operation" screen will open. Enter the confirmation number, then click *OK*.

5 When updating the firmware is completed, refresh the browser and log in to Settings again.

You can also download the latest firmware from the [Buffalo website](#).

Updating Automatically

- 1 From Settings, click *Management*.

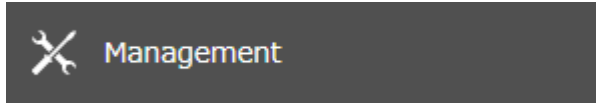

- 2 Click the settings icon () to the right of "Update".

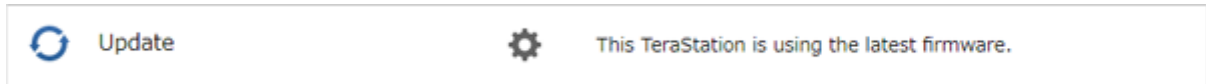

- 3 Click *Edit*.

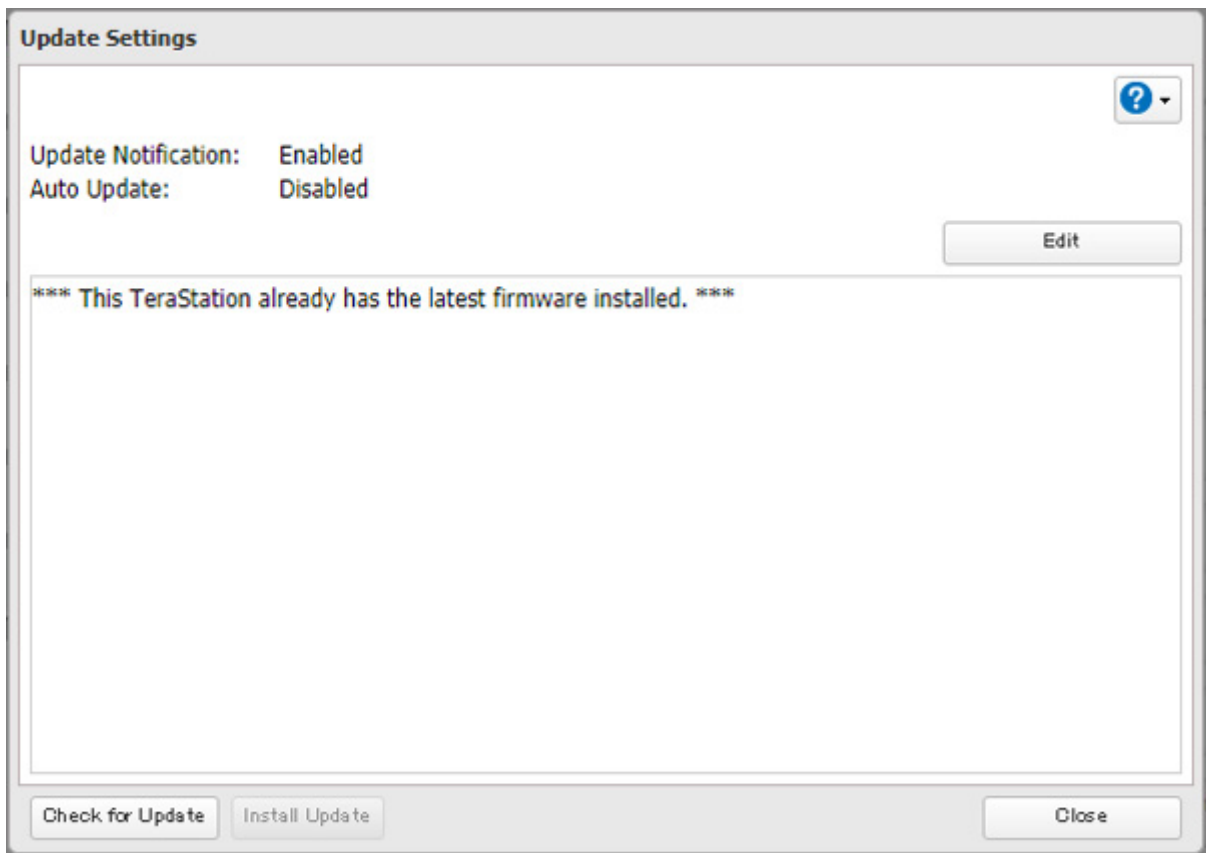

- 4** Select “Update the firmware automatically” and click *OK*.

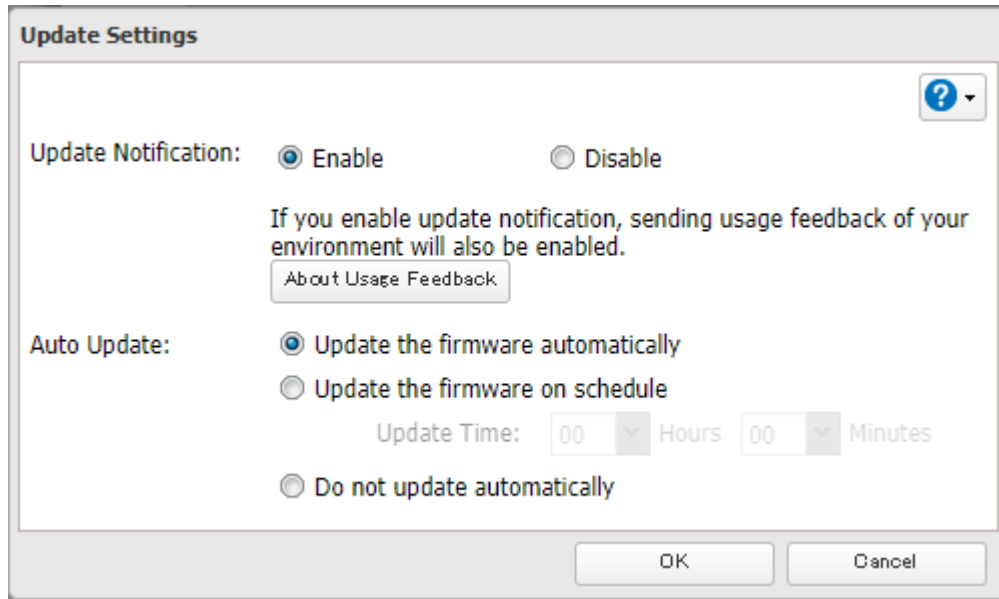

Alternatively, you may choose to schedule updates to occur during a specific time of day.

Configuring Update Notification

Configure whether or not to receive a notification when a new firmware version becomes available.

- 1** From Settings, click *Management*.

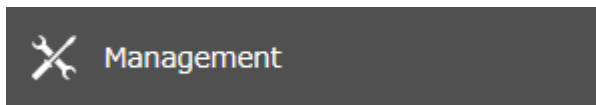

- 2** Click the settings icon (⚙️) to the right of “Update”.

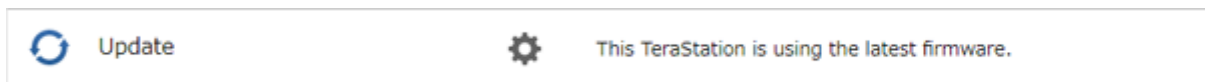

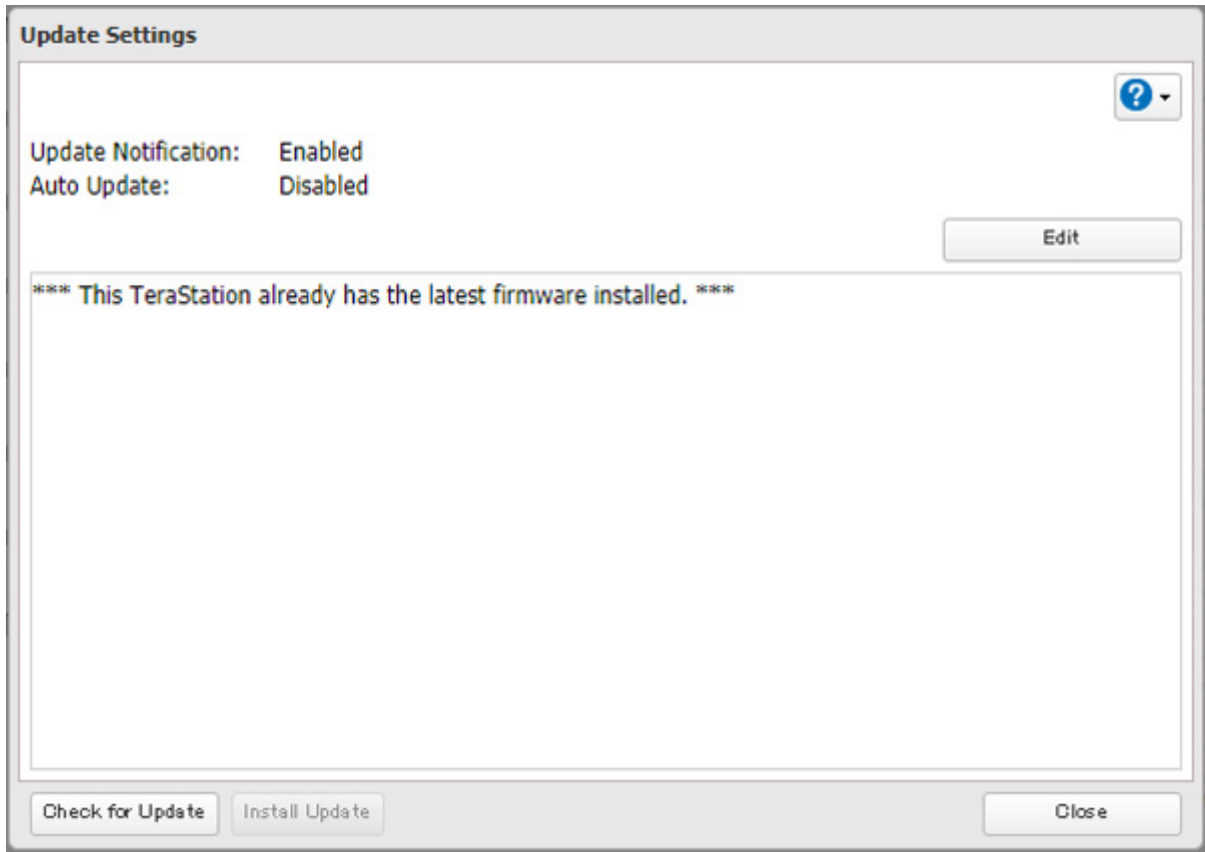
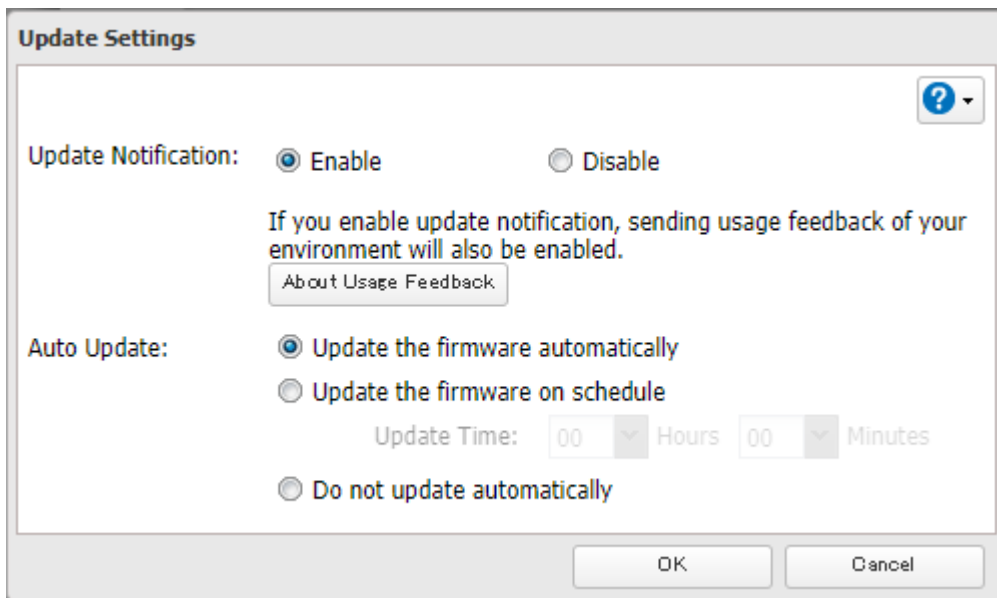
3 Click *Edit*.**4** Select to enable or disable update notification and click *OK*.

For further optimized firmware updates and product usability improvements, Buffalo may ask you to send your usage and environment information, such as the number of shared folders and client computers, and/or S.M.A.R.T. information. The collected information will only be used for improving future firmware stability and product development and no other purposes.

If update notification is enabled, it will also automatically enable sending usage feedback to Buffalo. If you don't want to send this information to us, disable update notification.

Name, Date, Time, and Language

Configure the TeraStation's hostname, date, time, and language as shown below.

Note: To change the settings of a TeraStation that is being used as an iSCSI drive, navigate to *Storage > iSCSI* in Settings and move the iSCSI switch to the **off** position temporarily before changing settings.

- 1 From Settings, click *Management*.

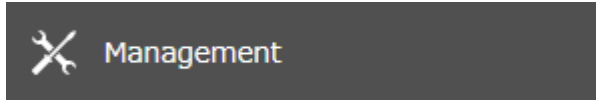

- 2 Click the settings icon (⚙️) to the right of "Name/Time/Language".

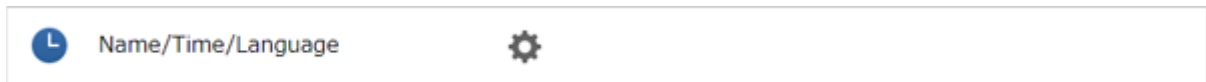

- 3 Click *Edit*.

- 4 Click the *Name* tab, then configure the TeraStation's name and description.

The name will be used for identifying your TeraStation on the network. When your TeraStation is detected, the name will be used as the hostname. The hostname may contain up to 15 alphanumeric characters and hyphens (-). The first and last characters should not be a hyphen; do not use the following word as a hostname: localhost.

 A dialog box titled "Name/Time/Language" with a red asterisk and a question mark icon in the top right corner. It has four tabs: "Name", "Time", "Language", and "Management Information". The "Name" tab is selected. Below the tabs are two text input fields: "Name *:" with the value "TS3410DA93" and "Description:" with the value "TeraStation". At the bottom right are "OK" and "Cancel" buttons.

- 5 Click the *Time* tab. Enable the NTP server and select the “Use default NTP server” checkbox. If you disable the NTP function, click *Use Local Date/Time* to use your computer’s time settings for the TeraStation.

By default, the TeraStation adjusts its clock automatically by using a default NTP server. This NTP server belongs to Internet Multi Feed Inc. For more information, visit <http://www.jst.mfeed.ad.jp>.

To use a different NTP server, clear the “Use default NTP server” checkbox and enter a new NTP IP address or its hostname, then click *OK*. If an NTP server is specified by name instead of IP address, make sure that a DNS server is configured for the TeraStation.

Note: The internal clocks of the TeraStation and other devices on your network may run at slightly different speeds. Over a long period of time, your network devices may show somewhat different times, which can cause network problems. If clocks on your network vary by more than five minutes, unexpected behavior may occur. For best results, keep all clocks on your network devices set to the same time by adjusting them regularly, or use an NTP server to correct them all automatically.

- 6 Click the *Language* tab and select the language to be used.

Note: This tab changes the language used by the TeraStation for email notifications and other functions. To change the language displayed in Settings, go to Settings and click *Language* from the menu bar. Choose your desired language from the drop-down list.

- 7** Click the *Management Information* tab. Enter the desired location and administrator information.

The screenshot shows a dialog box titled "Name/Time/Language". It has four tabs: "Name", "Time", "Language", and "Management Information". The "Management Information" tab is selected. In the top right corner, there is a red asterisk followed by the word "Required" and a blue question mark icon. Below the tabs, there are two text input fields: "Location:" and "Administrator:". At the bottom right, there are two buttons: "OK" and "Cancel".

- 8** When all settings are completed, click *OK*.

Beep Alerts

You can set the TeraStation to beep if certain errors occur.

- 1** From Settings, click *Management*.

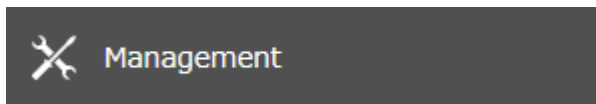

- 2** Click the settings icon () to the right of "Notifications".



- 3** Click *Edit*.

- 4** Click the *Alert Sound* tab.

- 5** Select the triggers to make the alert beep, then click *OK*.

The screenshot shows a dialog box titled "Notification Settings". It has two tabs: "Alert Sound" and "Front Panel". The "Alert Sound" tab is selected. In the top right corner, there is a blue question mark icon. Below the tabs, there is a section titled "Triggers When Beeping:" followed by four checked checkboxes: "Overheating", "Drive error", "Fan failure", and "UPS power failure". At the bottom right, there are two buttons: "OK" and "Cancel".

LEDs

You may adjust the brightness of the LEDs on the TeraStation.

- 1 From Settings, click *Management*.

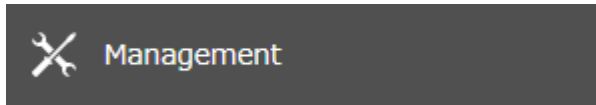

- 2 Click the settings icon () to the right of "Notifications".

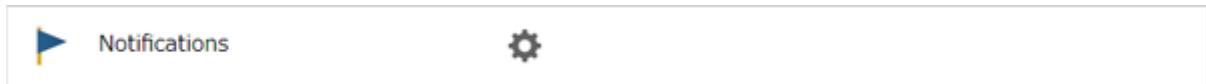

- 3 Click *Edit*.

- 4 Click the *Front Panel* tab.

- 5 Configure your settings, then click *OK*.

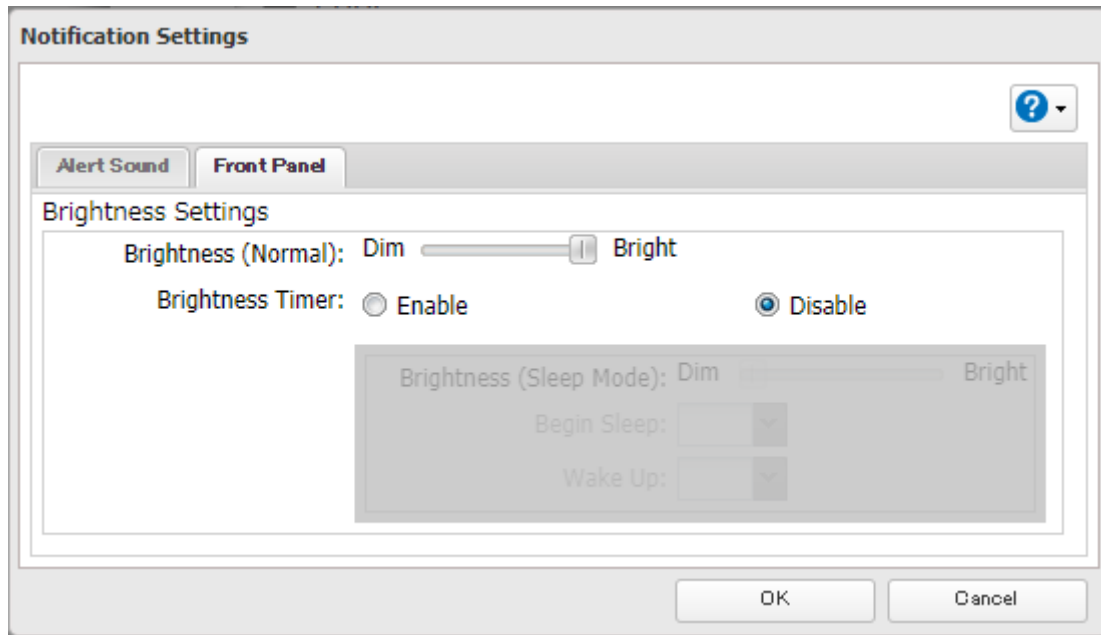

Proxy Server

If you place the TeraStation on a network that passes through a proxy server, configuring the proxy server settings is recommended. Unless you configure the proxy settings, firmware updates in Settings will not work. To configure the settings, follow the procedure below.

- 1 From Settings, click *Network*.



- 2** Click the settings icon () to the right of “Proxy Server”.



- 3** Enable “Proxy Server”.

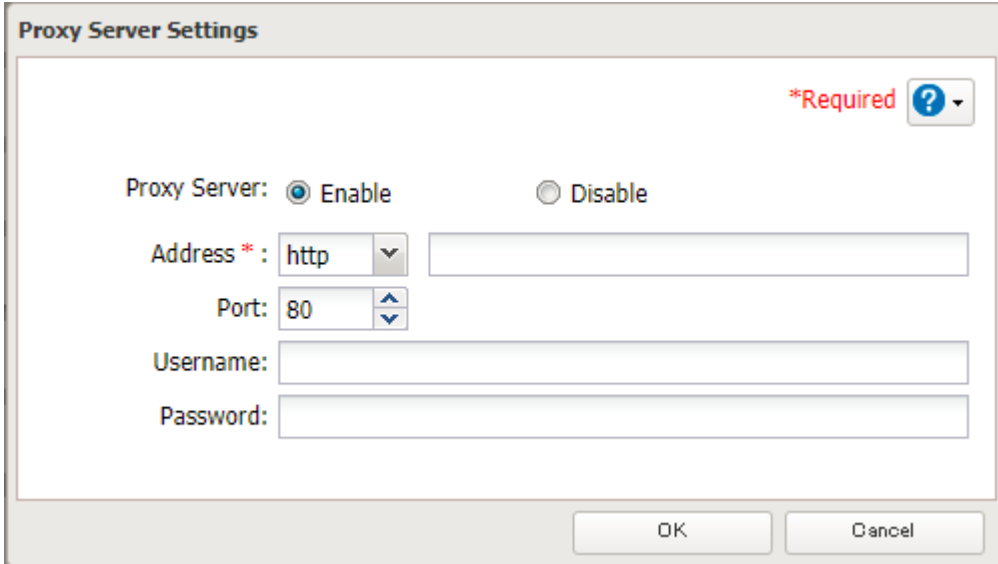

- 4** Enter the proxy server IP address or hostname, port number, username and password, then click *OK*.

Once you configure the proxy server settings, you may use the settings for other cloud storage services such as Amazon S3 or Dropbox by selecting the “Configured settings” option on each settings page.

Jumbo Frames

If your other network devices support jumbo frames, you may be able to improve network performance.

- 1** From Settings, click *Network*.



- 2** Click the settings icon () to the right of “IP Address”.



3 Click *Edit*.

IP Address List

Interface	Type	DHCP	IP Address	Subnet Mask	MTU Size	More D
LAN Port 1	1GbE	✓	192.168.10.69	255.255.255.0	1500 bytes	▶
LAN Port 2	1GbE	✓	—	—	1500 bytes	▶

Wake-on-LAN: Disabled
 Gateway Owner: Automatically assigned (LAN port 1)
 Default Gateway Address: 192.168.10.1
 DNS Owner: Automatically assigned
 Primary DNS Server: 192.168.10.1
 Secondary DNS Server: Not assigned
 Services Restarted After: 1 seconds











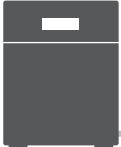



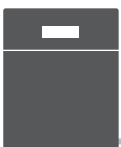

Allowed Protocols for Each Port Port Trunking FQDN Mapping Edit Close

4 Select or enter the desired MTU size and click *OK*.

IP Address List

Interface	DHCP	IP Address	Subnet Mask	MTU Size
LAN Port 1	<input checked="" type="checkbox"/>	192.168.10.28	255.255.255.0	4084
LAN Port 2	<input checked="" type="checkbox"/>		255.255.255.0	1500

MTU sizes of 1500–9216 bytes are supported. The stated size doesn't include 14 bytes of header and 4 bytes of FCS. The default MTU size is 1500 bytes. MTU sizes of 1501 bytes or more are considered jumbo frames.

Connection			Transmission	
				Transfer data using jumbo frames.
				Transfer data without using jumbo frames.
				Transfer data without using jumbo frames.
				No data can be transferred.

Note: Make sure the TeraStation's MTU size is smaller than the hub or router's. Larger MTU sizes may not transfer the data to the TeraStation correctly.

Changing the IP Address

Normally, the TeraStation's IP address is set automatically by a DHCP server on your network. If you prefer, you can set it manually. An easy way to do this is to change it on NAS Navigator2. The procedure to change the IP address in Settings is below.

Note: If the TeraStation is being used as an iSCSI drive, to change the settings, navigate to *Storage > iSCSI* in Settings and move the iSCSI switch to the **off** position temporarily before changing settings.

- 1 From Settings, click *Network*.



- 2 Click the settings icon () to the right of "IP Address".



3 Click *Edit*.

IP Address List

Interface	Type	DHCP	IP Address	Subnet Mask	MTU Size	More D
LAN Port 1	1GbE	✓	192.168.10.69	255.255.255.0	1500 bytes	▶
LAN Port 2	1GbE	✓	—	—	1500 bytes	▶

Wake-on-LAN: Disabled
 Gateway Owner: Automatically assigned (LAN port 1)
 Default Gateway Address: 192.168.10.1
 DNS Owner: Automatically assigned
 Primary DNS Server: 192.168.10.1
 Secondary DNS Server: Not assigned
 Services Restarted After: 1 seconds

Allowed Protocols for Each Port Port Trunking FQDN Mapping Edit Close

4 Clear the “DHCP” checkbox and enter the desired IP address and its subnet mask.

IP Address List

Interface	DHCP	IP Address	Subnet Mask	MTU Size
LAN Port 1	<input type="checkbox"/>	192.168.10.28	255.255.255.0	1500
LAN Port 2	<input checked="" type="checkbox"/>		255.255.255.0	1500

- 5** Select “User (static)” for both “Gateway Owner” and “DNS Owner” options from the drop-down list, then enter the desired default gateway address and DNS server addresses.

Wake-on-LAN: Enable
 Disable

Gateway Owner: User (static) ▼
 Default Gateway Address: 192.168.10.1

DNS Owner: User (static) ▼
 Primary DNS Server: 192.168.10.1
 Secondary DNS Server:

Services Restarted After: 1 ▼ seconds

OK Cancel

- 6** Click *OK*.

Notes:

- Only one default gateway and DNS address can be configured for all LAN ports. Different network addresses cannot be assigned to the LAN ports.
- Do not set the IP address of the same segment for all LAN ports. This may cause unstable network communication.
- Network services such as SMB or AFP will restart when the Ethernet cable is disconnected/reconnected or if a network issue occurs. You can specify the time to delay the restart at the “Services Restarted After” option.
- When you disable DHCP, all addresses including default gateway and DHCP server addresses cannot be assigned automatically, even if you can select the “Assign automatically” options for them.

Mapping IP Address and Hostname

The TeraStation allows you to map an IP address and a hostname (FQDN) of another host you would like the TeraStation to communicate with, such as the domain controller. If you configure the mapping pair, the TeraStation can be accessed using the configured pair when name resolution is needed. Follow the procedure below to configure FQDN mapping.

- 1** From Settings, click *Network*.



- 2** Click the settings icon () to the right of “IP Address”.



3 Click *FQDN Mapping*.

The screenshot shows the 'IP Address List' configuration window. It contains a table with the following data:

Interface	Type	DHCP	IP Address	Subnet Mask	MTU Size	More D
LAN Port 1	1GbE	✓	192.168.10.69	255.255.255.0	1500 bytes	▶
LAN Port 2	1GbE	✓	—	—	1500 bytes	▶

Below the table, the following settings are displayed:

- Wake-on-LAN: Disabled
- Gateway Owner: Automatically assigned (LAN port 1)
- Default Gateway Address: 192.168.10.1
- DNS Owner: Automatically assigned
- Primary DNS Server: 192.168.10.1
- Secondary DNS Server: Not assigned
- Services Restarted After: 1 seconds

At the bottom, there are buttons for 'Allowed Protocols for Each Port', 'Port Trunking', 'FQDN Mapping', 'Edit', and 'Close'.

4 Click *Add*.

The screenshot shows the 'Mapped IP Addresses' configuration window. It features a table with two columns: 'FQDN' and 'IP Address'. The table is currently empty. Above the table are 'Add' and 'Delete' buttons. Below the table are 'Select All' and 'Deselect All' buttons. At the bottom of the window are 'OK' and 'Cancel' buttons. A help icon (?) is located in the top right corner.

- 5** Enter the hostname (FQDN) and the IP address that you want to map, then click *OK*.

The screenshot shows a dialog box titled "FQDN Mapping Settings". In the top right corner, there is a red asterisk followed by the word "*Required" and a blue question mark icon. Below this, there are two text input fields. The first is labeled "FQDN * :" and is currently empty. The second is labeled "IP Address * :" and is also empty. At the bottom of the dialog, there are two buttons: "OK" and "Cancel".

- 6** Click *OK* again to apply settings.

Boot Authentication

Boot authentication allows you to authenticate the TeraStation while it's booting, and also prevents the TeraStation from being used in an unauthorized or unexpected manner, such as in cases of theft.

If authentication fails, the TeraStation will stay on, but all functions and services are stopped. Users will not be able to log in to Settings to make changes or access any shares.

Notes Before Use

- To use boot authentication, a Windows PC is necessary to serve as the authentication server.
- When activating boot authentication, the drives on the TeraStation will be formatted and all data on the drives will be erased. Back up any important data to another device. Even though the data is deleted, the RAID array will be kept as is.
- Assigning the TeraStation a static IP address is recommended for boot authentication.
- When boot authentication settings finish, export the configuration file for backup. Refer to the "Exporting Managed TeraStations to a File" section in the Boot Authentication Tool help for the procedure.
- Boot authentication cannot be enabled if any of the following functions are enabled: drive encryption, LVM, iSCSI, and failover. Conversely, these functions cannot be enabled while boot authentication is enabled.

Important Notice

This feature was developed with the intention of preventing critical data leakage by rendering the TeraStation unusable in cases of misoperation or missing important setting files. Before configuring boot authentication, back up the data on the TeraStation by referring to the "[Backing Up Data on the TeraStation](#)" section in chapter 5, and then create a USB initialization drive by referring to the "[Creating a USB Initialization Drive](#)" subsection above. With these preparations, a TeraStation that is unusable may be initialized and reverted to a usable state.

If any of the situations below occur, the TeraStation will stop booting and become inaccessible.

- The TeraStation is unable to communicate with the authentication server due to the server crashing or it being on another network.
- The TeraStation unit has been deleted from Boot Authentication Tool or the Boot Authentication Tool database has been erased.
- Security level is configured to "High" and the incorrect passcode is entered three times.

Setting Up the Authentication Server on a Windows PC

To set up the authentication server, follow the procedure below. The authentication server must be placed on the local network or VPN.

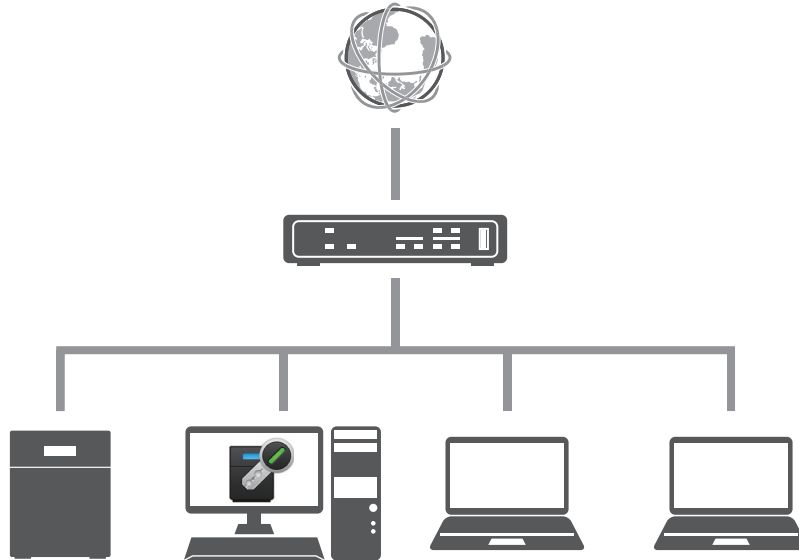



Note: For proper operation, make sure that the TeraStation and the authentication server are on a network with only one router. If there are two or more routers on the network, the authentication server may not acquire the correct TeraStation status. For example, if the TeraStation's IP address has been changed, its status does not change to "Warning".

- 1** Download the application for the authentication server, "Boot Authentication Tool", from the [Buffalo website](#) and install it onto the Windows PC.
- 2** Register the specific port number that is used on the application as a firewall exception rule. Navigate to *Control Panel > System and Security > Windows Firewall* on the authentication server.
- 3** Click *Advanced settings*.
- 4** Click and right-click *Inbound Rules*, then click *New Rule*.
- 5** Select "Port" and click *Next*.
- 6** Select "TCP", enter the port number that is used on the application to the right of "Specific local ports", and click *Next*. The default port number on the application is "7010". The port number can be confirmed on the *Options* tab of the application.
- 7** Click *Next*, then click *Next* again.
- 8** Enter a desired name for the setting and click *Finish* to complete.

Configuring Boot Authentication on the TeraStation

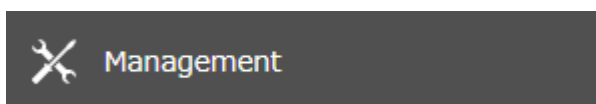
- 1** From Settings, click *Management*.





- 2** Click the settings icon () to the right of “Boot Authentication”.

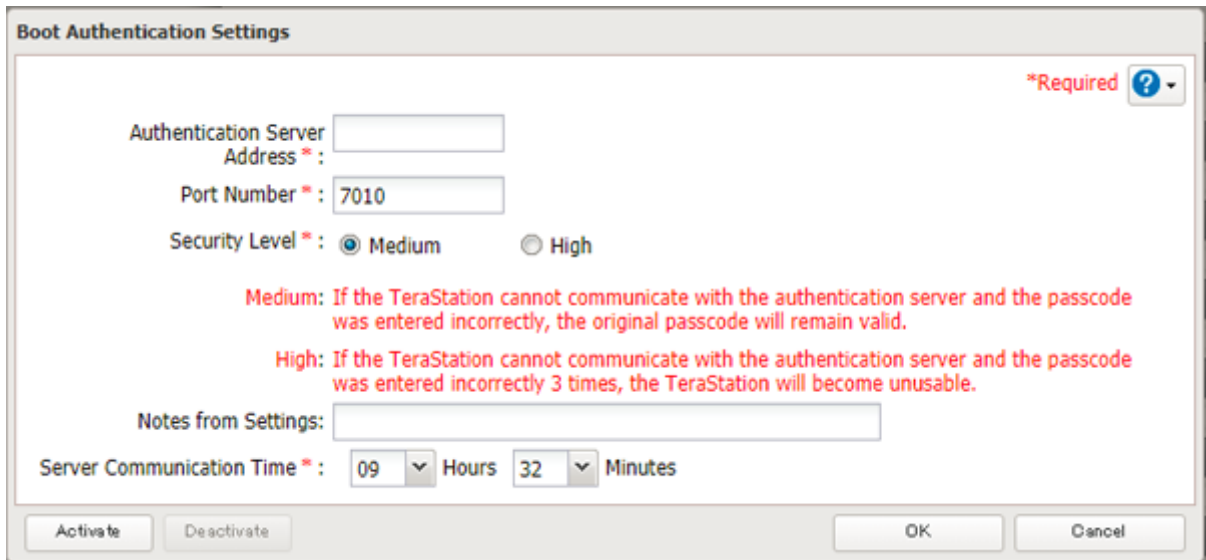

- 3** Click *Edit*.

- 4** Enter the authentication server’s IP address or hostname and port number, specify the security level and communication time settings, then click *Activate*.



Boot Authentication Settings *Required 

Authentication Server Address * :

Port Number * :

Security Level * : Medium High

Medium: If the TeraStation cannot communicate with the authentication server and the passcode was entered incorrectly, the original passcode will remain valid.

High: If the TeraStation cannot communicate with the authentication server and the passcode was entered incorrectly 3 times, the TeraStation will become unusable.

Notes from Settings:

Server Communication Time * : Hours Minutes

- 5** The drive formatting process will start. Click *Yes*.

- 6** The “Confirm Operation” screen will open. Enter the confirmation number, then click *OK*.

- 7** The format will begin. Wait until it finishes. When formatting finishes and the TeraStation is added to Boot Authentication Tool, boot authentication setting is completed.

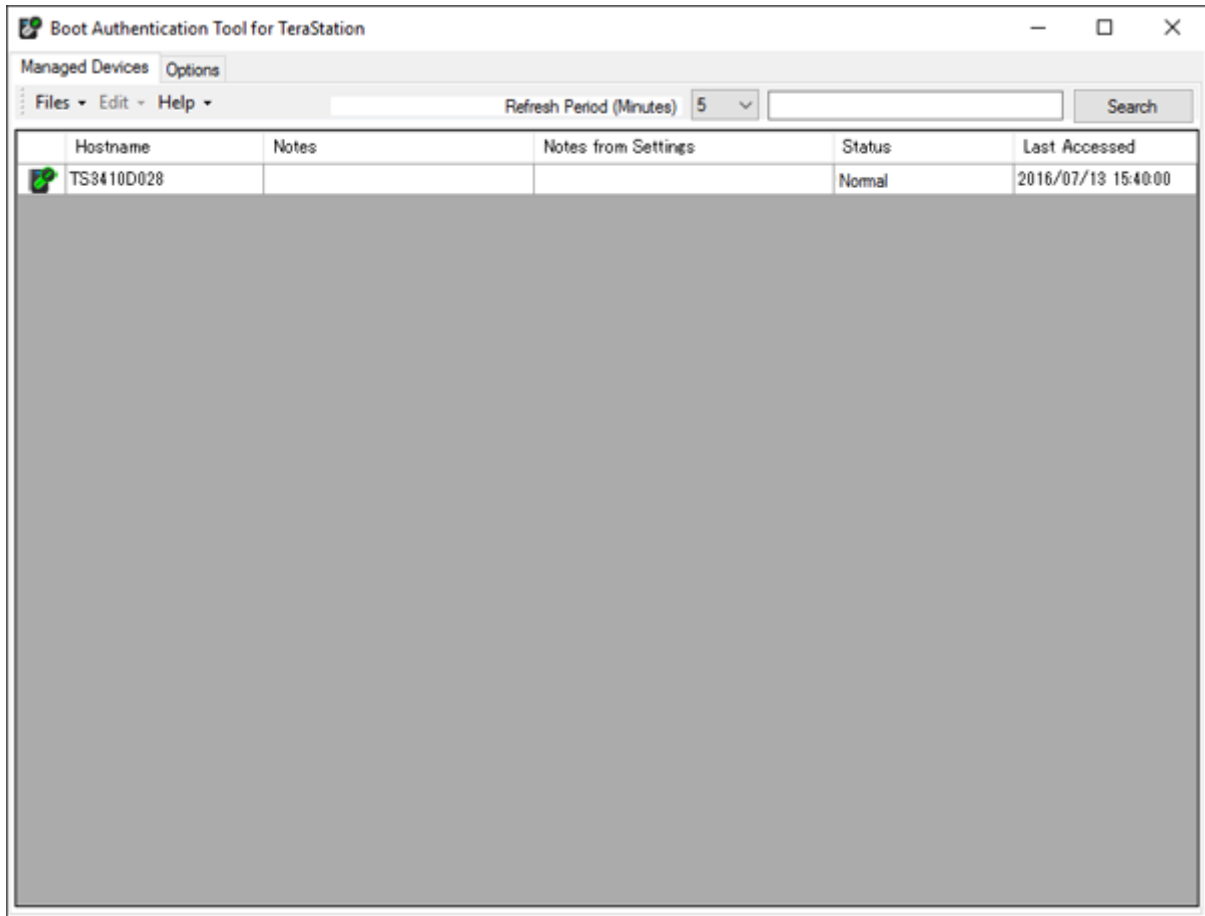

Note: To activate, deactivate, or change the boot authentication settings, the TeraStation must be communicating with the authentication server.

If the TeraStation Cannot Be Accessed

If the TeraStation cannot communicate with the authentication server or vice versa, such as in a case of network failure, the TeraStation will not be accessible. If the TeraStation is not accessible, manually authenticate the TeraStation by following the procedure below.

Note: The procedure defines an “authentication server administrator” as someone who manages the authentication server using Boot Authentication Tool, and a “user” as one attempting to access the TeraStation from a remote location.

- 1 When the user tries to access the TeraStation's Settings and the TeraStation is not available, the screen below will be displayed. Have the user forward the decryption key to the authentication server administrator.

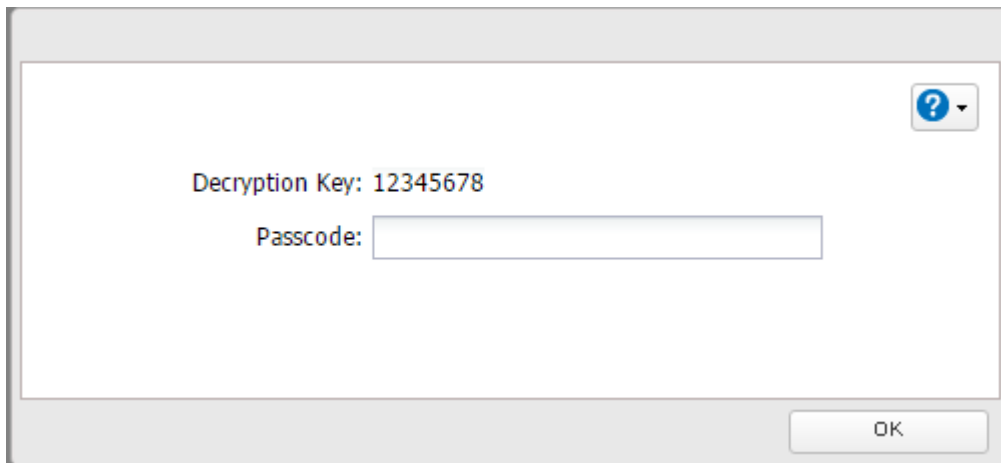

A dialog box with a light gray background and a white content area. In the top right corner of the content area is a blue question mark icon with a dropdown arrow. The text "Decryption Key: 12345678" is displayed in the center. Below it, the label "Passcode:" is followed by an empty text input field. At the bottom right of the dialog box is an "OK" button.

- 2 Open Boot Authentication Tool on the authentication server.
- 3 From Boot Authentication Tool, right-click the target TeraStation from the list and click *Decrypt Passcode*.
- 4 Enter the decryption key received from the user and click *Decrypt*.

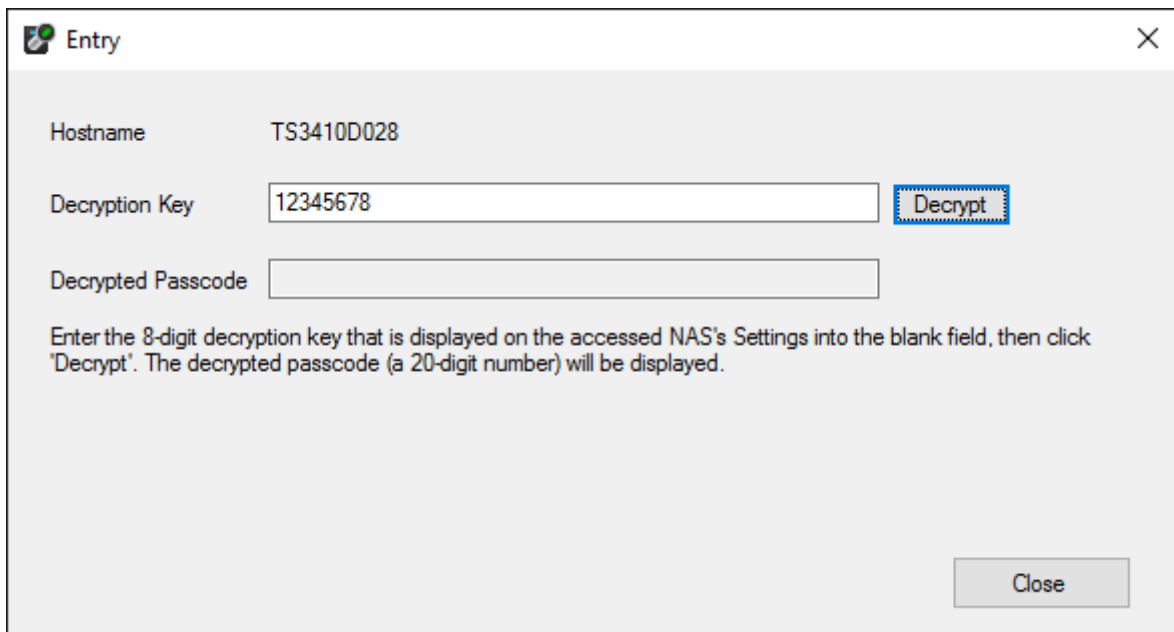

A dialog box titled "Entry" with a close button (X) in the top right corner. The dialog contains the following fields and controls:

- Hostname: TS3410D028
- Decryption Key: 12345678 (text input field)
- Decrypted Passcode: (empty text input field)
- A "Decrypt" button with a blue dashed border, located to the right of the Decryption Key field.

Below the fields, there is a text instruction: "Enter the 8-digit decryption key that is displayed on the accessed NAS's Settings into the blank field, then click 'Decrypt'. The decrypted passcode (a 20-digit number) will be displayed."

At the bottom right of the dialog box is a "Close" button.

5 The decrypted 20-digit passcode will be displayed. Send the passcode to the user.

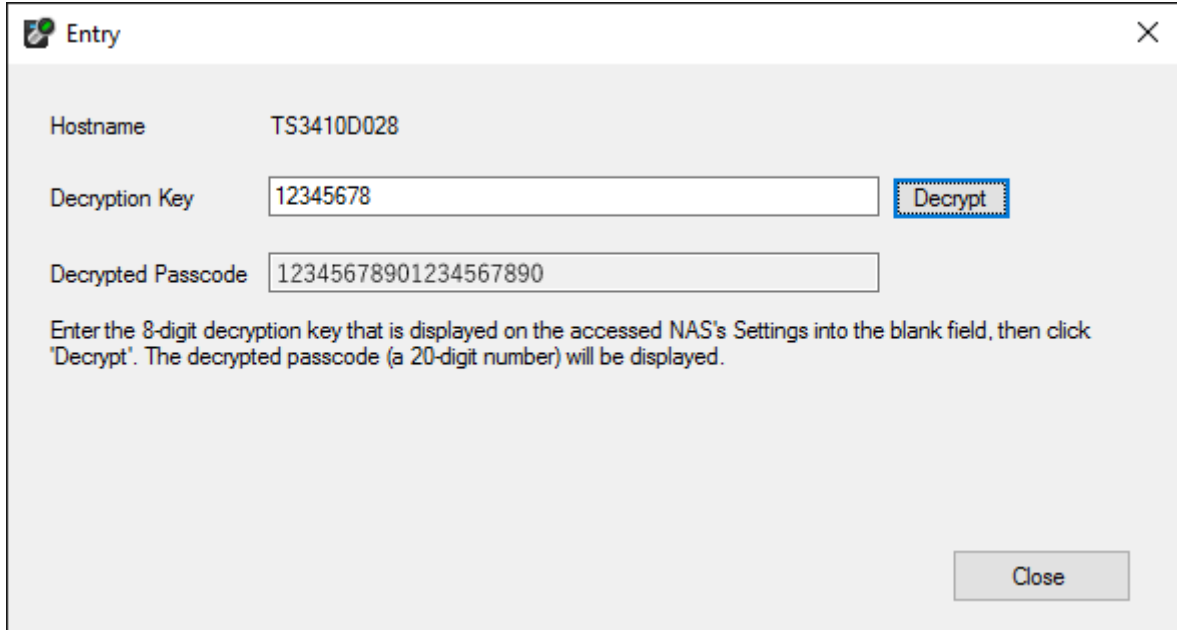

6 The user can then enter the 20-digit passcode into Settings and click *OK*.

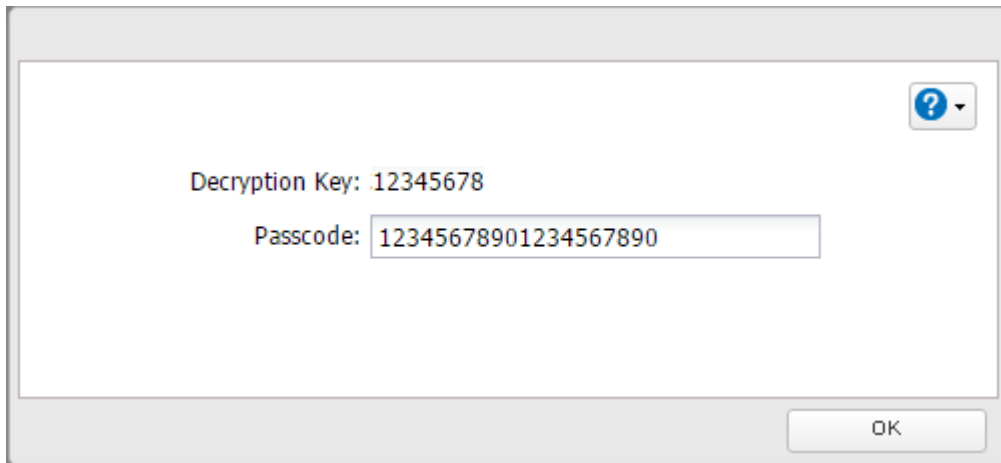

Once the passcode is authenticated, the TeraStation will become available. The user can click *OK* to log in to Settings.

Chapter 8 Drive Replacement

Drive replacement procedures will vary depending on what RAID mode is configured for the TeraStation. Refer to the replacement procedure in the following sections corresponding to the configured RAID mode. The following drive replacement examples use the case of the TS3410DN and TS3420DN TeraStation models.

LEDs

Drives in the TeraStation show a green status LED during normal operation. If a drive fails, its error LED will glow red.

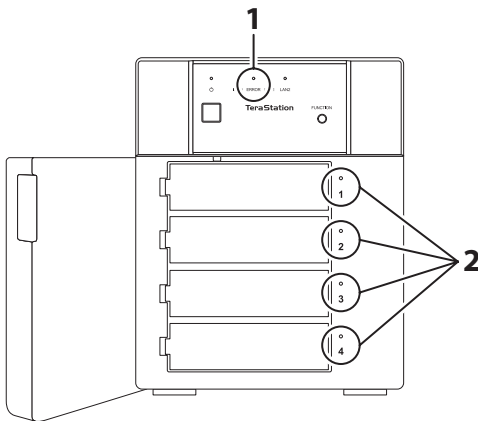

1 Error LED

Glows red if a drive has failed.

2 Status LEDs

The failed drive's status LED will be glowing a steady red. A drive with a red status LED is ready to hot-swap.

Notes:

- Do not unplug a drive whose status LED is green instead of red. Dismount it first or shut down the TeraStation before swapping a working drive. If you remove the drive without properly dismounting it, data may be lost and the TeraStation may malfunction.
- For the replacement drive, use a Buffalo OP-HDN series drive. The replacement drive should be the same size or larger as the original drive. If a larger drive is used, the extra space will not be usable in a RAID array.
- To avoid damaging the TeraStation with static electricity, ground yourself by touching something made of metal before handling any sensitive electronic parts.
- After a drive is replaced, it will take about 30 minutes before normal file reading and writing operations are restored. Settings may not be accessible during this period.
- Do not change the order of the drives on the TeraStation. For example, pulling out the drive in slot 1 and replacing it with the drive in slot 2 may cause data to be corrupted or lost.
- If the status LEDs do not change after a new drive is installed, click *Redetect Drive* in Settings.

Drive Replacement Procedure

Using a Redundant RAID Mode or JBOD and TeraStation Is On

Back up the saved data to another location before replacing the failed drive. If one or more drives fail during drive replacement, data can no longer be retrieved from the TeraStation.

- 1 Open the front cover with the included key.

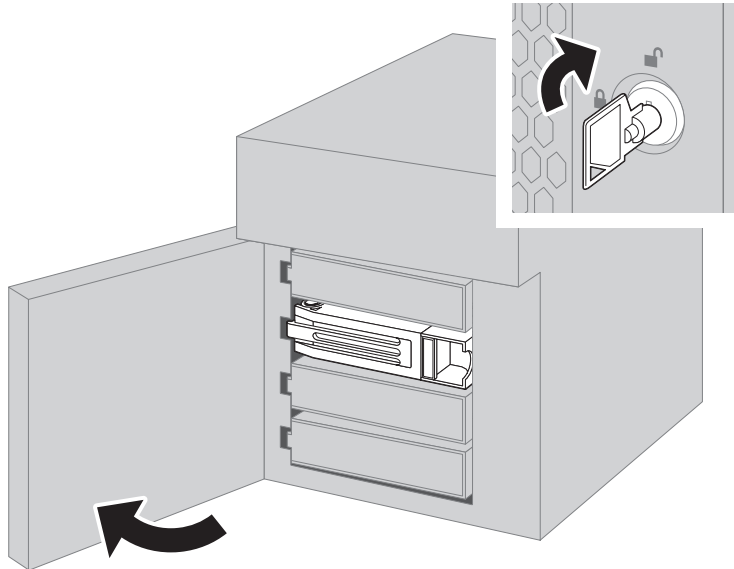

- 2 The failed drive's status LED will be glowing red. Push its unlock button and swing the lock mechanism out.

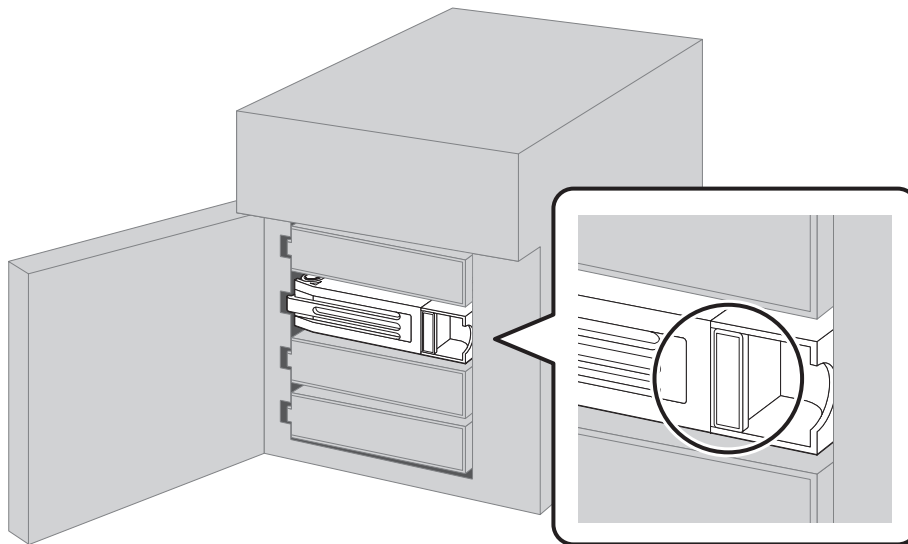

Drives without red status LEDs lit are still on. Do not unplug or remove them.

3 Pull out the drive cartridge and remove it from the TeraStation.

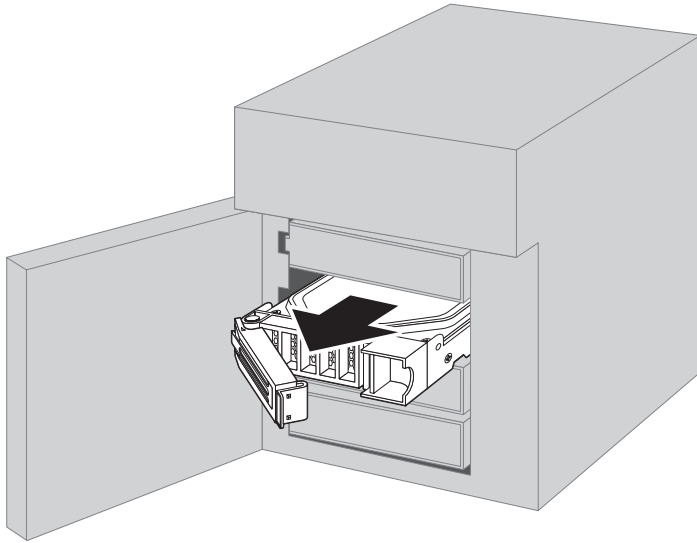

4 Insert the new drive into the empty slot with the lock mechanism remaining open.

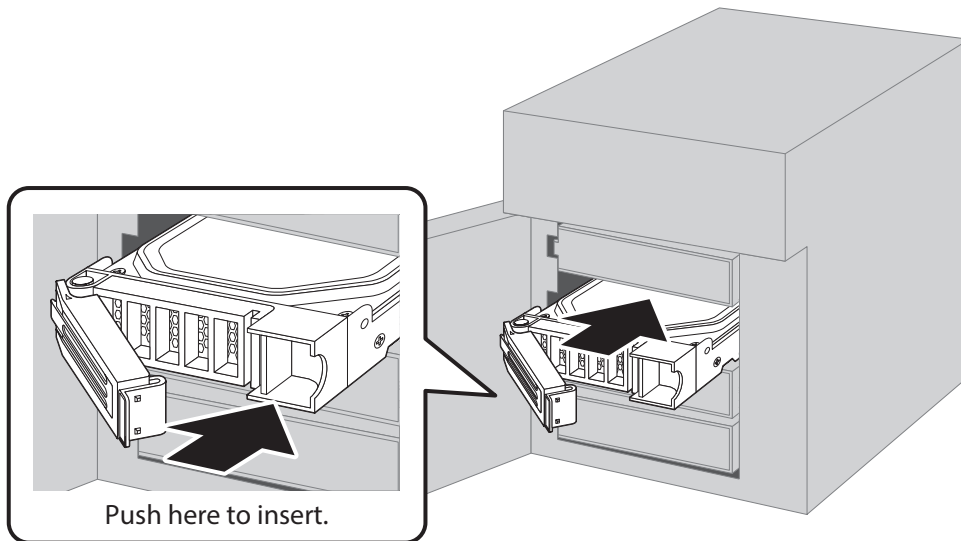

5 Swing the lock back down until it clicks into place.

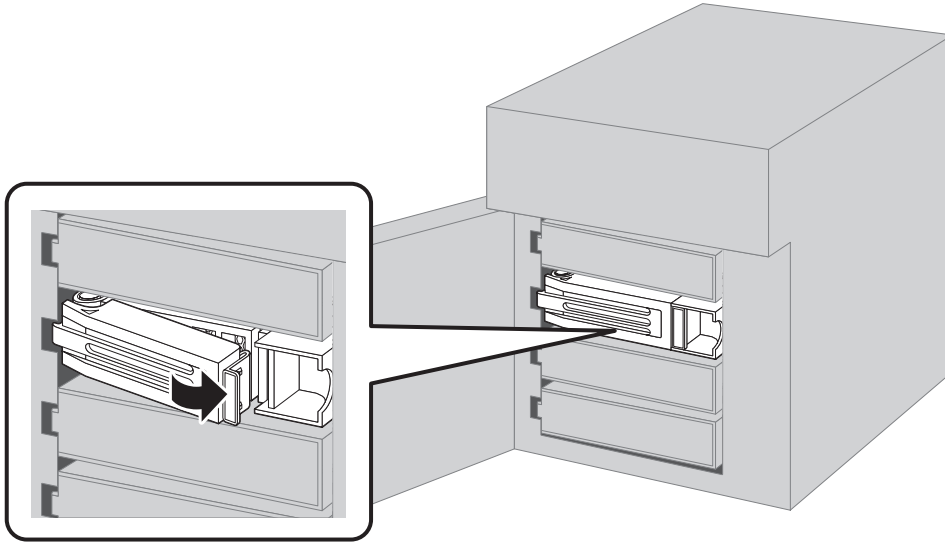

6 When the replaced drive is recognized, the status LED will flash red and the I31 message will appear on the Dashboard in Settings and NAS Navigator2.

7 Close the front cover.

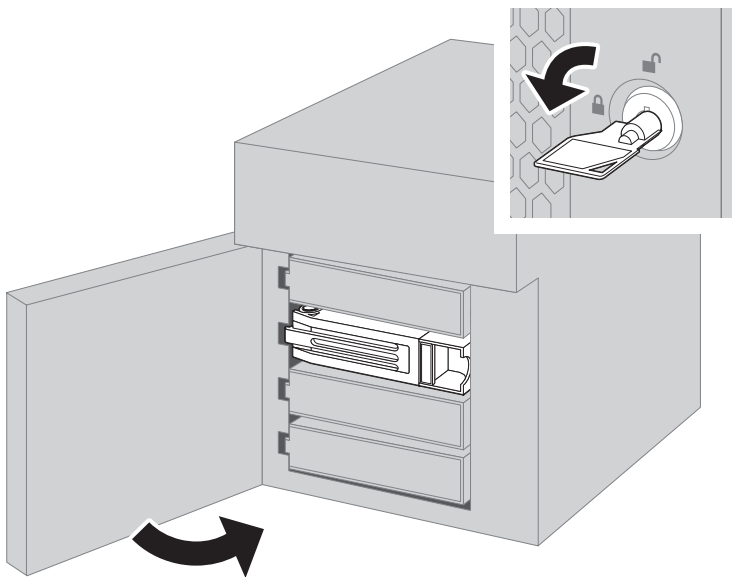

8 Press the function button. The TeraStation will beep once. Press and hold the button until the TeraStation beeps again.

If replacing multiple malfunctioning drives at once, you will have to rebuild the RAID array from Settings. Log in to Settings and navigate to *Storage > RAID*, click the RAID array that held the failed drive, then select the replaced drives and click *Recover RAID Array*.

This action will differ depending on whether the TeraStation was in a redundant RAID mode or JBOD before replacing the drive.

For a redundant RAID mode:

The TeraStation will start rebuilding the RAID array. After a few minutes, the I18 message will be displayed until the array is rebuilt.

For JBOD:

The drive will be formatted as an individual drive. Next, create a shared folder by referring to the [“Adding a Shared Folder”](#) section in chapter 3.

Using a Redundant RAID Mode or JBOD and TeraStation Is Off

Back up the saved data to another location before replacing the failed drive. If one or more drives fail during drive replacement, data can no longer be retrieved from the TeraStation.

- 1** Open the front cover with the included key.
- 2** The failed drive’s status LED will be glowing red. Push its unlock button and swing the lock mechanism out.
- 3** Pull out the drive cartridge and remove it from the TeraStation.
- 4** Insert the new drive into the empty slot with the lock mechanism remaining open.
- 5** Swing the lock back down until it clicks into place.
- 6** Press the power button on the TeraStation.
- 7** When the replaced drive is recognized, the status LED will flash red and the I32 message will appear on the Dashboard in Settings and NAS Navigator2.
- 8** Close the front cover.

This action will differ depending on whether the TeraStation was in a redundant RAID mode or JBOD before replacing the drive.

For a redundant RAID mode:

You will have to rebuild the RAID array from Settings.

- (1) From Settings, navigate to *Storage > RAID*.
- (2) Click the RAID array that held the failed drive, then select the replaced drive and click *Recover RAID Array*.

For JBOD:

Format the replaced drive by referring to the [“Formatting Drives”](#) section in chapter 4. Next, create a shared folder by referring to the [“Adding a Shared Folder”](#) section in chapter 3.

Using RAID 0

Drives in a RAID 0 array do not automatically turn off in the event of a malfunction. Shut down the TeraStation before replacing the failed drive. This section describes the process of replacing a drive with **the TeraStation off**.

Note: If a drive malfunctions in a RAID 0 array, all data on the RAID array will be lost. All of the settings for the shared folders (such as access restrictions) are erased after replacing a drive from a RAID 0 array.

- 1** Turn off the TeraStation.
- 2** Open the front cover with the included key.
- 3** The failed drive’s status LED will be blinking red. Push its unlock button and swing the lock mechanism out.
- 4** Pull out the drive cartridge and remove it from the TeraStation.

- 5** Insert the new drive into the empty slot with the lock mechanism remaining open.
 - 6** Swing the lock back down until it clicks into place.
 - 7** Press the power button on the TeraStation.
 - 8** When the replaced drive is recognized, the status LED will flash red and the I32 message will appear on the Dashboard in Settings and NAS Navigator2.
 - 9** Close the front cover.
 - 10** Delete the RAID array that held the failed drive by referring to the [“Using JBOD”](#) section in chapter 4.
 - 11** Format the replaced drive by referring to the [“Formatting Drives”](#) section in chapter 4.
 - 12** Create a new RAID 0 array by referring to the [“Changing RAID Mode”](#) section in chapter 4.
- The new RAID 0 array will be created. Next, create a shared folder by referring to the [“Adding a Shared Folder”](#) section in chapter 3.

Using a Hot Spare

If your TeraStation’s drives are in a redundant RAID mode and you have a hot spare enabled, a malfunctioning drive in the array is replaced with a hot spare and the RAID array is rebuilt automatically. The status LED will continue to glow red for the failed drive even after the RAID array is rebuilt with the hot spare. After you replace the failed drive with a new drive, follow the procedure below to configure the new drive as a hot spare. This section describes the replacement process for a drive while **the TeraStation is still on**.

- 1** Open the front cover with the included key.
- 2** The failed drive’s status LED will be glowing red. Push its unlock button and swing the lock mechanism out.
- 3** Pull out the drive cartridge and remove it from the TeraStation.
- 4** Insert the new drive into the empty slot with the lock mechanism remaining open.
- 5** Swing the lock back down until it clicks into place.
- 6** When the replaced drive is recognized, the status LED will flash red and the I31 message will appear on the Dashboard in Settings and NAS Navigator2.
- 7** Close the front cover.
- 8** Press the function button. The TeraStation will beep once. Press and hold the button until the TeraStation beeps again.

The replaced drive will be automatically registered as a hot spare. To use the replaced drive as a normal drive rather than a hot spare, navigate to *Storage > RAID* and click the RAID array, select the new drive, and click *Set as a normal drive*.

Replacing a Non-Malfunctioning Drive

Do not replace a drive that is not malfunctioning.

If you must change a drive that is not malfunctioning, either first dismount it in Settings, referring to the [“Dismounting Drives”](#) section in chapter 4, or shut down the TeraStation before replacing the drive. If you need to replace more than one drive all at once, replace the drives one at a time to preserve your data. When replacing the non-malfunctioning drive, the RAID array will function as below:

Operating in RAID 0 Mode

All data on the RAID array will be deleted after replacing the drive. You will be unable to use the TeraStation until you delete and rebuild the RAID array with the new drive.

Operating in JBOD

All data on that drive will be deleted after replacing the drive. You will be unable to use the TeraStation until you format the new drive.

Operating in a Redundant RAID Mode

If you are using a redundant RAID mode such as RAID 1, 5, or 6, the RAID array will be in degraded mode after replacing the drive. You will be unable to use the TeraStation until you rebuild the RAID array with the new drive.

Chapter 9 Utilities

NAS Navigator2

NAS Navigator2 is a utility program that makes it easy to display Settings, change the Buffalo NAS device's IP address, or check its drives. To install NAS Navigator2, refer to the appropriate procedure below for your computer.

Windows

Download the NAS Navigator2 installer from the d.buffalo website, accessible from either <http://d.buffalo.jp/TS3010/> or <http://d.buffalo.jp/TS3020/>.

Refer to the app help for more detailed information on operating the app. To open the help, open NAS Navigator2 and navigate to *Menu > Help*.

macOS

Download the NAS Navigator2 app from Mac App Store and install it.

Refer to the app help for more detailed information on operating the app. To open the help, click the link below.

http://buffalo.jp/support_s/guide2/manual/nasnavi2/99/en/

NovaBACKUP

NovaBACKUP is a Windows utility that lets you back up data on your computer.

The NovaBACKUP installer is available from the d.buffalo website, accessible from either <http://d.buffalo.jp/TS3010/> or <http://d.buffalo.jp/TS3020/>. Select the region and model to go to your specific model's d.buffalo website.

Download the NovaBACKUP installer and install it onto your computer.

To download the installer, you will need the serial number of your TeraStation. The serial number is printed on the label on the back or the top of the unit. For the TS3410RN and TS3420RN TeraStation models, the serial number is located on the front as well. Refer to the "[Diagrams](#)" section in chapter 1 for information on where to find the serial number.

Chapter 10 Appendix

TeraStation Does Not Work Properly

If an error occurs that prevents the TeraStation from booting up properly, one or more of the following symptoms may occur. In such a case, try the corresponding corrective action to recover from the error, described in each section below. If the error is still not resolved, contact Buffalo technical support for assistance.

- The power LED keeps blinking instead of turning into a solid glow; follow the procedure at the [“Power LED Keeps Blinking”](#) section below.
- An “i” symbol is displayed with the TeraStation icon and the I61 message appears on NAS Navigator2; follow step 3 and after at the [“Power LED Keeps Blinking”](#) section below.
- An “i” symbol is displayed with the TeraStation icon and “EM” is added to your TeraStation’s hostname on NAS Navigator2; follow the procedure at the [“Booting the TeraStation in Emergency Mode”](#) section below.

Power LED Keeps Blinking

While the TeraStation’s power LED keeps blinking, you may see the I61 message on NAS Navigator2. In such a case, follow the procedure below to recover from drive setup mode.

- 1** Press and hold down the power button for three seconds to turn off the TeraStation.
- 2** Turn it on while holding down the function button. You should hold down the function button for at least 10 seconds after pressing the power button.
- 3** When the power LED changes from blinking to glowing, let go of the function button and open Settings from NAS Navigator2.
- 4** Make sure that “Recover firmware” is selected from the drop-down list under “Action”, then click *Start Setup*.

The screenshot shows the 'Drive Setup' window with the following table:

Drive	Status	Info	Version	Model Name	Capacity	Primary Drive	Action
Drive 1	Recognized	System#1_(D:1/4)	4.52-0.34	ST1000VN002-2EY102	931 GB	⊛	Recover firmware ▾
Drive 2	Recognized	System#1_(D:2/4)	4.52-0.34	ST1000VN002-2EY102	931 GB		Recover firmware
Drive 3	Recognized	System#1_(D:3/4)	4.52-0.34	ST1000VN002-2EY102	931 GB		Recover firmware
Drive 4	Recognized	System#1_(D:4/4)	4.52-0.34	ST1000VN002-2EY102	931 GB		Recover firmware

Below the table, there are two radio button options for selecting the action to take when recovering the firmware:

- Revert settings to those of the last shutdown
This will revert settings to those that were saved before the last shutdown.
- Revert settings to those of the last boot (Time When Boot Occurred: 10/15/2019 16:21:16)
This will revert settings to those that were saved during the last boot.

At the bottom, there is a text block with instructions and two buttons: 'Redetect Drive' and 'Start Setup'.

Note: There are two more options for “Action” other than “Recover firmware”. The details for all options are below:

- **Use the drive's firmware:** The TeraStation will boot using the firmware on the drive.
- **Recover firmware:** The TeraStation will be recovered using the firmware on the NAND flash.
- **Format drive:** The drive will be formatted.

5 The “Confirm Operation” screen will open. Enter the confirmation number, then click *OK*.

6 The recovery process will start. When the process is completed, click *OK*.

7 The TeraStation will shut down automatically. Press the power button to turn it on.

The TeraStation will be recovered from the malfunction that is keeping the power LED blinking. Make sure the TeraStation finishes booting properly.

Notes:

- If the TeraStation does not recover from the error after trying the procedure above, try again from the first step.
- If the TeraStation did not power off properly in the previous shutdown, a message will appear in the window as below:

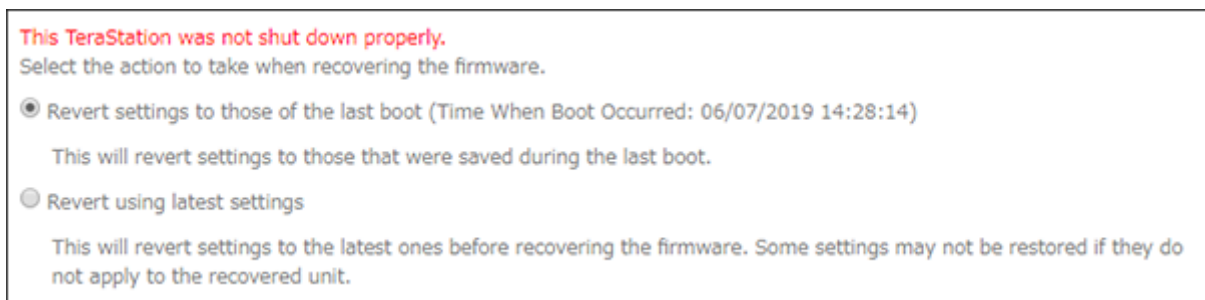

Booting the TeraStation in Emergency Mode

If the TeraStation boots up in emergency mode, depending on your TeraStation model, an “i” symbol is displayed with the TeraStation icon and “EM” is added to your TeraStation’s hostname.

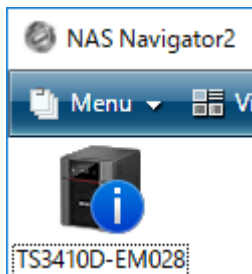

To recover from emergency mode, follow the procedure below.

- 1** Download the firmware updater from the [Buffalo website](#).
- 2** Extract the downloaded file by double-clicking it and launch the updater.
- 3** Update the firmware for the TeraStation unit that is currently in emergency mode.

When the “i” symbol and “EM” disappear from the icon and the hostname on NAS Navigator2, the TeraStation is no longer in emergency mode.

Notes:

- Try updating the firmware several times. Even if it fails after the “Partition not found.” message appears, it may succeed after several tries.

- If the TeraStation does not shut down properly due to a power outage or the power cable getting disconnected while the TeraStation is on, data on the TeraStation may be corrupted when the TeraStation boots in emergency mode. In such a case, the corrupted data may not be recoverable even if you try the procedure above.
- When the “Updating may have failed.” message appears, restart the TeraStation and check whether the unit has been recovered from emergency mode.

Cleaning the Dustproof Filter

If your TeraStation has a front cover and you are trying to clean the dustproof filter on the front cover, follow the procedure below.

- 1** Open the front cover with the included key.

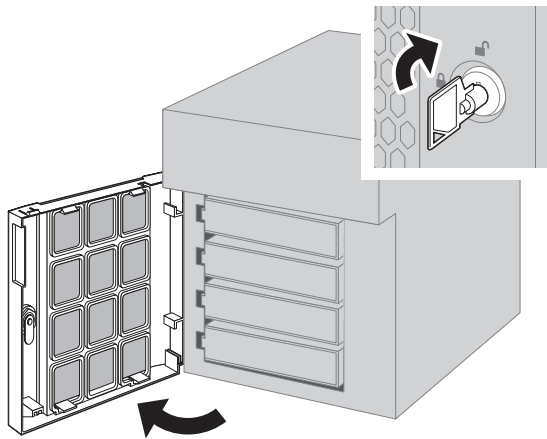

- 2** Remove the front cover while holding the hook downward.

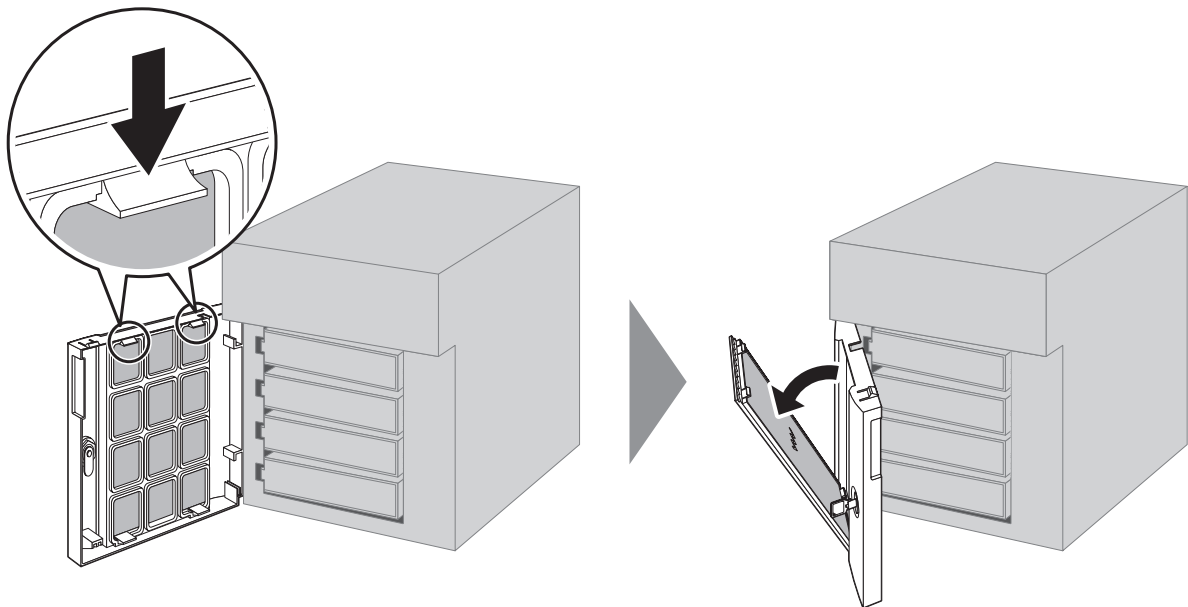

3 Remove the dustproof filter from the front cover and clear any dust, such as by using a vacuum cleaner.

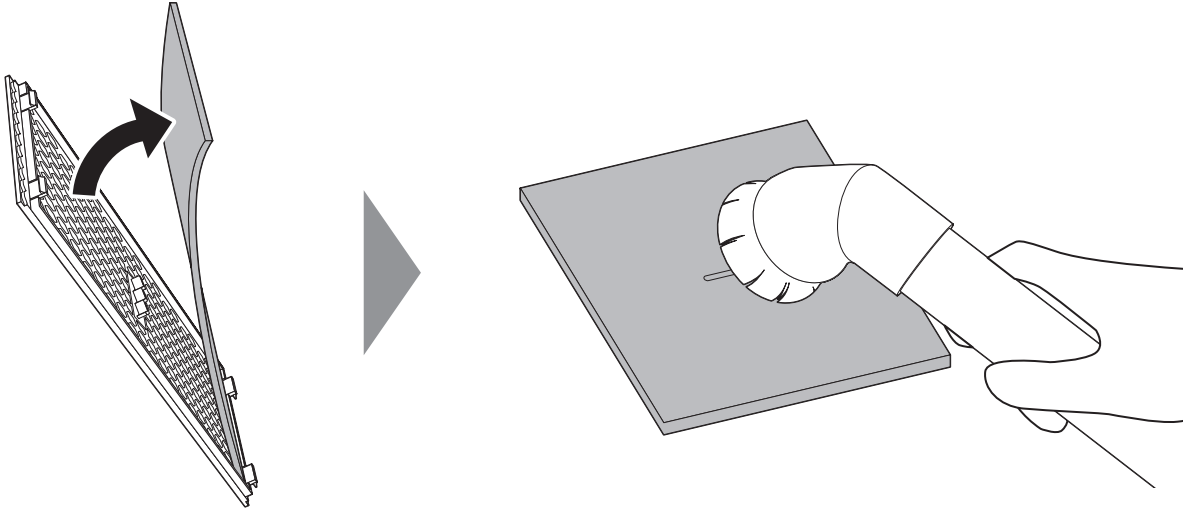

4 When cleaning is completed, return the filter and the front cover.

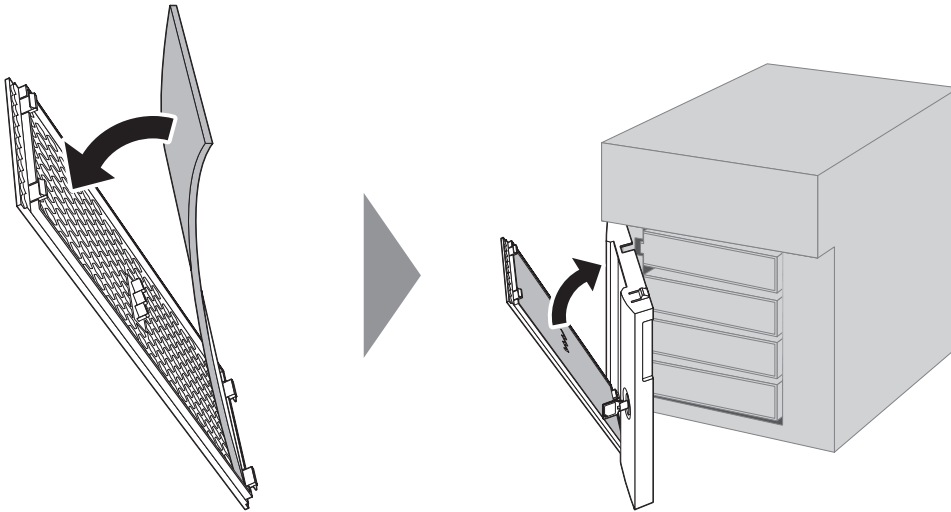

5 Close the front cover.

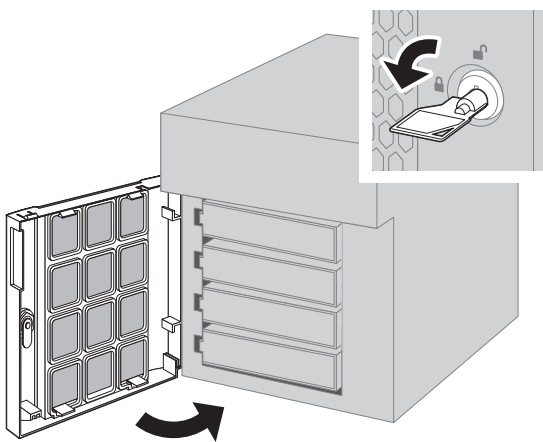

Info and Error LEDs

This section explains the details of the event/error code that appears when an event occurs. If there is a corresponding corrective action described below for the code, try it first. If the code is still displayed after trying the corrective action, contact Buffalo technical support for assistance.

Errors

If an error occurs, the error LED will glow red. You can also confirm the current status from the Dashboard in Settings or by using NAS Navigator2. If NAS Navigator2 displays the error as an unknown error, check the Dashboard in Settings for the error details.

Code	Description	Corrective Action
E10	The TeraStation is running on the UPS battery due to a power outage.	Shut down the TeraStation safely and wait until the power outage ends. If certain settings are configured, the TeraStation may shut down automatically when the error is detected.
	If the setting to use the UPS connected to this TeraStation has been configured, the UPS cable may be disconnected.	Verify that the UPS cable or LAN cable is connected properly.
	If the setting to use the UPS connected to another TeraStation on the same network has been configured, the LAN cable of this TeraStation may be disconnected.	
E11	An error occurred in the fan speed.	Check that no foreign objects or dust are clogging the fan. If any foreign objects or dust are found, use a pair of tweezers, an air duster, or other tools to remove them.
E12	A rise in the system temperature may have exceeded the allowable safety value.	Move the TeraStation to a cool location. Do not place objects in the area around the TeraStation.
E14	The RAID array cannot be mounted.	If the message appears after initial bootup, make sure drives are inserted properly by referring to the “Re-Inserting Drives” section in chapter 1. For all other cases, run a drive check on the RAID array by referring to the “Checking Drives” section in chapter 4.
E16	Unable to find the drive.	Re-insert the drive by referring to the “Re-Inserting Drives” section in chapter 1.
E22	Unable to mount the drive.	Format the drive. After formatting, if the error still appears after rebooting, replace the drive.
E27	Unable to find the failover backup TeraStation.	Reconfigure the failover backup TeraStation for failover by referring to the “Configuring Failover” section in chapter 5.
E30	An error occurred, so the drive was removed from the RAID array.	Replace the drive by referring to the drive replacement sections in chapter 8.

Status

After you change any settings, the info LED will glow amber. You can also confirm the current status from the Dashboard in Settings or by using NAS Navigator2. If NAS Navigator2 displays the status as unknown, check the Dashboard in Settings for the status details.

You can click the “Clear” button to delete messages from the Dashboard.

Code	Description	Corrective Action
I01	Checking the system area.	-
I10	A rise in the system temperature may have exceeded the allowable safety value.	Move the TeraStation to a cool location. Do not place objects in the area around the TeraStation.
I11	The drive has too many bad sectors.	Replace the drive by referring to the drive replacement sections in chapter 8.
I12	Operating in degraded mode.	Check if the E30 error is also displayed. If it is, refer to the corrective action for the E30 error.
I13	Formatting the RAID array.	-
I14	Checking the RAID array.	-
I15	Examining the error status of the RAID array. Note: Transfer speeds are slower during the examination process.	-
I16	Creating the RAID array.	-
I17	Resynchronizing the RAID array. Note: Transfer speeds are slower during resynchronization.	-
I18	Rebuilding the RAID array. Note: Transfer speeds are slower during the rebuilding process.	-
I19	Rewriting the TeraStation.	-
I20	Formatting the drive.	-
I21	Checking the drive.	-
I23	The initialization process has been started by using the init button and settings are being initialized.	-
I25	Updating the TeraStation firmware.	Do not turn off the TeraStation’s power.
I26	The initialization process has been started by using Settings and all settings are being initialized.	-
I27	Checking the USB drive.	-
I28	Formatting the USB drive.	-
I31	Appears when pressing the function button to rebuild the RAID array after replacing the drive.	Press the function button to rebuild the RAID array.
I32	Appears after replacing the drive when the RAID array needs to be rebuilt in Settings or formatting is necessary.	From Settings, either rebuild the RAID array or format the drive.

Code	Description	Corrective Action
I33	An error occurred in replication, or synchronization between the main TeraStation and the backup TeraStation failed during failover configuration.	From Settings, navigate to <i>Backup > Replication</i> and click <i>Resync</i> to execute resynchronization. If you configured the subfolders' access restrictions to be inherited to the replication or failover destinations, disable them or change the destinations.
I34	A virus scan found a virus.	Delete the infected files from the quarantine folder.
I37	The initialization process has been started by using the USB initialization drive and settings are being initialized.	-
I38	Settings initialization is completed.	-
I40	Beginning settings initialization. All data on the drive in slot 1 will be deleted.	-
I41	Press the function button to start the settings initialization process.	-
I42	Preparing to start the settings initialization process.	-
I43	The TeraStation was started from the USB initialization drive, but the settings cannot be initialized from this USB initialization drive.	-
I44	Initialization from the USB initialization drive was initiated, but the drive in slot 1 was not detected.	Make sure that the drive in slot 1 is present and fully inserted into its slot.
I45	Initialization failed.	-
I46	Data migration or conversion (RAID migration) is in progress.	Do not turn off the TeraStation's power.
I47	Data migration or conversion (RAID migration) is in progress.	Do not turn off the TeraStation's power.
I48	This TeraStation is ready to become the failover backup device for the main TeraStation.	Press and hold down the function button of the failover backup TeraStation until it stops beeping to accept failover backup status.
I49	The main TeraStation in the failover configuration cannot be found.	Make sure that the main TeraStation is on, working, and connected to the network.
I50	Failover maintenance is in progress.	Do not turn off the TeraStation's power.
I51	Initializing the failover configuration.	Do not turn off the TeraStation's power.
I52	A new firmware version has been released.	Update the firmware by referring to the "Updating the Firmware" section in chapter 7.
I54	The backup job failed.	Refer to the "Backup Logs for If Backup Fails" section in chapter 5 and try the respective corrective actions.
I55	Authentication during initialization of settings failed.	Settings can only be restored for the TeraStation whose settings were originally saved.

Code	Description	Corrective Action
I59	Boot authentication failed.	Try using manual authentication instead by referring to the “If the TeraStation Cannot Be Accessed” section in chapter 7.
I61	The unit is in drive setup mode.	Recover from drive setup mode by referring to the “Power LED Keeps Blinking” section.
I64	Connecting to the cloud storage service failed.	Open Settings and check the status of the job that failed for a cloud service. Refer to the error log on the job list of the specific cloud storage service and check the cause of the error.
I65	The free space has decreased past the configured threshold percentage.	Increase the free space or change the threshold to a lower value.
I66	The free space has decreased to 1% or less.	Increase the free space.
I70	There is not enough space to save file access logs.	Delete file access logs to free up space.
I71	The space is occupied so older logs were removed.	Delete file access logs to free up space.
I72	The target folder for saving logs has been changed to the system area.	Reconfigure the settings by referring to the “Changing Archive Rules for File Access Logs” section in chapter 7.

Default Settings

Administrator's Name	admin	
Password	password	
Shared Folders	<p>“share” and “info” for both Windows and macOS computers. *The recycle bin is enabled by default. **It is a read-only share.</p>	
IP Address	<p>The TeraStation will get its IP address automatically from a DHCP server on the network. If no DHCP server is available, then an IP address will be assigned as follows: IP Address: 169.254.xxx.xxx (“xxx” is a number randomly assigned when booting the TeraStation.) Subnet Mask: 255.255.0.0</p>	
Registered Groups	<p>“hdusers”, “admin”, and “guest” You cannot edit or delete these default groups.</p>	
Microsoft Network Group Settings	WORKGROUP	
MTU Size	1500 bytes	
SMB	Enabled	
	SMB Protocol	Auto
	Recycle Bin Permissions	All users
	macOS Temp Files	Keep when original file is deleted
AFP	Enabled	
FTP	Disabled	
SFTP	Disabled	
WebAccess	Disabled	

NFS	Disabled
rsync	Disabled
RAID Scanning	Disabled
iSCSI	Disabled
Amazon S3	Disabled
Dropbox Sync	Disabled
Microsoft Azure Storage Sync	Disabled
Microsoft OneDrive Sync	Disabled
Antivirus	Disabled
SNMP	Disabled
Time Machine	Disabled
NTP	Enabled
Email Notification	Disabled
Init Button Settings	Restore admin username and password to factory defaults
Boot Authentication	Disabled
RAID Mode	TS3210DN, TS3220DN: RAID 1 TS3410DN, TS3420DN, TS3410RN, TS3420RN (with two drives included): RAID 1 TS3410DN, TS3420DN, TS3410RN, TS3420RN: RAID 5

Specifications

Check the [Buffalo website](#) for the latest product information and specifications.

1GbE LAN Interface	Standards Compliance	IEEE 802.3ab (1000BASE-T), IEEE 802.3u (100BASE-TX), IEEE 802.3 (10BASE-T)
	Data Transfer Rates	10/100/1000 Mbps (auto sensing)
	Number of Ports	TS3210DN, TS3410DN, TS3410RN: 2 TS3220DN, TS3420DN, TS3420RN: 1
2.5GbE LAN Interface	Standard Compliance	IEEE 802.3bz (2.5GBASE-T), IEEE 802.3ab (1000BASE-T), IEEE 802.3u (100BASE-TX)
	Data Transfer Rates	2.5 Gbps, 100/1000 Mbps (auto sensing)
	Number of Ports	TS3220DN, TS3420DN, TS3420RN: 1
Common Specs for LAN Interface	Connector Type	RJ-45 8-pin (auto MDI-X)
	Supported Protocols	TCP/IP
	Network File Services	SMB/CIFS, AFP, FTP/SFTP, NFS, HTTP/HTTPS, SNMP
	MTU Sizes	1500–9216 bytes
USB Interface	Standards Compliance	USB 3.0
	Data Transfer Rates	Max. 5 Gbps
	Number of Ports	TS3210DN, TS3220DN, TS3410DN, TS3420DN: 2 TS3410RN, TS3420RN: 3
	Connector Type	Type A

Internal Drive	Number of Drive Bays	TS3210DN, TS3220DN: 2 TS3410DN, TS3420DN, TS3410RN, TS3420RN: 4
	Drive Interface	SATA 6 Gbps
	Supported RAID	TS3210DN, TS3220DN: 0, 1, JBOD (individual drives) TS3410DN, TS3420DN, TS3410RN, TS3420RN: 0, 1, 5, 6, 10, JBOD (individual drives)
	Replacement Drive	Buffalo OP-HDN series drive Note: The replacement drive should be the same size or larger as the original drive. The drives listed above are available from the Buffalo website .
Others	Power Supply	TS3210DN, TS3410DN: AC 100–240 V, 1.5 A, 50/60 Hz TS3220DN, TS3420DN: AC 100–240 V, 1.2 A, 50/60 Hz TS3410RN, TS3420RN: AC 100–240 V, 2.5–1.25 A, 50/60 Hz
	Dimensions (W × H × D, excluding protruding parts)	TS3210DN, TS3220DN: 170 × 170 × 260 mm; 6.7 × 6.7 × 9.1 in. TS3410DN, TS3420DN: 170 × 215 × 260 mm; 6.7 × 8.5 × 9.1 in. TS3410RN, TS3420RN: 430 × 44.3 × 430 mm; 16.9 × 1.7 × 16.9 in.
	Weight	TS3210DN: approx. 4.8 kg; 10.6 lbs TS3220DN: approx. 4.7 kg; 10.4 lbs TS3410DN (with two drives included): approx. 5.6 kg; 12.3 lbs TS3410DN, TS3420DN: approx. 7.0 kg; 15.4 lbs TS3420DN (with two drives included): approx. 5.2 kg; 11.5 lbs TS3410RN: approx. 8.5 kg; 18.7 lbs TS3410RN (with two drives included): approx. 6.8 kg; 15.0 lbs TS3420RN: approx. 8.6 kg; 19.0 lbs TS3420RN (with two drives included): approx. 6.7 kg; 14.8 lbs
	Power Consumption	TS3210DN, TS3220DN, TS3410DN, TS3420DN: max. 85 W TS3410RN, TS3420RN: max. 100 W
	Operating Environment	Temperature: 0–40°C; 32–104°F Humidity: 10–85% non-condensing
	Compatible Devices	Windows PCs and Intel Mac computers with wired or wireless Ethernet connection.
	Supported OS	<ul style="list-style-type: none"> • TS3210DN, TS3410DN, and TS3410RN: Windows 10, 8.1, 7 SP1 or later Windows Server 2019, 2016, 2012 R2, 2012, 2008 R2, 2008 macOS 10.15, 10.14, 10.13, 10.12, 10.11, 10.10, 10.9 • TS3220DN, TS3420DN, and TS3420RN: Windows 10, 8.1, 7 SP1 or later Windows Server 2019, 2016, 2012 R2, 2012 macOS 10.15, 10.14, 10.13, 10.12, 10.11