

Grandstream Networks, Inc.

GWN76XX Wireless Access Points

User Manual



GWN7630
Enterprise 802.11ac Wave-2
4x4 Wi-Fi Access Point



GWN7615
Enterprise 802.11ac Wave-2
3x3:3 Wi-Fi Access Point



GWN7610
Enterprise 802.11ac
Wi-Fi Access Point



GWN7605
Enterprise 802.11ac Wave-2
2x2 Wi-Fi Access Point



GWN7600
Enterprise 802.11ac Wave-2
Wi-Fi Access Point



GWN7630LR
Outdoor Long Range 802.11ac
Wave-2 4x4:4 Wi-Fi Access Point



GWN7605LR
Outdoor Long-Range 802.11ac
Wave-2 2x2:2 Wi-Fi Access Point



GWN7600LR
Outdoor Long Range 802.11ac
Wave-2 Wi-Fi Access Point



COPYRIGHT

©2020 Grandstream Networks, Inc. <http://www.grandstream.com>

All rights reserved. Information in this document is subject to change without notice. Reproduction or transmittal of the entire or any part, in any form or by any means, electronic or print, for any purpose without the express written permission of Grandstream Networks, Inc. is not permitted.

The latest electronic version of this guide is available for download here:

<http://www.grandstream.com/support>

Grandstream is a registered trademark and Grandstream logo is trademark of Grandstream Networks, Inc. in the United States, Europe and other countries.

CAUTION

Changes or modifications to this product not expressly approved by Grandstream, or operation of this product in any way other than as detailed by this guide, could void your manufacturer warranty.

WARNING

Please do not use a different power adaptor with devices as it may cause damage to the products and void the manufacturer warranty.



FCC Caution

Any changes or modifications to this unit not expressly approved by the party responsible for compliance could void the user's authority to operate the equipment.

This device complies with 15 of the FCC Rules. Operation is subject to the following two conditions: (1) This device may not cause harmful interference, and (2) this device must accept any interference received, including interference that may cause undesired operation.

Note:

This equipment has been tested and found to comply with the limits for a Class B digital device, pursuant to Part 15 of the FCC Rules. These limits are designed to provide reasonable protection against harmful interference in a residential installation. This equipment generates, uses, and can radiate radio frequency energy and, if not installed and used in accordance with the instructions, may cause harmful interference to radio communications. However, there is no guarantee that interference will not occur in a particular installation. If this equipment does cause harmful interference to radio or television reception, which can be determined by turning the equipment off and on, the user is encouraged to try to correct the interference by one or more of the following measures:

- Reorient or relocate the receiving antenna.
- Increase the separation between the equipment and receiver.
- Connect the equipment into an outlet on a circuit different from that to which the receiver is connected.
- Consult the dealer or an experienced radio/TV technician for help

This equipment complies with FCC radiation exposure limits set forth for an uncontrolled environment. This equipment should be installed and operated with minimum distance 20cm between the radiator & your body.

This transmitter must not be co-located or operating in conjunction with any other antenna transmitter.

ISED Warning

This device complies with Innovation, Science, and Economic Development Canada licence-exempt RSS standard(s). Operation is subject to the following two conditions:

- (1) this device may not cause interference, and
- (2) this device must accept any interference, including interference that may cause undesired operation of the device.



Le présent appareil est conforme aux CNR d'Innovation, Sciences et Développement économique Canada applicables aux appareils radio exempts de licence. L'exploitation est autorisée aux deux conditions suivantes:

- (1) l'appareil ne doit pas produire de brouillage, et
- (2) l'utilisateur de l'appareil doit accepter tout brouillage radio électrique subi, même si le brouillage est susceptible d'en compromettre le fonctionnement.

ISED Warning

This equipment complies with ISED radiation exposure limits set forth for an uncontrolled environment. This equipment should be installed and operated with minimum distance 20cm between the radiator & your body.

This transmitter must not be co-located or operating in conjunction with any other antenna or transmitter. Cet équipement est conforme aux ISED RF limites d'exposition aux radiations dans un environnement non contrôlé. Cet émetteur ne doit pas être situé ou opérant en conjonction avec une autre antenne ou émetteur.

CE Warranty

Frequency;

2.4G Wi-Fi: 2412-2472MHz;

5G Wi-Fi: 5150-5250MHz;

Output power:

2.4G Wi-Fi:

802.11b: 18.23dBm;

802.11g: 18.96dBm;

802.11n20: 18.69dBm;

802.11n40: 18.38dBm.

5G Wi-Fi:

802.11a: 21.24dBm;

802.11n20: 21.27dBm;

802.11n40: 22.13dBm;

802.11ac: 21.19dBm;

802.11ac40: 22.16dBm;

802.11ac80: 22.22dBm.



GNU GPL INFORMATION

GWN76XX firmware contains third-party software licensed under the GNU General Public License (GPL). Grandstream uses software under the specific terms of the GPL. Please see the GNU General Public License (GPL) for the exact terms and conditions of the license.

Grandstream GNU GPL related source code can be downloaded from Grandstream web site:

<http://www.grandstream.com/support/faq/gnu-general-public-license>



Table of Contents

DOCUMENT PURPOSE	14
CHANGE LOG	15
Firmware Version 1.0.15.20	15
Firmware Version 1.0.15.18	15
Firmware Version 1.0.15.5	15
Firmware Version 1.0.15.4	15
Firmware Version 1.0.15.6	15
Firmware Version 1.0.11.10	15
Firmware Version 1.0.11.8	16
Firmware Version 1.0.9.13	16
Firmware Version 1.0.9.12	16
Firmware Version 1.0.8.18	16
Firmware Version 1.0.8.9	16
Firmware Version 1.0.7.13	17
Firmware Version 1.0.6.43	17
Firmware Version 1.0.6.41	17
Firmware Version 1.0.5.15	18
Firmware Version 1.0.5.13	18
Firmware Version 1.0.4.22	18
Firmware Version 1.0.4.20	18
Firmware Version 1.0.4.12	18
Firmware Version 1.0.3.25	19
Firmware Version 1.0.3.21	19
Firmware Version 1.0.3.19	19
Firmware Version 1.0.2.108	19
Firmware Version 1.0.2.15	20



Firmware Version 1.0.1.31	20
Firmware Version 1.0.1.27	20
WELCOME	21
PRODUCT OVERVIEW	23
Technical Specifications.....	23
INSTALLATION	37
Equipment Packaging	37
GWN76XX Access Point Ports	39
Power and Connect GWN76XX Access Point.....	40
Warranty.....	41
Wall/Ceiling Mount Installation GWN7630/GWN7605/GWN7610/GWN7600	41
<i>Wall Mount</i>	41
<i>Ceiling Mount</i>	42
Mounting Instructions for GWN7600LR.....	43
Mounting Instructions for GWN7630LR/GWN7605LR	44
<i>Wall Mount</i>	44
<i>Pole Mount</i>	45
GETTING STARTED.....	46
LED Patterns.....	46
Discover the GWN76XX	47
<i>Method 1: Discover the GWN76XX using its MAC address</i>	47
<i>Method 2: Discover the GWN76XX using GWN Discovery Tool</i>	48
Use the Web GUI.....	48
<i>Access Web GUI</i>	49
<i>WEB GUI Languages</i>	49
<i>Overview Page</i>	50
<i>Save and Apply Changes</i>	51
GWN MANAGEMENT PLATFORMS	52



GWN.Cloud	52
GWN.Manager	52
USING GWN76XX AS STANDALONE ACCESS POINT	53
Connect to GWN76XX Default Wi-Fi Network.....	53
USING GWN76XX AS MASTER ACCESS POINT CONTROLLER.....	54
Login Page.....	55
Discover and Pair Other GWN76XX Access Point	55
AP Location.....	58
Transfer AP – Transfer Network Group.....	59
Failover Master	59
<i>Failover Mode</i>	60
Takeover Feature	61
Transfer to Master.....	62
Client Bridge	63
SSID.....	65
CLIENTS CONFIGURATION.....	72
Clients	72
Clients Access.....	73
Time Policy.....	75
Banned Clients.....	76
CAPTIVE PORTAL	77
Guest.....	77
Policy List.....	78
<i>Internal Splash Page</i>	79
<i>External Splash Page</i>	81
Splash Page.....	83
Vouchers	84
<i>Voucher Feature Description</i>	84



<i>Voucher Configuration</i>	84
<i>Using Voucher with GWN Captive Portal</i>	87
MESH NETWORK	88
BANDWIDTH RULES	91
SYSTEM SETTINGS	93
Maintenance	93
<i>Basic</i>	93
<i>Upgrade</i>	94
<i>Access</i>	95
<i>Syslog</i>	96
<i>Logserver</i>	96
Debug	97
<i>Capture (GWN7610/GWN7600 Only)</i>	97
<i>Core Files</i>	100
<i>Ping/Traceroute</i>	100
<i>Syslog</i>	101
<i>One Key Debug</i>	102
Email/Notification	103
DHCP Server	106
Static DHCP	107
SCHEDULE	109
LED SCHEDULE	111
UPGRADING AND PROVISIONING	112
Upgrading Firmware	112
<i>Upgrading via Web GUI</i>	112
Upgrading Slave Access Points	113
<i>Sequential Upgrade</i>	114
Provisioning and Backup	115



<i>Download Configuration</i>	115
<i>Upload Configuration</i>	115
<i>Configuration Server</i>	116
Reset and reboot	116
Syslog	116
EXPERIENCING THE GWN76XX WIRELESS ACCESS POINTS.....	117



Table of Tables

Table 1: GWN7630 Technical Specifications	23
Table 1: GWN7615 Technical Specifications	24
Table 2: GWN7610 Technical Specifications	26
Table 3: GWN7600LR Technical Specifications	33
Table 4: GWN7630LR Technical Specifications	34
Table 5: GWN7630/GWN7610/GWN7615/GWN7605/GWN7600 Equipment Packaging	37
Table 6: GWN7600LR Equipment Packaging	38
Table 7: GWN7630LR Equipment Packaging	39
Table 8: GWN76XX AP Ports Description	40
Table 9: LED Patterns	46
Table 10: Overview	50
Table 11: Device Configuration	57
Table 12: Wi-Fi	66
Table 13: Time Policy Parameters	75
Table 14: Captive Portal – Policy List – Splash Page is “Internal”	79
Table 15: Captive Portal – Policy List – Splash Page is “External”	81
Table 16: Voucher Parameters	86
Table 17: Mesh configuration on GWN76XX	90
Table 18: Bandwidth Rules	91
Table 19: Basic	93
Table 20: Upgrade	94
Table 21: Access	95
Table 22: Syslog Parameters	96
Table 23: Logserver Parameters	96
Table 24: Debug	98
Table 25: Email Setting	104
Table 26: Email Events	105
Table 27: DHCP Server Parameters	106
Table 28: LEDs	111
Table 29: Network Upgrade Configuration	112

Table of Figures

Figure 1: GWN7630 or GWN7610 or GWN7605 or GWN7600 Equipment Packaging	37
Figure 2: GWN7600LR Equipment Package	38
Figure 3: GWN7630LR/GWN7605LR Equipment Package	39



Figure 4: GWN7630/GWN7615	39
Figure 5: GWN7610/GWN7600 Ports	39
Figure 6: GWN7600LR Ports	39
Figure 7: GWN7630LR.....	39
Figure 8: Connecting GWN AP - GWN7600 as example.....	41
Figure 9: Wall Mount – Steps 1 & 2	41
Figure 10: Wall Mount – Steps 3 & 4	41
Figure 11: Wall Mount – Steps 5 & 6.....	42
Figure 12: Ceiling Mount – Steps 1 & 2	42
Figure 13: Ceiling Mount – Step 3	42
Figure 14: Ceiling Mount – Step 4	42
Figure 15: Ceiling Mount – Steps 5 & 6	43
Figure 16: GWN7600LR Vertical Mounting.....	43
Figure 17: GWN7600LR Horizontal Mounting	44
Figure 18: GWN7630LR/GWN7605LR Mounting Instructions.....	44
Figure 19: GWN7630LR/GWN7605LR Wall Mount.....	44
Figure 20: GWN7630LR/GWN7605LR Pole Mount.....	45
Figure 21: Discover the GWN76XX using its MAC Address.....	47
Figure 22: GWN Discovery Tool.....	48
Figure 23: GWN76XX Web GUI Login Page	49
Figure 24: GWN76XX Web GUI Language (Login page).....	49
Figure 25: GWN76XX Web GUI Language (Web Interface).....	50
Figure 26: GWN76XX Dashboard (GWN7600 as example).....	50
Figure 27: Apply Changes.....	51
Figure 28: GWN.Cloud Architecture.....	52
Figure 29: GWN Manager Architecture.....	52
Figure 30: MAC Tag Label	53
Figure 31: Login Page.....	54
Figure 32: Setup Wizard	55
Figure 33: Discover and Pair GWN76XX.....	56
Figure 34: Discovered Devices	56
Figure 35: GWN76XX Online	56
Figure 36: Failover Master	59
Figure 37: Failover Mode GUI.....	60
Figure 38: Takeover - Step 1.....	61
Figure 39: Takeover - Step 2.....	61
Figure 40: Takeover - Step 3.....	62
Figure 41: Switch to Master	62
Figure 42: Transfer Master Role to another device confirmation message	63
Figure 43: Then new assigned Master AP web interface.....	63
Figure 44: Client Bridge	64
Figure 45: Client Bridge	64



Figure 46: Client Bridge Mode	64
Figure 47: SSID.....	65
Figure 48: Add a new SSID.....	65
Figure 49: Device Membership	71
Figure 50: Clients	72
Figure 51: Clients - Select Items	73
Figure 52: Global Blacklist	73
Figure 53: Managing the Global Blacklist	74
Figure 54: Adding Client Access List.....	74
Figure 55: Adding New Access List.....	74
Figure 56: Blacklist Access List.....	75
Figure 57: Ban/Unban Client.....	76
Figure 58: Captive Portal – Guest Page	77
Figure 59: Captive Portal - Guest Page - Select Items.....	77
Figure 60: Captive Portal - Policy List.....	78
Figure 61: Add a New Policy.....	79
Figure 62: Authentication rules	82
Figure 63: Captive Portal – Splash Page.....	83
Figure 64: Add Voucher Sample	85
Figure 65: Vouchers List	86
Figure 66: Captive Portal with Voucher authentication	87
Figure 67: Access Points Status	89
Figure 68: Mesh settings for GWN76XX.....	89
Figure 69: MAC Address Bandwidth Rule.....	92
Figure 70: Bandwidth Rules	92
Figure 71: Capture Page.....	98
Figure 72: Capture Files.....	100
Figure 73: IP Ping	101
Figure 74: IP Traceroute	101
Figure 75: Syslog	102
Figure 76: One Key Debug	103
Figure 77: One Key Debug file.....	103
Figure 78: Email	104
Figure 79: Notification	105
Figure 80: DHCP Binding.....	107
Figure 81: Static DHCP Devices List	108
Figure 82: Create New Schedule	109
Figure 83: Schedules List.....	110
Figure 84: LED Scheduling Sample.....	111
Figure 85: Access Points.....	114
Figure 86: Choosing multiple devices	114
Figure 87: All-at-Once and Sequential Upgrade	115



DOCUMENT PURPOSE

This document describes how to configure the GWN76XX via Web GUI in standalone mode, with other GWN76XX Access Points as Master/Slave architecture and more. The intended audiences of this document are network administrators. Please visit <http://www.grandstream.com/support> to download the latest “GWN76XX User Manual”.

This guide covers following topics:

- [Product Overview](#)
- [Installation](#)
- [Getting Started](#)
- [GWN Management Platforms](#)
- [Using GWN76XX as Standalone Access Point](#)
- [Using GWN76XX as Master Access Point Controller](#)
- [Failover Master](#)
- [Client Bridge](#)
- [SSIDs](#)
- [Clients Configuration](#)
- [System Settings](#)
- [LED Schedule](#)
- [Captive Portal](#)
- [Vouchers](#)
- [Mesh Network](#)
- [Bandwidth Rules](#)
- [DHCP Server](#)
- [Schedule](#)
- [LED Schedule](#)
- [Maintenance](#)
- [Upgrading and Provisioning](#)
- [Experiencing the GWN76XX Wireless Access Point](#)



CHANGE LOG

This section documents significant changes from previous versions of the GWN76XX user manuals. Only major new features or major document updates are listed here. Minor updates for corrections or editing are not documented here.

Firmware Version 1.0.15.20

Product Name: GWN7610 / GWN7600 / GWN7600LR / GWN7630 / GWN7630LR

- Added support for more DFS channels [Scene]

Firmware Version 1.0.15.18

Product Name: GWN7605

- Added support for CE/RCM DFS channels [Scene]

Firmware Version 1.0.15.5

Product Name: GWN7605

- This is the initial version for GWN7605

Firmware Version 1.0.15.4

Product Name: GWN7610 / GWN7600 / GWN7600LR/ GWN7630 / GWN7630LR

- Added support of GWM Manager. [GWN Manager]
- Added LED pattern of yellow to indicate Mesh disconnection. [LED Patterns]
- Upgraded TLS to version 1.2. [Maintenance]

Firmware Version 1.0.15.6

Product Name: GWN7630 / GWN7630LR

- Added support for FCC DFS channels on gwn7630/gwn7630lr. [Scene]

Firmware Version 1.0.11.10

Product Name: GWN7630LR

- This is the initial version for GWN7630LR.



Firmware Version 1.0.11.8

Product Name: GWN7610 / GWN7600 / GWN7600LR / GWN7630

- Added support of DFS channel in EU for GWN7630. [Scene]
- Added support for Client Steering. [Client Steering]
- Added support for Minimum Rate Control. [Minimum Access Rate Limit]
- Added support for batch operations for Takeover. [Takeover Feature]
- Added support for Client inactivity timeout. [Client Inactivity Timeout]
- Enhanced Voucher feature by displaying remaining bytes. [Vouchers]
- Changed LED Pattern. [LED Patterns]
- Changed Local Master External Portal Configuration. [External Splash Page]
- Changed default setting of Mesh to OFF. [MESH NETWORK]
- Removed WeChat from Wi-Fi portal authentication.

Firmware Version 1.0.9.13

Product Name: GWN7610 / GWN7600 / GWN7600LR

- No major changes.

Firmware Version 1.0.9.12

Product Name: GWN7610 / GWN7600 / GWN7600LR / GWN7630

- Added support for random password for web login after reset. [Access Web GUI]
- Added support for Takeover feature. [Takeover Feature]
- Added support for Transfer to Master Feature. [Transfer to Master]
- Updated the Email/Notification configuration page. [Email/Notification]
- Updated the Mesh Configuration page. [MESH NETWORK]
- Added support for one key debugging. [One Key Debug]

Firmware Version 1.0.8.18

Product Name: GWN7610 / GWN7600 / GWN7600LR

- Added support of ARP Proxy. [ARP Proxy]
- Enhanced Bandwidth Rules by adding option to limit bandwidth Per-User. [Range Constraint]

Firmware Version 1.0.8.9

Product Name: GWN7610 / GWN7600 / GWN7600LR

- No major changes



Firmware Version 1.0.7.13

Product Name: GWN7610 / GWN7600 / GWN7600LR

- Added support of Radio Resource Management (RRM). [Dynamic Channel Assignment] [Transmit Power Control] [Coverage Hole Detection]
- Added Mesh for GWN7610. [MESH NETWORK]
- Added External Captive Portal support. [External Splash Page]
- Added AP Scheduling Reboot. [Reboot Schedule]
- Enhanced Wi-Fi Service by adding configurable options of [Beacon Interval], [DTIM Period], and [Multicast to Unicast].
- Enhanced Client Information. [Clients]
- Enhanced Captive Portal features. [Failsafe Mode] [Byte Limit] [Enable Daily Limit] [Force to Follow]
- Added Static DHCP feature [Static DHCP]

Firmware Version 1.0.6.43

Product Name: GWN7610

- Added date time display on Overview Page. [Overview Page]
- Added new feature scheduling module. [SCHEDULE]
- Added possibility to print/delete multiple vouchers. [Vouchers]
- Added expiration period to vouchers. [Vouchers]
- Added DHCP Server. [DHCP Server]
- Added support for GWN.Cloud. [GWN]
- Added support for Transfer AP and Transfer Network Group. [Transfer AP – Transfer Network Group]

Firmware Version 1.0.6.41

Product Name: GWN7600 / GWN7600LR

- Added date time display on Overview Page. [Overview Page]
- Added new feature scheduling module. [SCHEDULE]
- Added possibility to print/delete multiple vouchers. [Vouchers]
- Added expiration period to vouchers. [Vouchers]
- Added DHCP Server. [DHCP Server]
- Added support for GWN.Cloud [GWN]
- Added support for Transfer AP and Transfer Network Group. [Transfer AP – Transfer Network Group]
- Added support for Outdoor/Indoor Scene Wi-Fi channel configuration (Applicable for GWN7600LR Only). [Scene]



Firmware Version 1.0.5.15

Product Name: GWN7610

- Added support for New Firmware Reminder on Master Web [New Firmware Notification]
- Added support for Sequential Upgrade [Sequential Upgrade]
- Added support for Feature Scheduling [SCHEDULE]
- Added support for Master Direction. [Master Direction]
- Added support for Master Transfer [Transfer to Master]
- Added support for Airtime Fairness [Airtime Fairness]
- Added support for Social login/Voucher [Vouchers]

Firmware Version 1.0.5.13

Product Name: GWN7600 / GWN7600LR

- Added support for New Firmware Reminder on Master Web [New Firmware Notification]
- Added support for Sequential Upgrade [Sequential Upgrade]
- Added support for Feature Scheduling [SCHEDULE]
- Added support for Master Transfer [Transfer to Master]
- Added support for Master Direction. [Master Direction]
- Added support for Airtime Fairness [Airtime Fairness]
- Added support for Social login/Voucher [Vouchers]
- Added support for Mesh Network [MESH NETWORK]

Firmware Version 1.0.4.22

Product Name: GWN7610

- Included patch for WPA2 4-way handshake vulnerability [VU#228519]

Firmware Version 1.0.4.20

Product Name: GWN7610

- Added support for Timed Client Disconnect and Enhanced Client Blocking [CLIENTS CONFIGURATION]
- Added support for Client Bridge [Client Bridge]
- Added support for Syslog server [Syslog]
- Added support for Configurable Web UI access port [Web HTTP Access]
- Added support for E-mail notifications [Email/Notification]

Firmware Version 1.0.4.12

Product Name: GWN7600 / GWN7600LR



- Added support for Timed Client Disconnect and Enhanced Client Blocking [CLIENTS CONFIGURATION]
- Added support for Client Bridge [Client Bridge]
- Added support for Syslog server [Syslog]
- Added support for Configurable Web UI access port [Web HTTP Access]
- Added support for E-mail notifications [Email/Notification]
- Included patch for WPA2 4-way handshake vulnerability [VU#228519]

Firmware Version 1.0.3.25

Product Name: GWN7600 / GWN7600LR

- No major changes.

Firmware Version 1.0.3.21

Product Name: GWN7610

- No major changes.

Firmware Version 1.0.3.19

Product Name: GWN7610 / GWN7600 / GWN7600LR

- Added support for captive portal [CAPTIVE PORTAL]
- Added support for 802.11k/r/v [Enable Voice Enterprise]
- Added support for failover master [Failover Master]
- Added support for VLAN assignment via RADIUS [Enable Dynamic VLAN]
- Added support for Select SSID Band [SSID Band]
- Added support for Exact Radio Power Configuration in dBm [Custom Wireless Power]
- Added support for AP Location [AP Location]
- Added support for Per-Client/Per-SSID bandwidth rules [BANDWIDTH RULES]
- Added option to limit clients count per SSID [Wireless Client Limit]
- Added support for Wi-Fi Schedule [SCHEDULE]
- Added support for LED control [LED SCHEDULE]
- Added option to enable/disable DHCP option 66 & 43 override [Allow DHCP options 66 and 43 override]

Firmware Version 1.0.2.108

Product Name: GWN7610

- Added Controller protocol security enhancement. [Controller Protocol Security Enhancement]
- Added support for LED control. [LED SCHEDULE]



- Added support for Captive Portal. [CAPTIVE PORTAL]
- Added support for Wi-Fi schedule. [SCHEDULE]
- Added Client Isolation enhancement. [Client Isolation]
- Added support to store Syslog locally on the unit and display it on Web GUI. [Syslog]

Firmware Version 1.0.2.15

Product Name: GWN7610

- Added New Overview Page.
- Added Web UI enhancement.
- Added support for Password change on first boot.
- Added Country code selection into setup wizard.

Firmware Version 1.0.1.31

Product Name: GWN7600 / GWN7600LR

- This is the initial version.

Firmware Version 1.0.1.27

Product Name: GWN7610

- This is the initial version.



WELCOME

Thank you for purchasing Grandstream GWN76XX Enterprise Wireless Access Point.

The GWN7630/ GWN7610/GWN7610 are high-performance 802.11ac wireless access point for small to medium sized businesses, multiple floor offices, commercial locations and branch offices. GWN7630 and GWN76105/GWN7610 offers respectively a dual-band 4x4:4 MIMO and a 3x3:3 MIMO technology and a sophisticated antenna design for maximum network throughput and expanded Wi-Fi coverage range. To ensure easy installation and management, the GWN7630/GWN7615/GWN7610 uses a controller-less distributed network management design in which the controller is embedded within the product's Web user interface. This allows each access point to manage a network of up to 50 GWN76XX independently without needing separate controller hardware/software and without a single point-of-failure.

The GWN7600 is a mid-tier Wave-2 802.11ac Wi-Fi access point for small to medium sized businesses, multiple floor offices, commercial locations and branch offices. The GWN7600LR Outdoor Long-range 802.11ac Wave-2 Wi-Fi Access Point is designed to provide extended coverage support. Ideal for outdoor Wi-Fi solutions thanks to its waterproof casing and heat resistant technology. The GWN7600/GWN7600LR come equipped with dual-band, 2x2:2 MU-MIMO with beam-forming technology and a sophisticated antenna design for maximum network throughput and expanded Wi-Fi coverage range for both Indoor (GWN7600) and Outdoor deployment (GWN7600LR).

To ensure easy installation and management, the GWN7600/GWN7600LR uses a controller-less distributed network management design in which the controller is embedded within the product's web user interface. This allows each access point to manage a network of up to 30 GWN76XX series APs independently without needing separate controller hardware/software and without a single point-of-failure. This wireless access point can be paired with any third-party routers as well as Grandstream GWN series routers. With support for advanced QoS, low-latency real-time applications, 450+ concurrent client devices per AP and dual Gigabit network ports with PoE, the GWN7600/GWN7600LR is an ideal Wi-Fi access point for medium wireless network deployments with medium-to-high user density.

The GWN7630LR is an outdoor long-range Wi-Fi access point for medium to large businesses and enterprises who need to provide long-range coverage in both indoor and outdoor spaces. It offers weatherproof casing and heat resistant technology, dual-band 4x4:4 MU-MIMO technology, and a sophisticated antenna design for maximum network throughput that supports 200+ clients and an expanded 300-meter coverage range. the GWN7630LR is an ideal outdoor Wi-Fi access point for enterprises, multiple floor offices, warehouses, hospitals, schools and more.



The GWN7605/GWN7605LR is a high-performance-to-price 802.11ac Wave-2 Wi-Fi access point for small to medium sized businesses, multiple floor offices, commercial locations and branch offices. It offers dual-band 2x2:2 MU-MIMO with beam-forming technology and a sophisticated antenna design for maximum network throughput and expanded Wi-Fi coverage range. To ensure easy installation and management, the GWN7605/GWN7605LR uses a controller-less distributed network management design in which the controller is embedded within the product's web user interface. With a slight difference in the GWN7605LR which is an outdoor Wi-Fi access point that offers extended coverage range support for both indoor and outdoor deployments. Both products are supported by GWN.Cloud and GWN Manager, Grandstream's cloud and on-premise Wi-Fi management platforms. Excellent Wi-Fi APs for voice-over-Wi-Fi deployments and offer a seamless connection with Grandstream's Wi-Fi-capable IP phones. With support for advanced QoS, low-latency real-time applications, mesh networks, captive portals, 100+ concurrent clients per AP and dual Gigabit network ports with PoE/PoE+, they are ideal Wi-Fi access points for medium wireless network deployments with medium user density.

 **Caution:**

Changes or modifications to this product not expressly approved by Grandstream, or operation of this product in any way other than as detailed by this User Manual, could void your manufacturer warranty.

Note (VU#228519): "Out of the box" Grandstream Access Points are not affected by this issue. APs with old firmware are only affected after changing into client-bridge mode. Please refer to our white paper of "WPA Security Vulnerability" [here](#).

PRODUCT OVERVIEW

Technical Specifications

Table 1: GWN7630 Technical Specifications

Wi-Fi Standards	IEEE 802.11 a/b/g/n/ac (Wave-2).
Antennas	4x 2.4 GHz, gain 4dBi, internal antenna 4x 5 GHz, gain 5dBi, internal antenna
Wi-Fi Data Rates	IEEE 802.11ac: 6.5 Mbps to 1733Mbps IEEE 802.11a: 6, 9, 12, 18, 24, 36, 48, 54 Mbps IEEE 802.11n: 6.5Mbps to 600Mbps IEEE 802.11b: 1, 2, 5.5, 11Mbps IEEE 802.11g: 6, 9, 12, 18, 24, 36, 48, 54 Mbps <i>*Actual throughput may vary depending on many factors including environmental conditions, distance between devices, radio interference in the operating environment and mix of devices in the network.</i>
Frequency Bands	2.4 GHz Radio: 2412 – 2484 GHz 5 GHz Radio: 5180-5825 GHz (FCC, IC, RCM)
Channel Bandwidth	2.4G: 20 and 40 MHz 5G: 20, 40, 80 MHz
Wi-Fi and System Security	WEP, WPA/WPA2-PSK, WPA/WPA2-Enterprise (TKIP/AES), anti-hacking secure boot and critical data/control lockdown via digital signatures, unique security certificate and random default password per device
MIMO	4x4:4 2.4GHz (MIMO) 4x4:4 5GHz (MU-MIMO)
Coverage Range	575ft. (175 meters) <i>*coverage range can vary based on environment</i>
Maximum TX Power	2.4G: 27 dBm 5G: 25 dBm <i>*Maximum power varies by country, frequency band and MCS rate</i>
Receiver Sensitivity	2.4G 802.11b: -96dBm@1Mbps, -88dBm@11Mbps; 802.11g: -93dBm @6Mbps, -75dBm@54Mbps; 802.11n 20MHz: -73dBm @MCS7; 802.11n 40MHz:-70dBm @MCS7



	5G 802.11a: -92dBm @6Mbps, -74dBm @54Mbps; 802.11ac 20MHz: -67dBm@MCS8; 802.11ac: HT40:- 63dBm @MCS9; 802.11ac 80MHz: -59dBm @MCS9; <i>* Receiver sensitivity varies by frequency band, channel width and MCS rate</i>
SSIDs	15 SSIDs per radio
Concurrent Clients	200+
Network Interfaces	2x autosensing 10/100/1000 Base-T Ethernet Ports
Auxiliary Ports	1x Reset Pinhole, 1x Kensington lock
Mounting	Indoor wall mount or ceiling mount, kits included
LEDs	3 tri-color LEDs for device tracking and status indication
Network Protocols	IPv4, 802.1Q, 802.1p, 802.1x, 802.11e/WMM
QoS	802.11e/WMM, VLAN, TOS
Network Management	Embedded controller in GWN7610 allows it to auto-discover, auto-provision and manage up to 50 GWN76XX in a network GWN.Cloud offers a free cloud management platform for unlimited GWN APs
Auto Power Saving	Self-power adaptation upon auto detection of PoE or PoE+
Power and Green Energy Efficiency	Power over Ethernet 802.3af/802.3at compliant Maximum Power Consumption: 16.5W; Supports 802.3 az.
Environmental	Operation: 0°C to 40°C Storage: -10°C to 60°C Humidity: 10% to 90% Non-condensing
Physical	Unit Dimension: 205.3 x 205.3 x 45.9mm; Unit Weight: 590g Unit + Mounting Kits Dimension: 205.3 x 205.3 x 50.9mm; Unit + Mounting Kits Weight: 710g Entire Package Dimension: 258 x 247 x 86mm; Entire Package Weight:930g
Package Content	GWN7630 802.11ac Wireless AP, Mounting Kits, Quick Start Guide
Compliance	FCC, CE, RCM, IC

Table 2: GWN7615 Technical Specifications

Wi-Fi Standards	IEEE 802.11a/b/g/n/ac (Wave-2)
Antennas	3 dual band internal antennas 2.4GHz, gain 3dBi 5 GHz, gain 3dBi

Wi-Fi Data Rates	IEEE 802.11ac: 6.5 Mbps to 1300Mbps IEEE 802.11a: 6, 9, 12, 18, 24, 36, 48, 54 Mbps IEEE 802.11n: 6.5 Mbps to 450 Mbps IEEE 802.11b: 1, 2, 5.5, 11Mbps IEEE 802.11g: 6, 9, 12, 18, 24, 36, 48, 54 Mbps <i>*Actual throughput may vary depending on many factors including environmental conditions, distance between devices, radio interference in the operating environment and mix of devices in the network</i>
Frequency Bands	2.4 GHz Radio: 2412 – 2484 MHz 5 GHz Radio: 5180-5825 MHz
Channel Bandwidth	2.4G: 20 and 40MHz 5G: 20, 40, and 80MHz
Wi-Fi and System Security	WEP, WPA/WPA2-PSK, WPA/WPA2 Enterprise, anti-hacking secure boot and critical data/control lockdown via digital signatures, unique security certificate and random default password per device
MIMO	3×3:3 2.4G(MIMO) 3×3:3 5G(MU-MIMO)
Coverage Range	Up to 175 meters <i>*coverage range can vary based on environment</i>
Maximum TX Power	2.4G: 26 dBm 5G: 24 dBm
Receiver Sensitivity	2.4G 802.11b: -96dBm@1Mbps, -88dBm@11Mbps; 802.11g: -93dBm @6Mbps, -75dBm@54Mbps; 802.11n 20MHz: -73dBm @MCS7; 802.11n 40MHz:-70dBm @MCS7 5G 802.11a: -92dBm @6Mbps, -74dBm @54Mbps; 802.11ac 20MHz: -67dBm@MCS8; 802.11ac: HT40:- 63dBm @MCS9; 802.11ac 80MHz: -59dBm @MCS9
SSIDs	16 SSID per radio
Concurrent Clients	200+
Network Interfaces	2× autosensing 10/100/1000 Base-T Ethernet Ports
Auxiliary Ports	1× Reset Pinhole , 1× Kensington lock
Mounting	Indoor wall mount or ceiling mount, kits included
LEDs	1× tri-color LED for device tracking and status indication
Network Protocols	IPv4, IPv6, 802.1Q, 802.1p, 802.1x, 802.11e/WMM
QoS	802.11e/WMM, VLAN, TOS



Network Management	≤ 50 APs: Light-weight Master in AP ≤ 3000 APs: On-Premise controller ≤ +∞ APs: Cloud management
Power and Green Energy Efficiency	POE 802.3af/ 802.3at; Max Consumption: 12.5W
Environmental	Operation: 0°C to 40°C Storage: -10°C to 60°C Humidity: 10% to 90% Non-condensing
Physical	Unit Dimension: 205.4 x 205.4 x 45.9mm; Unit Weight: 500g Entire Package Dimension: 258 x 247 x 86mm; Entire Package Weight: 867.3g
Package Content	GWN7615 802.11ac Wireless AP, Mounting Kits, Quick Start Guide
Compliance	FCC, CE, RCM, IC

Table 3: GWN7610 Technical Specifications

Wi-Fi Standards	IEEE 802.11 a/b/g/n/ac
Antennas	3x 2.4 GHz, gain 3 dBi, internal antenna, 3x 5 GHz, gain 3 dBi, internal antenna
Wi-Fi Data Rates	IEEE 802.11ac: 6.5 Mbps to 1300 Mbps IEEE 802.11a: 6, 9, 12, 18, 24, 36, 48, 54 Mbps IEEE 802.11n: 6.5 Mbps to 450 Mbps IEEE 802.11b: 1, 2, 5.5, 11 Mbps IEEE 802.11g: 6, 9, 12, 18, 24, 36, 48, 54 Mbps <i>*Actual throughput may vary depending on many factors including environmental conditions, distance between devices, radio interference in the operating environment and mix of devices in the network</i>
Frequency Bands	2.4GHz radio: 2.400 - 2.4835 GHz 5GHz radio: 5.150 - 5.250 GHz, 5.725 - 5.850 GHz (FCC, IC, RCM)
Channel Bandwidth	2.4G: 20 and 40 MHz 5G: 20,40 and 80 MHz
Wi-Fi and System Security	WEP, WPA/WPA2-PSK, WPA/WPA2-Enterprise (TKIP/AES), anti-hacking secure boot and critical data/control lockdown via digital signatures, unique security certificate and random default password per device
MIMO	3x3:3 2.4GHz, 3x3:3 5GHz
Coverage Range	575ft. (175 meters) <i>*coverage range can vary based on environment</i>



Maximum TX Power	5G: 26dBm (FCC) / 20dBm (CE) 2.4G: 26dBm (FCC) / 17dBm (CE) <i>*Maximum power varies by country, frequency band and MCS rate</i>
Receiver Sensitivity	2.4G 802.11b:-92dBm@11Mbps; 802.11g:-76dBm@54Mbps; 802.11n 20MHz: -73dBm@MCS7; 802.11n 40MHz:-70dBm@MCS7 5G 802.11a:-94dBm@6Mbps; 801.11a:-77dBm@54Mbps; 802.11ac 20MHz: -69dBm@MCS8; 802.11ac HT40:-65dBm@MCS9; 802.11ac 80MHz: 1dBm@MCS9 <i>* Receiver sensitivity varies by frequency band, channel width and MCS rate</i>
SSIDs	16 SSIDs per access point
Concurrent Clients	250+
Network Interfaces	2x autosensing 10/100/1000 Base-T Ethernet Ports
Auxiliary Ports	1x USB 2.0 port, 1x Reset Pinhole, 1x Kensington lock
Mounting	Indoor wall mount or ceiling mount, kits included
LEDs	3 multi-color LEDs for device tracking and status indication
Network Protocols	IPv4, 802.1Q, 802.1p, 802.1x, 802.11e/WMM
QoS	802.11e/WMM, VLAN, TOS
Network Management	Embedded controller in GWN7610 allows it to auto-discover, auto-provision and manage up to 50 GWN76XX s in a network. GWN.Cloud offers a free cloud management platform for unlimited GWN Aps
Auto Power Saving	Self-power adaptation upon auto detection of PoE or PoE+
Power and Green Energy Efficiency	DC Input: 24VDC/1A Power over Ethernet 802.3af/802.3at compliant Maximum Power Consumption: 13.8W
Environmental	Operation: 0°C to 50°C Storage: -10°C to 60°C Humidity: 10% to 90% Non-condensing
Physical	Unit Dimension: 205.3 x 205.3 x 45.9mm; Unit Weight: 540g Unit + Mounting Kits Dimension: 205.3 x 205.3 x 50.9mm; Unit + Mounting Kits Weight: 600g Entire Package Dimension: 258 x 247 x 86mm; Entire Package Weight: 900g
Package Content	GWN7610 802.11ac Wireless AP, Mounting Kits, Quick Start Guide



Compliance	FCC, CE, RCM, IC
-------------------	------------------

Table 3: GWN7605 Technical Specifications

Wi-Fi Standards	IEEE 802.11 a/b/g/n/ac (Wave-2)
Antennas	2 dual band internal antennas 2.4GHz, gain 3dBi 5 GHz, gain 4dBi
Wi-Fi Data Rates	IEEE 802.11ac: 6.5 Mbps to 867 Mbps IEEE 802.11a: 6, 9, 12, 18, 24, 36, 48, 54 Mbps IEEE 802.11n: 6.5Mbps to 300Mbps. IEEE 802.11b: 1, 2, 5.5, 11 Mbps IEEE 802.11g: 6, 9, 12, 18, 24, 36, 48, 54 Mbps <i>*Actual throughput may vary depending on many factors including environmental conditions, distance between devices, radio interference in the operating environment and mix of devices in the network</i>
Frequency Bands	2.4GHz radio : 2412 – 2484 MHz 5GHz radio : 5180-5825 MHz
Channel Bandwidth	2.4G: 20 and 40 MHz 5G: 20,40 and 80 MHz
Wi-Fi and System Security	WEP, WPA/WPA2-PSK, WPA/WPA2-Enterprise (TKIP/AES), anti-hacking secure boot and critical data/control lockdown via digital signatures, unique security certificate and random default password per device
MIMO	2x2:2 2.4GHz (MIMO) 2x2:2 5GHz (MU-MIMO)
Coverage Range	Up to 165 meters <i>*coverage range can vary based on environment</i>
Maximum TX Power	5G: 24dBm 2.4G: 22dBm <i>*Maximum power varies by country, frequency band and MCS rate</i>
Receiver Sensitivity	2.4G 802.11b: -96dBm@1Mbps, -88dBm@11Mbps; 802.11g: -93dBm @6Mbps, -75dBm@54Mbps; 802.11n 20MHz: -73dBm @MCS7; 802.11n 40MHz:-70dBm @MCS7



5G	802.11a: -92dBm @6Mbps, -74dBm @54Mbps; 802.11ac 20MHz: -67dBm@MCS8; 802.11ac: HT40:- 63dBm @MCS9; 802.11ac 80MHz: -59dBm @MCS9 * Receiver sensitivity varies by frequency band, channel width and MCS rate
SSIDs	8 SSIDs per radio
Concurrent Clients	100+
Network Interfaces	2x autosensing 10/100/1000 Base-T Ethernet Ports
Auxiliary Ports	1x Reset Pinhole, 1x Kensington lock
Mounting	Indoor wall mount or ceiling mount, kits included
LEDs	3 multi-color LEDs for device tracking and status indication
Network Protocols	IPv4, IPv6, 802.1Q, 802.1p, 802.1x, 802.11e/WMM
QoS	802.11e/WMM, VLAN, TOS
Network Management	≤ 50 APs: Light-weight Master in AP ≤ 3000 APs: On-Premise controller ≤ +∞ APs: Cloud management
Power and Green Energy Efficiency	DC Input: 24VDC/1A Power over Ethernet 802.3af/802.3at compliant Maximum Power Consumption: 13.8W
Environmental	Operation: 0°C to 40°C Storage: -10°C to 60°C Humidity: 10% to 90% Non-condensing
Physical	Unit Dimension: 180.4mmx180.4mmx40.8mm; Unit Weight: 388.2g Entire Package Dimension: 228.5x220x79mm; Entire Package Weight: 719.3g
Package Content	GWN7610 802.11ac Wireless AP, Mounting Kits, Quick Start Guide
Compliance	FCC, CE, RCM, IC

Table 3: GWN7605LR Technical Specifications

Wi-Fi Standards	IEEE 802.11a/b/g/n/ac (Wave-2)
Antennas	2 dual band external antennas 2.4GHz, gain 3.5dBi 5 GHz, gain 3.5dBi



Wi-Fi Data Rates	IEEE 802.11ac: 6.5 Mbps to 867 Mbps IEEE 802.11a: 6, 9, 12, 18, 24, 36, 48, 54 Mbps IEEE 802.11n: 6.5Mbps to 300Mbps IEEE 802.11b: 1, 2, 5.5, 11Mbps IEEE 802.11g: 6, 9, 12, 18, 24, 36, 48, 54 Mbps <i>*Actual throughput may vary depending on many factors including environmental conditions, distance between devices, radio interference in the operating environment and mix of devices in the network</i>
Frequency Bands	2.4GHz Radio: 2412 – 2484 MHz 5 GHz Radio: 5180-5825 MHz
Channel Bandwidth	2.4G: 20 and 40MHz 5G: 20, 40 and 80 MHz
Wi-Fi and System Security	WEP, WPA/WPA2-PSK, WPA/WPA2 Enterprise, anti-hacking secure boot and critical data/control lockdown via digital signatures, unique security certificate and random default password per device
MIMO	2×2:2 2.4GHz (MIMO) 2×2:2 5GHz (MU-MIMO)
Coverage Range	Up to 250 meters <i>*coverage range can vary based on environment</i>
Maximum TX Power	2.4G: 24 dBm 5G: 22dBm
Receiver Sensitivity	2.4G 802.11b: -96dBm@1Mbps, -88dBm@11Mbps; 802.11g: -93dBm @6Mbps, -75dBm@54Mbps; 802.11n 20MHz: -73dBm @MCS7; 802.11n 40MHz:-70dBm @MCS7 5G 802.11a: -92dBm @6Mbps, -74dBm @54Mbps; 802.11ac 20MHz: -67dBm@MCS8; 802.11ac: HT40:- 63dBm @MCS9; 802.11ac 80MHz: -59dBm @MCS9
SSIDs	8 SSID per radio
Concurrent Clients	100+
Network Interfaces	2× autosensing 10/100/1000 Base-T Ethernet Ports
Auxiliary Ports	1× Reset Pinhole
Mounting	Outdoor metal bar mount or wall mount, kits included
LEDs	1 tri-color LED for device tracking and status indication
Network Protocols	IPv4, IPv6, 802.1Q, 802.1p, 802.1x, 802.11e/WMM



QoS	802.11e/WMM, VLAN, TOS
Network Management	Embedded controller can manage up to 50 local GWN APs GWN.Cloud offers a free cloud management platform for almost unlimited GWN Aps GWN.Manager offers premise-based software controller for up to 3,000 GWN APs
Power and Green Energy Efficiency	POE 802.3af/ 802.3at; Maximum Power Consumption: 10.16W
Environmental	Operation: -30°C to 60°C Storage: -30°C to 70°C Humidity: 10% to 90% Non-condensing
Physical	Physical Unit Dimension: 358.3mm(L)*115mm(W)*45.3mm(H); Unit Weight: 500g Entire Package Dimension: 258 × 247× 86mm; Entire Package Weight:655.3g
Package Content	GWN7605LR 802.11ac Wave-2 Wireless AP, Mounting Kits, Quick Start Guide
Water Proof	IP66-level weatherproof capability when installed vertically
Compliance	FCC, CE, RCM, IC

Table 4: GWN7600 Technical Specifications

Wi-Fi Standards	IEEE 802.11 a/b/g/n/ac (Wave-2)
Antennas	2x 2.4 GHz, gain 3 dBi, internal antenna, 2x 5 GHz, gain 3 dBi, internal antenna
Wi-Fi Data Rates	IEEE 802.11ac: 6.5 Mbps to 877 Mbps IEEE 802.11a: 6, 9, 12, 18, 24, 36, 48, 54 Mbps IEEE 802.11n: 6.5 Mbps to 300 Mbps; 400 Mbps with 256-QAM on 2.4GHz IEEE 802.11b: 1, 2, 5.5, 11 Mbps IEEE 802.11g: 6, 9, 12, 18, 24, 36, 48, 54 Mbps *Actual throughput may vary depending on many factors including environmental conditions, distance between devices, radio interference in the operating environment and mix of devices in the network.
Frequency Bands	2.4GHz radio : 2.400 - 2.4835 GHz 5GHz radio: 5.150 - 5.250 GHz, 5.725 - 5.850 GHz
Channel Bandwidth	2.4G: 20 and 40 MHz 5G: 20,40 and 80 MHz



Wi-Fi and System Security	WEP, WPA/WPA2-PSK, WPA/WPA2-Enterprise (TKIP/AES), anti-hacking secure boot and critical data/control lockdown via digital signatures, unique security certificate and random default password per device.
MIMO	2x2:2 2.4GHz, 2x2:2 5GHz
Coverage Range	Up to 541ft. (165 meters) for GWN7600. *Coverage range can vary based on environment
Maximum TX Power	5G: 22dBm 2.4G: 22dBm *Maximum power varies by country, frequency band and MCS rate.
Receiver Sensitivity	2.4G 802.11b:-99dBm @1Mbps,-91dBm @11Mbps;802.11g:-93dBm @6Mbps,-75dBm @54Mbps; 80.11n 20MHz:-72dBm @MCS7;802.11n 40MHz:-69dBm @MCS7 5G 802.11a:-91dBm @6Mbps,-74dBm @54Mbps;802.11ac 20MHz:-67dBm @MCS8;802.11ac HT40:-63dBm @MCS9;802.11ac 80MHz:-60dBm @MCS9
BSSID	16 SSIDs per radio
Concurrent Clients	450+
Network Interfaces	2x autosensing 10/100/1000 Base-T Ethernet Ports
Auxiliary Ports	1x USB 2.0 port, 1x Reset Pinhole, 1x Kensington lock
Mounting	Indoor wall mount or ceiling mount, kits included
LEDs	multi-color LEDs for device tracking and status indication
Network Protocols	IPv4, 802.1Q, 802.1p, 802.1x, 802.11e/WMM
QoS	802.11e/WMM, VLAN, TOS
Network Management	Embedded controller in GWN7600 allows it to auto-discover, auto-provision and manage up to 30 GWN76XX in a network GWN.Cloud offers a free cloud management platform for unlimited GWN APs
Power and Green Energy Efficiency	DC Input: 24VDC/1A Power over Ethernet (802.3af) compliant Maximum Power Consumption: 13.8W
Temperature & Humidity	Operation: 0°C to 40°C Storage: -10°C to 60°C Humidity: 10% to 90% Non-condensing



Physical	Unit Dimension: 205.3 x 205.3 x 45.9mm; Unit Weight: 526g Unit + Mounting Kits Dimension: 205.3 x 205.3 x 53.9mm; Unit + Mounting Kits Weight : 610g Entire Package Dimension: 228.5*220*79mm; Entire Package Weight: 854g
Package Content	GWN7600 Wave-2 802.11ac Wireless AP, Mounting Kits, Quick Installation Guide
Compliance	FCC, CE, RCM, IC

Table 4: GWN7600LR Technical Specifications

Wi-Fi Standards	IEEE 802.11 a/b/g/n/ac (Wave-2)
Antennas	2x 2.4 GHz, gain 4 dBi, internal antenna 2x 5 GHz, gain 5 dBi, internal antenna
Wi-Fi Data Rates	IEEE 802.11ac: 6.5 Mbps to 867 Mbps IEEE 802.11a: 6, 9, 12, 18, 24, 36, 48, 54 Mbps IEEE 802.11n: 6.5 Mbps to 300 Mbps; 400Mbps with 256-QAM on 2.4GHz IEEE 802.11b: 1, 2, 5.5, 11 Mbps IEEE 802.11g: 6, 9, 12, 18, 24, 36, 48, 54 Mbps *Actual throughput may vary depending on many factors including environmental conditions, distance between devices, radio interference in the operating environment and mix of devices in the network
Frequency Bands	2.4GHz radio: 2.400 - 2.4835 GHz 5GHz radio: 5.150 - 5.250 GHz, 5.725 - 5.850 GHz
Channel Bandwidth	2.4G: 20 and 40 MHz 5G: 20,40 and 80 MHz
Wi-Fi and System Security	WEP, WPA/WPA2-PSK, WPA/WPA2 Enterprise (TKIP/AES), anti-hacking secure boot and critical data/control lockdown via digital signatures, unique security certificate and random default password per device
MIMO	2x2:2 2.4GHz (MIMO), 2x2:2 5GHz (MU-MIMO)
Coverage Range	Up to 984ft. (300 meters) *Coverage range can vary based on environment
Maximum TX Power	5G: 22dBm (FCC) / 20dBm (CE) 2.4G: 22dBm (FCC) / 17dBm (CE) *Maximum power varies by country, frequency band and MCS rate
Receiver Sensitivity	2.4G 802.11b: -99dBm@1Mbps, -91dBm@11Mbps; 802.11g:-93dBm@6Mbps, -75dBm@54Mbps; 802.11n 20MHz: -72dBm@MCS7; 802.11n 40MHz: -69dBm @MCS7



	5G 802.11a: -91dBm@6Mbps, -74dBm@54Mbps; 802.11ac 20MHz: -67dBm@MCS8; 802.11ac; HT40: -63dBm@MCS9; 802.11ac 80MHz: -60dBm@MCS9
SSIDs	16 SSIDs per access point
Concurrent Clients	450+
Network Interfaces	2x autosensing 10/100/1000 Base-T Ethernet Ports
Auxiliary Ports	1x Reset Pinhole
Mounting	Outdoor base bracket and cover bracket included
LEDs	multicolor LED for device tracking and status indication
Network Protocols	IPv4, 802.1Q, 802.1p, 802.1x, 802.11e/WMM
QoS	802.11e/WMM, VLAN, TOS
Network Management	Embedded controller in GWN7600LR allows it to auto-discover, auto-provision and manage up to 30 GWN76XX s in a network GWN.Cloud offers a free cloud management platform for unlimited GWN APs
Power and Green Energy Efficiency	Power over Ethernet 802.3af and 802.3at compliant Maximum Power Consumption: 12.9 W (PoE supply) 23.0 W (PoE+ supply)
Temperature & Humidity	Operation: -30°C to 60°C Storage: -30°C to 70°C Humidity: 5% to 95% Non-condensing
Physical	Unit Dimension: 290×150×35mm; Unit Weight: 708g Unit + Mounting Kits Dimension: 290×150×56mm; Unit + Mounting Kits Weight: 1528.2g Entire Package Dimension: 423×187×97mm; Entire Package Weight: 1844g
Package Content	Enterprise 802.11ac Wave-2 Outdoor Long Range Wi-Fi Access Point, Mounting Kits, Quick Installation Guide
Waterproof Grade	IP66-level weatherproof capability when installed vertically
Compliance	FCC, CE, RCM, IC

Table 5: GWN7630LR Technical Specifications

Wi-Fi Standards	IEEE 802.11 a/b/g/n/ac (Wave-2)
Antennas	4 detachable/changeable dual-band omnidirectional antennas 2.4GHz, gain 3.5dBi 5GHz, gain 3.5dB
Wi-Fi Data Rates	IEEE 802.11ac: 6.5 Mbps to 1733Mbps



	<p>IEEE 802.11a: 6, 9, 12, 18, 24, 36, 48, 54 Mbps</p> <p>IEEE 802.11n: 6.5Mbps to 600Mbps</p> <p>IEEE 802.11b: 1, 2, 5.5, 11Mbps</p> <p>IEEE 802.11g: 6, 9, 12, 18, 24, 36, 48, 54 Mbps</p> <p>*Actual throughput may vary depending on many factors including environmental conditions, distance between devices, radio interference in the operating environment and mix of devices in the network</p>
Frequency Bands	<p>2.4 GHz Radio: 2412 – 2484 MHz</p> <p>5GHz Radio: 5150-5250MHz, 5250-5350MHz, 5470-5725MHz, 5725-5850MHz</p> <p>*Not all frequency bands can be used in all regions.</p>
Channel Bandwidth	<p>2.4G: 20 and 40 MHz</p> <p>5G: 20,40 and 80 MHz</p>
Wi-Fi and System Security	WEP, WPA/WPA2-PSK, WPA/WPA2 Enterprise, anti-hacking secure boot and critical data/control lockdown via digital signatures, unique security certificate and random default password per device
MIMO	4x4:4 2.4G (MIMO), 4x4:4 5G (MU-MIMO)
Coverage Range	<p>Up to 984ft. (300 meters)</p> <p>*Coverage range can vary based on environment</p>
Maximum TX Power	<p>2.4G: 27 dBm</p> <p>5G: 25 dBm</p> <p>*Maximum power varies by country, frequency band and MCS rate</p>
Receiver Sensitivity	<p>2.4G</p> <p>802.11b: -96dBm@1Mbps, -88dBm@11Mbps; 802.11g: -93dBm @6Mbps, -75dBm@54Mbps; 802.11n 20MHz: -73dBm @MCS7; 802.11n 40MHz:-70dBm @MCS7</p> <p>5G</p> <p>802.11a: -92dBm @6Mbps, -74dBm @54Mbps; 802.11ac 20MHz: -67dBm@MCS8; 802.11ac: HT40:- 63dBm @MCS9; 802.11ac 80MHz: -59dBm @MCS9</p>
SSIDs	16 SSIDs per access point
Concurrent Clients	200+
Network Interfaces	2x autosensing 10/100/1000 Base-T Ethernet Ports
Auxiliary Ports	1x Reset Pinhole
Mounting	Wall mount or pole mount - kits included
LEDs	1x tri-color LEDs for device tracking and status indication
Network Protocols	IPv4, 802.1Q, 802.1p, 802.1x, 802.11e/WMM
QoS	802.11e/WMM, VLAN, TOS



Network Management	<p>Embedded controller can manage up to 50 local GWN APs</p> <p>GWN.Cloud offers a free cloud management platform for unlimited GWN APs</p>
Power and Green Energy Efficiency	<p>PoE 802.3af/ 802.3at;</p> <p>Max Consumption: 16.5W</p>
Temperature & Humidity	<p>Operation: -30°C to 60°C</p> <p>Storage: -30°C to 70°C</p> <p>Humidity: 5% to 95% Non-condensing</p>
Physical	<p>Unit Dimension: 533.1 × 115 × 40mm; Unit Weight: 564g</p> <p>Unit + Mounting Kits Dimension : 533.1×115 ×62mm; Unit + Mounting Kits Weight : 706g</p> <p>Entire Package Dimension: 258 × 247× 86mm; Entire Package Weight: 978g</p>
Package Content	GWN7630LR 802.11ac Wireless AP, Mounting Kits, Quick Installation Guide
Waterproof Grade	IP66-level weatherproof capability when installed vertically
Compliance	FCC, CE, RCM, IC



INSTALLATION

Before deploying and configuring the GWN76XX, the device needs to be properly powered up and connected to the network. This section describes detailed information on installation, connection and warranty policy of the GWN76XX.

Equipment Packaging

Table 6: GWN7630/GWN7610/GWN7615/GWN7605/GWN7600 Equipment Packaging

Main Case (GWN7630 or GWN7610 or GWN7615 or GWN7605 or GWN7600)	Yes (1)
Mounting Bracket	Yes (1)
Ceiling Mounting Bracket	Yes (1)
Plastic Expansion Bolt	Yes (3)
M3 NUT	Yes (3)
Screw (PM 3 x 50)	Yes (3)
Screw (PM 3.5 x 20)	Yes (3)
Quick Installation Guide	Yes (1)
GPL License	Yes (1) GWN7605/7615 No

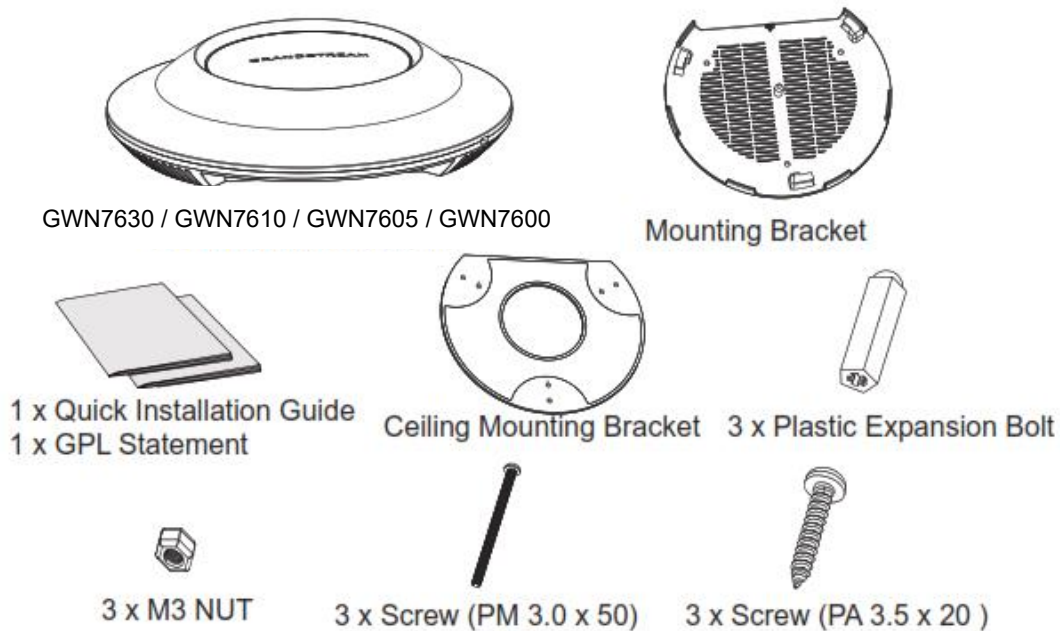

Figure 1: GWN7630 or GWN7610 or GWN7605 or GWN7600 Equipment Packaging

Below is the equipment packaging for GWN7600LR model.

Table 7: GWN7600LR Equipment Packaging

Main Case	Yes (1)
Cover Interface	Yes (1)
Base Bracket	Yes (1)
Cover Bracket	Yes (1)
Assembled Screw	Yes (4)
Locknut	Yes (4)
Anchors + Screws	Yes (4)
Screw (PM8 x 115)	Yes (4)
Quick Installation Guide	Yes (1)
GPL License	Yes (1)



Figure 2: GWN7600LR Equipment Package

Below is the equipment packaging for GWN7630LR/ GWN7605LR model.

Table 8: GWN7630LR Equipment Packaging

Main Case	Yes (1)
Antenna	GWN7630LR: Yes (4) GWN7605LR: Yes (2)
Base Bracket	Yes (1)
Screw (PM 3.0x7)	Yes (4)
Expansion Screw	Yes (4)
Metal Strap	Yes (2)
Quick Installation Guide	Yes (1)

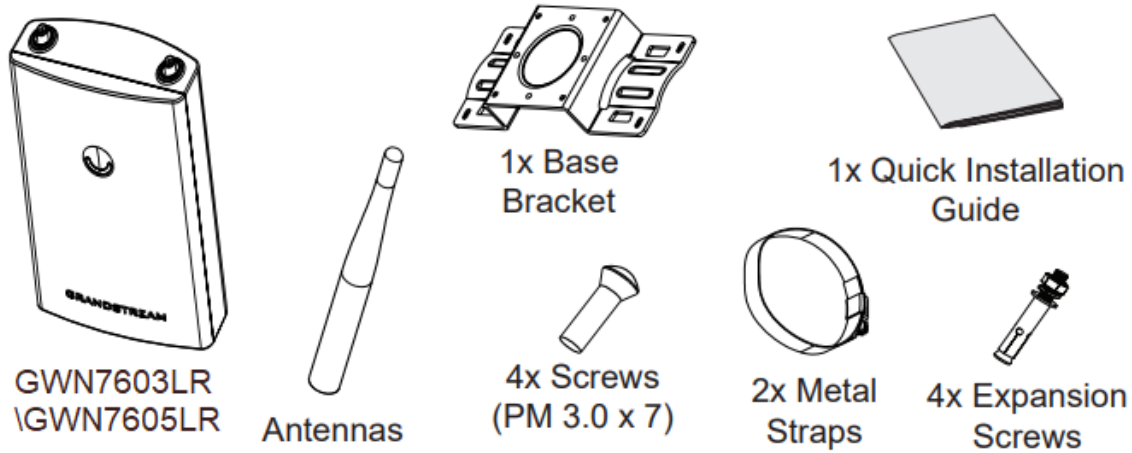
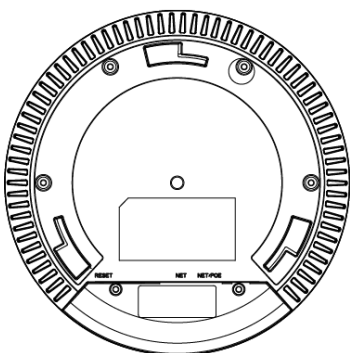

Figure 3: GWN7630LR/GWN7605LR Equipment Package

GWN76XX Access Point Ports



**Figure 4: GWN7630/GWN7615
/GWN7605 Ports**

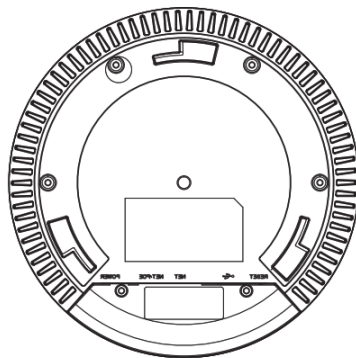

Figure 5: GWN7610/GWN7600 Ports

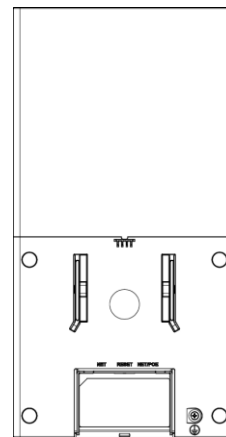
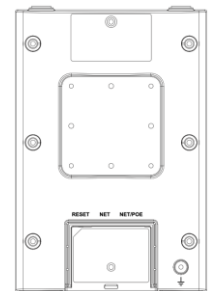



Figure 6: GWN7600LR Ports



**Figure 7: GWN7630LR
/GWN7605LR Ports**

Table 9: GWN76XX AP Ports Description

Port	Description
Power	Power adapter connector (24V, 1A) * Available on GWN7610 and GWN7600 only
NET/PoE	Ethernet RJ45 port (10/100/1000Mbps) supporting PoE/PoE+. * GWN7600 supports PoE (802.3af) only
NET	Ethernet RJ45 port (10/100/1000Mbps) to your router or another GWN76XX series.
	USB 2.0 port (for future IOT & location-based applications) * Available on GWN7610 and GWN7600 only
RESET	Factory reset button. Press for 7 seconds to reset factory default settings. Quick press will only reboot the unit.

Power and Connect GWN76XX Access Point

Step 1:

Connect one end of a RJ-45 Ethernet cable into the NET or PoE/NET port of the GWN76XX unit.

Step 2:

Connect the other end of the Ethernet cable(s) into a LAN port to your Network. (Use PoE/PoE+ switch for GWN7615/GWN7605/ GWN7605LR/GWN7600LR).

Step 3:

For GWN7610/GWN7600 only, connect the 24V DC power adapter into the power jack on the back of the access point. Insert the main plug of the power adapter into a surge-protected power outlet. Otherwise, PoE can be used if the switch port does provide PoE power.

Notes:

- GWN7630/ GWN7615/GWN7610/GWN7605/GWN7605LR/GWN7600LR/GWN7630LR can be powered using PoE(802.3af)/PoE+(802.3at) switch via PoE/NET port while GWN7600 can be powered using PoE (802.3af) switch via PoE/NET port. In this case, both power and network connectivity will be provided over the PoE/NET port.
- GWN7630/GWN7610 has a PoE detection daemon that will monitor the status and update maximum allowable power for USB ports in real time.

Step 4:

Wait for the GWN76XX to boot up and acquire an IP address from the DHCP Server.

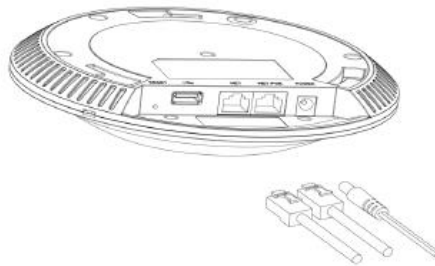

Figure 8: Connecting GWN AP - GWN7600 as example

Warranty

If the GWN76XX Wireless Access Point was purchased from a reseller, please contact the company where the device was purchased for replacement, repair or refund.

If the device was purchased directly from Grandstream, contact our Technical Support Team for an RMA (Return Materials Authorization) number before the product is returned. Grandstream reserves the right to remedy warranty policy without prior notification.

Wall/Ceiling Mount Installation GWN7630/GWN7605/GWN7610/GWN7600

GWN7630/GWN7610/GWN7615/GWN7600/GWN7605 can be mounted on the wall or ceiling, please refer to the following steps for the appropriate installation. This is the GWN7600 example:

Wall Mount

Step1:

Position the mounting bracket at the desired location on the wall with the arrow pointing up.

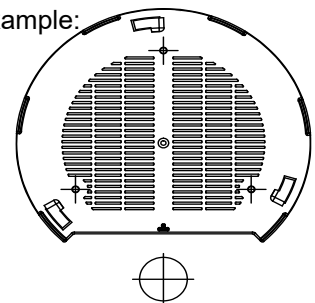

Figure 9: Wall Mount – Steps 1 & 2

Step 2:

Use a pencil to mark the four mounting holes (screw holes DIA 5.5mm, reticle hole DIA 25mm).

Step 3:

Insert screw anchors into the 5.5 mm holes. Attach the mounting bracket to the wall by inserting the screws into the anchors.

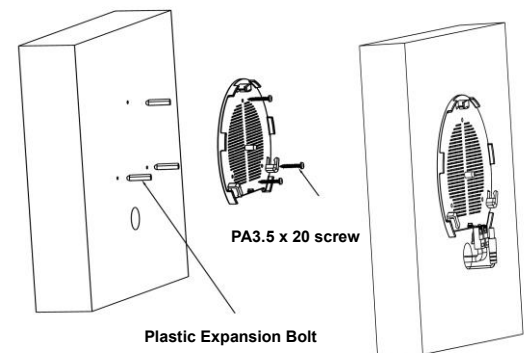

Figure 10: Wall Mount – Steps 3 & 4

Step 4:

Connect the power cable and the Ethernet cable (RJ45) to the correct ports of your GWN7630/GWN7610/GWN7615/ GWN7605 /GWN7600.

Step 5:

Align the arrow on the GWN AP with the arrow on the locking tab of the mounting bracket and ensure that your GWN is firmly seated on the mounting bracket.

Step 6:

Turn the GWN clockwise until it locks into place and fits the locking tab.

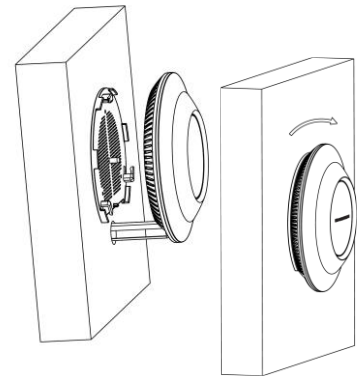

Figure 11: Wall Mount – Steps 5 & 6

Ceiling Mount

Step 1:

Remove the ceiling tile.

Step 2:

Place the ceiling backing plate in the center of the ceiling tile and mark the mounting screw holes (screw holes DIA 5.5mm, reticle hole DIA 25mm).

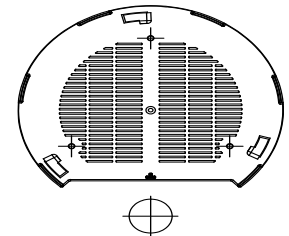

Figure 12: Ceiling Mount – Steps 1 & 2

Step 3:

Insert the screws through the mounting bracket.

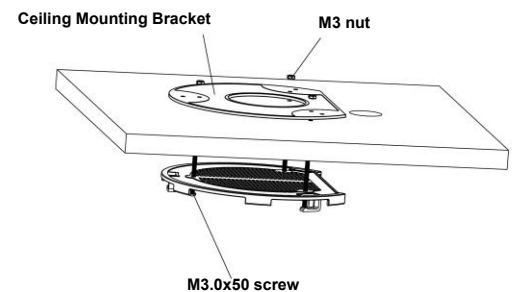

Figure 13: Ceiling Mount – Step 3

Step 4:

Connect the power cable and the Ethernet cable (RJ45) to the correct ports of your GWN7600.

Step 5:

Align the arrow on the GWN AP with the arrow on the locking tab of the mounting bracket and ensure that your GWN is firmly seated on the mounting bracket and connect the network and power cables.

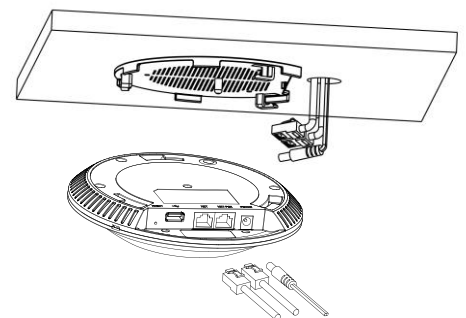

Figure 14: Ceiling Mount – Step 4

Step 6:

Turn the GWN clockwise until it locks into place and fits the locking tab.

Note:

Ceiling mounting is recommended for optimal coverage performance.

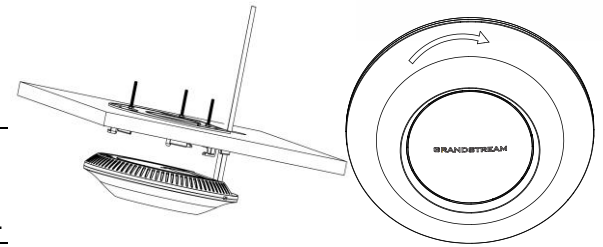

Figure 15: Ceiling Mount – Steps 5 & 6

Mounting Instructions for GWN7600LR

Please refer to the following steps for the mounting your GWN7600LR correctly.

1. Prepare the Cover Bracket by inserting the 4 screws (PM8) into corresponding holes.
2. Attach the Cover Bracket with screws on the vertical/horizontal Mounting Bolt were GWN7600LR will be installed.
3. Assemble the Base Bracket with the Cover Bracket using provided locknuts and screws (PM8).
4. Connect the Ethernet cable (RJ45) to the correct ports of your GWN7600LR.
5. Align the GWN7600LR with the Base Bracket and pull it down to the right position.
6. Install the 2x Assembled screws to fix GWN7600LR on the Mounting Bolt.

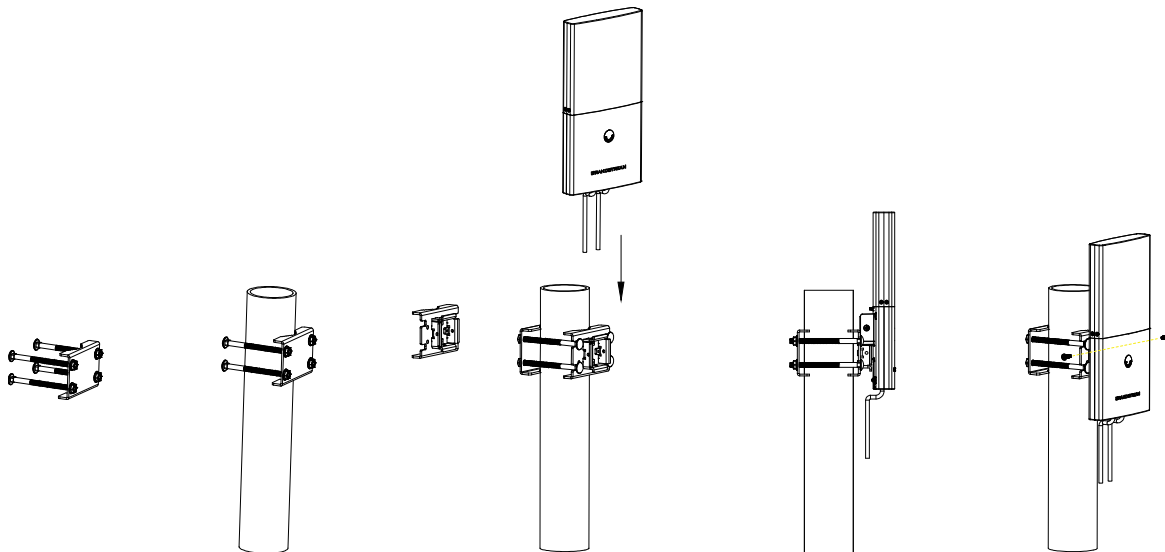

Figure 16: GWN7600LR Vertical Mounting

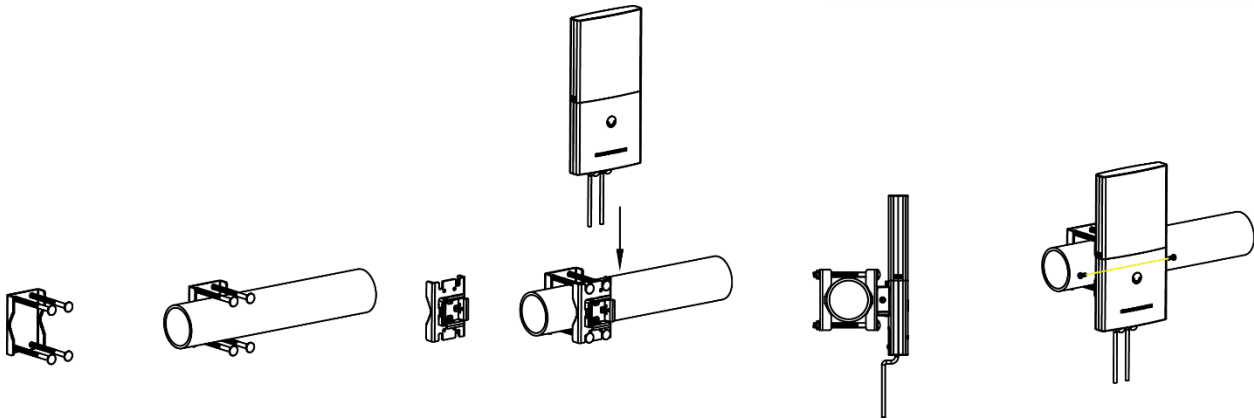

Figure 17: GWN7600LR Horizontal Mounting

Mounting Instructions for GWN7630LR/GWN7605LR

GWN7630LR can be mounted on the wall or on a metal bar. Please refer to the following steps for the appropriate installation.

1. Connect the Ethernet cable (RJ45) to the correct port of your GWN7630LR/GWN7605LR and insert the cover bracket.
2. Connect each antenna to an antenna connector by rotating it clockwise.
3. Attach the Base bracket with screws (PM 3.0x7) on the back of GWN7630LR /GWN7605LR access point.

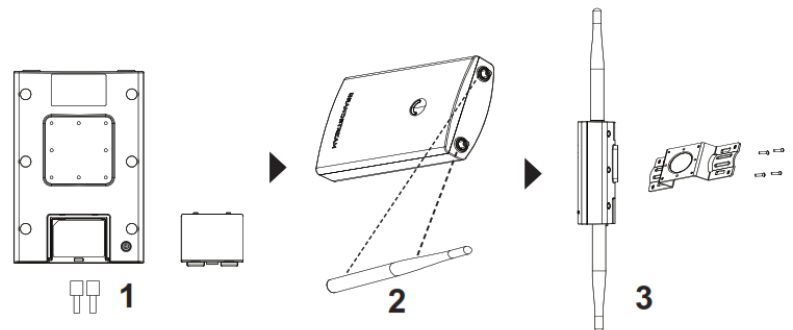

Figure 18: GWN7630LR/GWN7605LR Mounting Instructions

Wall Mount

4. Drill four holes on the wall referring to the positions of the ones on the base bracket. Then, fix an expansion screw in each hole.
5. Attach the GWN7630LR/GWN7605LR access point by securing the Base Bracket with the expansion screws on the wall.

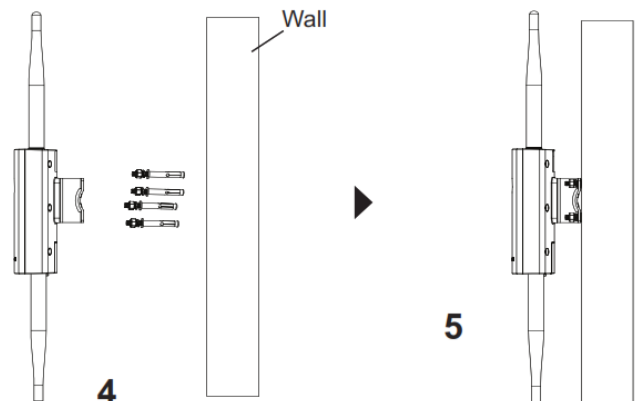

Figure 19: GWN7630LR/GWN7605LR Wall Mount

Pole Mount

4. Open the metal straps by turning the locking mechanism counter-clockwise. You can loosen it by hand or use a flathead screwdriver.
5. Straighten out the end of the metal straps and slide it through the back of the base bracket.
6. Wrap the metal strap around the pole and use a flathead screwdriver to tighten the locking mechanism by turning it clockwise.

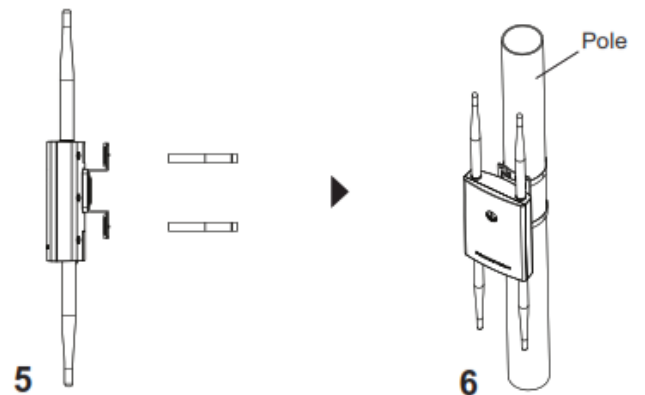

Figure 20: GWN7630LR/GWN7605LR Pole Mount

GETTING STARTED

The GWN76XX Wireless Access Point provides an intuitive web GUI configuration interface for easy management to give users access to all the configurations and options for the GWN76XX's setup.

This section provides step-by-step instructions on how to read LED patterns, discover the GWN76XX and use its Web GUI interface.

LED Patterns

The panel of the GWN76XX has different LED patterns for different activities, to help users read the status of the GWN76XX whether it's powered up correctly, provisioned, in upgrading process and more, for more details please refer to the below table.

Table 10: LED Patterns

LED Status	Indication
OFF	Unit is powered off or abnormal power supply.
Blinking green	Firmware update in progress.
Solid green	Firmware update successful.
Blinking red	Delete paired slave - Factory reset initiated.
Solid red	Firmware update failed.
Solid purple	Unit not provisioned.
Blinking blue	Unit provisioning in progress.
Solid blue	Unit is provisioned successfully.
Blinking White	Used for Access Point location feature
Yellow	Mesh disconnection.

Discover the GWN76XX

Once the GWN76XX is powered up and connected to the Network correctly, users can discover the GWN76XX using one of the below methods:

Method1: Discover the GWN76XX using its MAC address

1. Locate the MAC address on the MAC tag of the unit, which is on the underside of the device, or on the package.
2. From a computer connected to same Network as the GWN76XX , type in the following address using the GWN76XX's MAC address on your browser https://gwn_<mac>.local
For example, if a GWN76XX has the MAC address **00:0B:82:8B:58:30**, this unit can be accessed by typing https://gwn_000b828b5830.local/ on the browser.

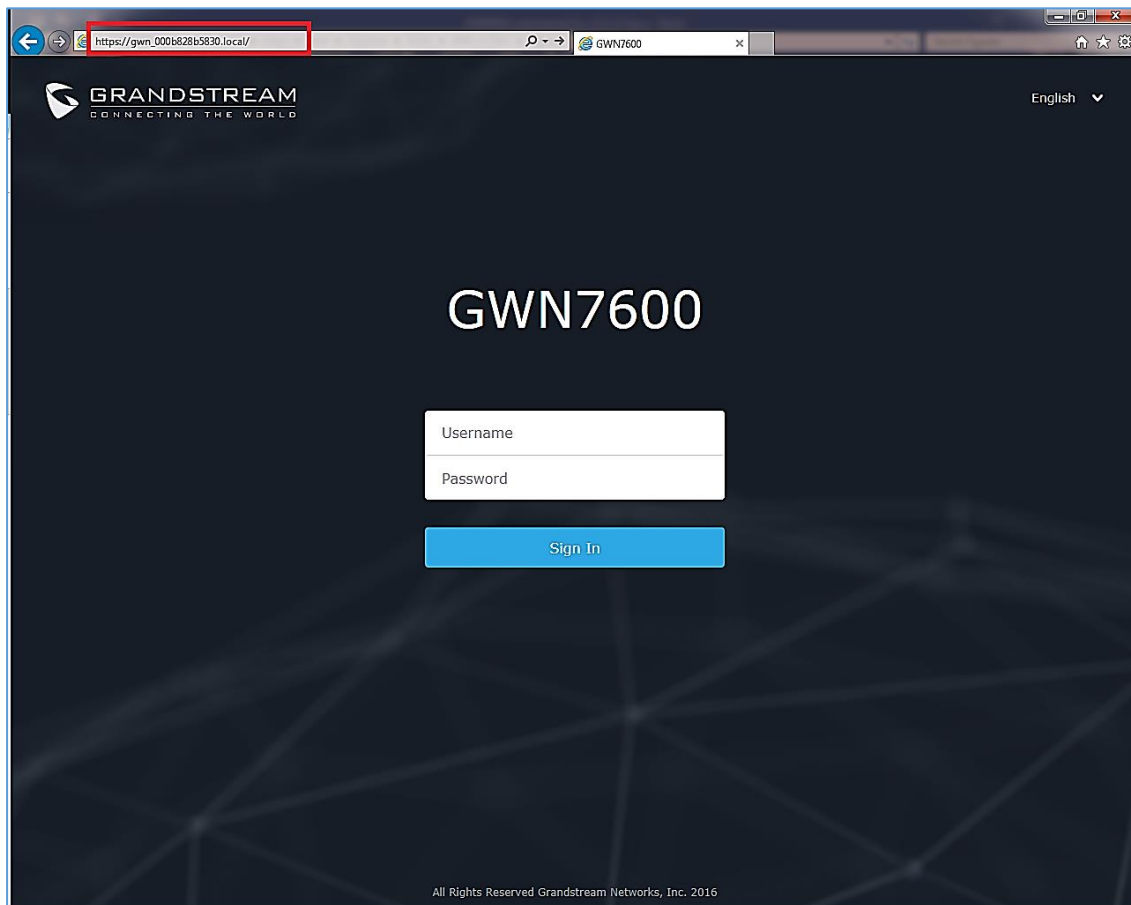
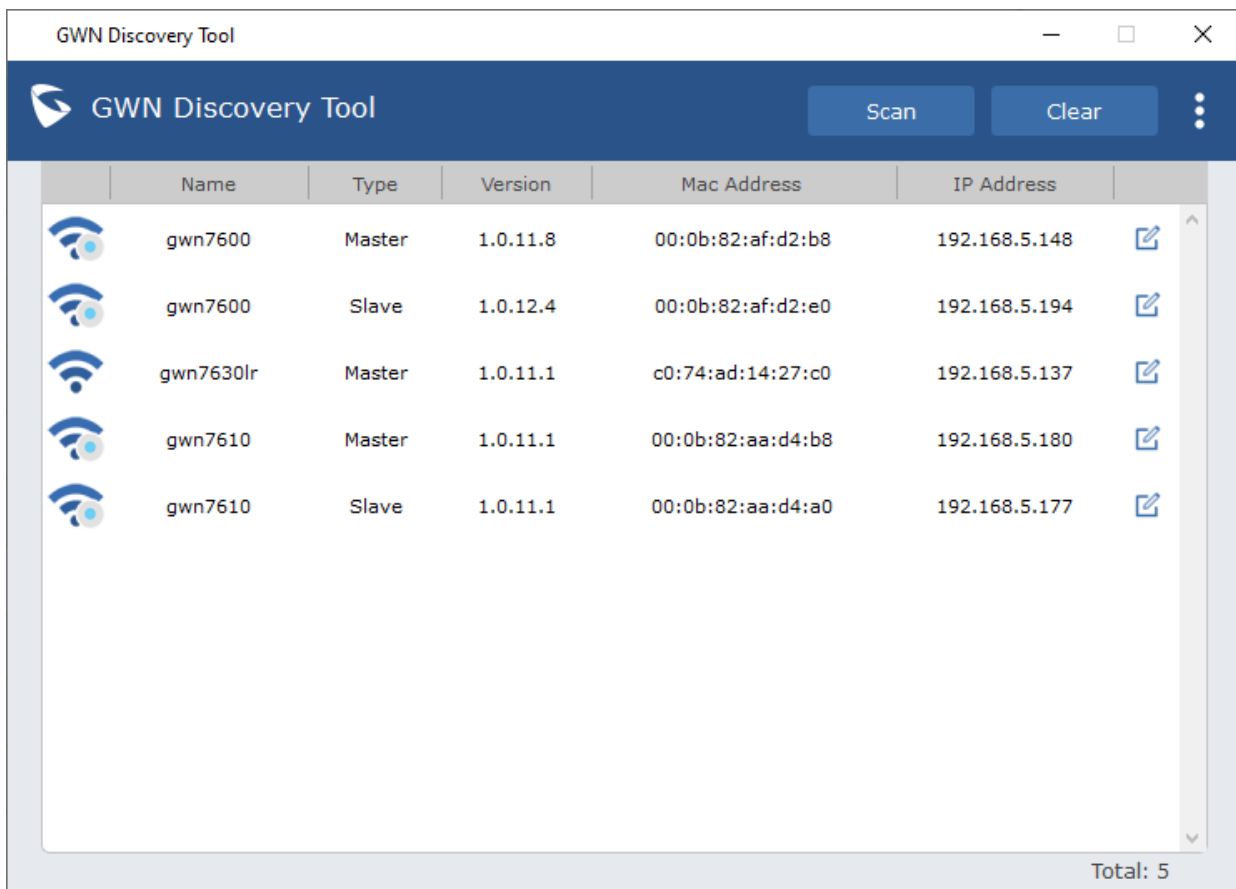

Figure 21: Discover the GWN76XX using its MAC Address

Method 2: Discover the GWN76XX using GWN Discovery Tool

1. Download and install **GWN Discovery Tool** from the following link:
<http://www.grandstream.com/support/tools>
2. Open the GWNDISCOVERYTool, click on **Select** to define the network interface, then click on **Scan**.
3. The tool will discover all GWN76XX Access Points connected on the network showing their MAC, IP addresses and firmware version.
4. Click on **Manage Device** to be redirected directly to the GWN76XX's configuration interface, or type in manually the displayed IP address on your browser.



The screenshot shows the GWN Discovery Tool interface. At the top, there is a header with the Grandstream logo and the text 'GWN Discovery Tool'. Below the header, there are two buttons: 'Scan' and 'Clear'. A table displays the results of the scan, with columns for Name, Type, Version, Mac Address, and IP Address. Each row also includes a Wi-Fi icon and a link icon. At the bottom right of the table area, it says 'Total: 5'.

Name	Type	Version	Mac Address	IP Address
gwn7600	Master	1.0.11.8	00:0b:82:af:d2:b8	192.168.5.148
gwn7600	Slave	1.0.12.4	00:0b:82:af:d2:e0	192.168.5.194
gwn7630lr	Master	1.0.11.1	c0:74:ad:14:27:c0	192.168.5.137
gwn7610	Master	1.0.11.1	00:0b:82:aa:d4:b8	192.168.5.180
gwn7610	Slave	1.0.11.1	00:0b:82:aa:d4:a0	192.168.5.177

Total: 5

Figure 22: GWN Discovery Tool

Use the Web GUI

Users can access then the GWN76XX using its WebGUI, the following sections will explain how to access and use the Web Interface.

Access Web GUI

The GWN76XX embedded Web server responds to HTTPS GET/POST requests. Embedded HTML pages allow users to configure the device through a Web browser such as Microsoft IE, Mozilla Firefox, Google Chrome and etc.

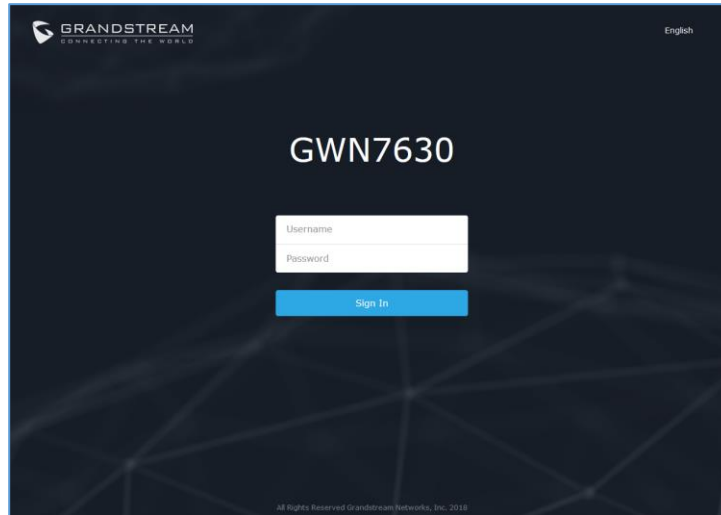

Figure 23: GWN76XX Web GUI Login Page

To access the Web GUI:

1. Make sure to use a computer connected to the same local Network as the GWN76XX.
2. Ensure the device is properly powered up.
3. Open a Web browser on the computer and type in the URL using the MAC address as shown in [Discover the GWN76XX] or the IP address using the following format: https://IP_Address
4. Enter the administrator's login and password to access the Web Configuration Menu. The default administrator's username is always "admin" and password is the unique default *Wi-Fi Password* available on the sticker on the back of the unit.

WEB GUI Languages

Currently the GWN76XX series web GUI supports **English** and **Simplified Chinese**.

Users can select the displayed language at the upper right of the web GUI either before or after login.

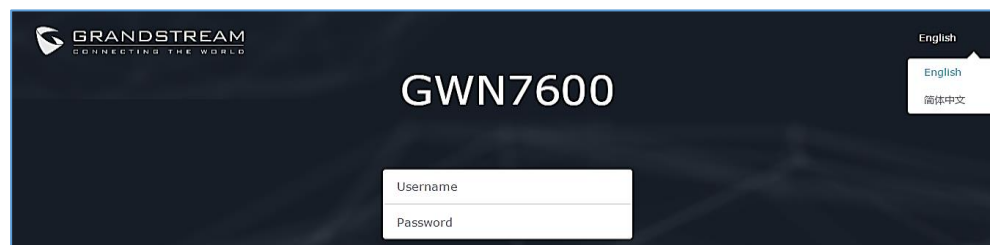

Figure 24: GWN76XX Web GUI Language (Login page)





Figure 25: GWN76XX Web GUI Language (Web Interface)

Overview Page

Overview is the first page shown after successful login to the GWN76XX's Web Interface. Overview page provides an overall view of the GWN76XX information presented in a Dashboard style for easy monitoring along with firmware version and date-time information at the top.

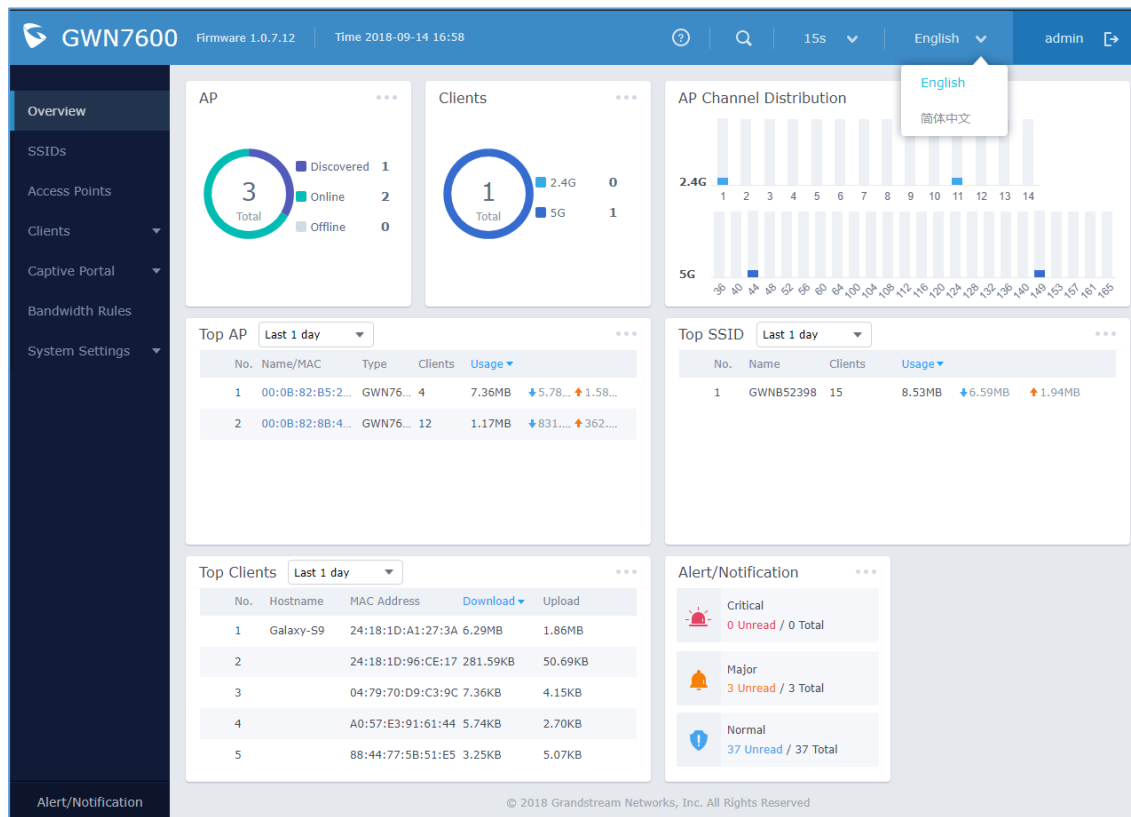







Figure 26: GWN76XX Dashboard (GWN7600 as example)

Users can quickly see the status of the GWN76XX for different items, please refer to the following table:

Table 11: Overview

Item	Description
AP	Shows the number of Access Point that are Discovered, Paired (Online) and Offline. Users may click on  to go to Access Points page for basic and advanced configuration options for the APs



Clients	Shows the total number of connected clients, and a count for clients connected to each Channel. Users may click on  to go to Clients page for more options.
AP Channel Distribution	Shows the Channel used for all APs that are paired with this Access Point.
Top AP	Shows the Top APs list, users may assort the list by number of clients connected to each AP or data usage combining upload and download. Users may click on  to go to Access Points page for basic and advanced configuration options for the APs.
Top SSID	Shows the Top SSIDs list, users may assort the list by number of clients connected to each SSID or data usage combining upload and download. Users may click on  to go to SSID page for more options.
Top Clients	Shows the Top Clients list, users may assort the list of clients by their upload or download. Users may click on  to go to Clients page for more options.
Alert/Notification	Shows 3 types of Alert/Notifications: Critical, Major and Normal. Users can click  to pop up the list of Alert and Notifications.

Note that Overview page in addition to other tabs can be updated each 15s, 1min ,2min and 5min or Never by clicking  in the upper bar menu (Default is 15s).

New Firmware Notification: Starting from firmware version 1.0.5.13/1.0.5.14, and once a different OFFICIAL firmware is released on Grandstream Networks website, the master AP will popup reminder notification to the administrator in order to upgrade the device. You can click on **New** button in order to be redirected to the release note of the new firmware version, for upgrading steps please refer to section [UPGRADING AND PROVISIONING].

Save and Apply Changes

When clicking on "Save" button after configuring or changing any option on the web GUI pages. A message mentioning the number of changes will appear on the upper menu. Click  button to apply changes.

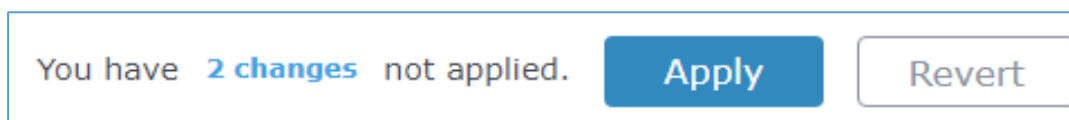

Figure 27: Apply Changes

GWN MANAGEMENT PLATFORMS

GWN.Cloud

Starting from firmware 1.0.6.41/1.0.6.43, the GWN76XX can be managed by your **GWN.Cloud** account, **GWN.Cloud** web interface now can be accessed at <https://www.gwn.cloud>.



Figure 28: GWN.Cloud Architecture

GWN.Manager

Starting from firmware 1.0.13.1, the GWN76XX can be managed and monitored by your **GWN Manager** account, GWN Manager On-premise Access Points Controller platform can be installed using the link below: <https://www.grandstream.com/support/firmware>



Figure 29: GWN Manager Architecture

Please refer to [GWN Management Platform User Guide](#) for more detailed information.



USING GWN76XX AS STANDALONE ACCESS POINT

The GWN76XX can be used in Standalone mode, where it can act as Master Access Point Controller or in Slave mode and managed by another GWN76XX Master.

This section will describe how to use and configure the GWN76XX in standalone mode.

Connect to GWN76XX Default Wi-Fi Network

GWN76XX can be used as standalone access point out of box, or after factory reset with Wi-Fi enabled by default.

After powering the GWN76XX and connecting it to the network, GWN76XX will broadcast a default SSID based on its MAC address **GWN [MAC's last 6 digits]** and a random password.

Note that GWN76XX's default SSID and password information are printed on the MAC tag of the unit as shown on the below figure.

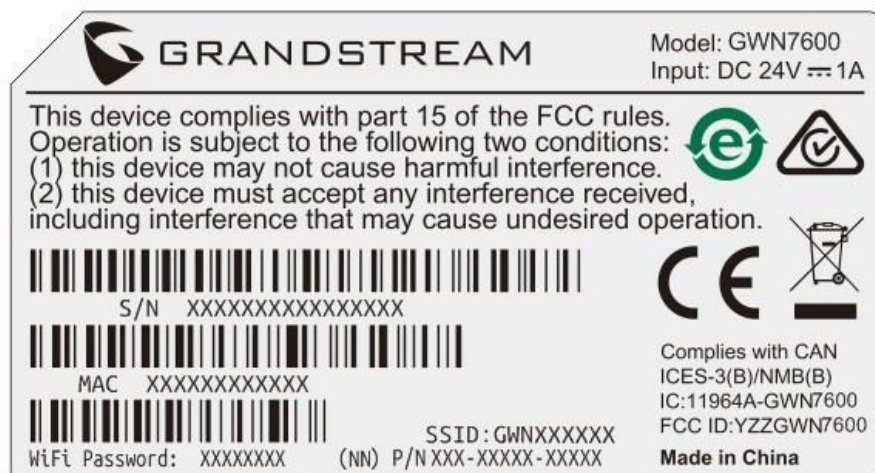

Figure 30: MAC Tag Label

USING GWN76XX AS MASTER ACCESS POINT CONTROLLER

Master Mode allows a GWN76XX to act as an Access Point Controller managing other GWN76XX access points. This will allow users adding other access points under one controller and managing them in an easy and a centralized way.

Master/Slave mode is helpful with large installations that needs more coverage area zones with the same controller.

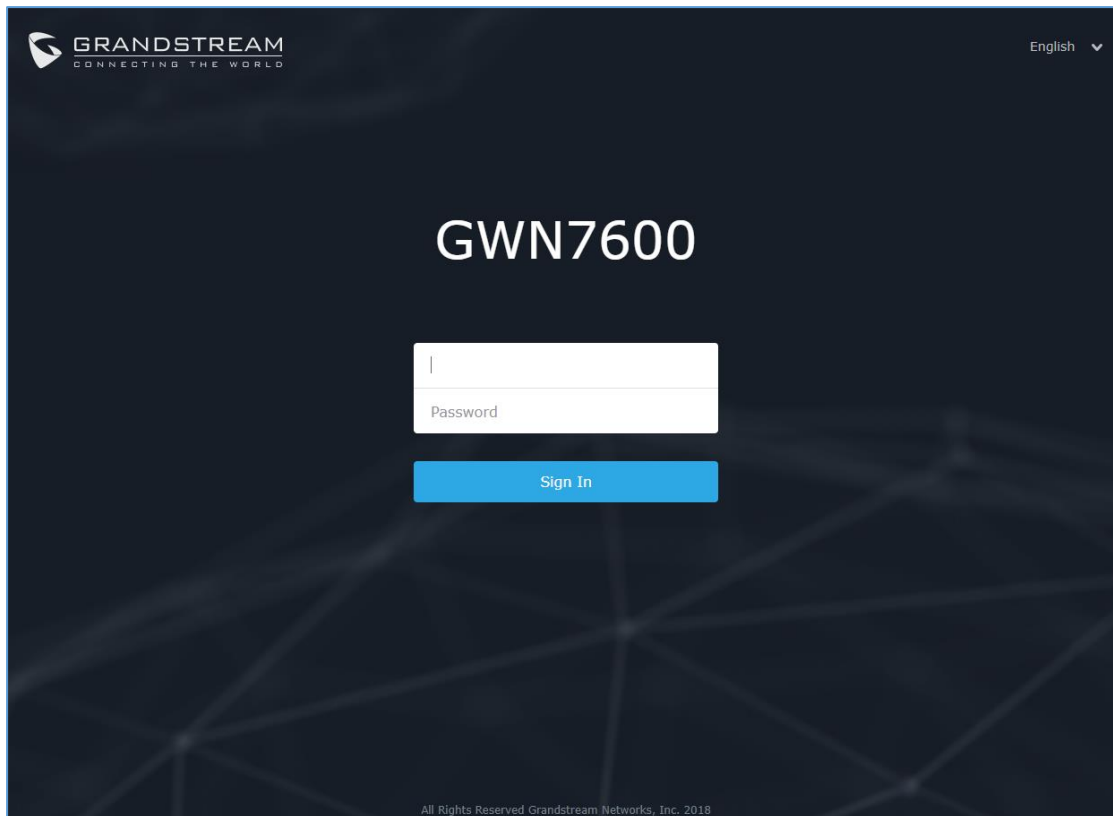



Figure 31: Login Page

 **Warning:**

“Set unit as Master” option will forbid the GWN76XX Access Point from being paired by other Master GWN76XX and can only act as a Master Access point controller.

Users will need to perform a factory reset to the GWN76XX , or unpair it from the initial GWN76XX to make it open to Master Access Point mode again.

Login Page

After login, users can use the Setup Wizard tool to go through the configuration setup or exit and configure it manually. Setup Wizard can be accessed anytime by clicking on  while on the web interface.

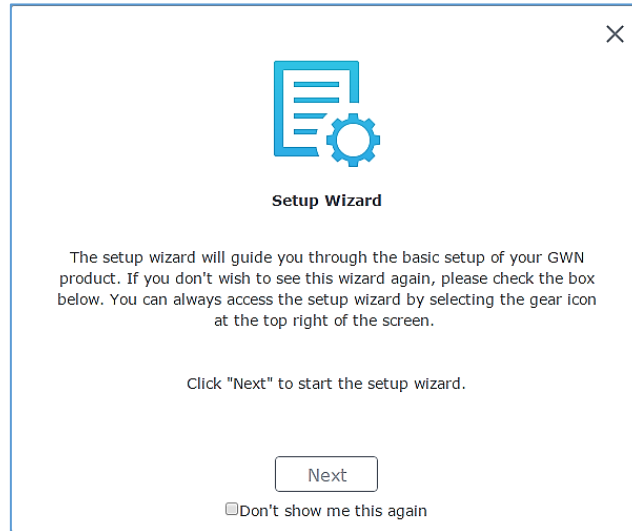

Figure 32: Setup Wizard

Discover and Pair Other GWN76XX Access Point

First, note that by default the GWN controller access point will automatically discover all APs connected to the same LAN (broadcast domain), but starting from firmware 1.0.5.13/1.0.514 a new possibility has been added in order to pair and provision remote APs using DHCP option 43 with master direction explained below.

Master Direction

To pair and manage access points located on remote networks, the admin needs to configure the IP address of master AP on DHCP option 43 which will be send to the slave access point during booting stage and allow the save/master connection to be established remotely. GWN76XX accepts option 224 encapsulated in option 43, and the syntax is in TLV format. A simple example of DHCP 43 configuration would be:

224(Type)12(Length)10.157.0.234(Value) translated into Hex as e00c31302e3135372e302e323334

Scenario example: a company has two offices connected via VPN (master AP located on network 192.168.1.0/24 and slave AP located on remote network 192.168.2.0/2). On remote network the admin can set DHCP option 43 using GWN7000 router as following value:

encap:43,224,"192.168.1.100".

After that, the slave AP will be listed on the master AP discovered devices and ready for pairing and provisioning process which is described on the next steps.

To Pair a GWN76XX access point connected to the same Network as the GWN76XX follows the below steps:

1. Connect to the GWN76XX Web GUI as Master and go to **Access Points**.

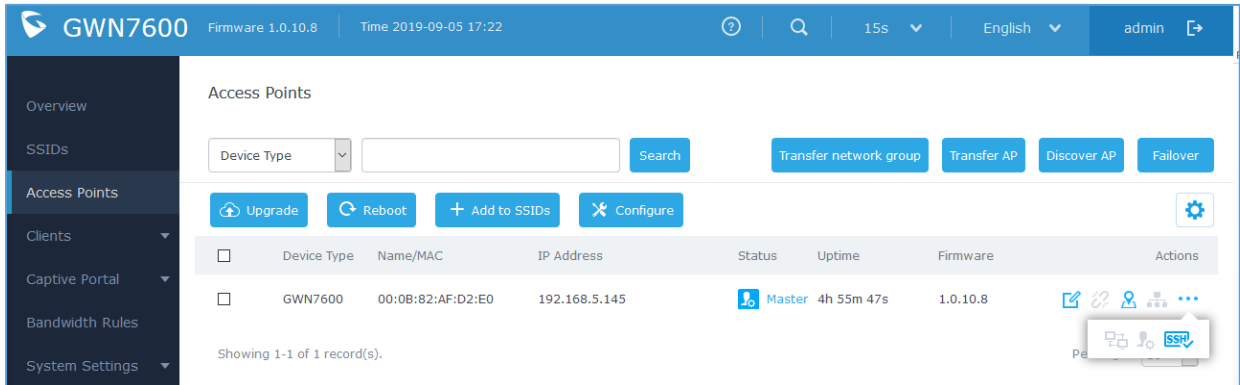



Figure 33: Discover and Pair GWN76XX

2. Click on  to discover access points within GWN76XX Network, the following page will appear.



Discovered Devices						
Device Type	MAC	IP Address	Firmware	Type	Actions	
GWN7610	00:0B:82:AA:D4:A0	192.168.5.177	1.0.6.38	Wired		
GWN7610	00:0B:82:8B:4D:...	192.168.5.156	1.0.7.12	Wired		

Figure 34: Discovered Devices

3. Click on Pair  under Actions, to pair the discovered access point as slave with the GWN76XX acting as Master.

4. The paired GWN76XX will appear Online, users can click on  to unpair it.













<input type="checkbox"/>	GWN7600	00:0B:82:AF:D2:E0	192.168.5.145	 Master	23h 46m 46s	1.0.10.8	    
<input type="checkbox"/>	GWN7630	00:0B:82:9A:96:58	192.168.5.121	Online	1h 15m 13s	1.0.10.8	    

Figure 35: GWN76XX Online

5. Users can click  on next to Master or paired access point to check device configuration for its status, users connected to it and configuration. Refer to below table for Device Configuration tabs.





6. Now an easier way to transfer your master authority from one unit to another available unit is available on Access Point management page. By clicking the  then  “**Transfer to Master**” button the designated slave unit will be upgraded to master and current master will be downgraded to slave accordingly.

Table 12: Device Configuration

Field	Description
Status	Shows the device’s status information such as MAC, Product Model, Part Number, Boot Version, Firmware version, IP Address, Link Speed, Uptime, and Users count via different Radio channels.
Clients	Shows the connected users to the GWN76XX access point.
Configuration	<ul style="list-style-type: none"> • Device Name: Set GWN76XX’s name to be shown next to MAC address. • Fixed IP: Set a static IP for the GWN76XX, default is unchecked. • Airtime Fairness: Allow faster clients to have more airtime than slower clients. <i>This feature is not supported on GWN7630/GWN7630LR.</i> • Band Steering: When Frequency is set to Dual-Band, users can check this option to enable Band Steering on the Access Point, this will help redirecting clients to a radio band accordingly for efficient use and to benefit from the maximum throughput supported by the client. • Client Steering: This feature will help Wi-Fi client to roam to other APs within same Network. parameters of RSSI Threshold and Client Access Threshold parameters will show up only when Client Steering is enabled. • Mode: Choose the mode for the frequency band, 802.11n/g/b for 2.4 GHz and 802.11ac for 5GHz. • Channel Width: Choose the Channel Width, note that wide channel will give better speed/throughput, and narrow channel will have less interference. 20Mhz is suggested in very high-density environment. • 40MHz Channel Location: Configure the 40MHz channel location when using 20MHz/40MHz in Channel Width, users can set it to be Secondary below Primary, Primary below Secondary or Auto. • Channel: Select Auto, or a specified channel, default is Auto. Note that the proposed channels depend on Country Settings under System Settings→Maintenance.



- **Enable Short Guard Interval:** Check to activate this option to increase throughput.
- **Active Spatial Streams:** Choose active spatial stream if Auto, 1 or 2 streams.
- **Radio Power:** Set the Radio Power, it can be Low, Medium or High.
- **Custom Wireless Power(dBm):** allows users to set a custom wireless power for both 5GHz/2.4GHz band, the value of this field must be between 1 and 31.
- **Allow Legacy Devices(802.11b):** Check to support 802.11b devices to connect the AP in 802.11n/g mode.
- **Dynamic Channel Assignment:** Once enabled, AP will try to allocate and move the best channel during operation, unlike Auto Channel Selection (ACS) which scan and assign channel when Wi-Fi interface goes up for one time. *This feature is not supported on GWN7610, GWN7630, GWN7630LR and GWN7605.*
- **Transmit Power Control:** TPC algorithm runs every 10 minutes. AP acquires the RSSI information of the neighbor by wireless scanning and establishes the neighbor table. The algorithm requires that there must be at least 3 neighbor APs with RSSI larger than -70dbm. Otherwise, power will not be adjusted. *This feature is not supported on GWN7610, GWN7630, GWN7630LR and GWN7605.*
- **Coverage Hole Detection:** CHD enables AP to decide whether to increase the AP power by the current SNR and SNR threshold of the connected clients. *This feature is not supported on GWN7610, GWN7630, GWN7630LR and GWN7605.*

Note

If a GWN76XX is not being discovered or the pair icon is grey color, make sure that it is not being paired with another GWN76XX Access Point acting as Master Controller, if yes users will need to unpair it first, or reset it to factory default settings in order to make it available for pairing by other GWN76XX Access Point Controller

AP Location

GWN supports a handy feature which allows users to locate other Access points by blinking LED. To use the feature, navigate on the master web GUI under “Access Points” page and click on the icon  near the desired AP, and it corresponding unit will start blinking the LEDs.



Transfer AP – Transfer Network Group

Users can easily transfer the AP from local master to the **GWN** account by clicking on  .
 When you already have Network/WIFI configurations on your cloud account, using this feature will let you choose existing Network/SSID to adopt your local AP.

Note: Local configurations will not be transferred.



feature will allow you to transfer your local configurations to your cloud account.

For more details, please refer to [GWN.Cloud User Guide](#).

Failover Master

In a Master-Slave architecture, having a backup Master is critical for redundancy and failover function, thus, and in order to avoid a single point of failure in your wireless network, you can specify a slave AP as failover master. Whenever it detects the master is down, it will promote itself as failover master within a time frame of around 20~30 minutes by entering failover mode. After then, if the master AP comes back, failover master will automatically go back to slave mode, or if the master doesn't come back to alive, Administrator can login using “failover” account to turn the failover master as true master and take over all controls.

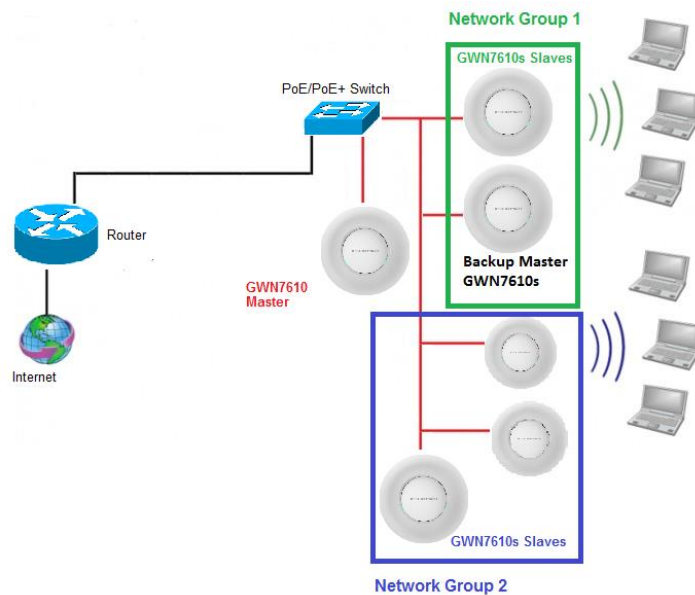

Figure 36: Failover Master

Users could select the failover Master by following below steps:

- Log into web GUI of the master GWN.
- Go to Access Points page.
- Press **Failover**
- Select from the available paired Slave Aps the candidate to become a failover Master.
- Save and Apply the settings.

Failover Mode

Once failover slave has been selected, the primary master will send the configuration of the network to the failover slave and the slave will start monitoring the status of the primary master to detect any failure for any reason (network connection loss, power outage).

In case of failure, the failover slave will promote itself to a temporary backup master while waiting for the primary master to come back.

During the failover mode users could access the web GUI of the failover slave using a special failover account with same admin password.

- **Username = failover**
- **Password = admin password**

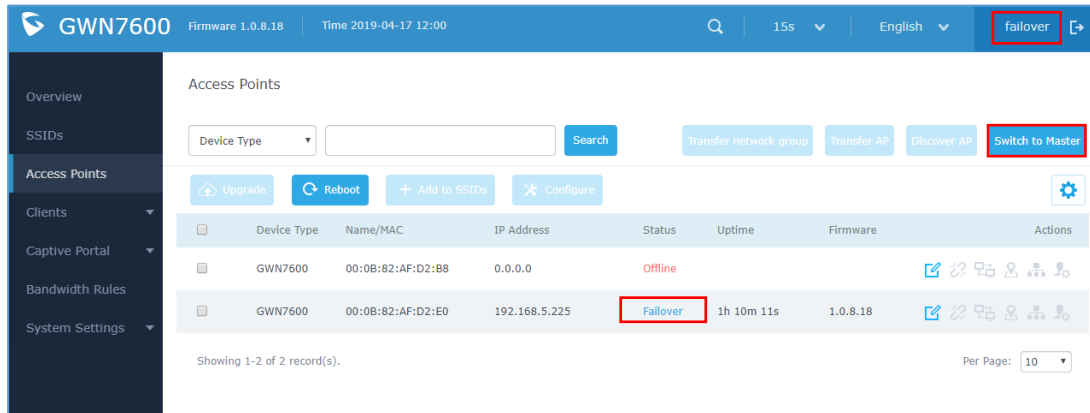

Figure 37: Failover Mode GUI

The failover mode has only read permission on the configuration and very limited options, users still can reboot other slave Access points in case it is needed.

Users also can press on « **Switch to Master** » button in order to set the failover slave as the new primary master of the wireless network, once this is done they have full write permission control over the web GUI option as usual. Use that button to switch to master and takeover the rest of the APs.

Important notes:

- If you click « **Switch to Master** », this would be become a non-revertible behavior. Failover Slave will become actual master and the prior master can't take back the control anymore.
- When Failover Slave is switched to Master, you will use the Prior Master AP credentials: username: admin, and the admin password.
- Otherwise, when original master comes back online, then Failover Slave will become slave again to prior original Master.

Takeover Feature

This feature is used to re-pair the slave APs whose master has gone offline with another master AP in the same subnet. Please follow the steps to takeover slave APs from other master:

Step 1. Login to the Web GUI of Master and click on “Discover APs” in the Access Points Page.

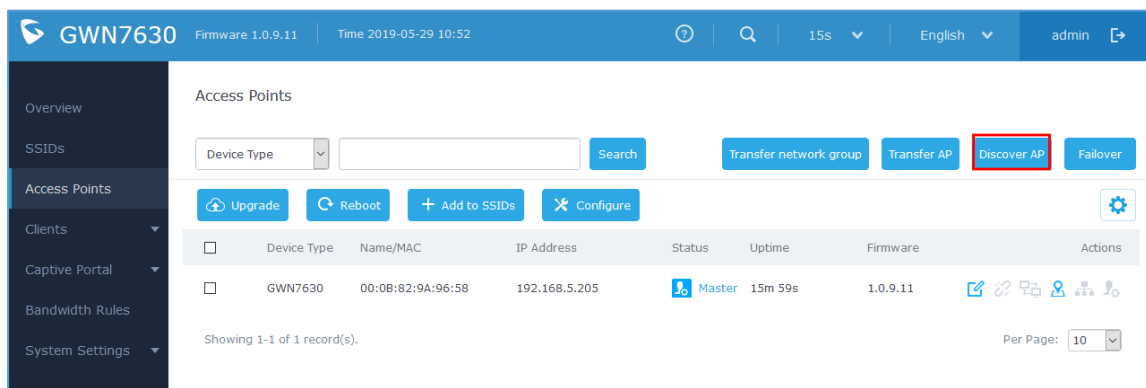

Figure 38: Takeover - Step 1

Step 2. Select the one or multiple APs to be taken over then click on “takeover” button of the target AP.

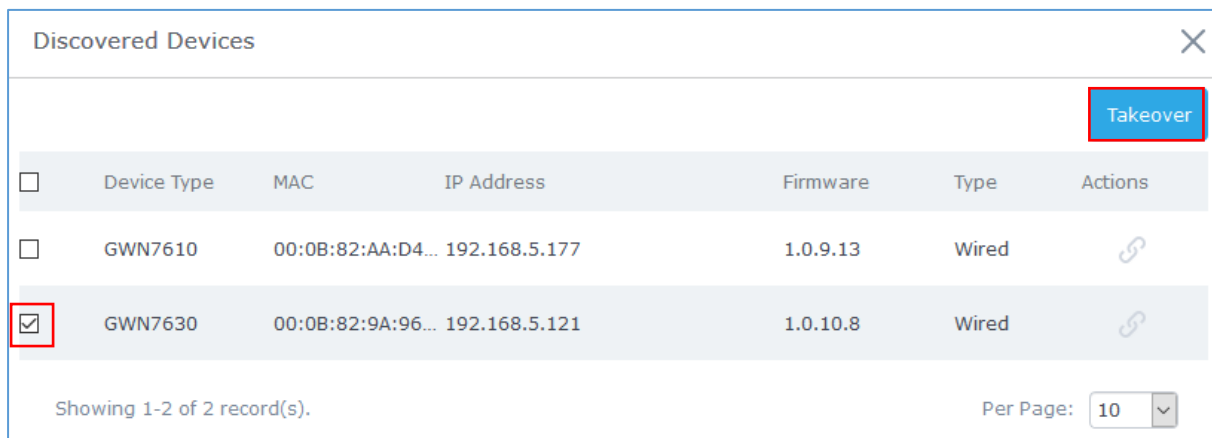

Figure 39: Takeover - Step 2

Step 3. Enter the Takeover key which is the admin password of the previous master AP.

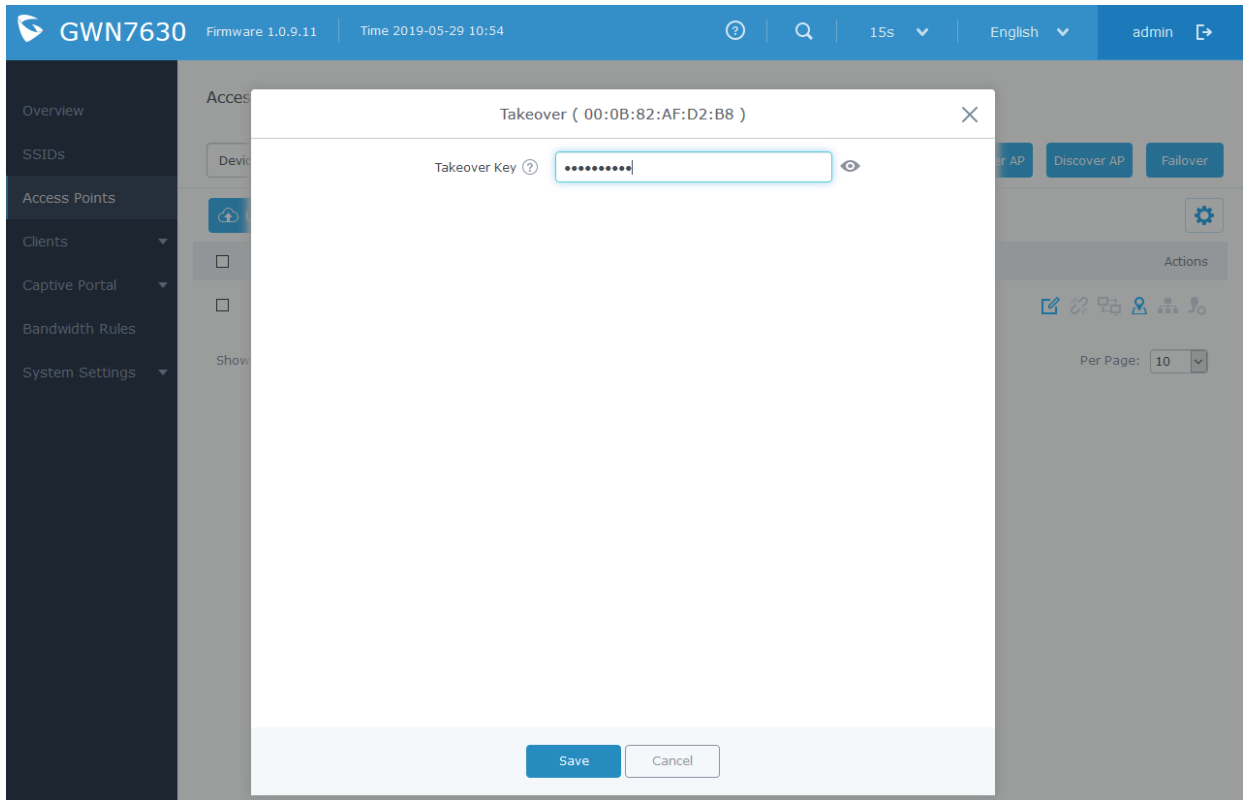

Figure 40: Takeover - Step 3

Transfer to Master

From the Master Access Point, the Administrator do have the capability to assign any Slave Access point to become the new Master to manage all the already paired Access points.

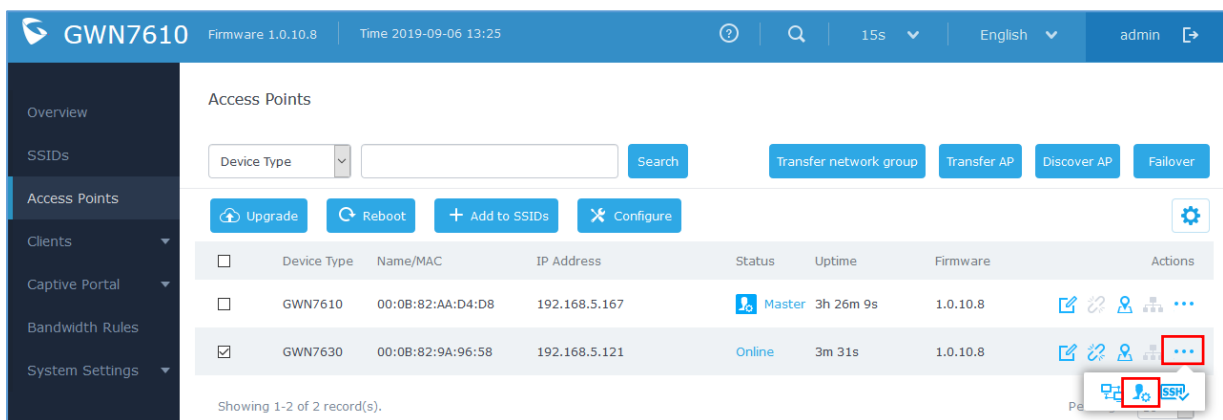

Figure 41: Switch to Master

After you click on  then press the “Switch to Master” button, the following warning message will

prompt in order to confirm the procedure:

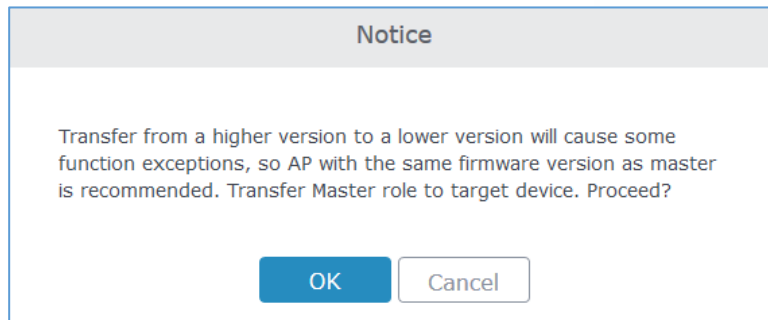

Figure 42: Transfer Master Role to another device confirmation message

When the process is finished, the original Master will turn to be a slave for the new Assigned Master, and to login to the new Master AP web interface, you will need to use the previous Master Admin password.

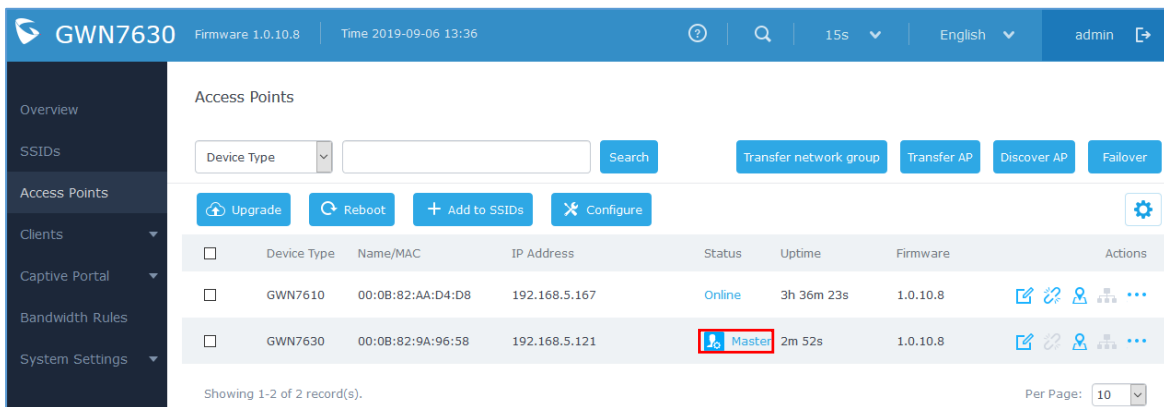



Figure 43: Then new assigned Master AP web interface

Note:

- All the previously existed paired APs will be provisioned with the new Master AP.
- The Switch to Master option is unlimited action and doesn't require any reset for the already paired Aps.

Client Bridge

The Client Bridge feature allows an access point to be configured as a client for bridging wired only clients wirelessly to the network. When an access point is configured in this way, it will share the Wi-Fi connection to the LAN ports transparently. This is not to be confused with a mesh setup. The client will not accept wireless clients in this mode.

Once a SSID has the Client Bridge Support enabled, the AP adopted in this SSID can be turned in to Bridge Client mode by click the  then the Bridge button .

Please be noted that once an AP it turned into Client Bridge mode, it cannot be controlled by a Master anymore, and a factory reset is required to turn it back into normal AP mode.





<input type="checkbox"/>	GWN7610	00:0B:82:8B:4E:28	192.168.6.37	Online	1.0.3.21	   
--------------------------	---------	-------------------	--------------	--------	----------	---

Figure 44: Client Bridge



Device Type	Name/MAC	IP Address	Status	Uptime
GWN7600	00:0B:82:AF:D2:58	192.168.5.100	Master	51m 53s
GWN7600	bridge 00:0B:82:AF:D2:E0	192.168.5.225	Online Bridge	2m 49s

Figure 45: Client Bridge

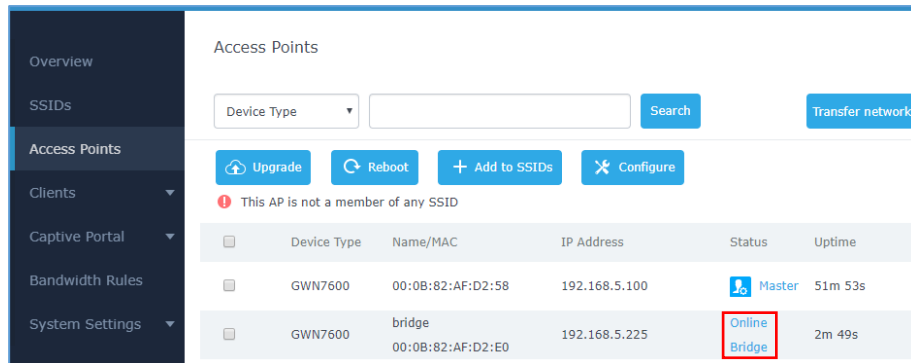
In order to verify, you may access the bridged AP configuration, then under **Status**, the option “Client Bridge Mode” would be set to **Isolated** like shown on the figure down below:

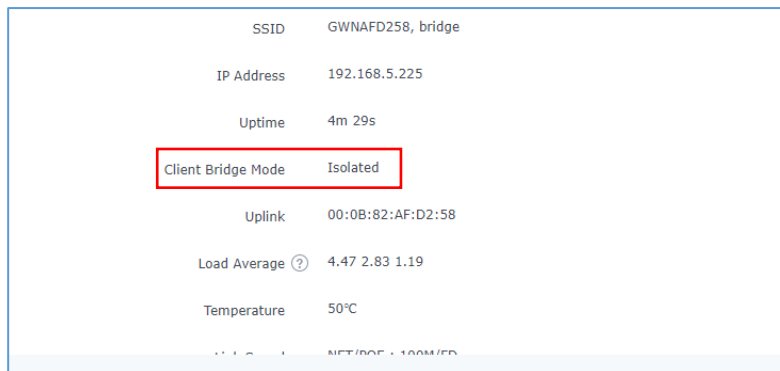

SSID	GWNAFD258, bridge
IP Address	192.168.5.225
Uptime	4m 29s
Client Bridge Mode	Isolated
Uplink	00:0B:82:AF:D2:58
Load Average	4.47 2.83 1.19
Temperature	50°C

Figure 46: Client Bridge Mode

Important Notes :

- The access point that will be operating on bridge mode, must be set with a fixed IP address before activating the bridge mode on the access point.
- Users must enable client bridge support option under SSID or SSID Wi-Fi settings in order to have it fully functional. See **[Client Bridge Support]**

SSID

When using GWN76XX as Master Access Point, users can create different SSIDs and assign GWN76XX Slave Access Points to them.

Log in as Master to the GWN76XX WebGUI and go to **SSIDs**.

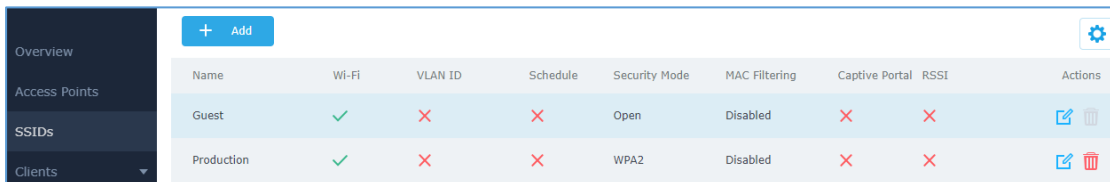





Name	Wi-Fi	VLAN ID	Schedule	Security Mode	MAC Filtering	Captive Portal	RSSI	Actions
Guest	✓	✗	✗	Open	Disabled	✗	✗	 
Production	✓	✗	✗	WPA2	Disabled	✗	✗	 

Figure 47: SSID

GWN7610/GWN7600/GWN7605/GWN7600LR/GWN7630LR can support up to 16 SSIDs and GWN7630 can support up to 15 SSIDs, click on  to add a new SSID.

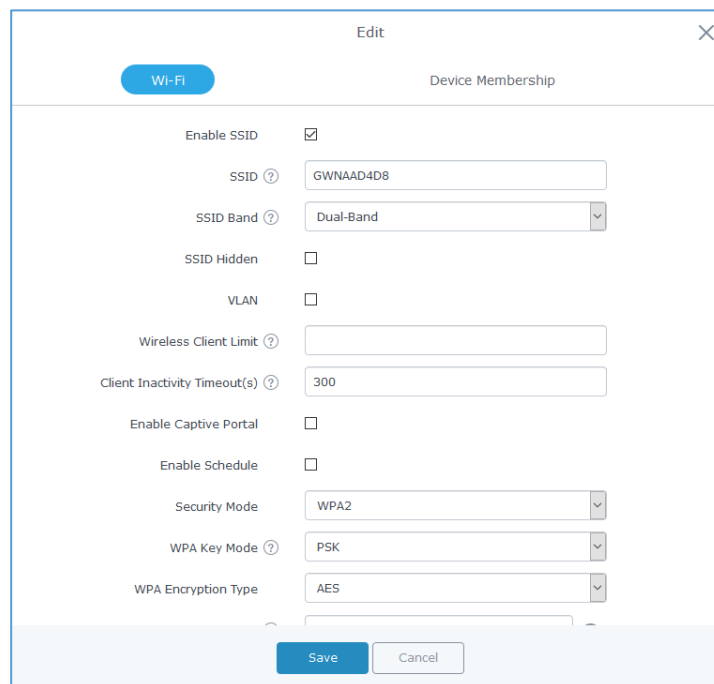

Figure 48: Add a new SSID

When editing or adding a new SSID, users will have two tabs to configure:

- **Wi-Fi:** Please refer to the below table for Wi-Fi tab options

Table 13: Wi-Fi

Field	Description
Enable SSID	Check to enable Wi-Fi for the SSID.
SSID	Set or modify the SSID name.
SSID Band	Select the Wi-Fi band the GWN will use, three options are available: <ul style="list-style-type: none"> • Dual-Band • 2.4GHz • 5Ghz
SSID Hidden	Select to hide SSID. SSID will not be visible when scanning for Wi-Fi, to connect a device to hidden SSID, users need to specify SSID name and authentication password manually.
VLAN	Enter the VLAN ID corresponding to the SSID.
Wireless Client Limit	Configure the limit for wireless client. If there's an SSID per-radio on a SSID, each SSID will have the same limit. So, setting a limit of 50 will limit each SSID to 50 users independently. If set to 0 the limit is disabled.
Enable Captive Portal	Click on the checkbox to enable the captive portal feature.
Client Inactivity Timeout(s)	AP will remove the client's entry if the client generates no traffic at all for the specified time period. The client inactivity timeout is set to 300 seconds by default. Range from 60-3600 seconds.
Captive Portal Policy	Select the captive portal policy already created on the "CAPTIVE PORTAL" web page to be used in the created SSID.
Enable Schedule	Check the box and choose a schedule to apply for the selected SSID.
Security Mode	Set the security mode for encryption, 5 options are available: <ul style="list-style-type: none"> • WEP 64-bit: Using a static WEP key. The characters can only be 0-9 or A-F with a length of 10, or printable ASCII characters with a length of 5. • WEP 128-bit: Using a static WEP key. The characters can only be 0-9 or A-F with a length of 26, or printable ASCII characters with a length of 13. • WPA/WPA2: Using "PSK" or "802.1x" as WPA Key Mode, with "AES" or "AES/TKIP" Encryption Type. • WPA2: Using "PSK" or "802.1x" as WPA Key Mode, with "AES" or "AES/TKIP" Encryption Type. Recommended configuration for authentication. • Open: No password is required. Users will be connected without authentication. Not recommended for security reasons.



WEP Key	<p>Enter the password key for WEP protection mode.</p> <p><i>This field is available only when “Security Mode” is set to “WEP 64-bit” or “WEP 128-bit”.</i></p>
WPA Key Mode	<p>Two modes are available:</p> <ul style="list-style-type: none"> • PSK: Use a pre-shared key to authenticate to the Wi-Fi. • 802.1X: Use a RADIUS server to authenticate to the Wi-Fi. <p><i>This field is available only when “Security Mode” is set to “WPA/WPA2” or “WPA2”.</i></p>
WPA Encryption Type	<p>Two modes are available:</p> <ul style="list-style-type: none"> • AES: This method changes dynamically the encryption keys making them nearly impossible to circumvent. • AES/TKIP: use both Temporal Key Integrity Protocol and Advanced Encryption Standard for encryption, this provides the most reliable security. <p><i>This field is available only when “Security Mode” is set to “WPA/WPA2” or “WPA2”.</i></p>
WPA Pre-Shared Key	<p>Set the access key for the clients, and the input range should be: 8-63 ASCII characters or 8-64 hex characters.</p> <p><i>This field is available only when “Security Mode” is set to “WPA/WPA2” or “WPA2”.</i></p>
RADIUS Sever Address	<p>Configures RADIUS authentication server address.</p> <p><i>This field is available only when “WPA Key Mode” is set to “802.1x”.</i></p>
RADIUS Server Port	<p>Configures RADIUS Server Listening port.</p> <p>Default is: 1812.</p> <p><i>This field is available only when “WPA Key Mode” is set to “802.1x”.</i></p>
RADIUS Server Secret	<p>Enter the secret password for client authentication with RADIUS server.</p> <p><i>This field is available only when “WPA Key Mode” is set to “802.1x”.</i></p>
RADIUS Accounting Server	<p>Configures the address for the RADIUS accounting server.</p> <p><i>This field is available only when “WPA Key Mode” is set to “802.1x”.</i></p>
RADIUS Accounting Server Port	<p>Configures RADIUS accounting server listening port.</p> <p>Defaults to 1813.</p> <p><i>This field is available only when “WPA Key Mode” is set to “802.1x”.</i></p>
RADIUS Accounting Server Secret	<p>Enter the secret password for client authentication with RADIUS accounting server.</p> <p><i>This field is available only when “WPA Key Mode” is set to “802.1x”.</i></p>
RADIUS NAS ID	<p>Enter the RADIUS NAS ID.</p>



	<i>This field is available only when “WPA Key Mode” is set to “802.1x”.</i>
Client Bridge Support	<p>Configures the client bridge support to allow the access point to be configured as a client for bridging wired only clients wirelessly to the network.</p> <p>When an access point is configured in this way, it will share the Wi-Fi connection to the LAN ports transparently.</p> <p>Once a SSID has a Client Bridge Support enabled, the AP adopted in this SSID can be turned in to Bridge Client mode by click the Bridge button.</p> <p>Note: This feature isn't supported on GWN7602.</p>
Client Time Policy	Select a time policy to be applied to all clients connected to this SSID.
Use MAC Filtering	<p>Choose Blacklist/Whitelist to specify MAC addresses to be excluded/included from connecting to the zone's Wi-Fi.</p> <p>Default is Disabled.</p>
Enable Dynamic VLAN	<p>When enabled, clients will be assigned IP address from corresponding VLAN configured on the RADIUS user profile.</p> <p><i>This field is available only when “WPA Key Mode” is set to “802.1x”.</i></p>
Client Isolation	<p>Client isolation feature blocks any TCP/IP connection between connected clients to GWN76XX's Wi-Fi access point. Client isolation can be helpful to increase security for Guest networks/Public Wi-Fi.</p> <p>Three modes are available:</p> <ul style="list-style-type: none"> • Radio Mode: Wireless clients can access to the internet services, GWN7xxx router and the access points GWN76XX but they cannot communicate with each other. • Internet Mode: Wireless clients will be allowed to access only the internet services and they cannot access any of the management services, either on the router nor the access points GWN76XX. <p>Gateway MAC Mode: Wireless clients can only communicate with the gateway, the communication between clients is blocked and they cannot access any of the management services on the GWN76XX access points.</p>
Minimum Access Rate Limit	<ul style="list-style-type: none"> • Specify whether to limit the minimum access rate for clients. When enabled, it will help to eliminate the legacy connection which slow the total performance of the Wi-Fi network. Range from 1 to 54 Mbps.
Gateway MAC Address	This field is required when using Client Isolation , so users will not lose access to the Network (usually Internet). Type in the default LAN Gateway's MAC address (router's MAC address for instance) in



	<p>hexadecimal separated by “:”.</p> <p>Example: 00:0B:82:8B:4D:D8</p>
RSSI Enabled	<p>Check to enable RSSI function, this will lead the AP to disconnect users below the configured threshold in Minimum RSSI (dBm).</p>
Minimum RSSI (dBm)	<p>Enter the minimum RSSI value in dBm. If the signal value is lower than the configured minimum value, the client will be disconnected.</p> <p>The input range is from “-94” or “-1”.</p>
Beacon Interval	<p>Configures interval between beacon transmissions/broadcasts.</p> <p>The Beacon signals help to keep the network synchronized and provide main information about the network such as SSID, Timestamp...</p> <ul style="list-style-type: none"> • Using High Beacon Interval: AP will be sending beacon broadcast less frequently. This will help to get better throughput, thus better speed/performance. It also helps to save Wi-Fi clients energy consumption. • Using Low Beacon Interval: AP will be sending beacon broadcast more frequently. This can help in environments with weak signal areas; sending more frequently beacons will increase chances to be received by Wi-Fi clients with weak signal. <p>Notes:</p> <ol style="list-style-type: none"> 1. When AP enables several SSIDs with different interval values, the max value will take effect. 2. When AP enables less than 3 SSIDs, the interval value which will be effective are the values from 40 to 500. 3. When AP enables more than 2 but less than 9 SSIDs, the interval value which will be effective are the values from 100 to 500. 4. When AP enables more than 8 SSIDs, the interval value which will be effective are the values from 200 to 500. 5. Mesh feature will take up a share when it is enabled. <p>Default value is 100ms. Valid range: 40 – 500 ms.</p>
DTIM Period	<p>Configures the frequency of DTIM (Delivery Traffic Indication Message) transmission per each beacon broadcast. Clients will check the AP for buffered data at every configured DTIM Period. You may set a high value for power saving consideration.</p>



	<p>Default value is 1, meaning that AP will have DTIM broadcast every beacon.</p> <p>If set to 10, AP will have DTIM broadcast every 10 beacons.</p> <p>Valid range: 1 – 10.</p>
Multicast to Unicast	<p>Once selected, AP will convert multicast streams into unicast streams over the wireless link. Which helps to enhance the quality and reliability of video/audio stream and preserve the bandwidth available to the non-video/audio clients.</p>
Enable Voice Enterprise	<p>Check to enable/disable Voice Enterprise. The roaming time will be reduced once enable voice enterprise.</p> <ul style="list-style-type: none"> • The 802.11k standard helps clients to speed up the search for nearby APs that are available as roaming targets by creating an optimized list of channels. When the signal strength of the current AP weakens, your device will scan for target APs from this list. • When your client device roams from one AP to another on the same network, 802.11r uses a feature called Fast Basic Service Set Transition (FT) to authenticate more quickly. FT works with both pre-shared key (PSK) and 802.1X authentication methods. • 802.11v allows client devices to exchange information about the network topology, including information about the RF environment, making each client network aware, facilitating overall improvement of the wireless network. <p>Note: 11R is required for enterprise audio feature, 11V and 11K are optional. <i>This field is available only when “Security Mode” is set to “WPA/WPA2” or “WPA2”.</i></p>
Enable 11R	<p>Check to enable 802.11r. <i>This field is available only when “Security Mode” is set to “WPA/WPA2” or “WPA2”.</i></p>
Enable 11K	<p>Check to enable 802.11k</p>
Enable 11V	<p>Check to enable 802.11v</p>
ARP Proxy	<p>This option will enable GWN AP to answer the ARP requests from its LAN for its connected Wi-Fi clients. This is mainly to reduce the airtime consumed by ARP Packets</p>



- **Device Membership:** Used to add or remove paired access points to the SSID.

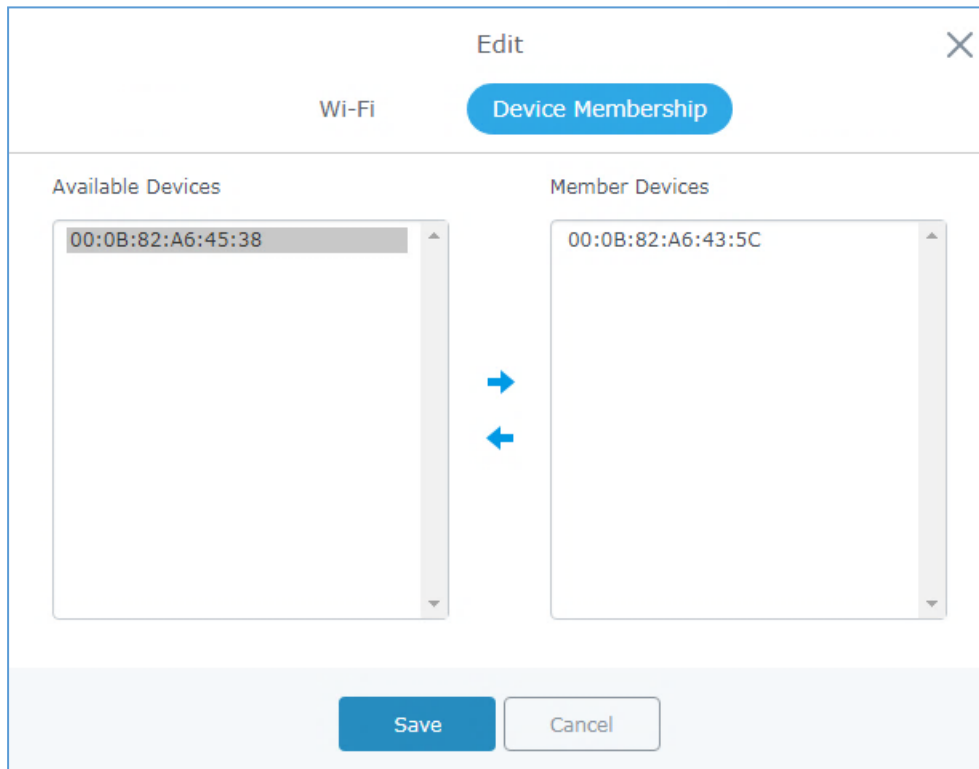

Figure 49: Device Membership



Click on ➔ to add the GWN76XX to the SSID or click on ➜ to remove it.

CLIENTS CONFIGURATION

Users can configure clients' parameters, time policy and also check the list of the clients that has been banned after time disconnect policy has been enabled. Below we discuss each section of this menu:



Clients

Users can access clients list connected to GWN76XX from **Web GUI** → **Clients** → **Clients** to perform different actions to wireless clients.

MAC	Hostname	Manufacture	OS	Type	IP Address	Radio/Chann	Status	RSSI	SSID	AP	Station Mode	Link Rate	Throughput	Aggregate	Actions
24:18:1D:A1:27:...	Galaxy-S9	SAMSUNG	Android	Wire...	192.168.5.171	5GHz	Online	34	GWNBS2398	00:08:82:B5:23:...	11AC_VHT...	TX:650Mbps RX:585Mbps	TX:140B/s RX:266B/s	TX:1.44MB RX:5.68MB	  

Showing 1-1 of 1 records. Per Page: 10

Figure 50: Clients

- Click on  under Actions to check client's status and modify basic settings such Device's Name.
- Click on  to block a client's MAC address from connecting to the zone's SSID.
- Click on  to release Wi-Fi offline client IP lease.

Users can press  button to customize items to display on the page. Following items are supported:

Select up to 16 items

- MAC
- Hostname
- Manufacture
- OS
- Type
- IP Address
- Radio/Channel
- Status
- RSSI
- Bridge
- SSID
- AP
- Station Mode
- Link Rate
- Throughput
- Aggregate

[Default](#)

Figure 51: Clients - Select Items

Clients Access

From this menu, users can manage in global way the blacklist of clients that will be blocked from accessing the Wi-Fi network, click on **Client Access** to add or remove MAC addresses of client from global blacklist.

Name	MAC Addresses	Actions
Global Blacklist	(2) 48:4B:AA:08:3F:92, 48:4B:AA:08:3F:90	✎ 🗑

Figure 52: Global Blacklist

Edit

Name

MAC Addresses

48:4B:AA:08:3F:92 -

48:4B:AA:08:3F:90 -

Add new item +

Figure 53: Managing the Global Blacklist

A second option is to add custom access lists that will be used as matching mechanism for MAC address filtering option under SSIDs to allow (whitelist) or disallow (blacklist) clients access to the Wi-Fi network.

Click on + Add in order to create new access list, then fill it with all MAC addresses to be matched.

Add

Name

MAC Addresses

Add new item +

Enable Schedule

Schedule

Figure 54: Adding Client Access List

Users can check « Enable Schedule » to assign a schedule for the list when it will take effect.

+ Add

Name	MAC Addresses	Actions
Global Blacklist		✎ 🗑
Access List 1	(3) 48:4B:AA:08:3F:90, 48:4B:AA:08:3F:91, 48:4B:AA:08:3F:92	✎ 🗑

Figure 55: Adding New Access List

Once this is done, this access list can be used under SSID Wi-Fi settings to filter clients either using whitelist or blacklist mode.

Edit

Wi-Fi
Device Membership

Enable Captive Portal

Enable Schedule

Security Mode Open ▼

Client Bridge Support ?

Client Time Policy None ▼

Use MAC Filtering Blacklist ▼

MAC Blacklist ? Access List 1

Figure 56: Blacklist Access List

Time Policy

The timed client disconnect feature allows the system administrator to set a fixed time for which clients should be allowed to connect to the access point, after which the client will no longer be allowed to connect for a user configurable cool-down period.

The configuration is based on a policy where the administrator can set the amount of time for which clients are allowed to connect to the Wi-Fi and reconnect type and value after which they will be allowed to connect back after they have been disconnected.

To create a new policy, go under **Clients→Time Policy** and add new one. then set the following parameters:

Table 14: Time Policy Parameters

Option	Description
Name	Enter the name of the policy
Enabled	Check the box to enable the policy
Limit Client Connection Time	Sets amount of time a client may be connected.
Client Reconnect Timeout Type	Select the method with which we will reset a client's connection timer so they may reconnect again. Options are: <ul style="list-style-type: none"> Reset Daily. Reset Weekly.

	<ul style="list-style-type: none"> • Reset Hourly. • Timed Reset.
Client Reconnect Timeout	If “Timed Reset” is selected, this is the period for which the client will have to wait before reconnecting.
Day of the Week	If “Reset Weekly” is selected, this is the day when the reset will be applied.
Hour of the Day	If “Reset Weekly” or “Reset Daily” is selected, this is the hour and day when the reset will be applied.

Note: Time tracking shall be accounted for on a per-policy basis, such that a client connected to any SSID assigned the time tracking policy will accrue a common counter, regardless of which SSID they are connected to (as long as those SSIDs all share the same time tracking policy).

Banned Clients

Click on **Banned Clients** menu to view the list of the clients that have been banned after time disconnect feature has taken effect, these clients will not be allowed to connect back until timeout reset or you can unblock a client by clicking on the icon  .



Banned Clients			
MAC Addresses	Time Policy	Release Time	Actions
A0:CB:FD:F4:DF:FE	5minute	2017-08-24 11:40:00	
30:75:12:FF:37:89	5minute	2017-08-24 11:40:00	
DC:09:4C:A4:38:BE	5minute	2017-08-24 11:41:00	

Figure 57: Ban/Unban Client

CAPTIVE PORTAL

Captive Portal feature on GWN76XX AP helps to define a Landing Page (Web page) that will be displayed on Wi-Fi clients' browsers when attempting to access Internet. Once connected to a GWN76XX AP, Wi-Fi clients will be forced to view and interact with that landing page before Internet access is granted. The Captive Portal feature can be configured from the GWN76XX Web page under "Captive Portal". The page contains following sub-menus: **Guest**, **Policy List**, **Splash Page** and **Vouchers**.

Guest

This section lists the clients connected or trying to connect to Wi-Fi via Captive Portal.

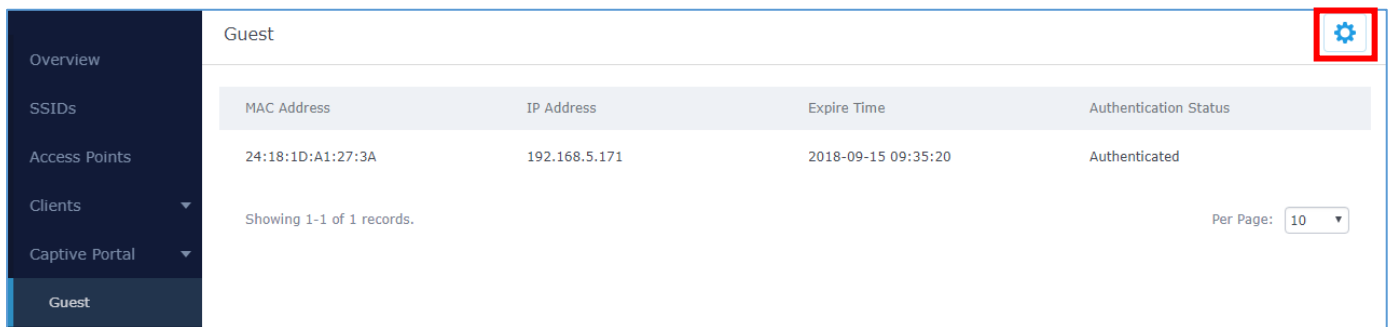

MAC Address	IP Address	Expire Time	Authentication Status
24:18:1D:A1:27:3A	192.168.5.171	2018-09-15 09:35:20	Authenticated

Showing 1-1 of 1 records. Per Page: 10

Figure 58: Captive Portal – Guest Page

Users can press  button to customize items to display on the page. Following items are supported:

Select up to 8 items

- Name
- MAC Address
- IP Address
- Email
- Gender
- Age Range
- Expire Time
- Authentication Status

[Default](#)

Figure 59: Captive Portal - Guest Page - Select Items

Policy List

Users can customize a portal policy in this page.

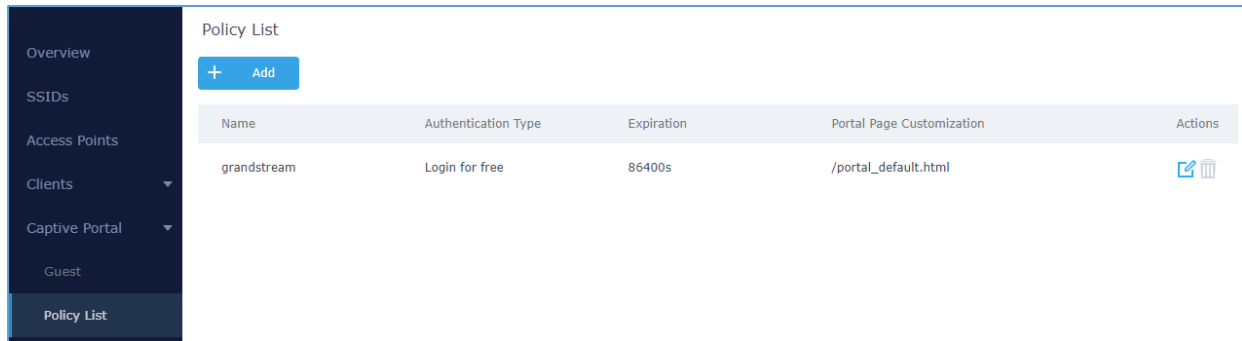





Name	Authentication Type	Expiration	Portal Page Customization	Actions
grandstream	Login for free	86400s	/portal_default.html	 

Figure 60: Captive Portal - Policy List

- Click on  to edit the policy.
- Click on  to delete the policy.
- Click on  to add a policy.

The policy configuration page allows adding multiple captive portal policies which will be applied to SSIDs and contains options for different authentication types a splash page that can be easily configured as shown on the next section.

Administrator can use an internal or external splash page.

Add ✕

Basic
Auth Rule

Name

Splash Page

Authentication Type

Expiration

Use Default Portal Page

Portal Page Customization

Landing Page

Enable Daily Limit

Enable HTTPS

Save
Cancel

Figure 61: Add a New Policy

Internal Splash Page

Below table lists the items policy add page configures

Table 15: Captive Portal – Policy List – Splash Page is “Internal”

Field	Description
Name	Enter the name of the Captive Portal policy
Splash Page	Select Splash Page type, Internal or External.
Authentication Type	Following types of authentication are available: <ul style="list-style-type: none"> Login for free: when choosing this option, the landing page feature will not provide any type of authentication, instead it will prompt users to accept the license agreement to gain access to internet.

	<ul style="list-style-type: none"> • RADIUS Server: Choosing this option will allow users to set a RADIUS server to authenticate connecting clients. • Social Login Authentication: Choosing this option will allow users to enable authentication Facebook or Twitter. • Vouchers: Choose this page when using authentication via Vouchers. • Login with Password: Choose this page when using authentication via a password.
Expiration	Configures the period of validity, after the valid period, the client will be re-authenticated again.
If Authentication Type is set to “RADIUS Authentication”	
RADIUS Server Address	Fill in the IP address of the RADIUS server.
RADIUS Server Port	Set the RADIUS server port, the default value is 1812.
RADIUS Server Secret	Fill in the key of the RADIUS server.
RADIUS Authentication Method	Select the RADIUS authentication method, 3 methods are available: PAP, CHAP and MS-CHAP.
If Authentication Type is set to “Social Login Authentication”	
Facebook	Check to enable/disable Facebook Authentication
Facebook App ID	Fill in the Facebook App ID.
Facebook APP Key	Set the key for the portal, once clients want to connect to the Wi-Fi___33, they should enter this key.
Twitter	Check this box to enable Twitter Authentication.
Force to Follow	If checked, users need to Follow owner before been authenticated.
Owner	Enter the app Owner to use Twitter Login API. <i>This field appears only when Force to Follow is checked.</i>
Consumer Key	Enter the app Key to use Twitter Login API.
Consumer Secret	Enter the app secret to use Twitter Login API.
For all Authentication Types	
Use Default Portal Page	<p>If checked, the users will be redirected to the default portal page once connected to the GWN.</p> <p>If unchecked, users can manually select which Portal Page to use from Portal Page Customization drop-down list.</p>
Portal Page Customization	<p>Select the customized portal page (if “Use Default Portal Page” is unchecked).</p> <ul style="list-style-type: none"> • <i>/facebook.html</i>



	<ul style="list-style-type: none"> • <i>/password_auth.html</i> • <i>/portal_default.html</i> • <i>/portal_pass.html</i> • <i>/portal_tip.html</i> • <i>/social_auth.html</i> • <i>/status.html</i> • <i>/twitter.html</i> • <i>/twitter_website.html</i> • <i>/vouchers_auth.html</i>
Landing Page	Choose the landing page, 2 options are available: <ul style="list-style-type: none"> • Redirect to the Original URL. • Redirect to External Page.
Redirect External Page URL Address	Once the landing page is set to redirect to external page, user should set the URL address for redirecting. <i>This field appears only when Landing Page is set to “Redirect to an External Page”.</i>
Enable Daily Limit	If enabled, captive portal will limit user connection by times of one day.
Failsafe Mode	If checked, AP will grant access to STA if AP can't reach to external authentication server. <i>This option is available only when Authentication Type is set to “RADIUS Server” or “Vouchers”.</i>
Enable HTTPS	Check to enable/disable HTTPS service.

Notes:

1. If Facebook authentication is configured, you will need to log in your Facebook account of <https://developers.facebook.com/apps> , and set the OAuth redirect to : <https://cwp.gwn.cloud:8443/GsUserAuth.cgi?GsUserAuthMethod=3>
2. If Twitter authentication is configured, you will need to log in your Twitter account of <https://apps.twitter.com/app>, and set the callback URLs to: <http://cwp.gwn.cloud:8080/GsUserAuth.cgi>

External Splash Page

Table 16: Captive Portal – Policy List – Splash Page is “External”

Field	Description
Name	Enter the name of the Captive Portal policy
Splash Page	Select to either use Internal or External Splash Page.



External Splash Page URL	Enter the External Splash Page URL, and make sure to enter the pre-authentication rules request by the external portal platform in the pre-authentication configuration option.
RADIUS Server Address	Fill in the IP address of the RADIUS server.
RADIUS Server Port	Set the RADIUS server port, the default value is 1812.
RADIUS Server Secret	Fill in the key of the RADIUS server.
RADIUS Accounting Server Address	Configures the address for the RADIUS accounting server.
RADIUS Accounting Server Port	Configures RADIUS accounting server listening port (default is 1813).
RADIUS Accounting Server Secret	Enter the secret password for client authentication with RADIUS accounting server.
Accounting Update Interval	Enter Update Interval for RADIUS Accounting Server. The interval unit can be set by seconds, minutes, hours or days.
RADIUS NAS ID	Enter RADIUS NAS ID. <i>This field appears only when Splash Page is set to "External".</i>
Redirect URL	Specify URL where to redirect clients after authentication.

In case social media authentication is used, the user needs to allow some traffic between the AP and social media platforms (Facebook API as example) to send authentication credentials and receive reply, this traffic can be allowed using the Authentication rules which are explained below.

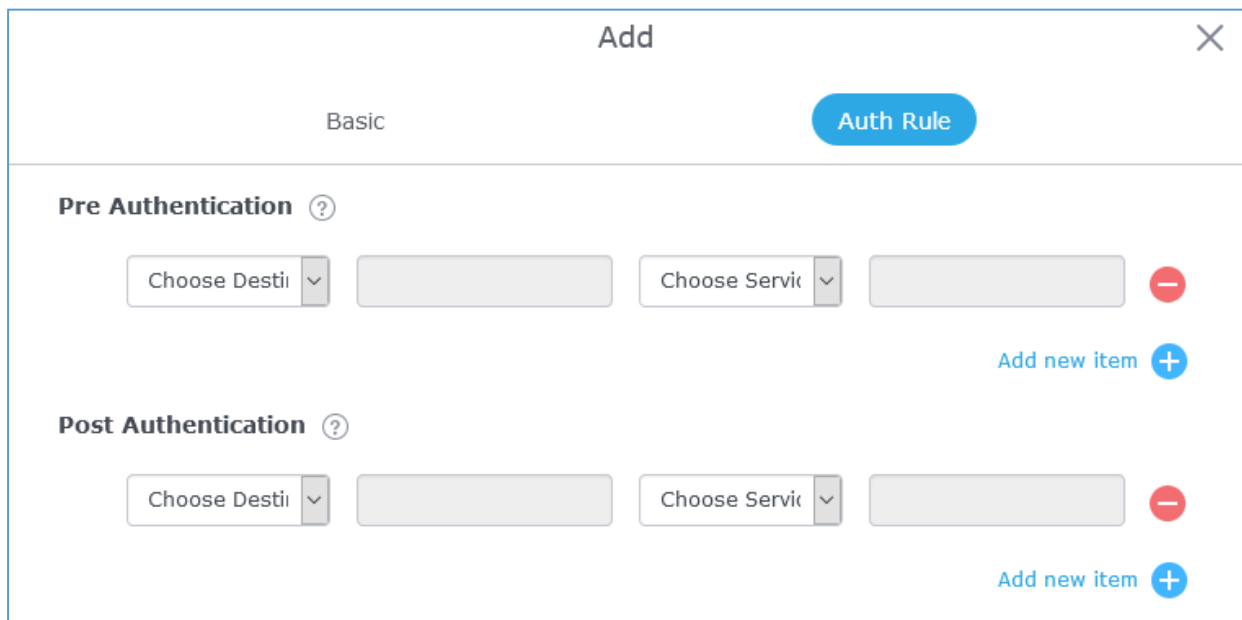

Figure 62: Authentication rules

Pre-Authentication Rules

Using this option, users can set rules to match traffic that will be allowed for connected Wi-Fi users before authentication process. This can be needed for example to setup Facebook authentication where some traffic should be allowed to Facebook server(s) to process the user's authentication. Or simply to be used to allow some type of traffic for unauthenticated users.

Post-Authentication Rules

On the other hand, post authentication rules are used to match traffic that will be banned for Wi-Fi clients after authentication. As an example, if you want to disallow connected Wi-Fi clients to issue Telnet or SSH traffic after authentication then you can set post authentication rules to match that traffic and once a connected client passes the authentication process they will be banned from issuing telnet and SSH connections.

Splash Page

Files configuration page allows users to view and upload HTML pages and related files (images...).

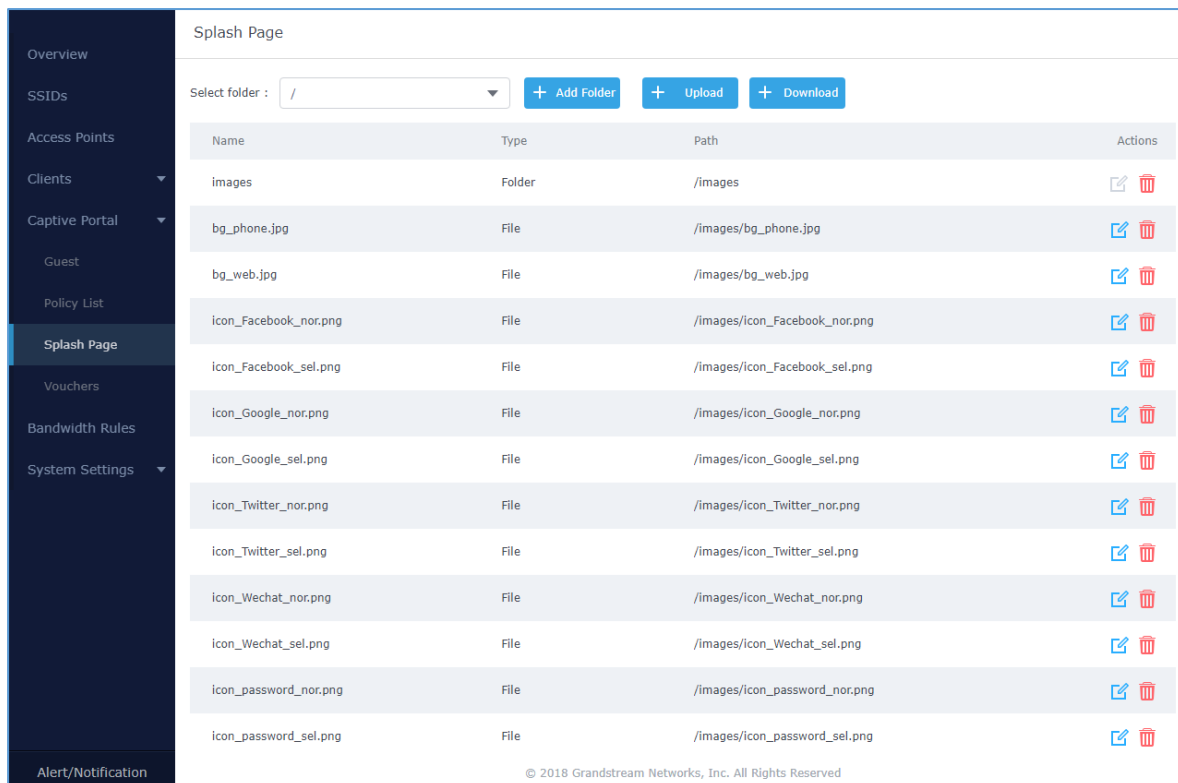



Name	Type	Path	Actions
images	Folder	/images	
bg_phone.jpg	File	/images/bg_phone.jpg	
bg_web.jpg	File	/images/bg_web.jpg	
icon_facebook_nor.png	File	/images/icon_facebook_nor.png	
icon_facebook_sel.png	File	/images/icon_facebook_sel.png	
icon_google_nor.png	File	/images/icon_google_nor.png	
icon_google_sel.png	File	/images/icon_google_sel.png	
icon_twitter_nor.png	File	/images/icon_twitter_nor.png	
icon_twitter_sel.png	File	/images/icon_twitter_sel.png	
icon_wechat_nor.png	File	/images/icon_wechat_nor.png	
icon_wechat_sel.png	File	/images/icon_wechat_sel.png	
icon_password_nor.png	File	/images/icon_password_nor.png	
icon_password_sel.png	File	/images/icon_password_sel.png	

Figure 63: Captive Portal – Splash Page

User can add folder in corresponding folder by selecting the folder and click on .

- Click on  to upload a file from local device.

- Click on  to download the files in Captive Portal folder.
- Click on  to edit the corresponding file, in another word, to replace the file with a new one.
- Click on  to delete the file.

Vouchers

Voucher Feature Description

Voucher feature will allow clients to have internet access for a limited duration using a code that is randomly generated from GWN controller.

As an example, a coffee shop could offer internet access to customers via Wi-Fi using voucher codes that can be delivered on each command. Once the voucher expires the client can no longer connect to the internet.

Note that multiple users can use a single voucher for connection with expiration duration of the voucher that starts counting after first successful connection from one of the users that are allowed.

Another interesting feature is that the admin can set data bandwidth limitation on each created voucher depending on the current load on the network, users' profile (VIP customers get more speed than regular ones...etc.) and the internet connection available (fiber, DSL or cable...etc.) to avoid connection congestion and slowness of the service.

Each created voucher can be printed and served to the customers for usage, and the limit is 1000 vouchers.

The usage of voucher feature needs to be combined with captive portal that is explained after this section, in order to have the portal page requesting clients to enter voucher code for authentication.



Voucher Configuration

To configure/create vouchers for clients to use, follow below steps:

1. On controller web GUI, navigate under "**Captive Portal → Vouchers**"
2. Click on  button in order to add a new voucher.
3. Enter voucher details which are explained on the next table.
4. Press save to create the voucher(s).



Notes:

- Users can specify how many vouchers to generate which have the same profile, this way the GWN will generate as many vouchers as needed which do have the same settings avoiding creating them one by one.
- The admin can verify the status of each vocoder on the list (In use, not used, expired ...etc.).
- Press  to print the voucher,  to delete it or  to renew the voucher.

×
CREATE VOUCHERS

Create Number One Time
The field cannot be empty.

Max Devices ?
The field cannot be empty.

Byte Limit M ▼

Duration minutes ▼
The field cannot be empty.

Validity Time ?
The field cannot be empty.

Download Limit Mbps ▼

Upload Limit Mbps ▼

Notes

Save
Cancel

Figure 64: Add Voucher Sample

The below figure shows the status of the vouchers after GWN randomly generates the code for each one.

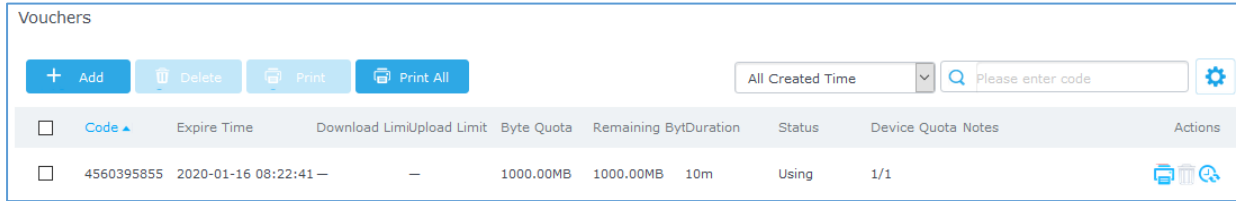



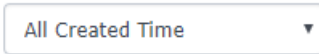

Figure 65: Vouchers List

Users can click on buttons  **Delete** and  **Print** to delete and print multiple vouchers or click  **Print All** button to print all vouchers at once.

Also, users can use the drop-down list filter  to filter the vouchers that were created at specific date-time.

The following table summarizes description for voucher configuration parameters:

Table 17: Voucher Parameters

Field	Description
Create Number One Time	Specify how many vouchers to generate which will have same profile/settings (duration, bandwidth and number of users). Valid range: 1 – 1000.
Max Devices	Specify how many users can use same voucher. Valid range: 1 – 5.
Byte Limit	Specify download byte limit for the voucher. The unit can be either M (Megabyte) or G (Gigabyte). Valid range: 10 – 1048576 (M) 1 – 1024 (G)
Duration	Specify the duration after which the voucher will expire, and clients will be disconnected from internet. Note: in case or multiple users, the duration will start counting after first user starts using the voucher.
Validity Time	Set the validity period of credentials, limited to 1-365 integer. The unit is day.
Download Limit	Set the downstream bandwidth speed limit (in Kbps or Mbps).
Upload Limit	Set the upstream bandwidth speed limit (in Kbps or Mbps).
Notes	Notes for the admin when checking the list of vouchers.

Using Voucher with GWN Captive Portal

In order to successfully use the voucher feature, users will need to create a captive portal in order to request voucher authentication codes from users before allowing them access to internet. More details about captive portal will be covered on next section but for voucher configuration please follow below steps.

1. Go under “**Captive Portal → Captive portal**” menu.
2. Press  in order to add new captive portal policy.
3. Set the following parameters as shown on the screenshot for basic setup then save and apply.

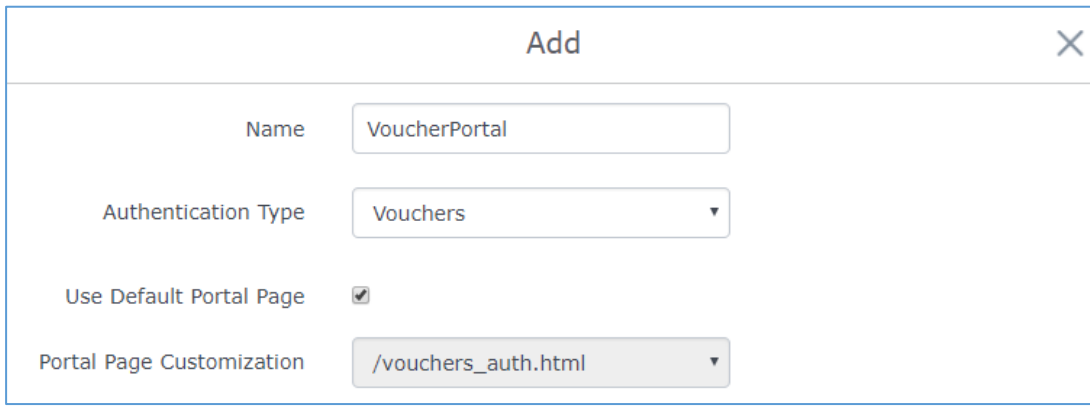

Add ×	
Name	<input type="text" value="VoucherPortal"/>
Authentication Type	<input type="text" value="Vouchers"/>
Use Default Portal Page	<input checked="" type="checkbox"/>
Portal Page Customization	<input type="text" value="/vouchers_auth.html"/>

Figure 66: Captive Portal with Voucher authentication

Then go under your SSID configuration page and enable the generated captive portal under Wi-Fi settings tab.

MESH NETWORK

In Mesh Network, wireless connection is established between multiple Aps, which is used to pass-through data traffic rather than client association. Each AP will evaluate the performance of wireless channel based on several factors and choose one or multiple appropriate APs to setup connection.

In a mesh network, access points are categorized to two types:

- **CAP (Central Access Point):** this is an access point that has an uplink connection to the wired network.
- **RE (Range Extender):** This is an access point that participate on the mesh network topology and has a wireless uplink connection to the central network.

In order to deploy mesh access points (RE), users/installers can follow below steps:

1. Make sure to have the master and CAP access points already deployed (sometimes the CAP access points can be the master controller of the network).
2. Next, we need to pair the RE access points to the master. This can be done in two ways:
 - A. Connect all REs to the same wired LAN as the master then perform the normal process of discovery/pairing [process](#), and after successfully pairing the APs they can be deployed on the field.
 - B. REs can also be discovered wirelessly when powered via PSU or PoE Injector, and admin can configure them after discovery. This requires that the REs must be within the range of the Master or CAP Slave's signals coverage.

Note: If there are other GWN APs broadcasting in the same field with different subnet, RE may be wirelessly connected to those networks and cannot be discovered and paired by your Master. Therefore, it is recommended to use the first method of wired pairing and then deploy those REs.

3. After that all slave access points have been deployed and paired to the master, you can directly manage them to operate the mesh network. Mesh service configuration is the same as transitional GWN WLAN.
4. Log into the master page, and under Access Points page you can see the information, for example the AP in the “**Online Wireless**” state **is the RE** (Range Extender) with a wireless uplink to the CAP. The APs showing “**Online**” state are either a wired **master** or **CAP**.



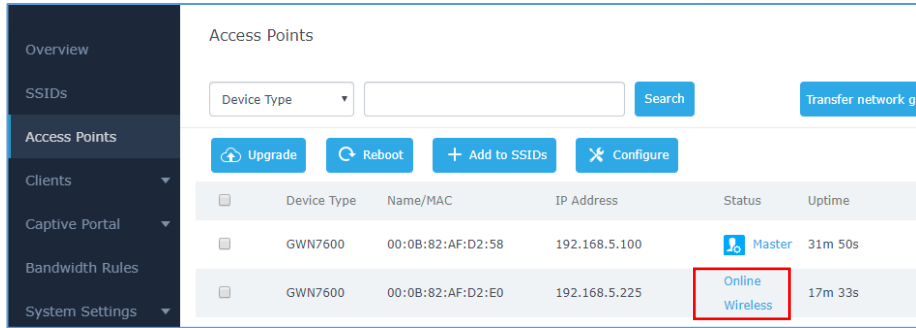

Device Type	Name/MAC	IP Address	Status	Uptime
GWN7600	00:0B:82:AF:D2:58	192.168.5.100	Master	31m 50s
GWN7600	00:0B:82:AF:D2:E0	192.168.5.225	Online Wireless	17m 33s

Figure 67: Access Points Status

For Global mesh network settings, on GWN76XX, navigate to the menu “**System Settings → Mesh**” for setting up the following parameters described below:

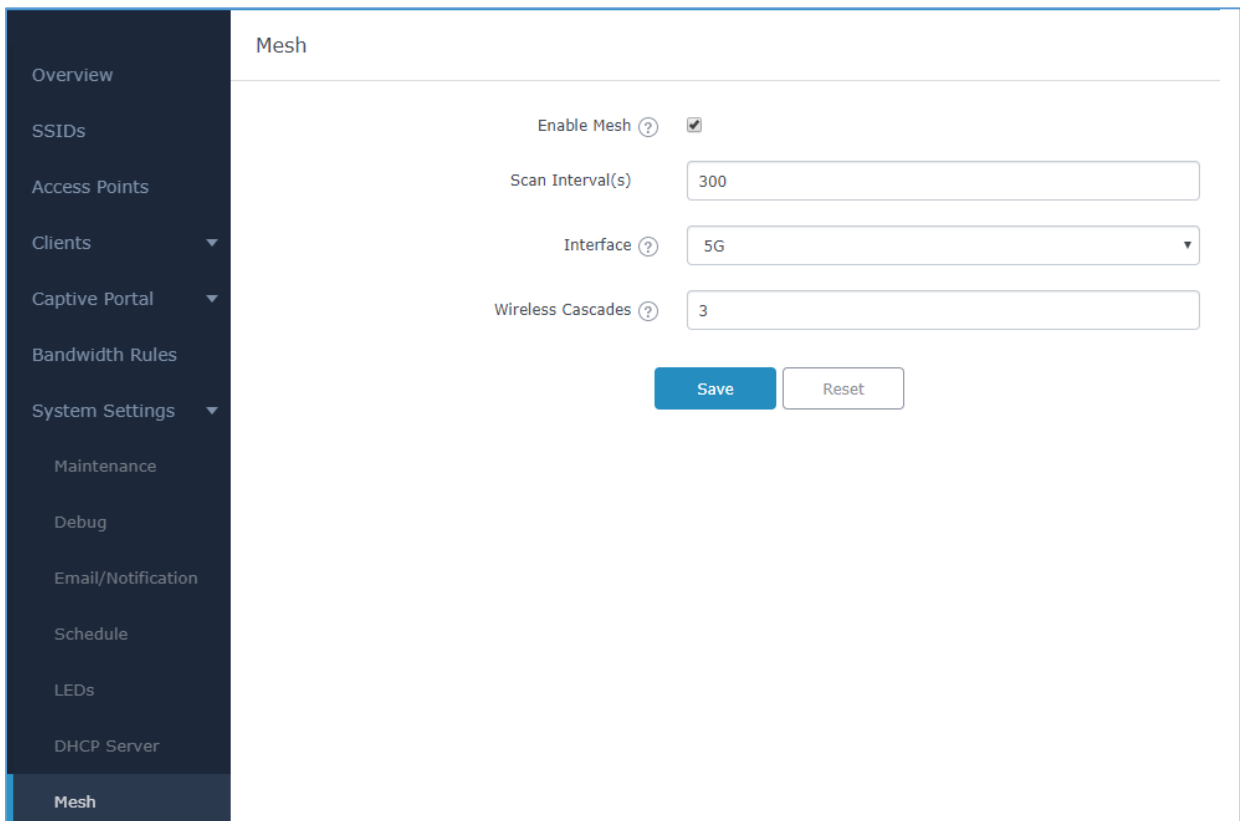

Mesh

Enable Mesh

Scan Interval(s)

Interface

Wireless Cascades

Figure 68: Mesh settings for GWN76XX

The following table down below describes the Mesh configuration settings for the GWN76XX:

Table 18: Mesh configuration on GWN76XX

Filed	Description
Enable Mesh	When checked the Mesh feature will be activated. Default is disabled.
Scan Interval	Interval in seconds to scan for available Mesh neighbors. Must be less than or equal to 300 seconds.
Interface	Select either 2.4GHz or 5GHz band.
Wireless cascades	Define how many AP can be cascaded wirelessly with the AP. The minimum value is 1 and maximum value is 3.

For more detailed information about GWN Mesh network feature, you may refer to the following technical document: [Mesh Network Guide](#).

BANDWIDTH RULES

The bandwidth rule is a GWN76XX feature that allows users to limit bandwidth utilization per SSID or client (MAC address or IP address).

This option can be configured from the GWN76XX WebGUI under “Bandwidth Rules”.

Click  to add a new rule, the following table provides an explanation about different options for bandwidth rules.

Table 19: Bandwidth Rules

Field	Description
Enable	Enable/Disable the Bandwidth rule.
SSID	Select which SSID will be affected by the bandwidth rule limitation.
Range Constraint	Choose the type of rule to be applied on bandwidth utilization from the dropdown list, three options are available: <ul style="list-style-type: none"> • Per-SSID: Set a bandwidth limitation on the SSID level. • Per-User: Set a bandwidth limitation per Client. • MAC: Set a bandwidth limitation per MAC address. • IP Address: Set a bandwidth limitation per IP address.
MAC	Enter the MAC address of the device to which the limitation will be applied, this option appears only when MAC type is selected.
IP address	Enter the IP address of the device to which the limitation will be applied, this option appears only when IP Address type is selected.
Enable Schedule	Enable this option to assign a schedule for the bandwidth rule.
Upload Limit	Specify the limit for the upload bandwidth using Kbps or Mbps.
Download Limit	Specify the limit for the download bandwidth using Kbps or Mbps.

The following figure shows an example of MAC address rule limitation.



Add

Enable

SSID All None

GWN9A9658

Range Constraint ▼
MAC

MAC ▼
00:0b:82:15:af:19

Enable Schedule (?)

Upload Limit ▼
2 Mbps

Download Limit ▼
2 Mbps

Figure 69: MAC Address Bandwidth Rule

The following figure shows examples of bandwidth rules:

+ Add	Enabled	SSID	Range Constraint	MAC/IP Address	Upload Limit	Download Limit	Actions
	✓	GWNAAD4D8	Per-SSID		100Mbps	150Mbps	✎ 🗑️

Figure 70: Bandwidth Rules

Note:

The same settings for bandwidth management are available from the following menus:

Per-Client

Navigate on the web GUI under “Clients→Edit→Bandwidth Rules” where you can set the Upstream and Downstream rate in Mbps.

SYSTEM SETTINGS

Maintenance

Users can access Maintenance page from GWN76XX **WebGUI**→**System Settings**→ **Maintenance**.

Basic

Basic page allows Country and Time configuration.

Table 20: Basic

Field	Description
Rebind Protection	Anti-domain name hijacking protection. If enabled, when the address returned by the superior DNS is a private LAN address, it will be regarded as a domain name hijacking, thus discarding the analytical result. If disabled, the analytical results will not be discarded.
Legacy TLS Compatibility	Due to the security enhancement, unless Legacy TLS Compatibility (only available on 1.0.15.4 or higher version) is enabled, master AP on 1.0.15.4 or higher firmware will not compatible with slave AP on firmware lower than 1.0.15.4. Master AP on firmware lower than 1.0.15.4 will also not be compatible with slave AP on firmware 1.0.15.4 or higher. Cloud and GWN Manager will still support both firmwares. Default is enabled.
Web HTTP Access	Enables Web HTTP Access. By default, it's disabled.
Web HTTPS Port	Specifies HTTPS port. By default, is 443.
Country	Select the country from the drop-down list. This can affect the number of channels depending on the country standards.
Scene	Depending deployment type (Indoor or Outdoor) then additional 5Ghz channels (DFS Channels) will be available to be used. This option is only available for certain countries and only effective for GWN7600LR (CE) , GWN7630LR and GWN7630 (CE, FCC, RCM, IC) , GWN7605 (CE, RCM)
Time Zone	Configure time zone for the GWN76XX. Make sure to reboot the device to take effect.
NTP Server	Configure the IP address or URL of the NTP server. The device will obtain the date and time from the configured server.
Date Display Format	Change the Date Display Format, three options are possible YYYY/MM/DD, MM/DD/YYYY and DD/MM/YYYY.
Reboot Schedule	Select the time schedule when AP will be rebooted.



Refer to [SCHEDULE] to define time.





Upgrade

The Upgrade Web page allows upgrade related configuration.

Table 21: Upgrade

Field	Description
Authenticate Config File	Authenticates configuration file before acceptance. The default setting is No.
XML Config File Password	The password for encrypting the XML configuration file using OpenSSL. The password is to decrypt the XML configuration file is it is encrypted via OpenSSL
Upgrade Via	Allow users to choose the method to load the firmware and config: TFTP, HTTP or HTTPS.
Firmware Server	Define the IP address or URL for the firmware upgrade server. Make sure all files relevant to the firmware are updated completely
Config Server	Configure the IP address of URL for the file server.
Check/Download New Firmware and Config at Boot	Configure whether to enable/disable automatic upgrade and provisioning when reboot.
Allow DHCP options 66 and 43 override	Enable/Disable DHCP options 66 and 43 to override the upgrade and provisioning settings
Automatic Upgrade	Set automatic upgrade every intervals/day/week. The device will request to upgrade automatically according to the setup time. The default setting is Disabled
X Hours	Select the time period to check for firmware upgrade. <i>This field is available when select "Check every X Hours" in "Automatic Upgrade"</i>
Hour of Day (0-23)	Defines the hour of the day (0-23) to check the HTTP/TFTP server for firmware upgrade or configuration file changes. <i>This field is available when select "Check at Hour of Day" and "Check at Day of Week" in "Automatic Upgrade"</i>
Day of Week	Defines the day of the week to check the HTTP/TFTP server for firmware upgrade or configuration file changes. <i>This field is available when select "Check at Day of Week" in</i>

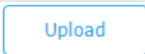
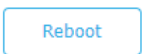

	<i>"Automatic Upgrade"</i>
Upgrade Now	Click on  button to begin the upgrade. Note that the device will reboot after downloading the firmware.
Download Configuration	Click on  button to download the device configuration file to PC.
Upload Configuration	Click on  to select a compressed config file to restore the config; after succeeding, the device will reboot automatically.
Reboot	Click on  button to reboot device.
Factory Reset	Click on  to restore the device and all online APs to factory default settings.

Access

The Access Web page provide configuration for admin and user password.

Table 22: Access

Field	Description
Current Administrator Password	Enter the current administrator password
New Administrator Password	Change the current password. This field is case sensitive with a maximum length of 32 characters.
Confirm New Administrator Password	Enter the new administrator password one more time to confirm.
New User Password	Configure the password for user-level Web GUI access. This field is case sensitive with a maximum length of 32 characters.



Confirm New User Password

Enter the new User password again to confirm.

Syslog

The syslog Web page provides configuration settings for syslog.

Table 23: Syslog Parameters

Field	Description
Syslog Server	Enter the IP address or URL of Syslog server.
Syslog Level	Select the level of Syslog, 5 levels are available: None , Debug , Info , Warning and Error .
Log DNS Queries	Check to log DNS Queries.

Logserver

The Logserver page allows the user to configure syslog server on GWN7610/GWN7600 in order to save log messages on connected external USB drive.

First connect a USB drive to the Access point, then configure the parameters and make sure to start the server in order to collect messages from devices sending syslog to GWN.

Following table gives description for configuration parameters of GWN Logserver:

Table 24: Logserver Parameters

Option	Description
Logrotate File Size	Select the size of file to trigger rotation, if left empty, then the router will use only the Logrotate frequency rules to trigger rotation. Default is 5 M. Units can be M (Megabytes) or K (Kilobytes).
Logrotate File Count	Select the Maximum number of rotates files to keep. Default is 56 files.
Logrotate Mode	Choose the time rotation frequency mode (default every 3 hours). <ul style="list-style-type: none"> • Every X Minutes (0-59). • Every X hour (0-23) • X hour of day (0-23). • X day of week (Sunday-Saturday) + X hour of day (0-23).
Hours	Enter the number of hours period after which trigger file rotation.
Minutes	Enter the number of Minutes period after which trigger file rotation.



Hour of the day	Enter the hour of day at which trigger file rotation.
Day of the week	Enter Day of the week + hour of day, at which trigger file rotation.
Devices	Select the path (a USB partition) to store collected logs. Required.
Enable Logserver	Enables the Logserver.

After setting up the Logserver and saving the settings, users need to connect an USB external storage and press Start button to start collecting logs.

All log messages from all devices will be put on one single file, and the router will keep rotating and creating new files based on the configured rotation policy.

- Under **Syslog File List**, users can select a device and press **List** button to list all saved logs on this device.
- Press **Download** button to download a saved log.
- Press **Clear** button to remove logs.

Debug

GWN76XX offers many features for managing and monitoring connected clients to SSIDs, as well as debugging and troubleshooting.

Capture (GWN7610/GWN7600 Only)

This section is used to generate packet trace captures from SSIDs interfaces which will help to sniff packets within the SSID for troubleshooting purpose or monitoring. Users will need to plug a USB device to the USB port on the back of the GWN7610/GWN7600. To access Capture page, go to **System Settings**→**Debug**→**Capture**.



Overview
 Access Points
 Network Group ▾
 Clients ▾
 Captive Portal ▾
 Bandwidth Rules
 System Settings ▾
 Maintenance
Debug
 Email/Notification
 Schedule
 LEDs
 Mesh
 About

Debug

Capture
Core Files
Ping/Traceroute
Syslog

Required Options

File Name ?

Interface ?

Device ?

Advanced Options

File Size ? Rotate Count ?

Direction ?

Filtering Options

Source Port Destination Port

Source IP Destination IP

Protocol

Start
Status: Idle
Current Size: 0

Captured File List

Device ? List

Figure 71: Capture Page







The below table will show different fields used on debug page:

Table 25: Debug

Required Options	
File Name	Enter the name of the capture file that will be generated.
Interface	Choose a SSID as Interface on which the traffic will be captured.
Device	Choose a device plugged to USB port to save the capture once started.
Advanced Options	
File Size	Set a File size that the capture will not exceed.
Rotate Count	Set a value for rotating captures.
Direction	Choose if you want to get all traffic or only outgoing or incoming to the chosen interface.



Filtering Options	
Custom Filter	Check this option when adding custom filtering rule. When selected, the default filtering options will be hidden (Source Port, Destination Port...etc).
Custom Filtering Rule	Configures a filter expression in which traffic should be captured, for example: icmp and host 8.8.8.8. Once configured, then you need to click on Validate.
Source Port	Set the Source Port to filter capture traffic coming from the defined source port.
Destination Port	Set the Destination Port to filter capture traffic coming from the defined port.
Source IP	Set the Source IP to filter capture traffic coming from the defined source IP.
Destination IP	Set Destination IP to filter capture traffic coming from the defined destination IP.
Protocol	Choose ALL or a specific protocol to capture (IP, ARP, RARP, TCP, UDP, ICMP)
Filtering Options Logic	Choose the filtering logic between all filter options to either “And” or “Or” when capturing traffic.
Device	Select the device from which you want to list the captured file.

- Click on  to start capturing on a certain device plugged to the USB port.
- Click on  to stop the capture.
- Click on  to show the captured files on a chosen device, users could check the capture files details.
- Click on  to delete all files.
- Click on  next to a capture file to download it on a local folder.
- Click on  to delete the corresponding capture file.

Captured File List

Device ?













File Name	File Size	File Count	Last Modified	Actions
710_07-10-17_15h-39m-07s	128.00KB	1	07-10-2017 15:41:32	 
3333_07-10-17_11h-41m-33s	24.00KB	1	07-10-2017 11:41:50	 
aaaaaaaaaaaaaaaaaaaaaaaa_07-04-17_...	16.00KB	1	07-04-2017 16:56:16	 
3ee_04-28-17_06h-26m-13s	4.00KB	1	04-28-2017 06:26:16	 
uu_04-26-17_08h-20m-21s	1.50MB	1	04-26-2017 08:32:02	 
abc_04-21-17_01h-36m-56s	8.00KB	1	04-21-2017 01:37:12	 

Figure 72: Capture Files

Core Files

The Core Files Web page displays core dumps generated when the GWN76XX crashes. This is helpful for troubleshooting purposes, if any core dump found on this page please help to contact our support team for further investigation using following link: <https://partnerconnect.grandstream.com/>

Ping/Traceroute

Ping and Traceroute are useful debugging tools to verify reachability with other clients across the network. The GWN76XX offers both Ping and Traceroute tools for IPv4 protocol.

To use these tools, go to GWN76XX **WebGUI** → **System Settings** → **Debug** → **Ping/Traceroute**.

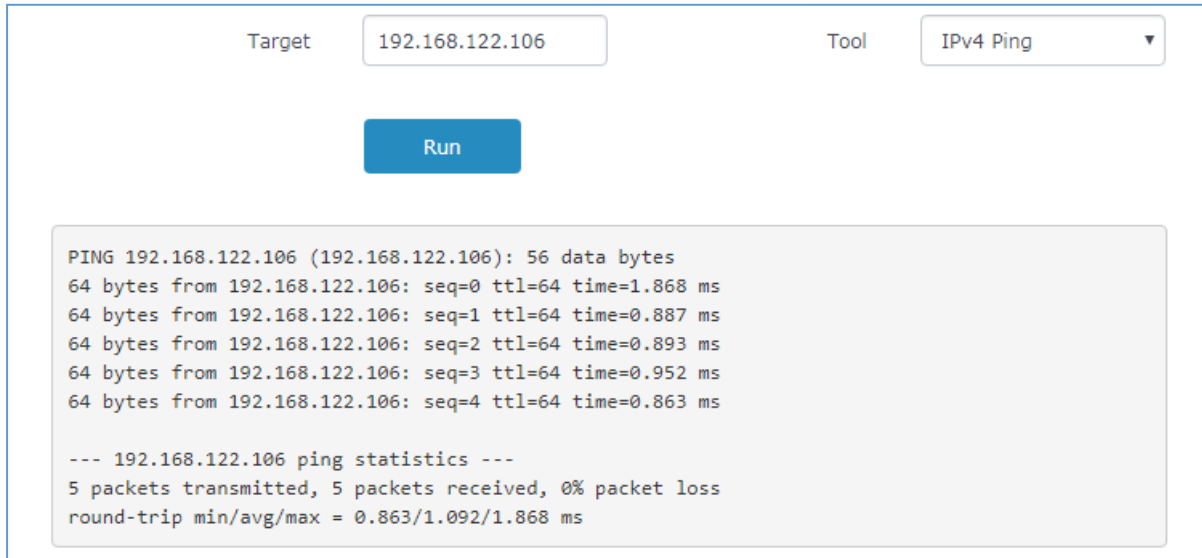

Figure 73: IP Ping

- Next to **Tool** choose from the dropdown menu:
 - IPv4 Ping for an IPv4 Ping test to Target
 - IPv4 Traceroute for an IPv4 Traceroute to Target
- Type in the destination's IP address in **Target** field.
- Click on **Run**.

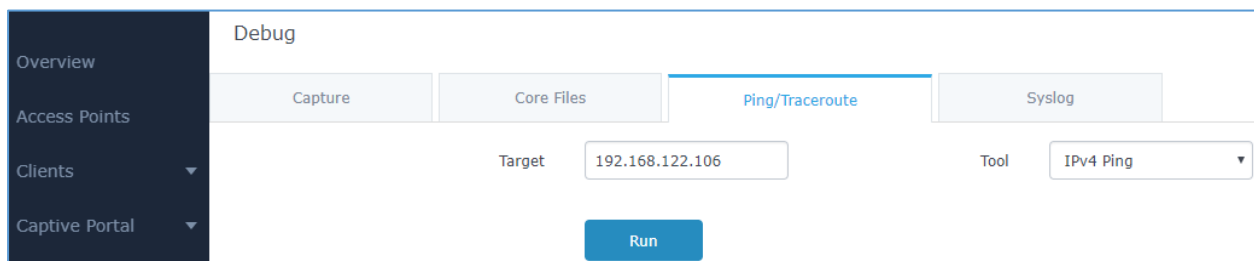

Figure 74: IP Traceroute

Syslog

The syslog Web page displays logs generated by the GWN76XX for troubleshooting purpose as shown in figure below.

Syslog messages are also displayed in real time under Web GUI → **System Settings** → **Debug** → **Syslog**.

Debug

Capture
Core Files
Ping/Traceroute
Syslog

1. Tue Mar 14 15:17:05 2017 daemon.debug procd: stop /etc/rc.d/S50telnet boot
2. Tue Mar 14 15:17:05 2017 daemon.debug procd: start /etc/rc.d/S50uhttpd boot
3. Tue Mar 14 15:17:05 2017 daemon.debug procd: stop /etc/init.d/telnet running
4. Tue Mar 14 15:17:05 2017 kern.info kernel: ol_if_ufs_takedown: called
5. Tue Mar 14 15:17:05 2017 kern.info kernel: ol_ath_phyerr_detach: called
6. Tue Mar 14 15:17:05 2017 kern.info kernel: ieee80211_bsteering_detach: Band steering terminated
7. Tue Mar 14 15:17:05 2017 daemon.debug procd: Finished hotplug_exec instance, pid=2056
8. Tue Mar 14 15:17:05 2017 kern.info kernel: acfg_detach Netlink socket released
9. Tue Mar 14 15:17:05 2017 kern.info kernel: ieee80211_ifdetach: ATF terminated
10. Tue Mar 14 15:17:05 2017 kern.info kernel: Green-AP : Green-AP : Detached
11. Tue Mar 14 15:17:05 2017 kern.info kernel:
12. Tue Mar 14 15:17:05 2017 kern.warn kernel: Green-AP : Detached
13. Tue Mar 14 15:17:05 2017 kern.info kernel: CE_fini 2649 Cleaning up HTT Tx CE
14. Tue Mar 14 15:17:05 2017 kern.info kernel: CE_fini Cleaning up HTT MSG CE(5)
15. Tue Mar 14 15:17:05 2017 kern.info kernel: ol_tx_me_exit: Already Disabled !!!
16. Tue Mar 14 15:17:05 2017 kern.info kernel: ol_if_spectral_detach
17. Tue Mar 14 15:17:05 2017 kern.info kernel: SPECTRAL : Module removed (spectral = cca00000)
18. Tue Mar 14 15:17:05 2017 kern.info kernel:
19. Tue Mar 14 15:17:05 2017 kern.info kernel: releasing the socket (null) and val of ic is ce2c04c0
20. Tue Mar 14 15:17:05 2017 daemon.debug procd: ubus event ubus.object.add
21. Tue Mar 14 15:17:05 2017 daemon.debug procd: ubus path network.interface.loopback

All Rights Reserved Grandstream Networks, Inc. 2017

Figure 75: Syslog

One Key Debug

This feature is useful when AP is paired, as users can still login to the paired AP using “admin” username and “SSH” password (**System → Settings → SSH Password**).

User will have access to the usual Capture, Ping/Traceroute and Syslog and to One Key Debug feature that allows collecting more information that can be share with support for troubleshooting purposes directly from the Access Points web interface.



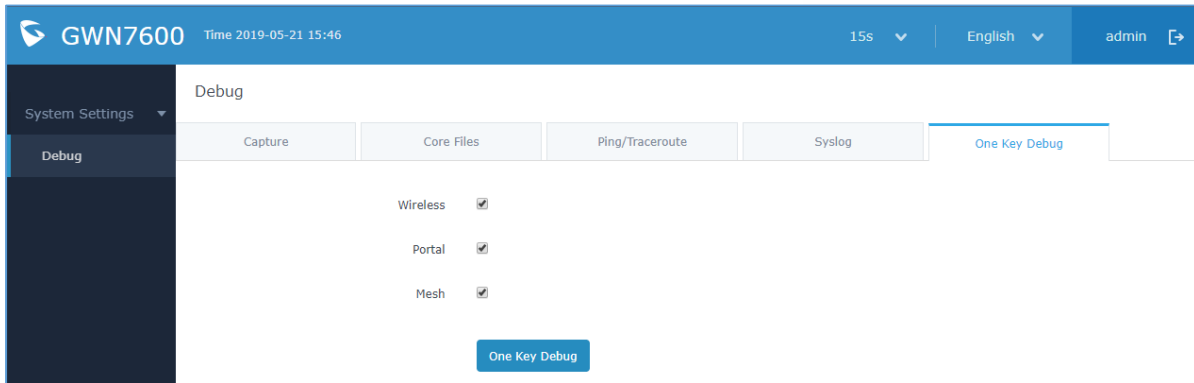

Figure 76: One Key Debug

After selecting the features to debug (Wireless: clients connections, SSIDs..., Captive portal debugging or Mesh network) then you should press the **One Key Debug** button, and after 30 min the debug file will be available under Core file.

Note:

If paired with GWN.Cloud, the debug file will be available under Core file of each AP.

In Master/Slave architecture, the debug file will be available under Core file of the Master AP.

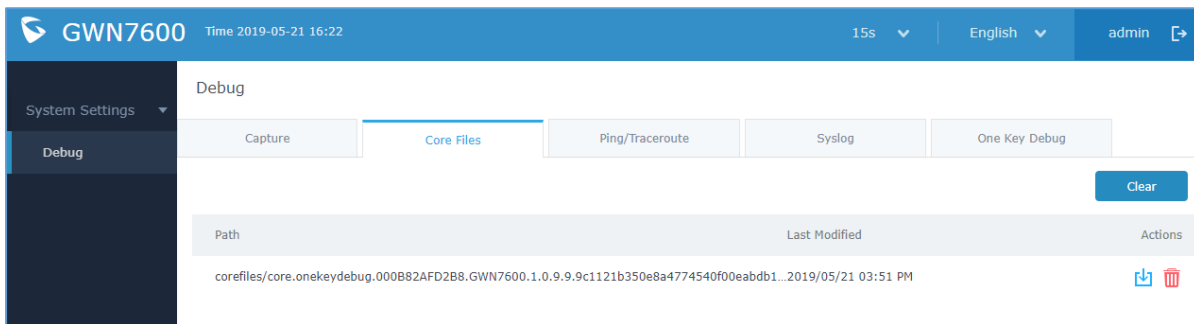

Figure 77: One Key Debug file

Email/Notification

The Email/Notification page allows the administrator to select a predefined set of system events and to send notifications upon the change of the set events.

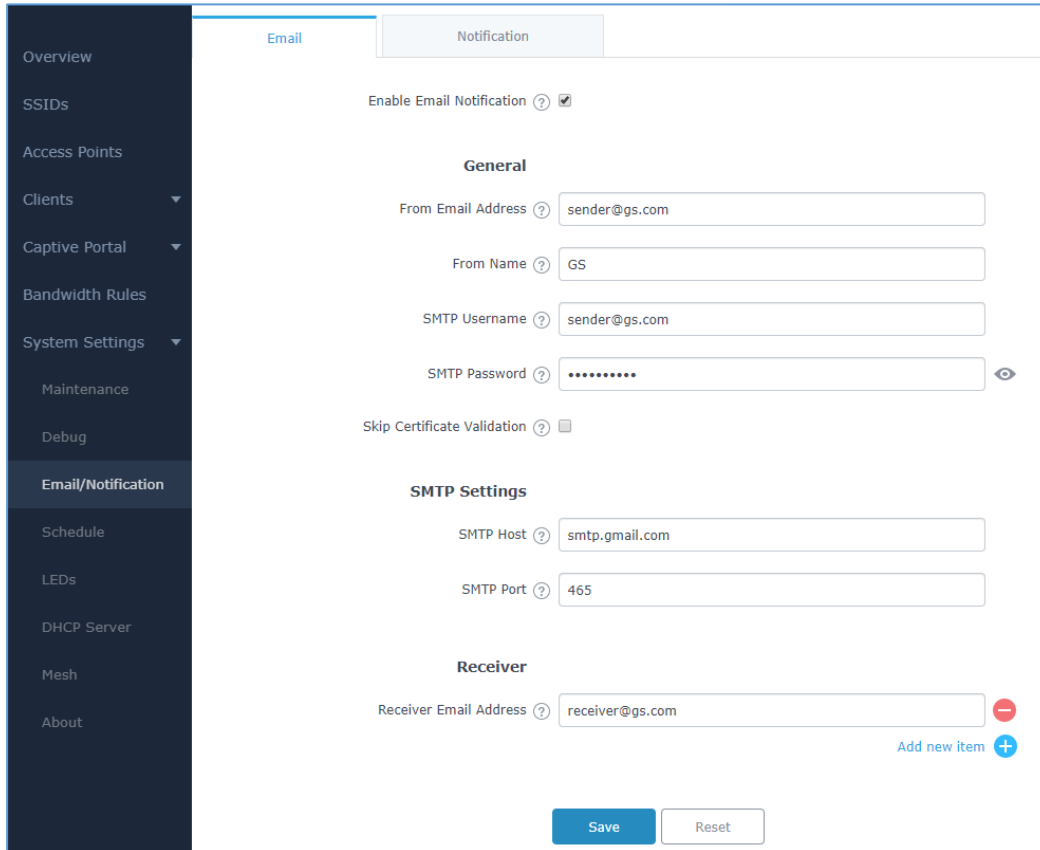

Figure 78: Email

Table 26: Email Setting

Filed	Description
Enable Email Notification	Once enabled, AP will send related notification email to the receivers. Note: if no event is specified in the Notification page, server will send an empty mail.
General	
From Email Address	Specify the email address of the notification sender. If the address is not specified, AP will use the SMTP username as a sender.
From Name	Specifies the name of the notification sender.
SMTP Username	Specifies the username to login to the mail server
Email Address	Specifies the email address of the administrator where to receive notifications.
Skip Certificate Validation	Check this box to skip the certificate validation
SMTP Settings	
SMTP Host	Configures the SMTP Email Server IP or Domain Name.

SMTP Port	Specifies the Port number used by server to send email.
Receiver Email Address	Specifies the email addresses to receive notifications.

Email/Notification

Email

Notification

Enabled

Memory Usage ?

CPU Usage ?

Firmware Upgrade ?

SSID ?

Time Zone Change ?

Administrator Password Change ?

AP Offline ?

Figure 79: Notification

The following table describes the notifications configuration settings.

Table 27: Email Events

Filed	Description
Enabled	Enable/disable the notification. By default, it's disabled
Memory Usage	Configures whether to send notification if memory usage is greater than the configured threshold. By default, it's disabled.
Memory Usage Threshold (%)	Specifies the Memory Usage Threshold (%). Must be integer between 1 and 100.
CPU Usage	Configures whether to send notification if CPU usage is greater than the configured threshold. By default, it's disabled.
CPU Usage	Specifies the CPU Usage Threshold (%). Must be integer between 1 and 100.

Threshold (%)	
Firmware upgrade	Configures whether to send notification on firmware upgrade. Default is disabled.
SSID	Configures whether to send notification if any SSID is enabled. Default is disabled.
Time Zone Change	Configures whether to send notification on time zone change. Default is disabled.
Administrator Password Change	Configures whether to send notification on admin password change. Default is disabled.
AP Offline	Configures whether to send notification when AP going offline. Default is disabled.

DHCP Server

By default, GWN has DHCP relay, but users could create and manage multiple DHCP server pools which will be mapped to the SSID using VLAN tag, for example when creating a DHCP pool under “**System Settings** → **DHCP Server**” users need to set a VLAN ID and same one should be set under SSID to map the configured DHCP pool with the SSID. This way users could configure multiple SSIDs mapped to multiple VLANs on the network in which case they are isolated by layer 2 switching.

The table below summarizes the configuration parameters for DHCP server.

Table 28: DHCP Server Parameters

Field	Description
Name	Set the name of the DHCP Pool.
Enable	Enable/Disable the DHCP pool.
VLAN ID	Set a VLAN ID, same one should be set on SSID settings to map it with the DHCP pool.
DHCP Server Static Address	Configure the static address of the DHCP server (through which GWN Master AP will be accessible).
DHCP Server Subnet Mask	Sets the subnet mask for the DHCP Pool.
DHCP Start Address	Set the start address for DHCP
DHCP End Address	Set the end address for DHCP
DHCP Lease Time	Set the DHCP lease time for the clients (default 12h).
DHCP Options	Add the Option items for DHCP, detailed option contents can be found via: https://wiki.openwrt.org/doc/howto/dhcp.dnsmasq



DHCP Gateway	Set the gateway for DHCP, and it is better to set the gateway, should be different that the static IP of the access point and on the same subnet.
DHCP Preferred DNS	Set the preferred DNS for DHCP
DHCP Alternated DNS	Set the alternated DNS for DHCP

Static DHCP

Users can use the feature in order to set static DHCP binding to certain clients, to whom you do not want the IP address to change.

To configure Static DHCP, please follow below steps:

1. Go under the menu “**System Settings → DHCP Server → Static DHCP**”.
2. Click  button to create a new entry.
3. Enter the name of the device, along with its MAC address and IP address

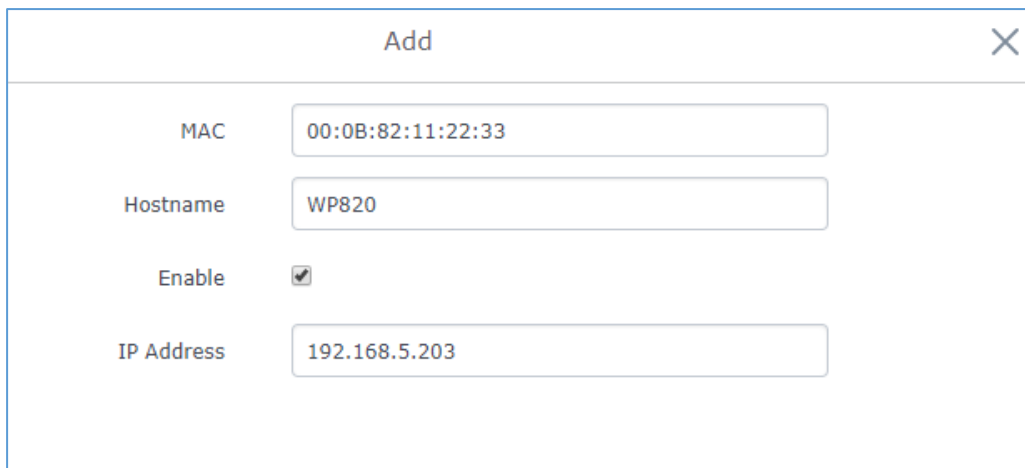

The screenshot shows a modal dialog box titled "Add" with a close button (X) in the top right corner. It contains four input fields:

- MAC:** 00:0B:82:11:22:33
- Hostname:** WP820
- Enable:**
- IP Address:** 192.168.5.203

Figure 80: DHCP Binding

4. Press Save and Apply to submit the changes.

DHCP Server

DHCP Server Static DHCP

[+ Add](#)

MAC	Hostname	Enable	IP Address	Actions
00:0B:82:11:22:33	WP820	✓	192.168.5.203	✎ 🗑️

Figure 81: Static DHCP Devices List

SCHEDULE

Users can use the schedule configuration menu to set specific schedule for GWN features while giving the flexibility to specify the date and time to turn ON/OFF the selected feature.

The Schedule can be used for settings up specific time for Wi-Fi where the service will be active or for LED schedule or bandwidth rules ...etc.

To configure a new schedule, follow below steps:

1. Go under “**Schedule**” and click on **Create New Schedule**.

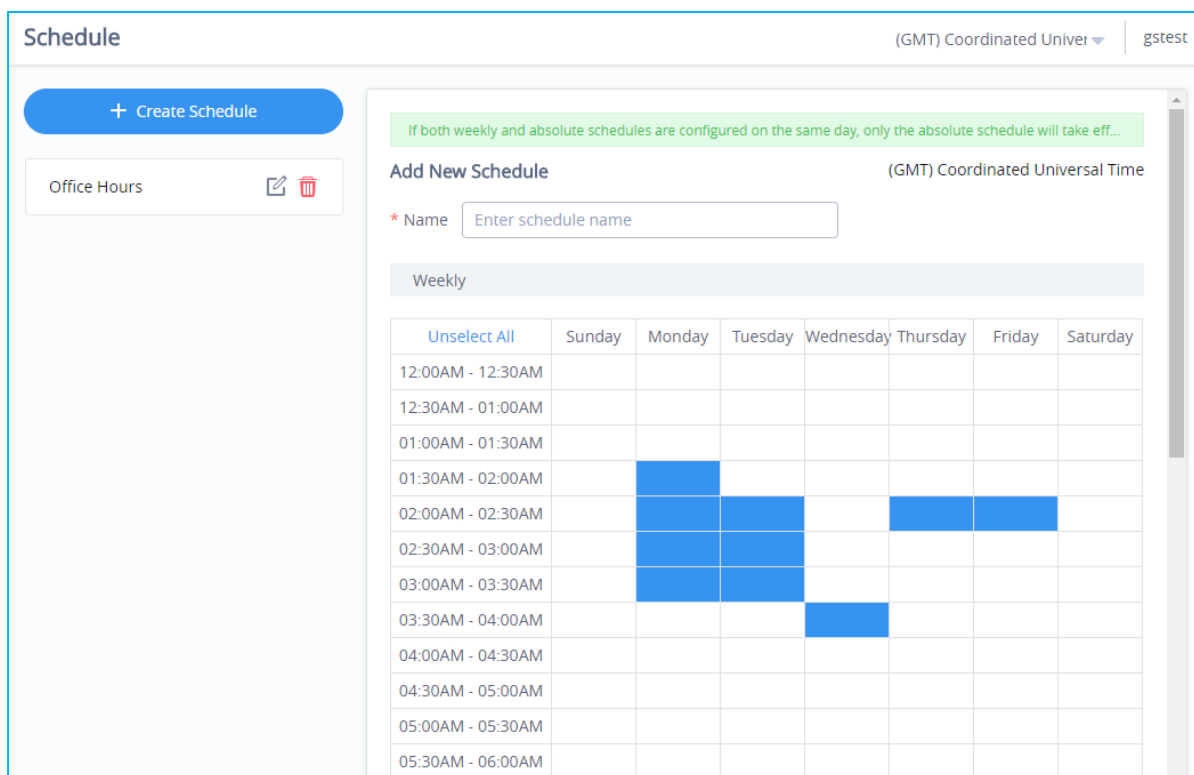

Schedule (GMT) Coordinated Universal Time | gstest

+ Create Schedule

Office Hours [edit] [delete]

Add New Schedule (GMT) Coordinated Universal Time

* Name

Weekly

Unselect All	Sunday	Monday	Tuesday	Wednesday	Thursday	Friday	Saturday
12:00AM - 12:30AM							
12:30AM - 01:00AM							
01:00AM - 01:30AM							
01:30AM - 02:00AM		■					
02:00AM - 02:30AM		■	■		■	■	
02:30AM - 03:00AM		■	■				
03:00AM - 03:30AM		■	■				
03:30AM - 04:00AM				■			
04:00AM - 04:30AM							
04:30AM - 05:00AM							
05:00AM - 05:30AM							
05:30AM - 06:00AM							

Figure 82: Create New Schedule

2. Select the periods on each day that will be included on the schedule and enter a name for the schedule (ex: office hours).
3. Users can choose to set weekly schedule or absolute schedule (for specific days for example), and if both weekly schedule and absolute schedules are configured on the same day then the absolute schedule will take effect and the weekly program will be cancelled for that specific date.
4. Once the schedule periods are selected, click on **Save** to save the schedule.

The list of created schedules will be displayed as shown on the figure below. With the possibility to edit or delete each schedule:

The screenshot shows a web interface for managing schedules. At the top, it says 'Schedule' and '(GMT) Coordinated Univer' with a dropdown arrow and 'gstest'. Below this is a '+ Create Schedule' button. A sidebar on the left contains a search box with 'Office Hours' and edit/delete icons. The main area is titled 'Office Hours' and '(GMT) Coordinated Universal Time'. It displays a calendar for April 2018. The calendar has columns for Sun, Mon, Tues, Wed, Thu, Fri, and Sat. The dates 1 through 30 are shown. A 'Weekly' schedule is highlighted in blue, covering the days from Sunday to Tuesday. The date 15 is circled in blue. At the bottom, there is a copyright notice: 'Copyright © 2018 Grandstream Networks, Inc. All rights reserved.' and a language dropdown set to 'English'.

Figure 83: Schedules List

LED SCHEDULE

GWN76XX Access Points series support also the LED schedule feature. This feature is used to set the timing when the LEDs are ON and when they will go OFF at customer’s convenience.

This can be useful for example when the LEDs become disturbing during some periods of the day, this way with the LED scheduler, you can set the timing so that the LEDs are off at night after specific hours and maintain the Wi-Fi service for other clients without shutting down the AP.

To configure LED schedule, on the GWN76XX WebGUI navigate to “**System Settings→LEDs**”.

Following options are available:

Table 29: LEDs

Field	Description
LEDs Always Off	Configure whether to disable the AP LED dictator
Schedule	Please choose a schedule to assign to LEDs, users can configure schedules under the menu <i>SCHEDULE</i>

Following example on the next page sets the LEDs to be turned on from 8am till 8pm every day.

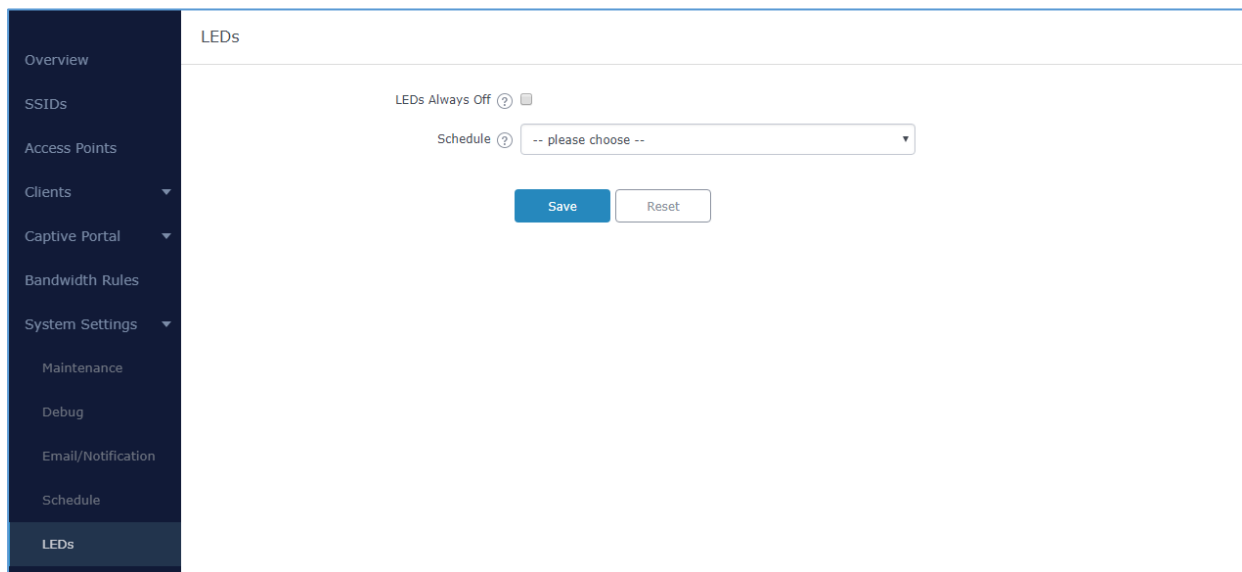

Figure 84: LED Scheduling Sample

UPGRADING AND PROVISIONING

Upgrading Firmware

The GWN76XX can be upgraded to a new firmware version remotely or locally. This section describes how to upgrade your GWN76XX.

Upgrading via Web GUI

The GWN76XX can be upgraded via TFTP/HTTP/HTTPS by configuring the URL/IP Address for the TFTP/HTTP/HTTPS server and selecting a download method. Configure a valid URL for TFTP, HTTP or HTTPS; the server name can be FQDN or IP address.

Examples of valid URLs:

firmware.grandstream.com/BETA

192.168.5.87





The upgrading configuration can be accessed via:

Web GUI→System Settings→Maintenance→Upgrade

Table 30: Network Upgrade Configuration

Field	Description
Authenticate Config File	Authenticates configuration file before acceptance. The default setting is No.
XML Config File Password	The password for encrypting the XML configuration file using OpenSSL. The password is to decrypt the XML configuration file is it is encrypted via OpenSSL
Upgrade Via	Allow users to choose the method to load the firmware and config: TFTP, HTTP or HTTPS.
Firmware Server	Define the IP address or URL for the firmware upgrade server. Make sure all files relevant to the firmware are updated completely
Config Server	Configure the IP address of URL for the file server.
Check/Download New Firmware and Config at Boot	Configure whether to enable/disable automatic upgrade and provisioning when reboot.
Allow DHCP options 66 and 43 override	Enable/Disable DHCP options 66 and 43 to override the upgrade and provisioning settings

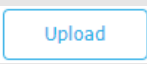

Automatic Upgrade	Set automatic upgrade every intervals/day/week. The device will request to upgrade automatically according to the setup time. The default setting is Disabled
X Hours	Select the time period to check for firmware upgrade. <i>This field is available when select "Check every X Hours" in "Automatic Upgrade"</i>
Hour of Day (0-23)	Defines the hour of the day (0-23) to check the HTTP/TFTP server for firmware upgrade or configuration file changes. <i>This field is available when select "Check at Hour of Day" and "Check at Day of Week" in "Automatic Upgrade"</i>
Day of Week	Defines the day of the week to check the HTTP/TFTP server for firmware upgrade or configuration file changes. <i>This field is available when select "Check at Day of Week" in "Automatic Upgrade"</i>
Upgrade Now	Click on  button to begin the upgrade. Note that the device will reboot after downloading the firmware. Note: Please save and apply your configuration first if there are any configuration modification.
Download Configuration	Click on  button to download the device configuration file to PC.
Upload Configuration	Click on  to select a compressed config file to restore the config; after succeeding, the device will reboot automatically.
Reboot	Click on  button to reboot device.
Factory Reset	Click on  to restore the device and all online APs to factory default settings.

Upgrading Slave Access Points

When the GWN76XX is being paired as slave using another GWN76XX Access Point acting as Controller, users can upgrade their paired access points from the GWN76XX Master Controller.

To upgrade a slave access point, log in to the GWN76XX acting as Master Controller and go to **Access Points**.



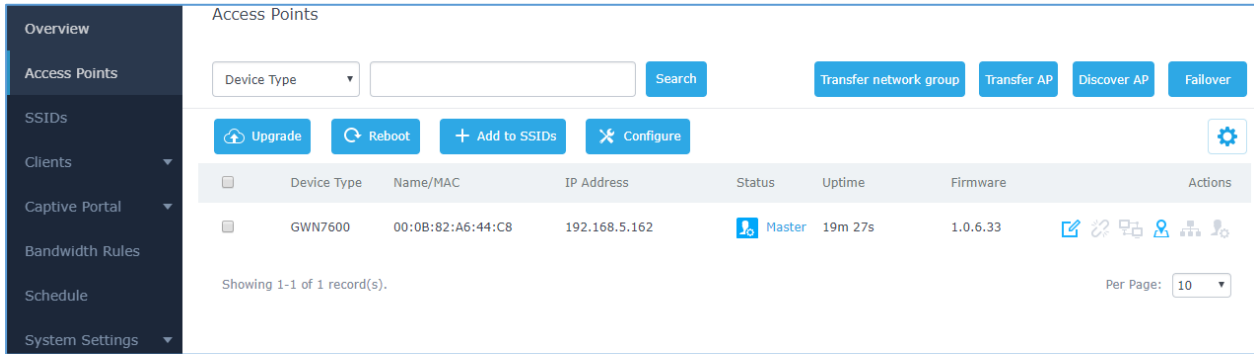



Figure 85: Access Points

Make sure that firmware server path is set correctly under Maintenance, check the desired APs to upgrade, and click on  to upgrade the selected paired access points.

Sequential Upgrade

If you choose multiple slave devices to upgrade their firmware, two options are available: “All-at-Once” and “Sequential”. “All-at-Once” will use the default method, all checked slaves will upgrade their firmware at the same time, while using “Sequential” upgrade method, the slaves will upgrade their firmware one by one in order to:

- Avoid entire Wi-Fi service interruption by full system firmware upgrade.
- Reduce network bandwidth consumption caused by firmware downloading.

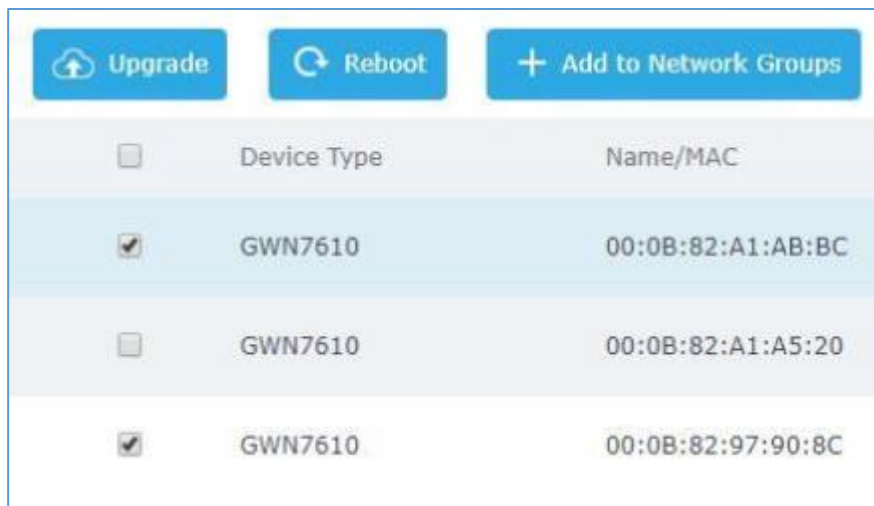

Figure 86: Choosing multiple devices

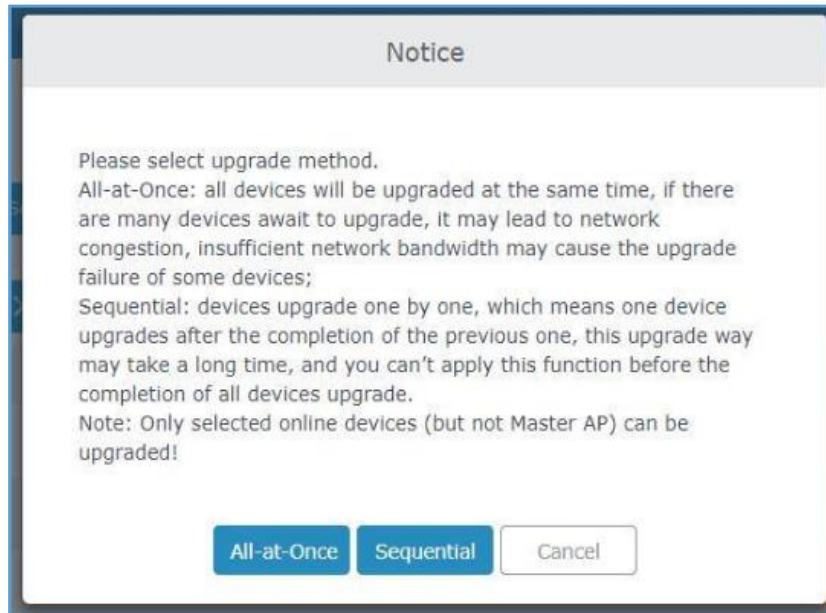
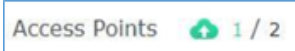

Figure 87: All-at-Once and Sequential Upgrade

Once you choose sequential upgrade, the following icon  will update you about the number of upgraded slaves out of the selected slaves.

Provisioning and Backup

The GWN76XX configuration can be backed up locally or via network. The backup file will be used to restore the configuration on GWN76XX when necessary.

Download Configuration

Users can download the GWN76XX configuration for restore purpose under **Web GUI→System Settings→Maintenance→Upgrade**.

Click on  to download locally the configuration file.

Upload Configuration

Users can upload configuration file to the GWN76XX under **Web GUI→System Settings→Maintenance→Upgrade**.



Click on  to browse for the configuration to upload.

Please note that the GWN76XX will reboot after the configuration file is restored successfully.

Configuration Server

Users can download and provision the GWN76XX by putting the config file on a TFTP/HTTP or HTTPS server and set Config Server to the TFTP/HTTP or HTTPS server used in order for the GWN76XX to be provisioned with that config server file.

Reset and reboot

- Users could perform a reboot and reset the device to factory functions under **Web GUI→System Settings→Maintenance→Upgrade** by clicking on  button.
-  Will restore all the GWN76XX itself to factory settings.

Syslog

On the GWN76XX, users could dump the syslog information to a remote server under **Web GUI→System Settings→Maintenance**. Enter the syslog server hostname or IP address and select the level for the syslog information. Five levels of syslog are available: None, Debug, Info, Warning, and Error.



EXPERIENCING THE GWN76XX WIRELESS ACCESS POINTS

Please visit our website: <http://www.grandstream.com> to receive the most up- to-date updates on firmware releases, additional features, FAQs, documentation and news on new products.

We encourage you to browse our [product related documentation](#), [FAQs](#) and [User and Developer Forum](#) for answers to your general questions. If you have purchased our products through a Grandstream Certified Partner or Reseller, please contact them directly for immediate support.

Our technical support staff is trained and ready to answer all your questions. Contact a technical support member or [submit a trouble ticket online](#) to receive in-depth support.

Thank you again for purchasing Grandstream GWN76XX Wireless Access Point, it will be sure to bring convenience and color to both your business and personal life

