



IB9387-HT-A, IB9387-EHT-A
IB9365-HT-A, IB9365-EHT-A

Bullet
Network Camera

User's Manual

2MP (IB9365) / 5MP (IB9387) • IP67 • IK10 • Day & Night • Smart Motion Detection •
Remote Focus • WDR Pro II • Smart Stream III • SNV II • 50M Smart IR • Shock Detection

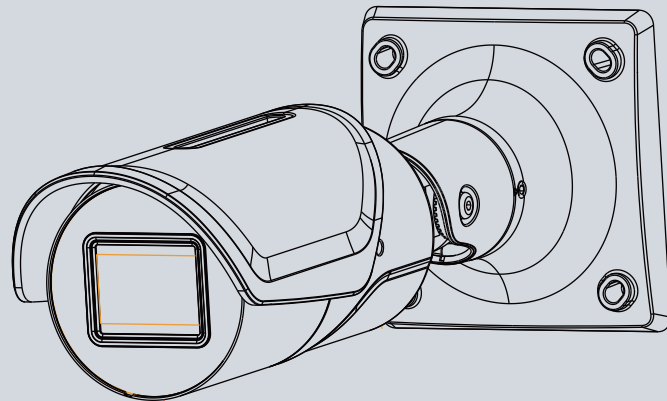

Rev. 1.0

Table of Contents

| | |
|---|-----------|
| Overview | 3 |
| Revision History | 4 |
| Read Before Use | 4 |
| Package Contents | 7 |
| Symbols and Statements in this Document | 7 |
| Physical Description | 8 |
| Hardware Installation | 11 |
| Software Installation | 19 |
| Network Deployment | 26 |
| Ready to Use | 27 |
| Accessing the Network Camera | 30 |
| Using Web Browsers | 30 |
| Using RTSP Players | 33 |
| Using 3GPP-compatible Mobile Devices | 34 |
| Using VIVOTEK Recording Software | 35 |
| Main Page | 36 |
| Client Settings | 41 |
| Configuration | 46 |
| System > General settings | 47 |
| System > Homepage layout | 49 |
| System > Logs | 52 |
| System > Parameters | 55 |
| System > Maintenance | 56 |
| Media > Image | 60 |
| Media > Video | 74 |
| Media > Video | 75 |
| Media > Video | 76 |
| Media > Audio | 85 |
| Network > General settings | 87 |
| Network > Streaming protocols | 94 |
| Network > SNMP (Simple Network Management Protocol) | 104 |
| Network > FTP | 105 |
| Bonjour | 106 |
| Security > User accounts | 107 |
| Security > HTTPS (Hypertext Transfer Protocol over SSL) | 109 |
| Security > Access List | 116 |
| PTZ > PTZ settings | 122 |
| Event > Event settings | 126 |
| Applications > Motion detection | 140 |
| Applications > Smart VCA | 141 |
| Applications > DI and DO | 142 |
| Applications > Tampering detection | 143 |
| Applications > Audio detection | 144 |
| Applications > Shock detection | 146 |

| | |
|---|------------|
| Applications > Package management - a.k.a., VADP (VIVOTEK Application Development Platform) ... | 147 |
| Recording > Recording settings | 150 |
| Local storage > Storage management | 155 |
| Storage > Content management | 158 |
| Appendix | 161 |
| URL Commands for the Network Camera | 161 |
| Technology License Notice | 425 |
| Electromagnetic Compatibility (EMC) | 426 |

Overview

The IB9387 and 9365 series is a camera line to come embedded with the Smart Motion Detection feature. The Smart Motion detection, with Human detection and tunable time filter, can eliminate the defects of traditional motion detection and facilitate the configuration at a surveillance site.

To learn more about this feature, download its User Guide in:

http://download.vivotek.com/downloadfile/solutions/vadp/smart-motion-detection-manual_en.pdf

A key feature in the Smart Motion detection is the Human detection. Based on a human silhouette database and the rapid responses via an artificial neural network technology, the Smart engine instantly recognizes human appearances in a video surveillance area. Since humans are the objects of interest in the majority of video surveillance, the Human detection feature enables users to quickly configure his installation.

With Human detection, light changes or swaying vegetation, vehicles passing by, or animal activities in the scene are not taken as event triggers. Only human activities will trigger an event. This helps reduce false alarms and the time and efforts for a camera configuration.

The 9365 series is an outdoor network camera capable of 1920 x 1080 resolution at 60 fps. With the most updated VIVOTEK SNV and WDR Pro technology, the 9365 series is capable of capturing the highest quality images in both low light and high contrast environments. The IB9387 features a 5MP resolution.

The 9387 and 9365 series also offers the best in night time surveillance technology. By adopting Smart IR II technology from VIVOTEK speed domes, the IR illuminators now align with the remote focus lens' focus angle to provide the best IR image quality at any lens setting. This feature optimizes IR intensity, reduces IR hotspots, and increases the IR effective range up to 50 meters.

Revision History

- Rev. 1.0: Initial release.

Read Before Use

The use of surveillance devices may be prohibited by law in your country. The Network Camera is not only a high-performance web-ready camera but can also be part of a flexible surveillance system. It is the user's responsibility to ensure that the operation of such devices is legal before installing this unit for its intended use.

It is important to first verify that all contents received are complete according to the Package Contents listed below. Take note of the warnings in the Quick Installation Guide before the Network Camera is installed; then carefully read and follow the instructions in the Installation chapter to avoid damage due to faulty assembly and installation. This also ensures the product is used properly as intended.

The Network Camera is a network device and its use should be straightforward for those who have basic networking knowledge. It is designed for various applications including video sharing, general security/surveillance, etc. The Configuration chapter suggests ways to best utilize the Network Camera and ensure proper operations. For creative and professional developers, the URL Commands of the Network Camera section serves as a helpful reference to customizing existing homepages or integrating with the current web server.



Caution! Hot surface! Do not touch.



IMPORTANT:

1. Please contact VIVOTEK's certified dealers for power adapters.
 2. Installation and maintenance service should only be performed by qualified technicians.
 3. If powered by a power adapter, the adapter should be properly grounded.
 4. The power cord must be connected to a socket or outlet with a ground connection.
-

 **NOTE:****Camera Hardware Preventative Maintenance:**

1. Visual inspection of all major components including accessories, cabling and connections where accessible for signs of deterioration or damage.
 2. Check and clean cameras, lenses and housings inside and out as needed.
 - Please do not scratch, damage, or leave fingerprints on the dome/front cover and/or lens because this may decrease image quality.
 - For general cleaning of dirty areas, it is suggested to use compressed air to remove dust and/or other debris in order not to damage the on-board components.
 - In order to clean oil stains, it is recommended to use a spray-type decomposing cleaner (absolutely avoid reciprocating wipes on the surface). After the oil has decomposed, spray it with water, dry with air, and/or absorb water with a cotton cloth or a soft cloth (dab, please avoid wiping).
 - Do not use harsh detergents, gasoline, benzene or acetone, etc. to clean as they may deform or cause damage to the product. Also, excessive cleaning could damage the surface.
 3. Check images for correct field of view (pan, tilt and zoom focus) and adjust as necessary.
 4. Check and replace the Micro SD memory card as needed.
 - Stop edge recording before removing the Micro SD memory card.
 - Make sure that the Micro SD memory card is right side up and do not insert it with force, otherwise it may be damaged.
 - When it is raining or the humidity is high, insertion or ejection of the Micro SD memory card is not recommended.
 5. Disassembly of the dome/front cover carries the risk of internal dew condensation, so please remember to replace the desiccant bags on the inside of the cameras before reassembly.
 6. Check that the camera view has not been blocked by obstacles and that you can see the property perimeter clearly.
 7. Make sure the interiors of cameras and accessories, like mounting kits and/or enclosures, are clean and dry.
 8. Make sure cameras are securely attached to the wall/ceiling/mounting kits.
-

⚠ IMPORTANT:

For some customers who already have their own web site or web control application, the Network Camera/Video Server can be easily integrated through URL syntax. This section specifies the external HTTP-based application programming interface. The HTTP-based camera interface provides the functionality to request a single image, control camera functions (PTZ, output relay etc.), and get and set internal parameter values. The image and CGI-requests are handled by the built-in Web server.

- To send URL commands in the address bar of your web browser, please remember to disable the Cross-Site Request Forgery (CSRF) protection in Configuration > Security > Miscellaneous.

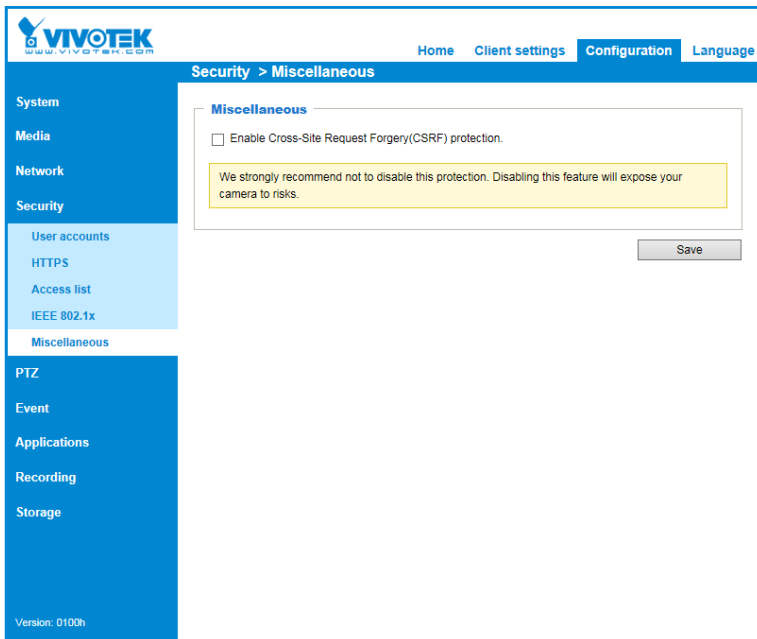

- For up-to-date documentation of URL commands, please go to VIVOTEK’s website, register an account with a business mail address and submit for authorization for SDK in Support > Downloads > SDK.

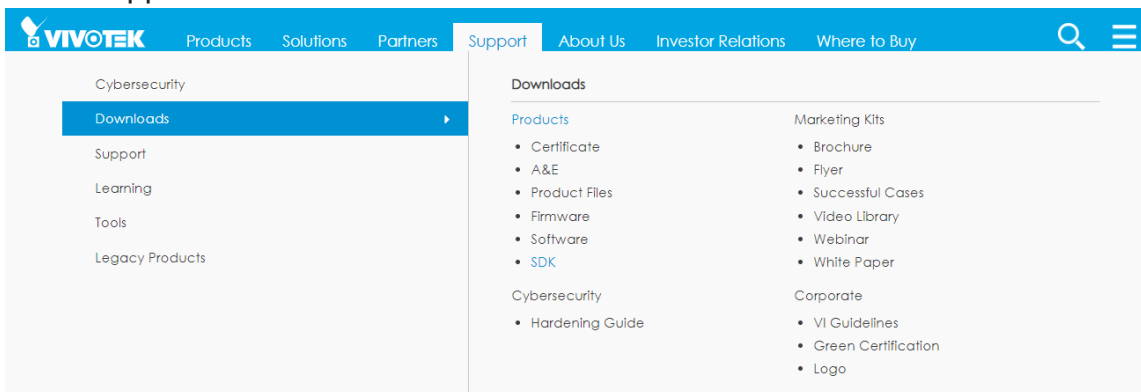

- For any further technical support, please contact our technical support department.

Package Contents

- IB9387 or IB9365
- Desiccant bag, screws, L wrench.
- Quick Installation Guide.
- Waterproof cable gland.



WARNING:

1. IR lights emit from this product.
2. Use live view to verify if the IR lights are on in the night mode.

Symbols and Statements in this Document



INFORMATION: provides important messages or advices that might help prevent inconvenient or problem situations.



NOTE: Notices provide guidance or advices that are related to the functional integrity of the machine.



Tips: Tips are useful information that helps enhance or facilitate an installation, function, or process.



WARNING: or IMPORTANT: These statements indicate situations that can be dangerous or hazardous to the machine or you.



Electrical Hazard: This statement appears when high voltage electrical hazards might occur to an operator.



IMPORTANT:

1. The camera is only to be connected to PoE networks without routing to outside plants.
2. For PoE connection, use only UL listed I.T.E. with PoE output.

1. La caméra ne doit être raccordée qu'à des réseaux PoE, sans routage vers des installations extérieures.
2. Pour les raccordements PoE, utilisez uniquement un équipement de TI homologué UL, avec une sortie PoE.

Use the camera only with a DC power supply that is UL listed, and limited power source (LPS) certified. The power supply should bear the UL listed and LPS marks. The power supply should also meet any safety and compliance requirements for the country of use.

n'utilisez la caméra qu'avec un bloc d'alimentation CC homologué UL, ainsi qu'avec une alimentation limitée (LPS) certifiée. Le bloc d'alimentation doit porter les indications d'homologation UL et LPS. Il doit également répondre aux exigences en matière de sécurité et de conformité relatives au pays d'utilisation.

Physical Description

Outer View

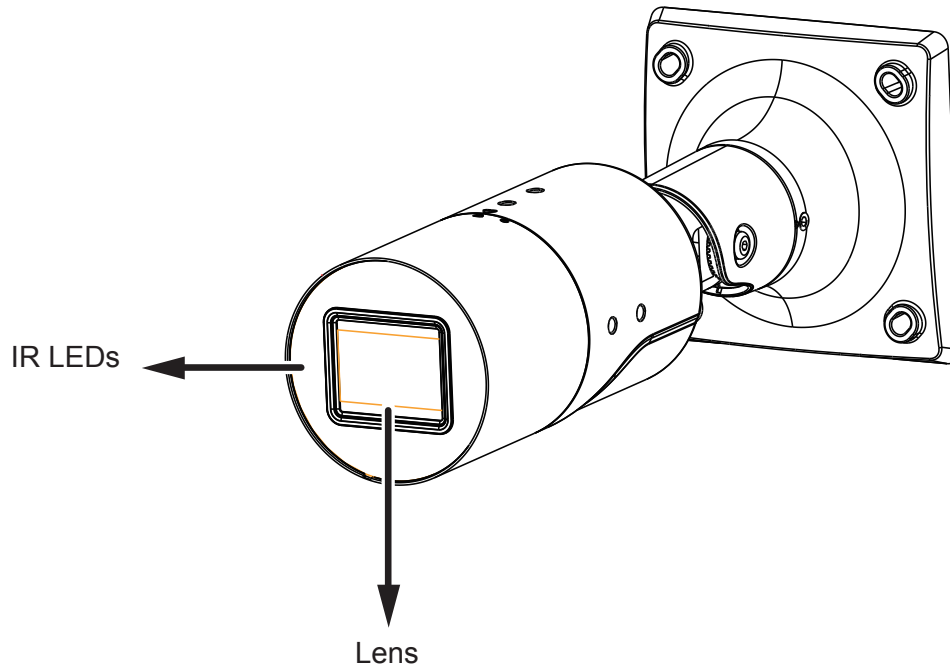

IMPORTANT:

Many copper coated aluminum (CCA) and other non-standard conductors cabling products are masqueraded as CAT5E or CAT6 cables. Please avoid using these CCA products especially when cascading PoE cameras. It is a must to use Ethernet cables compliant with the 3P/ETL standard.

Inner View

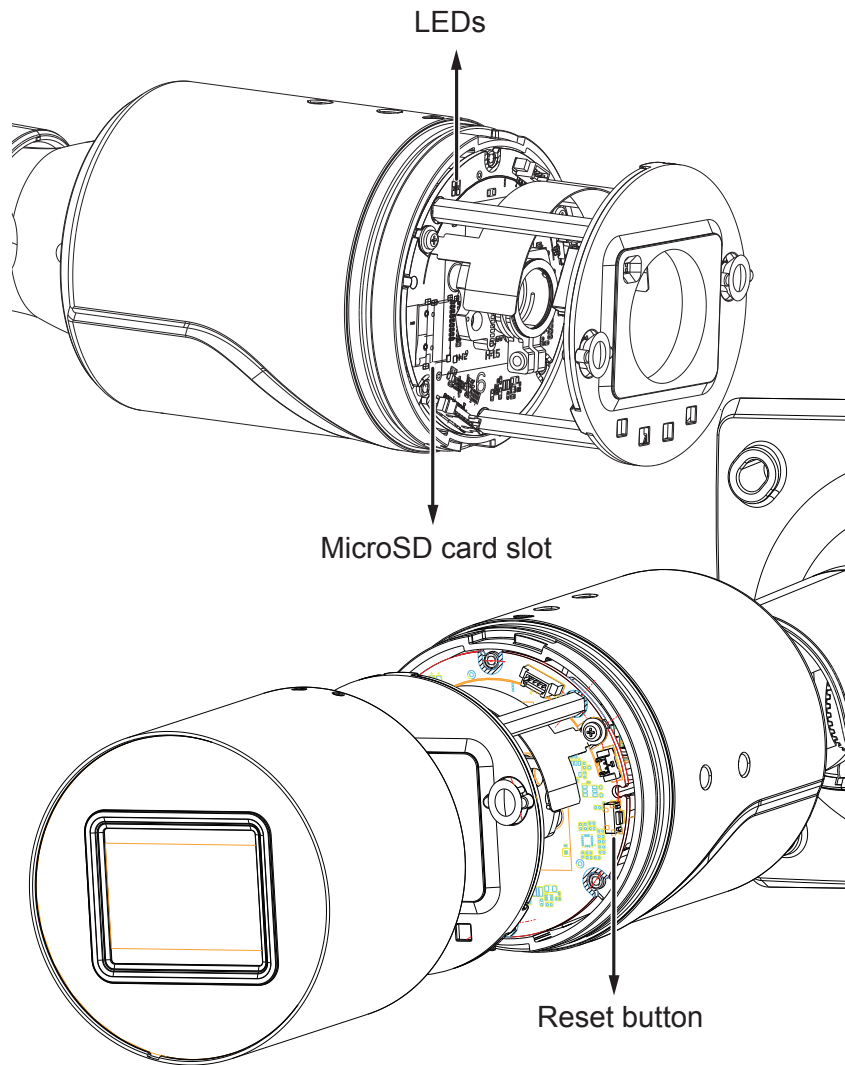

 **NOTE:**

Some of the suffix syntax used in model naming are listed below:

| | |
|----|-------------------------------------|
| E | w/ heater for extreme weather |
| Fx | Focal length w/ number |
| T | w/ Remote focus lens |
| R | w/ PoE repeater |
| H | w/ High Dynamic Range functionality |
| M | Manual focus lens |

 **IMPORTANT:**

802.3af or 802.3at

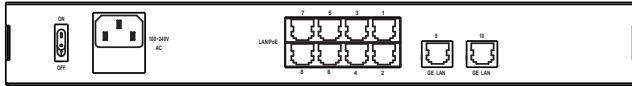

The E model camera comes with an embedded heater and requires an 802.3at PoE switch.

| Operating Temperature | Consumption & Power Input |
|------------------------|---|
| -40°C ~ 0°C, heater on | PoE 802.3at - max. 25W (PoE Plus mid-span or switch) |
| -40°C ~ 0°C, heater on | DC 12V input - 20.4W, 1.7A |
| -40°C ~ 0°C, heater on | AC 24V input 50~60Hz - 22W, 1.67A |
| ≥0°C, heater off | PoE: 12.95W (37V~57V, 0.33A~0.22A); DC 12V input - 10.8W, 0.9A; AC 24V -12.5W, 0.86A. |

Hardware Installation

⚠ IMPORTANT:

If you plan to use the Human Detection feature, make sure you measure the installation height of your camera. The height information is important for the accuracy of the video analytics results. Some of the other perspective information are automatically collected by the onboard S-sensor. The height information enables the horizontal and vertical keystone corrections of the field of view. Measure the distance between camera lens and the ground.

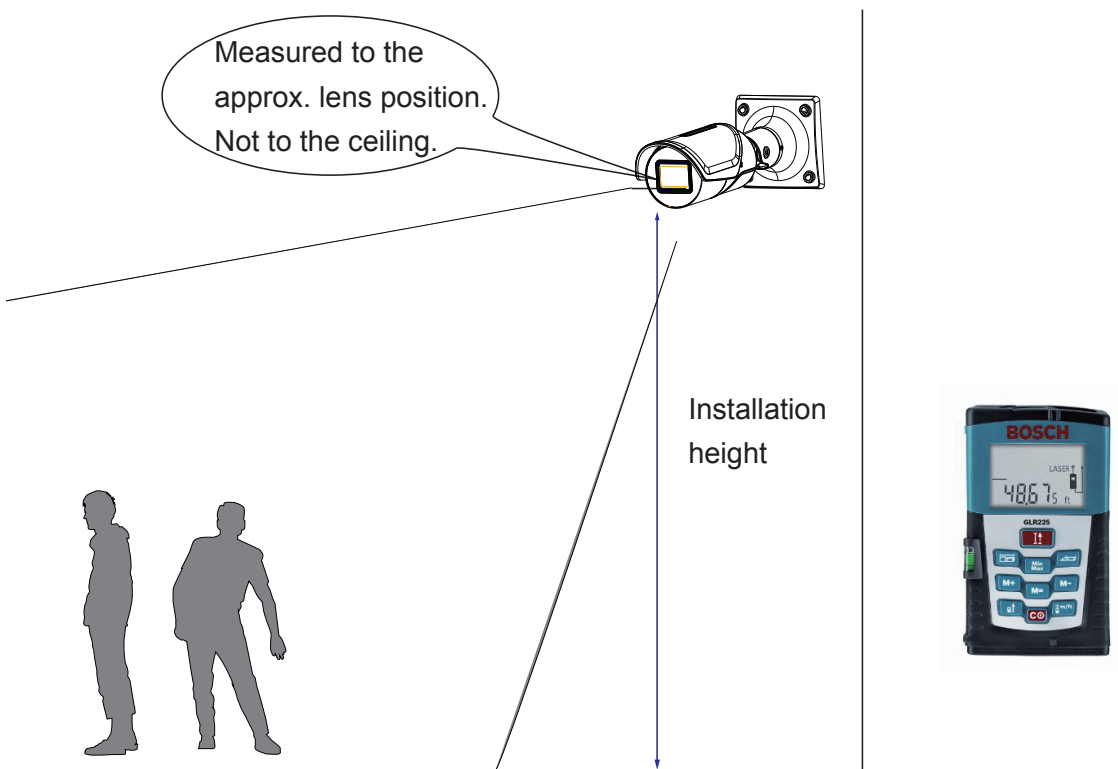

1. Jot down the camera's MAC address for later reference.

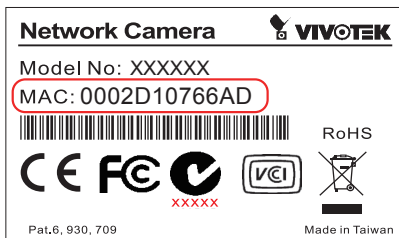

2. Open the camera canister by turning the outer half counter-clockwise.

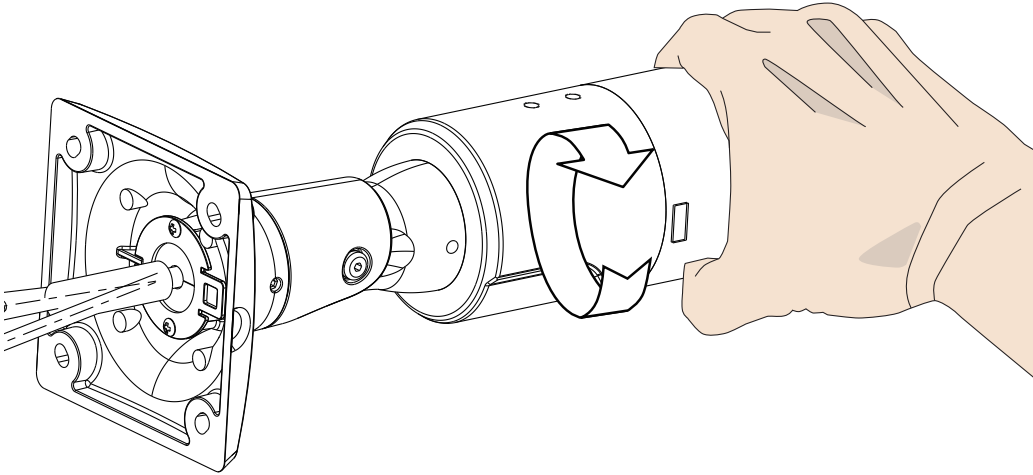

3. Install a MicroSD card if onboard storage is preferred.

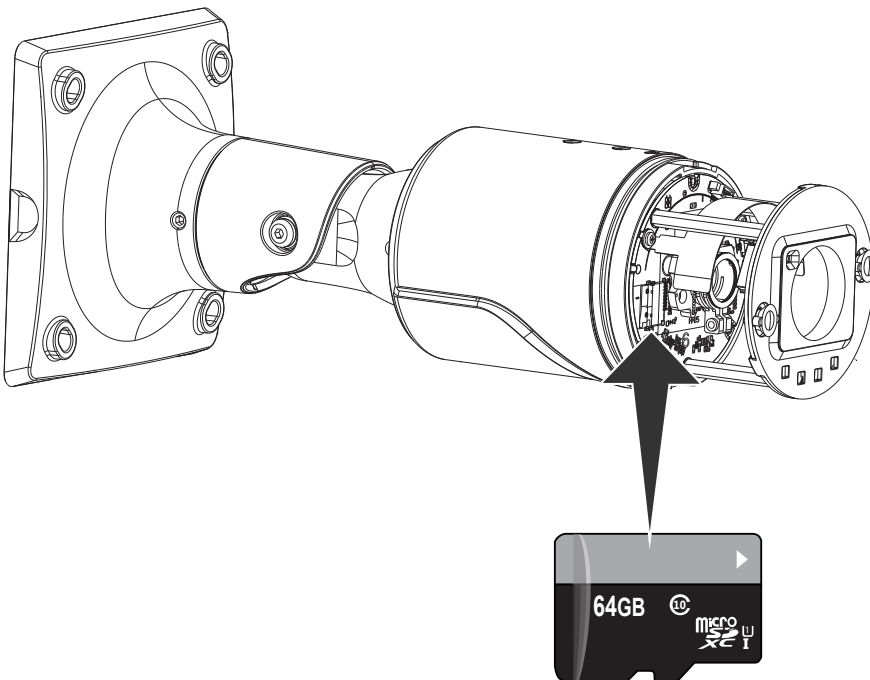

4. Replace the desiccant bag inside the canister.

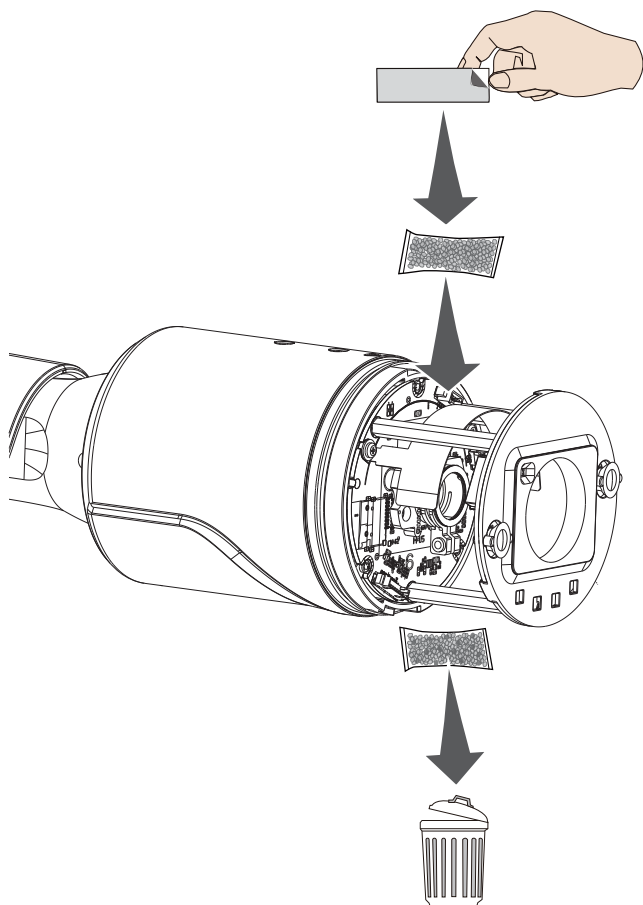

5. Install the canister cover by aligning and turning it clock-wise. There are alignment marks on the canister.

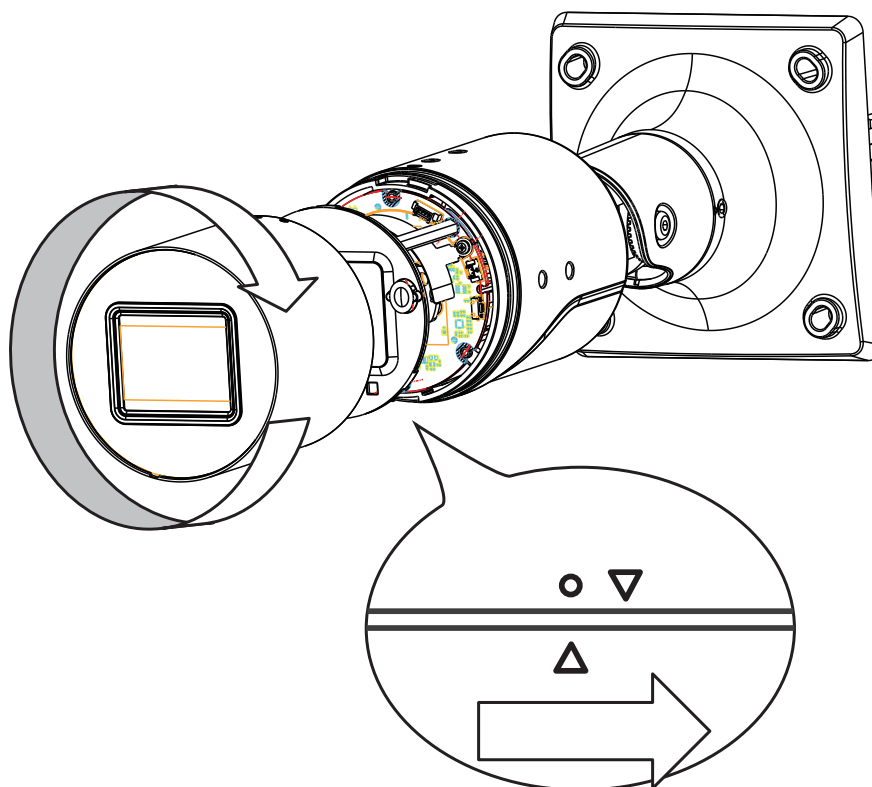

6. Install the sunshield. The position of sunshield can be adjusted.

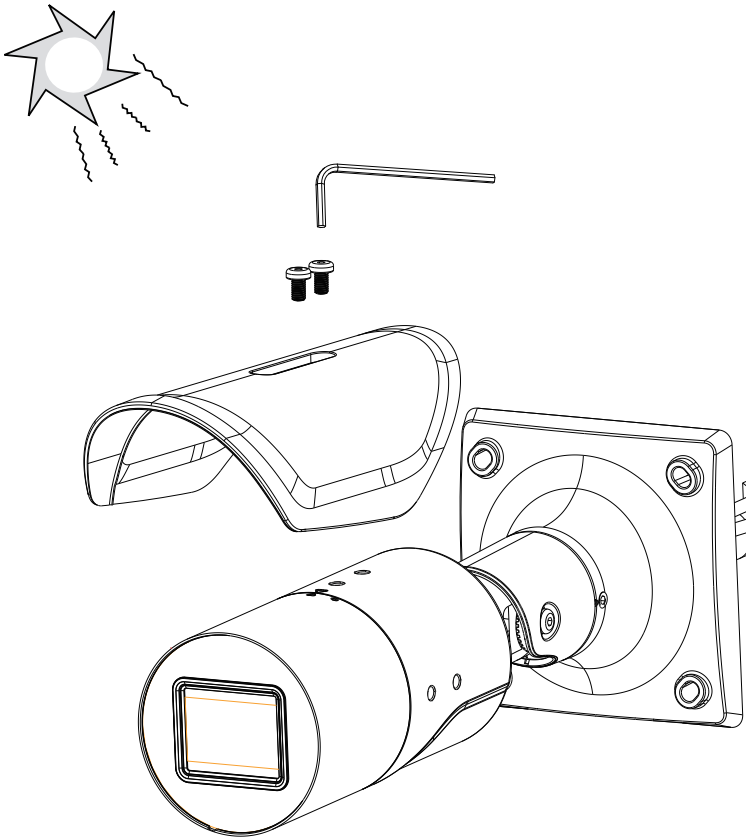

7. Use the alignment sticker to drill mounting holes on the wall, and install the conduit box.

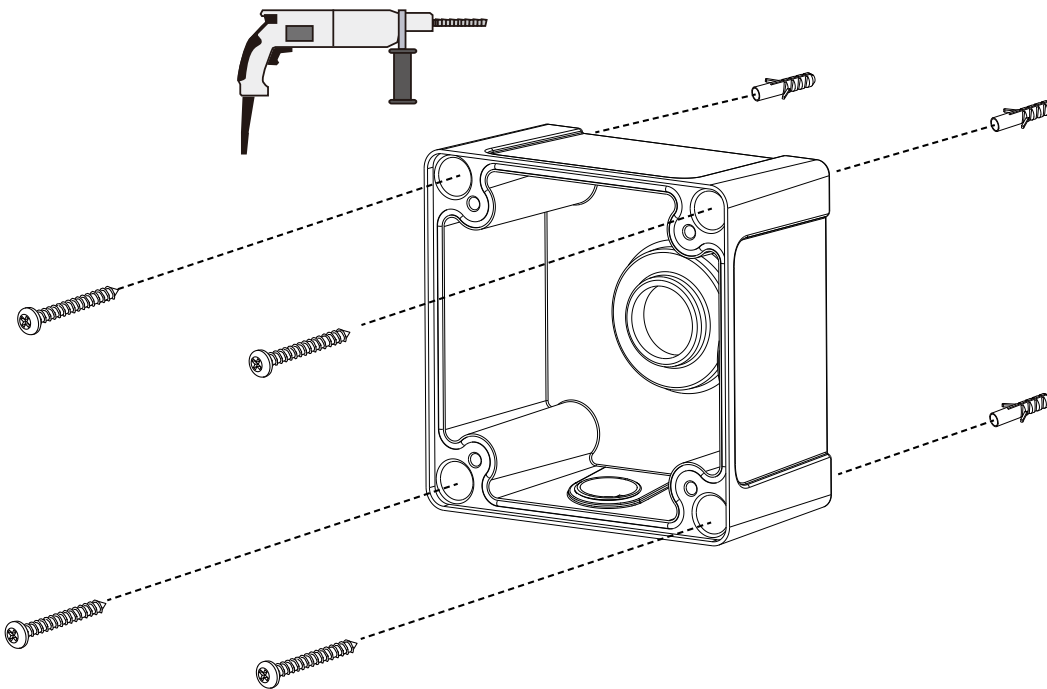

10. Attach the safety tether to the bottom of the camera.

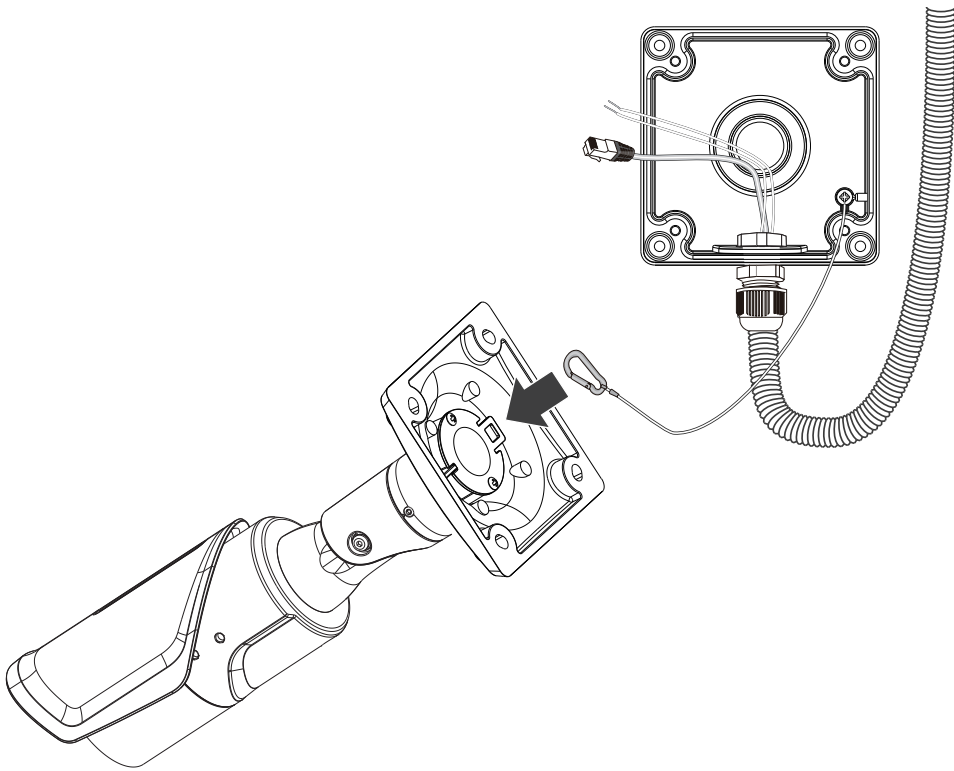

11. Shown below are the pinouts of the DI/DO terminals.

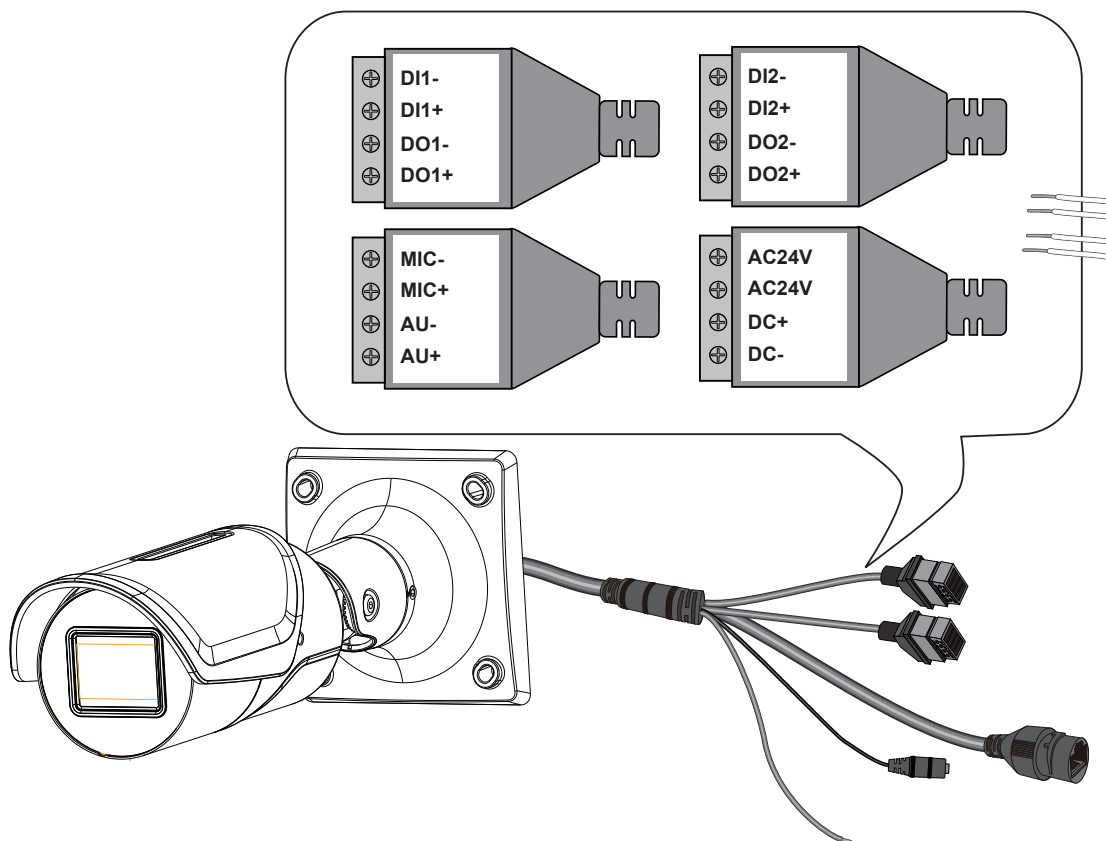

12. Install the components of the Ethernet cable gland to an Ethernet cable.

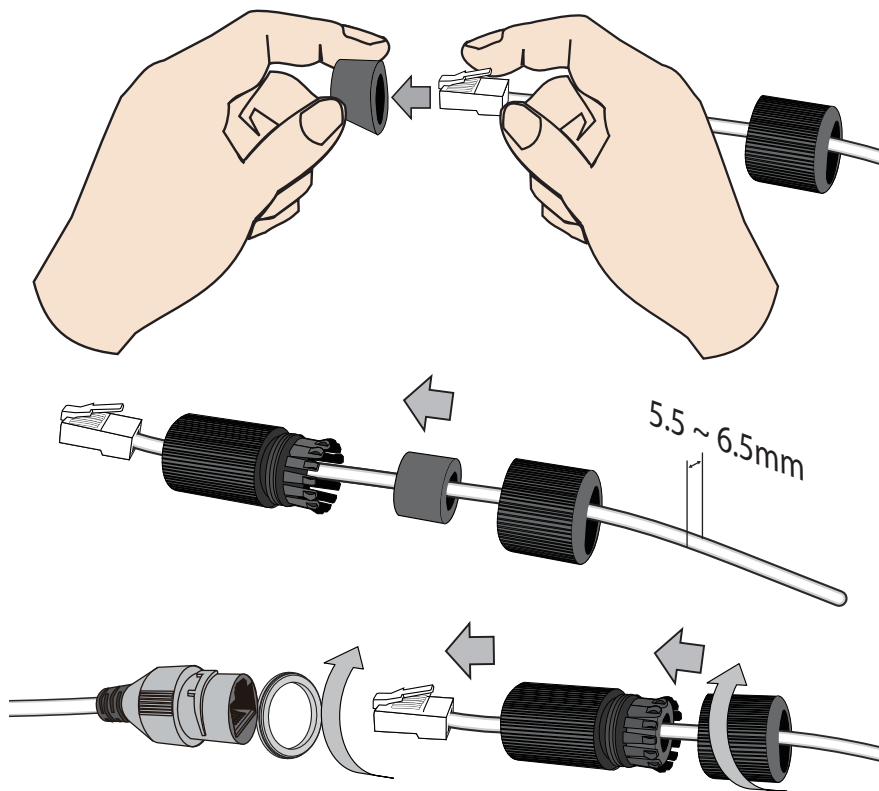

Use putties to seal the connections of every back-end cables.

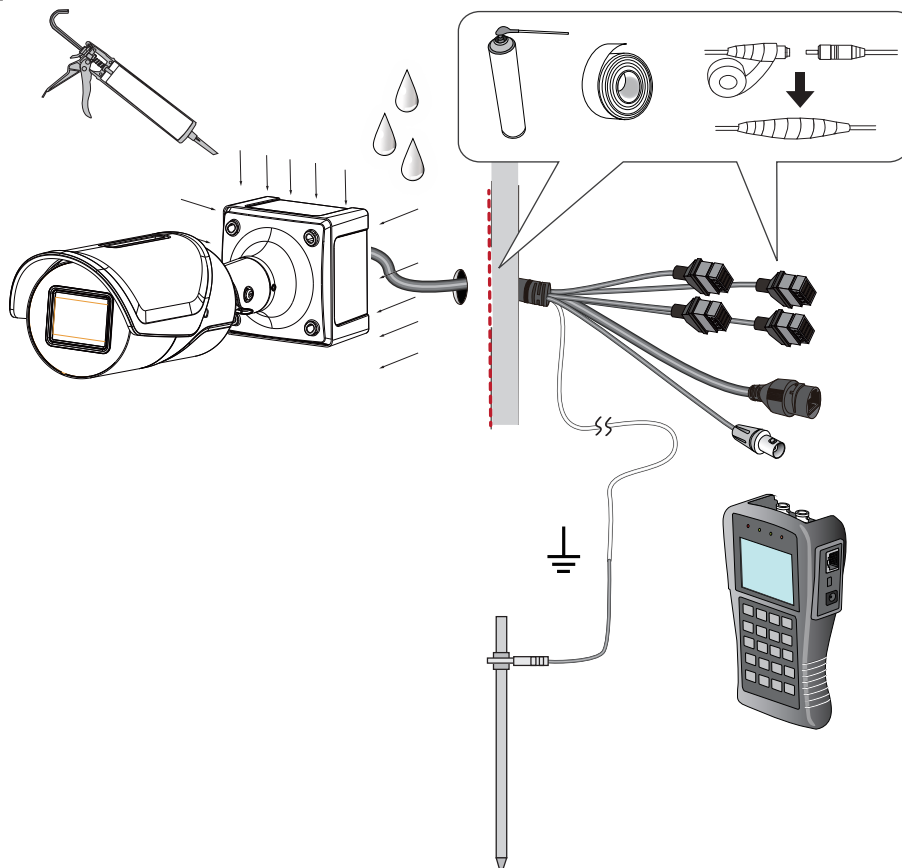

13. Install the camera to the box by driving 4 hex socket screws.

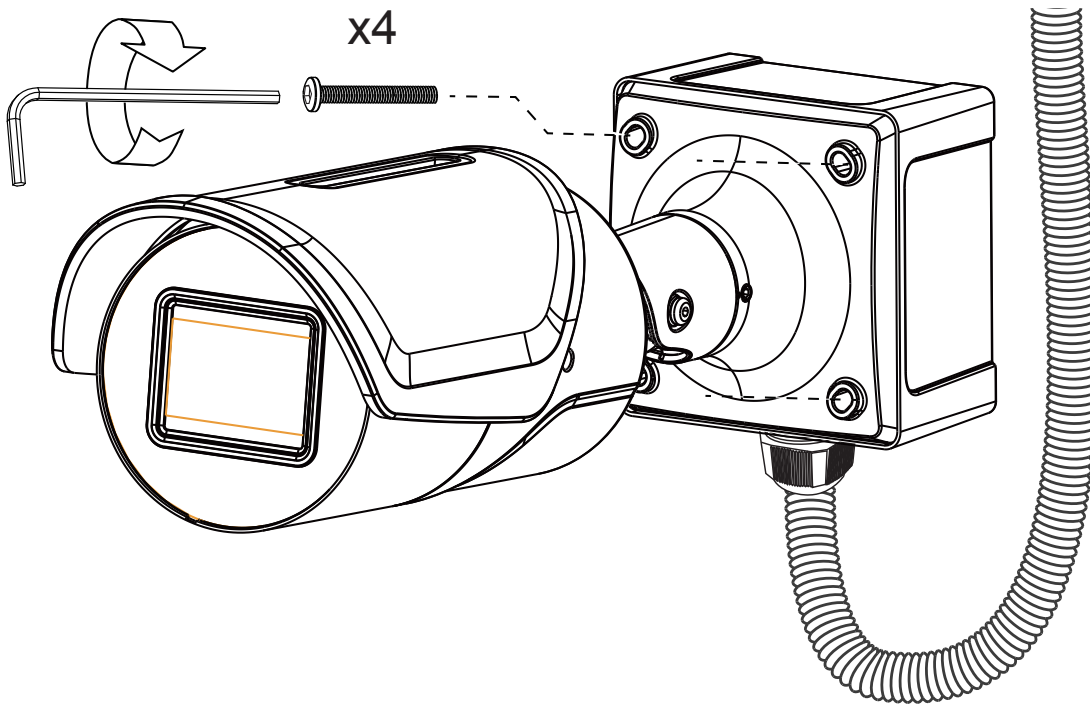

14. Please visit VIVOTEK’s website to Install the "Shepherd" software utility. The program will search for VIVOTEK Video Receivers, Video Servers or Network Cameras on the same LAN.

Double-click on the camera’s MAC address to open a web console with the camera.



Software Installation

15. Install the **Shepherd** utility, which helps you locate and configure your Network Camera in the local network. If your camera comes without the CD, go to VIVOTEK's website, and locate the utility in the Downloads > Software page.

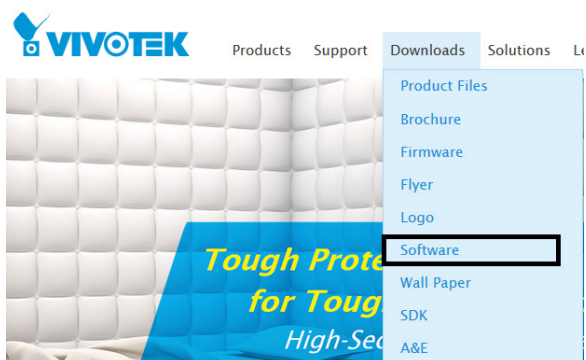

15-1. Run the Shepherd utility.

15-2. The program will conduct an analysis of your network environment.

| Status | Model | IP | MAC | Firmware |
|--------|----------------|-----------------|-------------------|----------|
| | AW-GET-094A... | 192.168.4.123 | 00-02-D1-2F-B7-3C | 0106 |
| | SD8161 | 192.168.50.4 | 00-02-D1-30-55-BF | 0100g6 |
| | FE9181-H | 192.168.50.3 | 00-02-D1-3E-1D-97 | 0100b3 |
| | IZ9361-EH | 192.168.4.148 | 00-02-D1-43-E6-52 | 0102f |
| | FD8177-H | 192.168.4.147 | 00-02-D1-48-F2-1C | 0100e_8 |
| | SD9366-EHL | 192.168.4.105 | 00-02-D1-4C-FB-EB | 0103a |
| | AW-GEU-086A... | 192.168.50.1 | 00-02-D1-4E-D8-14 | 0001 |
| | VAST | 169.254.214.242 | 00-50-56-C0-00-01 | 1.12.1.8 |
| | VAST | 192.168.4.113 | 2C-60-0C-FF-52-9F | 1.13.0.3 |
| | VAST | 192.168.4.131 | 2C-60-0C-FF-52-A0 | 1.12.1.8 |
| | VAST | 192.168.4.121 | 34-E6-D7-24-7D-C6 | 1.13.0.3 |
| | VAST | 192.168.4.118 | 54-53-ED-B3-B9-9E | 1.13.0.3 |
| | VAST | 169.254.07.777 | 68-0E-CA-1E-8D-10 | 1.12.1.9 |

15-3. The program will search for all VIVOTEK network devices on the same LAN.

15-4. After a brief search, the installer window will prompt. Click on the MAC and model name that matches the one printed on the product label. You can then double-click on the address to open a management session with the Network Camera.

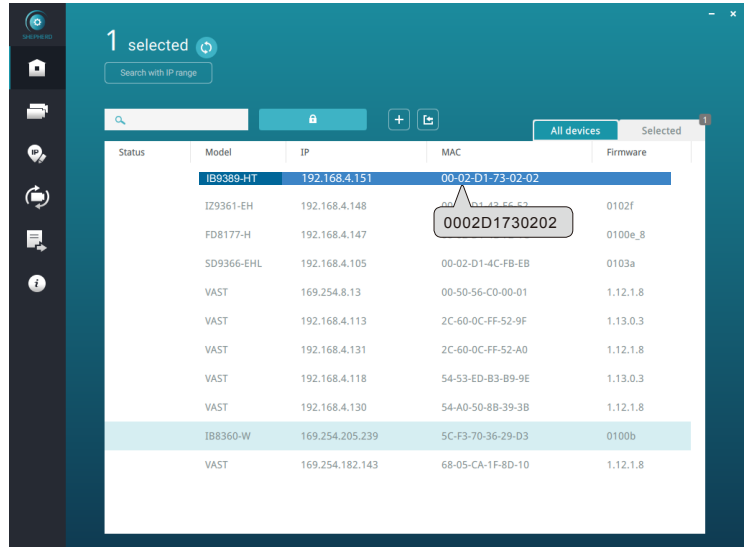

Forceful Password Configuration

16. The first time you log in to the camera, the firmware will prompt for a password configuration for security concerns.

16-1. Since your camera is used for the first time, there is no password. Enter “root” as the user name, and nothing for the password.



16-2. Enter the combination of alphabetic and numeric characters to fulfill the password strength requirement. The default name for the camera administrator is “root”, and can not be changed.

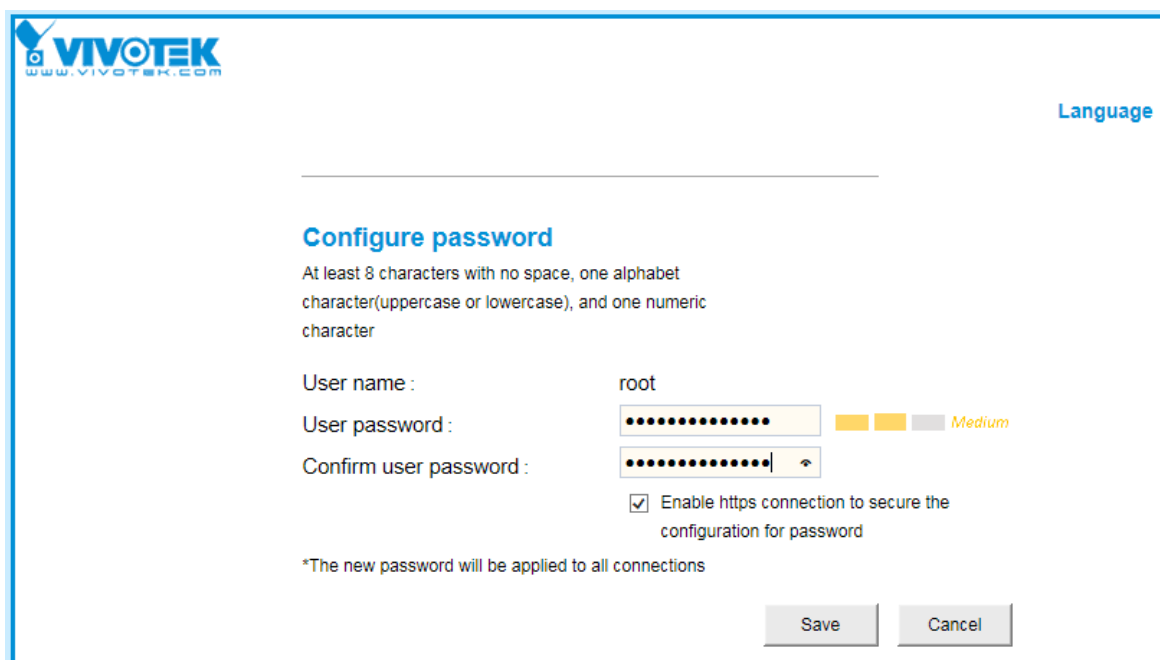

Some, but not all special ASCII characters are supported: !, \$, %, -, ., @, ^, _, and ~. You can use them in the password combination.

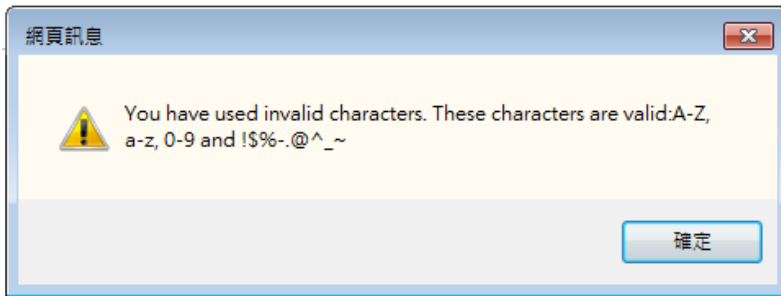

16-3. Another prompt will request for the password you just configured. Enter the password and then you can start configure your camera and see the live view.



17. Loosen, but not completely remove, the retention screws on the mounting bracket to adjust the camera's shooting direction. You can pan, tilt, or rotate the camera.

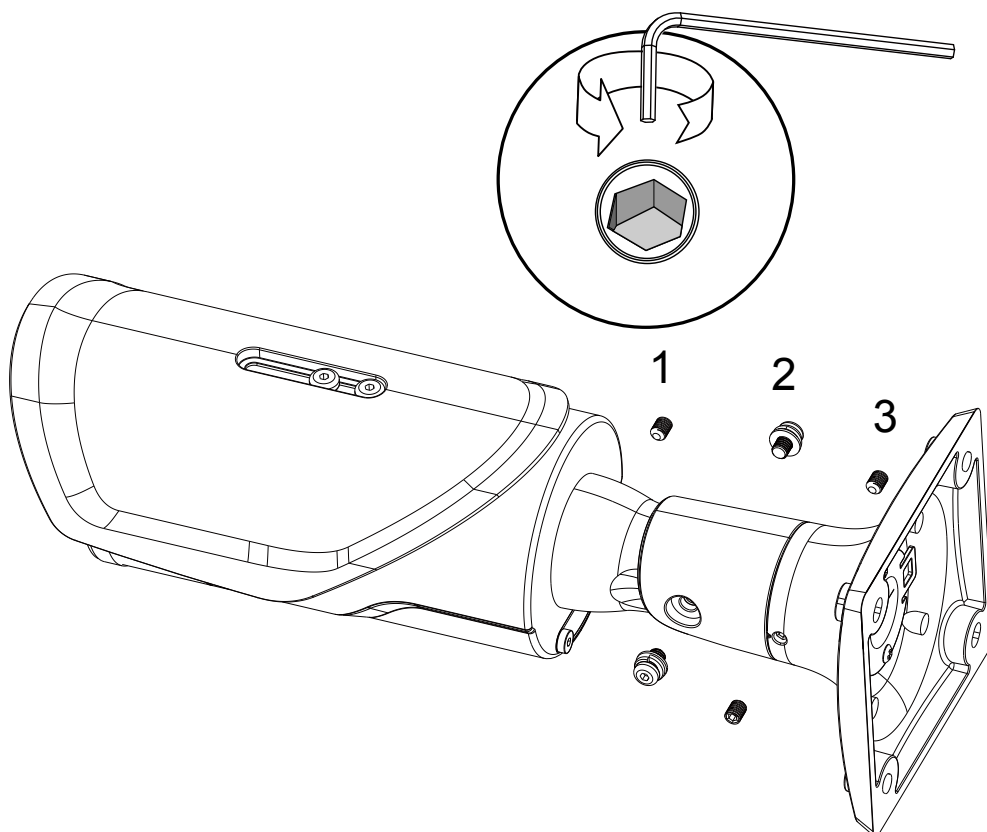

18. Move the lens around towards the field of view you want to capture.

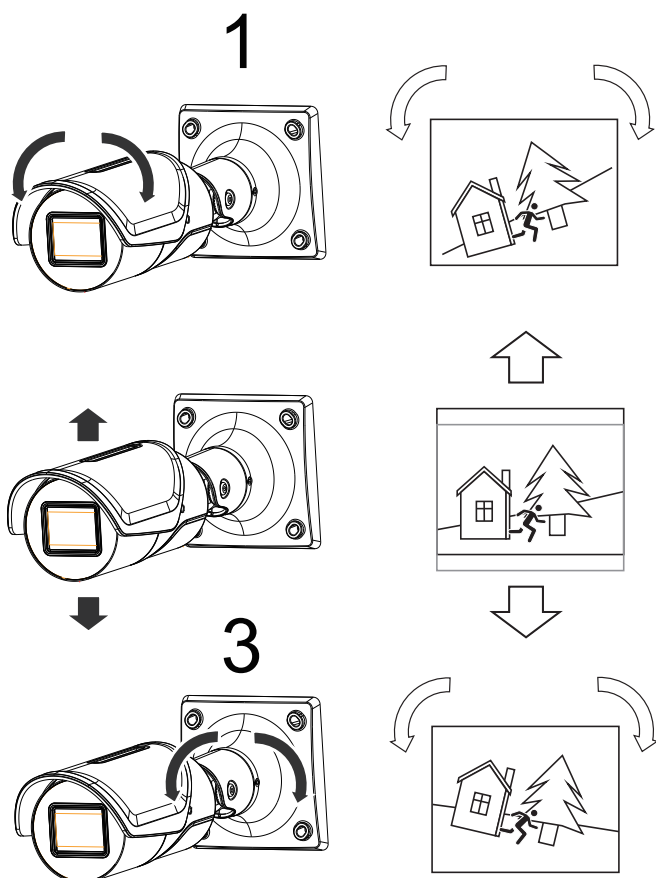

19. When done, tighten the retention screws using the L wrench.

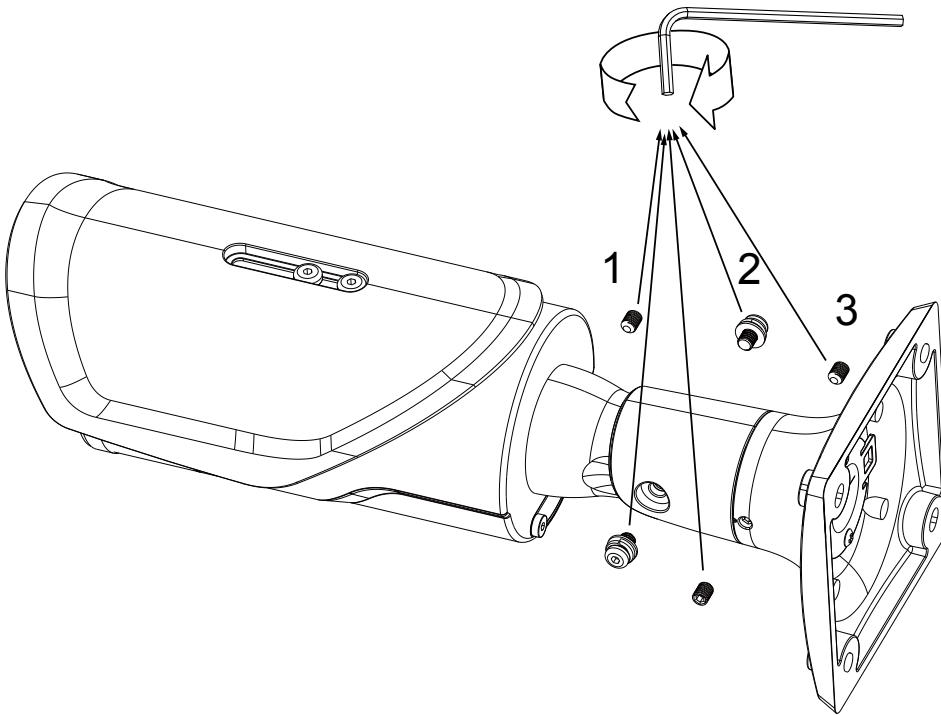

For the -HT and -EHT models, open a web console. From a web console, open the firmware configuration page. Enter the Configuration > Media > Image > Focus page. You will see a live stream on screen. If preferred, you can zoom in on the scene. Use the “Perform Auto Focus” function to automatically tune to a best image focus. Check the live view to ensure the image is in focus.

Configuration > Media > Image > Focus



LED Definitions

| | Item | LED status | Description |
|----------------|------|--|---|
| LED Definition | 1 | Steady Red | Powered and system booting, or network failed |
| | | Red LED off | Power off |
| | | Green LED off | Network is disconnected |
| | 2 | Steady Red and Green LED blinks every 1 sec. | Connected to network |
| | 3 | Green LED blinks every 1 sec. and RED LED blinks consecutively every 0.15 sec. | Upgrading firmware |
| | 4 | Green and RED blink every 0.15 sec, Green and RED light on, then blink again. | Restoring defaults |
| | 5 | RED LED is on, Green LED blinks and RED LED is constantly on. | Status after a reset (network connected) |
| | | Green and RED LEDs are constantly on. | Status after a reset (network disconnected) |

Hardware Reset

The reset button is used to reset the system or restore the factory default settings. Sometimes resetting the system can return the camera to normal operation. If the system problems remain after reset, restore the factory settings and install again.

Reset: Press the recessed reset button. Wait for the Network Camera to reboot.

Restore: Press and hold the reset button until the status LED rapidly blinks. Note that all settings will be restored to factory default. Upon successful restore, the status LED will blink green and red during normal operation.

SD/SDHC/SDXC Card Capacity

This network camera is compliant with **SD/SDHC/SDXC 16GB / 8GB / 32GB / 64GB** and other preceding standard SD cards.

Network Deployment

General Connection (PoE)

● When using a PoE-enabled switch

The Network Camera is PoE-compliant, allowing transmission of power and data via a single Ethernet cable. Follow the below illustration to connect the Network Camera to a PoE-enabled switch via Ethernet cable.

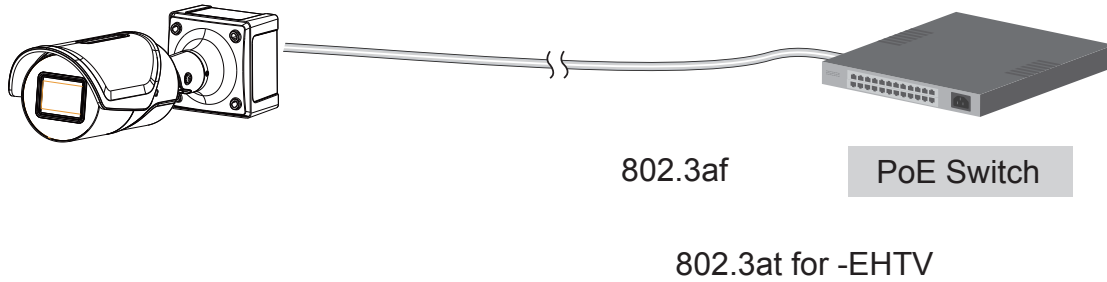

● When using a non-PoE switch

Use a PoE power injector (optional) to connect between the Network Camera and a non-PoE switch.

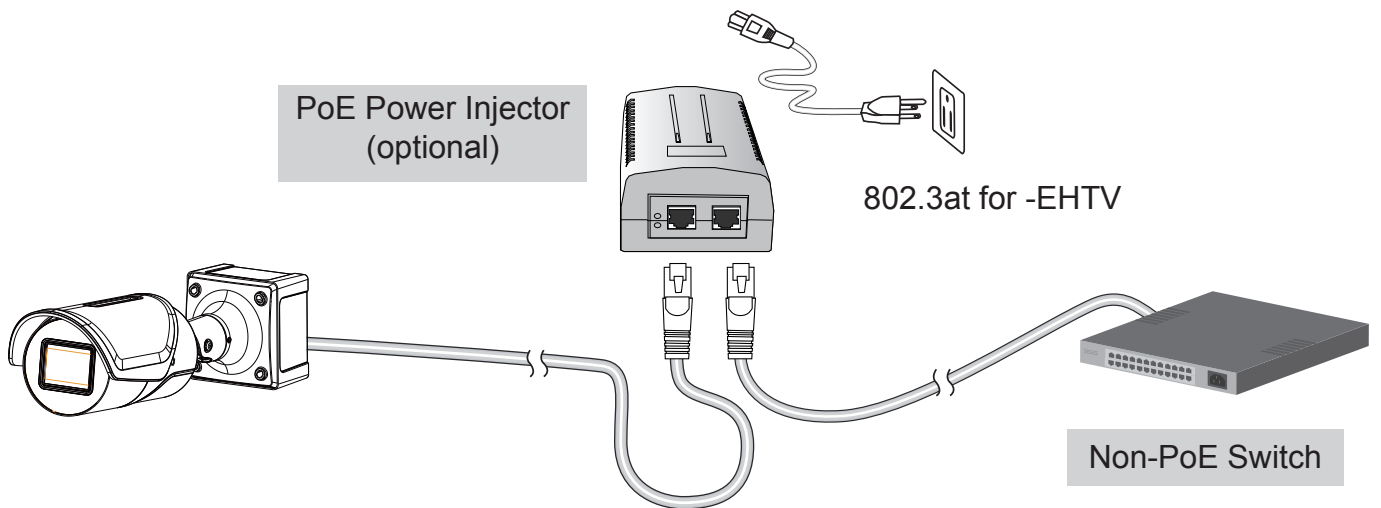

Ready to Use

1. A browser session with the Network Camera should prompt as shown below.
2. You should be able to see live video from your camera. You may also install the 32-channel recording software from VIVOTEK's website in a deployment consisting of multiple cameras. For its installation details, please refer to its related documents.



IMPORTANT:

- The "E" models, e.g., FD9365-EHTV-A, are able to operate in low temperature environments. However, when starting these cameras in a very low temperature condition, e.g., -40°C , the embedded heater may take half an hour to warm up the camera. When the temperature within the canister reaches -10°C , the camera automatically starts.

Internet connection via a router

Before setting up the Network Camera over the Internet, make sure you have a router and follow the steps below.

1. Connect your Network Camera behind a router, the Internet environment is illustrated below. Regarding how to obtain your IP address, please refer to Software Installation on page 20 for details.

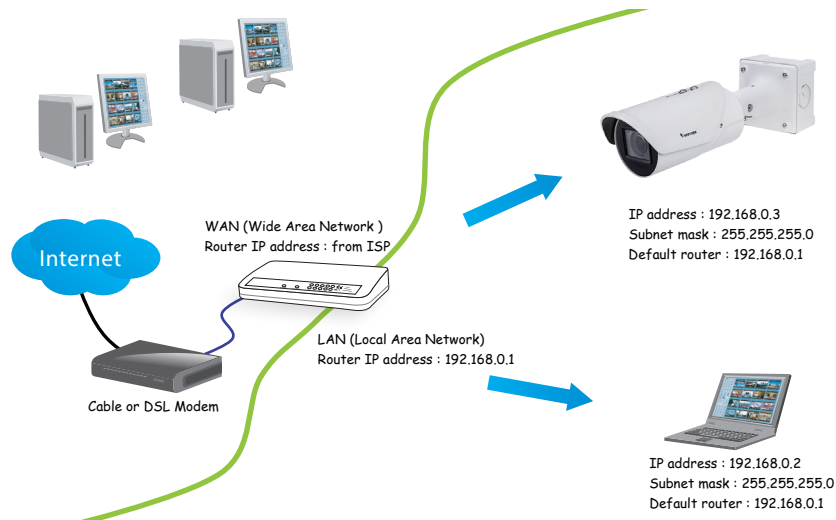

2. In this case, if the Local Area Network (LAN) IP address of your Network Camera is 192.168.0.3, please forward the following ports for the Network Camera on the router.

- HTTP port: default is 80
- RTSP port: default is 554
- RTP port for video: default is 5556
- RTCP port for video: default is 5557

If you have changed the port numbers on the Network page, please open the ports accordingly on your router. For information on how to forward ports on the router, please refer to your router's user's manual.

3. Find out the public IP address of your router provided by your ISP (Internet Service Provider). Use the public IP and the secondary HTTP port to access the Network Camera from the Internet. Please refer to Network Type on page 88 for details.

Internet connection with static IP

Choose this connection type if you are required to use a static IP for the Network Camera. Please refer to LAN setting on page 87 for details.

Internet connection via PPPoE (Point-to-Point over Ethernet)

Choose this connection type if you are connected to the Internet via a DSL Line. Please refer to PPPoE on page 88 for details.

For example, your router and IP settings may look like this:

| Device | IP Address: internal port | IP Address: External Port (Mapped port on the router) |
|---------------------|---------------------------|---|
| Public IP of router | 122.146.57.120 | |
| LAN IP of router | 192.168.2.1 | |
| Camera 1 | 192.168.2.10:80 | 122.146.57.120:8000 |
| Camera 2 | 192.168.2.11:80 | 122.146.57.120:8001 |
| ... | ... | ... |

Configure the router, virtual server or firewall, so that the router can forward any data coming into a preconfigured port number to a network camera on the private network, and allow data from the camera to be transmitted to the outside of the network over the same path.

| From | Forward to |
|---------------------|-----------------|
| 122.146.57.120:8000 | 192.168.2.10:80 |
| 122.146.57.120:8001 | 192.168.2.11:80 |
| ... | ... |

When properly configured, you can access a camera behind the router using the HTTP request as follows: `http://122.146.57.120:8000`

If you change the port numbers on the Network configuration page, please open the ports accordingly on your router. For example, you can open a management session with your router to configure access through the router to the camera within your local network. Please consult your network administrator for router configuration if you have troubles with the configuration.

For more information with network configuration options (such as that of streaming ports), please refer to Configuration > Network Settings. VIVOTEK also provides the automatic port forwarding feature as an NAT traversal function with the precondition that your router must support the UPnP port forwarding feature.

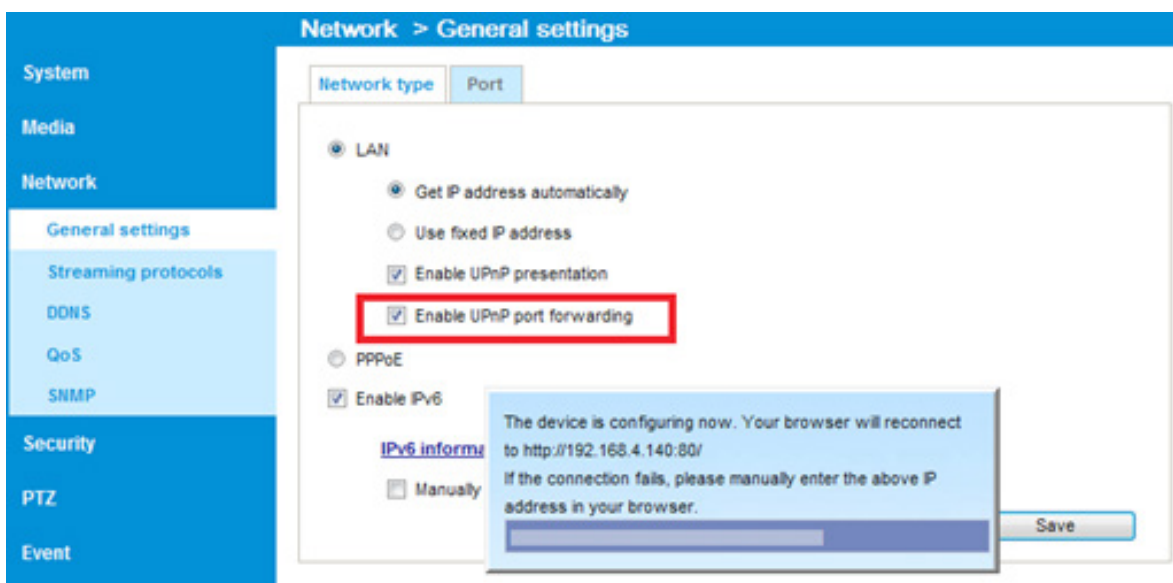

Accessing the Network Camera

This chapter explains how to access the Network Camera through web browsers, RTSP players, 3GPP-compatible mobile devices, and VIVOTEK recording software.

Using Web Browsers

Use Installation Wizard 2 (IW2) to access the Network Cameras on LAN.

If your network environment is not a LAN, follow these steps to access the Network Camera:

1. Launch your web browser (e.g., Microsoft® Internet Explorer or Mozilla Firefox).
2. Enter the IP address of the Network Camera in the address field. Press **Enter**.
3. Live video will be displayed in your web browser.
4. If it is the first time installing the VIVOTEK network camera, an information bar will prompt as shown below. Follow the instructions to install the required plug-in on your computer.

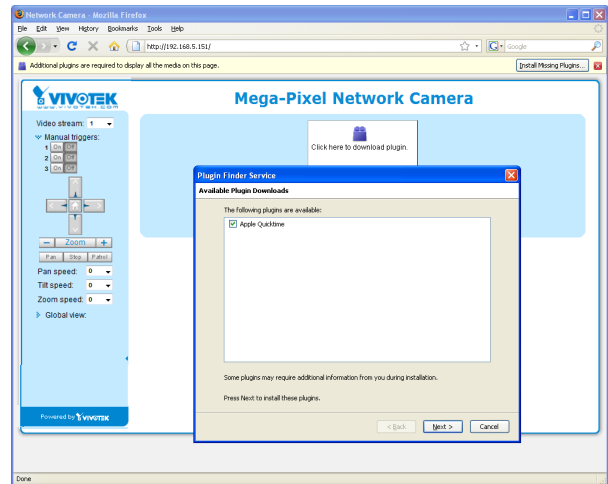
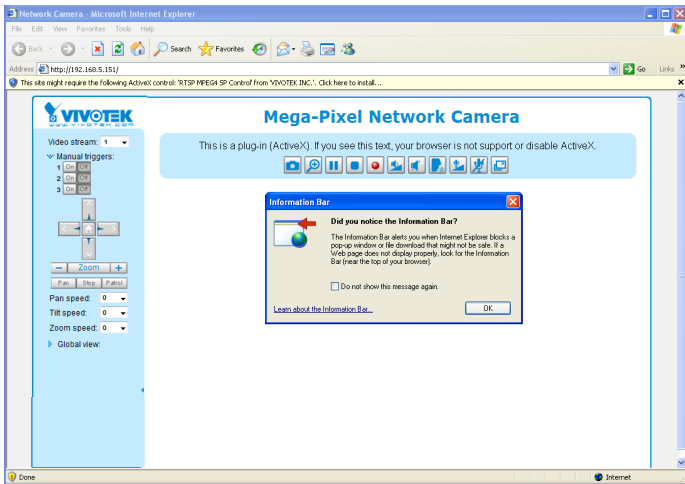

NOTE:

- For Mozilla Firefox or Chrome users, your browser will use QuickTime to stream the live video. If you don't have QuickTime on your computer, please download it first, then launch the web browser.

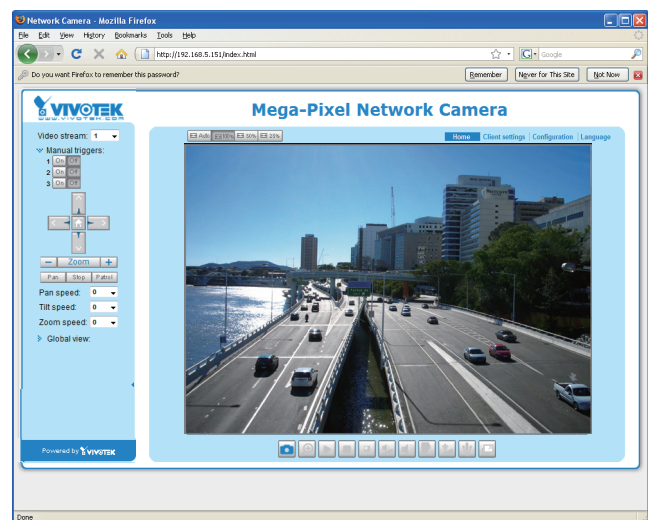
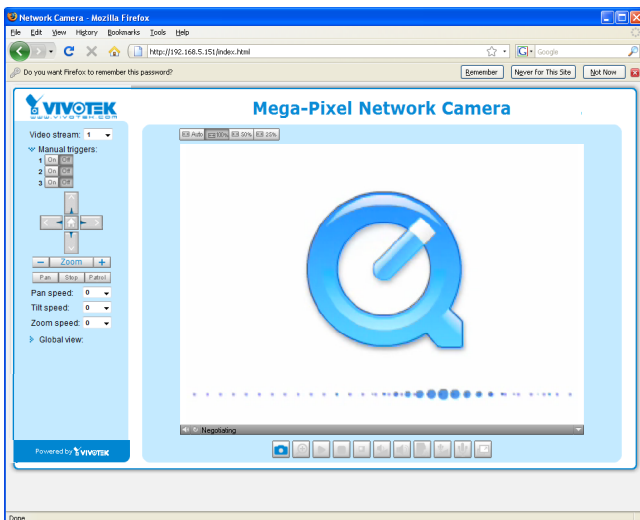

► *By default, the Network Camera is not password-protected. To prevent unauthorized access, it is highly recommended to set a password for the Network Camera. For more information about how to enable password protection, please refer to Security on page 107.*

► *If you see a dialog box indicating that your security settings prohibit running ActiveX® Controls, please enable the ActiveX® Controls for your browser.*

1. *Choose Tools > Internet Options > Security > Custom Level.*

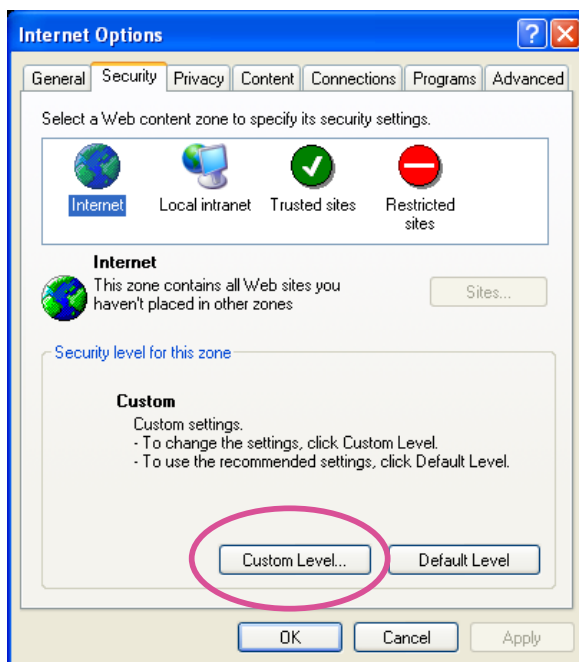

2. *Look for Download signed ActiveX® controls; select Enable or Prompt. Click OK.*

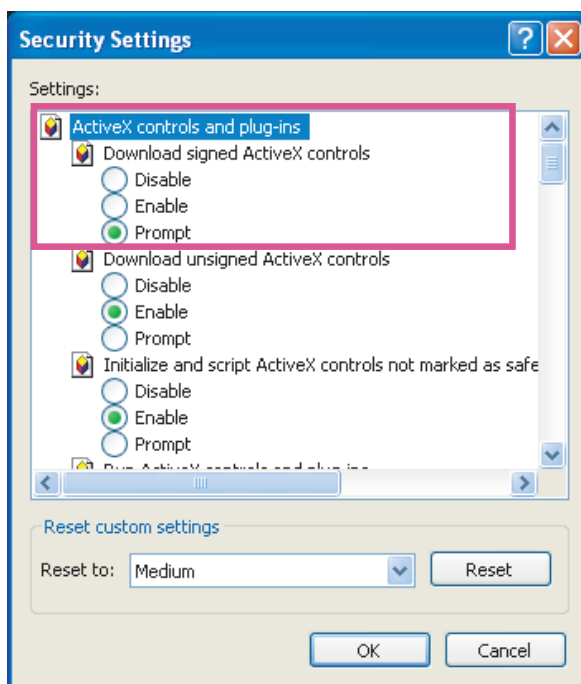

3. *Refresh your web browser, then install the ActiveX® control. Follow the instructions to complete installation.*

! IMPORTANT:

- Currently the Network Camera utilizes a 32-bit ActiveX plugin. You CAN NOT open a management/view session to the camera using a 64-bit IE browser.
- If you encounter this problem, try execute the Iexplore.exe program from C:\Windows\SysWOW64. A 32-bit version of IE browser will be installed.
- On Windows 7, the 32-bit explorer browser can be accessed from here:
[C:\Program Files \(x86\)\Internet Explorer\Iexplore.exe](C:\Program Files (x86)\Internet Explorer\Iexplore.exe)
- If you open a web session from the Shepherd utility, a 32-bit IE browser will be opened.

💡 Tips:

1. The onscreen Java control can malfunction under the following situations: A PC connects to different cameras that are using the same IP address (or the same camera running different firmware versions). Removing your browser cookies will solve this problem.
2. If you encounter problems with displaying the configuration menus or UI items, try disable the Compatibility View on IE8 or IE9.

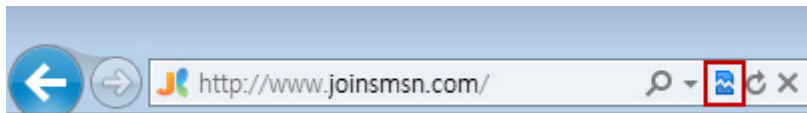

You may also press the F12 key to open the developer tools utility, and then change the Browser Mode to the genuine IE8 or IE9 mode.

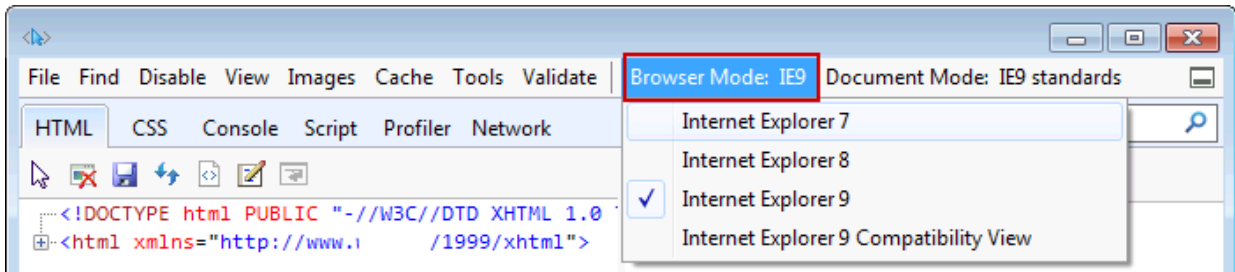

- In the event of plug-in compatibility issues, you may try to uninstall the plug-in that was previously installed.

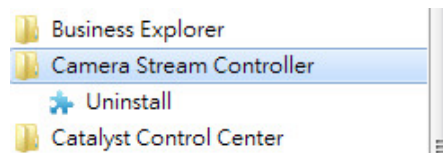

Using RTSP Players

To view the streaming media using RTSP players, you can use one of the following players that support RTSP streaming.



Quick Time Player



VLC media player

1. Launch the RTSP player.
2. Choose File > Open URL. A URL dialog box will pop up.
3. The address format is `rtsp://<ip address>:<rtsp port>/<RTSP streaming access name for stream1 or stream2>`

As most ISPs and players only allow RTSP streaming through port number 554, please set the RTSP port to 554. For more information, please refer to RTSP Streaming on page 95.

For example:

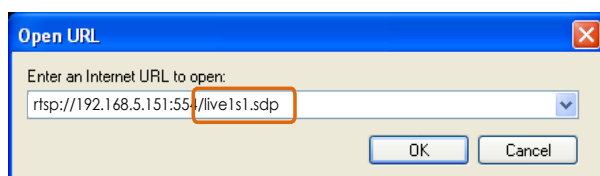

4. The live video will be displayed in your player.
For more information on how to configure the RTSP access name, please refer to RTSP Streaming on page 95 for details.



Using 3GPP-compatible Mobile Devices

To view the streaming media through 3GPP-compatible mobile devices, make sure the Network Camera can be accessed over the Internet. For more information on how to set up the Network Camera over the Internet, please refer to Setup the Network Camera over the Internet on page 26.

To utilize this feature, please check the following settings on your Network Camera:

1. Because most players on 3GPP mobile phones do not support RTSP authentication, make sure the authentication mode of RTSP streaming is set to disable.
For more information, please refer to RTSP Streaming on page 95.
2. As the the bandwidth on 3G networks is limited, you will not be able to use a large video size. Please set the video streaming parameters as listed below.
For more information, please refer to Stream settings on page 75.

| | |
|-----------------------------------|-----------|
| Video Mode | H.264 |
| Frame size | 176 x 144 |
| Maximum frame rate | 5 fps |
| Intra frame period | 1S |
| Video quality (Constant bit rate) | 40kbps |

3. As most ISPs and players only allow RTSP streaming through port number 554, please set the RTSP port to 554. For more information, please refer to RTSP Streaming on page 95.
4. Launch the player on the 3GPP-compatible mobile devices (e.g., QuickTime).
5. Type the following URL commands into the player.
The address format is `rtsp://<public ip address of your camera>:<rtsp port>/<RTSP streaming access name for stream # with small frame size and frame rate>`.
For example:

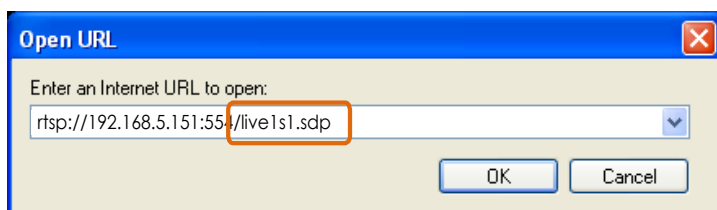

You can configure Stream #2 into the suggested stream settings as listed above for live viewing on a mobile device.

Using VIVOTEK Recording Software

You can download a VAST recording software, allowing simultaneous monitoring and video recording for multiple Network Cameras. Please install the recording software; then launch the program to add the Network Camera to the Channel list. For detailed information about how to use the recording software, please refer to the user's manual of the software or download it from <http://www.vivotek.com>.

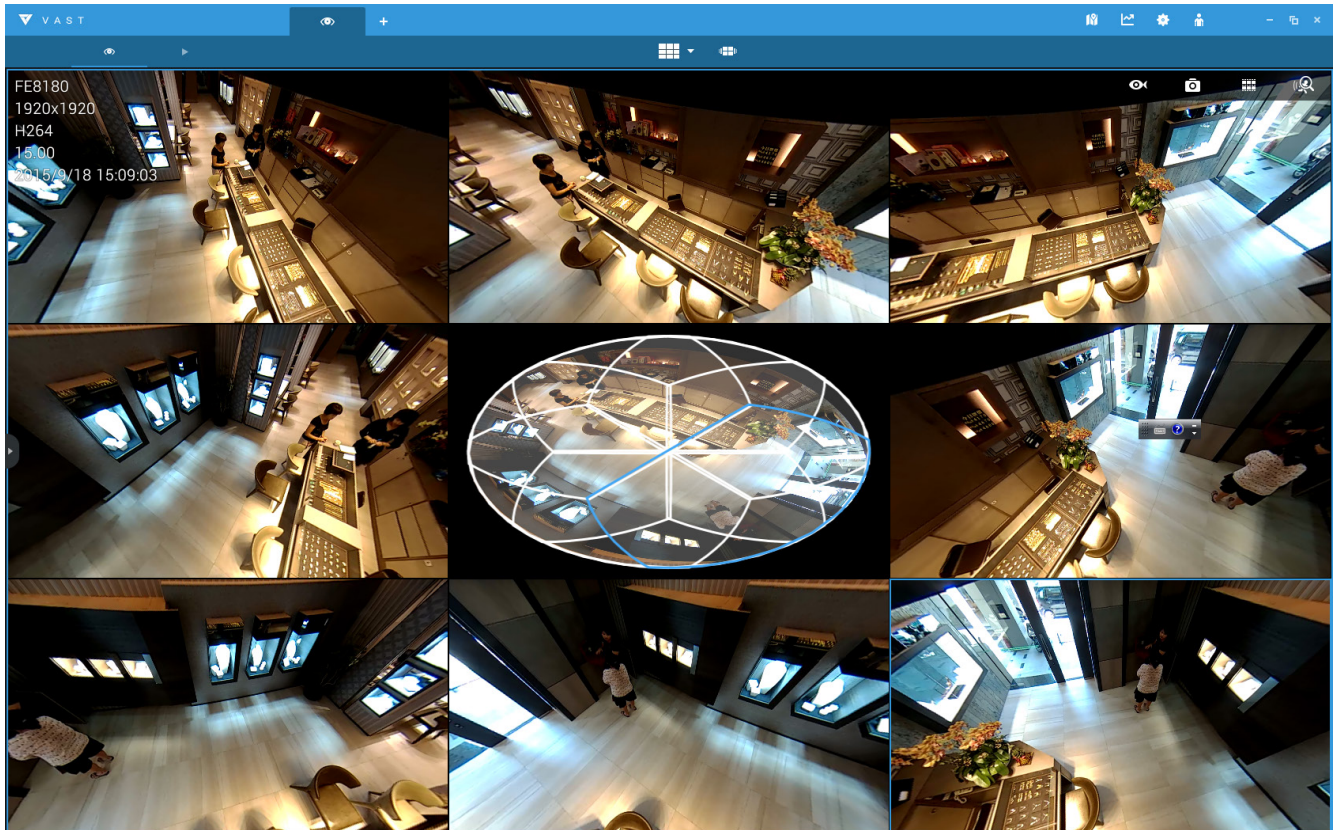

Tips:

1. If you encounter problems with displaying live view or the onscreen plug-in control, you may try to remove the plug-ins that might have been installed on your computer. Remove the following folder: C:\Program Files (x86)\Camera Stream Controller\.
2. If you forget the root (administrator) password for the camera, you can restore the camera defaults by pressing the reset button for longer than 5 seconds.
3. If DHCP is enabled in your network, and the camera cannot be accessed, run the Shepherd utility to search the network. If the camera has been configured with fixed IP that does not comply with your local network, you may see its default IP 169.254.x.x. If you still cannot find the camera, you can restore the camera to its factory defaults.
4. If you change your network parameters, e.g., added a connection to a LAN card, re-start the Shepherd utility.

Main Page

This chapter explains the layout of the main page. It is composed of the following sections: VIVOTEK INC. Logo, Host Name, Camera Control Area, Configuration Area, Menu, and Live Video Window.



VIVOTEK INC. Logo

Click this logo to visit the VIVOTEK website.

Host Name

The host name can be customized to fit your needs. The name can be changed especially there are many cameras in your surveillance deployment. For more information, please refer to System on page 47.

Camera Control Area

Video Stream: This Network Camera supports multiple streams (streams 1 and 2) simultaneously. You can select any of them for live viewing. For more information about multiple streams, please refer to page 75 for detailed information.

Manual Trigger: Click to enable/disable an event trigger manually. Please configure an event setting on the Application page before you enable this function. A total of 3 event configuration can be configured. For more information about event setting, please refer to page 125. If you want to hide this item on the homepage, please go to **Configuration > System > Homepage Layout > General settings > Customized button** to deselect the "show manual trigger button" checkbox.

Configuration Area

Client Settings: Click this button to access the client setting page. For more information, please refer to Client Settings on page 41.

Configuration: Click this button to access the configuration page of the Network Camera. It is suggested that a password be applied to the Network Camera so that only the administrator can configure the Network Camera. For more information, please refer to Configuration on page 46.

Language: Click this button to choose a language for the user interface. Language options are available in: English, Deutsch, Español, Français, Italiano, 日本語, Português, 簡體中文, and 繁體中文. Please note that you can also change a language on the Configuration page; please refer to page 46.

Hide Button

You can click the hide button to hide or display the control panel.

Resize Buttons



Click the Auto button, the video cell will resize automatically to fit the monitor.

Click 100% is to display the original homepage size.

Click 50% is to resize the homepage to 50% of its original size.

Click 25% is to resize the homepage to 25% of its original size.

Live Video Window

- The following window is displayed when the video mode is set to H.264 or H.265:
H.265/264 Protocol and Media Options



Video Title: The video title can be configured. For more information, please refer to Video Settings on page 60.

H.264 or H.265 Protocol and Media Options: The transmission protocol and media options for H.264 or H.265 video streaming. For further configuration, please refer to Client Settings on page 41.

Time: Display the current time. For further configuration, please refer to Media > Image > General settings on page 60.

Title and Time: The video title and time can be stamped on the streaming video. For further configuration, please refer to Media > Image > General settings on page 65.

PTZ Panel: This Network Camera supports “digital” (e-PTZ) pan/tilt/zoom control, which allows roaming a smaller view frame within a large view frame. Please refer to PTZ settings on page 122 for detailed information.

Global View: Click on this item to display the Global View window. The Global View window contains a full view image (the largest frame size of the captured video) and a floating frame (the viewing region of the current video stream). The floating frame allows users to control the e-PTZ function (Electronic Pan/Tilt/Zoom). For more information about e-PTZ operation, please refer to E-PTZ Operation on page 122. For more information about how to set up the viewing region of the current video stream, please refer to page 122.

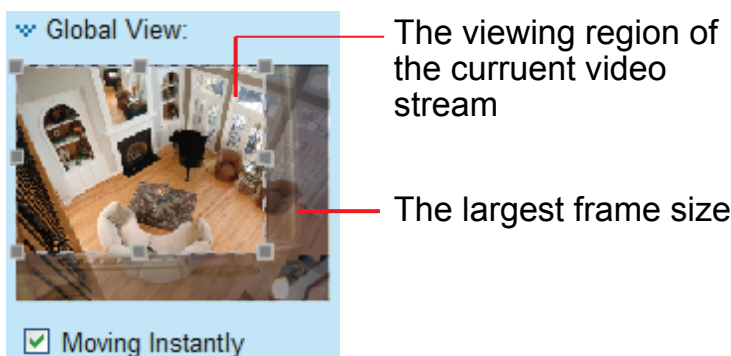



Note that the PTZ buttons on the panel are not operational unless you are showing only a portion of the full image. If the live view window is displaying the full view, the PTZ buttons are not functional.



Video Control Buttons: Depending on the Network Camera model and Network Camera configuration, some buttons may not be available.

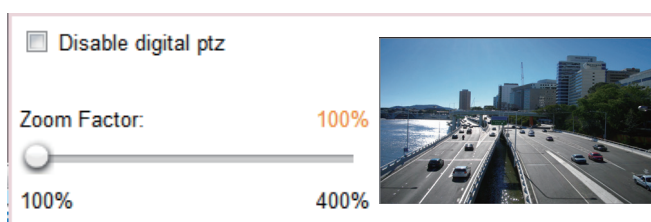

 **Snapshot:** Click this button to capture and save still images. The captured images will be displayed in a pop-up window. Right-click the image and choose **Save Picture As** to save it in JPEG (*.jpg) or BMP (*.bmp) format.



 **Digital Zoom:** Click and uncheck “Disable digital zoom” to enable the zoom operation. The navigation screen indicates the part of the image being magnified. To control the zoom level, drag the slider bar. To move to a different area you want to magnify, drag the navigation screen.







 **Pause:** Pause the transmission of the streaming media. The button becomes the  Resume button after clicking the Pause button.



 **Stop:** Stop the transmission of the streaming media. Click the  Resume button to continue transmission.



 **Start MP4 Recording:** Click this button to record video clips in MP4 file format to your computer. Press the  Stop MP4 Recording button to end recording. When you exit the web browser, video recording stops accordingly. To specify the storage destination and file name, please refer to MP4 Saving Options on page 42 for details.

 **Volume:** When the  Mute function is not activated, move the slider bar to adjust the volume on the local computer.

 **Mute:** Turn off the volume on the local computer. The button becomes the  Audio On button after clicking the Mute button.

 **Talk:** Click this button to talk to people around the Network Camera. Audio will project from the external speaker connected to the Network Camera. Click this button  again to end talking transmission.

 **Mic Volume:** When the  Mute function is not activated, move the slider bar to adjust the microphone volume on the local computer.

 **Mute:** Turn off the  Mic volume on the local computer. The button becomes the  Mic On button after clicking the Mute button.

 **Full Screen:** Click this button to switch to full screen mode. Press the “Esc” key to switch back to normal mode.

**NOTE:**

1. For a megapixel camera, it is recommended to use monitors of the 24" size or larger, and are capable of 1600x1200 or better resolutions.
 2. Below are the defaults for **Audio** settings:
 - For cameras with built-in microphone: **Not Muted.**
 - For cameras without built-in microphone: **Muted.**
-

■ The following window is displayed when the video mode is set to MJPEG:





Video Title: The video title can be configured. For more information, please refer to Media > Image on page 65.

Time: Display the current time. For more information, please refer to Media > Image on page 65.



Title and Time: Video title and time can be stamped on the streaming video. For more information, please refer to Media > Image on page 65.

Video Control Buttons: Depending on the Network Camera model and Network Camera configuration, some buttons may not be available.

 **Snapshot:** Click this button to capture and save still images. The captured images will be displayed in a pop-up window. Right-click the image and choose **Save Picture As** to save it in JPEG (*.jpg) or BMP (*.bmp) format.

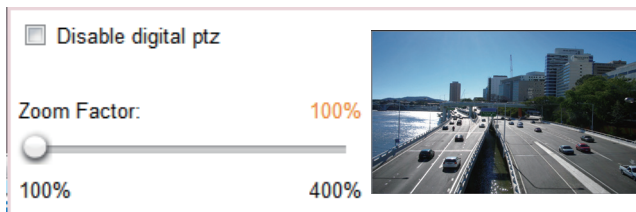
 **Digital Zoom:** Click and uncheck “Disable digital zoom” to enable the zoom operation. The navigation screen indicates the part of the image being magnified. To control the zoom level, drag the slider bar. To move to a different area you want to magnify, drag the navigation screen.



 **Start MP4 Recording:** Click this button to record video clips in MP4 file format to your computer. Press the  **Stop MP4 Recording** button to end recording. When you exit the web browser, video recording stops accordingly. To specify the storage destination and file name, please refer to MP4 Saving Options on page 42 for details.

 **Full Screen:** Click this button to switch to full screen mode. Press the “Esc” key to switch back to normal mode.

Client Settings

This chapter explains how to select the stream transmission mode and saving options on the local computer. When completed with the settings on this page, click **Save** on the page bottom to enable the settings.

H.265/H.264 Media Options

Select to stream video or audio data or both. This is enabled only when the video mode is set to H.264.

H.265/H.264 Protocol Options

H.265/H.264 protocol options

TCP

Depending on your network environment, there are four transmission modes of H.264 streaming:

UDP unicast: This protocol allows for more real-time audio and video streams. However, network packets may be lost due to network burst traffic and images may be broken. Activate UDP connection when occasions require time-sensitive responses and the video quality is less important. Note that each unicast client connecting to the server takes up additional bandwidth and the Network Camera allows up to ten simultaneous accesses.

UDP multicast: This protocol allows multicast-enabled routers to forward network packets to all clients requesting streaming media. This helps to reduce the network transmission load of the Network Camera while serving multiple clients at the same time. Note that to utilize this feature, the Network Camera must be configured to enable multicast streaming at the same time. For more information, please refer to RTSP Streaming on page 95.

TCP: This protocol guarantees the complete delivery of streaming data and thus provides better video quality. The downside of this protocol is that its real-time effect is not as good as that of the UDP protocol.

HTTP: This protocol allows the same quality as TCP protocol without needing to open specific ports for streaming under some network environments. Users inside a firewall can utilize this protocol to allow streaming data through.

Two way audio

Two way audio

Half-duplex
 Full-duplex

Half duplex: Audio is transmitted from one direction at a time, e.g., from a PC holding a web console with the camera.

Full duplex: Audio is transmitted in both directions simultaneously.

MP4 Saving Options

MP4 saving options

Folder:

File name prefix:

Add date and time suffix to file name

Users can record live video as they are watching it by clicking on the main page. Here, you can specify the storage destination and file name.

Folder: Specify a storage destination on your PC for the recorded video files. The location can be changed.

File name prefix: Enter the text that will be appended to the front of the video file name. A specified folder will be automatically created on your local hard disk.

Add date and time suffix to the file name: Select this option to append the date and time to the end of the file name.



Local Streaming Buffer Time

Local streaming buffer time

Millisecond

In the case of encountering unsteady bandwidth, live streaming may lag and video streaming may not be very smoothly. If you enable this option, the live streaming will be stored temporarily on your PC's cache memory for a few milli seconds before being played on the live viewing window. This will help you see the streaming more smoothly. If you enter 3,000 Millisecond, the streaming will delay for 3 seconds.

Joystick settings

Enable Joystick

Connect a joystick to a USB port on your management computer. Supported by the plug-in (Microsoft's DirectX), once the plug-in for the web console is loaded, it will automatically detect if there is any joystick on the computer. The joystick should work properly without installing any other driver or software.

Then you can begin to configure the joystick settings of connected devices. Please follow the instructions below to enable joystick settings.

1. Select a detected joystick, if there are multiple, from the Selected joystick menu. If your joystick is not detected, it may be defective.
2. Click Calibrate or Configure buttons to configure the joystick-related settings.

Joystick settings

Selected joystick: Macally AirStick



NOTE:

- If you want to assign Preset actions to your joystick, the preset locations should be configured in advance in the **Configuration > PTZ** page. In Windows, use the search function on the Start menu to search for Game Controller.
- If your joystick is not working properly, it may need to be calibrated. Click the **Calibrate** button to open the Game Controllers window located in Microsoft Windows control panel and follow the instructions for trouble shooting.
- The joystick will appear in the **Game Controllers** list in the Windows Control panel. If you want to check out for your devices, go to the following page: Start -> Control Panel -> Game Controllers.



Buttons Configuration

In the Button Configuration window, the left column shows the actions you can assign, and the right column shows the functional buttons and assigned actions. The number of buttons may differ from different joysticks.

Please follow the steps below to configure your joystick buttons:

1. Choosing one of the actions and click **Assign** will pop up a dialog. Then you can assign this action to a button by pressing the joystick button or select it from the drop-down list.
For example: Assign **Home** (move to home position) to Button 1.

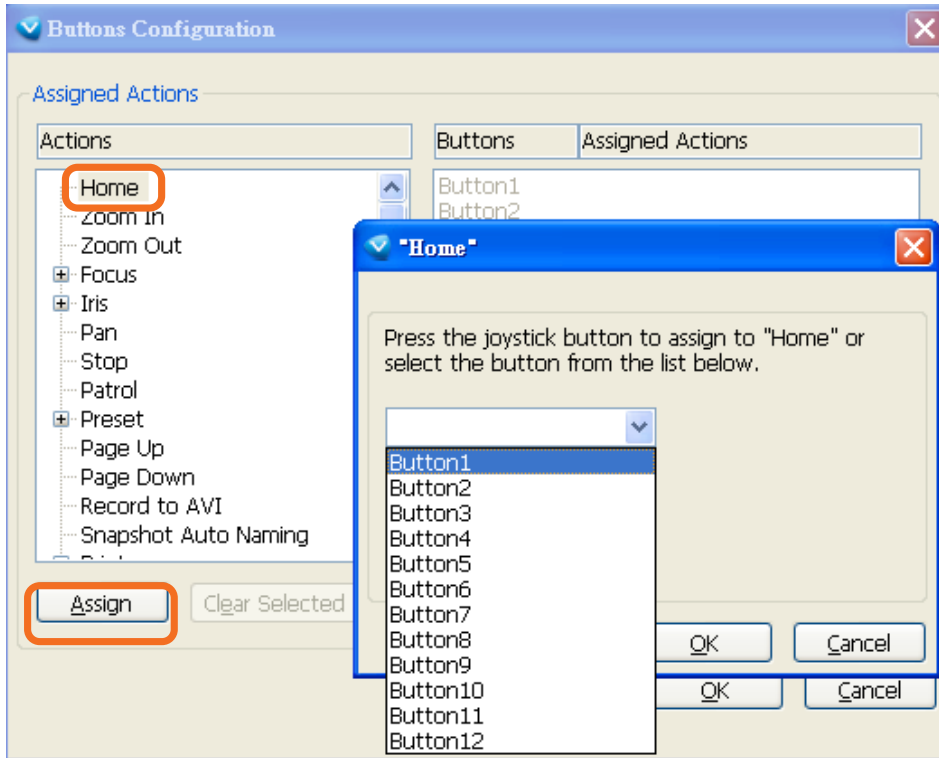

2. Click **OK** to confirm the configuration.

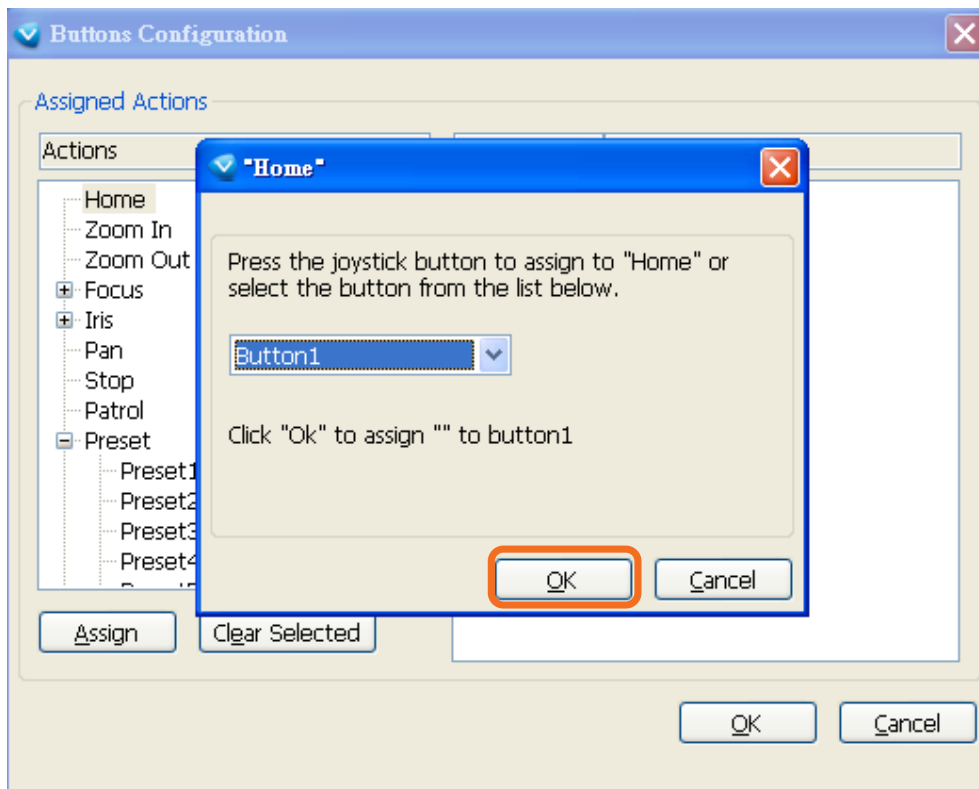

Buttons Configuration

Click the **Configure Buttons** button, a window will prompt as shown below. Please follow the steps below to configure your joystick buttons:

1. Select a button number from the Button # pull-down menu.

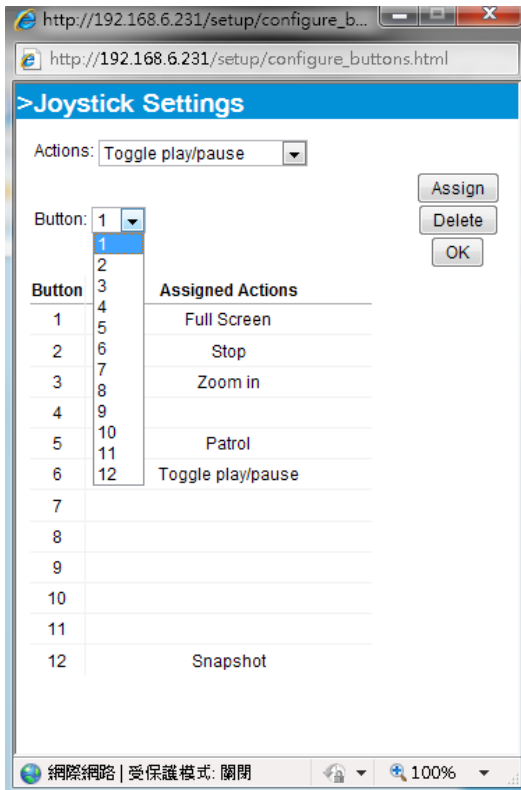

Tips:

If you are not sure of the locations of each button, use the **Properties** window in the **Game Controllers** utility.

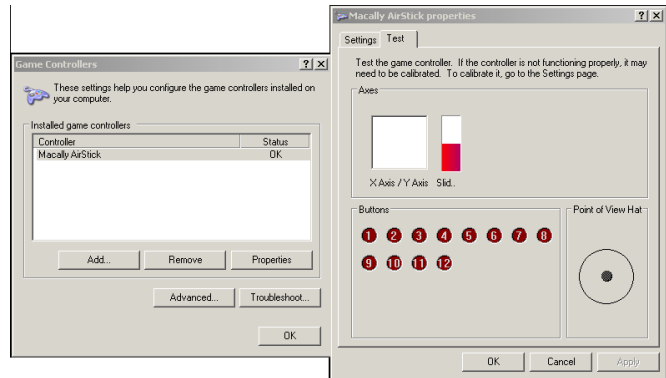

2. Select a corresponding action, such as Patrol or Preset#.

3. Click the **Assign** button to assign an action to the button. You can delete an association by selecting a button number, and then click the **Delete** button.

Repeat the process until you are done with the configuration of all preferred actions.

The buttons you define should appear on the button list accordingly.

4. Please remember to click the **Save** button on the Client settings page to preserve your settings.

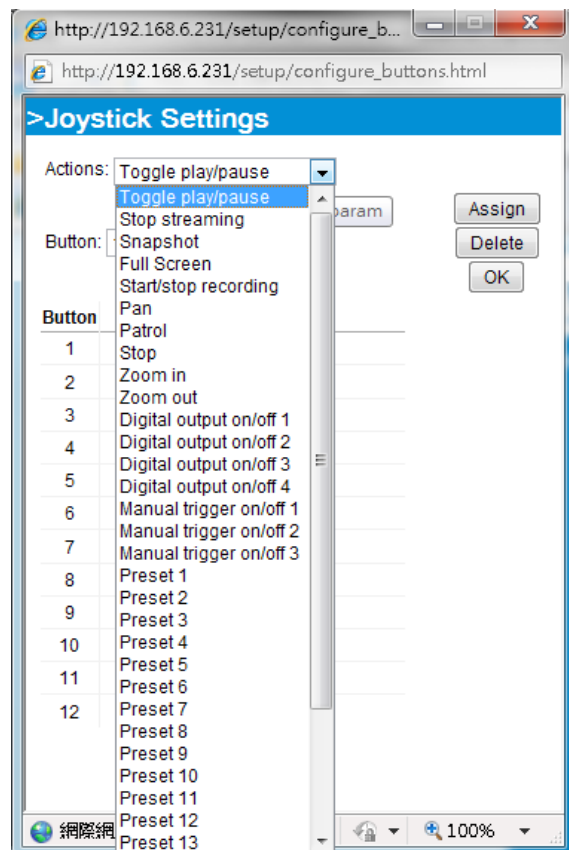

Configuration

Click **Configuration** on the main page to enter the camera setting pages. Note that only Administrators can access the configuration page.

VIVOTEK provides an easy-to-use user interface that helps you set up your network camera with minimal effort. In order to simplify the user interface, detailed information will be hidden unless you click on the function item. When you click on the first sub-item, the detailed information for the first sub-item will be displayed; when you click on the second sub-item, the detailed information for the second sub-item will be displayed and that of the first sub-item will be hidden.

The following is the interface of the main page:

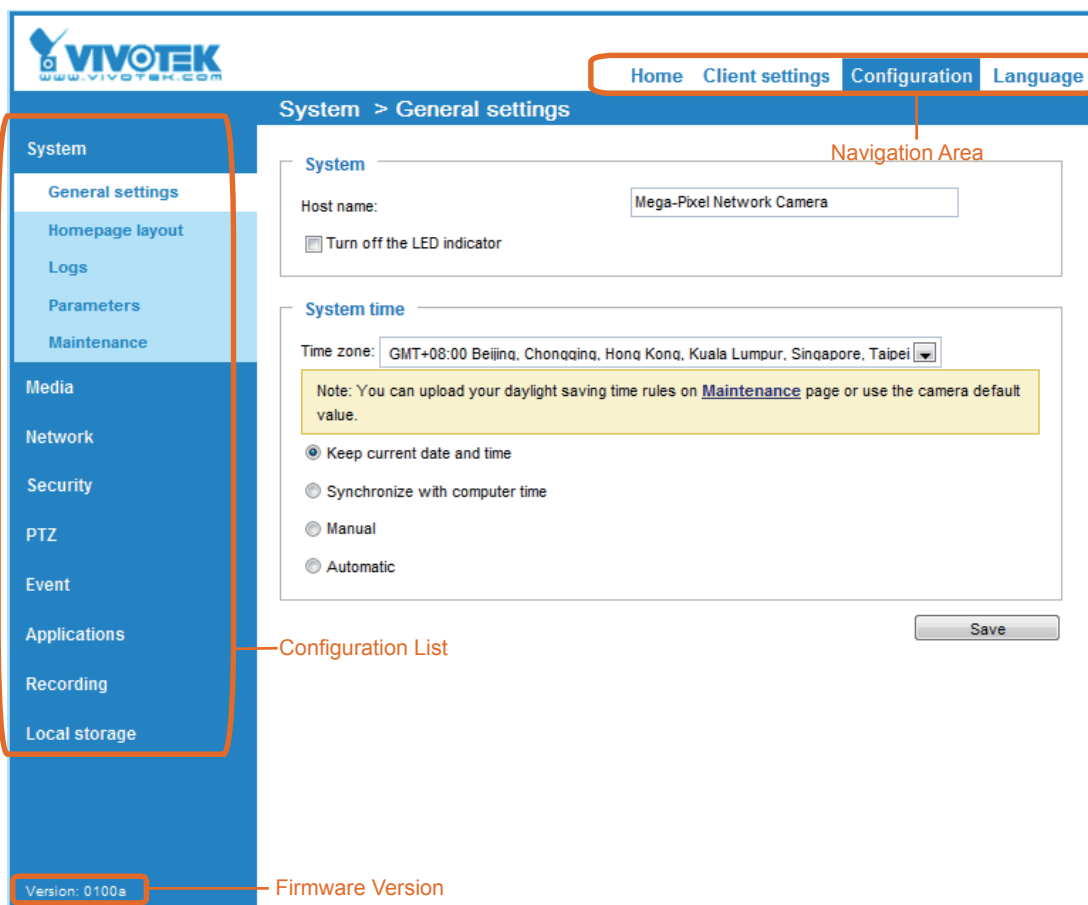

Each function on the configuration list will be explained in the following sections.

The Navigation Area provides access to all different views from the **Home** page (for live viewing), **Configuration** page, and multi-language selection.

System > General settings

This section explains how to configure the basic settings for the Network Camera, such as the host name and system time. It is composed of the following two columns: System, and System Time. When finished with the settings on this page, click **Save** at the bottom of the page to enable the settings.

System

System

Host name:

Turn off the LED indicator

Host name: Enter a desired name for the Network Camera. The text will be displayed at the top of the main page, and also on the view cells of the ST7501 and VAST management software.

Turn off the LED indicators: If you do not want others to notice the network camera is in operation, you can select this option to turn off the LED indicators.

System time

System time

Time zone: GMT+08:00 Beijing, Chongqing, Hong Kong, Kuala Lumpur, Singapore, Taipei

Note: You can upload your daylight saving time rules on [Maintenance](#) page or use the camera default value.

Keep current date and time
 Synchronize with computer time
 Manual
 Automatic

Keep current date and time: Select this option to preserve the current date and time of the Network Camera. The Network Camera's internal real-time clock maintains the date and time even when the power of the system is turned off.

Synchronize with computer time: Select this option to synchronize the date and time of the Network Camera with the local computer. The read-only date and time of the PC is displayed as updated.

Manual: The administrator can enter the date and time manually. Note that the date and time format are [yyyy/mm/dd] and [hh:mm:ss].

Automatic: The Network Time Protocol is a protocol which synchronizes computer clocks by periodically querying an NTP Server.

NTP server: Assign the IP address or domain name of the time-server. Leaving the text box blank connects the Network Camera to the default time servers. The precondition is that the camera must have the access to the Internet.

Update interval: Select to update the time using the NTP server on an hourly, daily, weekly, or monthly basis.

Time zone : Select the appropriate time zone from the list. If you want to upload Daylight Savings Time rules, please refer to **System > Maintenance > Import/ Export files** on page 57 for details.

System > Homepage layout

This section explains how to set up your own customized homepage layout.

General settings

This column shows the settings of your homepage layout. You can manually select the background and font colors in Theme Options (the second tab on this page). The settings will be displayed automatically in this Preview field. The following shows the homepage using the default settings:



- Hide Powered by VIVOTEK: If you check this item, it will be removed from the homepage.

Logo graph

Here you can change the logo that is placed at the top of your homepage.

Logo graph

A customized logo (Gif, JPG or PNG) can be uploaded for main page. It will be resized to 160x50 pixels to replace the previous logo.

Default
 Custom



Logo link:

Follow the steps below to upload a new logo:

1. Click **Custom** and the Browse field will appear.
2. Select a logo from your files.
3. Click **Upload** to replace the existing logo with a new one.
4. Enter a website link if necessary.
5. Click **Save** to enable the settings.

Customized button

If you want to hide manual trigger buttons on the homepage, please uncheck this item. This item is checked by default.

Customized button

Show manual trigger button

Theme Options

Here you can change the color of your homepage layout. There are three types of preset patterns for you to choose from. The new layout will simultaneously appear in the **Preview** filed. Click **Save** to enable the settings.

General settings | Theme options

Font Color

Background Color of the Control Area

Font Color of the Configuration Area

Background Color of the Configuration Area

Preset patterns

Font Color of the Video Title

Background Color of the Video Area

Frame Color

Color

| | |
|---------------------------------|---------|
| Font color: | #000000 |
| Font color of video title: | #098BD6 |
| Bk color of control area: | #C4EAFF |
| Bk color of configuration area: | #0186D1 |
| Bk color of video area: | #C4EAFF |
| Frame color: | #0186D1 |

Save

General settings | Theme options

VIVOTEK
www.vivotek.com

Mega-Pixel Network

Video stream 1

Manual triggers:

Digital output: On Off

Powered by VIVOTEK

General settings | Theme options

VIVOTEK
www.vivotek.com

Mega-Pixel Network

Video stream 1

Manual triggers:

Digital output: On Off

Powered by VIVOTEK

- Follow the steps below to set up the customized homepage:
 1. Click **Custom** on the left column.
 2. Click the field where you want to change the color on the right column.

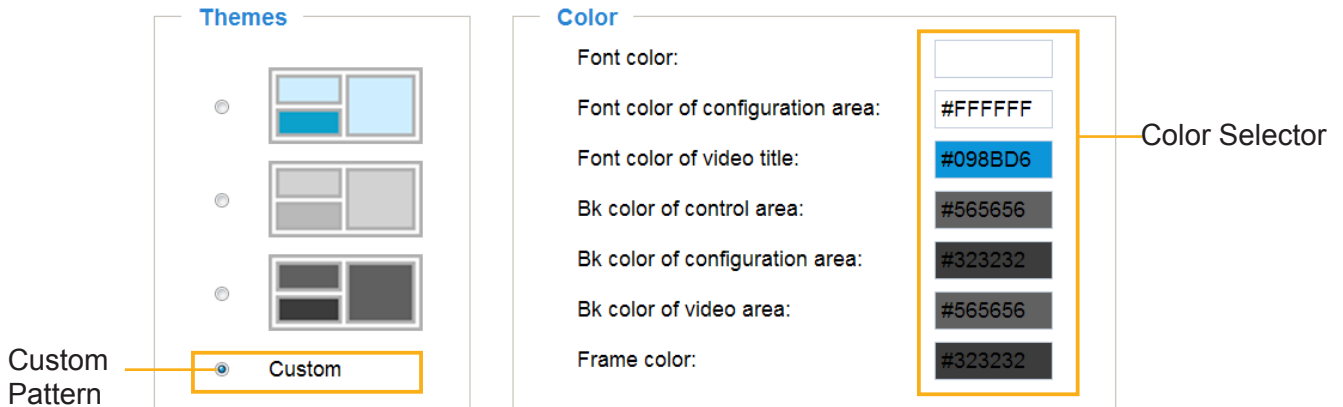

3. The palette window will pop up as shown below.

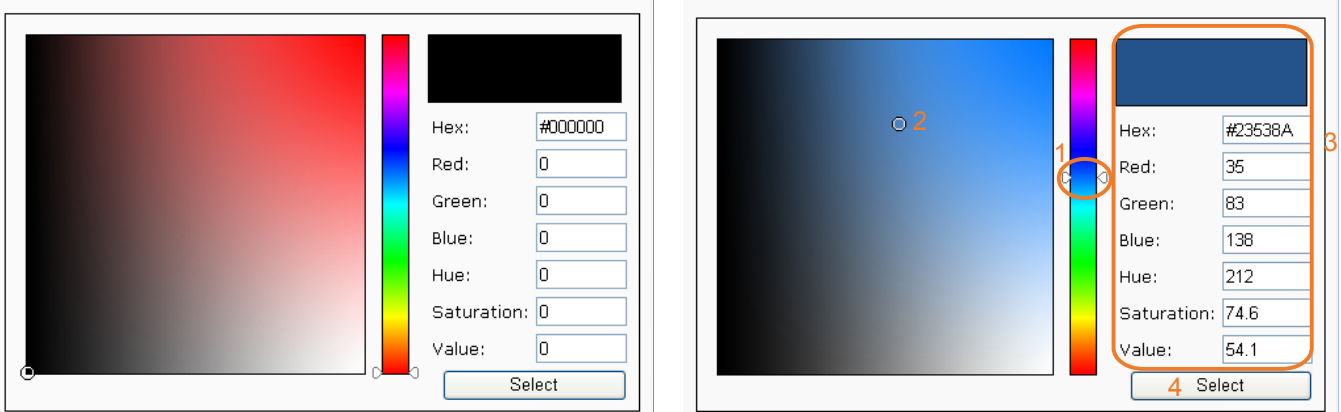

4. Drag the slider bar and click on the left square to select a desired color.
5. The selected color will be displayed in the corresponding fields and in the **Preview** column.
6. Click **Save** to enable the settings.

System > Logs

This section explains how to configure the Network Camera to send the system log to a remote server as backup.

Log server settings

Log server settings

Enable remote log

IP address:

port:

Follow the steps below to set up the remote log:

1. Select **Enable remote log**.
2. In the IP address text box, enter the IP address of the remote server.
2. In the port text box, enter the port number of the remote server.
3. When completed, click **Save** to enable the setting.

You can configure the Network Camera to send the system log file to a remote server as a log backup. Before utilizing this feature, it is suggested that the user install a log-recording tool to receive system log messages from the Network Camera. An example is Kiwi Syslog Daemon. Visit <http://www.kiwisyslog.com/kiwi-syslog-daemon-overview/>.

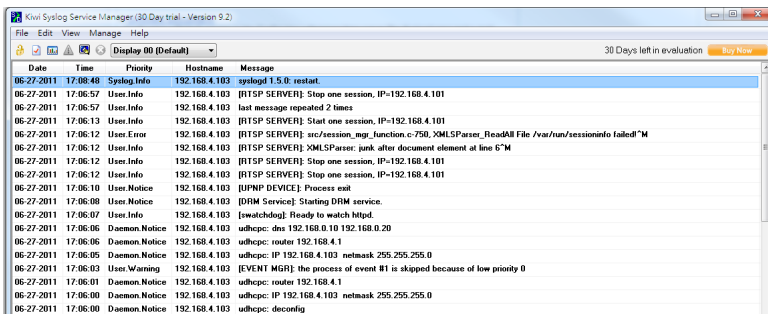

System log

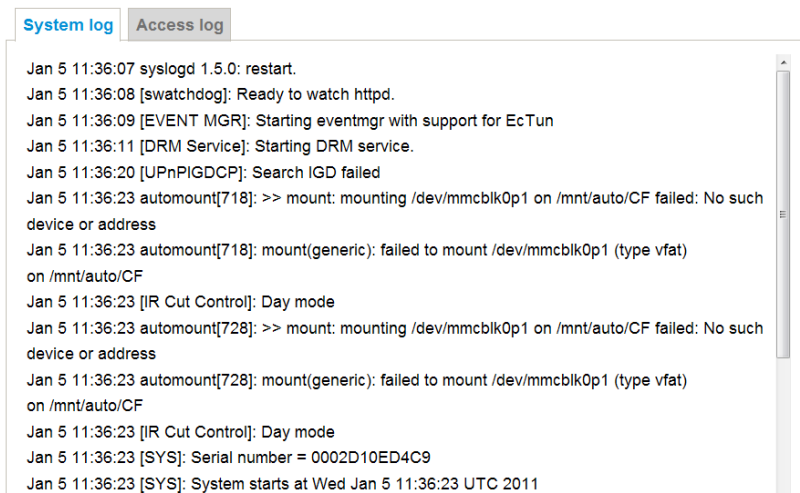

This column displays the system log in a chronological order. The system log is stored in the Network Camera's buffer area and will be overwritten when reaching a certain limit.

You can install the included VAST recording software, which provides an Event Management function group for delivering event messages via emails, GSM short messages, onscreen event panel, or to trigger an alarm, etc. For more information, refer to the VAST User Manual.

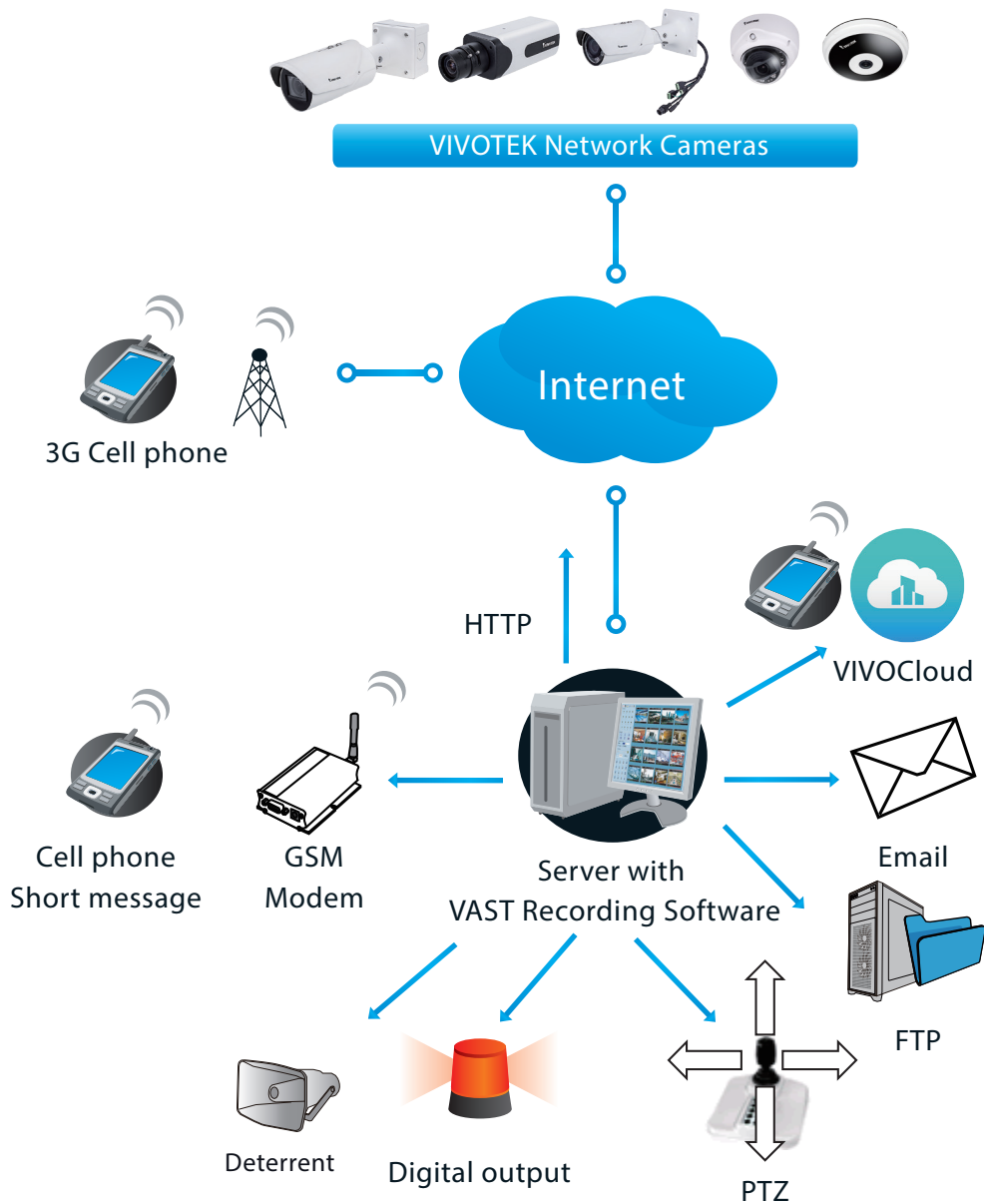

Access log

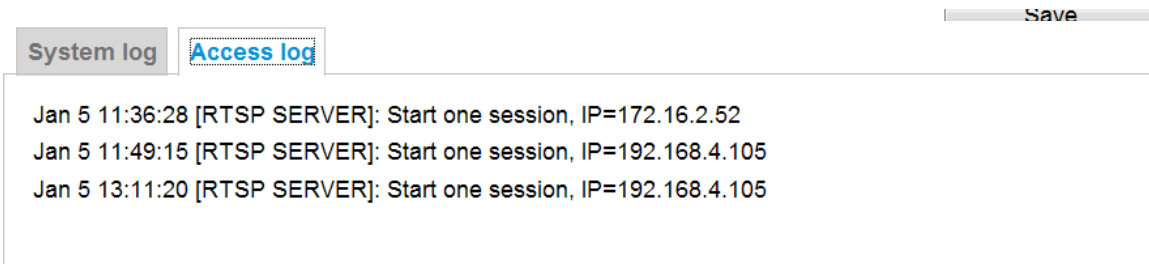

Access log displays the access time and IP address of all viewers (including operators and administrators) in a chronological order. The access log is stored in the Network Camera's buffer area and will be overwritten when reaching a certain limit.

VADP log

The VADP log displays information for the pre-loaded VADP module, such as the TrendMicro IoT security package. The information includes, package size, activation time, memory size taken, records of automated updates, etc.

System > Parameters

The View Parameters page lists the entire system's parameters. If you need technical assistance, please provide the information listed on this page.

Parameters

```
system_hostname='IB9387-HT-A'  
system_ledoff='0'  
system_lowlight='1'  
system_date='2019/12/17'  
system_time='09:29:14'  
system_datetime=''  
system_ntp='watch.stdtime.gov.tw'  
system_timezoneindex='320'  
system_daylight_enable='0'  
system_daylight_dstactualmode='1'  
system_daylight_auto_begintime='NONE'  
system_daylight_auto_endtime='NONE'  
system_daylight_timezones=',-360,-320,-280,-240,-241,-200,-201,-160'  
system_updateinterval='3600'  
system_info_modelname='IB9387-HT-A'  
system_info_extendedmodelname='IB9387-HT-A'  
system_info_serialnumber='0002D1885A21'  
system_info_firmwareversion='IB9387A-VVTK-0100e'  
system_info_language_count='10'  
system_info_language_i0='English'  
system_info_language_i1='Deutsch'  
system_info_language_i2='Español'  
system_info_language_i3='Français'  
system_info_language_i4='Italiano'  
system_info_language_i5='日本語'  
system_info_language_i6='Português'  
system_info_language_i7='简体中文'  
system_info_language_i8='繁體中文'  
system_info_language_i9='Русский'  
system_info_language_i10=''  
system_info_language_i11=''
```

System > Maintenance

This chapter explains how to restore the Network Camera to factory default, upgrade firmware version, etc.

General settings > Upgrade firmware

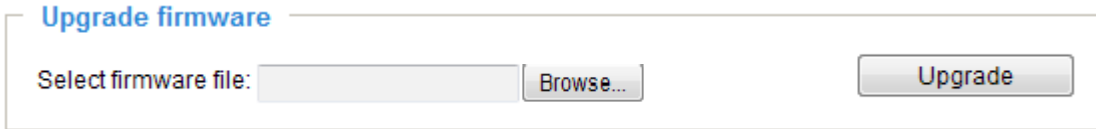

This feature allows you to upgrade the firmware of your Network Camera. It takes a few minutes to complete the process.

Note: Do not power off the Network Camera during the upgrade!

Follow the steps below to upgrade the firmware:

1. Download the latest firmware file from the VIVOTEK website. The file is in .pkg file format.
2. Click **Browse...** and locate the firmware file.
3. Click **Upgrade**. The Network Camera starts to upgrade and will reboot automatically when the upgrade completes.

If the upgrade is successful, you will see “Reboot system now!! This connection will close”. After that, re-access the Network Camera.

The following message is displayed when the upgrade has succeeded.

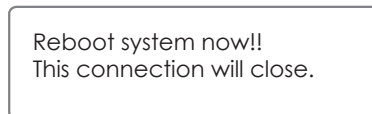

The following message is displayed when you have selected an incorrect firmware file.

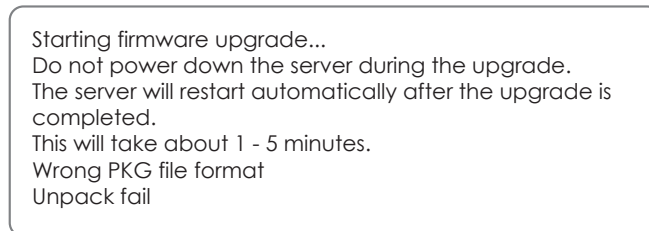

General settings > Reboot

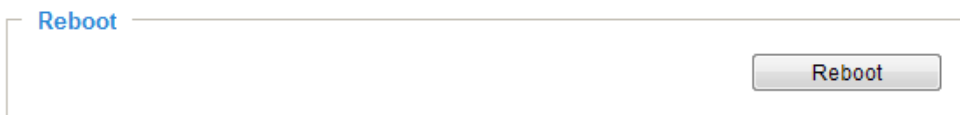

This feature allows you to reboot the Network Camera, which takes about one minute to complete. When completed, the live video page will be displayed in your browser. The following message will be displayed during the reboot process.

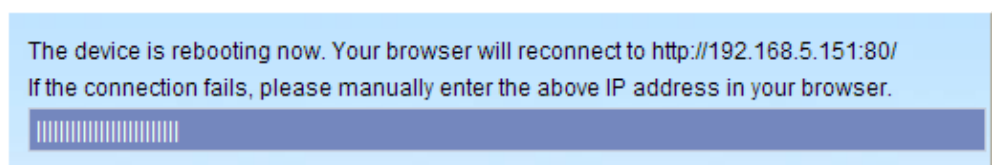

If the connection fails after rebooting, manually enter the IP address of the Network Camera in the address field to resume the connection.

General settings > Restore

Restore

Restore all settings to factory default except settings in

Network Daylight saving time Custom language VADP Focus position

Restore

This feature allows you to restore the Network Camera to factory default settings.

Network: Select this option to retain the Network Type settings (please refer to Network Type on page 88).

Daylight Saving Time: Select this option to retain the Daylight Saving Time settings (please refer to Import/Export files below on this page).

Custom Language: Select this option to retain the Custom Language settings.

VADP: Retain the VADP modules (3rd-party software stored on the SD card) and related settings.

Focus position: Retain the lens focus position using the previously saved position parameters.

If none of the options is selected, all settings will be restored to factory default. The following message is displayed during the restoring process.

The device is rebooting now. Your browser will reconnect to <http://192.168.5.151:80/>
If the connection fails, please manually enter the above IP address in your browser.

Import/Export files

This feature allows you to Export / Update daylight saving time rules, custom language file, configuration file, and server status report.

General settings **Import/Export files**

Export files

| | |
|--|--------|
| Export daylight saving time configuration file | Export |
| Export language file | Export |
| Export configuration file | Export |
| Export server status report | Export |

Upload files

| | | |
|------------------------------------|-----------|--------|
| Update daylight saving time rules: | Browse... | Upload |
| Update custom language file: | Browse... | Upload |
| Upload configuration file: | Browse... | Upload |

Export daylight saving time configuration file: Click to set the start and end time of DST (Daylight Saving).

Follow the steps below to export:

1. In the Export files column, click **Export** to export the daylight saving time configuration file from the Network Camera.
2. A file download dialog will pop up as shown below. Click **Open** to review the XML file or click **Save** to store the file for editing.

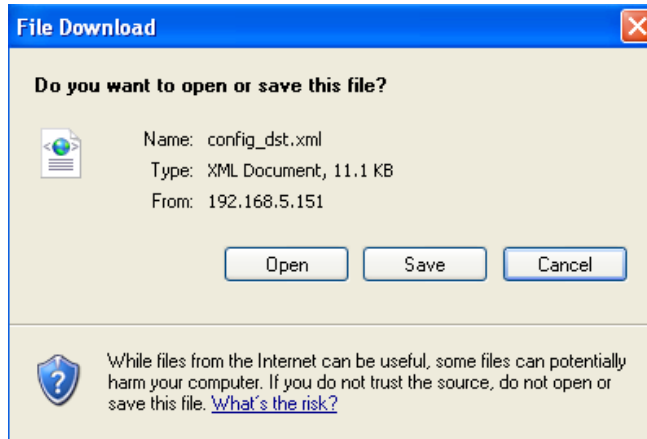

- Open the file with Microsoft® Notepad and locate your time zone; set the start and end time of DST. When completed, save the file.

In the example below, DST begins each year at 2:00 a.m. on the second Sunday in March and ends at 2:00 a.m. on the first Sunday in November.

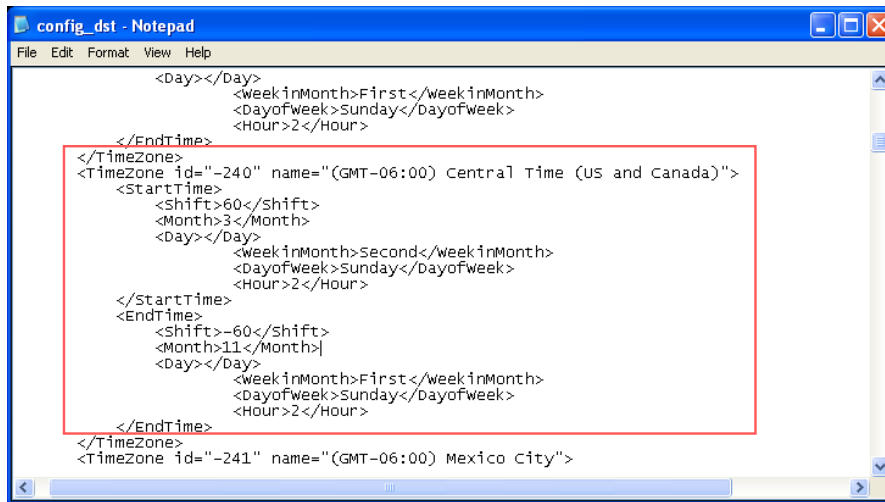

Update daylight saving time rules: Click **Browse...** and specify the XML file to update.

If the incorrect date and time are assigned, you will see the following warning message when uploading the file to the Network Camera.

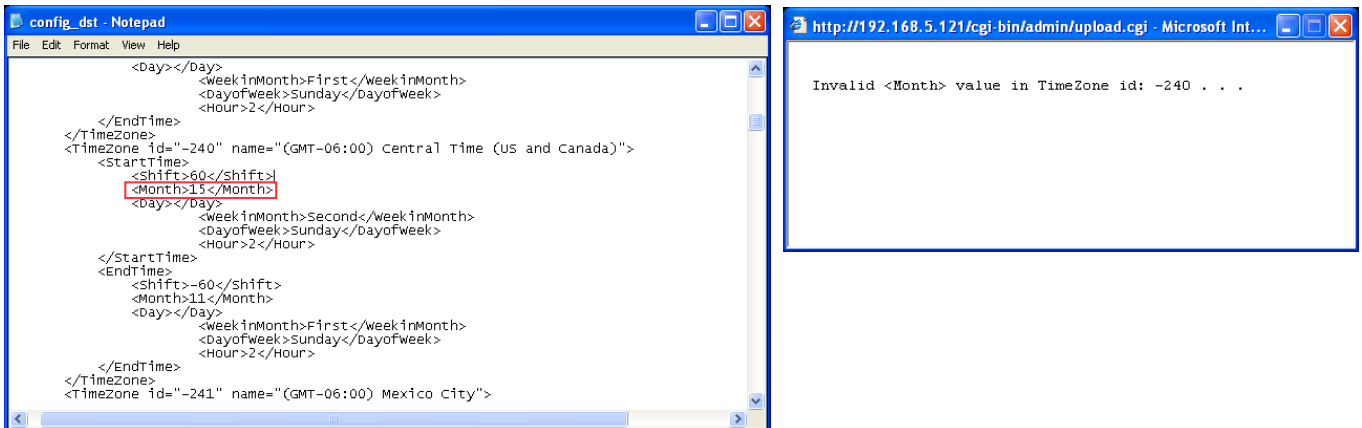

The following message is displayed when attempting to upload an incorrect file format.

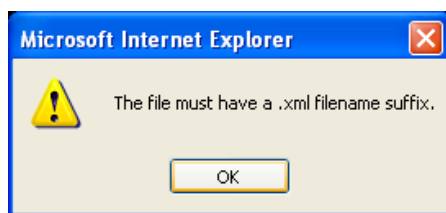

Export language file: Click to export language strings. VIVOTEK provides nine languages: English, Deutsch, Español, Français, Italiano, 日本語, Português, 简体中文, and 繁體中文.

Update custom language file: Click **Browse...** and specify your own custom language file to upload.

Export configuration file: Click to export all parameters for the device and user-defined scripts.

Update configuration file: Click **Browse...** to update a configuration file. Please note that the model and firmware version of the device should be the same as the configuration file. If you have set up a fixed IP or other special settings for your device, it is not suggested to update a configuration file.

Export server status report: Click to export the current server status report, such as time, logs, parameters, process status, memory status, file system status, network status, kernel message ... and so on.

Tips:

- If a firmware upgrade is accidentally disrupted, say, by a power outage, you still have a last resort method to restore normal operation. See the following for how to bring the camera back to work:

Applicable scenario:

- Power disconnected during firmware upgrade.
- Unknown reason causing abnormal LED status, and a Restore cannot recover normal working condition.

You can use the following methods to activate the camera with its backup firmware:

- Press and hold down the reset button for at least one minute.
- Power on the camera until the Red LED blinks rapidly.
- After boot up, the firmware should return to the previous version before the camera hanged. (The procedure should take 5 to 10 minutes, longer than the normal boot-up process). When this process is completed, the LED status should return to normal.

Media > Image

This section explains how to configure the image settings of the Network Camera. It is composed of the following columns: General settings, IR control, Image settings, Exposure, Focus, and Privacy mask. The Focus window is available only for models that come with motorized lens.

General settings

General settings
Illuminators
Image settings
Exposure
Focus
Privacy mask

Video settings

Video title

Show timestamp and video title in video and snapshots

Position of timestamp and video title on image: Top

Timestamp and video title font-size: 30

Video font (.ttf): Default Upload

Mount type: Ceiling Wall Floor

Color: B/W Color

Power line frequency: 50 Hz 60 Hz

Video orientation: Flip Mirror

Rotate

Video title

Show timestamp and video title in video and snapshots: Enter a name that will be displayed on the title bar of the live video as the picture shown below. A zoom indicator will be displayed on the Home page when you zoom in/out on the live viewing window as shown below. You may zoom in/out on the image by scrolling the mouse wheel inside the live viewing window, and the maximum zoom in will be up to 12 times.

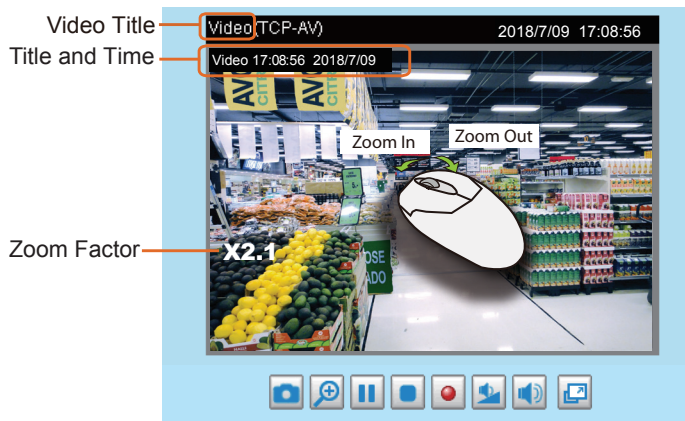

Position of timestamp and video title on image: Select to display time stamp and video title on the top or at the bottom of the video stream.

Timestamp and video title font size: Select the font size for the time stamp and title.

Video font (.ttf): You can select a True Type font file for the display of textual messages on video.

Mount type: There are 3 Mount types - Ceiling, Wall, and Floor. Selecting the correct mount type enables the camera image to display the correct video orientation.

Color: Select to display color or black/white video streams.

Power line frequency: Set the power line frequency consistent with local utility settings to eliminate image flickering associated with fluorescent lights. Note that after the power line frequency is changed, you must disconnect and reconnect the power cord of the Network Camera in order for the new setting to take effect.

Video orientation: Flip - vertically reflect the display of the live video; Mirror - horizontally reflect the display of the live video. Select both options if the Network Camera is installed upside-down (e.g., on the ceiling) to correct the image orientation. Please note that if you have preset locations, those locations will be cleared after flip/mirror setting.

Rotate -

Rotate Degrees

The rotation here indicates clockwise rotation. Rotation can be applied with flip, mirror, and physical lens rotation (see below) settings to adapt to different mounting locations.

The figures in the illustration are shown in a consecutive order.

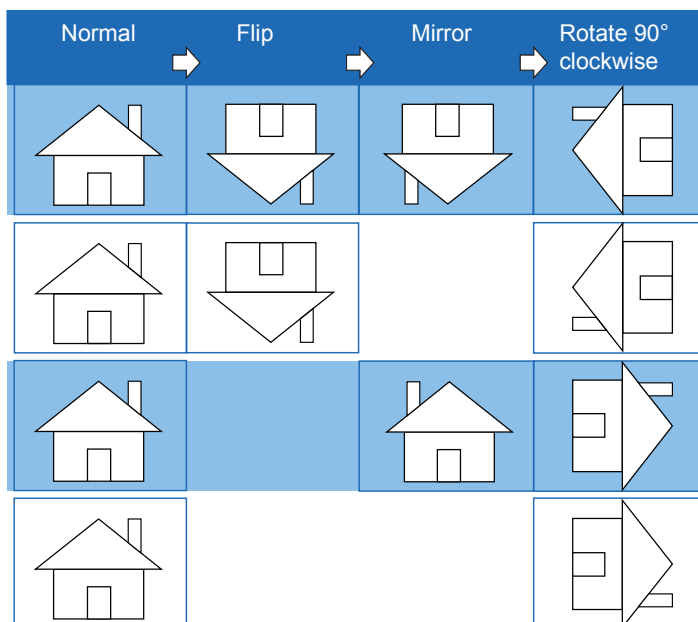

The camera may be installed on a vertical, side-facing, or tilted surface in order to accommodate the interior or exterior design of a building. The interior of a building can be shaped as a narrow rectangular space, such as a corridor. The conventional HD image, such as that of a 16:9 aspect ratio, will be incongruous with its wide horizontal view. With video rotation, the camera can more readily cover the field of view on a tall and narrow scene.

Day/Night Settings

Day/Night settings

Switch to B/W in night mode

IR cut filter:

Light sensor sensitivity:

Switch to B/W in night mode

Select this to enable the Network Camera to automatically switch to Black/White during night mode.

IR cut filter

With a removable IR-cut filter, this Network Camera can automatically remove the filter to let Infrared light pass into the sensor during low light conditions.

- Auto mode (The **Day/Night Exposure Profile** will not be available if Auto mode is selected)
The Network Camera automatically removes the filter by judging the level of ambient light.
- Day mode
In day mode, the Network Camera switches on the IR cut filter at all times to block infrared light from reaching the sensor so that the colors will not be distorted.
- Night mode
In night mode, the Network Camera switches off the IR cut filter at all times for the sensor to accept infrared light, thus helping to improve low light sensitivity.
- Synchronize with digital input
If an external IR device is connected that comes with its own light sensor, you can use a digital input from it to trigger the IR cut filter. Doing so can synchronize the detection of light level between the camera and the external IR device.
- Schedule mode
The Network Camera switches between day mode and night mode based on a specified schedule. Enter the start and end time for day mode. Note that the time format is [hh:mm] and is expressed in 24-hour clock time. By default, the start and end time of day mode are set to 07:00 and 18:00.

Light sensor sensitivity

Tune the responsiveness of the IR filter to lighting conditions as Low, Normal, or High.

When completed with the settings on this page, click **Save** to enable the settings.

Illuminators

Turn on built-in IR illuminator in night mode

Select this to turn on the camera's onboard IR illuminator when the camera detects low light condition and enters the night mode.

Turn on external IR illuminator in night mode

Select this to turn on the external IR illuminator when the camera detects low light condition and enters the night mode. A Digital Output connection to external IR is needed. _

Select the digital output from below, Digital output 1 or Digital output 2.

Anti-overexposure: When enabled, the camera automatically adjusts the IR projection to adjacent objects in order to avoid over-exposure in the night mode.

The Smart IR function is more beneficial when the spot of intrusions or an object of your interest is close to the lens and the IR lights. For example, if an intruder has a chance of getting near the range of 3 meters, Smart IR can effectively reduce the over-exposure. For a surveillance area at a greater distance, e.g., 5 meters or farther away, the Smart IR function may not bring as significant benefits as in close range.

Smart IR disabled; distance: 5M

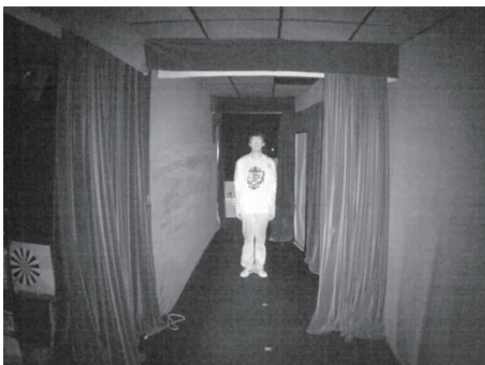

Smart IR enabled; distance: 5M



Smart IR disabled; distance: 3M



Smart IR enabled; distance: 3M



 **Tips:**

If there is an object in close proximity, the IR lights reflected back from it can mislead the Smart IR's calculation of light level. To solve this problem, you can place an "Exposure Exclude" window on an unavoidable object in the Exposure setting window. See page 72 for how to do it.

You can also configure the "Exposure Exclude" window in a night mode "Profile" setting so that your day time setting is not affected.

>Profile of exposure settings

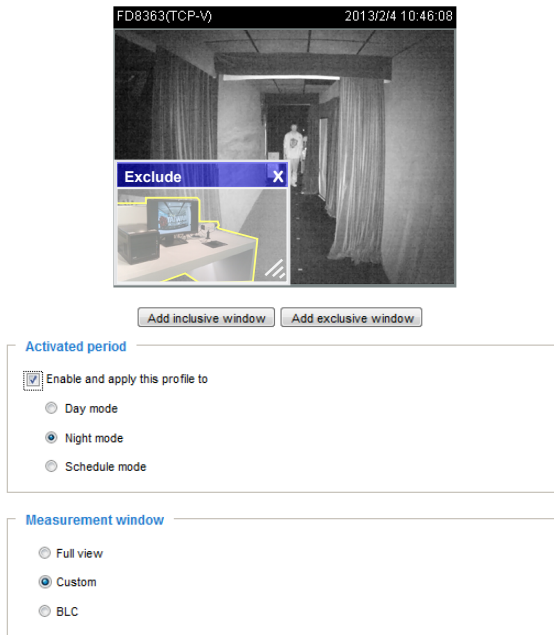

FD8363(TCP-V) 2013/2/4 10:46:08

Exclude X

Add inclusive window Add exclusive window

Activated period

Enable and apply this profile to

- Day mode
- Night mode
- Schedule mode

Measurement window

- Full view
- Custom
- BLC

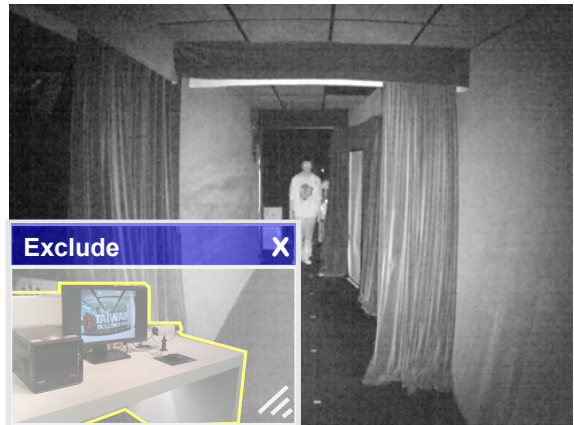
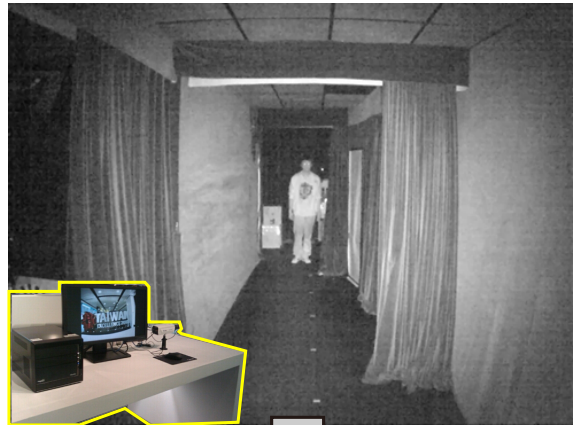

Image settings

On this page, you can tune the White balance and Image adjustment.

Sensor Setting 2:
For special situations

Sensor Setting 1:
For normal situations



White balance: Adjust the value for the best color temperature.

■ You may follow the steps below to adjust the white balance to the best color temperature.

1. Place a sheet of paper of white or cooler-color temperature color, such as blue, in front of the lens, then allow the Network Camera to automatically adjust the color temperature.
2. Click the **On** button to **Fix current value** and confirm the setting while the white balance is being measured.

■ You may also manually tune the color temperature by pulling the RGain and BGain slide bars.

Image Adjustment

- **Brightness**: Adjust the image brightness level, which ranges from 0% to 100%.
- **Contrast**: Adjust the image contrast level, which ranges from 0% to 100%.
- **Saturation**: Adjust the image saturation level, which ranges from 0% to 100%.
- **Sharpness**: Adjust the image sharpness level, which ranges from 0% to 100%.
- **Gamma curve**: Adjust the image sharpness level, which ranges from 0.45 to 1, from Detailed to Contrast. You may let firmware **Optimize** your display or select the **Manual** mode, and pull the slide bar pointer to change the preferred level of Gamma correction towards higher contrast or towards the higher luminance for detailed expression for both dark and lighted areas of an image.

This option is disabled when the WDR feature is enabled.

Defog: Defog helps improve the visibility quality of captured image in poor weather conditions such as smog, fog, or smoke.

Noise reduction

- **Enable noise reduction:** Check to enable noise reduction in order to reduce noises and flickers in image. This applies to the onboard 3D Noise Reduction feature. Use the slide bar to adjust the reduction strength. Note that applying this function to the video channel will consume system computing power.

3D Noise Reduction is mostly applied in low-light conditions. When enabled in a low-light condition with fast moving objects, trails of after-images may occur. You may then select a lower strength level or disable the function.

Note that the **Preview** button has been cancelled, all changes made to image settings is directly shown on screen. You can click **Restore** to recall the original settings without incorporating the changes. When completed with the settings on this page, click **Save** to enable the setting. You can also click on **Profile mode** to adjust all settings above in a tabbed window for special lighting conditions.

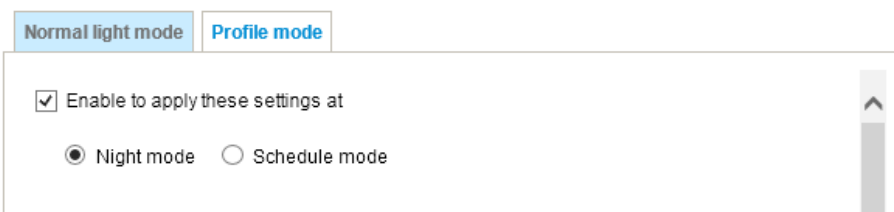

Enable to apply these settings at: Select the mode this profile to apply to: Day mode, Night mode, or Schedule mode. Please manually enter a range of time if you choose the Schedule mode. Then check **Save** to take effect.

Enable digital image stabilizer

If you experience problems such as vibration occurs when on a pole mount, try enable the image stabilizer.

Exposure

On this page, you can set the Exposure measurement window, Exposure level, Exposure mode, Exposure time, Gain control, and Day/Night mode settings. You can configure two sets of Exposure settings: one for normal situations, the other for special situations, such as the day/night/schedule mode.

General settings | Illuminators | Image settings | **Exposure** | Focus | Privacy mask

Auto 100%

Normal light mode | Profile mode

Exposure strategy

Measurement window: Full view Custom Center

Metering mode: Auto BLC HLC

Exposure control

Exposure level: 0

Exposure mode: Auto

Iris mode: Outdoor

AE speed adjustment

Enable AE speed adjustment

Restore Save

Sensor Setting 2:
For special situations

Sensor Setting 1:
For normal situations

Exposure strategy:

Measurement window: This function allows users to set measurement window(s) for low light compensation. For example, where low-light objects are posed against an extremely bright background. You may want to exclude the bright sunlight shining through a building's corridor.

- Full view: Calculate the full range of view and offer appropriate light compensation.
- Custom: This option allows you to manually add customized windows as inclusive or exclusive regions. A total of 10 windows can be configured. Please refer to the next page for detailed illustration.

The inclusive window refers to the “weighted window”; the exclusive window refers to “ignored window”. It adopts the weighted averages method to calculate the value. The inclusive windows have a higher priority. You can overlap these windows, and, if you place an exclusive window within a larger inclusive window, the exclusive part of the overlapped windows will be deducted from the inclusive window. An exposure value will then be calculated out of the remaining of the inclusive window.

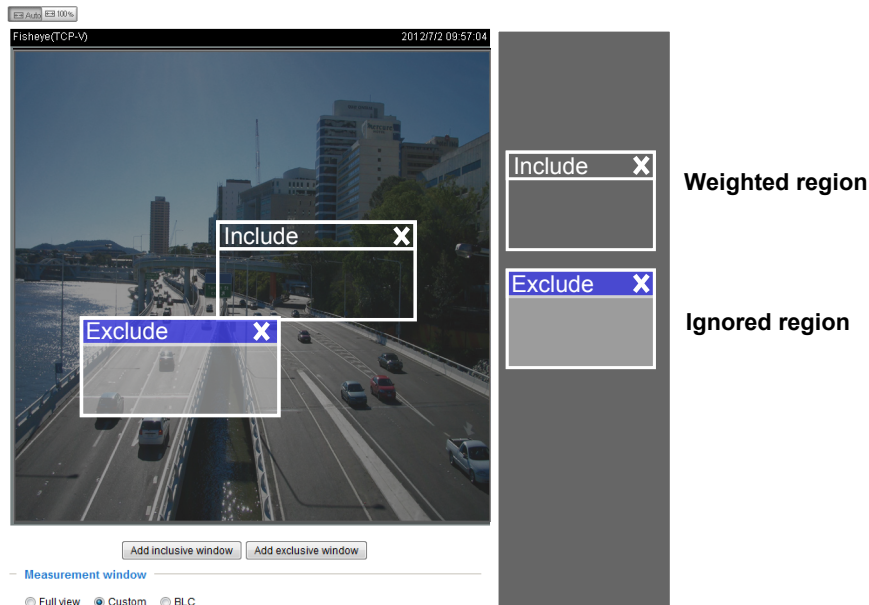

- **Auto:** Firmware automatically determines an optimal exposure level.
- **BLC** (Back Light Compensation): This option will automatically add a “weighted region” in the middle of the window and give the necessary light compensation.
- **HLC:** (Highlight Compensation). Firmware detects strong light sources and compensates on affected spots to enhance the overall image quality. For example, the HLC helps reduce the glares produced by spotlights or headlights.

Exposure control:

■ **Exposure level:** You can manually set the Exposure level, which ranges from -2.0 to +2.0 (dark to bright). You can click and drag the semi-circular pointers on the **Exposure time** and **Gain control** slide bars to specify a range of shutter time and Gain control values within which the camera can automatically tune to an optimal imaging result. You may prefer a shorter shutter time to better capture moving objects, while a faster shutter reduces light and needs to be compensated by electrical brightness gains.

■ **Exposure mode:** (available when WDR Pro is disabled)

You can click and drag the semi-circular pointers on the **Exposure time** and **Gain control** slide bars to specify a range of shutter time and Gain control values within which the camera can automatically tune to an optimal imaging result. You can also configure the iris size to control the amount of light. For example, you may prefer a shorter shutter time to better capture moving objects, while a faster shutter reduces light and needs to be compensated by electrical brightness gains.

■ **Flickerless:** Under some circumstances when there is a difference between the video capture frequency and local AC power frequency (NTSC or PAL), the mismatch causes color shifts or flickering images. If the above mismatch occurs, select the **Flickerless** checkbox, and the range of Exposure time (the shutter time) will be limited to a range in order to match the AC power frequency. When selected, the exposure time will be forced to stay longer than 1/120 second. For cameras that come with fixed iris lens, setting the exposure time to longer than 1/120 second may introduce too much lights to the lens. Users can use this option to observe whether the result of long exposure time is satisfactory.

Auto: If you set Exposure mode as **Auto**, the Exposure time and Gain control will not be configurable since the sensor library will automatically adjust the value according to the ambient light. Then you can configure iris mode as “indoor” or “outdoor” to reach the best image quality.

■ **Iris mode:** Select Indoor or Outdoor iris mode to adapt to the installation. The preset iris aperture setting will apply.

■ **AE Speed Adjustment:**

This function applies when you need to monitor fast changing lighting conditions. For example, the camera may need to monitor a highway lane or entrance of a parking area at night where cars passing by with their lights on can bring fast changes in light levels. The same applies if the camera is installed on a vehicle, and when it needs to adapt to fast changes of light when entering and leaving a tunnel.

■ **WDR Pro:**

This refers to the Wide Dynamic Range function that enables the camera to capture details in a high contrast environment. Use the checkbox to enable the function, and use the slide bar to select the strength of the WDR Pro functionality, depending on the lighting condition at the installation site. You can select a higher effect when the contrast is high (between the shaded area and the light behind the objects).

Enable WDR enhanced: This function allows users to identify more image details with an extreme contrast from an object of interest with one shadowed side against a bright background, e.g., an entrance. You may select the **Enable WDR enhanced** checkbox, and then adjust the strength (low, medium, high) to reach the best image quality.

You can click **Restore** to recall the original settings without incorporating the changes. When completed with the settings on this page, click **Save** to enable the settings.

If you want to configure another sensor setting for day/night/schedule mode, please click **Profile** to open the Profile of exposure settings page as shown below.

Activated period: Select the mode this profile to apply to: Day mode, Night mode, or Schedule mode. Please manually enter a range of time if you choose Schedule mode. Then check **Save** to take effect.

Please follow the steps below to set up a profile:

1. Select the **Profile mode** tab.
2. Select the applicable mode: Night mode or Schedule mode. Please manually enter a range of time if you choose the Schedule mode.
3. Configure Exposure control settings in the following columns. Please refer to previous discussions for detailed information.
4. Click **Save** to enable the setting and click **Close** to exit the page.

General settings | Illuminators | Image settings | Exposure | Focus | Privacy mask

Auto 100%

Normal light mode | Profile mode

Enable to apply these settings at

Night mode Schedule mode

— Exposure strategy —

Measurement window: Full view Custom BLC HLC

— Exposure control —

Exposure level: 0

Exposure mode: Auto

Iris mode: Outdoor

Restore Save

Focus

Focus here refers to the **Remote Focus**, applicable to Network Cameras that are equipped with a stepping motor lens. The automated focus adjustment function eliminates the needs to physically adjust camera focus. In an outdoor deployment consisting of a large number of cameras, the auto focus function can be very helpful when these cameras become out of focus after days or weeks of operation. And that can easily result from the effects of natural forces, e.g., shrink and expand due to a wide range of operating temperatures and the vibration caused by wind.



Below is the procedure to perform the automated Focus function:

1. Select from the bottom of the screen whether you want to perform focus adjustment on the **Full view** or within a **Custom** focus window. You can create a custom window and click and drag the window to a desired position on screen.
2. It is recommended to **Reset** to the default back focus position of the sensor board.
3. You can use the **Fully-opened iris** checkbox (default) to increase the iris size for a better focus adjustment result.
4. Click to select the **Fully-opened iris** or the **Full-range scan** buttons. When a full-range scan is selected, a full-range scan through the camera's entire focal length can take about 30 to 80 seconds. If not, the auto focus scan will only go through the length where optimal focus may occur, and that takes about 15 to 20 seconds. In theory, best results of the auto scan can be acquired when the camera's iris is fully open.

5. Wait for the scan to complete. After a short while, the clearest image obtained should be displayed and the optimal focus range achieved. Use the arrow marks on the sides to fine-tune the focus if you are not satisfied with the results. You may still need to use the arrow marks to fine-tune the focus depending on the live image on your screen. ">" means moving from wide to tele end; and "<" tele to wide.

The methodology of using the Resize Buttons at the upper left corner of the streaming window is the same as that on the home page.

Focus window:

By default, the optimal focus is found on a full view window. You may designate a custom window within your current field of view to acquire the best focus out of it. However, you can not place a focus window on a distant background, e.g., a hall way that stretches away for 3 meters or farther. Doing so you will not benefit from the Focus window function.

- **Full view:** The focus tuning takes place by referring to the full view.
- **Custom:** You can create a focus window and drag it to a place of interest in your view window. Note that it is recommended to use this function only when you have a solid object in your view window that is showing a consistent color or texture. This function will not take effect if you set the focus window on a distant background.

Privacy mask

Click **Privacy Mask** to open the settings page. On this page, you can block out sensitive zones to address privacy concerns.

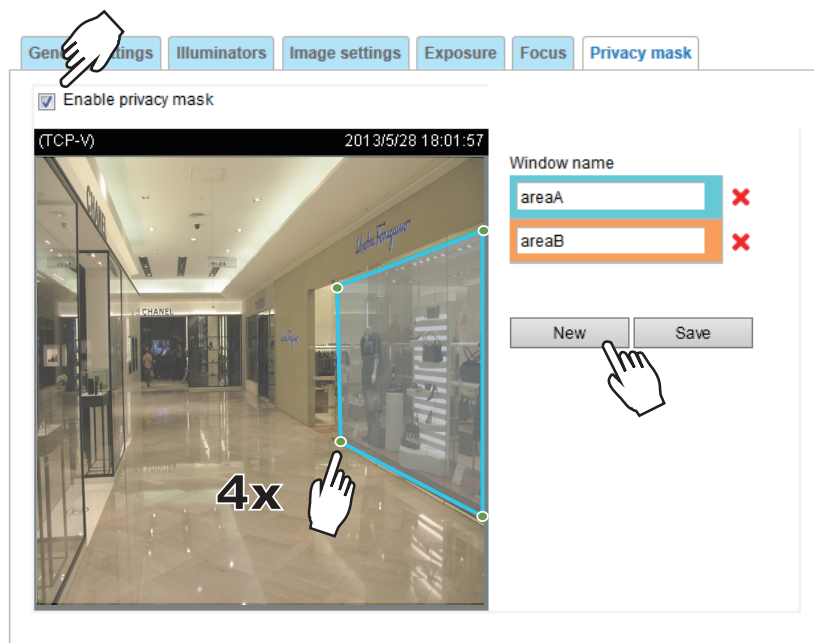

- To configure privacy mask windows,
 1. Click **New** to add a new window.
 2. You can use 4 mouse clicks to create a new masking window, which is recommended to be at least twice the size of the object (height and width) you want to cover.
 3. Enter a Window Name and click **Save** to enable the setting.
 4. Click on the **Enable privacy mask** checkbox to enable this function.



NOTE:

- ▶ *Up to 5 privacy mask windows can be configured on the same screen.*
- ▶ *If you want to delete the privacy mask window, please click the 'x' mark on the side of window name.*

Media > Video

Mode

Mode **Stream**

1080P FULL HD (16:9) (MAX 30fps)(WDR Pro)

1080P FULL HD (16:9) (MAX 60fps)

The applicable video modes include:

- **1080P Full HD (16:9) (max. 30fps)(WDR Pro)**: If the need should arise for a high contrast lighting environment, select this mode with the WDR Pro feature.
- **1080P Full HD (16:9) (max. 60fps)**: If the need should arise for monitoring fast vehicles at 60fps, select this mode.

IB9387

Mode **Stream**

5-Megapixel (4:3) (MAX 30fps)(WDR Pro)

4-Megapixel (16:9) (MAX 30fps)(WDR Pro)

1080P FULL HD (16:9) (MAX 60fps)(WDR Pro)

The applicable video modes include:

- **5-Magapixel (4:3) (max. 30fps)(WDR Pro)**: If the need should arise for a high contrast lighting environment, select this mode with the WDR Pro feature.
- **4-Magapixel (16:9) (max. 30fps)(WDR Pro)**: With a different screen display ratio, select this mode with the WDR Pro feature.
- **1080P Full HD (16:9) (max. 60fps)(WDR Pro)**: If the need should arise for monitoring fast vehicles at 60fps, select this mode.

Media > Video

Stream settings

Mode
Stream

- ▶ Video settings for stream 1
- ▶ Video settings for stream 2
- ▶ Video settings for stream 3 [Viewing Window](#)

This Network Camera supports multiple streams with frame sizes ranging from 640 x 360 to 1920 x 1080 pixels

The definition of multiple streams:

- Stream 1: The default frame size for Stream 1 is set to the 1920 x 1080. (IB9387: 2560x1920)
- Stream 2: The default frame size for Stream 2 is set to the 1920 x 1080. (IB9387: 2560x1920)
- Stream 3: The default frame size for Stream 3 is set to the 640 x 360. Users can define the "Region of Interest" (viewing region) and the "Output Frame Size" (size of the live view window).

Click **Viewing Window** to open the viewing region settings page. On this page, you can configure the **Region of Interest** and the **Output Frame Size** for a video stream. For example, you can crop only a portion of the image that is of your interest, and thus save the bandwidth needed to transmit the video stream. As shown below, the area of your interest in a parking lot should be the vehicles. The blue sky is of little value for the surveillance purpose.





Please follow the steps below to set up those settings for a stream:

1. Select a stream for which you want to set up the viewing region.
2. Select a **Region of Interest** from the drop-down list. The floating frame, the same as the one in the Global View window on the home page, will resize accordingly. If you want to set up a customized viewing region, you can also resize and drag the floating frame to a desired position with your mouse.
3. Choose a proper **Output Frame Size** from the drop-down list according to the size of your monitoring device.

NOTE:

- ▶ All the items in the “Region of Interest” should not be larger than the “Output Frame Size” (current maximum resolution).

■ The parameters of the multiple streams:

| | Region of Interest | Output frame size |
|----------|--------------------------------------|--------------------------------------|
| Stream 1 | Fixed | Fixed |
| Stream 2 | Fixed | Fixed |
| Stream 3 | 2560 x 1920 ~ 640 x 360 (Selectable) | 2560 x 1920 ~ 640 x 360 (Selectable) |

When completed with the settings in the Viewing Window, click **Save** to enable the settings and click **Close** to exit the window. The selected **Output Frame Size** will immediately be applied to the **Frame size** of each video stream. Then you can go back to the home page to test the e-PTZ function. For more information about the e-PTZ function, please refer to page 122.

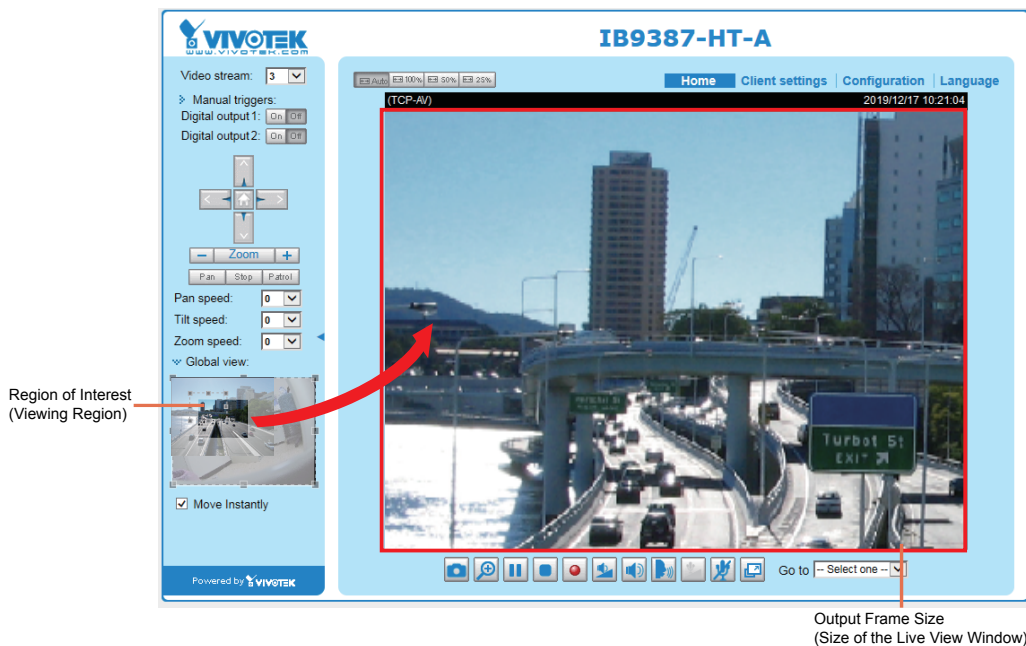

Output Frame Size
(Size of the Live View Window)

Click the stream item to display the detailed information. The maximum frame size will follow your settings in the above Viewing Window sections.

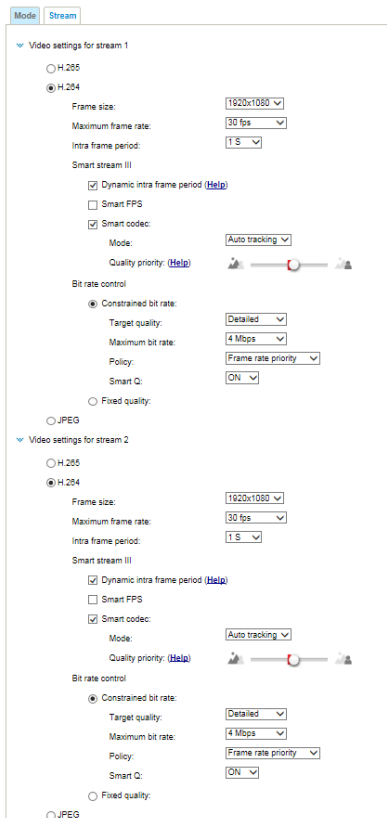

This Network Camera provides real-time H.265, H.264 and MJPEG compression standards (Triple Codec) for real-time viewing. If the **H.265** or **H.264** mode is selected, the video is streamed via RTSP protocol. There are several parameters through which you can adjust the video performance:

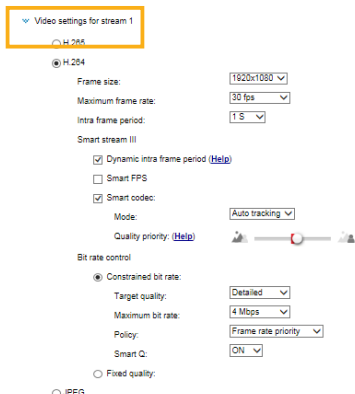

■ **Frame size**

You can set up different video resolutions for different viewing devices. For example, you can configure a smaller frame size and lower bit rate for remote viewing on mobile phones and a larger video size and a higher bit rate for live viewing on web browsers, or recording the stream to an NVR. Note that a larger frame size takes up more bandwidth.

■ **Maximum frame rate**

This limits the maximum refresh frame rate per second. Set the frame rate higher for smoother video quality and for recognizing moving objects in the field of view.

If the power line frequency is set to 50Hz , the frame rates are selectable at 1fps, 2fps, 3fps, 5fps, 8fps, 10fps, 12fps, 15fps, and up to 25fps. If the power line frequency is set to 60Hz, the frame rates are selectable at 1fps, 2fps, 3fps, 5fps, 8fps, 10fps, 12fps, 15fps, and up to 30fps. You can also select **Customize** and manually enter a value.

The frame rate will decrease if you select a higher resolution.

■ Intra frame period

Determine how often for firmware to plant an I frame. The shorter the duration, the more likely you will get better video quality, but at the cost of higher network bandwidth consumption. Select the intra frame period from the following durations: 1/4 second, 1/2 second, 1 second, 2 seconds, 3 seconds, and 4 seconds.

■ Smart stream III

■ Dynamic Intra frame period

High quality motion codecs, such as H.265, utilize the redundancies between video frames to deliver video streams at a balance of quality and bit rate.

The encoding parameters are summarized and illustrated below. The **I-frames** are completely self-referential and they are largest in size. The **P-frames** are predicted frames. The encoder refers to the previous I- or P-frames for redundant image information.

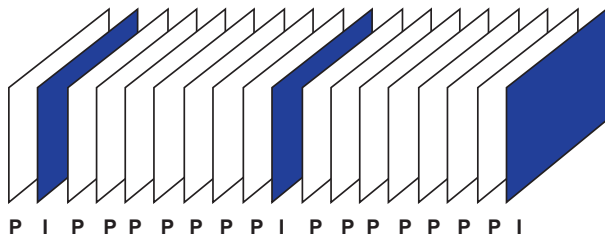

H.264/265 Frame Types

By dynamically prolonging the intervals for I-frames insertion to up to 10 seconds, the bit rates required for streaming a video can be tremendously reduced. When streaming a video of a static scene, the Dynamic Intra frame feature can save up to 53% of bandwidth. The amount of bandwidth thus saved is also determined by the activities in the field of view. If activities occur in the scene, firmware automatically shortens the I-frame insertion intervals in order to maintain image quality. In the low light or night conditions, the sizes of P-frames tend to be enlarged due to the noises, and hence the bandwidth saving effect is also reduced.

Streaming a typical 2MP scene normally requires 3~4Mb/s of bandwidth. With the Dynamic Intra frame function, the bandwidth for streaming a medium-traffic scene can be reduced to 2~3Mb/s, and during the no-traffic period of time, down to 500kb/s.

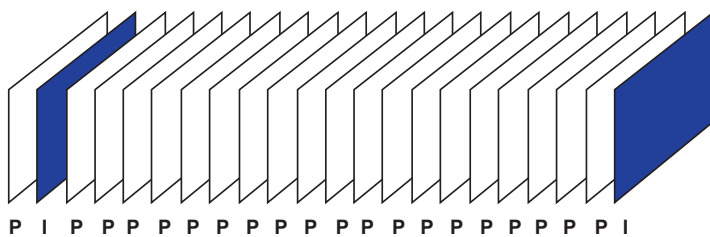

Static scene

Dynamic Intra Frame w/ static scenes

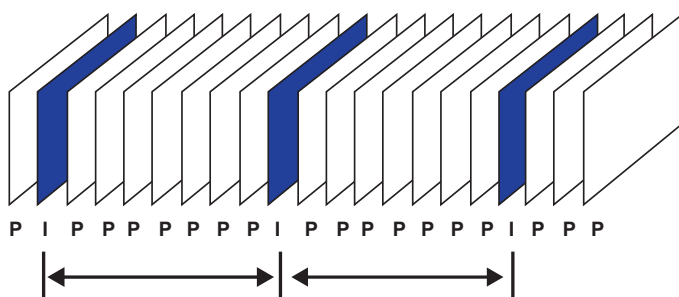

Activities

Dynamic Intra Frame w/ activities in scenes

With the H.265 codec in an optimal scenario and when Dynamic Intra frame is combined with the Smart Stream function, an 80% of bandwidth saving can be achieved compared with using H.264 without enabling these bandwidth-saving features.

■ Smart FPS

In a static scene, the algorithm puts old frames in queue when no motions occur in scene. When motions occur, the encoding returns to normal to deliver real-time streaming.

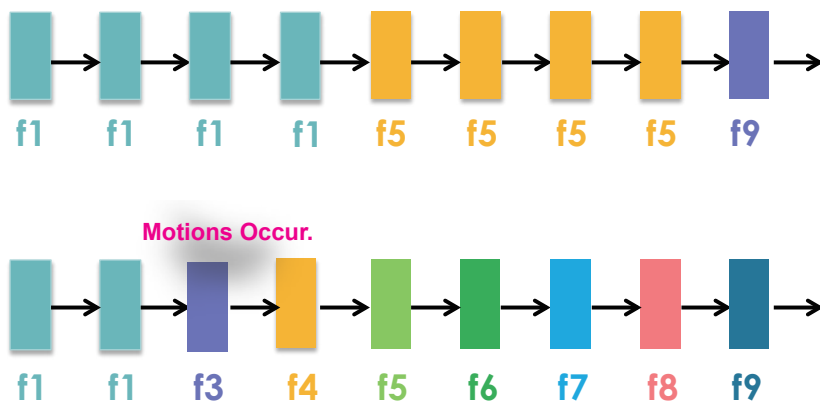

By queuing the old frames from a static scene, both the computing efforts and the size of P frames are reduced. It is beneficial for keeping up with the frame rate requirements.

A default frame difference threshold, 1%, is embedded in firmware for returning from Smart FPS to normal encoding when motions occur.



NOTE:

Comparing with Smart Stream II, Smart Stream III has two more configurable options: [Smart Q](#), and [Smart FPS](#).

- **Smart codec:** Smart codec effectively reduces the quality of the whole or the non-interested areas on a screen and therefore reduces the bandwidth consumed.

You can manually specify the video quality for the foreground and the background areas.



Select an operation mode if Smart codec is preferred.

- **Auto tracking:** The Auto mode configures the whole screen into the non-interested area. The video quality of part of the screen returns to normal when one or more objects move in that area. The remainder of the screen where there are no moving objects (no pixel changes) will still be transmitted in low-quality format.
- **Manual:** The Manual mode allows you to configure 3 ROI windows (Region of Interest, with Foreground quality) on the screen. Areas not included in any ROI windows will be considered as the non-interested areas. The details in the ROI areas will be transmitted in a higher-quality video format.

As illustrated below, the upper screen may contain little details of your interest, while the sidewalk on the lower screen is included in an ROI window.



As the result, the lower screen is constantly displayed in high details, while the upper half is transmitted using a lower-quality format. Although the upper half is transmitted using a lower quality format, you still have an awareness of what is happening on the whole screen.

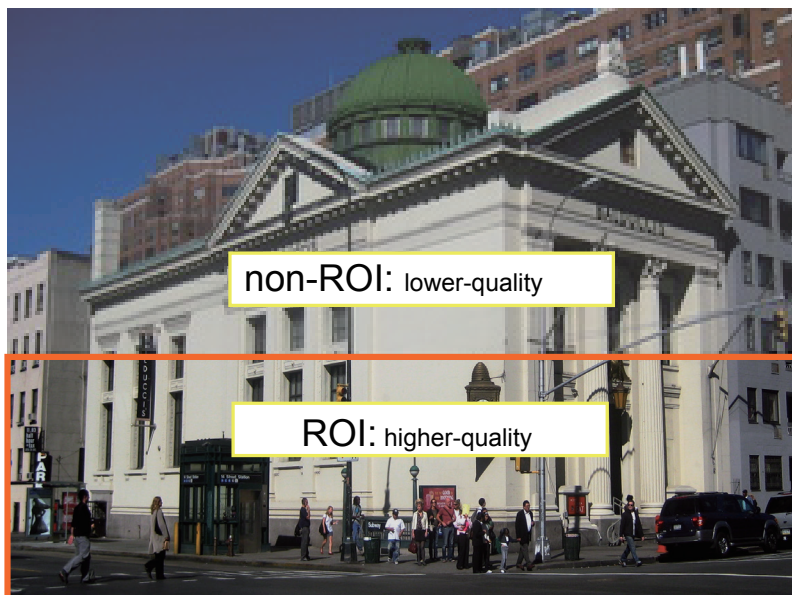

- **Hybrid:** The major difference between the “Manual” mode and the “Hybrid” mode is that:

In the “**Hybrid**” mode, any objects entering the non-interested area will restore the video quality of the moving objects and the area around them. The video quality of the associated non-interested area is immediately restored to normal to cover the moving objects.

In the “**Manual**” mode, the non-interested area is always transmitted using a low-quality format regardless of the activities occurring inside.

Quality priority: ([Help](#))



- **Quality priority:** Use the slide bar to tune the quality contrast between the ROI and non-interested areas.

The farther the slide bar button is to the right, the higher the image quality of the ROI areas. On the contrary, the farther the slide bar button to the left, the higher the image quality of the non-interested area.

In this way, you may set up an ROI window as a privacy mask by covering a protected area using an ROI window, while the rest of the screen becomes the non-interested area. You may then configure the non-interested area to have a high image quality, or vice versa.

You should also select the Maximum bit rate from the pull-down menu as the threshold to contain the bandwidth consumption for both the high- and low-quality video sections in a smart stream.

■ Bit rate control

Constrained bit rate:

A complex scene generally produces a larger file size, meaning that higher bandwidth will be needed for data transmission. The bandwidth utilization is configurable to match a selected level, resulting in mutable video quality performance. The bit rates are selectable at the following rates: 20Kbps, 30Kbps, 40Kbps, 50Kbps, 64Kbps, 128Kbps, 256Kbps, 512Kbps, 768Kbps, 1Mbps, 2Mbps, 3Mbps, 4Mbps, 6Mbps, 8Mbps, 10Mbps, 12Mbps, 14Mbps, ~ to 80Mbps. You can also select **Customize** and manually enter a value up to 80Mbps.

- - **Target quality:** Select a desired quality ranging from Medium to Excellent.
- **Maximum bit rate:** select a bit rate from the pull-down menu. The bit rate ranges from 20kbps to a maximum of 80Mbps. The bit rate then becomes the Average or Upper bound bit rate number. The Network Camera will strive to deliver video streams around or within the bit rate limitation you impose.
- **Policy:** If Frame Rate Priority is selected, the Network Camera will try to maintain the frame rate per second performance, while the image quality will be compromised. If Image quality priority is selected, the Network Camera may drop some video frames in order to maintain image quality.

Smart Q: Select ON or OFF to enable or disable the feature. Smart Q is scene-aware. The Smart Q reduces frame size and bit rate consumption through the following:

- Dynamically adjusting the image quality for scenes in different luminosities in low light frames. Less noises means less of the bandwidth consumed.
- Endorsing different qualities for the I frames and P frames, and hence reduces the frame size.
- Dividing a single frame into different sections, and giving these sections different qualities. For a highly complex area, such as an area with dense vegetation, screen windows, or repeated patterns (complex textiles patterns like wall paper), having a lower quality value actually poses little effects on human eyes.

Unnecessary quality is unrecognized by human eyes and wastes the bit rate.

The Smart Q streaming can save up to 50% to 80% of bandwidth in different illumination conditions while keeping the same imaging quality. These numbers come from the comparison between Smart Stream II and Smart Stream III streamings.

Fixed quality:

On the other hand, if **Fixed quality** is selected, all frames are transmitted with the same quality; bandwidth utilization is therefore unpredictable. The video quality can be adjusted to the following settings: Medium, Standard, Good, Detailed, and Excellent. You can also select **Customize** and manually enter a value.

Maximum bit rate: With the guaranteed image quality, you might still want to place a bit rate limitation to control the size of video streams for bandwidth and storage concerns. The configurable bit rate starts from 1Mbps to 80Mbps.

The Maximum bit rate setting in the Fixed quality configuration can ensure a reasonable and limited use of network bandwidth. For example, in low light conditions where a Fixed quality setting is applied, video packet sizes can tremendously increase when noises are produced with electrical gains.

You may also manually enter a bit rate number by selecting the **Customized** option.

If the **JPEG** mode is selected, the Network Camera sends consecutive JPEG images to the client, producing a moving effect similar to a filmstrip. Every single JPEG image transmitted guarantees the same image quality, which in turn comes at the expense of variable bandwidth usage. Because the media contents are a combination of JPEG images, no audio data is transmitted to the client. There are three parameters provided in MJPEG mode to control the video performance:

JPEG

Frame size:

Maximum frame rate:

Bit rate control

Constrained bit rate:

Fixed quality:

Quality:

Maximum bit rate:

■ Frame size

You can set up different video resolution for different viewing devices. For example, set a smaller frame size and lower bit rate for remote viewing on mobile phones and a larger video size and a higher bit rate for live viewing on web browsers. Note that a larger frame size takes up more bandwidth.

■ Maximum frame rate

This limits the maximum refresh frame rate per second. Set the frame rate higher for smoother video quality.

If the power line frequency is set to 50Hz, the frame rates are selectable at 1fps, 2fps, 3fps, 5fps, 8fps, 10fps, 15fps, and up to 25fps. If the power line frequency is set to 60Hz, the frame rates are selectable at 1fps, 2fps, 3fps, 5fps, 8fps, 10fps, 15fps, and up to 30fps. You can also select **Customize** and manually enter a value. The frame rate will decrease if you select a higher resolution.

■ Video quality

Refer to the previous page setting an average or upper bound threshold for controlling the bandwidth consumed for transmitting motion jpegs. The configuration method is identical to that for H.264.

For Constant Bit Rate and other settings, refer to the previous page for details.



NOTE:

- ▶ *Video quality and fixed quality refers to the **compression rate**, so a lower value will produce higher quality.*
- ▶ *Converting high-quality video may significantly increase the CPU loading, and you may encounter streaming disconnection or video loss while capturing a complicated scene. In the event of occurrence, we suggest you customize a lower video resolution or reduce the frame rate to obtain smooth video.*

Media > Audio

Audio Settings

Mute: Select this option to disable audio transmission from the Network Camera to all clients. Note that if muted, no audio data will be transmitted even if audio transmission is enabled on the Client Settings page. In that case, the following message is displayed:

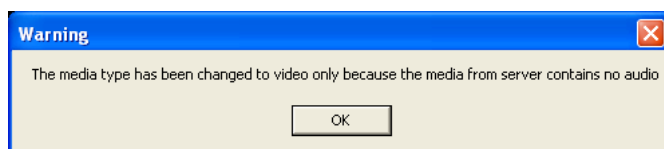

External microphone input: Select the gain of the external audio input according to ambient conditions. Adjust the gain from 0% to 100%.

Audio type: Select audio codec and the sampling bit rate .

- G.711 also provides good sound quality and requires about 64Kbps. Select pcmu (μ -Law) or pcma (A-Law) mode.
- G.726 is a speech codec standard covering voice transmission at rates of 16, 24, 32, and 40kbit/s.

When completed with the settings on this page, click **Save** to enable the settings. __

Audio clips

- Output gain: Use the slide bar to change the audio output gains value.
- Audio clip: When the camera's audio input is connected to a microphone, you can record a short period of audio recordings (1 to 10 seconds). You can also use the camera's embedded microphone to record an audio clip, if available. Because the memory space is limited, a recording count down will be available on screen.

You can also upload an audio file to the camera's flash memory. With amplified speakers, you can playback the audio, e.g., to deter an intruder. A maximum of 2 audio clips in wav format are supported. The maximum size of the audio file to be uploaded is 2,000Kbytes.

The voice alert is enabled in the **Event settings > action > Play Audio Clip**. The action can be associated with triggering conditions.

Audio settings
Audio clips

— **Output gain** —

85%

— **Audio clip** —

Add a new audio clip:

Record a sound file (*.wav) from camera:

Name:

Wait for seconds before recording [1~10]

Upload a pre-recorded sound file (*.wav):

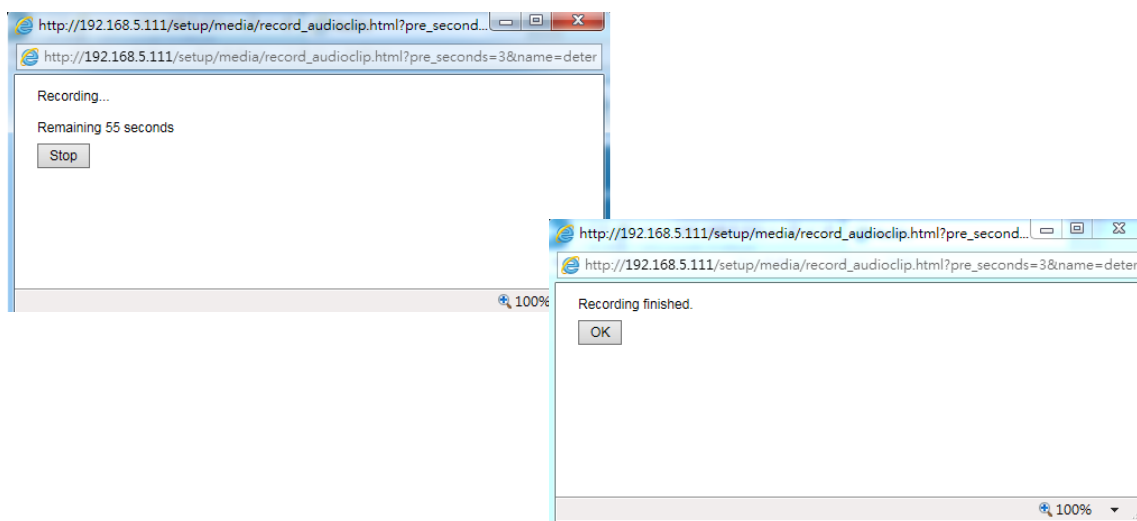

Network > General settings

This section explains how to configure a wired network connection for the Network Camera.

Network Type

Network type

LAN

Get IP address automatically

Use fixed IP address

Enable UPnP presentation

Enable UPnP port forwarding

PPPoE

Enable IPv6

Save

LAN

Select this option when the Network Camera is deployed on a local area network (LAN) and is intended to be accessed by local computers. The default setting for the Network Type is LAN. Please remember to click on the **Save** button when you complete the Network setting.

Get IP address automatically: Select this option to obtain an available dynamic IP address assigned by the DHCP server each time the camera is connected to the LAN.

Use fixed IP address: Select this option to manually assign a static IP address to the Network Camera.

Network type

LAN

Get IP address automatically

Use fixed IP address

IP address: 172.16.168.10

Subnet mask: 255.255.0.0

Default router: 172.16.0.1

Primary DNS: 192.168.0.21

Secondary DNS: 192.168.0.22

Primary WINS server: 192.168.0.21

Secondary WINS server: 192.168.0.22

Enable UPnP presentation

Enable UPnP port forwarding

PPPoE

Enable IPv6

Save

1. You can make use of VIVOTEK Installation Wizard 2 on the software CD to easily set up the Network Camera on LAN. Please refer to Software Installation on page 19 for details.
2. Enter the Static IP, Subnet mask, Default router, and Primary DNS provided by your ISP or network administrator.

Subnet mask: This is used to determine if the destination is in the same subnet. The default value is "255.255.255.0".

Default router: This is the gateway used to forward frames to destinations in a different subnet. Invalid router setting will disable the transmission to destinations across different subnets.

Primary DNS: The primary domain name server that translates hostnames into IP addresses.

Secondary DNS: Secondary domain name server that backups the Primary DNS.

Primary WINS server: The primary WINS server that maintains the database of computer names and IP addresses.

Secondary WINS server: The secondary WINS server that maintains the database of computer names and IP addresses.

Enable UPnP presentation: Select this option to enable UPnP™ presentation for your Network Camera so that whenever a Network Camera is presented to the LAN, the shortcuts to connected Network Cameras will be listed in My Network Places. You can click the shortcut to link to the web browser. Currently, UPnP™ is supported by Windows XP or later. Note that to utilize this feature, please make sure the UPnP™ component is installed on your computer.

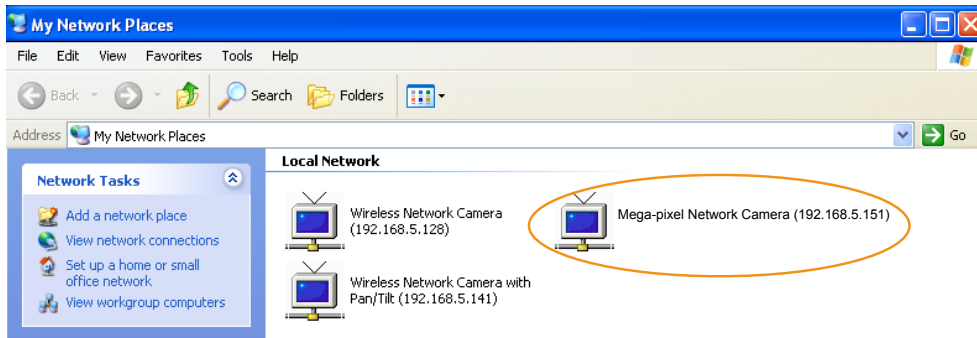

Enable UPnP port forwarding: To access the Network Camera from the Internet, select this option to allow the Network Camera to open ports automatically on the router so that video streams can be sent out from a LAN. To utilize of this feature, make sure that your router supports UPnP™ and it is activated.

PPPoE (Point-to-point over Ethernet)

Select this option to configure your Network Camera to make it accessible from anywhere as long as there is an Internet connection. Note that to utilize this feature, it requires an account provided by your ISP.

Follow the steps below to acquire your Network Camera’s public IP address.

1. Set up the Network Camera on the LAN.
2. Go to Configuration > Event > Event settings > Add server (please refer to Add server on page 130) to add a new email or FTP server.
3. Go to Configuration > Event > Event settings > Add media (please refer to Add media on page 135).

Select System log so that you will receive the system log in TXT file format which contains the Network Camera’s public IP address in your email or on the FTP server.

4. Go to Configuration > Network > General settings > Network type. Select PPPoE and enter the user name and password provided by your ISP. Click **Save** to enable the setting.

Network type

LAN

PPPoE

User name:

Password:

Confirm password:

Enable IPv6

5. The Network Camera will reboot.
6. Disconnect the power to the Network Camera; remove it from the LAN environment.

**NOTE:**

- ▶ If the default ports are already used by other devices connected to the same router, the Network Camera will select other ports for the Network Camera.
- ▶ If UPnP™ is not supported by your router, you will see the following message:
Error: Router does not support UPnP port forwarding.
- ▶ Steps to enable the UPnP™ user interface on your computer:
Note that you must log on to the computer as a system administrator to install the UPnP™ components.

1. Go to Start, click **Control Panel**, then click **Add or Remove Programs**.

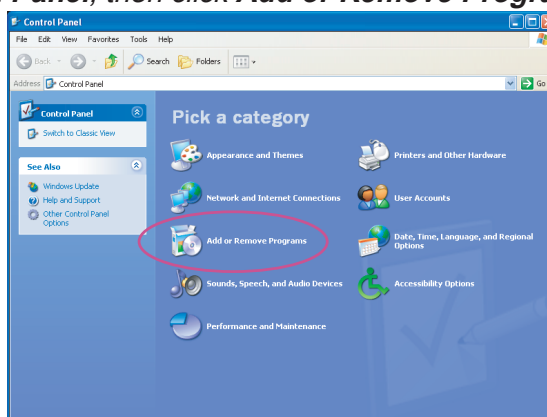

2. In the Add or Remove Programs dialog box, click **Add/Remove Windows Components**.

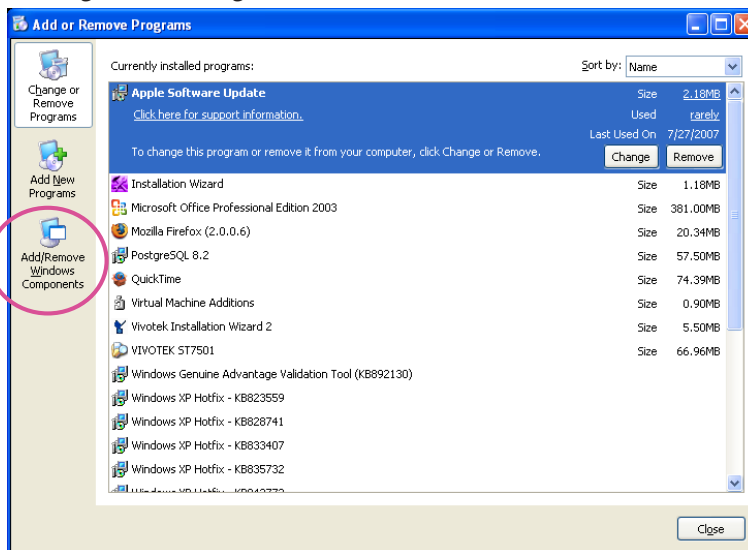

3. In the Windows Components Wizard dialog box, select **Networking Services** and click **Details**.

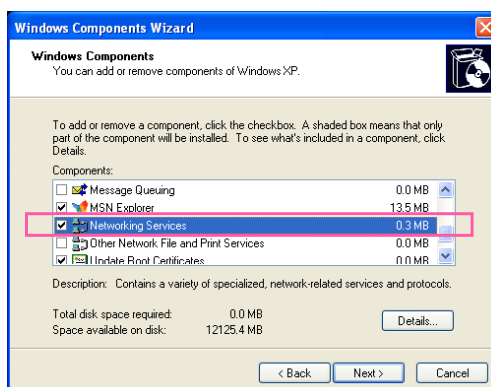

4. In the Networking Services dialog box, select **Universal Plug and Play** and click **OK**.

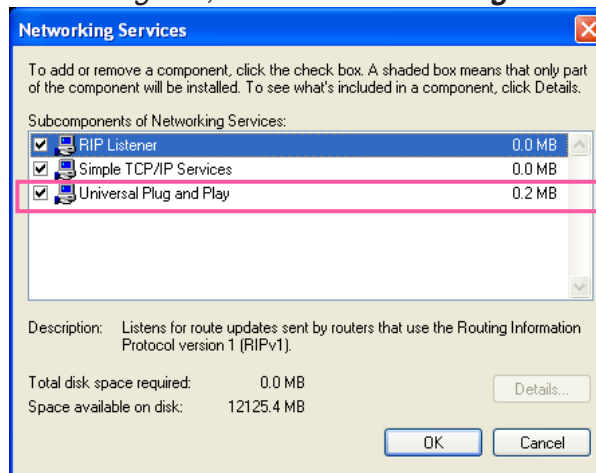

5. Click **Next** in the following window.

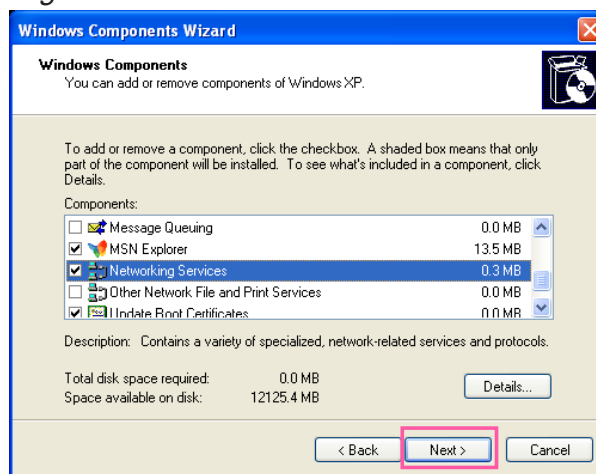

6. Click **Finish**. UPnP™ is enabled.

► **How does UPnP™ work?**

UPnP™ networking technology provides automatic IP configuration and dynamic discovery of devices added to a network. Services and capabilities offered by networked devices, such as printing and file sharing, are available among each other without the need for cumbersome network configuration. In the case of Network Cameras, you will see Network Camera shortcuts under My Network Places.

► **Enabling UPnP port forwarding allows the Network Camera to open a secondary HTTP port on the router-not HTTP port-meaning that you have to add the secondary HTTP port number to the Network Camera's public address in order to access the Network Camera from the Internet. For example, when the HTTP port is set to 80 and the secondary HTTP port is set to 8080, refer to the list below for the Network Camera's IP address.**

| From the Internet | In LAN |
|----------------------------|--|
| http://203.67.124.123:8080 | http://192.168.4.160 or http://192.168.4.160:8080 |

► **If the PPPoE settings are incorrectly configured or the Internet access is not working, restore the Network Camera to factory default; please refer to Restore on page 57 for details. After the Network Camera is reset to factory default, it will be accessible on the LAN.**

Enable IPv6

Select this option and click **Save** to enable IPv6 settings.

Please note that this only works if your network environment and hardware equipment support IPv6. The browser should be Microsoft® Internet Explorer 6.5, Mozilla Firefox 3.0 or above.

Network type

LAN

PPPoE

User name:

Password:

Confirm password:

Enable IPv6

[IPv6 information](#)

Manually setup the IP address

When IPv6 is enabled, by default, the network camera will listen to router advertisements and be assigned with a link-local IPv6 address accordingly.

IPv6 Information: Click this button to obtain the IPv6 information as shown below.

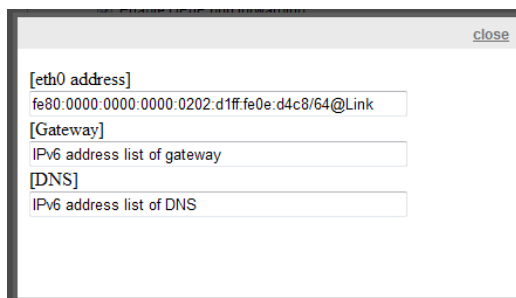

If your IPv6 settings are successful, the IPv6 address list will be listed in the pop-up window. The IPv6 address will be displayed as follows:

Refers to Ethernet

| | |
|---|---|
| [eth0 address] | |
| 2001:0c08:2500:0002:0202:d1ff:fe04:65f4/64@Global | — Link-global IPv6 address/network mask |
| fe80:0000:0000:0000:0202:d1ff:fe04:65f4/64@Link | — Link-local IPv6 address/network mask |
| [Gateway] | |
| fe80::211:d8ff:fea2:1a2b | |
| [DNS] | |
| 2010:05c0:978d:: | |

Enable IPv6

IPv6 information

Manually setup the IP address

Optional IP address / Prefix length /

Optional default router

Optional primary DNS

Network > Streaming protocols

HTTP streaming

To utilize HTTP authentication, make sure that you have set a password for the Network Camera first; please refer to Security > User account on page 107 for details.

| HTTP | RTSP | SIP |
|--|------|-----|
| Authentication: <input type="text" value="digest"/> | | |
| HTTP port: <input type="text" value="80"/> | | |
| Secondary HTTP port: <input type="text" value="8080"/> | | |
| Access name for stream 1: <input type="text" value="video1s1.mjpg"/> | | |
| Access name for stream 2: <input type="text" value="video1s2.mjpg"/> | | |
| Access name for stream 3: <input type="text" value="video1s3.mjpg"/> | | |
| <input type="button" value="Save"/> | | |

Authentication: Depending on your network security requirements, the Network Camera provides two types of security settings for an HTTP transaction: basic and digest.

If **basic** authentication is selected, the password is sent in plain text format and there can be potential risks of being intercepted. If **digest** authentication is selected, user credentials are encrypted using MD5 algorithm and thus provide better protection against unauthorized accesses.

HTTP port / Secondary HTTP port: By default, the HTTP port is set to 80 and the secondary HTTP port is set to 8080. They can also be assigned to another port number between 1025 and 65535. If the ports are incorrectly assigned, the following warning messages will be displayed:

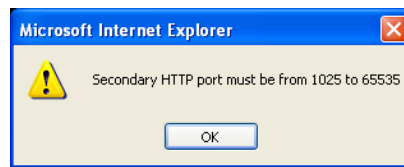

To access the Network Camera on the LAN, both the HTTP port and secondary HTTP port can be used to access the Network Camera. For example, when the HTTP port is set to 80 and the secondary HTTP port is set to 8080, refer to the list below for the Network Camera's IP address.

| |
|---------------------------|
| On the LAN |
| http://192.168.4.160 or |
| http://192.168.4.160:8080 |

Access name for stream 1 ~ 3: This Network camera supports multiple streams simultaneously. The access name is used to identify different video streams. Users can click **Media > Video > Stream settings** to set up the video quality of linked streams. For more information about how to set up the video quality, please refer to Stream settings on page 75.

When using **Mozilla Firefox** to access the Network Camera and the video mode is set to JPEG, users will receive video comprised of continuous JPEG images. This technology, known as "server push", allows the Network Camera to feed live pictures to Mozilla Firefox.

URL command -- <http://<ip address>:<http port>/<access name for stream 1, 2, 3>>

For example, when the Access name for [stream 2](http://192.168.5.151/video1s2.mjpg) is set to [video1s2.mjpg](http://192.168.5.151/video1s2.mjpg):

1. Launch Mozilla Firefox or Netscape.
2. Type the above URL command in the address bar. Press **Enter**.
3. The JPEG images will be displayed in your web browser.

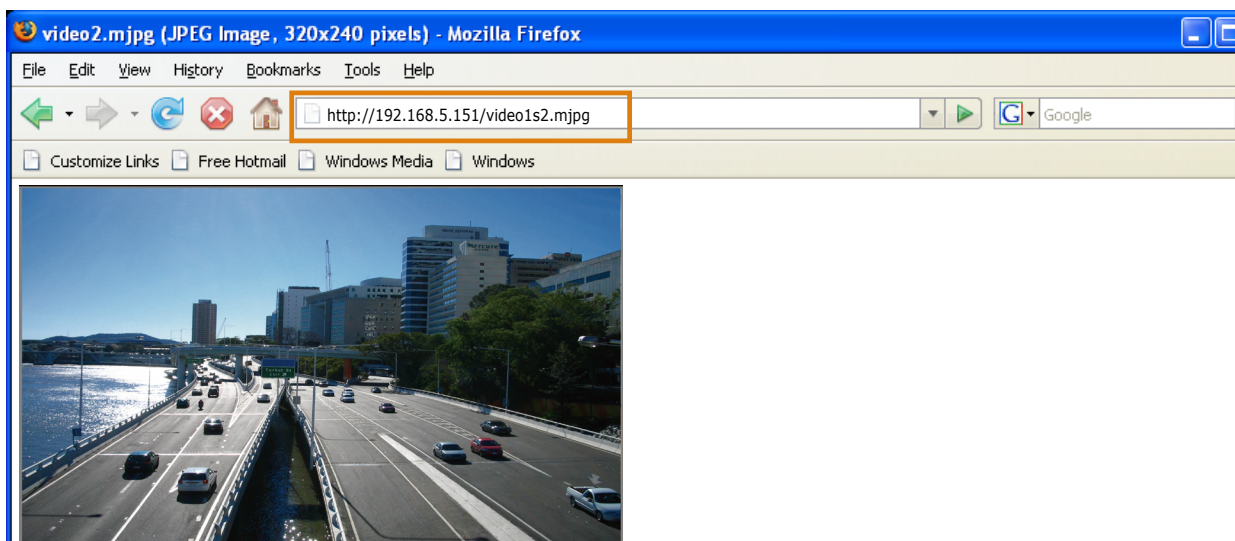

NOTE:

- ▶ *Microsoft® Internet Explorer does not support server push technology; therefore, you will not be able to access a video stream using <http://<ip address>:<http port>/<access name for stream 1, 2, 3>>.*

RTSP Streaming

To utilize RTSP streaming authentication, make sure that you have set a password for controlling the access to video stream first. Please refer to Security > User account on page 107 for details.

| HTTP | RTSP | SIP |
|--|------|-----|
| Authentication: <input type="text" value="digest"/> | | |
| RTSP port: <input type="text" value="554"/> | | |
| RTP port for video: <input type="text" value="5556"/> | | |
| RTCP port for video: <input type="text" value="5557"/> | | |
| RTP port for metadata: <input type="text" value="6556"/> | | |
| RTCP port for metadata: <input type="text" value="6557"/> | | |
| RTP port for audio: <input type="text" value="5558"/> | | |
| RTCP port for audio: <input type="text" value="5559"/> | | |
| Access name for stream 1: <input type="text" value="live1s1.sdp"/> | | |
| Access name for stream 2: <input type="text" value="live1s2.sdp"/> | | |
| Access name for stream 3: <input type="text" value="live1s3.sdp"/> | | |
| ✦ Multicast settings for stream 1 | | |
| ✦ Multicast settings for stream 2 | | |
| ✦ Multicast settings for stream 3 | | |
| <input type="button" value="Save"/> | | |

Authentication: Depending on your network security requirements, the Network Camera provides three types of security settings for streaming via RTSP protocol: disable, basic, and digest. If **basic** authentication is selected, the password is sent in plain text format, but there can be potential risks of it being intercepted. If **digest** authentication is selected, user credentials are encrypted using MD5 algorithm, thus providing better protection against unauthorized access. The availability of the RTSP streaming for the three authentication modes is listed below:

| | Quick Time player | VLC |
|---------|-------------------|-----|
| Disable | O | O |
| Basic | O | O |
| Digest | O | X |

Access name for stream 1 ~ 3: This Network camera supports multiple streams simultaneously. The access name is used to differentiate the streaming source.

If you want to use an **RTSP player** to access the Network Camera, you have to set the video mode to **H.264 or H.265** and use the following RTSP URL command to request transmission of the streaming data.

`rtsp://<ip address>:<rtsp port>/<access name for stream 1 to 3>`

For example, when the access name for **stream 1** is set to **live1s1.sdp**:

1. Launch an RTSP player.
2. Choose File > Open URL. A URL dialog box will pop up.
3. Type the above URL command in the text box.
4. The live video will be displayed in your player as shown below.

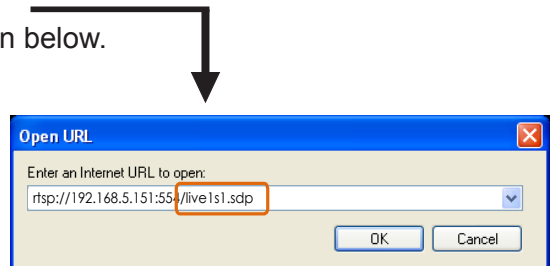

RTSP port /RTP port for video, audio/ RTCP port for video, audio

- RTSP (Real-Time Streaming Protocol) controls the delivery of streaming media. By default, the port number is set to 554.
- The RTP (Real-time Transport Protocol) is used to deliver video and audio data to the clients. By default, the RTP port for video is set to 5556.
- The RTCP (Real-time Transport Control Protocol) allows the Network Camera to transmit the data by monitoring the Internet traffic volume. By default, the RTCP port for video is set to 5557.

The ports can be changed to values between 1025 and 65535. The RTP port must be an even number and the RTCP port is the RTP port number plus one, and thus is always an odd number. When the RTP port changes, the RTCP port will change accordingly.

If the RTP ports are incorrectly assigned, the following warning message will be displayed:

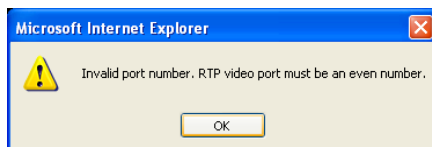

Multicast settings for streams: Click the items to display the detailed configuration information. Select the Always multicast option to enable multicast for video streams.

Multicast settings for stream 1
 Always multicast
 Multicast group address:
 Multicast video port:
 Multicast RTCP video port:
 Multicast metadata port:
 Multicast RTCP metadata port:
 Multicast audio port:
 Multicast RTCP audio port:
 Multicast TTL [1~255]:

Multicast settings for stream 2
 Always multicast
 Multicast group address:
 Multicast video port:
 Multicast RTCP video port:
 Multicast metadata port:
 Multicast RTCP metadata port:
 Multicast audio port:
 Multicast RTCP audio port:
 Multicast TTL [1~255]:

Multicast settings for stream 3

Unicast video transmission delivers a stream through point-to-point transmission; multicast, on the other hand, sends a stream to the multicast group address and allows multiple clients to acquire the stream at the same time by requesting a copy from the multicast group address. Therefore, enabling multicast can effectively save Internet bandwidth.

The ports can be changed to values between 1025 and 65535. The multicast RTP port must be an even number and the multicast RTCP port number is the multicast RTP port number plus one, and thus is always odd. When the multicast RTP port changes, the multicast RTCP port will change accordingly.

If the multicast RTP video ports are incorrectly assigned, the following warning message will be displayed:

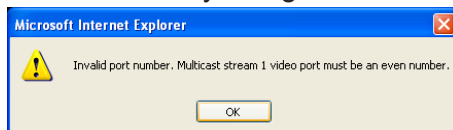

Multicast TTL [1~255]: The multicast TTL (Time To Live) is the value that tells the router the range a packet can be forwarded.

| Initial TTL | Scope |
|-------------|-----------------------------------|
| 0 | Restricted to the same host |
| 1 | Restricted to the same subnetwork |
| 32 | Restricted to the same site |
| 64 | Restricted to the same region |
| 128 | Restricted to the same continent |
| 255 | Unrestricted in scope |



IMPORTANT:

The Multicast metadata port is utilized by VIVOTEK VADP modules to transfer video analytics results, PTZ stream, textual data, and event messages between the camera and the client side running and observing the video analysis. If your client side computer is located outside the local network, you may need to open the associated TCP port on routers and firewall.

SIP

SIP is short for Session Initiation Protocol. If necessary, you can change the default port number, 5060, to one between 1025 and 65535.

Two way audio port:

The Network Camera supports two way audio communication so that operators can transmit and receive audio simultaneously. By using the Network Camera's built-in or external microphone and an external speaker, you can communicate with people around the Network Camera.

Note that as JPEG only transmits a series of JPEG images to the client, to enable the two-way audio function, make sure the video mode is set to H.264 on the Media > Video > Stream settings page and the media option is set to "Media > Video > Stream settings" on the Client Settings page. Please refer to Client Settings on page 46 and Stream settings on page 77.

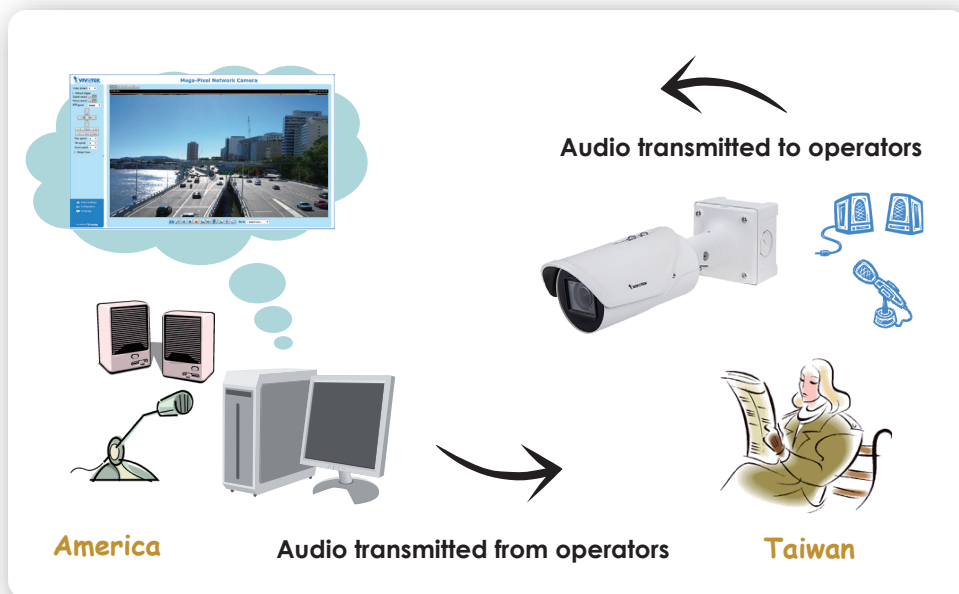

Network > DDNS

This section explains how to configure the dynamic domain name service for the Network Camera. DDNS is a service that allows your Network Camera, especially when assigned with a dynamic IP address, to have a fixed host and domain name.

Express link

Express Link is a free service provided by VIVOTEK server, which allows users to register a domain name for a network device. One URL can only be mapped to one MAC address. This service will examine if the host name is valid and automatically open a port on your router. If using DDNS, the user has to manually configure UPnP port forwarding. Express Link is more convenient and easier to set up.

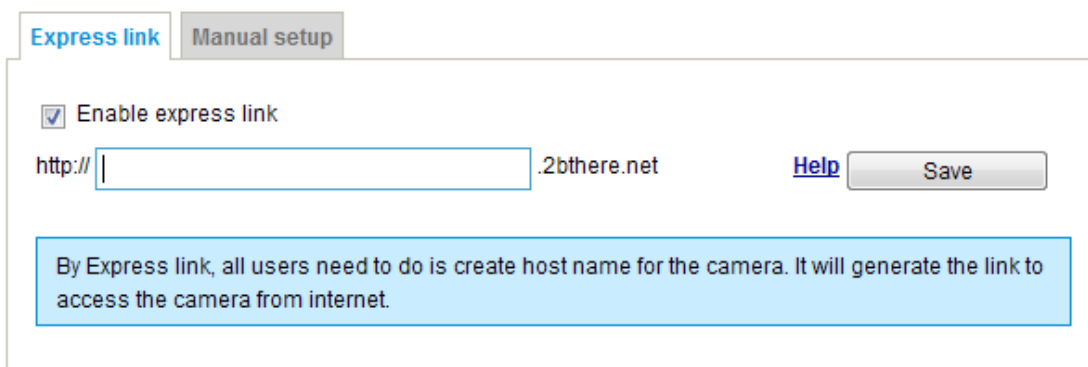

Express link Manual setup

Enable express link

http:// .2bthere.net [Help](#)

By Express link, all users need to do is create host name for the camera. It will generate the link to access the camera from internet.

Please follow the steps below to enable Express Link:

1. Make sure that your router supports UPnP port forwarding and it is activated.
2. Check **Enable express link**.
3. Enter a host name for the network device and click **Save**. If the host name has been used by another device, a warning message will show up. If the host name is valid, it will display a message as shown below.



Express link Manual setup

Enable express link

http:// 0002D1123456 .2bthere.net [Help](#)

The camera can now be accessed at <http://0002D1123456.2bthere.net>

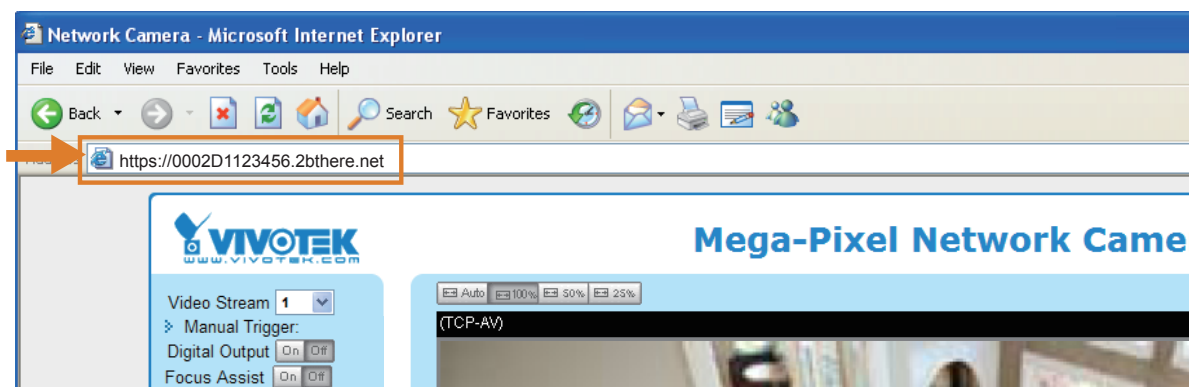

Manual setup

DDNS: Dynamic domain name service

DDNS: Dynamic domain name service

Enable DDNS:

Provider:

Host name:

User name:

Password:

Enable DDNS: Select this option to enable the DDNS setting.

Provider: Select a DDNS provider from the provider drop-down list. VIVOTEK offers **Safe100.net**, a free dynamic domain name service, to VIVOTEK customers. It is recommended that you register **Safe100.net** to access VIVOTEK's Network Cameras from the Internet. Additionally, we offer other DDNS providers, such as Dyn dns.org(Dynamic), Dyn dns.org(Custom), TZO.com, DHS.org, CustomSafe100, dyn-interfree.it. Note that before utilizing this function, please apply for a dynamic domain account first.

■ Safe100.net

1. In the DDNS column, select **Safe100.net** from the drop-down list. Click **I accept** after reviewing the terms of the Service Agreement.
2. In the Register column, fill in the Host name (xxxx.safe100.net), Email, Key, and Confirm Key, and click **Register**. After a host name has been successfully created, a success message will be displayed in the DDNS Registration Result column.

Register

Host name:

Email:

Key:

Confirm key:

To apply for a domain name for the camera, or to modify the previously registered information, fill in the following fields and then click "Register".

DDNS Registration Result

Upon successful registration, you can click **copy** to automatically upload relevant information to the DDNS form or you can manually fill it in. Then, click "Save" to save new settings.

3. Click **Copy** and all the registered information will automatically be uploaded to the corresponding fields in the DDNS column at the top of the page as seen in the picture.

DDNS: Dynamic domain name service

Enable DDNS:

Provider: [*.safe100.net]

Host name:

Email:

Key:

Register

Host name:

Email:

Key:

Confirm key:

To apply for a domain name for the camera, or to modify the previously registered information, fill in the following fields and then click "Register".

DDNS Registration Result:

[Register] Successfully Your account information has been mailed to registered e-mail address

Upon successful registration, you can click [copy](#) to automatically upload relevant information to the DDNS form or you can manually fill it in. Then, click "Save" to save new settings.

4. Select Enable DDNS and click **Save** to enable the setting.

■ CustomSafe100

VIVOTEK offers documents to establish a CustomSafe100 DDNS server for distributors and system integrators. You can use CustomSafe100 to register a dynamic domain name if your distributor or system integrators offer such services.

1. In the DDNS column, select CustomSafe100 from the drop-down list.
2. In the Register column, fill in the Host name, Email, Key, and Confirm Key; then click **Register**. After a host name has been successfully created, you will see a success message in the DDNS Registration Result column.
3. Click **Copy** and all for the registered information will be uploaded to the corresponding fields in the DDNS column.
4. Select Enable DDNS and click **Save** to enable the setting.

Forget key: Click this button if you have forgotten the key to Safe100.net or CustomSafe100. Your account information will be sent to your email address.

Refer to the following links to apply for a dynamic domain account when selecting other DDNS providers:

- [Dyndns.org\(Dynamic\) / Dyndns.org\(Custom\)](http://www.dyndns.com/): visit <http://www.dyndns.com/>

Network > QoS (Quality of Service)

Quality of Service refers to a resource reservation control mechanism, which guarantees a certain quality to different services on the network. Quality of service guarantees are important if the network capacity is insufficient, especially for real-time streaming multimedia applications. Quality can be defined as, for instance, a maintained level of bit rate, low latency, no packet dropping, etc.

The following are the main benefits of a QoS-aware network:

- The ability to prioritize traffic and guarantee a certain level of performance to the data flow.
- The ability to control the amount of bandwidth each application may use, and thus provide higher reliability and stability on the network.

Requirements for QoS

To utilize QoS in a network environment, the following requirements must be met:

- All network switches and routers in the network must include support for QoS.
- The network video devices used in the network must be QoS-enabled.

QoS models

CoS (the VLAN 802.1p model)

IEEE802.1p defines a QoS model at OSI Layer 2 (Data Link Layer), which is called CoS, Class of Service. It adds a 3-bit value to the VLAN MAC header, which indicates the frame priority level from 0 (lowest) to 7 (highest). The priority is set up on the network switches, which then use different queuing disciplines to forward the packets.

Below is the setting column for CoS. Enter the **VLAN ID** of your switch (0~4095) and choose the priority for each application (0~7).

CoS

Enable CoS

VLAN ID:

Live video: ▼

Live audio: ▼

Event/Alarm: ▼

Management: ▼

If you assign Video the highest level, the switch will handle video packets first.



NOTE:

- ▶ A VLAN Switch (802.1p) is required. Web browsing may fail if the CoS setting is incorrect.
- ▶ The Class of Service technologies do not guarantee a level of service in terms of bandwidth and delivery time; they offer a "best-effort." Users can think of CoS as "coarsely-grained" traffic control and QoS as "finely-grained" traffic control.
- ▶ Although CoS is simple to manage, it lacks scalability and does not offer end-to-end guarantees since it is based on L2 protocol.

QoS/DSCP (the DiffServ model)

DSCP-ECN defines QoS at Layer 3 (Network Layer). The Differentiated Services (DiffServ) model is based on packet marking and router queuing disciplines. The marking is done by adding a field to the IP header, called the DSCP (Differentiated Services Codepoint). This is a 6-bit field that provides 64 different class IDs. It gives an indication of how a given packet is to be forwarded, known as the Per Hop Behavior (PHB). The PHB describes a particular service level in terms of bandwidth, queueing theory, and dropping (discarding the packet) decisions. Routers at each network node classify packets according to their DSCP value and give them a particular forwarding treatment; for example, how much bandwidth to reserve for it.

Below are the setting options of DSCP (DiffServ Codepoint). Specify the DSCP value for each application (0~63).

QoS/DSCP

Enable QoS/DSCP

Live video:

Live audio:

Event/Alarm:

Management:

Note that different vendors of network devices might have different methodologies and unique implementations. Shown below is a sample corresponding information from a Cisco switch. You should enter a DSCP tag value according to the information provided by the network devices.

| Ingress DSCP | Output Queue | Ingress DSCP | Output Queue | Ingress DSCP | Output Queue | Ingress DSCP | Output Queue |
|--------------|--------------|--------------|--------------|--------------|--------------|--------------|--------------|
| 0(BE) | 1 | 16(CS2) | 2 | 32(CS4) | 3 | 48(CS6) | 3 |
| 1 | 1 | 17 | 2 | 33 | 3 | 49 | 3 |
| 2 | 1 | 18(AF21) | 2 | 34(AF41) | 3 | 50 | 3 |
| 3 | 1 | 19 | 2 | 35 | 3 | 51 | 3 |
| 4 | 1 | 20(AF22) | 2 | 36(AF42) | 3 | 52 | 3 |
| 5 | 1 | 21 | 2 | 37 | 3 | 53 | 3 |
| 6 | 1 | 22(AF23) | 2 | 38(AF43) | 3 | 54 | 3 |
| 7 | 1 | 23 | 2 | 39 | 3 | 55 | 3 |
| 8(CS1) | 1 | 24(CS3) | 3 | 40(CS5) | 4 | 56(CS7) | 3 |
| 9 | 1 | 25 | 3 | 41 | 4 | 57 | 3 |
| 10(AF11) | 1 | 26(AF31) | 3 | 42 | 4 | 58 | 3 |
| 11 | 1 | 27 | 3 | 43 | 4 | 59 | 3 |
| 12(AF12) | 1 | 28(AF32) | 3 | 44 | 4 | 60 | 3 |
| 13 | 1 | 29 | 3 | 45 | 4 | 61 | 3 |
| 14(AF13) | 1 | 30(AF33) | 3 | 46(EF) | 4 | 62 | 3 |
| 15 | 1 | 31 | 3 | 47 | 4 | 63 | 3 |

Queue 1 has the lowest priority, queue 4 has the highest priority.

QoS/DSCP

Enable QoS/DSCP

Live video:

Live audio:

Event/Alarm:

Management:

QoS Baseline/Technical Marketing Classification and Marking Recommendations

| Application | Layer3 Classification | | | Layer 2 CoS/MPLS EXP | |
|---------------------------------------|-----------------------|----------|-------|----------------------|-------|
| | IPP | PHB | DSCP | | |
| IP Routing | 6 | CS6 | 48 | 6 | |
| Voice | 5 | EF | 46 | 5 | |
| Interactive Video | 4 | AF41 | 34 | 4 | QoS B |
| Streaming-Video | 4 | CS4 | 32 | 4 | |
| Locally-defined Mission-Critical Data | 3 | - | 25 | 3 | |
| Call-signaling | 3 | AF31/CS3 | 26/24 | 3 | |
| Transactional Data | 2 | AF21 | 18 | 2 | |
| Network Management | 2 | CS2 | 16 | 2 | |
| Bulk Data | 1 | AF11 | 10 | 1 | |

Network > SNMP (Simple Network Management Protocol)

This section explains how to use the SNMP on the network camera. The Simple Network Management Protocol is an application layer protocol that facilitates the exchange of management information between network devices. It helps network administrators to remotely manage network devices and find, solve network problems with ease.

- The SNMP consists of the following three key components:
 1. Manager: Network-management station (NMS), a server which executes applications that monitor and control managed devices.
 2. Agent: A network-management software module on a managed device which transfers the status of managed devices to the NMS.
 3. Managed device: A network node on a managed network. For example: routers, switches, bridges, hubs, computer hosts, printers, IP telephones, network cameras, web server, and database.

Before configuring SNMP settings on the this page, please enable your NMS first.

SNMP Configuration

Enable SNMPv1, SNMPv2c

Select this option and enter the names of Read/Write community and Read Only community according to your NMS settings.

Enable SNMPv1, SNMPv2c

SNMPv1, SNMPv2c Settings

Read/Write community:

Read only community:

Enable SNMPv3

This option contains cryptographic security, a higher security level, which allows you to set the Authentication password and the Encryption password.

- Security name: According to your NMS settings, choose Read/Write or Read Only and enter the community name.
- Authentication type: Select MD5 or SHA as the authentication method.
- Authentication password: Enter the password for authentication (at least 8 characters).
- Encryption password: Enter a password for encryption (at least 8 characters).

Enable SNMPv3

SNMPv3 Settings

Read/Write Security name:

Authentication Type:

Authentication Password:

Encryption Password:

Read only Security name:

Authentication Type:

Authentication Password:

Encryption Password:

Network > FTP

The newer firmware disabled the FTP port for security concerns. You can manually enable the FTP server service to enable the FTP function. You can disable the FTP server function when it is not in use.

FTP port: The FTP server allows the user to save recorded video clips. You can utilize VIVOTEK's Shepherd utility to upgrade the firmware via FTP server. By default, the FTP port is set to 21. It can also be assigned to another port number between 1025 and 65535.



Tips:

You can FTP the camera's IP address to download videos recorded in the SD card, or use the "<http://ip/cgi-bin/admin/lscrtl.cgi?cmd=search>" command to examine the recorded files on your SD card.

Bonjour

To access the camera from a Mac computer, go to Safari, click on Bonjour and select the camera from a drop-down list.

You can go to Safari > Preferences to enter your user name and password, and provide the root password the first time you access the camera. The camera main page will open in your browser.

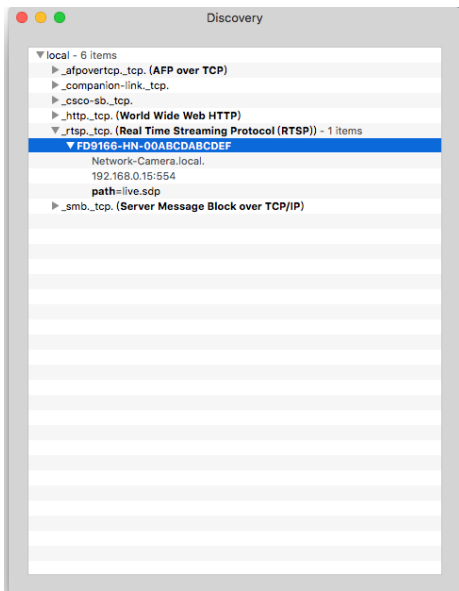

Some later iOSes may come without the Bonjour option. Install the Discovery utility instead.

Find the Discovery (formerly Bonjour Browser) from the Mac App Store.

Discovery is a utility that displays all the Bonjour services on your local network or on Wide-Area Bonjour domains. The utility is previously called Bonjour Browser, it is now distributed on the Mac App Store.

Discovery requires macOS 10.12 or higher. For older versions of Mac OS you can download the old version of Bonjour Browser.

Bonjour Browser (obsolete)

<http://www.tildesoft.com/files/BonjourBrowser.dmg> - Version 1.5.6

Discovery for iOS

<https://itunes.apple.com/us/app/discovery-dns-sd-browser/id305441017?mt=8>

Security > User accounts

This section explains how to enable password protection and create multiple accounts.

Account management

Security > User accounts

The screenshot shows the 'Account management' tab selected. A dropdown menu is set to '--New user--'. The 'User name' field contains 'front_guard'. The 'User password' field is masked with dots, and a strength indicator shows 'Medium'. The 'Confirm user password' field is also masked with dots. The 'Privilege' dropdown is set to 'Operator'. At the bottom, there are 'Delete', 'Add', and 'Update' buttons.

The administrator account name is “root”, which is permanent and can not be deleted. If you want to add more accounts in the Account management window, please apply the password for the “root” account first.

The administrator can create up to 20 user accounts.

To create a new user,

1. Click to unfold the pull-down menu. Select **New user**.
2. Enter the new user’s name and password. Type the password identically in both text boxes.
Some, but not all special ASCII characters are supported: !, \$, %, -, ., @, ^, _, and ~.
You can use them in the password combination.

The strength of your password combination is shown on the right, use the combination of alphabetic, numeric, upper case, and lower case characters until the password strength is good enough.

3. Select the privilege level for the new user account. Click **Add** to enable the setting.
The privilege levels are listed below:

| | |
|---------------|---|
| Administrator | Full control |
| Operator | Control DO, white-light illuminator, snapshot, and PTZ; unable to enter the camera Configuration page. |
| Viewer | Control DO, white-light illuminator, view, listen, PTZ, and talk through the camera interface. |

Access rights are sorted by user privilege (Administrator, Operator, and Viewer). Only administrators can access the Configuration page. Although operators cannot access the Configuration page, they can use the URL Commands to get and set the value of parameters. For more information, please refer to URL Commands of the Network Camera on page 161. Viewers can only access the main page for live viewing.

Here you also can change a user’s access rights or delete user accounts.

1. Select an existing account to modify.
2. Make necessary changes and click **Update** or **Delete** to enable the setting.

Privilege management

| Account management | Privilege management | |
|--|--|---|
| <input type="checkbox"/> Allow anonymous viewing | | |
| Operator: | <input checked="" type="checkbox"/> Digital output | <input checked="" type="checkbox"/> PTZ control |
| Viewer: | <input type="checkbox"/> Digital output | <input checked="" type="checkbox"/> PTZ control |
| <input type="button" value="Save"/> | | |

Digital Output & PTZ control: You can modify the management privilege as operators or viewers. Select or de-select the checkboxes, and then click **Save** to enable the settings. If you give Viewers the privilege, Operators will also have the ability to control the Network Camera through the main page. (Please refer to Configuration on page 46).

Allow anonymous viewing: If you select this item, any client can access the live stream without entering a User ID and Password.

Security > HTTPS (Hypertext Transfer Protocol over SSL)

This section explains how to enable authentication and encrypted communication over SSL (Secure Socket Layer). It helps protect streaming data transmission over the Internet on higher security level.

Create and Install Certificate Method

Before using HTTPS for communication with the Network Camera, a **Certificate** must be created first. There are three ways to create and install a certificate:

Create self-signed certificate

1. Select this option from a pull-down menu.
2. In the first column, select **Enable HTTPS secure connection**, then select a connection option: "HTTP & HTTPS" or "HTTPS only".
3. Click **Create certificate** to generate a certificate.

The screenshot shows the 'HTTPS' configuration page. The 'Enable HTTPS secure connection' checkbox is checked. Under 'Mode', 'HTTP & HTTPS' is selected. Under 'Certificate', the 'method' dropdown is set to 'Create self-signed certificate'. The 'Certificate information' section is expanded, showing fields for Country (TW), State or province (Asia), Locality (Asia), Organization (VIVOTEK.Inc), Organization unit (VIVOTEK.Inc), Common name (www.vivotek.com), and Validity (3650 days). A blue progress bar and a message box 'Please wait while the certificate is being generated...' are overlaid on the form. The 'Create certificate' button at the bottom right is highlighted with a yellow box.

4. The Certificate Information will automatically be displayed as shown below. You can click **Certificate properties** to view detailed information about the certificate.

The screenshot shows the 'Certificate information' panel. The status is 'Active'. The method is 'Create self-signed certificate'. The fields for Country (TW), State or province (Asia), Locality (Asia), Organization (VIVOTEK.Inc), Organization unit (VIVOTEK.Inc), and Common name (www.vivotek.com) are displayed. At the bottom, there is a link for 'Certificate properties' and a 'Remove certificate' button.

5. Click **Save** to preserve your configuration, and your current session with the camera will change to the encrypted connection.
6. If your web session does not automatically change to an encrypted HTTPS session, click **Home** to return to the main page. Change the URL address from “<http://>” to “<https://>” in the address bar and press **Enter** on your keyboard. Some Security Alert dialogs will pop up. Click **OK** or **Yes** to enable HTTPS.

https://

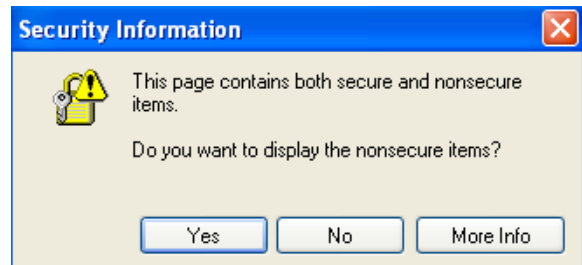
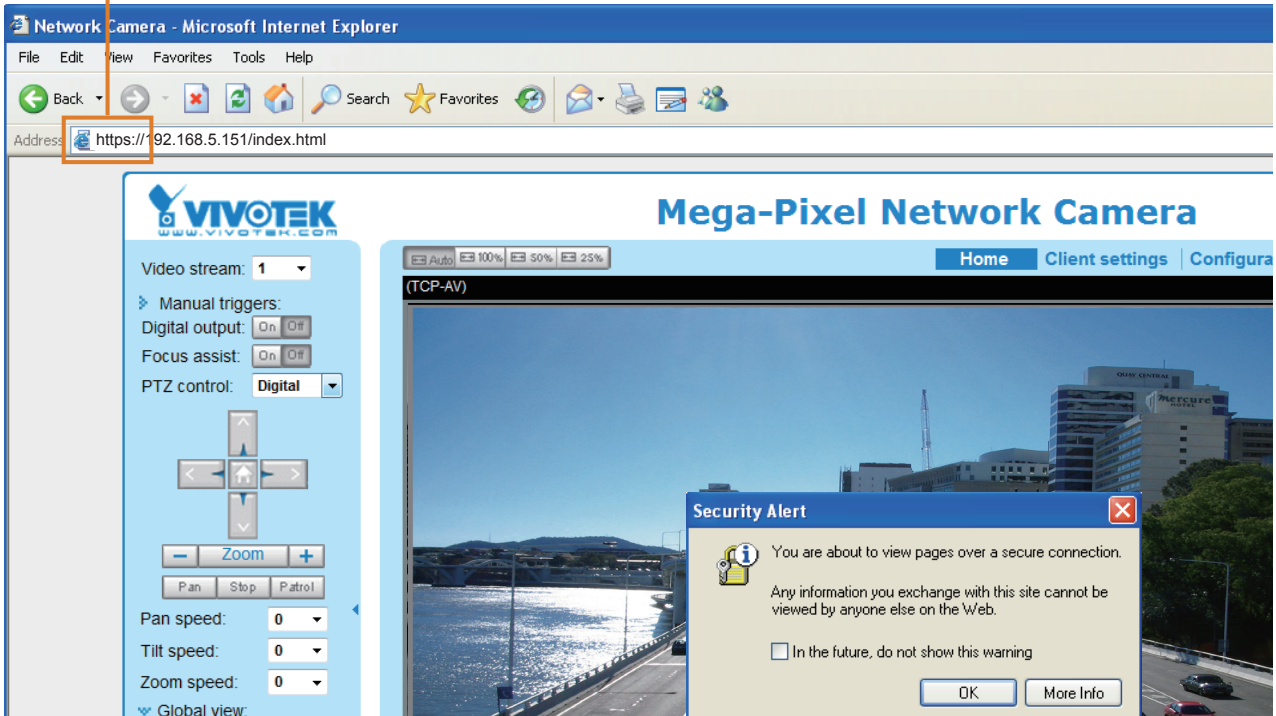

Create certificate request and install

1. Select the option from the **Method** pull-down menu.
2. Click **Create certificate** to proceed.
3. The following information will show up in a pop-up window after clicking **Create**. Then click **Save** to generate the certificate request.

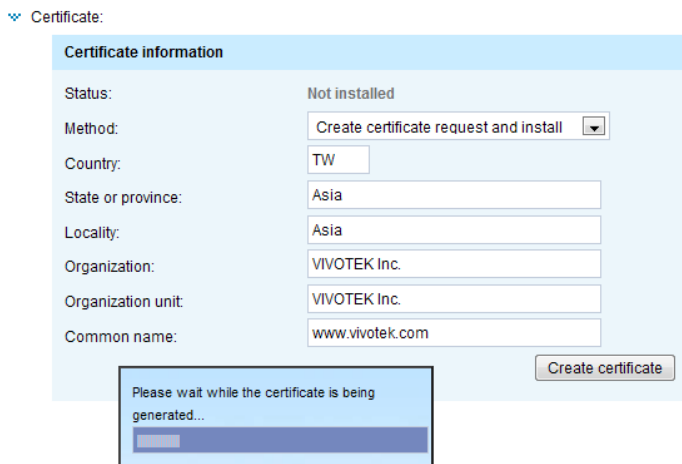

4. The Certificate request window will prompt.

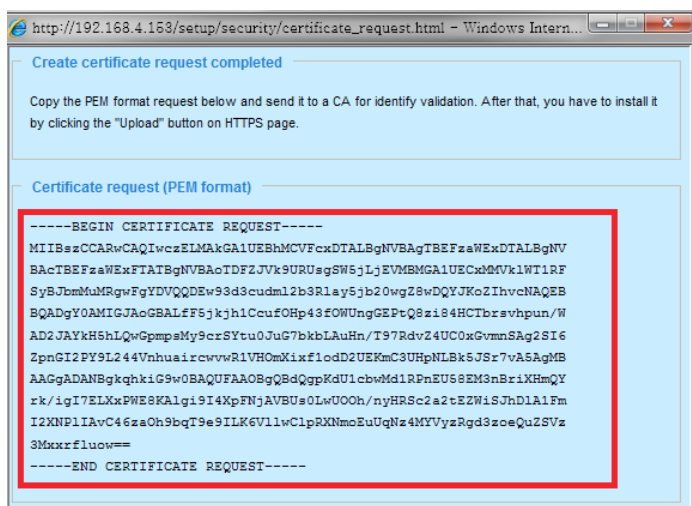

If you see the following Information bar, click **OK** and click on the Information bar at the top of the page to allow pop-ups.

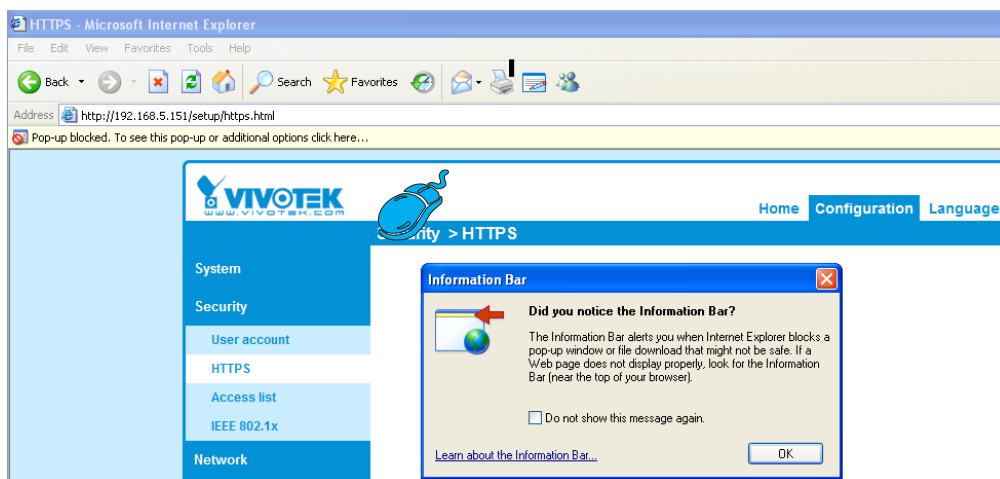

- Open a new edit, paste the certificate contents, and press ENTER at the end of the contents to add an empty line.

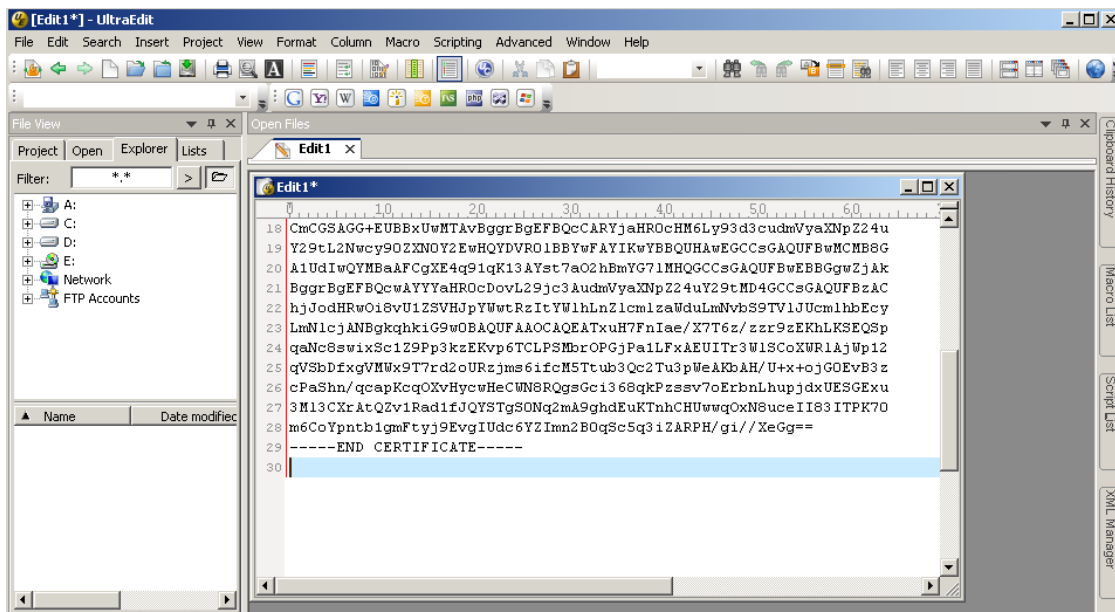

- Convert file format from DOS to UNIX. Open **File** menu > **Conversions** > **DOS to Unix**.

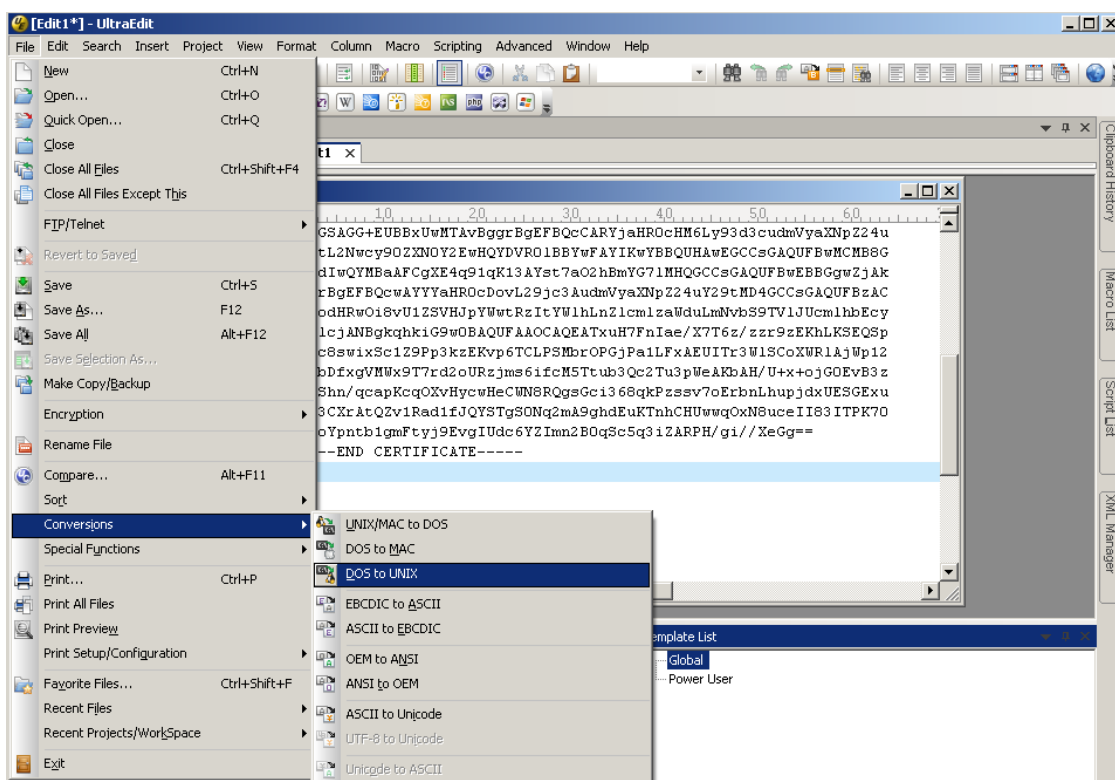

9. Save the edit using the “.crt” extension, using a file name like “CAcert.crt.”

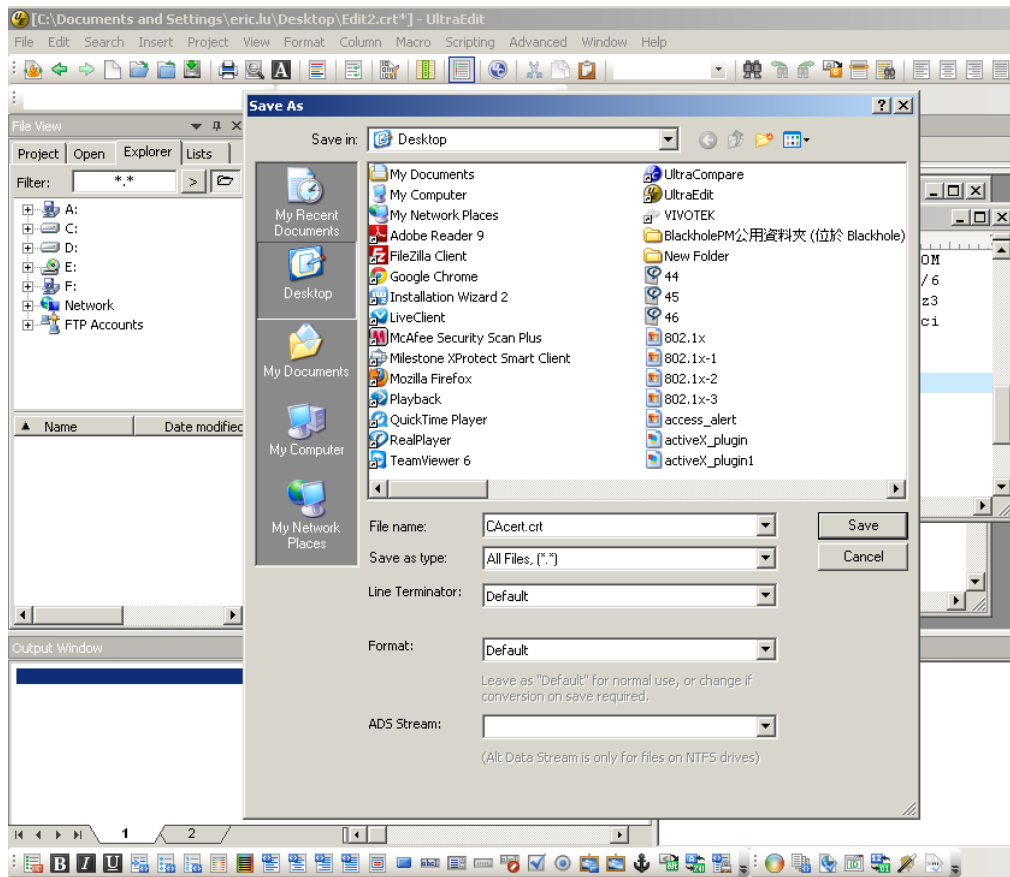

10. Return to the original firmware session, use the **Browse** button to locate the crt certificate file, and click **Upload** to enable the certification.

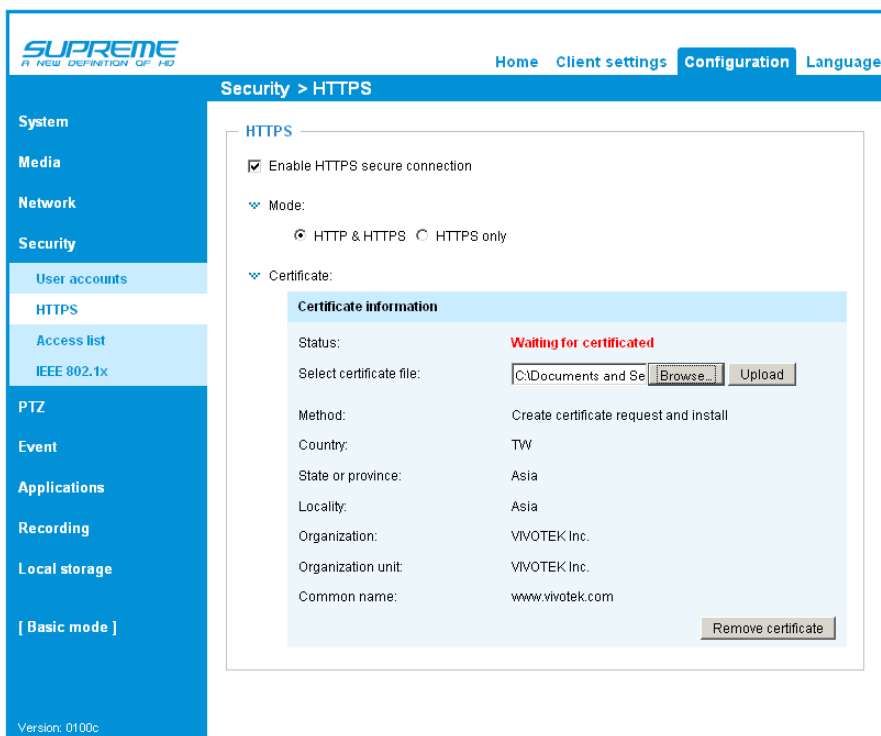

11. When the certificate file is successfully loaded, its status will be stated as **Active**. Note that a certificate must have been created and installed before you can click on the **“Save”** button for the configuration to take effect.

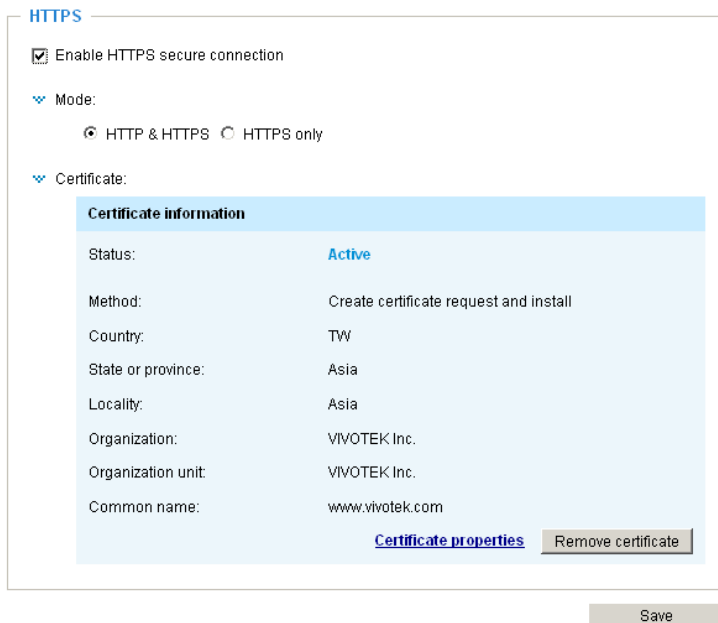

12. To begin an encrypted HTTPS session, click **Home** to return to the main page. Change the URL address from **“http://”** to **“https://”** in the address bar and press **Enter** on your keyboard. Some Security Alert dialogs will pop up. Click **OK** or **Yes** to enable HTTPS.

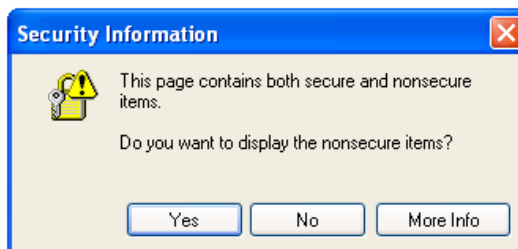
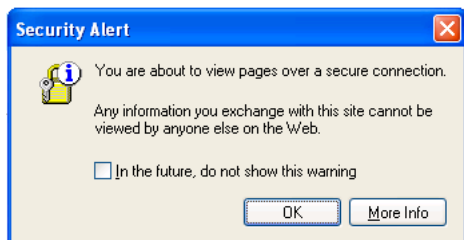

Security > Access List

This section explains how to control access permission by verifying the client PC's IP address.

General Settings

General settings

Maximum number of concurrent streaming:

Maximum number of concurrent streaming connection(s) limited to: Simultaneous live viewing for 1~10 clients (including stream 1 to stream 3). The default value is 10. If you modify the value and click **Save**, all current connections will be disconnected and automatically attempt to re-link (IE Explorer or Quick Time Player).

View Information: Click this button to display the connection status window showing a list of the current connections. For example:

| | IP address | Elapsed time | User ID |
|--------------------------|---------------|--------------|---------|
| <input type="checkbox"/> | 172.16.2.53 | 00:00:05 | |
| <input type="checkbox"/> | 192.168.4.104 | 01:49:35 | |

Note that only consoles that are currently displaying live streaming will be listed in the View Information list.

- IP address: Current connections to the Network Camera.
- Elapsed time: How much time the client has been at the webpage.
- User ID: If the administrator has set a password for the webpage, the clients have to enter a user name and password to access the live video. The user name will be displayed in the User ID column. If the administrator allows clients to link to the webpage without a user name and password, the User ID column will be empty.

There are some situations that allow clients access to the live video without a user name and password:

1. The administrator does not set up a root password. For more information about how to set up a root password and manage user accounts, please refer to Security > User account on page 107.
2. The administrator has set up a root password, but set **RTSP Authentication** to "disable". For more information about **RTSP Authentication**, please refer to RTSP Streaming on page 95.
3. The administrator has set up a root password, but allows anonymous viewing. For more information about **Allow Anonymous Viewing**, please refer to page 107.

- **Refresh:** Click this button to refresh all current connections.
- **Add to deny list:** You can select entries from the Connection Status list and add them to the Deny List to deny access. Please note that those checked connections will only be disconnected temporarily and will automatically try to re-link again (IE Explore or Quick Time Player). If you want to enable the denied list, please check **Enable access list filtering** and click **Save** in the first column.
- **Disconnect:** If you want to break off the current connections, please select them and click this button. Please note that those checked connections will only be disconnected temporarily and will automatically try to re-link again (IE Explore or Quick Time Player).

Filter

Enable access list filtering: Check this item and click **Save** if you want to enable the access list filtering function.

Filter type: Select **Allow** or **Deny** as the filter type. If you choose **Allow Type**, only those clients whose IP addresses are on the Access List below can access the Network Camera, and the others cannot. On the contrary, if you choose **Deny Type**, those clients whose IP addresses are on the Access List below will not be allowed to access the Network Camera, and the others can.

The screenshot shows a web interface for configuring filters. At the top, there is a title 'Filter' and a checkbox labeled 'Enable access list filtering'. Below this, the 'Filter type' is set to 'Deny' using radio buttons, with 'Allow' also available. The interface is divided into two main sections: 'IPv4 access list' and 'IPv6 access list'. Each section contains a large empty text area for entering rules, and below each text area are two buttons: 'Add' and 'Delete'.

Then you can **Add** a rule to the following Access List. Please note that the IPv6 access list column will not be displayed unless you enable IPv6 on the Network page. For more information about **IPv6 Settings**, please refer to Network > General settings on page 87 for detailed information.

There are three types of rules:

Single: This rule allows the user to add an IP address to the Allowed/Denied list.
For example:

Network: This rule allows the user to assign a network address and corresponding subnet mask to the Allow/Deny List. The address and network mask are written in CIDR format.
For example:

IP address range 192.168.2.x will be blocked.

If IPv6 filter is preferred, you will be prompted by the following window. Enter the IPv6 address and the two-digit prefix length to specify the range of IP addresses in your configuration.

Range: This rule allows the user to assign a range of IP addresses to the Allow/Deny List.
Note: This rule only applies to IPv4 addresses.
For example:

Administrator IP address

Always allow the IP address to access this device: You can check this item and add the Administrator's IP address in this field to make sure the Administrator can always connect to the device.

Security > IEEE 802.1X

Enable this function if your network environment uses IEEE 802.1x, which is a port-based network access control. The network devices, intermediary switch/access point/hub, and RADIUS server must support and enable 802.1x settings.

The 802.1x standard is designed to enhance the security of local area networks, which provides authentication to network devices (clients) attached to a network port (wired or wireless). If all certificates between client and server are verified, a point-to-point connection will be enabled; if authentication fails, access on that port will be prohibited. 802.1x utilizes an existing protocol, the Extensible Authentication Protocol (EAP), to facilitate communication.

- The components of a protected network with 802.1x authentication:



1. Supplicant: A client end user (camera), which requests authentication.
2. Authenticator (an access point or a switch): A “go between” which restricts unauthorized end users from communicating with the authentication server.
3. Authentication server (usually a RADIUS server): Checks the client certificate and decides whether to accept the end user’s access request.

- VIVOTEK Network Cameras support two types of EAP methods to perform authentication: **EAP-PEAP** and **EAP-TLS**.

Please follow the steps below to enable 802.1x settings:

1. Before connecting the Network Camera to the protected network with 802.1x, please apply a digital certificate from a Certificate Authority (i.e., your network administrator) which can be validated by a RADIUS server.
2. Connect the Network Camera to a PC or notebook outside of the protected LAN. Open the configuration page of the Network Camera as shown below. Select **EAP-PEAP** or **EAP-TLS** as the EAP method. In the following blanks, enter your ID and password issued by the CA, then upload related certificate(s).

IEEE 802.1x

Enable IEEE 802.1x

EAP method: EAP-PEAP ▼

Identity:

Password:

CA certificate:

Status: no file

IEEE 802.1x

Enable 802.1x

EAP method: EAP-TLS

Identity:

Private key password:

CA certificate:

Status: no file

client certificate:

Status: no file

Client private key:

Status: no file

3. When all settings are complete, move the Network Camera to the protected LAN by connecting it to an 802.1x enabled switch. The devices will then start the authentication automatically.

NOTE:

- ▶ *The authentication process for 802.1x:*
- 1. *The Certificate Authority (CA) provides the required signed certificates to the Network Camera (the supplicant) and the RADIUS Server (the authentication server).*
- 2. *A Network Camera requests access to the protected LAN using 802.1X via a switch (the authenticator). The client offers its identity and client certificate, which is then forwarded by the switch to the RADIUS Server, which uses an algorithm to authenticate the Network Camera and returns an acceptance or rejection back to the switch.*
- 3. *The switch also forwards the RADIUS Server's certificate to the Network Camera.*
- 4. *Assuming all certificates are validated, the switch then changes the Network Camera's state to authorized and is allowed access to the protected network via a pre-configured port.*

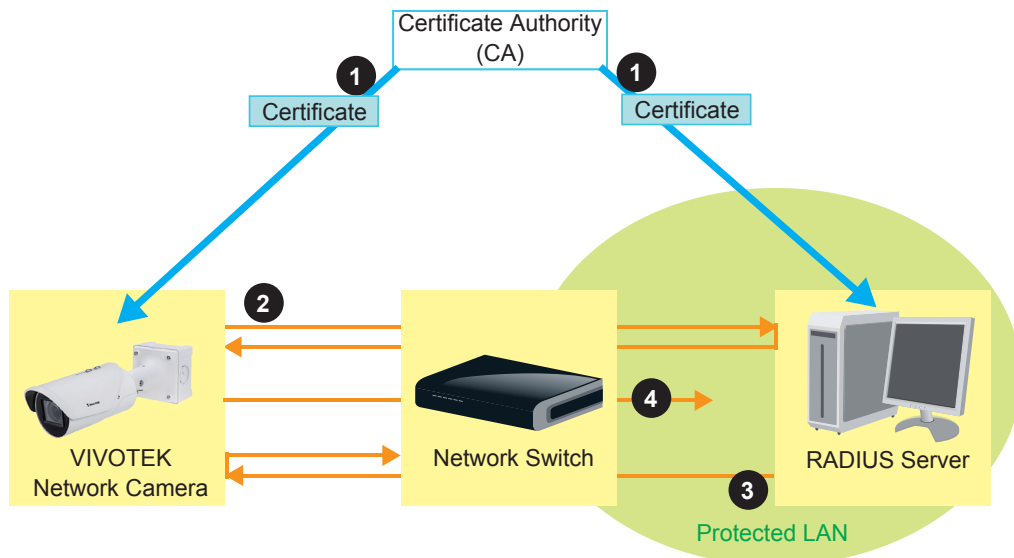

Security > Miscellaneous

The embedded TrendMicro utility provides the protection against Cross-Site Request Forgery. Cross-site request forgery is also known as one-click attack or session riding and is abbreviated as CSRF. CSRF is a type of malicious exploit of a website, in this case, the camera. Unauthorized commands are transmitted from a user that the web application trusts, using the mechanism of forging a trusted user's own request with a request containing his own cookies, etc. Different ways can be used for a malicious website to transmit such commands. They can be specially-crafted image tags, hidden forms, and JavaScript XMLHttpRequests. The malicious attack can occur without users' interaction or even knowing it.

Miscellaneous

Enable Cross-Site Request Forgery(CSRF) protection.

We strongly recommend not to disable this protection. Disabling this feature will expose your camera to risks.

Save

PTZ > PTZ settings

This section explains how to control the Network Camera’s Pan/Tilt/Zoom operation.

Digital: Control the e-PTZ operation. Within a field of view, it allows users to quickly move the focus to a target area for close-up viewing without physically moving the camera.

Digital PTZ Operation (E-PTZ Operation)

The e-PTZ control settings section will be displayed as shown below:

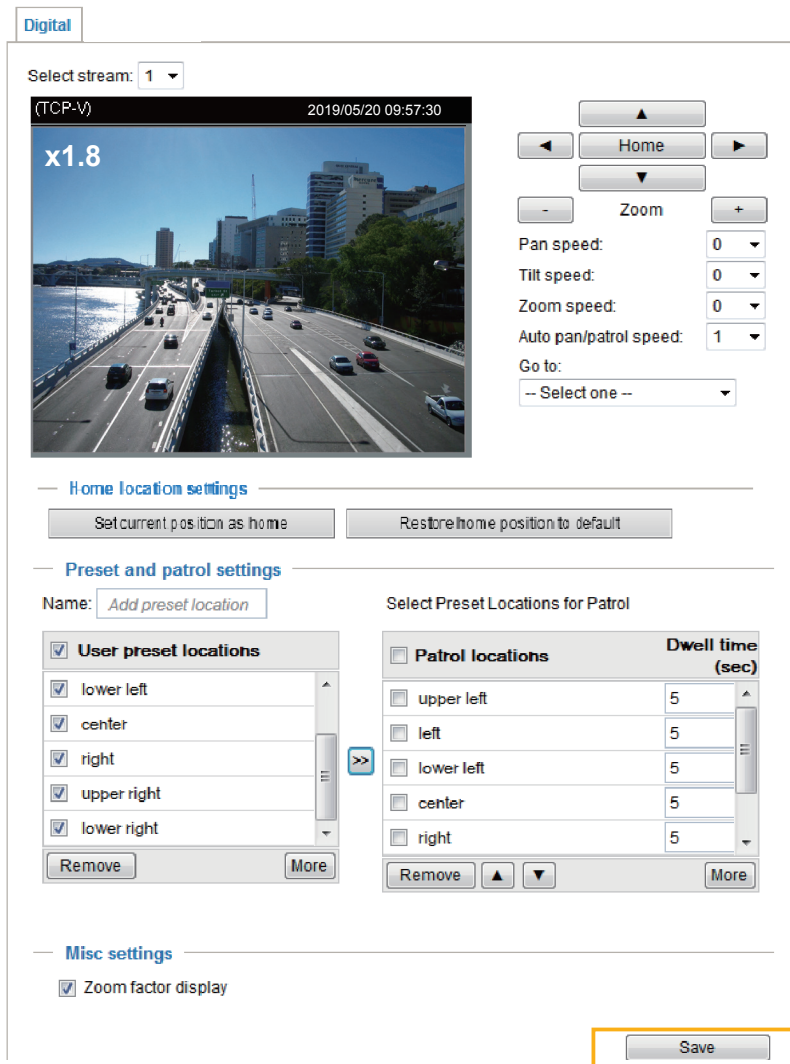

For e-PTZ related details, please refer to page 124.

Auto pan/patrol speed: Select the speed from 1~5 (slow/fast) to set up the Auto pan/patrol speed control.

Zoom factor display

If you check this item, the zoom indicator will be displayed on the home page when you zoom in/out the live viewing window as shown on the next page.

When completed with the e-PTZ settings, click **Save** to enable the settings on this page.

Home page in the E-PTZ Mode



- The e-Preset Positions will also be displayed on the home page. Select one from the drop-down list, and the Network Camera will move to the selected position.
- If you have set up different preset positions for different streams, you can select one of the video streams to display its separate preset positions.

Global View

In addition to using the e-PTZ control panel, you can also use the mouse to drag or resize the floating frame to pan/tilt/zoom the viewing region. The live view window will also move to the viewing region accordingly.

Moving Instantly

If you check this item, the live view window will switch to the new viewing region instantly after you move the floating frame. If not selected, the process of moving from one position to another will be shown.

Click on Image

The e-PTZ function also supports “Click on Image“. When you click on any point of the Global View Window or Live View Window, the viewing region will also move to that point.

Note that the “Click on Image” function only applies when you have configured a smaller “Region of Interest” out of the maximum output frame! e.g., an 800 x 600 region from out of the camera’s maximum frame size.

Patrol button: Click this button, then the Network Camera will patrol among the selected preset positions continuously.

Patrol settings

You can select some preset positions for the Network Camera to patrol. Please follow the steps below to set up a patrol schedule:

1. Select the preset locations on the list, and click **>>**.
2. The selected preset locations will be displayed on the **Patrol locations** list.
3. Set the **Dwelling time** for the preset location during an auto patrol.
4. If you want to delete a preset location from the Patrol locations list, select it and click **Remove**.
5. Select a location and click **▲ ▼** to rearrange the patrol order.
6. Select patrol locations you want to save in the list and click **Save** to enable the patrol settings.
7. To implement the patrol schedule, please go to homepage and click on the **Patrol** button.

Digital

Select stream: 2 ▼

(TCP-V)
2019/3/20 09:57:30

▲

▶

Home

▼

-

Zoom

+

Pan speed: 0 ▼

Tilt speed: 0 ▼

Zoom speed: 0 ▼

Auto pan/patrol speed: 1 ▼

Go to: -- Select one -- ▼

Home location settings

Set current position as home

Restore home position to default

Preset and patrol settings

Name: Add preset location

User preset locations

- upper left
- left
- lower left
- center
- right

Remove
More

Select Preset Locations for Patrol

Patrol locations

- upper left
- left
- lower left
- center
- right

Remove

▲
▼

More

Dwell time (sec)

-
-
-
-
-

Misc settings

Zoom factor display

Save

124 - User's Manual

**NOTE:**

- The Preset Positions will also be displayed on the Home page. Select one from the Go to menu, and the Network Camera will move to the selected preset position.
 - Click Patrol: The Network Camera will patrol along the selected positions repeatedly.
-

Event > Event settings

This section explains how to configure the Network Camera to respond to particular situations (event). A typical application is that when a motion is detected, the Network Camera sends buffered images to an FTP server or e-mail address as notifications. Click on **Help**, there is an illustration shown in the pop-up window explaining that an event can be triggered by many sources, such as motion detection or external digital input devices. When an event is triggered, you can specify what type of action that will be performed. You can configure the Network Camera to send snapshots or videos to your email address or FTP site.

Event

| Name | Status | Sun | Mon | Tue | Wed | Thu | Fri | Sat | Time | Trigger |
|------|--------|-----|-----|-----|-----|-----|-----|-----|------|---------|
|------|--------|-----|-----|-----|-----|-----|-----|-----|------|---------|

[Help](#)

close or Esc Key

Event Trigger → **Action (What to do)**

Ex.
Motion detection, Periodically,
Digital input, System boot

Media (What to send)

Ex.
Snapshot, Video Clip, System log

Server (Where to send)

Ex.
Email, FTP, HTTP Server,
Network storage

Event

To configure an event with reactive measures such as recording video or snapshots, it is necessary to configure the server and media settings so that the Network Camera will know what action to take (such as which server to send the media files to) when a trigger is activated. An event is an action initiated by a user-defined trigger source. In the **Event** column, click **Add** to open the event settings window. Here you can arrange three elements -- Schedule, Trigger, and Action to set an event. A total of 3 event settings can be configured.

Event

| Name | Status | Sun | Mon | Tue | Wed | Thu | Fri | Sat | Time | Trigger |
|------|--------|-----|-----|-----|-----|-----|-----|-----|------|---------|
|------|--------|-----|-----|-----|-----|-----|-----|-----|------|---------|

[Help](#)

Event name:

Enable this event

Priority: Normal ▼

Detect next motion detection or digital input after second(s).

1. Schedule

↓

2. Trigger

↓

3. Action

Event Schedule

Sun Mon Tue Wed Thu Fri Sat

Time

Always

From to [hh:mm]

- Event name: Enter a name for the event setting.
- Enable this event: Select this checkbox to enable the event setting.
- Priority: Select the relative importance of this event (High, Normal, or Low). Events with a higher priority setting will be executed first.
- Detect next motion detection or digital input after seconds: Enter the duration in seconds to pause motion detection after a motion is detected. This can prevent event-related actions to take place too frequently.

1. Schedule

Specify the period of time during which the event trigger will take effect. Please select the days of the week and the time in a day (in 24-hr time format) for the event triggering schedule. For example, you may prefer an event to be triggered only during the off-office hours.

2. Trigger

This is the cause or stimulus which defines when to trigger the Network Camera. The trigger source can be configured to use the Network Camera's built-in motion detection mechanism or external digital input devices.

There are several choices of trigger sources as shown on the next page. Select the item to display the detailed configuration options.

- Video motion detection

This option makes use of the built-in motion detection mechanism as a trigger source. To enable this function, you need to configure a Motion Detection Window first. For more information, please refer to Motion Detection on page 140 for details.

Video motion detection

Normal: door

Profile: hallway

Note: Please configure Motion detection first

- Periodically

This option allows the Network Camera to trigger periodically for every other defined minute. Up to 999 minutes are allowed.

Periodically

Trigger every other minutes

- Digital input

This option allows the Network Camera to use an external digital input device or sensor as a trigger source. Depending on your application, there are many choices with digital input devices on the market which help detect changes in temperature, vibration, sound, light, etc.

- System boot

This option triggers the Network Camera when the power to the Network Camera is disconnected and re-connected.

- Recording notify

This option allows the Network Camera to trigger when the recording disk is full or when recording starts to overwrite older data.

■ Audio detection

A preset threshold can be configured with an external microphone as the trigger to system event. The triggering condition can be an input exceeding or falling below a threshold. Audio detection can take place as a complement to motion detection or as a method to detect activities not covered by the camera's view.

■ Camera tampering detection

This option allows the Network Camera to trigger when the camera detects that it is being tampered with. To enable this function, you need to configure the Tampering Detection option first. Please refer to page 143 for detailed information.

- Camera tampering detection
 - Tampering detection Too dark Too bright Too blurry

Note: Please configure [Camera tampering detection](#) first

■ Manual Triggers

This option allows users to enable event triggers manually by clicking the on/off button on the homepage. Please configure 1 to 3 associated events before using this function.

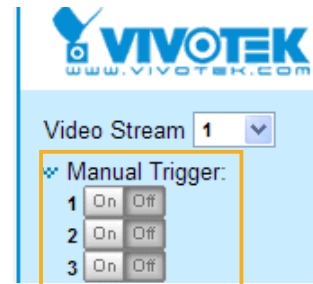
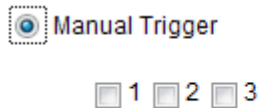

■ Shock detection

A shock accelerometer comes with the camera. If impact to the camera occurs, such as someone tries to destroy the camera, the impact can be detected and reported. The Shock detection configuration is found in Configuration > Applications > Shock detection.

■ VADP

It is presumed that you already uploaded and enabled the VADP modules before you can associate VADP triggers with an Event setting.

Click on the Set VADP Trigger button to open the VADP setup menu. The triggering conditions available with 3rd-party software modules known as VADP will be listed. Use the arrow buttons to select these triggers. Users may implant these modules for different purposes such as triggering motion detection, or applications related to video analysis, etc. Please refer to page 147 for the configuration options with VADP modules.

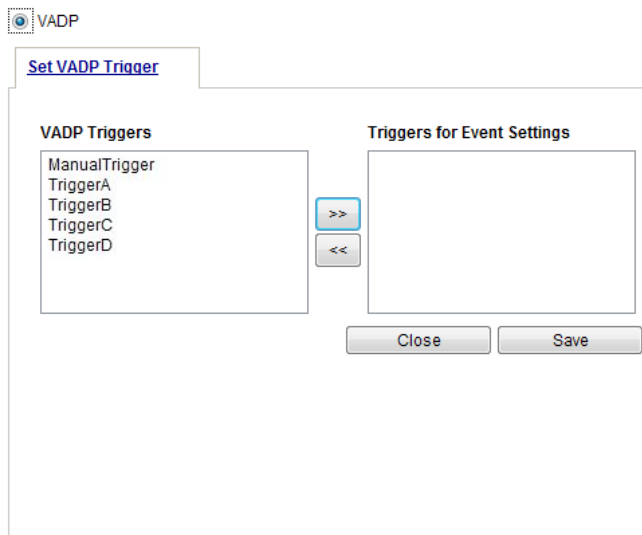

Once the triggers are configured, they will be listed under the VADP option.

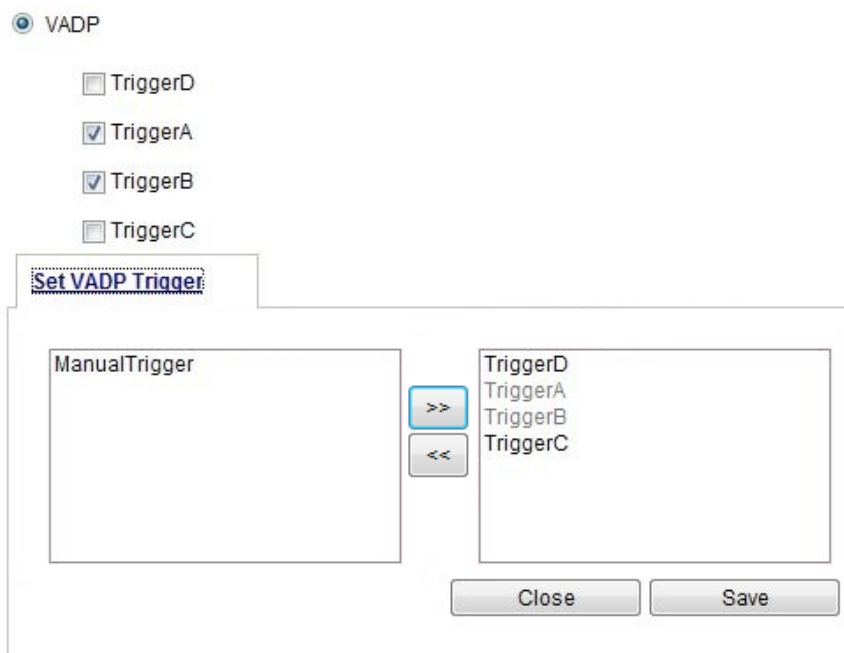

3. Action

Define the actions to be performed by the Network Camera when a trigger is activated.

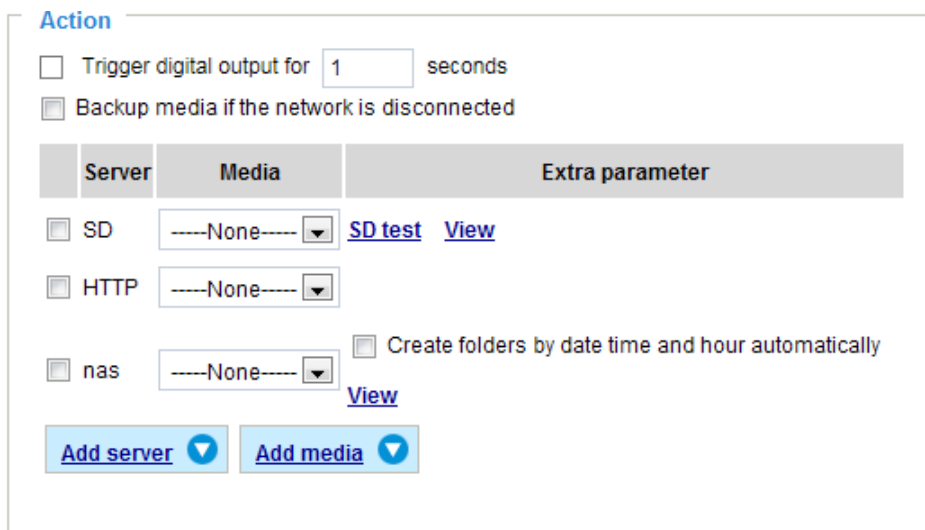

- Backup media if the network is disconnected

Select this option to backup media file on SD card if the network is disconnected. This function will only be displayed after you set up a network storage (NAS). The media to back up can include snapshot images, video, or system logs depending on your event settings.

- Play audio clip:

A pre-loaded audio clip can be configured to be played when one triggering condition is met. For example, playing a warning message to deter an intruder.

Add server

It is necessary to configure the server and media settings so that the Network Camera will know what action to take (such as which server to send the media files to) when a trigger is activated. Click **Add server** to open the server setting window. You can specify where the notification messages are sent to when a trigger is activated. A total of 5 server settings can be configured.

There are four choices of server types available: Email, FTP, HTTP, and Network storage. Select the item to display the detailed configuration options. You can configure either one or all of them.

Server type - Email

Select to send the media files via email when a trigger is activated.

- Server name: Enter a name for the server setting.
- Sender email address: Enter the email address of the sender.
- Recipient email address: Enter the email address of the recipient.
- Server address: Enter the domain name or IP address of the email server.
- User name: Enter the user name of the email account if necessary.
- Password: Enter the password of the email account if necessary.
- Server port: The default mail server port is set to 25. You can also manually set another port.

If your SMTP server requires a secure connection (SSL), select **This server requires a secure connection (SSL)**.

To verify if the email settings are correctly configured, click **Test**. The result will be shown in a pop-up window. If successful, you will also receive an email indicating the result.

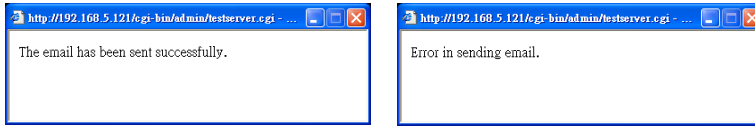

Click **Save server** to enable the settings.

Note that after you configure the first event server, the new event server will automatically display on the Server list. If you wish to add other server options, click **Add server**.



Server type - FTP

Select to send the media files to an FTP server when a trigger is activated.

Server name:

Server Type

Email

FTP

Server address:

Server port:

User name:

Password:

FTP folder name:

Passive mode

HTTP

Network storage

- Server name: Enter a name for the server setting.
- Server address: Enter the domain name or IP address of the FTP server.
- Server port: By default, the FTP server port is set to 21. It can also be assigned to another port number between 1025 and 65535.
- User name: Enter the login name of the FTP account.
- Password: Enter the password of the FTP account.
- FTP folder name
Enter the folder where the media files will be placed. If the folder name does not exist, the Network Camera will automatically create one on the FTP server.

■ **Passive mode**

Most firewalls do not accept new connections initiated from external requests. If the FTP server supports passive mode, select this option to enable passive mode FTP and allow data transmission to pass through the firewall. The firmware default has the Passive mode checkbox selected.

To verify if the FTP settings are correctly configured, click **Test**. The result will be shown in a pop-up window as shown below. If successful, you will also receive a test.txt file on the FTP server.

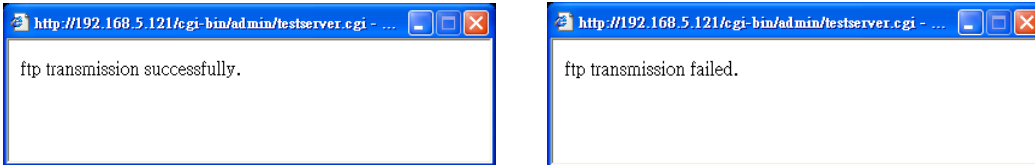

Click **Save server** to enable the settings.

Server type - HTTP

Select to send the media files to an HTTP server when a trigger is activated.

- **Server name:** Enter a name for the server setting.
- **URL:** Enter the URL of the HTTP server.
- **User name:** Enter the user name if necessary.
- **Password:** Enter the password if necessary.

To verify if the HTTP settings are correctly configured, click **Test**. The result will be shown in a pop-up window as shown below. If successful, you will receive a test.txt file on the HTTP server.



Click **Save server** to enable the settings.

Network storage:

Select to send the media files to a networked storage when a trigger is activated. Please refer to **NAS server** on page 153 for details. Note that only one NAS server can be configured.

Click **Save server** to enable the settings.

Action

Trigger digital output for seconds

Backup media if the network is disconnected

| Server | Media | Extra parameter |
|--------------------------------|--------------|---|
| <input type="checkbox"/> SD | ----None---- | SD test View |
| <input type="checkbox"/> Email | ----None---- | |
| <input type="checkbox"/> FTP | ----None---- | |
| <input type="checkbox"/> HTTP | ----None---- | |
| <input type="checkbox"/> NAS | ----None---- | <input type="checkbox"/> Create folders by date time and hour automatically View |

- **SD Test:** Click to test your SD card. The system will display a message indicating the result as a success or a failure. If you want to use your SD card for local storage, please format it before use. Please refer to page 135 for detailed information.
- **View:** Click this button to open a file list window. This function is only for SD card and Network Storage. If you click the View button for an SD card, a Local storage page will prompt so that you can manage the recorded files on SD card. For more information about Local storage, please refer to page 155. If you click the View button for a Network storage, a file directory window will prompt for you to view recorded data on Network storage. For detailed illustration, please refer to the next page.
- **Create folders by date, time, and hour automatically:** If you select this item, the system will automatically create folders by the date when video footages are stored onto the networked storage.

The following is an example of a file destination with video clips:

| | | | | |
|--------------------------|--------------------------|--------------------------|--------------------------|--|
| <input type="checkbox"/> | <input type="checkbox"/> | <input type="checkbox"/> | 20190120 | |
| <input type="checkbox"/> | <input type="checkbox"/> | <input type="checkbox"/> | 20190121 | |
| <input type="checkbox"/> | <input type="checkbox"/> | <input type="checkbox"/> | 20190122 | |

Click to delete selected items

The format is: YYYYMMDD
Click to open the directory

Click to delete all recorded data

Click [20190120](#) to open the directory:

The format is: HH (24r)

Click to open the file list for that hour

< 07 08 09 10 11 12 13 14 15 16 17 >

| | file name | size | date | time |
|--------------------------|-----------------------------------|---------|------------|----------|
| <input type="checkbox"/> | Recording1 58.mp4 | 2526004 | 2019/01/20 | 07:58:28 |
| <input type="checkbox"/> | Recording1 59.mp4 | 2563536 | 2019/01/20 | 07:59:28 |

Click to delete selected items

Click to go back to the previous level of the directory

Click to delete all recorded data

< 07 08 09 10 11 12 13 14 15 16 17 >

| | file name | size | date | time |
|--------------------------|-----------------------------------|---------|------------|----------|
| <input type="checkbox"/> | Recording1 58.mp4 | 2526004 | 2019/01/20 | 07:58:28 |
| <input type="checkbox"/> | Recording1 59.mp4 | 2563536 | 2019/01/20 | 07:59:28 |

The format is: File name prefix + Minute (mm)

You can set up the file name prefix on Add media page. Please refer to next page for detailed information.

Add media

Click **Add media** to open the media setting window. You can specify the type of media that will be sent when a trigger is activated. A total of 5 media settings can be configured. There are three choices of media types available: Snapshot, Video Clip, and System log. Select the item to display the detailed configuration options. You can configure either one or all of them.

Media type - Snapshot

Select to send snapshots when a trigger is activated.

- Media name: Enter a name for the media setting.
- Source: Select to take snapshots from any of the video streams.
- Send pre-event images
The Network Camera has a buffer to temporarily hold data up to a certain limit. Enter a number to decide how many images to capture before a trigger is activated. Up to 7 images can be generated.
- Send post-event images
Enter a number to decide how many images to capture after a trigger is activated. Up to 7 images can be generated.

For example, if both the Send pre-event images and Send post-event images are set to 7, a total of 15 images can be generated after a trigger is activated.

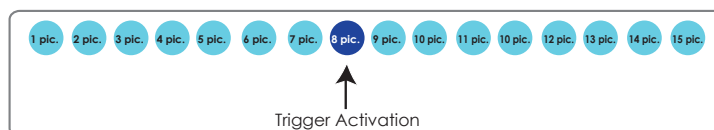

- File name prefix
Enter the text that will be appended to the front of the file name.

- Add date and time suffix to the file name
Select this option to add a date/time suffix to the file name.
For example:

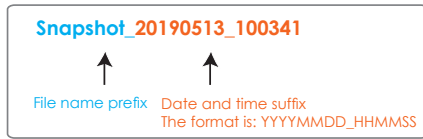

Click **Save media** to enable the settings.

Note that after you set up the first media server, a new column for media server will automatically display on the Media list. If you wish to add more media options, click **Add media**.

Media type - Video clip

Select to send video clips when a trigger is activated.

- Media name: Enter a name for the media setting.
- Source: Select a video stream as the source of video clip.
- Pre-event recording
The Network Camera has a buffer to temporarily hold data up to a certain limit. Enter a number to decide the duration of recording before a trigger is activated. Up to 9 seconds can be set.
- Maximum duration
Specify the maximum recording duration in seconds. The duration can be up to 10 seconds. For example, if pre-event recording is set to five seconds and the maximum duration is set to ten seconds, the Network Camera continues to record for another 4 seconds after a trigger is activated.

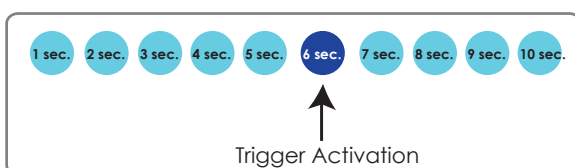

- **Maximum file size**
Specify the maximum file size allowed. Some users may need to stitch the video clips together when searching and packing up forensic evidence.
- **File name prefix**
Enter the text that will be appended to the front of the file name.
For example:



Click **Save media** to enable the settings.

Media type - System log

Select to send a system log when a trigger is activated.

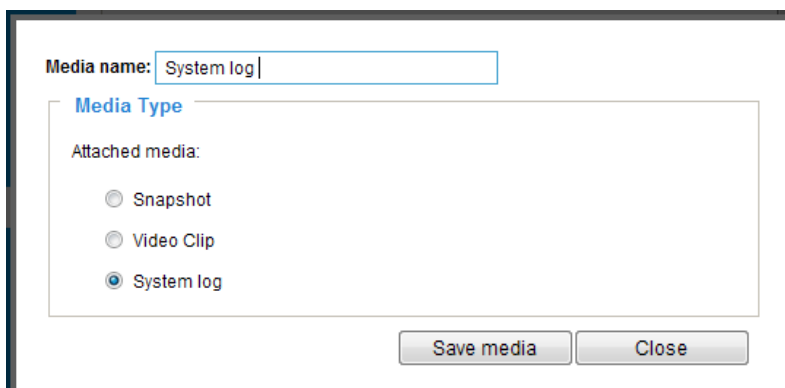

Click **Save media** to enable the settings, then click **Close** to exit the page.

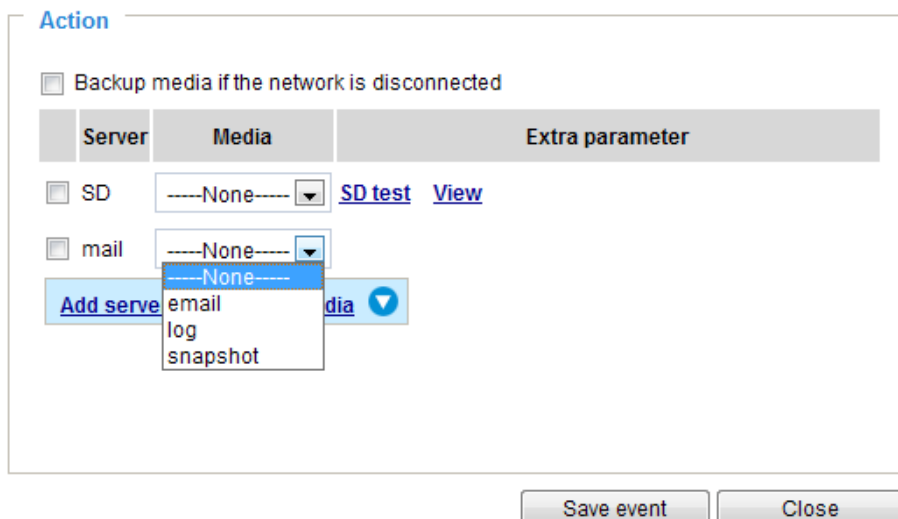

In the Event settings column, the Servers and Medias you configured will be listed; please make sure the Event -> Status is indicated as **ON**, in order to enable the event triggering action.

When completed, click the **Save event** button to enable the settings and click **Close** to exit Event Settings page. The new Event / Server settings / Media will appear in the event drop-down list on the Event setting page.

Please see the example of the Event setting page below:

Event

| Name | Status | Sun | Mon | Tue | Wed | Thu | Fri | Sat | Time | Trigger | |
|------------------------|-----------|-----|-----|-----|-----|-----|-----|-----|-------------|---------|--------|
| event1 | ON | V | V | V | V | V | V | V | 00:00~24:00 | seq | Delete |

Add [Help](#)

Server settings

| Name | Type | Address/Location | |
|----------------------|------|---------------------|--------|
| HTTP | http | http://192.168.5.10 | Delete |

Add

Media

Available memory space: 13000KB

| Name | Type | |
|----------------------------|-----------|--------|
| Snapshot | snapshot | Delete |
| Video clip | videoclip | Delete |
| System log | systemlog | Delete |

Add

Customized script

| Name | Date | Time |
|------|------|------|
|------|------|------|

Add

When the Event Status is **ON**, the event configuration above is triggered by motion detection, the Network Camera will automatically send snapshots via e-mail.

If you want to stop the event trigger, you can click on the **ON** button to turn it to **OFF** status or click the **Delete** button to remove the event setting.

To remove a server setting from the list, select a server name from the drop-down list and click **Delete**. Note that you can only delete a server setting when it is not applied in an existing event setting.

To remove a media setting from the list, select a media name from the drop-down list and click **Delete**. Note that you can only delete a media setting when it is not applied in an existing event setting.

Customized Script

This function allows you to upload a sample script (.xml file) to the camera, which will save your time on configuring the settings. Please note that there is a limited number of customized scripts you can upload; if the current amount of customized scripts has reached the limit, an alert message will prompt. If you need more information, please contact VIVOTEK technical support.

Customized Script

| Name | Date | Time |
|-----------------------|----------|----------|
| User1 | 20190213 | 18:13:46 |
| User2 | 20190213 | 18:11:32 |

Click to upload a file
Add
User1 ▾
Delete

```

<?xml version="1.0" encoding="UTF-8"?>
<eventmgr version="0102">
<maxprocess>1</maxprocess>
<!-- From 08:30:00-20:30:00 on Monday to Friday every week -->
<schedule id="0">
<duration>
<weekday>1-5</weekday>
<time>08:30:00-20:30:00</time>
</duration>
</schedule>
<!-- Motion -->
<motion condition="0">
<status id="0">trigger</status>
<status id="1">trigger</status>
</motion>
<event id="0">
<description>Mail system log to email address</description>
<condition>0</condition>
<scheduleno>0</scheduleno>
<delay>10</delay>
<!-- users can send email with title "Motion" to recipient pudding.yang@vivotek.com. The body of mail is the log messages -->
<process>
/usr/bin/smtpolient -s "Motion" -f IP7139@vivotek.com -b /var/log/messages -S ma.vivotek.tw -M 3 pudding.yang@vivotek.com
</process>
<priority>0</priority>
</event>
</eventmgr>
                
```

Upload

Click to modify the script online

Applications > Motion detection

The camera comes with a Smart Motion Detection utility as its pre-loaded VCA package. Please refer to its User Guide for more information:

http://download.vivotek.com/downloadfile/solutions/vadp/smart-motion-detection-manual_en.pdf

Click on Configuration > Applications > Motion detection. The Smart Motion utility will be automatically started.

If Human detection is applied, make sure you measured the height of your camera at the installation site. It is important for a correct video analysis. You should enter the installation height in the Motion detection Settings page.

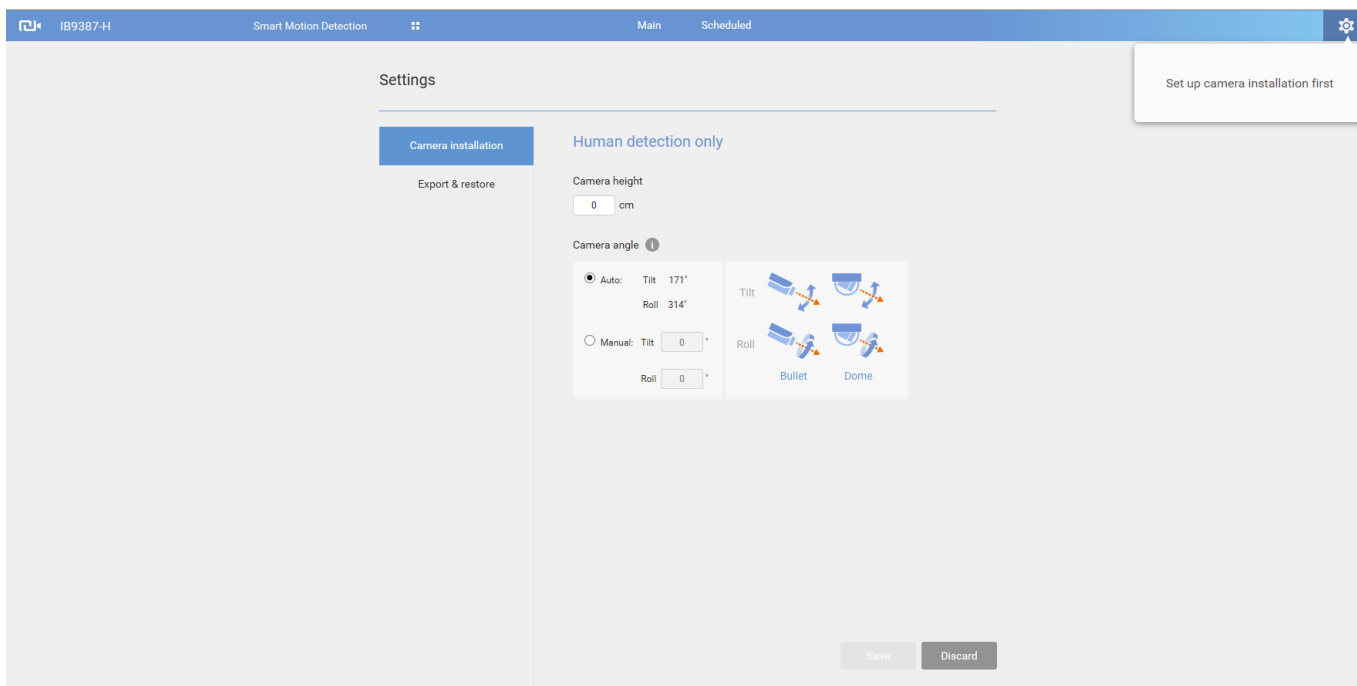
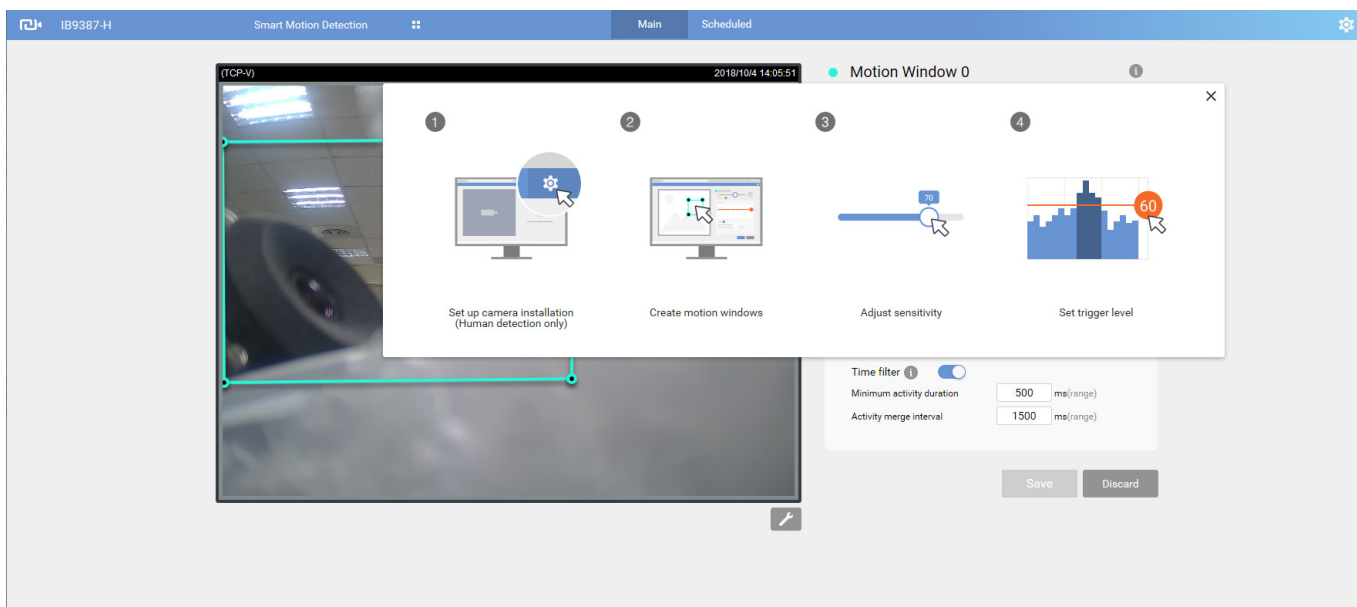

Applications > Smart VCA

Smart VCA provides the following features:

[Intrusion detection](#), [Loitering detection](#), [Missing object detection](#), [Unattended Object detection](#), [Line Crossing detection](#), and [Face detection](#).

Please refer to Smart VCA's user documentation for more information.

Click on Configuration > Applications > Smart VCA. The Smart VCA utility will be automatically started. The Smart Motion detection and Smart VCA share the same utility window.

If Smart VCA is applied, make sure you measured the height of your camera at the installation site. It is important for a correct video analysis. You should enter the installation height in the Smart VCA Settings page.

Applications > DI and DO

Applications > DI and DO

| | |
|-------------------------------------|--|
| Digital input 1 | |
| Normal status: | <input type="radio"/> High <input checked="" type="radio"/> Low |
| Current status: | Low |
| Digital input 2 | |
| Normal status: | <input type="radio"/> High <input checked="" type="radio"/> Low |
| Current status: | Low |
| Digital output 1 | |
| Normal status: | <input checked="" type="radio"/> Open <input type="radio"/> Grounded |
| Current status: | Open |
| Digital output 2 | |
| Normal status: | <input checked="" type="radio"/> Open <input type="radio"/> Grounded |
| Current status: | Open |
| <input type="button" value="Save"/> | |

Digital input: Select High or Low as the Normal status for the digital input connection. Connect the digital input pin of the Network Camera to an external device to detect the current connection status.

Digital output: Select Grounded or Open to define the normal status for the digital output. Connect the digital output pin of the Network Camera to an external device to determine the current status.

Set up the event source as DI on **Event > Event settings > Trigger**. Please refer to page 126 for detailed information.

Applications > Tampering detection

This section explains how to set up camera tamper detection. With tamper detection, the camera is capable of detecting incidents such as **redirection**, **blocking or defocusing**, or even **spray paint**.

Camera tampering detection

Tampering detection
 Trigger duration seconds [10~600]
 Trigger threshold [0~100]

Image too dark detection
 Trigger duration seconds [1~10]
 Trigger threshold [0~100]

Image too bright detection
 Trigger duration seconds [1~10]
 Trigger threshold [0~100]

Image too blurry detection
 Trigger duration seconds [1~10]
 Trigger threshold [0~100]

Please follow the steps below to set up the camera tamper detection function:

1. Click to select the checkbox before tampering conditions: Tampering detection, Image too dark, Image too bright, and Image too blurry. Enter the tamper trigger duration. (10 sec. ~ 10 min.). The duration specifies the set of time before the tampering is considered as a real alarm. This helps avoid false alarms by short-lived changes.

The tamper alarm will be triggered only when the tampering factor (the difference between current frame and pre-saved background) exceeds the trigger threshold. Conditions such as image too dark, too bright, or too blurry (defocused) can also be configured as tampering conditions. The Trigger threshold determines how sensitive is your tamper detection setting. Lower the threshold number, easier to trigger.

Too bright: shining a flash light. The average lighting level of the scene is taken into consideration.

Too dark: covering the objective or spraying paint.

Too blurry: blurry scene can be the result of strong interference on the device, such as EMI interference.

2. You can configure Tampering Detection as a trigger element to the proactive event configurations in **Event -> Event settings -> Trigger**. For example, when the camera is tampered with, camera can be configured to send the pre- and post-event video clips to a networked storage device. Please refer to page 127 for detailed information.

Applications > Audio detection

Audio detection, along with video motion detection, is applicable in the following scenarios:

1. Detection of activities not covered by camera view, e.g., a loud input by gun shots or breaking a door/window.
2. A usually noisy environment, such as a factory, suddenly becomes quiet due to a breakdown of machines.
3. A PTZ camera can be directed to turn to a preset point by the occurrence of audio events.
4. Dark environments where video motion detection may not function well.

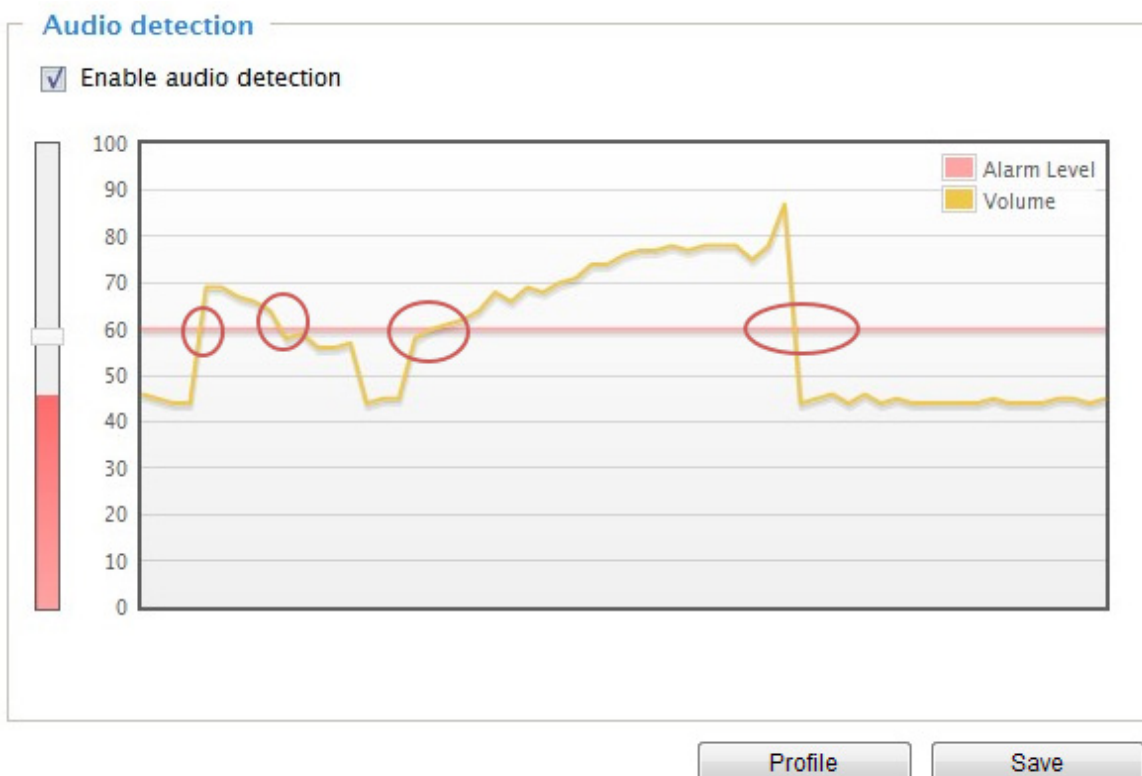

The red circles indicate where the audio alarms can be triggered when breaching or falling below the preset threshold.

How to configure Audio detection:

1. Once the Audio detection window is opened, the current sound input will be interactively indicated by a fluctuating yellow wave diagram.
2. Use a mouse click to drag the Alarm level tab to a preferred location on the slide bar.
3. Select the “Enable audio detection” checkbox and click Save to enable the feature.



NOTE:

1. Note that the volume numbers (0~100) on the side of wave diagram does not represent decibel (dB). Sound intensity level has already been mapped to preset values. You can, however, use the real-world inputs at your installation site that are shown on the wave diagram to configure an alarm level.
2. To configure this feature, you must not mute the audio in **Configuration > Media > Audio**. The default of the camera can be muted due to the lack of an internal microphone. An external microphone is provided by users.

You can use the **Profile** window to configure a different Audio detection setting. For example, a place can be noisy in the day time and become very quiet in the night.

1. Click on the **Enable this profile** checkbox. Once the Audio detection window is opened, the current sound input will be interactively indicated by a fluctuating yellow wave diagram.
2. Use a mouse click to drag the **Alarm level** tab to a preferred location on the slide bar.
3. Select the **Day**, **Night**, or **Schedule** mode check circles. You may also manually configure a period of time during which this profile will take effect.
4. Click **Save** and then click **Close** to complete your configuration.

>Audio detection profile settings

Audio detection

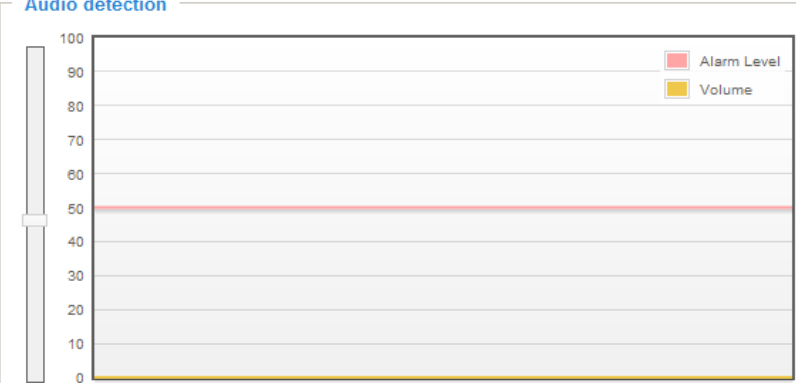

The graph displays a vertical scale from 0 to 100. A red horizontal line represents the 'Alarm Level' at the 50 mark. A yellow wave represents the 'Volume', which is currently near the 0 mark. A legend in the top right corner identifies the red line as 'Alarm Level' and the yellow wave as 'Volume'.

General settings

Enable this profile

This profile is applied to:

Day mode

Night mode

Schedule mode

From to [hh:mm]

IMPORTANT:

- If the Alarm level and the received volume are set within a range of 20% on the wave diagram, frequent alarms will be triggered. It is recommended to set the Alarm level farther apart from the detected sound level.
- To configure and enable this feature, you **must not** configure video stream #1 into **Motion JPEG**. If an external microphone input is connected and recording of audio stream is preferred, audio stream is transmitted between camera and viewer/recording station **along with stream #1**.
- Refer to page 85 for Audio settings, and page 74 for video streaming settings.

Applications > Shock detection

The camera comes with a shock accelerometer. The shock sensor can detect impacts to the camera. For example, when a person deliberately tries to destroy the camera, the camera can report the event to the administrator.

Normally, a 5kgm impact can cause the detected impact level to surge to 50% on the scale. Configure the Alarm Level to a preferred percentage on the chart. Click the **Enable shock detector** checkbox and click **Save** to complete the configuration.

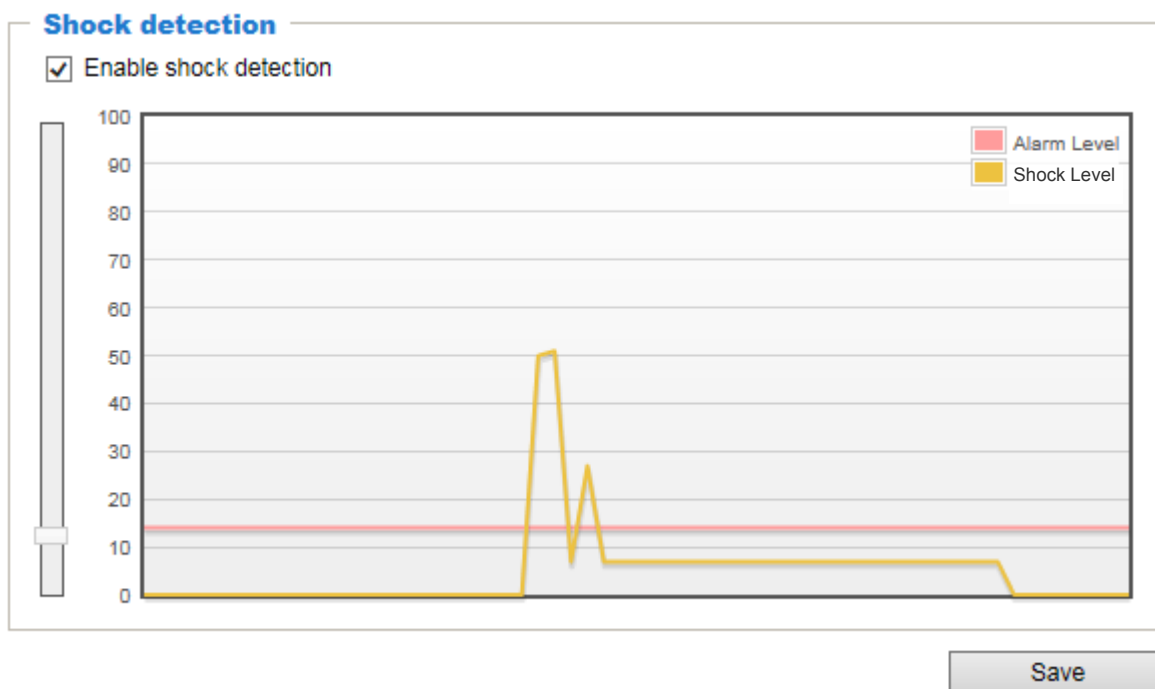

You should then go to Event settings to configure the shock detection as a triggering source. See page 126 for Event configuration.

The measurement range of the sensor is $\pm 16G$.

For every one G force ($g = 9.8 \text{ m/s}^2$) perceived, the sensor acquires a reading of 512.

The value acquired by a 2 G acceleration will look like the following:

$$512 * 2 / 16 = 64$$

Suppose that all 3-axis readings are equal (for simplicity reasons only), the shock level shown on the Shock detection chart will be $(64 + 64 + 64) * 100 / 1024 = 18.75$.

Applications > Package management - a.k.a., VADP (VIVOTEK Application Development Platform)

The camera comes embedded with the Smart Motion Detection feature. The Smart Motion detection, with Human detection and tunable time filter, can eliminate the defects of traditional motion detection and facilitate the configuration at a surveillance site.

To learn more about this feature, download its User Guide in:

http://download.vivotek.com/downloadfile/solutions/vadp/smart-motion-detection-manual_en.pdf

Upload package

Save to SD card

Select file

Resource status

▼ Storage status:

| | | | |
|---------------|--------------|------------|--------------|
| storage_size: | 10240 KBytes | Free size: | 10240 KBytes |
|---------------|--------------|------------|--------------|

▼ SD card status: Detached

| | | | |
|-------------|----------|------------|----------|
| Total size: | 0 KBytes | Free size: | 0 KBytes |
| Used size: | 0 KBytes | Use (%): | 0 % |

▼ Memory status:

| | | | |
|-------------|--------------|------------|--------------|
| Total size: | 24576 KBytes | Free size: | 24576 KBytes |
|-------------|--------------|------------|--------------|

Package list

| Module name | Vendor | Version | Status | License |
|---|--------|---------|--------|---------|
| <input type="button" value="Backup"/> <input type="button" value="Reload"/> <input type="button" value="Restore"/> <input type="button" value="Start"/> <input type="button" value="Stop"/> | | | | |

Users can store and execute VIVOTEK's or 3rd-party software modules onto the camera's flash memory or SD card. These software modules can apply in video analysis for intelligent video applications such as license plate recognition, object counting, or as an agent for edge recording, etc.

- Once the software package is successfully uploaded, the module configuration (vadp.xml) information is displayed. When uploading a module, the camera will examine whether the module fits the predefined VADP requirements. Please contact our technical support or the vendor of your 3rd-party module for the parameters contained within.
- Users can also run VIVOTEK's VADP packages as a means to access updated functionality instead of replacing the entire firmware.
- Note that for some cameras the flash is too small to hold VADP packages. These cameras will have its "Save to SD card" checkbox selected and grayed-out for all time.
- The file system of SD card (FAT32) does not support soft (symbolic) link. It will return failure if your module tries to create soft links on SD card.

To utilize a software module, acquire the software package and click **Browse** and **Upload** buttons. The screen message for a successful upload is shown below:

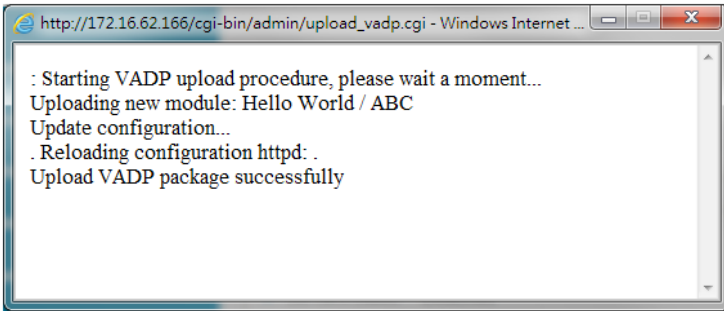

To start a module, select the checkcircle in front, and click the **Start** button.



If you should need to remove a module, select the checkcircle in front and then click the **Stop** button. By then the module status will become **OFF**, and the **X** button will appear at the end of the row. Click on the **X** button to remove an existing module.



When prompted by a confirm message, Click **Yes** to proceed.

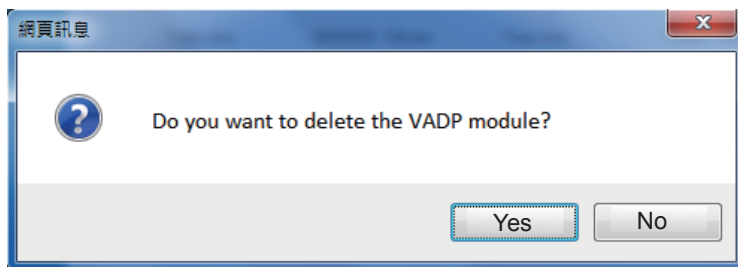

Note that the actual memory consumed while operating the module will be indicated on the **Memory status** field. This helps determine whether a running module has consumed too much of system resources.

On the License page, register and activate the license for using VIVOTEK's VADP modules. You should acquire the license key elsewhere, and manually upload to the network camera.

Follow the onscreen instruction on VIVOTEK's website for the registration procedure.

Status License

Manual License

To receive a license key for VADP application, go to <http://www.vivotek.com> and join the WTK member. This device's VADP number is:

`BbM79RE=OdGu1PIUEqJRFgc6sac0Rs7g4PXl`

Select file No file selected.

Recording > Recording settings

This section explains how to configure the recording settings for the Network Camera.

Recording Settings

Insert your SD card and click here to test

Recording settings

| Name | Status | Sun | Mon | Tue | Wed | Thu | Fri | Sat | Time | Source | Destination | Delete |
|------|--------|-----|-----|-----|-----|-----|-----|-----|------|--------|-------------|--------|
| | | | | | | | | | | | | |

Add [SD test](#)

Note: Before setup recording, you may setup network storage via [NAS server](#) page



NOTE:

- ▶ Please remember to format your SD card via the camera's web console (in the Local storage . SD card management page) when using it for the first time. Please refer to page 155 for detailed information.

Recording Settings

Click **Add** to open the recording setting window. On this page, you can define the adaptive recording, recording source, recording schedule, and recording capacity. A total of 2 recording settings can be configured.

Recording name:

Enable this recording

With adaptive recording

Pre-event recording: seconds [0~9]

Post-event recording: seconds [0~10]

Priority:

Source:

1. Trigger

2. Destination

Trigger

Schedule

Sun Mon Tue Wed Thu Fri Sat

Time

Always

From to [hh:mm]

Network fail

Note: To enable recording notification please configure [Event](#) first

Close Save

- Recording name: Enter a name for the recording setting.
- Enable this recording: Select this option to enable video recording.
- With adaptive recording: Select this option will activate the frame rate control according to alarm trigger. The frame control means that when there is a triggered alarm, the frame rate will raise up to the value you've configured on the Video quality page. Please refer to page 78 for more information.

If you enable adaptive recording on a camera, only when an event is triggered on Camera A will the server record the full frame rate streaming data; otherwise, it will only request the I frame data during normal monitoring, thus effectively saves bandwidths and storage space.

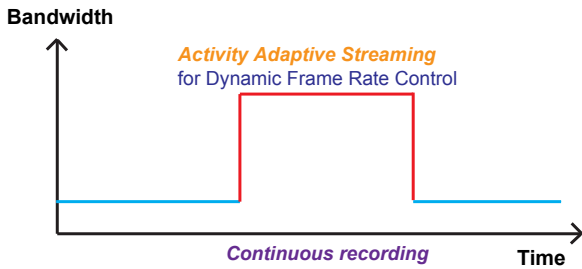
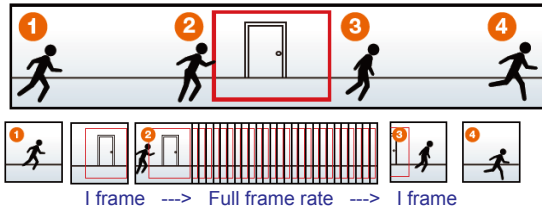

NOTE:

- ▶ To enable adaptive recording, please make sure you've set up the trigger source such as Motion Detection, DI Device, or Manual Trigger.
- ▶ When there is no alarm trigger:
 - JPEG mode: record 1 frame per second.
 - H.264 mode: record the I frame only.
- ▶ When the I frame period is >1s on Video settings page, firmware will force decrease the I frame period to 1s when adaptive recording is enabled.

The alarm trigger includes: motion detection and DI detection. Please refer to Event Settings on page 126.

- Pre-event recording and post-event recording
The Network Camera has a buffer that temporarily holds data for a period of time. Therefore, when an event occurs, the camera can retrieve image frames taken several seconds ago. Enter a number to define the duration of recording before and after a trigger is activated.
- Priority: Select the relative importance of this recording (High, Normal, or Low). Recording with a higher priority setting will be executed first.
- Source: Select a video stream as the recording source.

NOTE:

- ▶ To enable recording notification please configure **Event settings** first . Please refer to page 126.

Please follow the steps below to set up the recording.

1. Trigger

Select a trigger source.

Trigger

Schedule

Sun Mon Tue Wed Thu Fri Sat

Time

Always

From to [hh:mm]

Network fail

- Schedule: The server will start to record files on the local storage or network storage (NAS).
- Network fail: Since network fail, the server will start to record files on the local storage (SD card).

2. Destination

You can select the SD card or network storage (NAS) for the recorded video files. If you have not configured a NAS share, see details in the following.

Priority:

Source:

Destination

Destination:

Capacity:

Entire free space

Reserved space: Mbytes

Enable cyclic recording

Recording file management

Maximum duration: minutes [1~30]

Maximum file size: MB [100~2000]

File name prefix:

Note: To enable recording notification please configure [Event](#) first

NAS server

Click **Add NAS server** to open the server setting window and follow the steps below to set up:

1. Fill in the information for your server.

For example:

1. Trigger

↓

2. Destination

Destination:

Add NAS server

Server name: ³

Server type

Network storage

Network storage location: ¹

(For example: \\my_nas\disk\folder)

Workgroup:

User name: ²

Password: ⁴

Network storage path (\\server name or IP address\folder name)

User name and password for your server

2. Click **Test** to check the setting. The result will be shown in the pop-up window.

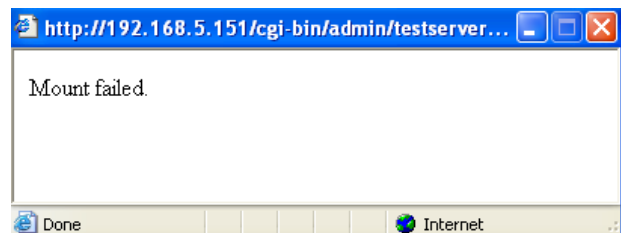
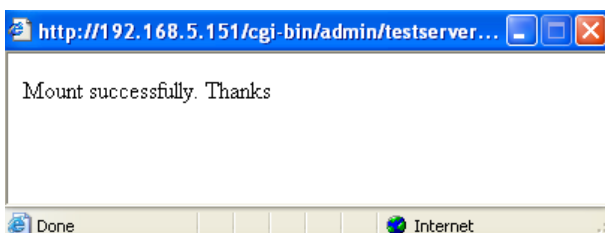

If successful, you will receive a test.txt file on the networked storage.

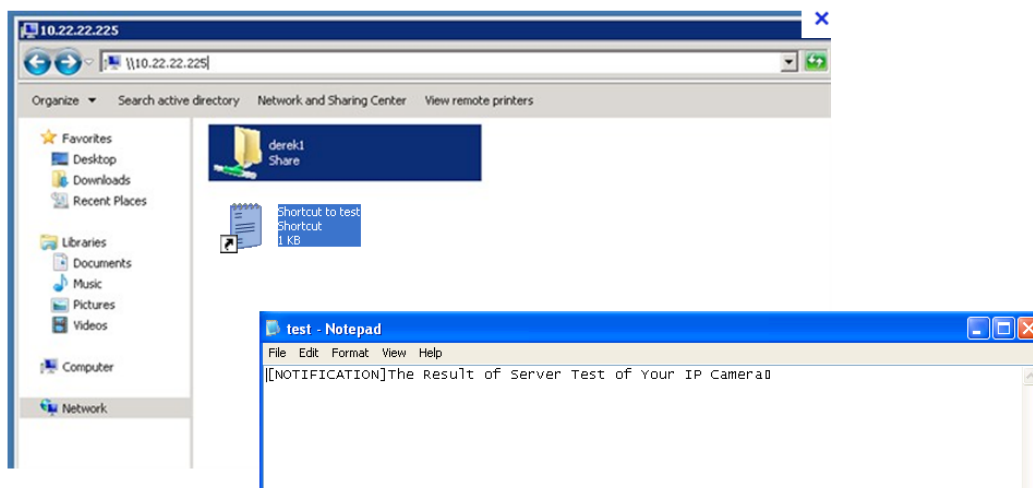

3. Enter a server name.

4. Click **Save** to complete the settings and click **Close** to exit the page.

Recording name:

Enable this recording

With adaptive recording ([Help](#))

Pre-event recording: seconds [0-9]

Post-event recording: seconds [0-10]

Priority:

Source:

Destination

Destination:

Capacity:

Entire free space

Reserved space: Mbytes

Enable cyclic recording

Recording file management

Maximum duration: minutes [1-30]

Maximum file size: MB [100-900]

File name prefix:

Note: To enable recording notification please configure [Event](#) first

- **Capacity:** You can choose either the entire free space available or limit the reserved space. The recording size limit must be larger than the reserved amount for cyclic recording. The reserved space is a small amount of space used only for the transaction stage when the capacity is about to be used up or recycled.
- **Enable cyclic recording:** If you check this item, when the maximum capacity is reached, the oldest file will be overwritten by the latest one. The reserved amount is reserved for the transaction stage when the storage space is about to be full and new data arrives. The minimum for the Reserved space must be larger than 15 MegaBytes.
- **Recording file management:** You can manually assign the Maximum duration and the Maximum file size for each recording footage. You may need to stitch individual files together under some circumstances. You may also designate a file name prefix by filling in the responsive text field.
- **File name prefix:** Enter the text that will be appended to the front of the file name.

If you want to enable recording notification, please click [Event](#) to configure event triggering settings. Please refer to **Event > Event settings** on page 126 for more details.

When completed, select **Enable this recording**. Click **Save** to enable the setting and click **Close** to exit this page. When the system begins recording, it will send the recorded files to the network storage. The new recording name will appear in the drop-down list on the recording page as shown below.

To remove a recording setting from the list, select a recording name from the drop-down list and click **Delete**.

| Recording settings | | | | | | | | | | | | |
|------------------------------------|--------------------|-------------------------|-----|-----|-----|-----|-----|-----|-------------|---------|---------------------|--------|
| Name | Status | Sun | Mon | Tue | Wed | Thu | Fri | Sat | Time | Source | Destination | Delete |
| recording | ON | V | V | V | V | V | V | V | 00:00~24:00 | stream1 | NAS | Delete |
| <input type="button" value="Add"/> | | SD test | | | | | | | | | | |

- Click [recording \(Name\)](#): Opens the Recording Settings page to modify.
- Click [ON \(Status\)](#): The Status will become [OFF](#) and stop recording.
- Click [NAS \(Destination\)](#): Opens the file list of recordings as shown below. For more information about folder naming rules, please refer to page 133 for details.

| | |
|---|--------------------------|
| <input type="checkbox"/> | 20190210 |
| <input type="checkbox"/> | 20190211 |
| <input type="checkbox"/> | 20190212 |
| <input type="button" value="Delete"/> <input type="button" value="Delete all"/> | |

Local storage > Storage management



NOTE:

- It is recommended to turn OFF the recording activity before you remove an SD card from the camera.
- The lifespan of an SD card is limited. Regular replacement of the SD card can be necessary.
- Camera filesystem takes up several megabytes of memory space. The storage space cannot be used for recording.
- Using an SD card that already contains data recorded by another device should not be used in this camera.
- Please do not modify or change the folder names in the SD card. That may result in camera malfunctions.

This section explains how to manage the local storage on the Network Camera. Here you can view SD card status, and implement SD card control.

SD card status

This column shows the status and reserved space of your SD card. Please remember to format the SD card when using for the first time.

SD card status

SD card status: Detached — no SD card

Total size: 0 KBytes Free size: 0 KBytes

Used size: 0 KBytes Use (%): 0 %

SD card status

SD card status: Ready

File system: FAT32

| | | | |
|-------------|-----------------|------------|-----------------|
| Total size: | 15323496 KBytes | Free size: | 15087976 KBytes |
| Used size: | 235520 KBytes | Use (%): | 1.537 % |

SD card format

The Linux kernel EXT4 file system format applies to SD card larger than 32GB. However, if EXT4 is applied, the computers running Windows will not be able to access the contents on the SD card unless using some 3rd-party software .

SD card format

Ext4
Ext4
 FAT32

SD card control

SD card control

Enable cyclic storage

Enable automatic disk cleanup

Maximum duration for keeping files: days

- **Enable cyclic storage:** Check this item if you want to enable cyclic recording. When the maximum capacity is reached, the oldest file will be overwritten by the latest one.
- **Enable automatic disk cleanup:** Check this item and enter the number of days you wish to retain a file. For example, if you enter “7 days”, the recorded files will be stored on the SD card for 7 days.

Click **Save** to enable your settings.

NAS management

On the NAS setup page you can configure your NAS (Networked Storage) configuration, test, mount, or unmount the networked storage.

Network storage path
(\\server name or IP address\folder name)

NAS setup

Network storage location:

(For example: \\my_nas\disk\folder)

Workgroup:

User name:

Password:

User name and password for log in to a NAS user account

You can use the **Test** button to check the setting. The result will be shown in the pop-up window.

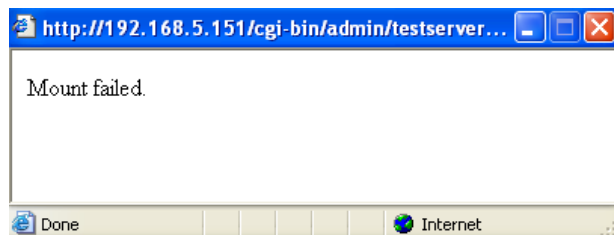
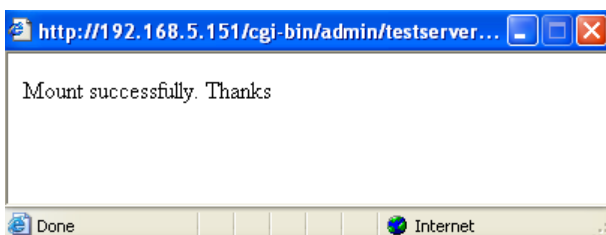

NAS control

NAS control

Minimum reserved storage space: %

Enable cyclic storage

Enable automatic disk cleanup

Maximum duration for keeping files: days

- **Minimum reserved storage space:** This can be used to configure the percentage of space threshold for the camera commencing space clean-ups. The minimum reserved space is 512MB for SD card; 1GB for a network share.
- **Enable cyclic storage:** Check this item if you want to enable cyclic recording. When the maximum capacity is reached, the oldest file will be overwritten by the latest one.
- **Enable automatic disk cleanup:** Check this item and enter the number of days you wish to retain a file. For example, if you enter “7 days”, the recorded files will be stored on the network share for 7 days.

Click **Save** to enable your settings.

Storage > Content management

This section explains how to manage the content of recorded videos on the Network Camera. Here you can search and view the records and view the searched results.

Searching and Viewing the Records

This column allows the user to set up search criteria for recorded data. If you do not select any criteria and click **Search** button, all recorded data will be listed in the **Search Results** column.

Search

Device target

All devices
 SD
 nas

Trigger type

Backup
 System boot
 Digital input
 Motion
 Network fail
 Recording notify
 Periodically
 Shock detection
 smartsd
 Tampering detection
 VADP
 Manual triggers
 Audio detection

Media type

Video clip
 Snapshot
 Text

Time

Search for last

From: :

to: :

- File attributes: Select one or more items as your search criteria.
- Trigger time: Manually enter the time range you want to search for contents created at a specific point in time.

Click **Search** and the recorded data corresponding to the search criteria will be listed in **Search Results** window.

Search Results

The following is an example of search results. There are four columns: Trigger time, Media type, Trigger type, and Locked. Click  to sort the search results in either direction.

Numbers of entries displayed on one page

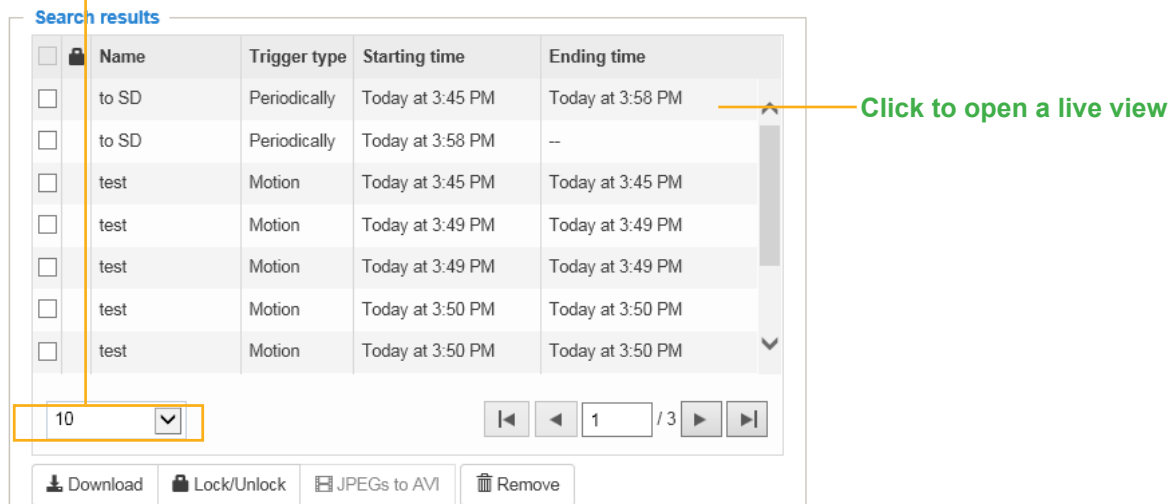

Search results

| <input type="checkbox"/> | Name | Trigger type | Starting time | Ending time |
|--------------------------|-------|--------------|------------------|------------------|
| <input type="checkbox"/> | to SD | Periodically | Today at 3:45 PM | Today at 3:58 PM |
| <input type="checkbox"/> | to SD | Periodically | Today at 3:58 PM | -- |
| <input type="checkbox"/> | test | Motion | Today at 3:45 PM | Today at 3:45 PM |
| <input type="checkbox"/> | test | Motion | Today at 3:49 PM | Today at 3:49 PM |
| <input type="checkbox"/> | test | Motion | Today at 3:49 PM | Today at 3:49 PM |
| <input type="checkbox"/> | test | Motion | Today at 3:50 PM | Today at 3:50 PM |
| <input type="checkbox"/> | test | Motion | Today at 3:50 PM | Today at 3:50 PM |

10 / 3

Download Lock/Unlock JPEGs to AVI Remove

Click to open a live view

- Play: Click on a search result which will highlight the selected item. A Play window will appear on top for immediate review of the selected file.
For example:



- Download: Click on a search result to highlight the selected item in purple as shown above. Then click the **Download** button and a file download window will pop up for you to save the file.
- JPEGs to AVI: This functions only applies to “JPEG“ format files such as snapshots. You can select several snapshots from the list, then click this button. Those snapshots will be converted into an AVI file.

- **Lock/Unlock:** Select the checkbox in front of a desired search result, then click this button. The selected items will become Locked, which will not be deleted during cyclic recording. You can click again to unlock the selections.

For example:

Search results

| <input type="checkbox"/> | | Name | Trigger type | Starting time | Ending time |
|-------------------------------------|--|-------|--------------|------------------|------------------|
| <input type="checkbox"/> | | to SD | Periodically | Today at 3:45 PM | Today at 3:58 PM |
| <input type="checkbox"/> | | to SD | Periodically | Today at 3:58 PM | -- |
| <input checked="" type="checkbox"/> | | test | Motion | Today at 3:45 PM | Today at 3:45 PM |
| <input checked="" type="checkbox"/> | | test | Motion | Today at 3:49 PM | Today at 3:49 PM |
| <input checked="" type="checkbox"/> | | test | Motion | Today at 3:49 PM | Today at 3:49 PM |
| <input type="checkbox"/> | | test | Motion | Today at 3:50 PM | Today at 3:50 PM |
| <input type="checkbox"/> | | test | Motion | Today at 3:50 PM | Today at 3:50 PM |

10 1 / 3

Click to switch pages

- **Remove:** Select the desired search results, then click this button to delete the files.

Appendix

URL Commands for the Network Camera

1. Overview

For some customers who already have their own web site or web control application, the Network Camera/Video Server can be easily integrated through URL syntax. This section specifies the external HTTP-based application programming interface. The HTTP-based camera interface provides the functionality to request a single image, control camera functions (PTZ, output relay etc.), and get and set internal parameter values. The image and CGI-requests are handled by the built-in Web server.

2. Style Convention

In URL syntax and in descriptions of CGI parameters, text within angle brackets denotes content that is to be replaced with either a value or a string. When replacing the text string, the angle brackets should also be replaced. An example of this is the description of the name for the server, denoted with `<servername>` in the URL syntax description below, that is replaced with the string `myserver` in the URL syntax example further down in the page.

URL syntax is denoted with the word "Syntax:" written in bold face followed by a box with the referenced syntax as shown below. For example, name of the server is written as `<servername>` and is intended to be replaced with the name of the actual server. This can either be a name, e.g., "mywebcam" or "thecam.adomain.net" or the associated IP number for the server, e.g., 192.168.0.220.

Syntax:

```
http://<servername>/cgi-bin/viewer/video.jpg
```

Description of returned data is written with "Return:" in bold face followed by the returned data in a box. All data is returned in HTTP format, i.e., each line is separated with a Carriage Return and Line Feed (CRLF) printed as `\r\n`.

Return:

```
HTTP/1.0 <HTTP code> <HTTP text>\r\n
```

URL syntax examples are written with "Example:" in bold face followed by a short description and a light grey box with the example.

Example: request a single snapshot image

```
http://mywebserver/cgi-bin/viewer/video.jpg
```

3. General CGI URL Syntax and Parameters

CGI parameters are written in lower-case and as one word without any underscores or other separators. When the CGI request includes internal camera parameters, these parameters must be written exactly as they are named in the camera or video server. The CGIs are organized in functionally-related directories under the cgi-bin directory. The file extension .cgi is required.

Syntax:

```
http://<servername>/cgi-bin/<subdir>[/<subdir>...]/<cgi>.<ext>  
[?<parameter>=<value>[&<parameter>=<value>...]]
```

Example: Set digital output #1 to active

<http://mywebserver/cgi-bin/dido/setdo.cgi?do1=1>

4. Security Level

| SECURITY LEVEL | SUB-DIRECTORY | DESCRIPTION |
|----------------|---------------|---|
| 0 | anonymous | Unprotected. |
| 1 [view] | viewer | Can view, listen, and talk to camera. |
| 4 [operator] | operator | Operator access rights can modify most of the camera's parameters except some privileges and network options. |
| 6 [admin] | admin | Administrator access rights can fully control the camera's operations. |
| 7 | N/A | Internal APIs. Unable to be changed by any external interfaces. |

A viewer account can access all APIs with security level 0 and 1. An operator account can access all APIs with security level 0, 1, or 4. An admin account can access all APIs except internal APIs.

Access management is based on the URL directory structure and is described in following paragraphs.

5. Get Server Parameter Values

Note: The access right depends on the URL directory.

Method: GET/POST

Syntax:

```
http://<servername>/cgi-bin/<anonymous>/getparam.cgi? [<parameter>]
[&<parameter>...]

http://<servername>/cgi-bin/<viewer>/getparam.cgi? [<parameter>]
[&<parameter>...]

http://<servername>/cgi-bin/<operator>/getparam.cgi? [<parameter>]
[&<parameter>...]

http://<servername>/cgi-bin/<admin>/getparam.cgi? [<parameter>]
[&<parameter>...]
```

Where the *<parameter>* should be *<group>[_<name>]* or *<group>[.<name>]*. If you do not specify any parameters, all the parameters on the server will be returned. If you specify only *<group>*, the parameters of the related group will be returned.

When querying parameter values, the current parameter values are returned.

A successful control request returns parameter pairs as follows:

Return:

```
HTTP/1.0 200 OK\r\n
Content-Type: text/html\r\n
Content-Length: <length>\r\n
\r\n
<parameter pair>
```

where *<parameter pair>* is

```
<parameter>=<value>\r\n
```

```
[<parameter pair>]
```

<length> is the actual length of content.

Example: Request IP address and its response

Request:

```
http://192.168.0.123/cgi-bin/admin/getparam.cgi?network_ipaddress
```

Response:

```
HTTP/1.0 200 OK\r\n
```

```
Content-Type: text/html\r\n
```

```
Content-Length: 33\r\n
```

```
\r\n
```

```
network.ipaddress=192.168.0.123\r\n
```

6. Set Server Parameter Values

Note: The access right depends on the URL directory.

Method: GET/POST

Syntax:

```

http://<servername>/cgi-bin/<anonymous>/setparam.cgi? <parameter>=<value>
[&<parameter>=<value>...][&return=<return page>]

http://<servername>/cgi-bin/<viewer>/setparam.cgi? <parameter>=<value>
[&<parameter>=<value>...][&return=<return page>]

http://<servername>/cgi-bin/<operator>/setparam.cgi? <parameter>=<value>
[&<parameter>=<value>...][&return=<return page>]

http://<servername>/cgi-bin/<admin>/setparam.cgi? <parameter>=<value>
[&<parameter>=<value>...][&return=<return page>]
    
```

| PARAMETER | DESCRIPTION |
|----------------------------|--|
| <parameter> | A full path like: "videoin_c0_s0_h264_resolution", "videoin_c0_s0_h264_maxframe", etc. |
| <value> | The assigned <value> to the <parameter>. |
| <return page> | Redirect to the page <return page>after the <parameter> is assigned. The <return page>can be a full URL path or relative path according to the current path. If you omit this parameter, it will redirect to an empty page. (Note: The return page can be a general HTML file (.htm, .html). It cannot be a CGI command or have any extra parameters. This parameter must be placed at the end of the parameter list. |

Return:

```

HTTP/1.0 200 OK\r\n
Content-Type: text/html\r\n
Context-Length: <length>\r\n
\r\n
<parameter pair>
    
```

where<parameter pair> is

<parameter>=<value>\r\n

[<parameter pair>]

Only the parameters that you set and are readable will be returned.

Example: Set the IP address of server to 192.168.0.123:

Request:

http://myserver/cgi-bin/admin/setparam.cgi?network_ipaddress=192.168.0.123

Response:

HTTP/1.0 200 OK\r\n

Content-Type: text/html\r\n

Content-Length: 33\r\n

\r\n

network.ipaddress=192.168.0.123\r\n

7. Available Parameters on the Server

Valid values:

| VALID VALUES | DESCRIPTION |
|--|--|
| string[<n>] | Text strings shorter than 'n' characters. The characters “’,<, >, & are invalid. |
| string[n~m] | Text strings longer than 'n' characters and shorter than 'm' characters. The characters “’,<, >, & are invalid. |
| password[<n>] | The same as string but displays "*" instead. |
| <integer> | Any single integer number in 32-bits. The range is -2147483648~2147483647. |
| <positive integer> | Any single positive integer number in 32-bits. The range is 1~ 4294967295. |
| <m> ~ <n> | Any number between 'm' and 'n'. |
| domain name[<n>] | A string limited to a domain name shorter than 'n' characters (eg. www.ibm.com). |
| email address [<n>] | A string limited to an email address shorter than 'n' characters (eg. joe@www.ibm.com). |
| <ip address> | A string limited to an IP address (eg. 192.168.1.1). |
| <mac address> | A string limited to contain a MAC address without hyphens or colons. |
| <boolean> | A boolean value of 1 or 0 represents [Yes or No], [True or False], [Enable or Disable]. |
| <value1>, <value2>, <value3>, ... | Enumeration. Only given values are valid. |
| blank | A blank string. |
| everything inside <> | A description |
| integer primary key | SQLite data type. A 32-bit signed integer. The value is assigned a unique integer by the server. |
| <text> | SQLite data type. The value is a text string, stored using the database encoding (UTF-8, UTF-16BE or UTF-16-LE). |
| <coordinate> | x, y coordinate (eg. 0,0) |
| <window size> | window width and height (eg. 800x600) |
| <W,H> | The format for coordinate in 2D. W is the pixel number of width. H is the pixel number of height. EX: (176,144) |

| VALID VALUES | DESCRIPTION |
|---------------|---|
| <WxH> | The format for resolution. W is the pixel number of width. H is the pixel number of height. Ex: 1920x1080, 2048x1536 |
| available | The API is listed in product WebAPIs. |
| non-available | The API is not in product WebAPIs. |
| valid | The API is listed in product WebAPIs, and is functional. |
| non-valid | The API is listed in product WebAPIs, but is malfunction in this status. |
| <decimal> | Any decimal number expressed in 32-bits ranging from 1.18e-38~3.40e+38. |

NOTE: The camera should not be restarted when parameters are changed.

7.1 System

Group: **system**

| NAME | VALUE | SECURITY (get/set) | DESCRIPTION |
|----------|------------------------------------|-----------------------|---|
| hostname | string[64] | 1/6 | Host name of server (Network Camera, Wireless Network Camera, Video Server, Wireless Video Server). |
| ledoff | <boolean> | 6/6 | Turn on (0) or turn off (1) all led indicators. |
| date | <YYYY/MM/DD >, keep, auto | 6/6 | Current date of system. Set to 'keep' to keep date unchanged. Set to 'auto' to use NTP to synchronize date. |
| time | <hh:mm:ss>, keep, auto | 6/6 | Current time of the system. Set to 'keep' to keep time unchanged. Set to 'auto' to use NTP to synchronize time. |
| datetime | <MMDDhhmm YYYY.ss> | 6/6 | Another current time format of the system. |
| ntp | <domain name>, <ip address>, | 6/6 | NTP server. *Do not use "skip to invoke default server" for default value. |

| NAME | VALUE | SECURITY (get/set) | DESCRIPTION |
|---------------|------------|-----------------------|---|
| | <blank> | | |
| timezoneindex | -489 ~ 529 | 6/6 | <p>Indicate timezone and area.</p> <p>-480: GMT-12:00 Eniwetok, Kwajalein</p> <p>-440: GMT-11:00 Midway Island, Samoa</p> <p>-400: GMT-10:00 Hawaii</p> <p>-360: GMT-09:00 Alaska</p> <p>-320: GMT-08:00 Las Vegas, San_Francisco, Vancouver</p> <p>-280: GMT-07:00 Mountain Time, Denver</p> <p>-281: GMT-07:00 Arizona</p> <p>-240: GMT-06:00 Central America, Central Time, Mexico City, Saskatchewan</p> <p>-200: GMT-05:00 Eastern Time, New York, Toronto</p> <p>-201: GMT-05:00 Bogota, Lima, Quito, Indiana</p> <p>-180: GMT-04:30 Caracas</p> <p>-160: GMT-04:00 Atlantic Time, Canada, La Paz, Santiago</p> <p>-140: GMT-03:30 Newfoundland</p> <p>-120: GMT-03:00 Brasilia, Buenos Aires, Georgetown, Greenland</p> <p>-80: GMT-02:00 Mid-Atlantic</p> <p>-40: GMT-01:00 Azores, Cape_Verde_IS.</p> <p>0: GMT Casablanca, Greenwich Mean Time: Dublin, Edinburgh, Lisbon, London</p> <p>40: GMT 01:00 Amsterdam, Berlin, Rome, Stockholm, Vienna, Madrid, Paris</p> <p>41: GMT 01:00 Warsaw, Budapest, Bern</p> <p>80: GMT 02:00 Athens, Helsinki, Istanbul, Riga</p> <p>81: GMT 02:00 Cairo</p> <p>82: GMT 02:00 Lebanon, Minsk</p> <p>83: GMT 02:00 Israel</p> |

| NAME | VALUE | SECURITY (get/set) | DESCRIPTION |
|------------------------|--------------------|-----------------------|--|
| | | | 120: GMT 03:00 Baghdad, Kuwait, Riyadh, Moscow, St. Petersburg, Nairobi 121: GMT 03:00 Iraq 140: GMT 03:30 Tehran 160: GMT 04:00 Abu Dhabi, Muscat, Baku, Tbilisi, Yerevan 180: GMT 04:30 Kabul 200: GMT 05:00 Ekaterinburg, Islamabad, Karachi, Tashkent 220: GMT 05:30 Calcutta, Chennai, Mumbai, New Delhi 230: GMT 05:45 Kathmandu 240: GMT 06:00 Almaty, Novosibirsk, Astana, Dhaka, Sri Jayawardenepura 260: GMT 06:30 Rangoon 280: GMT 07:00 Bangkok, Hanoi, Jakarta, Krasnoyarsk 320: GMT 08:00 Beijing, Chongqing, Hong Kong, Kuala Lumpur, Singapore, Taipei 360: GMT 09:00 Osaka, Sapporo, Tokyo, Seoul, Yakutsk 380: GMT 09:30 Adelaide, Darwin 400: GMT 10:00 Brisbane, Canberra, Melbourne, Sydney, Guam, Vladivostok 440: GMT 11:00 Magadan, Solomon Is., New Caledonia 480: GMT 12:00 Aucklan, Wellington, Fiji, Kamchatka, Marshall Is. 520: GMT 13:00 Nuku'Alofa |
| daylight_enable | <boolean> | 6/6 | Enable automatic daylight saving time in time zone. |
| daylight_dstactualmode | <positive integer> | 6/7 | Check if current time is under daylight saving time. (Used internally) |

| NAME | VALUE | SECURITY (get/set) | DESCRIPTION |
|-------------------------|---|-----------------------|--|
| daylight_auto_begintime | string[19] | 6/7 | Display the current daylight saving start time. |
| daylight_auto_endtime | string[19] | 6/7 | Display the current daylight saving end time. |
| daylight_timezones | string | 6/6 | List time zone index which support daylight saving time. |
| updateinterval | 0, 3600, 86400, 604800, 2592000 | 6/6 | 0 to Disable automatic time adjustment, otherwise, it indicates the seconds between NTP automatic update intervals. |
| restore | 0, <positive integer> | 7/6 | Restore the system parameters to default values after <value> seconds. |
| reset | 0, <positive integer> | 7/6 | Restart the server after <value> seconds if <value> is non-negative. |
| restoreexceptnet | 0, <positive integer> | 7/6 | Restore the system parameters to default values except (ipaddress, subnet, router, dns1, dns2, pppoe). This command can cooperate with other "restoreexceptXYZ" commands. When cooperating with others, the system parameters will be restored to the default value except for a union of the combined results. |
| restoreexceptdst | 0, <positive integer> | 7/6 | Restore the system parameters to default values except all daylight saving time settings. This command can cooperate with other "restoreexceptXYZ" commands. When cooperating with others, the system parameters will be restored to default values except for a union of combined results. |
| restoreexceptlang | 0, | 7/6 | Restore the system parameters to default |

| NAME | VALUE | SECURITY (get/set) | DESCRIPTION |
|-------------------------|--------------------------|-----------------------|--|
| | <positive integer> | | values except the custom language file the user has uploaded. This command can cooperate with other "restoreexceptXYZ" commands. When cooperating with others, the system parameters will be restored to the default value except for a union of the combined results. |
| restoreexceptvadp | 0, <positive integer> | 7/6 | Restore the system parameters to default values except the vadp parameters and VADP modules that stored in the system. This command can cooperate with other "restoreexceptXYZ" commands. When cooperating with others, the system parameters will be restored to the default value except for a union of the combined results. |
| restoreexceptfocusvalue | 0, <positive integer> | 7/6 | Restore the system parameters to default values except zoom and focus value. This command can cooperate with other "restoreexceptXYZ" commands. When cooperating with others, the system parameters will be restored to the default value except for a union of the combined results. * Only available when "capability_image_c<0~(n-1)>_remotefocus" != 0. |
| restoreexceptlen | 0, <positive integer> | 7/6 | Restore the system parameters to default values except lens profile. This command can cooperate with other "restoreexceptXYZ" commands. When cooperating with others, the system parameters will be restored to the default value except for a union of the combined results. |

| NAME | VALUE | SECURITY (get/set) | DESCRIPTION |
|------|-------|-----------------------|--|
| | | | * Only available when "capability_image_c<0~(n-1)>_lensconfiguration_support" != 0. |

7.1.1 System.Info

Subgroup of **system: info** (The fields in this group are unchangeable.)

| NAME | VALUE | SECURITY (get/set) | DESCRIPTION |
|-------------------------|--|-----------------------|--|
| modelname | string[40] | 0/7 | Internal model name of the server |
| extendedmodelname | string[40] | 0/7 | ODM specific model name of server (eg. DCS-5610). If it is not an ODM model, this field will be equal to "modelname" |
| serialnumber | <mac address> | 1/7 | 12 characters MAC address (without hyphens). |
| firmwareversion | string[40] | 0/7 | Firmware version, including model, company, and version number in the format:<MODEL-BRAND-VERSION> |
| language_count | <positive integer> | 0/7 | Number of webpage languages available on the server. |
| language_i<0~(count-1)> | string[16] language_i0 : English language_i1 : Deutsch language_i2 : Español language_i3 : Français language_i4 : Italiano language_i5 : 日本語 language_i6 : Português | 0/7 | Available language lists. |

| NAME | VALUE | SECURITY (get/set) | DESCRIPTION |
|----------------------------------|--|-----------------------|--|
| | language_i7 : 简体中文 language_i8 : 繁體中文 | | |
| customlanguage_maxcount | 0,<positive integer> | 0/6 | Maximum number of custom languages supported on the server. |
| customlanguage_count | 0,<positive integer> | 0/6 | Number of custom languages which have been uploaded to the server. |
| customlanguage_i<0~(maxcount-1)> | string | 0/6 | Custom language name. |

7.2 Status

Group: **status**

| NAME | VALUE | SECURITY (get/set) | DESCRIPTION |
|---|----------------------|-----------------------|---|
| di_i<0~(capability_ndi-1)> <product dependent> | <boolean> | 1/7 | 0 => Inactive, normal 1 => Active, triggered (capability_ndi > 0) |
| do_i<0~(capability_ndo-1)> <product dependent> | <boolean> | 1/7 | 0 => Inactive, normal 1 => Active, triggered (capability_ndo > 0) |
| onlinenum_rtsp | 0,<positive integer> | 6/7 | Current number of RTSP connections. |
| onlinenum_httppush | 0,<positive integer> | 6/7 | Current number of HTTP push server connections. |
| onlinenum_sip | 0,<positive integer> | 6/7 | Current number of SIP connections. |
| eth_i0 | <string> | 1/7 | Get network information from mii-tool. |
| vi_i<0~(capability_nvi-1)> <product dependent> | <boolean> | 1/7 | Virtual input 0 => Inactive 1 => Active (capability_nvi > 0) |

7.2.1 Status per Channel

Group: **status_c<0~(n-1)>** for n channel products

n denotes the value of "capability_nvideoin"

| NAME | VALUE | SECURITY (get/set) | DESCRIPTION |
|---------------|-----------|-----------------------|---|
| signal_detect | <boolean> | 1/7 | Indicates whether the video source is connected or not. * Only available when capability_videoin_type is 0 or 1. |
| signal_type | ntsc,pal | 1/7 | The actual modulation type. * Only available when capability_videoin_type is 0 or 1. |

7.3 Digital Input Behavior Define

Group: **di_i<0~(n-1)>** for n is the value of "capability_ndi" (**capability_capability_ndi > 0**)

| NAME | VALUE | SECURITY (get/set) | DESCRIPTION |
|-------------|--------------|-----------------------|--|
| normalstate | high, low | 1/1 | Indicates open circuit or closed circuit (inactive status) |

7.4 Digital Output Behavior Define

Group: **do_i<0~(n-1)>** for n is the value of "capability_ndo" (**capability_ndo > 0**)

| NAME | VALUE | SECURITY (get/set) | DESCRIPTION |
|-------------|-------------------|-----------------------|---|
| normalstate | open, grounded | 1/1 | Indicate open circuit or closed circuit (inactive status) |

7.5 Security

1. Group: security

| NAME | VALUE | SECURITY (get/set) | DESCRIPTION |
|------------------------|-----------------------------|-----------------------|---|
| privilege_do | view, operator, admin | 1/6 | Indicate which privileges and above can control digital output (capability_ndo > 0) |
| privilege_camctrl | view, operator, admin | 1/6 | Indicate which privileges and above can control PTZ (capability_ptzenabled > 0 or capability_eptz > 0) |
| user_i0_name | string[64] | 6/7 | User name of root |
| user_i<1~20>_name | string[64] | 6/7 | User name |
| user_i0_pass | password[64] | 7/6 | Root password |
| user_i<1~20>_pass | password[64] | 7/6 | User password |
| user_i0_privilege | view, operator, admin | 6/7 | Root privilege |
| user_i<1~20>_privilege | view, operator, admin | 6/6 | User privilege |

7.6 Network

Group: **network**

| NAME | VALUE | SECURITY (get/set) | DESCRIPTION |
|------------|--------------------|-----------------------|---|
| preprocess | <positive integer> | 6/6 | <p>An 32-bit integer, each bit can be set separately as follows: Bit 0 => HTTP service; Bit 1=> HTTPS service; Bit 2=> FTP service; Bit 3 => Two way audio and RTSP Streaming service;</p> <p>To stop service before changing its port settings. It's recommended to set this parameter when change a service port to the port occupied by another service currently. Otherwise, the service may fail.</p> <p>Stopped service will auto-start after changing port settings.</p> <p>Ex: Change HTTP port from 80 to 5556, and change RTP port for video from 5556 to 20480. Then, set preprocess=9 to stop both service first. "/cgi-bin/admin/setparam.cgi?network_preprocess=9&network_http_port=5556&network_rtp_videoport=20480"</p> |
| type | lan, pppoe | 6/6 | Network connection type. |
| resetip | <boolean> | 6/6 | 1 => Get ipaddress, subnet, router, dns1, dns2 from DHCP server at next reboot. |

| NAME | VALUE | SECURITY (get/set) | DESCRIPTION |
|-----------|--------------|-----------------------|--|
| | | | 0 => Use preset ipaddress, subnet, router, dns1, and dns2. |
| ipaddress | <ip address> | 6/6 | IP address of server. |
| subnet | <ip address> | 6/6 | Subnet mask. |
| router | <ip address> | 6/6 | Default gateway. |
| dns1 | <ip address> | 6/6 | Primary DNS server. |
| dns2 | <ip address> | 6/6 | Secondary DNS server. |
| wins1 | <ip address> | 6/6 | Primary WINS server. |
| wins2 | <ip address> | 6/6 | Secondary WINS server. |

7.6.1 802.1x

Subgroup of **network: ieee8021x** (*capability_protocol_ieee8021x > 0*)

| NAME | VALUE | SECURITY (get/set) | DESCRIPTION |
|--------------------|----------------------|-----------------------|--|
| enable | <boolean> | 6/6 | Enable/disable IEEE 802.1x |
| eapmethod | eap-peap, eap-tls | 6/6 | Selected EAP method |
| identity_peap | string[64] | 6/6 | PEAP identity |
| identity_tls | string[64] | 6/6 | TLS identity |
| password | string[200] | 7/6 | Password for TLS |
| privatekeypassword | string[200] | 7/6 | Password for PEAP |
| ca_exist | <boolean> | 6/6 | CA installed flag |
| ca_time | 0,<positive integer> | 6/7 | CA installed time. Represented in EPOCH |
| ca_size | 0,<positive integer> | 6/7 | CA file size (in bytes) |
| certificate_exist | <boolean> | 6/6 | Certificate installed flag (for TLS) |
| certificate_time | 0,<positive integer> | 6/7 | Certificate installed time. Represented in EPOCH |
| certificate_size | 0,<positive integer> | 6/7 | Certificate file size (in bytes) |
| privatekey_exist | <boolean> | 6/6 | Private key installed flag (for TLS) |
| privatekey_time | 0,<positive integer> | 6/7 | Private key installed time. Represented in EPOCH |
| privatekey_size | 0,<positive integer> | 6/7 | Private key file size (in bytes) |

7.6.2 QOS

Subgroup of **network: qos_cos** (*capability_protocol_qos_cos > 0*)

| NAME | VALUE | SECURITY (get/set) | DESCRIPTION |
|------------------------------|-----------|-----------------------|--|
| enable | <boolean> | 6/6 | Enable/disable CoS (IEEE 802.1p) |
| vlanid | 1~4095 | 6/6 | VLAN ID |
| video | 0~7 | 6/6 | Video channel for CoS |
| audio <product dependent> | 0~7 | 6/6 | Audio channel for CoS (capability_naudioin > 0) |
| eventalarm | 0~7 | 6/6 | Event/alarm channel for CoS |
| management | 0~7 | 6/6 | Management channel for CoS |
| eventtunnel | 0~7 | 6/6 | Event/Control channel for CoS |

Subgroup of **network: qos_dscp** (*capability_protocol_qos_dscp > 0*)

| NAME | VALUE | SECURITY (get/set) | DESCRIPTION |
|-------------|-----------|-----------------------|---|
| enable | <boolean> | 6/6 | Enable/disable DSCP |
| video | 0~63 | 6/6 | Video channel for DSCP |
| audio | 0~63 | 6/6 | Audio channel for DSCP (capability_naudioin > 0) |
| eventalarm | 0~63 | 6/6 | Event/alarm channel for DSCP |
| management | 0~63 | 6/6 | Management channel for DSCP |
| eventtunnel | 0~63 | 6/6 | Event/Control channel for DSCP |

7.6.3 IPV6

Subgroup of **network: ipv6** (*capability_protocol_ipv6 > 0*)

| NAME | VALUE | SECURITY (get/set) | DESCRIPTION |
|----------------|--------------|-----------------------|---|
| enable | <boolean> | 6/6 | Enable IPv6. |
| addonipaddress | <ip address> | 6/6 | IPv6 IP address. |
| addonprefixlen | 0~128 | 6/6 | IPv6 prefix length. |
| addonrouter | <ip address> | 6/6 | IPv6 router address. |
| addondns | <ip address> | 6/6 | IPv6 DNS address. |
| allowoptional | <boolean> | 6/6 | Allow manually setup of IP address setting. |

7.6.4 FTP

Subgroup of **network: ftp**

| NAME | VALUE | SECURITY (get/set) | DESCRIPTION |
|--------|----------------|-----------------------|------------------------|
| port | 21, 1025~65535 | 6/6 | Local ftp server port. |
| enable | <boolean> | 6/6 | Enable ftp. |

7.6.5 HTTP

Subgroup of **network: http**

| NAME | VALUE | SECURITY (get/set) | DESCRIPTION |
|---|---------------------|-----------------------|--|
| port | 80, 1025 ~ 65535 | 1/6 | HTTP port. |
| alternateport | 1025~65535 | 6/6 | Alternate HTTP port. |
| authmode | basic, digest | 1/6 | HTTP authentication mode. |
| s<0~(capability_nmediastream-1)>_accessname | string[32] | 1/6 | <p>Http server push access name for stream N, N= 1~ capability_nmediastream. (capability_protocol_spush_mjpeg =1 and capability_nmediastream > 0)</p> <p>The value are shown as video1s1.mjpg = c0_s0_accessname, (channel1stream1) video1s2.mjpg = c0_s1_accessname, (channel1stream2) video1s3.mjpg = c0_s2_accessname, (channel1stream3) video1s4.mjpg = c0_s3_accessname, (channel1stream4) etc.</p> <p>* We replace this parameter with "network_http_c<0~(capability_nvideoin-1)>_s<0~(capability_nmediastream-1)>_accessname" when the version number (httpversion)</p> |

| NAME | VALUE | SECURITY (get/set) | DESCRIPTION |
|------------------|-----------|-----------------------|-------------------------------------|
| | | | is equal or greater than 0311c. |
| anonymousviewing | <boolean> | 1/6 | Enable anonymous streaming viewing. |

7.6.6 HTTP per Channel

Subgroup of **network**: **http_c<0~(n-1)>** for n channel products

n denotes the value of "capability_nvideoin"

| NAME | VALUE | SECURITY (get/set) | DESCRIPTION |
|---|------------|-----------------------|--|
| s<0~(capability_nmedia stream-1)>_accessname <product dependent> | string[32] | 1/6 | Http server push access name for channel N and stream M, N= 1~ capability_nvideoin, M= 1~ capability_nmediastream. (capability_protocol_push_mjpeg =1 and capability_nmediastream > 0) The value are shown as video1s1.mjpg = c0_s0_accessname, (channel1stream1) video1s2.mjpg = c0_s1_accessname, (channel1stream2) video2s1.mjpg = c1_s0_accessname, (channel2stream1) video2s2.mjpg = c1_s1_accessname, (channel2stream2) etc. * We support this parameter when the version number (httpversion) is equal or greater than 0311c. |

7.6.7 HTTPS Port

Subgroup of **network**: **https** (capability_protocol_https > 0)

| NAME | VALUE | SECURITY (get/set) | DESCRIPTION |
|------|----------------------|-----------------------|-------------|
| port | 443, 1025 ~ 65535 | 1/6 | HTTPS port. |

7.6.8 RTSP

Subgroup of **network: rtsp** (**capability_protocol_rtsp > 0**)

| NAME | VALUE | SECURITY (get/set) | DESCRIPTION |
|--|------------------------------|-----------------------|--|
| port | 554, 1025 ~ 65535 | 1/6 | RTSP port. (capability_protocol_rtsp=1) |
| anonymousviewing | <boolean> | 1/6 | Enable anonymous streaming viewing. |
| authmode | disable, basic, digest | 1/6 | RTSP authentication mode. (capability_protocol_rtsp=1) |
| s<0~(capability_nmediastream*capability_nvideoin)-1>_accessname <product dependent> | string[32] | 1/6 | RTSP access name for channel/stream N, N= 1~ capability_nmediastream. (capability_protocol_spush_mjpeg =1 and capability_nmediastream > 0) The value are shown as live1s1.sdp = c0_s0_accessname, (channel1stream1) live1s2.sdp = c0_s1_accessname, (channel1stream2) live1s3.sdp = c0_s2_accessname, (channel1stream3) live1s4.sdp = c0_s3_accessname, (channel1stream4) etc. * Values start with prefix "cgi-bin" are prohibited. For example, "c, cg, cgi, cgi-, cgi-b, cgi-bi, cgi-bin" are not allowed. * We modify the value of RTSP access name after version number(httpversion) is 0311c |

7.6.9 RTSP Multicast

Subgroup of `network_rtsp_s<0~(n-1)>_multicast`

n denotes the value of "capability_nmediastream * capability_nvideoin"

| NAME | VALUE | SECURITY (get/set) | DESCRIPTION |
|--|-----------------|-----------------------|---|
| alwaysmulticast | <boolean> | 4/4 | Enable always multicast. |
| ipaddress | <ip address> | 4/4 | Multicast video IP address. * We replace "network_rtsp_s<0~(n-1)>_multicast_ipaddress" with " network_rtsp_s<0~(n-1)>_multicast_videoipadd ress". * Reserved for compatibility, and suggest don't use this since [httpversion] > 0304a |
| videoipaddress | <ip address> | 4/4 | Multicast video IP address. * We support this parameter when the version number (httpversion) is equal or greater than 0304a. |
| audioipaddress <product dependent> | <ip address> | 4/4 | Multicast audio IP address. * We support this parameter when the version number (httpversion) is equal or greater than 0304a. * Only available when capability_naudioin > 0 |
| metadataipaddres s | <ip address> | 4/4 | Multicast metadata IP address. * We support this parameter when the version number (httpversion) is equal or greater than 0304a. |
| videoport | 1025 ~ 65535 | 4/4 | Multicast video port. |
| audioport <product dependent> | 1025 ~ 65535 | 4/4 | Multicast audio port. * Only available when capability_naudioin > 0 |
| metadataport | 1026~6553 4 | 4/4 | Multicast metadata port. |
| ttl | 1 ~ 255 | 4/4 | Multicasttime to live value. |

7.6.10 SIP Port

Subgroup of **network: sip** (*capability_protocol_sip* > 0)

| NAME | VALUE | SECURITY (get/set) | DESCRIPTION |
|------|--------------|-----------------------|-------------|
| port | 1025 ~ 65535 | 1/6 | SIP port. |

7.6.11 RTP Port

Subgroup of **network: rtp**

| NAME | VALUE | SECURITY (get/set) | DESCRIPTION |
|--------------|--------------|-----------------------|--------------------------------|
| videoport | 1025 ~ 65535 | 6/6 | Video channel port for RTP. |
| audioport | 1025 ~ 65535 | 6/6 | Audio channel port for RTP. |
| metadataport | 1025 ~ 65535 | 6/6 | Metadata channel port for RTP. |

7.6.12 PPPoE

Subgroup of **network: pppoe** (*capability_protocol_pppoe* > 0)

| NAME | VALUE | SECURITY (get/set) | DESCRIPTION |
|------|--------------|-----------------------|--------------------------|
| user | string[128] | 6/6 | PPPoE account user name. |
| pass | password[64] | 7/6 | PPPoE account password. |

7.6.13 Bonjour

Subgroup of **network: service_bonjour**

| NAME | VALUE | SECURITY (get/set) | DESCRIPTION |
|-------------|-----------|-----------------------|---|
| enable | <boolean> | 6/6 | Enable bonjour service feature. * We support this parameter when the version number (<i>httpversion</i>) is equal or greater than 0312a. |
| servicename | <string> | 6/6 | A friendly name for bonjour service. * We support this parameter when the version number (<i>httpversion</i>) is equal |

| NAME | VALUE | SECURITY (get/set) | DESCRIPTION |
|------|-------|-----------------------|------------------------|
| | | | or greater than 0312a. |

7.7 IP Filter

Group: **ipfilter**

| NAME | VALUE | SECURITY (get/set) | DESCRIPTION |
|-----------------|---|-----------------------|--|
| enable | <boolean> | 6/6 | Enable access list filtering. |
| admin_enable | <boolean> | 6/6 | Enable administrator IP address. |
| admin_ip | string[43] | 6/6 | Administrator IP address. |
| maxconnection | 1~ "capability_protocol_maxconnection" | 6/6 | Maximum number of (s). |
| type | 0, 1 | 6/6 | Ipfilter policy : 0 => allow 1 => deny |
| ipv4list_i<0~9> | Single address: <ip address> Network address: <ip address / network mask> Range address:<start ip address - end ip address> | 6/6 | IPv4 address list. |
| ipv6list_i<0~9> | string[43] | 6/6 | IPv6 address list. |

7.8 Video Input

<Not supported anymore>

Group: **videoin**

| NAME | VALUE | SECURITY (get/set) | DESCRIPTION |
|-------------------------------------|--|-----------------------|--|
| cmosfreq | 50, 60 | 4/4 | CMOS frequency. * Only available when capability_videoin_type is 2. |
| whitebalance <product dependent> | auto, panorama, manual, rbgain, widerange, outdoor, indoor, sodiumauto, etc (Available values are listed in "capability_image_c<0~(n-1)>_wbmode") | 4/4 | Modes of white balance. "auto" : Auto white balance "panorama" : indicates that camera would try to balance the white balance effect of every sensor. "rbgain" : Use rgain and bgain to set white balance manually. "manual" : 2 cases: a. if "rbgain" is not supported, this means keep current white balance status. b. if "rbgain" is supported, "rgain" and "bgain" are updated to the current values which is got from white balance module. Then, act as rbgain mode "widerange" : Auto Tracing White balance (2000K to 10000K). "outdoor" : auto white balance mode specifically for outdoor. "indoor" : auto white balance mode specifically for indoor. "sodiumauto" : sodium vapor lamps. * Only available when "capability_image_c<0~(n-1)>_wbmode" != "-" |
| exposurelevel | 0~12 | 4/4 | Exposure level "0,12": This range takes the concept |

| NAME | VALUE | SECURITY (get/set) | DESCRIPTION |
|---------------------------------------|---|-----------------------|--|
| | | | <p>from DC's exposure tuning options. The definition is:</p> <p>0: EV -2.0 1: EV -1.7 2: EV -1.3 3: EV -1.0 4: EV -0.7 5: EV -0.3 6: EV 0 7: EV +0.3 8: EV +0.7 9: EV +1.0 10: EV +1.3 11: EV +1.7 12: EV +2.0</p> <p>* Only available when "capability_image_c<0~(n-1)>_exposure_mode" !=0</p> |
| irismode | fixed, indoor, outdoor <product independent> | 4/4 | <p>Control DC-Iris mode.</p> <p>"outdoor": Auto-setting DC-Iris to get best quality, but easy to meet rolling or flicker effect in indoor environment.</p> <p>"indoor": Avoid rolling and flicker effect first.</p> <p>"fixed": Open the iris to maximum.</p> <p>* Only available when "capability_image_c<0~(n-1)>_iristype" =dciris</p> |
| enableblc <Not support anymore> | <boolean> | 4/4 | <p>Enable backlight compensation.</p> <p>* Not support this parameter anymore when the version number (httpversion) is equal or greater than 0301a.</p> <p>* It's recommended to use "exposurewin_c<0~(n-1)>_mode" to</p> |

| NAME | VALUE | SECURITY (get/set) | DESCRIPTION |
|---------------------------------------|--|-----------------------|---|
| | | | switch on/off BLC. |
| color | 0, 1 | 4/4 | 0 => monochrome 1 => color * Only available when " capability_videoin_c<0~(n-1)>_color_ support" is 1. |
| flip | <boolean> | 4/4 | Flip the image. |
| mirror | <boolean> | 4/4 | Mirror the image. |
| rotate | 0,90,180,270 | 1/4 | The rotation angle of image. Support only in Rotation mode. * Only available when " capability_videoin_c<0~(n-1)>_rotatio n"=1 |
| ptzstatus <Not support anymore> | 0,<positive integer> | 1/7 | A 32-bit integer, each bit can be set separately as follows: Bit 0 => Support camera control function; 0(not support), 1(support) Bit 1 => Built-in or external camera; 0 (external), 1(built-in) Bit 2 => Support pan operation; 0(not support), 1(support) Bit 3 => Support tilt operation; 0(not support), 1(support) Bit 4 => Support zoom operation; 0(not support), 1(support) Bit 5 => Support focus operation; 0(not support), 1(support)(SD/PZ/IZ series only) |
| text | string[64] | 1/4 | Enclose caption. |
| imprnttimestamp | <boolean> | 4/4 | Overlay time stamp on video. |
| minexposure <product dependent> | <1~32000>, <5~32000>, <1~8000>, <5~8000>, | 4/4 | Minimum exposure time 1~32000 => 1s ~ 1/32000s 5~32000 => 1/5s ~ 1/32000s 1~8000 => 1s ~ 1/8000s |

| NAME | VALUE | SECURITY (get/set) | DESCRIPTION |
|------------------------------------|---|-----------------------|---|
| | etc. * Available value is listed in "capability_image_c<0~(n-1)>_exposure_minrange" | | 5~8000 => 1/5s ~ 1/8000s etc. * Only available when "capability_image_c<0~(n-1)>_exposure_minrange" != "-" * Only valid when "piris_mode"=manual or "irismode"=fixed * Only available when "capability_image_c<0~(n-1)>_exposure_rangetype" is "twovalues". |
| maxexposure <product dependent> | <1~32000>, <5~32000>, <1~8000>, <5~8000>, etc. * Available value is listed in "capability_image_c<0~(n-1)>_exposure_maxrange" | 4/4 | Maximum exposure time 1~32000 => 1s ~ 1/32000s 5~32000 => 1/5s ~ 1/32000s 1~8000 => 1s ~ 1/8000s 5~8000 => 1/5s ~ 1/8000s etc. * This parameter may also restrict image frame rate from sensor due to sensor generates a frame per exposure time. Ex: If this is set to 1/5s ~ 1/8000s and camera takes 1/5s on the night, then sensor only outputs 5 frame/s. * Only available when "capability_image_c<0~(n-1)>_exposure_maxrange" != "-" * Only valid when "piris_mode"=manual or "irismode"=fixed * Only available when "capability_image_c<0~(n-1)>_exposure_rangetype" is "twovalues". |
| enablepreview | <boolean> | 1/4 | Usage for UI of exposure settings. Preview settings of video profile. * Only available when |

| NAME | VALUE | SECURITY (get/set) | DESCRIPTION |
|------|-------|-----------------------|---|
| | | | "capability_image_c<0~(n-1)>_exposure_mode" !=0 |

7.8.1 Video Input Setting per Channel

Group: **videoin_c<0~(n-1)>** for n channel products, and m is stream number

n denotes the value of "capability_nvideoin", m denotes the value of "capability_nmediastream"

| NAME | VALUE | SECURITY(get/set) | DESCRIPTION |
|--|---|-----------------------|--|
| cmosfreq | 50, 60 | 4/4 | CMOS frequency. * Only available when "capability_videoin_type" is 2 |
| mode | 0 ~ "capability_videoin_c<0~(n-1)>_nmode"-1 | 4/4 | Indicate the video mode on use. |
| whitebalance <product dependent> | auto, panorama, manual, rbgain, widerange, outdoor, indoor, sodiumauto, etc (Available values are listed in "capability_image_c<0~(n-1)>_wbmode") | 4/4 | Modes of white balance. " auto ": Auto white balance " panorama ": indicates that camera would try to balance the white balance effect of every sensor. " rbgain ": Use rgain and bgain to set white balance manually. " manual ": 2 cases: a. if "rbgain" is not supported, this means keep current white balance status. b. if "rbgain" is supported, "rgain" and "bgain" are updated to the current values which is got from white balance module. Then, act as rbgain mode " widerange ": Auto Tracing White balance (2000K to 10000K). " outdoor ": auto white balance mode specifically for outdoor. " indoor ": auto white balance mode specifically for indoor. " sodiumauto ": sodium vapor lamps. * Only available when "capability_image_c<0~(n-1)>_wbmo |

| NAME | VALUE | SECURITY(get/set) | DESCRIPTION |
|---------------|-------|-----------------------|---|
| | | | de" !="-" |
| rgain | 0~100 | 4/4 | Manual set rgain value of gain control setting. 0: Weak <-> 100: Strong * Only available when "rbgain" is listed in "capability_image_c<0~(n-1)>_wbmode". * Only valid when "videoin_c<0~(n-1)>_whitebalance" != auto * Normalized range. |
| bgain | 0~100 | 4/4 | Manual set bgain value of gain control setting. 0: Weak <-> 100: Strong * Only available when "rbgain" is listed in "capability_image_c<0~(n-1)>_wbmode". * Only valid when "videoin_c<0~(n-1)>_whitebalance" != auto * Normalized range. |
| exposurelevel | 0~12 | 4/4 | Exposure level "0,12": This range takes the concept from DC's exposure tuning options. The definition is: 0: EV -2.0 1: EV -1.7 2: EV -1.3 3: EV -1.0 4: EV -0.7 5: EV -0.3 6: EV 0 7: EV +0.3 8: EV +0.7 |

| NAME | VALUE | SECURITY(get/set) | DESCRIPTION |
|-------------------------------------|---|-----------------------|---|
| | | | 9: EV +1.0 10: EV +1.3 11: EV +1.7 12: EV +2.0 * Only available when "capability_image_c<0~(n-1)>_exposure_mode" !=0 |
| exposuremode <product dependent> | auto, shutterpriority, irispriority, qualitypriority, manual, etc (Available options are list in "capability_image_c<0~(n-1)>_exposure_modetype") | 4/4 | Select exposure mode. "auto" : Automatically adjust the Iris, Gain and Shutter Speed to fit the exposure level. "shutterpriority" : Manually adjust with variable Shutter Speed, and keep adjusting Iris, Gain automatically. "irispriority" : Manually adjust with variable Iris, and keep adjusting Gain and Shutter speed automatically. "qualitypriority" : Automatically adjust the Iris, Gain and Shutter Speed by VIVOTEK quality algorithm. "manual" : Manually adjust with variable Shutter, Iris and Gain. * We support this parameter when the version number (httpversion) is equal or greater than 0302a. * Only available when "capability_image_c<0~(n-1)>_exposure_mode" !=0 |
| irismode | fixed, indoor, outdoor <product dependent> | 4/4 | Control DC-Iris mode. "outdoor" : Auto-setting DC-Iris to get best quality, but easy to meet rolling or flicker effect in indoor environment. "indoor" : Avoid rolling and flicker effect first. "fixed" : Open the iris to maximum. |

| NAME | VALUE | SECURITY(get/set) | DESCRIPTION |
|--|---------------------------|-----------------------|--|
| | | | * Only available when "capability_image_c<0~(n-1)>_iristype "=dciris |
| piris_mode <product dependent> | manual, indoor, outdoor,- | 1/4 | Control P-Iris mode. " outdoor ": Auto-setting P-Iris to get best quality, but easy to meet rolling or flicker effect in indoor environment. " indoor ": Avoid rolling and flicker effect first. " manual ": Manual set P-Iris by "piris_position". "-": not support. (only available when "capability_image_c<0~(n-1)>_sensor type" is "smartsensor") * Only available when "capability_image_c<0~(n-1)>_iristype "=piris |
| piris_position <product dependent> | 1~100 | 1/4 | Manual set P-Iris. 1: Open <-> 100: Close * Only valid when "piris_mode"=manual or "capability_image_c<0~(n-1)>_sensor type" is "smartsensor" * Only available when "capability_image_c<0~(n-1)>_iristype "=piris |
| enableblc <Not support anymore> | <boolean> | 4/4 | Enable backlight compensation * Not support this parameter anymore when the version number (httpversion) is equal or greater than 0301a. * It's recommended to use "exposurewin_c<0~(n-1)>_mode" to switch on/off BLC. |
| maxgain | 0~100 | 4/4 | Maximum gain value. |

| NAME | VALUE | SECURITY(get/set) | DESCRIPTION |
|-----------|-------|-----------------------|---|
| | | | <p>0: Low <-> 100: High</p> <ul style="list-style-type: none"> * Only available when "capability_image_c<0~(n-1)>_agc_maxgain" != "-" * Only valid when "piris_mode"=manual or "irismode"=fixed * Normalized range. * Only available when "capability_image_c<0~(n-1)>_exposure_rangetype" is "twovalues". |
| mingain | 0~100 | 4/4 | <p>Minimum gain value.</p> <p>0: Low <-> 100: High</p> <ul style="list-style-type: none"> * Only available when "capability_image_c<0~(n-1)>_agc_mingain" != "-" * Only valid when "piris_mode"=manual or "irismode"=fixed * Normalized range. * Only available when "capability_image_c<0~(n-1)>_exposure_rangetype" is "twovalues". |
| gainvalue | 0~100 | 4/4 | <p>Gain value.</p> <p>0: Low <-> 100: High</p> <ul style="list-style-type: none"> * Only available when "capability_image_c<0~(n-1)>_agc_maxgain" != "-" and "capability_image_c<0~(n-1)>_exposure_rangetype" is "onevalue". * Normalized range. * We support this parameter when the version number (httpversion) is equal or greater than 0302a. |
| color | 0, 1 | 4/4 | <p>0 => monochrome</p> <p>1 => color</p> |

| NAME | VALUE | SECURITY(get/set) | DESCRIPTION |
|------------------------------------|---|--------------------|---|
| | | | * Only available when " capability_videoin_c<0~(n-1)>_color_ support" is 1. |
| flip | <boolean> | 4/4 | Flip the image. |
| mirror | <boolean> | 4/4 | Mirror the image. |
| rotate | 0,90,180,270 | 1/4 | The rotation angle of image. Support only in Rotation mode (capability_videoin_c<0~(n-1)>_rotation=1) |
| ptzstatus <Not support anymore> | 0,<positive integer> | 1/7 | A 32-bit integer, each bit can be set separately as follows: Bit 0 => Support camera control function; 0(not support), 1(support) Bit 1 => Built-in or external camera; 0 (external), 1(built-in) Bit 2 => Support pan operation; 0(not support), 1(support) Bit 3 => Support tilt operation; 0(not support), 1(support) Bit 4 => Support zoom operation; 0(not support), 1(support) Bit 5 => Support focus operation; 0(not support), 1(support)(SD/PZ/IZ series only) |
| text | string[64] | 1/4 | Enclose caption. |
| imprnttimesta mp | <boolean> | 4/4 | Overlay time stamp on video. |
| textonvideo_p osition | top, bottom | 4/4 | Text on video string position |
| textonvideo_si ze | 20~40 | 4/4 | Text on video font size |
| textonvideo_fo ntpath | /usr/share/font/Default.ttf , /mnt/flash2/upload.ttf | 4/4 | Choose camera default font file (/usr/share/font/Default.ttf) or user uploaded font file(/mnt/flash2/upload.ttf). |
| textonvideo_u | Depends on the font file | 1/7 | Show the uploaded font file name. |

| NAME | VALUE | SECURITY(get/set) | DESCRIPTION |
|------------------------------------|---|--------------------|--|
| ploadfilename | name uploaded by user | | |
| minexposure <product dependent> | <p><1~32000>, <5~32000>, <1~8000>, <5~8000>, etc.</p> <p>* Available value is listed in "capability_image_c<0~(n-1)>_exposure_minrange"</p> | 4/4 | <p>Minimum exposure time 1~32000 => 1s ~ 1/32000s 5~32000 => 1/5s ~ 1/32000s 1~8000 => 1s ~ 1/8000s 5~8000 => 1/5s ~ 1/8000s etc.</p> <p>* Only available when "capability_image_c<0~(n-1)>_exposure_minrange" != "-"</p> <p>* Only valid when "piris_mode"=manual or "irismode"=fixed</p> <p>* Only available when "capability_image_c<0~(n-1)>_exposure_rangetype" is "twovalues".</p> |
| maxexposure <product dependent> | <p><1~32000>, <5~32000>, <1~8000>, <5~8000>, etc.</p> <p>* Available value is listed in "capability_image_c<0~(n-1)>_exposure_maxrange"</p> | 4/4 | <p>Maximum exposure time 1~32000 => 1s ~ 1/32000s 5~32000 => 1/5s ~ 1/32000s 1~8000 => 1s ~ 1/8000s 5~8000 => 1/5s ~ 1/8000s etc.</p> <p>* This parameter may also restrict image frame rate from sensor due to sensor generates a frame per exposure time. Ex: If this is set to 1/5s ~ 1/8000s and camera takes 1/5s on the night, then sensor only outputs 5 frame/s.</p> <p>* Only available when "capability_image_c<0~(n-1)>_exposure_maxrange" != "-"</p> <p>* Only valid when "piris_mode"=manual or "irismode"=fixed</p> <p>* Only available when</p> |

| NAME | VALUE | SECURITY(get/set) | DESCRIPTION |
|--|--|-----------------------|---|
| | | | "capability_image_c<0~(n-1)>_exposure_rangetype" is "twovalues". |
| shuttervalue <product dependent> | <1~32000>, <5~32000>, <1~8000>, <5~8000>, etc. * Available value is listed in "capability_image_c<0~(n-1)>_exposure_maxrange" | 4/4 | Exposure time 1~32000 => 1s ~ 1/32000s 5~32000 => 1/5s ~ 1/32000s 1~8000 => 1s ~ 1/8000s 5~8000 => 1/5s ~ 1/8000s etc. * This parameter may also restrict image frame rate from sensor due to sensor generates a frame per exposure time. Ex: If this is set to 1/5s ~ 1/8000s and camera takes 1/5s on the night, then sensor only outputs 5 frame/s. * Only available when "capability_image_c<0~(n-1)>_exposure_maxrange" != "-" and "capability_image_c<0~(n-1)>_exposure_rangetype" is "onevalue". * We support this parameter when the version number (httpversion) is equal or greater than 0302a. |
| enablepreview | <boolean> | 1/4 | Usage for UI of exposure settings. Preview settings of video profile. * Only available when "capability_image_c<0~(n-1)>_exposure_mode" != 0 |
| meteringmode | auto, blc, hlc * Available value is listed in "capability_image_c<0~(n-1)>_exposure_meteringmode" | 4/4 | " auto ": The algorithm chooses the best metering strategy. " blc ": This metering method increases the weight of dark area. " hlc ": The metering method can detect strong light and make affected area clear. |

| NAME | VALUE | SECURITY(get/set) | DESCRIPTION |
|-----------------------|--|-----------------------|---|
| | | | * We support this parameter when the version number (httpversion) is equal or greater than 0311a. |
| crop_position | <coordinate> (x,y) | 1/7 | Crop left-top corner coordinate. |
| crop_size | <window size> (WxH) | 1/7 | Crop width and height. (width must be 16x or 32x and height must be 8x) |
| zoomratiodisplay | <boolean> | 1/4 | Indicates multiple of zoom in is "on-screen display" or not. * We support this parameter when the version number (httpversion) is equal or greater than 0302a. |
| bracketing_level | 1~100 | 4/4 | <ul style="list-style-type: none"> ● The total available lists (capability_image_c<0~(n-1)>_exposure_bracketing_range) will be normalized to 1~100 scale. ● For example, the total available list is 7. (2x,3x,4x,5x,6x,7x,8x) ● 1 ~ 14 that correspond with 2x. ● 15 ~ 30 that correspond with 3x. *Only available when "capability_image_c<0~(n-1)>_exposure_bracketing_mode"=1. * We support this parameter when the version number (httpversion) is equal or greater than 0310a. |
| s<0~(m-1)>_enableeptz | <boolean> | 4/4 | Indicate whether stream supports eptz or not |
| s<0~(m-1)>_codec_type | Listed at "capability_videoin_codec" " Possible values are: mjpeg, h264,h265 <product dependent> | 1/4 | Codec type for this stream |
| s<0~(m-1)>_resolution | Available options are list in | 1/4 | Video resolution in pixels. |

| NAME | VALUE | SECURITY(get/set) | DESCRIPTION |
|-------------------------------------|--|-----------------------|--|
| solution | "capability_videoin_c<0~(n-1)>_resolution". Besides, available options is referred to "capability_videoin_c<0~(n-1)>_maxresolution" and "capability_videoin_c<0~(n-1)>_minresolution" | | |
| s<0~(m-1)>_smartfps_enable | <boolean> | 4/4 | Enable "Smart fps" function. * Only available when "capability_videoin_c<0~(n-1)>_smartfps_support" is 1. * We support this parameter when the version number (httpversion) is equal or greater than 0309a. |
| s<0~(m-1)>_h264_dintraperiod_enable | <boolean> | 4/4 | Enable "Dynamic intra frame period". * Only available when "capability_videoin_c<0~(n-1)>_dintra period_support" is 1. * We support this parameter when the version number (httpversion) is equal or greater than 0301c. |
| s<0~(m-1)>_h264_intraperiod | 250, 500, 1000, 2000, 3000, 4000 | 4/4 | The time interval between two I-frames (Intra coded picture). The unit is millisecond (ms). |
| s<0~(m-1)>_h264_ratecontrol mode | cbr, vbr | 4/4 | cbr : Constant bit rate mode. vbr : Fixed quality mode, all frames are encoded in the same quality. |
| s<0~(m-1)>_h264_quant | 1~5, 99, 100 | 4/4 | Set the pre-defined quality level: 1: Medium 2: Standard 3: Good 4: Detailed 5: Excellent 100: Use the quality level in |

| NAME | VALUE | SECURITY(get/set) | DESCRIPTION |
|---------------------------------------|---|-----------------------|--|
| | | | "qpercent" 99: Use the quality level in "qvalue" * Only valid when "h264_ratecontrolmode"= vbr. |
| s<0~(m-1)>_h2 64_qvalue | 0~51 | 4/4 | Manual video quality level input. The Q value which is used by encoded library directly. * Only valid when "h264_ratecontrolmode"= vbr and s<0~(m-1)>_h264_quant = 99. |
| s<0~(m-1)>_h2 64_qpercent | 1~100 | 4/4 | Select customized quality in a normalized full range. 1: Worst quality 100: Best quality * Only valid when "h264_ratecontrolmode"= vbr and "quant"= 100. |
| s<0~(m-1)>_h2 64_maxvbrbitr ate | 20000~"capability_videoin _c<0~(n-1)>_h264_maxbit rate" | 4/4 | The maximum allowed bit rate in fixed quality mode. When the bit rate exceeds this value, frames will be dropped to restrict the bit rate. * Only valid when "h264_ratecontrolmode"= vbr |
| s<0~(m-1)>_h2 64_cbr_quant | 1~5, 100 | 4/4 | Set the pre-defined quality level: 1: Medium 2: Standard 3: Good 4: Detailed 5: Excellent 100: Use the quality level in "cbr_qpercent" * Only available when "h264_ratecontrolmode"= cbr. |
| s<0~(m-1)>_h2 64_cbr_qperce | 1~100 | 4/4 | Select customized quality in a normalized full range. |

| NAME | VALUE | SECURITY(get/set) | DESCRIPTION |
|-------------------------------------|---|-----------------------|--|
| nt | | | 1: Worst quality 100: Best quality * Only valid when "h264_ratecontrolmode"= cbr and "quant"= 100. |
| s<0~(m-1)>_h264_bitrate | 20000~"capability_videoin_c<0~(n-1)>_h264_maxbitrate" | 4/4 | The target bit rate in constant bit rate mode. * Only valid when "h264_ratecontrolmode"= cbr |
| s<0~(m-1)>_h264_prioritypolicy | framerate,imagequality | 4/4 | Set prioritypolicy * Only valid when "h264_ratecontrolmode"= cbr |
| s<0~(m-1)>_h264_maxframe | 1~"capability_videoin_c<0~(n-1)>_h264_maxframerate" | 1/4 | The maximum frame rates of a H264 stream at different resolutions("capability_videoin_c<0~(n-1)>_resolution") are recorded in "capability_videoin_c<0~(n-1)>_h264_maxframerate" |
| s<0~(m-1)>_h264_profile | 0~2 | 1/4 | Indicate H264 profiles 0: baseline 1: main profile 2: high profile |
| s<0~(m-1)>_h264_smartq_enable | <boolean> | 4/4 | Enable "Smart Q" function. * Only available when "capability_videoin_c<0~(n-1)>_smartq_support" is 1. * We support this parameter when the version number (httpversion) is equal or greater than 0309a. |
| s<0~(m-1)>_h265_dintraperiod_enable | <boolean> | 4/4 | Enable "Dynamic intra frame period". * Only available when "capability_videoin_c<0~(n-1)>_dintraperiod_support" is 1 and h265 is listed in "capability_videoin_codec". * We support this parameter when the version number (httpversion) is |

| NAME | VALUE | SECURITY(get/set) | DESCRIPTION |
|---|-------------------------------------|-----------------------|--|
| | | | equal or greater than 0301c. |
| s<0~(m-1)>_h2 65_intraperiod | 250, 500, 1000, 2000, 3000, 4000 | 4/4 | The time interval between two I-frames (Intra coded picture). The unit is millisecond (ms). * Only available when h265 is listed in "capability_videoin_codec". |
| s<0~(m-1)>_h2 65_ratecontrol mode | cbr, vbr | 4/4 | cbr : Constant bit rate mode. vbr : Fixed quality mode, all frames are encoded in the same quality. * Only available when h265 is listed in "capability_videoin_codec". |
| s<0~(m-1)>_h2 65_quant | 1~5, 99, 100 | 4/4 | Set the pre-defined quality level: 1: Medium 2: Standard 3: Good 4: Detailed 5: Excellent 100: Use the quality level in "qpercent" 99: Use the quality level in "qvalue" * Only available when h265 is listed in "capability_videoin_codec" and "h265_ratecontrolmode"= vbr. |
| s<0~(m-1)>_h2 65_qvalue | 0~51 | 4/4 | Manual video quality level input. The Q value which is used by encoded library directly. * Only available when h265 is listed in "capability_videoin_codec". * Only valid when "h265_ratecontrolmode"= vbr and s<0~(m-1)>_h265_quant = 99. |
| s<0~(m-1)>_h2 65_qpercent | 1~100 | 4/4 | Select customized quality in a normalized full range. 1: Worst quality 100: Best quality * Only available when h265 is listed in |

| NAME | VALUE | SECURITY(get/set) | DESCRIPTION |
|-------------------------------|---|-----------------------|--|
| | | | "capability_videoin_codec". * Only valid when "h265_ratecontrolmode"= vbr and "quant"= 100. |
| s<0~(m-1)>_h265_maxvbrbitrate | 20000~"capability_videoin_c<0~(n-1)>_h265_maxbitrate" | 4/4 | The maximum allowed bit rate in fixed quality mode. When the bit rate exceeds this value, frames will be dropped to restrict the bit rate. * Only available when h265 is listed in "capability_videoin_codec". * Only valid when "h265_ratecontrolmode"= vbr |
| s<0~(m-1)>_h265_cbr_quant | 1~5, 100 | 4/4 | Set the pre-defined quality level: 1: Medium 2: Standard 3: Good 4: Detailed 5: Excellent 100: Use the quality level in "cbr_qpercent" * Only available when h265 is listed in "capability_videoin_codec" and "h265_ratecontrolmode"= cbr. |
| s<0~(m-1)>_h265_cbr_qpercent | 1~100 | 4/4 | Select customized quality in a normalized full range. 1: Worst quality 100: Best quality * Only available when h265 is listed in "capability_videoin_codec". * Only valid when "h265_ratecontrolmode"= cbr and "quant"= 100. |
| s<0~(m-1)>_h265_cbr_target | 20000~"capability_videoin_c<0~(n-1)>_h265_maxbitrate" | 4/4 | The target bit rate in constant bit rate |

| NAME | VALUE | SECURITY(get/set) | DESCRIPTION |
|--|--|-----------------------|--|
| 65_bitrate | _c<0~(n-1)>_h265_maxbit rate" | | mode. * Only available when h265 is listed in "capability_videoin_codec". * Only valid when "h265_ratecontrolmode"= cbr |
| s<0~(m-1)>_h2 65_prioritypoli cy | framerate,imagequality | 4/4 | Set prioritypolicy * Only available when h265 is listed in "capability_videoin_codec". * Only valid when "h265_ratecontrolmode"= cbr |
| s<0~(m-1)>_h2 65_maxframe | 1~"capability_videoin_c<0 ~(n-1)>_h265_maxframe rate" | 1/4 | The maximum frame rates of a H265 stream at different resolutions("capability_videoin_c<0~ (n-1)>_resolution") are recorded in "capability_videoin_c<0~(n-1)>_h265 _maxframerate" * Only available when h265 is listed in "capability_videoin_codec". |
| s<0~(m-1)>_h2 65_profile | Available values are listed in " capability_videoin_c<0~(n -1)>_h265_profile" | 1/4 | Indicate H265 profiles * Only available when h265 is listed in "capability_videoin_codec". |
| s<0~(m-1)>_h2 65_smartq_en able | <boolean> | 4/4 | Enable "Smart Q" function. * Only available when h265 is listed in "capability_videoin_codec". * Only available when "capability_videoin_c<0~(n-1)>_smart q_support" is 1. * We support this parameter when the version number (httpversion) is equal or greater than 0309a. |
| s<0~(m-1)>_mj peg_ratecontr olmode | cbr, vbr | 4/4 | cbr : Constant bit rate mode. vbr : Fixed quality mode, all frames are encoded in the same quality. |
| s<0~(m-1)>_mj | 1~5, | 4/4 | * Only valid when |

| NAME | VALUE | SECURITY(get/set) | DESCRIPTION |
|--------------------------------|---|-----------------------|--|
| peg_quant | 99, 100 | | "mjpeg_ratecontrolmode"= vbr. Set the pre-defined quality level: 1: Medium 2: Standard 3: Good 4: Detailed 5: Excellent 100: Use the quality level in "qpercent" 99: Use the quality level in "qvalue" |
| s<0~(m-1)>_mjpeg_qvalue | 10~200 (Only valid when "capability_api_httpversion" format is XXXXX_1 or XXXXX_3 or XXXXX_4 ex: 0301a_1 or 0301a_3 or 0301a_4) or 1~99 (Only valid when "capability_api_httpversion" format is XXXXX_2, ex: 0301a_2) <product dependent> | 4/4 | Manual video quality level input. The Q value which is used by encoded library directly. * Only valid when "mjpeg_ratecontrolmode"= vbr and s<0~(m-1)>_mjpeg_quant = 99 |
| s<0~(m-1)>_mjpeg_qpercent | 1~100 | 4/4 | Select customized quality in a normalized full range. 1: Worst quality 100: Best quality * Only valid when "mjpeg_ratecontrolmode"= vbr and s<0~(m-1)>_mjpeg_quant = 100. |
| s<0~(m-1)>_mjpeg_maxvbrbitrate | 20000~"capability_videoinput_c<0~(n-1)>_mjpeg_maxbitrate" | 4/4 | The maximum allowed bit rate in fixed quality mode. When the bit rate exceeds this value, frames will be dropped to restrict the bit rate. * Only valid when |

| NAME | VALUE | SECURITY(get/set) | DESCRIPTION |
|---------------------------------|--|-----------------------|---|
| | | | "mjpeg_ratecontrolmode"= vbr |
| s<0~(m-1)>_mjpeg_cbr_quant | 1~5, 100 | 4/4 | Set the pre-defined quality level: 1: Medium 2: Standard 3: Good 4: Detailed 5: Excellent 100: Use the quality level in "cbr_qpercent" * Only valid when "mjpeg_ratecontrolmode"= cbr. |
| s<0~(m-1)>_mjpeg_cbr_qpercent | 1~100 | 4/4 | Select customized quality in a normalized full range. 1: Worst quality 100: Best quality * Only valid when "mjpeg_ratecontrolmode"= cbr and "quant"= 100. |
| s<0~(m-1)>_mjpeg_bitrate | 20000~"capability_videoin_c<0~(n-1)>_mjpeg_maxbitrate" | 4/4 | The target bit rate in constant bit rate mode. * Only valid when "mjpeg_ratecontrolmode"= cbr |
| s<0~(m-1)>_mjpeg_prioritypolicy | framerate,imagequality | 4/4 | Set prioritypolicy * Only valid when "mjpeg_ratecontrolmode"= cbr |
| s<0~(m-1)>_mjpeg_maxframe | 1~"capability_videoin_c<0~(n-1)>_mjpeg_maxframerate" | 1/4 | The maximum frame rates of a mjpeg stream at different resolutions("capability_videoin_c<0~(n-1)>_resolution") are recorded in "capability_videoin_c<0~(n-1)>_mjpeg_maxframerate" |
| s<0~(m-1)>_ratiocorrect | <boolean> | 1/4 | Change resolution to fit 4:3 ratio. For PAL: D1/4CIF(720/704x576) -> (768x576) |

| NAME | VALUE | SECURITY(get/set) | DESCRIPTION |
|---|-----------|-----------------------|--|
| | | | CIF(352x288)->(384x288) For NTSC: D1/4CIF(720/704x480) -> (640x480) CIF(352x240)->(320x240) * Only available when capability_videoin_type is 0 or 1. |
| wdrpro_mode <product dependent> | 0, 1, 2 | 4/4 | 0: Disable WDR Pro. 1: Enable WDR Pro. * Only valid when "capability_image_c<0~(n-1)>_wdrpro _mode" = 1 2: Enable WDR Pro II. * Only valid when "capability_image_c<0~(n-1)>_wdrpro _mode" = 2 |
| wdrpro_streng th <product dependent> | 1~100 | 4/4 | The strength of WDR Pro. The bigger value means the stronger strength of WDR Pro. * Only available when "capability_image_c<0~(n-1)>_wdrpro _strength" is 1 |
| wdrc_mode <product dependent> | <boolean> | 4/4 | Enable WDR enhanced. * Only available when "capability_image_c<0~(n-1)>_wdrc_ mode" is 1 |
| wdrc_strength <product dependent> | 1~100 | 4/4 | The strength of WDR enhanced. The bigger value means the stronger strength of WDR enhanced. * Only available when "capability_image_c<0~(n-1)>_wdrc_ mode" is 1 |
| aespeed_mod e <product dependent> | <boolean> | 4/4 | Turning AE converge speed on or off. 0: off 1: on * Only available when "capability_image_c<0~(n-1)>_aespee |

| NAME | VALUE | SECURITY(get/set) | DESCRIPTION |
|---|----------------------|-----------------------|--|
| | | | d" is 1 |
| aespeed_spe dlevel <product dependent> | 1~100 | 4/4 | The speed level of AE converge speed. 1~20: level 1 21~40: level 2 41~60: level 3 61~80: level 4 81~100: level 5 Level 1~4(low ~ high) The higher speed level meas shorter AE converged time during AE executing. * Only available when "capability_image_c<0~(n-1)>_aespee d" is 1 |
| aespeed_sensi tivity <product dependent> | 1~100 | 4/4 | The sensitivity of AE converge speed. 1~20: level 1 21~40: level 2 41~60: level 3 61~80: level 4 81~100: level 5 Level 1~4(low ~ high) The higher sensitivity level meas that it is easy to be trigger while scene changed. * Only available when "capability_image_c<0~(n-1)>_aespee d" is 1 and "capability_image_c<0~(n-1)>_aespee dsupportsensitivity" is 1. |
| flickerless <product dependent> | <boolean> | 4/4 | Turn on(1) or turn off(0) the flickerless mode * Only available when "capability_image_c<0~(n-1)>_flickerl ess" is 1. |
| mounttype | ceiling, wall, floor | 1/6 | Hardware installation. * Only available when |

| NAME | VALUE | SECURITY(get/set) | DESCRIPTION |
|---|--|--------------------|--|
| | | | "capability_videoin_c<0~(n-1)>_mounttype" != "-". |
| enablewatermark <product dependent> | 0, 1 | 1/6 | 0: Not to add watermarks on images 1: Add watermarks on images * Only available when "capability_fisheye" > 0 |
| s<0~(m-2)>_fisheyedewarpmode <product dependent> | '1O, 1P, 2P, 1R, 4R' for ceiling/floor mount '1O, 1P, 1R, 4R' for wall mount <product dependent> | 1/4 | Local dewarp mode. "1O" is original mode (disable). Supported dewarp mode is different by mount type. (videoin_c<0~(n-1)>_mounttype) Supported mode list could be extracted from (capability_videoin_c<0~(n-1)>_localdewarp_typeceilingmount) and (capability_videoin_c<0~(n-1)>_localdewarp_typewallmount) * Only available when "capability_fisheylowdewarp_c<0~(capability_nvideoin)-1>" > 0 |

Group: videoin_c<0~(n-1)>_s<0~(m-1)>_h264_smartstream2 (capability_smartstream_support=1 and capability_smartstream_version>=2.0)

Group: videoin_c<0~(n-1)>_s<0~(m-1)>_h265_smartstream2 (capability_smartstream_support=1, capability_smartstream_version>=2.0 and h265 is listed in "capability_videoin_codec")

n denotes the value of "capability_nvideoin", m denotes the value of "capability_nmediastream"

| NAME | VALUE | SECURITY (get/set) | DESCRIPTION |
|--------|----------------------------|--------------------|---|
| enable | <boolean> | 4/4 | Enable or Disable smart codec function |
| mode | autotracking,manual,hybrid | 4/4 | Set Smart stream mode "autotracking": only available when "capability_smartstream_mode_autotracking" is 1. "manual": only available when "capability_smartstream_mode_man |

| NAME | VALUE | SECURITY (get/set) | DESCRIPTION |
|-----------------|--------------------------|-----------------------|--|
| | | | ual" is 1. "hybrid" : only available when "capability_smartstream_mode_hybrid" is 1. |
| qualitypriority | -5,-4,-3,-2,-1,1,2,3,4,5 | 4/4 | The differential value of Q between the regions of interest (ROI) and the areas of non-interest (non-ROI) of the display image. If the value is a positive number, the video quality of ROI is better than the non-ROI areas. The level is from 1 to 5. Level 5 is the maximum level of the quality difference between the ROI and non-ROI areas. If the value is a negative number, the video quality of non-ROI areas is better than the ROI. The level is from -1 to -5. Level -5 is the maximum level of the quality difference between the ROI and non-ROI areas. |

Group: **videoin_c<0~(n-1)>_s<0~(m-1)>_h264_smartstream2_win_i<0~(k-1)>**
 (capability_smartstream_support=1, capability_smartstream_version>=2.0 and capability_smartstream_mode_manual = 1)

Group: **videoin_c<0~(n-1)>_s<0~(m-1)>_h265_smartstream2_win_i<0~(k-1)>**
 (capability_smartstream_support=1, capability_smartstream_version>=2.0 and h265 is listed in "capability_videoin_codec" and capability_smartstream_mode_manual = 1)

n denotes the value of "capability_nvideoin", m denotes the value of " capability_nmediastream", k denotes the value of "capability_smartstream_nwindow_manual".

| NAME | VALUE | SECURITY (get/set) | DESCRIPTION |
|--------|-------------|-----------------------|---|
| enable | <boolean> | 4/4 | Enable or disable the window. |
| home | 0~320,0~240 | 4/4 | Left-top corner coordinate of the window. |
| size | 0~320x0~240 | 4/4 | Width and height of the window |

7.8.1.1 Alternative Video Input Profiles per Channel

In addition to the primary setting of video input, there can be alternative profile video input setting for each channel which might be for different scene of light (daytime or nighttime).

Group: **videoin_c<0~(n-1)>_profile_i<0~(m-1)>** for n channel products and m profile

n denotes the value of "capability_nvideoin" and m denotes the value of

"capability_nvideoinprofile" (**capability_nvideoinprofile > 0**)

| NAME | VALUE | SECURITY (get/set) | DESCRIPTION |
|---------------------------------------|---|-----------------------|--|
| enable | <boolean> | 4/4 | Enable/disable this profile setting |
| policy | night, schedule | 4/4 | The mode which the profile is applied to. * Not support "policy=day" anymore when the version number (httpversion) is equal or greater than 0301a. |
| begintime | hh:mm | 4/4 | Begin time of schedule mode. |
| endtime | hh:mm | 4/4 | End time of schedule mode. |
| minexposure <product dependent> | <1~32000>, <5~32000>, <1~8000>, <5~8000>, etc. * Available value is listed in "capability_image_c<0~(n-1)>_exposure_minrange" | 4/4 | Minimum exposure time 1~32000 => 1s ~ 1/32000s 5~32000 => 1/5s ~ 1/32000s 1~8000 => 1s ~ 1/8000s 5~8000 => 1/5s ~ 1/8000s etc. * Only available when "capability_image_c<0~(n-1)>_exposure_minrange" != "-" * Only valid when "piris_mode"=manual or "irismode"=fixed * Only available when "capability_image_c<0~(n-1)>_exposure_rangetype" is "twovalues". |
| maxexposure <product dependent> | <1~32000>, <5~32000>, <1~8000>, <5~8000>, etc. | 4/4 | Maximum exposure time 1~32000 => 1s ~ 1/32000s 5~32000 => 1/5s ~ 1/32000s 1~8000 => 1s ~ 1/8000s 5~8000 => 1/5s ~ 1/8000s |

| NAME | VALUE | SECURITY (get/set) | DESCRIPTION |
|---|--|-----------------------|---|
| | <p>* Available value is listed in "capability_image_c<0~(n-1)>_exposure_maxrange"</p> | | <p>etc. * This parameter may also restrict image frame rate from sensor due to sensor generates a frame per exposure time. Ex: If this is set to 1/5s ~ 1/8000s and camera takes 1/5s on the night, then sensor only outputs 5 frame/s. * Only available when "capability_image_c<0~(n-1)>_exposure_maxrange" != "-" * Only valid when "piris_mode"=manual or "irismode"=fixed * Only available when "capability_image_c<0~(n-1)>_exposure_rangetype" is "twovalues".</p> |
| <p>shuttervalue <product dependent></p> | <p><1~32000>, <5~32000>, <1~8000>, <5~8000>, etc. * Available value is listed in "capability_image_c<0~(n-1)>_exposure_maxrange"</p> | <p>4/4</p> | <p>Exposure time 1~32000 => 1s ~ 1/32000s 5~32000 => 1/5s ~ 1/32000s 1~8000 => 1s ~ 1/8000s 5~8000 => 1/5s ~ 1/8000s etc. * This parameter may also restrict image frame rate from sensor due to sensor generates a frame per exposure time. Ex: If this is set to 1/5s ~ 1/8000s and camera takes 1/5s on the night, then sensor only outputs 5 frame/s. * Only available when "capability_image_c<0~(n-1)>_exposure_maxrange" != "-" and "capability_image_c<0~(n-1)>_exposure_rangetype" is "onevalue". * We support this parameter when</p> |

| NAME | VALUE | SECURITY (get/set) | DESCRIPTION |
|-------------------------------------|--|-----------------------|--|
| | | | the version number (httpversion) is equal or greater than 0302a. |
| enablebhc <Not support anymore> | <boolean> | 4/4 | Enable backlight compensation. * Not support this parameter anymore when the version number (httpversion) is equal or greater than 0301a. * It's recommended to use "exposurewin_c<n>_mode" to switch on/off BLC. |
| exposurelevel | 0~12 | 4/4 | Exposure level "0,12": This range takes the concept from DC's exposure tuning options. The definition is: 0: EV -2.0 1: EV -1.7 2: EV -1.3 3: EV -1.0 4: EV -0.7 5: EV -0.3 6: EV 0 7: EV +0.3 8: EV +0.7 9: EV +1.0 10: EV +1.3 11: EV +1.7 12: EV +2.0 *Only available when "capability_image_c0_exposure_mode" != 0 |
| exposuremode <product dependent> | auto, shutterpriority, irispriority, qualitypriority, manual, etc | 4/4 | Select exposure mode. " auto ": Automatically adjust the Iris, Gain and Shutter Speed to fit the exposure level. " shutterpriority ": Manually adjust with variable Shutter Speed, and keep |

| NAME | VALUE | SECURITY (get/set) | DESCRIPTION |
|--|--|-----------------------|---|
| | <p>(Available options are list in "capability_image_c<0~(n-1)>_exposure_modetype")</p> | | <p>adjusting Iris, Gain automatically. "irispriority": Manually adjust with variable Iris, and keep adjusting Gain and Shutter speed automatically. "qualitypriority": Automatically adjust the Iris, Gain and Shutter Speed by VIVOTEK quality algorithm. "manual": Manually adjust with variable Shutter, Iris and Gain. * We support this parameter when the version number (httpversion) is equal or greater than 0302a. *Only available when "capability_image_c0_exposure_mod e" != 0</p> |
| <p>whitebalance <product dependent></p> | <p>auto, panorama, manual, rbgain, widerange, outdoor, indoor, sodiumauto, etc</p> <p>(Available values are listed in "capability_image_c<0~(n-1)>_wbmode")</p> | <p>4/4</p> | <p>Modes of white balance. "auto": Auto white balance "panorama": indicates that camera would try to balance the white balance effect of every sensor. "rbgain": Use rgain and bgain to set white balance manually. "manual": 2 cases: a. if "rbgain" is not supported, this means keep current white balance status. b. if "rbgain" is supported, "rgain" and "bgain" are updated to the current values which is got from white balance module. Then, act as rbgain mode "widerange": Auto Tracing White balance (2000K to 10000K). "outdoor": auto white balance mode specifically for outdoor. "indoor": auto white balance mode</p> |

| NAME | VALUE | SECURITY (get/set) | DESCRIPTION |
|---------|-------|-----------------------|---|
| | | | specifically for indoor. "sodiumauto" : sodium vapor lamps. * Only available when "capability_image_c<0~(n-1)>_wbmode" != "-" |
| rgain | 0~100 | 4/4 | Manual set rgain value of gain control setting. 0: Weak <-> 100: Strong * Only available when "rbgain" is listed in "capability_image_c<0~(n-1)>_wbmode". * Only valid when "videoin_c<0~(n-1)>_whitebalance" != auto * Normalized range. |
| bgain | 0~100 | 4/4 | Manual set bgain value of gain control setting. 0: Weak <-> 100: Strong * Only available when "rbgain" is listed in "capability_image_c<0~(n-1)>_wbmode". * Only valid when "videoin_c<0~(n-1)>_whitebalance" != auto * Normalized range. |
| maxgain | 0~100 | 4/4 | Maximum gain value. 0: Low <-> 100: High * Only available when "capability_image_c<0~(n-1)>_agc_maxgain" != "-" * Only valid when "piris_mode"=manual or "irismode"=fixed * Normalized range. |

| NAME | VALUE | SECURITY (get/set) | DESCRIPTION |
|--------------|---|-----------------------|---|
| | | | * Only available when "capability_image_c<0~(n-1)>_exposure_rangetype" is "twovalues". |
| mingain | 0~100 | 4/4 | Minimum gain value. 0: Low <-> 100: High * Only available when "capability_image_c<0~(n-1)>_agc_mingain" != "-" * Only valid when "piris_mode"=manual or "irismode"=fixed * Normalized range. * Only available when "capability_image_c<0~(n-1)>_exposure_rangetype" is "twovalues". |
| gainvalue | 0~100 | 4/4 | Gain value. 0: Low <-> 100: High * Only available when "capability_image_c<0~(n-1)>_agc_maxgain" != "-" and "capability_image_c<0~(n-1)>_exposure_rangetype" is "onevalue". * Normalized range. * We support this parameter when the version number (httpversion) is equal or greater than 0302a. |
| meteringmode | auto, blc, hlc * Available value is listed in "capability_image_c<0~(n-1)>_exposure_meteringmode" | 4/4 | " auto ": The algorithm chooses the best metering strategy. " blc ": This metering method increases the weight of dark area. " hlc ": The metering method can detect strong light and make affected area clear. * We support this parameter when the version number (httpversion) is equal or greater than 0311a. |

| NAME | VALUE | SECURITY (get/set) | DESCRIPTION |
|---------------------------------------|---|-----------------------|--|
| piris_mode <product dependent> | manual, indoor, outdoor,- | 1/4 | Control P-Iris mode. "outdoor" : Auto-setting P-Iris to get best quality, but easy to meet rolling or flicker effect in indoor environment. "indoor" : Avoid rolling and flicker effect first. "manual" : Manual set P-Iris by "piris_position". "-" : not support (only available when "capability_image_c<0~(n-1)>_sensor type" is "smartsensor") * Only available when "capability_image_c<0~(n-1)>_iristype"="piris |
| piris_position <product dependent> | 1~100 | 1/4 | Manual set P-Iris. 1: Open <-> 100: Close * Only valid when "piris_mode"=manual or "capability_image_c<0~(n-1)>_sensor type" is "smartsensor" * Only available when "capability_image_c<0~(n-1)>_iristype"="piris |
| irismode | fixed, indoor, outdoor <product dependent> | 4/4 | Control DC-Iris mode. "outdoor" : Auto-setting DC-Iris to get best quality, but easy to meet rolling or flicker effect in indoor environment. "indoor" : Avoid rolling and flicker effect first. "fixed" : Open the iris to maximum. * Only available when "capability_image_c<0~(n-1)>_iristype"="dciris |
| wdrpro_mode | 0, 1, 2 | 4/4 | 0: Disable WDR Pro. |

| NAME | VALUE | SECURITY (get/set) | DESCRIPTION |
|---|-----------|-----------------------|---|
| <product dependent> | | | 1: Enable WDR Pro. * Only valid when "capability_image_c<0~(n-1)>_wdrpro_mode" = 1 2: Enable WDR Pro II. * Only valid when "capability_image_c<0~(n-1)>_wdrpro_mode" = 2 |
| wdrpro_strength <product dependent> | 1~100 | 4/4 | The strength of WDR Pro. The bigger value means the stronger strength of WDR Pro. * Only available when "capability_image_c<0~(n-1)>_wdrpro_strength" is 1 |
| wdrc_mode <product dependent> | <boolean> | 4/4 | Enable WDR enhanced. * Only available when "capability_image_c<0~(n-1)>_wdrc_mode" is 1 |
| wdrc_strength <product dependent> | 1~100 | 4/4 | The strength of WDR enhanced. The bigger value means the stronger strength of WDR enhanced. * Only available when "capability_image_c<0~(n-1)>_wdrc_mode" is 1 |
| aespeed_mode <product dependent> | <boolean> | 4/4 | Turning AE converge speed on or off. 0: off 1: on * Only available when "capability_image_c<0~(n-1)>_aespeed" is 1 |
| aespeed_speedlevel <product dependent> | 1~100 | 4/4 | The speed level of AE converge speed. 1~20: level 1 21~40: level 2 41~60: level 3 61~80: level 4 81~100: level 5 |

| NAME | VALUE | SECURITY (get/set) | DESCRIPTION |
|--|-----------|-----------------------|---|
| | | | <p>Level 1~4(low ~ high)</p> <p>The higher speed level meas shorter AE converged time during AE executing.</p> <p>* Only available when "capability_image_c<0~(n-1)>_aespeed" is 1</p> |
| aespeed_sensitivity <product dependent> | 1~100 | 4/4 | <p>The sensitivity of AE converge speed.</p> <p>1~20: level 1 21~40: level 2 41~60: level 3 61~80: level 4 81~100: level 5</p> <p>Level 1~4(low ~ high)</p> <p>The higher sensitivity level meas that it is easy to be trigger while scene changed.</p> <p>* Only available when "capability_image_c<0~(n-1)>_aespeed" is 1 and "capability_image_c<0~(n-1)>_aespeedsupportsensitivity" is 1.</p> |
| flickerless <product dependent> | <boolean> | 4/4 | <p>Turn on(1) or turn off(0) the flickerless mode</p> <p>* Only available when "capability_image_c<0~(n-1)>_flickerless" is 1</p> |

7.9 Time Shift Settings

Group: **timeshift** for n channel products and m stream

n denotes the value of "capability_nvideoin", m denotes the value of "capability_nmediastream"

(capability_timeshift > 0)

| NAME | VALUE | SECURITY (get/set) | DESCRIPTION |
|-----------------------------------|-----------|-----------------------|--|
| enable <Not supported anymore> | <boolean> | 4/4 | Enable time shift streaming. * We replace this parameter with "timeshift_c<0~(n-1)>_enable" when the version number (httpversion) is equal or greater than 0312a. |
| c<0~(n-1)>_enable | <boolean> | 4/4 | Enable time shift streaming. * We support this parameter when the version number (httpversion) is equal or greater than 0312a. |
| c<0~(n-1)>_s<0~(m-1)>_allow | <boolean> | 4/4 | Enable time shift streaming for specific stream. |

7.10 IR Cut Control

<Not supported anymore>

Group: **ircutcontrol** (`capability__nvideoinprofile`> 0 and `capability_daynight_c<0~(n-1)>_support` > 0)

n denotes the value of "capability_nvideoin"

| NAME | VALUE | SECURITY (get/set) | DESCRIPTION |
|---|---|-----------------------|--|
| mode <Not recommended to use this> | auto, day, night, di, schedule...etc * Available values are listed in "capability_daynight_c<0~(n-1)>_mode" <product dependent> | 6/6 | Set IR cut control mode * We replace this parameter with "ircutcontrol_c0_mode" when the version number (httpversion) is equal or greater than 0312a. |
| sir <product dependent> <Not recommended to use this> | <boolean> | 6/6 | Enable/disable Smart IR * Only available when "capability_daynight_c<0~"capability_nvideoin"-1>_smartir" is 1 * We replace this parameter with "ircutcontrol_c<0~(n-1)>_sir" when the version number (httpversion) is equal or greater than 0312a. |
| daymodebetime <Not recommended to use this> | 00:00~23:59 | 6/6 | Day mode begin time * We replace this parameter with "ircutcontrol_c<0~(n-1)>_daymodebetime" when the version number (httpversion) is equal or greater than 0312a. |
| daymodeendtime <Not recommended to use this> | 00:00~23:59 | 6/6 | Day mod end time * We replace this parameter with "ircutcontrol_c<0~(n-1)>_daymodeendtime" when the version number (httpversion) is equal or greater than |

| NAME | VALUE | SECURITY (get/set) | DESCRIPTION |
|---|-----------|-----------------------|--|
| | | | 0312a. |
| disableirled <Not recommended to use this> | <boolean> | 6/6 | Enable/disable built-in IR led * Only available when "capability_daynight_illuminators_builtin_support > 0" and irled is listed in "capability_daynight_illuminators_builtin_type" * We replace this parameter with "ircutcontrol_illuminators_builtin_irled_enabled" when the version number (httpversion) is equal or greater than 0312a. |
| enableextled <Not recommended to use this> | <boolean> | 1/6 | Enable/disable external IR led * Only available when "capability_daynight_illuminators_external_support > 0". * We replace this parameter with "ircutcontrol_illuminators_external_d_o_enabled" when the version number (httpversion) is equal or greater than 0312a. |
| enablewled <Not recommended to use this> | <boolean> | 6/6 | Enable/disable built-in White led * Only available when "capability_daynight_illuminators_builtin_support > 0" and whiteled is listed in "capability_daynight_illuminators_builtin_type" * We replace this parameter with "ircutcontrol_illuminators_builtin_whiteled_enabled" when the version number (httpversion) is equal or greater than 0312a. |
| bwmode <Not recommended to use this> | <boolean> | 6/6 | Switch to B/W in night mode if enabled. * Only available when "capability_daynight_c<0~(n-1)>_ |

| NAME | VALUE | SECURITY (get/set) | DESCRIPTION |
|--|---|-----------------------|---|
| | | | blackwhitemode" is 1. * We replace this parameter with "ircutcontrol_c<0~(n-1)>_bwmode" when the version number (httpversion) is equal or greater than 0312a. |
| sensitivity <Not recommended to use this> | low,normal,high,1~10 0 | 6/6 | Sensitivity of day/night control. There are two value format: "low,normal,high" : if capability_daynight_c<0~(n-1)>_ircutsensitivity_type=options "1~100" : if capability_daynight_c<0~(n-1)>_ircutsensitivity_type=normalize * Only available when "capability_daynight_c<0~(n-1)>_ircutsensitivity_type" is not "-". * We replace this parameter with ircutcontrol_c<0~(n-1)>_sensitivity" when the version number (httpversion) is equal or greater than 0312a. |
| spectrum_mode <Not recommended to use this> | visible, ir, irenhanced, blueenhanced <product dependent> * Available values are listed in "capability_daynight_c<0~(n-1)>_spectrum_mode". | 6/6 | Set spectrum method . * Only available when "capability_daynight_illuminators_spectrum_support > 0". * We replace this parameter with "ircutcontrol_illuminators_spectrum_mode" when the version number (httpversion) is equal or greater than 0312a. |

| | | | |
|--|--|--|--|
| | | | |
|--|--|--|--|

7.10.1 IR cut control setting per channel

Group: `ircutcontrol_c<0~(n-1)>` for n channel products (`capability_daynight_c<0~(n-1)>_support > 0`)

n denotes the value of "capability_nvideoin"

| NAME | VALUE | SECURITY (get/set) | DESCRIPTION |
|---|--|-----------------------|---|
| mode | auto, day, night, di, schedule...etc * Available values are listed in "capability_daynight_c<0~(n-1)>_mode" <product dependent> | 6/6 | Set IR cut control mode * We support this parameter when the version number (httpversion) is equal or greater than 0312a. |
| sir <product dependent> | <boolean> | 6/6 | Enable/disable Smart IR * Only available when "capability_daynight_c<0~"capability_nvideoin"-1>_smartir" is 1 * We support this parameter when the version number (httpversion) is equal or greater than 0312a. |
| daymodebegintime | 00:00~23:59 | 6/6 | Day mode begin time * We support this parameter when the version number (httpversion) is equal or greater than 0312a. |
| daymodeendtime | 00:00~23:59 | 6/6 | Day mod end time * We support this parameter when the version number (httpversion) is equal or greater than 0312a. |
| bwmode | <boolean> | 6/6 | Switch to B/W in night mode if enabled. |

| | | | |
|-------------|-----------------------|-----|--|
| | | | <p>* Only available when "capability_daynight_c<0~(n-1)>_blackwhitemode" is 1.</p> <p>* We support this parameter when the version number (httpversion) is equal or greater than 0312a.</p> |
| sensitivity | low,normal,high,1~100 | 6/6 | <p>Sensitivity of day/night control.</p> <p>There are two value format:</p> <p>"low,normal,high": if capability_daynight_c<0~(n-1)>_ircutsensitivity_type=options</p> <p>"1~100": if capability_daynight_c<0~(n-1)>_ircutsensitivity_type=normalize</p> <p>* Only available when "capability_daynight_c<0~(n-1)>_ircutsensitivity_type" is not "-".</p> <p>* We support this parameter when the version number (httpversion) is equal or greater than 0312a.</p> |

7.10.2 IR cut control Illuminators

Group: **ircutcontrol_illuminators** (capability_daynight_c<0~(n-1)>_support > 0)

n denotes the value of "capability_nvideoin"

| NAME | VALUE | SECURITY (get/set) | DESCRIPTION |
|-----------------------|-----------|-----------------------|---|
| builtin_irmed_enabled | <boolean> | 6/6 | <p>Enable/disable built-in IR led</p> <p>* Only available when "capability_daynight_illuminators_builtin_support > 0" and "irmed" is listed in "capability_daynight_illuminators_builtin_type"</p> <p>* We support this parameter when the version number (httpversion) is</p> |

| | | | |
|---|--------------------------------|-----|---|
| | | | equal or greater than 0312a. |
| builtin_whiteled_enabled | <boolean> | 6/6 | Enable/disable built-in white led * Only available when "capability_daynight_illuminators_builtin_support > 0" and "whiteled" is listed in "capability_daynight_illuminators_builtin_type" * We support this parameter when the version number (httpversion) is equal or greater than 0312a. |
| external_do_enabled | <boolean> | 1/6 | Enable/disable external led mounted on do1 * Only available when "capability_daynight_illuminators_external_support > 0" and "do" is listed in "capability_daynight_illuminators_external_interface". * We support this parameter when the version number (httpversion) is equal or greater than 0312a. |
| external_do<2~(capability_ndo)>_enabled | <boolean> | 1/6 | Enable/disable external led mounted on do<2~(capability_ndo)> * Only available when "capability_ndo > 1" * Only available when "capability_daynight_illuminators_external_support > 0" and "do<2~(capability_ndo)>" are listed in "capability_daynight_illuminators_external_interface". * We support this parameter when the version number (httpversion) is equal or greater than 0312a. |
| spectrum_mode | visible, ir, irenhanced, | 6/6 | Set spectrum method . * We support this parameter when the version number (httpversion) is |

| | | | |
|--|--|--|---|
| | blueenhanced <product dependent> * Available values are listed in "capability_daynig ht_illuminators _spectrum_mode" . | | equal or greater than 0312a. * Only available when "capability_daynight_illuminators_ spectrum_support > 0". |
|--|--|--|---|

7.11 Image Setting per Channel

Group: **image_c<0~(n-1)>** for n channel products and m profile

n denotes the value of "capability_nvideoin" and m denotes the value of "capability_nvideoinprofile"

| NAME | VALUE | SECURITY (get/set) | DESCRIPTION |
|---|----------|-----------------------|--|
| brightness <Not recommended to use this> | -5~5,100 | 4/4 | -5: Darker <-> 5: Bright 100: Use " image_c<n>_brightnesspercent" * Only available when bit 0 of "capability_image_c<0~(n-1)>_basicse tting" is 1 * We replace "brightness" with "brightnesspercent". * This parameter will not be used after the version number (httpversion) is equal or greater than 0400a. |
| contrast <Not recommended to use this> | -5~5,100 | 4/4 | -5: Less contrast <-> 5: More contrast 100: Use " image_c<0~(n-1)>_contrastpercent" * Only available when bit 1 of "capability_image_c<0~(n-1)>_basicse tting" is 1. * We replace "contrast" with "contrastpercent". * This parameter will not be used after the version number (httpversion) |

| NAME | VALUE | SECURITY (get/set) | DESCRIPTION |
|---|----------|-----------------------|---|
| | | | is equal or greater than 0400a. |
| saturation <Not recommended to use this> | -5~5,100 | 4/4 | -5: Less saturation <-> 5: More saturation 100: Use " image_c<n>_saturationpercent" * Only available when bit 2 of "capability_image_c<0~(n-1)>_basicsetting" is 1. * We replace "saturation" with "saturationpercent". * This parameter will not be used after the version number (httpversion) is equal or greater than 0400a. |
| sharpness <Not recommended to use this> | -3~3,100 | 4/4 | -3: Softer <-> 3: Sharper 100: Use " image_c<0~(n-1)>_sharpnesspercent" * Only available when bit 3 of "capability_image_c<0~(n-1)>_basicsetting" is 1. * We replace "sharpness" with "sharpnesspercent". * This parameter will not be used after the version number (httpversion) is equal or greater than 0400a. |
| brightnesspercent | 0~100 | 4/4 | Set brightness in the normalized range. 0: Darker <-> 100: Bright * Only available when bit 0 of "capability_image_c<0~(n-1)>_basicsetting" is 1. |
| contrastpercent | 0~100 | 4/4 | Set contrast in the normalized range. 0: Less contrast <-> 100: More contrast * Only available when bit 1 of "capability_image_c<0~(n-1)>_basicsetting" is 1 |

| NAME | VALUE | SECURITY (get/set) | DESCRIPTION |
|-------------------------------------|-----------|-----------------------|--|
| saturationpercent | 0~100 | 4/4 | Set saturation in the normalized range. 0: Less saturation <-> 100: More saturation * Only available when bit 2 of "capability_image_c<0~(n-1)>_basicsetting" is 1. |
| sharpnesspercent | 0~100 | 4/4 | Set sharpness in the normalized range. 0: Softer <-> 100: Sharper * Only available when bit 3 of "capability_image_c<0~(n-1)>_basicsetting" is 1 |
| gammacurve <product dependent> | 0~100 | 4/4 | 0: Fine-tuned gamma curve by Vivotek. 1: Gamma value = 0.01 2: Gamma value = 0.02 3: Gamma value = 0.03 ... 100: Gamma value = 1 * Note: Although we set gamma value to 100 level, but not all gamma values are valid. Internal module will take the closest valid one. For example, 1~45 may all be mapped to gamma value = 0.45, etc. * Only available when "capability_image_c<0~(n-1)>_gammacurve" is 1 |
| lowlightmode <product dependent> | <boolean> | 4/4 | Enable/disable low light mode. * Only available when "capability_image_c<0~(n-1)>_lowlightmode" is 1 |
| hlm <product dependent> | <boolean> | 4/4 | Enable/disable highlight mask. * Only available when "capability_image_c<0~(n-1)>_hlm" is |

| NAME | VALUE | SECURITY (get/set) | DESCRIPTION |
|--|-----------|-----------------------|--|
| | | | 1 |
| dnr_mode <product dependent> | <boolean> | 4/4 | 3D noise reduction. 0:disable 1:enable * Only available when "capability_image_c<0~(n-1)>_dnr" is 1 |
| dnr_strength <product dependent> | 1~100 | 4/4 | Strength of 3DNR * Only available when "capability_image_c<0~(n-1)>_dnr" is 1 |
| defog_mode <product dependent> | <boolean> | 4/4 | Enable/disable defog mode. 0:disable 1:enable * Only available when "capability_image_c<0~(n-1)>_defog_ mode" is 1 |
| defog_strength <product dependent> | 1~100 | 4/4 | Strength of defog * Only available when "capability_image_c<0~(n-1)>_defog_ mode" is 1 |
| eis_mode <product dependent> | <boolean> | 4/4 | Electronic image stabilizer 0:disable 1:enable * Only available when 'eis' is listed in "capability_image_c<0~(n-1)>_is_mod e". |
| eis_strength <product dependent> | 1~100 | 4/4 | Strength of electronic image stabilizer * Only available when 'eis' is listed in "capability_image_c<0~(n-1)>_is_mod e". |
| dis_mode <product dependent> | <boolean> | 4/4 | Digital image stabilizer 0:disable 1:enable * Only available when 'dis' is listed in "capability_image_c<0~(n-1)>_is_mod |

| NAME | VALUE | SECURITY (get/set) | DESCRIPTION |
|-------------------------------------|--|-----------------------|--|
| | | | e". |
| dis_strength <product dependent> | 1~100 | 4/4 | Strength of digital image stabilizer * Only available when 'dis' is listed in "capability_image_c<0~(n-1)>_is_mode". |
| scene_mode <product dependent> | visibility, noiseless, lpcparkinglot, lpcstreet, lpchighway, auto, deblur, lpcfreesway <product dependent> * Available values are listed in "capability_image_c<0~(n-1)>_scenemode_supporttype" | 4/4 | Value of scene mode * Only available when "capability_image_c<0~(n-1)>_scenemode_support" is 1 |
| restoreatwb | <positive integer> | 4/4 | Restore of adjusting white balance of image according to mode settings |
| freeze <product dependent> | <boolean> | 4/4 | Enable/disable Image freeze while patrolling. 0: disable 1: enable * Only available when "capability_image_c<0~(n-1)>_freeze" is 1 |
| deinterlace_enable | <boolean> | 4/4 | Enable/disable deinterlace function. 0: disable 1: enable * Only available when "capability_image_c<0~(n-1)>_deinterlace_support" is 1. |
| deinterlace_mode | spatial,blend | 4/4 | Users can choose between two different deinterlacing techniques: |

| NAME | VALUE | SECURITY (get/set) | DESCRIPTION |
|----------------|---|-----------------------|--|
| | | | <p>Spatial mode provides the best image quality, while Blend mode provides better image quality (than not using the deinterlace function at all).</p> <p>* Only available when "capability_image_c<0~(n-1)>_deinterlace_support" is 1.</p> |
| xoffset | 0~100 | 4/4 | <p>Adjusting the image to proper position horizontally.</p> <p>* Only available when the bit 4 of capability_image_c<0~(n-1)>_basicsetting is 1.</p> |
| yoffset | 0~100 | 4/4 | <p>Adjusting the image to proper position vertically.</p> <p>* Only available when the bit 5 of capability_image_c<0~(n-1)>_basicsetting is 1.</p> |
| lens_alignment | 0~100 | 4/4 | <p>Stitch the sensors together into focused position.</p> <p>* Only available when "capability_image_c<0~(n-1)>_lens_alignment" is 1.</p> |
| lens_ldc_mode | <boolean> | 4/4 | <p>Enable/disable lens distortion correction.</p> <p>* Only available when "capability_image_c<0~(n-1)>_lens_ldc_support" is 1.</p> |
| palette_mode | Available value is listed in "capability_image_c<0~(n-1)>_palette_mode" | 1/4 | <p>Set color palette option.</p> <p>* Only available when "capability_image_c<0~(n-1)>_palette_support" is 1.</p> <p>* Not support "policy=day" anymore when the version number</p> |

| NAME | VALUE | SECURITY (get/set) | DESCRIPTION |
|--|--------------------|-----------------------|--|
| | | | (httpversion) is equal or greater than 0310a. |
| profile_i<0~(m-1)>_enable | <boolean> | 4/4 | Enable/disable this profile setting |
| profile_i<0~(m-1)>_policy | night, schedule | 4/4 | The mode which the profile is applied to. * Not support "policy=day" anymore when the version number (httpversion) is equal or greater than 0301a. |
| profile_i<0~(m-1)>_begintime | hh:mm | 4/4 | Begin time of schedule mode. |
| profile_i<0~(m-1)>_endtime | hh:mm | 4/4 | End time of schedule mode. |
| profile_i<0~(m-1)>_brightness <Not recommended to use this> | -5~5,100 | 4/4 | -5: Darker <-> 5: Bright 100: Use " image_c<0~(n-1)>_brightnesspercent" * Only available when bit 0 of "capability_image_c<0~(n-1)>_basicsetting" is 1 * We replace "profile_i0_brightness" with "profile_i0_brightnesspercent". * This parameter will not be used after the version number (httpversion) is equal or greater than 0400a. |
| profile_i<0~(m-1)>_contrast <Not recommended to use this> | -5~5,100 | 4/4 | -5: Less contrast <-> 5: More contrast 100: Use " image_c<0~(n-1)>_contrastpercent" * Only available when bit 1 of "capability_image_c<0~(n-1)>_basicsetting" is 1. |

| NAME | VALUE | SECURITY (get/set) | DESCRIPTION |
|--|----------|-----------------------|--|
| | | | <p>* We replace "profile_i0_contrast" with "profile_i0_contrastpercent".</p> <p>* This parameter will not be used after the version number (httpversion) is equal or greater than 0400a.</p> |
| profile_i<0~(m-1)> _saturation <Not recommended to use this> | -5~5,100 | 4/4 | <p>-5: Less saturation <-> 5: More saturation</p> <p>100: Use "image_c<0~(n-1)>_saturationpercent"</p> <p>* Only available when bit 2 of "capability_image_c<0~(n-1)>_basicsetting" is 1.</p> <p>* We replace "profile_i0_saturation" with "profile_i0_saturationpercent".</p> <p>* This parameter will not be used after the version number (httpversion) is equal or greater than 0400a.</p> |
| profile_i<0~(m-1)> _sharpness <Not recommended to use this> | -3~3,100 | 4/4 | <p>-5: Less saturation <-> 5: More saturation</p> <p>100: Use "image_c<0~(n-1)>_saturationpercent"</p> <p>* Only available when bit 2 of "capability_image_c<0~(n-1)>_basicsetting" is 1.</p> <p>* We replace "profile_i0_saturation" with "profile_i0_saturationpercent".</p> <p>* This parameter will not be used after the version number (httpversion) is equal or greater than 0400a.</p> |
| profile_i<0~(m-1)> _brightnesspercent | 0~100 | 4/4 | <p>Set brightness in the normalized range.</p> <p>0: Darker <-> 100: Bright</p> |

| NAME | VALUE | SECURITY (get/set) | DESCRIPTION |
|--------------------------------------|-------|-----------------------|--|
| | | | * Only available when bit 0 of "capability_image_c<0~(n-1)>_basicsetting" is 1. |
| profile_i<0~(m-1)>_contrastpercent | 0~100 | 4/4 | Set contrast in the normalized range. 0: Less contrast <-> 100: More contrast * Only available when bit 1 of "capability_image_c<0~(n-1)>_basicsetting" is 1 |
| profile_i<0~(m-1)>_saturationpercent | 0~100 | 4/4 | Set saturation in the normalized range. 0: Less saturation <-> 100: More saturation * Only available when bit 2 of "capability_image_c<0~(n-1)>_basicsetting" is 1. |
| profile_i<0~(m-1)>_sharpnesspercent | 0~100 | 4/4 | Set sharpness in the normalized range. 0: Softer <-> 100: Sharper * Only available when bit 3 of "capability_image_c<0~(n-1)>_basicsetting" is 1 |
| profile_i<0~(m-1)>_gammacurve | 0~100 | 4/4 | 0: Fine-tuned gamma curve by Vivotek. 1: Gamma value = 0.01 2: Gamma value = 0.02 3: Gamma value = 0.03 ... 100: Gamma value = 1 * Note: Although we set gamma value to 100 level, but not all gamma values are valid. Internal module will take the closest valid one. For example, 1~45 may all be mapped to gamma value = 0.45, etc. * Only available when |

| NAME | VALUE | SECURITY (get/set) | DESCRIPTION |
|---|-----------|-----------------------|--|
| | | | "capability_image_c<0~(n-1)>_gammacurve" is 1 |
| profile_i<0~(m-1)> _lowlightmode <product dependent> | <boolean> | 4/4 | Enable/disable low light mode. * Only available when "capability_image_c<0~(n-1)>_lowlightmode" is 1 |
| profile_i<0~(m-1)> _hlm <product dependent> | <boolean> | 4/4 | Enable/disable highlight mask. * Only available when "capability_image_c<0~(n-1)>_hlm" is 1 |
| profile_i<0~(m-1)> _dnr_mode <product dependent> | <boolean> | 4/4 | 3D noise reduction. 0:disable 1:enable * Only available when "capability_image_c<0~(n-1)>_dnr" is 1 |
| profile_i<0~(m-1)> _dnr_strength <product dependent> | 1~100 | 4/4 | Strength of 3DNR * Only available when "capability_image_c<0~(n-1)>_dnr" is 1 |
| profile_i<0~(m-1)> _defog_mode <product dependent> | <boolean> | 4/4 | Enable/disable defog mode. 0:disable 1:enable * Only available when "capability_image_c<0~(n-1)>_defog_mode" is 1 |
| profile_i<0~(m-1)> _defog_strength <product dependent> | 1~100 | 4/4 | Strength of defog * Only available when "capability_image_c<0~(n-1)>_defog_mode" is 1 |
| profile_i<0~(m-1)> _eis_mode <product dependent> | <boolean> | 4/4 | Electronic image stabilizer 0:disable 1:enable * Only available when 'eis' is listed in "capability_image_c<0~(n-1)>_is_mode". |

| NAME | VALUE | SECURITY (get/set) | DESCRIPTION |
|---|-----------|-----------------------|---|
| profile_i<0~(m-1)> _eis_strength <product dependent> | 1~100 | 4/4 | Strength of electronic image stabilizer * Only available when 'eis' is listed in "capability_image_c<0~(n-1)>_is_mod e". |
| profile_i<0~(m-1)> _dis_mode <product dependent> | <boolean> | 4/4 | Digital image stabilizer 0:disable 1:enable * Only available when 'dis' is listed in "capability_image_c<0~(n-1)>_is_mod e". |
| profile_i<0~(m-1)> _dis_strength <product dependent> | 1~100 | 4/4 | Strength of digital image stabilizer * Only available when 'dis' is listed in "capability_image_c<0~(n-1)>_is_mod e". |

7.12 Exposure Window Setting per Channel

Group: **exposurewin_c<0~(n-1)>** for n channel products

n denotes the value of "capability_nvideoin"

(Only available when "capability_image_c<0~(n-1)>_exposure_mode"=1)

| NAME | VALUE | SECURITY (get/set) | DESCRIPTION |
|------|---|-----------------------|--|
| mode | auto, custom,blc,hlc,center * Available values are listed in "capability_image_c<0~(n-1)>_exposure_winmode" | 4/4 | " auto ": Use full image view as the only exposure window. " custom ": Use custom windows. " blc ": Use BLC(Back Light Compensation), and the only exposure window is located at the center of view. " hlc ": Use HLC (High Light Compensation), and to perform the masking of bright light area. " center ": Use Center window as metering area and give the necessary light compensation. |

Group: **exposurewin_c<0~(n-1)>_win_i<0~(k-1)>**

n denotes the value of "capability_nvideoin",

k denotes the value of "capability_image_c<0~(n-1)>_exposure_winnum".

(Only available when "capability_image_c<0~(n-1)>_exposure_mode"=1 and when custom is listed in "capability_image_c<0~(n-1)>_exposure_winmode" and valid when

"exposurewin_c<0~(n-1)>_mode"=custom or "exposurewin_c<0~(n-1)>_mode"=hlc)

| NAME | VALUE | SECURITY (get/set) | DESCRIPTION |
|--------|---------------|-----------------------|---|
| enable | <boolean> | 4/4 | Enable or disable the window. |
| policy | 0~1 | 4/4 | 0: Indicate exclusive. 1: Indicate inclusive. * Only available when exclusive is listed in "capability_image_c<0~(n-1)>_exposure_wintype". |
| home | <0~320,0~240> | 4/4 | Left-top corner coordinate of the |

| NAME | VALUE | SECURITY (get/set) | DESCRIPTION |
|---------|---|-----------------------|--|
| | | | <p>window.</p> <p>* Only available when qvga is listed in "capability_image_c<0~(n-1)>_exposure_windomain".</p> |
| size | <0~320x0~240> | 4/4 | <p>Width and height of the window.</p> <p>* Only available when qvga is listed in "capability_image_c<0~(n-1)>_exposure_windomain".</p> |
| homepx | <0~W,0~H> W: 0~ The current image width -1 H: 0~ The current image height -1 | 4/4 | <p>Left-top corner coordinate of the window.</p> <p>* Only available when px is listed in "capability_image_c<0~(n-1)>_exposure_windomain".</p> |
| sizepx | <0~Wx0~ H> W: 0~ The current image width -1 H: 0~ The current image height -1 | 4/4 | <p>Width and height of the window.</p> <p>* Only available when px is listed in "capability_image_c<0~(n-1)>_exposure_windomain".</p> |
| homestd | <0~9999,0~9999> | 4/4 | <p>Left-top corner coordinate of the window.</p> <p>* Only available when std is listed in "capability_image_c<0~(n-1)>_exposure_windomain".</p> |
| sizestd | <0~9999x0~9999> | 4/4 | <p>Width and height of the window.</p> <p>* Only available when std is listed in "capability_image_c<0~(n-1)>_exposure_windomain".</p> |

Group: **exposurewin_c<0~(n-1)>_profile_i<0~(m-1)>** for n channel product and m profile, n denotes the value of "capability_nvideoin", m denotes the value of "capability_nvideoinprofile",

(Only available when "capability_image_c<0~(n-1)>_exposure_mode"=1)

| NAME | VALUE | SECURITY (get/set) | DESCRIPTION |
|------|---|-----------------------|---|
| mode | auto, custom,blc,hlc,center * Available values are listed in "capability_image_c<0~(n-1)>_exposure_winmode" | 4/4 | The mode indicates how to decide the exposure. "auto" : Use full view as the only one exposure window. "custom" : Use inclusive and exclusive window. "blc" : Use BLC(Back Light Compensation), and the only exposure window is located at the center of view. "hlc" : Use HLC (High Light Compensation), and to perform the masking of bright light area. "center" : Use Center window as metering area and give the necessary light compensation. |

Group: **exposurewin_c<0~(n-1)>_profile_i<0~(m-1)>_win_i<0~(k-1)>** for m profile and n channel product,

n denotes the value of "capability_nvideoin", m denotes the value of "capability_nvideoinprofile", k denotes the value of "capability_image_c<0~(n-1)>_exposure_winnum".

(Only available when "capability_image_c<0~(n-1)>_exposure_mode"=1 and when custom is listed in "capability_image_c<0~(n-1)>_exposure_winmode" and valid when "exposurewin_c<0~(n-1)>_mode"=custom or "exposurewin_c<0~(n-1)>_mode"=hlc)

| NAME | VALUE | SECURITY (get/set) | DESCRIPTION |
|--------|---------------|-----------------------|---|
| enable | <boolean> | 4/4 | Enable or disable the window. |
| policy | 0~1 | 4/4 | 0: Indicate exclusive. 1: Indicate inclusive. * Only available when exclusive is listed in "capability_image_c<0~(n-1)>_exposure_wintype". |
| home | <0~320,0~240> | 4/4 | Left-top corner coordinate of the window. |

| NAME | VALUE | SECURITY (get/set) | DESCRIPTION |
|---------|---|-----------------------|---|
| | | | * Only available when qvga is listed in "capability_image_c<0~(n-1)>_exposure_windomain". |
| size | <0~320x0~240> | 4/4 | Width and height of the window. * Only available when qvga is listed in "capability_image_c<0~(n-1)>_exposure_windomain". |
| homepx | <0~W,0~H> W: 0~ The current image width -1 H: 0~ The current image height -1 | 4/4 | Left-top corner coordinate of the window. * Only available when px is listed in "capability_image_c<0~(n-1)>_exposure_windomain". |
| sizepx | <0~Wx0~ H> W: 0~ The current image width -1 H: 0~ The current image height -1 | 4/4 | Width and height of the window. * Only available when px is listed in "capability_image_c<0~(n-1)>_exposure_windomain". |
| homestd | <0~9999,0~9999> | 4/4 | Left-top corner coordinate of the window. * Only available when std is listed in "capability_image_c<0~(n-1)>_exposure_windomain". |
| sizestd | <0~9999x0~9999> | 4/4 | Width and height of the window. * Only available when std is listed in "capability_image_c<0~(n-1)>_exposure_windomain". |

7.13 Audio Input per Channel

Group: `audioin_c<0~(n-1)>` (`capability_ndaudioin>0`)

n denotes the value of "capability_ndaudioin"

| NAME | VALUE | SECURITY (get/set) | DESCRIPTION |
|--|--|-----------------------|---|
| source <Not recommended to use this> | micin, linein <product dependent> | 4/4 | micin => use built-in microphone input. linein => use external microphone input. * Reserved for compatibility, and suggest don't use this since the version number (httpversion) is equal or greater than 0301a. * We replace "source" with "input". More details, please refer the parameter description of "input". |
| input | intmic, extmic <product dependent> | 4/4 | intmic: Internal (built-in) microphone. (Only available when capability_audio_intmic = 1) extmic: External microphone input. (Only available when capability_audio_extmic =1) * Note: If physical microphone switch is showed on product, this value is updated during booting to fit switch status. |
| volume_internal | 0~100 | 4/4 | Volume when take internal microphone as input source. 0: Minimum 100: Maximum * Only available when the channel supports internal microphone (The related bit of "capability_audio_intmic" is equal to 1). |

| NAME | VALUE | SECURITY (get/set) | DESCRIPTION |
|---|-------|-----------------------|---|
| volume_external | 0~100 | 4/4 | Volume when take external microphone as input source. 0: Minimum 100: Maximum * Only available when the channel supports external microphone (The related bit of "capability_audio_extmic" is equal to 1). |
| mute | 0, 1 | 1/4 | 0: Mute off 1: Mute on |
| gain <Not recommended to use this> | 0~100 | 4/4 | Gain of input. (audioin_c<0~(n-1)>_source = linein) * Reserved for compatibility, and suggest don't use this since the version number (httpversion) is equal or greater than 0301a. * We replace "gain" with "volume_internal" and "volume_external". More details, please refer the parameter description of "volume_internal" and "volume_external". |
| boostmic <Not recommended to use this> | 0~100 | 4/4 | Enable microphone boost. Gain of input. (audioin_c<0~(n-1)>_source = micin) * Reserved for compatibility, and suggest don't use this since the version number (httpversion) is equal or greater than 0301a. * We replace "boostmic" with "volume_internal" and "volume_external". More details, please refer the parameter |

| NAME | VALUE | SECURITY (get/set) | DESCRIPTION |
|------------------------------|---|-----------------------|--|
| | | | description of "volume_internal" and "volume_external". |
| s0_codecstype | aac4, gamr, g711, g726 (Available codec are listed in "capability_audioin_codec") | 4/4 | Set audio codec type for input. aac4: Advanced Audio Coding (AAC) gamr: Adaptive Multi-Rate (AMR) g711: G.711 g726: G.726 |
| s0_aac4_bitrate | 16000, 32000, 48000, 64000, 96000, 128000 | 4/4 | Set AAC4 bitrate in bps. * Only available if AAC is supported. |
| s0_gamr_bitrate | 4750, 5150, 5900, 6700, 7400, 7950, 10200, 12200 | 4/4 | AMR encoded bitrate in bps. * Only available if AMR is supported. |
| s0_g711_mode | pcmu, pcma | 4/4 | Set G.711 companding algorithm. pcmu: μ -law algorithm pcma: A-law algorithm * Only available if G.711 is supported. |
| s0_g726_bitrate | 16000, 24000, 32000, 40000 | 4/4 | Set G.726 encoded bitrate in bps. * Only available if G.726 is supported. |
| s0_g726_bitstreampackingmode | little, big | 4/4 | Set G.726 bit streaming packing mode. little: Little-endian bitstream format. big: Big-endian bitstream format. * Only available if G.726 is supported. |

| NAME | VALUE | SECURITY (get/set) | DESCRIPTION |
|------------------------|--------------------|-----------------------|--|
| s0_g726_vlcmode | 0, 1 | 4/4 | Enable vlcmode for G.726. 0: Standard mode. 1: Solve compatibility problem with VLC player. * Only available if G.726 is supported. |
| aec_enable | <boolean> | 4/4 | Enable acoustic echo cancellation. * Only available when "capability_audio_aecmode" is "manual". * We support this parameter when the version number (httpversion) is equal or greater than 0306b. |
| alarm_enable | <boolean> | 4/4 | Enable audio detection |
| alarm_level | 1~100 | 4/4 | Audio detection alarm level |
| profile_i0_enable | <boolean> | 4/4 | Enable/disable this profile setting |
| profile_i0_policy | night, schedule | 4/4 | The mode which the profile is applied to. * Not support "policy=day" anymore when the version number (httpversion) is equal or greater than 0301a. |
| profile_i0_begintime | hh:mm | 4/4 | Begin time of schedule mode. |
| profile_i0_endtime | hh:mm | 4/4 | End time of schedule mode. |
| profile_i0_alarm_level | 1~100 | 4/4 | Audio detection alarm level |

7.14 Audio Output per Channel

Group: **audioout_c<0~(n-1)>** for n channel products (**capability_naudioout>0**)

n denotes the value of "capability_naudioout"

| NAME | VALUE | SECURITY (get/set) | DESCRIPTION |
|--------|-------|-----------------------|------------------------|
| volume | 0~100 | 4/4 | Adjusting audio volume |

7.15 Play an Audio Clip

Group: **audioclip_i<0~1>** (**capability_audio_audioclip=1**)

| NAME | VALUE | SECURITY (get/set) | DESCRIPTION |
|------|----------------------|-----------------------|--|
| name | string[40] | 1/4 | Specify the audio clip name that can be played when an event occurs. |
| size | 0,<positive integer> | 1/4 | The size of audio clip. |

Group: **audioclip** (**capability_audio_audioclip=1**)

| NAME | VALUE | SECURITY (get/set) | DESCRIPTION |
|-------------------|-------|-----------------------|---|
| prerecord_seconds | 1~10 | 1/4 | Indicates the seconds that can be waited before audio clip start to record. |

7.16 Motion Detection Settings

Group: **motion_c<0~(n-1)>** for n channel products

n denotes the value of "capability_nvideoin"

| NAME | VALUE | SECURITY (get/set) | DESCRIPTION |
|-----------------|-----------|-----------------------|---|
| enable | <boolean> | 4/4 | Enable motion detection. |
| win_sensitivity | 0 ~ 100 | 4/4 | Sensitivity of all motion detection windows. * The value "0" is reserved for compatibility and will not be used after the version number (httpversion) is equal or greater than 0400a. |

Group: **motion_c<0~(n-1)>_win_i<0~(k-1)>**

n denotes the value of "capability_nvideoin", k denotes the value of "capability_nmotion".

| NAME | VALUE | SECURITY (get/set) | DESCRIPTION |
|------------|----------------------|-----------------------|---------------------------------|
| enable | <boolean> | 4/4 | Enable motion detection window. |
| name | string[14] | 4/4 | Name of motion window. |
| polygonstd | 0 ~ 9999,0 ~ 9999, 0 | 4/4 | Coordinate of polygon window |

| NAME | VALUE | SECURITY (get/set) | DESCRIPTION |
|---|---|-----------------------|--|
| | ~ 9999,0 ~ 9999, 0 ~ 9999,0 ~ 9999, 0 ~ 9999,0 ~ 9999 | | position. (4 points: x0,y0,x1,y1,x2,y2,x3,y3) * Only available when "capability_motion_wintype" = polygon. * Only available when std is listed in "capability_motion_windomain" |
| objsize | 1 ~ 100 | 4/4 | Percent of motion detection window. |
| sensitivity <Not recommended to use this> | 0 ~ 100 | 4/4 | Sensitivity of motion detection window. * We replace "sensitivity" with "win_sensitivity". * This parameter will not be used after the version number (httpversion) is equal or greater than 0400a. |
| polygonpx <Not recommended to use this> | 0 ~ W,0 ~ H, 0 ~ W,0 ~ H, 0 ~ W,0 ~ H, 0 ~ W,0 ~ H W: 0~ The current image width -1 H: 0~ The current image height -1 | 4/4 | Coordinate of polygon window position. (4 points: x0,y0,x1,y1,x2,y2,x3,y3) * Only available when "capability_motion_wintype" = polygon. * Only available when px is listed in "capability_motion_windomain". * It's recommended to use polygonsd * This parameter will not be used after the version number (httpversion) is equal or greater than 0400a. |
| polygon <Not recommended to use this> | 0 ~ 320,0 ~ 240, 0 ~ 320,0 ~ 240, 0 ~ 320,0 ~ 240, 0 ~ 320,0 ~ 240 | 4/4 | Coordinate of polygon window position. (4 points: x0,y0,x1,y1,x2,y2,x3,y3) * Only available when "capability_motion_wintype" = polygon. * Only available when qvga is listed in "capability_motion_windomain". * It's recommended to use polygonsd * This parameter will not be used after |

| NAME | VALUE | SECURITY (get/set) | DESCRIPTION |
|---|---------|-----------------------|--|
| | | | the version number (httpversion) is equal or greater than 0400a. |
| left <Not recommended to use this> | 0 ~ 320 | 4/4 | Left coordinate of window position. * Only available when "capability_motion_wintype" = rectangle. * Only available when qvga is listed in "capability_motion_windomain". * It's recommended to use polygonsd * This parameter will not be used after the version number (httpversion) is equal or greater than 0400a. |
| top <Not recommended to use this> | 0 ~ 240 | 4/4 | Top coordinate of window position. * Only available when "capability_motion_wintype" = rectangle. * Only available when qvga is listed in "capability_motion_windomain". * It's recommended to use polygonsd * This parameter will not be used after the version number (httpversion) is equal or greater than 0400a. |
| width <Not recommended to use this> | 0 ~ 320 | 4/4 | Width of motion detection window. * Only available when "capability_motion_wintype" = rectangle. * Only available when qvga is listed in "capability_motion_windomain". * It's recommended to use polygonsd * This parameter will not be used after the version number (httpversion) is equal or greater than 0400a. |
| height <Not recommended to use this> | 0 ~ 240 | 4/4 | Height of motion detection window. * Only available when "capability_motion_wintype" = rectangle. |

| NAME | VALUE | SECURITY (get/set) | DESCRIPTION |
|------|-------|-----------------------|---|
| | | | * Only available when qvga is listed in "capability_motion_windomain". * It's recommended to use polygonsd * This parameter will not be used after the version number (httpversion) is equal or greater than 0400a. |

Group: **motion_c<0~(n-1)>_profile_i<0~(m-1)>** for m profile and n channel product, n denotes the value of "capability_nvideoin", m denotes the vaule of " capability_nmotionprofile ", (**capability_nmotionprofile > 0**)

| NAME | VALUE | SECURITY (get/set) | DESCRIPTION |
|-----------------|--------------------|-----------------------|---|
| enable | <boolean> | 4/4 | Enable profile 1 ~ (m-1). |
| policy | night, schedule | 4/4 | The mode which the profile is applied to. * Not support "policy=day" anymore when the version number (httpversion) is equal or greater than 0301a. |
| begintime | hh:mm | 4/4 | Begin time of schedule mode. |
| endtime | hh:mm | 4/4 | End time of schedule mode. |
| win_sensitivity | 0 ~ 100 | 4/4 | Sensitivity of all motion detection windows. * The value "0" is reserved for compatibility and will not be used after the version number (httpversion) is equal or greater than 0400a. |

Group: **motion_c<0~(n-1)>_profile_i<0~(m-1)>_win_i<0~(k-1)>** for m profile and n channel product, n denotes the value of "capability_nvideoin", m denotes the vaule of "capability_nmotionprofile", k denotes the value of "capability_nmotion".

| NAME | VALUE | SECURITY (get/set) | DESCRIPTION |
|--------|-----------|-----------------------|---------------------------------|
| enable | <boolean> | 4/4 | Enable motion detection window. |

| NAME | VALUE | SECURITY (get/set) | DESCRIPTION |
|---|---|-----------------------|--|
| name | string[14] | 4/4 | Name of motion window. |
| polygonstd | 0 ~ 9999,0 ~ 9999, 0 ~ 9999,0 ~ 9999, 0 ~ 9999,0 ~ 9999, 0 ~ 9999,0 ~ 9999 | 4/4 | Coordinate of polygon window position. (4 points: x0,y0,x1,y1,x2,y2,x3,y3) * Only available when "capability_motion_wintype" = polygon. * Only available when std is listed in "capability_motion_windomain" |
| objsize | 1 ~ 100 | 4/4 | Percent of motion detection window. |
| sensitivity <Not recommended to use this> | 0 ~ 100 | 4/4 | Sensitivity of motion detection window. * We replace "sensitivity" with "win_sensitivity". * This parameter will not be used after the version number (httpversion) is equal or greater than 0400a. |
| polygonpx <Not recommended to use this> | 0 ~ W,0 ~ H, 0 ~ W,0 ~ H, 0 ~ W,0 ~ H, 0 ~ W,0 ~ H W: 0~ The current image width -1 H: 0~ The current image height -1 | 4/4 | Coordinate of polygon window position. (4 points: x0,y0,x1,y1,x2,y2,x3,y3) * Only available when "capability_motion_wintype" = polygon. * Only available when px is listed in "capability_motion_windomain". * It's recommended to use polygonsd * This parameter will not be used after the version number (httpversion) is equal or greater than 0400a. |
| polygon <Not recommended to use this> | 0 ~ 320,0 ~ 240, 0 ~ 320,0 ~ 240, 0 ~ 320,0 ~ 240, 0 ~ 320,0 ~ 240 | 4/4 | Coordinate of polygon window position. (4 points: x0,y0,x1,y1,x2,y2,x3,y3) * Only available when "capability_motion_wintype" = polygon. * Only available when qvga is listed in "capability_motion_windomain". * It's recommended to use polygonsd * This parameter will not be used after the version number (httpversion) is equal or greater than 0400a. |
| left <Not recommended | 0 ~ 320 | 4/4 | Left coordinate of window position. * Only available when |

| NAME | VALUE | SECURITY (get/set) | DESCRIPTION |
|---|---------|-----------------------|---|
| to use this> | | | "capability_motion_wintype" = rectangle. * Only available when qvga is listed in "capability_motion_windomain". * It's recommended to use polygonsd * This parameter will not be used after the version number (httpversion) is equal or greater than 0400a. |
| top <Not recommended to use this> | 0 ~ 240 | 4/4 | Top coordinate of window position. * Only available when "capability_motion_wintype" = rectangle. * Only available when qvga is listed in "capability_motion_windomain". * It's recommended to use polygonsd * This parameter will not be used after the version number (httpversion) is equal or greater than 0400a. |
| width <Not recommended to use this> | 0 ~ 320 | 4/4 | Width of motion detection window. * Only available when "capability_motion_wintype" = rectangle. * Only available when qvga is listed in "capability_motion_windomain". * It's recommended to use polygonsd * This parameter will not be used after the version number (httpversion) is equal or greater than 0400a. |
| height <Not recommended to use this> | 0 ~ 240 | 4/4 | Height of motion detection window. * Only available when "capability_motion_wintype" = rectangle. * Only available when qvga is listed in "capability_motion_windomain". * It's recommended to use polygonsd * This parameter will not be used after |

| NAME | VALUE | SECURITY (get/set) | DESCRIPTION |
|------|-------|-----------------------|--|
| | | | the version number (httpversion) is equal or greater than 0400a. |

7.17 Tampering Detection Settings

Group: **tampering_c<0~(n-1)>** for n channel products (**capability_tampering > 0**)

n denotes the value of "capability_nvideoin"

| NAME | VALUE | SECURITY (get/set) | DESCRIPTION |
|------------------|----------------------|-----------------------|---|
| enable | <boolean> | 4/4 | Enable or disable tamper detection. |
| threshold | 0~100 | 4/4 | Threshold of tamper detection. |
| duration | 10~600 | 4/4 | If tampering value exceeds the "threshold" for more than "duration" second(s), then tamper detection is triggered. |
| ignorewidth | 0,<positive integer> | 1/7 | Indicate the width to offset to start to analysis the image. |
| dark_enable | <boolean> | 4/4 | Enable or disable image too dark detection |
| dark_threshold | 0~100 | 4/4 | Threshold of image too dark detection |
| dark_duration | 1~10 | 4/4 | If image too dark value exceeds the "threshold" for more than "duration" second(s), then image too dark detection is triggered. |
| bright_enable | <boolean> | 4/4 | Enable or disable image too bright detection |
| bright_threshold | 0~100 | 4/4 | Threshold of image too bright detection |
| bright_duration | 1~10 | 4/4 | If image too bright value exceeds the "threshold" for more than "duration" second(s), then image too bright detection is triggered. |
| blurry_enable | <boolean> | 4/4 | Enable or disable image too blurry detection |
| blurry_threshold | 0~100 | 4/4 | Threshold of image too blurry detection |

| NAME | VALUE | SECURITY (get/set) | DESCRIPTION |
|-----------------|-------|-----------------------|---|
| blurry_duration | 1~10 | 4/4 | If image too blurry value exceeds the "threshold" for more than "duration" second(s), then image too blurry detection is triggered. |

7.18 DDNS

Group: **ddns** (*capability_protocol_ddns > 0*)

| NAME | VALUE | SECURITY (get/set) | DESCRIPTION |
|--------------------------|--|-----------------------|--|
| enable | <boolean> | 6/6 | Enable or disable the dynamic DNS. |
| provider | DyndnsDynamic, DyndnsCustom, Safe100 | 6/6 | DyndnsDynamic => dyndns.org (dynamic) DyndnsCustom => dyndns.org Safe100 => safe100.net |
| <provider>_hostname | string[128] | 6/6 | Your DDNS hostname. |
| <provider>_usernameemail | string[64] | 6/6 | Your user name or email to login to the DDNS service provider |
| <provider>_passwordkey | string[64] | 7/6 | Your password or key to login to the DDNS service provider. |

7.19 Express Link

Group: **expresslink**

| PARAMETER | VALUE | SECURITY (get/set) | DESCRIPTION |
|-----------|--|-----------------------|--|
| enable | <boolean> | 6/6 | Enable or disable express link. |
| state | onlycheck, onlyoffline, checkonline, badnetwork | 6/6 | Camera will check the status of network environment and express link URL |
| url | string[64] | 6/6 | The url user define to link to camera |

7.20 UPnP Presentation

Group: **upnppresentation**

| NAME | VALUE | SECURITY (get/set) | DESCRIPTION |
|--------|-----------|-----------------------|--|
| enable | <boolean> | 6/6 | Enable or disable the UPnP presentation service. |

7.21 UPnP Port Forwarding

Group: **upnpportforwarding**

| NAME | VALUE | SECURITY (get/set) | DESCRIPTION |
|---------------|-----------|-----------------------|--|
| enable | <boolean> | 6/6 | Enable or disable the UPnP port forwarding service. |
| upnpmatstatus | 0~3 | 6/7 | The status of UPnP port forwarding, used internally. 0 = OK, 1 = FAIL, 2 = no IGD router, 3 = no need for port forwarding |

7.22 System Log

Group: **syslog**

| NAME | VALUE | SECURITY (get/set) | DESCRIPTION |
|-----------------|-----------------|-----------------------|--|
| enableremotelog | <boolean> | 6/6 | Enable remote log. |
| serverip | <IP address> | 6/6 | Log server IP address. |
| serverport | 514, 1025~65535 | 6/6 | Server port used for log. |
| level | 0~7 | 6/6 | Levels used to distinguish the importance of the information: 0: LOG_EMERG 1: LOG_ALERT 2: LOG_CRIT 3: LOG_ERR 4: LOG_WARNING 5: LOG_NOTICE 6: LOG_INFO |

| NAME | VALUE | SECURITY (get/set) | DESCRIPTION |
|---------------|-------|-----------------------|---|
| | | | 7: LOG_DEBUG |
| setparamlevel | 0~2 | 6/6 | Show log of parameter setting. 0: disable 1: Show log of parameter setting set from external. 2. Show log of parameter setting set from external and internal. |

7.23 SNMP

Group: **snmp** (*capability_protocol_snmp > 0*)

| NAME | VALUE | SECURITY (get/set) | DESCRIPTION |
|---------------|---------------|-----------------------|--|
| v2 | <boolean> | 6/6 | SNMP v2 enabled. 0 for disable, 1 for enable |
| v3 | <boolean> | 6/6 | SNMP v3 enabled. 0 for disable, 1 for enable |
| secnamerw | string[31] | 6/6 | Read/write security name |
| secnamero | string[31] | 6/6 | Read only security name |
| authpwrw | string[8~128] | 7/6 | Read/write authentication password |
| authpwro | string[8~128] | 7/6 | Read only authentication password |
| authtyperw | MD5,SHA | 6/6 | Read/write authentication type |
| authtypero | MD5,SHA | 6/6 | Read only authentication type |
| encryptpwrw | string[8~128] | 7/6 | Read/write passwrđ |
| encryptpwro | string[8~128] | 7/6 | Read only password |
| encrypttyperw | DES | 6/6 | Read/write encryption type |
| encrypttypero | DES | 6/6 | Read only encryption type |
| rwcommunity | string[31] | 6/6 | Read/write community |
| rocommunity | string[31] | 6/6 | Read only community |
| syslocation | string[128] | 6/6 | System location |
| syscontact | string[128] | 6/6 | System contact |

7.24 Layout Configuration

Group: layout

| NAME | VALUE | SECURITY (get/set) | DESCRIPTION |
|---------------------------------|--|-----------------------|--|
| logo_default | <boolean> | 1/6 | 0 => Custom logo 1 => Default logo |
| logo_link | string[128] http://www.vivotek.com | 1/6 | Hyperlink of the logo |
| logo_powerbyvvtk_hidden | <boolean> | 1/6 | 0 => display the power by vivotek logo 1 => hide the power by vivotek logo |
| custombutton_manualtrigger_show | <boolean> | 1/6 | Show or hide manual trigger (VI) button in homepage 0 -> Hidden 1 -> Visible |
| theme_option | 1~4 | 1/6 | 1~3: One of the default themes. 4: Custom definition. |
| theme_color_font | string[7] | 1/6 | Font color |
| theme_color_configfont | string[7] | 1/6 | Font color of configuration area. |
| theme_color_titlefont | string[7] | 1/6 | Font color of video title. |
| theme_color_controlbackground | string[7] | 1/6 | Background color of control area. |
| theme_color_configbackground | string[7] | 1/6 | Background color of configuration area. |
| theme_color_videobackground | string[7] | 1/6 | Background color of video area. |
| theme_color_case | string[7] | 1/6 | Frame color |

7.25 Privacy Mask

Group: **privacymask_c<0~(n-1)>** for n channel products and m privacy mask window.

n denotes the value of "capability_nvideoin" and m denotes the value of

"capability_videoin_c<0~(n-1)>_nprivacymask"

| NAME | VALUE | SECURITY (get/set) | DESCRIPTION |
|----------------------------|---|-----------------------|--|
| enable | <boolean> | 4/4 | Enable privacy mask. |
| win_i<0~(m-1)>_enable | <boolean> | 4/4 | Enable privacy mask window. |
| win_i<0~(m-1)>_name | string[14] | 4/4 | Name of the privacy mask window. |
| win_i<0~(m-1)>_left | 0 ~ 320 | 4/4 | Left coordinate of window position. * Only available when "capability_image_c<0~(n-1)>_privacy mask_wintype" = rectangle. |
| win_i<0~(m-1)>_top | 0 ~ 240 | 4/4 | Top coordinate of window position. * Only available when "capability_image_c<0~(n-1)>_privacy mask_wintype" = rectangle. |
| win_i<0~(m-1)>_width | 0 ~ 320 | 4/4 | Width of privacy mask window. * Only available when "capability_image_c<0~(n-1)>_privacy mask_wintype" = rectangle. |
| win_i<0~(m-1)>_height | 0 ~ 240 | 4/4 | Height of privacy mask window. * Only available when "capability_image_c<0~(n-1)>_privacy mask_wintype" = rectangle. |
| win_i<0~(m-1)>_polygo n | 0 ~ 320,0 ~ 240, 0 ~ 320,0 ~ 240, 0 ~ 320,0 ~ 240, 0 ~ 320,0 ~ 240 | 4/4 | Coordinate of polygon window position. (4 points: x0,y0,x1,y1,x2,y2,x3,y3) * Only available when "capability_image_c<n>_privacymask _wintype" = polygon. * Only available when qvga is listed in "capability_image_c<0~(n-1)>_privacy mask_windomain". |
| win_i<0~(m-1)>_polygo | 0 ~ W,0 ~ H, | 4/4 | Coordinate of polygon window |

| NAME | VALUE | SECURITY (get/set) | DESCRIPTION |
|-------------------------------|--|-----------------------|---|
| npx | 0 ~ W, 0 ~ H, 0 ~ W, 0 ~ H, 0 ~ W, 0 ~ H W: 0 ~ The current image width -1 H: 0 ~ The current image height -1 | | position. (4 points: x0,y0,x1,y1,x2,y2,x3,y3) * Only available when "capability_image_c<0~(n-1)>_privacy mask_wintype" = polygon. * Only available when px is listed in "capability_image_c<0~(n-1)>_privacy mask_windomain". |
| win_i<0~(m-1)>_polygo nstd | 0 ~ 9999, 0 ~ 9999, 0 ~ 9999, 0 ~ 9999, 0 ~ 9999, 0 ~ 9999, 0 ~ 9999, 0 ~ 9999 | 4/4 | Coordinate of polygon window position. (4 points: x0,y0,x1,y1,x2,y2,x3,y3) * Only available when "capability_image_c<0~(n-1)>_privacy mask_wintype" = polygon. * Only available when std is listed in "capability_image_c<0~(n-1)>_privacy mask_windomain". |

7.26 3D Privacy Mask

Group: **privacymask3d_c<0~(n-1)>** for n channel products and m privacy mask window.

(**capability_image_c<0~(n-1)>_privacymask_wintype = 3Drectangle**)

n denotes the value of "capability_nvideoin" and m denotes the value of
"capability_videoin_c<0~(n-1)>_nprivacymask"

| NAME | VALUE | SECURITY (get/set) | DESCRIPTION |
|---------------------|---|-----------------------|--|
| enable | <boolean> | 4/4 | Enable the 3D privacy mask |
| color | 0~" capability_image_c<0~(n- 1)>_privacymask_ncolor" -1 | 4/4 | Privacy mask color |
| win_i<0~(m-1)>_name | string[40] | 4/4 | Name of the privacy mask window. |
| win_i<0~(m-1)>_pan | "capability_ptz_c<0~(n-1) >_minpan" ~ "capability_ptz_c<0~(n-1) | 4/4 | Pan position of window position. * Only available when bit0 of |

| NAME | VALUE | SECURITY (get/set) | DESCRIPTION |
|-----------------------|--|-----------------------|---|
| | >_maxpan" | | "capability_camctrl_c<0~(n-1)>_buildinpt" is "1" |
| win_i<0~(m-1)>_tilt | "capability_ptz_c<0~(n-1)>_mintilt" ~ "capability_ptz_c<0~(n-1)>_maxtilt" | 4/4 | Tilt position of window position. * Only available when bit1 of "capability_camctrl_c<0~(n-1)>_buildinpt" is "1" |
| win_i<0~(m-1)>_zoom | "capability_ptz_c<0~(n-1)>_minzoom" ~ "capability_ptz_c<0~(n-1)>_maxzoom" | 4/4 | Zoom position of window position. |
| win_i<0~(m-1)>_fliped | <boolean> | 4/4 | Flip side of window position. 0: Non-flip side 1: Flip side |

7.27 Capability

Group: **capability**

| NAME | VALUE | SECURITY (get/set) | DESCRIPTION |
|-----------------|---|-----------------------|---|
| api_httpversion | <string> This number start with 0301a. | 0/7 | The version of VIVOTEK WebAPI with 4 integers plus 1 alphabet, There are composed by "major version", "minor version", "revision", "_platform". ex: 0301a_1 <u>Major version</u> Increase the major version when change, remove the old features/interfaces or the firmware has substantially change in architecture and not able to roll back to previous version. This may cause incompatibility with supporting software. <u>Minor version</u> Increase the minor version when add new features/interfaces without |

| NAME | VALUE | SECURITY (get/set) | DESCRIPTION |
|------------------------------|--------------------------|-----------------------|--|
| | | | <p>change the old features and interfaces.</p> <p><u>Revision</u> Increase the revision when fix bugs without change any features of the output.</p> <p><u>platform</u> This is a constant, it is used to distinguish between different platforms</p> <p><u>API version format:</u> MMmmr_k Where "MM" is the major version, "mm" is the minor version and "r" is the revision. 'M' and 'm' and 'k' are decimal digit from 0 to 9, while 'r' is an alphabetic. EX: 0302b_1 => Major version = 03, minor version = 02, revision = b, platform = 1 The 4 integer numbers are WebAPI version, we use short name: [httpversion] for it in this document. The 5th character is model-based version for API bug-fix and it's default to "a". Ex: If some APIs in a model does not follow the API definition of 0301a_1, we will fix them and change this API value to 0301b_1.</p> |
| bootuptime | <positive integer> | 0/7 | Server bootup time. |
| nir <Not support anymore> | 0, <positive integer> | 0/7 | Number of IR interfaces. (Recommand to use capability_daynight_c<0~"capability_nvideoin"-1>_builtinir for built-in IR and |

| NAME | VALUE | SECURITY (get/set) | DESCRIPTION |
|--|--------------------------|-----------------------|---|
| | | | capability_daynight_c<0~"capability_nvideoin"-1>_externalir for external IR) * Not support this parameter anymore when the version number (httpversion) is equal or greater than 0301a. |
| npir | 0, <positive integer> | 0/7 | Number of PIRs. |
| ndi | 0, <positive integer> | 0/7 | Number of digital inputs. |
| nvi | 0, <positive integer> | 0/7 | Number of virtual inputs (manual trigger) |
| ndo | 0, <positive integer> | 0/7 | Number of digital outputs. |
| naudioin | 0, <positive integer> | 0/7 | The number of audio input channel. 0 means no audio input support. |
| naudioout | 0, <positive integer> | 0/7 | The number of audio output channel |
| nvideoin | <positive integer> | 0/7 | Number of video inputs. |
| nvideoout | 0, <Positive Integer> | 0/7 | Number of video out interface. |
| nvideoinprofile | <positive integer> | 0/7 | Number of video input profiles. |
| nmediastream | <positive integer> | 0/7 | Number of media stream per channels. |
| naudiosetting <Not support anymore> | <positive integer> | 0/7 | Number of audio settings per channel. * Not support this parameter anymore when the version number (httpversion) is equal or greater than 0301a. * We replace "naudiosetting" with "naudioin". More details, please refer the parameter description of "volume_internal" and "volume_external". |
| nuart | 0, | 0/7 | Number of UART interfaces. |

| NAME | VALUE | SECURITY (get/set) | DESCRIPTION |
|----------------|-----------------------|-----------------------|--|
| | <positive integer> | | |
| nmotion | <positive integer> | 0/7 | The number of motion window. |
| nmotionprofile | 0, <positive integer> | 0/7 | Number of motion profiles. |
| nevent | 0, <positive integer> | 0/7 | Number of event. * We support this parameter when the version number (httpversion) is equal or greater than 0311c. |
| nrecording | 0, <positive integer> | 0/7 | Number of recording. * We support this parameter when the version number (httpversion) is equal or greater than 0309a. |
| ptzenabled | 0, <positive integer> | 0/7 | An 32-bit integer, each bit can be set separately as follows: Bit 0 => Support camera control function; 0(not support), 1(support) Bit 1 => (only available when bit0 is 1) Built-in or external video source; 0(external), 1(built-in) Bit 2 => (only available when bit0 is 1) Support pan operation; 0(not support), 1(support) Bit 3 => (only available when bit0 is 1) Support tilt operation; 0(not support), 1(support) Bit 4 => (only available when bit0 is 1) Support zoom operation; 0(not support), 1(support) (only available when RS-485 interface is supported or SD/PZ/PT/PD/video server series) Bit 5 => (only available when bit0 is 1) Support focus operation; 0(not support), 1(support) (only available when RS-485 interface |

| NAME | VALUE | SECURITY (get/set) | DESCRIPTION |
|--|-----------------------|-----------------------|--|
| | | | <p>is supported or SD/PZ/PT/PD/video server series)</p> <p>Bit 6 => (only available when bit0 is 1) Reserved bit; always 0.</p> <p>Bit 7 => (only available when bit0 is 1) External or built-in PT; 0(built-in), 1(external)</p> |
| windowless | <boolean> | 0/7 | Indicate whether to support windowless plug-in. |
| evctrlchannel | <boolean> | 0/7 | Indicate whether to support HTTP tunnel for event/control transfer. |
| joystick | <boolean> | 0/7 | Indicate whether to support joystick control. |
| remotefocus <Not recommended to use this> | 0,<positive integer> | 0/7 | <p>An 4-bit integer, which indicates the supportive application of remotefocus.</p> <p>If the value of this parameter is larger than 0, it means that the camera supports remotefocus function.</p> <p>bit 0 => Indicate whether to support both zoom and focus function.</p> <p>bit 1 => Only support zoom function.</p> <p>bit 2 => Only support focus function.</p> <p>bit 3 => Currently, this is a reserved bit, and the default value is 0.</p> <p>* It's strongly non-recommended to use this.</p> <p>* This is reserved for compatibility and will not be used after the version number (httpversion) is equal or greater than 0400a.</p> <p>* We replace "capability_remotefocus" with "capability_image_c0_remotefocus".</p> |
| npreset | 0, <positive integer> | 0/7 | Number of preset locations |

| NAME | VALUE | SECURITY (get/set) | DESCRIPTION |
|---------------------|-----------------------|-----------------------|---|
| presettourdirection | <boolean> | 0/7 | <p>Indicate whether to support preset tour direction function. It means users can choose which direction the preset tour goes.</p> <p>* We support this parameter when the version number (httpversion) is equal or greater than 0307a.</p> |
| eptz | 0, <positive integer> | 0/7 | <p>For "nvideoin" = 1, the definition is as following: A 32-bits integer, each bit can be set separately as follows: Bit 0 => 1st stream supports ePTZ or not. Bit 1 => 2nd stream supports ePTZ or not, and so on.</p> <p>For nvideoin >= 2, the definition is different: First all 32 bits are divided into groups for channel. Ex: nvideoin = 2, bit 0~15 are the 1st group for 1st channel, bit 16~31 are the 2nd group for 2nd channel. nvideoin = 3, bit 0~9 are the 1st group for 1st channel, bit 10~19 are the 2nd group for 2nd channel, bit 20~31 are the 3rd group for 3rd channel. Then, the 1st bit of the group indicates 1st stream of a channel support ePTZ or not. The 2nd bit of the group indicates 2nd stream of a channel support ePTZ or not, and so on.</p> <p>* For most products, the last stream of a channel will not support ePTZ. It is reserved for full view of the</p> |

| NAME | VALUE | SECURITY (get/set) | DESCRIPTION |
|---|---|-----------------------|---|
| | | | channel. For some dual-stream products, both streams support ePTZ. |
| nanystream | 0, <positive integer> | 0/7 | number of any media stream per channel |
| iva | <boolean> | 0/7 | Indicate whether to support Intelligent Video analysis |
| whitelight <Not recommended to use this> | <boolean> | 0/7 | Indicate whether to support white light led. * We replace this parameter with "capability_daynight_c<0~(n-1)>_built_inwled" when the version number (httpversion) is equal or greater than 0309d. |
| iris | <boolean> | 0/7 | Indicate whether to support iris control. |
| supportsd | <boolean> | 0/7 | Indicate whether to support local storage. |
| fisheye | <boolean> | 0/7 | The parameter is used to determine whether the product is fisheye or not. |
| tampering | <boolean> | 0/7 | Indicate whether to support tampering detection. |
| tamperingmode | tamper,toodark,toobright,tooblurry | 0/7 | Available tampering mode list. * Only available when "capability_tampering" is 1. |
| adaptiverecording | <boolean> | 0/7 | Indicate whether to support adaptive recording. |
| adaptivestreaming | <boolean> | 0/7 | Indicate whether to support adaptive streaming. |
| supporttriggertypes | seq,boot,motion,networkfail,recnotify,tampering,vi,vadp,divolalarms,temperature,pir,visignal,backup,smartsd,shockalarm,virestore <product dependent> | 0/7 | list all the trigger types which are supported in the camera: "seq" = Periodic condition "boot" = System boot "motion" = Video motion detection "networkfail" = network connection failure "recnotify" = Recording notification. |

| NAME | VALUE | SECURITY (get/set) | DESCRIPTION |
|---|----------------------|--------------------|--|
| | | | "tampering" = Tamper detection. "vi" = Virtual input (Manual trigger) "vadp" = VADP trigger. "di" = Digital input. "volalarm" = Audio detection. "temperature" = Temperature detection. "pir" = PIR detection. "visignal" = Video input signal loss. "backup" = Backing up recorded files. "smartsd" = Lifetime detection of SD card. "shockalarm" = Shock detection. "virestore" = Video input signal restore. * Only available when [httpversion] >= 0301a |
| media_num | 0,<positive integer> | 0/7 | Number of media number. * We support this parameter when the version number (httpversion) is equal or greater than 0311c. |
| storage_dbenabled | <boolean> | 0/7 | Media files are indexed in database. |
| protocol_https | < boolean > | 0/7 | Indicate whether to support HTTP over SSL. |
| protocol_rtsp | < boolean > | 0/7 | Indicate whether to support RTSP. |
| protocol_sip | <boolean> | 0/7 | Indicate whether to support SIP. |
| protocol_maxconnection | <positive integer> | 0/7 | The maximum number of allowed simultaneous connections. |
| protocol_maxgenc connection <Not Recommended to use this> | <positive integer> | 0/7 | The maximum general streaming connections . * We replaced this parameter with "capability_protocol_maxconnection" when the version number (httpversion) is equal or greater than 0311c. |

| NAME | VALUE | SECURITY (get/set) | DESCRIPTION |
|--|--|-----------------------|---|
| protocol_rtp_multi cast_scalable | <boolean> | 0/7 | Indicate whether to support scalable multicast. |
| protocol_rtp_multi cast_backchannel | <boolean> | 0/7 | Indicate whether to support backchannel multicast. |
| protocol_rtp_tcp | <boolean> | 0/7 | Indicate whether to support RTP over TCP. |
| protocol_rtp_http | <boolean> | 0/7 | Indicate whether to support RTP over HTTP. |
| protocol_spush_mj peg | <boolean> | 0/7 | Indicate whether to support server push MJPEG. |
| protocol_snmp | <boolean> | 0/7 | Indicate whether to support SNMP. |
| protocol_ipv6 | <boolean> | 0/7 | Indicate whether to support IPv6. |
| protocol_pppoe | <boolean> | 0/7 | Indicate whether to support PPPoE. |
| protocol_ieee8021 x | <boolean> | 0/7 | Indicate whether to support IEEE802.1x. |
| protocol_qos_cos | <boolean> | 0/7 | Indicate whether to support CoS. |
| protocol_qos_dscp | <boolean> | 0/7 | Indicate whether to support QoS/DSCP. |
| protocol_ddns | <boolean> | 0/7 | Indicate whether to support DDNS. |
| videoin_type | 0, 1, 2 | 0/7 | 0 => Interlaced CCD 1 => Progressive CCD 2 => CMOS |
| videoin_nresolutio n | <positive integer> | 0/7 | This equals "capability_videoin_c0_nresolution". * This is kept for compatibility. |
| videoin_resolution | A list of <WxH> <product dependent> | 0/7 | This equals "capability_videoin_c0_resolution". * This is kept for compatibility. |
| videoin_maxframer ate | A list of <Integer> | 0/7 | This equals "capability_videoin_c0_maxframerate". * This is kept for compatibility. |
| videoin_mjpeg_ma | A list of <Integer> and | 0/7 | This equals |

| NAME | VALUE | SECURITY (get/set) | DESCRIPTION |
|---------------------------|--|-----------------------|---|
| xframerate | "_" | | "capability_videoin_c0_mjpeg_maxframerate". * This is kept for compatibility. |
| videoin_h264_maxframerate | A list of <Integer> and "_" | 0/7 | This equals "capability_videoin_c0_h264_maxframerate". * This is kept for compatibility. |
| videoin_codec | mjpeg, h264, h265 <product dependent> | 0/7 | Available codec of a device, split by comma. The sequence is not limited. EX: FD8183 supports H.264 and MJPEG, then this is "mjpeg,h264". IP9171 supports H.264, MJPEG and H.265, then this is "mjpeg,h264,h265" |
| videoin_streamcodec | A list of <Positive Integer> | 0/7 | This equals "capability_videoin_c0_streamcodec". * This is kept for compatibility. |
| videoin_flexiblebitrate | <boolean> | 0/7 | Indicate whether to support flexible bit rate control. |
| videoout_codec | A list of the available codec types separated by commas <product dependent> | 0/7 | Available codec list. "-": not supported |
| timeshift | <boolean> | 0/7 | Indicate whether to support time shift caching stream. |
| audio_aec | <boolean> | 0/7 | Indicate whether to support acoustic echo cancellation. |
| audio_aecmode | auto, manual | 0/7 | Indicate the acoustic echo cancellation control mode. " auto ": control by camera automatically. " manual ": Manually turn on/off the control mode. *Only available when "capability_audio_aec" is "1". |

| NAME | VALUE | SECURITY (get/set) | DESCRIPTION |
|-----------------|--|-----------------------|---|
| | | | * We support this parameter when the version number (httpversion) is equal or greater than 0306b. |
| audio_aecaffect | -, maxframerate:fixed:1 5 <product dependent> | 0/7 | <p>When acoustic echo cancellation function is enabled, some features may become malfunction or be forced to a given value. The affected functions are list here.</p> <p>The format is "Affect API name":"Policy":"Description"</p> <p>"Policy" can be categorized into following groups:</p> <ul style="list-style-type: none"> - (disabled) : UI turns grey and users can't select it. - (unchanged) : UI keeps the status as before and user can't change it. - (hidden) : UI is hidden. - (fixed) : UI is fixed to one selection or value. - (ranged) : UI is fixed to multiple selections or values. - (enabled) : UI is checked. - (notsupport) : the affected function is not available. <p>"Affect API name" can be described in hierarchy, such as "exposurewin.mode.blc:disabled:" which means blc exposure window is disabled. API name can be one word as well, such as "exposurelevel:fixed:6" which means exposurelevel is fixed to level 6.</p> <p>"Description" can be a nonnegative integer or string or NULL.</p> <p>For example: "maxframerate: fixed:15" which</p> |

| NAME | VALUE | SECURITY (get/set) | DESCRIPTION |
|---------------------------------------|----------------------|-----------------------|--|
| | | | means the max frame rate is 15fps when acoustic echo cancellation function is enabled. "-" means no feature is affected. * Only available when "capability_audio_aec" is "1". * We support this parameter when the version number (httpversion) is equal or greater than 0306b. |
| audio_mic <Not support anymore> | <boolean> | 0/7 | Indicate whether to support built-in microphone input. * Not support this parameter anymore when the version number (httpversion) is equal or greater than 0301a. * We replace "audio_mic" with "audio_intmic". |
| audio_intmic | <0~Positive Integer> | 0/7 | Internal (Built-in) Microphone. 0: Not support 1: Support Bit 0 for CH0, bit 1 for CH1, and so on. |
| audio_extmic | <0~Positive Integer> | 0/7 | External Microphone. 0: Not support 1: Support Bit 0 for CH0, bit 1 for CH1, and so on. |
| audio_alarm | <0~Positive Integer> | 0/7 | 0: Not support audio alarm. 1: Support audio alarm. Bit 0 for CH0, bit 1 for CH1, and so on. |
| audio_linein <Not support anymore> | <boolean> | 0/7 | Indicate whether to support external line input. * Not support this parameter anymore when the version number (httpversion) is equal or greater than 0301a. * It will be replaced by audio_intmic and audio_extmic. |

| NAME | VALUE | SECURITY (get/set) | DESCRIPTION |
|--|---|-----------------------|---|
| audio_lineout | <boolean> | 0/7 | Indicate whether to support line output. |
| audio_michardwar eswitch | <boolean> | 0/7 | Indicate whether the hardware supports built-in/external mic switch |
| audio_headphoneo ut <Not support anymore> | <boolean> | 0/7 | Indicate whether to support headphone output. * Not support this parameter anymore when the version number (httpversion) is equal or greater than 0301a. |
| audio_audioclip | <boolean> | 0/7 | Indicate whether to support audio clip function. * We support this parameter when the version number (httpversion) is equal or greater than 0309a. |
| audioin_codec | aac4, gamr, g711, g726, - <product dependent> | 0/7 | Available audio codec. We take comma to split codec without any space. "aac4": Advanced Audio Coding (AAC) "gamr": Adaptive Multi-Rate (AMR) "g711": G.711 "g726": G.726 "-": Not supported. |
| audioout_codec | g711, - <product dependent> | 0/7 | Available codec list for SIP. "-": Not supported. |
| motion_wintype | rectangle, polygon,- | 0/7 | The supported motion window type. "polygon": The window is a 2D polygon shape. "rectangle": The window is a 2D rectangle shape. "-": Not supported. |
| motion_windomai n | qvga, px, std, - | 0/7 | The domain to set an motion window. "qvga": a 320x240 range to represent the whole image. "px": Locate a window in the image |

| NAME | VALUE | SECURITY (get/set) | DESCRIPTION |
|----------------------------------|--------------------|-----------------------|---|
| | | | with pixels. "std" : A normalized 0~9999 range. "-" : Not supported. |
| smartstream_support | <boolean> | 0/7 | Indicate whether smart stream is supported. |
| smartstream_version | <integer> | 0/7 | Number of smart stream version. * Only available when "capability_smartstream_support" is 1 |
| smartstream_nstream | <positive integer> | 0/7 | Number of stream that support smart stream. * Only available when "capability_smartstream_support" is 1 |
| smartstream_window | qvga, px, std, - | 0/7 | The domain to set an focus window. "qvga" : a 320x240 range to represent the whole image. "px" : Locate a window in the image with pixels. "std" : A normalized 0~9999 range. "-" : Not supported. * Only available when "capability_smartstream_support" is 1 |
| smartstream_mode_autotracking | <boolean> | 0/7 | Indicate whether autotracking smart stream is supported. * Only available when "capability_smartstream_support" is 1 |
| smartstream_mode_manual | <boolean> | 0/7 | Indicate whether manual smart stream is supported. * Only available when "capability_smartstream_support" is 1 |
| smartstream_mode_hybrid | <boolean> | 0/7 | Indicate whether hybrid(autotracking+manual) smart stream is supported. * Only available when "capability_smartstream_support" is 1 |
| smartstream_nwindow_autotracking | <positive integer> | 0/7 | Maximum number of tracking window of autotracking. * Only available when |

| NAME | VALUE | SECURITY (get/set) | DESCRIPTION |
|--|--------------------|-----------------------|---|
| | | | "capability_smartstream_support" is 1 |
| smartstream_nwindow_manual | <positive integer> | 0/7 | Maximum number of tracking window of manual. * Only available when "capability_smartstream_support" is 1 |
| smartstream_nwindow_hybrid_autotracking | <positive integer> | 0/7 | Maximum number of tracking window of autotracking in hybrid mode. * Only available when "capability_smartstream_support" is 1 |
| smartstream_nwindow_hybrid_manual | <positive integer> | 0/7 | Maximum number of tracking window of manual in hybrid mode. * Only available when "capability_smartstream_support" is 1 |
| vadp_supportfeature | <positive integer> | 0/7 | An 32-bit integer, each bit can be set separately as follows: Bit 0 => VADP interface Bit 1 => Capture video raw data Bit 2 => Support encode jpeg Bit 3 => Capture audio raw data Bit 4 => Support event trigger Bit 5 => Support license registration Bit 6 => Support shared memory API Bit 7 => Support digital signature of package Bit 8 => Support snapshot |
| vadp_npackage | <positive integer> | 0/7 | Indicate the maximum number of VADP package that can be uploaded to the device. |
| camctrl_httpstunnel <Not support anymore> | <boolean> | 0/7 | Indicate whether to support httpstunnel. * Not support this parameter anymore when the version number (httpversion) is equal or greater than 0301b. * It will be replaced by capability_camctrl_ptztunnel. |

| NAME | VALUE | SECURITY (get/set) | DESCRIPTION |
|---------------------|--------------------|-----------------------|---|
| camctrl_ptztunnel | <boolean> | 0/7 | Indicate whether to support ptztunnel. * We support this parameter when the version number (httpversion) is equal or greater than 0301b. This equals "capability_camctrl_c0_ptztunnel". * This is kept for compatibility. |
| camctrl_privilege | <boolean> | 0/7 | Indicate whether to support "Manage Privilege" of PTZ control in the security page. 1: support both /cgi-bin/camctrl/camctrl.cgi and /cgi-bin/viewer/camctrl.cgi 0: support only /cgi-bin/viewer/camctrl.cgi This is equivalent to "capability_camctrl_c0_privilege". * This is kept for compatibility. |
| uart_httptunnel | <boolean> | 0/7 | Indicate whether to support HTTP tunnel for UART transfer. |
| transmission_mode | Tx, Rx, Both | 0/7 | Indicate transmission mode of the machine: TX = server, Rx = receiver box, Both = DVR. |
| network_wire | <boolean> | 0/7 | Indicate whether to support Ethernet. |
| network_wireless | <boolean> | 0/7 | Indicate whether to support wireless. |
| network_dualmode | <boolean> | 0/7 | Indicate whether network dual mode is supported. * Only available when "capability_network_wireless" is "1". * We support this parameter when the version number (httpversion) is equal or greater than 0305a. |
| wireless_s802dot11b | <boolean> | 0/7 | Indicate whether to support wireless 802.11b+. |

| NAME | VALUE | SECURITY (get/set) | DESCRIPTION |
|----------------------------|-----------|-----------------------|---|
| wireless_s802dot11g | <boolean> | 0/7 | Indicate whether to support wireless 802.11g. |
| wireless_s802dot11n | <boolean> | 0/7 | Indicate whether to support wireless 802.11n. |
| wireless_beginchannel | 1 ~ 14 | 0/7 | Indicate the begin channel of wireless network |
| wireless_endchannel | 1 ~ 14 | 0/7 | Indicate the end channel of wireless network |
| wireless_encrypt_wep | <boolean> | 0/7 | Indicate whether to support wireless WEP. |
| wireless_encrypt_wpa | <boolean> | 0/7 | Indicate whether to support wireless WPA. |
| wireless_encrypt_wpa2 | <boolean> | 0/7 | Indicate whether to support wireless WPA2. |
| wireless_apmode_enable | <boolean> | 0/7 | Indicate whether wireless AP mode is supported. * Only available when "capability_network_wireless" is "1". * We support this parameter when the version number (httpversion) is equal or greater than 0305a. |
| wireless_apmode_ssidprefix | <string> | 0/7 | Indicate the prefix of broadcasted SSID when camera is in wireless AP mode. * Only available when "capability_wireless_apmode_enable" is "1". * We support this parameter when the version number (httpversion) is equal or greater than 0305a. |
| derivative_brand | <boolean> | 0/7 | Indicate whether to support the upgrade function for the derivative brand. For example, if the value is true, the VVTK product can be upgraded to VVXX. (TCVV<->TCXX is excepted) |

| NAME | VALUE | SECURITY (get/set) | DESCRIPTION |
|--|--------------------|-----------------------|--|
| test_ac | <boolean> | 0/7 | Indicate whether to support test ac key. |
| version_onvifdaemon | <string> | 0/7 | Indicate ONVIF daemon version |
| version_onviftesttool | <string> | 0/7 | Indicate ONVIF test tool version |
| version_genetec | <string> | 0/7 | Indicate Genetec daemon version * We support this parameter when the version number (httpversion) is equal or greater than 0312a. |
| media_totalspace | <positive integer> | 0/7 | Available memory space (KB) for media. |
| media_snapshot_maxpreevent | <positive integer> | 0/7 | Maximum snapshot number before event occurred. |
| media_snapshot_maxpostevent | <positive integer> | 0/7 | Maximum snapshot number after event occurred. |
| media_snapshot_maxsize | <positive integer> | 0/7 | Maximum size (KB) of a snapshot. |
| media_videoclip_maxsize | <positive integer> | 0/7 | Maximum size (KB) of a videoclip. |
| media_videoclip_maxlength | <positive integer> | 0/7 | Maximum length (second) of a videoclip. |
| media_videoclip_maxpreevent | <positive integer> | 0/7 | Maximum duration (second) after event occurred in a videoclip. |
| image_iris_type <Not recommended to use this> | <string> | 0/7 | Indicate iris type. <ul style="list-style-type: none"> ● "piris": P-Iris ● "dciris": DC-Iris ● "-": No Iris control support * When "capability_iris"=0, this value must be "-". * Note: For some box-type cameras, this value may be varied depending on mounted lens. * We replace "capability_image_iris_type" with "capability_image_c0_iris_type". |

| NAME | VALUE | SECURITY (get/set) | DESCRIPTION |
|---|--------------------------|-----------------------|---|
| | | | * Reserved for compatibility, and suggest don't use this since [httpversion] > 0301a |
| image_focusassist <Not recommended to use this> | <boolean> | 0/7 | Indicate whether to support focus assist. * We replace "capability_image_focusassist" with "capability_image_c0_focusassist". * Reserved for compatibility, and suggest don't use this since [httpversion] > 0301a |
| localstorage_manageable | <boolean> | 0/7 | Indicate whether manageable local storage is supported. * Only available when "capability_supportsd" is 1 or "capability_storage_dbenabled" is 1. |
| localstorage_seamless | 0, <positive integer> | 0/7 | Indicate whether seamless recording is supported. One bit represents one channel. Ex: "3" means channel 0 and channel1 support seamless recording . * Only available when "capability_supportsd" is 1 or "capability_storage_dbenabled" is 1. |
| localstorage_maximum <Not recommended to use this> | 0, <positive integer> | 0/7 | The maximum MOD connection numbers. * Only available when "capability_supportsd" is 1 or "capability_storage_dbenabled" is 1. * We replace this parameter with "capability_storage_management_modnum" when the version number (httpversion) is equal or greater than 0312a. |
| localstorage_modversion | <string> | 0/7 | Indicate MOD daemon version. * Only available when |

| NAME | VALUE | SECURITY (get/set) | DESCRIPTION |
|---------------------------------|--------------------------|-----------------------|---|
| | | | "capability_supportsd" is 1 or "capability_storage_dbenabled" is 1. |
| localstorage_storm grversion | <string> | 0/7 | Indicate storage manager daemon version. * Only available when "capability_supportsd" is 1 or "capability_storage_dbenabled" is 1. |
| localstorage_supp ortedge | 0, <positive integer> | 0/7 | An 32-bit integer, which indicates the supportive application of edge storage. If the value of this parameter is larger than 0, it means that the camera supports edge recording function. bit 0 : It supports to record directly to an on-board SD-Card. bit 1~: Currently, they are reserved bit, and the default value is 0. * Only available when "capability_supportsd" is 1 or "capability_storage_dbenabled" is 1. |
| localstorage_slcon num | 0,<positive integer> | 0/7 | The maximum seamless connection number for each channel. * Only available when "capability_supportsd" is 1 or "capability_storage_dbenabled" is 1. |
| localstorage_smart sd | <boolean> | 0/7 | The "Lifetime and Log SD Card" feature allows users to obtain the card's remaining lifetime information. 0: Non-support this feature 1: Support this feature * Only Sony SD card can support this function now. * Only available when "capability_supportsd" is 1 or "capability_storage_dbenabled" is 1. |
| remotecamctrl_ma | 0, <positive integer> | 0/7 | Indicate whether to support remote |

| NAME | VALUE | SECURITY (get/set) | DESCRIPTION |
|--|-----------------------|-----------------------|---|
| ster | | | auxiliary camera (master side), this value means supporting max number of auxiliary camera. |
| remotecamctrl_slave | <boolean> | 0/7 | Indicate whether to support remote camera control (slave side). |
| fisheyelocaldewarp_c<0~(capability_nvideoin)-1> <product dependent> | 0, <positive integer> | 0/7 | Indicate the supported streams of local dewarp. One bit represents one supported stream. The LSB indicates stream 0. Ex: "3" means stream 0 and stream 1 support local dewarp. * Only available when "capability_fisheye" > 0 |
| shockalarm_support | <boolean> | 0/7 | Indicate whether to support the shock detection. * We support this parameter when the version number (httpversion) is equal or greater than 0306e. |
| layout_redirection | <string> | 0/7 | Indicate which function will be redirected to the vadv package path. "-": Not supported. * We support this parameter when the version number (httpversion) is equal or greater than 0309a. |

Group: **capability_camctrl_c<0~(n-1)>** n denotes the value of "capability_nvideoin" (capability_ptzenabled > 0)

* We support this group when the version number (httpversion) is equal or greater than 0303b.

| PARAMETER | VALUE | SECURITY (get/set) | DESCRIPTION |
|-----------|-----------|-----------------------|--|
| ptztunnel | <boolean> | 0/7 | Indicate whether to support ptztunnel in this video input. |

| PARAMETER | VALUE | SECURITY (get/set) | DESCRIPTION |
|------------|-----------|-----------------------|--|
| privilege | <boolean> | 0/7 | Indicate whether to support “Manage Privilege” of PTZ control in the security page in this video input. 1: support both /cgi-bin/camctrl/camctrl.cgi and /cgi-bin/viewer/camctrl.cgi 0: support only /cgi-bin/viewer/camctrl.cgi |
| rs485 | <boolean> | 0/7 | An 32-bit integer, each bit can be set separately as follows: Bit 0 => support rs485-in Bit 1 => support rs485-out |
| buildinpt | <boolean> | 0/7 | An 32-bit integer, each bit can be set separately as follows: Bit 0 => support build-in pan Bit 1 => support build-in tilt |
| zoommodule | <boolean> | 0/7 | Indicate whether to support zoom lens. In our product, only SD series and IZ series use the zoom lens. * Both varifocal and zoom lenses are built with movable elements that permit changing the effective focal length. And the key difference between a varifocal and a zoom lens can be explained by thinking about a lens that has been focused on an object at any focal length. A varifocal will need to be refocused whenever the focal length is adjusted; the zoom will stay in focus when the focal length is adjusted. |

| PARAMETER | VALUE | SECURITY (get/set) | DESCRIPTION |
|-----------|--|-----------------------|---|
| focusmode | auto,onetimeauto,spotlight,manual <product dependent> | 0/7 | <p>Focus mode selection:</p> <p>"auto": Camera will automatically adjust the focus position full time to adapt a clear picture.</p> <p>"onetimeauto": Camera will automatically adjust the focus position one time, which follows any PTZ control.</p> <p>"spotlight": Camera will automatically adjust the focus position full time, and to consider a spotlight avoidance situation.</p> <p>"manual": Turn off the automatically focus function. For user to control the focus position manually as their purpose.</p> <p>* Only available when "capability_camctrl_c<0~(n-1)_zoommodule" is 1.</p> <p>* We support this parameter when the version number (httpversion) is equal or greater than 0304a.</p> |

Group: **capability_ptz_c<0~(n-1)>** n denotes the value of "capability_nvideoin" (capability_ptzenabled > 0 and capability_camctrl_c<0~(n-1)>_zoommodule !=0)

* We support this group when the version number (httpversion) is equal or greater than 0303b.

| PARAMETER | VALUE | SECURITY (get/set) | DESCRIPTION |
|------------|-----------------------|-----------------------|--|
| panspeedlv | 0, <positive integer> | 0/7 | <p>The maximum speed level of pan motion.</p> <p>*Only available when bit0 of "capability_camctrl_c<0~(n-1)>_buildinpt" is "1"</p> |

| PARAMETER | VALUE | SECURITY (get/set) | DESCRIPTION |
|--------------|-----------------------|-----------------------|---|
| minpan | 0, <positive integer> | 0/7 | The lower limit for pan position. *Only available when bit0 of "capability_camctrl_c<0~(n-1)>_buildin pt" is "1" |
| maxpan | 0, <positive integer> | 0/7 | The upper limit for pan position. *Only available when bit0 of "capability_camctrl_c<0~(n-1)>_buildin pt" is "1" |
| minpanangle | <integer> | 0/7 | The lower limit for pan angle. *Only available when bit0 of "capability_camctrl_c<0~(n-1)>_buildin pt" is "1" |
| maxpanangle | <integer> | 0/7 | The upper limit for pan angle. *Only available when bit0 of "capability_camctrl_c<0~(n-1)>_buildin pt" is "1" |
| tiltspeedlv | 0, <positive integer> | 0/7 | The maximum speed level of tilt motion. *Only available when bit1 of "capability_camctrl_c<0~(n-1)>_buildin pt" is "1" |
| mintilt | 0, <positive integer> | 0/7 | The lower limit for tilt position. *Only available when bit1 of "capability_camctrl_c<0~(n-1)>_buildin pt" is "1" |
| maxtilt | 0, <positive integer> | 0/7 | The upper limit for tilt position. *Only available when bit1 of "capability_camctrl_c<0~(n-1)>_buildin pt" is "1" |
| mintiltangle | <integer> | 0/7 | The lower limit for tilt angle. *Only available when bit1 of "capability_camctrl_c<0~(n-1)>_buildin pt" is "1" |

| PARAMETER | VALUE | SECURITY (get/set) | DESCRIPTION |
|--------------|-----------------------|-----------------------|---|
| maxtiltangle | <integer> | 0/7 | The upper limit for tilt angle. *Only available when bit1 of "capability_camctrl_c<0~(n-1)>_buildinpt" is "1" |
| zoomspeedlv | 0, <positive integer> | 0/7 | The maximum speed level of zoom motion. *Only available when the value of "capability_camctrl_c<0~(n-1)>_zoommodule" is "1" |
| minzoom | 0, <positive integer> | 0/7 | The lower limit for zoom position. *Only available when the value of "capability_camctrl_c<0~(n-1)>_zoommodule" is "1" |
| maxzoom | 0, <positive integer> | 0/7 | The upper limit for zoom position. *Only available when the value of "capability_camctrl_c<0~(n-1)>_zoommodule" is "1" |
| maxdzoom | 0, <positive integer> | 0/7 | The upper limit for digital zoom position. *Only available when the value of "capability_camctrl_c<0~(n-1)>_zoommodule" is "1" |
| focusspeedlv | 0, <positive integer> | 0/7 | The maximum speed level of focus motion. *Only available when the value of "capability_camctrl_c<0~(n-1)>_zoommodule" is "1" |
| minfocus | 0, <positive integer> | 0/7 | The lower limit for focus position. *Only available when the value of "capability_camctrl_c<0~(n-1)>_zoommodule" is "1" |
| maxfocus | 0, <positive integer> | 0/7 | The upper limit for focus position. *Only available when the value of "capability_camctrl_c<0~(n-1)>_zoommodule" is "1" |

Group: **capability_daynight_c<0~(n-1)>** n denotes the value of "capability_nvideoin"

| PARAMETER | VALUE | SECURITY (get/set) | DESCRIPTION |
|-------------|-----------|-----------------------|--|
| support | <boolean> | 0/7 | Indicate whether the camera supports day/night mode switch |
| builtinir | <boolean> | 0/7 | Indicate whether to support built-in IR led. * We replaced this parameter with "capability_daynight_illuminators_builtin_support" when the version number (httpversion) is equal or greater than 0312a. |
| builtinwled | <boolean> | 0/7 | Indicate whether to support built-in white led. * We replaced this parameter with "capability_daynight_illuminators_builtin_type=whiteled" when the version number (httpversion) is equal or greater than 0312a. |
| externalir | <boolean> | 0/7 | Indicate whether to support external IR led. * We replaced this parameter with "capability_daynight_illuminators_external_support" when the version number (httpversion) is equal or greater than 0312a. |
| optimizedir | <boolean> | 0/7 | Indicate whether to support optimized IR control technology. * We replaced this parameter with "capability_daynight_illuminators_optimizedir" when the version number (httpversion) is equal or greater than 0312a. |
| smartir | <boolean> | 0/7 | Indicate whether to support smart IR. |
| ircutfilter | <boolean> | 0/7 | Indicate whether to support IR cut. |
| lightsensor | <boolean> | 0/7 | Indicate whether to support light sensor. |

| PARAMETER | VALUE | SECURITY (get/set) | DESCRIPTION |
|-------------------------------|--------------------------|-----------------------|---|
| blackwhitemode | <boolean> | 0/7 | Indicate whether to support automatically switch to Black & White display during the night mode. * We support this parameter when the version number (httpversion) is equal or greater than 0302a. |
| ircutsensitivity_type | <string> | 0/7 | Indicate the cgi interface of "ircutcontrol_sensitivity". "options" : the value of "ircutcontrol_sensitivity" parameter is "low, normal,high". "normalize" : the value of "ircutcontrol_sensitivity" parameter is "1~100" "-":not support * Only available when "capability_daynight_c<0~(n-1)>_support" is 1. * We support this parameter when the version number (httpversion) is equal or greater than 0302a. |
| ircutsensitivity_supportlevel | 0, <positive integer> | 0/7 | The value indicate the support strength level of ircutsensitivity. * Only available when "capability_daynight_c<0~(n-1)>_support" is 1 and "capability_daynight_c<0~(n-1)>_ircutsensitivity_type" is not "-". * We support this parameter when the version number (httpversion) is equal or greater than 0302a. |

| PARAMETER | VALUE | SECURITY (get/set) | DESCRIPTION |
|------------------|------------------------------|-----------------------|--|
| extled_interface | do <product dependent> | 0/7 | The device interface of external IR led: "do": digital output * Only available when "capability_daynight_c<0~(n-1)>_externalir" is 1 * We replaced this parameter with "capability_daynight_illuminators_external_interface" when the version number (httpversion) is equal or greater than 0312a. |
| spectrum_support | <boolean> | 0/7 | Indicate whether to support proposed a brightness enhancement method based on CCM(Color Correction Matrix) model to improve the brightness effect of the images if the IR and blue light exists. * Only available when "capability_daynight_c<0~(n-1)>_support" is 1 * We replaced this parameter with "capability_daynight_illuminators_spectrum_support" when the version number (httpversion) is equal or greater than 0312a. |

| PARAMETER | VALUE | SECURITY (get/set) | DESCRIPTION |
|---------------|---|-----------------------|--|
| spectrum_mode | visible,ir,irenanced, blueenhanced <product dependent> | 0/7 | <p>Indicate the spectrum mode.</p> <p>"visible": The ideal default setting for visible light.</p> <p>"ir": The ideal default setting for IR light.</p> <p>"irenanced": This CCM model increases the brightness effect of IR light.</p> <p>"blueenhanced": This CCM model increases the brightness effect of blue light.</p> <p>*Only available when "capability_daynight_c<0~(n-1)>_support" is 1 and "capability_daynight_c<0~(n-1)>_spectrum_support" is 1</p> <p>* We replaced this parameter with "capability_daynight_illuminators_spectrum_mode" when the version number (httpversion) is equal or greater than 0312a.</p> |

| PARAMETER | VALUE | SECURITY (get/set) | DESCRIPTION |
|-----------|---|-----------------------|--|
| mode | auto,daynight,di,di2, di3,di4,schedule,- <product dependent> | 0/7 | <p>Indicate the day / night switch mode.</p> <p>"auto": The Camera automatically judges the current operation mode by the level of ambient light detected.</p> <p>"daynight": support day mode and night mode. In day mode, the camera streams color video. In night mode, the camera streams black and white video in low light environments.</p> <p>"di": the camera automatically switches the current mode when a ditigal input 1 is triggered.</p> <p>"di2": the camera automatically switches the current mode when a ditigal input 2 is triggered.</p> <p>"di3": the camera automatically switches the current mode when a ditigal input 3 is triggered.</p> <p>"di4": the camera automatically switches the current mode when a ditigal input 4 is triggered.</p> <p>"schedule": The Camera switches between day mode and night mode based on a specified schedule.</p> <p>"-": not support</p> <p>* We support this parameter when the version number (httpversion) is equal or greater than 0309d.</p> |

Group: **capability_daynight_illuminators**

| PARAMETER | VALUE | SECURITY (get/set) | DESCRIPTION |
|-------------|-----------|-----------------------|--|
| optimizedir | <boolean> | 0/7 | <p>Indicate whether to support optimized IR control technology.</p> <p>* We support this parameter when the version number (httpversion) is equal or greater than 0312a.</p> |

| | | | |
|--------------------|--|-----|--|
| builtin_support | <boolean> | 0/7 | Indicate whether to support built-in led. * We support this parameter when the version number (httpversion) is equal or greater than 0312a. |
| builtin_type | irled,whiteled,- <product dependent> | 0/7 | Indicate whether to support built-in led type. " irled ": IR led " whiteled ": white led "-": not support * We support this parameter when the version number (httpversion) is equal or greater than 0312a. |
| external_support | <boolean> | 0/7 | Indicate whether to support external led. * We support this parameter when the version number (httpversion) is equal or greater than 0312a. |
| external_interface | do,do2,do3,do4 <product dependent> | 0/7 | The device interface of external led: " do ": digital output 1 " do2 ": digital output 2 " do3 ": digital output 3 " do4 ": digital output 4 * We support this parameter when the version number (httpversion) is equal or greater than 0312a. |
| spectrum_support | <boolean> | 0/7 | Indicate whether to support proposed a brightness enhancement method based on CCM(Color Correction Matrix) model to improve the brightness effect of the images if the IR and blue light exists. * Only available when "capability_daynight_c<0~(n-1)>_support" is 1 * We support this parameter when the version number (httpversion) is equal or greater than 0312a. |

| | | | |
|---------------|---|-----|--|
| spectrum_mode | visible,ir,irenhanced,blueenhanced <product dependent> | 0/7 | <p>Indicate the spectrum mode.</p> <p>"visible": The ideal default setting for visible light.</p> <p>"ir": The ideal default setting for IR light.</p> <p>"irenhanced": This CCM model increases the brightness effect of IR light.</p> <p>"blueenhanced": This CCM model increases the brightness effect of blue light.</p> <p>*Only available when "capability_daynight_c<0~(n-1)>_support" is 1 and "capability_daynight_illuminators_spectrum_support" is 1</p> <p>* We support this parameter when the version number (httpversion) is equal or greater than 0312a.</p> |
|---------------|---|-----|--|

Group: **capability_storage_management**

| PARAMETER | VALUE | SECURITY (get/set) | DESCRIPTION |
|-----------|--------------------------------|--------------------|---|
| ndevice | <positive integer> | 0/7 | <p>Indicate the number of storage devices.</p> <p>* We support this parameter when the version number (httpversion) is equal or greater than 0312a.</p> |
| device | sd, nas <product dependent> | 0/7 | <p>Indicate the supported storage devices.</p> <p>* Only available when "capability_storage_dbenabled" is 1.</p> <p>* We support this parameter when the version number (httpversion) is equal or greater than 0312a.</p> |
| modnum | 0, <positive integer> | 0/7 | <p>The maximum MOD connection numbers.</p> <p>* Only available when "capability_storage_dbenabled" is 1.</p> <p>* We support this parameter when the version number (httpversion) is equal or greater than 0312a.</p> |

Group: **capability_videoin_c<0~(n-1)>** n denotes the value of "capability_nvideoin"

| PARAMETER | VALUE | SECURITY (get/set) | DESCRIPTION |
|----------------|--|-----------------------|---|
| lens_type | fisheye, fixed, varifocal, changeable, motor, ics,- <product dependent> | 0/7 | The lens type of this channel. "fisheye" : Fisheye lens "fixed" : Build-in fixed-focus lens. "varifocal" : Build-in varifocal lens. "changeable" : changeable lens. Like box-type camera, users can install any C-Mount or CS-Mount lens as they wish. "motor" : Lens with motor to support zoom, focus, etc. "ics" : An i-CS lens is an intelligent CS-mount lens that contains information about, among other things, its own geometrical distortion and the exact position of its zoom, focus, and iris opening. "-" : N/A * Only available when [httpversion] >= 0301a |
| color_support | <boolean> | 0/7 | 1 : camera can select to display color or black/white video streams. 0: camera do not support this feature. * We support this parameter when the version number (httpversion) is equal or greater than 0310a. |
| eptz_zoomratio | <string> | 0/7 | Indicate the support zoom ratio of eptz. "-" : not support ePTZ * We support this parameter when the version number (httpversion) is equal or greater than 0310a. |
| rotation | <boolean> | 0/7 | Indicate current mode whether support video rotation |

| PARAMETER | VALUE | SECURITY (get/set) | DESCRIPTION |
|----------------|-----------------------------|-----------------------|--|
| rotationaffect | - <product dependent> | 0/7 | <p>When rotation is enabled, some features may become malfunction or be forced to a given value. The affected functions are list here.</p> <p>The format is "Affect API name":"Policy":"Description"</p> <p>"Policy" can be categorized into following groups:</p> <ul style="list-style-type: none"> - (disabled) : UI turns grey and users can't select it. - (unchanged) : UI keeps the status as before and user can't change it. - (hidden) : UI is hidden. - (fixed) : UI is fixed to one selection or value. - (ranged) : UI is fixed to multiple selections or values. - (enabled) : UI is checked. - (notsupport) : the affected function is not available. <p>"Affect API name" can be described in hierarchy, such as "exposurewin.mode.blc:disabled:" which means blc exposure window is disabled. API name can be one word as well, such as "exposurelevel:fixed:6" which means exposurelevel is fixed to level 6.</p> <p>"Description" can be a nonnegative integer or string or NULL.</p> <p>"-" means no feature is affected.</p> <p>* When "rotation"=0, this value must be "-"</p> <p>* We support this parameter when the version number (httpversion) is equal or greater than 0304b.</p> |

| PARAMETER | VALUE | SECURITY (get/set) | DESCRIPTION |
|---------------|---|-----------------------|--|
| rotationangle | <string> | 0/7 | The different angles which camera supports for rotation. * Only available when "capability_videoin_c<0~(n-1)>_rotation" is 1. * We support this parameter when the version number (httpversion) is equal or greater than 0309b. |
| orientation | flip,mirror,rotation <product dependent> | 0/7 | Indicates the camera supports flip, mirror or rotation. * We support this parameter when the version number (httpversion) is equal or greater than 0309b. |
| streamcodec | <positive integer> | 0/7 | Represent supported codec types of each stream. This contains a list of positive integers, split by comma. Each one stands for a stream, and the definition is as following: Bit 0: Support MPEG4. Bit 1: Support MJPEG Bit 2: Support H.264 Bit 3: Support H.265 |
| mode | 0,<positive integer> | 0/7 | Indicate current video mode. |
| nmode | <positive integer> | 0/7 | Indicate how many video modes supported by this channel. |
| maxsize | <WxH> | 0/7 | The maximum resolution of all modes in this channel, the unit is pixel. |
| nprivacymask | 0, <positive integer> | 0/7 | Number of privacy mask per channel |
| nresolution | <positive integer> | 0/7 | The maximum resolution options (listed in "resolution") in current video mode. |

| PARAMETER | VALUE | SECURITY (get/set) | DESCRIPTION |
|---------------|---|-----------------------|---|
| resolution | A list of <WxH> <product dependent> | 0/7 | Resolution options in current video mode. These options are the possible options for "videoin_c<n>_s<m>_resolution". The last one is the maximum resolution in current mode. |
| maxresolution | A list of <Integer> | 0/7 | Represent supported maximum resolution of each stream in current video mode. * The element number is defined as "capability_nmediastream". |
| minresolution | A list of <Integer> | 0/7 | Represent supported minimum resolution of each stream in current video mode. * The element number is defined as "capability_nmediastream". * We support this parameter when the version number (httpversion) is equal or greater than 0304b. |
| maxframerate | A list of <Integer> | 0/7 | Indicate frame rate that the video source outputs in current video mode. One to one mapping to the resolution in "resolution". * The element number is defined as "nresolution" in this group. * This parameter may be changed when "videoin_c<n>_cmofreq"=50 or "videoin_c<n>_modulation"=pal. Ex: 30 fps is changed to 25 fps, 60 fps is changed to 50 fps, and so on. |

| PARAMETER | VALUE | SECURITY (get/set) | DESCRIPTION |
|--------------------|--------------------------------------|-----------------------|--|
| mjpeg_maxframerate | A list of <Positive Integer> and "-" | 0/7 | <p>Maximum fps that the device can encoded with MJPEG on resolutions in current video mode.</p> <p>"-" means not support.</p> <p>* One to one mapping to the resolution in "resolution".</p> <p>* The element number is defined as "nresolution" in this group.</p> <p>* This parameter may be changed when "videoin_c<n>_cmosfreq"=50 or "videoin_c<n>_modulation"=pal.</p> <p>Ex: 30 fps is changed to 25 fps, 60 fps is changed to 50 fps, and so on.</p> <p>* Only available when 'mjpeg' is listed in "capability_videoin_codec".</p> |
| mjpeg_maxbitrate | <positive integer>, - | 0/7 | <p>Maximum bitrates of MJPEG.</p> <p>The unit is bps.</p> <p>"-" means MJPEG does not support bit rate control.</p> <p>* Only available when 'mjpeg' is listed in "capability_videoin_codec".</p> |
| h264_maxframerate | A list of <Positive Integer> and "-" | 0/7 | <p>Maximum fps that the device can encoded with H.264 on resolutions in current video mode.</p> <p>"-" means not support.</p> <p>* One to one mapping to the resolution in "resolution".</p> <p>* The element number is defined as "nresolution" in this group.</p> <p>* This parameter may be changed when "videoin_c<n>_cmosfreq"=50 or "videoin_c<n>_modulation"=pal.</p> <p>Ex: 30 fps is changed to 25 fps, 60 fps is changed to 50 fps, and so on.</p> <p>* Only available when 'h264' is listed in "capability_videoin_codec".</p> |

| PARAMETER | VALUE | SECURITY (get/set) | DESCRIPTION |
|-------------------|--------------------------------------|-----------------------|--|
| h264_maxbitrate | <positive integer> | 0/7 | Maximum bitrates of H.264. The unit is bps. * Only available when 'h264' is listed in "capability_videoin_codec". |
| h264_profile | baseline,main,high | 0/7 | Indicate H264 profiles * Only available when 'h264' is listed in "capability_videoin_codec". * We support this parameter when the version number (httpversion) is equal or greater than 0309a. |
| h265_maxframerate | A list of <Positive Integer> and "-" | 0/7 | Maximum fps that the device can encoded with H.265 on resolutions in current video mode. "-" means not support. * One to one mapping to the resolution in "resolution". * The element number is defined as "nresolution" in this group. * This parameter may be changed when "videoin_c<n>_cmosfreq"=50 or "videoin_c<n>_modulation"=pal. Ex: 30 fps is changed to 25 fps, 60 fps is changed to 50 fps, and so on. * Only available when 'h265' is listed in "capability_videoin_codec". |
| h265_maxbitrate | <positive integer> | 0/7 | Maximum bitrates of H.265. The unit is bps. * Only available when 'h265' is listed in "capability_videoin_codec". |
| h265_profile | main,main10 <product dependent> | 0/7 | Indicate H265 profiles * Only available when 'h265' is listed in "capability_videoin_codec". * We support this parameter when the version number (httpversion) is equal or greater than 0309a. |

| PARAMETER | VALUE | SECURITY (get/set) | DESCRIPTION |
|---|---|-----------------------|--|
| fisheye_mounttype <Not recommended to use this> | ceiling, wall, floor <product dependent> | 0/7 | Indicate the supported type. wall mount: 180° panoramic view ceiling mount: 360° surround view without blind spots floor mount: 360° surround view without blind spots * Only available when "capability_fisheye" > 0 * It's recommended to use "capability_videoin_c<0~(n-1)>_mounttype" |
| mounttype | ceiling, wall, floor,- <product dependent * Available values are listed in " capability_videoin _c<0~(n-1)>_mou ntype " | 0/7 | Indicate the supported mount type. "-": not support * We support this parameter when the version number (httpversion) is equal or greater than 0309c. |
| dintraperiod_support | <boolean> | 0/7 | 0: Non-support "Dynamic intra frame period" 1: Support "Dynamic intra frame period" "Dynamic intra frame period" can be used to reduce bitrate by reducing the number of I-frame. * We support this parameter when the version number (httpversion) is equal or greater than 0301c. |

| PARAMETER | VALUE | SECURITY (get/set) | DESCRIPTION |
|------------------|---|-----------------------|---|
| cameraunit_name | CU8131, CU8171, CU8161-H, CU8162-H, CU8163-H, CU8361-H, ..., - <product dependent> | 0/7 | A "camera unit" name of a split-type camera system, which the camera unit and the video core are separated. -: If the camera is not a split-type camera system, the value of this parameter is "-". * We support this parameter when the version number (httpversion) is equal or greater than 0302b. |
| cmosfreq_support | <boolean> | 0/7 | 0: The power line frequency(50/60Hz) is detected by camera automatically. 1: The power line frequency(50/60Hz) can be set by user. * We support this parameter when the version number (httpversion) is equal or greater than 0308a. |
| smartfps_support | <boolean> | 0/7 | Indicate whether to support Smart fps function. * We support this parameter when the version number (httpversion) is equal or greater than 0309a. |
| smartq_support | <boolean> | 0/7 | Indicate whether to support Smart Q function. * We support this parameter when the version number (httpversion) is equal or greater than 0309a. |

Group: **capability_videoin_c<0~(n-1)>_localdewarp**

(**capability_fisheycallocaldewarp_c<0~(capability_nvideoin)-1> > 0**)

n denotes the value of "capability_nvideoin"

| PARAMETER | VALUE | SECURITY (get/set) | DESCRIPTION |
|------------------|--------------------|-----------------------|--|
| typeceilingmount | 1O, 1P, 2P, 1R, 4R | 0/7 | Available dewarp types of ceiling and floor mount. |
| typewallmount | 1O, 1P, 1R, 4R | 0/7 | Available dewarp types of wall mount. |

| PARAMETER | VALUE | SECURITY (get/set) | DESCRIPTION |
|---------------|-----------------|-----------------------|--|
| resolutionC1P | A list of <WxH> | 0/7 | Available resolutions of 1P mode of ceiling and floor mount. |
| resolutionC2P | A list of <WxH> | 0/7 | Available resolutions of 2P mode of ceiling and floor mount. |
| resolutionC1R | A list of <WxH> | 0/7 | Available resolutions of 1R mode of ceiling and floor mount. |
| resolutionC4R | A list of <WxH> | 0/7 | Available resolutions of 4R mode of ceiling and floor mount. |
| resolutionW1P | A list of <WxH> | 0/7 | Available resolutions of 1P mode of wall mount. |
| resolutionW1R | A list of <WxH> | 0/7 | Available resolutions of 1R mode of wall mount. |
| resolutionW4R | A list of <WxH> | 0/7 | Available resolutions of 4R mode of wall mount. |

Group: **capability_videoin_c<0~(n-1)>_mode<0~(m-1)>** n denotes the value of "capability_nvideoin", m denotes the value of "capability_videoin_c<0~(n-1)>_nmode"

| PARAMETER | VALUE | SECURITY (get/set) | DESCRIPTION |
|-----------|-----------|-----------------------|---|
| rotation | <boolean> | 0/7 | Indicate this mode whether support video rotation |

| PARAMETER | VALUE | SECURITY (get/set) | DESCRIPTION |
|----------------|-----------------------|-----------------------|--|
| eptz | 0, <positive integer> | 0/7 | <p>Indicate this mode whether support eptz.</p> <p>For "nvideoin" = 1, the definition is as following: A 32-bits integer, each bit can be set separately as follows: Bit 0 => 1st stream supports ePTZ or not. Bit 1 => 2nd stream supports ePTZ or not, and so on.</p> <p>For nvideoin >= 2, the definition is different: First all 32 bits are divided into groups for channel. Ex: nvideoin = 2, bit 0~15 are the 1st group for 1st channel, bit 16~31 are the 2nd group for 2nd channel. nvideoin = 3, bit 0~9 are the 1st group for 1st channel, bit 10~19 are the 2nd group for 2nd channel, bit 20~31 are the 3rd group for 3rd channel. Then, the 1st bit of the group indicates 1st stream of a channel support ePTZ or not. The 2nd bit of the group indicates 2nd stream of a channel support ePTZ or not, and so on.</p> <p>* We support this parameter when the version number (httpversion) is equal or greater than 0304b.</p> |
| wdrpro | 0, 1, 2 | 0/7 | <p>Indicate this mode whether support WDR pro.</p> <p>0: Non-support WDR Pro 1: Support WDR Pro 2: Support WDR Pro and WDR Pro II</p> <p>* We support this parameter when the version number (httpversion) is equal or greater than 0304b.</p> |
| effectivepixel | <WxH> | 0/7 | <p>The visible area of full scene in this video mode.</p> <p>The unit is pixel in source.</p> <p>* If "effectivepixel"<"capability_videoin_c<0~(n-1)>_maxsize", then the visible area is located at the center of full scene.</p> |

| PARAMETER | VALUE | SECURITY (get/set) | DESCRIPTION |
|---------------|---------------------|-----------------------|--|
| outputsize | <WxH> | 0/7 | <p>The output size of source, equal to the captured size by device, in this video mode. The unit is pixel.</p> <p>This value is used as a basic coordinate system for many features, like ePTZ, privacy mask, motion, etc.</p> <p>* Source (most for image sensor) may perform scale or binning, etc on image data, and output data with smaller size. This parameter is designed to represent this.</p> |
| binning | 0, 1, 3 | 0/7 | <p>Indicate binning is used or not in this video mode.</p> <p>0: No binning 1: 2x2 binning 3: 3x3 binning</p> <p>* Binning is a technology to increase light sensitivity by combining multiple pixels to one. The drawback is reduced resolution. We design this parameter to disclose this information.</p> |
| nresolution | <positive integer> | 0/7 | How many resolution options in this video mode. |
| resolution | A list of <WxH> | 0/7 | <p>Resolution options in this video mode. The last one is the maximum resolution in this video mode.</p> <p>* The element number is defined as "nresolution" in this group.</p> |
| maxresolution | A list of <Integer> | 0/7 | <p>Represent supported maximum resolution of each stream in current video mode.</p> <p>* The element number is defined as "capability_nmediastream".</p> |

| PARAMETER | VALUE | SECURITY (get/set) | DESCRIPTION |
|---------------|--------------------------------------|-----------------------|--|
| minresolution | A list of <Integer> | 0/7 | <p>Represent supported minimum resolution of each stream in current video mode.</p> <p>* The element number is defined as "capability_nmediastream".</p> <p>* We support this parameter when the version number (httpversion) is equal or greater than 0304b.</p> |
| maxframerate | A list of <Positive Integer> | 0/7 | <p>Indicates frame rate that the video source outputs in this video mode.</p> <p>* One to one mapping to the resolution in "resolution".</p> <p>* The element number is defined as "nresolution" in this group.</p> <p>* This parameter records the frame rate when "videoin_c<0~(n-1)>_cmosfreq"=60 or "videoin_c<0~(n-1)>_modulation"=ntsc</p> |
| maxfps_mjpeg | A list of <Positive Integer> and "-" | 0/7 | <p>Maximum fps which the device can encoded with MJPEG on resolutions in this video mode.</p> <p>"-" means not support.</p> <p>* One to one mapping to the resolution in "resolution".</p> <p>* The element number is defined as "nresolution" in this group.</p> <p>* This parameter records the frame rate when "videoin_c<0~(n-1)>_cmosfreq"=60 or "videoin_c<0~(n-1)>_modulation"=ntsc</p> <p>* Only available when 'mjpeg' is listed in "capability_videoin_codec".</p> |

| PARAMETER | VALUE | SECURITY (get/set) | DESCRIPTION |
|-------------|--------------------------------------|-----------------------|--|
| maxfps_h264 | A list of <Positive Integer> and "-" | 0/7 | Maximum fps which the device can encoded with H.264 on resolutions in this video mode. "-" means not support. * One to one mapping to the resolution in "resolution". * The element number is defined as "nresolution" in this group. * This parameter records the frame rate when "videoin_c<0~(n-1)>_cmosfreq"=60 or "videoin_c<0~(n-1)>_modulation"=ntsc * Only available when 'h264' is listed in "capability_videoin_codec". |
| maxfps_h265 | A list of <Positive Integer> and "-" | 0/7 | Maximum fps which the device can encoded with H.265 on resolutions in this video mode. "-" means not support. * One to one mapping to the resolution in "resolution". * The element number is defined as "nresolution" in this group. * This parameter records the frame rate when "videoin_c<0~(n-1)>_cmosfreq"=60 or "videoin_c<0~(n-1)>_modulation"=ntsc * Only available when 'h265' is listed in "capability_videoin_codec". |
| description | <string[128]> | 0/7 | Description about this mode. |

Group: **capability_image_c<0~(n-1)>** n denotes the value of "capability_nvideoin"

| NAME | VALUE | SECURITY (get/set) | DESCRIPTION |
|--------------|-----------------------|-----------------------|---|
| basicsetting | 0, <positive integer> | 0/7 | A 32-bits integer, each bit can be set separately as follows: Bit 0 => Supports Brightness or not. |

| NAME | VALUE | SECURITY (get/set) | DESCRIPTION |
|---------------------|--|-----------------------|--|
| | | | <p>Bit 1 => Supports Contrast or not.</p> <p>Bit 2 => Supports Saturation or not.</p> <p>Bit 3 => Supports Sharpness or not.</p> <p>Bit 4 => Supports adjusting the image to proper position horizontally or not.</p> <p>Bit 5 => Supports adjusting the image to proper position vertically or not.</p> |
| hlm | <boolean> | 0/7 | <p>Hightlight Mask: The function will strengthen the image contrast and mask the specified zone of image if any strong spot-light exists.</p> <p>* We support this parameter when the version number (httpversion) is equal or greater than 0311a.</p> |
| wdrpro_mode | 0, 1, 2 | 0/7 | <p>0: Non-support WDR Pro</p> <p>1: Support WDR Pro</p> <p>2: Support WDR Pro and WDR Pro II</p> |
| wdrpro_strength | 0, 1 | 0/7 | <p>0: Non-support tuning strength of WDR Pro</p> <p>1: Support tuning strength of WDR Pro</p> <p>* If "capability_image_c<0~(n-1)>_wdrpro"=1, this may be either 0 or 1.</p> |
| wdrpro_supportlevel | 0, <positive integer> | 0/7 | <p>This contains a list of positive integers, split by comma.</p> <p>If "wdrpro_mode" =1, then the value indicate the support strength level of WDR Pro.</p> <p>If "wdrpro_mode" =2, then the first number indicate the support strength level of WDR Pro, and the ssecond number indicate the support strength level of WDR Pro II.</p> |
| wdrpro_affect | -, exposurewin.mode :fixed:auto, | 0/7 | <p>When WDR Pro is enabled, some features may become malfunction or be forced to a given value. The</p> |

| NAME | VALUE | SECURITY (get/set) | DESCRIPTION |
|------|--|-----------------------|--|
| | exposurelevel:hid den; exposurelevel:fixed :<x>; exposurelevel:fixed :<x>/<x>; exposuremode:fixe d:auto, gammacurve:disabl ed; exposurewin.mode .blc:hidden; exposurewin.mode .hlc:hidden; exposuretime:hid den; gaincontrol:hidden: , flickerless:unchang ed; wdrc:enabled; wdrc:enabled:only once, wdrc:unchanged; <x>: nonnegative integer <product dependent> | | affected functions are list here. The format is "Affect API name":"Policy":"Description" "Policy" can be categorized into following groups: - (disabled) : UI turns grey and users can't select it. - (unchanged) : UI keeps the status as before and user can't change it. - (hidden) : UI is hidden. - (fixed) : UI is fixed to one selection or value. - (ranged) : UI is fixed to multiple selections or values. - (enabled) : UI is checked. - (notsupport) : the affected function is not available. - (onlyonce) : when wdrpro is enabled, wdrc is checked; when wdrpro is disable, wdrc is unchecked. "Affect API name" can be described in hierarchy, such as "exposurewin.mode.blc:disabled:" which means blc exposure window is disabled. API name can be one word as well, such as "exposurelevel:fixed:6" which means exposurelevel is fixed to level 6. "Description" can be a nonnegative integer or string or NULL. For example: "exposurelevel:fixed:6/8/12" which means exposurelevel is fixed to level 6, level 8 and level 12. "-" means no feature is affected. * When "wdrpro"=0, this value must |

| NAME | VALUE | SECURITY (get/set) | DESCRIPTION |
|--------------------|---|--------------------|---|
| | | | be "-" |
| wdrpro_description | <string> | 0/7 | Description about WDR Pro mode. * Only available when "capability_image_c<0~(n-1)>_wdrpro_mode" > 0 |
| wdrc_mode | 0, 1 | 0/7 | 0: Non-support WDR Enhanced 1: Support WDR Enhanced |
| wdrc_supportlevel | 0, <positive integer> | 0/7 | Indicate the support strength level of WDR Enhanced. |
| wdrc_affect | -, gammacurve:disabled; <x>: nonnegative integer <product dependent> | 0/7 | When WDR Enhanced is enabled, some features may become malfunction or be forced to a given value. The affected functions are list here. The format is "Affect API name":"Policy":"Description" "Policy" can be categorized into following groups: - (disabled) : UI turns grey and users can't select it. - (unchanged) : UI keeps the status as before and user can't change it. - (hidden) : UI is hidden. - (fixed) : UI is fixed to one selection or value. - (ranged) : UI is fixed to multiple selections or values. - (enabled) : UI is checked. - (notsupport) : the affected function is not available. "Affect API name" can be described in hierarchy, such as "exposurewin.mode.blc:disabled:" which means blc exposure window is disabled. API name can be one word as well, such as |

| NAME | VALUE | SECURITY (get/set) | DESCRIPTION |
|-------------|--------------------|-----------------------|---|
| | | | <p>"exposurelevel:fixed:6" which means exposurelevel is fixed to level 6.</p> <p>"Description" can be a nonnegative integer or string or NULL.</p> <p>For example:</p> <p>"exposurelevel:fixed:6/8/12" which means exposurelevel is fixed to level 6, level 8 and level 12.</p> <p>"-" means no feature is affected.</p> <p>* When "wdrc"=0, this value must be "-"</p> |
| dnr | 0,1 | 0/7 | <p>0: Non-support 3D digital noise reduction</p> <p>1: Support 3D digital noise reduction</p> |
| dnrstrength | <positive integer> | 0/7 | <p>Indicate the support strength level of 3D digital noise reduction.</p> <p>* Only available when "capability_image_c<0~(n-1)>_dnr" > 0.</p> <p>* We support this parameter when the version number (httpversion) is equal or greater than 0306d.</p> |
| dnrtype | 2d,3d | 0/7 | <p>Description about DNR type.</p> <p>* Only available when "capability_image_c<0~(n-1)>_dnr" > 0.</p> <p>* We support this parameter when the version number (httpversion) is equal or greater than 0308a.</p> |
| eis | 0,1 | 0/7 | <p>0: Non-support electronic image stabilizer</p> <p>1: Support electronic image stabilizer</p> |
| is_mode | eis, dis, - | 0/7 | <p>Indicate the image stabilizer mode.</p> <p>"eis": electronic image stabilizer</p> <p>"dis": digital image stabilizer</p> <p>"-": not support</p> |

| NAME | VALUE | SECURITY (get/set) | DESCRIPTION |
|-----------------|---|-----------------------|--|
| | | | * We support this parameter when the version number (httpversion) is equal or greater than 0302a. |
| is_strength | <boolean> | 0/7 | 0: Non-support tuning strength of image stabilizer mode. 1: Support tuning strength of image stabilizer mode. * Only available when "capability_image_c<0~(n-1)>_is_mode" is not "-". * We support this parameter when the version number (httpversion) is equal or greater than 0302a. |
| is_supportlevel | 0, <positive integer> | 0/7 | Indicate the support strength level of image stabilizer mode. * Only available when "capability_image_c<0~(n-1)>_is_mode" is not "-". * We support this parameter when the version number (httpversion) is equal or greater than 0302a. |
| is_affect | -, <x>: nonnegative integer <product dependent> | 0/7 | When Is mode is not "-", some features may become malfunction or be forced to a given value. The affected functions are list here. The format is "Affect API name":"Policy":"Description" "Policy" can be categorized into following groups: - (disabled) : UI turns grey and users can't select it. - (unchanged) : UI keeps the status as before and user can't change it. - (hidden) : UI is hidden. - (fixed) : UI is fixed to one selection or |

| NAME | VALUE | SECURITY (get/set) | DESCRIPTION |
|--|--|-----------------------|---|
| | | | <p>value.</p> <ul style="list-style-type: none"> - (ranged) : UI is fixed to multiple selections or values. - (enabled) : UI is checked. - (notsupport) : the affected function is not available. <p>"Affect API name" can be described in hierarchy, such as "exposurewin.mode.blc: disabled:" which means blc exposure window is disabled. API name can be one word as well, such as "exposurelevel:fixed:6" which means exposurelevel is fixed to level 6. "Description" can be a nonnegative integer or string or NULL. "- " means no feature is affected. * Only available when "capability_image_c<0~(n-1)>_is_mode" is not "-". * We support this parameter when the version number (httpversion) is equal or greater than 0302a.</p> |
| scenemode_support | 0,1 | 0/7 | <p>0: Non-support scene mode 1: Support scene mode</p> |
| scenemode_supporttype <product dependent> | visibility, noiseless, lpcparkinglot, lpcstreet, lpchighway, auto, deblur, lpcfreesway <product dependent> | 0/7 | <p>list all the scene mode which are supported in the camera. * Only available when "capability_image_c<0~(n-1)>_scenemode_support" is 1</p> |
| wbmode | auto, | 0/7 | Available white balance mode. |

| NAME | VALUE | SECURITY (get/set) | DESCRIPTION |
|--------------------|--|-----------------------|--|
| | panorama, manual, rbgain, widerange, outdoor,indoor, sodiumauto, - <product dependent> | | "-" means white balance is not supported. |
| iristype | piris, dciris, - | 0/7 | Indicate iris type. "piris": P-Iris "dciris": DC-Iris "-": No Iris control support * Note: For some cameras, this value may be varied depending on mounted lens. |
| sensortype | rawsensor, smartsensor, thermalsensor, - | 0/7 | Indicate sensor type. " rawsensor ": Raw sensor " smartsensor ": Smart sensor " thermalsensor ": Thermal sensor "-": N/A * We support this parameter when the version number (httpversion) is equal or greater than 0302a. |
| exposure_mode | 0,1 | 0/7 | 0: Non-support exposure control. 1: Support exposure control. |
| exposure_modetype | auto, shutterpriority, irispriority, manual <product dependent> | 0/7 | Available mode of exposure setting. * Only available when "capability_image_c<0~(n-1)>_exposure_mode" is 1. * We support this parameter when the version number (httpversion) is equal or greater than 0302a. |
| exposure_rangetype | onevalue, twovalues | 0/7 | Support interface of exposure range. " onevalue ": The parameter is a constant value. |

| NAME | VALUE | SECURITY (get/set) | DESCRIPTION |
|--------------------------------|-------------------------|-----------------------|--|
| | | | <p>"twovalues": Need two parameters to indicate the exposure range.</p> <p>* Only available when "capability_image_c<0~(n-1)>_exposure_mode" is 1.</p> <p>* We support this parameter when the version number (httpversion) is equal or greater than 0302a.</p> |
| exposure_shuttervalue etype | fixed, maximum, - | 0/7 | <p>* One to one mapping to the mode type in "exposure_modetype".</p> <p>"fixed": The shutter value is the assigned value (videoin_c<0~(n-1)>_shuttervalue).</p> <p>"maximum": The shutter value can be up to the assigned value (videoin_c<0~(n-1)>_shuttervalue).</p> <p>"-": not support.</p> <p>* Only available when "capability_image_c<0~(n-1)>_exposure_mode" is 1 and "capability_image_c<0~(n-1)>_exposure_rangetype" is "onevalue".</p> <p>* We support this parameter when the version number (httpversion) is equal or greater than 0302a.</p> |
| exposure_gainvalue type | fixed, maximum, - | 0/7 | <p>* One to one mapping to the mode type in "exposure_modetype".</p> <p>"fixed": The shutter value is the assigned value (videoin_c<0~(n-1)>_gainvalue).</p> <p>"maximum": The shutter value can be up to the assigned value (videoin_c<0~(n-1)>_gainvalue)</p> <p>"-": not support.</p> <p>* Only available when "capability_image_c<0~(n-1)>_exposure_mode" is 1 and "capability_image_c<0~(n-1)>_exposure_rangetype" is "onevalue".</p> <p>* We support this parameter when the version number (httpversion) is equal or greater than 0302a.</p> |

| NAME | VALUE | SECURITY (get/set) | DESCRIPTION |
|--------------------------|---|-----------------------|--|
| | | | exposure_mode" is 1 and "capability_image_c<0~(n-1)>_exposure_rangetype" is "onevalue". * We support this parameter when the version number (httpversion) is equal or greater than 0302a. |
| exposure_automode_affect | -, exposurewin.mode .blc:hidden;, defog:disabled;, wdrpro:disabled;, exposurelevel:hidden;, defaultgain:fixed:x or others <x>: nonnegative integer <product dependent> | 0/7 | When exposure auto mode is enabled, some features may become malfunction or be forced to a given value. The affected functions are list here. The format is "Affect API name":"Policy":"Description" "Policy" can be categorized into following groups: - (disabled) : UI turns grey and users can't select it. - (unchanged) : UI keeps the status as before and user can't change it. - (hidden) : UI is hidden. - (fixed) : UI is fixed to one selection or value. - (ranged) : UI is fixed to multiple selections or values. - (enabled) : UI is checked. - (notsupport) : the affected function is not available. "Affect API name" can be described in hierarchy, such as "exposurewin.mode.blc:disabled:" which means blc exposure window is disabled. API name can be one word as well, such as "exposurelevel:fixed:6" which means exposurelevel is fixed to level 6. |

| NAME | VALUE | SECURITY (get/set) | DESCRIPTION |
|-------------------------------------|--|-----------------------|--|
| | | | <p>"Description" can be a nonnegative integer or string or NULL.</p> <p>"-" means no feature is affected.</p> <p>* Only available when auto is listed in "capability_image_c<0~(n-1)>_exposure_modetype" and "capability_image_c<0~(n-1)>_exposure_mode" is 1.</p> <p>* We support this parameter when the version number (httpversion) is equal or greater than 0302a.</p> |
| exposure_shutterprioritymode_affect | <p>-, exposurewin.mode .blc:hidden;, defog:disabled;, wdrpro:disabled;, exposurelevel:hid den;, defaultgain:fixed:x or others <x>: nonnegative integer <product dependent></p> | 0/7 | <p>When exposure shutter priority mode is enabled, some features may become malfunction or be forced to a given value. The affected functions are list here.</p> <p>The format is "Affect API name":"Policy":"Description"</p> <p>"Policy" can be categorized into following groups:</p> <ul style="list-style-type: none"> - (disabled) : UI turns grey and users can't select it. - (unchanged) : UI keeps the status as before and user can't change it. - (hidden) : UI is hidden. - (fixed) : UI is fixed to one selection or value. - (ranged) : UI is fixed to multiple selections or values. - (enabled) : UI is checked. - (notsupport) : the affected function is not available. <p>"Affect API name" can be described in hierarchy, such as "exposurewin.mode.blc:disabled:"</p> |

| NAME | VALUE | SECURITY (get/set) | DESCRIPTION |
|--|--|-----------------------|--|
| | | | <p>which means blc exposure window is disabled. API name can be one word as well, such as "exposurelevel:fixed:6" which means exposurelevel is fixed to level 6. "Description" can be a nonnegative integer or string or NULL. "-" means no feature is affected.</p> <p>* Only available when shutterpriority is listed in "capability_image_c<0~(n-1)>_exposure_modetype" and "capability_image_c<0~(n-1)>_exposure_mode" is 1.</p> <p>* We support this parameter when the version number (httpversion) is equal or greater than 0302a.</p> |
| <p>exposure_irispriority mode_affect</p> | <p>-, exposurewin.mode .blc:hidden:, defog:disabled:, wdrpro:disabled:, exposurelevel:hid den:, defaultgain:fixed:x or others <x>: nonnegative integer <product dependent></p> | <p>0/7</p> | <p>When exposure iris priority mode is enabled, some features may become malfunction or be forced to a given value. The affected functions are list here.</p> <p>The format is "Affect API name":"Policy":"Description"</p> <p>"Policy" can be categorized into following groups:</p> <ul style="list-style-type: none"> - (disabled) : UI turns grey and users can't select it. - (unchanged) : UI keeps the status as before and user can't change it. - (hidden) : UI is hidden. - (fixed) : UI is fixed to one selection or value. - (ranged) : UI is fixed to multiple selections or values. |

| NAME | VALUE | SECURITY (get/set) | DESCRIPTION |
|-------------------------------------|---|-----------------------|--|
| | | | <p>- (enabled) : UI is checked.</p> <p>- (notsupport) : the affected function is not available.</p> <p>"Affect API name" can be described in hierarchy, such as "exposurewin.mode.blc:disabled:" which means blc exposure window is disabled. API name can be one word as well, such as "exposurelevel:fixed:6" which means exposurelevel is fixed to level 6.</p> <p>"Description" can be a nonnegative integer or string or NULL.</p> <p>"-" means no feature is affected.</p> <p>* Only available when irispriority is listed in "capability_image_c<0~(n-1)>_exposure_modetype" and "capability_image_c<0~(n-1)>_exposure_mode" is 1.</p> <p>* We support this parameter when the version number (httpversion) is equal or greater than 0302a.</p> |
| exposure_qualityprioritymode_affect | -, exposurewin.mode.blc:hidden:, defog:disabled:, wdrpro:disabled:, exposurelevel:hidden:, defaultgain:fixed:x or others <x>: nonnegative integer <product dependent> | 0/7 | <p>When exposure quality priority mode is enabled, some features may become malfunction or be forced to a given value. The affected functions are list here.</p> <p>The format is "Affect API name":"Policy":"Description"</p> <p>"Policy" can be categorized into following groups:</p> <p>- (disabled) : UI turns grey and users can't select it.</p> <p>- (unchanged) : UI keeps the status as before and</p> |

| NAME | VALUE | SECURITY (get/set) | DESCRIPTION |
|----------------------------|---|-----------------------|---|
| | | | <p>user can't change it.</p> <ul style="list-style-type: none"> - (hidden) : UI is hidden. - (fixed) : UI is fixed to one selection or value. - (ranged) : UI is fixed to multiple selections or values. - (enabled) : UI is checked. - (notsupport) : the affected function is not available. <p>"Affect API name" can be described in hierarchy, such as "exposurewin.mode.blc:disabled:" which means blc exposure window is disabled. API name can be one word as well, such as "exposurelevel:fixed:6" which means exposurelevel is fixed to level 6. "Description" can be a nonnegative integer or string or NULL. "-" means no feature is affected.</p> <p>* Only available when qualitypriority is listed in "capability_image_c<0~(n-1)>_exposure_modetype" and "capability_image_c<0~(n-1)>_exposure_mode" is 1.</p> <p>* We support this parameter when the version number (httpversion) is equal or greater than 0305a.</p> |
| exposure_manualmode_affect | -, exposurewin.mode.blc:hidden;, defog:disabled;, wdrpro:disabled;, exposurelevel:hidden; | 0/7 | <p>When exposure manual mode is enabled, some features may become malfunction or be forced to a given value. The affected functions are list here.</p> <p>The format is "Affect API name":"Policy":"Description"</p> |

| NAME | VALUE | SECURITY (get/set) | DESCRIPTION |
|---------------------|--|-----------------------|--|
| | icrmode.auto:notes support: or others <x>: nonnegative integer <product dependent> | | <p>"Policy" can be categorized into following groups:</p> <ul style="list-style-type: none"> - (disabled) : UI turns grey and users can't select it. - (unchanged) : UI keeps the status as before and user can't change it. - (hidden) : UI is hidden. - (fixed) : UI is fixed to one selection or value. - (ranged) : UI is fixed to multiple selections or values. - (enabled) : UI is checked. - (notsupport) : the affected function is not available. <p>"Affect API name" can be described in hierarchy, such as "exposurewin.mode.blc:disabled:" which means blc exposure window is disabled. API name can be one word as well, such as "exposurelevel:fixed:6" which means exposurelevel is fixed to level 6. "Description" can be a nonnegative integer or string or NULL. "- " means no feature is affected.</p> <p>* Only available when manual is listed in "capability_image_c<0~(n-1)>_exposure_modetype" and "capability_image_c<0~(n-1)>_exposure_mode" is 1.</p> <p>* We support this parameter when the version number (httpversion) is equal or greater than 0302a.</p> |
| exposure_levelrange | -, "0,12" | 0/7 | Available range for "videoin_c<0~(n-1)>_exposurelevel" |

| NAME | VALUE | SECURITY (get/set) | DESCRIPTION |
|--------------------------------|--|-----------------------|--|
| | | | <p>* When "exposure_mode"=0, this value must be set to "-".</p> <p>* Only available when "capability_image_c<0~(n-1)>_exposure_mode" is 1.</p> |
| exposure_winmode | auto, custom, blc, hlc, center, - <product dependent> | 0/7 | <p>Available options for "exposurewin_c<0~(n-1)>_mode"</p> <p>* "-" means group: exposurewin is not supported.</p> <p>* When exposure_mode="0", this value must be set to "-".</p> <p>* Only available when "capability_image_c<0~(n-1)>_exposure_mode" is 1.</p> |
| exposure_meteringmode | auto, blc, hlc <product dependent> | 0/7 | <p>Available options for "videoin_c<0~(n-1)>_meteringmode"</p> <p>* Only available when "capability_image_c<0~(n-1)>_exposure_mode" is 1.</p> |
| exposure_hlcmode_supportwindow | <boolean> | 0/7 | <p>Indicate whether to support exposure window in hlc mode.</p> <p>* Only available when "capability_image_c<0~(n-1)>_exposure_mode" is 1 and hlc is listed in "capability_image_c<0~(n-1)>_exposure_winmode".</p> |
| exposure_hlcmode_affect | -, sir:hidden: or others <x>: nonnegative integer <product dependent> | 0/7 | <p>When hlc mode is enabled, some features may become malfunction or be forced to a given value. The affected functions are list here. The format is "Affect API name":"Policy":"Description"</p> <p>"Policy" can be categorized into following groups:</p> <p>- (disabled) : UI turns grey and users can't select it.</p> |

| NAME | VALUE | SECURITY (get/set) | DESCRIPTION |
|------------------|-------------------------------|-----------------------|---|
| | | | <ul style="list-style-type: none"> - (unchanged) : UI keeps the status as before and user can't change it. - (hidden) : UI is hidden. - (fixed) : UI is fixed to one selection or value. - (ranged) : UI is fixed to multiple selections or values. - (enabled) : UI is checked. - (notsupport) : the affected function is not available. <p>"Affect API name" can be described in hierarchy, such as "exposurewin.mode.blc:disabled:" which means blc exposure window is disabled. API name can be one word as well, such as "exposurelevel:fixed:6" which means exposurelevel is fixed to level 6. >Description" can be a nonnegative integer or string or NULL. "- " means no feature is affected.</p> <p>* Only available when "capability_image_c<0~(n-1)>_exposure_mode" is 1 and hlc is listed in "capability_image_c<0~(n-1)>_exposure_winmode".</p> <p>* We support this parameter when the version number (httpversion) is equal or greater than 0304a.</p> |
| exposure_wintype | inclusive, exclusive, - | 0/7 | <p>The supported exposure window type.</p> <p>"inclusive": The image inside a window is the target area of exposure control.</p> <p>"exclusive": The image inside a window is omitted by exposure</p> |

| NAME | VALUE | SECURITY (get/set) | DESCRIPTION |
|--------------------------|------------------------------|-----------------------|--|
| | | | control. "-": Not supported. * Only available when "capability_image_c<0~(n-1)>_exposure_mode" is 1. |
| exposure_windomain | qvga, px, std, - | 0/7 | The domain to set an exposure window. " qvga ": a 320x240 range to represent the whole image. " px ": Locate a window in the image with pixels. " std ": A normalized 0~9999 range. "-": Not supported. * Only available when "capability_image_c<0~(n-1)>_exposure_mode" is 1. |
| exposure_winum | 0, <Positive Integer> | 0/7 | Indicate the number of custom exposure windows. * If no "custom" is listed in "exposure_winmode", this should be 0. * Only available when "capability_image_c<0~(n-1)>_exposure_mode" is 1. |
| exposure_ntsc_totalrange | A list of <Positive Integer> | 0/7 | Available total range for NTSC analog output. * Only available when "capability_image_c<0~(n-1)>_exposure_mode" is 1. * We support this parameter when the version number (httpversion) is equal or greater than 0301a. |
| exposure_pal_totalrange | A list of <Positive Integer> | 0/7 | Available total range for PAL analog output. * Only available when "capability_image_c<0~(n-1)>_exposure_mode" is 1. |

| NAME | VALUE | SECURITY (get/set) | DESCRIPTION |
|--------------------------|--|-----------------------|---|
| | | | <p>exposure_mode" is 1.</p> <p>* We support this parameter when the version number (httpversion) is equal or greater than 0301a.</p> |
| exposure_maxrange | <p>"1,32000", "1,8000", -, or others <product dependent></p> | 0/7 | <p>Available range for "videoin_c<n>_maxexposure"</p> <p>"1,32000" => 1s ~ 1/32000s "1,8000" => 1s ~ 1/8000s etc.</p> <p>"-" means maximum exposure time is not available.</p> <p>* When "exposure_mode"=0, this value must be set to "-".</p> <p>* Only available when "capability_image_c<0~(n-1)>_exposure_mode" is 1.</p> |
| exposure_minrange | <p>"1,32000", "1,8000", -, or others <product dependent></p> | 0/7 | <p>Available range for "videoin_c<n>_minexposure"</p> <p>"1,32000" => 1s ~ 1/32000s "1,8000" => 1s ~ 1/8000s etc.</p> <p>"-" means minimum exposure time is not available.</p> <p>* When "exposure_mode"=0, this value must be set to "-".</p> <p>* Only available when "capability_image_c<0~(n-1)>_exposure_mode" is 1.</p> |
| exposure_bracketing_mode | <boolean> | 0/7 | <p>0: Non-support Auto Exposure Bracketing (AEB)</p> <p>1: Support Auto Exposure Bracketing (AEB)</p> <p>Auto Exposure Bracketing (AEB) is a term that is used to signify a process where the camera automatically takes two or more exposures but with</p> |

| NAME | VALUE | SECURITY (get/set) | DESCRIPTION |
|---------------------------|---|-----------------------|--|
| | | | different exposure values. * Only available when "capability_image_c<0~(n-1)>_exposure_mode" is 1. * We support this parameter when the version number (httpversion) is equal or greater than 0310a. |
| exposure_bracketing_range | A list of ratio For example: 2x,3x,4x | 0/7 | The input parameter decides how much ratio of exposure compensation will be expanded on the next stream, which is based on the original exposure time (first stream). * Only available when "capability_image_c<0~(n-1)>_exposure_bracketing_mode" is 1. * We support this parameter when the version number (httpversion) is equal or greater than 0310a. |
| privacymask_wintype | rectangle, polygon, 3Drectangle | 0/7 | The supported mask window type. "polygon" : The window is a 2D polygon shape. "rectangle" : The window is a 2D rectangle shape. "3Drectangle" : The window is a 3D rectangle shape. |
| privacymask_windowain | qvga, px, std, - | 0/7 | The domain to set an window. "qvga" : a 320x240 range to represent the whole image. "px" : Locate a window in the image with pixels. "std" : A normalized 0~9999 range. "-" : Not supported. |
| privacymask_ncolor | <Positive Integer> | 0/7 | Available total color numbers of privacy mask. |
| agc_maxgain | "0,100", "-" | 0/7 | Available range for "videoin_c<n>_maxgain" |

| NAME | VALUE | SECURITY (get/set) | DESCRIPTION |
|-------------------|--|-----------------------|---|
| | | | "0,100" => 0~100 percent "- " means "videoin_c<n>_maxgain" is not available. |
| agc_mingain | "0,100", "- " | 0/7 | Available range for "videoin_c<n>_mingain" "0,100" => 0~100 percent "- " means "videoin_c<n>_mingain" is not available. |
| flickerless | 0,1 | 0/7 | 0: Non-support flickerless 1: Support flickerless |
| flickerlessaffect | -, minexposure.lower bound:fixed:x or others <x>: nonnegative integer <product dependent> | 0/7 | When flickerless is enabled, some features may become malfunction or be forced to a given value. The affected functions are list here. The format is "Affect API name":"Policy":"Description" "Policy" can be categorized into following groups: - (disabled) : UI turns grey and users can't select it. - (unchanged) : UI keeps the status as before and user can't change it. - (hidden) : UI is hidden. - (fixed) : UI is fixed to one selection or value. - (ranged) : UI is fixed to multiple selections or values. - (enabled) : UI is checked. - (notsupport) : the affected function is not available. "Affect API name" can be described in hierarchy, such as "exposurewin.mode.blc:disable:" which means blc exposure window is disabled. API name can be one word |

| NAME | VALUE | SECURITY (get/set) | DESCRIPTION |
|--------------------|---|-----------------------|--|
| | | | as well, such as "exposurelevel:fixed:6" which means exposurelevel is fixed to level 6. "Description" can be a nonnegative integer or string or NULL. "- " means no feature is affected. * When "flickerless" = 0, this value must be "- " |
| defog_mode | 0,1 | 0/7 | 0: Non-support defog 1: Support defog |
| defog_strength | 0, 1 | 0/7 | 0: Non-support tuning strength of defog 1: Support tuning strength of defog * If "capability_image_c<0~(n-1)>_defog_mode"=1, this may be either 0 or 1. |
| defog_supportlevel | 0, <positive integer> | 0/7 | The value indicate the support strength level of defog. |
| defog_affect | -, wdrc:unchanged: contrast:hidden: or others <x>: nonnegative integer <product dependent> | 0/7 | When defog is enabled, some features may become malfunction or be forced to a given value. The affected functions are list here. The format is "Affect API name":"Policy":"Description" "Policy" can be categorized into following groups: - (disabled) : UI turns grey and users can't select it. - (unchanged) : UI keeps the status as before and user can't change it. - (hidden) : UI is hidden. - (fixed) : UI is fixed to one selection or value. - (ranged) : UI is fixed to multiple selections or values. |

| NAME | VALUE | SECURITY (get/set) | DESCRIPTION |
|----------------------------|--------------------|-----------------------|--|
| | | | <p>- (enabled) : UI is checked.</p> <p>- (notsupport) : the affected function is not available.</p> <p>"Affect API name" can be described in hierarchy, such as "exposurewin.mode.blc:disabled:" which means blc exposure window is disabled. API name can be one word as well, such as "exposurelevel:fixed:6" which means exposurelevel is fixed to level 6.</p> <p>"Description" can be a nonnegative integer or string or NULL.</p> <p>"-" means no feature is affected.</p> <p>* When "defog" = 0, this value must be "-"</p> |
| aespeed | 0,1 | 0/7 | <p>0: Non-support AE speed</p> <p>1: Support AE speed</p> |
| aespeedsupportlevel | <positive integer> | 0/7 | <p>The value indicate the support strength level of aespeed.</p> <p>* Only available when "capability_image_c<0~(n-1)>_aespeed" is 1.</p> |
| aespeedsupportssensitivity | 0,1 | 0/7 | <p>0: Non-support tuning the sensitivity of AE converge speed.</p> <p>1: Support tuning the sensitivity of AE converge speed.</p> <p>* Only available when "capability_image_c<0~(n-1)>_aespeed" is 1.</p> |
| gammacurve | 0,1 | 0/7 | <p>0: Non-support tuning Gamma curve</p> <p>1: Support tuning Gamma curve</p> |
| lowlightmode | -,0,1 | 0/7 | <p>-: Internal parameter, must not open to user.</p> <p>0: Non-support low light mode</p> <p>1: Support low light mode</p> |

| NAME | VALUE | SECURITY (get/set) | DESCRIPTION |
|---------------------------|---|-----------------------|--|
| focusassist | 0,1 | 0/7 | 0: Non-support focus assist 1: Support focus assist |
| remotefocus | 0,<positive integer> | 0/7 | An 4-bit integer, which indicates the supportive application of remotefocus in this channel. If the value of this parameter is larger than 0, it means that the camera supports remotefocus function in this channel. bit 0 => Indicate whether to support both zoom and focus function. bit 1 => Only support zoom function. bit 2 => Only support focus function. bit 3 => Currently, this is a reserved bit, and the default value is 0. |
| focuswindow | qvga, px, std, - | 0/7 | The domain to set a focus window. "qvga": a 320x240 range to represent the whole image. "px": Locate a window in the image with pixels. "std": A normalized 0~9999 range. "-": Not supported. |
| focuswindow_nwindow | 0,<positive integer> | 0/7 | Number of focus window |
| focuswindow_range | <leftrange,rightrange,toprange,lowrange> <product dependent> | 0/7 | Available range for focuswindow. * We support this parameter when the version number (httpversion) is equal or greater than 0305d. * -: Not supported. |
| lensconfiguration_support | 0,1 | 0/7 | Indicate whether to support different image library configuration files for specific exchangeable lens. |
| freeze | <boolean> | 0/7 | 0: Non-support image freeze feature 1: Support image freeze feature * We support this parameter when |

| NAME | VALUE | SECURITY (get/set) | DESCRIPTION |
|------------------------------|----------------------|-----------------------|---|
| | | | the version number (httpversion) is equal or greater than 0302a. |
| autotrack_support | <boolean> | 0/7 | 0: Non-support auto tracking feature 1: Support auto tracking feature * We support this parameter when the version number (httpversion) is equal or greater than 0302a. |
| smartsensor_iris_total_range | A list of iris value | 0/7 | Available total step for iris value. * We support this parameter when the version number (httpversion) is equal or greater than 0302a. * Only available when "capability_image_c<0~(n-1)>_sensor_type" is "smartsensor" |
| deinterlace_support | <boolean> | 0/7 | Indicate whether to support deinterlace function. * We support this parameter when the version number (httpversion) is equal or greater than 0308a. |
| deinterlace_mode | spatial, blend | 0/7 | Spatial mode provides the best image quality, while Blend mode provides better image quality (than not using the deinterlace function at all). * Only available when capability_image_c<0~(n-1)>_deinterlace_support is 1 |
| lens_alignment | <boolean> | 0/7 | Indicate whether to support lens alignment function. * We support this parameter when the version number (httpversion) is equal or greater than 0309b. |
| lens_alignmentlevel | <positive integer> | 0/7 | The value indicate the support level of alignment. * Only available when "capability_image_c<0~(n-1)>_lens_al |

| NAME | VALUE | SECURITY (get/set) | DESCRIPTION |
|------------------|---------------------------|-----------------------|--|
| | | | ignment" is 1. |
| lens_ldc_support | <boolean> | 0/7 | Indicate whether to support lens distortion correction function. * We support this parameter when the version number (httpversion) is equal or greater than 0309d. |
| palette_support | <boolean> | 0/7 | Indicate support color palettes or not. Thermal cameras provide a choice of color palettes on the camera, that help quickly distinguish thermal variations and patterns in an image. The color tones correspond to the apparent surface temperatures of the target. * We support this parameter when the version number (httpversion) is equal or greater than 0310a. |
| palette_mode | A list of palette options | 0/7 | Palette options used in thermal surveillance. *Only available when "capability_image_c<0~(n-1)>_palette_support "=1. * We support this parameter when the version number (httpversion) is equal or greater than 0310a. |

Group: **capability_peripheral_c<0~(n-1)>** n denotes the value of "capability_nvideoin"

| PARAMETER | VALUE | SECURITY (get/set) | DESCRIPTION |
|---------------|-----------|-----------------------|---|
| devicecontrol | <boolean> | 0/7 | Indicate whether to support the peripheral device control. * We support this parameter when the version number (httpversion) is equal or greater than 0305c. |

7.28 Customized Event Script

Group: **event_customtaskfile_i<0~2>**

| PARAMETER | VALUE | SECURITY (get/set) | DESCRIPTION |
|-----------|--------------|-----------------------|---|
| name | string[40] | 6/6 | Custom script identification of this entry. |
| date | string[4~20] | 6/6 | Date of custom script. |
| time | string[4~20] | 6/6 | Time of custom script. |

7.29 Event Setting

Group: **event_i<0~(n-1)>** n denotes the value of "capability_nevent"

(capability_nevent > 0)

| PARAMETER | VALUE | SECURITY (get/set) | DESCRIPTION |
|-----------|------------|-----------------------|---|
| name | string[40] | 6/6 | Identification of this entry. |
| enable | 0, 1 | 6/6 | Enable or disable this event. |
| priority | 0, 1, 2 | 6/6 | Indicate the priority of this event: "0"= low priority "1"= normal priority "2"= high priority |
| delay | 1~999 | 6/6 | Delay in seconds before detecting the next event. |

| PARAMETER | VALUE | SECURITY (get/set) | DESCRIPTION |
|---------------|--|-----------------------|--|
| trigger | boot, di, pir, motion, seq, recnotify, tampering, vi, volalarm, visignal, vadp, smartsd <product dependent> | 6/6 | Indicate the trigger condition: "boot" = System boot. "di" = Digital input. "pir" = PIR detection. "motion" = Video motion detection. "seq" = Periodic condition. "visignal" = Video input signal loss. "recnotify" = Recording notification. "tampering" = Tamper detection. "vi" = Virtual input (Manual trigger). "volalarm" = Audio detection. "smartsd" = Lifetime detection of SD card. "shockalarm" = Shock detection. "virestore" = Video input signal restore. "vadp" = VADP trigger. * "smartsd" is only valid when smart SD card is inserted |
| triggerstatus | string[40] | 6/6 | The status for event trigger |
| di | 0,<positive integer> | 6/6 | Indicate the source id of di trigger. This field is required when trigger condition is "di". One bit represents one digital input. The LSB indicates DI 0. * Only available when "capability_ndi" > 0 |
| mdwin | 0,<positive integer> | 6/6 | Indicate the source window id of motion detection. This field is required when trigger condition is "md". One bit represents one window. The LSB indicates the 1 st window. For example, to detect the 1 st and 3 rd windows, set mdwin as 5. |
| mdwin0 | 0,<positive integer> | 6/6 | Similar to mdwin. The parameter takes effect when profile 1 of motion detection is enabled. |

| PARAMETER | VALUE | SECURITY (get/set) | DESCRIPTION |
|-----------------------------|----------------------|-----------------------|---|
| vi | 0,<positive integer> | 6/6 | Indicate the source id of vi trigger. This field is required when trigger condition is "vi". One bit represents one digital input. The LSB indicates VI 0. |
| vadp <product dependent> | 0,<positive integer> | 6/6 | Indicate the source id of vadp event notification. Each bit corresponds to one vadp source, and the LSB indicates source id 0. For example, to detect event from any one of source id 0, 1 and 3, set vadp to 11. * Only available when vadp is listed in "capability_supporttriggertypes" |
| valevel | 0,1 | 6/6 | Select audio detection event. 0: not select 1: select |
| valevel0 | 0,1 | 6/6 | Select audio detection profile event. 0: not select 1: select |
| inter | 1~999 | 6/6 | Interval of snapshots in minutes. This field is used when trigger condition is "seq". |
| weekday | 0~127 | 6/6 | Indicate which weekday is scheduled. One bit represents one weekday. bit0 (LSB) = Saturday bit1 = Friday bit2 = Thursday bit3 = Wednesday bit4 = Tuesday bit5 = Monday bit6 = Sunday For example, to detect events on Friday and Sunday, set weekday as 66. |
| begintime | hh:mm | 6/6 | Begin time of the weekly schedule. |

| PARAMETER | VALUE | SECURITY (get/set) | DESCRIPTION |
|---|---------------|-----------------------|---|
| endtime | hh:mm | 6/6 | End time of the weekly schedule. (00:00 ~ 24:00 sets schedule as always on) |
| lowlightcondition <product dependent> | 0, 1 | 6/6 | Switch on white light LED in low light condition 0 => Do action at all times 1 => Do action in low-light conditions |
| action_do_i<0~(ndo-1)>_enable | <boolean> | 6/6 | Enable or disable trigger digital output. * Only available when "capability_ndo" > 0 |
| action_do_i<0~(ndo-1)>_duration | 1~999 | 6/6 | Duration of the digital output trigger in seconds. * Only available when "capability_ndo" > 0 |
| action_cf_enable | <Boolean> | 6/6 | Enable or disable sending media to SD card. * Only available when "capability_supportsd" > 0 |
| action_cf_folder <Not recommended to use this> | string[128] | 6/6 | Path to store media. * Only available when "capability_supportsd" > 0 |
| foldername | string[128] | 6/6 | Path to store media. * We support this parameter when the version number (httpversion) is equal or greater than 0312a. |
| action_cf_media | NULL, 0~4,101 | 6/6 | Index of the attached media. 101 means "Recording Notify" * Only available when "capability_supportsd" > 0 |
| action_cf_datefolder | <boolean> | 6/6 | Enable this to create folders by date, time, and hour automatically. * Only available when "capability_supportsd" > 0 |

| PARAMETER | VALUE | SECURITY (get/set) | DESCRIPTION |
|--|---------------|-----------------------|---|
| action_cf_backup | <Boolean> | 6/6 | Enable or disable the function that send media to SD card for backup if network is disconnected. * Only available when "capability_supportsd" > 0 |
| action_server_i<0~4>_enable | <boolean> | 6/6 | Enable or disable this server action. |
| action_server_i<0~4>_media | NULL, 0~4,101 | 6/6 | Index of the attached media. 101 means "Recording Notify" |
| action_server_i<0~4>_datefolder | <boolean> | 6/6 | Enable this to create folders by date, time, and hour automatically. |
| action_goto_enable <product dependent> | <boolean> | 6/6 | Enable/disable ptz goto preset position on event triggered. * Only available when "capability_ptzenabled" > 0. |
| action_goto_name <product dependent> | string[40] | 6/6 | Specify the preset name that ptz goto on event triggered. * Only available when "capability_ptzenabled" > 0. |
| action_goto_sync <product dependent> | <boolean> | 6/6 | Capture media after moving to the location. * Only available when the bit4 of capability_ptzenabled is 1 and the bit7 of capability_ptzenabled is 0, or capability_camctrl_c0_zoommodule > 0 |
| action_autotrack_enable <product dependent> | <boolean> | 6/6 | Enable/disable auto tracking on event triggerd. * Only available when the bit4 of capability_ptzenabled is 1 and the bit7 of capability_ptzenabled is 0 |
| action_audioclip_enable | <boolean> | 6/6 | Enable/disable the function the play an audio clip when an event is triggered. * Only available when "capability_audio_audioclip" is 1. |

| PARAMETER | VALUE | SECURITY (get/set) | DESCRIPTION |
|------------------------|----------------------|-----------------------|---|
| action_audioclip_media | 0,<positive integer> | 6/6 | Indicate the source id of audioclip event notification. * Only available when "capability_audio_audioclip" is 1. |
| tampering | 0,<positive integer> | 6/6 | Indicate the source channel id of tampering detection. A 4-bit integer, each bit represents each channel. bit 0 => tampering detection for first channel. bit 1 => tampering detection for second channel. bit 2 => tampering detection for third channel. bit 3 => tampering detection for fourth channel. * We support this parameter when the version number (httpversion) is equal or greater than 0311c. |

7.30 Server Setting for Event Action

Group: server_i<0~4>

| PARAMETER | VALUE | SECURITY (get/set) | DESCRIPTION |
|---------------|-------------------------------|-----------------------|---|
| name | string[40] | 6/6 | Identification of this entry |
| type | email, ftp, http, ns | 6/6 | Indicate the server type: "email" = email server "ftp" = FTP server "http" = HTTP server "ns" = network storage |
| http_url | string[128] | 6/6 | URL of the HTTP server to upload. |
| http_username | string[64] | 6/6 | Username to log in to the server. |
| http_passwd | string[64] | 7/6 | Password of the user. |
| ftp_address | string[128] | 6/6 | FTP server address. |

| PARAMETER | VALUE | SECURITY (get/set) | DESCRIPTION |
|----------------------|-------------|-----------------------|--|
| ftp_username | string[64] | 6/6 | Username to log in to the server. |
| ftp_passwd | string[64] | 7/6 | Password of the user. |
| ftp_port | 0~65535 | 6/6 | Port to connect to the server. |
| ftp_location | string[128] | 6/6 | Location to upload or store the media. |
| ftp_passive | <boolean> | 6/6 | Enable or disable passive mode. 0 = disable passive mode 1 = enable passive mode |
| email_address | string[128] | 6/6 | Email server address. |
| email_sslmode | <boolean> | 6/6 | Enable support SSL. |
| email_port | 0~65535 | 6/6 | Port to connect to the server. |
| email_username | string[64] | 6/6 | Username to log in to the server. |
| email_passwd | string[64] | 7/6 | Password of the user. |
| email_senderemail | string[128] | 6/6 | Email address of the sender. |
| email_recipientemail | string[640] | 6/6 | Email address of the recipient. |
| ns_location | string[128] | 6/6 | Location to upload or store the media. |
| ns_username | string[64] | 6/6 | Username to log in to the server. |
| ns_passwd | string[64] | 7/6 | Password of the user. |
| ns_workgroup | string[64] | 6/6 | Workgroup for network storage. |

7.31 Media Setting for Event Action

Group: **media_i<0~(n-1)>** n denotes the value of "capability_media_num"
(capability_media_num > 0)

| PARAMETER | VALUE | SECURITY (get/set) | DESCRIPTION |
|------------------|--|-----------------------|--|
| Name | string[40] | 6/6 | Identification of this entry |
| Type | snapshot, systemlog, videoclip, recordmsg | 6/6 | Media type to send to the server or store on the server. |
| snapshot_channel | 0~"capability_nvideoin"-1 | 6/6 | Indicate the source of media channel. 0 means the first channel. 1 means the second channel. 2 means the third channel. 3 means the fourth channel. * We support this parameter when the version number (httpversion) is equal or greater than 0311c. |
| snapshot_source | 0~"capability_nmediastream" "-1 | 6/6 | Indicate the source of media stream. 0 means the first stream. 1 means the second stream and etc. 2 means the third stream and etc. 3 means the fourth stream and etc. |
| snapshot_prefix | string[16] | 6/6 | Indicate the prefix of the filename. media_i0=> Snapshot1_ media_i1=> Snapshot2_ media_i2=> Snapshot3_ media_i3=> Snapshot4_ media_i4=> Snapshot5_ |

| PARAMETER | VALUE | SECURITY (get/set) | DESCRIPTION |
|-----------------------|--|-----------------------|--|
| snapshot_datesuffix | 0, 1 | 6/6 | Add date and time suffix to filename: 1 = Add date and time suffix. 0 = Do not add. |
| snapshot_preevent | 0~" capability_media_snapshot_ maxpreevent" | 6/6 | Indicates the number of pre-event images. |
| snapshot_postevent | 0~" capability_media_snapshot_ maxpostevent" | 6/6 | Indicates the number of post-event images. |
| videoclip_channel | 0~"capability_nvideoin"-1 | 6/6 | Indicate the source of media channel. 0 means the first channel. 1 means the second channel. 2 means the third channel. 3 means the fourth channel. * We support this parameter when the version number (httpversion) is equal or greater than 0311c. |
| videoclip_source | 0~"capability_nmediastream"-1 | 6/6 | Indicate the source of media stream. 0 means the first stream. 1 means the second stream and etc. 2 means the third stream and etc. 3 means the fourth stream and etc. |
| videoclip_prefix | string[16] | 6/6 | Indicate the prefix of the filename. |
| videoclip_preevent | 0 ~ " capability_media_videoclip_ maxpreevent" | 6/6 | Indicates the time for pre-event recording in seconds. |
| videoclip_maxduration | 1 ~ " capability_media_videoclip_ maxlength" | 6/6 | Maximum duration of one video clip in seconds. |

| PARAMETER | VALUE | SECURITY (get/set) | DESCRIPTION |
|-------------------|---|-----------------------|---|
| videoclip_maxsize | 50 ~ " capability_media_videoclip_ maxsize" | 6/6 | Maximum size of one video clip file in Kbytes. |

7.32 Recording

Group: `recording_i<0~(n-1)>` n denotes the value of "capability_nrecording"

(`capability_nrecording > 0`)

| PARAMETER | VALUE | SECURITY (get/set) | DESCRIPTION |
|-----------|-------------------------------|-----------------------|---|
| name | string[40] | 6/6 | Identification of this entry. |
| trigger | schedule, networkfail | 6/6 | The event trigger type schedule: The event is triggered by schedule networkfail: The event is triggered by the failure of network connection. |
| enable | <boolean> | 6/6 | Enable or disable this recording. |
| priority | 0, 1, 2 | 6/6 | Indicate the priority of this recording: "0" indicates low priority. "1" indicates normal priority. "2" indicates high priority. |
| channel | 0~"capability_nvideoin"-1 | 6/6 | Indicate the source of recording channel. 0 means the first channel. 1 means the second channel. 2 means the third channel. 3 means the fourth channel. * We support this parameter when the version number (httpversion) is equal or greater than 0311c. |
| source | 0~"capability_nmediastream"-1 | 6/6 | Indicate the source of media stream. 0 means the first stream. 1 means the second stream and so on. |

| PARAMETER | VALUE | SECURITY (get/set) | DESCRIPTION |
|------------------|-----------|-----------------------|--|
| maxretentiontime | <string> | 6/6 | <p>To specify the expired time for automatic clean up, and it only takes effect for video clip generated by recording_i <0~1>.</p> <p>Format is “P[Y]Y[MM]M[DDD]DT[hh]H[mm]M[ss]S’ , similar with ISO8601 with symbols P Ex. P7D, it means 7 days. P1DT10H, it means 1 days and 10 hours.</p> <p>The parameter takes effect when autocleanup_maxretentiontime_recording_enabled is enabled.</p> |
| notify | <boolean> | 6/6 | <p>0: Disable recording notification 1: Enable recording notification</p> |
| notifyserver | 0~31 | 6/6 | <p>Indicate which notification server is scheduled.</p> <p>One bit represents one application server (server_i0~i4). bit0 (LSB) = server_i0. bit1 = server_i1. bit2 = server_i2. bit3 = server_i3. bit4 = server_i4.</p> <p>For example, enable server_i0, server_i2, and server_i4 as notification servers; the notifyserver value is 21.</p> |

| PARAMETER | VALUE | SECURITY (get/set) | DESCRIPTION |
|---|-------------|-----------------------|--|
| weekday | 0~127 | 6/6 | Indicate which weekday is scheduled. One bit represents one weekday. bit0 (LSB) = Saturday bit1 = Friday bit2 = Thursday bit3 = Wednesday bit4 = Tuesday bit5 = Monday bit6 = Sunday For example, to detect events on Friday and Sunday, set weekday as 66. |
| begintime | hh:mm | 6/6 | Start time of the weekly schedule. |
| endtime | hh:mm | 6/6 | End time of the weekly schedule. (00:00~24:00 indicates schedule always on) |
| prefix | string[16] | 6/6 | Indicate the prefix of the filename. |
| dest | cf, 0~4 | 6/6 | The destination to store the recorded data. “cf” means local storage (CF or SD card). “0” means the index of the network storage. |
| cffolder <Not recommended to use this> | string[128] | 6/6 | Folder name. |
| foldername | string[128] | 6/6 | Folder name. * We support this parameter when the version number (httpversion) is equal or greater than 0312a. |
| maxsize | 100~2000 | 6/6 | Unit: Mega bytes. When this condition is reached, recording file is truncated. |
| maxduration | 60~3600 | 6/6 | Unit: Second When this condition is reached, recording file is truncated. |

| PARAMETER | VALUE | SECURITY (get/set) | DESCRIPTION |
|--------------------|-----------|-----------------------|--|
| adaptive_enable | <boolean> | 6/6 | Indicate whether the adaptive recording is enabled |
| adaptive_preevent | 0~9 | 6/6 | Indicate when is the adaptive recording started before the event trigger point (seconds) |
| adaptive_postevent | 0~10 | 6/6 | Indicate when is the adaptive recording stopped after the event trigger point (seconds) |

7.33 HTTPS

Group: **https** (*capability_protocol_https > 0*)

| NAME | VALUE | SECURITY (get/set) | DESCRIPTION |
|---------------------|-----------------------------|-----------------------|--|
| enable | <boolean> | 6/6 | To enable or disable secure HTTP. |
| policy | <Boolean> | 6/6 | If the value is 1, it will force HTTP connection redirect to HTTPS connection |
| method | auto, manual, install | 6/6 | auto =>Create self-signed certificate automatically. manual =>Create self-signed certificate manually. install =>Create certificate request and install. |
| status | -3 ~ 1 | 6/6 | Specify the https status. -3= Certificate not installed -2 = Invalid public key -1 = Waiting for certificate 0= Not installed 1 = Active |
| countryname | string[2] | 6/6 | Country name in the certificate information. |
| stateorprovincename | string[128] | 6/6 | State or province name in the certificate information. |
| localityname | string[128] | 6/6 | The locality name in the certificate information. |

| NAME | VALUE | SECURITY (get/set) | DESCRIPTION |
|------------------|-------------------------------|-----------------------|--|
| organizationname | string[64] VIVOTEK Inc. | 6/6 | Organization name in the certificate information. |
| unit | string[64] VIVOTEK Inc. | 6/6 | Organizational unit name in the certificate information. |
| commonname | string[64] www.vivotek.com | 6/6 | Common name in the certificate information. |
| validdays | 0 ~ 3650 | 6/6 | Valid period for the certification. |

7.34 Storage Management Setting

Group: **disk_i<0~(n-1)>** n denotes the value of "capability_storage_management_ndevice"
(capability_storage_management_ndevice > 0)

| PARAMETER | VALUE | SECURITY (get/set) | DESCRIPTION |
|------------------|--------------------------------|-----------------------|--|
| cyclic_enabled | <boolean> | 6/6 | Enable cyclic storage method. |
| cyclic_reserve | 10 ~ 99 | 6/6 | The reserved percentage of this disk. * We support this parameter when the version number (httpversion) is equal or greater than 0312a. |
| type | sd, nas <product dependent> | 6/7 | The storage device type. * We support this parameter when the version number (httpversion) is equal or greater than 0312a. |
| autocleanup_mode | targetbase, sourcebase | 6/6 | Specify the automatic clean up method for storage devices, where "targetbase" indicate the automatic clean up is based on the attached devices such as nas or sd card, whereas "sourcebase" indicate automatic clean up is based on the selected recording track. * We support this parameter when the version number (httpversion) is equal or greater than 0312a. |

| PARAMETER | VALUE | SECURITY (get/set) | DESCRIPTION |
|--|--------------------|-----------------------|---|
| autocleanup_enabled <Not recommended to use this> | <boolean> | 6/6 | <p>Enable automatic clean up method. Expired and not locked media files will be deleted.</p> <p>* For forward compatibility reservations, but only group disk_i0_autocleanup is effective.</p> <p>* Not recommended to use this. Please refers "autocleanup" group.</p> <p>* This parameter will not be used after the version number (httpversion) is equal or greater than 0400a.</p> |
| autocleanup_maxage <Not recommended to use this> | <positive integer> | 6/6 | <p>To specify the expired days for automatic clean up.</p> <p>* For forward compatibility reservations, but only group disk_i0_autocleanup is effective.</p> <p>* Not recommended to use this. Please refers "autocleanup" group.</p> <p>* This parameter will not be used after the version number (httpversion) is equal or greater than 0400a.</p> |

7.35 Region of Interest

Group: $roi_c<0\sim(n-1)>$ for n channel product and m is the index of video stream which support ePTZ.

($capability_eptz > 0$ or $capability_fisheye = 1$)

| PARAMETER | VALUE | SECURITY (get/set) | DESCRIPTION |
|-----------------------|---------------------------------|-----------------------|---|
| $s<0\sim(m-1)>_home$ | <W,H> <product dependent> | 1/6 | ROI left-top corner coordinate.* If the minimal window size is 64x64, then the "win_i0_home"=(0~resolution_W-64, 0~resolution_H-64), which the resolution is the value in current stream. * If the stream doesn't support ePTZ, the permissions of this parameter must be set as 1/7. |
| $s<0\sim(m-1)>_size$ | <WxH> <product dependent> | 1/6 | ROI width and height. The width value must be multiples of 16 and the height value must be multiples of 8 * The minimal window size is 64x64, and then resolution_W, resolution_H is the value in current stream. * If the stream doesn't support ePTZ, the permissions of this parameter must be set as 1/7. |

7.36 ePTZ Setting

Group: **eptz_c<0~(n-1)>** for n channel product. (**capability_eptz > 0 or capability_fisheye = 1**)

| PARAMETER | VALUE | SECURITY (get/set) | DESCRIPTION |
|--|-----------|-----------------------|---|
| osdzoom <Not recommended to use this> | <boolean> | 1/4 | Indicates multiple of zoom in is "on-screen display" or not. * Reserved for compatibility, and suggest don't use this since [httpversion] > 0302a * We replace "eptz_c<0~(n-1)>_osdzoom" with "videoin_c<0~(n-1)>_zoomratioidisplay". |
| smooth | <boolean> | 1/4 | Enable the ePTZ "move smoothly" feature |
| tiltspeed | -5 ~ 5 | 1/4 | Tilt speed * Only available when "capability_fisheye" is 1 |
| | | 1/7 | Tilt speed (It should be set by eCamCtrl.cgi rather than by setparam.cgi.) |
| panspeed | -5 ~ 5 | 1/4 | Pan speed * Only available when "capability_fisheye" is 1 |
| | | 1/7 | Pan speed (It should be set by eCamCtrl.cgi rather than by setparam.cgi.) |
| zoomspeed | -5 ~ 5 | 1/4 | Zoom speed * Only available when "capability_fisheye" is 1 |
| | | 1/7 | Zoom speed (It should be set by eCamCtrl.cgi rather than by setparam.cgi.) |
| autospeed | 1 ~ 5 | 1/4 | Auto pan/patrol speed * Only available when "capability_fisheye" is 1 |

| PARAMETER | VALUE | SECURITY (get/set) | DESCRIPTION |
|-------------|-------|-----------------------|--|
| | | 1/7 | Auto pan/patrol speed (It should be set by eCamCtrl.cgi rather than by setparam.cgi.) |
| rotatespeed | 1 ~ 5 | 1/4 | Rotate speed (only for Fisheye series) * Only available when "capability_fisheye" is 1 and "capability_fisheylowdewarp_c<0~(n-1)>" is 0 |

Group: **eptz_c<0~(n-1)>_s<0~(m-1)>** for n channel product and m is the index of video stream which support ePTZ if capability_eptz > 0; m is the index of stream number if capability_fisheye = 1.
(capability_eptz > 0 or capability_fisheye = 1)

| PARAMETER | VALUE | SECURITY (get/set) | DESCRIPTION |
|---------------------|------------------------------|-----------------------|---|
| patrolseq | string[120] | 1/4 | The patrol sequence of ePTZ. All the patrol position indexes will be separated by "," |
| patroldwelling | string[160] | 1/4 | The dwelling time (unit: second) of each patrol point, separated by ";" |
| preset_i<0~19>_name | string[40] | 1/4 | Name of ePTZ preset. * Only available when "capability_fisheye" is 1 |
| | | 1/7 | Name of ePTZ preset. (It should be set by ePreset.cgi rather than by setparam.cgi.) |
| preset_i<0~19>_pos | <W,H> <product dependent> | 1/4 | Left-top corner coordinate of the preset. * Only available when "capability_fisheye" is 1 |
| | | 1/7 | Left-top corner coordinate of the preset. (It should be set by ePreset.cgi rather than by setparam.cgi.) |
| preset_i<0~19>_size | <WxH> <product dependent> | 1/4 | Width and height of the preset. * Only available when "capability_fisheye" is 1 |

| PARAMETER | VALUE | SECURITY (get/set) | DESCRIPTION |
|-----------|-------|-----------------------|---|
| | | 1/7 | Width and height of the preset. (It should be set by ePreset.cgi rather than by setparam.cgi.) |

7.37 Focus Window Setting

Group: **focuswindow_c<0~(n-1)>** for n channel products

n denotes the value of "capability_nvideoin".

(capability_image_c<0~(n-1)>_focuswindow_nwindow > 0)

| PARAMETER | VALUE | SECURITY (get/set) | DESCRIPTION |
|---------------|---------------------------------|-----------------------|---|
| win_i0_enable | <boolean> | 4/4 | Enable or disable the window. |
| win_i0_home | <W,H> <product dependent> | 4/4 | Left-top corner coordinate of the window. * If the minimal window size is 192x144, then the "win_i0_home"=(0~resolution_W-192, 0~resolution_H-144), resolution_W and resolution_H based on "capability_image_c<0~(n-1)>_focuswindow_range" . |
| win_i0_size | <WxH> <product dependent> | 4/4 | Width and height of the window. * The minimal window size is 192x144, and resolution_W and resolution_H is based on "capability_image_c<0~(n-1)>_focuswindow_range" . |

7.38 Seamless Recording Setting

<Not supported anymore>

Group: **seamlessrecording**

(**capability_localstorage_seamless**> 0)

| PARAMETER | VALUE | SECURITY (get/set) | DESCRIPTION |
|---------------|-------------------------|-----------------------|--|
| diskmode | seamless, manageable | 1/6 | <p>“seamless” indicates enable seamless recording.</p> <p>“manageable” indicates disable seamless recording.</p> <p>* We replace this parameter with “seamlessrecording_c<0~(n-1)>_diskmode” when the version number (httpversion) is equal or greater than 0312a.</p> |
| maxconnection | 3 | 1/7 | <p>Maximum number of connected seamless streaming.</p> <p>* We replace this parameter with “seamlessrecording_c<0~(n-1)>_maxconnection” when the version number (httpversion) is equal or greater than 0312a.</p> |
| enable | <boolean> | 1/7 | <p>Indicate whether seamless recording is recording to local storage or not at present. (Read only)</p> <p>* We replace this parameter with “seamlessrecording_c<0~(n-1)>_triggerrecord” when the version number (httpversion) is equal or greater than 0312a.</p> |
| guid<0~2>_id | string[127] | 1/7 | <p>The connected seamless streaming ID. (Read only)</p> <p>* We replace this parameter with “seamlessrecording_c<0~(n-1)>_guid<0~2>_id” when the version number (httpversion) is equal or greater than 0312a.</p> |

| PARAMETER | VALUE | SECURITY (get/set) | DESCRIPTION |
|------------------|-------|-----------------------|--|
| guid<0~2>_number | 0~3 | 1/7 | Number of connected seamless streaming with guid<0~(k-1)>_id. (Read only) * We replace this parameter with "seamlessrecording_c<0~(n-1)>_guid<0~2>_number" when the version number (httpversion) is equal or greater than 0312a. |

7.38.1 Seamless recording setting per channel

Group: **seamlessrecording_c<0~(n-1)>** for n channel products

n denotes the value of "capability_nvideoin".

(**capability_localstorage_seamless**> 0)

| PARAMETER | VALUE | SECURITY (get/set) | DESCRIPTION |
|---------------|-------------------------|-----------------------|--|
| diskmode | seamless, manageable | 1/6 | "seamless" indicates enable seamless recording. "manageable" indicates disable seamless recording. * We support this parameter when the version number (httpversion) is equal or greater than 0312a. |
| maxconnection | 3 | 1/7 | Maximum number of connected seamless streaming. * We support this parameter when the version number (httpversion) is equal or greater than 0312a. |
| triggerrecord | <boolean> | 1/7 | Indicate whether seamless recording is recording to local storage or not at present. (Read only) * We support this parameter when the version number (httpversion) is equal or greater than 0312a. |

| | | | |
|----------------------|-------------|-----|--|
| guid<0~(k-1)>_id | string[127] | 1/7 | The connected seamless streaming ID. (Read only) * k denotes the value of "seamlessrecording_c<0~(n-1)>_maxconnection" * We support this parameter when the version number (httpversion) is equal or greater than 0312a. |
| guid<0~(k-1)>_number | 0~3 | 1/7 | Number of connected seamless streaming with guid<0~(k-1)>_id. (Read only) * k denotes the value of "seamlessrecording_c<0~(n-1)>_maxconnection" * We support this parameter when the version number (httpversion) is equal or greater than 0312a. |

7.39 VIVOTEK Application Development Platform Setting

Group: vadb

| NAME | VALUE | SECURITY (get/set) | DESCRIPTION |
|------------------------|----------------------|-----------------------|---|
| version | <string> | 6/7 | Indicate the VADP version. |
| resource_total_memory | 0,<positive integer> | 6/7 | Indicate total available memory size for VADP modules. |
| resource_total_storage | 0,<positive integer> | 6/7 | Indicate total size of the internal storage space for storing VADP modules. |
| resource_free_memory | 0,<positive integer> | 6/7 | Indicate free memory size for VADP modules. |
| resource_free_storage | 0,<positive integer> | 6/7 | Indicate current free storage size for uploading VADP modules. |
| module_number | 0,<positive integer> | 6/7 | Record the total module number that already stored in the system. |
| module_order | string[40] | 6/6 | The execution order of the enabled modules. |
| module_save2sd | <boolean> | 6/6 | Indicate if the module should be |

| NAME | VALUE | SECURITY (get/set) | DESCRIPTION |
|--------|-------------|-----------------------|--|
| | | | saved to SD card when user want to upload it. If the value is false, save module to the internal storage space and it will occupy storage size. |
| number | string[128] | 6/7 | This number is used to register license key for VADP application. |

Group: **vadp_module_i<0~(n-1)>** for n VADP package number (**capability_vadp_npackage > 0**)
n denotes the value of "capability_vadp_npackage".

| NAME | VALUE | SECURITY (get/set) | DESCRIPTION |
|----------------|-------------|-----------------------|---|
| enable | <boolean> | 6/6 | Indicate if the module is enabled or not. If yes, also add the index of this module to the module_order. |
| name | string[40] | 6/6 | Module name |
| extendedname | string[40] | 6/6 | Extended module name. If this value is not blank, it will be shown on the VADP UI first instead of vadp_module_i<n>_name. |
| url | string[120] | 6/6 | Define the URL string after the IP address if the module provides it own web page. |
| vendor | string[40] | 6/6 | The provider of the module. |
| vendorurl | string[120] | 6/6 | URL of the vendor. |
| version | string[40] | 6/6 | Version of the module. |
| license | string[40] | 6/6 | Indicate the license status of the module. |
| licmsg | string[128] | 6/6 | Indicate the message that will be show on license status when mouse over. |
| path | string[40] | 6/6 | Record the storage path of the module. |
| initscr | string[40] | 6/6 | The script that will handle operation commands from the system. |
| status | string[40] | 6/6 | Indicate the running status of the module. |
| statmsg | string[128] | 6/6 | Indicate the message that will be show on the running status when mouse over. |
| vvtklicensemec | string[40] | 6/7 | Indicate the module use VIVOTEK license mechanism |

Group: **vadp_schedule_i<0~(n-1)>** for n VADP package number
n denotes the value of "capability_vadp_npackage".

(Only available when "capability_vadp_npackage" > 0 and the version number of "vadp_version" >= "1.3.2.0")

| NAME | VALUE | SECURITY (get/set) | DESCRIPTION |
|-----------|-----------|-----------------------|--|
| enable | <boolean> | 6/6 | Enable or disable the schedule mode to control the execution of the VADP package |
| begintime | hh:mm | 6/6 | Begin time of the schedule |
| endtime | hh:mm | 6/6 | End time of the schedule |

Group: **vadp_event**

| NAME | VALUE | SECURITY (get/set) | DESCRIPTION |
|------------------------------|----------------------|-----------------------|---|
| ntrigger | 0,<positive integer> | 6/7 | Indicate the number of topics to be transferred to event manager for trigger. |
| triggerlist_i<0~(n-1)>_topic | string[256] | 6/6 | Indicate the event notification with this topic will be transferred to event manager as trigger. n is equal to ntrigger above. |

7.40 Camera PTZ Control

Group: **camctrl** (**capability_camctrl_ptztunnel > 0**)

| NAME | VALUE | SECURITY (get/set) | DESCRIPTION |
|-----------------|-----------|-----------------------|---------------------------------------|
| enableptztunnel | <boolean> | 1/4 | Enable PTZ tunnel for camera control. |

Group: **camctrl_c<0~(n-1)>** for n channel products (**capability_ptzenabled > 0**)

n denotes the value of "capability_nvideoin" and k denotes the value of "capability_npreset"

| NAME | VALUE | SECURITY (get/set) | DESCRIPTION |
|----------------|-------------|-----------------------|---|
| panspeed | -5 ~ 5 | 1/4 | Pan speed |
| tiltspeed | -5 ~ 5 | 1/4 | Tilt speed |
| zoomspeed | -5 ~ 5 | 1/4 | Zoom speed |
| focusspeed | -5 ~ 5 | 1/4 | Auto focus speed |
| patrolseq | string[120] | 1/4 | (For external device) The indexes of patrol points, separated by “,” |
| patroldwelling | string[160] | 1/4 | (For external device) |

| NAME | VALUE | SECURITY (get/set) | DESCRIPTION |
|----------------------------|-------------------------|-----------------------|---|
| | | | The dwelling time of each patrol point, separated by “,” * only available when capability_camctrl_c0_rs485=2 |
| preset_j<0~(k-1)>_name | string[40] | 1/4 | Name of the preset location. |
| preset_j<0~(k-1)>_dwelling | 0 ~ 999 | 1/4 | The dwelling time of each preset location * only available when capability_camctrl_c0_rs485=2 |
| uart | 0 ~ "capability_uart"-1 | 1/4 | Select corresponding uart (capability_uart>0). * only available when capability_camctrl_c0_rs485=2 |
| cameraid | 0~255 | 1/4 | Camera ID controlling external PTZ camera. |
| isptz | 0 ~ 2 | 1/4 | 0: disable PTZ commands. 1: enable PTZ commands with PTZ driver. 2: enable PTZ commands with UART tunnel. * only available when capability_camctrl_c0_rs485=2 |
| disablemdonptz | <boolean> | 1/4 | Disable motion detection on PTZ operation. |

7.41 Camera PTZ Control (IZ Series)

Group: `camctrl_c<0~(n-1)>` for n channel products (`capability_camctrl_c0_zoommodule = 1` and `capability_camctrl_c0_buildingpt = 0`)

n denotes the value of "capability_nvideoin" and k denotes the value of "capability_npreset"

| NAME | VALUE | SECURITY (get/set) | DESCRIPTION |
|------------|--|-----------------------|--|
| ccdtype | string[16] | 6/7 | (Internal used, read only) |
| motortype | string[16] | 6/7 | (Internal used, read only) |
| cameraid | 0 ~ 255 | 1/4 | <p>Camera ID controlling external PTZ camera.</p> <p>Note:</p> <p>Please set your speed dome to the appropriate baud rate, and Camera ID, e.g. 2400bps, camera ID 1,2,3,,,,etc.</p> <p>All Camera IDs on the same controlling system (NVR or rs485 keyboard) have to be distinct.</p> <p>Therefore, once you send a controlling signal, each camera will only accept the inputs with the corresponding ID.</p> |
| panspeed | -5 ~ 5 | 1/4 | Pan speed |
| tiltspeed | -5 ~ 5 | 1/4 | Tilt speed |
| zoomspeed | -5 ~ 5 | 1/4 | Zoom speed |
| autospeed | -5 ~ 5 | 1/4 | Auto pan speed |
| focusspeed | -5 ~ 5 | 1/4 | Auto focus speed |
| focusmode | auto, onetimeauto, spotlight, manual * Available values are listed in "capability_camctrl_c<0~(n-1)>_focusmode" | 1/4 | Indicate the focus control mode. |
| uart | 0 ~ "capability_nua | 1/4 | Select corresponding uart (<code>capability_nuart>0</code>). |

| NAME | VALUE | SECURITY (get/set) | DESCRIPTION |
|------------------------------------|--|-----------------------|---|
| | rt"-1 | | * only available when capability_camctrl_c0_rs485=2 |
| isptz | 0 ~ 2 | 1/4 | 0: disable PTZ commands. 1: enable PTZ commands with PTZ driver. 2: enable PTZ commands with UART tunnel. * only available when capability_camctrl_c0_rs485=2 |
| preset_i<0~(k-1)>_name | string[40] | 1/4 | Name of the preset location. |
| preset_i<0~(k-1)>_zoom | capability_ptz_ c<0~(n-1)>_min zoom ~ capability_ptz_ c<0~(n-1)>_ma xzoom | 1/4 | Zoom position at each preset location. |
| preset_i<0~(k-1)>_focus | capability_ptz_ c<0~(n-1)>_min focus ~ capability_ptz_ c<0~(n-1)>_ma xfocus | 1/4 | Focus position at each preset location. |
| preset_i<0~(k-1)>_ dwelling | 0 ~ 999 | 1/4 | The dwelling time of each preset location * only available when capability_camctrl_c0_rs485=2 |
| preset_i<0~(k-1)>_focus setting | sync, fixcurrent | 1/4 | The focus mode of each preset, which is essential and should be grouped with "preset_i<0~(k-1)>_name." * We support this parameter when the version number (httpversion) is equal or greater than 0305b. |
| patrolseq | string[120] | 1/4 | (For external device) The indexes of patrol points, separated by "," |
| patroldwelling | string[160] | 1/4 | (For external device) |

| NAME | VALUE | SECURITY (get/set) | DESCRIPTION |
|---------------------|--|-----------------------|--|
| | | | The dwelling time of each patrol point, separated by “,” * only available when capability_camctrl_c0_rs485=2 |
| disablemdonptz | <boolean> | 1/4 | Disable motion detection on PTZ operation. |
| defaulthome | <boolean> | 1/4 | This field tells system to use default home position or not. |
| axisz | capability_ptz_ c<0~(n-1)>_min zoom ~ capability_ptz_ c<0~(n-1)>_ma xzoom | 1/4 | Custom home zoom position. |
| axisf | capability_ptz_ c<0~(n-1)>_min focus ~ capability_ptz_ c<0~(n-1)>_ma xfocus | 1/4 | Custom home focus position. |
| digitalzoom | <boolean> | 1/4 | Enable/disable digital zoom |
| zoomenhance | <boolean> | 1/4 | Enable /disable zoom enhancement |
| returnhome | <boolean> | 1/4 | Enable/disable return home while idle. |
| returnhomeinterval | 1~999 | 1/4 | While idle over this time interval, idle action will be taken. |
| idleaction_enable | <boolean> | 1/4 | Enable/disable idle action while idle |
| idleaction_type | home | 1/4 | This field tells what kind of action should be taken while idle. |
| idleaction_interval | 1~999 | 1/4 | While idle over this time interval, idle action will be taken. |

PLEASE REFER TO PTZ CONTROL API

7.42 Camera PTZ Control (SD Series)

Group: `camctrl_c<0~(n-1)>` for n channel products (the bit7 of `capability_ptzenabled` is 0 and the bit4 of `capability_ptzenabled` is 1)

n denotes the value of "capability_nvideoin" and k denotes the value of "capability_npreset"

| NAME | VALUE | SECURITY (get/set) | DESCRIPTION |
|---|---|-----------------------|---|
| <code>ccdtype</code> | string[16] | 6/7 | (Internal used, read only) |
| <code>motortype</code> | string[16] | 6/7 | (Internal used, read only) |
| <code>cameraid</code> | 1 ~ 255 | 1/4 | <p>Camera ID controlling external PTZ camera.</p> <p>Note:</p> <p>Please set your speed dome to the appropriate baud rate, and Camera ID, e.g. 2400bps, camera ID 1,2,3,,,,etc.</p> <p>All Camera IDs on the same controlling system (NVR or rs485 keyboard) have to be distinct. Therefore, once you send a controlling signal, each camera will only accept the inputs with the corresponding ID.</p> |
| <code>panspeed</code> | -5 ~ 5 | 1/4 | Pan speed |
| <code>tiltspeed</code> | -5 ~ 5 | 1/4 | Tilt speed |
| <code>zoomspeed</code> | -5 ~ 5 | 1/4 | Zoom speed |
| <code>autospeed</code> | -5 ~ 5 | 1/4 | Auto pan speed |
| <code>focusspeed</code> | -5 ~ 5 | 1/4 | Auto focus speed |
| <code>focusmode</code> | auto, onetimeauto, spotlight, manual * Available values are listed in "capability_camctrl_c<0~(n-1)>_focusmode" | 1/4 | Indicate the focus control mode. |
| <code>preset_i<0~(k-1)>_name</code> | string[40] | 1/4 | Name of the preset location. |
| <code>preset_i<0~(k-1)>_pan</code> | capability_ptz_c<0~(| 1/4 | Pan position at each preset |

| NAME | VALUE | SECURITY (get/set) | DESCRIPTION |
|---------------------------------|--|-----------------------|---|
| | n-1)>_minpan ~ capability_ptz_c<0~(n-1)>_maxpan | | location. |
| preset_i<0~(k-1)>_tilt | capability_ptz_c<0~(n-1)>_mintilt ~ capability_ptz_c<0~(n-1)>_maxtilt | 1/4 | Tilt position at each preset location. |
| preset_i<0~(k-1)>_zoom | capability_ptz_c<0~(n-1)>_minzoom ~ capability_ptz_c<0~(n-1)>_maxzoom | 1/4 | Zoom position at each preset location. |
| preset_i<0~(k-1)>_focus | capability_ptz_c<0~(n-1)>_minfocus ~ capability_ptz_c<0~(n-1)>_maxfocus | 1/4 | Focus position at each preset location. |
| preset_i<0~(k-1)>_focus setting | sync, fixcurrent | 1/4 | The focus mode of each preset, which is essential and should be grouped with "preset_i<0~(k-1)>_name." * We support this parameter when the version number (httpversion) is equal or greater than 0305b. |
| preset_i<0~(k-1)>_fliped | <boolean> | 1/4 | Flip side at each preset location. |
| patrol_i<0~39>_name | string[40] | 1/4 | (For internal device) The name of patrol location |
| patrol_i<0~39>_dwelling | 0 ~ 999 | 1/4 | (For internal device) The dwelling time of each patrol location |
| disablemdonptz | <boolean> | 1/4 | Disable motion detection on PTZ operation. |
| defaulthome | <boolean> | 1/4 | This field tells system to use default home position or not. |
| axisx | capability_ptz_c<0~(n-1)>_minpan ~ capability_ptz_c<0~(n-1)>_maxpan | 1/4 | Custom home pan position. |

| NAME | VALUE | SECURITY (get/set) | DESCRIPTION |
|---------------------|---|-----------------------|--|
| | n-1)>_maxpan | | |
| axisy | capability_ptz_c<0~(n-1)>_mintilt ~ capability_ptz_c<0~(n-1)>_maxtilt | 1/4 | Custom home tilt position. |
| axisz | capability_ptz_c<0~(n-1)>_minzoom ~ capability_ptz_c<0~(n-1)>_maxzoom | 1/4 | Custom home zoom position. |
| axisf | capability_ptz_c<0~(n-1)>_minfocus ~ capability_ptz_c<0~(n-1)>_maxfocus | 1/4 | Custom home focus position. |
| axisflip | <boolean> | 1/4 | Custom home flip side. |
| returnhome | <boolean> | 1/4 | Enable/disable return home while idle. |
| returnhomeinterval | 1~999 | 1/4 | While idle over this time interval, idle action will be taken. |
| digitalzoom | <boolean> | 1/4 | Enable/disable digital zoom |
| idleaction_enable | <boolean> | 1/4 | Enable/disable idle action while idle |
| idleaction_type | pan,patrol,tour,home ,objtrack,prev | 1/4 | This field tells what kind of action should be taken while idle. |
| idleaction_interval | 1~999 | 1/4 | While idle over this time interval, idle action will be taken. |
| zoomenhance | <boolean> | 1/4 | Enable /disable zoom enhancement |
| tour_index | -1, 0~19 | 1/4 | Index of the enabled tour group, from 0 to 19. Set -1 to disable all the tour groups. |
| tour_i<0~19>_name | string[40] | 1/4 | Name of the tour. |
| tour_i<0~19>_type | <boolean> | 1/4 | 0 = Recorded tour 1 = Preset tour |
| tour_i<0~19>_speed | -5 ~ 5 | 1/4 | Preset tour: pan and tilt speed when moving between presets. |

| NAME | VALUE | SECURITY (get/set) | DESCRIPTION |
|------------------------|-------------------------|-----------------------|--|
| | | | Recorded tour: unnecessary. |
| tour_i<0~19>_direction | forward,backward,random | 1/4 | User can choose which direction the preset tour goes. "forward" : preset tour goes in forward order. "backward" : preset tour goes in backward order. "random" : the presets of the tour will be recalled randomly. * Only available when "capability_presettourdirection" is 1. * We support this parameter when the version number (httpversion) is equal or greater than 0307a. |
| tour_i<0~19>_checklist | string[512] | 1/4 | The indexes of preset positions, separated by “;” |
| tour_i<0~19>_dwelltime | string[512] | 1/4 | Preset tour: time to wait before moving to the next preset position, separated by “;” Recorded tour: number of seconds to wait before continuing a loop tour. |

PLEASE REFER TO PTZ CONTROL API

7.43 UART Control

Group: **uart** (*capability_uart > 0 and capability_fisheye = 0*)

| NAME | VALUE | SECURITY (get/set) | DESCRIPTION |
|----------------------------------|-------------|-----------------------|---|
| ptzdrivers_i<0~19, 127>_name | string[40] | 1/4 | Name of the PTZ driver. |
| ptzdrivers_i<0~19, 127>_location | string[128] | 1/4 | Full path of the PTZ driver. |
| enablehttptunnel | <boolean> | 1/4 | Enable HTTP tunnel channel to control UART. |

Group: **uart_i<0~(n-1)>** n is uart port count (*capability_uart > 0 and capability_fisheye = 0*)

| NAME | VALUE | SECURITY (get/set) | DESCRIPTION |
|---------------------|---|-----------------------|--|
| baudrate | 300,600,1200,2400, 4800,9600,19200,38400,57600,115200 | 4/4 | Set baud rate of COM port. |
| databit | 5,6,7,8 | 4/4 | Data bits in a character frame. |
| paritybit | none, odd, even | 4/4 | For error checking. |
| stopbit | 1,2 | 4/4 | "1": One stop bit is transmitted to indicate the end of a byte. "2": Two stop bits are transmitted to indicate the end of a byte. If you want to transfer the stopbit for 150% of the normal time used to transfer one bit, the <code>uart_i<0~(n-1)>_stopbit</code> should be set as 2 and the <code>uart_i<0~(n-1)>_databit</code> set as 5 as well. |
| uartmode | rs485, rs232 | 4/4 | RS485 or RS232. |
| customdrvcmd_i<0~9> | string[128] | 1/4 | PTZ command for custom camera. * only available when <code>capability_camctrl_c0_rs485=2</code> |

| NAME | VALUE | SECURITY (get/set) | DESCRIPTION |
|-----------------------|---|-----------------------|---|
| speedlink_i<0~4>_name | string[40] | 1/4 | Additional PTZ command name. * only available when capability_camctrl_c0_rs485=2 |
| speedlink_i<0~4>_cmd | string[40] | 1/4 | Additional PTZ command list. * only available when capability_camctrl_c0_rs485=2 |
| ptzdriver | 0~19, 127 (custom), 128 (no driver) | 1/4 | The PTZ driver is used by this COM port. * only available when capability_camctrl_c0_rs485=2 |

7.44 UART Control (SD Series)

Group: **uart_i<0~(n-1)>** n is uart port count (**capability_nuart > 0 and the bit7 of capability_ptzenabled is 0, the bit4 of capability_ptzenabled is 1**)

| NAME | VALUE | SECURITY (get/set) | DESCRIPTION |
|-----------|---|-----------------------|---|
| cameraid | 1~255 | 4/4 | Camera ID controlling external PTZ camera. Note: Please set your speed dome to the appropriate baud rate, and Camera ID, e.g. 2400bps, camera ID 1,2,3,,,,etc. All Camera IDs on the same controlling system (NVR or rs485 keyboard) have to be distinct. Therefore, once you send a controlling signal, each camera will only accept the inputs with the corresponding ID. |
| baudrate | 2400,4800,9600,19200,38400,57600,115200 | 4/4 | Set baud rate of COM port. |
| databit | 5,6,7,8 | 4/4 | Data bits in a character frame. |
| paritybit | none, odd, even | 4/4 | For error checking. |

| NAME | VALUE | SECURITY (get/set) | DESCRIPTION |
|----------|-------|-----------------------|--|
| stopbit | 1,2 | 4/4 | "1": One stop bit is transmitted to indicate the end of a byte. "2": Two stop bits are transmitted to indicate the end of a byte. If you want to transfer the stopbit for 150% of the normal time used to transfer one bit, the <code>uart_i<0~(n-1)>_stopbit</code> should be set as 2 and the <code>uart_i<0~(n-1)>_databit</code> set as 5 as well. |
| uartmode | rs485 | 4/7 | RS485 mode. |

7.45 Lens Configuration

Group: **lens** for n channel products

n denotes the value of "capability_nvideoin"

(`capability_image_c<0~(n-1)>_lensconfiguration_support = 1`)

| NAME | VALUE | SECURITY (get/set) | DESCRIPTION |
|----------|----------|-----------------------|---|
| selected | <string> | 6/7 | Current selected lens profile. e.g. <code>lens_selected=lens_default_i0</code> , it means chosen lens configuration is i0 lens of default group. |

Group: **lens_default**

| NAME | VALUE | SECURITY (get/set) | DESCRIPTION |
|--------------|----------------------|-----------------------|--|
| totalnumbers | 0,<positive integer> | 6/7 | Totoal support number of the default lens profiles |

Group: **lens_user**

| NAME | VALUE | SECURITY (get/set) | DESCRIPTION |
|--------------|----------------------|-----------------------|---|
| totalnumbers | 0,<positive integer> | 6/7 | Totoal support number of the user lens profiles |

Group: lens_default_i<0~(n-1)>

n denotes the value of "lens_default_totalnumbers"

| NAME | VALUE | SECURITY (get/set) | DESCRIPTION |
|------|----------|-----------------------|-------------------|
| name | <string> | 6/7 | Default lens name |

Group: lens_user_i<0~(n-1)>

n denotes the value of "lens_user_totalnumbers"

| NAME | VALUE | SECURITY (get/set) | DESCRIPTION |
|------|----------|-----------------------|------------------------|
| name | <string> | 6/7 | User-defined lens name |

7.46 Fisheye Info.Group: **fishyeinfo** (*capability_fisheye > 0*)

| NAME | VALUE | SECURITY (get/set) | DESCRIPTION |
|-------------------|--------------------------|-----------------------|-----------------------------------|
| revisedcenteraxis | <coordinate> | 6/7 | The actual center axis coordinate |
| radius | 0, <positive integer> | 6/7 | The actual center radius |

7.47 Fisheye Local Dewarp SettingGroup: **fishyedewarp_c<0~(n-1)>** (*capability_fisheylaldewarp_c<0~(n-1)> > 0*)

n denotes the value of "capability_nvideoin", m denotes the value of "capability_nmediastream"

| NAME | VALUE | SECURITY (get/set) | DESCRIPTION |
|----------------------------------|----------------------|-----------------------|--|
| panspeed | -5 ~ 5 <integer> | 1/4 | Pan speed of regional view |
| tiltspeed | -5 ~ 5 <integer> | 1/4 | Tilt speed of regional view |
| zoomspeed | -5 ~ 5 <integer> | 1/4 | Zoom speed of regional |
| s<0~(m-2)>_panora ma_panstart | 0~359 <integer> | 1/4 | Initial pan position of panorama view. (only available for 1P and 2P mode at ceiling or floor mount) |
| s<0~(m-2)>_region_ pan | -90~359 <integer> | 1/4 | Pan home angle of regional view Pan range of ceiling/floor mount is |

| NAME | VALUE | SECURITY (get/set) | DESCRIPTION |
|------------------------|----------------------|-----------------------|---|
| | | | [0~359]. Pan range of wall mount is [-90~90]. |
| s<0~(m-2)>_region_tilt | -90~90 <integer> | 1/4 | Tilt home angle of regional view Tilt range of ceiling/floor mount is [0~90]. Tilt range of wall mount is [-90~90]. |
| s<0~(m-2)>_region_zoom | 100~300 <integer> | 1/4 | Zoom home ratio of regional view |

[PLEASE REFER TO FISHEYE LOCAL DEWARP API](#)

7.48 PIR Behavior Define

Group: **pir** (*capability_npir > 0*)

| NAME | VALUE | SECURITY (get/set) | DESCRIPTION |
|--------|-----------|-----------------------|--------------------|
| enable | <boolean> | 1/1 | Enable/disable PIR |

7.49 Auto Tracking Setting

Group: **autotrack_c<0~(n-1)>** (*capability_image_c<0~(n-1)>_autotrack_support > 0*)

n denotes the value of "capability_nvideoin"

| PARAMETER | VALUE | SECURITY (get/set) | DESCRIPTION |
|---------------------------|--------|-----------------------|---|
| objsize_type | -1~2 | 1/4 | Type of object size. -1 : customized width and height 0 : object size = 30 x 30 1 : object size = 10 x 20 2 : object size = 10 x 10 |
| objsize_customized_width | 10~320 | 1/4 | The minimum width of tracking target. |
| objsize_customized_height | 10~240 | 1/4 | The minimum height of tracking target. |
| sensitivity | 0~2 | 1/4 | Tracking sensitivity. 0: Low 1: Medium 2: High |

7.50 Wireless

Group: **wireless** (`capability_network_wireless > 0`)

| PARAMETER | VALUE | SECURITY (get/set) | DESCRIPTION |
|-----------|--|-----------------------|--|
| ssid | string[32] | 6/6 | SSID for wireless lan settings. |
| wlmode | Infra, Adhoc | 6/6 | Wireless mode. Infra: Infrastructure |
| channel | 1~11 or 1~13 or 10~11 or 10~13 or 1~14 | 6/6 | A list of WLAN channels. Countries apply their own regulations to the allowable channels. 1~11: USA and Canada 1~13: Europe 10~11: Spain 10~13: France 1~14: Japan * Only valid when "wireless_wlmode" is "Adhoc" |
| encrypt | none, wep, wpa, wpa2 | 6/6 | Encryption method: none: NONE, wep: WEP, wpa: WPA, wpa2: WPA2PSK |
| authmode | OPEN, SHARED | 6/6 | Authentication mode. * Only valid when "wireless_encrypt" is "wep" |
| keylength | 64, 128 | 6/6 | Key length in bits. * Only valid when "wireless_encrypt" is "wep" |
| keyformat | HEX, ASCII | 6/6 | Key1 ~ key4 presentation format. * Only valid when "wireless_encrypt" is "wep" |
| keyselect | 1 ~ 4 | 6/6 | Default key number. * Only valid when "wireless_encrypt" is "wep" |

| PARAMETER | VALUE | SECURITY (get/set) | DESCRIPTION |
|--------------|---------------|-----------------------|---|
| key1 | password [26] | 6/6 | WEP key1 for encryption. * Only valid when "wireless_encrypt" is "wep" |
| key2 | password [26] | 6/6 | WEP key2 for encryption. * Only valid when "wireless_encrypt" is "wep" |
| key3 | password [26] | 6/6 | WEP key3 for encryption. * Only valid when "wireless_encrypt" is "wep" |
| key4 | password [26] | 6/6 | WEP key4 for encryption. * Only valid when "wireless_encrypt" is "wep" |
| algorithm | AES, TKIP | 6/6 | Algorithm * Only valid when "wireless_encrypt" is "wpa" or "wpa2" |
| presharedkey | password [64] | 6/6 | WPA/WPA2PSK mode pre-shared key. * Only valid when "wireless_encrypt" is "wpa" or "wpa2" |

7.51 Shock Detection

Group: **shock_c<0~(n-1)>** for n channel products

n denotes the value of "capability_nvideoin" (**capability_shockalarm_support > 0**)

| PARAMETER | VALUE | SECURITY (get/set) | DESCRIPTION |
|--------------|-----------|-----------------------|---|
| alarm_enable | <boolean> | 4/4 | Enable shock detection's alarm. |
| alarm_level | 1~100 | 4/4 | The value indicate the support strength level of shock detection's alarm. |

8. Useful Functions

8.1 Drive the Digital Output (**capability_ndo > 0**)

Note: This request requires Viewer privileges.

Method: GET/POST

Syntax:

```
[&do2=<state>]
[&do3=<state>][&do4=<state>]
```

Where state is 0 or 1; "0" means inactive or normal state, while "1" means active or triggered state.

| PARAMETER | VALUE | DESCRIPTION |
|-----------|-------|-----------------------------|
| do<num> | 0, 1 | 0 – Inactive, normal state |
| | | 1 – Active, triggered state |

Example: Drive the digital output 1 to triggered state and redirect to an empty page.

<http://myserver/cgi-bin/dido/setdo.cgi?do1=1>

8.2 Query Status of the Digital Input (**capability_ndi > 0**)

Note: This request requires Viewer privileges

Method: GET/POST

Syntax:

```
http://<servername>/cgi-bin/dido/getdi.cgi?[di0][&di1][&di2][&di3]
```

If no parameter is specified, all of the digital input statuses will be returned.

Return:

```
HTTP/1.0 200 OK\r\n
Content-Type: text/plain\r\n
Content-Length: <length>\r\n
\r\n
[di0=<state>]\r\n
[di1=<state>]\r\n
[di2=<state>]\r\n
```

```
[di3=<state>]\r\n
```

where <state> can be 0 or 1.

Example: Query the status of digital input 1 .

Request:

```
http://myserver/cgi-bin/dido/getdi.cgi?di1
```

Response:

```
HTTP/1.0 200 OK\r\n
```

```
Content-Type: text/plain\r\n
```

```
Content-Length: 7\r\n
```

```
\r\n
```

```
di1=1\r\n
```

8.3 Query Status of the Digital Output (**capability_ndo > 0**)

Note: This request requires Viewer privileges

Method: GET/POST

Syntax:

```
http://<servername>/cgi-bin/dido/getdo.cgi?[do0][&do1][&do2][&do3]
```

If no parameter is specified, all the digital output statuses will be returned.

Return:

```
HTTP/1.0 200 OK\r\n
```

```
Content-Type: text/plain\r\n
```

```
Content-Length: <length>\r\n
```

```
\r\n
```

```
[do0=<state>]\r\n
```

```
[do1=<state>]\r\n
```

```
[do2=<state>]\r\n
```

```
[do3=<state>]\r\n
```

where <state> can be 0 or 1.

Example: Query the status of digital output 1.

Request:

```
http://myserver/cgi-bin/dido/getdo.cgi?do1
```

Response:

```
HTTP/1.0 200 OK\r\n
Content-Type: text/plain\r\n
Content-Length: 7\r\n
\r\n
do1=1\r\n
```

8.4 Capture Single Snapshot

Note: This request requires Normal User privileges.

Method: GET/POST

Syntax:

```
http://<servername>/cgi-bin/viewer/video.jpg?[channel=<value>][&resolution=<value>]
[&quality=<value>][&streamid=<value>]
```

If the user requests a size larger than all stream settings on the server, this request will fail.

| PARAMETER | VALUE | DESCRIPTION |
|------------|--|---|
| channel | 0~(capability_nvideoin -1) | The channel number of the video source. |
| resolution | Available options are list in "capability_videoin_c<0~(n-1)>_resolution". Besides, available options is referred to "capability_videoin_c<0~(n-1)>_maxresolution" and "capability_videoin_c<0~(n-1)>_minresolution" | The resolution of the image. |
| quality | 1~5 | The quality of the image. |
| streamid | 0~(capability_nmediastream -1) | The stream number. |

The server will return the most up-to-date snapshot of the selected channel and stream in JPEG format. The size and quality of the image will be set according to the video settings on the server.

Return:

```
HTTP/1.0 200 OK\r\n
Content-Type: image/jpeg\r\n
[Content-Length: <image size>\r\n]
<binary JPEG image data>
```

8.5 Account Management

Note: This request requires Administrator privileges.

Method: POST

Syntax:

```
http://<servername>/cgi-bin/admin/editaccount.cgi?
method=<value>&username=<name>[&userpass=<value>][&privilege=<value>]
[&privilege=<value>][&return=<return page>]
```

| PARAMETER | VALUE | DESCRIPTION |
|-----------|---------------|---|
| method | add | Add an account to the server. When using this method, the "username" field is necessary. It will use the default value of other fields if not specified. |
| | delete | Remove an account from the server. When using this method, the "username" field is necessary, and others are ignored. |
| | edit | Modify the account password and privilege. When using this method, the "username" field is necessary, and other fields are optional. If not specified, it will keep the original settings. |
| username | <name> | The name of the user to add, delete, or edit. |
| userpass | <value> | The password of the new user to add or that of the old user to modify. The default value is an empty string. |
| privilege | view | The privilege of the user to add or to modify. |
| | operator | " view ": Viewer privilege. |
| | admin | " operator ": Operator privilege. " admin ": Administrator privilege. |
| return | <return page> | Redirect to the page <return page> after the parameter is assigned. The <return page> should be the relative path according to the root of camera. If you omit this parameter, it will redirect to an empty page. * If the <return page> is invalid path, it will ignore this parameter. |

8.6 Upgrade Firmware

Note: This request requires Administrator privileges.

Method: POST

Syntax:

```
http://<servername>/cgi-bin/admin/upgrade.cgi
```

Post data:

```
fimage=<file name>[&return=<return page>]\r\n\r\n<multipart encoded form data>
```

Server will accept the file named <file name> to upgrade the firmware and return with <return page> if indicated.

8.7 ePTZ Camera Control (**capability_eptz > 0 and**

Capability_fisheye = 0)

Note: This request requires camctrl privileges.

Method: GET/POST

Syntax:

```

http://<servername>/cgi-bin/camctrl/eCamCtrl.cgi?channel=<value>&stream=<value>
[&move=<value>] – Move home, up, down, left, right
[&auto=<value>] – Auto pan, patrol
[&zoom=<value>] –Zoom in, out
[&zooming=<value>&zs=<value>] –Zoom without stopping, used for joystick
[&x=<value>&y=<value>&w=<value>&h=<value>&resolution=<value>] - Zoom in, out on a specific
area
[&vx=<value>&vy=<value>&vs=<value>] – Shift without stopping, used for joystick
[&x=<value>&y=<value>&videosize=<value>&resolution=<value>&stretch=<value>] –Click on
image
(Move the center of image to the coordination (x,y) based on resolution or videosize.)
[ [&speedpan=<value>][&speedtilt=<value>][&speedzoom=<value>][&speedapp=<value>] ] – Set
speeds
[&return=<return page>]

```

Example:

```

http://myserver/cgi-bin/camctrl/eCamCtrl.cgi?channel=0&stream=0&move=right
http://myserver/cgi-bin/camctrl/eCamCtrl.cgi?channel=0&stream=1&vx=2&vy=2&vz=2
http://myserver/cgi-bin/camctrl/eCamCtrl.cgi?channel=0&stream=1&x=100&y=100&videosize=640x480&resolution=640x480&stretch=0

```

In zoom operation, there are two ways to control it, scale zoom and area zoom.

1. [Scale zoom]: contains two control method, relative movement and continuous movement
 - a. relative movement -

If you trigger a relative movement, it will only zoom certain ratio and stop by itself.

<http://IPAddr/cgi-bin/camctrl/eCamCtrl.cgi?stream=0&zoom=tele>

<http://IPAddr/cgi-bin/camctrl/eCamCtrl.cgi?stream=0&zoom=wide>

The zoom ratio to move by relative movement is according to the setting of speedzoom [-5~5].

<http://IPAddr/cgi-bin/camctrl/eCamCtrl.cgi?stream=0&speedzoom=5>

b. continuous movement -

If you trigger a continuous movement, you have to handle the stop time by yourself.

A continuous movement is convenient to integrate a joystick control.

<http://IPAddr/cgi-bin/camctrl/eCamCtrl.cgi?stream=0&zooming=tele&zs=1>

<http://IPAddr/cgi-bin/camctrl/eCamCtrl.cgi?stream=0&zooming=wide&zs=5>

zooming is used to indicate the moving direction, and zs is used to indicate the speed.

To stop a continuous movement, you have to use the command as below:

<http://IPAddr/cgi-bin/camctrl/eCamCtrl.cgi?stream=0&zoom=stop&zs=0>

2. [Area zoom]: it means to zoom in on a specific area, here is an example for a directly moving

[x, y] is the desired coordinate, and it will be the center after movement

[w, h] is the scaled area size

[resolution] is the base range of this coordinate system

The example shows [w, h] = [864, 488], which means to zoom in to ratio x2.2 based on [1920x1080].

Pay attention to that [x, y, w, h] are essential parameters in an area zoom case, and the stream index is counted from 0 as the first stream.

<http://IPAddr/cgi-bin/camctrl/eCamCtrl.cgi?channel=0&stream=0&x=912&y=297&w=864&h=488&resolution=1920x1080>

| PARAMETER | VALUE | DESCRIPTION |
|-----------|--------------|---|
| channel | <0~(n-1)> | Channel of video source. |
| stream | <0~(m-1)> | Stream. |
| move | home | Move to home ROI. |
| | up | Move up. |
| | down | Move down. |
| | left | Move left. |
| | right | Move right. |
| auto | pan | Auto pan. |
| | patrol | Auto patrol. |
| | stop | Stop auto pan/patrol. |
| zoom | wide | Zoom larger view with current speed. |
| | tele | Zoom further with current speed. |
| zooming | wide or tele | Zoom without stopping for larger view or further view with zs speed, used for joystick control. |
| zs | 0 ~ 6 | Set the speed of zooming, "0" means stop. |
| x | <integer> | The desired coordinate, and it will be the center after |

| PARAMETER | VALUE | DESCRIPTION |
|------------|---------------|---|
| y | <integer> | movement |
| w | <integer> | The scaled area size |
| h | <integer> | |
| resolution | <window size> | The resolution of streaming. |
| vx | <integer> | The direction of movement, used for joystick control. |
| vy | <integer> | |
| vs | 0 ~ 7 | Set the speed of movement, "0" means stop. |
| x | <integer> | x-coordinate clicked by user. It will be the x-coordinate of center after movement. |
| y | <integer> | y-coordinate clicked by user. It will be the y-coordinate of center after movement. |
| videosize | <window size> | The size of plug-in (ActiveX)window in web page |
| resolution | <window size> | The resolution of streaming. |
| stretch | <boolean> | 0 indicates that it uses resolution (streaming size) as the range of the coordinate system. 1 indicates that it uses videosize (plug-in size) as the range of the coordinate system. |
| speedpan | -5 ~ 5 | Set the pan speed. |
| speedtilt | -5 ~ 5 | Set the tilt speed. |
| speedzoom | -5 ~ 5 | Set the zoom speed. |
| speedapp | 1 ~ 5 | Set the auto pan/patrol speed. |
| return | <return page> | Redirect to the page <return page> after the parameter is assigned. The <return page> should be the relative path according to the root of camera. If you omit this parameter, it will redirect to an empty page. * If the <return page> is invalid path, it will ignore this parameter. |

8.8ePTZ Recall (**capability_eptz > 0 and capability_fisheye = 0**)

Note: This request requires camctrl privileges.

Method: GET/POST

Syntax:

```
http://<servername>/cgi-bin/camctrl/eRecall.cgi?channel=<value>&stream=<value>&recall=<value>[&return=<return page>]
```

| PARAMETER | VALUE | DESCRIPTION |
|-----------|-------------------------------------|---|
| channel | <0~(n-1)> | Channel of the video source. |
| stream | <0~(m-1)> | Stream. |
| recall | Text string less than 40 characters | One of the present positions to recall. |
| return | <return page> | Redirect to the page <return page> after the parameter is assigned. The <return page> should be the relative path according to the root of camera. If you omit this parameter, it will redirect to an empty page. * If the <return page> is invalid path, it will ignore this parameter. |

8.9ePTZ Preset Locations (**capability_eptz > 0 and capability_fisheye = 0**)

Note: This request requires Operator privileges.

Method: GET/POST

Syntax:

```
http://<servername>/cgi-bin/operator/ePreset.cgi?channel=<value>&stream=<value>[&addpos=<value>][&delpos=<value>][&return=<return page>]
```

| PARAMETER | VALUE | DESCRIPTION |
|-----------|-----------|------------------------------|
| channel | <0~(n-1)> | Channel of the video source. |
| stream | <0~(m-1)> | Stream. |

| PARAMETER | VALUE | DESCRIPTION |
|-----------|---------------------------------------|---|
| addpos | <Text string less than 40 characters> | Add one preset location to the preset list. |
| delpos | <Text string less than 40 characters> | Delete preset location from the preset list. |
| return | <return page> | Redirect to the page <return page> after the parameter is assigned. The <return page> should be the relative path according to the root of camera. If you omit this parameter, it will redirect to an empty page. * If the <return page> is invalid path, it will ignore this parameter. |

8.10 IP Filtering for ONVIF

Syntax:<product dependent>

```
http://<servername>/cgi-bin/admin/ipfilter.cgi?type[=<value>]
http://<servername>/cgi-bin/admin/ipfilter.cgi?method=add<v4/v6>&ip=<ipaddress>[&index=<value>][&return=<return page>]
http://<servername>/cgi-bin/admin/ipfilter.cgi?method=del<v4/v6>&index=<value>[&return=<return page>]
```

| PARAMETER | VALUE | DESCRIPTION |
|-----------|--------------|---|
| type | NULL | Get IP filter type |
| | allow, deny | Set IP filter type |
| method | addv4 | Add IPv4 address into access list. |
| | addv6 | Add IPv6 address into access list. |
| | delv4 | Delete IPv4 address from access list. |
| | delv6 | Delete IPv6 address from access list. |
| ip | <IP address> | Single address: <IP address> Network address: <IP address / network mask> Range address:<start IP address - end IP address> |
| index | <value> | The start position to add or to delete. |

8.11 UART HTTP Tunnel Channel (**capability_nuart > 0**)

Note: This request requires Operator privileges.

Method: GET and POST

Syntax:

```
http://<servername>/cgi-bin/operator/uartchannel.cgi?[channel=<value>]
```

```
-----
```

```
GET /cgi-bin/operator/uartchannel.cgi?[channel=<value>]
```

```
x-sessioncookie: string[22]
```

```
accept: application/x-vvtk-tunnelled
```

```
pragma: no-cache
```

```
cache-control: no-cache
```

```
-----
```

```
POST /cgi-bin/operator/uartchannel.cgi
```

```
x-sessioncookie: string[22]
```

```
content-type: application/x-vvtk-tunnelled
```

```
pragma : no-cache
```

```
cache-control : no-cache
```

```
content-length: 32767
```

```
expires: Sun, 9 Jan 1972 00:00:00 GMT
```

User must use GET and POST to establish two channels for downstream and upstream. The x-sessioncookie in GET and POST should be the same to be recognized as a pair for one session. The contents of upstream should be base64 encoded to be able to pass through a proxy server.

This channel will help to transfer the raw data of UART over the network.

Please see UART tunnel spec for detail information

| PARAMETER | VALUE | DESCRIPTION |
|-----------|-----------|-----------------------------|
| channel | 0 ~ (n-1) | The channel number of UART. |

8.12 Event/Control HTTP Tunnel Channel

(capability_evctrlchannel > 0)

Note: This request requires **Administrator** privileges.

Method: GET and POST

Syntax:

```
http://<servername>/cgi-bin/admin/ctrlevent.cgi
```

```
-----  
GET /cgi-bin/admin/ctrlevent.cgi
```

```
x-sessioncookie: string[22]
```

```
accept: application/x-vvtk-tunnelled
```

```
pragma: no-cache
```

```
cache-control: no-cache
```

```
-----  
POST /cgi-bin/admin/ ctrlevent.cgi
```

```
x-sessioncookie: string[22]
```

```
content-type: application/x-vvtk-tunnelled
```

```
pragma : no-cache
```

```
cache-control : no-cache
```

```
content-length: 32767
```

```
expires: Sun, 9 Jan 1972 00:00:00 GMT
```

User must use GET and POST to establish two channels for downstream and upstream. The x-sessioncookie in GET and POST should be the same to be recognized as a pair for one session. The contents of upstream should be base64 encoded to be able to pass through the proxy server.

This channel will help perform real-time event subscription and notification as well as camera control more efficiently. The event and control formats are described in another document.

See Event/control tunnel spec for detail information

8.13 Get SDP of Streams

Note: This request requires Viewer access privileges.

Method: GET/POST

Syntax:

```
http://<servername>/<network_rtsp_s<0~m-1>_accessname>
```

“m” is the stream number.

“network_accessname_<0~(m-1)>” is the accessname for stream “1” to stream “m”. Please refer to the “subgroup of network: rtsp” for setting the accessname of SDP.

You can get the SDP by HTTP GET.

When using scalable multicast, Get SDP file which contains the multicast information via HTTP.

8.14 Open the Network Stream

Note: This request requires Viewer access privileges.

Syntax:

For HTTP push server (MJPEG):

```
http://<servername>/<network_http_s<0~m-1>_accessname>
```

For RTSP (MP4), the user needs to input the URL below into an RTSP compatible player.

```
rtsp://<servername>/<network_rtsp_s<0~m-1>_accessname>
```

“m” is the stream number.

For details on streaming protocol, please refer to the “control signaling” and “data format” documents.

8.15 Send Data (**capability_nuart > 0**)

Note: This request requires Viewer privileges.

Method: GET/POST

Syntax:

```
http://<servername>/cgi-bin/viewer/senddata.cgi?
[com=<value>][&data=<value>][&flush=<value>] [&wait=<value>] [&read=<value>]
```

| PARAMETER | VALUE | DESCRIPTION |
|-----------|---|--|
| com | 1 ~ <max. com port number> | The target COM/RS485 port number. |
| data | <hex decimal data>[,<hex decimal data>] | The <hex decimal data> is a series of digits from 0 ~ 9, A ~ F. Each comma separates the commands by 200 milliseconds. |
| flush | yes,no | yes: Receive data buffer of the COM port will be cleared before read. no: Do not clear the receive data buffer. |
| wait | 1 ~ 65535 | Wait time in milliseconds before read data. |
| read | 1 ~ 128 | The data length in bytes to read. The read data will be in the return page. |

Return:

```
HTTP/1.0 200 OK\r\n
Content-Type: text/plain\r\n
Content-Length: <system information length>\r\n
\r\n
<hex decimal data>\r\n
```

Where hexadecimal data is digits from 0 ~ 9, A ~ F.

8.16 Storage Managements (**capability_stroage.dbenabled > 0**)

Note: This request requires **administrator** privileges.

Method: GET and POST

Syntax:

```
http://<servername>/cgi-bin/admin/lctrl.cgi?cmd=<cmd_type>[&<parameter>=<value>...]
```

The commands usage and their input arguments are as follows.

| PARAMETER | VALUE | DESCRIPTION |
|-----------|----------|---|
| cmd_type | <string> | Required. Command to be executed, including <i>search</i> , <i>insert</i> , <i>delete</i> , <i>update</i> , and <i>queryStatus</i> . |

Command: **search**

| PARAMETER | VALUE | DESCRIPTION |
|-------------|-----------------------|---|
| label | <integer primary key> | Optional. The integer primary key column will automatically be assigned a unique integer. |
| triggerType | <text> | Optional. Indicate the event trigger type. Please embrace your input value with single quotes. Ex. <i>mediaType='motion'</i> Support trigger types are product dependent. |
| mediaType | <text> | Optional. Indicate the file media type. Please embrace your input value with single quotes. Ex. <i>mediaType='videoclip'</i> Support trigger types are product dependent. |
| destPath | <text> | Optional. Indicate the file location in camera. Please embrace your input value with single quotes. Ex. <i>destPath ='/mnt/auto/CF/NCMF/abc.mp4'</i> |
| resolution | <text> | Optional. Indicate the media file resolution. Please embrace your input value with single quotes. |

| PARAMETER | VALUE | DESCRIPTION |
|-------------|--------------------|--|
| | | Ex. resolution='800x600' |
| isLocked | <boolean> | Optional. Indicate if the file is locked or not. 0: file is not locked. 1: file is locked. A locked file would not be removed from UI or cyclic storage. |
| triggerTime | <text> | Optional. Indicate the event trigger time. (not the file created time) Format is "YYYY-MM-DD HH:MM:SS" Please embrace your input value with single quotes. Ex. triggerTime='2008-01-01 00:00:00' If you want to search for a time period, please apply "TO" operation. Ex. triggerTime='2008-01-01 00:00:00'+TO+'2008-01-01 23:59:59' is to search for records from the start of Jan 1 st 2008to the end of Jan 1 st 2008. |
| limit | <positive integer> | Optional. Limit the maximum number of returned search records. |
| offset | <positive integer> | Optional. Specifies how many rows to skip at the beginning of the matched records. Note that the offset keyword is used after limit keyword. |

To increase the flexibility of search command, you may use "OR" connectors for logical "OR" search operations. Moreover, to search for a specific time period, you can use "TO" connector.

Ex. To search records triggered by motion or di or sequential and also triggered between 2008-01-01 00:00:00 and 2008-01-01 23:59:59.

```
http://<servername>/cgi-bin/admin/lscrtl.cgi?cmd=search&triggerType='motion'+OR+'di'+OR+'seq'
&triggerTime='2008-01-01 00:00:00'+TO+'2008-01-01 23:59:59'
```

Command: **delete**

| PARAMETER | VALUE | DESCRIPTION |
|-----------|-----------------------|--|
| label | <integer primary key> | Required. Identify the designated record. |

| PARAMETER | VALUE | DESCRIPTION |
|-----------|-------|-------------|
| | | Ex. label=1 |

Ex. Delete records whose key numbers are 1, 4, and 8.

```
http://<servername>/cgi-bin/admin/lscrtl.cgi?cmd=delete&label=1&label=4&label=8
```

Command: **update**

| PARAMETER | VALUE | DESCRIPTION |
|-----------|-----------------------|---|
| label | <integer primary key> | Required. Identify the designated record. Ex. label=1 |
| isLocked | <boolean> | Required. Indicate if the file is locked or not. |

Ex. Update records whose key numbers are 1 and 5 to be locked status.

```
http://<servername>/cgi-bin/admin/lscrtl.cgi?cmd=update&isLocked=1&label=1&label=5
```

Ex. Update records whose key numbers are 2 and 3 to be unlocked status.

```
http://<servername>/cgi-bin/admin/lscrtl.cgi?cmd=update&isLocked=0&label=2&label=3
```

Command: queryStatus

| PARAMETER | VALUE | DESCRIPTION |
|-----------|-------------------|--|
| retType | xml or javascript | Optional. Ex. retype=javascript The default return message is in XML format. |

Ex. Query local storage status and call for javascript format return message.

```
http://<servername>/cgi-bin/admin/lscrtl.cgi?cmd=queryStatus&retType=javascript
```

8.17 Virtual Input (**capability_nvi > 0**)

Note: Change virtual input (manual trigger) status.

Method: GET

Syntax:

```
http://<servername>/cgi-bin/admin/setvi.cgi?vi0=<value>[&vi1=<value>][&vi2=<value>]
[&return=<return page>]
```

| PARAMETER | VALUE | DESCRIPTION |
|-----------|--|---|
| vi<num> | state[(duration)nstate] Where "state" is 0, 1. "0" means inactive or normal state while "1" means active or triggered state. Where "nstate" is next state after duration. | Ex: vi0=1 Setting virtual input 0 to trigger state |
| | | Ex: vi0=0(200)1 Setting virtual input 0 to normal state, waiting 200 milliseconds , setting it to trigger state. Note that when the virtual input is waiting for next state, it cannot accept new requests. |
| return | <return page> | Redirect to the page <return page> after the parameter is assigned. The <return page> should be the relative path according to the root of camera. If you omit this parameter, it will redirect to an empty page. * If the <return page> is invalid path, it will ignore this parameter. |

| Return Code | Description |
|-------------|---|
| 200 | The request is successfully executed. |
| 400 | The request cannot be assigned, ex. incorrect parameters. Examples: setvi.cgi?vi0=0(10000)1(15000)0(20000)1 No multiple duration. setvi.cgi?vi3=0 VI index is out of range. setvi.cgi?vi=1 No VI index is specified. |
| 503 | The resource is unavailable, ex. Virtual input is waiting for next state. |

| | |
|--|---|
| | <p>Examples:</p> <p>setvi.cgi?vi0=0(15000)1</p> <p>setvi.cgi?vi0=1</p> <p>Request 2 will not be accepted during the execution time(15 seconds).</p> |
|--|---|

8.18 Open Timeshift Stream (**capability_timeshift > 0, timeshift_enable=1, timeshift_c<n>_s<m>_allow=1**)

Note: This request requires Viewer access privileges.

Syntax:

For HTTP push server (MJPEG):

```
http://<servername>/<network_http_s<m>_accessname>?maxsft=<value>[&tsmode=<value>&reftime=<value>&forcechk&minsft=<value>]
```

For RTSP (MP4 and H264), the user needs to input theURL below into an RTSP compatible player.

```
rtsp://<servername>/<network_rtsp_s<m>_accessname>?maxsft=<value>[&tsmode=<value>&reftime=<value>&forcechk&minsft=<value>]
```

“n” is the channel index.

“m” is the timeshift stream index.

For details on timeshift stream, please refer to the “TimeshiftCaching” documents.

| PARAMETER | VALUE | DEFAULT | DESCRIPTION |
|-----------|--------------------|---------|--|
| maxsft | <positive integer> | 0 | Request cached stream at most how many seconds ago. The value must be a positive integer. (>0) |
| tsmode | normal, adaptive | normal | Streaming mode: normal => Full FPS all the time. adaptive => Default send only I-frame for MP4 and H.264, and send 1 FPS for MJPEG. If DI or motion window are triggered, the streaming is changed to send full FPS for 10 seconds. (*Note: this parameter also works on non-timeshift streams.) tsmode must exactly match well-defined wording (normal, adaptive), unknown parameters are always |

| PARAMETER | VALUE | DEFAULT | DESCRIPTION |
|-----------|--------------------|---------------------------------------|--|
| | | | ignored. |
| reftime | mm:ss | The time camera receives the request. | Reference time for maxsft and minsft. (This provides more precise time control to eliminate the inaccuracy due to network latency.) Ex: Request the streaming from 12:20 rtsp://10.0.0.1/live.sdp?maxsft=10&reftime=12:30 |
| forcechk | N/A | N/A | Check if the requested stream enables timeshift, feature and if minsft is achievable. If false, return "415 Unsupported Media Type". |
| minsft | <positive integer> | 0 | How many seconds of cached stream client can accept at least. (Used by forcechk) The value must be a positive integer. (>0) |

| Return Code | Description |
|----------------------------|--|
| 400 Bad Request | Request is rejected because some parameter values are illegal. |
| 415 Unsupported Media Type | Returned, if forcechk appears, when minsft is not achievable or the timeshift feature of the target stream is not enabled. |

8.19 RemoteFocus

(capability_image_c<0~(n-1)>_remotefocus=1)

Note: This request requires Administrator privileges.

Method: GET/POST

Syntax:

```
http://<servername>/cgi-bin/admin/remotefocus.cgi?function=<value>[&direction=<value>]  
[&position=<value>][&steps=<value>][&iris]
```

| PARAMETER | VALUE | DESCRIPTION |
|-----------|---|--|
| function | zoom, focus, auto, scan, stop, positioning, irisopen, irisenable, getstatus | <p>Function type</p> <p>zoom - Move focus motor</p> <p>focus – Move focus motor</p> <p>auto – Perform auto focus</p> <p>scan – Perform focus scan</p> <p>stop – Stop current operation</p> <p>positioning – Position the motors</p> <p>irisopen – Fully open iris. It will maintain fully open iris status until sending function=irisenable cgi.</p> <p>irisenable – return back to user setting status of iris.</p> <p>getstatus–Information of motors, return value as below:</p> <p>remote_focus_zoom_motor_max: Maximum steps of zoom motor</p> <p>remote_focus_focus_motor_max: Maximum steps of focus motor</p> <p>remote_focus_zoom_motor_start: Start point of zoom motor</p> <p>remote_focus_zoom_motor_end: End point of zoom motor</p> <p>remote_focus_focus_motor_start: Start point of effective focal length</p> <p>remote_focus_focus_motor_end: End point of effective focal length</p> <p>remote_focus_zoom_motor: Current position of zoom motor</p> <p>remote_focus_focus_motor: Current position of focus motor</p> <p>remote_focus_zoom_enable: Current function of zoom motor</p> <p>remote_focus_focus_enable: Current function of focus motor</p> <p>remote_focus_iris_open: The current status of iris. 0: irisenable, 1: irisopen</p> <p>Current function of zoom/focus motor, return value as below:</p> <p>0: no service</p> <p>1: zooming</p> <p>2. focusing</p> <p>3: auto focus</p> <p>4: focus scan</p> <p>5: positioning (both zoom motor and focus motor)</p> <p>12: reset focus</p> |

| PARAMETER | VALUE | DESCRIPTION |
|-----------|---------------------------------|--|
| direction | direct, forward, backward | Motor's moving direction. It works only if function=zoom or function=focus. |
| position | 0~<motor_max> | Motor's position. It works only if function=zoom or function= focus and direction=direct. <motor_max> is refer to remote_focus_focus_motor_max or remote_focus_zoom_motor_max which replied from "function=getstatus" |
| steps | 1 ~ <motor_max> | Motor's moving steps. It works only if function=zoom or function=focus and direction=forward and direction=backward. <motor_max> is refer to remote_focus_focus_motor_max or remote_focus_zoom_motor_max which replied from "function=getstatus" * This parameter is for additional fine-tune, the value is from 1 to 30. |
| iris | N/A | Open iris or not. It works only if function=auto or function=scan. |

8.20 BackFocus (**capability_image_c<0~(n-1)>_remotefocus=4**)

Note: This request requires Administrator privileges.

Method: GET/POST

Syntax:

```
http://<servername>/cgi-bin/admin/remotefocus.cgi?function=<value>[&direction=<value>]  
[&position=<value>][&steps=<value>][&iris]
```

| PARAMETER | VALUE | DESCRIPTION |
|-----------|-------|-------------|
|-----------|-------|-------------|

| PARAMETER | VALUE | DESCRIPTION |
|-----------|---|---|
| function | focus, auto, scan, stop, positioning, irisopen, irisenable, resetfocus, getstatus | <p>Function type</p> <p>focus – Move focus motor</p> <p>auto – Perform auto focus</p> <p>scan – Perform focus scan</p> <p>stop – Stop current operation</p> <p>positioning – Position the motors</p> <p>resetfocus – reset focus position to default</p> <p>irisopen – Fully open iris. It will maintain fully open iris status until sending function=irisenable cgi.</p> <p>irisenable – return back to user setting status of iris.</p> <p>getstatus–Information of motors, return value as below:</p> <p>remote_focus_focus_motor_max: Maximum steps of focus motor</p> <p>remote_focus_focus_motor_start: Start point of effective focal length</p> <p>remote_focus_focus_motor_end: End point of effective focal length</p> <p>remote_focus_focus_motor: Current position of focus motor</p> <p>remote_focus_focus_enable: Current function of focus motor</p> <p>remote_focus_iris_open: The current status of iris. 0: irisenable, 1: irisopen</p> <p>Current function of zoom/focus motor, return value as below:</p> <p>0: no service</p> <p>1: zooming</p> <p>2. focusing</p> <p>3: auto focus</p> <p>4: focus scan</p> <p>5: positioning (both zoom motor and focus motor)</p> <p>12: reset focus</p> |
| direction | direct, forward, backward | <p>Motor's moving direction.</p> <p>It works only if function= focus.</p> |

| PARAMETER | VALUE | DESCRIPTION |
|-----------|-----------------|---|
| position | 0~<motor_max> | Motor's position. It works only if function=focus and direction=direct. <motor_max> is refer to remote_focus_focus_motor_max which replied from "function=getstatus" |
| steps | 1 ~ <motor_max> | Motor's moving steps. It works only if function=focus and direction=forward or direction=backward. <motor_max> is refer to remote_focus_focus_motor_max which replied from "function=getstatus" * This parameter is for additional fine-tune, the value is from 1 to 30. |
| iris | N/A | Open iris or not. It works only if function=auto or function=scan. |

8.21 Export Files

Note: This request requires Administrator privileges.

Method: GET

Syntax:

For daylight saving time configuration file:

```
http://<servername>/cgi-bin/admin/exportDst.cgi
```

For language file:

```
http://<servername>/cgi-bin/admin/export_language.cgi?currentlanguage=<value>
```

| PARAMETER | VALUE | DESCRIPTION |
|-----------------|-------|--|
| currentlanguage | 0~20 | Available language lists. Please refer to: system_info_language_i0 ~ system_info_language_i19. |

For setting backup file:

```
http://<servername>/cgi-bin/admin/export_backup.cgi?backup
```

8.22 Upload Files

Note: This request requires Administrator privileges.

Method: POST

Syntax:

For daylight saving time configuration file:

```
http://<servername>/cgi-bin/admin/upload_dst.cgi
```

Post data:

```
filename =<file name>\r\n\r\n<multipart encoded form data>
```

For language file:

```
http://<servername>/cgi-bin/admin/upload_lan.cgi
```

Post data:

```
filename =<file name>\r\n\r\n<multipart encoded form data>
```

For setting backup file:

```
http://<servername>/cgi-bin/admin/upload_backup.cgi
```

Post data:

```
filename =<file name>\r\n\r\n<multipart encoded form data>
```

Server will accept the file named <file name> to upload this one to camera.

8.23 Update Lens Configuration

(capability_image_c<0~(n-1)>_lensconfiguration_support > 0)

Note: This request requires Administrator privileges.

Method: GET

Syntax:

For list a name of lens currently used:

```
http://<servername>/cgi-bin/admin/update_lens.cgi?get_currentlens
```

For list all names of lens installed in camera:

```
http://<servername>/cgi-bin/admin/update_lens.cgi?list_lens
```

For choose selected lens configuration:

```
http://<servername>/cgi-bin/admin/update_lens.cgi?choose_lens=<value>
```

You need to reboot manually after you choose another lens configuration.

For choose selected lens configuration and reboot camera:

```
http://<servername>/cgi-bin/admin/update_lens.cgi?choose_reboot_lens=<value>
```

The camera will reboot after using this cgi.

For delete selected lens configuration:

```
http://<servername>/cgi-bin/admin/update_lens.cgi?delete_lens=<value>
```

| PARAMETER | VALUE | DESCRIPTION |
|-----------|----------|---|
| value | <string> | Available lens name. Please refer to: lens_default_i<0~(n-1)>_name lens_user_i<0~(n-1)>_name n is a positive integer. |

Method: POST

Syntax:

For upload user-defined lens configuration:

```
http://<servername>/cgi-bin/admin/update_lens.cgi?upload_lens
```

Post data:

```
upload_lens_profile_input = <file name>\r\n
\r\n
<multipart encoded form data>
```

Server will accept the file named <file name> to upload the lens profile to camera.

8.24 Media on Demand (**capability_localstorage.modnum > 0**)

Media on demand allows users to select and receive/watch/listen to metadata/video/audio contents on demand.

Note: This request requires Viewer access privileges.

Syntax:

```
rtsp://<servername>/mod.sdp? [&stime=<value>] [&etime=<value>] [&length =<value>] [&loctime =<value>] [&file=<value>] [&tsmode=<value>]
```

| PARAMETER | VALUE | DEFAULT | DESCRIPTION |
|-----------|-----------------------|---------|--|
| stime | <YYYYMMDD_HHMMSS.MMM> | N/A | Start time. |
| etime | <YYYYMMDD_HHMMSS.MMM> | N/A | End time. |
| length | <positive integer> | N/A | The length of media of interest. The unit is second. |
| loctime | <boolean> | 0 | Specify if start/end time is local time format. 1 for local time, 0 for UTC+0 |
| file | <string> | N/A | The media file to be played. |
| tsmode | <positive integer> | N/A | Timeshift mode, the unit is second. |

Ex.

| stime | etime | length | file | Description |
|-------|-------|--------|------|--|
| V | V | X | X | Play recordings between stime and etime rtsp://10.10.1.2/mod.sdp?stime=20110312_040400.000&etime=2011_0312_040510.000 |
| V | X | V | X | Play recordings for length seconds which start from stime rtsp://10.10.1.2/mod.sdp?stime=20110312_040400.000&length=120 |
| X | V | V | X | Play recordings for length seconds which ends at etime |

| | | | | |
|----------|----------|----------|----------|---|
| | | | | rtsp://10.10.1.2/mod.sdp?etime=20110312_040400.000&length=120 |
| X | X | X | V | Play file file |
| | | | | rtsp://10.10.1.2/mod.sdp?filename=/mnt/link0/ |

8.25 Fisheye Local Dewarp Camera Control (**capability_fisheye > 0 and capability_fisheye_localdewarp.c0 > 0, only support in 1R mode**)

Note: This request requires camctrl privileges.

Method: GET/POST

Syntax:

http://<servername>/cgi-bin/camctrl/fdCamCtrl.cgi?channel=<value>&stream=<value>
 [&move=<value>] – Move home, up, down, left, right
 [&zoom=<value>] – Zoom wide, tele
 [[&speedpan=<value>][&speedtilt=<value>][&speedzoom=<value>]] – Set speeds
 [&zooming=<value>&zs=<value>] – Zoom without stopping, used for joystick
 [&vx=<value>&vy=<value>&vs=<value>] – Shift without stopping, used for joystick
 [&x=<value>&y=<value>&videosize=<value>&resolution=<value>&stretch=<value>] – Click on image (Move the center of image to the coordination (x,y) based on resolution or videosize of 10 mode.)
 [&return=<return page>]

Example:

<http://myserver/cgi-bin/camctrl/fdCamCtrl.cgi?channel=0&stream=0&move=right>
<http://myserver/cgi-bin/camctrl/fdCamCtrl.cgi?channel=0&stream=0&zoom=tele>
<http://myserver/cgi-bin/camctrl/fdCamCtrl.cgi?channel=0&stream=0&move=top&speedtilt=-1>
<http://myserver/cgi-bin/camctrl/fdCamCtrl.cgi?channel=0&stream=0&zooming=tele&zs=2>
<http://myserver/cgi-bin/camctrl/fdCamCtrl.cgi?channel=0&stream=0&vx=5&vy=3&vs=2>
<http://myserver/cgi-bin/camctrl/fdCamCtrl.cgi?channel=0&stream=0&x=700&y=700&videosize=1920x1920&resolution=1920x1920&stretch=1>

| PARAMETER | VALUE | DESCRIPTION |
|-----------|-----------|--------------------------|
| channel | <0~(n-1)> | Channel of video source. |
| stream | <0~(m-1)> | Stream. |
| move | home | Move to home position. |
| | up | Move up. |
| | down | Move down. |

| PARAMETER | VALUE | DESCRIPTION |
|------------|---------------|---|
| | left | Move left. |
| | right | Move right. |
| zoom | wide | Zoom larger view with current speed. |
| | tele | Zoom further with current speed. |
| speedpan | -5 ~ 5 | Set the pan speed of current command. |
| speedtilt | -5 ~ 5 | Set the tilt speed of current command. |
| speedzoom | -5 ~ 5 | Set the zoom speed of current command. |
| zooming | wide or tele | Zoom without stopping for larger view or further view with zs speed, used for joystick control. |
| zs | 0 ~ 6 | Set the speed of zooming, "0" means stop. |
| vx | -6 ~ 6 | The direction of movement, used for joystick control. |
| vy | -6 ~ 6 | |
| vs | 0 ~ 7 | Set the speed of movement, "0" means stop. |
| x | <integer> | x-coordinate clicked by user. It will be the x-coordinate of center after movement. |
| y | <integer> | y-coordinate clicked by user. It will be the y-coordinate of center after movement. |
| videosize | <window size> | The size of plug-in (ActiveX) window in web page of 10 content. |
| resolution | <window size> | The resolution of streaming of 10 content. |
| stretch | <boolean> | 0 indicates that it uses resolution (streaming size) as the range of the coordinate system. 1 indicates that it uses videosize (plug-in size) as the range of the coordinate system. |
| return | <return page> | Redirect to the page <return page> after the parameter is assigned. The <return page> should be the relative path according to the root of camera. If you omit this parameter, it will redirect to an empty page. * If the <return page> is invalid path, it will ignore this parameter. |

PLEASE REFER TO FISHEYE LOCAL DEWARP API

8.26 3D Privacy Mask

(Capability_image_c<0~(n-1)>_privacymask_wintype = 3Drectangle)

n denotes the value of "capability_nvideoin"

Note: This request requires admin user privilege

Method: GET/POST

Syntax:

http://<servername>/cgi-bin/admin/setpm3d.cgi?method=<value>&maskname=<value>&[maskheight=<value>&maskwidth=<value>&videosize=<value>&return=<return page>]

| PARAMETER | VALUE | DESCRIPTION |
|------------|---------------|---|
| method | add | Add a 3D privacy mask at current location |
| | delete | Delete a 3D privacy mask |
| | edit | Edit a 3D privacy mask |
| maskname | string[40] | 3D privacy mask name |
| maskheight | integer | 3D privacy mask height |
| maskwidth | integer | 3D privacy mask width |
| videosize | <window size> | Optimal. The size of plug-in (ActiveX) window in web page is the size of the privacy window size. This field is not necessary, it will use the default value if not specified. 320x180 for 16:9 resolution and 320x240 for 4:3 resolution. |
| return | <return page> | Redirect to the page <return page> after the parameter is assigned. The <return page> should be the relative path according to the root of camera. If you omit this parameter, it will redirect to an empty page. * If the <return page> is invalid path, it will ignore this parameter. |

8.27 Camera Control

(capability_camctrl_c<0~(n-1)>_zoommodule = 1)

Note: This request requires Viewer privileges.

Method: GET/POST

Syntax: **(for control API)**

```

http://<servername>/cgi-bin/camctrl/camctrl.cgi?[channel=<value>][&camid=<value>]
[&move=<value>] – Move home, up, down, left, right
[&focus=<value>] – Focus operation
[&zoom=<value>] – Zoom in, out
[&zooming=<value>&zs=<value>] – Zoom without stopping, used for joystick
[&vx=<value>&vy=<value>&vs=<value>] – Shift without stopping, used for joystick
[&x=<value>&y=<value>&videosize=<value>&resolution=<value>&stretch=<value>] – Click on
image
(Move the center of image to the coordination (x,y) based on resolution or videosize.)
[ [&speedpan=<value>][&speedtilt=<value>][&speedzoom=<value>][&speedapp=<value>][&speedl
ink=<value>] ] – Set speeds
[&return=<return page>]

```

Example:

```

http://myserver/cgi-bin/camctrl/camctrl.cgi?channel=0&camid=1&move=right
http://myserver/cgi-bin/camctrl/camctrl.cgi?channel=0&camid=1&zoom=tele
http://myserver/cgi-bin/camctrl/camctrl.cgi?channel=0&camid=1&x=300&y=200&resolution=704x480&videosize=704x480&strech=1

```

Example: (set the ptz preset with focus mode)

* We support this function when the version number of the PTZ control module is equal or greater than 5.0.0.20.

```

http://myserver/cgi-bin/camctrl/camctrl.cgi?name=xxx&focussetting=sync&cam=getsetpreset

```

| PARAMETER | VALUE | DESCRIPTION |
|-----------|----------------------|----------------------------------|
| channel | <0~(n-1)> | Channel of video source. |
| camid | 0,<positive integer> | Camera ID. |
| move | home | Move to camera to home position. |
| | up | Move camera up. |

| PARAMETER | VALUE | DESCRIPTION |
|------------|-------------------------|---|
| | down | Move camera down. |
| | left | Move camera left. |
| | right | Move camera right. |
| speedpan | -5 ~ 5 | Set the pan speed. |
| speedtilt | -5 ~ 5 | Set the tilt speed. |
| speedzoom | -5 ~ 5 | Set the zoom speed. |
| speedfocus | -5 ~ 5 | Set the focus speed. |
| speedapp | -5 ~ 5 | Set the auto pan/patrol speed. |
| auto | pan | Auto pan. |
| | patrol | Auto patrol. |
| | stop | Stop camera. |
| zoom | wide | Zoom larger view with current speed. |
| | tele | Zoom further with current speed. |
| | stop | Stop zoom. |
| zooming | wide or tele | Zoom without stopping for larger view or further view with zs speed, used for joystick control. |
| zs | 0 ~ 8 <SD8362> | Set the speed of zooming, "0" means stop. |
| vx | <integer , excluding 0> | The slope of movement = v_y/v_x , used for joystick control. |
| vy | <integer> | |
| vs | 0 ~ 127 | Set the speed of movement, "0" means stop. |
| x | <integer> | x-coordinate clicked by user. It will be the x-coordinate of center after movement. |
| y | <integer> | y-coordinate clicked by user. It will be the y-coordinate of center after movement. |
| videosize | <window size> | The size of plug-in (ActiveX) window in web page |
| resolution | <window size> | The resolution of streaming. |
| stretch | <boolean> | 0 indicates that it uses resolution (streaming size) as the range of the coordinate system. 1 indicates that it uses videosize (plug-in size) as the range of the coordinate system. |

| PARAMETER | VALUE | DESCRIPTION |
|--------------|---|---|
| focus | auto | Auto focus. |
| | far | Focus on further distance. |
| | near | Focus on closer distance. |
| focussetting | sync | Applies the selected focus mode in camctrl_c<0~(n-1)>_focusmode to this preset. |
| | fixcurrent | Applies the current focus position to this preset. |
| | * We support this function when the version number of the PTZ control module is equal or greater than 5.0.0.20. | |
| cam | getsetpreset | <p>Adds a named preset at current position, and return the preset index.</p> <p>* We support this function when the version number of the PTZ control module is equal or greater than 5.0.0.20.</p> |

Syntax: **(for query API)**

```
http://<servername>/cgi-bin/camctrl/camctrl.cgi? [<parameter>] [&<parameter>...]
```

Example:

<http://myserver/cgi-bin/camctrl/camctrl.cgi?getpan>

Response:

HTTP/1.0 200 OK\r\n

Cache-control: no-cache\r\n

Pragma: no-cache\r\n

\r\n

pan=4117\r\n

| PARAMETER | VALUE | DESCRIPTION |
|------------|--|--|
| getversion | <string> | Get the version of the PTZ control module. |
| getaction | idle, autopan, tracking, tour, patrol, | <p>Get the current status of the camera.</p> <p>* We support this parameter when the version number (getversion) is equal or greater than 5.0.0.12</p> |
| getpan | 0, <positive integer> | <p>Get the current pan position.</p> <p>*Only available when bit0 of "capability_camctrl_c<0~(n-1)>_buildinpt" is "1"</p> |

| PARAMETER | VALUE | DESCRIPTION |
|-----------------|-----------------------|--|
| getpanangle | <integer> | Get the current pan angle. *Only available when bit0 of "capability_camctrl_c<0~(n-1)>_buildinpt" is "1" |
| gettilt | 0, <positive integer> | Get the current tilt position. *Only available when bit1 of "capability_camctrl_c<0~(n-1)>_buildinpt" is "1" |
| gettiltangle | <integer> | Get the current tilt angle. *Only available when bit1 of "capability_camctrl_c<0~(n-1)>_buildinpt" is "1" |
| getzoom | 0, <positive integer> | Get the current zoom position. |
| getratio | <decimal> | Get the current zoom ratio. |
| getfocus | 0, <positive integer> | Get the current focus position. |
| getminspeedlv | 0, <positive integer> | Get the minimum speed level of the PTZ control. Normally, the speed level is '0,' which denotes halting a continuous movement. |
| getmaxptspeedlv | 0, <positive integer> | Get the maximum speed level of pan/tilt moving. *Only available when "capability_camctrl_c<0~(n-1)>_buildinpt" > 0 |
| getmaxzspeedlv | 0, <positive integer> | Get the maximum speed level of zoom moving. |
| getmaxfspeedlv | 0, <positive integer> | Get the maximum speed level of focus moving. |
| getminpan | 0, <positive integer> | Get the lower limit for pan position. *Only available when bit0 of "capability_camctrl_c<0~(n-1)>_buildinpt" is "1" |
| getmaxpan | 0, <positive integer> | Get the upper limit for pan position. *Only available when bit0 of "capability_camctrl_c<0~(n-1)>_buildinpt" is "1" |
| getminpanangle | <integer> | Get the lower limit for pan angle. *Only available when bit0 of "capability_camctrl_c<0~(n-1)>_buildinpt" is "1" |
| getmaxpanangle | <integer> | Get the upper limit for pan angle. *Only available when bit0 of "capability_camctrl_c<0~(n-1)>_buildinpt" is "1" |
| getmintilt | 0, <positive integer> | Get the lower limit for tilt position. *Only available when bit1 of "capability_camctrl_c<0~(n-1)>_buildinpt" is "1" |
| getmaxtilt | 0, <positive integer> | Get the upper limit for tilt position. *Only available when bit1 of |

| PARAMETER | VALUE | DESCRIPTION |
|-----------------|-----------------------|--|
| | | "capability_camctrl_c<0~(n-1)>_buildinpt" is "1" |
| getmintiltangle | <integer> | Get the lower limit for tilt angle. *Only available when bit1 of "capability_camctrl_c<0~(n-1)>_buildinpt" is "1" |
| getmaxtiltangle | <integer> | Get the upper limit for tilt angle. *Only available when bit1 of "capability_camctrl_c<0~(n-1)>_buildinpt" is "1" |
| getminzoom | 0, <positive integer> | Get the lower limit for zoom position. |
| getmaxzoom | 0, <positive integer> | Get the upper limit for zoom position. |
| getmaxdzoom | 0, <positive integer> | Get the upper limit for digital zoom position. |
| getmaxratio | <decimal> | Get the maximum ratio of optical zoom. * We support this parameter when the version number (getversion) is equal or greater than 5.0.0.14 |
| getmaxdratio | <decimal> | Get the maximum ratio of digital zoom. * We support this parameter when the version number (getversion) is equal or greater than 5.0.0.14 |
| getminfocus | 0, <positive integer> | Get the lower limit for focus position. |
| getmaxfocus | 0, <positive integer> | Get the upper limit for focus position. |

8.28 Recall (**capability_camctrl_c<0~(n-1)>_zoommodule = 1**)

Note: This request requires Viewer privileges.

Method: GET

Syntax:

```
http://<servername>/cgi-bin/viewer/recall.cgi?
recall=<value>[&channel=<value>][&return=<return page>]
```

| PARAMETER | VALUE | DESCRIPTION |
|-----------|---------------------------|---|
| recall | string[30] | One of the present positions to recall. |
| channel | 0~"capability_nvideoin"-1 | Channel of the video source. |

8.29 Preset Locations

(capability_camctrl_c<0~(n-1)>_zoommodule = 1)

Note: This request requires Operator privileges.

Method: GET/POST

Syntax:

```
http://<servername>/cgi-bin/operator/preset.cgi?[channel=<value>]
[&addpos=<value>][&delpos=<value>][&return=<return page>]
```

| PARAMETER | VALUE | DESCRIPTION |
|-----------|---------------------------|---|
| addpos | string[30] | Add one preset location to the preset list. |
| channel | 0~"capability_nvideoin"-1 | Channel of the video source. |
| delpos | string[30] | Delete preset location from preset list. |
| return | <return page> | Redirect to the page <return page> after the parameter is assigned. The <return page> should be the relative path according to the root of camera. If you omit this parameter, it will redirect to an empty page. * If the <return page> is invalid path, it will ignore this parameter. |

8.30 SmartSD (**capability_localstorage_smartsd > 0**)

Note: This request requires Administrator privileges.

Method: GET/POST

Syntax:

```
http://<servername>/cgi-bin/admin/smartsd.cgi?function=<value>
```

| PARAMETER | VALUE | DESCRIPTION |
|-----------|-----------|--|
| function | getstatus | <p>Function type</p> <p>getstauts : Information of smartSD internal status return value as below:</p> <p>smartsd_lifetime_num: Accumulated amount of data that has been written</p> <p>smartsd_lifetime_den: Card-guaranteed amount of data that can be written</p> <p>smartsd_lifetime_rate: The ratio of smartsd_lifetime_num to smartsd_lifetime_den. It means the accumulated percentage amount of flash block has been written. The range is from 0 to 100 (unit: %). The SD card is recommended to be replaced if the percentage reaches above 90%.</p> <p>smartsd_spare_block_rate: Usage rate of spare blocks. It means the usage percentage of total spare block. The range is from 0 to 100 (unit: %). The SD card is recommended to be replaced if the percentage reaches above 90%.</p> <p>smartsd_data_size_per_unit: Size (in sectors) of data to be written when Life Information1 is updated.</p> <p>smartsd_num_of_sudden_power_failure: Indicates how many times power disconnection occurred during write/erase operations</p> <p>smartsd_operation_mode: Enables/disables power-off detection and write error notification</p> <p>smartsd_attached: Indicate the smartSD is attached or not.</p> |

8.31 Connect to AP (**capability_network_wireless > 0**)

Note: This request requires Administrator privileges.

Method: GET/POST

Syntax:

```
http://<servername>/cgi-bin/admin/connect_ap.cgi
```

| PARAMETER | VALUE | DESCRIPTION |
|-----------|-------|--|
| N/A | N/A | Apply the wireless settings and connect to AP. |

8.32 Get Wireless Information (**capability_network_wireless > 0**)

Note: This request requires Administrator privileges.

Method: GET/POST

Syntax:

```
http://<servername>/cgi-bin/admin/getwirelessinfo.cgi
```

| PARAMETER | VALUE | DESCRIPTION |
|-----------|-------|---|
| N/A | N/A | Get wireless information. Camera will return following information. <ol style="list-style-type: none"> 1. Wireless channel 2. Link quality 3. Signal level 4. Noise level 5. SNR 6. TX Rate 7. RX Rate |

8.33 Get Wireless Signal Strength (**capability_network_wireless** **> 0**)

Note: This request requires Administrator privileges.

Method: GET/POST

Syntax:

```
http://<servername>/cgi-bin/admin/getwlsignalstrength.cgi
```

| PARAMETER | VALUE | DESCRIPTION |
|-----------|-------|-------------------------------|
| N/A | N/A | Get wireless signal strength. |

8.34 WPS Transaction (**capability_network_wireless > 0**)

Note: This request requires Administrator privileges.

Method: GET/POST

Syntax:

```
http://<servername>/cgi-bin/admin/start_wps.cgi
```

| PARAMETER | VALUE | DESCRIPTION |
|-----------|-------|------------------------|
| N/A | N/A | Start WPS transaction. |

8.35 Peripheral Control (**capability_peripheral_c<0~(n-1)>_devicecontrol > 0**)

Note: This request requires Administrator privileges.

Method: GET/POST

Syntax: (**for control API**)

```
http://<servername>/cgi-bin/admin/peripheral.cgi?channel=<value>&operation=set
[&washer_mode=<value>] – Set washer mode
[&washer_status=<value>] – Set washer status
[&washer_dwelltime=<value>] – Set washer clean time
[&heater_status=<value>] – Set heater status
```

Example:

```
http://myserver/cgi-bin/admin/peripheral.cgi?channel=0&operation=set&washer\_mode=wiper&washer\_status=on
```

Response:

```
HTTP/1.0 200 OK\r\n
Cache-control: no-cache\r\n
Pragma: no-cache\r\n
\r\n
```

```
"washer_mode : OK\r\n"
"washer_status : FAIL\r\n"
```

| PARAMETER | VALUE | DESCRIPTION |
|------------------|---------------------------|--|
| channel | 0~"capability_nvideoin"-1 | Channel of the video source. |
| washer_mode | wiper | Apply the wiper to the mode of washer control system. |
| | washer | Apply the washer to the mode of washer control system. |
| washer_status | on | Enable the functionality of washer control system. |
| | off | Disable the functionality of washer control system. |
| washer_dwelltime | 15~999 | Apply washer washer control system operation time (including the time when spraying and wiper actions take place). |
| heater_status | auto | automatic control the heater component to keep the device in a workable environment. |
| | trigger | heater component is work in force heater once. |

Syntax: **(for query API)**

```
http://<servername>/cgi-bin/admin/peripheral.cgi?channel=<value>&operation=get
[&supportdevice] –Get support peripheral device
[&washer_supportmode] – Get washer support modes
[&washer_mode] – Get washer mode
[&washer_status] – Get washer status
[&washer_dwelltime] – Get washer clean time
[&heater_supportstatus] – Get heater support control status
[&heater_status] – Get heater status
```

Example:

```
http://myserver/cgi-bin/admin/peripheral.cgi?channel=0&operation=get&supportdevice&washer\_status
```

Response:

```
HTTP/1.0 200 OK\r\n
Cache-control: no-cache\r\n
```



```
Pragma: no-cache\r\n
\r\n
supportdevice=washer,heater\r\n
washer_status=off\r\n
```

| PARAMETER | VALUE | DESCRIPTION |
|----------------------|---------------------------|---|
| channel | 0~"capability_nvideoin"-1 | Channel of the video source. |
| supportdevice | N/A | Get support peripheral device. |
| washer_supportmode | N/A | Get the support mode of washer control system. |
| washer_mode | N/A | Get the current mode of washer control system. It return the value of "washer_mode" |
| washer_status | N/A | Get the current status of washer control module. The status is 'off' as default, which means the washer is stopped; and the status 'on' means the washer is running. |
| washer_dwelltime | N/A | Get the current washer clean period of washer control system. |
| heater_supportstatus | N/A | Get the support status of heater control system. |
| heater_status | N/A | Get the current heater status. Normally it will be 'auto', it means the heater device is control by internal algorithm to keep in a suitable environment; Otherwise is 'trigger', it means the heater device is force enable to heat to an internal condition. 'trigger' status will be transfer to 'auto' after reach the internal condition. |

8.36 Optimized IR control

(capability_daynight_c<0~(n-1)>_optimizedir > 0)

Note: This request requires Administrator privileges.

Method: GET/POST

Syntax:

[http://<servername>/cgi-bin/admin/optimizedir.cgi?function=<value>\[&channel=<value>\]](http://<servername>/cgi-bin/admin/optimizedir.cgi?function=<value>[&channel=<value>])

| PARAMETER | VALUE | DESCRIPTION |
|-----------|---------------------------|--|
| channel | 0~"capability_nvideoin"-1 | Channel of the video source. |
| function | getstatus, onetimeauto | <p>"onetimeauto": Camera will automatically adjust the IR zone one time only.</p> <p>"getstatus": Information of optimized IR control status and return value as below:</p> <p>optimizedir_c<0~(n-1)>_irmode: Indicate the IR current mode, available value is "auto" and "manual" mode.</p> <p>optimizedir_c<0~(n-1)>_irnum: The number of IR that camera supports.</p> <p>optimizedir_c<0~(n-1)>_irstrength: Only available when irmode is set as manual. It's a set of integers, which indicate the strength of each IR LED (e.g. 23,45,100,100).</p> <p>optimizedir_c<0~(n-1)>_irstatus: Current IR status, normal / adjusting: "normal": the IR LED strength has been fixed. "adjusting": the IR LED strength is adjusting.</p> <p>optimizedir_c<0~(n-1)>_supportmode: "auto": automatically adjust the IR control. "manual": manual adjustment.</p> |

Example:

<http://myserver/cgi-bin/admin/optimizedir.cgi?function=getstatus>

Response:

```
HTTP/1.0 200 OK\r\n
Cache-control: no-cache\r\n
Pragma: no-cache\r\n
\r\n
"optimizedir_c0_irmode='auto'"
"optimizedir_c0_irnum='5'"
"optimizedir_c0_irstrength='1,97,100,100,100'"
"optimizedir_c0_irstatus='normal'"
```

Syntax: **(for control API)**

[http://<servername>/cgi-bin/admin/optimizedir.cgi?channel=<value>&operation=<value>&irmode=manual\[&strength=<value>\]](http://<servername>/cgi-bin/admin/optimizedir.cgi?channel=<value>&operation=<value>&irmode=manual[&strength=<value>]) – Set IR strength

| PARAMETER | VALUE | DESCRIPTION |
|-----------|---------------------------|--|
| channel | 0~"capability_nvideoin"-1 | Channel of the video source. |
| operation | set, settoall | " set ": set the strength of each IR LED separately " settoall ": use fixed strength for all IR LED |
| irmode | auto, manual | Irmode needs to be set as manual for adjusting IR LED strength. |
| strength | 1~100 | If the operation is set as "set", the number of strength values need to be the same as it of irnum. However, it needs only one value for strength when the operation is set as "settoall". |

Example:

<http://myserver/cgi-bin/admin/optimizedir.cgi?channel=0&operation=set&irmode=manual&strength=50,70,50,50,50>

Response:

```
HTTP/1.0 200 OK\r\n
Cache-control: no-cache\r\n
Pragma: no-cache\r\n
\r\n
"optimizedir_c0_irstrength='50,70,50,50,50'"
"optimizedir_c0_irmode='manual'"
```

Example:

<http://myserver/cgi-bin/admin/optimizedir.cgi?channel=0&operation=settoall&irmode>manual&strength=100>

Response:

```
HTTP/1.0 200 OK\r\n
Cache-control: no-cache\r\n
Pragma: no-cache\r\n
\r\n
"optimizedir_c0_irstrength='100,100,100,100,100'"
"optimizedir_c0_irmode='manual'"
```

Example:

<http://myserver/cgi-bin/admin/optimizedir.cgi?channel=0&operation=set&irmode=auto&strength=50,70,50,50,50>

Response:

```
HTTP/1.0 200 OK\r\n
Cache-control: no-cache\r\n
Pragma: no-cache\r\n
\r\n
ERROR: Parameter "irmode" must be set as "manual"!
```

Example:

<http://myserver/cgi-bin/admin/optimizedir.cgi?channel=0&operation=set&strength=50,70,50,50,50>

Response:

```
HTTP/1.0 200 OK\r\n
Cache-control: no-cache\r\n
Pragma: no-cache\r\n
\r\n
ERROR: Must have the "irmode=manual" argument!
```

Syntax: **(for query API)**

<http://<servername>/cgi-bin/admin/optimizedir.cgi?channel=<value>&operation=get>

[&support_irmode] – list all adjustment mode that IR supports

[&irmode] – Get current IR mode

[&irnum] – Get the number of IR zone

| PARAMETER | VALUE | DESCRIPTION |
|----------------|---------------------------|--|
| channel | 0~"capability_nvideoin"-1 | Channel of the video source. |
| support_irmode | N/A | List all adjustment mode that IR supports |
| irmode | N/A | Get the current IR control mode. |
| irnum | N/A | Get the number of IR that camera supports. |

Example:

<http://myserver/cgi-bin/admin/optimizedir.cgi?channel=0&operation=get&irmode>

Response:

HTTP/1.0 200 OK\r\n

Cache-control: no-cache\r\n

Pragma: no-cache\r\n

\r\n

"optimizedir_c0_irmode='auto'"

8.37 Lens Thermal Control

(capability_image_c<0~(n-1)>_sensortype=thermalsensor)

Note: This request requires Administrator privileges.

Method: GET/POST

Syntax: **(for control API)**

<http://<servername>/cgi-bin/admin/thermalctrl.cgi?operation=set>

[&action=<value>](http://<servername>/cgi-bin/admin/thermalctrl.cgi?operation=set)

Example:

<http://myserver/cgi-bin/admin/thermalctrl.cgi?operation=set&action=shuttercompensate>

Response:

HTTP/1.0 200 OK\r\n

Cache-control: no-cache\r\n

Pragma: no-cache\r\n

```
\r\n
OK
```

Example:

<http://myserver/cgi-bin/admin/thermalctrl.cgi?operation=set&action=shuttercompensate>

Response:

```
HTTP/1.0 200 OK\r\n
Cache-control: no-cache\r\n
Pragma: no-cache\r\n
\r\n
ERROR: time out
```

Example:

<http://myserver/cgi-bin/admin/thermalctrl.cgi?operation=set&action=shuttercompensate>

Response:

```
HTTP/1.0 200 OK\r\n
Cache-control: no-cache\r\n
Pragma: no-cache\r\n
\r\n
ERROR: fail
```

| PARAMETER | VALUE | DESCRIPTION |
|-----------|-------------------|------------------------------------|
| action | shuttercompensate | Camera will do shutter compensate. |

Syntax: **(for query API)**

<http://<servername>/cgi-bin/admin/thermalctrl.cgi?operation=get&version=<value>>

| PARAMETER | VALUE | DESCRIPTION |
|-----------|-------|-----------------------------------|
| version | N/A | Indicate lensctrl thermal version |

Example:

<http://myserver/cgi-bin/admin/thermalctrl.cgi?function=get&version>

```

Response:
HTTP/1.0 200 OK\r\n
Cache-control: no-cache\r\n
Pragma: no-cache\r\n
\r\n
version=1120B15

```

8.38 Audio Clip Control (**capability_audio_audioclip=1**)

Note: This request requires Administrator privileges.

Method: GET/POST

Syntax: (**for control API**)

[http://<servername>/cgi-bin/admin/audioclip.cgi?operation=<value>\[&name=<value>\]\[&index=<value>\]](http://<servername>/cgi-bin/admin/audioclip.cgi?operation=<value>[&name=<value>][&index=<value>])

| PARAMETER | VALUE | DESCRIPTION |
|-----------|--|--|
| operation | startrecording, stoprecording, play, stopplayback, remove, download | " startrecording " = Record a new audio clip. " stoprecording " = Stop an ongoing recording. " play " = Play an audio clip. " stopplayback " = Stop to playback of an audio clip. " remove " = Delete a clip. " download " = Download a clip to the client. * Recording time is limited to 60 seconds. |
| name | <string> | Name of the audio clip. The audio clip the action applies to. We support two interfaces (name or index) to specify the media clip to be played. |
| index | 0, 1 | Number of the audio clip. The audio clip the action applies to. We support two interfaces (name or index) to specify the media clip to be played. |

Syntax: (**for control API**)

Add a new audio clip by uploading a file:

* File size is limited to 10MB.

* Support .wav format only

[http://<servername>/cgi-bin/admin/upload_audioclip.cgi\[&clipname=<value>\]\[&clipindex=<value>\]](http://<servername>/cgi-bin/admin/upload_audioclip.cgi[&clipname=<value>][&clipindex=<value>])

| PARAMETER | VALUE | DESCRIPTION |
|-----------|-------|-------------|
|-----------|-------|-------------|

| | | |
|-----------|----------|---------------------------|
| clipname | <string> | Name of the audio clip. |
| clipindex | 0, 1 | Number of the audio clip. |

<End of document>

Technology License Notice

AMR-NB Standard

THIS PRODUCT IS LICENSED UNDER THE AMR-NB STANDARD PATENT LICENSE AGREEMENT. WITH RESPECT TO THE USE OF THIS PRODUCT, THE FOLLOWING LICENSORS' PATENTS MAY APPLY:

TELEFONAKIEBOLAGET ERICSSON AB: US PAT. 6192335; 6275798; 6029125; 6424938; 6058359. NOKIA CORPORATION: US PAT. 5946651; 6199035. VOICEAGE CORPORATION: AT PAT. 0516621; BE PAT. 0516621; CA PAT. 2010830; CH PAT. 0516621; DE PAT. 0516621; DK PAT. 0516621; ES PAT. 0516621; FR PAT. 0516621; GB PAT. 0516621; GR PAT. 0516621; IT PAT. 0516621; LI PAT. 0516621; LU PAT. 0516621; NL PAT. 0516621; SE PAT. 0516621; US PAT. 5444816; AT PAT. 819303/AT E 198805T1; AU PAT. 697256; BE PAT. 819303; BR PAT. 9604838-7; CA PAT. 2216315; CH PAT. 819303; CN PAT. ZL96193827.7; DE PAT. 819303/DE69611607T2; DK PAT. 819303; ES PAT. 819303; EP PAT. 819303; FR PAT. 819303; GB PAT. 819303; IT PAT. 819303; JP PAT. APP. 8-529817; NL PAT. 819303; SE PAT. 819303; US PAT. 5664053. THE LIST MAY BE UPDATED FROM TIME TO TIME BY LICENSORS AND A CURRENT VERSION OF WHICH IS AVAILABLE ON LICENSOR'S WEBSITE AT [HTTP://WWW.VOICEAGE.COM](http://www.voiceage.com).



Notices from HEVC Advance:

THIS PRODUCT IS SOLD WITH A LIMITED LICENSE AND IS AUTHORIZED TO BE USED ONLY IN CONNECTION WITH HEVC CONTENT THAT MEETS EACH OF THE THREE FOLLOWING QUALIFICATIONS: (1) HEVC CONTENT ONLY FOR PERSONAL USE; (2) HEVC CONTENT THAT IS NOT OFFERED FOR SALE; AND (3) HEVC CONTENT THAT IS CREATED BY THE OWNER OF THE PRODUCT. THIS PRODUCT MAY NOT BE USED IN CONNECTION WITH HEVC ENCODED CONTENT CREATED BY A THIRD PARTY, WHICH THE USER HAS ORDERED OR PURCHASED FROM A THIRD PARTY, UNLESS THE USER IS SEPARATELY GRANTED RIGHTS TO USE THE PRODUCT WITH SUCH CONTENT BY A LICENSED SELLER OF THE CONTENT. YOUR USE OF THIS PRODUCT IN CONNECTION WITH HEVC ENCODED CONTENT IS DEEMED ACCEPTANCE OF THE LIMITED AUTHORITY TO USE AS NOTED ABOVE.

H.264

THIS PRODUCT IS LICENSED UNDER THE AVC PATENT PORTFOLIO LICENSE FOR THE PERSONAL AND NON-COMMERCIAL USE OF A CONSUMER TO (i) ENCODE VIDEO IN COMPLIANCE WITH THE AVC STANDARD ("AVC VIDEO") AND/OR (ii) DECODE AVC VIDEO THAT WAS ENCODED BY A CONSUMER ENGAGED IN A PERSONAL AND NON-COMMERCIAL ACTIVITY AND/OR WAS OBTAINED FROM A VIDEO PROVIDER LICENSED TO PROVIDE AVC VIDEO. NO LICENSE IS GRANTED OR SHALL BE IMPLIED FOR ANY OTHER USE. ADDITIONAL INFORMATION MAY BE OBTAINED FROM MPEG LA, L.L.C. SEE [HTTP://WWW.MPEGLA.COM](http://www.mpegla.com)

Electromagnetic Compatibility (EMC)

FCC Statement

This device complies with FCC Rules Part 15. Operation is subject to the following two conditions.

- This device may not cause harmful interference, and
- This device must accept any interference received, including interference that may cause undesired operation.

This equipment has been tested and found to comply with the limits for a Class B digital device, pursuant to Part 15 of the FCC Rules. These limits are designed to provide reasonable protection against harmful interference in a residential installation. This equipment generates, uses and can radiate radio frequency energy and, if not installed and used in accordance with the instructions, may cause harmful interference to radio communications. However, there is no guarantee that interference will not occur in a partial installation. If this equipment does cause harmful interference to radio or television reception, which can be determined by turning the equipment off and on, the user is encouraged to try to correct the interference by one or more of the following measures:

- Reorient or relocate the receiving antenna.
- Increase the separation between the equipment and receiver.
- Connect the equipment into an outlet on a circuit different from that to which the receiver is connected.
- Consult the dealer or an experienced radio/TV technician for help.

Shielded interface cables must be used in order to comply with emission limits.

CE Mark Warning

This is a Class B product. In a domestic environment, this product may cause radio interference, in which case the user may be required to take adequate measures.

VCCI Warning

この装置は、情報処理装置等電波障害自主規制協議会（VCCI）の基準に基づくクラスB情報技術装置です。この装置は、家庭環境で使用することを目的としていますが、この装置がラジオやテレビジョン受信機に近接して使用されると、受信障害を引き起こすことがあります。

取扱説明書に従って正しい取り扱いをして下さい

Liability

VIVOTEK Inc. cannot be held responsible for any technical or typographical errors and reserves the right to make changes to the product and manuals without prior notice. VIVOTEK Inc. makes no warranty of any kind with regard to the material contained within this document, including, but not limited to, the implied warranties of merchantability and fitness for any particular purpose.