

Acer LCD Monitor

User's Guide

Copyright © 2017. Acer Incorporated.
All Rights Reserved.

Acer LCD Monitor User Guide
Original Issue: 10/2017

Changes may be made periodically to the information in this publication without obligation to notify any person of such revisions or changes. Such changes will be incorporated in new editions of this manual or supplementary documents and publications. This company makes no representations or warranties, either expressed or implied, with respect to the contents hereof and specifically disclaims the implied warranties of merchantability or fitness for a particular purpose.

Record the model number, serial number, purchase date and place of purchase information in the space provided below. The serial number and model number are recorded on the label affixed to your computer. All correspondence concerning your unit should include the serial number, model number and purchase information.

No part of this publication may be reproduced, stored in a retrieval system, or transmitted, in any form or by any means, electronically, mechanically, by photocopy, recording or otherwise, without the prior written permission of Acer Incorporated.

Acer LCD Monitor User Guide

Model number: _____

Serial number: _____

Date of purchase: _____

Place of purchase: _____

Acer and the Acer logo are registered trademarks of Acer Incorporated. Other companies' product names or trademarks are used herein for identification purposes only and belong to their respective companies.

Special notes on LCD monitors

The following are normal with the LCD monitor and do not indicate a problem.

- Due to the nature of the fluorescent light, the screen may flicker during initial use. Turn off the power switch and then turn it on again to make sure the flicker disappears.
- You may find slightly uneven brightness on the screen depending on the desktop pattern you use.
- The LCD screen has 99.99% or more effective pixels. It may include blemishes of 0.01% or less such as a missing pixel or a pixel lit all the time.
- Due to the nature of the LCD screen, an afterimage of the previous screen may remain after switching the image, when the same image is displayed for hours. In this case, the screen is recovered slowly by changing the image or turning off the power switch for a few hours.
- Acer monitor is purposed for video and visual display of information obtained from electronic devices.

Information for your safety and comfort

Safety instructions

Read these instructions carefully. Keep this document for future reference. Follow all warnings and instructions marked on the product.

Cleaning your monitor

Please carefully follow these guidelines when cleaning the monitor:

- Always unplug the monitor before cleaning.
- Use a soft cloth to wipe the screen and cabinet front and sides.

Connecting/disconnecting the device

Observe the following guidelines when connecting and disconnecting power adapter from the LCD monitor:

- Make sure the monitor is attached to its base before connecting the power adapter to the AC power outlet.
- Make sure both the LCD monitor and the computer are turned off before connecting any cable or unplugging the power adapter.
- If the system has multiple sources of power, disconnect power from the system by unplugging all power adapters from the power supplies.

Accessibility

Be sure that the power outlet you plug the power cord into is easily accessible and located as close to the equipment operator as possible. When you need to disconnect power from the equipment, be sure to unplug the power cord from the electrical outlet.

Safe listening

To protect your hearing, follow these instructions.

- Gradually increase the volume until you can hear it clearly and comfortably and without distortion.
- After setting the volume level, do not increase it after your ears have adjusted.
- Limit the amount of time listening to music at high volume.
- Avoid turning up the volume to block out noisy surroundings.
- Turn the volume down if you can't hear people speaking near you.

Warnings

- Do not use this product near water.
- Do not place this product on an unstable cart, stand or table. If the product falls, it could be seriously damaged.
- Slots and openings are provided for ventilation to ensure reliable operation of the product and to protect it from overheating. These openings must not be blocked or covered. The openings should never be blocked by placing the product on a bed, sofa, rug or other similar surface. This product should never be placed near or over a radiator or heat register, or in a built-in installation unless proper ventilation is provided.
- Never push objects of any kind into this product through cabinet slots as they may touch dangerous voltage points or short-out parts that could result in a fire or electric shock. Never spill liquid of any kind onto or into the product.
- To avoid damage of internal components and to prevent battery leakage, do not place the product on a vibrating surface.
- Never use it under sporting, exercising, or any vibrating environment which will probably cause unexpected short current or damage internal devices.

Using electrical power

- This product should be operated from the type of power indicated on the marking label. If you are not sure of the type of power available, consult your dealer or local power company.
- Do not allow anything to rest on the power cord. Do not locate this product where people will walk on the cord.
- If an extension cord is used with this product, make sure that the total

ampere rating of the equipment plugged into the extension cord does not exceed the extension cord ampere rating. Also, make sure that the total rating of all products plugged into the wall outlet does not exceed the fuse rating.

- Do not overload a power outlet, strip or receptacle by plugging in too many devices. The overall system load must not exceed 80% of the branch circuit rating. If power strips are used, the load should not exceed 80% of the power strip's input rating.



.....

Warning! The grounding pin is a safety feature. Using a power outlet that is not properly grounded may result in electric shock and/or injury.



.....

Note: The grounding pin also provides good protection from unexpected noise produced by other nearby electrical devices that may interfere with the performance of this product.

Product servicing

Do not attempt to service this product yourself, as opening or removing covers may expose you to dangerous voltage points or other risks. Refer all servicing to qualified service personnel.

Unplug this product from the wall outlet and refer servicing to qualified service personnel when:

- the power cord or plug is damaged, cut or frayed
- liquid was spilled into the product
- the product was exposed to rain or water
- the product has been dropped or the case has been damaged
- the product exhibits a distinct change in performance, indicating a need for service
- the product does not operate normally after following the operating instructions



Note: Adjust only those controls that are covered by the operating instructions, since improper adjustment of other controls may result in damage and will often require extensive work by a qualified technician to restore the product to normal condition.

Potentially explosive environments

Switch off your device in any area with a potentially explosive atmosphere and obey all signs and instructions. Potentially explosive atmospheres include areas where you would normally be advised to turn off your vehicle engine. Sparks in such areas could cause an explosion or fire resulting in bodily injury or even death. Switch off the device near gas pumps at service stations. Observe restrictions on the use of radio equipment in fuel depots, storage and distribution areas; chemical plants; or where blasting operations are in progress. Areas with a potentially explosive atmosphere are often, but not always, marked. They include below deck on boats, chemical transfer or storage facilities, vehicles using liquefied petroleum gas (such as propane or butane), and areas where the air contains chemicals or particles such as grain, dust or metal powders.

Additional safety information

Your device and its enhancements may contain small parts. Keep them out of the reach of small children.

IT Equipment Recycling Information

Acer is strongly committed to environmental protection and views recycling, in the form of salvaging and disposal of used equipment, as one of the company's top priorities in minimizing the burden placed on the environment.

We at Acer are very conscious of the environmental effects of our business and strive to identify and provide the best working procedures to reduce the environmental impact of our products.

For more information and help when recycling, please go to this website:
<http://www.acer-group.com/public/Sustainability/>

Visit www.acer-group.com for further information on the features and benefits of our other products.

Disposal instructions

Do not throw this electronic device into the trash when discarding. To minimize pollution and ensure utmost protection of the global environment, please recycle. For more information on the Waste from Electrical and Electronics Equipment (WEEE) regulations, visit <http://www.acer-group.com/public/Sustainability>



LCD pixel statement

The LCD unit is produced with high-precision manufacturing techniques. Nevertheless, some pixels may occasionally misfire or appear as black or red dots. This has no effect on the recorded image and does not constitute a malfunction.

Tips and information for comfortable use

Computer users may complain of eyestrain and headaches after prolonged use. Users are also at risk of physical injury after long hours of working in front of a computer. Long work periods, bad posture, poor work habits, stress, inadequate working conditions, personal health and other factors greatly increase the risk of physical injury.

Incorrect computer usage may lead to carpal tunnel syndrome, tendonitis, tenosynovitis or other musculoskeletal disorders. The following symptoms may appear in the hands, wrists, arms, shoulders, neck or back:

- numbness, or a burning or tingling sensation
- aching, soreness or tenderness
- pain, swelling or throbbing
- stiffness or tightness
- coldness or weakness

If you have these symptoms, or any other recurring or persistent discomfort and/or pain related to computer use, consult a physician immediately and inform your company's health and safety department.

The following section provides tips for more comfortable computer use.

Finding your comfort zone

Find your comfort zone by adjusting the viewing angle of the monitor, using a footrest, or raising your sitting height to achieve maximum comfort. Observe the following tips:

- refrain from staying too long in one fixed posture
- avoid slouching forward and/or leaning backward
- stand up and walk around regularly to remove the strain on your leg muscles

Taking care of your vision

Long viewing hours, wearing incorrect glasses or contact lenses, glare, excessive room lighting, poorly focused screens, very small typefaces and low-contrast displays could stress your eyes. The following sections provide suggestions on how to reduce eyestrain.

Eyes

- Rest your eyes frequently.
- Give your eyes regular breaks by looking away from the monitor and focusing on a distant point.
- Blink frequently to keep your eyes from drying out.

Display

- Keep your display clean.
- Keep your head at a higher level than the top edge of the display so your eyes point downward when looking at the middle of the display.
- Adjust the display brightness and/or contrast to a comfortable level for enhanced text readability and graphics clarity.
- Eliminate glare and reflections by:
 - placing your display in such a way that the side faces the window or any light source
 - minimizing room light by using drapes, shades or blinds
 - using a task light
 - changing the display's viewing angle
 - using a glare-reduction filter
 - using a display visor, such as a piece of cardboard extended from the display's top front edge
- Avoid adjusting your display to an awkward viewing angle.
- Avoid looking at bright light sources, such as open windows, for extended periods of time.

Developing good work habits

Develop the following work habits to make your computer use more relaxing and productive:

- Take short breaks regularly and often.
- Perform some stretching exercises.
- Breathe fresh air as often as possible.
- Exercise regularly and maintain a healthy body.

Contents

Unpacking.....	1
Installing/removing base.....	2
Adjusting screen position.....	4
Connecting the power cord.....	5
Safety precautions.....	5
Cleaning the display	5
Connector pin assignment.....	7
Standard timing table.....	8
Installation	9
User control	10
Troubleshooting.....	20

Unpacking

When you unpack the box, ensure that the following items are present, and retain the packing materials for future shipment.

- LCD monitor
- Quick start guide
- Power adapter

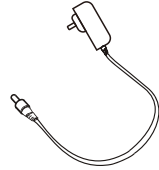
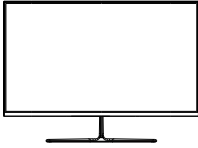

- DP cable
- HDMI cable (optional)

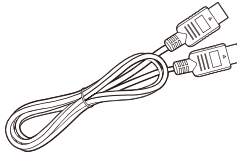
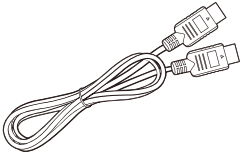



Installing/removing base

 Note: Unpack the monitor and base first. Carefully place the monitor face down on a flat surface - use a cloth pad to prevent scratching the screen.

1. Attach the monitor stand arm to the base.

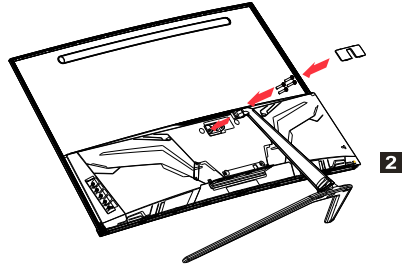
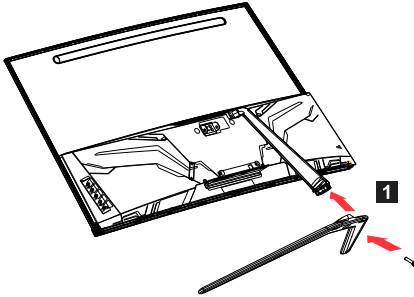
2. Secure the monitor to the arm of the monitor. Close the base cover.



 Note: If using a wall-mounting kit for mounting, we recommend using a VESA mounting kit (100 mm × 100 mm) and M4 × 10 (L) mm screws to secure the monitor to the wall.

Follow these instructions to remove the base from the monitor.



Note: Carefully place the monitor face down on a flat surface - use a cloth pad to prevent scratching the screen.

1. Remove the base cover.
Release the 4 black screws with a screwdriver.

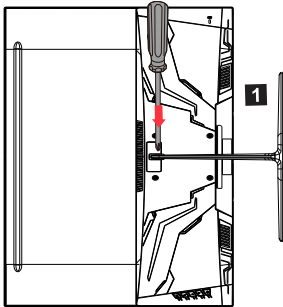

2. Removing the stand base from the monitor.

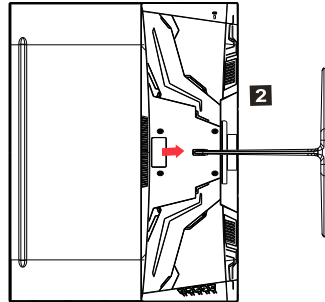

Adjusting screen position

For the best viewing position, adjust the display tilt.

- Tilt

See the illustration below for an illustration of the tilt range.

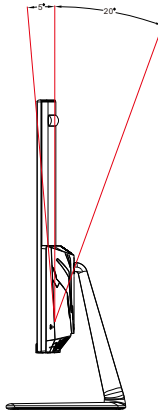



Connecting the power cord

(I) AC power

- Please first ensure the power cord you are using is the correct type required in your area.
- This monitor uses universal power and can run on 100/120 volts or 220/240 volts AC. The user does not need to make any adjustments.
- Plug one end of the power cord into the AC power input, and plug the other end into an AC power outlet.
- Areas where 120 volts are used:
Use a UL-compliant power cord kit, including SVT-type leads and a 10-amp/125-volt plug.
- Areas using 220/240 volts (outside the United States):
Use a power cord kit consisting of an H05VV-F cord and a 10 amp, 250 volt plug. This power cord kit must meet the safety standards for the country where you are installing the device.

(II) DC power supply

- Use the power adapter provided by the manufacturer, the specifications are:

22 inch/24 inch	Input: 100 - 240 V	Output: 12 V  2.0 A
27 inch/32 inch	Input: 100 - 240 V	Output: 12 V  3.5 A

Safety precautions

- Avoid placing the monitor or any other heavy objects on the power adapter, as this may cause fire or electric shock.
- Do not expose the monitor to rain, excessive humidity or dust, as this may cause fire or electric shock.
- Do not cover slots or openings on the monitor to facilitate normal heat dissipation. Place the monitor in a well-ventilated location.
- Avoid placing the display in front of an overly bright background, or where direct sunlight or other light sources may shine on the display surface. Place the monitor directly below your line of sight when staring straight ahead.
- Use extreme caution when handling the monitor.
- Please avoid hitting the display, and do not scratch the screen surface. The screen is fragile.
- To prevent damage to the monitor, do not lift the monitor using the stand.

Cleaning the display

When you clean the monitor, follow the instructions carefully.

- Before cleaning, unplug the monitor's power adapter.
- Use a soft cloth to gently wipe the screen and the front and sides of the case.
- Never spill any liquid directly onto or into the screen or its case.

- Do not use any ammonia- or alcohol-based cleaners on the LCD monitor screen or case.
- Acer is not responsible for damage caused by the use of any ammonia- or alcohol-based cleaners.

Connector pin assignment

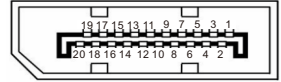

20-pin color display signal cable*

Threading	Explanations	Threading	Explanations
1.	Channel 0 real signal	11.	Monitor ground
2.	Monitor ground	12.	Channel 3 auxiliary signal
3.	Channel 0 auxiliary signal	13.	Reserved (protocol pull)
4.	Channel 1 real signal	14.	Reserved (protocol pull)
5.	Monitor ground	15.	Auxiliary channel real signal
6.	Channel 1 auxiliary signal	16.	Signal detection
7.	Channel 2 real signal	17.	Auxiliary channel auxiliary signal
8.	Monitor ground	18.	Hot plug detection
9.	Channel 2 auxiliary signal	19.	Monitor ground
10.	Channel 3 real signal	20.	3.3 V power supply

* Limited to specific models

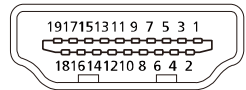

19-pin color display signal cable*

Threading	Use	Threading	Use
1.	TMDS data 2 +	10.	TMDS clock +
2.	TMDS data 2 mask	11.	TMDS clock mask
3.	TMDS data 2 -	12.	TMDS clock -
4.	TMDS data 1 +	13.	CEC
5.	TMDS data 1 mask	14.	Reserved (not connected on the device)
6.	TMDS data 1 -	15.	SCL
7.	TMDS data 0 +	16.	SDA
8.	TMDS data 0 mask	17.	DDC/CEC ground
9.	TMDS data 0 -	18.	+5 V power supply
		19.	Hot plug detection

* Limited to specific models

Standard timing table

Mode	Resolution		Remarks
IBM VGA	720 × 400p	70 Hz	
IBM VGA	640 × 480p	60 Hz	
VESA	640 × 480p	72 Hz	
VESA	640 × 480p	75 Hz	
VESA	800 × 600p	56 Hz	
VESA	800 × 600p	60 Hz	
VESA	800 × 600p	72 Hz	
VESA	800 × 600p	75 Hz	
VESA	1024 × 768p	60 Hz	
VESA	1024 × 768p	70 Hz	
VESA	1024 × 768p	75 Hz	
VESA	1280 × 1024p	75 Hz	
VESA STD	1920 × 1080p	60 Hz	
VESA STD	1280 × 1024p	60 Hz	
VESA STD	640 × 480p	100 Hz	
VESA STD	640 × 480p	120 Hz	
VESA STD	800 × 600p	100 Hz	
VESA STD	800 × 600p	120 Hz	
VESA STD	1024 × 768p	100 Hz	
VESA STD	1024 × 768p	120 Hz	
	1920 × 1080p	120 Hz	
	1920 × 1080p	100 Hz	
	1920 × 1080p	144 Hz	
	1920 × 1080p	165 Hz	Only for DP
	1280 × 720p	60 Hz	Only for DP
	1680 × 1050p	60 Hz	Only for HDMI

Installation

Follow these steps to install the monitor on your host system:
Steps

1. Turn off your computer and unplug the power cord.
2. Connect digital cable (Dual input models only)
 - a. Make sure the monitor and computer are powered off.
 - b. Connect one end of the HDMI/DP cable to the back of the monitor and the other end to the HDMI/DP port on your computer.

Note: The maximum display refresh rate for HDMI cables is 144 Hz.
The maximum display refresh rate for DP cables is 165 Hz.
3. Connect the audio cable (only Audio input model) (optional)
4. Plug the monitor power adapter into the power port on the back of the monitor.
5. Plug the computer power cable and monitor power adapter into the nearby power outlet.

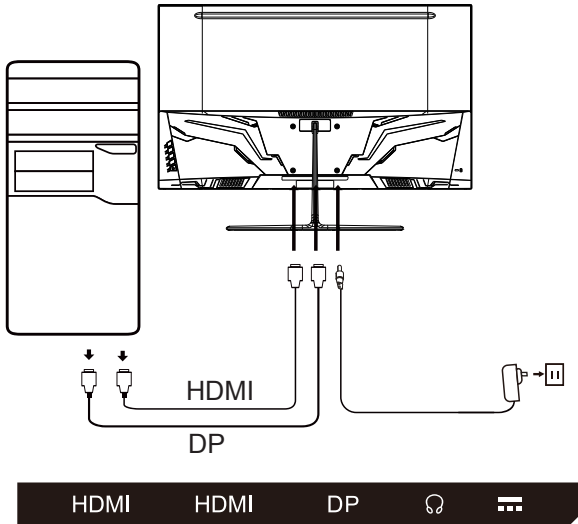

User control

Basic controls

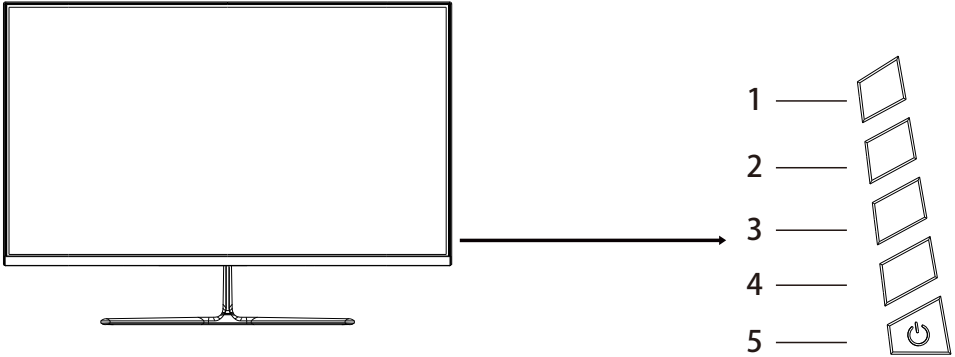

Number	Icon	Description
1		Go to the main menu.
2		Enter the source mode.
3		Enter the switch mode menu.
4		Enter brightness adjustment.
5		On/off

Adjust OSD settings



Note: The following is for general reference only. Actual product specifications may vary.

OSD (On Screen Display) can be used to adjust the settings of the LCD display. Press the MENU button to open the OSD. Use the OSD to adjust image quality, OSD position, and general settings. For information on advanced settings, see the following pages:

Home page

Buttons 1/2/3/4 can bring up the home page.

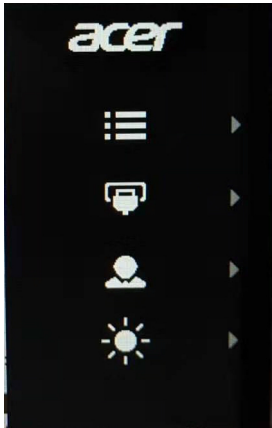

Feature page

Double-press Button 1 to select the menu function, and then use Buttons 1/2/3/4 to adjust the settings you need. When finished, use Button2 to return to the previous level or exit the menu.

Picture adjustment

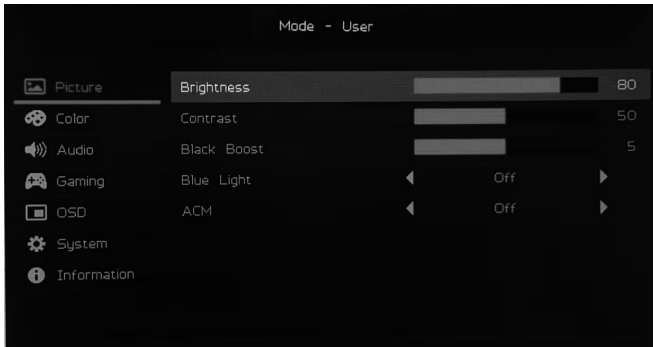

1. Double-press Button 1 to bring up the OSD.
2. Use Buttons 3/4 to select Picture from the OSD. Double-press Button 1 to navigate to the setting you want to adjust.
3. Use Buttons 3/4 to adjust the slider.
4. Brightness: Brightness can be adjusted from 0 - 100.

 Note: Adjusts the balance between light and dark.

5. Contrast: Contrast can be adjusted from 0 to 100.

 Note: Sets the degree of difference between light and dark areas.

6. Black Boost: This feature increases the richness of the display's dark levels - black becomes less black. The higher the setting, the greater the increase.
7. Blue Light: Filter blue light by adjusting different blue light display ratios (80%, 70%, 60%, 50%).



Note: The higher the value, the more blue light is displayed. For best protection, choose a lower value.

8. ACM: Turn ACM on or off. Default is off.

Color adjustment

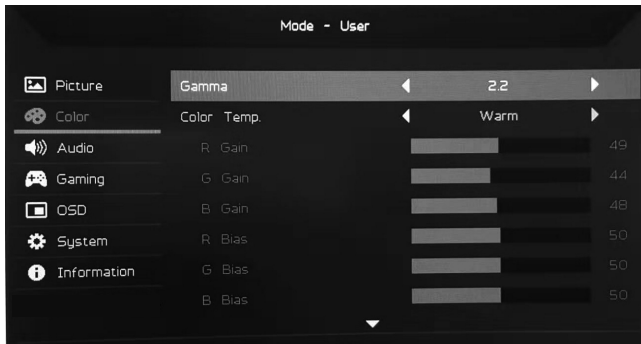
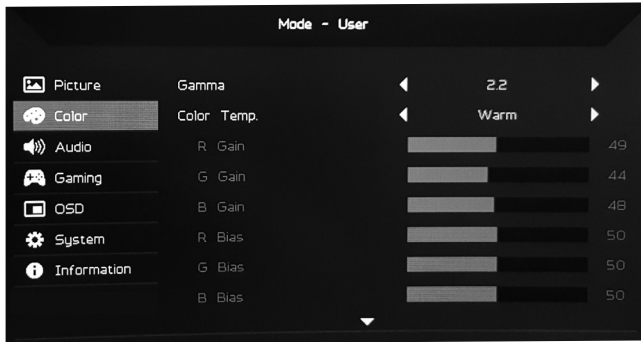

1. Double-click Button 1 to open the OSD.
2. Use Buttons 3/4 to select Color from the OSD. Double-press Button 1 to navigate to the setting you want to adjust.
3. Use Buttons 3/4 to adjust the slider.
4. Gamma Mode allows you to adjust the brightness and hue. The default value is 2.2 (the standard value for Windows).
5. Color Temperature: The default is warm. You can choose Cool, Warm, Normal, Blue Light or custom User Settings.
6. Modes: Select the preferred mode.
7. sRGB Mode is used to improve the color matching display with peripherals such as DSC or printers.
8. Grayscale Mode: Turn gray mode on or off.
9. Saturation: Saturation can be adjusted from 0-100.
10. 6-axis Hue: Adjust the red, green, blue, yellow, magenta and cyan hues.
11. 6-axis Saturate: Adjust the red, green, blue, yellow, magenta, and cyan saturation.

Volume adjustment

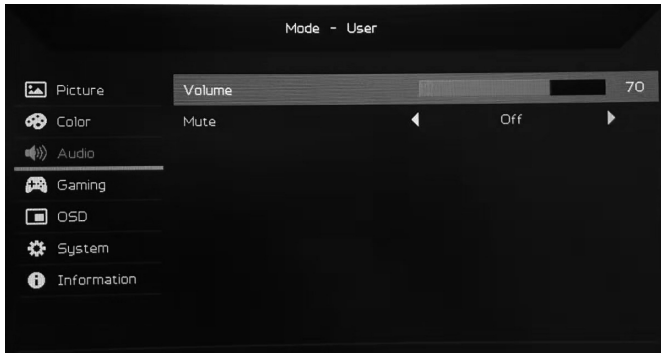

1. Double-click Button 1 to open the OSD.
2. Use Buttons 3/4 to select Audio from the OSD. Double-press Button 1 to navigate to the setting you want to adjust.
3. Use Buttons 3/4 to adjust the slider.
4. Volume: Adjusts the volume.
5. Mute: Audio on or off.

Game adjustment



1. Double-click Button 1 to open the OSD.
2. Use Buttons 3/4 to select Game from the OSD. Double-press Button 1 to navigate to the setting you want to adjust.
3. Use Buttons 3/4 to adjust the slider.
4. Over Drive: Select off, normal, or extreme.



Note:

1. If FreeSync is "On", Over Drive is automatically set to "Normal".
 2. If FreeSync is "Off", the user can set Over Drive to one of the following three settings: (a) Extreme (b) Normal (c) Off.
-
5. FreeSync: Select on or off. FreeSync is only available on AMD-supported graphics cards.
 6. Aim Point: Displays the aiming point on the screen for shooting games.

OSD adjustment



1. Double-click Button 1 to open the OSD.
2. Use Buttons 3/4 to select OSD from the OSD. Double-press Button 1 to navigate to the setting you want to adjust.
3. Use Buttons 3/4 to adjust the slider.
4. Language: Set the OSD menu language.
5. OSD Timeout: Adjust the delay before closing the OSD menu.
6. Transparency: Select transparency when using game mode. Transparency can be 0% (off), 20%, 40%, 60%, or 80%.
7. Refresh Rate Num: Displays the current refresh rate of the panel on the screen.
8. OSD Lock: The OSD lock function is used to prevent the OSD button from being accidentally pressed. To delete the OSD lock message, press and hold Buttons 1/2 for 3 seconds until the message disappears. If the OSD lock persists, check if Buttons 1/2 are functioning.

System adjustment

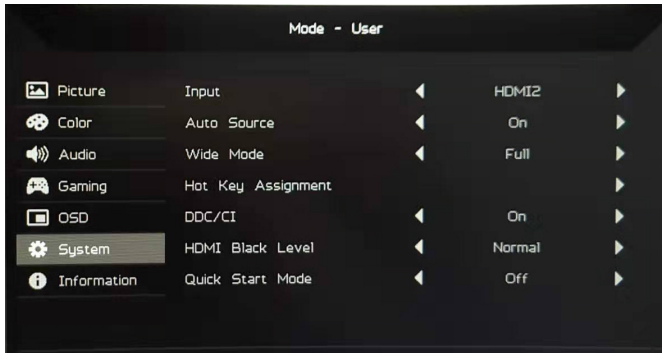

1. Double-click Button 1 to open the OSD.
 2. Use Buttons 3/4 to select System from the OSD. Double-press Button 1 to navigate to the setting you want to adjust.
 3. Use Buttons 3/4 to adjust the slider.
 4. Input: Select an available source from the available input sources.
 5. Auto Source: Automatically searches for available input sources.
 6. Hot Key Assignment: Select the function of Hotkey 1 or Hotkey 2
 7. Wide Mode: Choose the screen aspect ratio to use. The options are full screen and aspect ratio.
 8. DDC/CI: The monitor can be set using computer software.
-
-  Note: DDC/CI (abbreviation for Display Data Channel/Command Interface) can send monitor controls through software.
9. HDMI Black Level: Select the black level under the HDMI source. Options are normal and low.
 10. Quick Start Mode: Quickly enable the monitor.

Product information

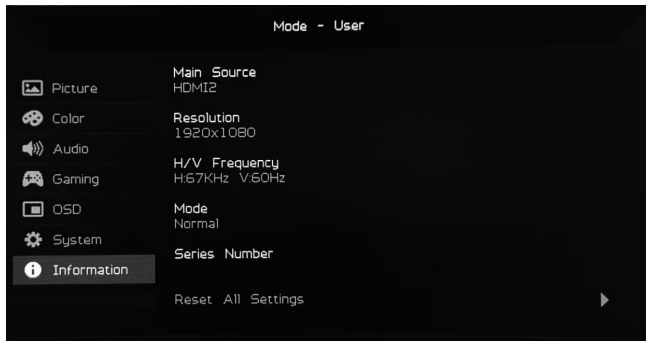

1. View the basic information of the machine.
2. Reset All Settings: Reset all settings to factory defaults.

Troubleshooting

Before sending your LCD monitor for repair, go through the troubleshooting checklist below to see if you can diagnose the problem.

(DP mode)

Problem	Status	Solution
No picture	LED lights up	<ul style="list-style-type: none"> Press the standby button to turn on.
	LED off	<ul style="list-style-type: none"> Check the power switch.
		<ul style="list-style-type: none"> Ensure that the AC power adapter is properly connected to the monitor.
LED flashes	<ul style="list-style-type: none"> Check that the video signal cable is properly connected to the back of the monitor. 	
	<ul style="list-style-type: none"> Check whether the computer system's power is on. 	
Picture abnormal	Picture is unstable	<ul style="list-style-type: none"> Check whether the graphics card specifications meet the monitor requirements. If they do not, the input signal frequency may not match.
	The display disappears, cannot be centered, or the is too large or small.	<ul style="list-style-type: none"> When the full screen image disappears, use the OSD to select another resolution or vertical frequency.
<ul style="list-style-type: none"> Before changing or disconnecting the signal cable or turning off the monitor, resize the image and wait for a few seconds. 		
Audio abnormal (only Audio input model) (optional)	No audio, or the volume is too low	<ul style="list-style-type: none"> Check whether the audio cable is connected to the PC.
		<ul style="list-style-type: none"> Check if the volume of the PC is set to minimum, and try to increase the volume.

(HDMI mode)

Problem	Status	Solution
No picture	LED lights up	<ul style="list-style-type: none">• Please use the OSD to maximize brightness and contrast, or reset it to a preset value.
	LED off	<ul style="list-style-type: none">• Check the power switch.• Ensure that the AC power adapter is properly connected to the monitor.
	LED flashes	<ul style="list-style-type: none">• Check that the video signal cable is properly connected to the back of the monitor.• Check whether the computer system's power is on.
Audio abnormal (only Audio input model) (optional)	No audio, or the volume is too low	<ul style="list-style-type: none">• Check whether the audio cable is connected to the PC.• Check if the volume of the PC is set to minimum, and try to increase the volume.



Acer Incorporated
8F, 88, Sec. 1, Xintai 5th Rd., Xizhi
New Taipei City 221, Taiwan

Declaration of Conformity

We,

Acer Incorporated

8F, 88, Sec. 1, Xintai 5th Rd., Xizhi, New Taipei City 221, Taiwan

And,

Acer Italy s.r.l.

Viale delle Industrie 1/A, 20020 Arese (MI), Italy

Tel: +39-02-939-921, Fax: +39-02 9399-2913

www.acer.it

Product:	LCD Monitor
Trade Name:	ACER
Model Number:	ED320QR
SKU Number:	ED320QR xxxxxx ("x" = 0~9, a~z, A~Z, or blank)

We, Acer Incorporated, hereby declare under our sole responsibility that the product described above is in conformity with the relevant Union harmonization legislations as below Directive and following harmonized standards and/or other relevant standards have been applied:

EMC Directive: 2014/30/EU

<input checked="" type="checkbox"/> EN55032:2012/AC:2013 Class B	<input checked="" type="checkbox"/> EN 55024:2010
<input checked="" type="checkbox"/> EN55032:2015/AC:2016 Class B	<input checked="" type="checkbox"/> EN61000-3-3:2013
<input checked="" type="checkbox"/> EN61000-3-2:2014 Class D	

LVD Directive: 2014/35/EU

<input checked="" type="checkbox"/> EN 60950-1:2006/A11:2009/A1:2010/A12:2011/A2:2013

RoHS Directive: 2011/65/EU

<input checked="" type="checkbox"/> EN 50581:2012

ErP Directive: 2009/125/EC

<input checked="" type="checkbox"/> Regulation (EC) No. 1275/ 2008; EN 50564:2011

Year to begin affixing CE marking: 2019.

RU Jan / Sr. Manager
Acer Incorporated (Taipei, Taiwan)

Aug. 02, 2019
Date



Acer America Corporation
333 West San Carlos St.,
Suite 1500
San Jose, CA 95110
U. S. A.
Tel : 254-298-4000
Fax : 254-298-4147
www.acer.com



Federal Communications Commission Declaration of Conformity

This device complies with Part 15 of the FCC Rules. Operation is subject to the following two conditions: (1) this device may not cause harmful interference, and (2) this device must accept any interference received, including interference that may cause undesired operation.

The following local Manufacturer /Importer is responsible for this declaration:

Product:	LCD Monitor
Model Number:	ED320QR
SKU Number:	ED320QR xxxxxx ("x" = 0~9, a ~ z, or A ~ Z)
Name of Responsible Party:	Acer America Corporation
Address of Responsible Party:	333 West San Carlos St. Suite 1500 San Jose, CA 95110 U. S. A.
Contact Person:	Acer Representative
Phone No.:	254-298-4000
Fax No.:	254-298-4147