

QUICK INSTALL GUIDE AND USER MANUAL

KVXLCDP-100, KVXLCDPF-100, KVXLCDP-200, KVXLCDPF-200

KVX SERIES 4K DP KVM EXTENDER

24/7 TECHNICAL SUPPORT AT 1.877.877.2269 OR VISIT BLACKBOX.COM

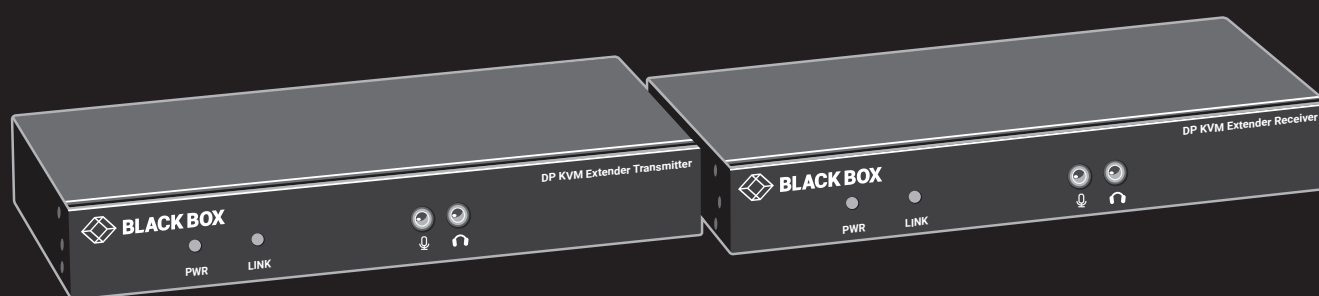

TABLE OF CONTENTS

QUICK INSTALLATION GUIDE	3
1. SPECIFICATIONS	4
2. OVERVIEW	6
2.1 Introduction.....	6
2.2 Features.....	6
2.3 What's Included.....	6
2.4 Hardware Description.....	7
2.4.1 Transmitter.....	7
2.4.2 Receiver.....	10
3. CONNECTION DIAGRAM	13
4. INSTALLATION	14
APPENDIX A. REGULATORY INFORMATION	15
A.1 FCC Statement.....	15
A.2 NOM Statement.....	16
APPENDIX B. DISCLAIMER/TRADEMARKS	17
B.1 Disclaimer.....	17
B.2 Trademarks.....	17



QUICK INSTALLATION GUIDE

Follow these steps to install the extender:

1. If you have the fiber models, install the SFPs in the transmitter and receiver. Compatible SFPs from Black Box are listed in the table below.

COMPATIBLE SFP MODULES		
PART NUMBER	DESCRIPTION	DISTANCE
1-GBPS CONNECTIONS		
LFP441	SFP 1.25-Gb, 850-nm Multimode Fiber, LC	550 m
LFP442	SFP 1.25-Gb, 1310-nm Single-mode Fiber, LC	20 km
LFP412	SFP with Extended Diagnostics - 1250-Mbps Multimode Fiber, 1310-nm	2 km
LFP413	SFP with Extended Diagnostics - 1250-Mbps Single-Mode Fiber, 1310-nm	10 km
LFP414	SFP with Extended Diagnostics - 1250-Mbps, Singlemode Fiber, 1310-nm	30 km
LFP416	SFP 1250-Mbps, Extended Diagnostics, 10/100/1000BASE-T, SGMII Interface, RJ-45	100 m

NOTE: Other SFPs may work but have not been validated by Black Box, we recommend you use the suggested SFPs to avoid technical incompatibilities. SFP is not included in the package, must be ordered separately.

2. Connect one end of a DisplayPort cable to the DisplayPort port on the source device (e.g. computer, server, or other IT device). Then connect the other end to the DP IN port located on the TX unit.
3. Connect the DisplayPort display to the DP OUT port on the TX unit.
4. Connect the DisplayPort display to the DP OUT port on the RX unit.
5. Connect the USB ports of the source device and the TX unit with a USB type A-B cable. Then plug a USB keyboard, mouse, or other USB devices into the USB ports of the RX unit.
6. Connect the RS-232 ports of the source device and the TX unit. Then connect the RS-232 ports of the RS-232 device on the RX unit side and the RX unit.
7. Connect the microphone/speaker ports of the source device and the TX unit with the audio microphone/speaker combo cable. Then, plug the microphone and speaker into the microphone and speaker ports of the RX unit.
8. For the CATx model, use a CAT5e cable to connect the CATx link ports on the TX unit and the RX unit.
9. For the fiber model, use two SFP modules and an optical fiber cable to connect the fiber link ports on the TX unit and the RX unit.
10. Plug the power adapter cable into the DC jacks on the TX and RX units.

NOTES:

- a. We recommend using the highest quality materials (cables, SFP, etc.) to ensure optimal transmission quality.
- b. If the screen does not display when you connect the computer:
 1. Make sure the device cables are correctly and firmly attached.
 2. Set your display device's (TV, monitor, etc.) input source as DisplayPort.
 3. Check the PC BIOS configuration of the video output setting.
 4. Connect your video source to the Display DIRECTLY to check if the video signal gets through.

NOTES:

1. Both the DisplayPort displays respectively connecting to TX and RX units MUST support the same maximum video resolution.
2. SFP module's bandwidth requirement is 1 Gbps minimum.
3. When plugging into any microphone or speaker ports of TX or RX units, digital DisplayPort audio extension will be disabled and only analog audio LINE-IN/LINE-OUT extension is enabled.

CHAPTER 1: SPECIFICATIONS**TABLE 1-1. TRANSMITTER SPECIFICATIONS**

Console Connection	
Video Output	N/A
Serial Control Port	(1) DB9 female
Host Connection	
Video Input	KVXLCDP-100, KVXLCDPF-100: (1) DisplayPort female; KVXLCDP-200, KVXLCDPF-200: (2) DisplayPort female
Local Out Video Connection	
Local Out	KVXLCDP-100, KVXLCDPF-100: (1) DisplayPort female; KVXLCDP-200, KVXLCDPF-200: (2) DisplayPort female
Link Port	
RJ-45 (KVXLCDP-100, KVXLCDP-200 transmitter)	CATx cable – max. length: 330 feet (100 meters)
SFP (KVXLCDPF-100, KVXLCDPF-200 transmitter)	Fiber optic cable – max. length: 18.6 miles (30 km), depending on SFP NOTE: The SFP module is not included. Must be ordered separately.
USB Interface	
Host	(1) USB Type B female
Device	N/A
Audio	
2-way analog audio	(1) Line In, (1) Line Out
Serial	
RS-232 Extension Port	(1) DB9 female
General	
LED indicator	Power: Red LED; Link: Green LED
DDC Supported	DDC, DDC2, DDC2B
Max. Video Resolution	4K @ 30 Hz, 3840 x 2160 @ 30 Hz (8-, 10-bit input)
OS Compatibility	OS Independent
Housing material	Chassis Metal
Operating Temperature	32 to 122° F (0 to 50° C)
Storage Temperature	-4 to +140° F (-20 to +60° C)
Relative Humidity	0 to 80%
Power Supply	External 5-VDC, 2-A power supply
Dimensions	KVXLCDP100, KVXLCDPF-100: 0.83" H x 7.09" W x 3.27" D (2.1 x 18 x 8.3 cm) KVXLCDP-200, KVXLCDPF-200: 1.71" H x 7.09" W x 3.27" D (4.4 x 18.0 x 8.3 cm)
Weight	KVXLCDP-100 transmitter: 0.82 lb. (0.372 kg) KVXLCDPF-100 transmitter: 0.83 lb. (0.378 kg) (no SFP); KVXLCDP-200 transmitter: 0.84 lb. (0.381 kg); KVXLCDPF-200 transmitter: 0.85 lb. (0.386 kg) (no SFP)



CHAPTER 1: SPECIFICATIONS

TABLE 1-2. RECEIVER SPECIFICATIONS

Console Connection	
Video Output	KVXLCDP-100, KVXLCDPF-100: (1) DisplayPort female; KVXLCDP-200, KVXLCDPF-200: (2) DisplayPort female
Serial Control Port	(1) DB9 male
Host Connection	
Video Input	N/A
Link Port	
RJ-45 (KVXLCDP-100 receiver)	CATx cable – max. length: 330 feet (100 meters)
SFP (KVXLCDPF-100 receiver)	Fiberoptic cable – max. length: 18.6 miles (30 km), depending on SFP NOTE: The SFP module is not included. Must be ordered separately.
USB Interface	
Host	N/A
Device	(4) USB 2.0 Type A female for USB device extension
Audio	
2-way analog audio	(1) MIC In, (1) Speaker Out
Serial	
RS-232 Extension Port	(1) DB9 male
General	
LED indicator	Power: Red LED; Link: Green LED
DDC Supported	DDC, DDC2, DDC2B
Max. Video Resolution	4K @ 30 Hz, 3840 x 2160 @ 30 Hz (8-bit output only)
OS Compatibility	OS Independent
Housing material	Chassis Metal
Operating Temperature	32 to 122° F (0 to 50° C)
Storage Temperature	-4 to +140° F (-20 to +60° C)
Relative Humidity	0 to 80%
Power Supply	External 5-VDC, 2-A power supply
Dimensions	KVXLCDP100, KVXLCDPF-100: 0.83" H x 7.09" W x 3.27" D (2.1 x 18 x 8.3 cm) KVXLCDP-200, KVXLCDPF-200: 1.71" H x 7.09" W x 3.27" D (4.4 x 18.0 x 8.3 cm)
Weight	KVXLCDP-100 receiver: 0.82 lb. (0.372 kg); KVXLCDPF-100 receiver: 0.83 lb. (0.378 kg) (no SFP); KVXLCDP-200 receiver: 0.85 lb. (0.386 kg); KVXLCDPF-200 receiver: 0.85 lb. (0.386 kg) (no SFP)

CHAPTER 2: OVERVIEW

2.1 INTRODUCTION

The K VX Series DisplayPort KVM Extender enables you to locally use one or two DisplayPort monitor(s), USB keyboard/mouse/other devices, speaker and microphone to operate a remote computer, server or other IT device featuring one or two DisplayPort video output(s). You can also view the DisplayPort video output(s) of the remote source devices via the DisplayPort output port(s) on the DisplayPort KVM Extender's TX unit.

There are four models of the K VX Series DisplayPort KVM Extender: a single-head KVXLCDP-100 via a CATx link, a dual-head KVXLCDP-200 via a CATx link, a single-head KVXLCDPF-100 via a fiberoptic link, and a dual-head KVXLCDPF-200 via a fiberoptic link. Each extender consists of a transmitter (TX) and a receiver (RX).

2.2 FEATURES

- ◆ Supports DisplayPort input/output video quality up to 4K @ 30 Hz, 3840 x 2160 @ 30 Hz.
- ◆ Has DisplayPort local video loopback on the TX unit.
- ◆ Provides remote access for video/USB/RS-232/audio extension distance up to 330 feet (100 meters) over CATx cable for model KVXLCDP-100 or KVXLCDP-200; up to 18.6 miles (30 km) over fiberoptic cable for model KVXLCDPF-100 or KVXLCDPF-200, depending on the SFP used.
- ◆ Single-head CATx and fiber and dual-head CATx and fiber versions available.
- ◆ The DisplayPort KVM Console Extender lets you control a server, or computer over single-mode or multimode fiber optic cable at distances of up to 30 km (depending on the SFP used, fiber type, and fiber bandwidth*).
- ◆ Offers transparent USB 2.0/1.1 extension.
- ◆ Uses analog audio LINE-IN/LINE-OUT extension.
- ◆ Supports bi-directional RS-232 control communication at a fixed baud rate of 115200.
- ◆ Automatic EDID update.

*NOTE: Reference the supported SFP chart on page 3.

2.3 WHAT'S INCLUDED

KVXLCDP-100:

- ◆ (1) DisplayPort Single-Head KVM CATx Extender Transmitter (TX)
- ◆ (1) DisplayPort Single-Head KVM CATx Extender Receiver (RX)
- ◆ (2) 5-VDC, 2-A power supplies
- ◆ (1) USB Type A to B cable
- ◆ (1) DisplayPort cable
- ◆ (1) audio microphone/speaker combo cable

KVXLCDPF-100:

- ◆ (1) DisplayPort Single-Head KVM Fiber Extender Transmitter (TX)
- ◆ (1) DisplayPort Single-Head KVM Fiber Extender Receiver (RX)
- ◆ (2) 5-VDC, 2-A power supplies
- ◆ (1) USB Type A to B cable
- ◆ (1) DisplayPort cable
- ◆ (1) audio microphone/speaker combo cable

NOTE: The SFP modules are not included.

KVXLCDP-200:

- ◆ (1) DisplayPort Dual-Head KVM CATx Extender Transmitter (TX)
- ◆ (1) DisplayPort Dual-Head KVM CATx Extender Receiver (RX)
- ◆ (2) 5-VDC, 2-A power supplies
- ◆ (1) USB Type A to B cable
- ◆ (2) DisplayPort cables
- ◆ (1) audio microphone/speaker combo cable

KVXLCDPF-200:

- ◆ (1) DisplayPort Dual-Head KVM Fiber Extender Transmitter (TX)
- ◆ (1) DisplayPort Dual-Head KVM Fiber Extender Receiver (RX)
- ◆ (2) 5-VDC, 2-A power supplies
- ◆ (1) USB Type A to B cable
- ◆ (2) DisplayPort cables
- ◆ (1) audio microphone/speaker combo cable

NOTE: The SFP modules are not included.



CHAPTER 2: OVERVIEW

2.4 HARDWARE DESCRIPTION

2.4.1 TRANSMITTER

FRONT PANEL

Figure 2-1 shows the front panel that is common to the single-head CATx and the fiber transmitters. Table 2-1 describes the components.

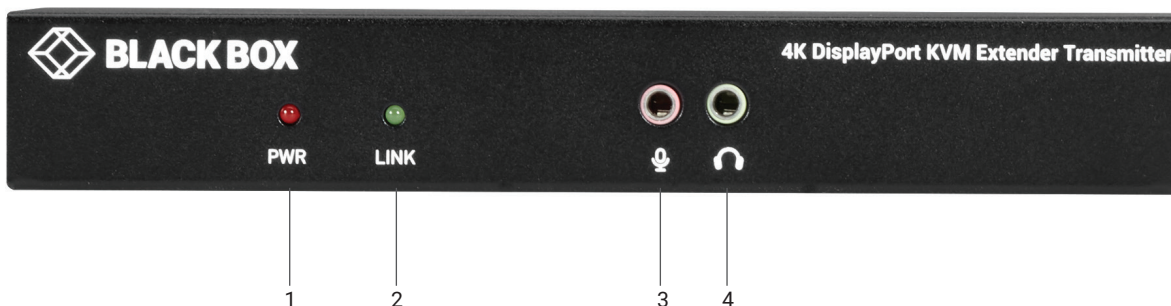

FIGURE 2-1. SINGLE-HEAD TRANSMITTER FRONT PANEL

Figure 2-2 shows the front panel that is common to the dual-head CATx and fiber transmitters. Table 2-1 describes the components.

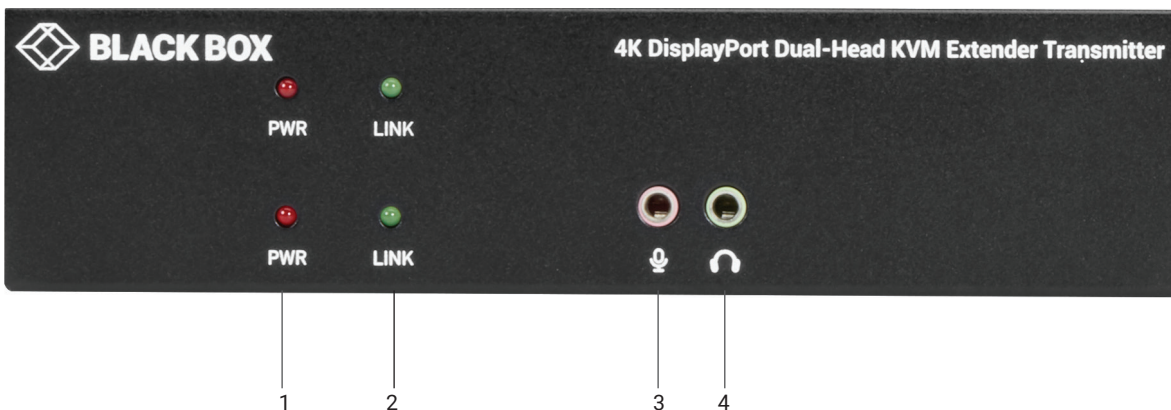

FIGURE 2-2. DUAL-HEAD TRANSMITTER FRONT PANEL

TABLE 2-1. TRANSMITTER FRONT-PANEL COMPONENTS

NUMBER IN FIGURE 2-1 OR 2-2	COMPONENT	DESCRIPTION
1	PWR LED	Lights when power to the transmitter is ON
2	Link LED	Lights when the link between transmitter and receiver units is ON; OFF when the link between transmitter and receiver units is OFF
3	Audio jack	Connects to analog audio input for audio extension
4	Audio jack	Connects to analog audio output for audio extension

CHAPTER 2: OVERVIEW

BACK PANEL

Figures 2-3 and 2-4 show the back panels of the single-head CATx and fiber transmitters. Table 2-2 describes their components.

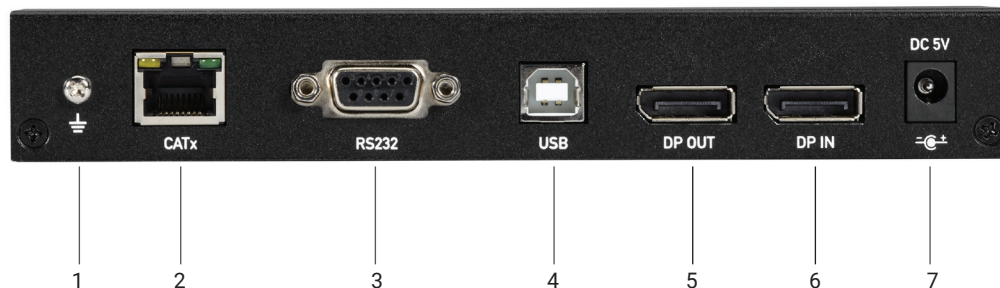

FIGURE 2-3. SINGLE-HEAD CATX TRANSMITTER BACK PANEL

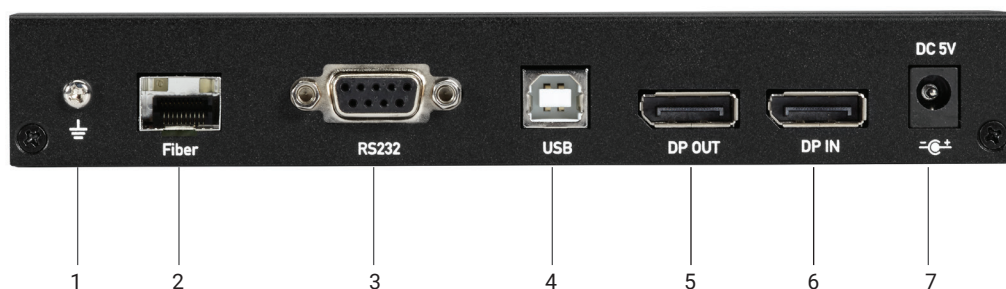

FIGURE 2-4. SINGLE-HEAD FIBER TRANSMITTER BACK PANEL

TABLE 2-2. SINGLE-HEAD TRANSMITTER BACK-PANEL COMPONENTS

NUMBER IN FIGURE 2-3 OR 2-4	COMPONENT	DESCRIPTION
1	Ground screw	Links to ground
2	For CATx model: RJ-45 connector; For Fiber model: SFP cage	For CATx Model: CATx link; For Fiber model: Install fiber SFP module here
3	DB9 connector	Connects to source device's RS-232 port for serial extension
4	USB Type B connector	Connects to source device's USB port
5	DisplayPort Out port	Connects to local out
6	DisplayPort In port	Connects to source device's signal for DisplayPort extension
7	Power connector	Links to 5-VDC power supply

Figures 2-5 and 2-6 show the back panels of the dual-head CATx and fiber transmitters. Table 2-3 describes their components.

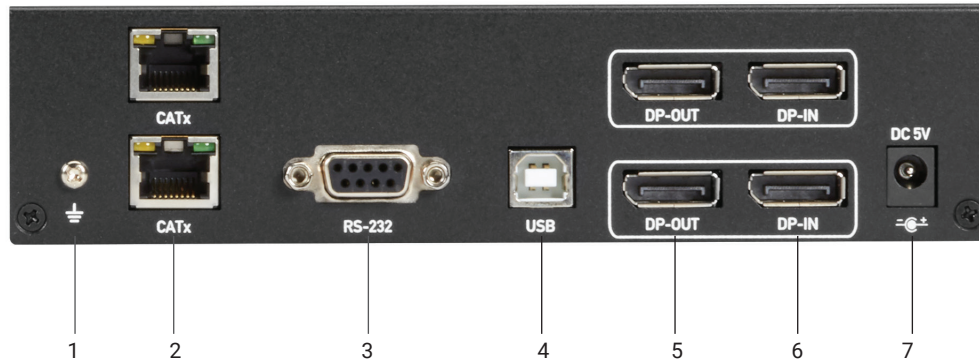

FIGURE 2-5. DUAL-HEAD CATX TRANSMITTER BACK PANEL

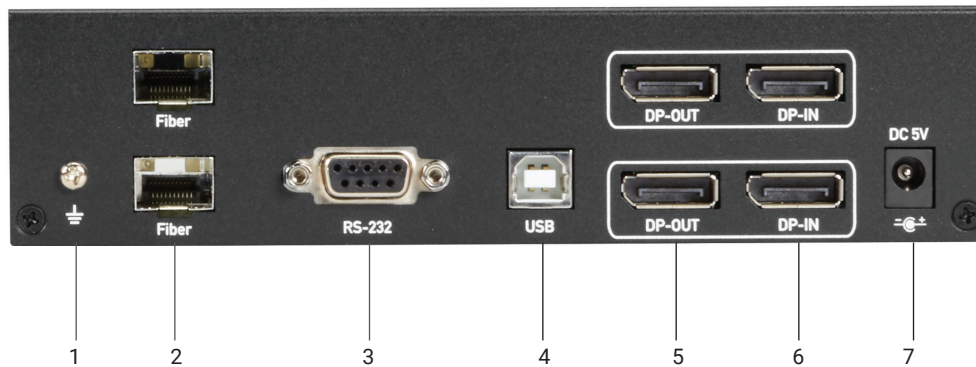

FIGURE 2-6. DUAL-HEAD FIBER TRANSMITTER BACK PANEL

TABLE 2-3. DUAL-HEAD TRANSMITTER BACK-PANEL COMPONENTS

NUMBER IN FIGURE 2-5 OR 2-6	COMPONENT	DESCRIPTION
1	Ground screw	Links to ground
2	For CATx model: RJ-45 connector; For Fiber model: SFP cage	For CATx Model: CATx link; For Fiber model: Install fiber SFP module here
3	DB9 connector	Connects to source device's RS-232 port for serial extension
4	USB Type B connector	Connects to source device's USB port
5	(2) DisplayPort Out ports	Connects to local outputs
6	(2) DisplayPort In ports	Connects to source devices' signals for DisplayPort extension
7	Power connector	Links to 5-VDC power supply

CHAPTER 2: OVERVIEW

2.4.2 RECEIVER

FRONT PANEL

Figure 2-7 shows the front panel that is common to the single-head CATx and fiber receivers. Table 2-4 describes its components.

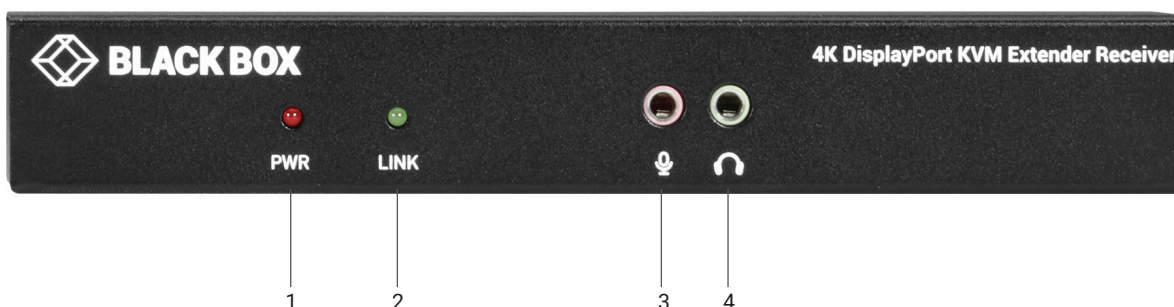

FIGURE 2-7. SINGLE-HEAD RECEIVER FRONT PANEL

Figure 2-8 shows the front panel that is common to the dual-head CATx and fiber receivers. Table 2-4 describes its components.

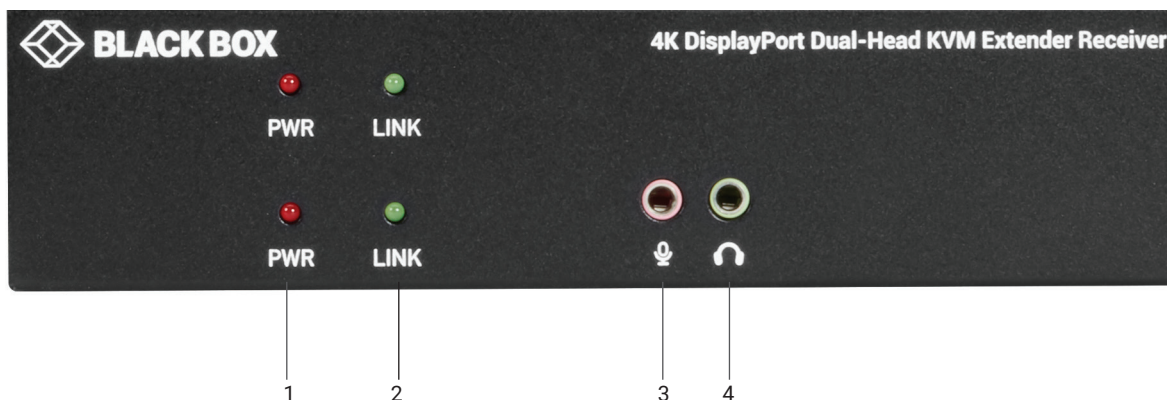

FIGURE 2-8. DUAL-HEAD RECEIVER FRONT PANEL

TABLE 2-4. RECEIVER FRONT-PANEL COMPONENTS

NUMBER IN FIGURE 2-4	COMPONENT	DESCRIPTION
1	PWR LED	Lights when power to the receiver is ON
2	Link LED	Lights when the link between transmitter and receiver units is ON; OFF when the link between transmitter and receiver units is OFF
3	Audio jack	Links to analog audio input for audio extension
4	Audio jack	Links to analog audio output for audio extension

CHAPTER 2: OVERVIEW

BACK PANEL

Figures 2-9 and 2-10 show the back panels of the single-head CATx and fiber receivers. Table 2-5 describes their components.



FIGURE 2-9. CATX RECEIVER BACK PANEL

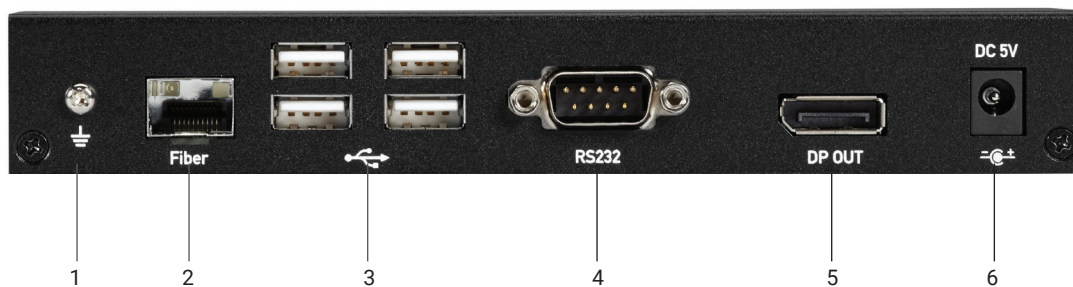

FIGURE 2-10. FIBER RECEIVER BACK PANEL

TABLE 2-5. RECEIVER BACK-PANEL COMPONENTS

NUMBER IN FIGURE 2-9 OR 2-10	COMPONENT	DESCRIPTION
1	Ground screw	Links to ground
2	For CATx model: RJ-45 connector For Fiber model: SFP cage	For CATx Model: CATx link For Fiber model: Install fiber SFP module here
3	(4) USB 2.0 Type A ports	Connect to USB device ports
4	DB9 connector	Connects to sink device's RS-232 port for serial extension
5	DisplayPort Out port	Connects to sink device's signal for DisplayPort video extension
6	Power connector	Links to 5-VDC power supply

CHAPTER 2: OVERVIEW

Figures 2-11 and 2-12 show the back panels of the dual-head CATx and fiber receivers. Table 2-6 describes their components.

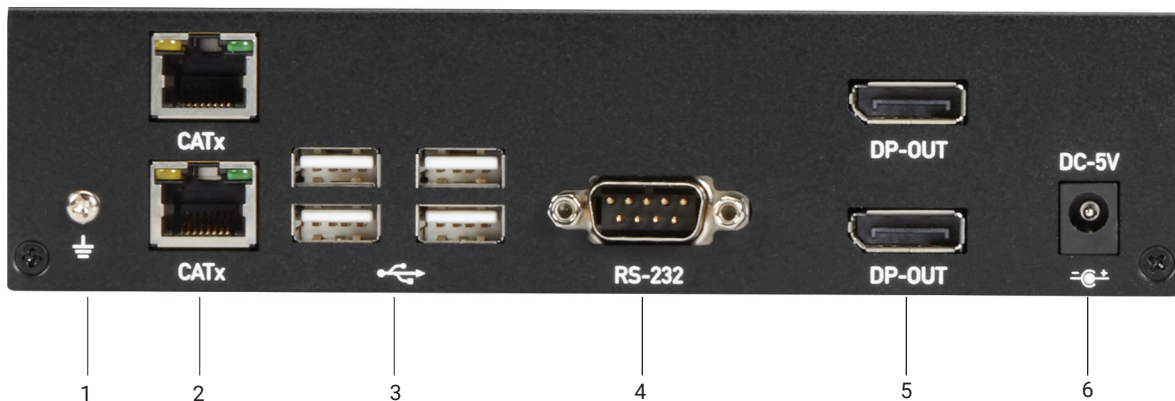

FIGURE 2-11. DUAL-HEAD CATX RECEIVER BACK PANEL

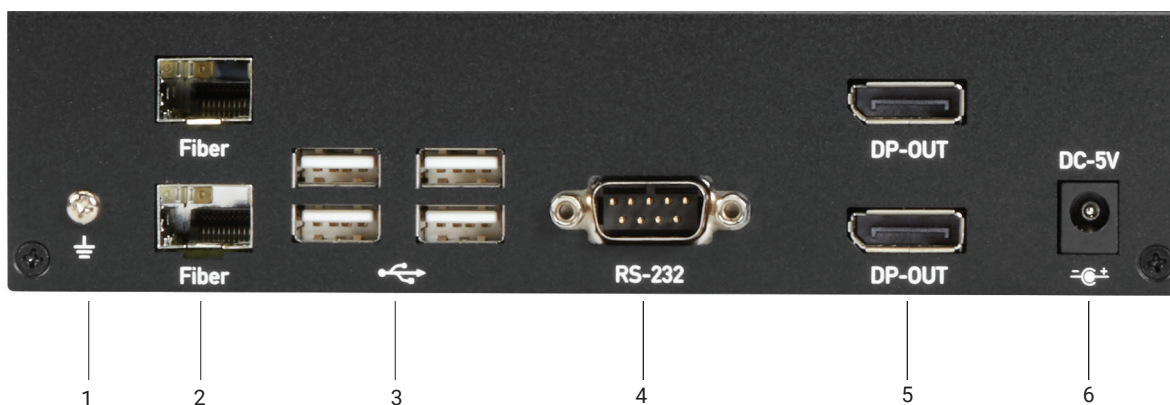

FIGURE 2-12. DUAL-HEAD FIBER RECEIVER BACK PANEL

TABLE 2-6. DUAL-HEAD RECEIVER BACK-PANEL COMPONENTS

NUMBER IN FIGURE 2-11 OR 2-12	COMPONENT	DESCRIPTION
1	Ground screw	Links to ground
2	For CATx model: RJ-45 connector For Fiber model: SFP cage	For CATx Model: CATx link For Fiber model: Install fiber SFP module here
3	(4) USB 2.0 Type A ports	Connect to USB device ports
4	DB9 connector	Connects to sink device's RS-232 port for serial extension
5	(2) DisplayPort Out ports	Connects to sink devices' signals for DisplayPort video extension
6	Power connector	Links to 5-VDC power supply

CHAPTER 3: CONNECTION DIAGRAM

Figures 3-1 and 3-2 show typical connections.

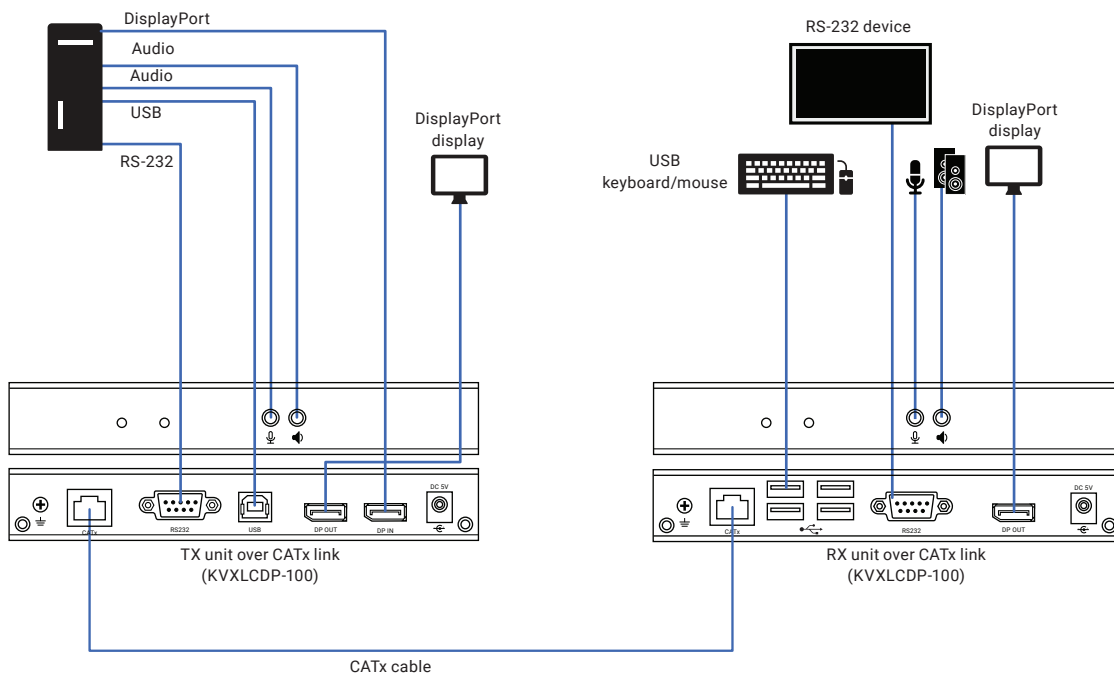

FIGURE 3-1. CATx MODEL CONNECTION DIAGRAM

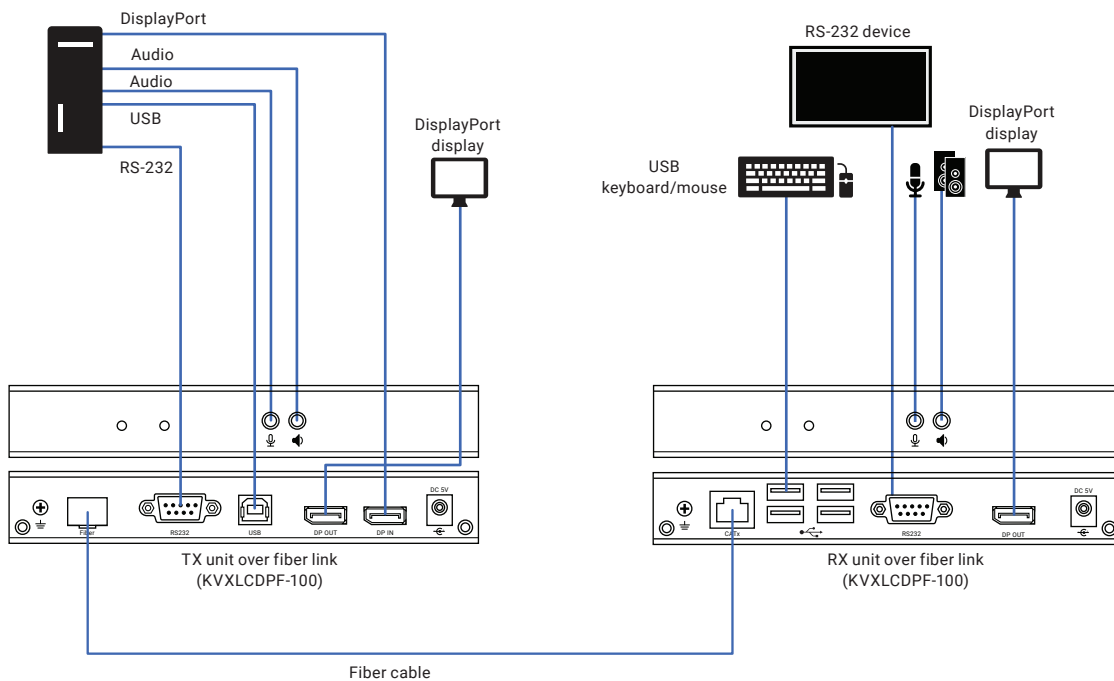

FIGURE 3-2. FIBER MODEL CONNECTION DIAGRAM

CHAPTER 4: INSTALLATION

Follow these steps to install the extender:

1. If you have the fiber models, install the SFPs in the transmitter and receiver. Compatible SFPs from Black Box are listed in the table on page 3 of this manual.

NOTE: Other SFPs may work but have not been validated by Black Box, we recommend you use the suggested SFPs to avoid technical incompatibilities.

NOTE: SFP is not included, must be ordered separately.

2. Connect one end of a DisplayPort cable to the DisplayPort port on the source device (e.g. computer, server or other IT device). Then connect the other end to the DisplayPort IN port located on the TX unit.
3. Connect the DisplayPort display to the DisplayPort OUT port on the TX unit.
4. Connect the DisplayPort display to the DisplayPort OUT port on the RX unit.
5. Connect the USB ports of the source device and the TX unit with a USB type A-B cable. Then plug a USB keyboard, mouse, or other USB devices into the USB ports of the RX unit.
6. Connect the RS-232 ports of the source device and the TX unit. Then connect the RS-232 ports of the RS-232 device on the RX unit side and the RX unit.
7. Connect the microphone/speaker ports of the source device and the TX unit with the audio microphone/speaker combo cable. Then, plug the microphone and speaker into the microphone and speaker ports of the RX unit.
8. For the CATx model, use a CAT5e cable to connect the CATx link ports on the TX unit and the RX unit.
9. For the fiber model, use two SFP modules and an optical fiber cable to connect the fiber link ports on the TX unit and the RX unit.
10. Plug the power adapter cable into the DC jacks on the TX and RX units.

NOTES:

- a. We recommend using the highest quality materials (cables, SFP, etc.) to ensure optimal transmission quality.
- b. If the screen does not display when you connect the computer:
 1. Make sure the device cables are correctly and firmly attached.
 2. Set your display device's (TV, monitor, etc.) input source as DisplayPort.
 3. Check the PC BIOS configuration of the video output setting.
 4. Connect your video source to the Display DIRECTLY to check if the video signal gets through.

NOTES:

1. Both the DisplayPort displays respectively connecting to TX and RX units MUST support the same maximum video resolution.
2. SFP module's bandwidth requirement is 1 Gbps minimum.
3. When plugging into any microphone or speaker ports of TX or RX units, digital DisplayPort audio extension will be disabled and only analog audio LINE-IN/LINE-OUT extension is enabled.



APPENDIX A: REGULATORY INFORMATION

A.1 FCC CLASS A STATEMENT

This equipment generates, uses, and can radiate radio-frequency energy, and if not installed and used properly, that is, in strict accordance with the manufacturer's instructions, may cause interference to radio communication. It has been tested and found to comply with the limits for a Class A computing device in accordance with the specifications in Subpart B of Part 15 of FCC rules, which are designed to provide reasonable protection against such interference when the equipment is operated in a commercial environment. Operation of this equipment in a residential area is likely to cause interference, in which case the user at his own expense will be required to take whatever measures may be necessary to correct the interference.

Changes or modifications not expressly approved by the party responsible for compliance could void the user's authority to operate the equipment.

This digital apparatus does not exceed the Class A limits for radio noise emission from digital apparatus set out in the Radio Interference Regulation of Industry Canada.

Le présent appareil numérique n'émet pas de bruits radioélectriques dépassant les limites applicables aux appareils numériques de la classe A prescrites dans le Règlement sur le brouillage radioélectrique publié par Industrie Canada.

APPENDIX A: REGULATORY INFORMATION

A.2 NOM STATEMENT

1. Todas las instrucciones de seguridad y operación deberán ser leídas antes de que el aparato eléctrico sea operado.
2. Las instrucciones de seguridad y operación deberán ser guardadas para referencia futura.
3. Todas las advertencias en el aparato eléctrico y en sus instrucciones de operación deben ser respetadas.
4. Todas las instrucciones de operación y uso deben ser seguidas.
5. El aparato eléctrico no deberá ser usado cerca del agua—por ejemplo, cerca de la tina de baño, lavabo, sótano mojado o cerca de una alberca, etc.
6. El aparato eléctrico debe ser usado únicamente con carritos o pedestales que sean recomendados por el fabricante.
7. El aparato eléctrico debe ser montado a la pared o al techo sólo como sea recomendado por el fabricante.
8. Servicio—El usuario no debe intentar dar servicio al equipo eléctrico más allá a lo descrito en las instrucciones de operación. Todo otro servicio deberá ser referido a personal de servicio calificado.
9. El aparato eléctrico debe ser situado de tal manera que su posición no interfiera su uso. La colocación del aparato eléctrico sobre una cama, sofá, alfombra o superficie similar puede bloquea la ventilación, no se debe colocar en libreros o gabinetes que impidan el flujo de aire por los orificios de ventilación.
10. El equipo eléctrico deber ser situado fuera del alcance de fuentes de calor como radiadores, registros de calor, estufas u otros aparatos (incluyendo amplificadores) que producen calor.
11. El aparato eléctrico deberá ser conectado a una fuente de poder sólo del tipo descrito en el instructivo de operación, o como se indique en el aparato.
12. Precaución debe ser tomada de tal manera que la tierra física y la polarización del equipo no sea eliminada.
13. Los cables de la fuente de poder deben ser guiados de tal manera que no sean pisados ni pellizcados por objetos colocados sobre o contra ellos, poniendo particular atención a los contactos y receptáculos donde salen del aparato.
14. El equipo eléctrico debe ser limpiado únicamente de acuerdo a las recomendaciones del fabricante.
15. En caso de existir, una antena externa deberá ser localizada lejos de las líneas de energía.
16. El cable de corriente deberá ser desconectado del cuando el equipo no sea usado por un largo periodo de tiempo.
17. Cuidado debe ser tomado de tal manera que objetos líquidos no sean derramados sobre la cubierta u orificios de ventilación.
18. Servicio por personal calificado deberá ser provisto cuando:
 - A: El cable de poder o el contacto ha sido dañado; u
 - B: Objetos han caído o líquido ha sido derramado dentro del aparato; o
 - C: El aparato ha sido expuesto a la lluvia; o
 - D: El aparato parece no operar normalmente o muestra un cambio en su desempeño; o
 - E: El aparato ha sido tirado o su cubierta ha sido dañada.



APPENDIX B: DISCLAIMER/TRADEMARKS

B.1 DISCLAIMER

Black Box Corporation shall not be liable for damages of any kind, including, but not limited to, punitive, consequential or cost of cover damages, resulting from any errors in the product information or specifications set forth in this document and Black Box Corporation may revise this document at any time without notice.

B.2 TRADEMARKS USED IN THIS MANUAL

Black Box and the Black Box logo type and mark are registered trademarks of Black Box Corporation.

Any other trademarks mentioned in this manual are acknowledged to be the property of the trademark owners.



**NEED HELP?
LEAVE THE TECH TO US**

**LIVE 24/7
TECHNICAL
SUPPORT**

1.877.877.2269

