



Maintenance and Service Guide

HP EliteDesk 705 G5 Desktop Mini

© Copyright 2019 HP Development Company, L.P.

AMD, Athlon, Radeon, and Ryzen are trademarks of Advanced Micro Devices, Inc. Bluetooth is a trademark owned by its proprietor and used by HP Inc. under license. Intel and vPro are trademarks of Intel Corporation or its subsidiaries in the U.S. and/or other countries. Microsoft and Windows are trademarks of the Microsoft group of companies. DisplayPort and the DisplayPort logo are trademarks owned by the Video Electronics Standards Association (VESA) in the United States and other countries.

The information contained herein is subject to change without notice. The only warranties for HP products and services are set forth in the express warranty statements accompanying such products and services. Nothing herein should be construed as constituting an additional warranty. HP shall not be liable for technical or editorial errors or omissions contained herein.

First Edition: November 2019

Document Part Number: L71697-001

Product notice

This guide describes features that are common to most models. Some features may not be available on your computer.

Not all features are available in all editions or versions of Windows. Systems may require upgraded and/or separately purchased hardware, drivers, software or BIOS update to take full advantage of Windows functionality. Windows 10 is automatically updated, which is always enabled. ISP fees may apply and additional requirements may apply over time for updates. Go to <http://www.microsoft.com> for details.

To access the latest user guides, go to <http://www.hp.com/support>, and follow the instructions to find your product. Then select **User Guides**.

Software terms

By installing, copying, downloading, or otherwise using any software product preinstalled on this computer, you agree to be bound by the terms of the HP End User License Agreement (EULA). If you do not accept these license terms, your sole remedy is to return the entire unused product (hardware and software) within 14 days for a full refund subject to the refund policy of your seller.

For any further information or to request a full refund of the price of the computer, please contact your seller.

Not all features are available in all editions of Windows. This computer may require upgraded and/or separately purchased hardware, drivers and/or software to take full advantage of Windows functionality. Go to <http://www.microsoft.com> for details.

Safety warning notice

 **WARNING!** To reduce the possibility of heat-related injuries or of overheating the computer, do not place the computer directly on your lap or obstruct the computer air vents. Use the computer only on a hard, flat surface. Do not allow another hard surface, such as an adjoining optional printer, or a soft surface, such as pillows or rugs or clothing, to block airflow. Also, do not allow the AC adapter to come into contact with the skin or a soft surface, such as pillows or rugs or clothing, during operation. The computer and the AC adapter comply with the user-accessible surface temperature limits defined by applicable safety standards.

About this guide





-  **WARNING!** Indicates a hazardous situation that, if not avoided, **could** result in serious injury or death.
 -  **CAUTION:** Indicates a hazardous situation that, if not avoided, **could** result in minor or moderate injury.
 -  **IMPORTANT:** Indicates information considered important but not hazard-related (for example, messages related to property damage). Warns the user that failure to follow a procedure exactly as described could result in loss of data or in damage to hardware or software. Also contains essential information to explain a concept or to complete a task.
 -  **NOTE:** Contains additional information to emphasize or supplement important points of the main text.
 -  **TIP:** Provides helpful hints for completing a task.
-

Table of contents

1 Computer features	1
Front panel components	2
Rear panel components	3
Serial number location	4
Changing from desktop to tower orientation	5
Attaching the computer to a mounting fixture	6
Installing a security lock	7
2 Illustrated parts catalog	8
Computer major components	8
Mass storage devices	10
Miscellaneous parts	11
3 Routine care, SATA drive guidelines, and disassembly preparation	13
Electrostatic discharge information	13
Generating static electricity	13
Preventing electrostatic damage to equipment	14
Personal grounding methods and equipment	14
Grounding the work area	15
Recommended materials and equipment	15
Operating guidelines	16
Routine care	16
General cleaning safety precautions	16
Cleaning the computer case	16
Cleaning the keyboard	17
Cleaning the monitor	17
Cleaning the mouse	17
Service considerations	17
Tools and software requirements	18
Screws	18
Cables and connectors	18
Hard drives	18
Lithium coin cell battery	19
SATA hard drives	19
SMART ATA drives	19
SATA hard drive cables	19

SATA data cable	19
Cable management	20
4 Removal and replacement procedures	21
Warnings and cautions	21
Preparation for disassembly	22
Front bezel dust filter	22
Access panel	23
Front bezel	24
Hood sensor	25
Speaker	26
Hard drive	27
Hard drive connector	28
Drive cage	29
Graphics processor and heat sink assembly	30
M.2 PCIe solid state drive (SSD)	31
WLAN module	33
Battery	35
Expansion connector board	37
Memory modules	38
Memory module specifications	38
Removing memory modules	38
Fan	41
Heat sink	42
Processor	44
System board	45
System board components	48
Internal WLAN antenna cables	49
5 Computer Setup (F10) Utility	51
Computer Setup (F10) Utilities	51
Using Computer Setup (F10) Utilities	51
Computer Setup—Main	53
Computer Setup—Security	55
Computer Setup—Advanced	58
Computer Setup—UEFI Drivers	63
Recovering the Configuration Settings	63
6 Troubleshooting without diagnostics	64
Safety and comfort	64

Before you call for technical support	64
Helpful hints	65
Solving general problems	66
Solving power problems	69
Solving hard drive problems	70
Solving media card reader problems	72
Solving display problems	73
Solving audio problems	77
Solving printer problems	79
Solving keyboard and mouse problems	81
Solving hardware installation problems	82
Solving network problems	83
Solving memory problems	85
Solving CD-ROM and DVD problems	87
Solving USB flash drive problems	89
Solving front panel component problems	90
Solving Internet access problems	90
Solving software problems	91
7 POST error messages	92
POST numeric codes and text messages	92
Interpreting POST diagnostic front panel lights and audible codes	96
8 Password security and resetting CMOS	98
Resetting the password jumper	98
Changing a setup or power-on password	99
Deleting a setup or power-on password	100
Clearing and resetting the CMOS	100
9 Using HP PC Hardware Diagnostics	102
Using HP PC Hardware Diagnostics Windows (select products only)	102
Downloading HP PC Hardware Diagnostics Windows	102
Downloading the latest HP PC Hardware Diagnostics Windows version	103
Downloading HP Hardware Diagnostics Windows by product name or number (select products only)	103
Installing HP PC Hardware Diagnostics Windows	103
Using HP PC Hardware Diagnostics UEFI	103
Starting HP PC Hardware Diagnostics UEFI	104
Downloading HP PC Hardware Diagnostics UEFI to a USB flash drive	104
Downloading the latest HP PC Hardware Diagnostics UEFI version	104

Downloading HP PC Hardware Diagnostics UEFI by product name or number (select products only)	105
Using Remote HP PC Hardware Diagnostics UEFI settings (select products only)	105
Downloading Remote HP PC Hardware Diagnostics UEFI	105
Downloading the latest Remote HP PC Hardware Diagnostics UEFI version	105
Downloading Remote HP PC Hardware Diagnostics UEFI by product name or number	105
Customizing Remote HP PC Hardware Diagnostics UEFI settings	105
10 Backing up, restoring, and recovering	107
Backing up information and creating recovery media	107
Using Windows tools	107
Using the HP Cloud Recovery Download Tool to create recovery media (select products only) ...	107
Restoring and recovery	108
Restoring, resetting, and refreshing using Windows tools	108
Recovering using HP Recovery media	108
Changing the computer boot order	108
Using HP Sure Recover (select products only)	109
11 Power cord set requirements	110
General requirements	110
Japanese power cord requirements	110
Country-specific requirements	111
12 Statement of memory volatility	112
Nonvolatile memory usage	114
Questions and answers	116
Using HP Sure Start (select models only)	117
13 Specifications	118
Index	119

1 Computer features

Features vary depending on the model. For support assistance and to learn more about the hardware and software installed on your computer model, run the HP Support Assistant utility.

 **NOTE:** You can use this computer model in a tower orientation or a desktop orientation.

See [Changing from desktop to tower orientation on page 5](#).



Front panel components

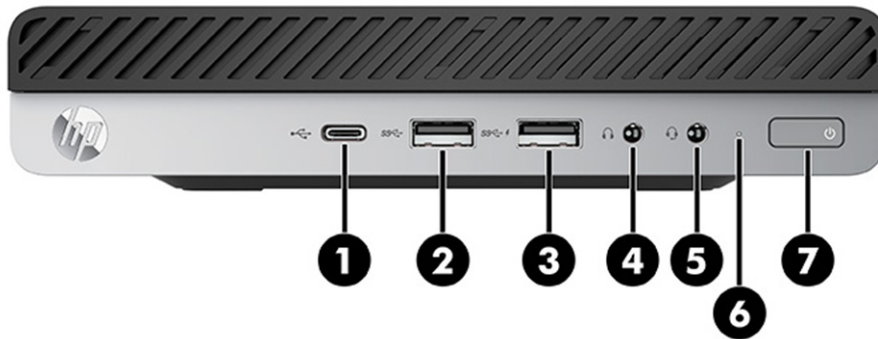









Table 1-1 Identifying the front panel components

Front panel components	
1	 USB Type-C port
2	 USB SuperSpeed port
3	 USB SuperSpeed port with HP Sleep and Charge
4	 Audio-out (headphone) jack
5	 Audio-out (headphone)/Audio-in (microphone) combo jack
6	 Hard drive activity light
7	 Power button

NOTE: The combo jack supports headphones, line output devices, microphones, line input devices, or CTIA style headsets.

NOTE: The light on the power button is normally white when the power is on. If the light flashes red, the computer displays a diagnostic code to indicate a problem. See [Interpreting POST diagnostic front panel lights and audible codes on page 96](#) the to interpret the code.

Rear panel components

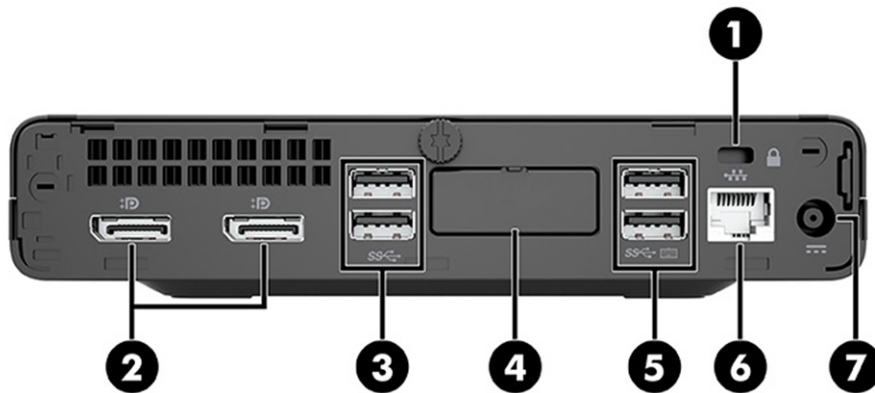







Table 1-2 Identifying the rear panel components

Rear panel components	
1	 Security cable slot
2	 DisplayPort™ monitor connectors (2)
3	 USB SuperSpeed ports (2)
4	Optional port*
5	 USB SuperSpeed ports* (2)
6	 RJ-45 (network) jack
7	Power cord connector

*Optional port offers choice of HDMI 2.0a, DisplayPort 1.2, VGA, serial port or USB Type-C.

**Bottom port allows for wake from keyboard.

Serial number location

Each computer has a unique serial number and a product ID number that are located on the exterior of the computer. Keep these numbers available when contacting customer service for assistance.

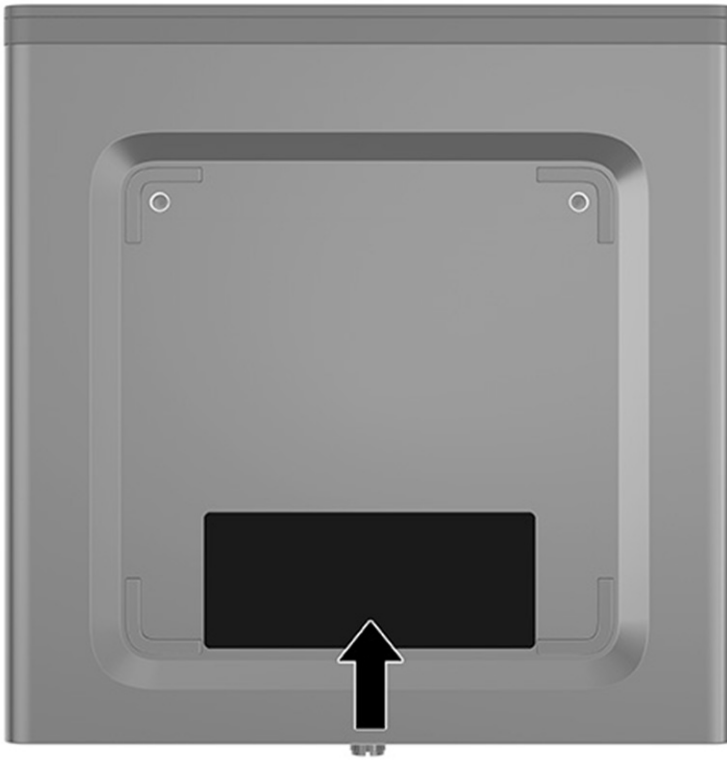

Changing from desktop to tower orientation

The computer can be used in a tower orientation with an optional tower stand that can be purchased from HP.

1. Remove or disengage any security devices that prohibit opening the computer.
2. Remove all removable media, such as a USB flash drive, from the computer.
3. Turn off the computer properly through the operating system, and turn off any external devices.
4. Disconnect the power cord from the AC outlet and disconnect any external devices.

 **IMPORTANT:** Regardless of the power state, voltage is always present on the system board as long as the system is plugged into an active AC outlet. To prevent damage to internal components, you must disconnect the power cord from the power source before opening the computer.

5. Orient the computer so that its right side is facing up and place the computer in the optional stand.



 **NOTE:** To stabilize the computer in a tower orientation, HP recommends the use of the optional tower stand.

6. Reconnect the power cord and any external devices, and then turn on the computer.

 **NOTE:** Ensure that at least 10.2 centimeters (4 inches) of space on all sides of the computer remains clear and free of obstructions.

7. Lock any security devices that were disengaged before the computer was moved.

Attaching the computer to a mounting fixture

The computer can be attached to a wall, swing arm, or other mounting fixture.



NOTE: This apparatus is intended to be supported by UL or CSA Listed wall mount bracket.



1. If the computer is on a stand, remove the computer from the stand and lay the computer down.
2. To attach the computer to a swing arm (sold separately), insert four screws through the holes on the swing arm plate and into the mounting holes on the computer.



IMPORTANT: This computer supports the VESA industry standard 100 mm mounting holes. To attach a third-party mounting solution to the computer, use the screws that are supplied with the solution. Verify that the manufacturer's mounting solution is compliant with the VESA standard and is rated to support the weight of the computer. For best performance, use the power cord and other cables provided with the computer.

To attach the computer to other mounting fixtures, follow the instructions included with the mounting fixture to ensure that the computer is safely attached.

Installing a security lock

You can attach a security cable lock to the rear of the computer. Use the key provided to attach and remove the lock.



To install a padlock, slide the padlock loop out from the rear of the computer and install the padlock in the loop.



 **NOTE:** The cable lock and padlock are designed to act as a deterrent, but they may not prevent the computer from being mishandled or stolen.

2 Illustrated parts catalog

 **NOTE:** HP continually improves and changes product parts. For complete and current information on supported parts for your computer, go to <http://partsurfer.hp.com>, select your country or region, and then follow the on-screen instructions.

Computer major components

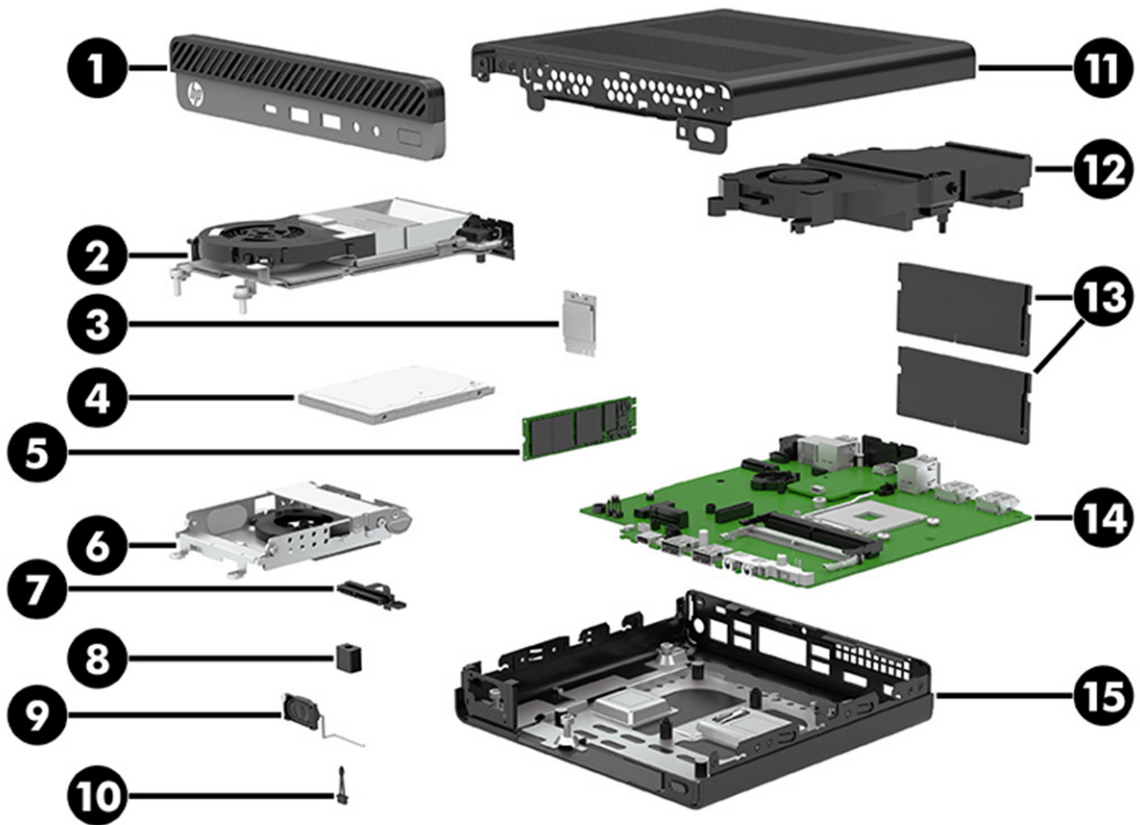

Item	Description
(1)	Front bezel
(2)	Graphics processor with heat sink, AMD® Radeon™ RX560 4 GB (includes replacement thermal material)
(3)	WLAN module
	Intel® Wi-Fi 6 + Bluetooth® 5 (802.11ax 2 × 2 non-vPro™)
	Intel 9260 802.11ac 2 × 2 + Bluetooth 5 PCIe (non-vPro)
	Intel 8265 802.11ac 2 × 2 with Bluetooth® M.2 Combo Card (non-vPro)
	Realtek RTL8822CE 802.11ac 2 × 2 Wi-Fi + Bluetooth
(4)	Hard drives

Item	Description
	1 TB, 7200 rpm, 7 mm
	500 GB, 7200 rpm, 7 mm
	500 GB, 7200 rpm, OPAL2, self-encrypting drive (SED), 7 mm
	500 GB, 5400 rpm, FIPS, 7 mm
	Solid-state drives, 2.5 inch, SATA-3, TLC
	512 GB, FIPS-140-2
	512 GB, OPAL 2, self-encrypting drive (SED)
	512 GB
	256 GB, FIPS-140-2
	256 GB, OPAL 2, self-encrypting drive (SED)
	256 GB
(5)	Solid-state drives, NVMe, M.2 2280, PCIe
	2 TB
	1 TB
	512 GB, self-encrypting drive, Opal 2, TLC
	512 GB, TLC
	512 GB, value
	256 GB, self-encrypting drive, Opal 2, TLC
	256 GB, TLC
	256 GB, value
	128 GB, TLC
(6)	Hard drive cage
(7)	Hard drive cable
(8)	Antenna cover
(9)	Speaker
(10)	Hood sensor
(11)	Access panel
(12)	Heat sink with fan (includes replacement thermal material)
(13)	Memory module (SODIMM)
	32 GB (PC4-2666)
	16 GB (PC4-2666)
	8 GB (PC4-2400)
	4 GB (PC4-2400)
(14)	System board (includes replacement thermal material)

Item	Description
(15)	Computer chassis
*	Processor (include replacement thermal material)
	AMD Ryzen™ 5 3400
	AMD Ryzen 5 3400GE
	AMD Ryzen 3 3200
	AMD Ryzen 3 3200GE
	AMD Athlon 300GE
*	Option board
	HDMI option board
	DisplayPort option board
	VGA option board
	Serial port option board
	USB Type-C option board
	USB Type-C option board with 100 W power delivery option board

* not illustrated

Mass storage devices

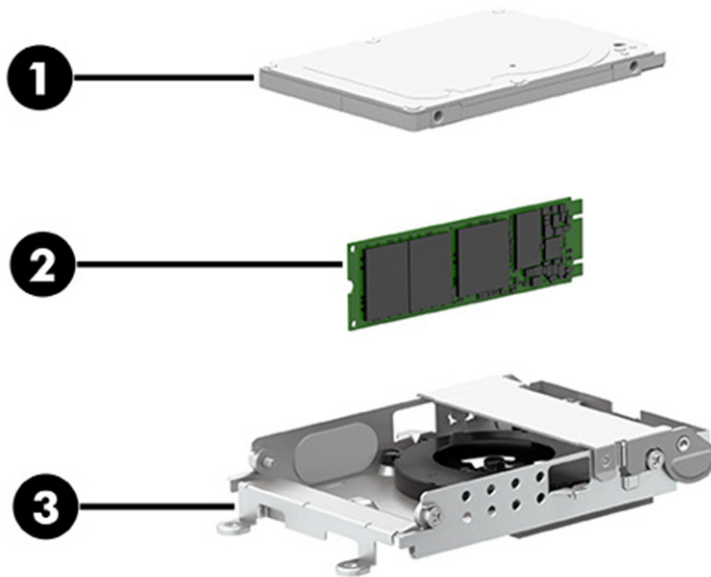

Item	Description
(1)	Hard drive
	1 TB, 7200 rpm, 7 mm
	500 GB, 7200 rpm, 7 mm

Item	Description
	500 GB, 7200 rpm, OPAL2, self-encrypting drive (SED), 7 mm
	500 GB, 5400 rpm, FIPS, 7 mm
	Solid-state drive, 2.5 inch, TLC
	512 GB, FIPS-140-2
	512 GB, OPAL 2, self-encrypting drive (SED)
	512 GB
	256 GB, FIPS-140-2
	256 GB, OPAL 2, self-encrypting drive (SED)
	256 GB
(2)	Solid-state drives, NVMe, M.2 2280, PCIe
	2 TB
	1 TB
	512 GB, self-encrypting drive, Opal 2, TLC
	512 GB, TLC
	512 GB, value
	256 GB, self-encrypting drive, Opal 2, TLC
	256 GB, TLC
	256 GB, value
	128 GB, TLC
(3)	Hard drive cage

Miscellaneous parts

Description
AC adapter
150 W, APFC
90 W, APFC
65 W, nPFC
Front bezel dust filter (not illustrated)
Antenna cable, wireless
Stand
EPS bracket
Quick release 2
HP USB-Type C to USB Type-A Hub

Description
Adapters
USB Type-C to DisplayPort
USB Type-C to USB 3.0
Keyboard
Washable, PVC, USB/PS2
USB
Conferencing, USB
USB, slim
Wireless keyboard and mouse
Smart card, slim, CCID, USB
Anti-microbial, slim
Grey, slim, USB
Collaboration, USB
Collaboration, wireless
Wireless, premium
Health care, wired, USB
Premium, wireless, keyboard and mouse
Mouse
USB, optical
USB, laser
USB, fingerprint
USB, premium
USB, antimicrobial
USB, hardened
USB, health care, wired
Power cord

3 Routine care, SATA drive guidelines, and disassembly preparation

This chapter provides general service information for the computer. Adherence to the procedures and precautions described in this chapter is essential for proper service.

 **IMPORTANT:** When the computer is plugged into an AC power source, voltage is always applied to the system board. You must disconnect the power cord from the power source before opening the computer to prevent system board or component damage.

Electrostatic discharge information

A sudden discharge of static electricity from your finger or other conductor can destroy static-sensitive devices or microcircuitry. Often the spark is neither felt nor heard, but damage occurs. An electronic device exposed to electrostatic discharge (ESD) might not appear to be affected at all and can work perfectly throughout a normal cycle. The device might function normally for a while, but it has been degraded in the internal layers, reducing its life expectancy.

Networks built into many integrated circuits provide some protection, but in many cases, the discharge contains enough power to alter device parameters or melt silicon junctions.

 **IMPORTANT:** To prevent damage to the device when you are removing or installing internal components, observe these precautions:

Keep components in their electrostatic-safe containers until you are ready to install them.

Before touching an electronic component, discharge static electricity by using the guidelines described in this section.

Avoid touching pins, leads, and circuitry. Handle electronic components as little as possible.

If you remove a component, place it in an electrostatic-safe container.

Generating static electricity

The following table shows how humidity affects the electrostatic voltage levels generated by different activities. A product can be degraded by 700 V.

- Different activities generate different amounts of static electricity.
- Static electricity increases as humidity decreases.

Table 3-1 Static electricity occurrence based on activity and humidity

Event	Relative humidity		
	55%	40%	10%
Walking across carpet	7,500 V	15,000 V	35,000 V
Walking across vinyl floor	3,000 V	5,000 V	12,000 V
Motions of bench worker	400 V	800 V	6,000 V
Removing DIPs (dual in-line packages) from plastic tube	400 V	700 V	2,000 V

Table 3-1 Static electricity occurrence based on activity and humidity (continued)

	Relative humidity		
	20%	40%	60%
Removing DIPs from vinyl tray	2,000 V	4,000 V	11,500 V
Removing DIPs from polystyrene foam	3,500 V	5,000 V	14,500 V
Removing bubble pack from PCB (printed circuit board)	7,000 V	20,000 V	26,500 V
Packing PCBs in foam-lined box	5,000 V	11,000 V	21,000 V

Multiple electric components can be packaged together in plastic tubes, trays, or polystyrene foam.

 **NOTE:** As little as 700 V can degrade a product.

Preventing electrostatic damage to equipment

Many electronic components are sensitive to ESD. Circuitry design and structure determine the degree of sensitivity. The following packaging and grounding precautions are necessary to prevent static electricity damage to electronic components.

- To avoid hand contact, transport products in static-safe containers such as tubes, bags, or boxes.
- Protect all electrostatic parts and assemblies with conductive or approved containers or packaging.
- Keep electrostatic-sensitive parts in their containers until they arrive at static-free stations.
- Place items on a grounded surface before removing them from their container.
- Always be properly grounded when touching a sensitive component or assembly.
- Avoid contact with pins, leads, or circuitry.
- Place reusable electrostatic-sensitive parts from assemblies in protective packaging or conductive foam.

Personal grounding methods and equipment

Use the following equipment to prevent static electricity damage to electronic components:

- **Wrist straps** are flexible straps with a maximum of 1 M Ω \pm 10% resistance in the ground cords. To provide proper ground, a strap must be worn snug against bare skin. The ground cord must be connected and fit snugly into the banana plug connector on the grounding mat or workstation.
- **Heel straps/Toe straps/Boot straps** can be used at standing workstations and are compatible with most types of shoes or boots. On conductive floors or dissipative floor mats, use them on both feet with a maximum of 1 M Ω \pm 10% resistance between the operator and ground.

Table 3-2 Static shielding protection levels

Static shielding protection levels	
Method	Voltage
Antistatic plastic	1,500
Carbon-loaded plastic	7,500
Metallized laminate	15,000

Grounding the work area

To prevent static damage at the work area, use the following precautions:

- Cover the work surface with approved static-dissipative material. Provide a wrist strap connected to the work surface and properly grounded tools and equipment.
- Use static-dissipative mats, foot straps, or air ionizers to give added protection.
- Handle electrostatic sensitive components, parts, and assemblies by the case or PCB laminate. Handle them only at static-free work areas.
- Turn off power and input signals before inserting and removing connectors or test equipment.
- Use fixtures made of static-safe materials when fixtures must directly contact dissipative surfaces.
- Keep work area free of nonconductive materials such as ordinary plastic assembly aids and polystyrene foam.
- Use field service tools, such as cutters, screwdrivers, and vacuums that are conductive.

Recommended materials and equipment

HP recommends the following materials and equipment to prevent static electricity:

- Antistatic tape
- Antistatic smocks, aprons, or sleeve protectors
- Conductive bins and other assembly or soldering aids
- Conductive foam
- Conductive tabletop workstations with ground cord of $1\text{ M}\Omega \pm 10\%$ resistance
- Static-dissipative table or floor mats with hard tie to ground
- Field service kits
- Static awareness labels
- Wrist straps and footwear straps providing $1\text{ M}\Omega \pm 10\%$ resistance
- Material handling packages
- Conductive plastic bags
- Conductive plastic tubes
- Conductive tote boxes
- Opaque shielding bags
- Transparent metallized shielding bags
- Transparent shielding tubes

Operating guidelines

To prevent overheating and to help prolong the life of the computer:

- Keep the computer away from excessive moisture, direct sunlight, and extremes of heat and cold.
- Operate the computer on a sturdy, level surface. Leave a 10.2 cm (4 inch) clearance on all vented sides of the computer and above the monitor to permit the required airflow.
- Never restrict the airflow into the computer by blocking any vents or air intakes. Do not place the keyboard, with the keyboard feet down, directly against the front of the desktop unit as this also restricts airflow.
- Occasionally clean the air vents on all vented sides of the computer. Lint, dust, and other foreign matter can block the vents and limit the airflow. Be sure to unplug the computer before cleaning the air vents.
- Never operate the computer with the cover or side panel removed.
- Do not stack computers on top of each other or place computers so near each other that they are subject to each other's recirculated or preheated air.
- If the computer is to be operated within a separate enclosure, intake and exhaust ventilation must be provided on the enclosure, and the same operating guidelines listed above will still apply.
- Keep liquids away from the computer and keyboard.
- Never cover the ventilation slots on the monitor with any type of material.
- Install or enable power management functions of the operating system or other software, including Sleep states.

Routine care

General cleaning safety precautions

1. Never use solvents or flammable solutions to clean the computer.
2. Never immerse any parts in water or cleaning solutions; apply any liquids to a clean cloth and then use the cloth on the component.
3. Always unplug the computer when cleaning with liquids or damp cloths.
4. Always unplug the computer before cleaning the keyboard, mouse, or air vents.
5. Disconnect the keyboard before cleaning it.
6. Wear safety glasses equipped with side shields when cleaning the keyboard.

Cleaning the computer case

Follow all safety precautions in [General cleaning safety precautions on page 16](#) before cleaning the computer.

To clean the computer case, follow these procedures:

- To remove light stains or dirt, use plain water with a clean, lint-free cloth or swab.
- For stronger stains, use a mild dishwashing liquid diluted with water. Rinse well by wiping it with a cloth or swab dampened with clear water.
- For stubborn stains, use isopropyl (rubbing) alcohol. No rinsing is needed because the alcohol evaporates quickly and does not leave a residue.

- After cleaning, always wipe the unit with a clean, lint-free cloth.
- Occasionally clean the air vents on the computer. Lint and other foreign matter can block the vents and limit the airflow.

Cleaning the keyboard

Follow all safety precautions in [General cleaning safety precautions on page 16](#) before cleaning the keyboard.

To clean the tops of the keys or the keyboard body, follow the procedures described in [Cleaning the computer case on page 16](#).

When cleaning debris from under the keys, review all rules in [General cleaning safety precautions on page 16](#) before following these procedures:

 **CAUTION:** Use safety glasses equipped with side shields before attempting to clean debris from under the keys.

- Visible debris underneath or between the keys might be removed by vacuuming or shaking.
- Canned, pressurized air might be used to clean debris from under the keys. Caution should be used as too much air pressure can dislodge lubricants applied under the wide keys.
- If you remove a key, use a specially designed key puller to prevent damage to the keys. This tool is available through many electronic supply outlets.

 **IMPORTANT:** Never remove a wide leveled key (like the space bar) from the keyboard. If these keys are improperly removed or installed, the keyboard may not function properly.

- You can clean under a key with a swab moistened with isopropyl alcohol and squeezed out. Be careful not to wipe away lubricants necessary for proper key functions. Use tweezers to remove any fibers or dirt in confined areas. Allow the parts to air dry before reassembly.

Cleaning the monitor

- Wipe the monitor screen with a clean cloth moistened with water or with a towelette designed for cleaning monitors. Do not use sprays or aerosols directly on the screen; the liquid may seep into the housing and damage a component. Never use solvents or flammable liquids on the monitor.
- To clean the monitor body follow the procedures in [Cleaning the computer case on page 16](#).

Cleaning the mouse

Before cleaning the mouse, be sure that the power to the computer is turned off.

- Clean the mouse ball by first removing the retaining plate and the ball from the housing. Pull out any debris from the ball socket and wipe the ball with a clean, dry cloth before reassembly.
- To clean the mouse body, follow the procedures in [Cleaning the computer case on page 16](#).

Service considerations

Keep these considerations in mind during the disassembly and assembly of the computer.

Tools and software requirements

To service the computer, you need the following tools:

- Torx T-15 screwdriver
- Flat-bladed screwdriver (may sometimes be used in place of the Torx screwdriver)
- Phillips P1 screwdriver
- Nonconductive, nonmarking pry tool
- Diagnostics software

Screws

The screws used in the computer are not interchangeable. They could have standard or metric threads and might be of different lengths. If an incorrect screw is used during the reassembly process, it can damage the unit. HP strongly recommends that all screws removed during disassembly be kept with the part that was removed and then returned to their proper locations.



IMPORTANT: As you remove each subassembly from the computer, place it away from the work area to prevent damage.

Cables and connectors

Apply only the tension required to seat or unseat the cables during insertion or removal from the connector. Handle cables by the connector whenever possible. In all cases, avoid bending or twisting the cables, and be sure that the cables are routed so that they cannot be caught or snagged by parts being removed or replaced.



IMPORTANT: When servicing this computer, be sure to place cables in their proper location during the reassembly process. Improper cable placement can damage the computer.

Hard drives

Handle hard drives as delicate, precision components, avoiding all physical shock and vibration. This applies to failed drives as well as replacement spares.

- If a drive must be mailed, place the drive in a bubble-pack mailer or other suitable protective packaging and label the package “Fragile: Handle With Care.”
- Do not remove hard drives from the shipping package for storage. Keep hard drives in their protective packaging until they are actually mounted in the computer.
- Avoid dropping drives from any height onto any surface.
- If you are inserting or removing a hard drive, turn off the computer. Do not remove a hard drive while the computer is on or in standby mode.
- Before handling a drive, be sure that you are discharged of static electricity. While handling a drive, avoid touching the connector.
- Do not use excessive force when inserting a drive.
- Avoid exposing a hard drive to liquids, temperature extremes, or products that have magnetic fields such as monitors or speakers.

Lithium coin cell battery

The battery that comes with the computer provides power to the real-time clock and has a minimum lifetime of about three years.

See the appropriate removal and replacement chapter for the chassis you are working on in this guide for instructions on the replacement procedures.

⚠ WARNING! This computer contains a lithium battery. There is a risk of fire and chemical burn if the battery is handled improperly. Do not disassemble, crush, puncture, short external contacts, dispose in water or fire, or expose it to temperatures higher than 140°F (60°C). Do not attempt to recharge the battery.

📄 NOTE: Do not dispose of batteries, battery packs, and accumulators with general household waste. In order to forward them to recycling or proper disposal, please use the public collection system or return them to HP, their authorized partners, or their agents.

SATA hard drives

Table 3-3 SATA hard drive characteristics

Serial ATA hard drive characteristics	
Number of pins/conductors in data cable	7/7
Number of pins in power cable	15
Maximum data cable length	100 cm (39.37 in)
Data interface voltage differential	400 mV to 700 mV
Drive voltages	3.3 V, 5 V, 12 V
Jumpers for configuring drive	N/A
Data transfer rate	6.0 Gbps

SMART ATA drives

The Self Monitoring Analysis and Recording Technology (SMART) ATA drives for the HP Personal Computers have built-in drive failure prediction that warns the user or network administrator of an impending failure or crash of the hard drive. The SMART drive tracks fault prediction and failure indication parameters such as reallocated sector count, spin retry count, and calibration retry count. If the drive determines that a failure is imminent, it generates a fault alert.

SATA hard drive cables

SATA data cable

Always use an HP-approved SATA 6.0 Gbps cable as it is fully backwards compatible with the SATA 1.5 Gbps drives.

Current HP desktop products ship with SATA 6.0 Gbps hard drives.

SATA data cables are susceptible to damage if overflexed. Never crease a SATA data cable and never bend it tighter than a 30 mm (1.18 in) radius.

The SATA data cable is a thin, 7-pin cable designed to transmit data for only a single drive.

Cable management

Always follow good cable management practices when working inside the computer.

- Keep cables away from major heat sources like the heat sink.
- Keep cables clear of sliding or moveable parts to prevent them from being cut or crimped when the parts are moved.
- When folding a flat ribbon cable, never fold to a sharp crease. Sharp creases may damage the wires.
- Do not bend any cable sharply. A sharp bend can break the internal wires.
- Never bend a SATA data cable tighter than a 30 mm (1.18 in) radius.
- Never crease a SATA data cable.

4 Removal and replacement procedures

Adherence to the procedures and precautions described in this chapter is essential for proper service. After completing all necessary removal and replacement procedures, run the Diagnostics utility to verify that all components operate properly.

 **NOTE:** Not all features listed in this guide are available on all computers.

 **NOTE:** HP continually improves and changes product parts. For complete and current information on supported parts for your computer, go to <http://partsurfer.hp.com>, select your country or region, and then follow the on-screen instructions.

Warnings and cautions

Before performing upgrades be sure to carefully read all of the applicable instructions, cautions, and warnings in this guide.

 **WARNING!** To reduce the risk of personal injury from electrical shock, hot surfaces, or fire:

Disconnect the power cord from the AC outlet and allow the internal system components to cool before you touch them.

Do not plug telecommunications or telephone connectors into the network interface controller (NIC) receptacles.

Do not disable the power cord grounding plug. The grounding plug is an important safety feature.

Plug the power cord into a grounded (earthed) AC outlet that is easily accessible at all times.

To reduce the risk of serious injury, read the *Safety & Comfort Guide*. The *Safety & Comfort Guide* also provides important electrical and mechanical safety information. The *Safety & Comfort Guide* is available on the web at <http://www.hp.com/ergo>.

 **WARNING!** Energized and moving parts inside.

Disconnect power to the equipment before removing the enclosure.

Replace and secure the enclosure before re-energizing the equipment.

 **IMPORTANT:** Static electricity can damage the electrical components of the computer or optional equipment. Before beginning these procedures, ensure that you are discharged of static electricity by briefly touching a grounded metal object. See [Electrostatic discharge information on page 13](#) for more information.

When the computer is plugged into an AC power source, voltage is always applied to the system board. To prevent damage to internal components, you must disconnect the power cord from the power source before opening the computer.

 **NOTE:** Your computer model may look slightly different from the illustrations in this chapter.

Preparation for disassembly

See [Routine care, SATA drive guidelines, and disassembly preparation on page 13](#) for initial safety procedures.

1. Remove or disengage any security devices that prohibit opening the computer.
2. Remove all removable media, such as a USB flash drive, from the computer.
3. Turn off the computer properly through the operating system, and then turn off any external devices.
4. Disconnect the power cord from the AC outlet and disconnect any external devices.

 **IMPORTANT:** Regardless of the power state, voltage is always present on the system board as long as the system is plugged into an active AC outlet. To prevent damage to internal components, you must disconnect the power cord from the power source before opening the computer.

5. If the computer is on a stand, remove the computer from the stand.

 **CAUTION:** Beware of sharp edges inside the chassis.

Front bezel dust filter

Some models are equipped with an optional front bezel dust filter. You must periodically clean the dust filter so that the dust collected on the filter does not impede air flow through the computer.

To remove, clean, and replace the dust filter:

1. Prepare the computer for disassembly ([Preparation for disassembly on page 22](#)).
2. To remove the dust filter, use your fingers to separate the filter from the front bezel at the tab locations shown in the following illustration.

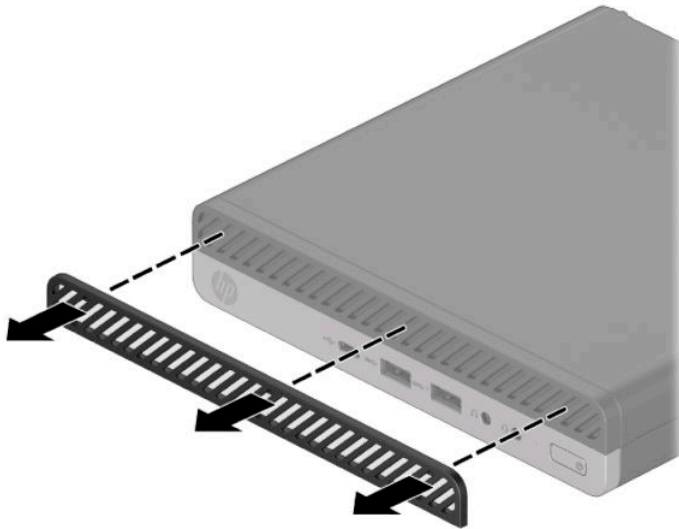

3. Use a soft brush or cloth to clean dust from the filter. If heavily soiled, rinse the filter clean with water.

To install the front bezel dust filter, reverse the removal procedure.

Access panel

To access internal components, you must remove the access panel:

1. Prepare the computer for disassembly ([Preparation for disassembly on page 22](#)).
2. Remove the thumbscrew on the rear of the computer **(1)**, and then slide the panel forward and lift it off the computer **(2)**.

 **NOTE:** If necessary, a Torx T15 or flat-bladed screwdriver can be used to loosen the thumbscrew.

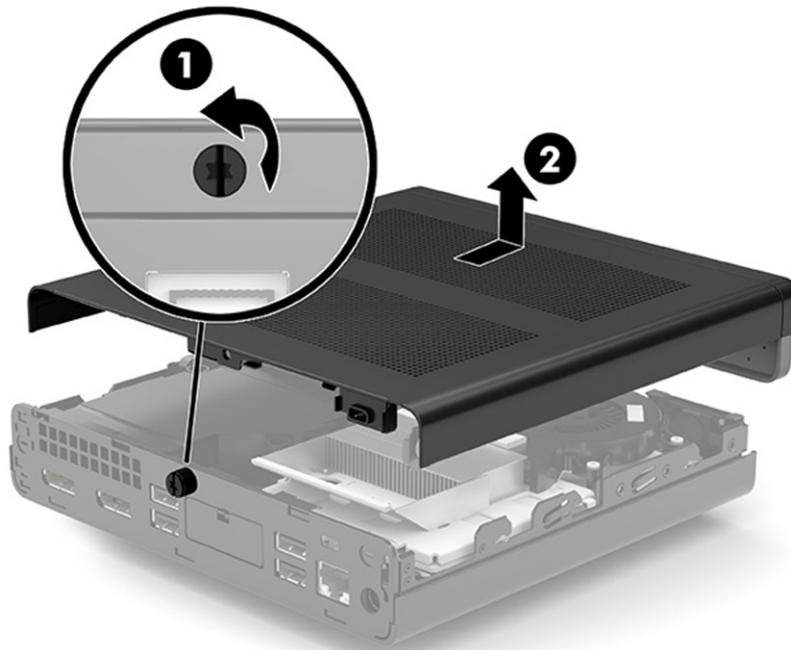

Front bezel

 **NOTE:** It is not necessary to remove the front bezel to access other components.

The front bezel is secured to the top cover by tabs.

1. Prepare the computer for disassembly ([Preparation for disassembly on page 22](#)).
2. Remove the access panel ([Access panel on page 23](#)).
3. Position the top cover upside-down so that you can access the inside of the bezel.
4. Remove the two Phillips screws **(1)** that secure the bezel to the access panel.
5. Simultaneously press the two top tabs (not the four bottom tabs) to disengage the bezel **(2)**.
6. Rotate the top of the bezel downward **(3)**, and then remove it from the access panel **(4)**.

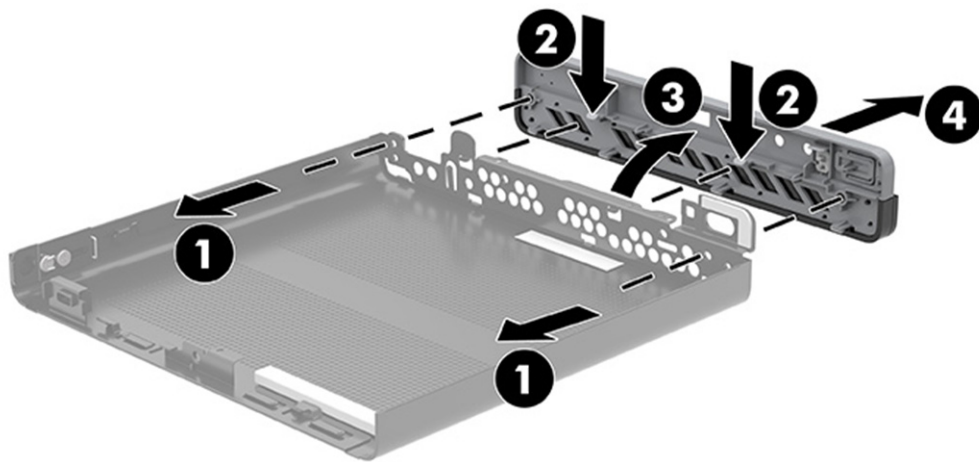

To install the front bezel, reverse the removal procedure.

Hood sensor

The hood sensor is located near the front of the computer.

1. Prepare the computer for disassembly ([Preparation for disassembly on page 22](#)).
2. Remove the access panel ([Access panel on page 23](#)).
3. Lift the rubber cover from the hood sensor **(1)**.
4. Disconnect the cable from the system board, and then lift the hood sensor out of the computer **(2)**.

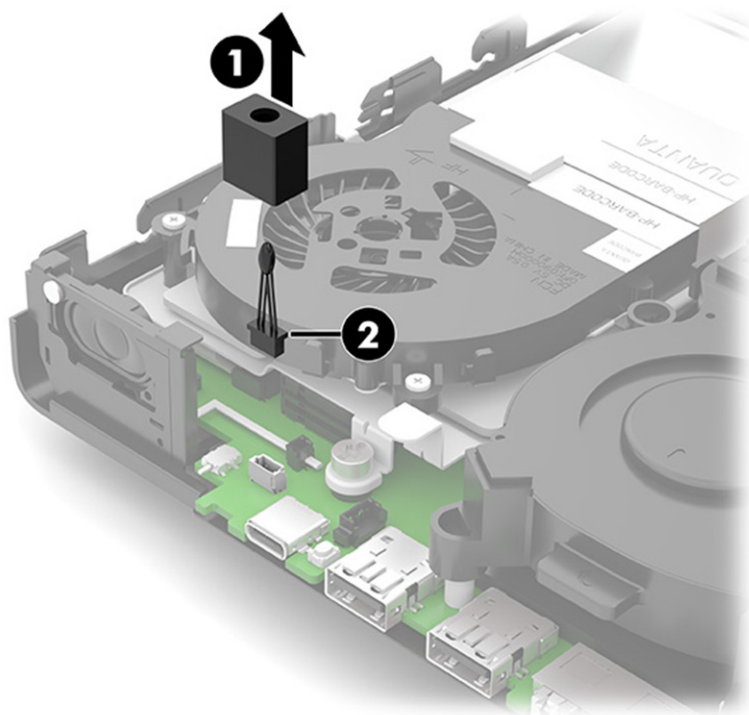

To install the hood sensor, reverse the removal procedure.

Speaker

A single speaker is located on the left side of the computer behind the front bezel, inside the chassis. It is secured by a white peg that you pull out to release.

To remove the speaker:

1. Prepare the computer for disassembly ([Preparation for disassembly on page 22](#)).
2. Remove the access panel ([Access panel on page 23](#)).
3. Disconnect the speaker cable from the system board connector **(1)**.
4. From the front of the computer, remove the peg that secures the speaker to the chassis **(2)**.
5. Remove the insulator and tape from the top and inside of the speaker **(3)**.
6. Lift the speaker straight up and out of the bracket on the inside of the chassis **(4)**.

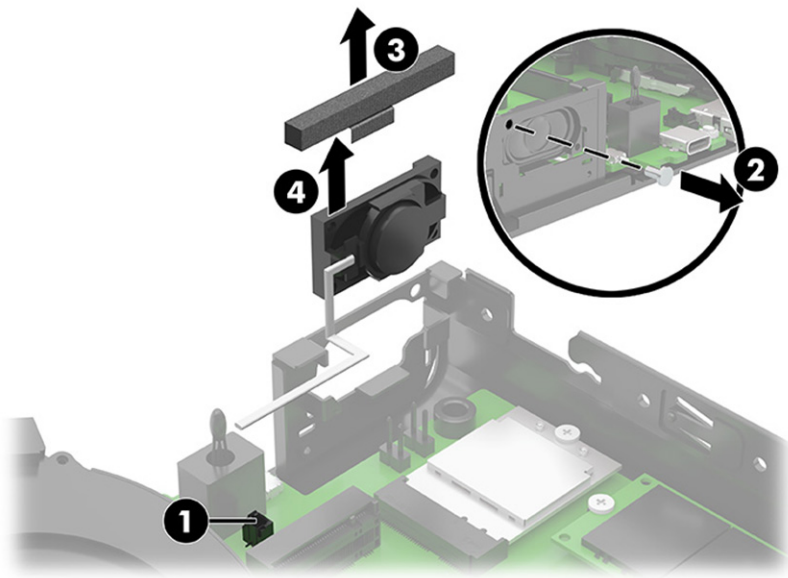

To install the speaker, reverse the removal procedures.

Hard drive

Models with a hard drive and drive cage do not include a separate graphics processor card.

For a list of available hard drives, see [Mass storage devices on page 10](#).

 **NOTE:** Before you remove the old hard drive, be sure to back up the data from the old hard drive so that you can transfer the data to the new hard drive.

1. Prepare the computer for disassembly ([Preparation for disassembly on page 22](#)).
2. Remove the access panel ([Access panel on page 23](#)).
3. Rotate the hard drive latch up **(1)** to disengage the hard drive from the cage. Then slide the drive toward the rear of the chassis until it stops, and then lift the hard drive up and out of the cage **(2)**.

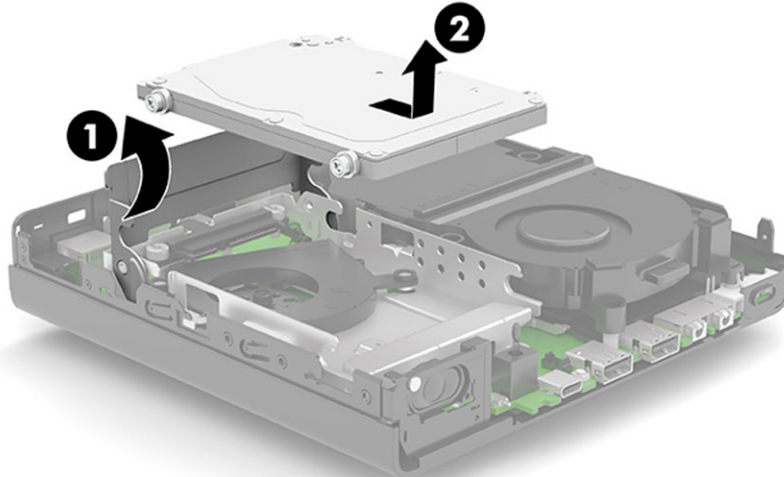

Hard drive connector

The hard drive connector is installed in the hard drive cage and connects to the system board.

1. Prepare the computer for disassembly ([Preparation for disassembly on page 22](#)).
2. Remove the access panel ([Access panel on page 23](#)).
3. Remove the hard drive ([Hard drive on page 27](#)).
4. Lift the connector latch on the system board **(1)**, and then disconnect the hard drive cable using the pull tab on the cable **(2)**.
5. Remove the two Torx T15 screws that secure the connector to the drive cage **(3)**.
6. Lift the hard drive connector out of the computer **(4)**.

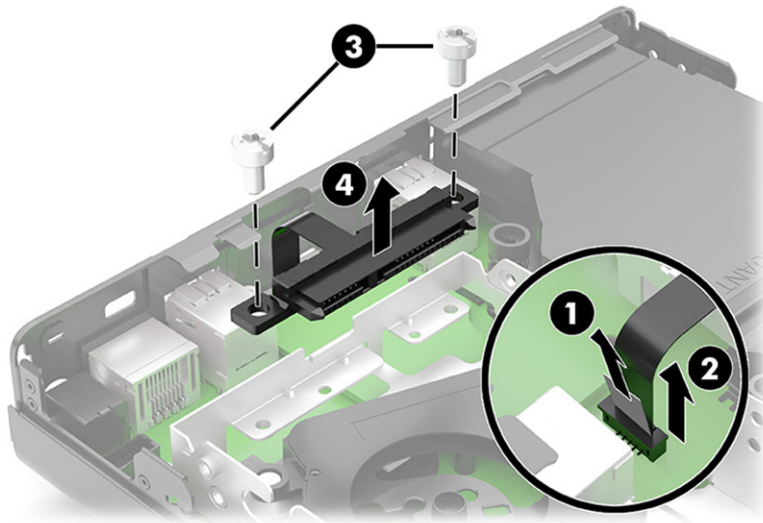

To install the hard drive connector, reverse the removal procedure.

Drive cage

1. Prepare the computer for disassembly ([Preparation for disassembly on page 22](#)).
2. Remove the access panel ([Access panel on page 23](#)).
3. Remove the hard drive ([Hard drive on page 27](#)).
4. Lift the connector latch on the system board **(1)**, and then disconnect the hard drive cable using the pull tab on the cable **(2)**.
5. Remove the two Torx T15 screws **(3)** that secure the hard drive cage to the chassis.
6. Slide the hard drive cage back, and then lift it out of the chassis **(4)**.

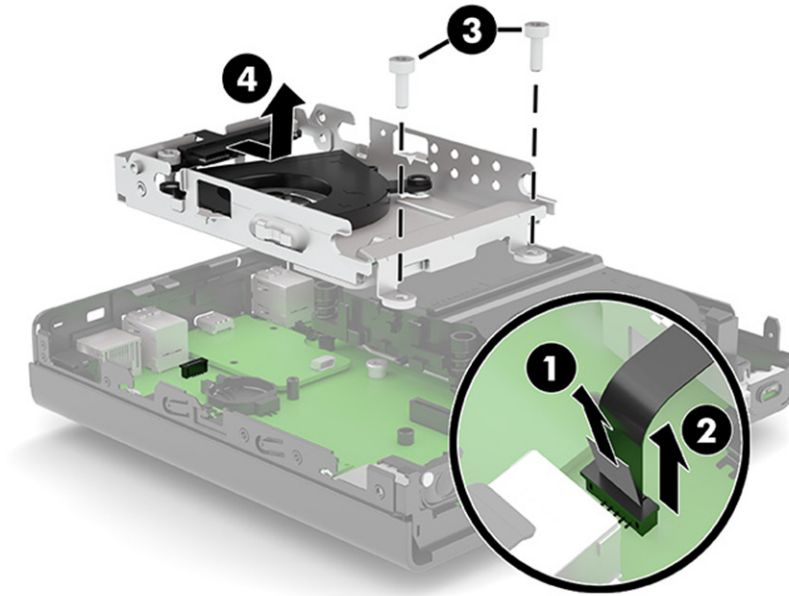

To install the drive cage, reverse the removal procedure.

Graphics processor and heat sink assembly

 **IMPORTANT:** Do not remove the heat sink/fan from the graphics processor. Remove the assembly as an entire unit.

For a list of available graphics processors, see [Computer major components on page 8](#).

1. Prepare the computer for disassembly ([Preparation for disassembly on page 22](#)).
2. Remove the access panel ([Access panel on page 23](#)).
3. Disconnect the fan cable from the system board (**1**).
4. Remove the two screws (**2**) that secure the graphics processor bracket to the chassis, and then lift the graphics processor assembly out of the chassis (**3**).

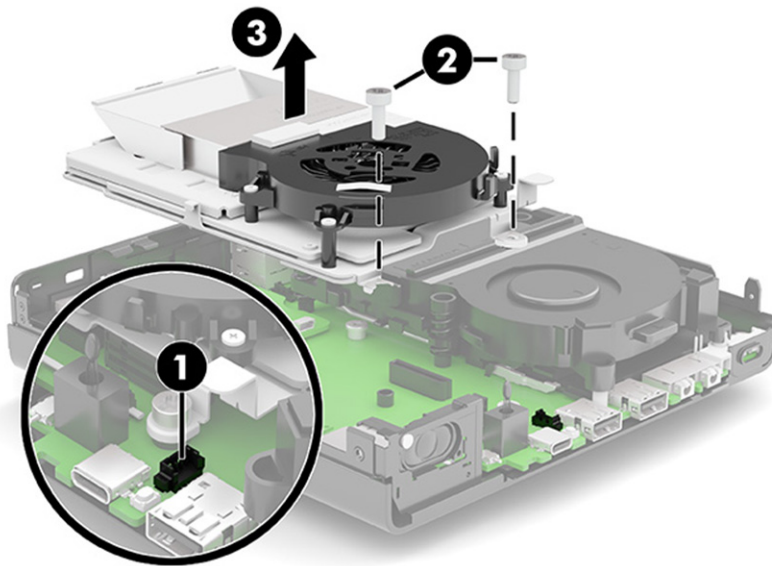

To install the graphic processor and heat sink, reverse the removal procedure.

M.2 PCIe solid state drive (SSD)

For a list of available solid-state drives, see [Mass storage devices on page 10](#).

1. Prepare the computer for disassembly ([Preparation for disassembly on page 22](#)).
2. Remove the access panel ([Access panel on page 23](#)).
3. In models with a hard drive, remove the hard drive ([Hard drive on page 27](#)) and drive cage ([Drive cage on page 29](#)).
4. In models with a discrete graphics processor, remove the graphics processor and heat sink assembly ([Graphics processor and heat sink assembly on page 30](#)).
5. Locate the M.2 solid-state drives on the system board.

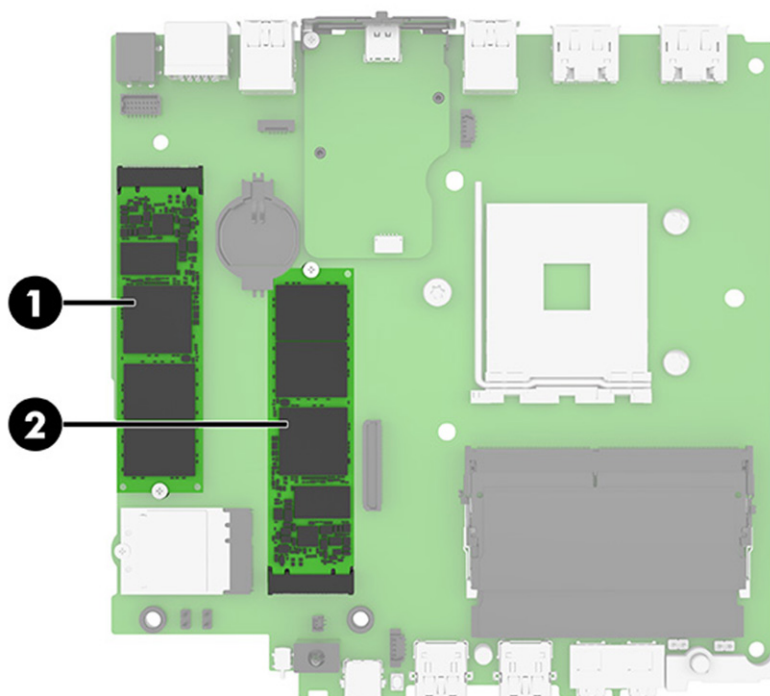

6. Remove the screw **(1)** securing the solid-state drive to the system board, and then pull the drive from the socket on the system board **(2)**.

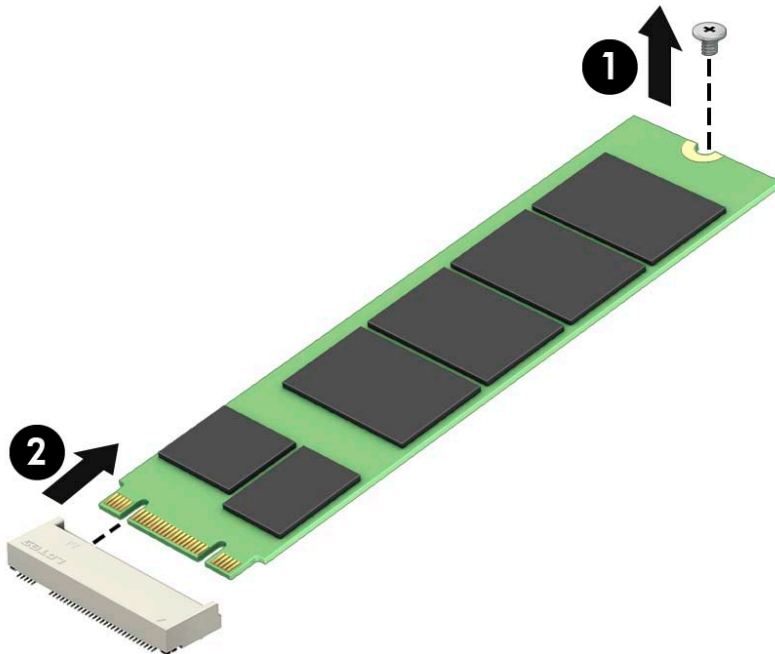

To replace the solid-state drive module, reverse the removal procedures.

WLAN module

For a list of available WLAN modules, see [Computer major components on page 8](#).

1. Prepare the computer for disassembly ([Preparation for disassembly on page 22](#)).
2. Remove the access panel ([Access panel on page 23](#)).
3. In models with a hard drive, remove the hard drive ([Hard drive on page 27](#)) and drive cage ([Drive cage on page 29](#)).
4. In models with a discrete graphics processor, remove the graphics processor and heat sink assembly ([Graphics processor and heat sink assembly on page 30](#)).
5. Locate the WLAN module on the system board.

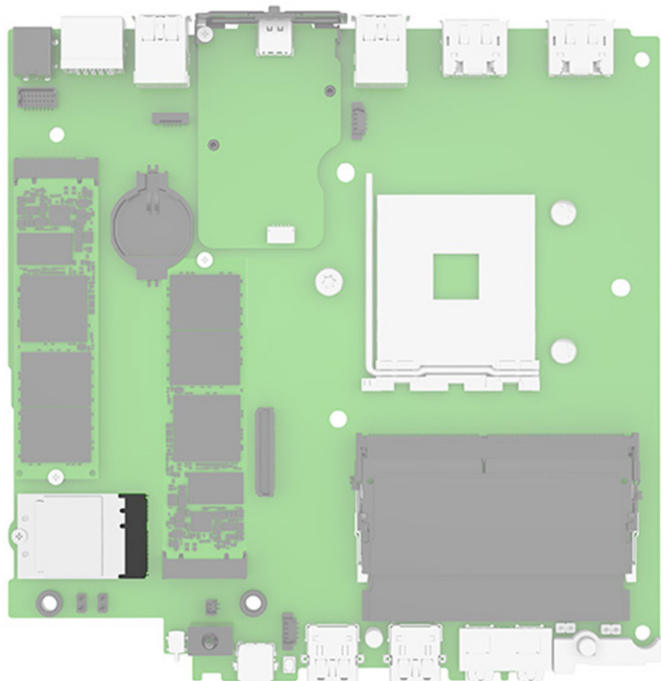

6. Disconnect both antenna cables **(1)** from the WLAN module.

7. Remove the screw **(2)** that secures the WLAN module to the system board, and then grasp the WLAN module by the sides and pull it out of the socket **(3)**.

 **NOTE:** You may need to use a small tool, such as a pair of tweezers or needle-nose pliers, to disconnect and connect the antenna cables.

 **IMPORTANT:** Only disconnect the antenna cables from the WLAN module when necessary, such as when specifically replacing the WLAN module or the antenna cables. Disconnecting the antennas from the module poses the risk that they do not get correctly reconnected. For other components that require removing the WLAN module, such as the system board, remove the module while leaving the antenna cables connected and place the WLAN module off to the side while removing and replacing the components.

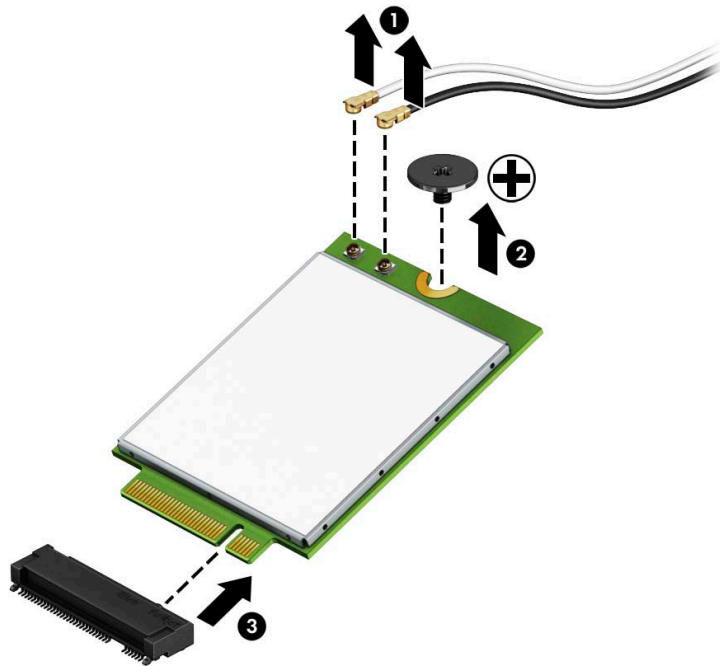

To replace the WLAN module, reverse the removal procedures.

Battery

The battery that comes with the computer provides power to the real-time clock. When replacing the battery, use a battery equivalent to the battery originally installed in the computer. The computer comes with a 3 V lithium coin cell battery.

 **WARNING!** The computer contains an internal lithium manganese dioxide battery. There is a risk of fire and burns if the battery is not handled properly. To reduce the risk of personal injury:

Do not attempt to recharge the battery.

Do not expose to temperatures higher than 60°C (140°F).

Do not disassemble, crush, puncture, short external contacts, or dispose of in fire or water.

Replace the battery only with the HP spare designated for this product.

 **IMPORTANT:** Before replacing the battery, back up the computer CMOS settings. When the battery is removed or replaced, the CMOS settings will be cleared.

Static electricity can damage the electronic components of the computer or optional equipment. Before beginning these procedures, be sure that you are discharged of static electricity by briefly touching a grounded metal object.

 **NOTE:** The lifetime of the lithium battery can be extended by plugging the computer into a live AC wall socket. The lithium battery is only used when the computer is not connected to AC power.

HP encourages customers to recycle used electronic hardware, HP original print cartridges, and rechargeable batteries. For more information about recycling programs, go to <http://www.hp.com/recycle>.

1. Prepare the computer for disassembly ([Preparation for disassembly on page 22](#)).
2. Remove the access panel ([Access panel on page 23](#)).
3. In models with a hard drive, remove the hard drive ([Hard drive on page 27](#)) and drive cage ([Drive cage on page 29](#)).
4. In models with a discrete graphics processor, remove the graphics processor and heat sink assembly ([Graphics processor and heat sink assembly on page 30](#)).

5. Locate the battery and battery holder on the system board.

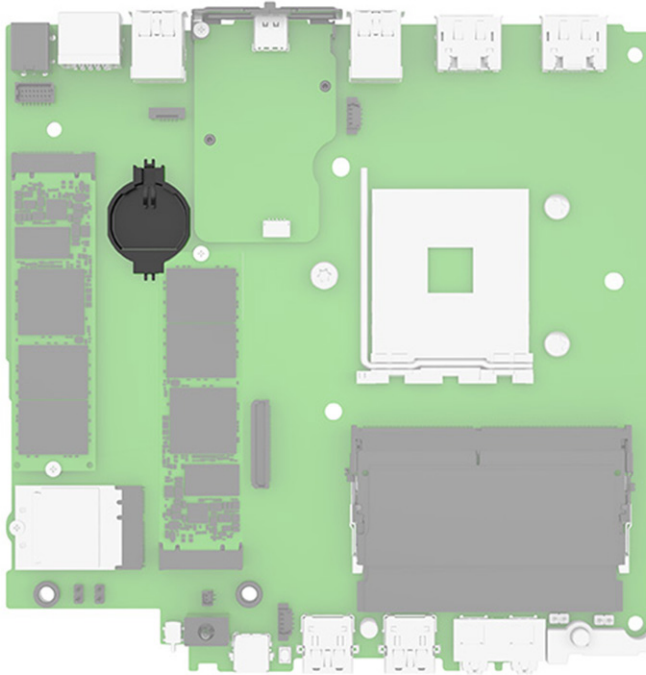

 **NOTE:** You may need to use a small tool, such as tweezers or needle-nose pliers, to remove and replace the battery.

6. Lift the battery out of the holder.

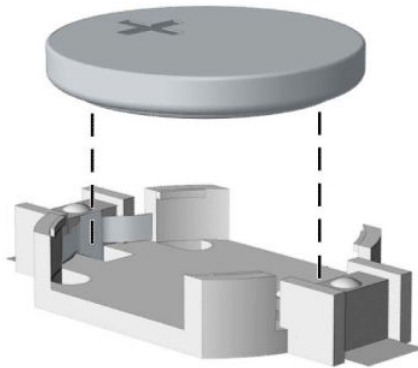

7. Slide the replacement battery into position, positive side up. The battery holder automatically secures the battery in the proper position.
8. Reassemble the computer.
9. Reset the date and time, your passwords, and any special system setups using Computer Setup.

Expansion connector board

For a list of available expansion connector boards, see [Computer major components on page 8](#).

An expansion board can be installed near the back of the system board that provides an additional connector on the rear I/O panel. The board is secured with two screws and connects to the a connector on the system board.

To remove the expansion connector board:

1. Prepare the computer for disassembly ([Preparation for disassembly on page 22](#)).
2. Remove the access panel ([Access panel on page 23](#)).
3. In models with a hard drive, remove the hard drive ([Hard drive on page 27](#)) and drive cage ([Drive cage on page 29](#)).
4. In models with a discrete graphics processor, remove the graphics processor and heat sink assembly ([Graphics processor and heat sink assembly on page 30](#)).
5. Remove the two Phillips screws **(1)** that secure the board to the system board.
6. Lift to disengage the board from the system board connector, and then remove the expansion connector board from the computer **(2)**.

 **NOTE:** Expansion connector board appearance may vary.

If a cable connects from the expansion connector board to the system board, disconnect the cable from the system board.

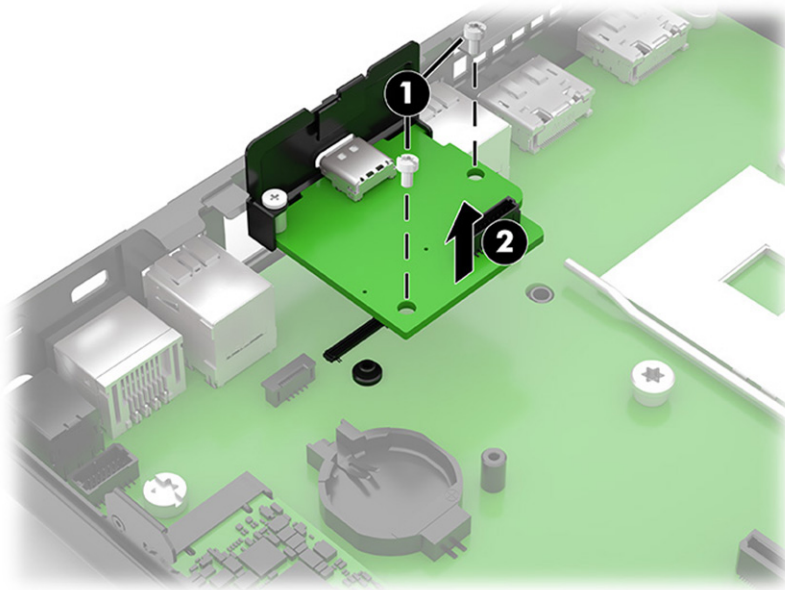

To install the expansion connector board, reverse the removal procedures.

Memory modules

The computer comes with at least one small outline, dual in-line memory module (SODIMM). To achieve maximum memory support, you can populate the system board with up to 32 GB of memory.

Memory module specifications

For proper system operation, the memory modules must meet the following qualifications:

Component	Specification
Memory modules	1.2 volt DDR4-SDRAM memory modules
Compliance	unbuffered non-ECC PC4-21300 DDR4-2666 MHz-compliant
Pins	industry-standard 260-pin containing the mandatory Joint Electronic Device Engineering Council (JEDEC) specification
Support	support CAS latency 17 DDR4 2400 MHz (17-17-17 timing)
Slots	2
Maximum memory	64
Supported	2 Gbit, 4 Gbit, 8 Gbit, and 16 Gbit non-ECC memory technologies single-sided and double-sided memory modules
Note	The system will not operate properly if you install unsupported memory modules. Memory modules constructed with ×8 and ×16 DDR devices are supported; memory modules constructed with ×4 SDRAM are not supported.

HP offers upgrade memory for this computer and advises that the consumer purchase it to avoid compatibility issues with unsupported third-party memory.

Removing memory modules

For a list of available memory modules, see [Computer major components on page 8](#).

There are two memory module slots on the system board, with one slot per channel. The slots are labeled DIMM1 and DIMM3. The DIMM1 slot operates in memory channel B. The DIMM3 slot operates in memory channel A.

Item	Description	System board label	Slot color
1	Memory module slot, Channel A	DIMM3	Black
2	Memory module slot, Channel B	DIMM1	Black

The system automatically operates in single-channel mode, dual-channel mode, or flex mode, depending on how the memory modules are installed.

- The system operates in single-channel mode if the memory module slots are populated in one channel only.
- The system operates in a higher-performing dual channel mode if the memory capacity of the memory module in Channel A is equal to the memory capacity of the memory module in Channel B.

- The system operates in flex mode if the memory capacity of the memory module in Channel A is not equal to the memory capacity of the memory module in Channel B. In flex mode, the channel populated with the least amount of memory describes the total amount of memory assigned to dual channel and the remainder is assigned to single channel. If one channel has more memory than the other, assign the larger amount to channel A.
- In any mode, the maximum operational speed is determined by the slowest memory module in the system.

 **IMPORTANT:** You must disconnect the power cord and wait approximately 30 seconds for the power to drain before adding or removing memory modules. Regardless of the power state, voltage is always supplied to the memory modules as long as the computer is plugged into an active AC outlet. Adding or removing memory modules while voltage is present may cause irreparable damage to the memory modules or system board.

The memory module slots have gold-plated metal contacts. When upgrading the memory, use memory modules with gold-plated metal contacts to prevent corrosion, oxidation, or both, resulting from having incompatible metals in contact with each other.

Static electricity can damage the electronic components of the computer or optional cards. Before beginning these procedures, ensure that you are discharged of static electricity by briefly touching a grounded metal object. For more information, see [Electrostatic discharge information on page 13](#).

When handling a memory module, be careful not to touch any of the contacts. Doing so may damage the module.

1. Prepare the computer for disassembly ([Preparation for disassembly on page 22](#)).
2. Remove the access panel ([Access panel on page 23](#)).
3. Tilt the fan up using the front tab and leave it in the up position.

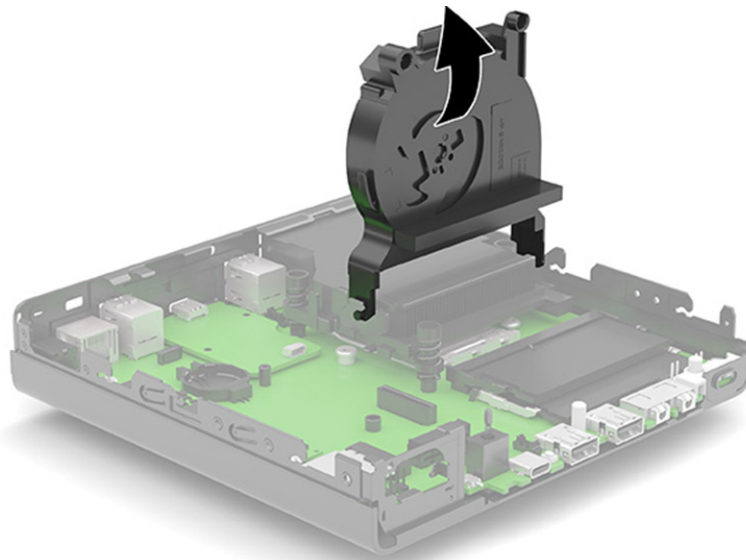

4. Locate the memory modules **(1)** and **(2)** on the system board.

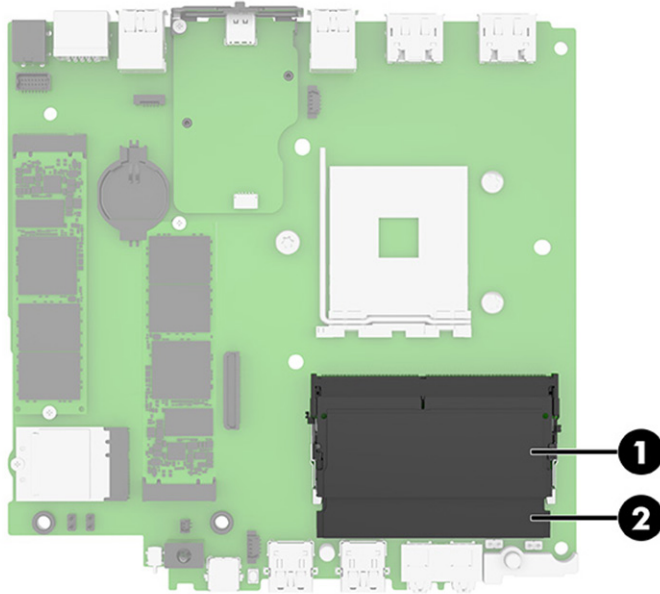

5. To remove a memory module, press outward on the two latches on each side of the memory module **(1)**, and then pull the memory module **(2)** out of the slot.

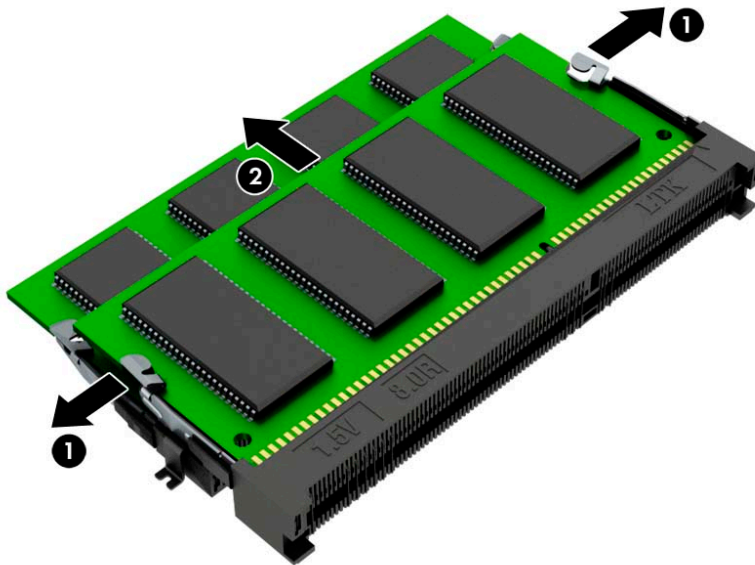

The computer automatically recognizes the new memory when you turn on the computer.

Fan

1. Prepare the computer for disassembly ([Preparation for disassembly on page 22](#)).
2. Remove the access panel ([Access panel on page 23](#)).
3. Disconnect the fan cable from the system board **(1)**.
4. Remove the fan cable from the clips on the side of the heat sink **(2)**.
5. Lift fan up to an approximate 45° angle **(3)**, and then pull it away from the heat sink **(4)**.

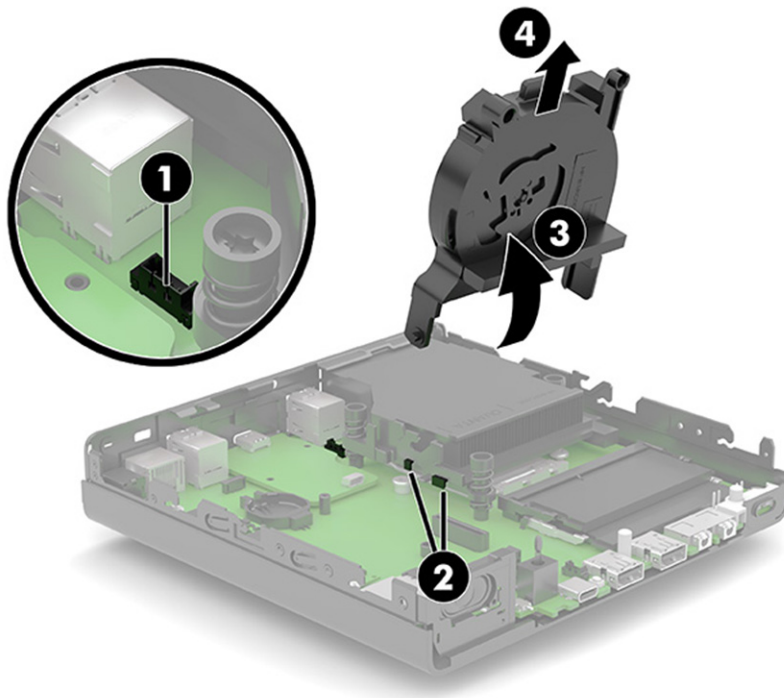

To install the fan, reverse the removal procedure.

Heat sink

 **IMPORTANT:** The bond between the heat sink and the processor may be very tight.

If the computer can start, before removing the heat sink, turn on the computer until it warms the heat sink. Warming the fan sink lessens the bond between the heat sink and the processor, thereby making separating them easier.

Be sure not to pull the processor out of the socket when you lift the heat sink, especially if you cannot warm the heat sink before removal. Inadvertently removing the processor can damage the pins.

The heat sink is secured with four captive Torx screws.

1. Prepare the computer for disassembly ([Preparation for disassembly on page 22](#)).
2. Remove the access panel ([Access panel on page 23](#)).
3. Remove the fan ([Fan on page 41](#)).
4. In the order indicated on the heat sink, loosen the three captive Torx screws **(1)** that secure the heat sink to the computer.
5. Lift the back of the heat sink **(2)**, and then pull heat sink toward front to the chassis to remove it **(3)**.

 **IMPORTANT:** Be sure the loosen the screws in the order indicated by the numbers stamped on the heat sink to avoid damaging the processor.

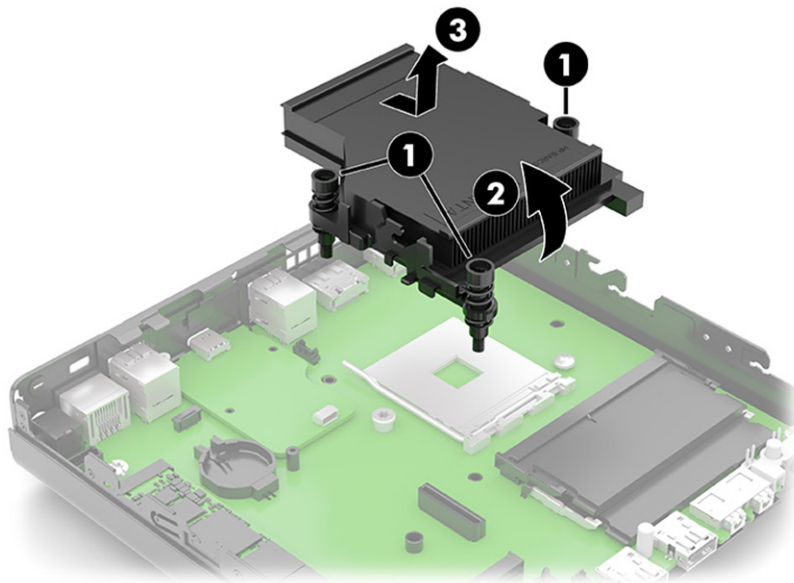

To replace the heat sink, reverse the removal procedures.

When replacing the heat sink, be sure to install thermal grease on the bottom of the heat sink.

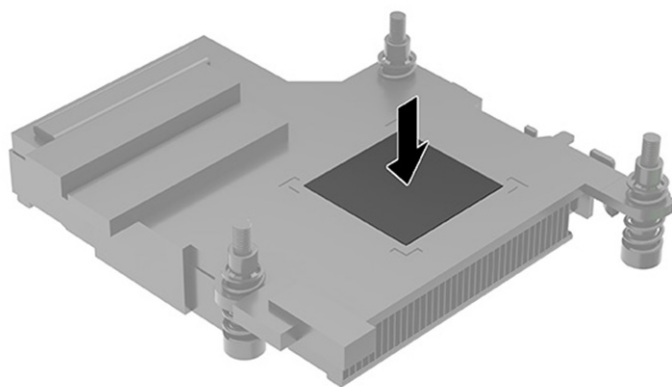

Processor

For a list of available processors, see [Computer major components on page 8](#).

1. Prepare the computer for disassembly ([Preparation for disassembly on page 22](#)).
2. Remove the access panel ([Access panel on page 23](#)).
3. Remove the fan ([Fan on page 41](#)).
4. Remove the heat sink ([Heat sink on page 42](#)).
5. Unlatch the locking lever from the side of the processor socket (**1**).
6. Rotate the locking lever to its fully open position (**2**).
7. Lift the processor straight up to remove it (**3**).

 **IMPORTANT:** Do NOT handle the pins in the processor socket. These pins are very fragile and handling them could cause irreparable damage. If pins are damaged it may be necessary to replace the system board.

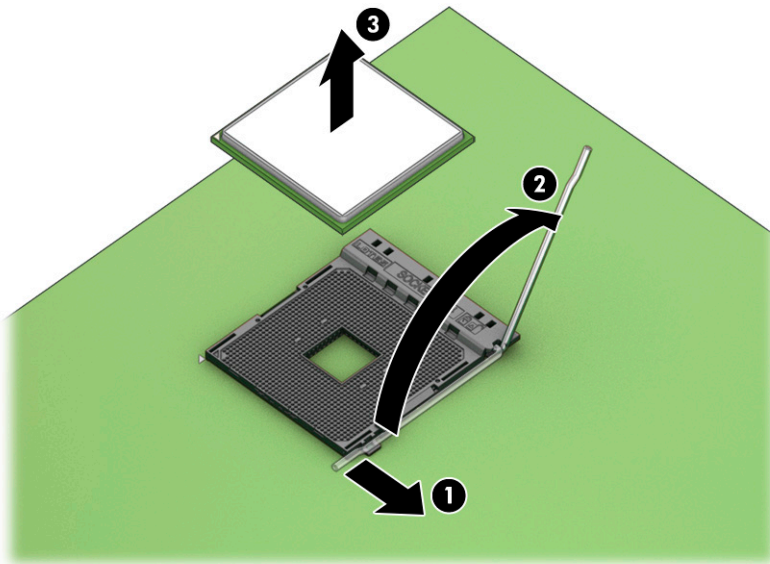

Reverse the removal procedure to install a new processor.

 **NOTE:** After installing a new processor onto the system board, update the system ROM to ensure that the latest version of the BIOS is being used on the computer. You can find the latest system BIOS at: <https://support.hp.com/us-en/drivers>.

System board

 **NOTE:** All system board spare part kits include replacement thermal material.

1. Prepare the computer for disassembly ([Preparation for disassembly on page 22](#)).
2. Remove the access panel ([Access panel on page 23](#)).
3. In models with a hard drive, remove the hard drive ([Hard drive on page 27](#)) and drive cage ([Drive cage on page 29](#)).
4. In models with a discrete graphics processor, remove the graphics processor and heat sink assembly ([Graphics processor and heat sink assembly on page 30](#)).
5. Remove the fan ([Fan on page 41](#)).
6. Remove the heat sink ([Heat sink on page 42](#)).
7. When replacing the system board, remove the following components from the defective system board and install them on the replacement system board (as applicable):
 - Memory modules ([Memory modules on page 38](#))
 - M.2 solid-state drive ([M.2 PCIe solid state drive \(SSD\) on page 31](#))
 - Processor ([Processor on page 44](#))
 - WLAN module ([WLAN module on page 33](#))
 - Expansion connector board ([Expansion connector board on page 37](#))
8. To remove the system board:
 - a. **On models with a hard drive**, disconnect the speaker cable from the system board (**1**), and then remove the three Torx T15 screws (**2**) that secure the system board to the computer.

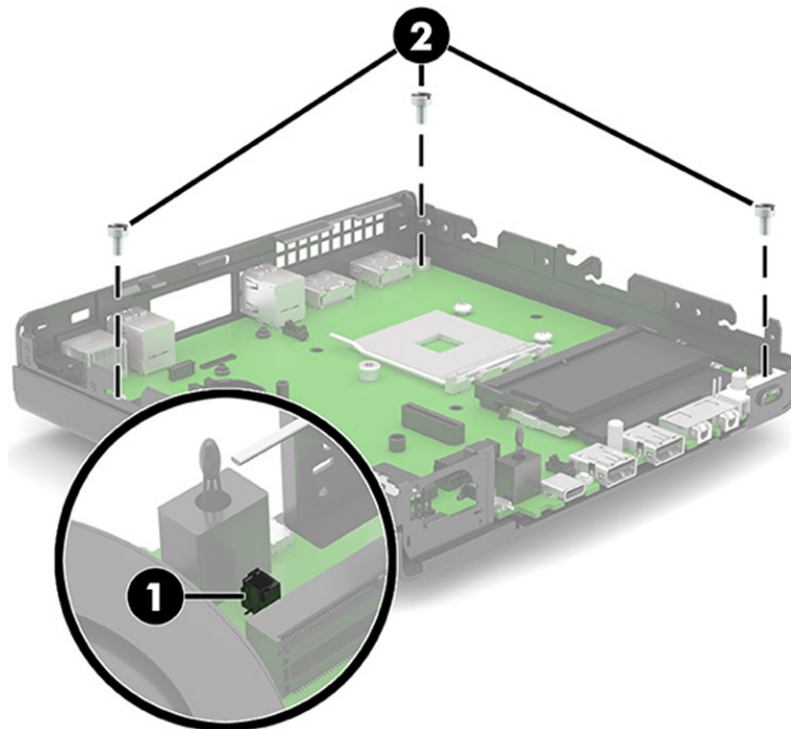

- b. **On models without a hard drive**, disconnect the speaker cable from the system board (1), and then remove the five Torx T15 screws (2) that secure the system board to the computer.

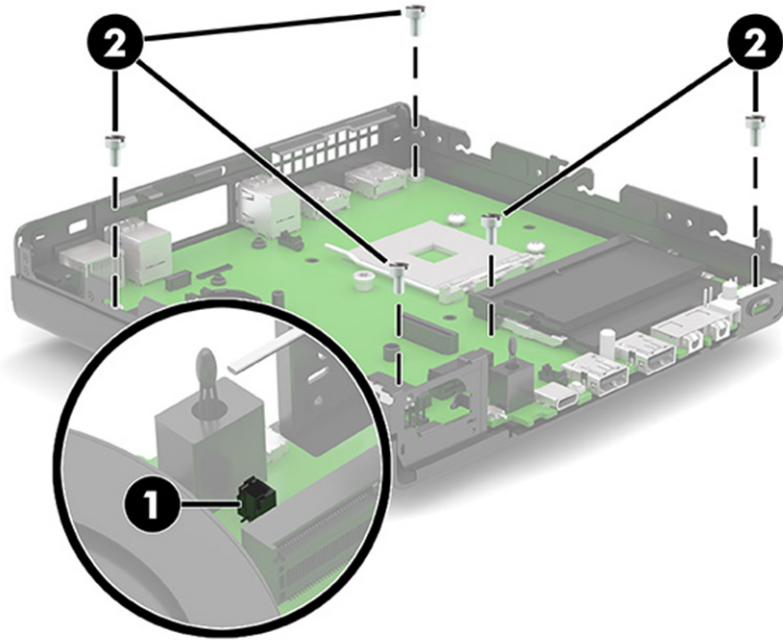

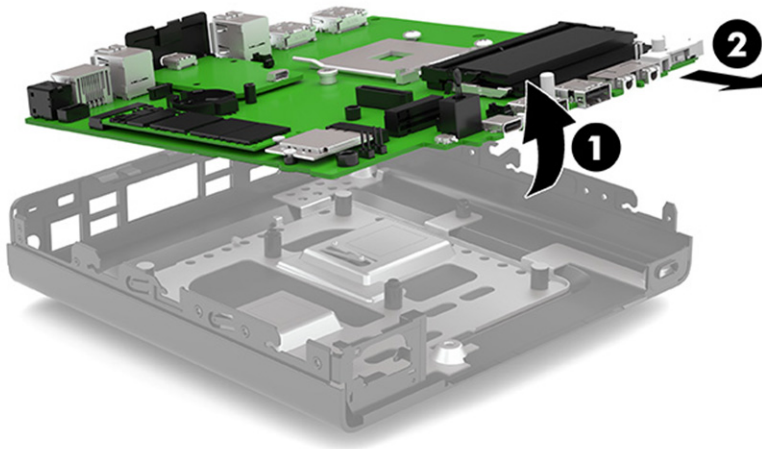

9. Lift the front of the system board (1), and then pull it out of the computer (2).

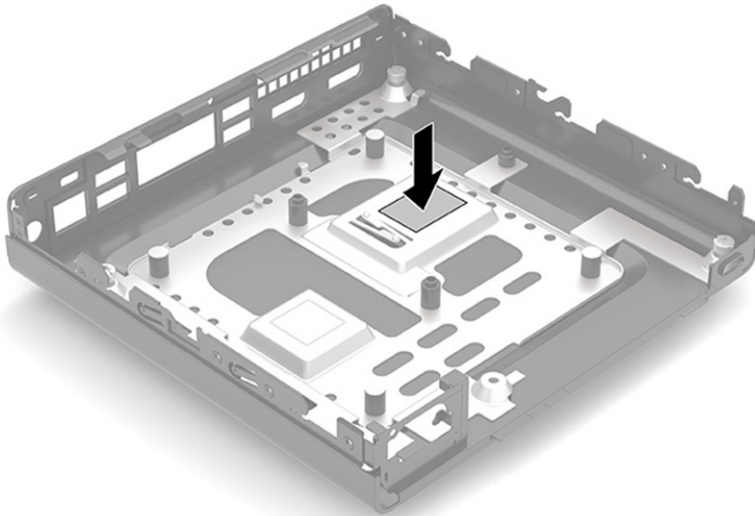

To install the system board, reverse the removal procedures.

When installing a system board be sure to install a thermal pad to service the system board graphics processor at the location on the chassis as shown in the following image.



 **NOTE:** When replacing the system board, you must change the chassis serial number in the BIOS.

System ID Setup Page

Setup Field Name	Comment	Label
Product Name	Enter the model name/number or marketing name.	Flexbuild
Serial Number	Enter the serial number of unit.	Support
SKU Number	Enter the SKU or product number including localization code.	Support
Asset Tag	Enter the 18-byte identifier assigned to the computer.	Support
Feature Byte	<p>Enter the feature byte string. The feature byte string is case sensitive.</p> <p>The label includes spaces after every four characters. You can enter or ignore these spaces – their only purpose is to help with data entry. There is a character limitation of 40 bytes per line. When you reach this limit, go</p> <p>If you make an error during data entry, the data will not validate, and the computer asks you to correct your data input.</p>	Flexbuild
Build ID	The build ID of the unit.	Flexbuild

System board components

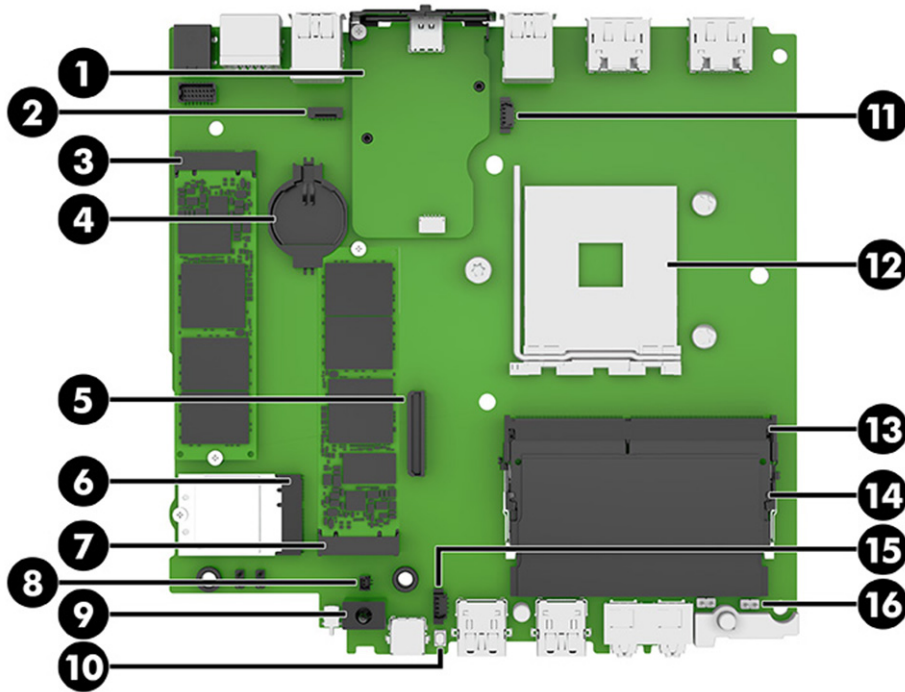

Callout	Sys Bd Label	Component	Callout	Sys Bd Label	Component
(1)	COMM_DP	Expansion board connector	(9)	HSENSE	Hood sensor
(2)	SATA	Hard drive	(10)	CMOS	CMOS reset button
(3)	SSD	Solid-state module	(11)	CPU FAN	Fan
(4)	BAT	RTC battery	(12)	CPU	Processor
(5)	MXM	Graphics card	(13)	DIMM3	Secondary memory
(6)	WLAN	WLAN module	(14)	DIMM1	Primary memory
(7)	SSD	Solid-state module	(15)	HDDFAN	Hard drive fan
(8)	SPKR	Speaker	(16)	PSWD	Password header and jumper

Internal WLAN antenna cables

The antennas route from the WLAN module to the cable connectors on the front and the rear of the computer.

To install the antennas:

1. Prepare the computer for disassembly ([Preparation for disassembly on page 22](#)).
2. Remove the access panel ([Access panel on page 23](#)).
3. Remove the hard drive ([Hard drive on page 27](#)).
4. Remove the drive cage ([Drive cage on page 29](#)).
5. Remove the fan ([Fan on page 41](#)).
6. Remove the heat sink ([Heat sink on page 42](#)).
7. If applicable, remove the expansion connector board ([Expansion connector board on page 37](#)).
8. Disconnect the antenna cables from the WLAN module ([WLAN module on page 33](#)).
9. Remove the system board ([System board on page 45](#)).
10. Remove the antenna cables from their routing paths along the interior sides of the computer chassis **(1)**.
11. On the rear of the computer, remove the antenna cover by pressing on the tab on the top of the cover **(2)**, and then rotating the top of the cover downward and off the computer **(3)**.



NOTE: One end of the antenna cover is slightly longer than the other, so be sure to correctly orientate the cover when replacing.

12. Pull the antenna off the chassis, and then pull the cable out of the computer **(4)**.

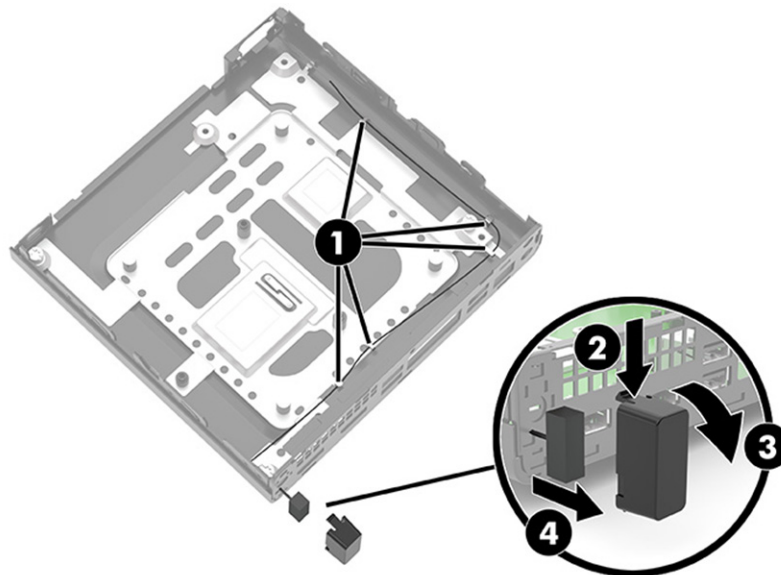

13. If the computer has dual antennas, from the front of the computer, remove the antenna cables from the clips in the chassis **(1)**.
14. Remove the Phillips screw **(2)** that secures the antenna to the chassis.

15. Rotate and remove the antenna **(3)**, and then pull the cable out of the front of the chassis **(4)**.

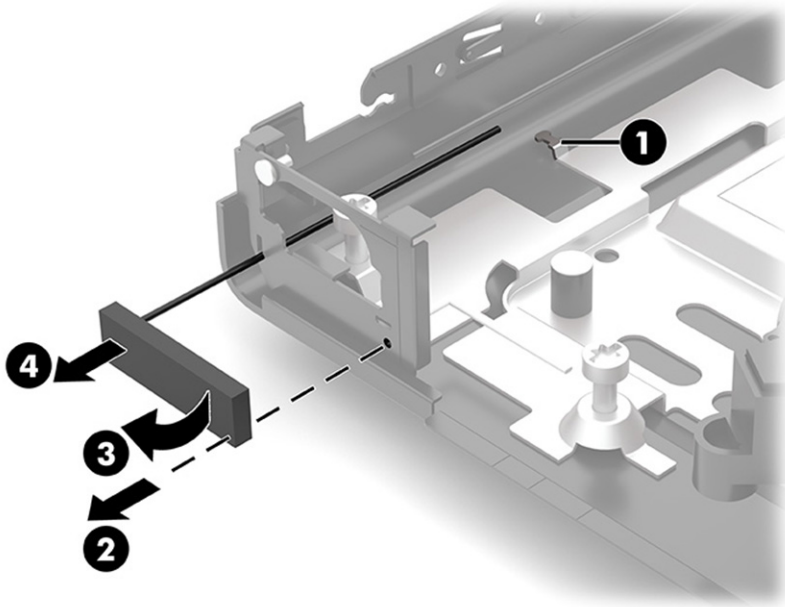

Reverse the removal procedure to install the WLAN antennas and cables.

5 Computer Setup (F10) Utility

Computer Setup (F10) Utilities

Use Computer Setup (F10) Utility to do the following:

- Change settings from the defaults or restore the settings to default values.
- View the system configuration, including settings for processor, graphics, memory, audio, storage, communications, and input devices.
- Modify the boot order of bootable devices such as hard drives, optical drives, or USB flash media devices.
- Enter the Asset Tag or property identification number assigned by the company to this computer.
- Enable the power-on password prompt during system restarts (warm boots) as well as during power-on.
- Establish an administrator password that controls access to the Computer Setup (F10) Utility and the settings described in this section.
- Establish minimum requirements for valid passwords, including length and required types of characters.
- Secure integrated I/O functionality, including the serial, USB, or audio, or embedded NIC, so that they cannot be used until they are unsecured.
- Enable or disable different types of boot sources.
- Configure features such as Secure Boot, power management, virtualization support, and language and keyboard type used in Setup and POST.
- Replicate the system setup by saving system configuration information on a USB device and restoring it on one or more computers.
- Enable or disable DriveLock security or securely erase a hard drive (when supported by drive).

Using Computer Setup (F10) Utilities

Computer Setup can be accessed only by turning the computer on or restarting the system. To access the Computer Setup Utilities menu, complete the following steps:

1. Turn on or restart the computer.
2. Repeatedly press **f10** when the monitor light turns green to access the utility.

You can also press **esc** to a menu that allows you to access different options available at startup, including the Computer Setup utility.

 **NOTE:** If you do not press **f10** at the appropriate time, you must restart the computer and again repeatedly press **f10** when the monitor light turns green to access the utility.

A choice of four headings appears in the Computer Setup Utilities menu: Main, Security, Advanced, and UEFI Drivers.

 **NOTE:** Selecting UEFI Drivers restarts the computer into the third-party option ROM management application. You can access this application directly by pressing **f3** during startup.

3. Use the arrow (left and right) keys to select the appropriate heading. Use the arrow (up and down) keys to select the option you want, and then press **enter**. To return to the Computer Setup Utilities menu, press **esc**.
4. To apply and save changes, select **Main > Save Changes and Exit**.
 - If you have made changes that you do not want applied, select **Ignore Changes and Exit**.
 - To restore settings from the Advanced and Main menus to original values, select **Apply Factory Defaults and Exit**.
 - To restore settings from the Advanced and Main menus to those previously saved by **Save Custom Defaults**, select **Apply Custom Defaults and Exit**. If no custom defaults have been saved, then factory defaults are used.

 **NOTE:** Settings in the **Security** menu are not modified by **Apply Defaults**. Those values are reset by **Restore Security Settings to Factory Defaults** at the bottom of the **Security** menu.

 **NOTE:** Not all settings shown in the following sections are available for all models.

 **IMPORTANT:** Do not turn the computer power off while the BIOS is saving the Computer Setup (F10) changes because the settings could become corrupted. It is safe to turn off the computer only after exiting the F10 Setup screen.

Computer Setup—Main



NOTE: Support for specific Computer Setup options can vary depending on the hardware configuration.

Table 5-1 Computer Setup—Main

Option	Description
System Information	<p>Lists all information in following list if Advanced System Information is selected. Lists smaller subset if Basic System Information is selected.</p> <ul style="list-style-type: none">• Product name• Installed memory size• Processor<ul style="list-style-type: none">Processor type• Processor cache size (L1/L2/L3)• Processor speed• Processor cores• MicroCode revision• Processor stepping• Memory speed• DIMM size (for each installed module)• Firmware<ul style="list-style-type: none">System BIOS version• Video BIOS version• Reference code revision• Super I/O firmware version• USB Type-C controller(s) firmware version• Service<ul style="list-style-type: none">Born on date• Serial number• SKU number• UUID (Universally Unique Identifier)• Asset tracking number• Feature byte• Build ID• Product family• System board ID• System board CT number• Communication<ul style="list-style-type: none">Integrated MAC Address

Table 5-1 Computer Setup—Main (continued)

Option	Description
System Diagnostics	<p>If the hard drive has HP PC Hardware Diagnostics installed, the application will launch. If HP PC Hardware Diagnostics is not installed, then a basic version built into the BIOS provides the capability to perform the following functions:</p> <ul style="list-style-type: none">• Provide detailed system information• Hardware subsystem tests• Component tests• Show test logs• Language selection
BIOS Event Log	<p>View BIOS Event Log</p> <p>Lists events with date and time.</p> <p>Export to USB key</p> <p>Be sure a USB key is installed before making this selection.</p> <p>Clear BIOS Event Log on Next Boot</p> <p>Select to clear the event log.</p>
Update System BIOS	<p>Lets you update the system BIOS from www.hp.com or another network server, from a removable USB drive, or from a file located on the hard drive.</p> <p>Displays current BIOS version information.</p> <ul style="list-style-type: none">• Check HP.com for BIOS Updates <p>The string that appears here depends on the setting in BIOS Update Preferences. This selection checks for the latest BIOS release revision on the network and lets you choose whether to download the BIOS image and update the computer.</p> <p>NOTE: If MS Windows BitLocker Drive Encryption (BDE) is enabled, you must suspend BDE temporarily before flashed. Be sure to obtain the BDE recovery password or recovery PIN before suspending BDE. You can enable BDE after updating the BIOS.</p> <ul style="list-style-type: none">• Lock BIOS Version <p>Prevents updates to BIOS.</p> <ul style="list-style-type: none">• Native OS Firmware Update Service• BIOS Rollback Policy <p>Lets you select whether a minimum BIOS version can be allocated. If Restricted rollback to older BIOS is selected, Minimum BIOS version becomes active. Select to enter the minimum BIOS version that can be rolled back to.</p> <ul style="list-style-type: none">■ Unrestricted rollback to older BIOS■ Restricted rollback to older BIOS• Allow BIOS updates using a network• BIOS Update Preferences <p>Allows the administrator to select the source of network updates (www.hp.com or another network server) and allows configuration of a periodic check for updates, including policies for:</p> <ul style="list-style-type: none">■ Check for updates and prompt the user to accept or reject the update at that time■ Check for updates and install all new versions■ Check for updates and install only new versions marked important

Table 5-1 Computer Setup—Main (continued)

Option	Description
	<ul style="list-style-type: none"> • Network Configuration Settings • Update System and Supported Device Firmware Using Local Media
Change Date and Time	Allows you to set system time and date.
Set Machine Unique Data	Lets you update the following values: <ul style="list-style-type: none"> • Feature Byte • Build ID • Serial Number • SKU Number • Product Family • System Board CT Number • Product Name
System IDs	Lets you set the following values: <ul style="list-style-type: none"> • Asset Tracking Number • Ownership Tag
Replicated Setup	<p>Backup current settings to USB device</p> <p>Saves system configuration to a formatted USB flash media device.</p> <p>Restore current settings from USB device</p> <p>Restores system configuration from a USB flash media device.</p>
Save Custom Defaults	Saves the current system configuration settings as the custom default set.
Apply Custom Defaults and Exit	Applies the custom default settings to the computer after rebooting. Does not apply to options in the Security menu.
Apply Factory Defaults and Exit	Restores the factory system configuration settings to the computer after rebooting. Does not apply to options in the Security menu.
Ignore Changes and Exit	Exits Computer Setup without applying or saving any changes.
Save Changes and Exit	Saves changes to current system configuration, exits Computer Setup, and reboots.
Suppress POST errors	Causes error messages not to display during Power-On Self Test.

Computer Setup—Security



NOTE: Support for specific Computer Setup options can vary depending on the hardware configuration.

Table 5-2 Computer Setup—Security

Option	Description
Create BIOS Administrator Password	Lets you set and enable a BIOS administrator password, which controls access to the following features: <ul style="list-style-type: none"> • Setup Menu (F10) • 3rd Party Option ROM Management (F3) • Update system ROM

Table 5-2 Computer Setup—Security (continued)

Option	Description
	<ul style="list-style-type: none"> • WMI commands that change system settings • BIOS Configuration Utility (BCU) • Alternative power-on password <p>NOTE: Creating a BIOS user disables the Fast Boot option.</p> <p>NOTE: If the password is set, it is required to change Computer Setup options, update the BIOS, and make changes to certain plug and play settings under Windows.</p>
Change BIOS Administrator Password	<p>Lets you change the BIOS administrator password.</p> <p>You must know the current password to be able to change it.</p>
Create POST Power-On Password	<p>Lets you set and enable a POST power-on password. The power-on password prompt appears after a power cycle or reboot. If the user does not enter the correct power-on password, the unit will not boot.</p> <p>NOTE: The administrator password might be used at the power-on password prompt.</p>
Change POST Power-On Password (This selection is active only if a POST Power-on password is set.)	<p>Lets you change the POST power-on password.</p> <p>You must know the current password to be able to change it.</p>
Password Policies	<p>Let you set the guidelines for a valid password. Options include:</p> <ul style="list-style-type: none"> • Password minimum length • Requires at least one symbol • Requires at least one number • Requires at least one upper case character • Requires at least one lower case character • Allow spaces <p>Clear Password Jumper</p> <p>Select Honor to allow or Ignore to not allow the absence of the password jumper to clear the passwords at boot up. Default is Honor.</p>
Administrator Authentication Policies	<p>Select to require Administrator authentication for various commands during boot, including F9 (Boot Menu), F11 (System Recovery), F12 (Network Boot), capsule update, and power-on.</p>
Security Configuration	<p>TPM Embedded Security</p> <ul style="list-style-type: none"> • TPM Specification Version Displays the current TPM version. • TPM Device Lets you set the Trusted Platform Module as available or hidden. • TPM State Select to enable the TPM. • ClearTPM Select to reset the TPM to an unowned state. After the TPM is cleared, it is also turned off. To temporarily suspend TPM operations, turn the TPM off instead of clearing it.

Table 5-2 Computer Setup—Security (continued)

Option	Description
	<p>IMPORTANT: Clearing the TPM resets it to factory defaults and turns it off. You will lose all created keys and data protected by those keys.</p> <ul style="list-style-type: none"> • TPM Activation Policy Select policy as f1 to boot, allow user to reject, or no prompts. <p>BIOS Sure Start</p> <ul style="list-style-type: none"> • Verify Boot Block on every boot. Default is disabled. • BIOS Data Recovery Policy. Default is Automatic. IMPORTANT: Only select Manual in situations in which forensic analysis is to be performed before HP Sure Start Recovery. When this policy is set to manual, HP Sure Start does not correct any issues that are found until the manual recovery key sequence is entered by the local user. This can result in a system that is unable to boot after inputting the manual recovery key sequence. • Sure Start BIOS Settings Protection. This setting requires setting the BIOS Administrator password. Default is disabled. • Sure Start Secure Boot Keys Protection. Default is enabled. • Sure Start Security Event Boot Notification. Default is Require Acknowledgment. <p>HP Secure Platform Management (SPM)</p> <ul style="list-style-type: none"> • HP Sure Run Current State (Inactive/Active) • Deactivate HP Sure Run • SPM Current State (Not provisioned/Provisioned) • Unprovision SPM <p>Physical Presence Interface. Notifies the user upon system power up when changes are made to system security policy. The user must agree to the changes to confirm them. Default is enabled.</p> <p>Smart Cover (Disable/Notify User) Lets you set an alert is the computer cover is removed.</p>
Utilities	<p>Hard Drive Utilities</p> <ul style="list-style-type: none"> • Save/Restore MBR of System Hard Drive NOTE: Windows 10 systems are generally not formatted to include an MBR. Instead they use GUID Partition Table (GPT) format, which better supports large hard drives. Enabling this feature saves the Master Boot Record (MBR) of the system hard drive. If the MBR is changed, the user is prompted to restore the MBR. Default is disabled. The MBR contains information needed to successfully boot from a disk and to access the data stored on the disk. Master Boot Record Security may prevent unintentional or malicious changes to the MBR, such as those caused by some viruses or by the incorrect use of certain disk utilities. It also allows you to recover the "last known good" MBR, should changes to the MBR be detected when the system is restarted. NOTE: Most operating systems control access to the MBR of the current bootable disk; the BIOS cannot prevent changes that may occur while the operating system is running. Restores the backup Master Boot Record to the current bootable disk. Default is disabled. Only appears if all of the following conditions are true: <ul style="list-style-type: none"> – MBR security is enabled – A backup copy of the MBR has been previously saved – The current bootable disk is the same disk from which the backup copy was saved

Table 5-2 Computer Setup—Security (continued)

Option	Description
	<p>IMPORTANT: Restoring a previously saved MBR after a disk utility or operating system has modified the MBR, may cause the data on the disk to become inaccessible. Only restore a previously saved MBR if you are confident that the current bootable disk's MBR has been corrupted or infected with a virus.</p> <ul style="list-style-type: none"> Save/Restore GPT of System Hard Drive Enabling this feature saves the GUID Partition Table (GPT) of the system hard drive. If the GPT is subsequently changed, the user is prompted to choose whether to restore GPT. DriveLock Allows you to assign or modify a master or user password for hard drives. When this feature is enabled, the user is prompted to provide one of the DriveLock passwords during POST. If neither is successfully entered, the hard drive remains inaccessible until one of the passwords is successfully provided during a subsequent cold-boot sequence. <p>NOTE: This selection appears only when at least one drive that supports the DriveLock feature is attached to the system.</p> <p>IMPORTANT: Be aware that these settings take place immediately. You do not have to save.</p> <p>IMPORTANT: Be sure to document the DriveLock password. If you lose a DriveLock password, the drive is permanently locked.</p> After you select a drive, the following options are available: <p>Set DriveLock Master Password. Sets the drive's master password but does not enable DriveLock.</p> <p>Enable DriveLock. Sets the drive's user password and enables DriveLock.</p> Secure Erase Lets you select a hard drive to completely erase. After a hard drive is erased with a program that uses Secure Erase firmware commands, no file recovery program, partition recovery program, or other data recovery method can extract data from the drive. Allow OPAL Hard Drive SID Authentication
Restore Security Settings to Default	This action resets security devices, clears BIOS passwords (not including DriveLock), and restores settings in the Security menu to factory defaults.

Computer Setup—Advanced



NOTE: Support for specific Computer Setup options can vary depending on the hardware configuration.

Table 5-3 Computer Setup—Advanced (for advanced users)

Option	Heading
Display Language	Lets you select the language of the menus in F10 Setup and the keyboard layout.
Scheduled Power-On	This feature wakes the system up from a powered off state at a specified date and time.
Boot Options	Select the devices that the computer can boot from, as well as other options, including: <ul style="list-style-type: none"> Startup Menu Delay(sec). Enabling this feature adds a user-specified delay to the POST process. One purpose for the delay is to provide additional time to activate hot keys such as esc for the Startup Menu or f10 for Computer Setup. Fast Boot. Default is enabled.

Table 5-3 Computer Setup—Advanced (for advanced users) (continued)

Option	Heading
	<ul style="list-style-type: none"> • CD-ROM Boot. Default is enabled. • USB Storage Boot. Default is enabled. • Network (PXE) Boot. Default is enabled. • After Power Loss. Default is Power Off. <ul style="list-style-type: none"> ■ Power off—causes the computer to remain powered off when power is restored. ■ Power on—causes the computer to power on automatically as soon as power is restored. ■ Previous state—causes the computer to power on automatically as soon as power is restored, if it was on when power was lost. <p>NOTE: If the system is configured to Power On from Keyboard Ports (see Power Management Options), then this setting is forced to Power On.</p> <ul style="list-style-type: none"> • Audio Alerts During Boot. Default is enabled. When disabled, most audible beeps from errors, warnings, and password prompts during boot up are suppressed. • Prompt on Memory Size Change. Default is enabled. • Prompt on Fixed Storage Change. Default is disabled. • NumLock on at boot. Default is disabled. • UEFI Boot Order. Default is enabled. Specify the order in which UEFI boot sources (such as a internal hard drive, USB hard drive, USB optical drive, or internal optical drive) are checked for a bootable operating system image. UEFI boot sources always have precedence over legacy boot sources.
HP Sure Recover	<p>HP Sure Recover</p> <p>Enable to cause system firmware to honor local and remote requests to install the operating system.</p> <p>Recover from Network</p> <p>Enable to cause system firmware to get the recovery agent from the network. Disable to cause firmware to get the agent from a local drive.</p> <p>Recover after Boot Failure</p> <p>If enabled and no bootable UEFI operating system is found, system firmware launches HP Sure Recover.</p>
Secure Boot Configuration	<p>Configure Legacy Support and Secure Boot</p> <p>Lets you turn off all legacy support on the computer, including booting to DOS, running legacy graphics cards, booting to legacy devices, and so on.</p> <p>Lets you be sure an operating system is legitimate before booting to it, making Windows resistant to malicious modification from preboot to full OS booting, preventing firmware attacks. UEFI and Windows Secure Boot only allow code signed by pre-approved digital certificates to run during the firmware and OS boot process.</p> <ul style="list-style-type: none"> • Legacy Support Enable and Secure Boot Disable • Legacy Support Disable and Secure Boot Enable • Legacy Support Disable and Secure Boot Disable <p>Default is Legacy Support Disable and Secure Boot Disable.</p> <p>Secure Boot Key Management</p> <p>Lets you manage the custom key settings.</p>

Table 5-3 Computer Setup—Advanced (for advanced users) (continued)

Option	Heading
	<p>Import Custom Secure Boot keys</p> <p>Default is disabled.</p> <p>Clear Secure Boot Keys</p> <p>Lets you delete any previously loaded custom boot keys. Clearing keys disables secure boot. Default is disabled.</p> <p>Reset Secure Boot keys to factory defaults</p> <p>Default is disabled.</p> <p>Enable MS UEFI CA key</p> <p>Disabling this setting alters the Secure Boot key list to further restrict the allowed software components. Set this option to disable to support Device Guard.</p>
System Options	<p>Configure Storage Controller for RAID</p> <p>Default is disabled.</p> <p>SVM CPU Virtualization</p> <p>Controls the virtualization features of the processor. Default is enabled.</p> <p>M.2 SSD</p> <p>Lets you disable the M.2 solid-state drive slot. Default is enabled.</p> <p>Allow PCIe/PCI SERR# Interrupt (enable/disable)</p> <p>Allows PCI devices to report PCI/PCIe System Error signals, such as address parity errors, data parity errors, and critical errors other than parity. Default is enabled.</p> <p>Power Button Override (disable/4 sec/15 sec/30 sec)</p> <p>Lets you disable or enable and select the number of seconds you have to hold down the power button for it to force the system to power off. Default is 4 sec.</p> <p>AMD DASH</p> <p>Default is enabled.</p> <p>USB Type-C Connector System Software Interface (UCSI)</p> <p>Allows the operating system to monitor and report USB Type-C events and status. Default is enabled.</p> <p>HP Application Driver</p> <p>Default is enabled.</p>
Built-In Device Options	<p>Embedded LAN Controller</p> <p>Select to show the device in the operating system. Default is enabled.</p> <p>Wake On LAN</p> <p>Lets you either disable the Wake On LAN feature, or configure where the computer boots, including the network or hard drive. Default is Boot to Network.</p> <p>Dust Filter</p> <p>Select to enable the Dust Filter replacement reminder, which can be set for 15, 30, 60, 90, 120, or 180 days. The reminder will show during POST after the reminder timer has expired.</p> <p>VGA Boot Device</p> <p>Use this option to manage which graphics device is used as the primary display.</p> <p>Audio Device</p>

Table 5-3 Computer Setup—Advanced (for advanced users) (continued)

Option	Heading
	<p>Select to show the device in the operating system. Default is enabled.</p> <p>Internal Speakers (does not affect external speakers)</p> <p>Clear to disable the chassis speaker or speakers. This function is applicable to normal audio playback in the operating system and does not affect the error or warning beeps during POST. Default is enabled.</p> <p>Increase Idle Fan Speed(%)</p> <p>Sets idle fan speed percentage. This setting only changes the minimum fan speed. The fan is still automatically controlled.</p> <p>M.2 USB/Bluetooth</p> <p>Default is enabled.</p> <p>LAN/WLAN Auto Switching</p> <p>Default is disabled.</p> <p>Wake on WLAN</p> <p>Default is disabled.</p>
Port Options	<p>Lets you enable or disable connectors and ports. Default for all is enabled.</p> <ul style="list-style-type: none">• SATA Connectors• Front USB Ports• Rear USB Ports• USB Option Port• USB Legacy Port Charging<ul style="list-style-type: none">Enables USB charging port capability when the system is in hibernate or shutdown state.• Rear USB Type-C Downstream Charging<ul style="list-style-type: none">Enables USB charging port capability when the system is in hibernate or shutdown state.• Front USB Type-C Downstream Charging<ul style="list-style-type: none">Enables USB charging port capability when the system is in hibernate or shutdown state.• Media Card Reader/SD+RDR USB<ul style="list-style-type: none">Enables USB charging port capability when the system is in hibernate or shutdown state.
Option ROM Launch Policy	<p>These policies control whether Legacy Option ROMs or UEFI drivers are loaded. Default is All UEFI.</p> <p>Configure Option ROM Launch Policy</p> <ul style="list-style-type: none">• All legacy• All UEFI• All UEFI except video
Power Management Options	<p>Runtime Power Management (enable/disable)</p> <p>Allows certain operating systems to reduce processor voltage and frequency when the current software load does not require the full capabilities of the processor. Default is enabled.</p> <p>Extended Idle Power States (enable/disable)</p> <p>Allows certain operating systems to decrease the processors power consumption when the processor is idle. Default is enabled.</p> <p>S5 Maximum Power Savings (enable/disable)</p>

Table 5-3 Computer Setup—Advanced (for advanced users) (continued)

Option	Heading
	<p>Enabling this feature reduces the power of the system as much as possible in the S5 state. Power is removed from the wake up circuitry, the expansion slots, and any management features while in S5. Default is disabled.</p> <p>SATA Power Management (enable/disable)</p> <p>Enables or disables SATA bus and/or device power management. Default is enabled.</p> <p>PCI Express Power Management (enable/disable)</p> <p>Enabling this option permits the PCI Express links to use Active Power State Management (ASPM) to enter lower power states while not in use. Default is enabled.</p> <p>Unique Sleep State Blink Rates (enable/disable)</p> <p>This feature is designed to provide a visual indication of what sleep state the system is in. Each sleep state has a unique blink pattern. Default is disabled.</p> <p>NOTE: A normal shutdown goes to the S4 state.</p> <p>S0 (On) = Solid white LED.</p> <p>S3 (Stand By)= 3 blinks at 1 Hz (50% duty cycle) followed by a pause of 2 s (white LED) — repeated cycles of 3 blinks and a pause.</p> <p>S4 (Hibernation)= 4 blinks at 1 Hz (50% duty cycle) followed by a pause of 2 s (white LED) — repeated cycles of 4 blinks and a pause.</p> <p>S5 (Soft Off) = LED is off.</p> <p>Power On from Keyboard Ports (enable/disable)</p> <p>When enabled, this feature allows a key press to power on the system when it is off (S5 state). If using a USB keyboard, it must be plugged into one of the rear ports labeled with the keyboard icon. Default is disabled.</p>
Remote Management Options	<p>Active Management (AMT) (Intel only) (enable/disable). Default is enabled.</p> <p>Allows you to discover, repair, and protect networked computing devices.</p> <p>USB Key Provisioning Support (enable/disable) Default is disabled.</p> <p>USB Redirection Support (enable/disable). Default is enabled.</p> <p>USB redirection allows USB devices plugged into a client computer to be transparently redirected to the guest operating system.</p> <p>Unconfigure AMT on next boot (Do Not Apply/Apply). Default is Do Not Apply.</p> <p>SOL Terminal Emulation Mode (ANSI / VT100). Default is ANSI.</p> <p>SOL terminal emulation mode is only activated during remote AMT redirection operations. The emulation options allow administrators to select which mode works best with their console.</p> <p>Show Unconfigure ME Confirmation Prompt (enable/disable). Default is enabled.</p> <p>Verbose Boot Messages (enable/disable). Default is enabled.</p> <p>Verbose boot shows additional logging information during the boot. mainly for debugging if something goes wrong during bootup.</p> <p>Watchdog Timer (enable/disable). Default is enabled.</p> <p>Allows you to set amount of time for a operating system and BIOS watchdog alert to be sent if the timers are not deactivated. BIOS watchdog is deactivated by BIOS and would indicate that a halt occurred during execution if the alert is sent to the management console. An operating system alert is deactivated by the operating system image and would indicate that a hang occurred during its initialization.</p> <ul style="list-style-type: none"> OS Watchdog Timer (min.) – (5/10/15/20/25). Default is 5 min.

Table 5-3 Computer Setup—Advanced (for advanced users) (continued)

Option	Heading
	<ul style="list-style-type: none">• BIOS Watchdog Timer (min.) – (5/10/15/20/25). Default is 5 min.
	CIRA Timeout (min.) (1/2/3/4/Never)
	CIRA is Customer Initiated Remote Assistance, an Intel service to help users employing Active Management Technology (AMT).

Computer Setup—UEFI Drivers

Lets you restart the computer into the 3rd Party Option ROM Management application. You can start this application directly by pressing **F3** during startup.

Recovering the Configuration Settings

This method of recovery requires that you first perform the **Save to Removable Media** command with the Computer Setup (F10) Utility before **Restore** is needed. (See [Computer Setup—Main on page 53](#) in the Computer Setup—File table.)

The **Save to Removable Media** option creates a file named HPSETUP.TXT on an inserted USB flash media device. This file can be edited to change the settings on Restore. An asterisk (*) marks the selected option for a setting.



NOTE: It is recommended that you save any modified computer configuration settings to a USB flash media device and save the device for possible future use.

To restore the configuration, insert the USB flash media device with the saved configuration and perform the **Restore from Removable Media** command with the Computer Setup (F10) Utility. (See [Computer Setup—Main on page 53](#) in the Computer Setup—File table.)

6 Troubleshooting without diagnostics

This chapter provides information on how to identify and correct minor problems, such as USB devices, hard drive, optical drive, graphics, audio, memory, and software problems. If you encounter problems with the computer, see the tables in this chapter for probable causes and recommended solutions.

 **NOTE:** For information on specific error messages that may appear on the screen during Power-On Self-Test (POST) at startup, see [POST error messages on page 92](#).

Safety and comfort

 **WARNING!** Misuse of the computer or failure to establish a safe and comfortable work environment may result in discomfort or serious injury. See the *Safety & Comfort Guide* at <http://www.hp.com/ergo> for more information on choosing a workspace and creating a safe and comfortable work environment. For more information, see the *Safety & Regulatory Information* guide.

Before you call for technical support

If you are having problems with the computer, try the following appropriate solutions to try to isolate the exact problem before calling for technical support.

- Run the HP diagnostic tool.
- Run the hard drive self-test in Computer Setup. See [Computer Setup \(F10\) Utility on page 51](#) for more information.
- Check the Power LED on the front of the computer to see if it is flashing red. The flashing lights are error codes that will help you diagnose the problem. See [POST error messages on page 92](#) for more information.
- If the screen is blank, plug the monitor into a different video port on the computer if one is available. Or, replace the monitor with a monitor that you know is functioning properly.
- If you are working on a network, plug another computer with a different cable into the network connection. There might be a problem with the network plug or cable.
- If you recently added new hardware, remove the hardware and see if the computer functions properly.
- If you recently installed new software, uninstall the software and see if the computer functions properly.
- Boot the computer to the Safe Mode to see if it will boot without all of the drivers loaded. When booting the operating system, use “Last Known Configuration.”
- See the comprehensive online technical support at <http://www.hp.com/support>.
- See [Helpful hints on page 65](#) in this guide.

To assist you in resolving problems online, HP Instant Support Professional Edition provides you with self-solve diagnostics. If you need to contact HP support, use HP Instant Support Professional Edition's online chat feature.

Access the Business Support Center (BSC) at <http://www.hp.com/go/bizsupport> for the latest online support information, software and drivers, proactive notification, and worldwide community of peers and HP experts.

If it becomes necessary to call for technical assistance, be prepared to do the following to be sure that your service call is handled properly:

- Be in front of your computer when you call.
- Write down the computer serial number, product ID number, and monitor serial number before calling.
- Spend time troubleshooting the problem with the service technician.
- Remove any hardware that was recently added to your system.
- Remove any software that was recently installed.
- Restore the system from the Recovery Disc Set that you created or restore the system to its original factory condition in System Software Requirement Disks (SSRD).



IMPORTANT: Restoring the system will erase all data on the hard drive. Be sure to back up all data files before running the restore process.



NOTE: For sales information and warranty upgrades (Care Packs), call your local authorized service provider or dealer.

Helpful hints

If you encounter problems with the computer, monitor, or software, see the following list of general suggestions before taking further action:

- Check that the computer and monitor are plugged into a working electrical outlet.
- Check that the voltage select switch (some models) is set to the appropriate voltage for your region (115 V or 230 V).
- Check that the computer is turned on and the white power light is on.
- Check that the monitor is turned on and the green monitor light is on.
- Check the Power LED on the front of the computer to see if it is flashing red. The flashing lights are error codes that will help you diagnose the problem. See [POST error messages on page 92](#) for more information.
- Turn up the brightness and contrast controls of the monitor if the monitor is dim.
- Press and hold any key. If the system beeps, then the keyboard should be operating correctly.
- Check all cable connections for loose connections or incorrect connections.
- Wake the computer by pressing any key on the keyboard or pressing the power button. If the system remains in suspend mode, shut down the computer by pressing and holding the power button for at least 4 s then press the power button again to restart the computer. If the system will not shut down, unplug the power cord, wait a few seconds, and then plug it in again. The computer will restart if it is set to power on automatically as soon as power is restored in Computer Setup. If it does not restart, press the power button to start the computer.
- Reconfigure the computer after installing a non-plug and play expansion board or other option. See [Solving hardware installation problems on page 82](#) for instructions.
- Be sure that all the needed device drivers have been installed. For example, if you are using a printer, you need a driver for that model printer.
- Remove all bootable media (CD/DVD or USB device) from the system before turning it on.

- If you have installed an operating system other than the factory-installed operating system, check to be sure that it is supported on the system.
- If the system has multiple video sources (embedded, PCI, or PCI-Express adapters) installed (embedded video on some models only) and a single monitor, the monitor must be plugged into the monitor connector on the source selected as the primary VGA adapter. During boot, the other monitor connectors are disabled and if the monitor is connected into these ports, the monitor will not function. You can select which source will be the default VGA source in Computer Setup.

 **IMPORTANT:** When the computer is plugged into an AC power source, there is always voltage applied to the system board. You must disconnect the power cord from the power source before opening the computer to prevent system board or component damage.

Solving general problems

You might be able to easily resolve the general problems described in this section. If a problem persists and you are unable to resolve it yourself or if you feel uncomfortable about performing the operation, contact an authorized dealer or reseller.

 **WARNING!** When the computer is plugged into an AC power source, voltage is always applied to the system board. To reduce the risk of personal injury from electrical shock and/or hot surfaces, be sure to disconnect the power cord from the wall outlet and allow the internal system components to cool before touching.

Cannot access the Computer Setup (F10) Utility when booting the computer.

Cause	Solution
The Computer Setup (F10) Utility is set to “fast boot” causing the F10 access screen to display too briefly when booting the computer.	<p>Before turning on the computer, press and hold F10. Turn on the computer and continue to hold F10 until the Computer Setup (F10) Utility is displayed.</p> <p>- or -</p> <p>Follow the Windows instructions for rebooting the computer into the Computer Setup (F10) Utility.</p>

Computer appears locked up and will not turn off when the power button is pressed.

Cause	Solution
Software control of the power switch is not functional.	<ol style="list-style-type: none"> 1. Press and hold the power button for at least 4 s until the computer turns off. 2. Disconnect the power cord from the electrical outlet.

Computer will not respond to keyboard or mouse.

Cause	Solution
Computer is in Sleep state.	<p>To resume from Sleep state, press the power button.</p> <p>IMPORTANT: When attempting to resume from Sleep state, do not hold down the power button for more than 4 s. Otherwise, the computer will shut down and you will lose any unsaved data.</p>
System has locked up.	Restart computer.

Computer date and time display is incorrect.

Cause	Solution
RTC (real-time clock) battery may need to be replaced. NOTE: Connecting the computer to a live AC outlet prolongs the life of the RTC battery.	Reset the date and time under Control Panel (Computer Setup can also be used to update the RTC date and time). If the problem persists, replace the RTC battery. See the Removal and Replacement section for instructions on installing a new battery, or contact an authorized dealer or reseller for RTC battery replacement. To access Control Panel in Windows 10, type <code>control panel</code> in the taskbar search box, and then select Control Panel.

There is no sound or sound volume is too low.

Cause	Solution
System volume might be set low or muted.	<ol style="list-style-type: none">1. Check the Computer Setup settings to be sure the internal system speaker is not muted (this setting does not affect the external speakers).2. Be sure the external speakers are properly connected and powered on and that the speakers' volume control is set correctly.3. Use the system volume control available in the operating system to be sure the speakers are not muted or to increase the volume.

Cannot remove computer cover or access panel.

Cause	Solution
Smart Cover Lock, featured on some computers, is locked.	Unlock the Smart Cover Lock using Computer Setup. In case of forgotten password, power loss, or computer malfunction, you must manually disable the Smart Cover lock . A key to unlock the Smart Cover Lock is not available from HP. Keys are typically available from a hardware store.

Poor performance.

Cause	Solution
Processor is too hot.	<ol style="list-style-type: none">1. Be sure airflow to the computer is not blocked. Leave a 10.2 cm (4 inch) clearance on all vented sides of the computer and above the monitor to permit the required airflow.2. Make sure fans are connected and working properly (some fans only operate when needed).3. Make sure the processor heat sink is installed properly.
Hard drive is full.	Transfer data from the hard drive to create more space on the hard drive.
Low on memory.	Add more memory.
Hard drive fragmented.	Defragment hard drive.

Poor performance.

Cause	Solution
Program previously accessed did not release reserved memory back to the system.	Restart the computer.
Virus resident on the hard drive.	Run virus protection program.
Too many applications running.	<ol style="list-style-type: none">1. Close unnecessary applications to free up memory.2. Add more memory.3. Some applications run in the background and can be closed by right-clicking on their corresponding icons in the task tray. To prevent these applications from launching at startup: In Windows 10:<ol style="list-style-type: none">a. Type <code>msconfig</code> in the taskbar search box, and then select msconfig.b. On the Startup tab of the System Configuration Utility, click Open Task Manager.c. Select applications that you do not want to launch automatically, and the click Disable.
Some software applications, especially games, are stressful on the graphics subsystem.	<ol style="list-style-type: none">1. Lower the display resolution for the current application or consult the documentation that came with the application for suggestions on how to improve performance by adjusting parameters in the application.2. Add more memory.3. Upgrade the graphics solution.
Cause unknown.	Restart the computer.

Computer powered off automatically and the Power LED flashes red four times and then white two times.

Cause	Solution
Processor thermal protection activated: A fan might be blocked or not turning. OR The heat sink is not properly attached to the processor.	<ol style="list-style-type: none">1. Make sure that the computer air vents are not blocked and the processor cooling fan is running.2. Open the access panel, press the power button, and see if the processor fan (or other system fan) spins. If the fan does not spin, make sure the fan cable is plugged onto the system board header.3. If fan a plugged in and not spinning, replace it.

System does not power on and the LEDs on the front of the computer are not flashing.

Cause	Solution
System unable to power on.	Press and hold the power button for less than 4 s. If the hard drive LED turns white, then: <ol style="list-style-type: none">1. If the product is equipped with a voltage selector, check that the voltage selector (located on the rear of the power

System does not power on and the LEDs on the front of the computer are not flashing.

Cause	Solution
	supply) is set to the appropriate voltage. Proper voltage setting depends on your region.
	<ol style="list-style-type: none">2. Remove the expansion cards one at a time until the 5V_aux light on the system board turns on.3. Replace the system board.
	OR
	Press and hold the power button for less than 4 s. If the hard drive LED does not turn on white then:
	<ol style="list-style-type: none">1. Check that the unit is plugged into a working AC outlet.2. Open the access panel and check that the power button cable is properly connected to the system board.3. Check that the power supply cables are properly connected to the system board.4. Check to see if the 5V_aux light on the system board is turned on. If it is turned on, then replace the power button assembly.5. If the 5V_aux light on the system board is off, then replace the power supply.6. Replace the system board.

Solving power problems

Common causes and solutions for power problems are listed in the following table.

Power supply shuts down intermittently.

Cause	Solution
If equipped with a voltage selector, voltage selector switch on rear of computer chassis (some models) not switched to correct line voltage (115 V or 230 V).	Select the proper AC voltage using the selector switch.
Power supply will not turn on because of internal power supply fault.	Replace the power supply.

Computer powered off automatically and the Power LED flashes red two times, once every second, followed by a 2 s pause, and the computer beeps two times. (Beeps stop after fifth iteration but LEDs continue flashing.)

Cause	Solution
Processor thermal protection activated: A fan might be blocked or not turning.	<ol style="list-style-type: none">1. Make sure that the computer air vents are not blocked and the processor cooling fan is running.2. Open the access panel, press the power button, and see if the processor fan (or other system fan) spins. If the fan does not spin, make sure the fan cable is plugged onto the system board header.3. If fan a plugged in and not spinning, replace it.
OR	
The heat sink is not properly attached to the processor.	

Power LED flashes Red four times, once every second, followed by a 2 s pause, and the computer beeps four times. (Beeps stop after fifth iteration but LEDs continue flashing.)

Cause	Solution
Power failure (power supply is overloaded).	<ol style="list-style-type: none">1. If equipped with a voltage selector, check that the voltage selector, located on the rear of the power supply (some models), is set to the appropriate voltage. Proper voltage setting depends on your region.2. Open the access panel and ensure the power supply cable is seated into the connector on the system board.3. Check if a device is causing the problem by removing all attached devices (such as hard drives or optical drives and expansion cards). Power on the system. If the system enters POST, then power off and replace one device at a time and repeat this procedure until failure occurs. Replace the device that is causing the failure. Continue adding devices one at a time to ensure all devices are functioning properly.4. Replace the power supply.5. Replace the system board.

Solving hard drive problems

Hard drive error occurs.

Cause	Solution
Hard disk has bad sectors or has failed.	<ol style="list-style-type: none">1. In Windows 10, type <code>file</code> in the taskbar search box, and then select File Explorer from the list of applications. In the left column, expand This PC, right-click on a drive, select Properties, and then select the Tools tab. Under Error checking, click Check.2. Use a utility to locate and block usage of bad sectors. If necessary, reformat the hard disk.

Disk transaction problem.

Cause	Solution
Either the directory structure is bad or there is a problem with a file.	In Windows 10, type <code>file</code> in the taskbar search box, and then select File Explorer from the list of applications. In the left column, expand This PC , right-click on a drive, select Properties , and then select the Tools tab. Under Error checking , click Check .

Drive not found (identified).

Cause	Solution
Cable could be loose.	Check cable connections.
The system may not have automatically recognized a newly installed device.	See reconfiguration directions in the Solving hardware installation problems on page 82 section. If the system still does not recognize the new device, check to see if the device is listed within

Drive not found (identified).

Cause	Solution
	Computer Setup. If it is listed, the probable cause is a driver problem. If it is not listed, the probable cause is a hardware problem. If this is a newly installed drive, run the Computer Setup utility and try adding a POST delay under Advanced > Boot Options .
The device is attached to a SATA port that has been hidden in Computer Setup.	Run the Computer Setup utility and ensure Device Available is selected for the device's SATA port in Advanced > Port Options .
Drive responds slowly immediately after power-up.	Run Computer Setup and increase the POST Delay in Advanced > Boot Options .

Nonsystem disk/NTLDR missing message.

Cause	Solution
The system is trying to start from the hard drive but the hard drive may have been damaged.	▲ Perform Drive Protection System (DPS) testing in system ROM.
System files missing or not properly installed.	<ol style="list-style-type: none">1. Insert bootable media and restart the computer.2. Boot to the windows installation media and select the recovery option. If only a restore kit is available, then select the File Backup Program option, and then restore the system.3. Install system files for the appropriate operating system.
Hard drive boot has been disabled in Computer Setup.	Run the Computer Setup utility and enable the hard drive entry in the Advanced > Boot Options list.
Bootable hard drive is not attached as first in a multiple hard drive configuration.	If attempting to boot from a hard drive, ensure it is attached to the system board dark blue SATA connector.
Bootable hard drive is not listed first in the Boot Order.	Run the Computer Setup utility and select Advanced > Boot Options and ensure the bootable hard drive is listed immediately under the Hard Drive entry.

Computer will not boot from hard drive.

Cause	Solution
The device is attached to a SATA port that has been hidden in Computer Setup.	<ol style="list-style-type: none">1. Check SATA cable connections.2. Run the Computer Setup utility and ensure Device Available is selected for the device's SATA port in Advanced > Port Options.
Boot order is not correct.	Run the Computer Setup utility and change boot sequence in Advanced > Boot Options .
Hard drive is damaged.	Observe if the front panel Power LED is blinking RED and if any beeps are heard. See POST error messages on page 92 to determine possible causes for the blinking red and beep codes. See the Worldwide Limited Warranty for terms and conditions.

Computer seems to be locked up.

Cause	Solution
Program in use has stopped responding to commands.	<ol style="list-style-type: none">1. Use the task manager to close programs that do not respond.2. Attempt the normal Windows “Shut Down” procedure. If this fails, press the power button for four or more seconds to turn off the power. To restart the computer, press the power button again.

Solving media card reader problems

Media card will not work in a digital camera after formatting it in Windows.

Cause	Solution
By default, Windows will format any media card with a capacity greater than 32MB with the FAT32 format. Some digital cameras use the FAT (FAT16 & FAT12) format and can not operate with a FAT32 formatted card.	Either format the media card in the digital camera or select FAT file system to format the media card in a computer with Windows.

A write-protected or locked error occurs when attempting to write to the media card.

Cause	Solution
Media card is locked. Locking the media card is a safety feature that prevents writing to and deleting from an SD/Memory Stick/PRO card.	If using an SD card, make sure that the lock tab located on the right of the SD card is not in the locked position. If using a Memory Stick/PRO card, make sure that the lock tab located on the bottom of the Memory Stick/PRO card is not in the locked position.

Can not write to the media card.

Cause	Solution
The media card is a read-only memory (ROM) card.	Check the manufacturer’s documentation included with your card to see if it writable. See the previous section for a list of compatible cards.
Media card is locked. Locking the media card is a safety feature that prevents writing to and deleting from an SD/Memory Stick/PRO card.	If using an SD card, make sure that the lock tab located on the right of the SD card is not in the locked position. If using a Memory Stick/PRO card, make sure that the lock tab located on the bottom of the Memory Stick/PRO card is not in the locked position.

Unable to access data on the media card after inserting it into a slot.

Cause	Solution
The media card is not inserted properly, is inserted in the wrong slot, or is not supported.	Make sure that the card is inserted properly with the gold contact on the correct side. The green LED will light if inserted properly.

Do not know how to remove a media card correctly.

Cause	Solution
The computer's software is used to safely eject the card.	In Windows 10, type <code>file</code> in the taskbar search box, and then select File Explorer from the list of applications. In the left column, expand This PC , right-click on the corresponding drive icon, and then select Eject . Pull the card out of the slot. NOTE: Never remove the card when the green LED is flashing.

After installing the media card reader and booting to Windows, the reader and the inserted cards are not recognized by the computer.

Cause	Solution
The operating system needs time to recognize the device if the reader was just installed into the computer and you are turning the PC on for the first time.	Wait a few seconds so that the operating system can recognize the reader and the available ports, and then recognize the media inserted in the reader.

After inserting a media card in the reader, the computer attempts to boot from the media card.

Cause	Solution
The inserted media card has boot capability.	<ol style="list-style-type: none">1. If you do not want to boot from the media card, remove it during boot or do not select the option to boot from the inserted media card during the boot process.2. During POST (Power On Self-Test), press F9 to modify the boot menu.3. Change the boot sequence in F10 Computer Setup.

Solving display problems

If you encounter display problems, see the documentation that came with the monitor and to the common causes and solutions listed in the following table.

Blank screen (no video).

Cause	Solution
If you have a system with an option card with display connectivity, the option card may not be seated correctly.	<ol style="list-style-type: none">1. Reseat the option card.2. Power on the system and retest.3. If the issue persists, replace the option card only.4. Power on the system and retest.5. If after reseating and replacing the option card the issue persists, the system board connector to the option card might be damaged. Replace the system board.
Monitor is not turned on and the monitor light is not on.	Turn on the monitor and check that the monitor light is on.
Bad monitor.	Try a different monitor.

Blank screen (no video).

Cause	Solution
The cable connections are not correct.	Check the cable connection from the monitor to the computer and to the electrical outlet.
You may have a screen blanking utility installed or energy saver features are enabled.	Press any key or click the mouse button and type your password (if set).
You are using a fixed-sync monitor and it will not sync at the resolution chosen.	Be sure that the monitor can accept the same horizontal scan rate as the resolution chosen.
Computer is in Sleep state.	Press the power button to resume from Sleep state. IMPORTANT: When attempting to resume from Sleep state, do not hold down the power button for more than 4 s. Otherwise, the computer will shut down and you will lose any unsaved data.
Monitor cable is plugged into the wrong connector.	Systems may have a monitor connection on both the motherboard or an add-in card. Try moving the monitor connection to a different connector on the back of the computer
Monitor settings in the computer are not compatible with the monitor.	<ol style="list-style-type: none">1. In Control Panel, select Category from the View by list, and then under Appearance and Personalization, select Adjust screen resolution. To access Control Panel in Windows 10, type <code>control panel</code> in the taskbar search box, and then select Control Panel from the list of applications.2. Expand the Resolution box, and then use the sliding control to reset the resolution.
Monitor is configured to use an input that is not active.	Use the monitor's on-screen menu controls to select the input that is being driven by the system. See the monitor's user documentation for more information on the on-screen controls and settings.

Blank screen and the power LED flashes Red five times, once every second, followed by a 2 s pause, and the computer beeps five times. (Beeps stop after fifth iteration but LEDs continue flashing.)

Cause	Solution
Pre-video memory error.	<ol style="list-style-type: none">1. Reseat DIMMs. Power on the system.2. Replace DIMMs one at a time to isolate the faulty module.3. Replace third-party memory with HP memory.4. Replace the system board.

Blank screen and the power LED flashes Red six times, once every second, followed by a 2 s pause, and the computer beeps six times. (Beeps stop after fifth iteration but LEDs continue flashing.)

Cause	Solution
Pre-video graphics error.	For systems with a graphics card: <ol style="list-style-type: none">1. Reseat the graphics card (if applicable). Power on the system.2. Replace the graphics card (if applicable).

Blank screen and the power LED flashes Red six times, once every second, followed by a 2 s pause, and the computer beeps six times. (Beeps stop after fifth iteration but LEDs continue flashing.)

Cause	Solution
	<ol style="list-style-type: none">3. Replace the system board. For systems with integrated graphics, replace the system board.

Blank screen and the power LED flashes Red seven times, once every second, followed by a 2 s pause, and the computer beeps seven times. (Beeps stop after fifth iteration but LEDs continue flashing.)

Cause	Solution
System board failure (ROM detected failure before video).	Replace the system board.

Monitor does not function properly when used with energy saver features.

Cause	Solution
Monitor without energy saver capabilities is being used with energy saver features enabled.	Disable monitor energy saver feature.

Dim characters.

Cause	Solution
The brightness and contrast controls are not set properly.	Adjust the monitor brightness and contrast controls.
Cables are not properly connected.	Check that the graphics cable is securely connected to the graphics card (if applicable) or video connector and the monitor.

Blurry video or requested resolution cannot be set.

Cause	Solution
If the graphics controller was upgraded, the correct graphics drivers may not be loaded.	Install the video drivers included in the upgrade kit.
Monitor is not capable of displaying requested resolution.	Change requested resolution.
Graphics card is bad.	Replace the graphics card.

The picture is broken up, rolls, jitters, or flashes.

Cause	Solution
The monitor connections might be incomplete or the monitor might be incorrectly adjusted.	<ol style="list-style-type: none">1. Be sure the monitor cable is securely connected to the computer.2. In a two-monitor system or if another monitor is in close proximity, be sure the monitors are not interfering with each other's electromagnetic field by moving them apart.

The picture is broken up, rolls, jitters, or flashes.

Cause	Solution
Monitor needs to be degaussed.	<ol style="list-style-type: none">Fluorescent lights or fans might be too close to the monitor. Degauss the monitor. See the documentation that came with the monitor for instructions.

Image is not centered.

Cause	Solution
Position may need adjustment.	Press the monitor's Menu button to access the OSD menu. Select ImageControl/ Horizontal Position or Vertical Position to adjust the horizontal or vertical position of the image.

"No Connection, Check Signal Cable" displays on screen.

Cause	Solution
Monitor video cable is disconnected.	Connect the video cable between the monitor and computer. IMPORTANT: Make sure that the computer power is off while connecting the video cable.

"Out of Range" is displayed on screen.

Cause	Solution
Video resolution and refresh rate are set higher than what the monitor supports.	Restart the computer and enter Safe Mode. Change the settings to a supported setting, and then restart the computer so that the new settings take effect. To enter Safe Mode in Windows 10: <ol style="list-style-type: none">Log in to the computer using an Administrator account.Type <code>msconfig</code> in the taskbar search box, and then select msconfig from the list of applications.Click the Boot tab, select Safe boot and then click OK.

High-pitched noise coming from inside a flat panel monitor.

Cause	Solution
Brightness settings, contrast settings, or both are too high.	Lower brightness settings, contrast settings, or both.

Fuzzy focus; streaking, ghosting, or shadowing effects; horizontal scrolling lines; faint vertical bars; or unable to center the picture on the screen (flat panel monitors using an analog VGA input connection only).

Cause	Solution
Flat panel monitor's internal digital conversion circuits might be unable to correctly interpret the output synchronization of the graphics card.	<ol style="list-style-type: none">1. Select the monitor's Auto-Adjustment option in the monitor's on-screen display menu.2. Manually synchronize the Clock and Clock Phase on-screen display functions. To download a SoftPaq that will assist you with the synchronization, go to the following website, select the appropriate monitor, and download either SP32347 or SP32202: http://www.hp.com/support
Graphics card is not seated properly or is bad (some models).	<ol style="list-style-type: none">1. Reseat the graphics card.2. Replace the graphics card.

Certain typed symbols do not appear correct.

Cause	Solution
The font that you are using does not support that particular symbol.	Use the Character Map to locate and select the appropriate symbol. You can copy the symbol from the Character Map into a document. In Windows 10, type <code>ch</code> in the taskbar search box, and then select Character Map from the list of applications.

Solving audio problems

If the computer has audio features and you encounter audio problems, see the common causes and solutions listed in the following table.

Headset microphone connected to the front is not working or is very quiet.

Cause	Solution
The front Headset connector supports CTIA (Cellular Telephone Industries Association) style headsets and not OMTP (Open Mobile Terminal Platform) style headsets. These differ by the microphone connections.	Make sure that a CTIA style headset is being used or use an OMTP style headset with a commercially available adapter that converts an OMTP headset to the CTIA pinout.

Sound cuts in and out.

Cause	Solution
Other open applications are using processor resources.	Shut down all open processor-intensive applications.

Sound does not come out of the speaker or headphones.

Cause	Solution
Software volume control is turned down or muted.	Double-click the Speaker icon on the taskbar, make sure that Mute is not selected, and use the volume slider to adjust the volume.
Audio is hidden in Computer Setup.	Enable the audio in Computer Setup: Advanced > Built-in Device Options .
The external speakers are not turned on.	Turn on the external speakers.
The audio device might be connected to the wrong jack.	Make sure the device is connected to the correct jack on the computer. The rear audio jack output is the green receptacle. The speakers should be plugged into the line-out jack and the headphones should be plugged into the headphone jack.
External speakers plugged into the wrong audio jack on a recently installed sound card.	See the sound card documentation for proper speaker connection. The rear audio jack output is the green receptacle.
Headphones or devices connected to the line-out connector mute the internal speaker.	Turn on and use headphones or external speakers, if connected, or disconnect headphones or external speakers.
Computer is in Sleep state.	Press the power button to resume from Sleep state. IMPORTANT: When attempting to resume from Sleep state, do not hold down the power button for more than 4 s. Otherwise, the computer will shut down and you will lose any unsaved data.
Internal speaker is disabled in Computer Setup.	Enable the internal speaker in Computer Setup. Select Advanced > Built-in Device Options .
The application is set to use a different audio device than speakers.	Some graphics cards support audio over the DisplayPort connection (if applicable), so multiple audio devices might be listed in Device Manager. Make sure the correct device is being used. To access Device Manager in Windows 10, type <code>device manager</code> in the taskbar search box, and then select Device Manager from the list of applications.
Some applications can select which audio output device is used.	Make sure the application has selected the correct audio device.
The operating system controls might be set to use a different audio device as the default output device than what is expected.	Set the operating system to use the correct audio device.

Sound from headphones is not clear or muffled.

Cause	Solution
Headphones are plugged into the rear audio output connector. The rear audio output connector is for powered audio devices and is not designed for headphone use.	Plug the headphones into the headphone connector on the front of the computer.

Computer appears to be locked up while recording audio.

Cause	Solution
The hard disk might be full.	Before recording, make sure there is enough free space on the hard disk. You can also try recording the audio file in a compressed format.

Line-in jack is not functioning properly.

Cause	Solution
Jack has been reconfigured in the audio driver or application software.	In the audio driver or application software, reconfigure the jack or set the jack to its default value.

There is no sound or sound volume is too low.

Cause	Solution
The application is set to use a different audio device than speakers.	Some graphics cards support audio over the DisplayPort connection (if applicable), so multiple audio devices might be listed in Device Manager. Make sure the correct device is being used. To access Device Manager in Windows 10, type <code>device manager</code> in the taskbar search box, and then select Device Manager from the list of applications.
Some applications can select which audio output device is used.	Make sure the application has selected the correct audio device.
The operating system controls might be set to use a different audio device as the default output device than what is expected.	Set the operating system to use the correct audio device.

Solving printer problems

If you encounter printer problems, see the documentation that came with the printer and to the common causes and solutions listed in the following table.

Printer will not print.

Cause	Solution
Printer is not turned on and online.	Turn the printer on and make sure it is online.
The correct printer drivers for the application are not installed.	<ol style="list-style-type: none">1. Install the correct printer driver for the application.2. Try printing using the MS-DOS command: <pre>DIR C:\ > [printer port]</pre>where <code>[printer port]</code> is the address of the printer being used. If the printer works, reload the printer driver. To run MS-DOS commands, press the Windows key + r, type <code>cmd</code> in the Open box, and then click OK.
If you are on a network, you may not have made the connection to the printer.	Make the proper network connections to the printer.
Printer may have failed.	Run printer self-test.

Printer will not turn on.

Cause	Solution
The cables may not be connected properly.	Reconnect all cables and check the power cord and electrical outlet.

Printer prints garbled information.

Cause	Solution
The correct printer driver for the application is not installed.	Install the correct printer driver for the application.
The cables may not be connected properly.	Reconnect all cables.
Printer memory might be overloaded.	Reset the printer by turning it off for one minute, and then turn it back on.

Printer will not print.

Cause	Solution
The printer might be out of paper.	Check the paper tray and refill it if it is empty.

Solving keyboard and mouse problems

If you encounter keyboard or mouse problems, see the documentation that came with the equipment and to the common causes and solutions listed in the following table.

A wireless keyboard/mouse is not working correctly. Symptoms include lagging mouse movement, jumpy mouse/keyboard, or no function of mouse/keyboard and external drive.

Cause	Solution
If your computer is equipped with USB 3.0 ports, connected USB 3.0 devices can interfere with the wireless keyboard USB receiver.	Connect the wireless keyboard USB receiver to a USB 2.0 port that is separated from ports with USB 3.0 devices. If you still experience interference, you may have to place the connectors farther apart using an external USB hub.

Keyboard commands and typing are not recognized by the computer.

Cause	Solution
Keyboard connector is not properly connected.	Shut down the computer, reconnect the keyboard to the back of the computer, and then restart the computer.
Program in use has stopped responding to commands.	Shut down your computer using the mouse and then restart the computer.
Keyboard needs repairs.	See the Worldwide Limited Warranty for terms and conditions.
Computer is in Sleep state.	Press the power button to resume from Sleep state. IMPORTANT: When attempting to resume from Sleep state, do not hold down the power button for more than 4 s. Otherwise, the computer will shut down and you will lose any unsaved data.

Mouse does not respond to movement or is too slow.

Cause	Solution
Mouse connector is not properly plugged into the back of the computer.	Shut down the computer using the keyboard. Windows 10: <ol style="list-style-type: none">1. Press the ctrl and esc keys at the same time (or press the Windows logo key) to display the Start menu.2. Use the arrow keys to scroll to and select the power icon at the top right on the menu, and then press enter.3. Use the arrow keys to select Shut Down, and then press enter.4. After the shutdown is complete, plug the mouse connector into the back of the computer (or the keyboard) and restart.
Program in use has stopped responding to commands.	Shut down the computer using the keyboard then restart the computer.
Mouse may need cleaning.	Remove the roller ball cover on the mouse and clean the internal components.
Mouse may need repair.	See the Worldwide Limited Warranty for terms and conditions.
Computer is in Sleep state.	Press the power button to resume from Sleep state.

Mouse does not respond to movement or is too slow.

Cause	Solution
	IMPORTANT: When attempting to resume from Sleep state, do not hold down the power button for more than 4 s. Otherwise, the computer will shut down and you will lose any unsaved data.

Mouse will only move vertically, horizontally, or movement is jerky.

Cause	Solution
Mouse roller ball or the rotating encoder shafts that make contact with the ball are dirty.	Remove roller ball cover from the bottom of the mouse and clean the internal components with a mouse cleaning kit available from most computer stores.

Solving hardware installation problems

You may need to reconfigure the computer when you add or remove hardware, such as an additional drive or expansion card. If you install a plug and play device, Windows automatically recognizes the device and configures the computer. If you install a non-plug and play device, you must reconfigure the computer after completing installation of the new hardware. In Windows, use the **Add Hardware Wizard** and follow the instructions that appear on the screen.

To open the Add Hardware Wizard, open a Command Prompt and open `hdwwiz.exe`.

 **WARNING!** When the computer is plugged into an AC power source, voltage is always applied to the system board. To reduce the risk of personal injury from electrical shock and/or hot surfaces, be sure to disconnect the power cord from the wall outlet and allow the internal system components to cool before touching.

A new device is not recognized as part of the system.

Cause	Solution
Device is not seated or connected properly.	Make sure the device is properly and securely connected and that pins in the connector are not bent down.
Cable(s) of new external device are loose or power cables are unplugged.	Make sure all cables are properly and securely connected and that pins in the cable or connector are not bent down.
Power switch of new external device is not turned on.	Turn off the computer, turn on the external device, and then turn on the computer to integrate the device with the computer system.
When the system advised you of changes to the configuration, you did not accept them.	Reboot the computer and follow the instructions for accepting the changes.
A plug and play board may not automatically configure when added if the default configuration conflicts with other devices.	Use Windows Device Manager to deselect the automatic settings for the board and choose a basic configuration that does not cause a resource conflict. You can also use Computer Setup to reconfigure or disable devices to resolve the resource conflict. To access Device Manager in Windows 10, type <code>device manager</code> in the taskbar search box, and then select Device Manager from the list of applications.
USB ports on the computer are disabled in Computer Setup.	Run the Computer Setup utility and make sure that Device available is selected for appropriate USB ports under Advanced > Port Options .

Computer will not start.

Cause	Solution
Wrong memory modules were used in the upgrade or memory modules were installed in the wrong location.	<ol style="list-style-type: none">1. Review the documentation that came with the system to determine if you are using the correct memory modules and to verify the proper installation. NOTE: DIMM1 or XMM1 must always be installed. DIMM1 must be installed before DIMM2, and DIMM3 must be installed before DIMM4.2. Observe the beeps and LED lights on the front of the computer. Beeps and flashing LEDs are codes for specific problems.3. If you still cannot resolve the issue, contact Customer Support.

Power LED flashes Red three times and then white two times.

Cause	Solution
Memory is installed incorrectly or is bad.	<p>IMPORTANT: To avoid damage to the DIMMs or the system board, you must unplug the computer power cord before attempting to reseat, install, or remove a DIMM module.</p> <ol style="list-style-type: none">1. Reseat DIMMs. Power on the system.2. Replace DIMMs one at a time to isolate the faulty module. NOTE: DIMM1 or XMM1 must always be installed. DIMM1 must be installed before DIMM2, and DIMM3 must be installed before DIMM43. Replace third-party memory with HP memory.4. Replace the system board.

Solving network problems

Some common causes and solutions for network problems are listed in the following table. These guidelines do not discuss the process of debugging the network cabling.

Network driver does not detect network controller.

Cause	Solution
Network controller is disabled.	<ol style="list-style-type: none">1. Run Computer Setup and enable network controller.2. Enable the network controller in the operating system using Device Manager. To access Device Manager in Windows 10, type <code>device manager</code> in the taskbar search box, and then select Device Manager from the list of applications.
Incorrect network driver.	Check the network controller documentation for the correct driver or obtain the latest driver from the manufacturer's website.

Network status link light never flashes.

NOTE: The network status light is supposed to flash when there is network activity.

Cause	Solution
No active network is detected.	Check cabling and network equipment for proper connection.
Network controller is not set up properly.	Check for the device status within Windows, such as Device Manager for driver load and the Network Connections applet within Windows for link status. To access Device Manager in Windows 10, type <code>device manager</code> in the taskbar search box, and then select Device Manager from the list of applications.
Network controller is disabled.	<ol style="list-style-type: none">1. Run Computer Setup and enable network controller.2. Enable the network controller in the operating system using Device Manager. To access Device Manager in Windows 10, type <code>device manager</code> in the taskbar search box, and then select Device Manager from the list of applications.
Network driver is not properly loaded.	Reinstall network drivers.
System cannot autosense the network.	Disable auto-sensing capabilities and force the system into the correct operating mode.

Diagnostics reports a failure.

Cause	Solution
The cable is not securely connected.	Make sure that the cable is securely attached to the network connector and that the other end of the cable is securely attached to the correct device.
The cable is attached to the incorrect connector.	Make sure that the cable is attached to the correct connector.
There is a problem with the cable or a device at the other end of the cable.	Make sure that the cable and device at the other end are operating correctly.
The network controller is defective.	Contact an authorized service provider.

Diagnostics passes, but the computer does not communicate with the network.

Cause	Solution
Network drivers are not loaded, or driver parameters do not match current configuration.	Make sure that the network drivers are loaded and that the driver parameters match the configuration of the network controller. Make sure that the correct network client and protocol is installed.
The network controller is not configured for this computer.	Select the Network and Sharing Center icon in the Control Panel and configure the network controller. To access Control Panel in Windows 10, type <code>control panel</code> in the taskbar search box, and then select Control Panel from the list of applications.

Network controller stopped working when an expansion board was added to the computer.

Cause	Solution
The network controller requires drivers.	Verify that the drivers were not accidentally deleted when the drivers for a new expansion board were installed.

Network controller stops working without apparent cause.

Cause	Solution
The cable is not securely connected.	Make sure that the cable is securely attached to the network connector and that the other end of the cable is securely attached to the correct device.
The network controller is defective.	Contact an authorized service provider.

New network card will not boot.

Cause	Solution
New network card might be defective or may not meet industry-standard specifications.	Install a working, industry-standard NIC, or change the boot sequence to boot from another source.

Cannot connect to network server when attempting Remote System Installation.

Cause	Solution
The network controller is not configured properly.	Verify Network Connectivity, that a DHCP Server is present, and that the Remote System Installation Server contains the NIC drivers for your NIC.

System setup utility reports unprogrammed EEPROM.

Cause	Solution
Unprogrammed EEPROM.	Contact an authorized service provider.

Solving memory problems

If you encounter memory problems, some common causes and solutions are listed in the following table.



IMPORTANT: Power may still be supplied to the DIMMs when the computer is turned off (depending on the Management Engine (ME) settings). To avoid damage to the DIMMs or the system board, you must unplug the computer power cord before attempting to reseat, install, or remove a memory module.

For those systems that support ECC memory, HP does not support mixing ECC and non-ECC memory. Otherwise, the computer will not boot the operating system.



NOTE: The memory count will be affected by configurations with the Management Engine (ME) enabled. The ME uses 8 MB of system memory in single channel mode or 16MB of memory in dual-channel mode to download, decompress, and execute the ME firmware for Out-of-Band (OOB), third-party data storage, and other management functions.

System will not boot or does not function properly after installing additional memory modules.

Cause	Solution
A memory module is not installed in the DIMM1 or XMM1 socket.	Make sure that a memory module is installed in the DIMM1 or XMM1 socket on the system board. This socket must be populated with a memory module.
Memory module is not the correct type or speed grade for the system or the new memory module is not seated properly.	Replace module with the correct industry-standard device for the computer. On some models, ECC and non-ECC memory modules cannot be mixed.

Out of memory error.

Cause	Solution
You have run out of memory to run the application.	Check the application documentation to determine the memory requirements.

Memory count during POST is wrong.

Cause	Solution
The memory modules may not be installed correctly.	Check that the memory modules have been installed correctly and that proper modules are used.
Integrated graphics may use system memory.	No action required.

Insufficient memory error during operation.

Cause	Solution
Too many Terminate and Stay Resident programs (TSRs) are installed.	Delete any TSRs that you do not need.
You have run out of memory for the application.	Check the memory requirements for the application or add more memory to the computer.

Power LED flashes red five times, once every second, followed by a 2 s pause, and the computer beeps five times. (Beeps stop after fifth iteration but LEDs continue flashing.)

Cause	Solution
Memory is installed incorrectly or is bad.	<ol style="list-style-type: none"> 1. Reseat DIMMs. Power on the system. 2. Replace DIMMs one at a time to isolate the faulty module. 3. Replace third-party memory with HP memory. 4. Replace the system board.

System memory is performing at a speed lower than DIMM specification.

Cause	Solution
If the system is populated with two DIMMs, it runs at the maximum speed of the DIMMs as allowed by the system hardware. However, if a single DIMM is added to a dual-memory configuration, DIMM speed may be reduced to the minimum system memory speed configuration, even if the additional DIMM is specified to run at the higher speed..	When the system is configured with two DIMMs in dual-channel mode, it might operate at a higher speed. Adding a single additional DIMM changes the mode and can reduce memory speed. To run at a higher memory speed, make sure to add a total of two DIMMs to cause the system to operate in a higher-performing dual-channel mode.

Solving CD-ROM and DVD problems

If you encounter CD-ROM or DVD problems, see the common causes and solutions listed in the following table or to the documentation that came with the optional device.

System will not boot from CD-ROM or DVD drive.

Cause	Solution
The device is attached to a SATA port that has been hidden in the Computer Setup utility.	Run the Computer Setup utility and ensure Device Available is selected for the device's SATA port in Advanced > Port Options .
Removable Media Boot is disabled in the Computer Setup utility.	Run the Computer Setup utility and enable booting to removable media in Advanced > Boot Options .
Network Boot is enabled in Computer Setup.	Run the Computer Setup utility and disable Network Boot in Advanced > Boot Options .
Non-bootable CD in drive.	Try a bootable CD in the drive.
Boot order not correct.	Run the Computer Setup utility and change boot sequence in Advanced > Boot Options .

Drive not found (identified).

Cause	Solution
Cable could be loose.	Check cable connections.
The system may not have automatically recognized a newly installed device.	See reconfiguration directions in the Solving hardware installation problems on page 82 section. If the system still does not recognize the new device, check to see if the device is listed within Computer Setup. If it is listed, the probable cause is a driver problem. If it is not listed, the probable cause is a hardware problem. If this is a newly installed drive, run the Computer Setup utility and try adding a POST delay under Advanced > Power-On Options .
The device is attached to a SATA port that has been hidden in Computer Setup.	Run the Computer Setup utility and ensure Device Available is selected for the device's SATA port in Advanced > Port Options .
Drive responds slowly immediately after power-up.	Run Computer Setup and increase the POST Delay in Advanced > Power-On Options .

CD-ROM or DVD devices are not detected or driver is not loaded.

Cause	Solution
Drive is not connected properly or not properly configured.	See the documentation that came with the optional device.

Movie will not play in the DVD drive.

Cause	Solution
Movie might be regionalized for a different country.	See the documentation that came with the DVD drive.
Decoder software is not installed.	Install decoder software.
Damaged media.	Replace media.
Movie rating locked out by parental lock.	Use DVD software to remove parental lock.
Media installed upside down.	Reinstall media.

Cannot eject compact disc (tray-load unit).

Cause	Solution
Disc not properly seated in the drive.	Turn off the computer and insert a thin metal rod into the emergency eject hole and push firmly. Slowly pull the tray out from the drive until the tray is fully extended, and then remove the disc.

CD-ROM, CD-RW, DVD-ROM, or DVD-R/RW drive cannot read a disc or takes too long to start.

Cause	Solution
Media is corrupt.	Try different media to confirm whether media is valid.
Media has been inserted upside down.	Reinsert the media with the label facing up.
The DVD-ROM drive takes longer to start because it has to determine the type of media played, such as audio or video.	Wait at least 30 s to let the DVD-ROM drive determine the type of media being played. If the disc still does not start, read the other solutions listed for this topic.
CD or DVD disc is dirty.	Clean CD or DVD with a CD cleaning kit, available from most computer stores.
Windows does not detect the CD-ROM or DVD-ROM drive.	<ol style="list-style-type: none">1. Use Device Manager to remove or uninstall the device. To access Device Manager in Windows 10, type <code>device manager</code> in the taskbar search box, and then select Device Manager from the list of applications.2. Restart the computer and let Windows detect the CD or DVD driver.

Recording or copying CDs is difficult or impossible.

Cause	Solution
Wrong or poor quality media type.	<ol style="list-style-type: none">1. Try using a slower speed when recording.2. Verify that you are using the correct media for the drive.3. Try a different brand of media. Quality varies widely between manufacturers.

Solving USB flash drive problems

If you encounter USB flash drive problems, common causes and solutions are listed in the following table.

USB flash drive is not seen as a drive letter in Windows.

Cause	Solution
The drive letter after the last physical drive is not available.	Change the default drive letter for the flash drive in Windows.

USB flash drive not found (identified).

Cause	Solution
The device is attached to a USB port that has been hidden in Computer Setup.	Run the Computer Setup utility and enable USB ports in Advanced > Port Options .
The device was not properly seated before power-up.	Ensure the device is fully inserted into the USB port before applying power to the system

System will not boot from USB flash drive.

Cause	Solution
Boot order is not correct.	Run the Computer Setup utility and change boot sequence in Advanced > Boot Options .
Removable Media Boot is disabled in the Computer Setup utility.	Run the Computer Setup utility and enable booting to removable media in Advanced > Boot Options . Ensure USB is enabled in Storage > Boot Order .

The computer boots to DOS after making a bootable flash drive.

Cause	Solution
Flash drive is bootable.	Install the flash drive only after the operating system boots.
Flash drive is defective.	Try a different flash drive.

Solving front panel component problems

If you encounter problems with devices connected to the front panel, see the common causes and solutions listed in the following table.

A USB device, headphone, or microphone is not recognized by the computer.

Cause	Solution
Device is not properly connected.	<ol style="list-style-type: none">1. Turn off the computer.2. Reconnect the device to the front of the computer and restart the computer.
The device does not have power.	If the USB device requires AC power, be sure one end is connected to the device and one end is connected to a live outlet.
The correct device driver is not installed.	<ol style="list-style-type: none">1. Install the correct driver for the device.2. You might need to reboot the computer.
The cable from the device to the computer does not work.	<ol style="list-style-type: none">1. If possible, replace the cable.2. Restart the computer.
The device is not working.	<ol style="list-style-type: none">1. Replace the device.2. Restart the computer.
USB ports on the computer are disabled in Computer Setup.	Run the Computer Setup utility and make sure that the USB ports are set to Enabled in Security > USB Security .

Solving Internet access problems

If you encounter Internet access problems, consult your Internet Service Provider (ISP) or see the common causes and solutions listed in the following table.

Unable to connect to the Internet.

Cause	Solution
Internet Service Provider (ISP) account is not set up properly.	Verify Internet settings or contact your ISP for assistance.
Web browser is not set up properly.	Verify that the Web browser is installed and set up to work with your ISP.
Cable/DSL modem is not plugged in.	Plug in cable/DSL modem. You should see a power LED light on the front of the cable/DSL modem.
Cable/DSL service is not available or has been interrupted due to bad weather.	Try connecting to the Internet at a later time or contact your ISP. (If the cable/DSL service is connected, the cable LED light on the front of the cable/DSL modem will be on.)
The CAT5 UTP cable is disconnected.	Connect the CAT5 UTP cable between the cable modem and the computer's RJ-45 connector. (If the connection is good, the PC LED light on the front of the cable/DSL modem will be on.)
IP address is not configured properly.	Contact your ISP for the correct IP address.
Cookies are corrupted. (A cookie is a small piece of information that a Web server can store temporarily with the Web browser. This is useful for having the browser remember some specific information that the Web server can later retrieve.)	Windows 10: <ol style="list-style-type: none">1. Type <code>control panel</code> in the taskbar search box, and then select Control Panel from the list of applications.

Unable to connect to the Internet.

Cause	Solution
	<ol style="list-style-type: none">Click Internet Options.In the Browsing history section, click the Delete button.Select the Cookies and website data check box and click the Delete button.

Cannot automatically launch Internet programs.

Cause	Solution
You must log on to your ISP before some programs will start.	Log on to your ISP and launch a program.

Solving software problems

Most software problems occur as a result of the following issues:

- The application was not installed or configured correctly.
- There is insufficient memory available to run the application.
- There is a conflict between applications.
- All the necessary device drivers might not have been installed.
- If you have installed an operating system other than the factory-installed operating system, it might not be supported on the system.

If you encounter software problems, see the applicable solutions listed in the following table.

Computer will not continue and the HP logo does not appear.

Cause	Solution
ROM issue - POST error has occurred.	Observe the beeps and LED lights on the front of the computer. See POST error messages on page 92 to determine possible causes. See the Worldwide Limited Warranty for terms and conditions.

“Illegal Operation has Occurred” error message is displayed.

Cause	Solution
Software being used is not Microsoft-certified for your version of Windows.	Verify that the software is certified by Microsoft for your version of Windows (see program packaging for this information).
Configuration files are corrupt.	If possible, save all data, close all programs, and restart the computer.

7 POST error messages

This chapter lists the error codes, error messages, and the various indicator light and audible sequences that you may encounter during Power-On Self-Test (POST) or computer restart, the probable source of the problem, and steps you can take to resolve the error condition.

POST Message Disabled suppresses most system messages during POST, such as memory count and non-error text messages. If a POST error occurs, the screen will display the error message. To manually switch to the POST Messages Enabled mode during POST, press any key (except **F10**, **F11**, or **F12**). The default mode is POST Message Disabled.

The speed at which the computer loads the operating system and the extent to which it is tested are determined by the POST mode selection.

Quick Boot is a fast startup process that does not run all of the system level tests, such as the memory test. Full Boot runs all of the ROM-based system tests and takes longer to complete.

Full Boot may also be enabled to run every 1 to 30 days on a regularly scheduled basis. To establish the schedule, reconfigure the computer to the Full Boot Every x Days mode, using Computer Setup.



NOTE: For more information on Computer Setup, see [Computer Setup \(F10\) Utility on page 51](#).

POST numeric codes and text messages

This section covers those POST errors that have numeric codes associated with them. The section also includes some text messages that may be encountered during POST.



NOTE: The computer will beep once after a POST text message is displayed on the screen.

Control panel message	Description	Recommended action
101-Option ROM Checksum Error	System ROM or expansion board option ROM checksum.	<ol style="list-style-type: none">1. Verify the correct ROM.2. Flash the ROM if needed.3. If an expansion board was recently added, remove it to see if the problem remains.4. Clear CMOS (see Password security and resetting CMOS on page 98).5. If the message disappears, there may be a problem with the expansion card.6. Replace the system board.
103-System Board Failure	DMA or timers.	<ol style="list-style-type: none">1. Clear CMOS. (see Password security and resetting CMOS on page 98.)2. Replace the system board.
162-System Options Not Set	Configuration incorrect. RTC (real-time clock) battery may need to be replaced.	Run Computer Setup and check the configuration in Advanced > Onboard Devices . Reset the date and time under Control Panel . If the problem persists, replace the RTC battery. See the Removal and Replacement section for instructions on installing a new battery, or

Control panel message	Description	Recommended action
		contact an authorized dealer or reseller for RTC battery replacement.
163-Time & Date Not Set	Invalid time or date in configuration memory. RTC (real-time clock) battery may need to be replaced.	Reset the date and time under Control Panel (Computer Setup can also be used). If the problem persists, replace the RTC battery. See the Removal and Replacement section for instructions on installing a new battery, or contact an authorized dealer or reseller for RTC battery replacement.
163-Time & Date Not Set	CMOS jumper may not be properly installed.	Check for proper placement of the CMOS jumper if applicable.
164-MemorySize Error	Memory amount has changed since the last boot (memory added or removed).	Press the F1 key to save the memory changes.
164-MemorySize Error	Memory configuration incorrect.	<ol style="list-style-type: none"> 1. Run Computer Setup or Windows utilities. 2. Make sure the memory module(s) are installed properly. 3. If third-party memory has been added, test using HP-only memory. 4. Verify proper memory module type.
201-Memory Error	RAM failure.	<ol style="list-style-type: none"> 1. Ensure memory modules are correctly installed. 2. Verify proper memory module type. 3. Remove and replace the identified faulty memory module(s). 4. If the error persists after replacing memory modules, replace the system board.
213-Incompatible Memory Module in Memory Socket(s) X, X, ...	A memory module in memory socket identified in the error message is missing critical SPD information, or is incompatible with the chipset.	<ol style="list-style-type: none"> 1. Verify proper memory module type. 2. Try another memory socket. 3. Replace DIMM with a module conforming to the SPD standard.
214-DIMM Configuration Warning	Populated DIMM Configuration is not optimized.	Rearrange the DIMMs so that each channel has the same amount of memory.
219-ECC Memory Module Detected ECC Modules not supported on this Platform	Recently added memory module(s) support ECC memory error correction.	<ol style="list-style-type: none"> 1. If additional memory was recently added, remove it to see if the problem remains. 2. Check product documentation for memory support information.
301-Keyboard Error	Keyboard failure.	<ol style="list-style-type: none"> 1. Reconnect keyboard with computer turned off. 2. Check connector for bent or missing pins. 3. Ensure that none of the keys are depressed. 4. Replace keyboard.
303-Keyboard Controller Error	I/O board keyboard controller.	<ol style="list-style-type: none"> 1. Reconnect keyboard with computer turned off.

Control panel message	Description	Recommended action
		<ol style="list-style-type: none"> 2. Replace the system board.
304-Keyboard or System Unit Error	Keyboard failure.	<ol style="list-style-type: none"> 1. Reconnect the keyboard with computer turned off. 2. Ensure that none of the keys are depressed. 3. Replace the keyboard. 4. Replace the system board.
501-Display Adapter Failure	Graphics display controller.	<ol style="list-style-type: none"> 1. Clear CMOS. (see Password security and resetting CMOS on page 98). 2. Verify monitor is attached and turned on.
510-Flash Screen Image Corrupted	Flash Screen image has errors.	Reflash the system ROM with the latest BIOS image.
512-Chassis, Rear Chassis, or Front Chassis Fan not Detected	Fan is not connected or may have malfunctioned.	<ol style="list-style-type: none"> 1. Reseat fan. 2. Reseat fan cable. 3. Replace fan.
514-CPU or Chassis Fan not Detected	Fan is not connected or may have malfunctioned.	<ol style="list-style-type: none"> 1. Reseat fan. 2. Reseat fan cable. 3. Replace fan.
660-Display cache is detected unreliable	Integrated graphics controller display cache is not working properly and will be disabled.	Replace system board if minimal graphics degrading is an issue.
1720-SMART Hard Drive Detects Imminent Failure	Hard drive is about to fail. (Some hard drives have a hard drive firmware patch that will fix an erroneous error message.)	<ol style="list-style-type: none"> 1. Determine if hard drive is giving correct error message. Run the Drive Protection System test under using F2 Diagnostics when booting the computer. 2. Apply hard drive firmware patch if applicable. (Available at http://www.hp.com/support.) 3. Back up contents and replace hard drive.
2212-USB Key Provisioning failure writing to device	USB device used for USB key provisioning will not allow BIOS to update provision file properly.	<ol style="list-style-type: none"> 1. Try a different USB key device for provisioning. 2. If the error persists, update to the latest BIOS version and ME firmware version. 3. If the error still persists, replace the system board.
2217-ME Firmware Version request failure	ME firmware is not properly responding to BIOS query for version information.	<ol style="list-style-type: none"> 1. Reboot the computer. 2. If the error persists, update to the latest BIOS version and ME firmware version. 3. If the error still persists, replace the system board.
2218-ME Firmware Version should be updated	ME firmware must be updated to match current functionality contained in the system BIOS.	<ol style="list-style-type: none"> 1. Update to the latest ME firmware version. 2. If the error persists and system BIOS has been recently updated, restore previous system BIOS version.

Control panel message	Description	Recommended action
		<ol style="list-style-type: none"> 3. If the error still persists, replace the system board.
2219-USB Key Provisioning file has invalid header identifier	Provisioning file contained on the USB key has been corrupted or is not a valid version for the current ME firmware.	<ol style="list-style-type: none"> 1. Recreate the provisioning file using third party management console software. 2. If the error persists and system BIOS has been recently updated, restore previous system BIOS version. Otherwise, update the ME firmware version. 3. If the error still persists, replace the system board.
2220-USB Key Provisioning file has mismatch version	Provisioning file contained on the USB key is not a valid version for the current ME firmware.	<ol style="list-style-type: none"> 1. Reboot the computer. 2. If the error persists and system BIOS has been recently updated, restore previous system BIOS version. Otherwise, update the ME firmware version. 3. If the error still persists, replace the system board.
Invalid Electronic Serial Number	Electronic serial number is missing.	Enter the correct serial number in Computer Setup.
Network Server Mode Active and No Keyboard Attached	Keyboard failure while Network Server Mode enabled.	<ol style="list-style-type: none"> 1. Reconnect keyboard with computer turned off. 2. Check connector for bent or missing pins. 3. Ensure that none of the keys are depressed. 4. Replace keyboard.
Parity Check 2	Parity RAM failure.	Run Computer Setup and Diagnostic utilities.

Interpreting POST diagnostic front panel lights and audible codes

This section covers the front panel light codes as well as the audible codes that may occur before or during POST that do not necessarily have an error code or text message associated with them.

CAUTION: When the computer is plugged into an AC power source, voltage is always applied to the system board. To reduce the risk of personal injury from electrical shock and/or hot surfaces, be sure to disconnect the power cord from the AC outlet and allow the internal system components to cool before touching.

NOTE: If you see flashing lights on a PS/2 keyboard, look for flashing lights on the front panel of the computer and see the following table to determine the front panel light codes.

Recommended actions in the following table are listed in the order in which they should be performed.

Not all diagnostic lights and audible codes are available on all models.

Table 7-1 Interpreting POST diagnostic front panel lights and audible codes

Activity	Beeps	Possible cause	Recommended action
White power light On.	None	Computer on.	None
White power light flashes every two seconds.	None	Computer in Suspend to RAM mode (some models only) or normal Suspend mode.	None required. Press any key or move the mouse to wake the computer.
Red power light flashes two times, once every second, followed by a two second pause. Beeps stop after fifth iteration but lights continue until problem is solved.	2	Processor thermal protection activated: A fan may be blocked or not turning. OR The heat sink/fan assembly is not properly attached to the processor.	<ol style="list-style-type: none"> 1. Ensure that the computer air vents are not blocked and the cooling fan is running. 2. Open hood, press power button, and see if the fan spins. If the processor fan is not spinning, make sure the fan's cable is plugged onto the system board header. 3. If fan is plugged in, but is not spinning, then replace fan. 4. Contact an authorized reseller or service provider.
Red power light flashes four times, once every second, followed by a two second pause. Beeps stop after fifth iteration but lights continue until problem is solved.	4	Power failure (power supply is overloaded).	<ol style="list-style-type: none"> 1. Check if a device is causing the problem by removing all attached devices. Power on the system. If the system enters the POST, then power off and replace one device at a time and repeat this procedure until failure occurs. Replace the device that is causing the failure. Continue adding devices one at a time to ensure all devices are functioning properly. 2. Replace the power supply. 3. Replace the system board.
Red power light flashes five times, once every second, followed by a two second pause. Beeps stop after fifth iteration but lights continue until problem is solved.	5	Pre-video memory error.	<p>CAUTION: To avoid damage to the DIMMs or the system board, you must unplug the computer power cord before attempting to reseat, install, or remove a DIMM module.</p> <ol style="list-style-type: none"> 1. Reseat DIMMs. 2. Replace DIMMs one at a time to isolate the faulty module. 3. Replace third-party memory with HP memory.

Table 7-1 Interpreting POST diagnostic front panel lights and audible codes (continued)

Activity	Beeps	Possible cause	Recommended action
			4. Replace the system board.
Red power light flashes six times, once every second, followed by a two second pause. Beeps stop after fifth iteration but lights continue until problem is solved.	6	Pre-video graphics error.	Replace the system board.
Red power light flashes seven times, once every second, followed by a two second pause. Beeps stop after fifth iteration but lights continue until problem is solved.	7	System board failure (ROM detected failure before video).	Replace the system board.
Red power light flashes eight times, once every second, followed by a two second pause. Beeps stop after fifth iteration but lights continue until problem is solved.	8	Invalid ROM based on bad checksum.	1. Reflash the system ROM with the latest BIOS image. 2. Replace the system board.
Red power light flashes nine times, once every second, followed by a two second pause. Beeps stop after fifth iteration but lights continue until problem is solved.	9	System powers on but is unable to boot.	1. Unplug the AC power cord from the computer, wait 30 seconds, and then plug the power cord back in to the computer. 2. Replace the system board.
System does not power on and lights are not flashing.	None	System unable to power on.	Press and hold the power button for less than 4 seconds. If the hard drive light turns white, the power button is working correctly. ▲ Replace the system board. OR Press and hold the power button for less than 4 seconds. If the hard drive light does not turn on white then: 1. Check that the unit is plugged into a working AC outlet. 2. Replace the power supply.

8 Password security and resetting CMOS

This computer supports security password features, which can be established through the Computer Setup Utilities menu.

This computer supports two security password features that are established through the Computer Setup Utilities menu: administrator password and power-on password. When you establish only an administrator password, any user can access all the information on the computer except Computer Setup. When you establish only a power-on password, the power-on password is required to access Computer Setup and any other information on the computer. When you establish both passwords, only the administrator password will give you access to Computer Setup.

When both passwords are set, the administrator password can also be used in place of the power-on password as an override to log in to the computer. This feature is useful for a network administrator.

If you forget one or both passwords, you can clear all passwords by turning off the system, opening the cover, temporarily removing the PSWD jumper, and booting once. This action erases the administrator and power-on passwords. You must restore the jumper to create new passwords.

 **IMPORTANT:** Pushing the CMOS button with power removed resets the BIOS settings to factory defaults. It can be useful to back up the BIOS settings or save them as custom defaults before resetting them in case they are needed later. Back up can be performed in Computer Setup or using the BiosConfigUtility tool available from www.hp.com. See [Computer Setup \(F10\) Utility on page 51](#) for information on backing up the BIOS settings.

Resetting the password jumper

 **IMPORTANT:** If you enable the stringent security feature in Computer Setup and you forget the setup password or the power-on password, the computer is inaccessible and can no longer be used.

Enabling the stringent password disables the ability to reset the password by moving the jumper on the system board.

If you lose or forget the password, the system board must be replaced. This scenario is not covered under warranty.

To prevent the computer from becoming permanently unusable, record your configured setup password or power-on password in a safe place away from your computer. Without these passwords, the computer cannot be unlocked.

To disable the power-on or setup password features, or to clear the power-on or setup passwords, complete the following steps:

1. Shut down the operating system properly, and then turn off the computer and any external devices, and disconnect the power cord from the power outlet.
2. With the power cord disconnected, press the power button again to drain the system of any residual power.

 **WARNING!** To reduce the risk of personal injury from electrical shock, hot surfaces, or both, be sure to disconnect the power cord from the AC outlet, and allow the internal system components to cool before touching.

 **IMPORTANT:** When the computer is plugged in, the power supply always has voltage applied to the system board even when the unit is turned off. Failure to disconnect the power cord can result in damage to the system.

Static electricity can damage the electronic components of the computer or optional equipment. Before beginning these procedures, ensure that you are discharged of static electricity by briefly touching a grounded metal object. See the *Safety & Regulatory Information* guide for more information.

3. Remove the access panel.
4. Locate the header and jumper.

 **NOTE:** The password jumper is either green or blue so that it can be easily identified. For assistance locating the password jumper and other system board components, see the system board components image at [System board components on page 48](#).

5. Remove the jumper from pins 1 and 2.
6. Place the jumper on either pin 1 or 2, but not both, so that it does not get lost.
7. Replace the access panel and reconnect the external equipment.
8. Plug in the computer and turn on power. Allow the operating system to start. This clears the current passwords and disables the password features.
9. Shut down the computer, unplug the power, and disconnect the external equipment.
10. Remove the access panel.
11. Place the jumper on pins 1 and 2.
12. Replace the access panel.
13. Reconnect the external equipment and plug in the computer.

Changing a setup or power-on password

To change the power-on or setup password, complete the following steps:

1. Turn on or restart the computer.
 - To change the setup password, go to step 2.
 - To change the power-on password, go to step 3.
2. To change the setup password, as soon as the computer turns on:
 - Press the **esc** key while “Press the ESC key for Startup Menu” message is displayed.
 - Press the **f10** key to enter Computer Setup.

3. When the key icon appears, type your current password, a slash (/) or alternate delimiter character, your new password, another slash (/) or alternate delimiter character, and your new password again as shown:

current password/new password/new password



NOTE: Type the new password carefully since the characters do not appear on the screen.

4. Press **enter**.

The new password will take effect the next time the computer is restarted.

Deleting a setup or power-on password

To delete the power-on or setup password, complete the following steps:

1. Turn on or restart the computer.

To delete the setup password, go to step 2.

To delete the power-on password, go to step 3.

2. To delete the setup password, as soon as the computer turns on:

- Press the **esc** key while “Press the ESC key for Startup Menu” message is displayed.

- Press the **f10** key to enter Computer Setup.

3. When the key icon appears, type your current password, a slash (/) or alternate delimiter character, your new password, another slash (/) or alternate delimiter character, and your new password again as shown:

current password/

4. Press **enter**.

Clearing and resetting the CMOS

The computer’s configuration memory (CMOS) stores information about the computer’s configuration.

The CMOS button resets CMOS but does not clear the power-on and setup passwords.

1. Turn off the computer and any external devices, and disconnect the power cord from the power outlet.
2. Disconnect the keyboard, monitor, and any other external equipment connected to the computer.



CAUTION: To reduce the risk of personal injury from electrical shock, hot surfaces, or both, be sure to disconnect the power cord from the AC outlet, and allow the internal system components to cool before touching.



IMPORTANT: When the computer is plugged in, the power supply always has voltage applied to the system board even when the unit is turned off. Failure to disconnect the power cord can result in damage to the system.

Static electricity can damage the electronic components of the computer or optional equipment. Before beginning these procedures, ensure that you are discharged of static electricity by briefly touching a grounded metal object. See the *Safety & Regulatory Information* guide for more information.

3. Remove the access panel.

 **IMPORTANT:** Pushing the CMOS button resets CMOS values to factory defaults. Back up the computer CMOS settings before resetting them in case you need them. Back up is easily done through Computer Setup. See [Computer Setup \(F10\) Utility on page 51](#) for information on backing up the CMOS settings.

4. Locate, press, and hold the CMOS button in for 5 seconds.

 **NOTE:** Make sure you have disconnected the AC power cord from the AC outlet. The CMOS button will not clear CMOS if the power cord is connected.



 **NOTE:** For assistance locating the CMOS button and other system board components, see the system board components image at [System board components on page 48](#).

5. Replace the access panel.
6. Reconnect the external devices.
7. Plug in the computer and turn on power.

 **NOTE:** You will receive POST error messages after clearing CMOS and rebooting advising you that configuration changes have occurred. Use Computer Setup to reset any special system setups along with the date and time.

For instructions on Computer Setup, see [Computer Setup \(F10\) Utility on page 51](#).

9 Using HP PC Hardware Diagnostics

Using HP PC Hardware Diagnostics Windows (select products only)

HP PC Hardware Diagnostics Windows is a Windows-based utility that allows you to run diagnostic tests to determine whether the computer hardware is functioning properly. The tool runs within the Windows operating system to diagnose hardware failures.

If HP PC Hardware Diagnostics Windows is not installed on your computer, first you must download and install it. To download HP PC Hardware Diagnostics Windows, see [Downloading HP PC Hardware Diagnostics Windows on page 102](#).

After HP PC Hardware Diagnostics Windows is installed, follow these steps to access it from HP Help and Support or HP Support Assistant.

1. To access HP PC Hardware Diagnostics Windows from HP Help and Support:

- a. Select the **Start** button, and then select **HP Help and Support**.
- b. Select **HP PC Hardware Diagnostics Windows**.

– or –

To access HP PC Hardware Diagnostics Windows from HP Support Assistant:

- a. Type `support` in the taskbar search box, and then select the **HP Support Assistant** app.

– or –

Select the question mark icon in the taskbar.

- b. Select **Troubleshooting and fixes**.
- c. Select **Diagnostics**, and then select **HP PC Hardware Diagnostics Windows**.

2. When the tool opens, select the type of diagnostic test that you want to run, and then follow the on-screen instructions.

 **NOTE:** To stop a diagnostic test, select **Cancel**.

When HP PC Hardware Diagnostics Windows detects a failure that requires hardware replacement, a 24-digit Failure ID code is generated. The screen displays one of the following options:

- A Failure ID link is displayed. Select the link and follow the on-screen instructions.
- Instructions for calling support are displayed. Follow those instructions.

Downloading HP PC Hardware Diagnostics Windows

- The HP PC Hardware Diagnostics Windows downloading instructions are provided in English only.
- You must use a Windows computer to download this tool because only .exe files are provided.

Downloading the latest HP PC Hardware Diagnostics Windows version

To download HP PC Hardware Diagnostics Windows, follow these steps:

1. Go to <http://www.hp.com/go/techcenter/pcdiags>. The HP PC Diagnostics home page is displayed.
2. Select **Download HP Diagnostics Windows**, and then select a location on your computer or a USB flash drive.

The tool downloads to the selected location.

– or –

You can use the following steps to download the HP PC Hardware Diagnostics Windows from the Microsoft Store:

1. Select the Microsoft app on your desktop or enter `Microsoft Store` in the taskbar search box.
2. Enter `HP PC Hardware Diagnostics Windows` in the **Microsoft Store** search box.
3. Follow the on-screen directions.

The tool downloads to the selected location.

Downloading HP Hardware Diagnostics Windows by product name or number (select products only)



NOTE: For some products, you might have to download the software to a USB flash drive by using the product name or number.

To download HP PC Hardware Diagnostics Windows by product name or number, follow these steps:

1. Go to <http://www.hp.com/support>.
2. Select **Get software and drivers**, select your type of product, and then enter the product name or number in the search box that is displayed.
3. In the **Diagnostics** section, select **Download**, and then follow the on-screen instructions to select the specific Windows diagnostics version to be downloaded to your computer or USB flash drive.

The tool downloads to the selected location.

Installing HP PC Hardware Diagnostics Windows

To install HP PC Hardware Diagnostics Windows, follow these steps:

- ▲ Navigate to the folder on your computer or the USB flash drive where the .exe file downloaded, double-click the .exe file, and then follow the on-screen instructions.

Using HP PC Hardware Diagnostics UEFI



NOTE: For Windows 10 S computers, you must use a Windows computer and a USB flash drive to download and create the HP UEFI support environment because only .exe files are provided. For more information, see [Downloading HP PC Hardware Diagnostics UEFI to a USB flash drive on page 104](#).

HP PC Hardware Diagnostics UEFI (Unified Extensible Firmware Interface) allows you to run diagnostic tests to determine whether the computer hardware is functioning properly. The tool runs outside the operating system so that it can isolate hardware failures from issues that are caused by the operating system or other software components.

If your PC does not start in Windows, you can use HP PC Hardware Diagnostics UEFI to diagnose hardware issues.

When HP PC Hardware Diagnostics UEFI detects a failure that requires hardware replacement, a 24-digit Failure ID code is generated. For assistance in solving the problem:

- ▲ Select **Contact HP**, accept the HP privacy disclaimer, and then use a mobile device to scan the Failure ID code that appears on the next screen. The HP Customer Support - Service Center page appears with your Failure ID and product number automatically filled in. Follow the on-screen instructions.

– or –

Contact support, and provide the Failure ID code.

 **NOTE:** To start diagnostics on a convertible computer, your computer must be in notebook mode, and you must use the attached keyboard.

 **NOTE:** If you need to stop a diagnostic test, press *esc*.

Starting HP PC Hardware Diagnostics UEFI

To start HP PC Hardware Diagnostics UEFI, follow these steps:

1. Turn on or restart the computer, and quickly press *esc*.
2. Press *f2*.

The BIOS searches three places for the diagnostic tools, in the following order:

- a. Connected USB flash drive

 **NOTE:** To download the HP PC Hardware Diagnostics UEFI tool to a USB flash drive, see [Downloading the latest HP PC Hardware Diagnostics UEFI version on page 104](#).

- b. Hard drive

- c. BIOS

3. When the diagnostic tool opens, select a language, select the type of diagnostic test you want to run, and then follow the on-screen instructions.

Downloading HP PC Hardware Diagnostics UEFI to a USB flash drive

Downloading HP PC Hardware Diagnostics UEFI to a USB flash drive can be useful in the following situations:

- HP PC Hardware Diagnostics UEFI is not included in the preinstallation image.
- HP PC Hardware Diagnostics UEFI is not included in the HP Tool partition.
- The hard drive is damaged.

 **NOTE:** The HP PC Hardware Diagnostics UEFI downloading instructions are provided in English only, and you must use a Windows computer to download and create the HP UEFI support environment because only .exe files are provided.

Downloading the latest HP PC Hardware Diagnostics UEFI version

To download the latest HP PC Hardware Diagnostics UEFI version to a USB flash drive:

1. Go to <http://www.hp.com/go/techcenter/pcdiags>. The HP PC Diagnostics home page is displayed.
2. Select **Download HP Diagnostics UEFI**, and then select **Run**.

Downloading HP PC Hardware Diagnostics UEFI by product name or number (select products only)

 **NOTE:** For some products, you might have to download the software to a USB flash drive by using the product name or number.

To download HP PC Hardware Diagnostics UEFI by product name or number (select products only) to a USB flash drive:

1. Go to <http://www.hp.com/support>.
2. Enter the product name or number, select your computer, and then select your operating system.
3. In the **Diagnostics** section, follow the on-screen instructions to select and download the specific UEFI Diagnostics version for your computer.

Using Remote HP PC Hardware Diagnostics UEFI settings (select products only)

Remote HP PC Hardware Diagnostics UEFI is a firmware (BIOS) feature that downloads HP PC Hardware Diagnostics UEFI to your computer. It can then execute the diagnostics on your computer, and it might upload results to a preconfigured server. For more information about Remote HP PC Hardware Diagnostics UEFI, go to <http://www.hp.com/go/techcenter/pcdiags>, and then select **Find out more**.

Downloading Remote HP PC Hardware Diagnostics UEFI

 **NOTE:** HP Remote PC Hardware Diagnostics UEFI is also available as a SoftPaq that you can download to a server.

Downloading the latest Remote HP PC Hardware Diagnostics UEFI version

To download the latest Remote HP PC Hardware Diagnostics UEFI version, follow these steps:

1. Go to <http://www.hp.com/go/techcenter/pcdiags>. The HP PC Diagnostics home page is displayed.
2. Select **Download Remote Diagnostics**, and then select **Run**.

Downloading Remote HP PC Hardware Diagnostics UEFI by product name or number

 **NOTE:** For some products, you might have to download the software by using the product name or number.

To download HP Remote PC Hardware Diagnostics UEFI by product name or number, follow these steps:

1. Go to <http://www.hp.com/support>.
2. Select **Get software and drivers**, select your type of product, enter the product name or number in the search box that is displayed, select your computer, and then select your operating system.
3. In the **Diagnostics** section, follow the on-screen instructions to select and download the **Remote UEFI** version for the product.

Customizing Remote HP PC Hardware Diagnostics UEFI settings

Using the Remote HP PC Hardware Diagnostics setting in Computer Setup (BIOS), you can perform the following customizations:

- Set a schedule for running diagnostics unattended. You can also start diagnostics immediately in interactive mode by selecting **Execute Remote HP PC Hardware Diagnostics**.
- Set the location for downloading the diagnostic tools. This feature provides access to the tools from the HP website or from a server that has been preconfigured for use. Your computer does not require the traditional local storage (such as a hard drive or USB flash drive) to run remote diagnostics.
- Set a location for storing the test results. You can also set the user name and password that you use for uploads.
- Display status information about the diagnostics run previously.

To customize Remote HP PC Hardware Diagnostics UEFI settings, follow these steps:

1. Turn on or restart the computer, and when the HP logo appears, press **f10** to enter Computer Setup.
2. Select **Advanced**, and then select **Settings**.
3. Make your customization selections.
4. Select **Main**, and then **Save Changes and Exit** to save your settings.

Your changes take effect when the computer restarts.

10 Backing up, restoring, and recovering

This chapter provides information about the following processes, which are standard procedure for most products:

- **Backing up your personal information**—You can use Windows tools to back up your personal information (see [Using Windows tools on page 107](#)).
- **Creating a restore point**—You can use Windows tools to create a restore point (see [Using Windows tools on page 107](#)).
- **Creating recovery media** (select products only)—You can use the HP Cloud Recovery Download Tool (select products only) to create recovery media (see [Using the HP Cloud Recovery Download Tool to create recovery media \(select products only\) on page 107](#)).
- **Restoring and recovery**—Windows offers several options for restoring from backup, refreshing the computer, and resetting the computer to its original state (see [Using Windows tools on page 107](#)).

 **IMPORTANT:** If you will be performing recovery procedures on a tablet, the tablet battery must be at least 70% charged before you start the recovery process.

IMPORTANT: For a tablet with a detachable keyboard, connect the tablet to the keyboard base before beginning any recovery process.

Backing up information and creating recovery media

Using Windows tools

 **IMPORTANT:** Windows is the only option that allows you to back up your personal information. Schedule regular backups to avoid information loss.

You can use Windows tools to back up personal information and create system restore points and recovery media.

 **NOTE:** If computer storage is 32 GB or less, Microsoft System Restore is disabled by default.

For more information and steps, see the Get Help app.

1. Select the **Start** button, and then select the **Get Help** app.
2. Enter the task you want to perform.

 **NOTE:** You must be connected to the Internet to access the Get Help app.

Using the HP Cloud Recovery Download Tool to create recovery media (select products only)

You can use the HP Cloud Recovery Download Tool to create HP Recovery media on a bootable USB flash drive.

For details:

- ▲ Go to <http://www.hp.com/support>, search for HP Cloud Recovery, and then select the result that matches the type of computer that you have.



NOTE: If you cannot create recovery media yourself, contact support to obtain recovery discs. Go to <http://www.hp.com/support>, select your country or region, and then follow the on-screen instructions.

Restoring and recovery

Restoring, resetting, and refreshing using Windows tools

Windows offers several options for restoring, resetting, and refreshing the computer. For details, see [Using Windows tools on page 107](#).

Recovering using HP Recovery media

You can use HP Recovery media to recover the original operating system and software programs that were installed at the factory. On select products, it can be created on a bootable USB flash drive using the HP Cloud Recovery Download Tool. For details, see [Using the HP Cloud Recovery Download Tool to create recovery media \(select products only\) on page 107](#).



NOTE: If you cannot create recovery media yourself, contact support to obtain recovery discs. Go to <http://www.hp.com/support>, select your country or region, and then follow the on-screen instructions.

To recover your system:

- ▲ Insert the HP Recovery media, and then restart the computer.

Changing the computer boot order

If your computer does not restart using the HP Recovery media, you can change the computer boot order. This is the order of devices listed in BIOS where the computer looks for startup information. You can change the selection to an optical drive or a USB flash drive, depending on the location of your HP Recovery media.

To change the boot order:



IMPORTANT: For a tablet with a detachable keyboard, connect the tablet to the keyboard base before beginning these steps.

1. Insert the HP Recovery media.
2. Access the system **Startup** menu.

For computers or tablets with keyboards attached:

- ▲ Turn on or restart the computer or tablet, quickly press **esc**, and then press **f9** for boot options.

For tablets without keyboards:

- ▲ Turn on or restart the tablet, quickly hold down the volume up button, and then select **f9**.

– or –

Turn on or restart the tablet, quickly hold down the volume down button, and then select **f9**.

3. Select the optical drive or USB flash drive from which you want to boot, and then follow the on-screen instructions.

Using HP Sure Recover (select products only)

Select computer models are configured with HP Sure Recover, a PC OS recovery solution built into the hardware and firmware. HP Sure Recover can fully restore the HP OS image without installed recovery software.

Using HP Sure Recover, an administrator or user can restore the system and install:

- Latest version of the operating system
- Platform-specific device drivers
- Software applications, in the case of a custom image

To access the latest documentation for HP Sure Recover, go to <http://www.hp.com/support>. Select **Find your product**, and then follow the on-screen instructions.

11 Power cord set requirements

The power supplies on some computers have external power switches. The voltage select switch feature on the computer permits it to operate from any line voltage of 100 V ac-120 V ac or 220 V ac-240 V ac. Power supplies on those computers that do not have external power switches are equipped with internal switches that sense the incoming voltage and automatically switch to the proper voltage.

The power cord set received with the computer meets the requirements for use in the country where you purchased the equipment.

Power cord sets for use in other countries must meet the requirements of the country where you use the computer.

General requirements

The following requirements are applicable to all countries:

1. The power cord must be approved by an acceptable accredited agency responsible for evaluation in the country where the power cord set will be installed.
2. The power cord set must have a minimum current capacity of 10A (7A Japan only) and a nominal voltage rating of 125 V ac or 250 V ac, as required by each country's power system.
3. The diameter of the wire must be a minimum of 0.75 mm² or 18AWG, and the length of the cord must be between 1.8 m (6 ft) and 3.6 m (12 ft).

The power cord should be routed so that it is not likely to be walked on or pinched by items placed upon it or against it. Particular attention should be paid to the plug, electrical outlet, and the point where the cord exits from the product.

 **WARNING!** Do not operate this product with a damaged power cord set. If the power cord set is damaged in any manner, replace it immediately.

Japanese power cord requirements

For use in Japan, use only the power cord received with this product.

 **IMPORTANT:** Do not use the power cord received with this product on any other products.

Country-specific requirements

Additional requirements specific to a country are shown in parentheses and explained in the following table.

Table 11-1 Power cord country-specific requirements

Country	Accrediting Agency	Country	Accrediting Agency
Australia (1)	EANSW	Italy (1)	IMQ
Austria (1)	OVE	Japan (3)	METI
Belgium (1)	CEBC	Norway (1)	NEMKO
Canada (2)	CSA	Sweden (1)	SEMKO
Denmark (1)	DEMKO	Switzerland (1)	SEV
Finland (1)	SETI	United Kingdom (1)	BSI
France (1)	UTE	United States (2)	UL
Germany (1)	VDE		

1. The flexible cord must be Type H05VV-F, 3-conductor, 0.75mm² conductor size. Power cord set fittings (appliance coupler and plug) must bear the certification mark of the agency responsible for evaluation in the country where it will be used.
2. The flexible cord must be Type SVT or equivalent, No. 18 AWG, 3 conductor. The plug must be a 2-pole grounding type with a NEMA 5-15P (15 A, 125 V) or NEMA 6-15P (15 A, 250 V) configuration.
3. Appliance coupler, flexible cord, and plug must bear a T mark and registration number in accordance with the Japanese Dentori Law. Flexible cord must be Type VCT or VCTF, 3-conductor, 0.75 mm² conductor size. Plug must be a 2-pole grounding type with a Japanese Industrial Standard C8303 (7 A, 125 V) configuration.

12 Statement of memory volatility

The purpose of this chapter is to provide general information regarding nonvolatile memory in HP Business computers. This chapter also provides general instructions for restoring nonvolatile memory that can contain personal data after the system has been powered off and the hard drive has been removed.

HP Business computer products that use Intel®-based or AMD®-based system boards contain volatile DDR memory. The amount of nonvolatile memory present in the system depends upon the system configuration. Intel-based and AMD-based system boards contain nonvolatile memory subcomponents as originally shipped from HP, assuming that no subsequent modifications have been made to the system and assuming that no applications, features, or functionality have been added to or installed on the system.

Following system shutdown and removal of all power sources from an HP Business computer system, personal data can remain on volatile system memory (DIMMs) for a finite period of time and will also remain in nonvolatile memory. Use the following steps to remove personal data from the computer, including the nonvolatile memory found in Intel-based and AMD-based system boards.

 **NOTE:** If your tablet has a keyboard base, connect to the keyboard base before beginning steps in this chapter.

Current BIOS steps

1. Follow steps (a) through (l) to restore the nonvolatile memory that can contain personal data. Restoring or reprogramming nonvolatile memory that does not store personal data is neither necessary nor recommended.
 - a. Turn on or restart the computer, and then press **esc** while the “Press the ESC key for Startup Menu” message is displayed at the bottom of the screen.

 **NOTE:** If the system has a BIOS administrator password, enter the password at the prompt.

- b. Select **Main**, select **Apply Factory Defaults and Exit**, and then select **Yes** to load defaults.

The computer will reboot.

- c. During the reboot, press **esc** while the “Press the ESC key for Startup Menu” message is displayed at the bottom of the screen.

 **NOTE:** If the system has a BIOS administrator password, enter the password at the prompt.

- d. Select the **Security** menu, select **Restore Security Settings to Factory Defaults**, and then select **Yes** to restore security level defaults.

The computer will reboot.

- e. During the reboot, press **esc** while the “Press the ESC key for Startup Menu” message is displayed at the bottom of the screen.

 **NOTE:** If the system has a BIOS administrator password, enter the password at the prompt.

- f. If an asset or ownership tag is set, select the **Security** menu and scroll down to the **Utilities** menu. Select **System IDs**, and then select **Asset Tracking Number**. Clear the tag, and then make the selection to return to the prior menu.

- g. If a DriveLock password is set, select the **Security** menu, and scroll down to **Hard Drive Utilities** under the **Utilities** menu. Select **Hard Drive Utilities**, select **DriveLock**, and then clear the check box for **DriveLock password on restart**. Select **OK** to proceed.
 - h. Select the **Main** menu, and then select **Reset BIOS Security to factory default**. Click **Yes** at the warning message.

The computer will reboot.
 - i. During the reboot, press **esc** while the “Press the ESC key for Startup Menu” message is displayed at the bottom of the screen.
-
-  **NOTE:** If the system has a BIOS administrator password, enter the password at the prompt.
- j. Select the **Main** menu, select **Apply Factory Defaults and Exit**, select **Yes** to save changes and exit, and then select **Shutdown**.
 - k. Reboot the system. If the system has a Trusted Platform Module (TPM) and/or fingerprint reader, one or two prompts will appear—one to clear the TPM and the other to Reset Fingerprint Sensor; press or tap **F1** to accept or **F2** to reject.
 - l. Remove all power and system batteries for at least 24 hours.
2. Complete one of the following:
- Remove and retain the storage drive.
 - or –
 - Clear the drive contents by using a third party utility designed to erase data from an SSD.
 - or –
 - Clear the contents of the drive by using the following BIOS Setup Secure Erase command option steps:

 **IMPORTANT:** If you clear data using Secure Erase, it cannot be recovered.

- a. Turn on or restart the computer, and then press **esc** while the “Press the ESC key for Startup Menu” message is displayed at the bottom of the screen.
- b. Select the **Security** menu and scroll down to the **Utilities** menu.
- c. Select **Hard Drive Utilities**.
- d. Under **Utilities**, select **Secure Erase**, select the hard drive storing the data you want to clear, and then follow the on-screen instructions to continue.

Nonvolatile memory usage

Table 12-1 Troubleshooting steps for nonvolatile memory usage

Nonvolatile Memory Type	Amount (Size)	Does this memory store customer data?	Does this memory retain data when power is removed?	What is the purpose of this memory?	How is data input into this memory?	How is this memory write-protected?
HP Sure Start flash (select models only)	8 MB	No	Yes	Provides protected backup of critical System BIOS code, EC firmware, and critical computer configuration data for select platforms that support HP Sure Start. For more information, see Using HP Sure Start (select models only) on page 117 .	Data cannot be written to this device via the host processor. The content is managed solely by the HP Sure Start Embedded Controller.	This memory is protected by the HP Sure Start Embedded Controller.
Real Time Clock (RTC) battery backed-up CMOS configuration memory	256 bytes	No	Yes	Stores system date and time and noncritical data.	RTC battery backed-up CMOS is programmed using Computer Setup (BIOS), or by changing the Microsoft® Windows date & time.	This memory is not write-protected.
Controller (NIC) EEPROM	64 KB (not customer accessible)	No	Yes	Stores NIC configuration and NIC firmware.	NIC EEPROM is programmed using a utility from the NIC vendor that can be run from DOS.	A utility must be used to write data to this memory and is available from the NIC vendor. Writing data to this ROM in an inappropriate manner will render the NIC non-functional.
DIMM Serial Presence Detect (SPD) configuration data	256 bytes per memory module, 128 bytes programmable (not customer accessible)	No	Yes	Stores memory module information.	DIMM SPD is programmed by the memory vendor.	Data cannot be written to this memory when the module is installed in a computer. The specific write-protection method varies by memory vendor.
System BIOS	9 MB	Yes	Yes	Stores system BIOS code and computer configuration data.	System BIOS code is programmed at the factory. Code is updated when the system BIOS is updated. Configuration data and settings are input using the Computer Setup (BIOS) or a custom utility.	NOTE: Writing data to this ROM in an inappropriate manner can render the computer non-functional. A utility must be used for writing data to this memory and is available on the HP website; go to http://www.hp.com/

Table 12-1 Troubleshooting steps for nonvolatile memory usage (continued)

Nonvolatile Memory Type	Amount (Size)	Does this memory store customer data?	Does this memory retain data when power is removed?	What is the purpose of this memory?	How is data input into this memory?	How is this memory write-protected?
Intel Management Engine Firmware (present only in select Elite or Z models. For more information, go to http://www.hp.com/support . Select Find your product , and then follow the on-screen instructions.)	1.5 MB or 7 MB	Yes	Yes	Stores Management Engine Code, Settings, Provisioning Data and iAMT third-party data store.	Management Engine Code is programmed at the factory. Code is updated via Intel secure firmware update utility. Unique Provisioning Data can be entered at the factory or by an administrator using the Management Engine (MEBx) setup utility. The third party data store contents can be populated by a remote management console or local applications that have been registered by an administrator to have access to the space.	support . Select Find your product , and then follow the on-screen instructions. The Intel chipset is configured to enforce hardware protection to block all direct read/write access to this area. An Intel utility must be used for updating the firmware. Only firmware updates digitally signed by Intel can be applied using this utility.
Bluetooth flash (select products only)	2 Mb	No	Yes	Stores Bluetooth configuration and firmware.	Bluetooth flash is programmed at the factory. Tools for writing data to this memory are not publicly available but can be obtained from the silicon vendor.	A utility must be used for writing data to this memory and is made available through newer versions of the driver whenever the flash requires an upgrade.
802.11 WLAN EEPROM	4 Kb to 8 Kb	No	Yes	Stores configuration and calibration data.	802.11 WLAN EEPROM is programmed at the factory. Tools for writing data to this memory are not made public.	A utility must be used for writing data to this memory and is typically not made available to the public unless a firmware upgrade is necessary to address a unique issue.
Webcam (select products only)	64 Kb	No	Yes	Stores webcam configuration and firmware.	Webcam memory is programmed using a utility from the device manufacturer that can be run from Windows.	A utility must be used for writing data to this memory and is typically not made available to the public unless a firmware upgrade is necessary to address a unique issue.
Fingerprint reader (select products only)	512 KB flash	Yes	Yes	Stores fingerprint templates.	Fingerprint reader memory is programmed by user enrollment in HP ProtectTools Security Manager.	Only a digitally signed application can make the call to write to the flash.

Questions and answers

1. How can the BIOS settings be restored (returned to factory settings)?



IMPORTANT: Restore defaults does not securely erase any data on your hard drive. See question and answer 6 for steps to securely erase data.

Restore defaults does not reset the Custom Secure Boot keys. See question and answer 7 for information about resetting the keys.

- a. Turn on or restart the computer, and then press **esc** while the “Press the ESC key for Startup Menu” message is displayed at the bottom of the screen.
- b. Select **Main**, and then select **Apply Factory Defaults and Exit**.
- c. Follow the on-screen instructions.
- d. Select **Main**, select **Save Changes and Exit**, and then follow the on-screen instructions.

2. What is a UEFI BIOS, and how is it different from a legacy BIOS?

The Unified Extensible Firmware Interface (UEFI) BIOS is an industry-standard software interface between the platform firmware and an operating system (OS). It is a replacement for the older BIOS architecture, but supports much of the legacy BIOS functionality.

Like the legacy BIOS, the UEFI BIOS provides an interface to display the system information and configuration settings and to change the configuration of your computer before an OS is loaded. BIOS provides a secure run-time environment that supports a Graphic User Interface (GUI). In this environment, you can use either a pointing device (Touchscreen, TouchPad, pointing stick, or USB mouse) or the keyboard to navigate and make menu and configuration selections. The UEFI BIOS also contains basic system diagnostics.

The UEFI BIOS provides functionality beyond that of the legacy BIOS. In addition, the UEFI BIOS works to initialize the computer’s hardware before loading and executing the OS; the run-time environment allows the loading and execution of software programs from storage devices to provide more functionality, such as advanced hardware diagnostics (with the ability to display more detailed system information) and advanced firmware management and recovery software.

HP has provided options in Computer Setup (BIOS) to allow you to run in legacy BIOS, if required by the operating system. Examples of this requirement would be if you upgrade or downgrade the OS.

3. Where does the UEFI BIOS reside?

The UEFI BIOS resides on a flash memory chip. A utility must be used to write to the chip.

4. What kind of configuration data is stored on the DIMM Serial Presence Detect (SPD) memory module? How would this data be written?

The DIMM SPD memory contains information about the memory module, such as size, serial number, data width, speed/timing, voltage, and thermal information. This information is written by the module manufacturer and stored on an EEPROM. This EEPROM cannot be written to when the memory module is installed in a computer. Third-party tools do exist that can write to the EEPROM when the memory module is not installed in a computer. Various third-party tools are available to read SPD memory.

5. What is meant by “Restore the nonvolatile memory found in Intel-based system boards”?

This message relates to clearing the Real Time Clock (RTC) CMOS memory that contains computer configuration data.

6. How can the BIOS security be reset to factory defaults and data erased?

 **IMPORTANT:** Resetting will result in the loss of information.

These steps will not reset Custom Secure Boot Keys. See question and answer 7 for information about resetting the keys.

- a. Turn on or restart the computer, and then press **esc** while the “Press the ESC key for Startup Menu” message is displayed at the bottom of the screen.
- b. Select **Security**, and then select **Restore Security Settings to Factory Defaults**.
- c. Follow the on-screen instructions.
- d. Select **Main**, select **Save Changes and Exit**, and then follow the on-screen instructions.

7. How can the Custom Secure Boot Keys be reset?

Secure Boot is a feature to make sure that only authenticated code can start on a platform. If you enabled Secure Boot and created Custom Secure Boot Keys, simply disabling Secure Boot will not clear the keys. You must also select to clear the Custom Secure Boot Keys. Use the same Secure Boot access procedure you used to create the Custom Secure Boot Keys, but make the selection to clear or delete all Secure Boot Keys.

- a. Turn on or restart the computer, and then press **esc** while the “Press the ESC key for Startup Menu” message is displayed at the bottom of the screen.
- b. Select the **Advanced** menu, select **Secure Boot Configuration**, select **Restore Secure Boot Keys**, and then follow the on-screen instructions.

Using HP Sure Start (select models only)

Select computer models are configured with HP Sure Start, a technology that continuously monitors your computer's BIOS for attacks or corruption. If the BIOS becomes corrupted or is attacked, HP Sure Start restores the BIOS to its previously safe state, without user intervention. Those select computer models ship with HP Sure Start configured and enabled. HP Sure Start is configured and already enabled so that most users can use the HP Sure Start default configuration. The default configuration can be customized by advanced users.

To access the latest documentation on HP Sure Start, go to <http://www.hp.com/support>. Select **Find your product**, and then follow the on-screen instructions.

13 Specifications

	U.S.	Metric
Dimensions		
Height	1.4 in	34 mm
Width	7.0 in	177 mm
Depth	6.9 in	175 mm
Approximate weight	2.8 lb	1.3 kg
Temperature range		
Operating	50° to 95°F	10° to 35°C
Nonoperating	-22° to 140°F	-30° to 60°C
Relative humidity (noncondensing)		
Operating	10% to 90%	10% to 90%
Nonoperating (38.7°C max wet bulb)	5% to 95%	5% to 95%
Maximum altitude (unpressurized)		
Operating	16,404 ft	5000 m
Nonoperating	50,000 ft	15,240 m
Power supply		
Standard efficiency	150 W	
	90 W	
	65 W	
Operating voltage range	90 V ac to 264 V ac	
Rated voltage range	100 V ac to 240 V ac	
Rated line frequency	50 Hz to 60 Hz	
Operating line frequency	47 Hz to 63 Hz	
Rated input current	150 W ≤ 2.2 A	
	90 W ≤ 1.2 A	
	65 W ≤ 1.6 A	
DC output	+19.5 V	

Index

A

- access panel
 - illustrated 9
 - locked 67
 - removal 23
- audible codes 96
- audio problems 77
- audio-out (headphone) jack, identifying 2
- audio-out (headphone)/audio-in (microphone) combo jack, identifying 2

B

- backup, creating 107
- backups 107
- battery
 - disposal 19
 - installation 35
 - removal 35
- battery replacement 35
- beep codes 96
- boot order, changing 108
- booting options
 - Full Boot 92
 - Quick Boot 92

C

- cable management 20
- cable pinouts, SATA data 19
- CD-ROM or DVD problems 87
- changing a power-on password 99
- changing a setup password 99
- cleaning
 - computer 16
 - mouse 17
 - safety precautions 16
- CMOS
 - backing up 98
 - clearing and resetting 100
- computer
 - specifications 118
- computer cleaning 16
- Computer Setup
 - access problem 66

- country power cord set requirements 111
- Customer Support 64

D

- deleting a power-on password 100
- deleting a setup password 100
- disassembly preparation 22
- drive cage
 - removal and replacement 29

E

- electrostatic discharge (ESD) 13
 - preventing damage 14
- error
 - codes 92, 96
 - messages 92
- expansion connector board
 - removal and replacement 37

F

- F10 Setup
 - access problem 66
- fan
 - removal and replacement 41
- flash drive problems 89
- flashing lights 96
- front bezel
 - illustrated 8
 - removal and replacement 24
- front bezel dust filter
 - illustrated 11
 - removal and replacement 22
- front panel components 2
- front panel problems 90

G

- general problems 66
- graphics processor and heat sink assembly
 - illustrated 8
 - removal and replacement 30
- grounding methods 14

H

- hard drive
 - installation 27
 - proper handling 18
 - removal 27
 - SATA characteristics 19
- hard drive connector
 - removal and replacement 28
- hard drive problems 70
- hard drives
 - sizes 8, 10
- hardware installation problems 82
- headphone (audio-out) jack 2
- heat sink
 - illustrated 9
 - removal and replacement 39, 42, 44
- helpful hints 65
- hood sensor
 - removal and replacement 25
- HP PC Hardware Diagnostics UEFI
 - downloading 104
 - starting 104
 - using 103
- HP PC Hardware Diagnostics Windows
 - downloading 102
 - installing 103
 - using 102
- HP Recovery media
 - recovery 108
- HP Sure Recover 109
- HP Sure Start 117

I

- installation guidelines 21
- installing
 - battery 35
 - hard drive 27
 - memory modules 38
 - security lock 7
 - solid state drive 31
 - WLAN module 33
- Internet access problems 90

- J**
- jacks
 - audio-out (headphone) 2
 - audio-out (headphone)/audio-in (microphone) combo 2
- K**
- keyboard
 - cleaning 17
 - keyboard problems 81
- L**
- lights
 - blinking PS/2 keyboard 96
- M**
- media card reader
 - problems 72
- memory
 - nonvolatile 112
 - problems 85
 - volatile 112
- memory modules
 - installation 38
 - maximum 38
 - removal 38
 - slots 38
 - specifications 38
- monitor problems 73
- mounting the computer 6
- mouse
 - cleaning 17
 - problems 81
- N**
- network problems 83
- nonvolatile memory 112
- numeric error codes 92
- O**
- operating guidelines 16
- optical drive
 - problems 87
- overheating, prevention 16
- P**
- password
 - clearing 98
 - power-on 98
 - setup 98
- passwords 99, 100
- ports
 - USB SuperSpeed 2, 3
 - USB SuperSpeed port with HP Sleep and Charge 2
 - USB Type-C 2
- POST error messages 92
- power cord set requirements
 - country specific 111
- power problems 69
- power supply
 - operating voltage range 118
- power-on password 98, 99, 100
- printer problems 79
- problems
 - audio 77
 - CD-ROM or DVD 87
 - Computer Setup 66
 - F10 Setup 66
 - flash drive 89
 - front panel 90
 - general 66
 - hard drive 70
 - hardware installation 82
 - Internet access 90
 - keyboard 81
 - Media Card Reader 72
 - memory 85
 - monitor 73
 - mouse 81
 - network 83
 - power 69
 - printer 79
 - software 91
- processors
 - illustrated 10
- product ID location 4
- R**
- rear panel components 3
- recovery 107
 - discs 108
 - HP Recovery partition 108
 - media 108
 - USB flash drive 108
- recovery media
 - creating using HP Cloud Recovery Download Tool 107
 - creating using Windows tools 107
- Remote HP PC Hardware Diagnostics
 - UEFI settings
 - customizing 105
 - using 105
- removal and replacement
 - drive cage 29
 - expansion connector board 37
 - fan 41
 - front bezel 24
 - front bezel dust filter 22
 - graphics processor and heat sink assembly 30
 - hard drive connector 28
 - heat sink 39, 42, 44
 - hood sensor 25
 - speaker 26
 - system board 45
 - WLAN antennas 49
- removing
 - access panel 23
 - battery 35
 - hard drive 27
 - memory modules 38
 - solid state drive 31
 - WLAN module 33
- removing personal data from volatile system memory 112
- resetting
 - CMOS 98
 - password jumper 98
- restoring 107
- S**
- safety and comfort 64
- safety precautions
 - cleaning 16
- SATA
 - connectors on system board 19
 - data cable pinouts 19
 - hard drive characteristics 19
 - screws, correct size 18
 - security cable slot, identifying 3
 - security lock
 - installation 7
 - serial number location 4
 - service considerations 17
 - setup password 98, 99, 100
 - slots
 - security cable 3

- software
 - problems 91
 - servicing computer 18
- solid state drive
 - installation 31
 - removal 31
- solid-state drives
 - sizes 9, 11
- speaker
 - illustrated 9
 - removal and replacement 26
- specifications
 - computer 118
- specifications, memory modules 38
- static electricity 13
- system board
 - illustrated 9
 - removal and replacement 45
 - SATA connectors 19
- system memory, removing personal data from volatile 112
- system restore point, creating 107

- WLAN module
 - installation 33
 - removal 33

T

- temperature control 16
- tools, servicing 18
- Torx T15 screwdriver 18
- tower conversion 5

U

- USB SuperSpeed port with HP Sleep and Charge, identifying 2
- USB SuperSpeed port, identifying 2
- USB SuperSpeed ports, identifying 3
- USB Type-C port, identifying 2

V

- ventilation, proper 16
- VESA mounting holes 6

W

- Windows
 - backup 107
 - recovery media 107
 - system restore point 107
- Windows tools, using 107
- WLAN antennas
 - removal and replacement 49