

DS9908

Hands-Free Imaging Scanner

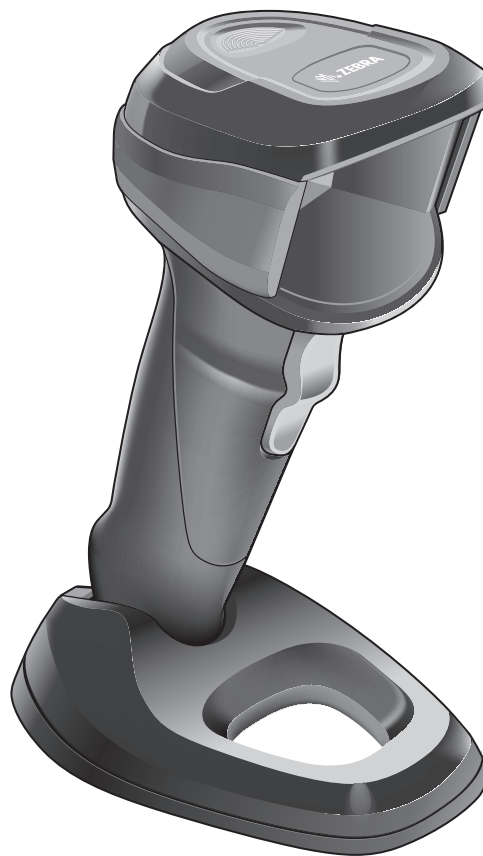

Quick Start Guide



ZEBRA

Copyright

© 2018 ZIH Corp. and/or its affiliates. All rights reserved. ZEBRA and the stylized Zebra head are trademarks of ZIH Corp., registered in many jurisdictions worldwide. All other trademarks are the property of their respective owners.

COPYRIGHTS & TRADEMARKS: For complete copyright and trademark information, go to www.zebra.com/copyright.

WARRANTY: For complete warranty information, go to www.zebra.com/warranty.

END USER LICENSE AGREEMENT: For complete EULA information, go to www.zebra.com/eula.

For Australia Only (Only for DCS products)

For Australia Only. This warranty is given by Zebra Technologies Asia Pacific Pte. Ltd., 71 Robinson Road, #05-02/03, Singapore 068895, Singapore. Our goods come with guarantees that cannot be excluded under the Australia Consumer Law. You are entitled to a replacement or refund for a major failure and compensation for any other reasonably foreseeable loss or damage. You are also entitled to have the goods repaired or replaced if the goods fail to be of acceptable quality and the failure does not amount to a major failure.

Zebra Technologies Corporation Australia's limited warranty above is in addition to any rights and remedies you may have under the Australian Consumer Law. If you have any queries, please call Zebra Technologies Corporation at +65 6858 0722. You may also visit our website: www.zebra.com for the most updated warranty terms.

Terms of Use

Proprietary Statement

This manual contains proprietary information of Zebra Technologies Corporation and its subsidiaries ("Zebra Technologies"). It is intended solely for the information and use of parties operating and maintaining the equipment described herein. Such proprietary information may not be used, reproduced, or disclosed to any other parties for any other purpose without the express, written permission of Zebra Technologies.

Product Improvements

Continuous improvement of products is a policy of Zebra Technologies. All specifications and designs are subject to change without notice.

Liability Disclaimer

Zebra Technologies takes steps to ensure that its published Engineering specifications and manuals are correct; however, errors do occur. Zebra Technologies reserves the right to correct any such errors and disclaims liability resulting therefrom.

Limitation of Liability

In no event shall Zebra Technologies or anyone else involved in the creation, production, or delivery of the accompanying product (including hardware and software) be liable for any damages whatsoever (including, without limitation, consequential damages including loss of business profits, business interruption, or loss of business information) arising out of the use of, the results of use of, or inability to use such product, even if Zebra Technologies has been advised of the possibility of such damages. Some jurisdictions do not allow the exclusion or limitation of incidental or consequential damages, so the above limitation or exclusion may not apply to you.

Features

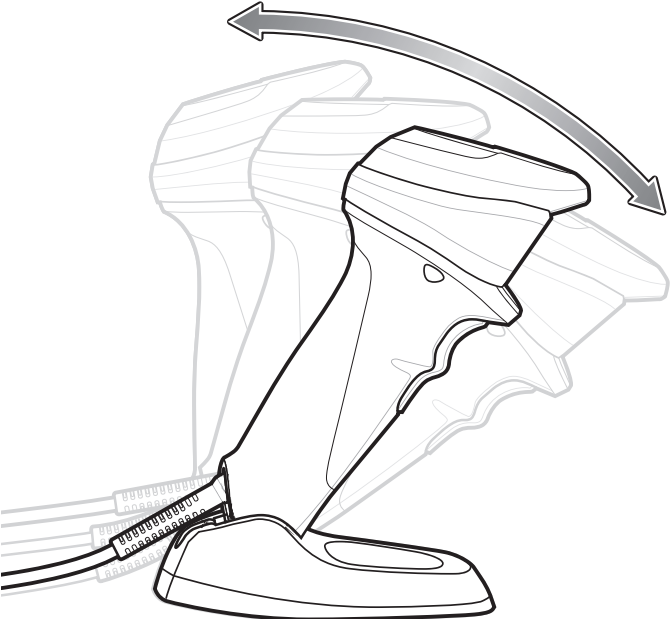
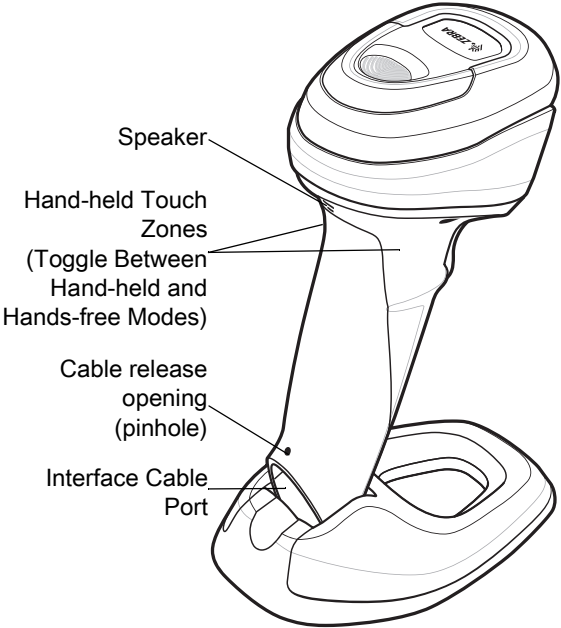
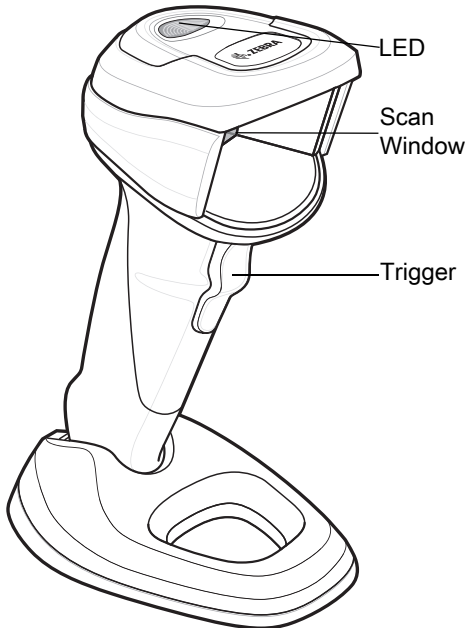

Cable Insertion

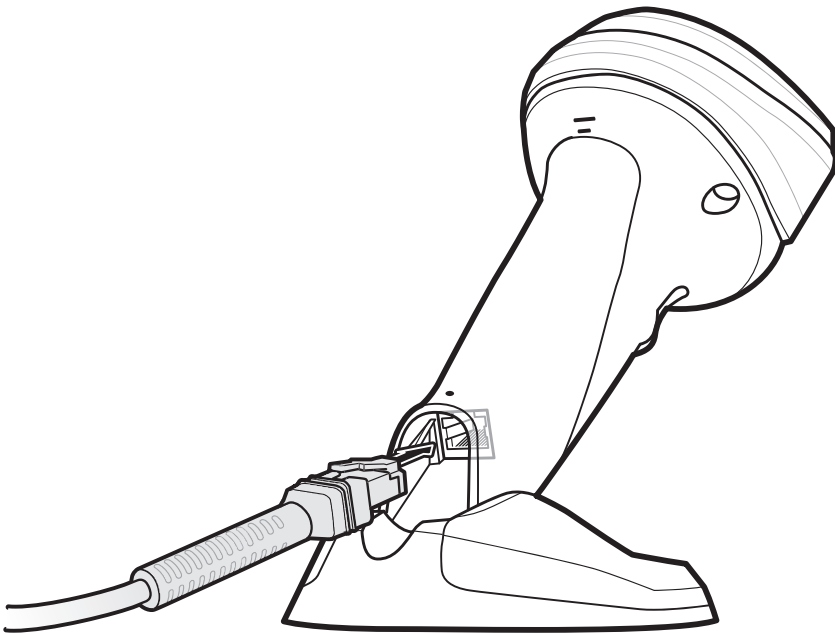

Cable Removal

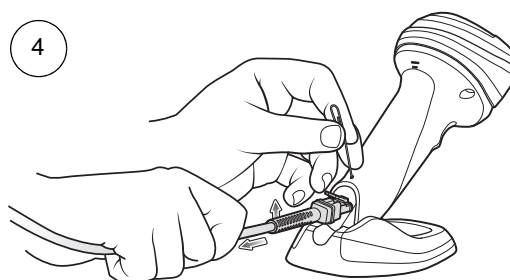
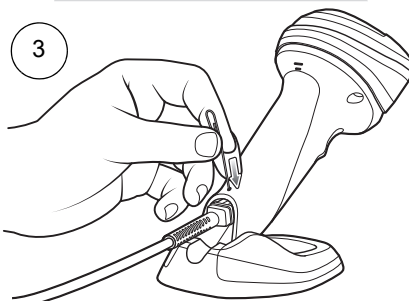
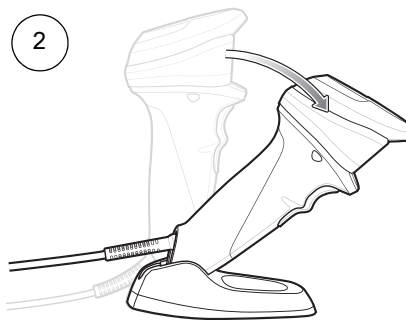
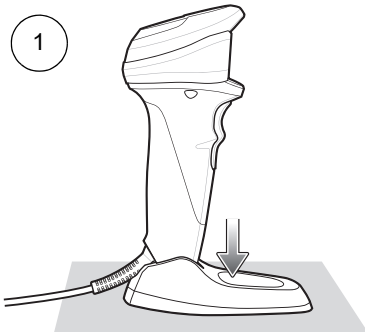

Wall Mounting

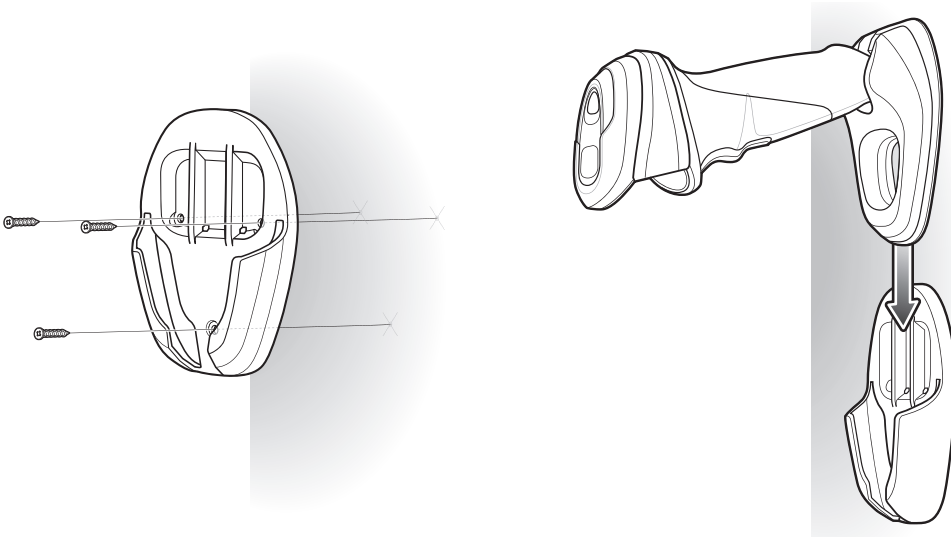
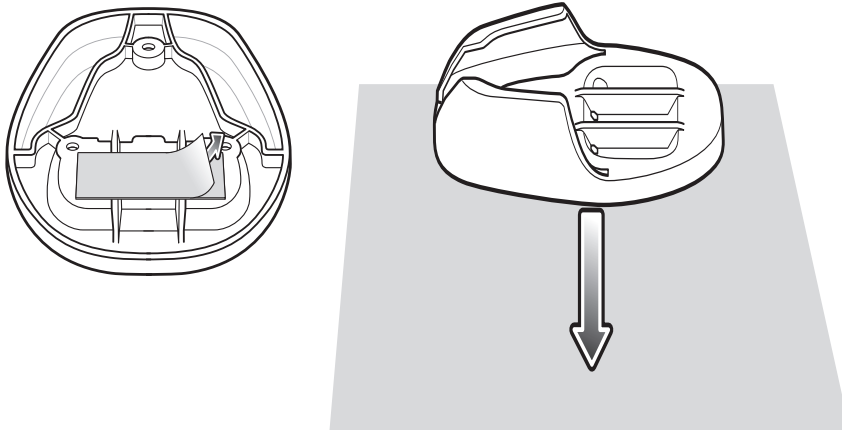
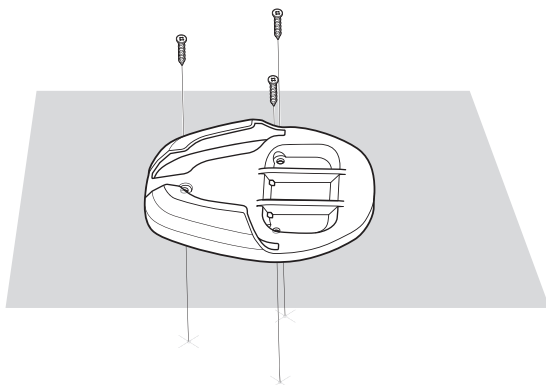

Table Mounting

Refer to Product Reference Guide for detailed instructions.



Or



Connect Host Interface

USB

The digital scanner automatically detects the host interface type and uses the default setting. If the default (*) does not meet your requirements, scan another host barcode below.

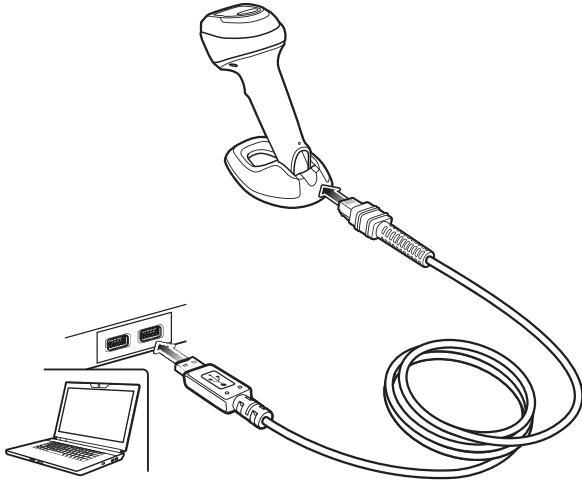

***USB Keyboard HID**

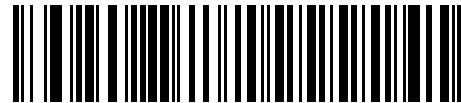

IBM Hand-Held USB



**IBM OPOS
(IBM Hand-Held USB with Full Scan Disable)**



Symbol Native API (SNAPI) with Imaging Interface

RS-232

The digital scanner automatically detects the host interface type and uses the default setting. If the default (*) does not meet your requirements, scan another host barcode below.

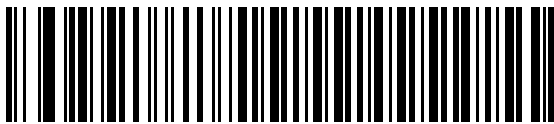
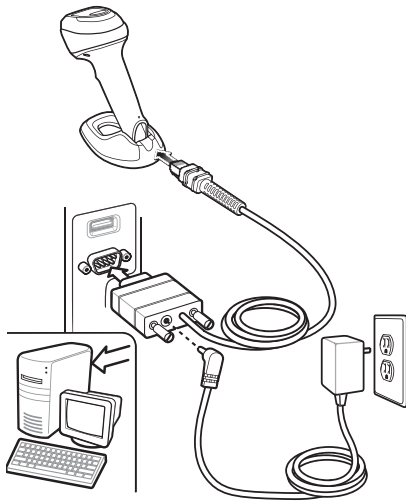

***Standard RS-232**

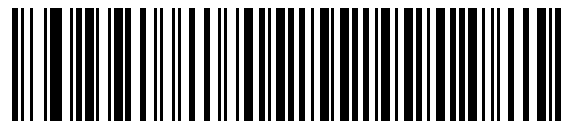

ICL RS-232

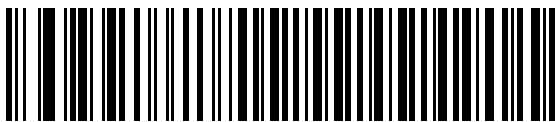

Nixdorf RS-232 Mode A

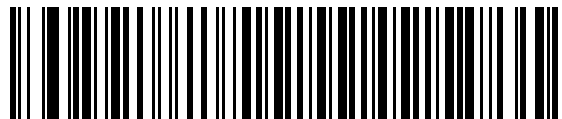

Nixdorf RS-232 Mode B

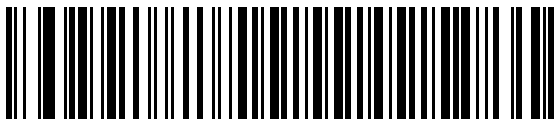

OPOS/JPOS



Fujitsu RS-232

IBM 46XX

The digital scanner automatically detects the host interface type, but there is no default setting. Scan one of the barcodes below to select the appropriate port.

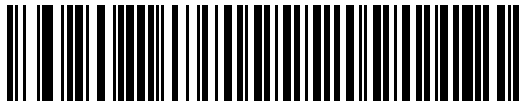
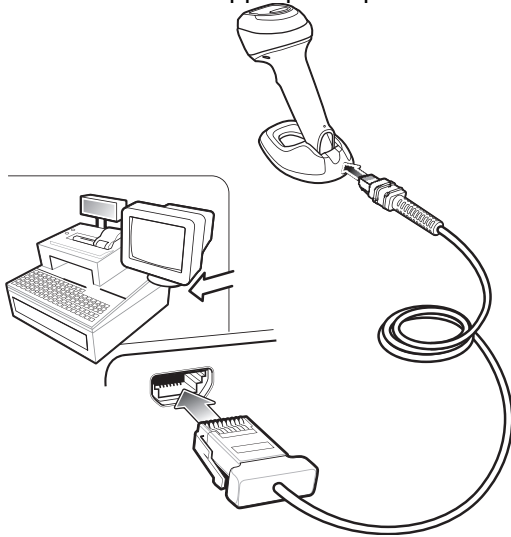

Non-IBM Scanner Emulation (Port 5B)

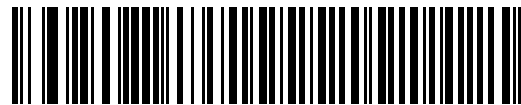

Hand-Held Scanner Emulation (Port 9B)

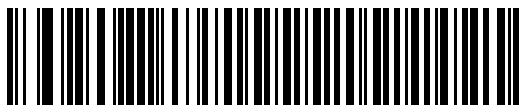
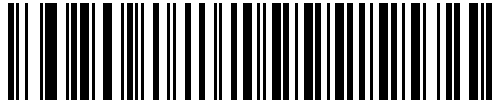
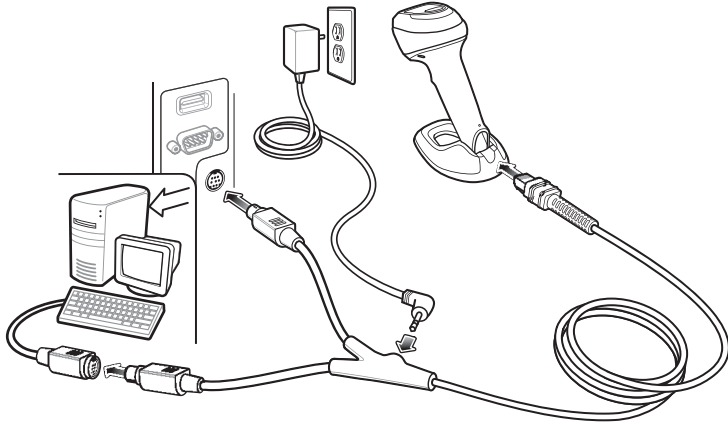

Table-Top Scanner Emulation (Port 17)

Keyboard Wedge

The digital scanner automatically detects the host interface type and uses the default setting. If the default (*) does not meet your requirements, scan the IBM PC/AT and IBM PC COMPATIBLE barcode below.



***IBM AT Notebook**

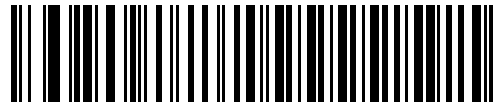

IBM PC/AT & IBM PC Compatibles

Set Defaults



Return to Factory Defaults

Add a Tab Key

To add a Tab key after scanned data, scan the barcode below.



Add a Tab Key

Add an Enter Key (Carriage Return /Line Feed)

To add an Enter key after scanned data, scan the barcode below.

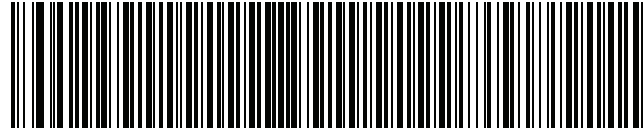

Add Enter Key

USB Caps Lock Override



USB-Override Caps Lock Key
(Enable)



*USB - Do Not Override Caps Lock Key
(Disable)

Scanning

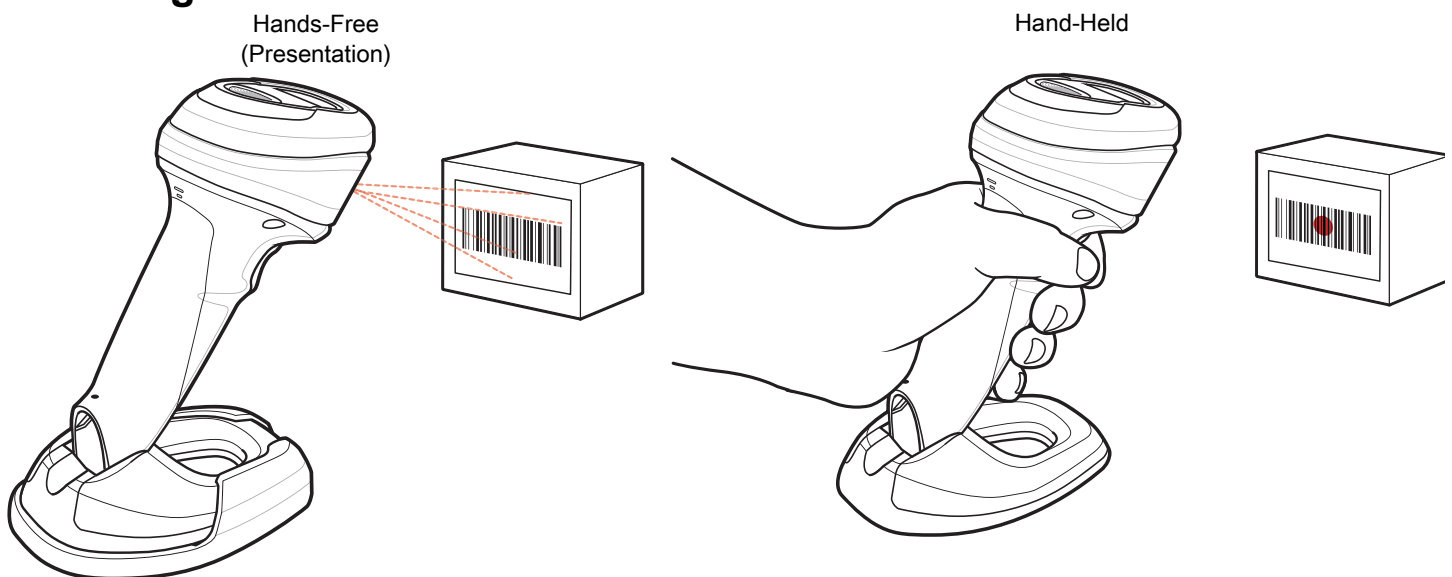

Hand-Held Aiming

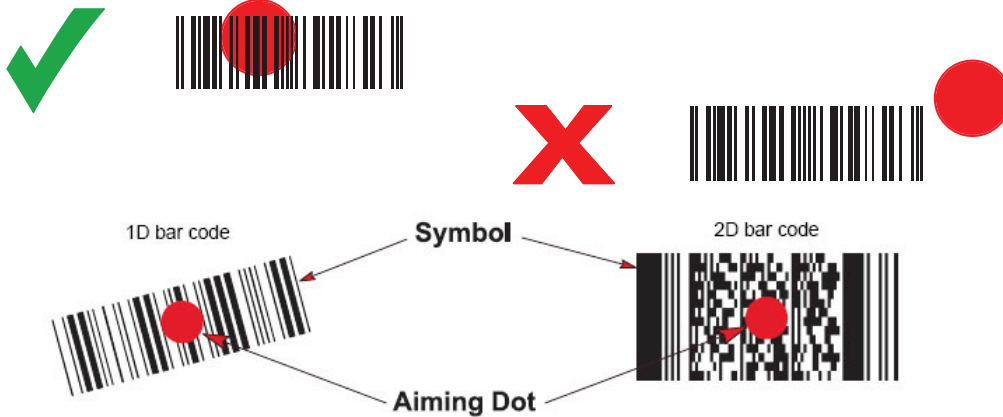

User Indications (By Default)

Indication	Beeper Sequence
Power up	Low/medium/high beeps
Barcode decoded	Medium beep
Transmission error detected; data is ignored	4 long low beeps
Successful parameter setting	High/low/high/low beeps
Correct programming sequence performed	High/low beeps
Incorrect programming sequence, or Cancel barcode scanned	Long low/long high beeps

Indication	LED Indicator
Hand-Held Scanning	
Digital scanner is on and ready to scan, or no power to scanner	Off
Barcode is successfully decoded	Green flash
Transmission error	Red
Hands-Free (Presentation) Scanning	
No power to scanner	Off
Digital scanner is ready to scan	Green
Barcode is successfully decoded	Off momentarily
Transmission error	Red

123Scan

123Scan is an easy-to-use, PC-based software tool that enables rapid and easy customized setup of a scanner via a barcode or USB cable. For more information, visit: www.zebra.com/123Scan.

Utility Functionality

- Device configuration
 - Electronic programming (USB cable)
 - Programming barcode(s)
- Data view - scan log (display scanned barcode data)
- Access asset tracking information
- Upgrade firmware and view release notes
- Remote management (SMS package generation).

Troubleshooting

Digital scanner not working	
No power to scanner	Connect scanner to powered host, or connect power supply.
Digital scanner disabled	Ensure that correct host interface cable is used.
Digital scanner decoding barcode, but data not transmitting to host	
Host interface not configured properly	Scan appropriate host parameter barcodes.
Interface cable is loose	Ensure all cable connections are secure.
Invalid ADF rule	Program the correct ADF rules.
Digital scanner not decoding barcode	
Digital scanner not programmed for barcode type	Ensure scanner is programmed to read type of barcode being scanned.
Barcode is unreadable	Ensure the barcode is not defaced; try scanning a test barcode of the same barcode type.
Distance between scanner and barcode incorrect	Move scanner closer to, or further from barcode.
Scanned data incorrectly displayed on host	
Host interface not configured properly	Scan appropriate host parameter barcodes.
Region improperly configured	Select appropriate country and language encoding scheme.

Recommended Usage Guide

Optimum Arm Position



Avoid Extreme Wrist Angles

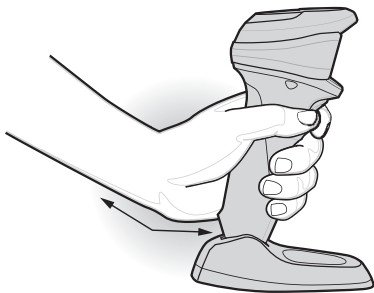

Avoid Bending and Reaching

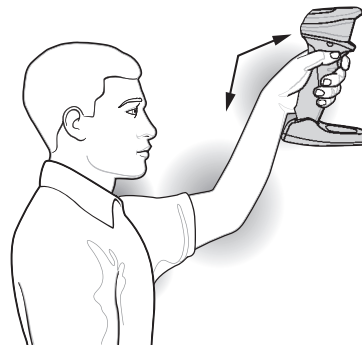

Alternate left and right hands taking breaks and task rotation recommended.

Health and Safety Recommendations



Ergonomic Recommendations

Caution: In order to avoid or minimize the potential risk of ergonomic injury follow the recommendations below. Consult with your local Health & Safety Manager to ensure that you are adhering to your company's safety programs to prevent employee injury.

- Reduce or eliminate repetitive motion
- Maintain a natural position
- Reduce or eliminate excessive force
- Keep objects that are used frequently within easy reach
- Perform tasks at correct heights
- Reduce or eliminate vibration
- Reduce or eliminate direct pressure
- Provide adjustable workstations
- Provide adequate clearance
- Provide a suitable working environment
- Improve work procedures.

Regulatory Information

This device is approved under Zebra Technologies Corporation.

This guide applies to Model Number DS9908.

All Zebra devices are designed to be compliant with the rules and regulations in the locations they are sold and will be labeled as required.

Local language translations are available at the following website: www.zebra.com/support.

Any changes or modifications to Zebra equipment not expressly approved by Zebra could void the user's authority to operate the equipment.

Declared maximum operating temperature: 50°C.

LED Devices

Classified as 'EXEMPT RISK GROUP' according to IEC 62471:2006 and EN 62471:2008.

Pulse duration: 1.5 ms

Power Supply

Use only a Zebra approved, certified LPS power supply rated 5.2Vdc, Min. 1.1A, 50 Deg. C. Use of any alternative power supply will invalidate the product warranty and may be dangerous.

Radio Frequency Interference Requirements

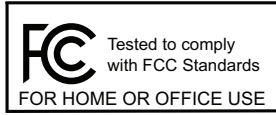

Note: This equipment has been tested and found to comply with the limits for a Class B digital device, pursuant to Part 15 of the FCC rules. These limits are designed to provide reasonable protection against harmful interference in a residential installation.

This equipment generates, uses and can radiate radio frequency energy and, if not installed and used in accordance with the instructions, may cause harmful interference to radio communications. However there is no guarantee that interference will not occur in a particular installation. If this equipment does cause harmful interference to radio or television reception, which can be determined by turning the equipment off and on, the user is encouraged to try to correct the interference by one or more of the following measures:

- Reorient or relocate the receiving antenna
- Increase the separation between the equipment and receiver
- Connect the equipment into an outlet on a circuit different from that to which the receiver is connected
- Consult the dealer or an experienced radio/TV technician for help.

Radio Frequency Interference Requirements - Canada

Innovation, Science and Economic Development Canada ICES-003.

Compliance Label: CAN ICES-3 (B)/NMB-3(B).



Marking and European Economic Area (EEA)

Statement of Compliance

Zebra hereby declares that this device is in compliance with all the applicable Directives, 2014/30/EU, 2014/35/EU and 2011/65/EU. The full text of the EU Declaration of Conformity is available at the following internet address:

www.zebra.com/doc.

Japan (VCCI) - Voluntary Control Council for Interference

Class B ITE

この装置は、クラスB情報技術装置です。この装置は、家庭環境で使用することを目的としていますが、この装置がラジオやテレビジョン受信機に近接して使用されると、受信障害を引き起こすことがあります。
取扱説明書に従って正しい取り扱いをして下さい。 VCCI-B

Korea Warning Statement for Class B ITE

기종별	사용자안내문
B급 기기 (가정용 방송통신기자재)	이 기기는 가정용(B급) 전자파적합기기로서 주로 가정에서 사용하는 것을 목적으로 하며, 모든 지역에서 사용할 수 있습니다.

China

通过访问以下网址可下载当地语言支持的产品说明书

www.zebra.com/support

合格证：



China RoHS Disclosure Table

部件名称 (Parts)	有害物质 					
	铅 (Pb)	汞 (Hg)	镉 (Cd)	六价铬 (Cr(VI))	多溴联苯 (PBB)	多溴二苯醚 (PBDE)
金属部件 (Metal Parts)	X	○	○	○	○	○
电路模块 (Circuit Modules)	X	○	○	○	○	○
电缆及电缆组件 (Cables and Cable Assemblies)	○	○	○	○	○	○
塑料和聚合物部件 (Plastic and Polymeric Parts)	○	○	○	○	○	○
光学和光学组件 (Optics and Optical Components)	○	○	○	○	○	○
电池 (Batteries)	○	○	○	○	○	○

本表格依据SJ/T 11364 的规定编制。

○: 表示该有害物质在该部件所有均质材料中的含量均在 GB/T 26572 规定的限量要求以下。

X: 表示该有害物质至少在该部件的某一均质材料中的含量超出GB/T 26572 规定的限量要求。(企业可在此处，根据实际情况对上表中打“x”的技术原因进行进一步说明。)

This table was created to comply with China RoHS requirements.

Taiwan

臺灣

公司資訊

台灣斑馬科技股份有限公司 / 台北市信義區松高路 9 號 13 樓

Taiwan RoHS Disclosure Table

限用物質含有情況標示聲明書

設備名稱：DS9908		型號 (型式)：Scanner Type designation (Type)				
單元 Unit	限用物質及其化學符號 Restricted substances and its chemical symbols					
	鉛 (Pb)	汞 (Hg)	鎘 (Cd)	六價鉻 (Cr ^{VI})	多溴聯苯 (PBB)	多溴二苯醚 (PBDE)
印刷電路板及電子組件	-	○	○	○	○	○
金屬零件	-	○	○	○	○	○
電纜及電纜組件	○	○	○	○	○	○
塑料和聚合物零件	○	○	○	○	○	○
光學與光學元件	○	○	○	○	○	○

備考1. “超出0.1 wt %”及“超出0.01 wt %”係指限用物質之百分比含量超出百分比含量基準值。

Note 1: “Exceeding 0.1 wt%” and “exceeding 0.01 wt%” indicate that the percentage content of the restricted substance exceeds the reference percentage value of presence condition.

備考2. “○”係指該項限用物質之百分比含量未超出百分比含量基準值。

Note 2: “○” indicates that the percentage content of the restricted substance does not exceed the percentage of reference value of presence.

備考3. “-”係指該項限用物質為排除項目。

Note 3: The “-” indicates that the restricted substance corresponds to the exemption.

Eurasian Customs Union

Евразийский Таможенный Союз

Данный продукт соответствует требованиям знака ЕАС.



TURKISH WEEE Statement of Compliance

EEE Yönetmeliğine Uygundur



Waste Electrical and Electronic Equipment (WEEE)

English: For EU Customers: All products at the end of their life must be returned to Zebra for recycling. For information on how to return product, please go to: www.zebra.com/weee.

Français: Clients de l'Union Européenne: Tous les produits en fin de cycle de vie doivent être retournés à Zebra pour recyclage. Pour de plus amples informations sur le retour de produits, consultez : www.zebra.com/weee.

Español: Para clientes en la Unión Europea: todos los productos deberán entregarse a Zebra al final de su ciclo de vida para que sean reciclados. Si desea más información sobre cómo devolver un producto, visite: www.zebra.com/weee.

Български: За клиенти от ЕС: След края на полезния им живот всички продукти трябва да се връщат на Zebra за рециклиране. За информация относно връщането на продукти, моля отидете на адрес: www.zebra.com/weee.

Deutsch: Für Kunden innerhalb der EU: Alle Produkte müssen am Ende ihrer Lebensdauer zum Recycling an Zebra zurückgesandt werden. Informationen zur Rücksendung von Produkten finden Sie unter www.zebra.com/weee.

Italiano: per i clienti dell'UE: tutti i prodotti che sono giunti al termine del rispettivo ciclo di vita devono essere restituiti a Zebra al fine di consentirne il riciclaggio. Per informazioni sulle modalità di restituzione, visitare il seguente sito Web: www.zebra.com/weee.

Português: Para clientes da UE: todos os produtos no fim de vida devem ser devolvidos à Zebra para reciclagem. Para obter informações sobre como devolver o produto, visite: www.zebra.com/weee.

Nederlands: Voor klanten in de EU: alle producten dienen aan het einde van hun levensduur naar Zebra te worden teruggezonden voor recycling. Raadpleeg www.zebra.com/weee voor meer informatie over het terugzenden van producten.

Polski: Klienci z obszaru Unii Europejskiej: Produkty wycofane z eksploatacji należy zwrócić do firmy Zebra w celu ich utylizacji. Informacje na temat zwrotu produktów znajdują się na stronie internetowej www.zebra.com/weee.

Čeština: Pro zákazníky z EU: Všechny produkty je nutné po skončení jejich životnosti vrátit společnosti Zebra k recyklaci. Informace o způsobu vrácení produktu najdete na webových stránkách: www.zebra.com/weee.

Eesti: EL klientidele: kõik tooted tuleb nende eluea lõppedes tagastada taaskasutamise eesmärgil Zebra'ile. Lisainformatsiooni saamiseks toote tagastamise kohta külastage palun aadressi: www.zebra.com/weee.

Magyar: Az EU-ban vásárlóknak: Minden tönkrement terméket a Zebra vállalathoz kell eljuttatni újrahasznosítás céljából. A termék visszajuttatásának módjával kapcsolatos tudnivalóként látogasson el a www.zebra.com/weee weboldalra.

Svenska: För kunder inom EU: Alla produkter som uppnått sin livslängd måste returneras till Zebra för återvinning. Information om hur du returnerar produkten finns på www.zebra.com/weee.

Suomi: Asiakkaat Euroopan unionin alueella: Kaikki tuotteet on palautettava kierrätettäväksi Zebra-yhtiöön, kun tuotetta ei enää käytetä. Lisätietoja tuotteen palauttamisesta on osoitteessa www.zebra.com/weee.

Dansk: Til kunder i EU: Alle produkter skal returneres til Zebra til recirkulering, når de er udtjent. Læs oplysningerne om returnering af produkter på: www.zebra.com/weee.

Ελληνικά: Για πελάτες στην Ε.Ε.: Όλα τα προϊόντα, στο τέλος της διάρκειας ζωής τους, πρέπει να επιστρέφονται στην Zebra για ανακύκλωση. Για περισσότερες πληροφορίες σχετικά με την επιστροφή ενός προϊόντος, επισκεφθείτε τη διεύθυνση www.zebra.com/weee στο Διαδίκτυο.

Malti: Għal klijenti fl-UE: il-prodotti kollha li jkunu waslu fl-aħħar tal-ħajja ta' l-użu tagħhom, iridu jiġu rritornati għand Zebra għar-riċiklaġġ. Għal aktar tagħrif dwar kif għandek tirritorna l-prodott, jekk jogħġbok żur: www.zebra.com/weee.

Românesc: Pentru clienții din UE: Toate produsele, la sfârșitul duratei lor de funcționare, trebuie returnate la Zebra pentru reciclare. Pentru informații despre returnarea produsului, accesați: www.zebra.com/weee.

Slovenski: Za kupce v EU: vsi izdelki se morajo po poteku življenjske dobe vrniti podjetju Zebra za reciklažo. Za informacije o vračilu izdelka obiščite: www.zebra.com/weee.

Slovenčina: Pre zákazníkov z krajín EU: Všetky výrobky musia byť po uplynutí doby ich životnosti vrátené spoločnosti Zebra na recykláciu. Bližšie informácie o vrátení výrobkov nájdete na: www.zebra.com/weee.

Lietuvių: ES vartotojams: visi gaminiai, pasibaigus jų eksploatacijos laikui, turi būti gražinti utilizuoti į kompaniją „Zebra“. Daugiau informacijos, kaip gražinti gaminį, rasite: www.zebra.com/weee.

Latviešu: ES klientiem: visi produkti pēc to kalpošanas mūža beigām ir jānogādā atpakaļ Zebra otrreizējai pārstrādei. Lai iegūtu informāciju par produktu nogādāšanu Zebra, lūdzu, skatiet: www.zebra.com/weee.

Türkçe: AB Müşterileri için: Kullanım süresi dolan tüm ürünler geri dönüşürme için Zebra'ya iade edilmelidir. Ürünlerin nasıl iade edileceği hakkında bilgi için lütfen şu adresi ziyaret edin: www.zebra.com/weee.

Hrvatski: Za kupce u Europskoj uniji: Svi se proizvodi po isteku vijeka trajanja moraju vratiti tvrtki Zebra na recikliranje. Informacije o načinu vraćanja proizvoda potražite na web-stranici: www.zebra.com/weee.