

## **Network Attached Storage**

### **TeraStation 6000**

# **User Manual**

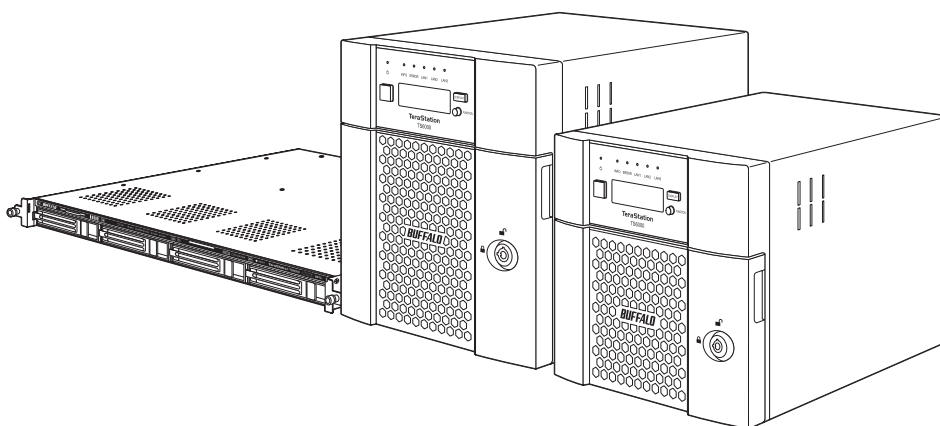

TS6200DN Series	TS6200DN0402	TS6200DN0802
TS6400DN Series	TS6400DN0804	TS6400DN1604
	TS6400DN3204	
TS6400RN Series	TS6400RN1604	TS6400RN3204

Please make sure to read this manual before using and follow the procedures. If you have any inquiries about the product, contact the number on the warranty statement or the packing box. Do not discard the included documents, the warranty statement, or the packing box.

***Americas: [www.buffaloamericas.com](http://www.buffaloamericas.com)***

***Europe: [www.buffalo-technology.com](http://www.buffalo-technology.com)***

***Asia Pacific: [www.buffalo-asia.com](http://www.buffalo-asia.com)***

# Notice

---

## Regulatory Compliance Information

---

### For Customers in the United States

This device complies with Part 15 of the FCC Rules. Operation is subject to the following two conditions: (1) this device may not cause harmful interference, and (2) this device must accept any interference received, including interference that may cause undesired operation.

**Note:** This equipment has been tested and found to comply with the limits for a Class A digital device, pursuant to Part 15 of the FCC Rules. These limits are designed to provide reasonable protection against harmful interference when the equipment is operated in a commercial environment. This equipment generates, uses, and can radiate radio frequency energy and, if not installed and used in accordance with the instruction manual, may cause harmful interference to radio communications. Operation of this equipment in a residential area is likely to cause harmful interference in which case the user will be required to correct the interference at his own expense.

### For Customers in Europe

Warning: This is a class A product. In a domestic environment this product may be cause radio interference in which case the user may be required to take adequate measures.

This product may cause interference if used in residential areas. Such use must be avoided unless the user takes special measures to reduce electromagnetic emissions to prevent interference to the reception of radio and television broadcasts.







### Environmental Information



- The equipment that you have purchased has required the extraction and use of natural resources for its production.
- The equipment may contain hazardous substances that could impact health and the environment.
- In order to prevent the dissemination of those substances into the environment, and to relieve pressure on natural resources, we encourage you to seek out an appropriate take-back program. Take-back programs will reuse or recycle materials of any end-of-life equipment in a responsible way.
- Products with the crossed-out wheeled-bin symbol above should not be recycled. Instead, seek out a take-back program as mentioned.
- If you need more information on the collection, reuse, and recycling of our end-of-life products, please contact your local or regional waste administration.

## Warning Symbols and Graphical Icons on the Product

Warning symbols are used on the product for safety operation and prevention of injury to you and damage to the unit. The following explains the meanings of symbols used on the product.

	This symbol indicates important warnings or cautions for operation and maintenance. Additional information will follow this symbol.
	This symbol indicates the presence of an alternating current.
	This symbol indicates that the equipment may carry risk of electric shock.
	This symbol indicates danger of hazardous high voltage.
	This symbol indicates a protective earthing terminal.
	This symbol indicates that the protective conductor should be connected first to the protective earthing terminal.

## Safety Precautions

Before using your device, basic safety instructions should always be followed.

- (1) Read these instructions.
- (2) Keep these instructions.
- (3) Heed all warnings and follow all instructions.
- (4) The socket-outlet shall be installed near the equipment and shall be easily accessible.
- (5) Only use the cables and accessories that are included in the package. Don't use other accessories or cables unless specifically instructed to in the documentation. Also, do not use USB cables that are 3 meters or longer to connect USB devices.
- (6) The device can only be used in a fixed location, such as a telecommunication center or a dedicated computer room. When you install the device, ensure that the protective earthing connection of the socket-outlet is verified by a technician.



Translation to Norwegian:

Utstyr som er koplet til beskyttelsesjord via nettplugg og/eller via annet jordtilkøpelt utstyr – og er tilkøpelt et kabel-TV nett, kan forårsake brannfare. For å unngå dette skal det ved tilkøpling av utstyret til kabel-TV nettet installeres en galvanisk isolator mellom utstyret og kabel-TV nettet.

Translation to Swedish:

Utrustning som är kopplad till skyddsjord via jordat vägguttag och/eller via annan utrustning och samtidigt är kopplad till kabel-TV nät kan i vissa fall medföra risk för brand. För att undvika detta skall vid anslutning av utrustningen till kabel-TV nät galvanisk isolator finnas mellan utrustningen och kabel-TV nätet.

- (7)  Do not ingest battery in case of a chemical burn hazard. This product contains a coin/button cell battery. If the battery is swallowed, it can cause severe internal burns within 2 hours and may lead to death. If you think batteries might have been swallowed or placed inside any part of the body, seek immediate medical attention.

- (8)    High touch current. Connect to earth before connecting to supply.

Notice

(9)  **Caution:** Do not remove the cover.

(10)  **Caution:** Slide/rail mounted equipment is not to be used as a shelf or a work space.

(11)  **Caution:** Be careful not to injure fingers when handling. Do not remove the cover.

(12)  **Caution:** Do not replace the battery. There is risk of explosion if the battery is replaced with one that is an incorrect type.



# Contents

<b>Notice .....</b>	<b>1</b>
Regulatory Compliance Information.....	1
Warning Symbols and Graphical Icons on the Product.....	2
Safety Precautions .....	2
<b>Chapter 1 Getting Started .....</b>	<b>11</b>
Diagrams.....	11
Turning the TeraStation On and Off.....	14
Creating an Initialization Drive.....	16
<b>Chapter 2 Configuration .....</b>	<b>17</b>
Running the Setup Wizard.....	17
Setting Up Through Setup Wizard .....	17
Opening Setup Wizard .....	20
Opening Settings .....	21
Checking the Device Information from Dashboard .....	23
<b>Chapter 3 File Sharing .....</b>	<b>24</b>
Configuring Shared Folders .....	24
Adding a Shared Folder.....	24
Recycle Bin.....	26
Read-Only Shares.....	26
Hidden Shares .....	27
Quotas .....	27

<b>Configuring Users .....</b>	<b>28</b>
Adding a User .....	28
Importing User Information.....	30
<b>Adding a Group .....</b>	<b>30</b>
<b>Configuring Access Restrictions for Shared Folders .....</b>	<b>33</b>
Local Users and Groups .....	33
Active Directory .....	34
<b>Configuring Access Restrictions for Subfolders .....</b>	<b>37</b>
Enabling Subfolders' Access Restrictions .....	37
Restoring Owner and Permission Settings .....	39
<b><u>Chapter 4 Storage Management .....</u></b>	<b><u>42</u></b>
<b>RAID Modes .....</b>	<b>42</b>
<b>Working with RAID Arrays .....</b>	<b>43</b>
Using JBOD.....	43
Changing RAID Mode .....	44
Shutting Down the TeraStation Automatically If Error Occurs.....	45
Configuring Actions for If a Drive Used for the RAID Array Has Not Been Discovered.....	47
Configuring a Hot Spare.....	50
Expanding RAID Capacity Without Deleting Data .....	51
RAID Scanning.....	54
<b>Adding an External Drive .....</b>	<b>55</b>
Connecting an External Drive .....	55
Compatibility .....	55
<b>Dismounting Drives .....</b>	<b>56</b>
Dismounting with the Function Button .....	56
Dismounting from Settings .....	56

<b>Checking Drives .....</b>	<b>57</b>
<b>S.M.A.R.T. ....</b>	<b>58</b>
<b>Displaying S.M.A.R.T. Information .....</b>	<b>58</b>
<b>Checking Drive Condition .....</b>	<b>59</b>
<b>Formatting Drives .....</b>	<b>60</b>
<b>Encrypting Drives.....</b>	<b>61</b>
<b>Erasing Data on the TeraStation Completely .....</b>	<b>61</b>
<b>Using the TeraStation as an iSCSI Device .....</b>	<b>62</b>
<b>Introduction .....</b>	<b>62</b>
<b>Creating an iSCSI Volume .....</b>	<b>62</b>
<b>Connecting or Disconnecting Volumes.....</b>	<b>65</b>
<b>Using with Multiple Computers.....</b>	<b>66</b>
<b>Configuring Access Restrictions .....</b>	<b>66</b>
<b>Expanding Volume Sizes .....</b>	<b>69</b>
<b>Deleting Volumes.....</b>	<b>70</b>
<b>Advanced Settings.....</b>	<b>71</b>

## **Chapter 5 Backup .....** **72**

<b>Using Snapshots.....</b>	<b>72</b>
<b>Overview .....</b>	<b>72</b>
<b>Application for iSCSI Volume Snapshots .....</b>	<b>72</b>
<b>Manually Creating a Snapshot.....</b>	<b>72</b>
<b>Accessing the Snapshots via SMB.....</b>	<b>75</b>
<b>Restoring Snapshots.....</b>	<b>77</b>
<b>Configuring Schedule Snapshot.....</b>	<b>82</b>
<b>Configuring Snapshot Archive Settings.....</b>	<b>86</b>
<b>Backing Up Data on the TeraStation.....</b>	<b>92</b>
<b>Preparing a Backup Destination.....</b>	<b>93</b>

Configuring a Backup Job .....	94
If Backing Up from rsync-Compatible Devices to the TeraStation .....	98
Backup Modes .....	99
Backup Logs When Backup Fails .....	100
<b>Replication.....</b>	<b>103</b>
Preparing a Replication Destination .....	104
Configuring a Replication Job .....	105
Synchronizing Between Source and Destination TeraStations Periodically.....	108
<b>Failover .....</b>	<b>109</b>
Before Configuring Failover.....	109
Usage Restrictions .....	110
Configuring Failover .....	111
Replacing to the Backup TeraStation Manually .....	113
Reconfiguring After Failover Occurs .....	113
Synchronizing Between Main and Backup TeraStations Periodically	115
<b>Backing Up Your Mac with Time Machine .....</b>	<b>116</b>
<b><u>Chapter 6 Remote Access .....</u></b>	<b><u>123</u></b>
WebAccess .....	123
FTP.....	125
Synchronizing with Dropbox .....	126
Configuring a New Job .....	127
Changing Job Settings .....	129
Creating a Shared Link (Windows Only).....	133
Using Microsoft Azure for Data Preservation .....	133
Creating a New Backup Job.....	133
Creating a New Restore Job .....	138

Changing Job Settings .....	142
<b>Synchronizing with Microsoft OneDrive .....</b>	<b>144</b>
Configuring a New Job .....	144
Changing Job Settings .....	151
Corrective Actions for in Case of Error .....	154

## **Chapter 7 Advanced Features ..... 156**

<b>Email Notification .....</b>	<b>156</b>
<b>Sleep Mode .....</b>	<b>158</b>
<b>Wake-on-LAN .....</b>	<b>160</b>
<b>UPS (Uninterruptible Power Supply) .....</b>	<b>161</b>
<b>Port Trunking.....</b>	<b>163</b>
<b>Offline Files for Windows.....</b>	<b>164</b>
<b>Accessing from an NFS Client.....</b>	<b>165</b>
<b>Encrypting Data Transmission .....</b>	<b>170</b>
Encrypting Settings Data .....	170
Encrypting FTP Transfer Data .....	170
SSL Keys .....	170
<b>SNMP .....</b>	<b>171</b>
<b>Saving and Applying Settings.....</b>	<b>172</b>
Saving Settings .....	172
Applying Settings .....	173
<b>Transferring Another TeraStation’s Settings.....</b>	<b>174</b>
Creating a Config File (.nas_config).....	174
Transferring Settings.....	175
<b>Restoring Factory Defaults.....</b>	<b>176</b>
Initializing from Settings .....	176

<b>Initializing with the USB Initialization Drive .....</b>	<b>176</b>
<b>Resetting the Administrator Password .....</b>	<b>178</b>
<b>Logs .....</b>	<b>178</b>
<b>Displaying TeraStation's Logs .....</b>	<b>178</b>
<b>Transferring Logs to the Syslog Server .....</b>	<b>179</b>
<b>Creating a Link to the Logs in the Shared Folder .....</b>	<b>180</b>
<b>Changing Archive Rules for File Access Logs .....</b>	<b>182</b>
<b>Updating the Firmware.....</b>	<b>183</b>
<b>Updating Manually .....</b>	<b>183</b>
<b>Updating Automatically .....</b>	<b>184</b>
<b>Configuring Update Notification .....</b>	<b>185</b>
<b>Name, Date, Time, and Language .....</b>	<b>187</b>
<b>Beep Alerts .....</b>	<b>189</b>
<b>LCD and LEDs .....</b>	<b>190</b>
<b>Proxy Server .....</b>	<b>190</b>
<b>Jumbo Frames .....</b>	<b>191</b>
<b>Changing the IP Address .....</b>	<b>193</b>
<b>Mapping IP Address and Hostname .....</b>	<b>195</b>
<b>Boot Authentication .....</b>	<b>196</b>
<b>Notes Before Use .....</b>	<b>197</b>
<b>Important Notice .....</b>	<b>197</b>
<b>Setting Up the Authentication Server on a Windows PC .....</b>	<b>197</b>
<b>Configuring Boot Authentication on the TeraStation.....</b>	<b>198</b>
<b>If the TeraStation Cannot Be Accessed .....</b>	<b>199</b>

## **Chapter 8 Drive Replacement..... 202**

<b>Replacing Drives .....</b>	<b>202</b>
-------------------------------	------------

LEDs .....	202
Using a Redundant RAID Mode .....	203
Using RAID 0 .....	205
Using JBOD .....	206
Using a Hot Spare.....	207
<b>Replacing a Non-Malfunctioning Drive.....</b>	<b>207</b>

## **Chapter 9 Utilities..... 209**

<b>NAS Navigator2 for Windows .....</b>	<b>209</b>
Mounting as a Network Drive .....	211
Changing the IP Address .....	212
<b>NAS Navigator2 for macOS .....</b>	<b>212</b>
Mounting as a Network Drive .....	214
Changing the IP Address .....	214
<b>NovaBACKUP .....</b>	<b>214</b>

## **Chapter 10 Appendix..... 215**

<b>TeraStation Does Not Work Properly .....</b>	<b>215</b>
Power LED Keeps Blinking .....	215
Booting the TeraStation in Emergency Mode.....	216
<b>Cleaning the Dustproof Filter .....</b>	<b>217</b>
<b>LCD Panel .....</b>	<b>219</b>
Modes .....	219
Errors.....	220
Status .....	221
<b>Default Settings .....</b>	<b>223</b>
<b>Specifications .....</b>	<b>224</b>

# Chapter 1 Getting Started

## Diagrams

Depending on the number or type of drives in the unit, the model name will be different. Check the sticker on the packing box for your unit's model name.

### TS6200DN

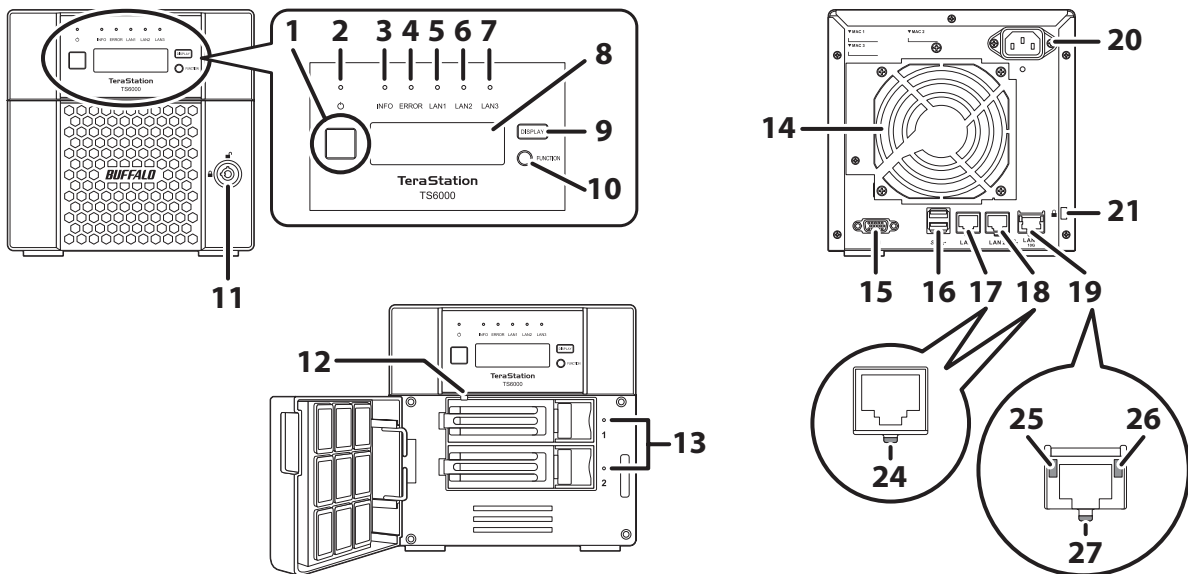

### TS6400DN

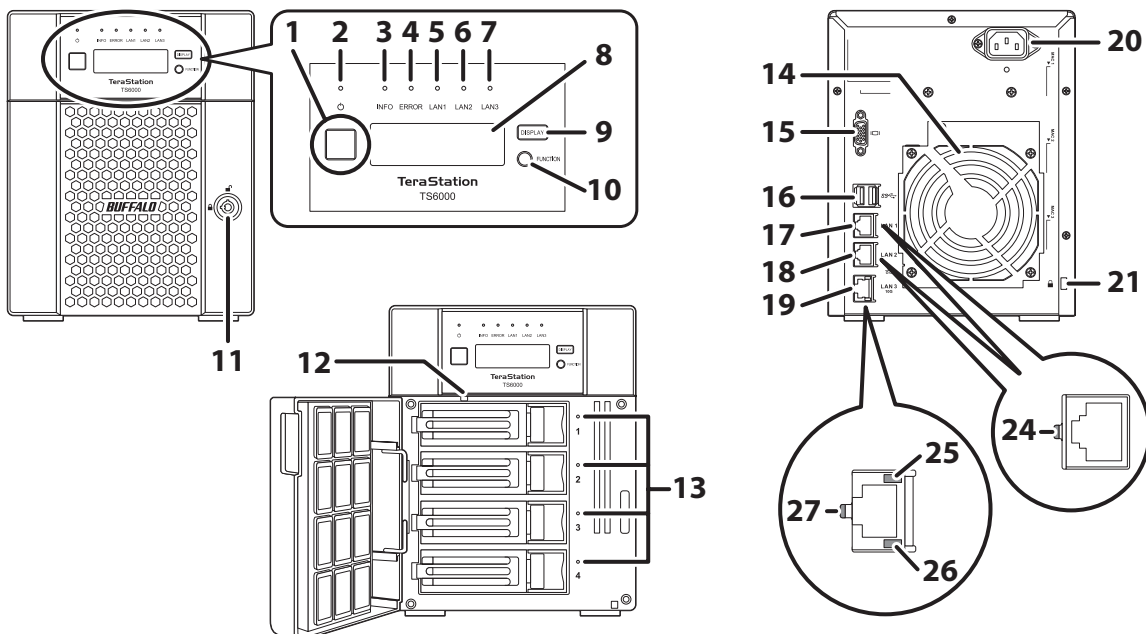



## TS6400RN

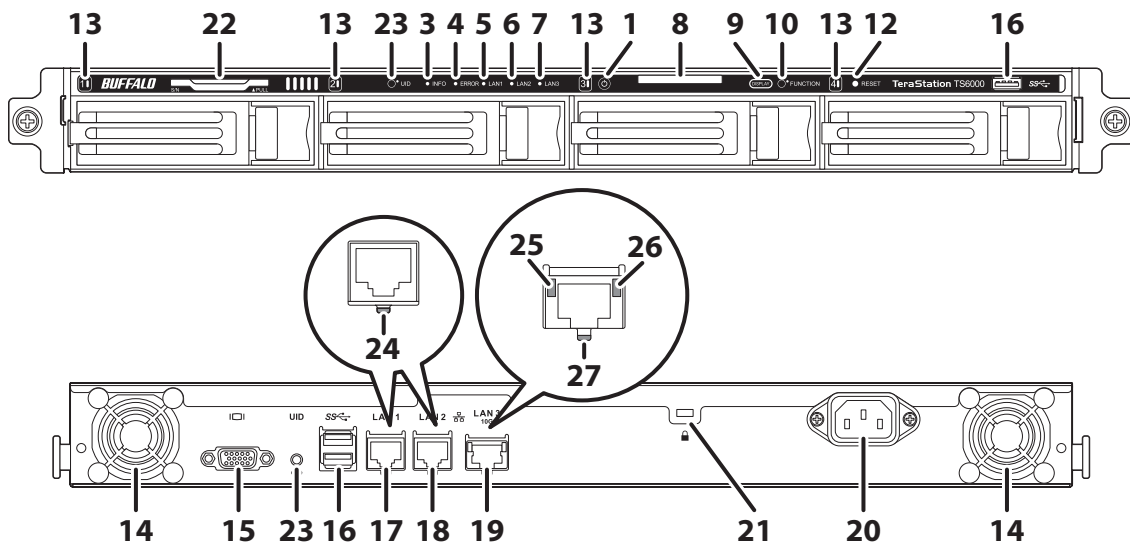

### 1 Power Button

To power on, connect the power cable and wait for 10 seconds, then press the power button. To power off, press and hold the power button for three seconds.

If the TeraStation beeps, pressing this button for a short period will stop the beeping.

### 2 Power LED

When the TeraStation is on, the LED glows green.

### 3 Info LED

If there is a status message, the info LED will light up amber. Check the LCD panel to see the status message.

### 4 Error LED

If there is an error, the error LED will light up red. Check the LCD panel to see the error message.

### 5 LAN1 LED

When LAN port 1 is connected, this LED glows green. It blinks when the connection is active.

### 6 LAN2 LED

When LAN port 2 is connected, this LED glows green. It blinks when the connection is active.

### 7 LAN3 LED

When LAN port 3 is connected, this LED glows blue. It blinks when the connection is active.

### 8 LCD Panel

This display shows the status of many TeraStation settings. It also displays errors and messages when available.

### 9 Display Button

Switches between the different display modes. Also, if the TeraStation is beeping, press this button to stop it.

### 10 Function Button

Use this button for dismounting USB devices, rebuilding RAID arrays, configuring failover, stopping the TeraStation's beeping, and initializing settings using a USB drive.

### 11 Drive Lock

Open the front panel with the key to replace drives or access the init button.

## 12 Init Button

Press and hold this button to initialize the TeraStation's admin username and password, IP settings, SSL, and service port restriction settings to their factory default values. The effects of this button can be changed in Settings.

## 13 Status LEDs

Normally, these LEDs blink green when drives are accessed. If a drive fails, its LED will turn red.

## 14 Fan

Spins to prevent overheating inside. Do not block the fan.

## 15 Not in use.

## 16 USB 3.0 Port

Compatible Buffalo USB drives, USB memory devices, and USB UPS connections can be connected. USB hubs are not compatible.

## 17 LAN Port 1 (1 GbE)

Connect an Ethernet cable to use this port for your network. It is available for communicating at max. 1000 Mbps.

## 18 LAN Port 2 (1 GbE)

Connect an Ethernet cable to use this port for your network. It is available for communicating at max. 1000 Mbps.

## 19 LAN Port 3 (10 GbE)

Connect an Ethernet cable to use this port for your network. It is available for communicating at max. 10 Gbps if using the included Ethernet or category 6A cable.

**Note:** To communicate at up to 10 Gbps, all network devices must be compatible with 10GbE.

## 20 Power Connector

Use the included power cable to connect to a UPS, surge protector, or outlet.

## 21 Anti-Theft Security Slot

Use this slot to secure your TeraStation with a cable lock (not included).

## 22 Serial Number

This sticker shows the TeraStation's serial number.

## 23 UID Button

Press the UID button on the front or the back of the unit to cycle the blue LED on and off.

## 24 Link/Act LED

Glows green when the TeraStation is connected to a network. It blinks when the connection is active.

## 25 Link/Act LED

Glows amber when the TeraStation is connected to a network at 100 Mbps. It blinks when the connection is active.

## 26 Link/Act LED

Glows green when the TeraStation is connected to a network at 1000 Mbps, 2.5 Gbps, or 5 Gbps. It blinks when the connection is active.

## 27 Link/Act LED

Glows blue when the TeraStation is connected to a network at 10 Gbps. It blinks when the connection is active.

---

# Turning the TeraStation On and Off

---

**Note:** Do not disconnect or reconnect the internal drives while turning on or off the TeraStation.

Press the power button on the TeraStation to turn it on.

To turn off the TeraStation, press and hold the power button for three seconds. Don't unplug the power cable without turning the TeraStation off first.

You can also shut down or restart the TeraStation remotely from Settings using the procedure below.

- 1 Double-click the NAS Navigator2 icon (  ) to start NAS Navigator2.
- 2 Right-click your TeraStation's icon and select *Settings*. For macOS, select the TeraStation's icon while holding down the control key, then select *Settings*.

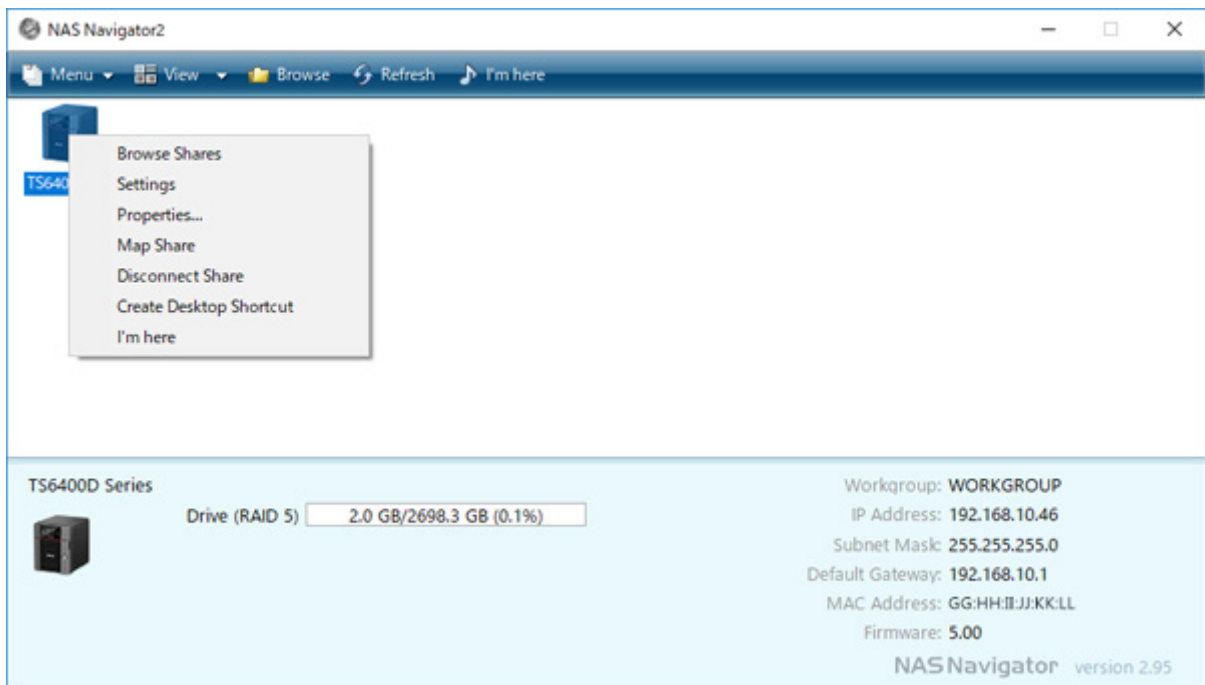

**3** Enter the username and password, then click *OK*.

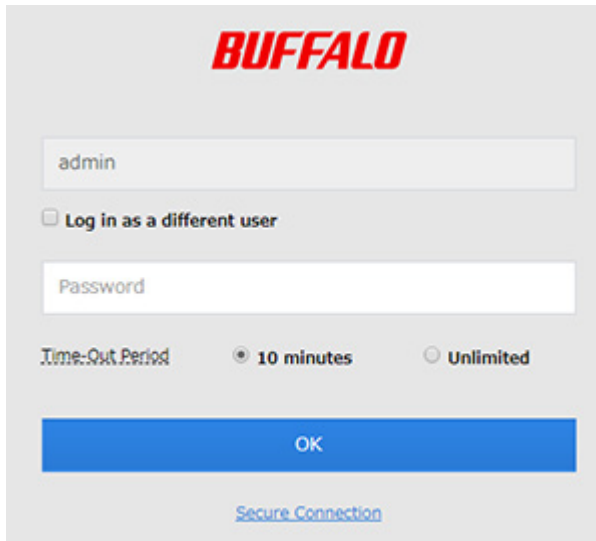

The login screen features the Buffalo logo at the top. Below it is a text input field containing the username "admin". A checkbox labeled "Log in as a different user" is present. Below the checkbox is a password input field labeled "Password". Underneath the password field, there are two radio buttons for "Time-Out Period": "10 minutes" (which is selected) and "Unlimited". At the bottom of the form is a large blue button labeled "OK". A link for "Secure Connection" is located at the very bottom of the screen.

**Note:** The default username and password are “admin” and “password”.

**4** Settings will open.

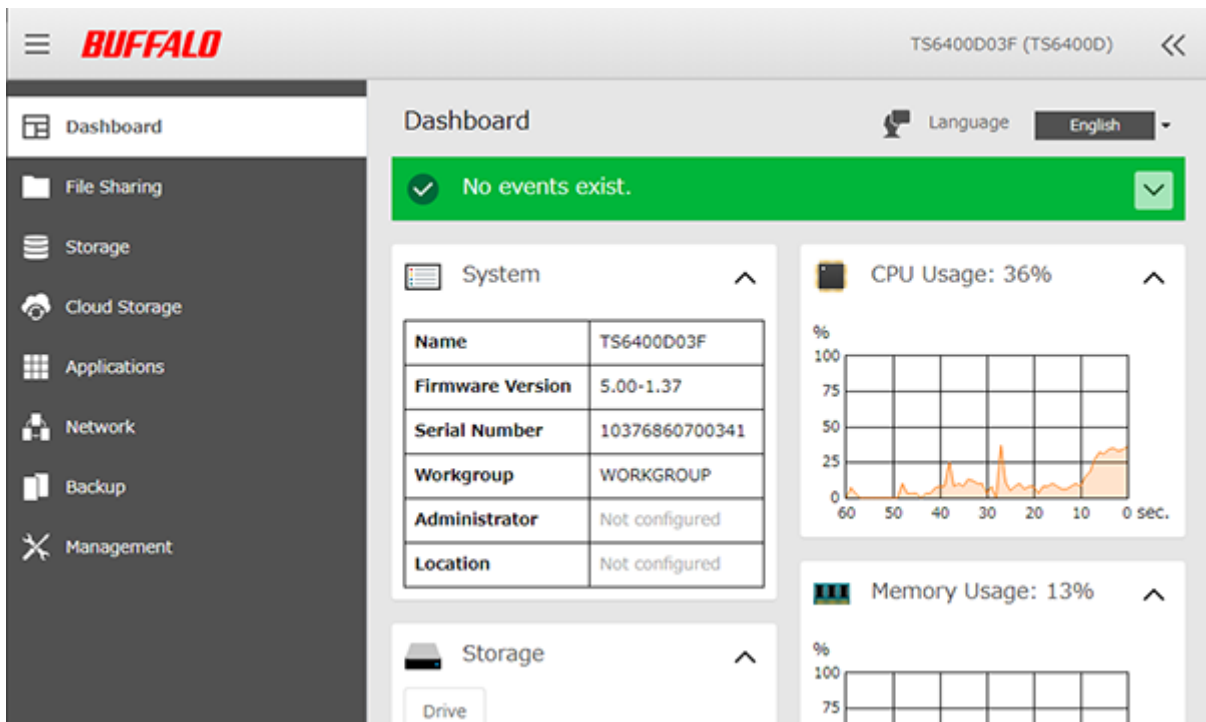

The dashboard interface includes a top navigation bar with the Buffalo logo and the device model "TS6400D03F (TS6400D)". A left sidebar contains menu items: Dashboard, File Sharing, Storage, Cloud Storage, Applications, Network, Backup, and Management. The main content area shows a "Dashboard" header with a language dropdown set to "English". A green notification bar at the top states "No events exist." Below this are several monitoring widgets: a "System" table, a "CPU Usage: 36%" line graph, and a "Memory Usage: 13%" bar chart.

Name	TS6400D03F
Firmware Version	5.00-1.37
Serial Number	10376860700341
Workgroup	WORKGROUP
Administrator	Not configured
Location	Not configured

**5** Click  at the top-right of Settings and choose *Shut Down*.

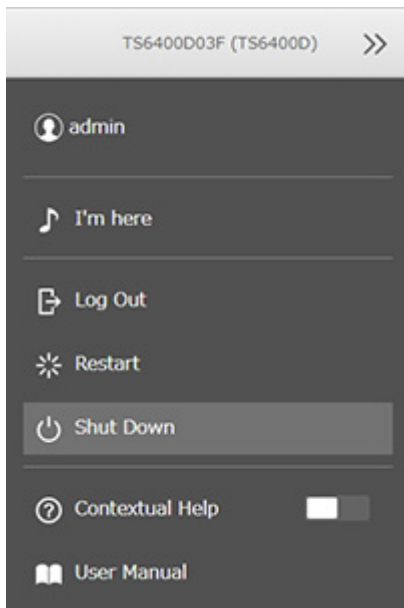

**6** Click Yes.

**7** The “Confirm Operation” screen will open. Enter the confirmation number, then click *OK*.

When the power LED on the front of the TeraStation turns off, the shutdown process is completed.

---

## Creating an Initialization Drive

---

We recommend creating an initialization drive as soon as possible. This USB drive can be used to initialize the TeraStation’s settings to its factory default values or recover the system if your TeraStation encounters an error that prevents the unit from booting. For the detailed procedure, refer to the [“Creating an Initialization Drive”](#) subsection in chapter 7.

# Chapter 2 Configuration

Configure and manage your TeraStation using the Settings interface, accessible from a browser window. Open the interface using the procedure below or type the TeraStation's IP address into the URL field of your browser.

**Note:** Microsoft Edge, Firefox, Google Chrome, Internet Explorer 9 or later, and Safari 9 or later are supported. If you have difficulty viewing Settings, check the following:

- If there are a large number of registered users, groups, or shared folders, use another browser instead of Internet Explorer.
- If you have a proxy server enabled in the browser settings, configure the exception settings for Settings or disable the proxy server.
- With Internet Explorer, set security to *Local intranet*. On Windows Server operating systems, higher-level security is configured by default. Set the security to a lower level temporarily.

---

## Running the Setup Wizard

---

### Setting Up Through Setup Wizard

---

When you access Settings for the first time, or after initializing the TeraStation's settings, the setup wizard will automatically be displayed. To set up the TeraStation using the wizard, follow the procedure below.

- 1 Double-click the NAS Navigator2 icon (  ) to start NAS Navigator2.
- 2 Right-click your TeraStation's icon and select *Settings*. For macOS, select the TeraStation's icon while holding down the control key, then select *Settings*.

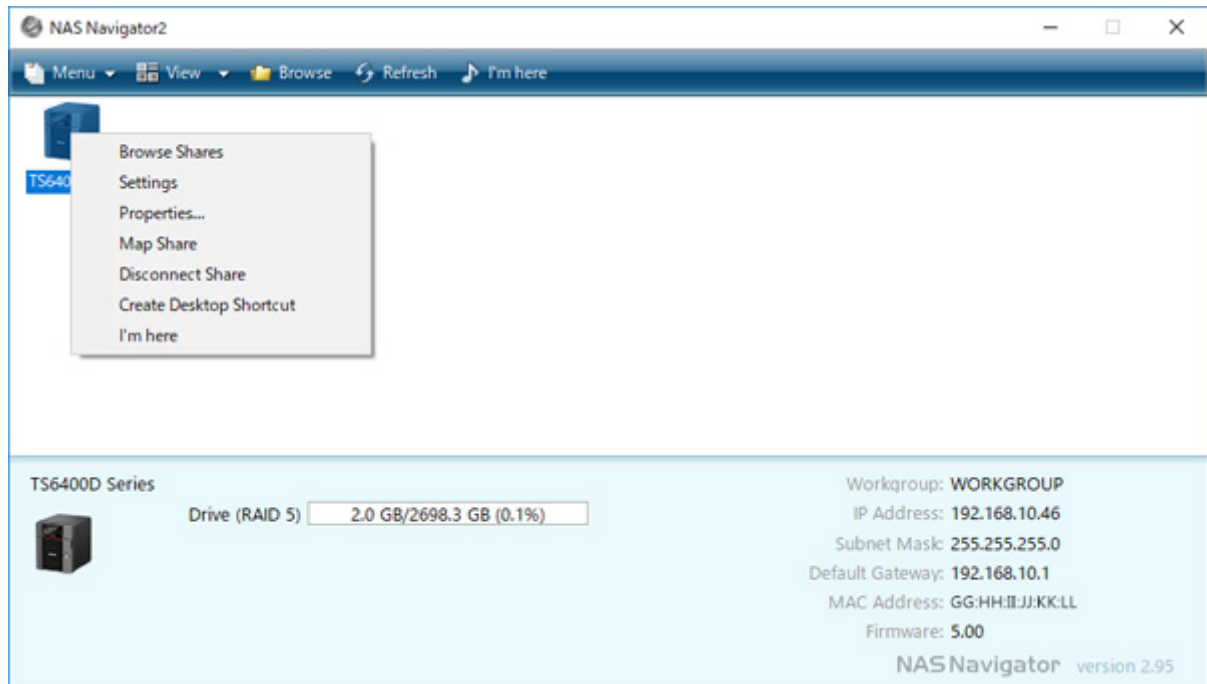

- 3** The password settings page will appear. Enter the desired new administrator password and click *Next*. If you click *Skip*, the administrator password will not change from the default value ("password").

### Change Administrator Password

**Change the administrator password.**  
For security, please choose a new administrator password below.

Show entered password

Password:

Enter the password again to confirm.

Confirm Password:

- 4** The time zone settings page will be displayed. If you need to change the time zone from that which is currently displayed on the page, select it from the drop-down list and click *Next*.

### Time Zone

**If the wrong time is displayed, change the time zone here.**

Time Zone:

- 5** The proxy server settings page will be displayed. If you place the TeraStation under a proxy network, set your proxy settings. Click *Next*.

### Proxy Server

**If your TeraStation is located on the network through the proxy server, configure the proxy server settings to use for communication.**  
Firmware update using Settings will not work properly through a proxy server. Configure your proxy server settings if you update the firmware from Settings.

Proxy Server:  Enable  Disable

Protocols \* : http  \*Required

Address \* :

Port: 80

Username:

Password:

- 6** The RAID settings page will be displayed. To change the RAID mode from the default mode, select the desired RAID mode and click *Next*, then click *Start* on the next page. The “Confirm Operation” screen will open so enter the confirmation number and click *OK*. Changing the RAID mode will begin.





If you want to keep the RAID mode as is, select “Keep current RAID mode” and click *Next*.

### RAID Mode



**Select your desired RAID mode.**  
 To avoid removing any important data unexpectedly, it is recommended to use a RAID mode that offers redundancy and back up regularly.  
 If a new drive is configured as a spare drive and an error occurs on another drive, the failed drive will be replaced with the new drive automatically to maintain redundancy.  
 If you change the RAID mode, all data on the drives will be lost.

**Keep current RAID mode**  
 Current RAID Mode: RAID 5 (Capacity: 2.7 TB, Drives Used for Array: 1, 2, 3, 4)  
 The wizard will finish without changing the RAID mode.

**RAID 5**  
 (Capacity: 2.70 TB, Drives Used for Array: 1, 2, 3, 4)

**RAID 5 + hot spare**  
 (Capacity: 1.80 TB, Drives Used for Array: 1, 2, 3 + Spare Drive: 4)  
 Identical data will be written to multiple drives with parity, resulting in both faster performance and redundancy in case a single drive fails.  
 Redundancy:   
 Performance: 

**RAID 6**  
 (Capacity: 1.80 TB, Drives Used for Array: 1, 2, 3, 4)

**RAID 6 + hot spare**  
 Identical data will be written to multiple drives with parity, resulting in redundancy in case up to two drives fail.  
 Redundancy:   
 Performance: 

**Note:** The RAID settings page will not be displayed if using the TS6200DN series TeraStations.

**7** The folder path to access shared folders will be displayed and setup will finish.

## Opening Setup Wizard

You may run the setup wizard even after the initial setup or initialization. To launch the setup wizard again, follow the procedure below.

**1** From Settings, click *Management*.

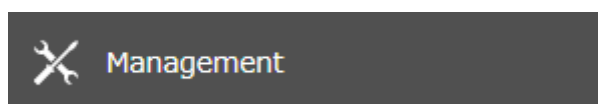

**2** Click the settings icon (  ) to the right of “Restore/Erase”.

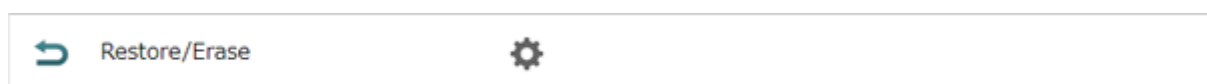

**3** Click *Execute Wizard*.

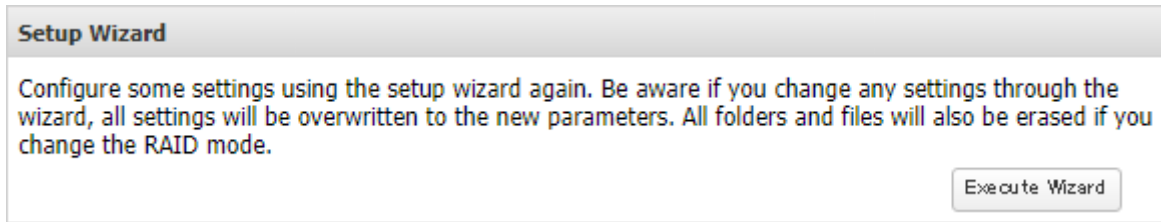

**4** The “Confirm Operation” screen will open. Enter the confirmation number, then click *OK*.

**5** Follow the procedure on the screen and finish the setup wizard.

---

## Opening Settings

---

**1** Double-click the NAS Navigator2 icon (  ) to start NAS Navigator2.

**2** Right-click your TeraStation’s icon and select *Settings*. For macOS, select the TeraStation’s icon while holding down the control key, then select *Settings*.

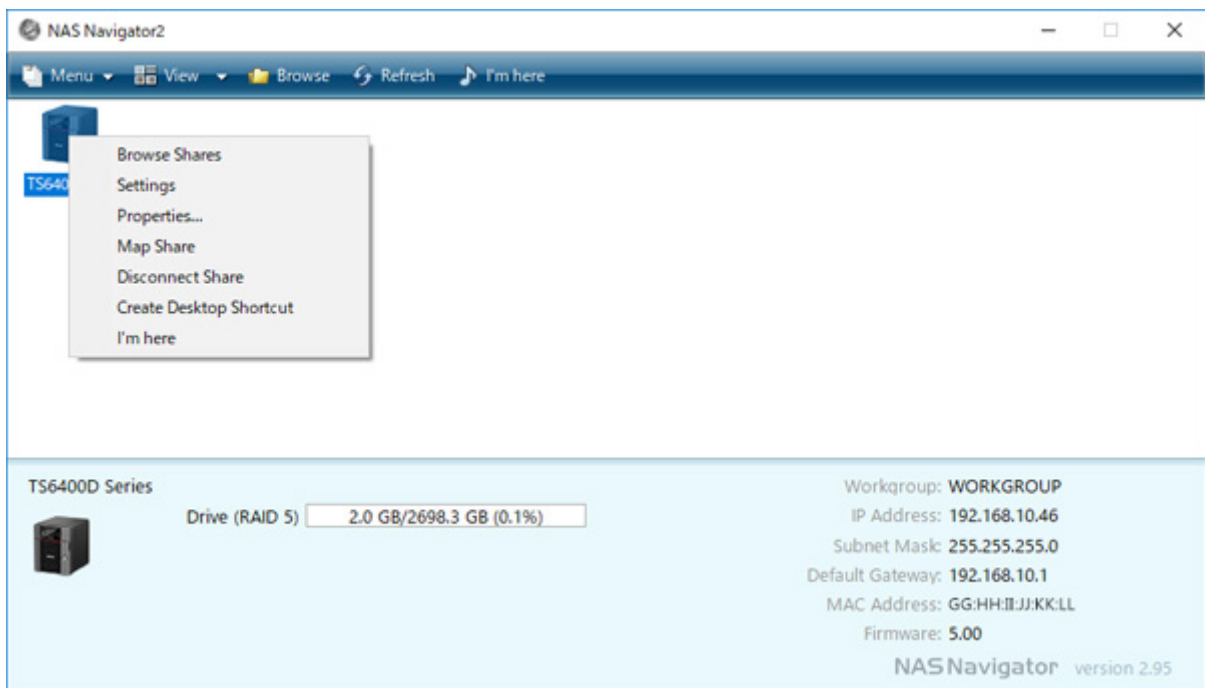

**3** Enter the username and password, then click *OK*.

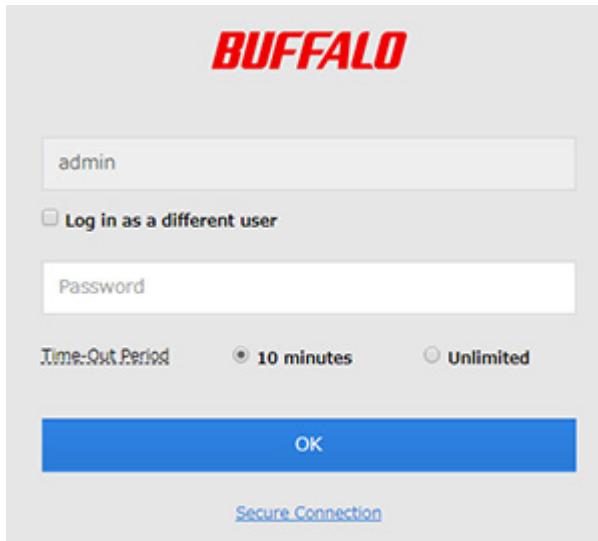

**Notes:**

- If the time-out period is set to “10 minutes”, you will be logged out of Settings after 10 minutes of inactivity.
- Click *Secure Connection* to log in using an encrypted connection.

**4** Settings will open.

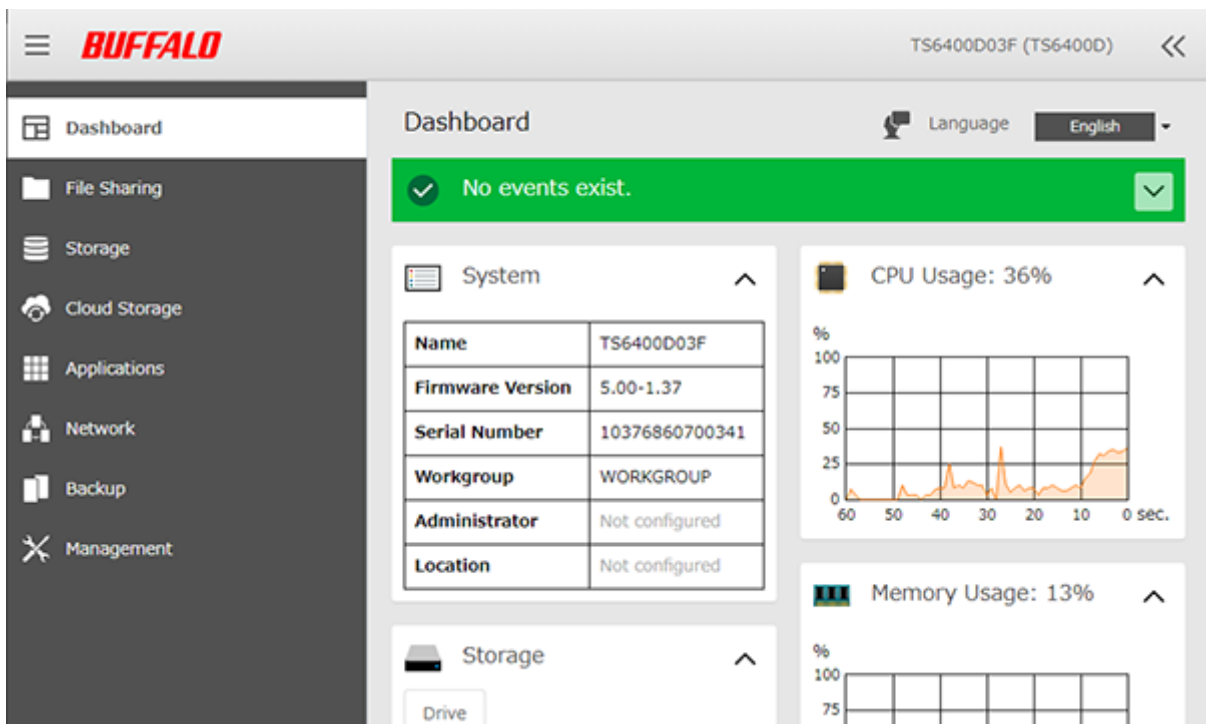

**Notes:**

- Username/Password Combinations:

Username	Password	Settings Available
admin (default)	password (default)	All
guest	blank	Guest user information
Your username	Your password	If a user is assigned as an administrator, all settings are available. If assigned to another group, only changing the password of logged-in users is available.

- Click  at the top-right of Settings and choose *I'm here* to play a tone from the TeraStation for easy location.

## Checking the Device Information from Dashboard

When opening the Settings interface, the Dashboard page will appear first. Dashboard will show the following device information:

- Notices, such as information events and errors
- System information, such as hostname, firmware version, IP address, etc.
- Drive information, such as used space of internal drives, LVM volumes, iSCSI volumes, etc.
- CPU and system memory usage
- Network information, such as IP address, link speed, sent and received rates, etc.

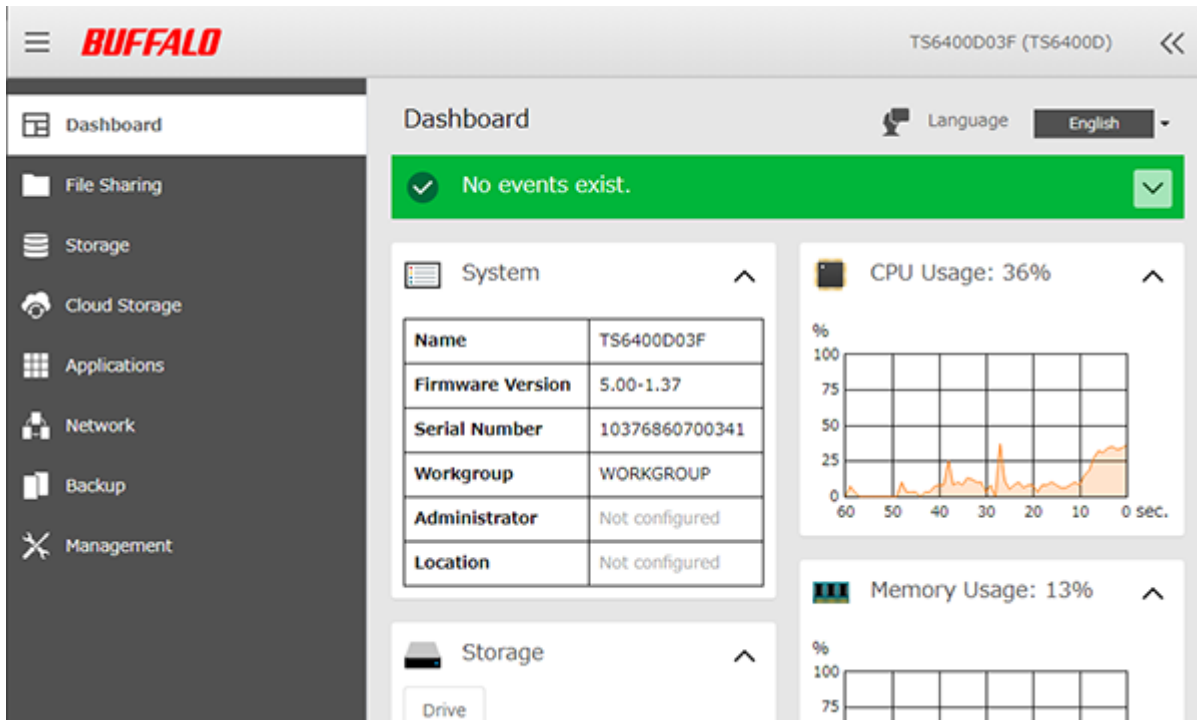

The screenshot shows the Buffalo TeraStation dashboard for device TS6400D03F (TS6400D). The interface includes a sidebar with navigation options like Dashboard, File Sharing, Storage, Cloud Storage, Applications, Network, Backup, and Management. The main content area displays a 'No events exist.' notification, a 'System' information table, and two performance graphs for CPU and Memory usage.

Name	TS6400D03F
Firmware Version	5.00-1.37
Serial Number	10376860700341
Workgroup	WORKGROUP
Administrator	Not configured
Location	Not configured

### Notes:

- If the number of files on the TeraStation increases, it will also raise the memory usage of the TeraStation. This memory usage will decrease after a certain period of time passes. To reduce the memory usage immediately, try the following operations:
  - Restarting the TeraStation.
  - Dismounting the USB drive.
- If there is not enough free space on the TeraStation, it may cause abnormal system behavior. Make sure that there is always at least 1 GB or larger of free space on the TeraStation.

# Chapter 3 File Sharing

You can create users and groups to access the shared folders on the TeraStation and configure access restrictions to limit access to key data.

## Configuring Shared Folders

### Adding a Shared Folder

- 1 From Settings, click *File Sharing*.

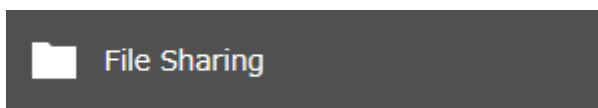

- 2 Click the settings icon (⚙) to the right of "Folder Setup".



- 3 Click *Create Folder*.

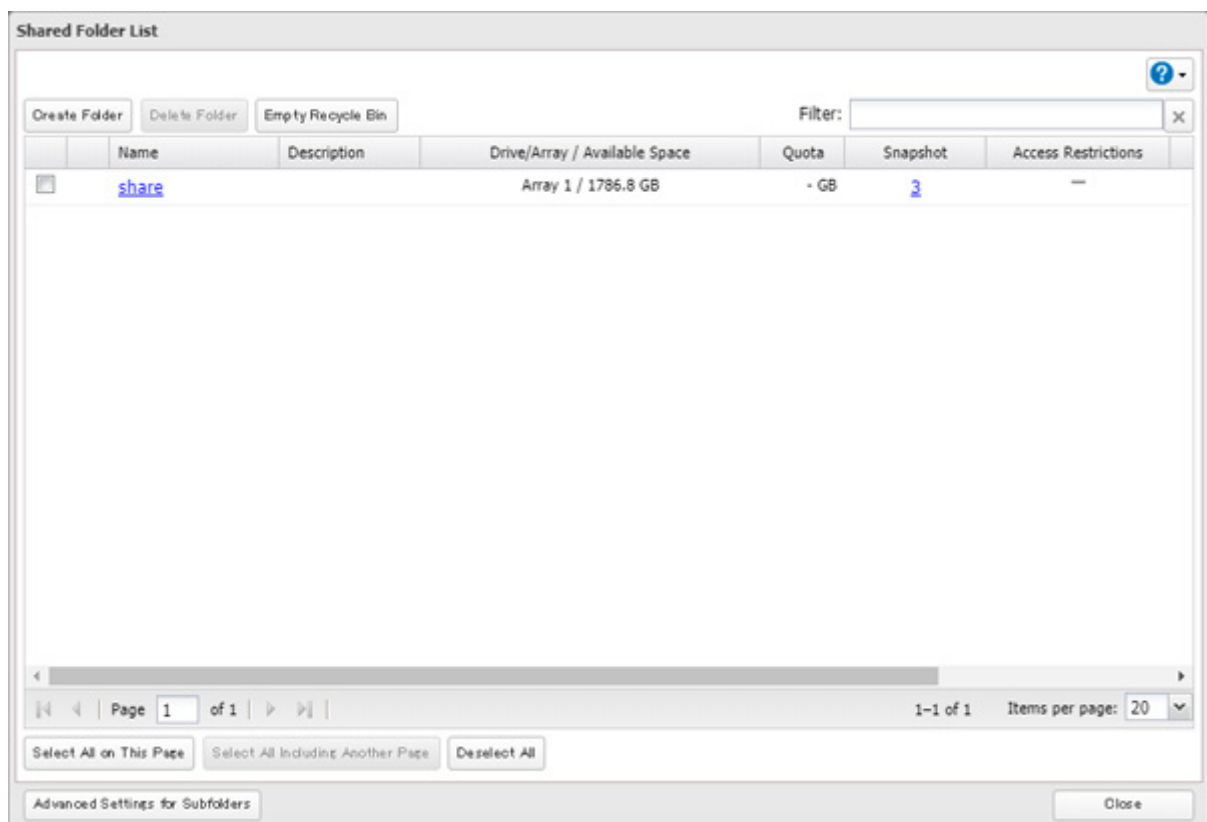

#### 4 Configure the desired settings, then click *OK*.

**Shared Folder Settings**

\*Required ?

Basic Option 1 Option 2 Access Restrictions

Copy Settings from: [dropdown]

Name \* : [text field]

Drive/Array: Drive 1 [dropdown]

Recycle Bin:  Enable  Disable

LAN Protocol Support:  SMB (Windows/Mac)  AFP (Mac)

FTP  Backup

SFTP  WebAccess

NFS

— NFS Path \_\_\_\_\_

OK Cancel

#### Notes:

- Names may contain up to 27 alphanumeric characters, hyphens (-), and underscores (\_). Multibyte characters are supported. The first character should not be a symbol.
- When you click the *Option 1* tab, you can enter the folder description. Descriptions may contain up to 75 alphanumeric characters, hyphens (-), underscores (\_), and spaces. Multibyte characters are supported. The first character should not be a space.
- You may create up to 400 shared folders.
- If the names of shared folders accessed via AFP and FTP connections contain multibyte characters, configure the client language in *Management > Name/Time/Language* to match the characters. If the setting does not match, the shared folder name will not be displayed correctly.
- The following characters are handled differently by macOS and Windows. Avoid using these characters when sharing data between macOS and Windows:  
— ~ // — ç £ ↵
- Windows does not support some characters that macOS and the TeraStation allow. If you create a filename on a Mac using any of the following symbols, it will not display correctly on a Windows computer. You may have to connect to the TeraStation via AFP in order to display or copy files that contain these symbols in their filenames.



Read-only shares and HFS Plus-formatted USB drives will have “(Read Only)” added to comments in File Explorer.

**Note:** Configure read-only file attribute in Settings. Configuring them from within Windows is not supported and may cause unexpected behavior.

## Hidden Shares

If hidden shares are enabled, shared SMB folders will not be displayed in Network, and only certain users are allowed to access them. To hide a shared SMB folder, follow the procedure below.

- 1 From Settings, navigate to *File Sharing > Folder Setup* and choose a shared folder.
- 2 Click the *Option 2* tab and select the “Hidden share (SMB only)” checkbox, then click *OK*.

### Notes:

- If protocols other than “SMB (Windows/Mac)” or “Backup” under “LAN Protocol Support” on the *Basic* tab are enabled, the hidden shares option will be grayed out and cannot be selected.
- Configure hidden share attribute in Settings. Configuring them from within Windows is not supported and may cause unexpected behavior.

To access a hidden folder, open File Explorer in your computer and enter “\\TeraStation name\shared folder name\$” into the address bar. For example, if the TeraStation name is “TSXXX001” and the shared folder name is “share”, enter “\\TSXXX001\share\$” to open it.

## Quotas

You can set a quota for each shared folder, as well as a threshold alert where you will receive an email notification if the space used exceeds the configured threshold. To configure email notifications for the quota, refer to the “[Email Notification](#)” section in chapter 7.

### Notes:

- When using quotas, disable the recycle bin or empty the trash folder often. The limited space includes the space used for trash.
- Quotas cannot be set for external drives connected to the TeraStation.

Follow this procedure to limit the shared folder space available for a user.

- 1 From Settings, click *File Sharing*.

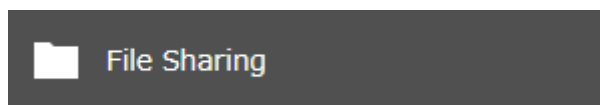

- 2 Click the settings icon (  ) to the right of “Folder Setup”.



- 3 Select the shared folder that will be given a quota.
- 4 Click the *Option 1* tab.



- 5** Enable quotas, choose the alert and the maximum amount of space the user will be allowed to use, and click *OK*.

Quota:  Enable   Disable

Quota Capacity:  GB

Quota Alert Capacity:  GB

## Configuring Users

### Adding a User

**Note:** The TeraStation can register a maximum 300 of users, which include the default users “admin” and “guest”.

- 1** From Settings, click *File Sharing*.

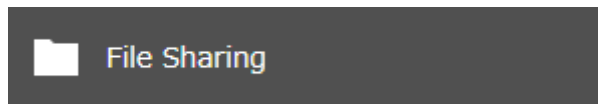

- 2** Click the settings icon (  ) to the right of “Users”.





- 3** Click *Create User*.

**User List**

Local Users Domain Users

Create User Import CSV File Delete User Filter:

Username	Description	Group	Access Restrictions for Shared Folders
<a href="#">admin</a>	System default admin user	1 	<input type="button" value="Edit"/>
<a href="#">guest</a>	System default guest user	1 	<input type="button" value="Edit"/>

Page 1 of 1 1-2 of 2 Items per page: 20

Select All on This Page Select All Including Another Page Deselect All

Close

#### 4 Enter the desired settings, then click *OK*.

**User Settings**

**Username \*** :

**User ID:**  
Enter a number between 1000 and 1999.

**Email:**

**Password \* :**

**Confirm Password \* :**

**Description:**

**Filter:**

Group	
<input checked="" type="checkbox"/>	hdusers
<input type="checkbox"/>	admin

**Primary Group:**  
hdusers

#### Notes:

- Usernames may contain up to 128 alphanumeric characters, hyphens (-), underscores (\_), periods (.), and the symbols ! # & @ \$ \* ^ %. The first character should not be a symbol.
- The user ID should be a number from 1000 to 1999. Each user ID should be unique. If this field is left blank, a user ID is assigned automatically.
- Do not duplicate user IDs, group IDs, usernames, or group names. Each should be distinct and unique.
- User descriptions may contain up to 75 alphanumeric characters, hyphens (-), underscores (\_), and spaces. Multibyte characters are supported. The first character should not be a symbol or space.
- Passwords may contain up to 20 alphanumeric characters, hyphens (-), underscores (\_), spaces, commas (,), periods (.), semicolons (;), tildes (~), and the symbols @ ! \$ & \* + : = ? [ ^ ] { \. The first character should not be a symbol unless it is an underscore.
- Use the same username and password for both Windows and the TeraStation or you may be unable to access shared folders.
- Do not use a name already in use as a group; do not use any of the following words as a username as these words are reserved for internal use by the TeraStation: \_lldpd, adm, admin, administrator, admins, all, apache, avahi, avahi-autoipd, backup, bin, crontab, daemon, dialout, dip, disk, ftp, ftpuser, fuse, gnats, guest, guests, halt, hdusers, irc, kmem, libuuid, list, lp, mail, man, messagebus, mysql, netdev, news, nobody, nogroup, none, ntp, openldap, operator, plugdev, proftpd, proxy, puppet, root, rpc, rpcuser, sambashare, sasl, shadow, shutdown, snmp, splx, src, ssh, sshd, staff, statd, sudo, sync, syslog, tmhttpd, tty, users, utmp, uucp, winbindd\_priv, www, www-data

## Importing User Information

---

You can import users in *File Sharing > Users* by clicking *Import CSV File*.

An example format for user data: Username (required), password (required), and user description (optional).

Example 1: Importing usernames, passwords, and comments

```
username1,password1,comment1
```

```
username2,password2,comment2
```

```
username3,password3,comment3
```

Example 2: Importing usernames and passwords

```
username1,password1,
```

```
username2,password2,
```

```
username3,password3,
```

### Guidelines:

- Use commas (,) as separators. Do not put spaces before or after commas. If you don't want user descriptions, use a comma after the password at the end.
- If a line is in an incorrect format, the username entered on that line will not be registered.
- If an unavailable name is used by a user or if the username already exists, an error will occur and cancel the import process. User whose usernames were entered during or after the error occurs will not be imported.
- Do not use commas (,) in the username, password, or user description.

**Note:** Imported users are added to the "hdusers" group automatically.

---

## Adding a Group

---

- 1 From Settings, click *File Sharing*.

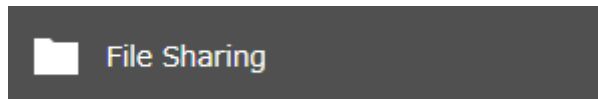

- 2 Click the settings icon (⚙️) to the right of "Groups".



**3** Click *Add Group*.

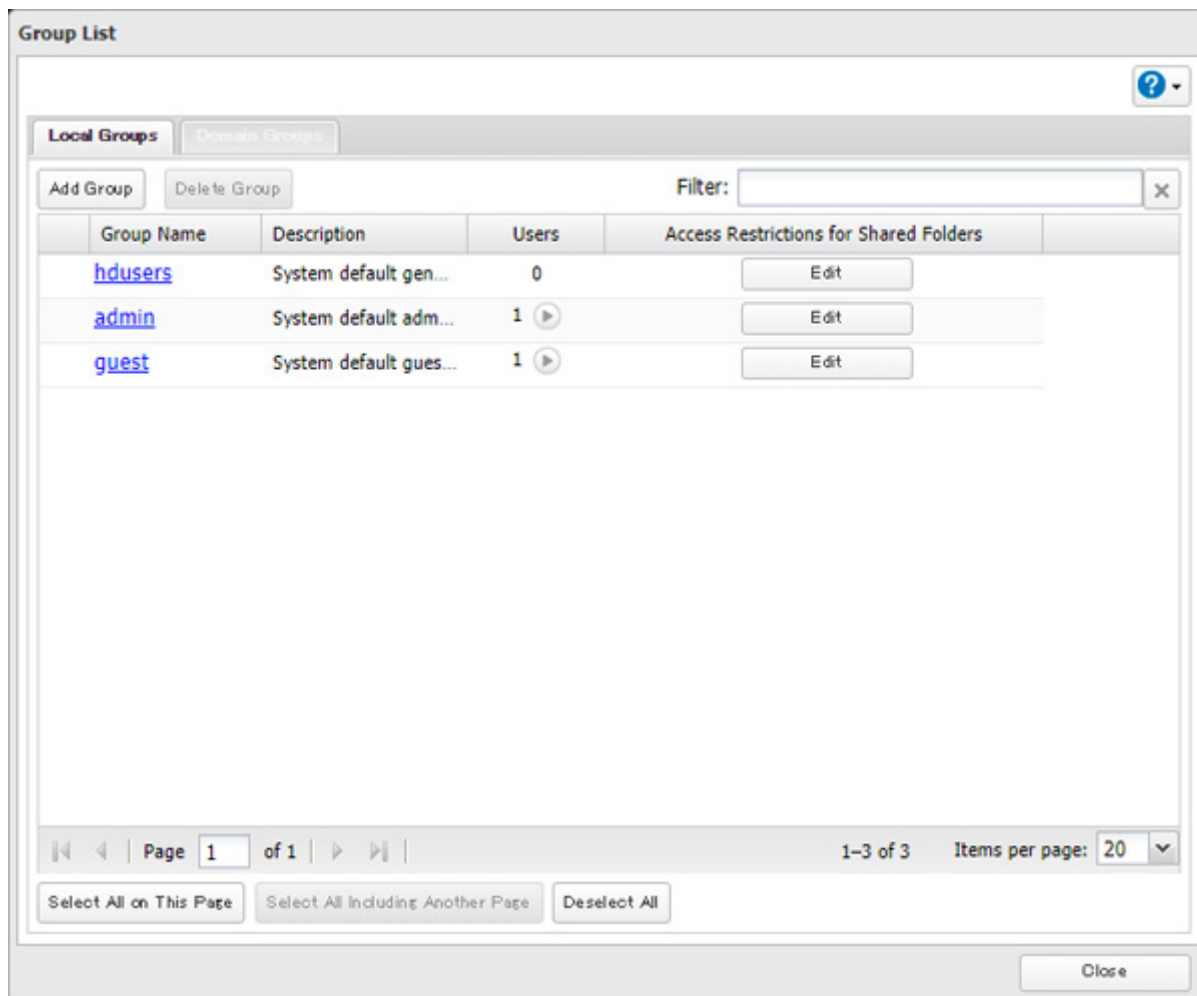

#### 4 Enter the desired settings, then click *OK*.

**Group Settings**

\*Required ?

Group Name \* :

Group ID:  
Enter a number between 1000 and 1999.

Group Privileges:  
General users ▼

Select a recipient for group notifications:

User (with email address configured)  
Disabled ▼

Email address

Description:

Filter:

Username
<input type="checkbox"/> admin

Select All Deselect All

OK Cancel

#### Notes:

- Group names may contain up to 20 alphanumeric characters, hyphens (-), underscores (\_), and periods (.). The first character should not be a symbol.
- Group descriptions may contain up to 75 alphanumeric characters, hyphens (-), underscores (\_), and spaces. Multibyte characters are supported. The first character should not be a symbol or space.
- If the group ID field is left blank, a group ID is automatically assigned. Use numbers between 1000 and 1999 to set a group ID manually. Don't use duplicate group IDs.
- You may register up to 300 groups with the TeraStation.
- If you are logged in as a member of the general users group, you can change only your own password. If you're logged in as an administrator, you can change any setting, including other users' passwords. If you are logged in as a member of the power users group, you can create and edit shared folders, users, and groups.
- Do not use a name in use as a user; do not use any of the following words as a group name as these words are reserved for internal use by the TeraStation: \_lldpd, adm, admin, administrator, admins, all, apache, avahi, avahi-autoipd, backup, bin, crontab, daemon, dialout, dip, disk, ftp, ftpuser, fuse, gnats, guest, guests, halt, hdusers, irc, kmem, libuuid, list, lp, mail, man, messagebus, mysql, netdev, news, nobody, nogroup, none, ntp, openldap, operator, plugdev, proftpd, proxy, puppet, root, rpc, rpcuser, sambashare, sasl, shadow, shutdown, snmp, splx, src, ssh, sshd, staff, statd, sudo, sync, syslog, tmhttpd, tty, users, utmp, uucp, winbindd\_priv, www, www-data

## Configuring Access Restrictions for Shared Folders

You may restrict access to specific shared folders, including external USB drives.

### Notes:

- Shared folders with limited access can still be used as backup destinations.
- If you grant both read-only and read and write access to the users or groups, the attribute will become as below:

	Group with read and write access	Group with read-only access	Group with no access
User with read and write access	R/W	R	R/W
User with read-only access	R/W	R	R
User with no access	R/W	R	-

R/W: Read and write, R: Read-only, -: No access

## Local Users and Groups

- 1 From Settings, click *File Sharing*.

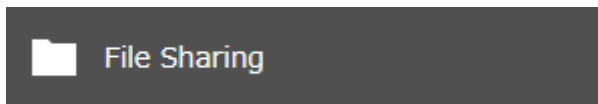

- 2 Click the settings icon (⚙️) to the right of "Folder Setup".



- 3 Click the shared folder that you want to set access restrictions for.

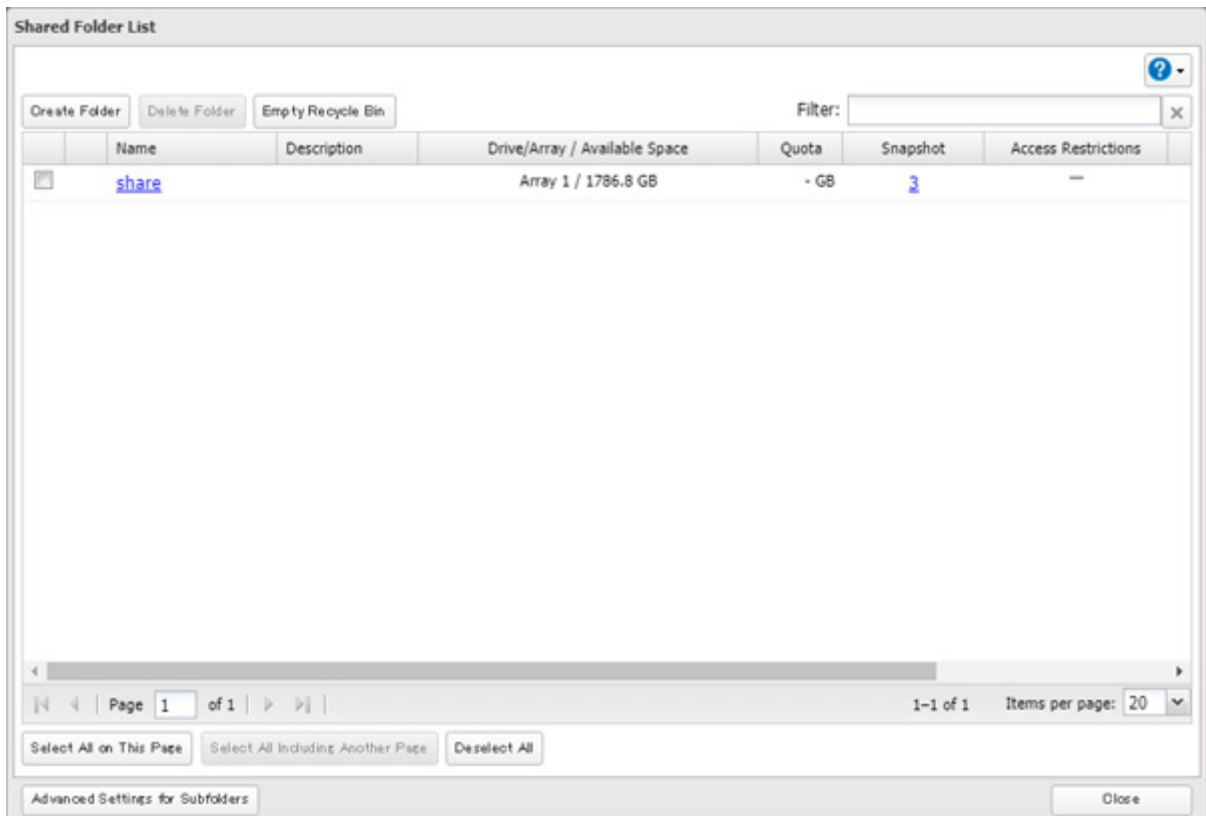

**4** Click the *Access Restrictions* tab.

**5** Enable “Access Restrictions for Shared Folders”.

Access Restrictions for Shared Folders:  Enable  Disable

**6** Select the level of access for the user or group.

: Read and write access allowed : Read access allowed : Access prohibited

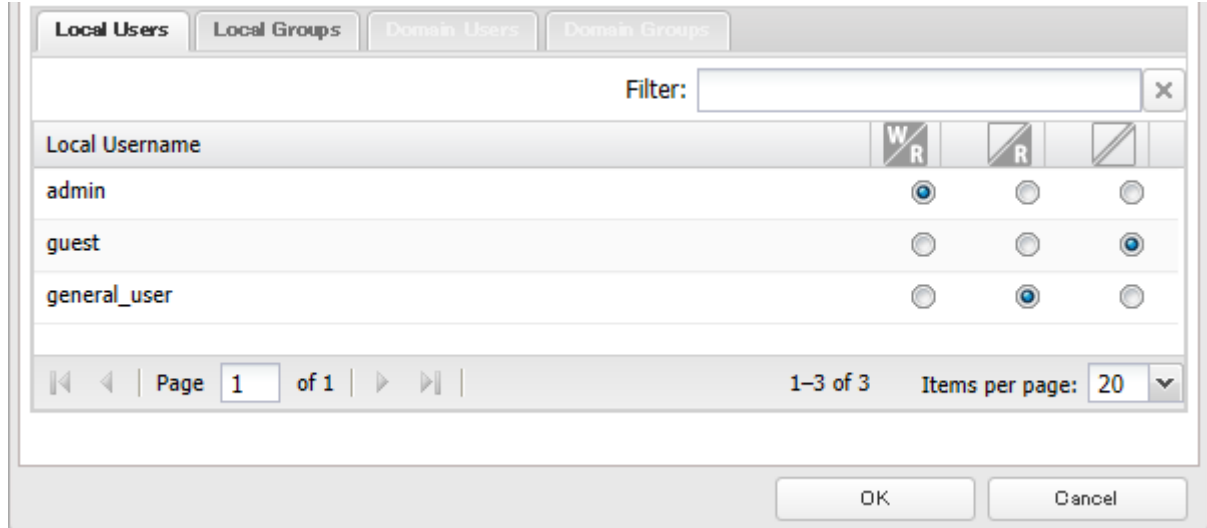

**7** Click *OK*.

**Note:** The example above shows access restriction by a user. To restrict access by group, click the *Local Groups* tab and select group permissions.

## Active Directory

If there is an Active Directory environment, the TeraStation will use account information from the Active Directory domain controller to set access restrictions for TeraStation's shared folders. There is no need to perform individual account management for the TeraStation. If multiple TeraStations are installed on the network, the account information is centrally managed in Active Directory, greatly reducing the operations required for installation and management.

### Notes:

- If usernames or group names from Active Directory include multibyte characters, you will not be able to configure access restrictions for them.
- The TeraStation supports a domain environment with a maximum of 10,000 users and groups.

**1** From Settings, click *Network*.



**2** Click the settings icon ( ) to the right of “Workgroup/Domain”.

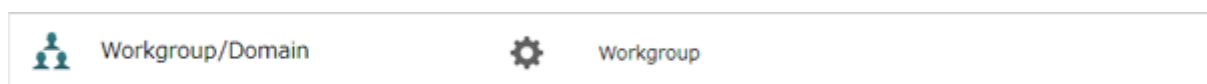

**3** Click *Edit*.

**4** Select “Active Directory”, then click *Next*.

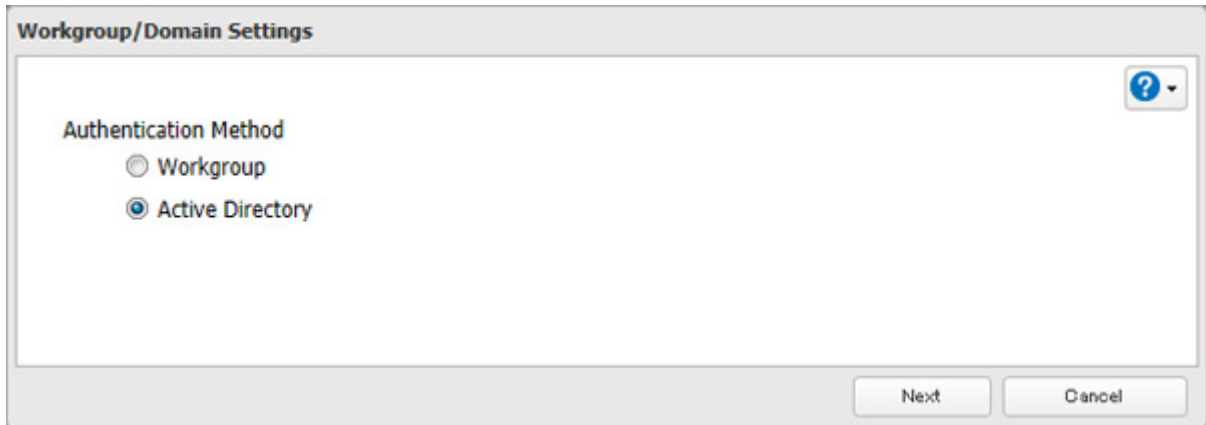

**5** Enter the domain controller information and click *Search*. The domain controller on the same network will be detected and required settings will be entered into each field automatically. Or, enter the settings manually.

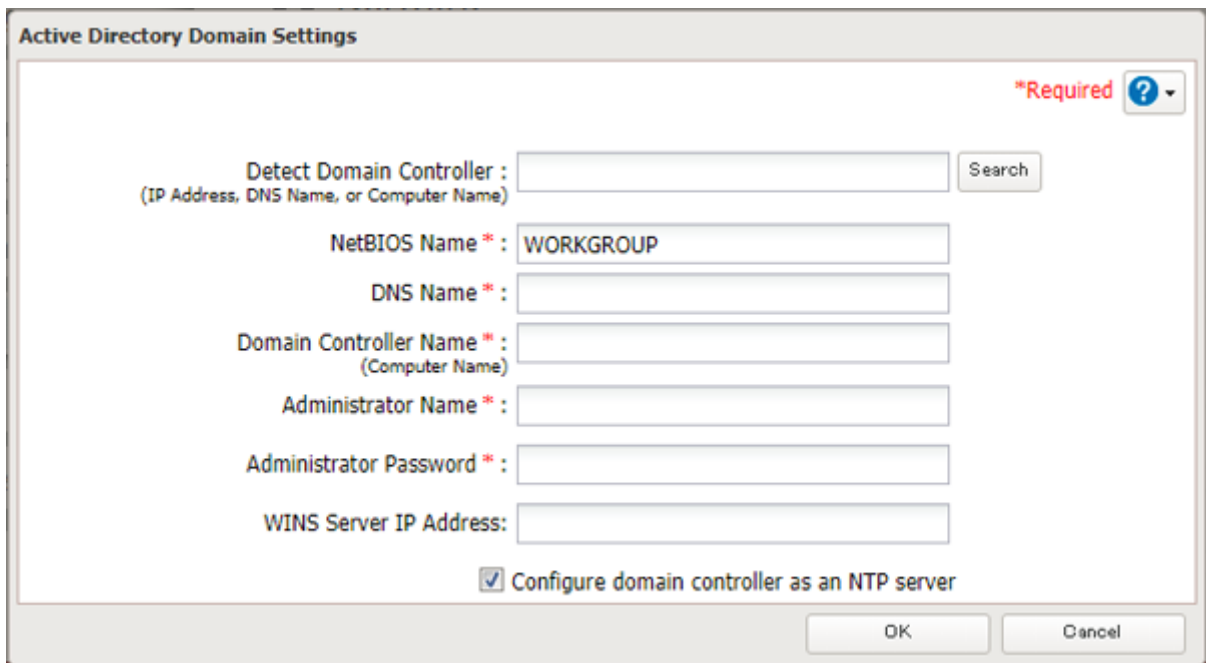

**6** If there is a difference of more than five minutes between the TeraStation’s clock and the domain controller’s clock, joining the domain or authenticating domain users and groups may fail. For best results, select “Configure domain controller as an NTP server” if the domain controller can function as the NTP server.

**7** Click *OK*.

**8** Click the settings icon (  ) to the right of “Folder Setup”.





**9** Click the shared folder that you want to set access restrictions for.

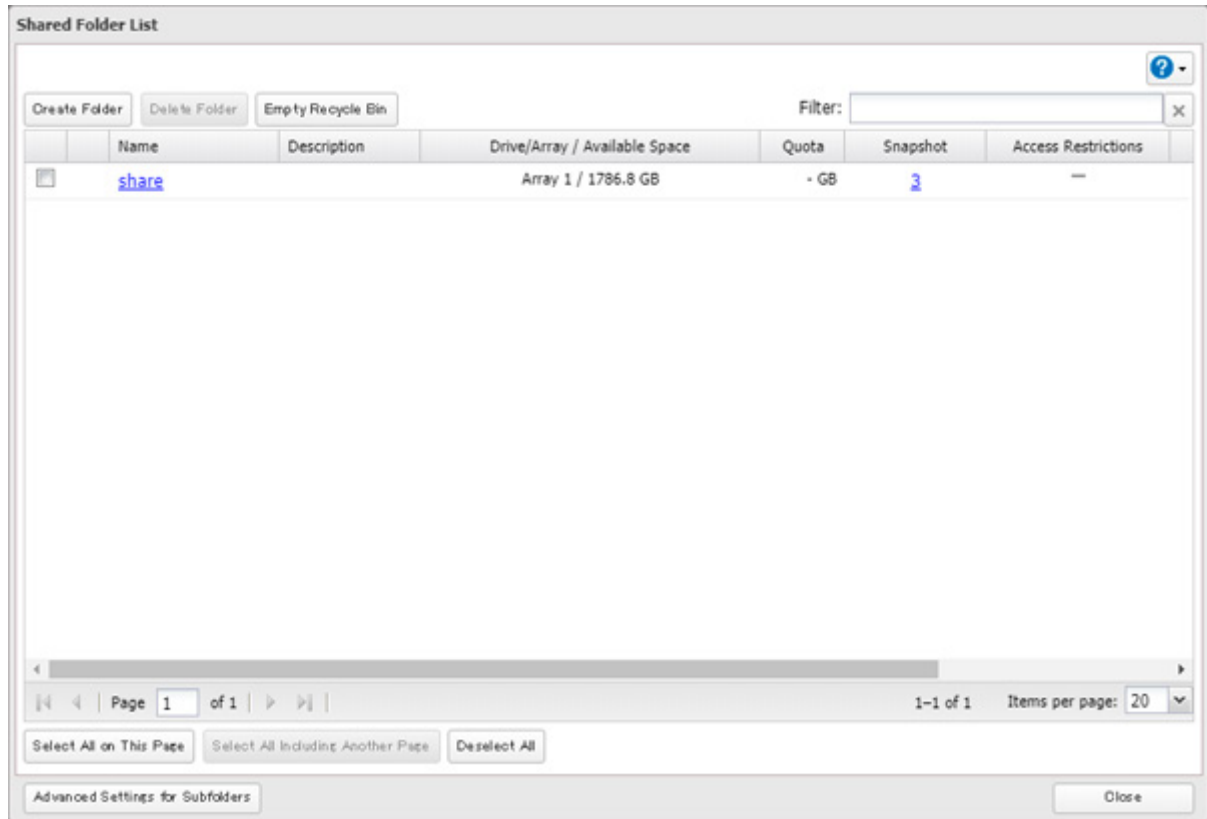

**10** Click the *Access Restrictions* tab.

**11** Enable “Access Restrictions for Shared Folders”.

Access Restrictions for Shared Folders:  Enable  Disable

**12** Select the level of access for the user or group.

: Read and write access allowed : Read access allowed : Access prohibited

**13** Click *OK*.

#### Notes:

- To have the TeraStation join an Active Directory domain, configure it to use a DNS server that can resolve names for the Active Directory domain.
- After building an Active Directory domain, the administrator password for joining the domain must be changed at least once, or joining the Active Directory domain will fail.
- The DNS name and NetBIOS name of Active Directory domains should be identical.
- To use the TeraStation as a member server in an Active Directory domain, the TeraStation should be logged in to the domain and accessed from a computer that is not a member of the domain with a valid domain account.
- If the TeraStation is a member server of an Active Directory domain, you cannot connect as a guest user via AFP.
- If your TeraStation is a member server in an Active Directory domain and you change the authentication method to “Workgroup”, the account on the domain controller will not be deleted automatically.
- If FTP is enabled, local and domain group access restrictions from the AD network do not work. Use user access restrictions instead.
- If you allow read and write or read-only access for most users, group access restrictions are recommended.

- Depending on the domain controller’s policy settings, the domain controller may force the TeraStation to leave the Active Directory domain. If this occurs, the TeraStation will lose the domain users and groups so if you have configured access restrictions using domain accounts, these users will no longer be able to access shared folders. In such a case, change the policy settings on the domain controller or let the TeraStation join the Active Directory domain again.

---

## Configuring Access Restrictions for Subfolders

---

You may restrict access to subfolders in shared folders by configuring access permissions from your computer using Windows File Explorer.

**Notes:**

- Depending on the environment, the function may not work properly even if it’s enabled. We recommend verifying the functionality before using.
- Access permissions configuring from File Explorer is available up to 18 files and 24 folders. This number of available access permissions may vary if access permissions are inherited from the parent object. The number of available access permissions are not many so using group access permissions is recommended if the permission level is the same to the multiple users; it will save spending the number of available access permissions.

---

## Enabling Subfolders’ Access Restrictions

---

- 1** From Settings, click *File Sharing*.

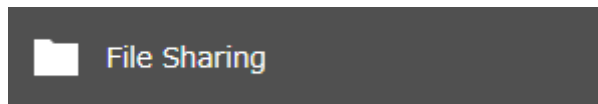

- 2** Click the settings icon (  ) to the right of “Folder Setup”.



- 3** Click the shared folder that you want to set access restrictions for.

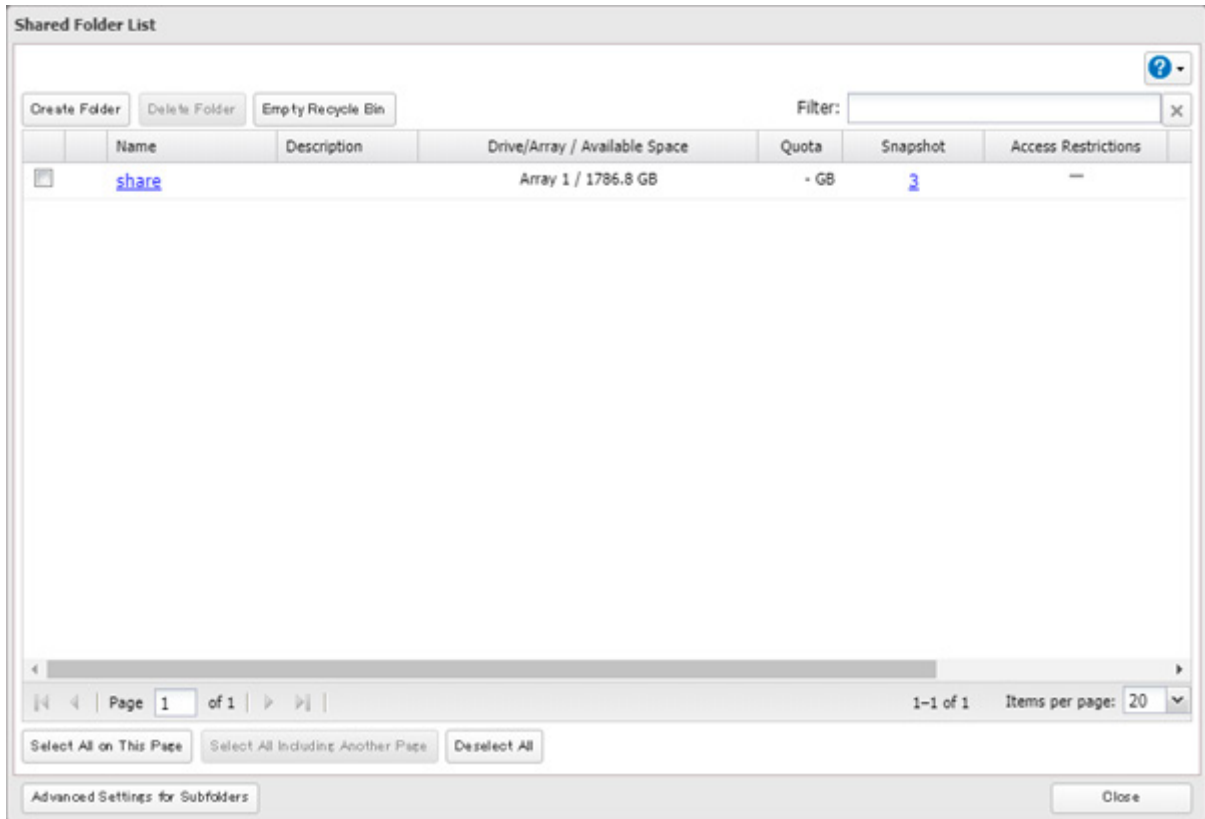

- 4** Clear all checkboxes for “LAN Protocol Support” other than “SMB (Windows/Mac)”, “Backup”, and “NFS”.
- 5** Click the *Option 2* tab.
- 6** Enable “Access Restrictions for Subfolders”.

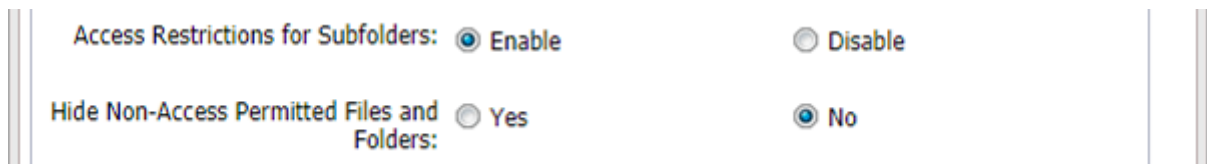

**Note:** If “Hide Non-Access Permitted Files and Folders” is enabled, non-access permitted sub-files and folders will not be displayed in shared folders.

- 7** Click *OK*.

Enabling subfolders’ access restrictions finished. Next, configure access permissions for each user or group to files and folders in subfolders from File Explorer.

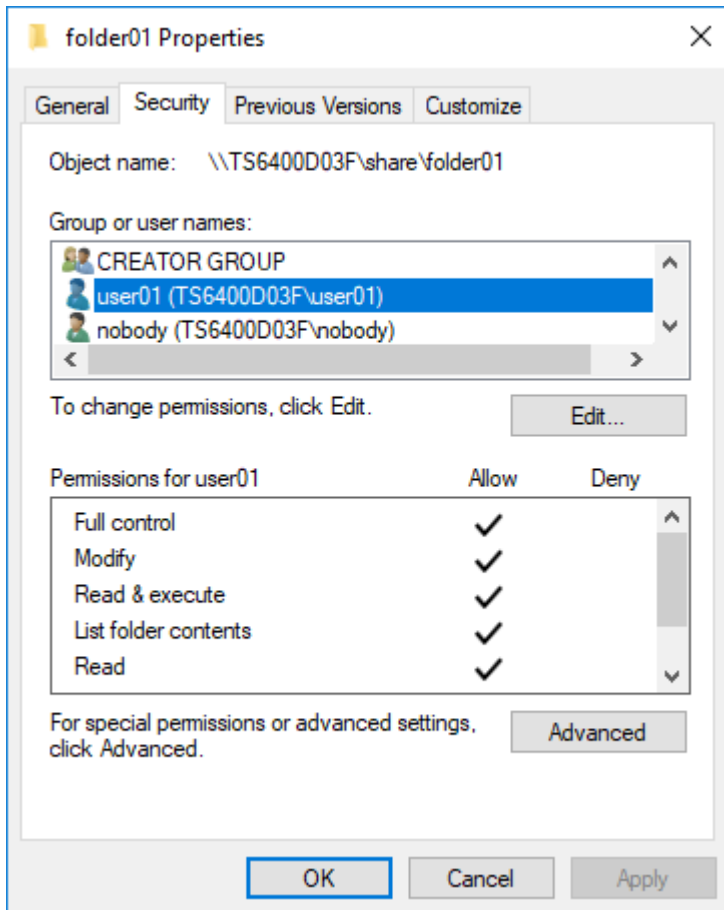

You may also configure access permissions for domain users and groups. You should have the TeraStation join your Active Directory domain before configuring access permissions from File Explorer.

**Notes:**

- If enabling subfolders' access restrictions for a USB drive, the drive should be formatted using Btrfs, XFS, or ext3.
- To back up files to a backup destination with access permission settings of files and folders in subfolders unchanged, make sure that the same workgroup name, user IDs, and group IDs are configured between the backup source and destination.
- If you enable subfolders' access restrictions and then clear the "Read & execute" checkbox under "Allow" on File Explorer for users or groups access permissions, these users or groups cannot be allowed to read and execute even if subfolders' access restrictions are disabled in Settings. If you deny reading and executing on the same window, this will remain after disabling subfolders' access restrictions.
- If the TeraStation's settings have been initialized but you configure the same UID and GID for new users and groups, access permissions to files and folders in subfolders may be inherited.

## Restoring Owner and Permission Settings

If you changed the owner to an unexpected user or accidentally lost permissions to a specific folder, restore them by following the procedure below.

- 1 From Settings, click *File Sharing*.

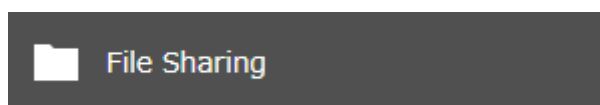

2 Click the settings icon (  ) to the right of "Folder Setup".



3 Click *Advanced Settings for Subfolders*.

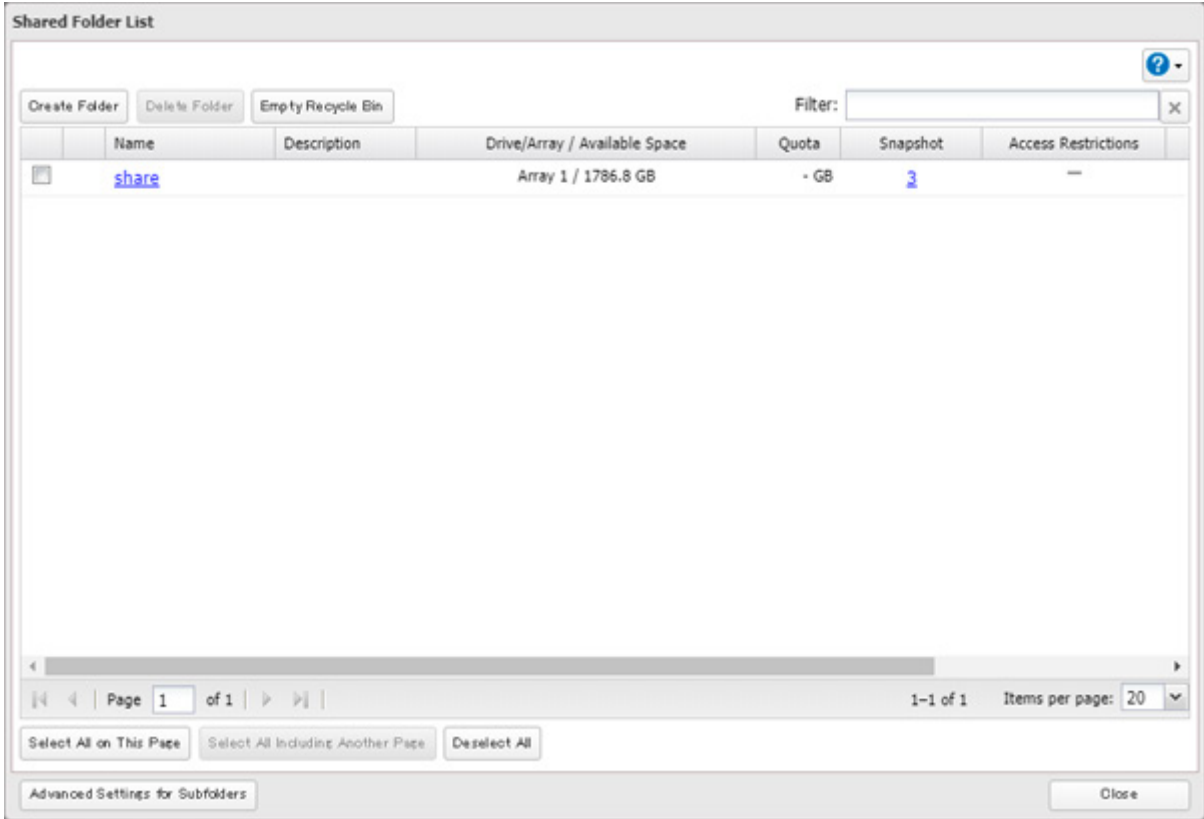

- 4** Select a folder to restore permissions from the tree.

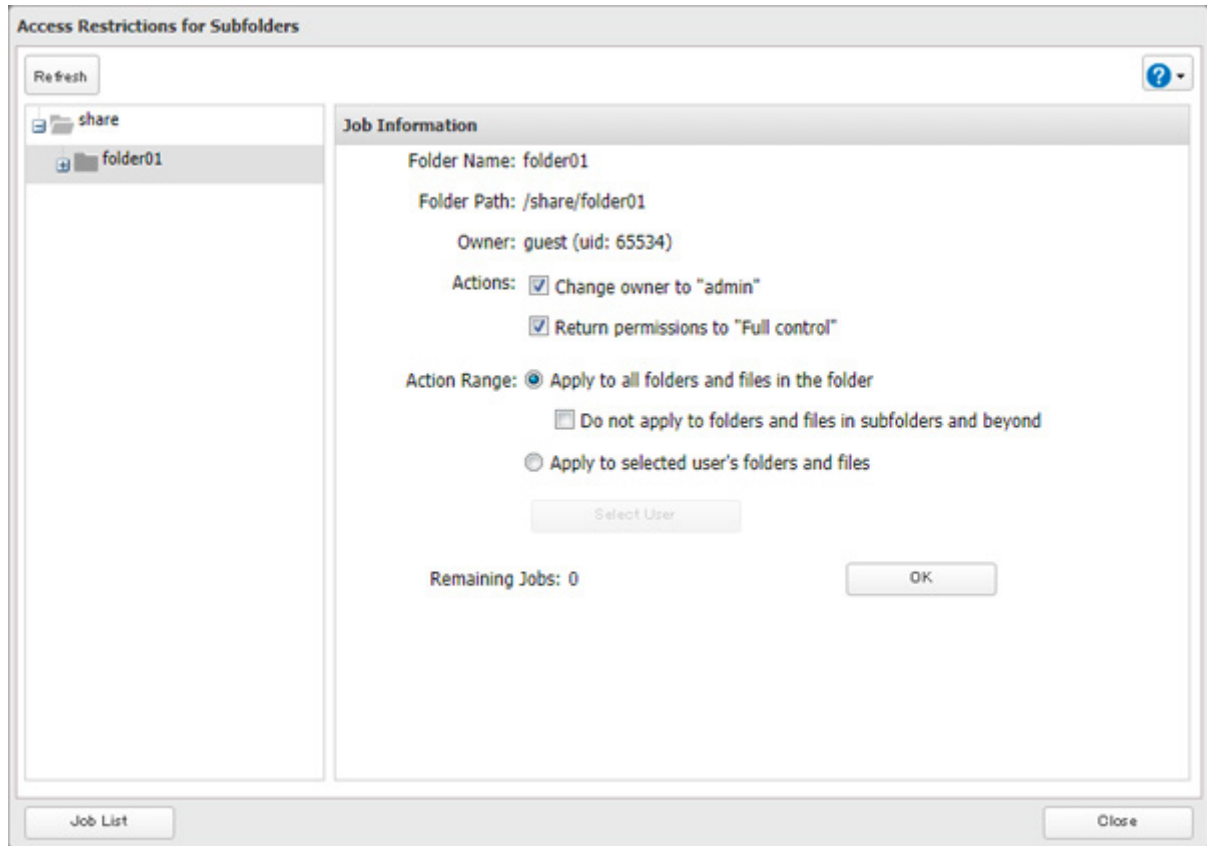

**Note:** If you select a root shared folder from the tree, the action will not be run to the recycle bin. To run the action, select the recycle bin instead.

- 5** Select actions and action range to run, then click *OK*.
- 6** The "Confirm Operation" screen will open. Enter the confirmation number, then click *OK*.

# Chapter 4 Storage Management

---

## RAID Modes

---

TeraStations support many types of RAID. The type of RAID arrays available for use depends on how many drives are installed in your TeraStation.

### Notes:

- If you change the RAID mode, all data on the array is deleted. This is true for every procedure in this chapter. Always back up any important data before performing actions that affect your RAID array.
- Some RAID arrays allow you to change the RAID mode without losing data by adding drives. To change a RAID mode by adding drives to the existing array, refer to the [“Expanding RAID Capacity Without Deleting Data”](#) section below.
- Drive capacity is displayed in Settings in actual gigabytes. The Properties window in Windows may show GiB instead, which will be a smaller number.
- If the TeraStation is restarted or shut down while changing the RAID mode, the message that appears on the LCD panel will change from I46 or I47 to I18.
- RAID 5, 6, or 10 are only available for TeraStations with three or more drives inserted. Please check Settings on your model before changing the RAID mode.

### RAID 6

RAID 6 arrays are available for TeraStations with four or more drives. RAID 6 combines four or more drives into a single array. The usable space is equal to the sum of the capacity of all drives minus the capacity of two drives. For example, if four drives are combined into a RAID 6 array, the usable space is the sum of the capacity of two drives. If two drives in the array are damaged, you can recover data by replacing them. If three or more drives are damaged, your data is lost.

### RAID 5

RAID 5 arrays are available for TeraStations with three or more drives. RAID 5 combines three or more drives into a single array. The usable space is equal to the sum of the capacity of the drives minus the capacity of one drive. For example, if four drives are combined into a RAID 5 array, the usable space is the sum of three drives. If one drive in the array is damaged, you can recover data by replacing the damaged drive. If two or more drives are damaged at the same time, your data is lost.

### RAID 10

RAID 10 arrays are available for TeraStations with four or more drives. In this mode, mirrored pairs of drives in RAID 1 arrays are combined into a RAID 0 array. The usable space is equal to the capacity of the smallest drive multiplied by the number of drives divided by two.

## RAID 1

Combines two or more drives into a mirrored array. The available space in the array is the capacity of a single drive. Identical data is written to each drive. If a drive is damaged, data can be recovered by replacing the damaged drive. As long as one drive in the array remains undamaged, all data in the array can be recovered.

## RAID 0

Combines two or more drives into a single array. The usable drive space is the total space of all drives used. This simple RAID mode offers faster performance than RAID modes that include parity. If a single drive in the array fails, then all data in the array is lost.

## JBOD

This mode uses the drives inside the TeraStation as individual drives. The drive space you can use is the total capacity of all drives in the TeraStation. If any drives are damaged, then the data on that drive is lost.

---

## Working with RAID Arrays

---

To change RAID settings, navigate to *Storage > RAID* in Settings.

### Using JBOD

---

With JBOD, each drive in the TeraStation is addressed separately. To put drives from an array into JBOD, follow the procedure below.

- 1 From Settings, click *Storage*.



- 2 Click the settings icon (  ) to the right of "RAID".





**3** Click the array to delete.

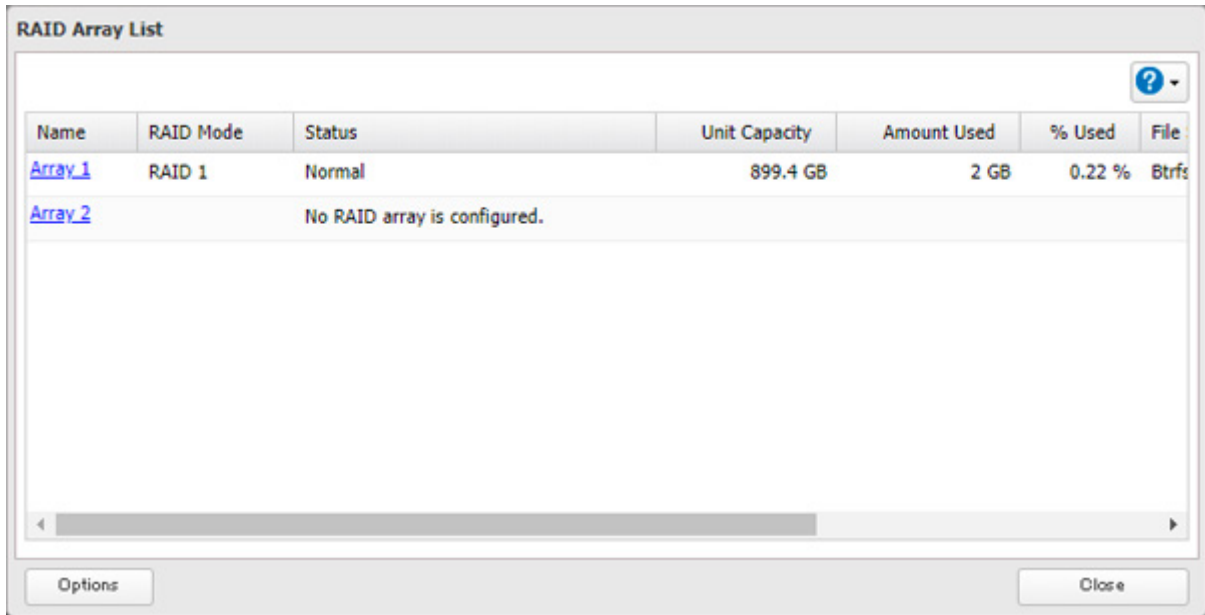

**4** Click *Delete RAID Array*.

**5** The “Confirm Operation” screen will open. Enter the confirmation number, then click *OK*.

**6** Click *OK* when completed. Next, create a shared folder by referring to the [“Adding a Shared Folder”](#) section in chapter 3.

## Changing RAID Mode

To change the RAID mode, first put the drives into JBOD by referring to the [“Using JBOD”](#) section above. Then, follow the procedure below.

**1** From Settings, click *Storage*.



**2** Click the settings icon (⚙️) to the right of “RAID”.

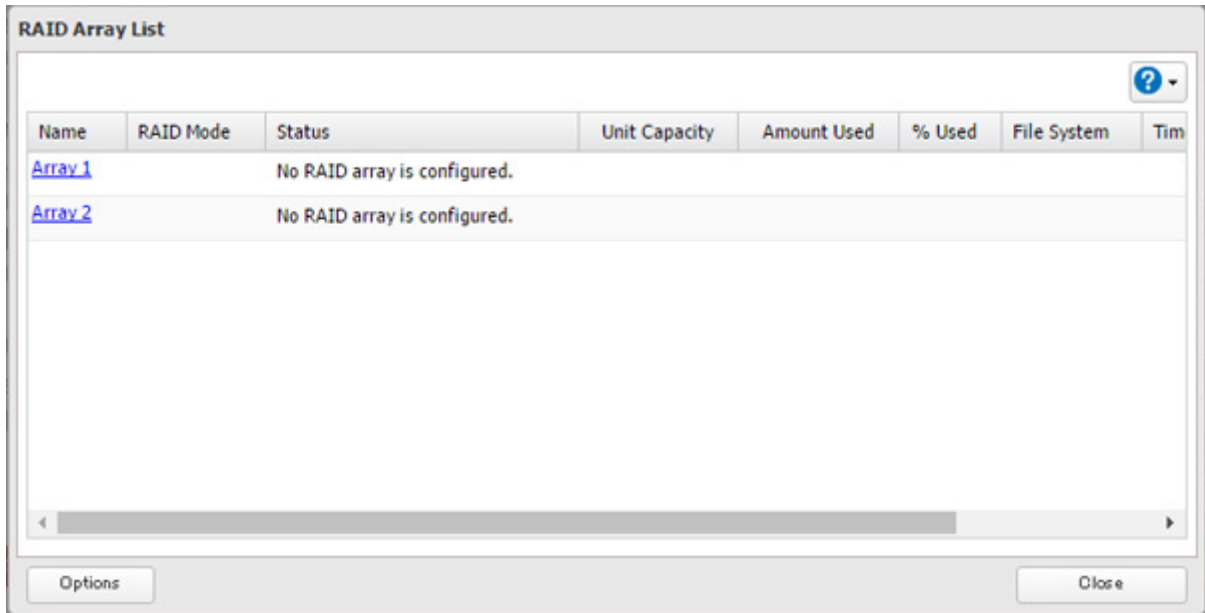
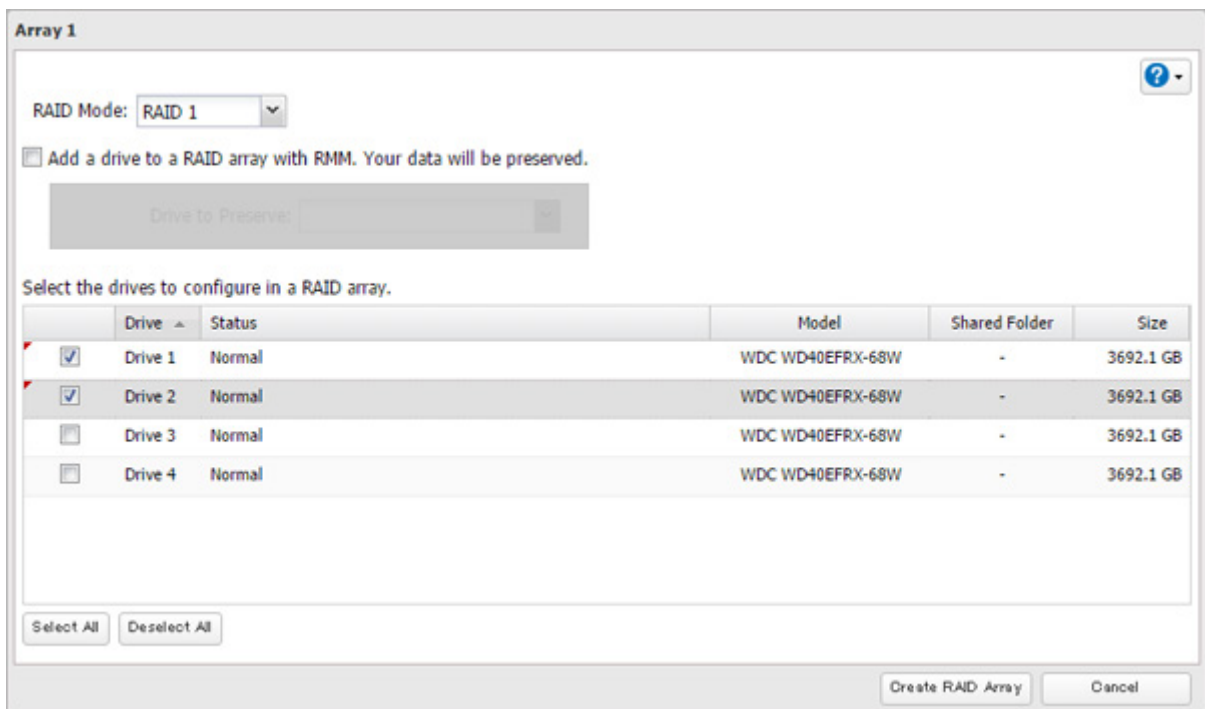

**3** Choose a RAID array.**4** Select a RAID mode and the drives to be used, then click *Create RAID Array*.**5** Click *OK*.**6** The “Confirm Operation” screen will open. Enter the confirmation number, then click *OK*.**7** Click *OK* when completed. Next, create a shared folder by referring to the [“Adding a Shared Folder”](#) section in chapter 3.

## **Shutting Down the TeraStation Automatically If Error Occurs**

This function will shut down the TeraStation automatically if an error occurs on a drive that is used in a redundant RAID array. To configure auto shutdown, follow the procedure below.

1 From Settings, click *Storage*.



2 Click the settings icon (⚙️) to the right of "RAID".



3 Click *Options*.

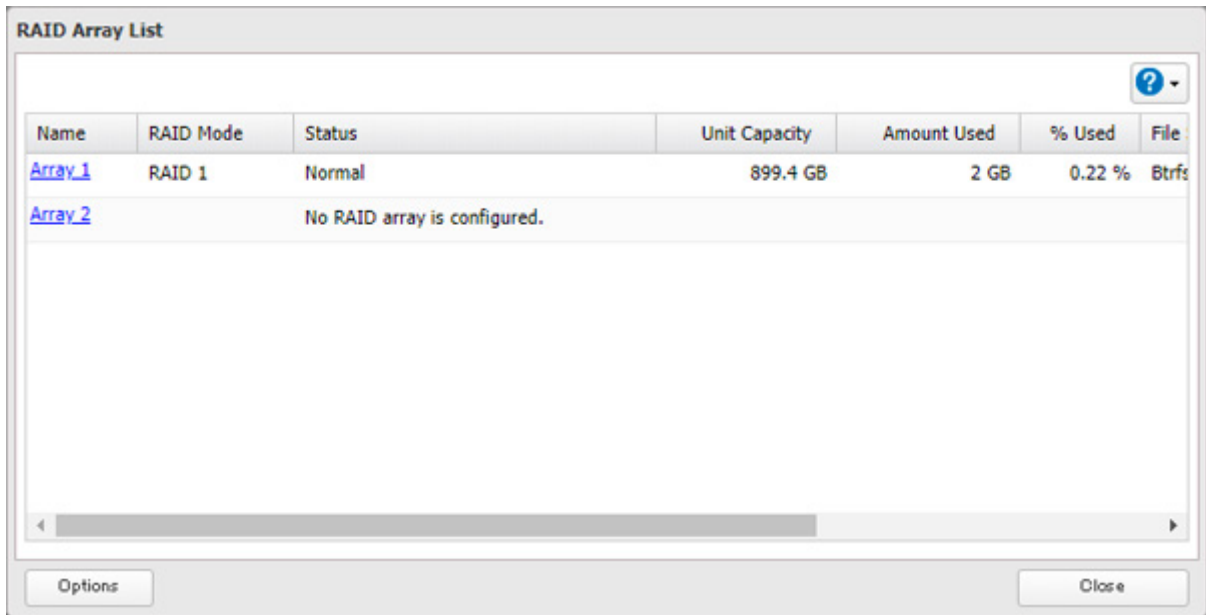

4 Click *Edit*.

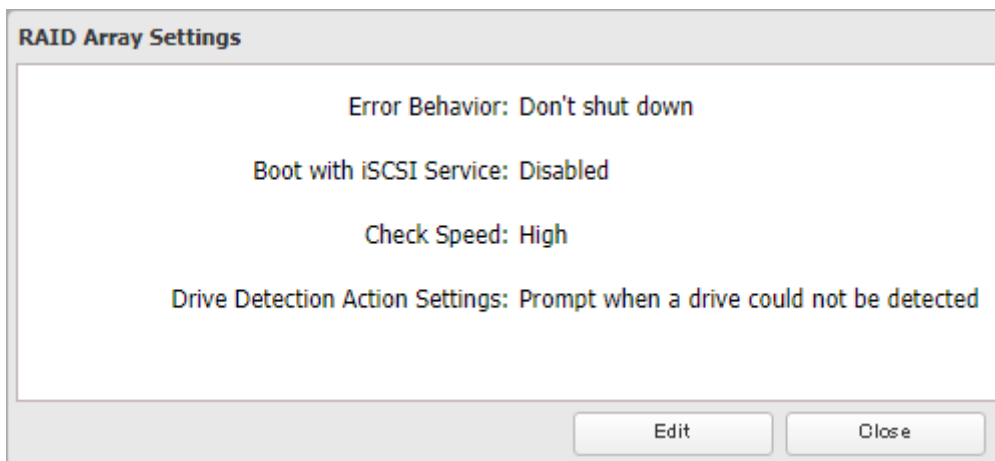

- 5** Change the “Error Behavior” option to “Shut down” and click *OK*.

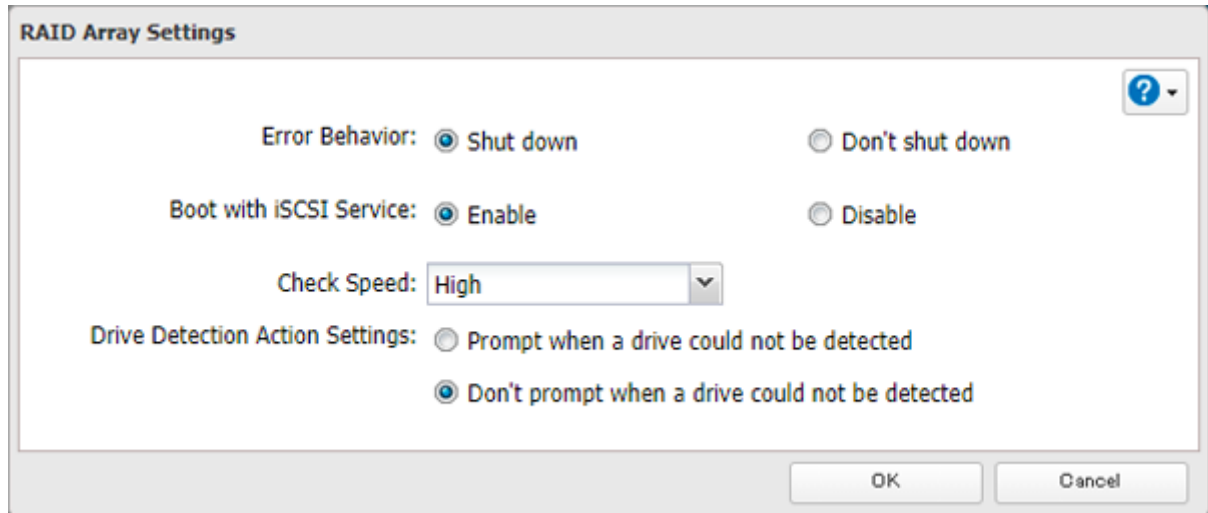

## Configuring Actions for If a Drive Used for the RAID Array Has Not Been Discovered

The TeraStation can configure actions for if a drive used for the RAID array cannot be mounted when booting.

### Displaying or Hiding the Confirmation Screen

Configure to display or hide the confirmation screen for selecting actions for if a drive used for the RAID array cannot be mounted when booting. It is configured to display the confirmation screen by default. To hide the screen, follow the procedure below.

- 1** From Settings, click *Storage*.



- 2** Click the settings icon (⚙) to the right of “RAID”.



**3** Click *Options*.

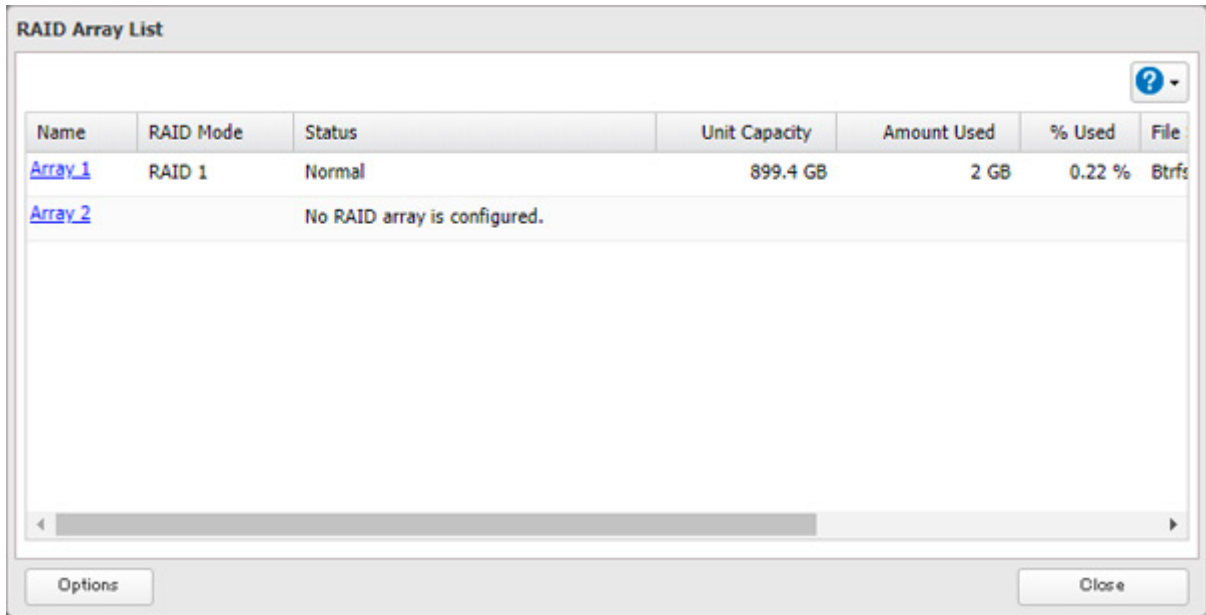

**4** Click *Edit*.

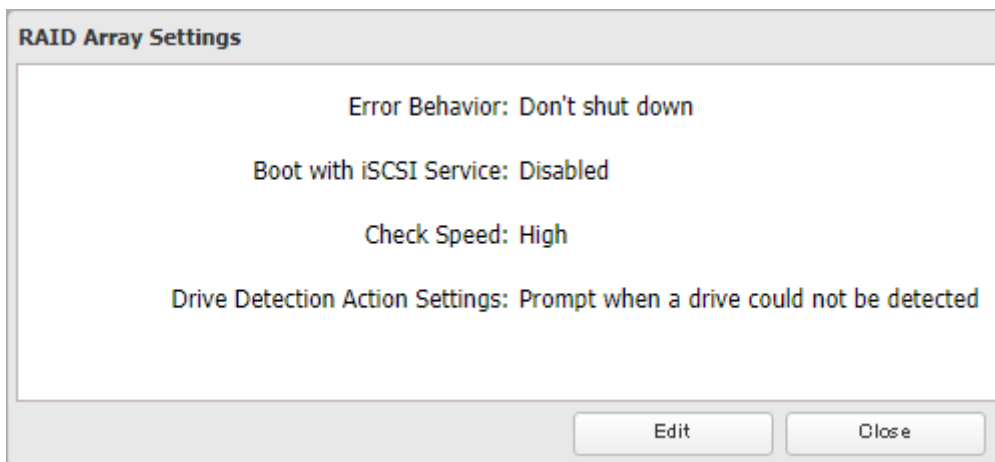

**5** Change the “Drive Detection Action Settings” option to “Don’t prompt when a drive could not be detected” and click *OK*.

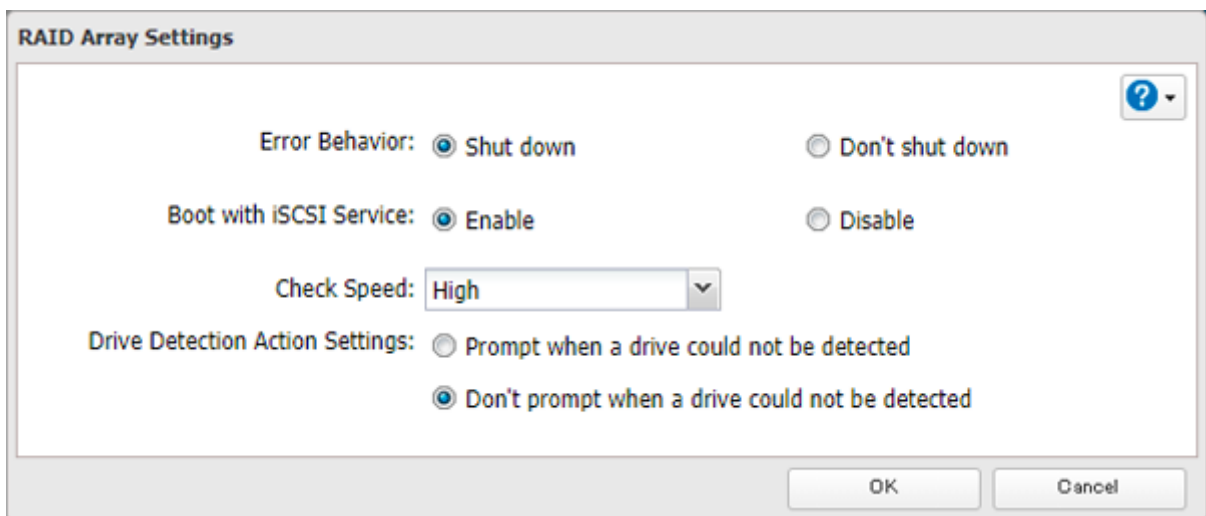

When the confirmation screen is hidden, an undetected drive will automatically be dismounted from the TeraStation and the TeraStation will be in degraded mode if a redundant RAID mode is configured. If RAID 0 is configured, the RAID array will be corrupted so that data will be lost. It is recommended to proceed without changing settings that makes the confirmation screen appear.

## Selecting the Action on the Confirmation Screen

When the confirmation screen is displayed, the following screen will appear after logging in to Settings if the drive used for the RAID array could not be mounted. Select the action to run when the screen appears.

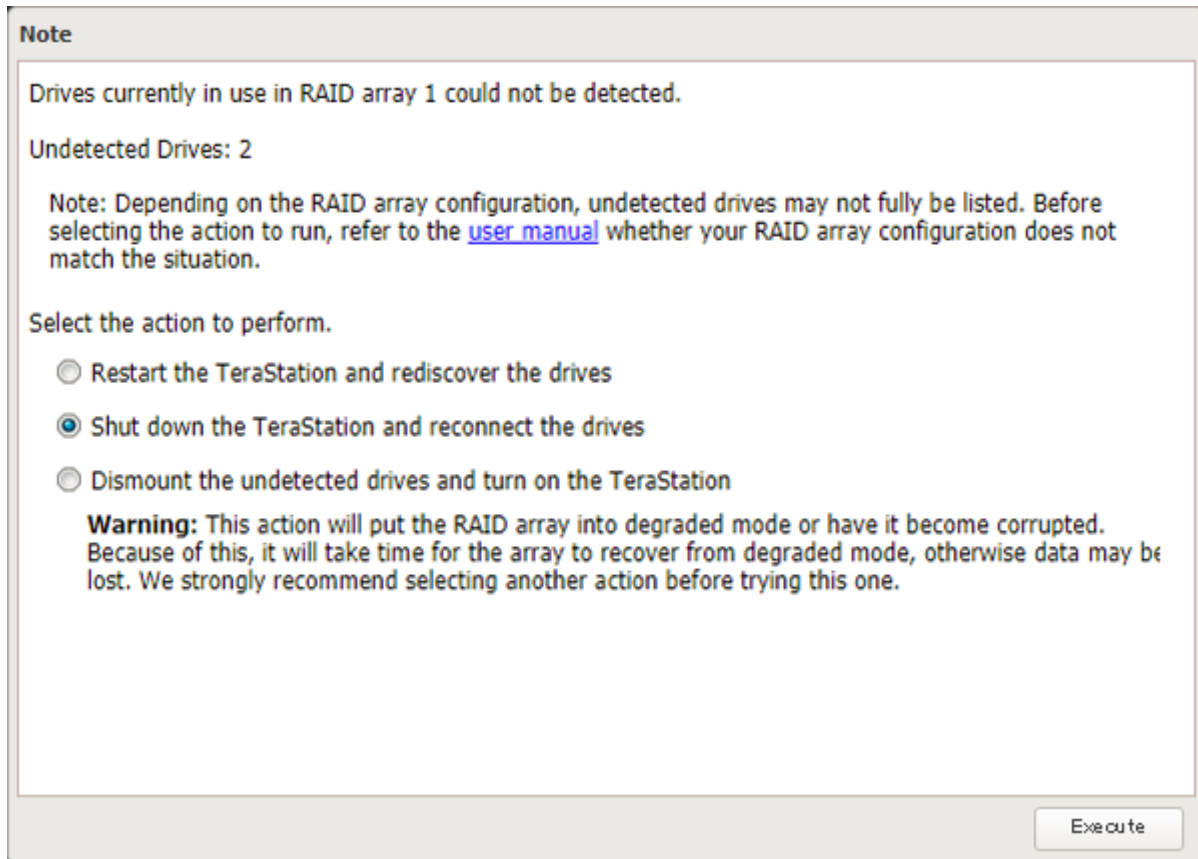

**Note**

Drives currently in use in RAID array 1 could not be detected.

Undetected Drives: 2

Note: Depending on the RAID array configuration, undetected drives may not fully be listed. Before selecting the action to run, refer to the [user manual](#) whether your RAID array configuration does not match the situation.

Select the action to perform.

- Restart the TeraStation and rediscover the drives
- Shut down the TeraStation and reconnect the drives
- Dismount the undetected drives and turn on the TeraStation

**Warning:** This action will put the RAID array into degraded mode or have it become corrupted. Because of this, it will take time for the array to recover from degraded mode, otherwise data may be lost. We strongly recommend selecting another action before trying this one.

Execute

## Conditions and Corrective Actions If Undetected Drives Aren't Displayed Properly

Even when you configure the NAS to show the confirmation screen if a drive being used for the RAID array cannot be mounted, undetected drives will not be displayed under the following conditions. If you are using any of the RAID array configurations below, follow the corrective action.

Conditions	Corrective Actions
RAID 10 has been configured.	<ol style="list-style-type: none"> <li><b>1</b> Refer to the <a href="#">“Selecting the Action on the Confirmation Screen”</a> section above on how to access the confirmation screen.</li> <li><b>2</b> Select “Shut down the TeraStation and reconnect the drives” and click <i>Execute</i>.</li> <li><b>3</b> After the TeraStation shuts down, confirm that all drives have been inserted properly.</li> <li><b>4</b> Press the power button to power on the TeraStation.</li> <li><b>5</b> Log in to Settings and make sure the confirmation screen doesn’t appear.</li> </ol>
Multiple arrays have been configured.	

## Configuring a Hot Spare

If you have a hot spare configured and an array fails, the TeraStation immediately switches over to the hot spare. To use a hot spare, you need an extra drive that’s not part of any array and a RAID 1 or RAID 5 array.

### Notes:

- All data on the hot spare drive is deleted when it is configured as a hot spare and again when it changes from a spare to a drive in the array.
- A hot spare cannot be configured for TeraStation models with only two-drives included.

**1** From Settings, click *Storage*.



**2** Click the settings icon (⚙️) to the right of “RAID”.

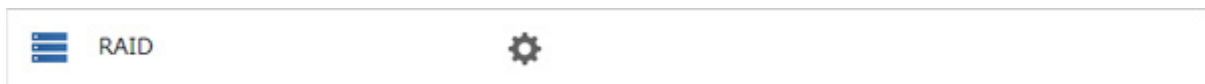

**3** Choose a RAID array.

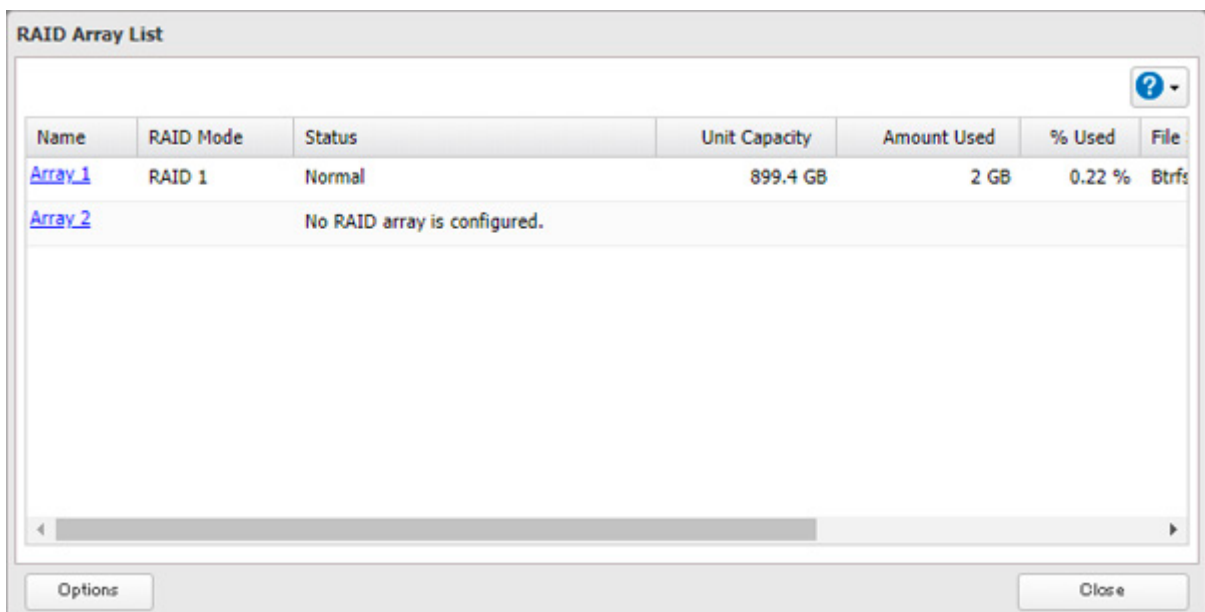

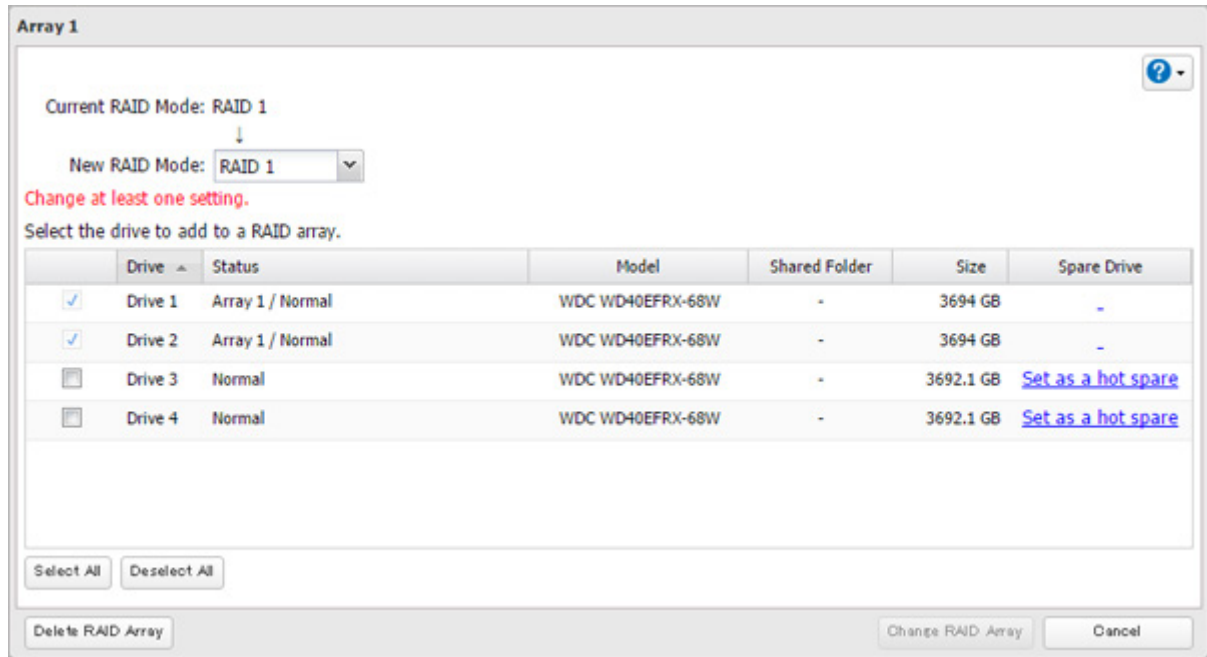
**4** Click *Set as a hot spare*.**5** Click *Yes*.**6** The “Confirm Operation” screen will open. Enter the confirmation number, then click *OK*.**7** Click *OK* when completed.

**Note:** To turn the hot spare back to a normal drive, choose *Set as a normal drive*.

## Expanding RAID Capacity Without Deleting Data

---

You can create or expand a RAID array without erasing data on the drive by using RMM (RAID Mode Manager).

### Drives Are Currently in JBOD

If the drives are currently in JBOD (not in a RAID array), you may change it to a RAID 1 array. To create the RAID 1 array using RMM, you must have at least two drives available in JBOD.

**1** From Settings, click *Storage*.**2** Click the settings icon (⚙️) to the right of “RAID”.

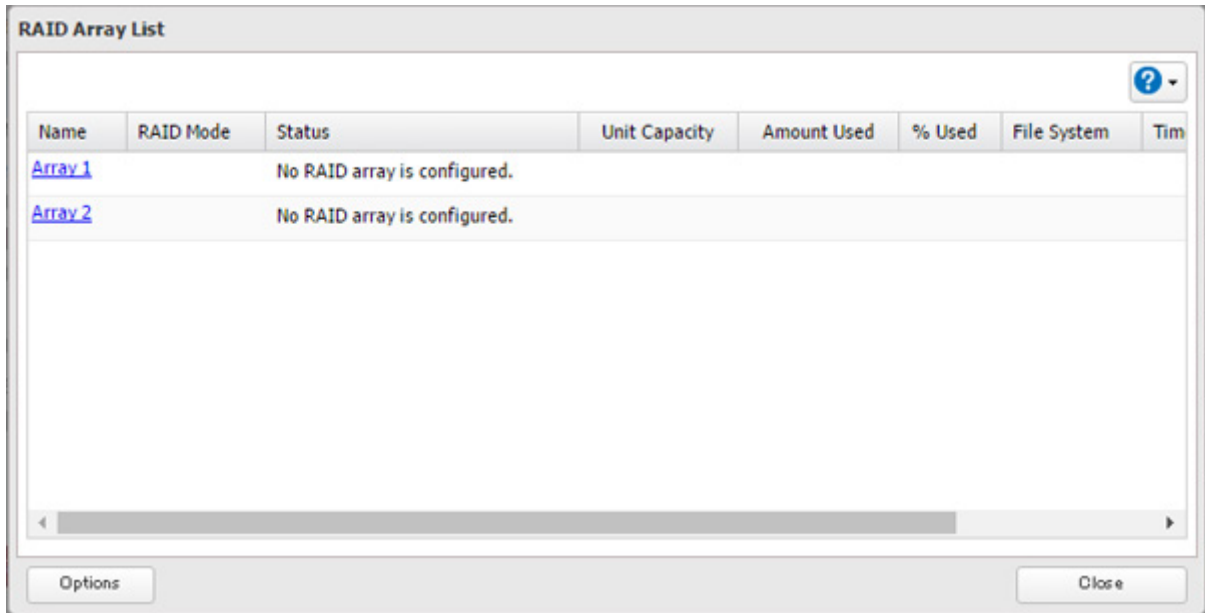
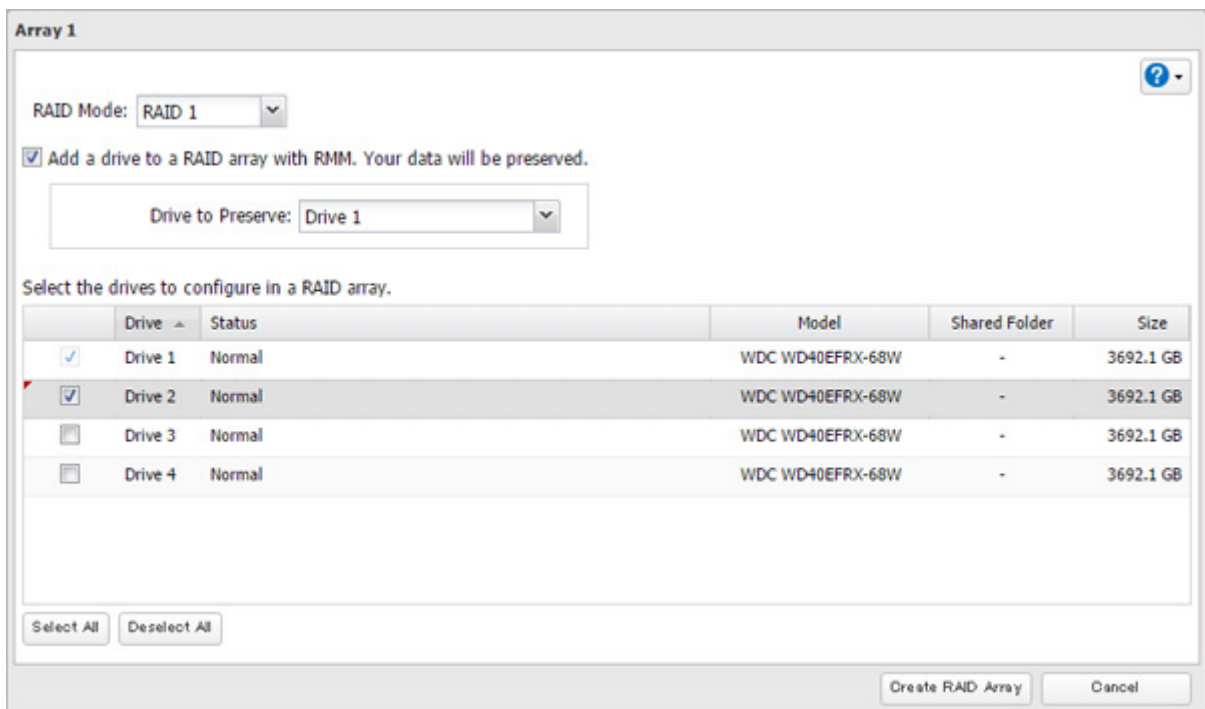

**3** Choose a RAID array.**4** Set the RAID mode to "RAID 1".**5** Select the "Add a drive to a RAID array with RMM. Your data will be preserved." checkbox.**6** Select the drive whose data will be saved from the drop-down list.**7** Select the drive to add to the RAID array.**8** Click *Create RAID Array*.**9** The "Confirm Operation" screen will open. Enter the confirmation number, then click *OK*.**10** Click *OK* when completed.

## Drives Are Currently in RAID 1 or RAID 5

If the drives are currently in a RAID 1 or a RAID 5 array, you can use RMM to add drives to the RAID array, then change the RAID mode.

**Note:** RMM can be used to expand an array by only one drive per operation. To expand by two or more drives, RMM must be activated multiple times. For example, if you want to create a RAID 6 array by adding two drives, change the RAID mode to RAID 5 first using one drive, then change it to RAID 6 using another drive.

- 1 From Settings, click *Storage*.



- 2 Click the settings icon (  ) to the right of "RAID".



- 3 Choose a RAID array.

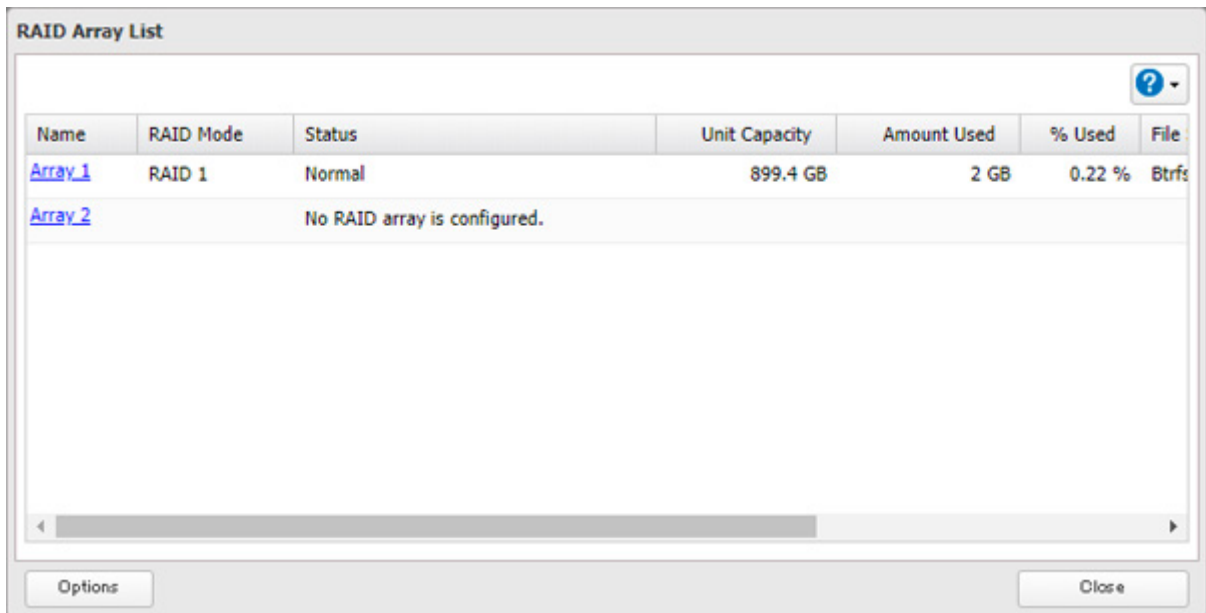

- 4** Select one drive to add to the RAID array. If changing the RAID mode, choose the desired mode for the array from the drop-down list. If not, keep the current RAID mode as is.

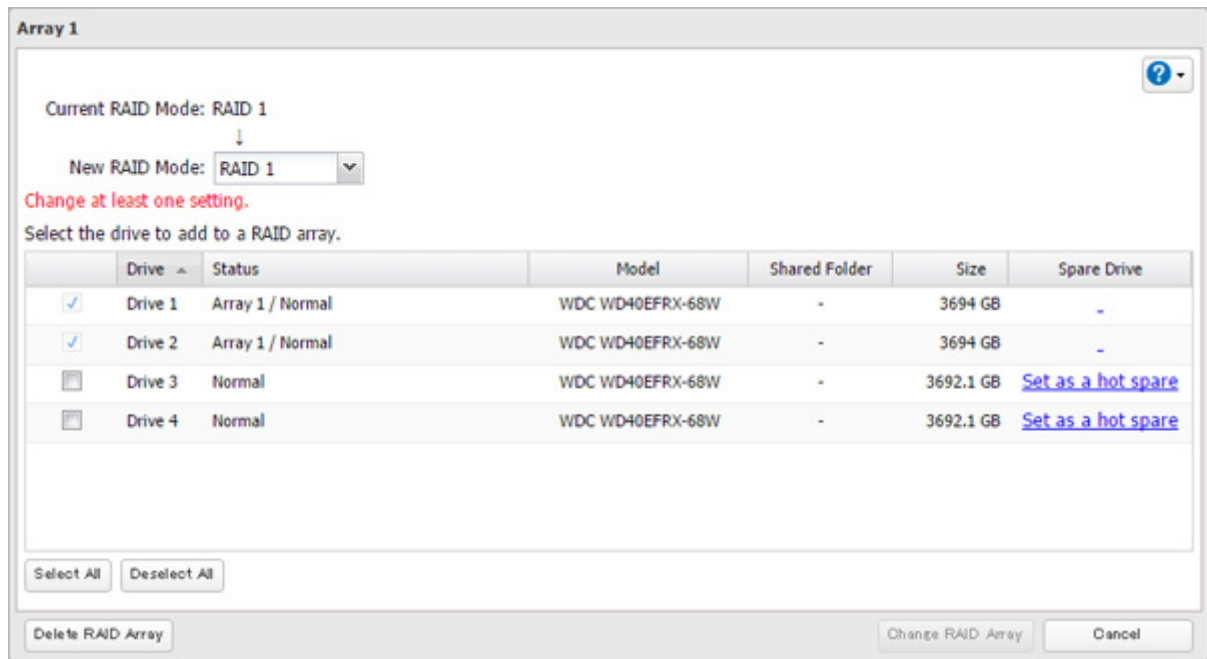

- 5** Click *Change RAID Array*.
- 6** The “Confirm Operation” screen will open. Enter the confirmation number, then click *OK*.
- 7** Click *OK* when completed.

## RAID Scanning

A RAID scan checks your RAID array for bad sectors and if it finds any, it automatically repairs them. Arrays other than RAID 0 are supported. For best results, run a RAID scan regularly.

- 1** From Settings, click *Storage*.



- 2** Move the RAID scanning switch to the  position to enable RAID scanning.



- 3** Click the settings icon (  ) to the right of “RAID Scanning”.

- 4** Click *Edit*.

## 5 Select when to run the scan and click *OK*.

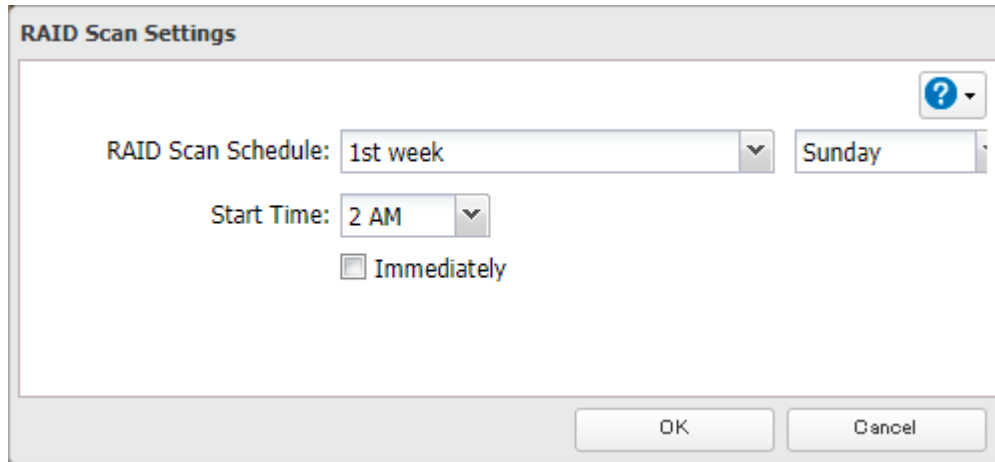

### Notes:

- Select the “Immediately” checkbox to run a RAID scan immediately.
- To stop a RAID scan, click *Cancel RAID Scan*.

## Adding an External Drive

### Connecting an External Drive

Your TeraStation includes USB ports (the number of ports depends on your model), and you can connect external drives to these ports. Once connected, they appear as shared folders on the TeraStation. Formatted drives are detected automatically. Unformatted drives should be formatted in Settings.

After a USB drive is recognized, the TeraStation adds “usbdisk x” to the shared folder list, where “x” is the USB port to which the drive is connected.

### Compatibility

Supported file systems for external USB drives are below:

File Systems	Recommended Situation
Btrfs	Connecting to this TeraStation.
XFS	Connecting to another Buffalo NAS device.
Ext3*	Connecting to another Buffalo NAS device that is a TS-X or older model.
NTFS**	Connecting to Windows computers. The NTFS-formatted drive can use many more functions of the operating system than an exFAT drive.
HFS Plus**,***	Connecting to Mac computers. The HFS Plus-formatted drive can use many more functions of the operating system than an exFAT drive.
exFAT*	Connecting to both Windows and Mac computers.
FAT32	Connecting to both Windows and Mac computers.

\*The available USB drive size is up to 16 TB.

\*\*This cannot be formatted from Settings.

\*\*\*This is read-only from the TeraStation. Files on the USB drive can be copied to the TeraStation.

Connect only one device to each USB port of the TeraStation. Note that only the first partition of a connected USB drive is mounted. Additional partitions are not recognized.

**Notes:**

- If your USB 3.0 drive is not reconfigured after rebooting the TeraStation, unplug and reconnect it.
- When copying a file that is over 100 MB to a FAT32-formatted USB drive using File Explorer, an error message may appear. In such a case, use an FTP or SFTP connection to copy the file.
- When copying files from a shared folder to a FAT32-formatted USB drive, the progress bar may not be displayed or the file copying may fail. Using a file system other than FAT32 is recommended for the USB drive.

---

## Dismounting Drives

---

If the TeraStation is powered on, dismount drives (internal and external) before unplugging them. You may dismount external drives using the function button, or dismount any drive from Settings. If the TeraStation is off, then all drives are already dismounted and may be unplugged safely.

**Note:** Do not dismount internal drives while a RAID array is rebuilding or RMM is being configured. If you do, data on the drives may be lost.

### Dismounting with the Function Button

---

When you press the function button, the TeraStation will beep once. Press and hold the button until the TeraStation beeps again and the button starts blinking blue. When the dismount is completed, the function button will stop blinking and return to glowing. You may now unplug any USB drives safely.

After 60 seconds, the function button will go out and any drives that have not yet been unplugged will be remounted.

### Dismounting from Settings

---

- 1 From Settings, click *Storage*.



- 2 Click *Drives* to dismount an internal drive or *USB Drives* to dismount an external drive.

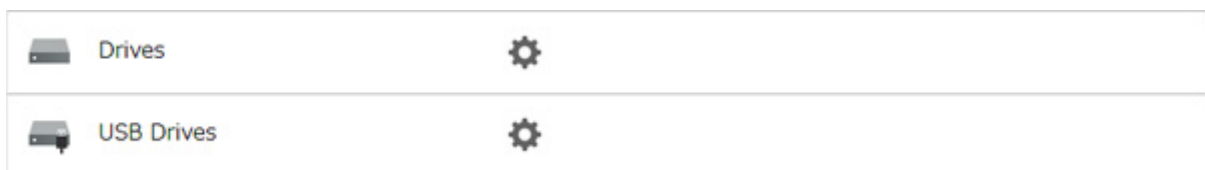

- 3** Select the drive to dismount and click *Dismount Drive*.

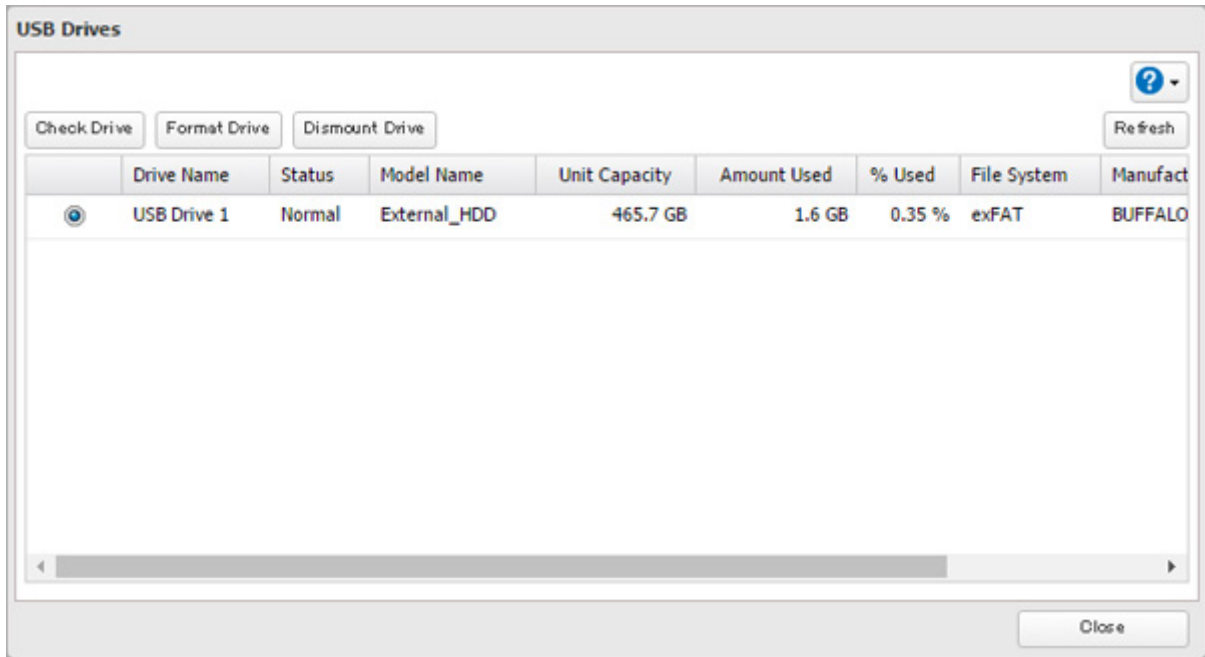

- 4** The “Confirm Operation” screen will open. Enter the confirmation number, then click *OK*.
- 5** When the dismounting process is completed, it is safe to unplug the drive. Disconnect the drive from the TeraStation.

**Note:** To remount the drive, unplug it and then plug it back in.

## Checking Drives

A drive check tests the data on a drive in the TeraStation or one that is connected via USB for integrity. Errors are fixed automatically. With large drives, a drive check may run for many hours. Shared folders cannot be accessed during a drive check. Do not turn off the TeraStation until the drive check is finished. Use the procedure below to run a drive check.

- 1** From Settings, click *Storage*.



- 2** Select *Drives* to check an internal drive or *USB Drives* to check an external drive.

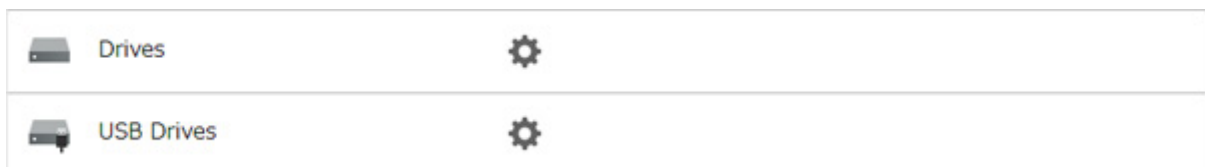

- 3** Select the drive or array to test, then click *Check Drive*.

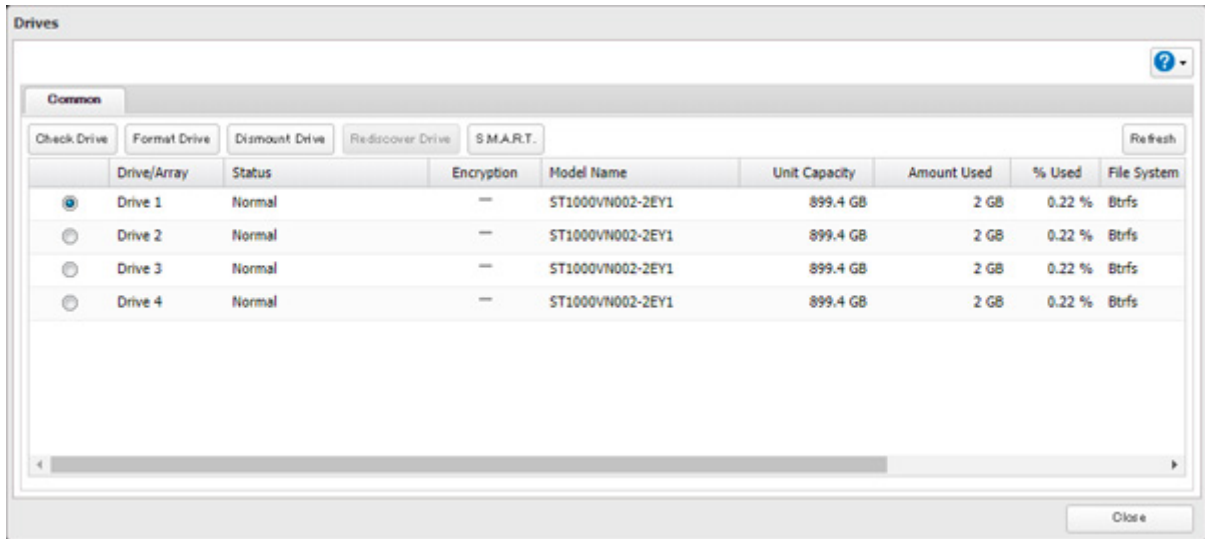

- 4** Click *Check*. You have the option of deleting information files from macOS during the check if desired.

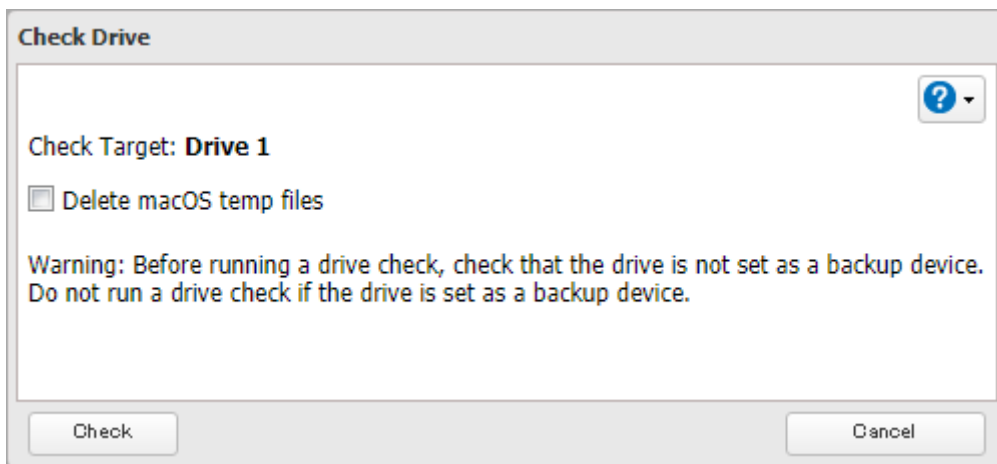

## S.M.A.R.T.

S.M.A.R.T. (Self-Monitoring, Analysis, and Reporting Technology) monitors internal drives to detect and report various indicators of reliability, in the hope of anticipating failures. When a failure is anticipated by S.M.A.R.T., the user may choose to replace the drive to avoid outages and data loss. Follow the procedure below to check S.M.A.R.T. information for the TeraStation's internal drives.

**Note:** S.M.A.R.T. information is only available for internal drives.

## Displaying S.M.A.R.T. Information

- 1** From Settings, click *Storage*.



- 2** Click the settings icon (⚙️) to the right of "Drives".

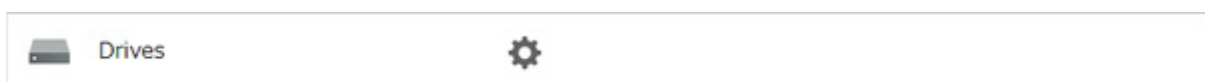

**3** Select a drive to check and click *S.M.A.R.T.*

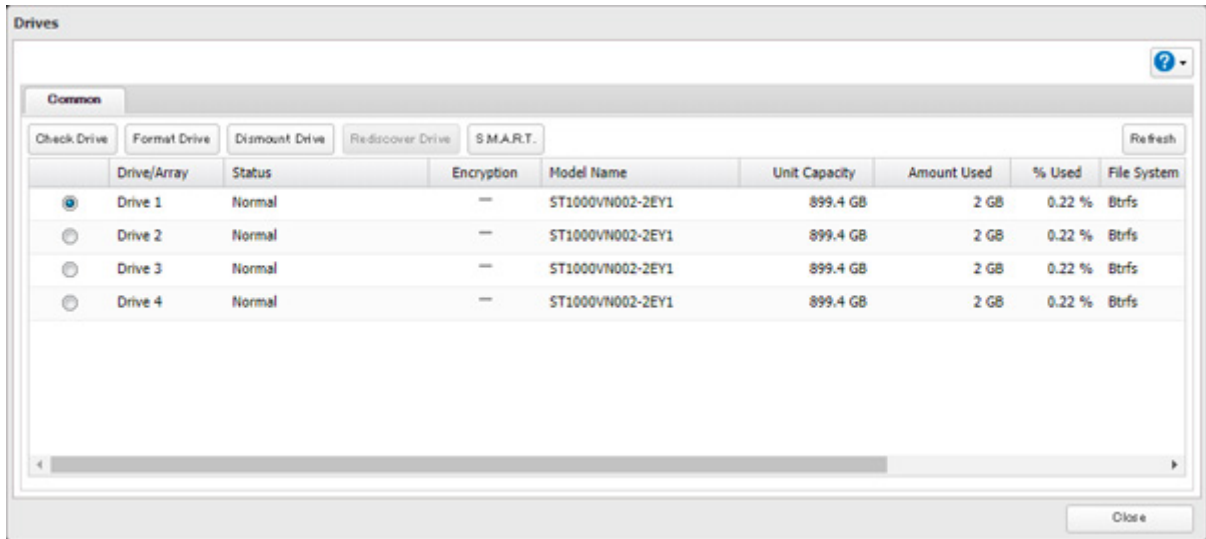

**4** The S.M.A.R.T. information for the drive will be displayed. Different information may be displayed depending on the brand of drives in your TeraStation. Critical attributes are displayed in bold.

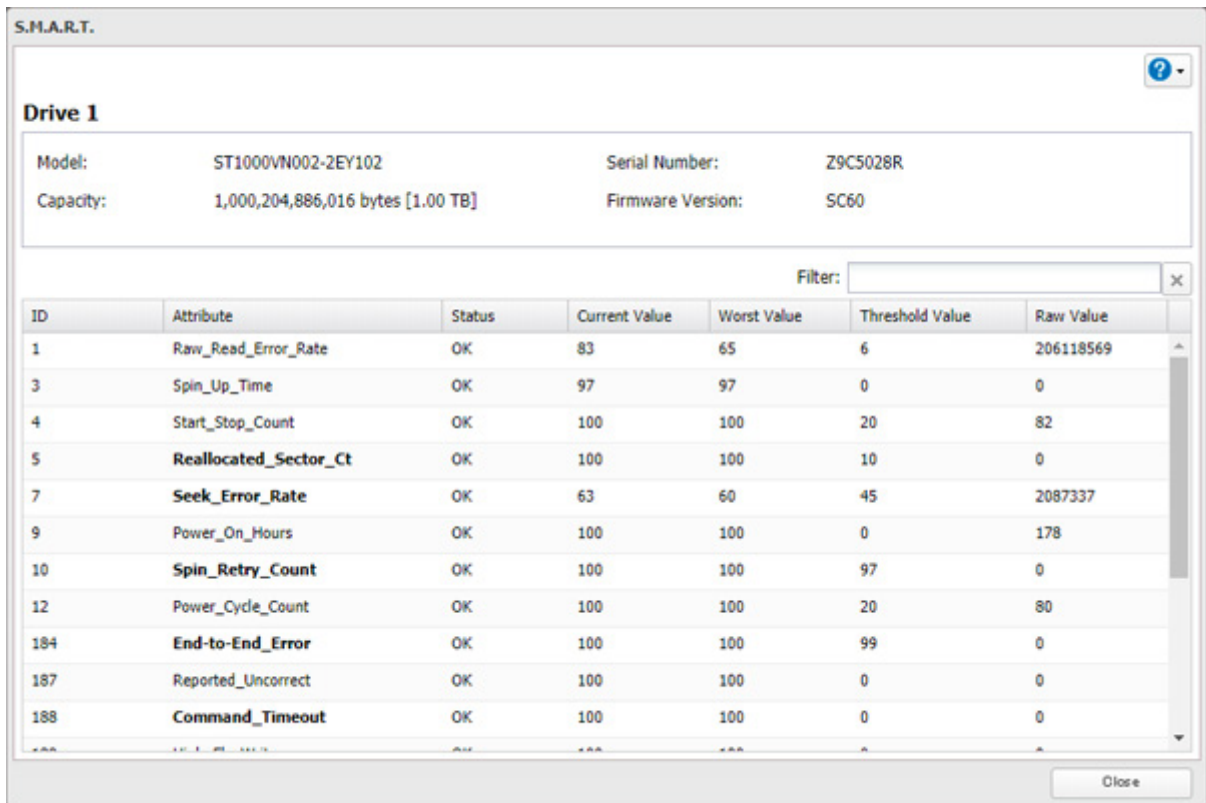

## Checking Drive Condition

Attributes with the worst value that is equal to or less than the threshold value may be significant. If an attribute reports a failure, or has had one in the past, it will be displayed in the status column. In such a case, replacing that drive is recommended.



## Formatting Drives

### Notes:

- Under some circumstances, data deleted when a drive is formatted can be recovered. To ensure that data is “gone forever”, a format might not be sufficient. Refer to the [“Erasing Data on the TeraStation Completely”](#) section below.
- After a drive is formatted, the “% Used” and “Amount Used” in Settings will not be 0. This is because some drive space is used for the system area.

**1** From Settings, click *Storage*.



**2** Select *Drives* to format an internal drive or *USB Drives* to format an external drive.

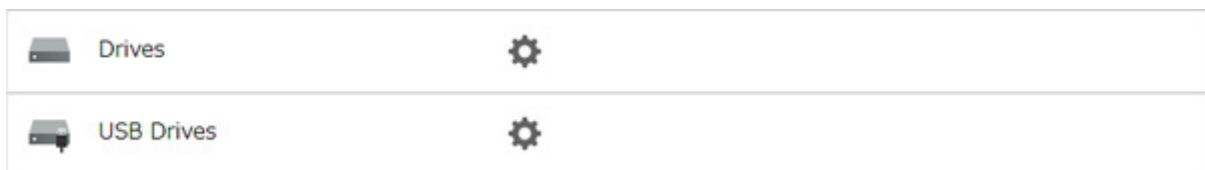

**3** Select the drive or array to format, then click *Format Drive*.

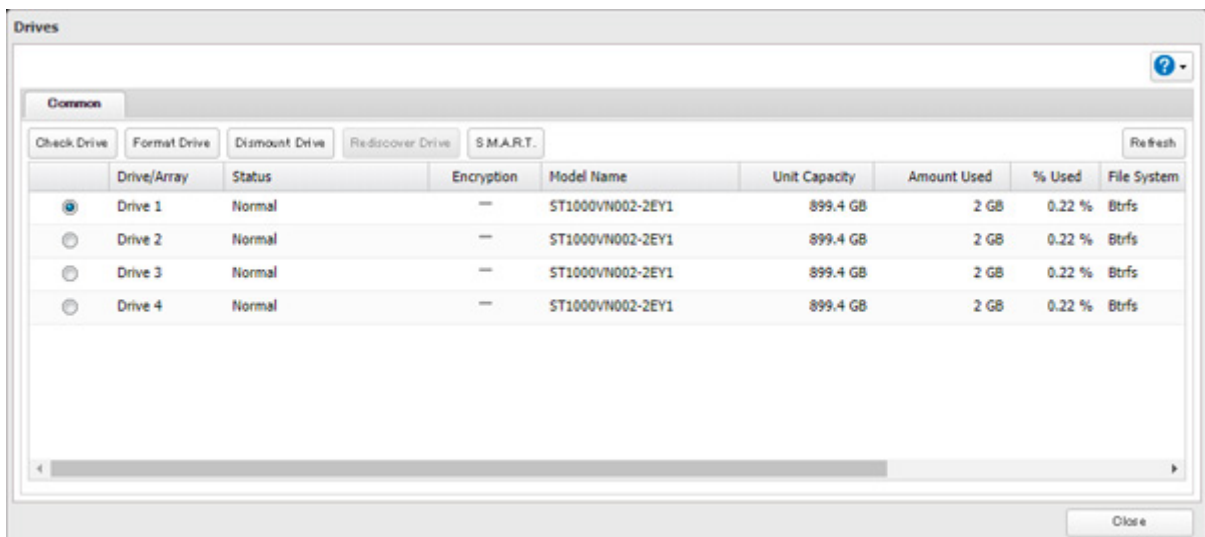

**4** Select a format type, then click *Format*.

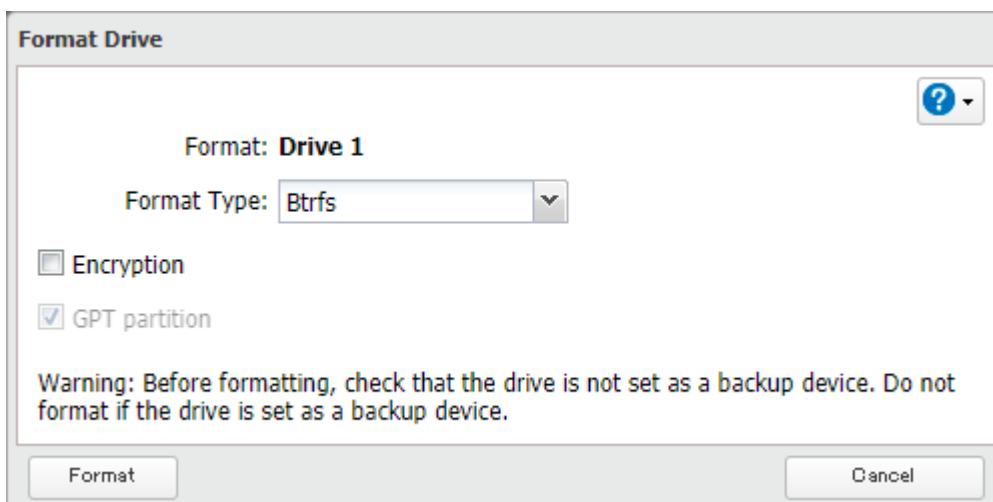

- 5 The “Confirm Operation” screen will open. Enter the confirmation number, then click *OK*.
- 6 Depending on the size and the formatted file system of your drive, the format may take several minutes or several hours to complete. “Formatting” will be displayed on the LCD panel until the format is completed. Click *OK* when completed.

**Notes:**

- Do not turn off or disconnect power to the TeraStation while formatting a drive.
- For drives of 2.2 TB or larger, make sure that the “GPT partition” checkbox is selected.

---

## Encrypting Drives

---

Internal drives (and arrays) can be encrypted with 256-bit AES during formatting. Encrypted drives and arrays are then readable only from that specific TeraStation. To decrypt a drive or array, clear the “Encryption” checkbox and format it again.

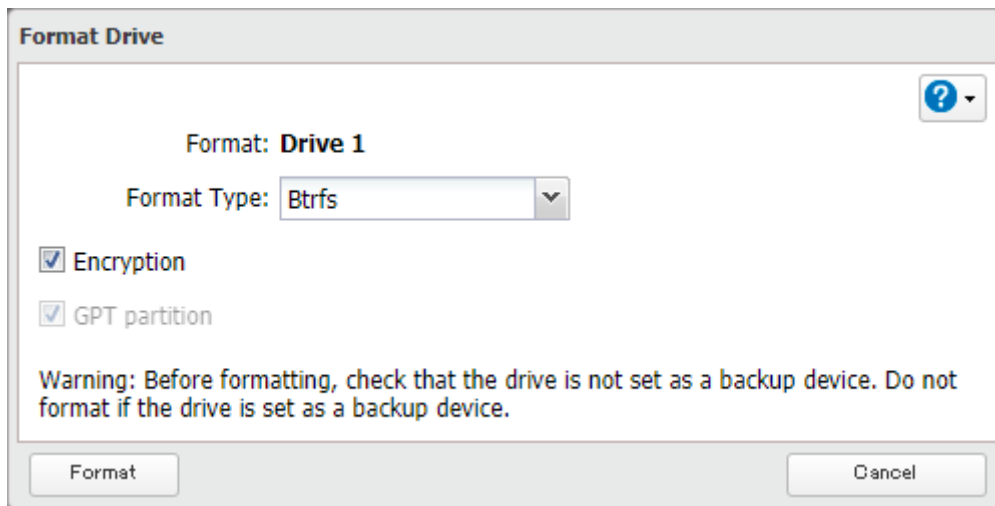

---

## Erasing Data on the TeraStation Completely

---

Under some circumstances, data from formatted drives can be recovered. The drive erasure process in this section does a much more thorough job of erasing data. This procedure is recommended for removing all data from a drive in a way that makes it nearly impossible to recover with current tools. The TeraStation will then be in the following state:

- All drives in JBOD
- An empty shared folder on each drive
- All settings returned to their default values
- All logs deleted

If you remove a drive and then erase all data on the TeraStation, the LCD panel will show the E22 message and the number of the removed drive. You can still use the TeraStation.

Follow the procedure below to completely and permanently erase all data from your TeraStation.

- 1 From Settings, click *Management*.

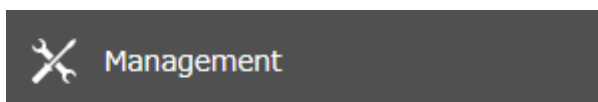

- 2 Click the settings icon (  ) to the right of “Restore/Eraser”.



- 3 Click *Erase TeraStation*.

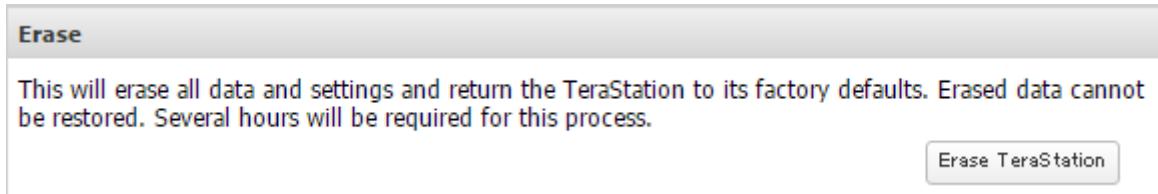

- 4 The “Confirm Operation” screen will open. Enter the confirmation number, then click *OK*.
- 5 All data on the TeraStation will be permanently erased.

---

## Using the TeraStation as an iSCSI Device

---

### Introduction

iSCSI is a protocol for carrying SCSI commands over IP networks. Unlike traditional SAN protocols such as Fibre Channel, which requires special-purpose cabling, iSCSI can be run over long distances using existing network infrastructure. Normal Windows formatting such as NTFS is supported.

### Differences Between NAS and iSCSI

With iSCSI, the TeraStation is connected to a single computer, such as a server. Other computers on the network access files on the TeraStation through the computer it's connected to. The TeraStation can be used as a local drive from Windows Server. Features of Windows Server such as Active Directory can be used normally.

As a NAS, the TeraStation is a server, and computers (including other servers) on the network can access shared folders on it directly. A separate server is not required, and features such as backup are built-in.

### Network Configuration

Use gigabit or faster network equipment with iSCSI. For best results, a dedicated network for iSCSI is recommended, separate from the regular network. By default, the IP address of the TeraStation is automatically assigned from a DHCP server. However, in this case, if you turn off and restart the TeraStation, the IP address may be changed and the volumes on the TeraStation may not be accessible. To avoid changing the IP address unexpectedly, using a static IP address for the TeraStation is recommended.

### Connection Tool

The Microsoft iSCSI Software Initiator is already installed on your computer. You don't need to download and install it.

### Creating an iSCSI Volume

---

To use the TeraStation as an iSCSI drive, create a volume first. Configure the TeraStation as described below.

**Notes:**

- If the volume settings are changed, all data on the volume will be erased. Before changing any settings, back up any important data.
- The TeraStation can have up to 255 volumes, but we recommend creating no more than 32. Exceeding this volume amount may cause irreparable damage to the unit.
- Do not use a name already in use as a shared folder name; do not use any of the following words as an iSCSI volume name as these words are reserved for internal use by the TeraStation: array *x*, authtest, disk *x*, global, homes, info, lost+found, lp, medicartridge *x*, msdfs\_root, mt-daapd, printers, ram, spool, usbdisk *x*. Any instances of “*x*” denote a number (for example: array1 or disk3)
- There are two options for the “Backstore” setting to select the type of iSCSI volume. Refer to the differences below.
  - **File I/O** (recommended): This type of volume can specify the volume size and multiple volumes can be created on one drive or RAID array. This also allows you to expand the volume size after the volume is created and data has been stored.  
Snapshots can create on the iSCSI volume. The volume can also be set as a backup folder.
  - **Block I/O**: This type of volume will create an iSCSI volume for a whole drive or RAID array. However, if you enable LVM, you can create multiple volumes on the drive or the RAID array or expand the volume size later, just like a file I/O volume. It is recommended to enable LVM if you want to create multiple volumes on one drive or RAID array, or expand the volume later.  
The block I/O volume affords higher performance than the file I/O volume because there won’t be any delays to the file system.  
**Be aware that block I/O volumes with LVM enabled cannot use snapshots. The volumes also cannot be used as the backup folders.**

**1** From Settings, click *Storage*.



**2** Move the iSCSI switch to the  position to enable iSCSI.



**3** Click the settings icon (  ) to the right of “iSCSI”.

#### 4 Click *Create Volume*.

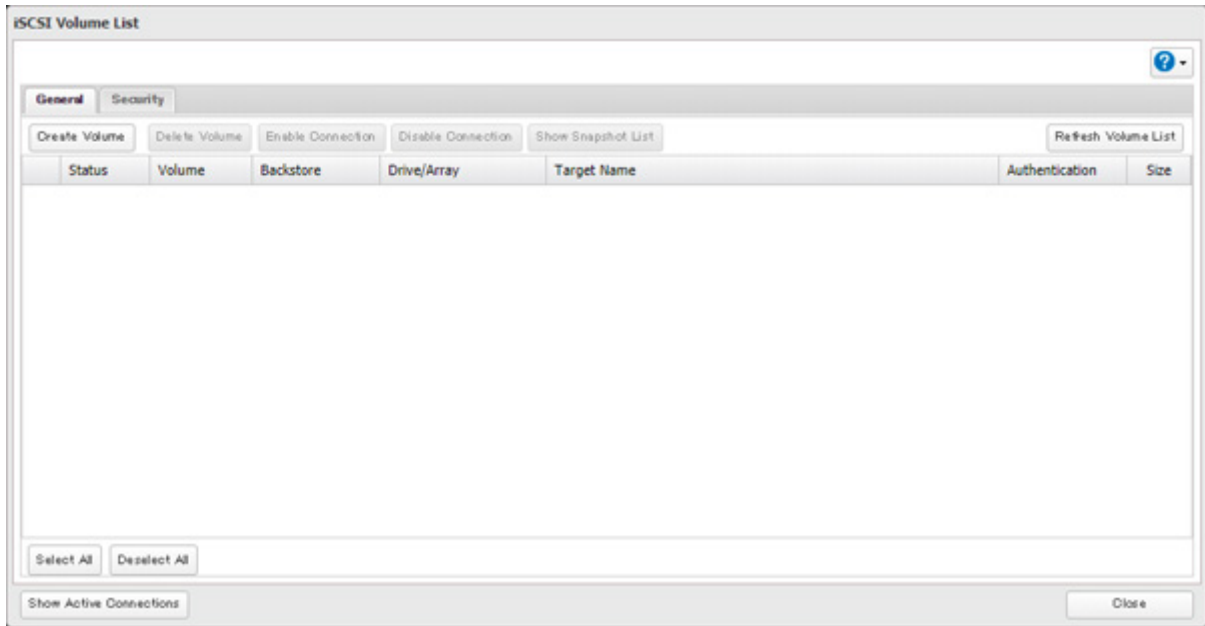

#### 5 Enter a volume name, volume description, drive or array where a volume will be created, and volume size. Click *OK* when completed.

If you enabled LVM for the target drive or array, or selected “File I/O” for the “Backstore” option, the volume size that you specify here can be changed later. To change the volume size, refer to the [“Expanding Volume Sizes”](#) section below.

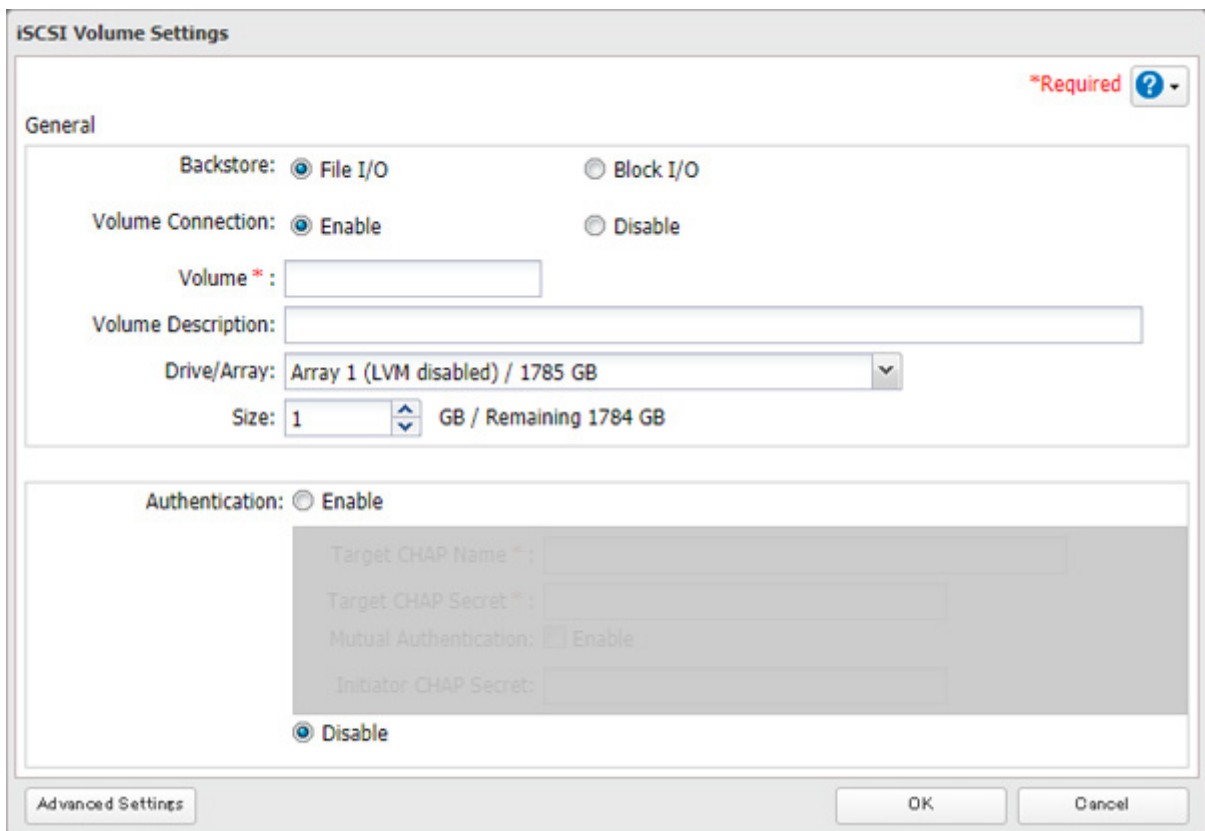

#### 6 Click *OK*, then click *OK* again.

**Notes:**

- If you click *Disable Connection* for the selected volume in *Storage > iSCSI* in Settings, the selected iSCSI volume can no longer be accessed. If you click *Enable Connection*, the volume will become accessible from the iSCSI initiator software.
- If you selected “Block I/O” for the “Backstore” option, write cache (WCE) cannot be configured from the “Advanced Settings” page.

## Connecting or Disconnecting Volumes

---

**Note:** When changing iSCSI volume settings, the iSCSI service will restart so iSCSI volumes will be unable to connect temporarily. It is recommended to disconnect the volume before changing the volume settings.

### Connecting Volumes

To connect a volume, follow the procedure below.

**Note:** Do not shut down the TeraStation while connecting to an iSCSI volume. It may cause unexpected data erasure. Make sure all connections are disconnected before shutdown.

- 1 From Windows, navigate to *Control Panel > System and Security > Administrative Tools > iSCSI Initiator*.
- 2 Enter the IP address of the TeraStation into the “Target” field and click *Quick Connect*.

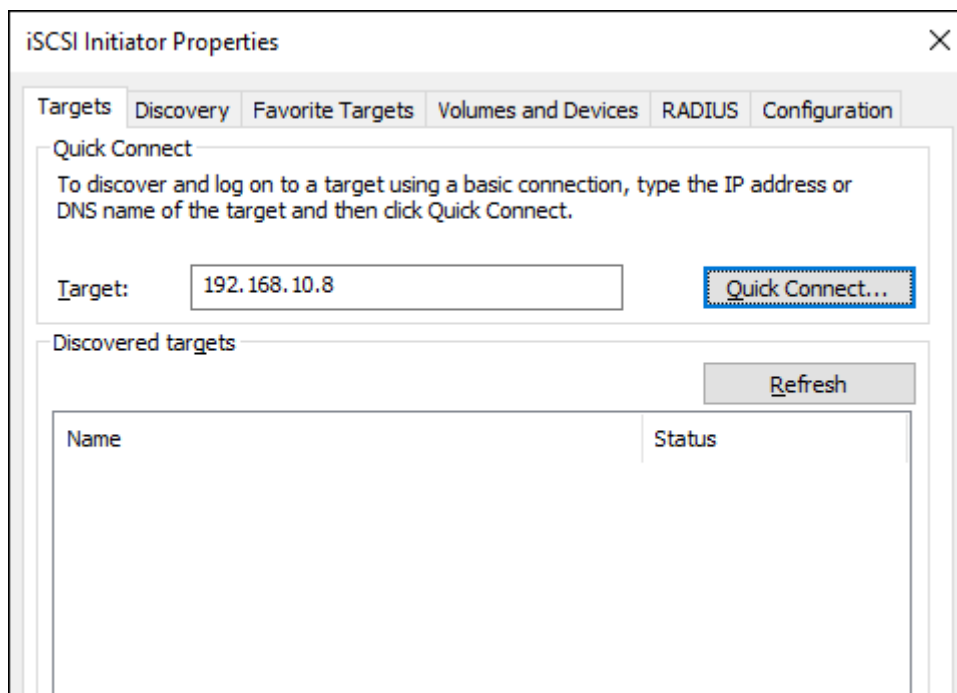

- 3 Confirm if the connection is established and click *Done*.

### Formatting Volumes

If using the connected volume for the first time, the volume should be formatted to be used as a local drive. Follow the procedure below for formatting.

- 1 From Windows, navigate to *Control Panel > System and Security > Administrative Tools > Computer Management*.
- 2 Click *Disk Management*.  
When the “Initialize Disk” screen appears, click *OK* without changing any settings.

- 3 Right-click the drive volume that shows the status “Unallocated” and click *New Simple Volume* from the displayed menu. Follow the screen to finish formatting.

When the formatting process is completed, the drive will be visible as an icon in Computer or This PC and can be used as a normal drive on the computer.

## Disconnecting a Volume

- 1 From Windows, navigate to *Control Panel > System and Security > Administrative Tools > iSCSI Initiator*. The status of the connecting volume will be displayed as “Connected” under “Discovered targets”.
- 2 Select a volume to disconnect and click *Disconnect*.
- 3 Click *Yes*.
- 4 When the volume status is displayed as “Inactive”, the disconnection was carried out properly.

## Using with Multiple Computers

If the TeraStation is divided into multiple volumes (or drives), it can be used with multiple computers. However, it is not recommended to access a single volume or drive from multiple computers at the same time for security reasons.

When using the TeraStation as an iSCSI device, it should only connect to a single initiator unless the computer running the initiator also has clustering enabled and configured on its operating system. To avoid using multiple initiators for access, enable mutual authentication.

### Checking Whether iSCSI Volume Is Connected

To check whether an iSCSI volume is connected, navigate to *Storage > iSCSI*. Current volumes will be listed. If “Connected” is displayed under “Status”, the volume is currently connected to the client.

## Configuring Access Restrictions

A CHAP name and secret can be configured for the entire iSCSI volume or each existing volume. Access restrictions can be configured so that entering a target CHAP name and secret is required for each connection.

The TeraStation can perform mutual authentication (two-way authentication). Dual passwords ensure that only authorized client computers can access the volume on the TeraStation.

Follow the procedure below to enable access restrictions.

### Configuring Access Restrictions for the Entire TeraStation

- 1 From Settings, click *Storage*.



- 2 Click the settings icon (⚙️) to the right of “iSCSI”.

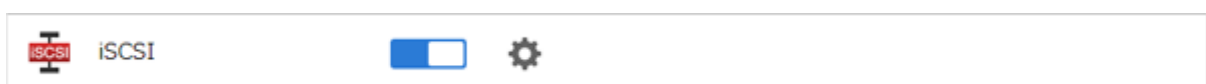

- 3 Click the *Security* tab.
- 4 Click *Edit* under “Access Control (Target Discovery)”.



- 5 Enable authentication, enter the target CHAP name and secret, and click *OK*.

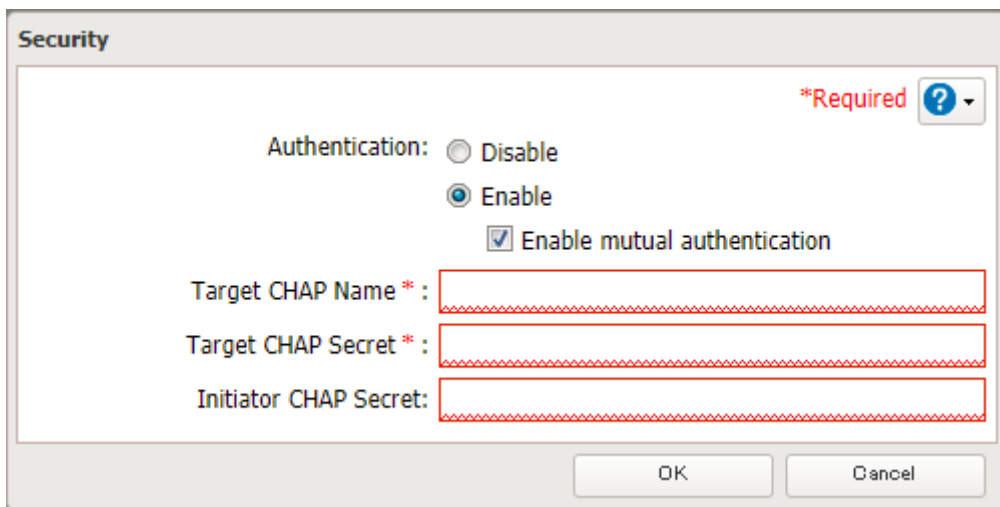

**Note:** To enable mutual authentication in addition to target CHAP name and secret authentication, select the “Enable mutual authentication” checkbox and enter the initiator CHAP secret. To search or connect the volume which has mutual authentication enabled from Microsoft iSCSI Initiator, initiator CHAP secret settings should be configured.

- 6 Click *OK* when completed.

## Connecting Volumes on the Access-Restricted TeraStation

If access restrictions are configured for the entire iSCSI volume, that volume will not be detected by Microsoft iSCSI Initiator. To connect that volume, the target CHAP name and secret should be authenticated.

- 1 Open the Microsoft iSCSI Initiator.
- 2 Register the initiator CHAP secret to your computer first. If you didn’t enable mutual authentication, skip this step.  
Click *CHAP* on the *Configuration* tab. Enter the configured initiator CHAP secret into the “Initiator CHAP secret” field and click *OK*.
- 3 From the *Discovery* tab, click *Discover Portal*.
- 4 Enter the TeraStation’s IP address into the “IP address or DNS name” field and click *Advanced*.
- 5 Select the “Enable CHAP log on” checkbox and enter the target CHAP name into the “Name” field and the target CHAP secret into the “Target secret” field.



If mutual authentication is enabled, select the “Perform mutual authentication” checkbox.

**6** Click *OK*, then click *OK* again.

**7** The iSCSI volumes on the TeraStation will be listed under “Discovered targets” on the *Targets* tab. Select the desired volume to connect and click *Connect*.

**8** Click *OK*.

**9** When the status of the selected volume is displayed as “Connected”, the connection is established properly.

## Configuring Access Restrictions for Individual Volumes

If access restrictions are configured for a volume, that volume cannot be accessed unless the target CHAP name and secret are authenticated.

**1** From Settings, click *Storage*.



**2** Click the settings icon (  ) to the right of “iSCSI”.



**3** Click the volume to enable access restrictions.

**4** Enable authentication, enter the target CHAP name and secret, and click *OK*.

 A dialog box titled "iSCSI Volume Settings" with a grey border. In the top right corner, there is a red asterisk followed by the word "Required" and a blue question mark icon. The dialog is divided into two main sections. The first section, labeled "General", contains the following fields: "Backstore: File I/O", "Volume Connection:" with radio buttons for "Enable" (selected) and "Disable", "Volume: volume01", "Volume Description:" with an empty text box, "Drive/Array: Array 1 / 1798 GB", "Size: 10 GB + 0" (with a small spinner box) "GB = 10 GB / Remaining 1784 GB", and "Target Name: iqn.2004-08.jp.buffalo.6084bdc0003f.volume01". The second section, labeled "Authentication:", contains radio buttons for "Enable" (selected) and "Disable". Under "Enable", there are four text input fields: "Target CHAP Name \*:", "Target CHAP Secret \*:", "Mutual Authentication:" with a checkbox for "Enable", and "Initiator CHAP Secret:". At the bottom of the dialog, there are three buttons: "Advanced Settings" (disabled), "OK", and "Cancel".

**Note:** To enable mutual authentication, select the “Enable” checkbox to the right of “Mutual Authentication” and enter the initiator CHAP secret.

**5** Click *OK* when completed.

## Connecting to Individual Volumes that Are Access-Restricted

**1** Open the Microsoft iSCSI Initiator.

**2** Register the initiator CHAP secret to your computer first. If you didn’t enable mutual authentication, skip this step.

Click *CHAP* on the *Configuration* tab. Enter the configured initiator CHAP secret into the “Initiator CHAP secret” field and click *OK*.

**3** From the *Discovery* tab, click *Discover Portal*.

**4** Enter the TeraStation’s IP address into the “IP address or DNS name” field and click *OK*.

**5** The iSCSI volumes on the TeraStation will be listed under “Discovered targets” on the *Targets* tab. Select the desired volume to connect and click *Connect*.

**6** Click *Advanced*.

**7** Select the “Enable CHAP log on” checkbox and enter the target CHAP name into the “Name” field and the target CHAP secret into the “Target secret” field.

If mutual authentication is enabled, select the “Perform mutual authentication” checkbox.

**8** Click *OK*, then click *OK* again.

**9** When the status of the selected volume is displayed as “Connected”, the connection is established properly.

## Expanding Volume Sizes

The volume size of the existing volumes can be expanded after they are created.

### Notes:

- Expanding the volume size may erase all data on the volume depending on the formatting type. Backing up the data before expanding the volume size is recommended.
- To expand the volume size, the volume should have “File I/O” selected for the “Backstore” option, or the volume needs to have been created in a drive or array with LVM enabled.

**1** From Settings, click *Storage*.



**2** Click the settings icon (  ) to the right of “iSCSI”.

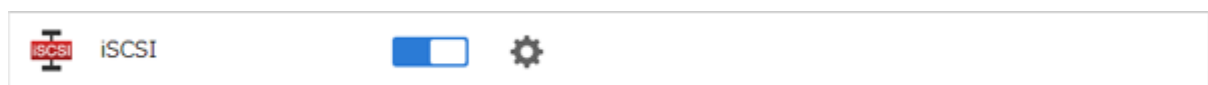

**3** Select the volume to expand.

- 4** Enter the desired volume size to add and click *OK*.

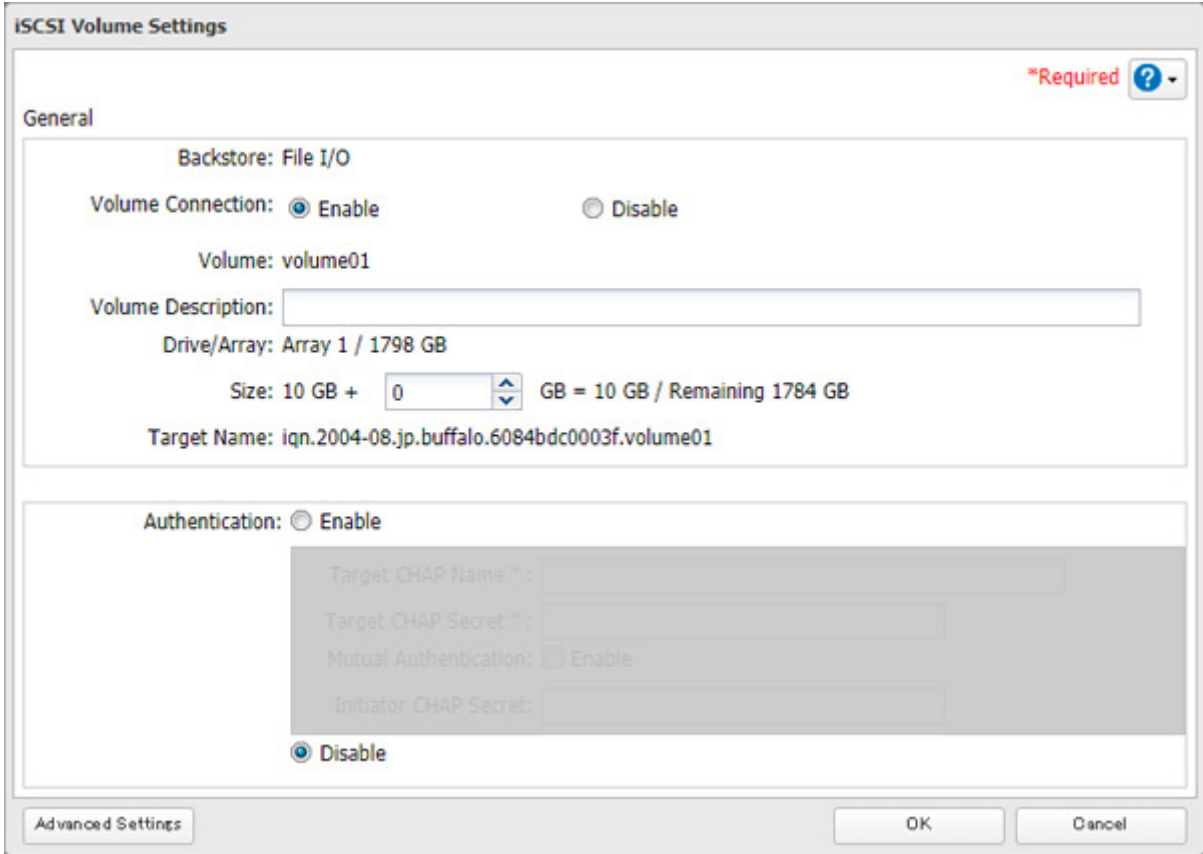

The image shows the "iSCSI Volume Settings" dialog box. It has a title bar with "iSCSI Volume Settings" and a "Required" indicator with a question mark icon. The "General" section includes:
 

- Backstore: File I/O
- Volume Connection:  Enable  Disable
- Volume: volume01
- Volume Description: [text input field]
- Drive/Array: Array 1 / 1798 GB
- Size: 10 GB + [0] GB = 10 GB / Remaining 1784 GB
- Target Name: iqn.2004-08.jp.buffalo.6084bdc0003f.volume01

 The "Authentication" section includes:
 

- Authentication:  Enable  Disable
- Target CHAP Name \*: [text input field]
- Target CHAP Secret \*: [text input field]
- Mutual Authentication:  Enable
- Initiator CHAP Secret: [text input field]

 At the bottom, there are buttons for "Advanced Settings", "OK", and "Cancel".

- 5** Click *OK*.

## Deleting Volumes

To delete an existing volume, follow the procedure below.

**Note:** Deleting a volume will erase all data on the volume. Back up the data before deleting the volume.

- 1** From Settings, click *Storage*.



- 2** Click the settings icon (  ) to the right of "iSCSI".



**3** Select the volume to delete and click *Delete Volume*.

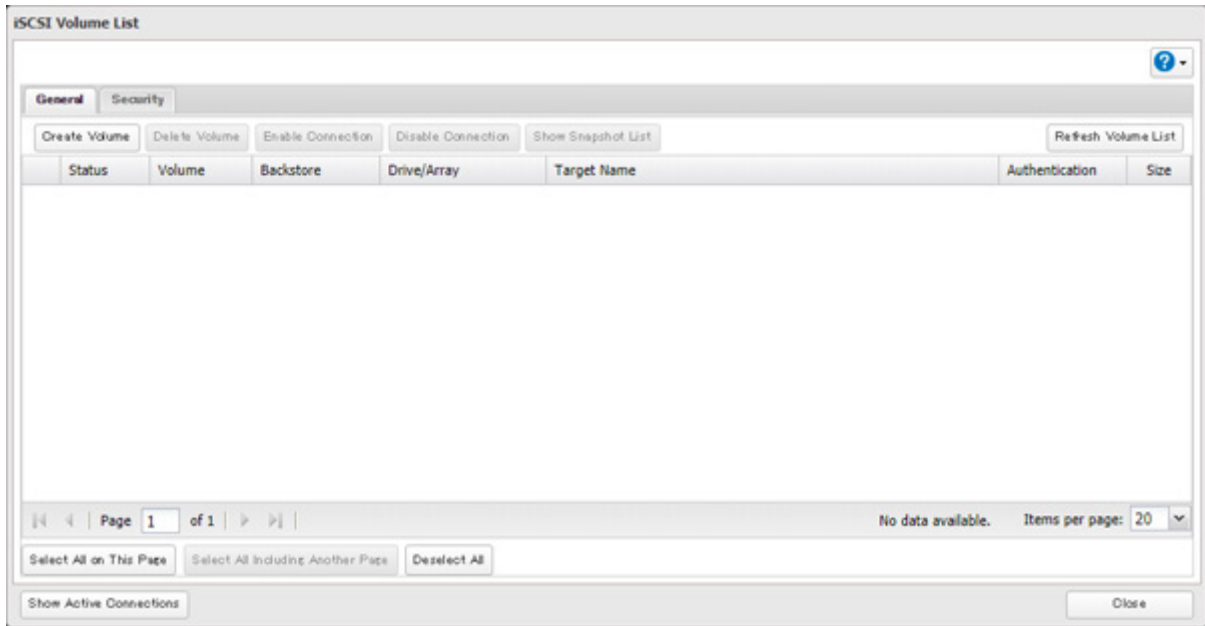

**4** Confirm that the volume is correctly selected on the screen and click *OK*.

**5** The “Confirm Operation” screen will open. Enter the confirmation number, then click *OK*.

**6** Click *OK*.

## Advanced Settings

You can configure the following advanced parameters for each iSCSI volume.

Advanced Parameter	Description
HeaderDigest	Controls the HeaderDigest usage by the iSCSI target portal group endpoint.
DataDigest	Controls the DataDigest usage by the iSCSI target portal group (TPG) endpoint.
MaxConnections	Controls the usage of Multiple Connections per Session (MC/S). Initiator and target negotiate the maximum number of connections requested and/or acceptable.
InitialR2T	Turns on or off the default use of R2T (Ready to Transfer) for unidirectional and the output part of bidirectional commands.
ImmediateData	Indicates whether the initiator and target have agreed to support immediate data on this session.
MaxRecvDataSegmentLength	Maximum data segment length in bytes the initiator and target can receive in an iSCSI Protocol Data Unit (PDU).
MaxXmitDataSegmentLength	Maximum data segment length in bytes that can be sent.
MaxBurstLength	Maximum iSCSI data payload in a Data-In or a solicited Data-Out iSCSI sequence, in bytes.
FirstBurstLength	Maximum amount in bytes of unsolicited data an iSCSI initiator can send to the target during the execution of a single SCSI command.
MaxOutstandingR2T	The R2T PDUs that can be in transition before an acknowledge PDU is received.
QueuedCommands	Maximum number of commands queued to any session of this target.
File I/O Write Sync	Synchronous file I/O provides reliability but slower performance. Asynchronous writes are faster, but buffered data will be lost if a power outage occurs.
Write Cache (WCE)	Increases performance. This cannot be used when block I/O is selected.
LUN	Number used to identify a local unit.

# Chapter 5 Backup

---

## Using Snapshots

---

### Overview

Snapshot is a function that creates a virtual copy of the data currently stored in a shared folder or iSCSI volume on the TeraStation. Once a snapshot has been created and saved, files and folders that are subsequently modified or deleted can be restored from the point at which the snapshot was created. The TeraStation allows you to not only create a snapshot manually, but also schedule automatic snapshots and auto-archive them to save TeraStation capacity.

The created snapshots will be saved on the TeraStation. As with any file, if a drive malfunctions, all saved snapshots on that drive will be erased along with the data.

### Application for iSCSI Volume Snapshots

To create an iSCSI volume snapshot in the environment where the iSCSI volumes on the TeraStation are connected using a virtual machine, we recommend using the Buffalo-offered Windows Server application “Snapshot Agent for TeraStation”, available from the [Buffalo website](#).

The application can create both application-consistent and crash-consistent snapshots. An application-consistent snapshot contains all current data in memory and all I/O operations. Restoring from an application-consistent snapshot reverts the virtual machine to the exact same state as when the snapshot was created. A crash-consistent snapshot, on the other hand, creates a snapshot of all the current files but not ongoing processes. Restoring from a crash-consistent snapshot only recovers saved data. Refer to the application help for detailed usage procedures.

### Manually Creating a Snapshot

---

#### For Shared Folders

- 1 From Settings, click *File Sharing*.

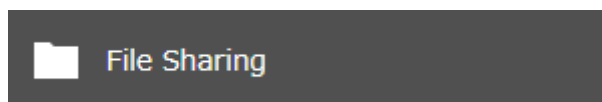

- 2 Click the settings icon (⚙️) to the right of “Folder Setup”.



**3** Click the number under “Snapshot” for the shared folder on the shared folder list.

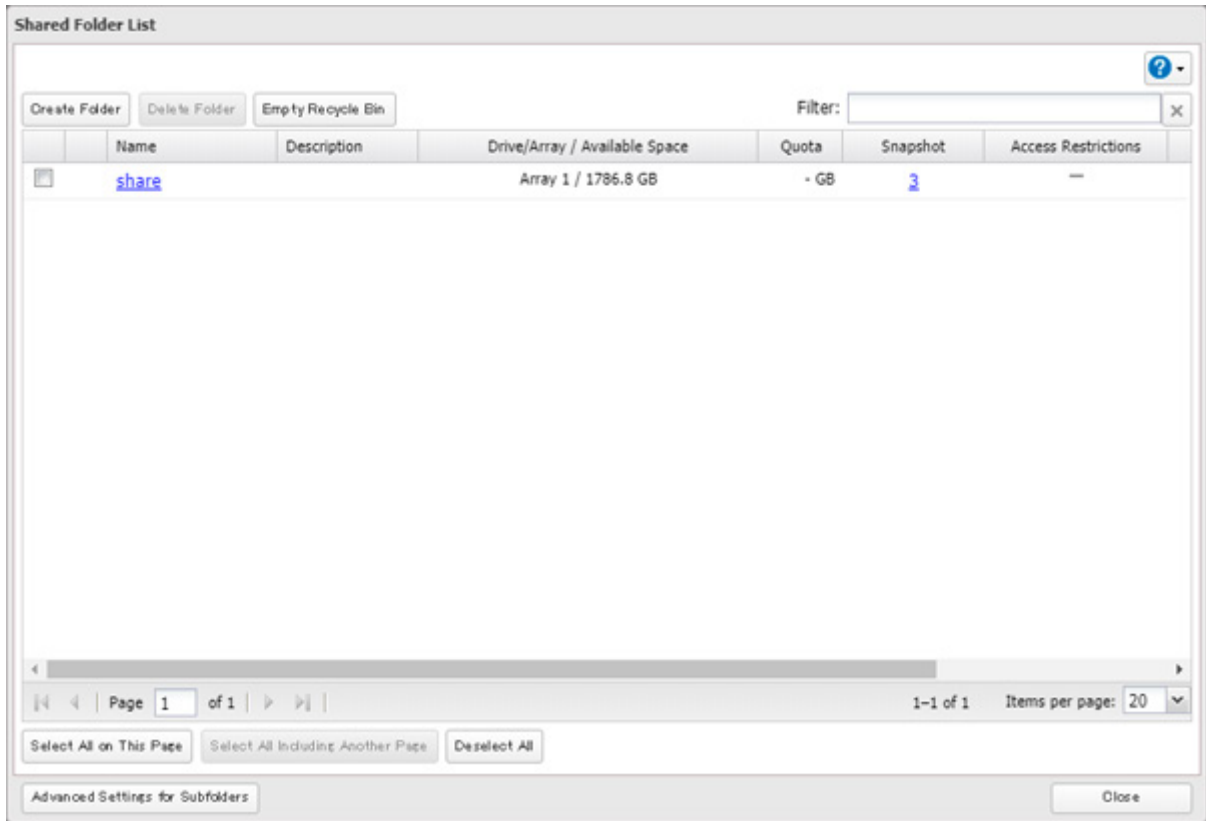

**4** Click *Create*.

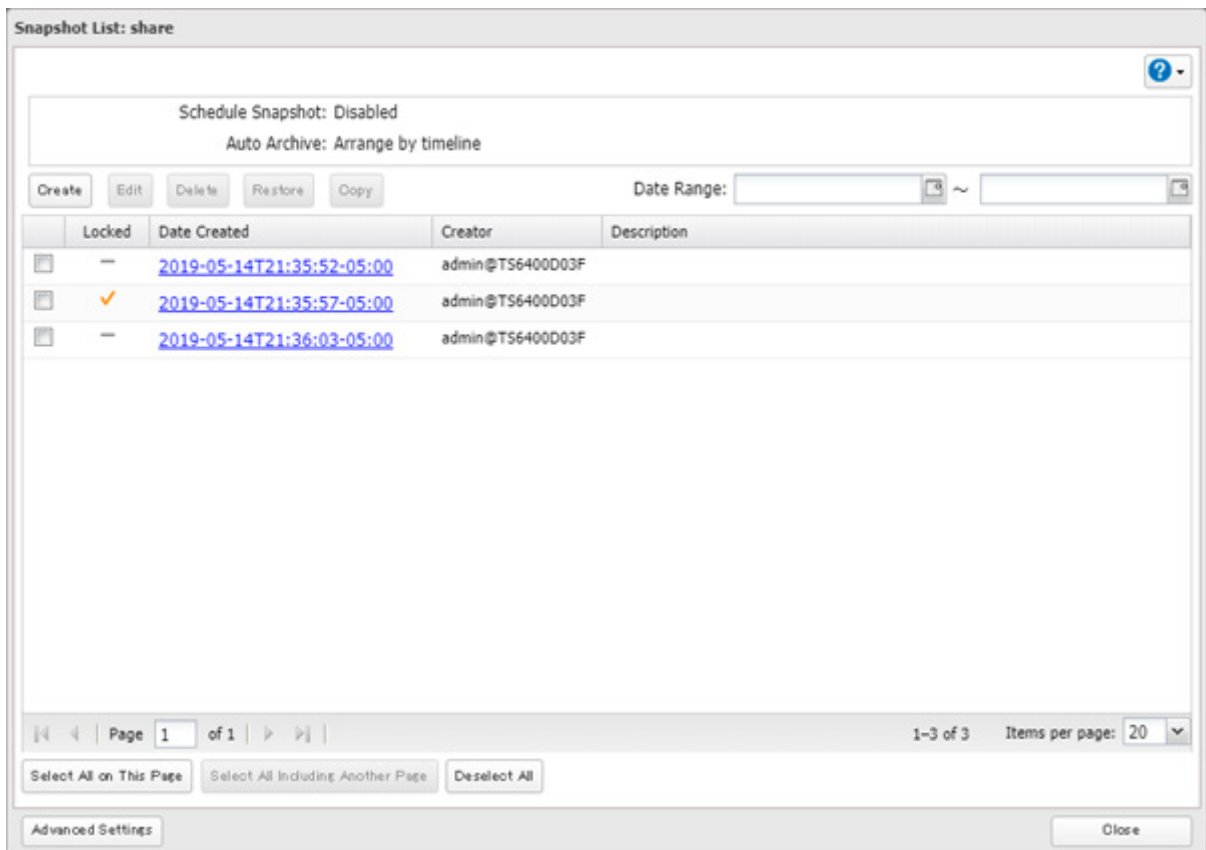

- 5** Select or clear the “Lock” checkbox to determine whether the created snapshot will be locked or unlocked and enter a short description, then click *OK*. A locked snapshot cannot be deleted due to auto-archiving.

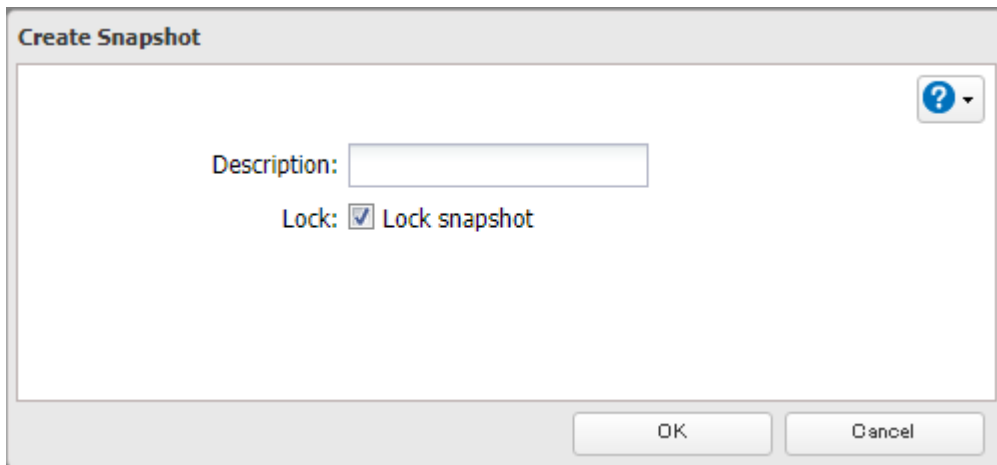

The snapshot will be created on the shared folder.

**Note:** Up to 1024 snapshots can be created for a shared folder. We recommend keeping no more than 65,536 snapshots total on a TeraStation. If you have created more than 65,536 snapshots, it may result in unexpected system behavior and slowdown.

## For iSCSI Volumes

- 1** From Settings, click *Storage*.



- 2** Click the settings icon (⚙️) to the right of “iSCSI”.

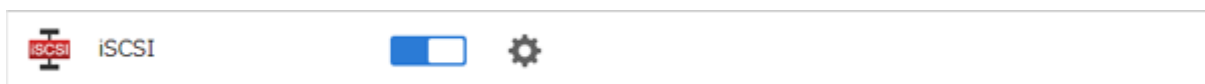

- 3** Select the checkbox for the target iSCSI volume and click *Show Snapshot List*.

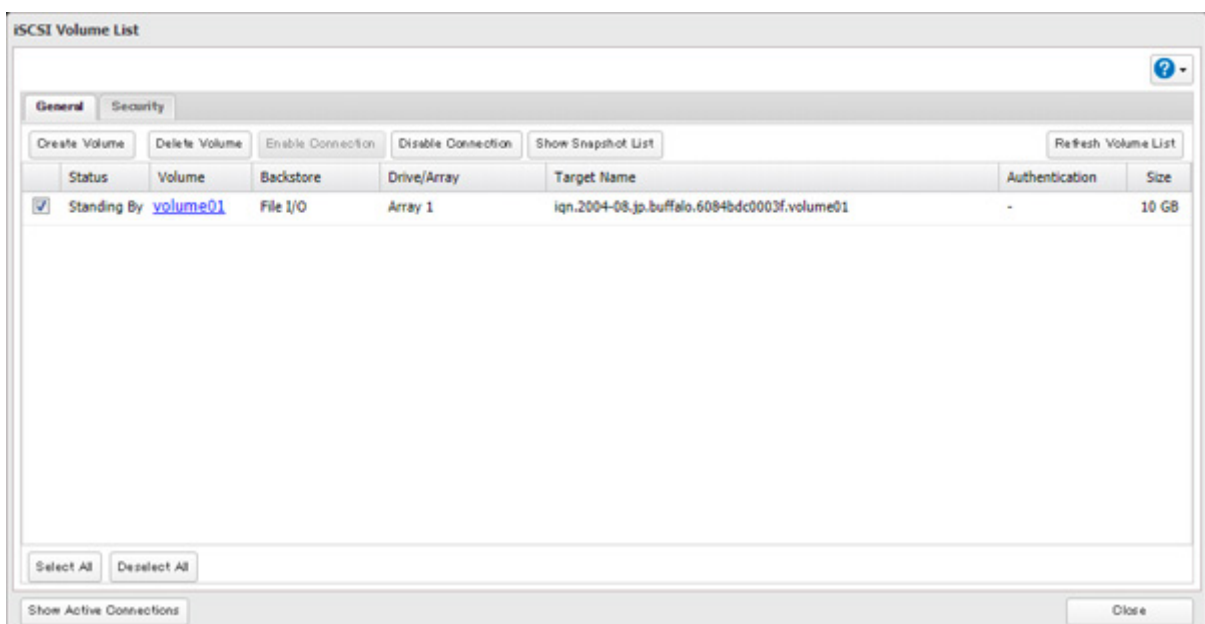

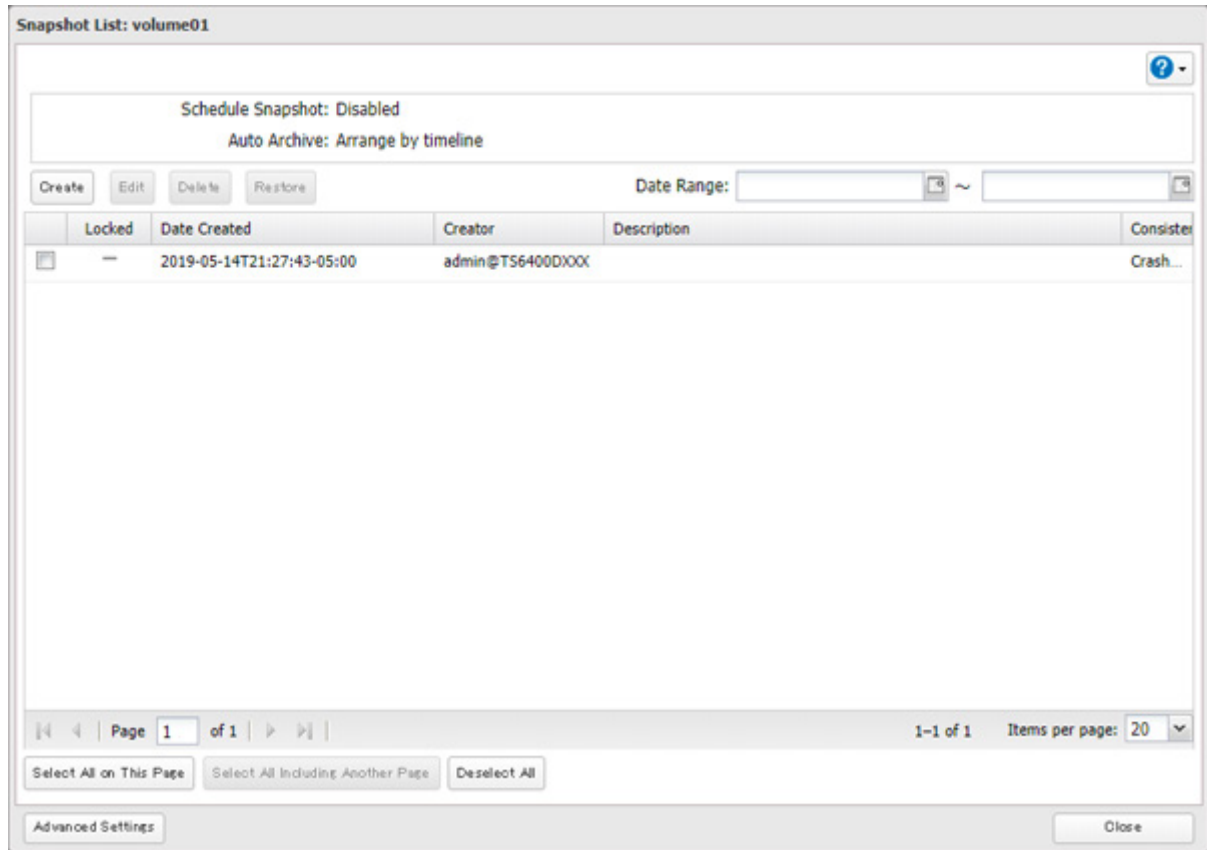
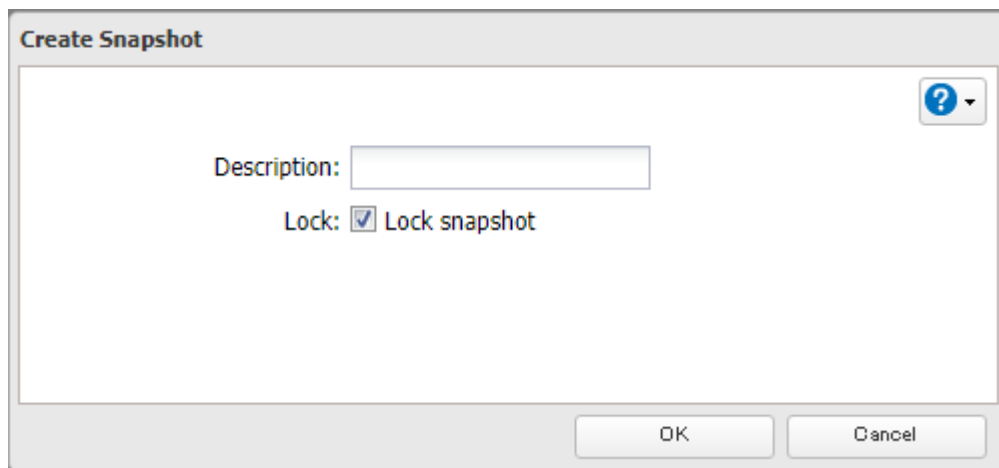
**4** Click *Create*.**5** Select or clear the "Lock" checkbox to determine whether the created snapshot will be locked or unlocked and enter a short description, then click *OK*. A locked snapshot cannot be deleted due to auto-archiving.

The snapshot will be created on the iSCSI volume.

**Note:** Up to 1024 snapshots can be created for an iSCSI volume. We recommend keeping no more than 65,536 snapshots total on a TeraStation. If you have created more than 65,536 snapshots, it may result in unexpected system behavior and slowdown.

## Accessing the Snapshots via SMB

---

From a Windows computer, you can access snapshots using the "Restore previous versions" option.



**1** From Settings, click *File Sharing*.

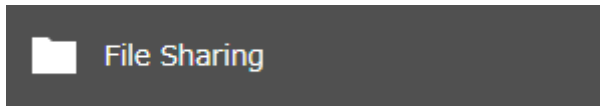

**2** Click the settings icon (  ) to the right of "Folder Setup".



**3** Click the shared folder to access snapshots from the computer.

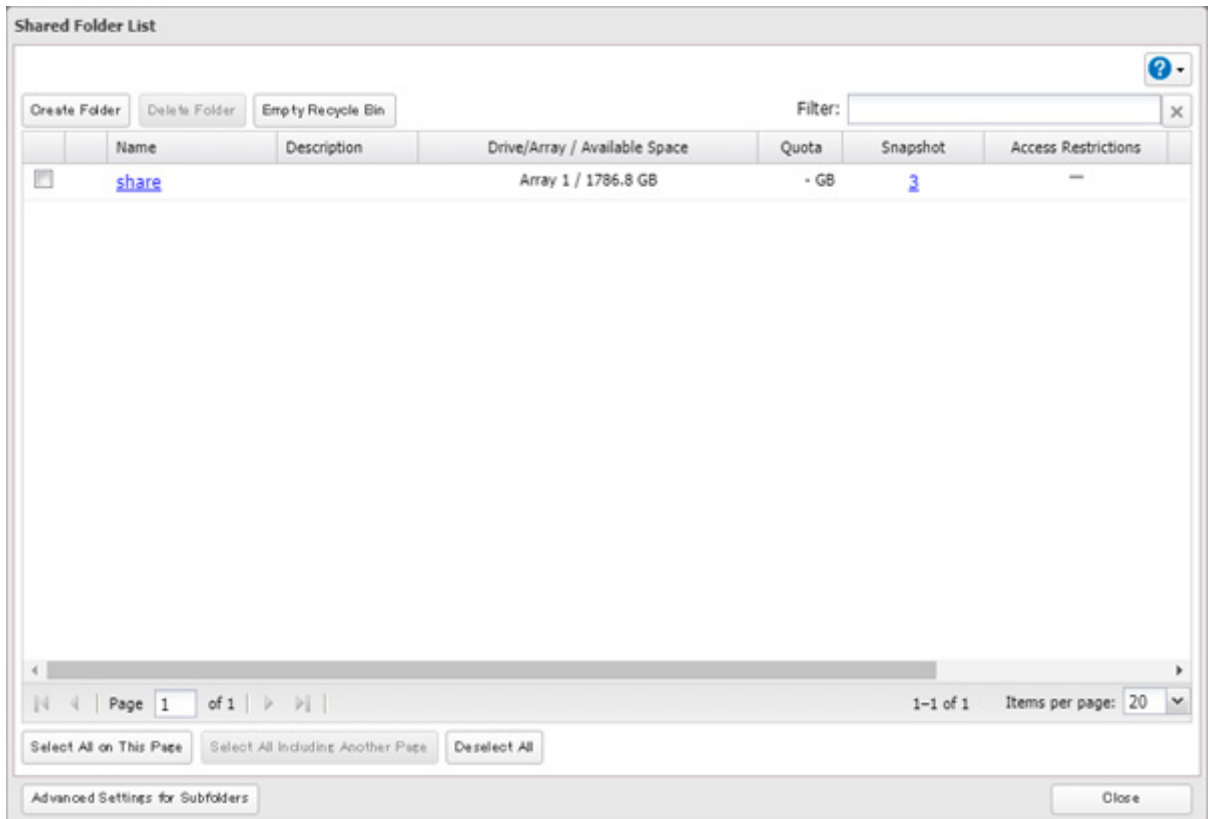

**4** Click the *Option 2* tab.

**5** Enable shadow copy and click *OK*.

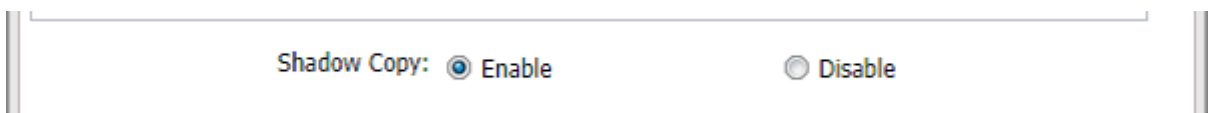

- 6 From the computer, access the TeraStation using File Explorer and right-click the shared folder to view snapshots.

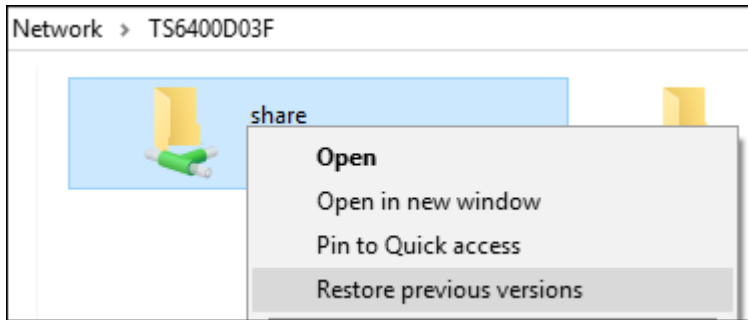

- 7 Click *Restore previous versions*.

- 8 The entire history of created snapshots will appear. Select the snapshot and the action to be taken for the snapshot.

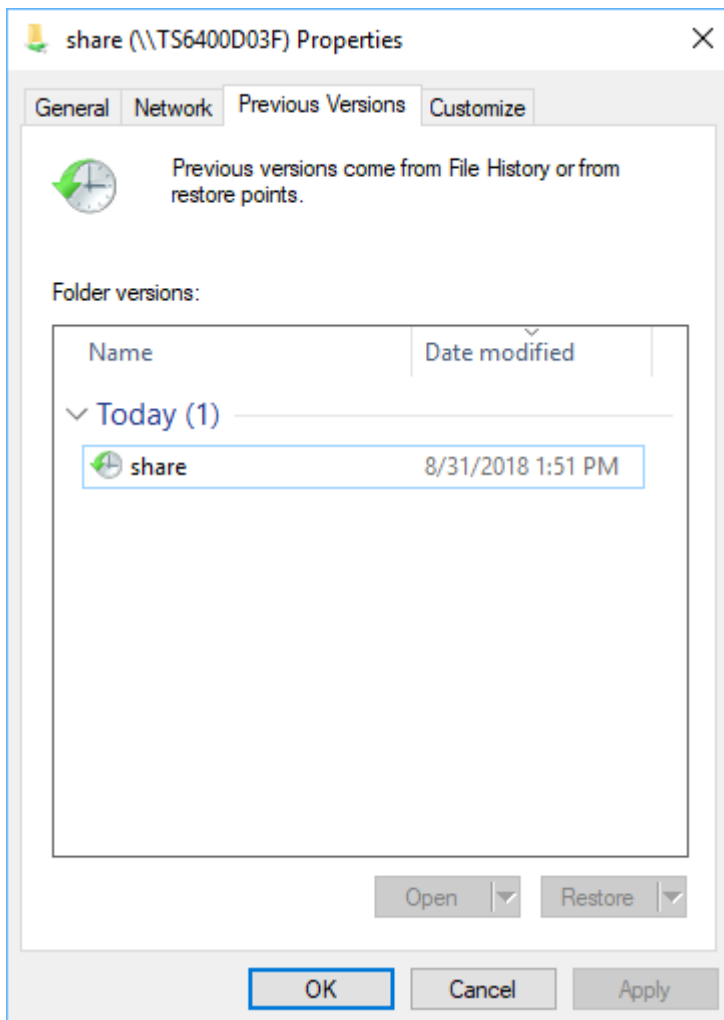

## Restoring Snapshots

To restore the created snapshots to the shared folder or the iSCSI volume, follow the procedure below.

### For Shared Folders

**Note:** When restoring snapshots, the file sharing service will restart so shared folders will become inaccessible temporarily.

**1** From Settings, click *File Sharing*.

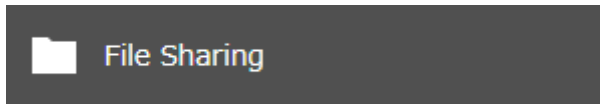

**2** Click the settings icon (  ) to the right of "Folder Setup".



**3** Click the number under "Snapshot" for the shared folder on the shared folder list.

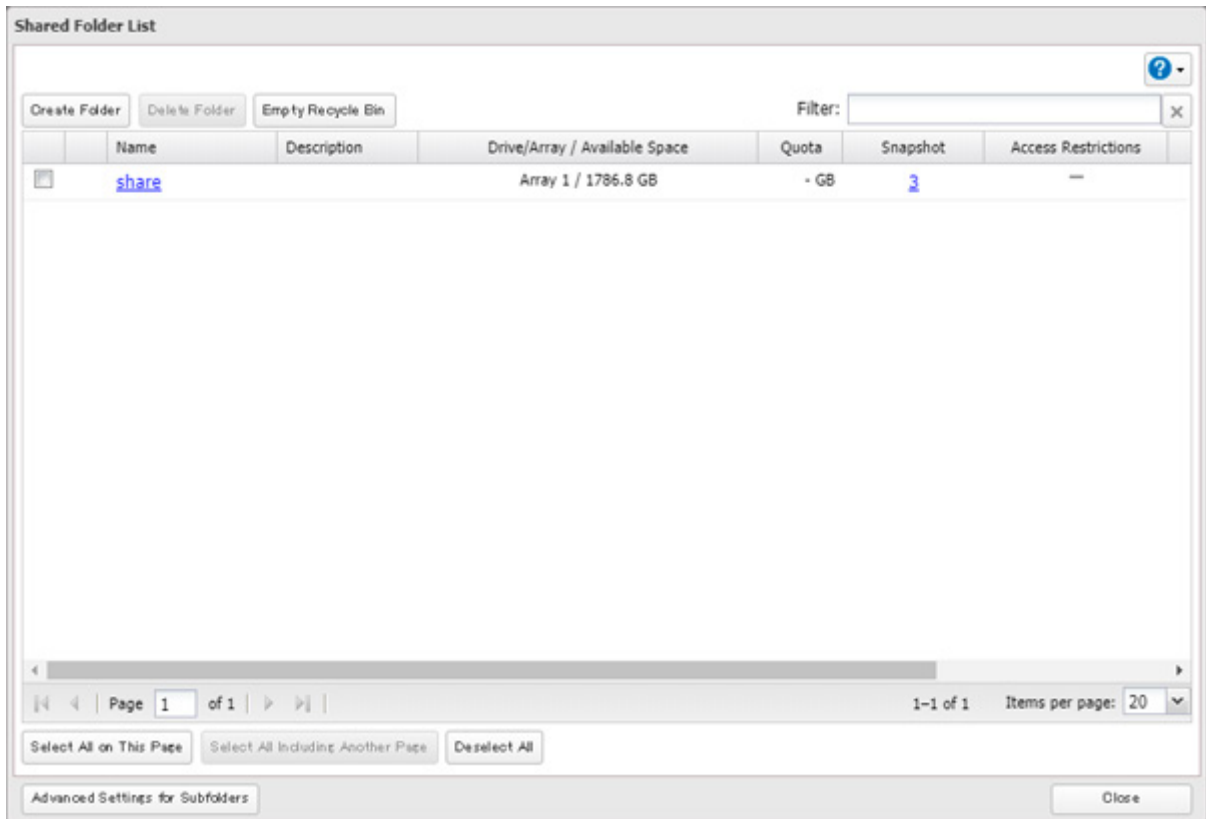

- 4 Select the checkbox for the target snapshot and then click *Restore*.

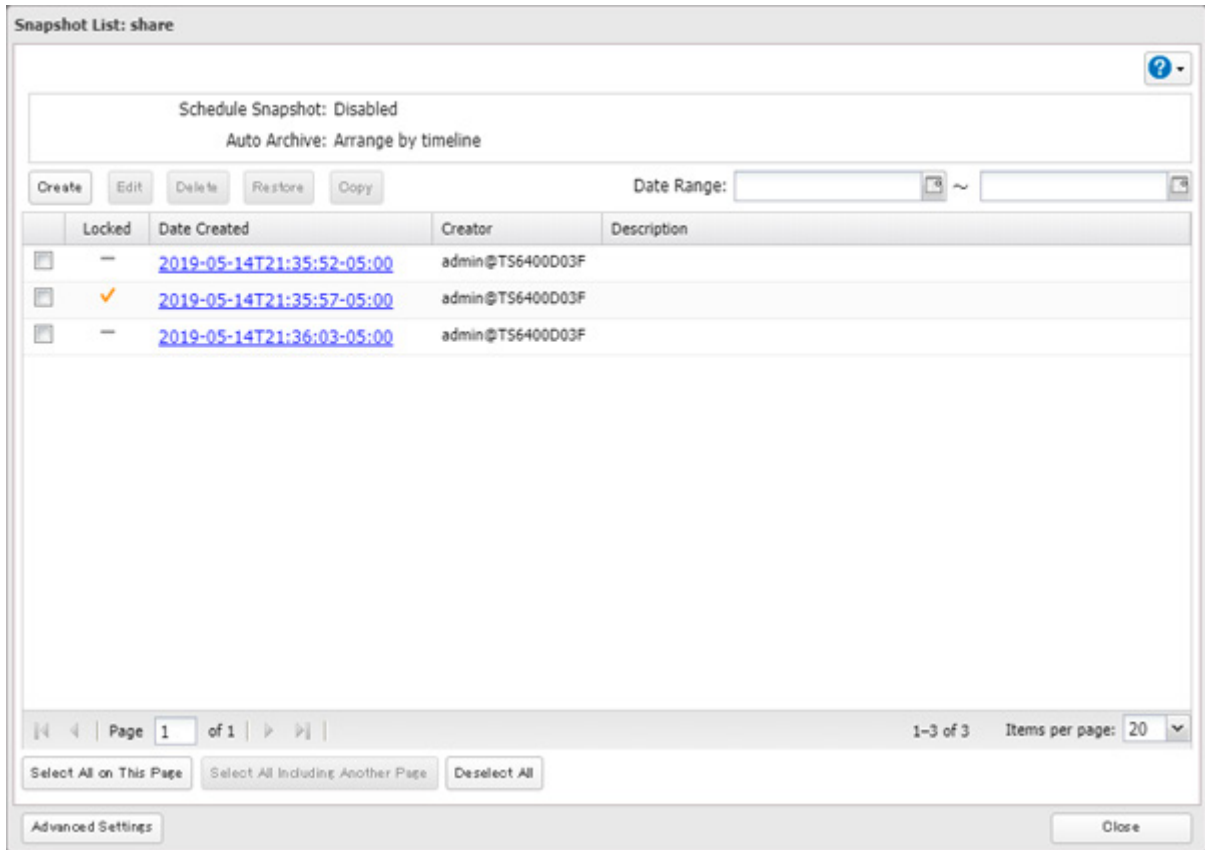

- 5 A new snapshot will be created before restoring the snapshot. Select or clear the "Lock" checkbox to determine whether the created snapshot will be locked or unlocked and enter a short description, then click *OK*. A locked snapshot cannot be deleted due to auto-archiving.

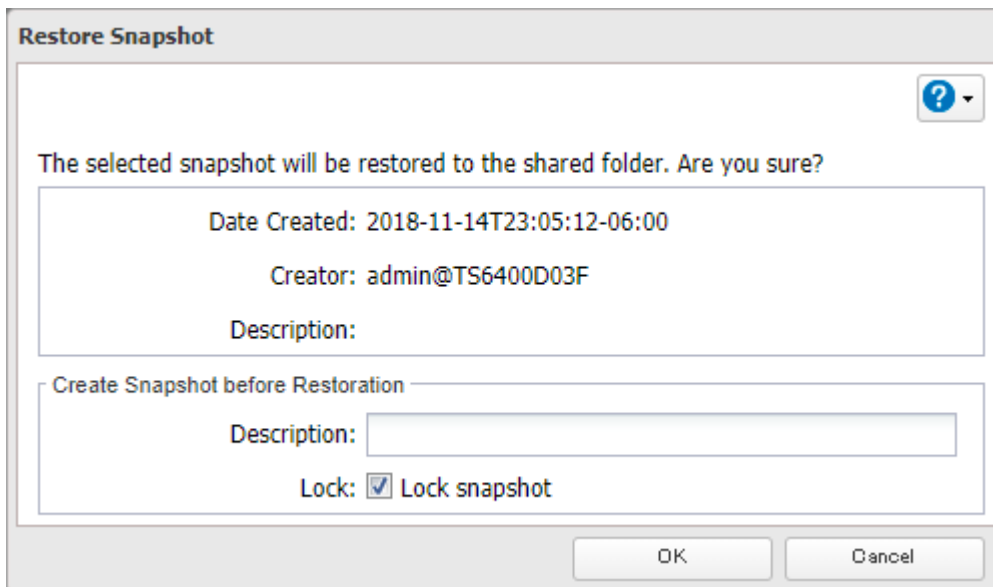

- 6 Click *OK* when completed.

## For iSCSI Volumes

**Note:** When restoring snapshots, the iSCSI service will restart so iSCSI volumes will become unable to connect temporarily. If you have saved the virtual machine to the iSCSI volume, shut down the virtual machine before restoring.

- 1 From Settings, click *Storage*.



- 2 Click the settings icon (  ) to the right of "iSCSI".



- 3 Select the checkbox for the target iSCSI volume and click *Show Snapshot List*.

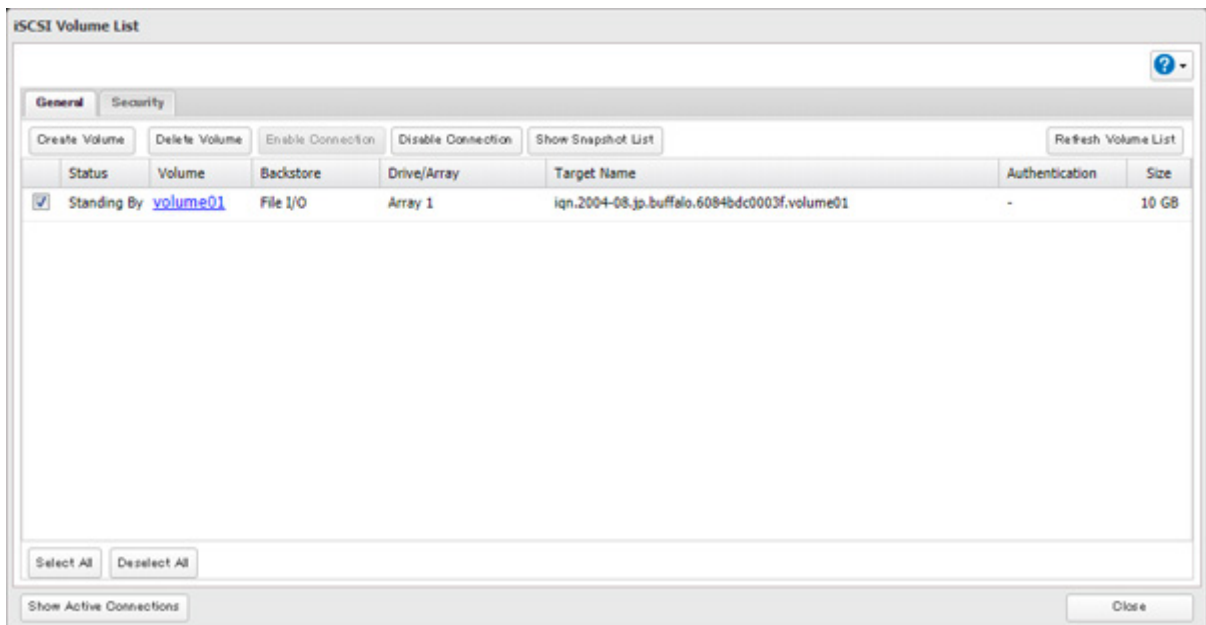

- 4** Select the checkbox for the target snapshot and then click *Restore*.

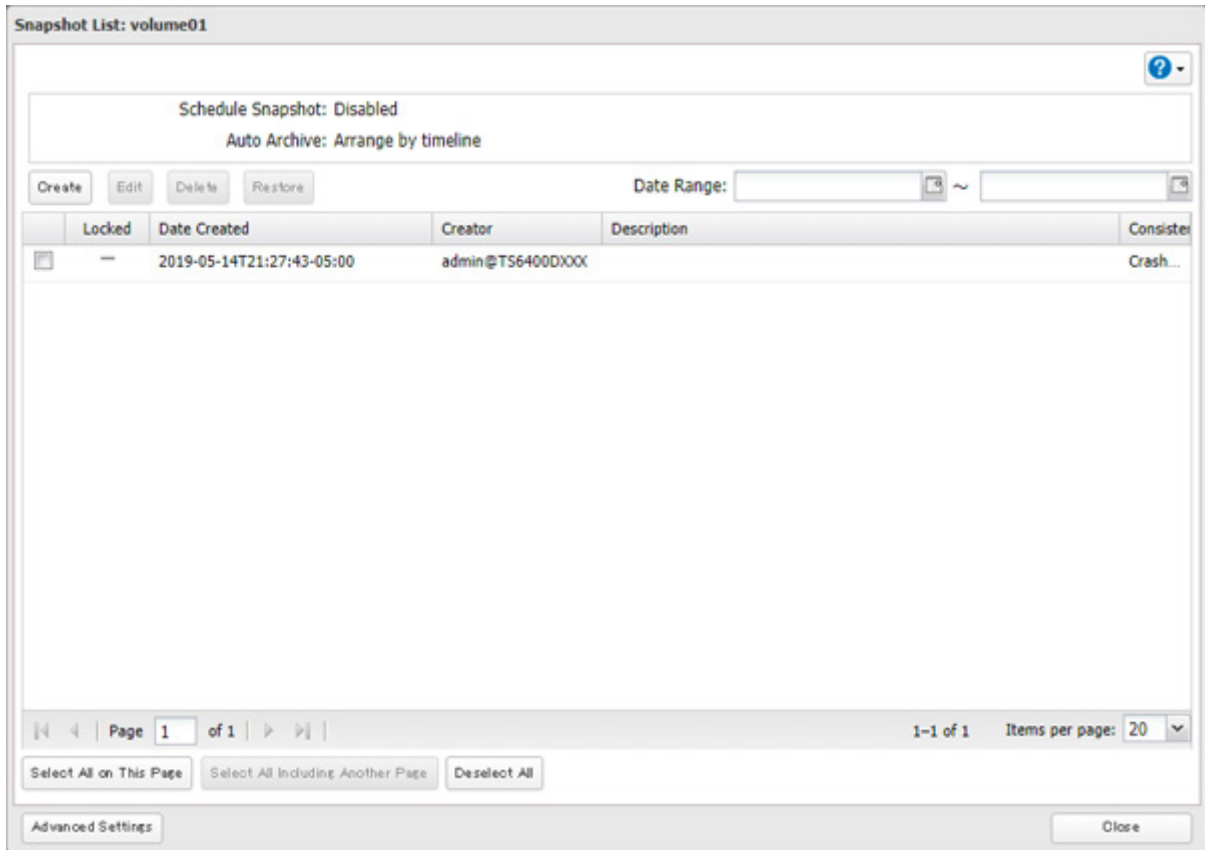

- 5** A new snapshot will be created before restoring the snapshot. Select or clear the “Lock” checkbox to determine whether the created snapshot will be locked or unlocked and enter a short description, then click *OK*. A locked snapshot cannot be deleted due to auto-archiving.

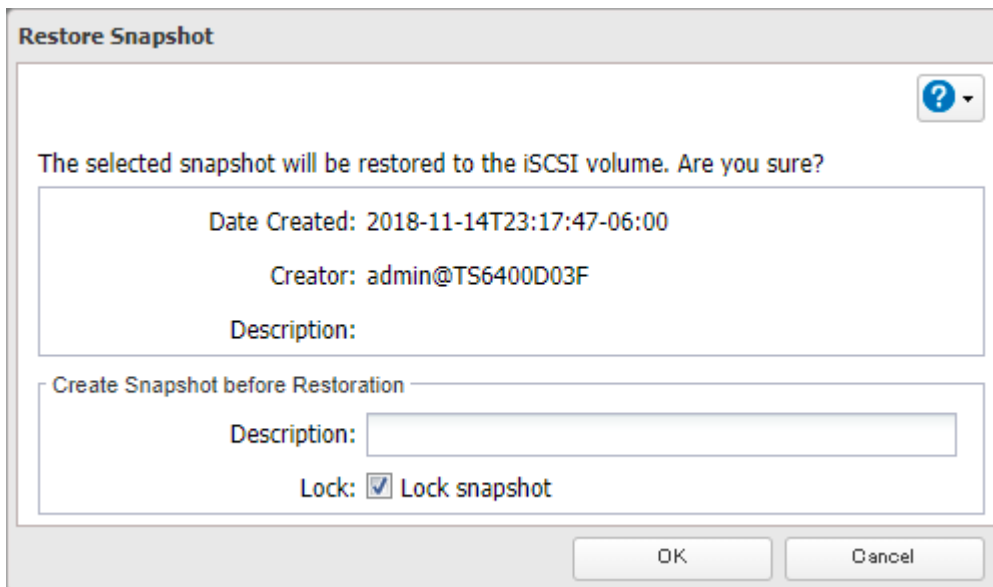

- 6** Click *OK* when completed.

If you have saved the virtual machine to the iSCSI volume and you are using Snapshot Agent for TeraStation, next restore the snapshot of the virtual machine using vCenter Server’s management console.

## Configuring Schedule Snapshot

If you want to create a snapshot for the purpose of regular backups, follow the procedure below.

### For Shared Folders

- 1 From Settings, click *File Sharing*.

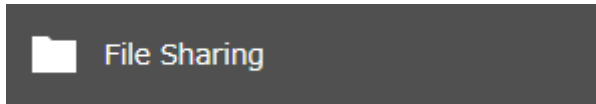

- 2 Click the settings icon (⚙️) to the right of "Folder Setup".



- 3 Click the number under "Snapshot" for the shared folder on the shared folder list.

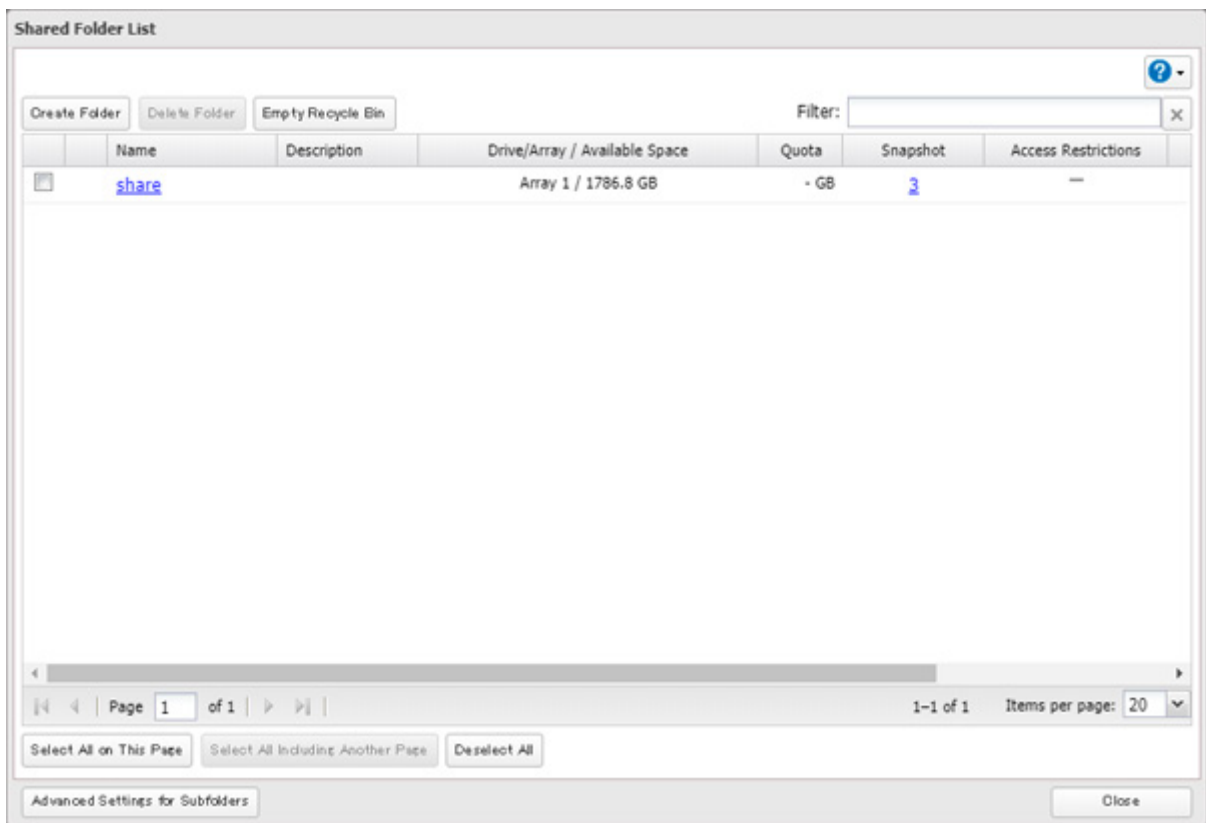

**4** Click *Advanced Settings* at the lower-left corner of the window.

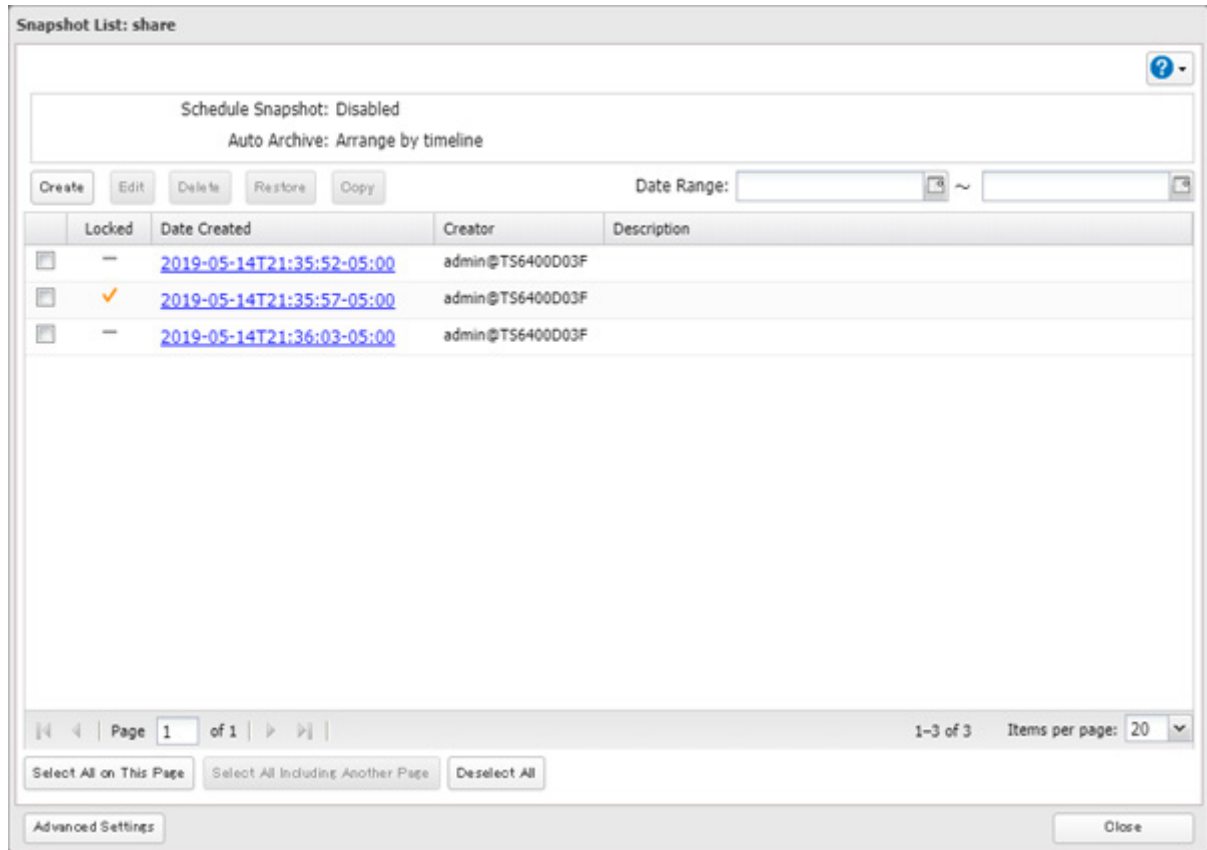

**5** Click the *Schedule* tab.

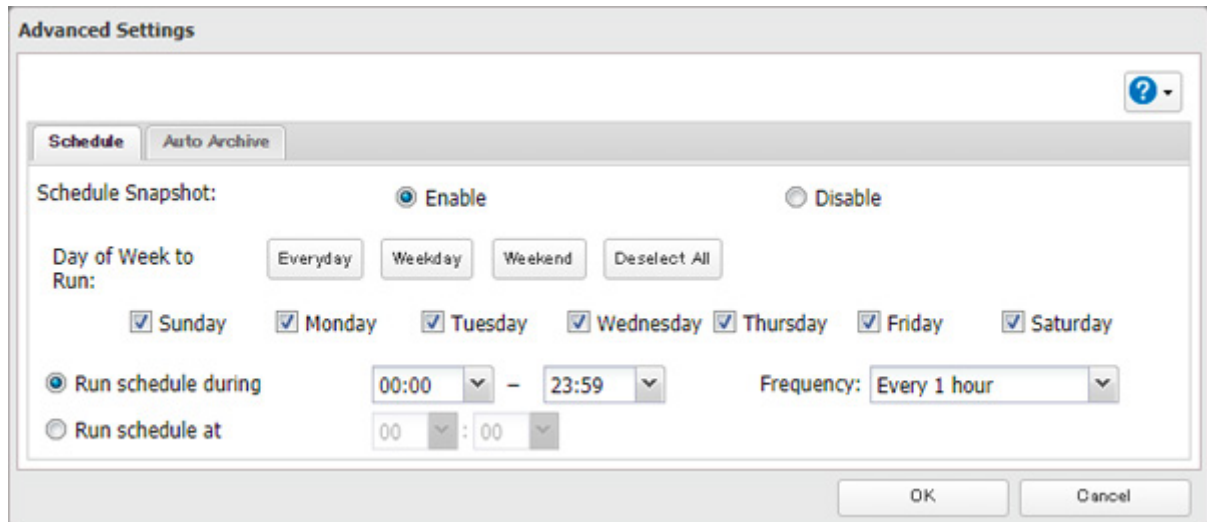

**6** Enable schedule snapshot.

**7** Select the day of the week and time for when to automatically create a snapshot.

**8** Click *OK*.



## For iSCSI Volumes

1 From Settings, click *Storage*.



2 Click the settings icon (⚙️) to the right of "iSCSI".



3 Select the checkbox for the target iSCSI volume and click *Show Snapshot List*.

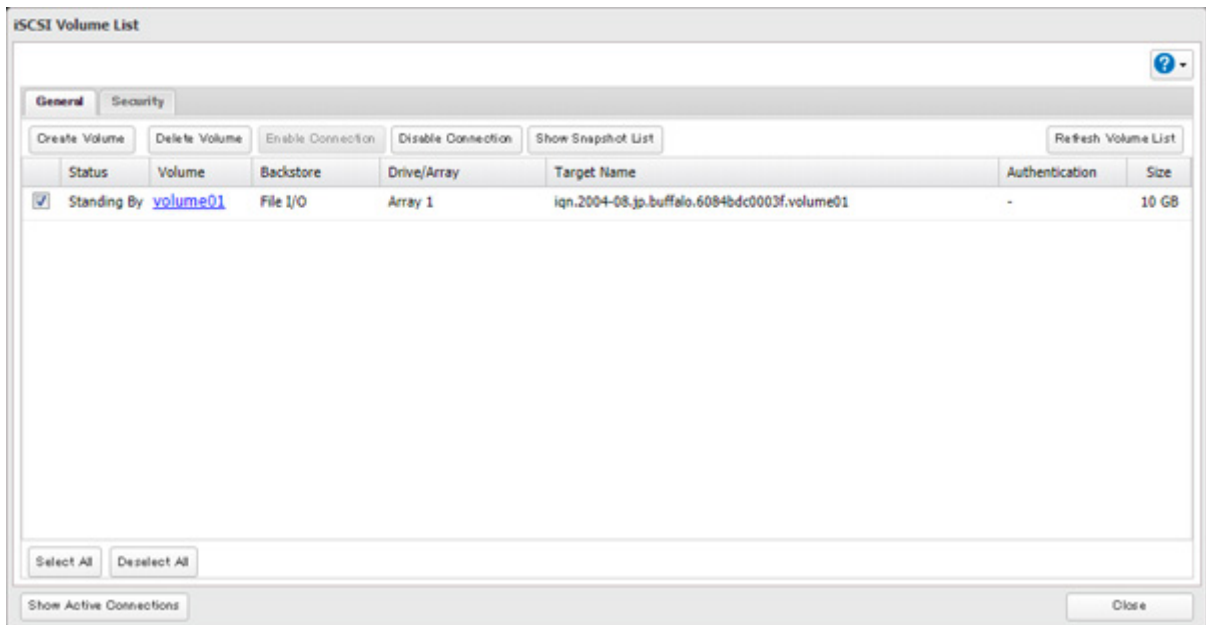

**4** Click *Advanced Settings* at the lower-left corner of the window.

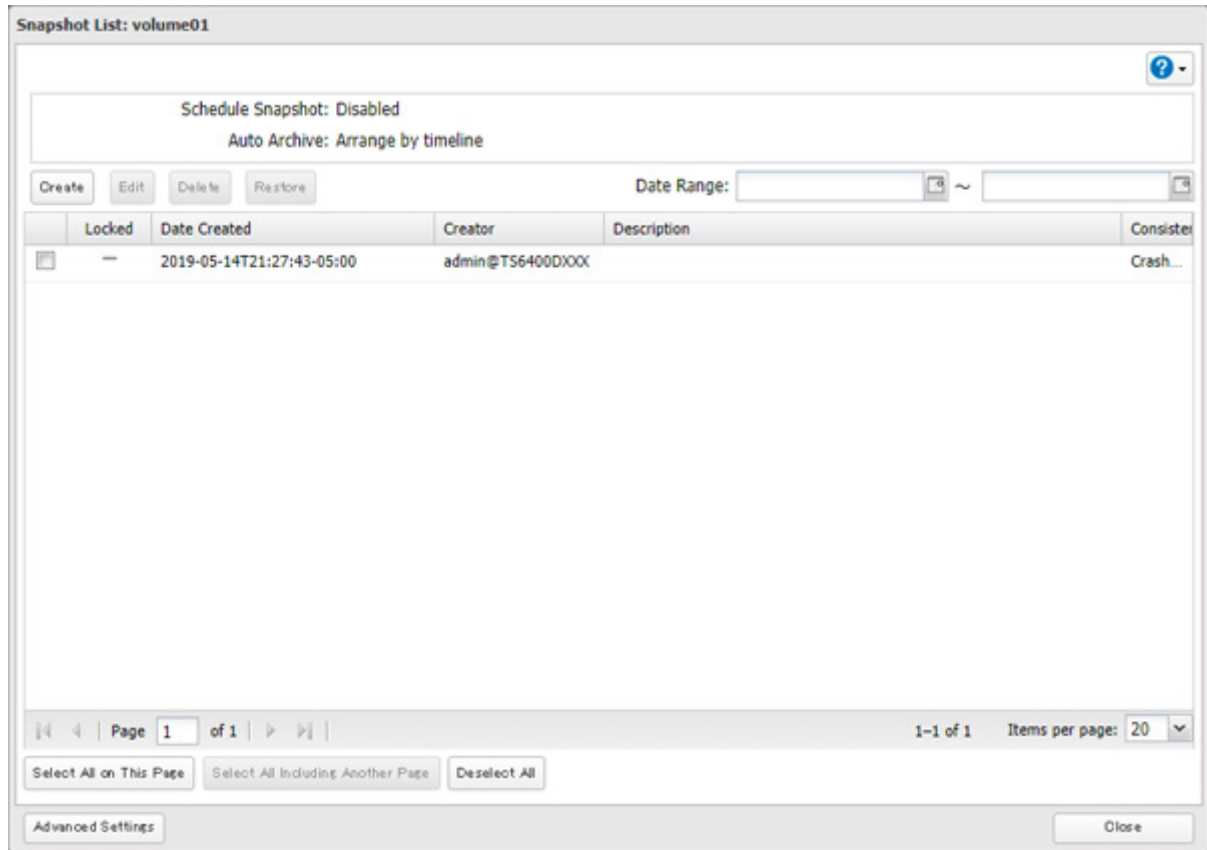

**5** Click the *Schedule* tab.

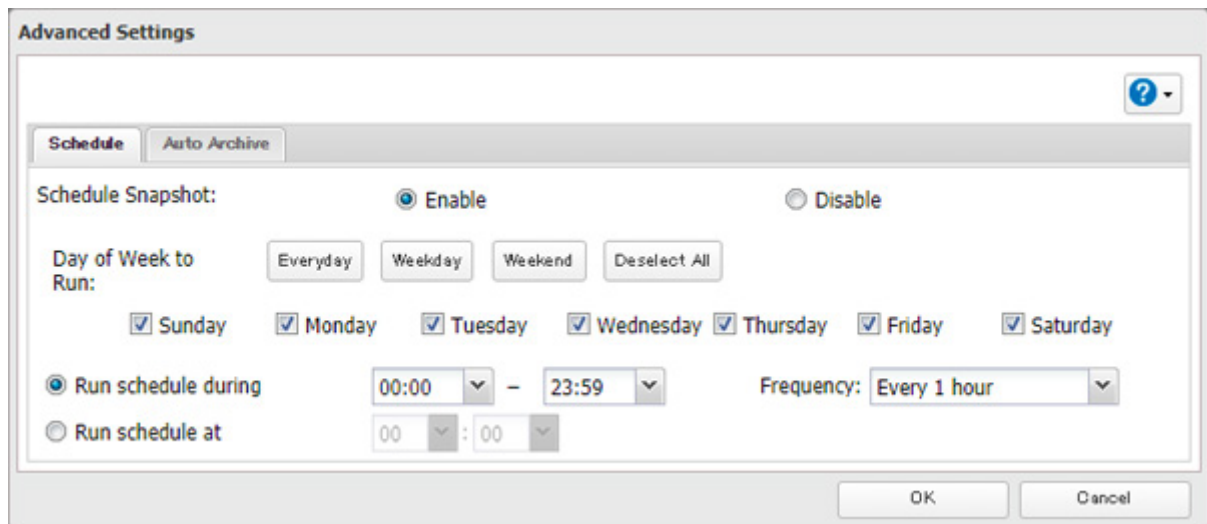

**6** Enable schedule snapshot.

**7** Select the day of the week and time when to automatically create a snapshot.

**8** Click *OK*.

## Configuring Snapshot Archive Settings

If you regularly create snapshots, it will use up capacity on the TeraStation. Snapshot archive settings will allow you to save capacity on created snapshots by automatically deleting older snapshots. You can set either a version-based or a timeline-based rule to delete snapshots.

**Note:** The locked snapshots will be kept even if archive settings are in effect.

### For Shared Folders

- 1 From Settings, click *File Sharing*.

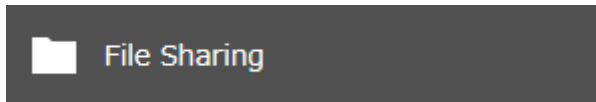

- 2 Click the settings icon (  ) to the right of "Folder Setup".



- 3 Click the number under "Snapshot" for the shared folder on the shared folder list.

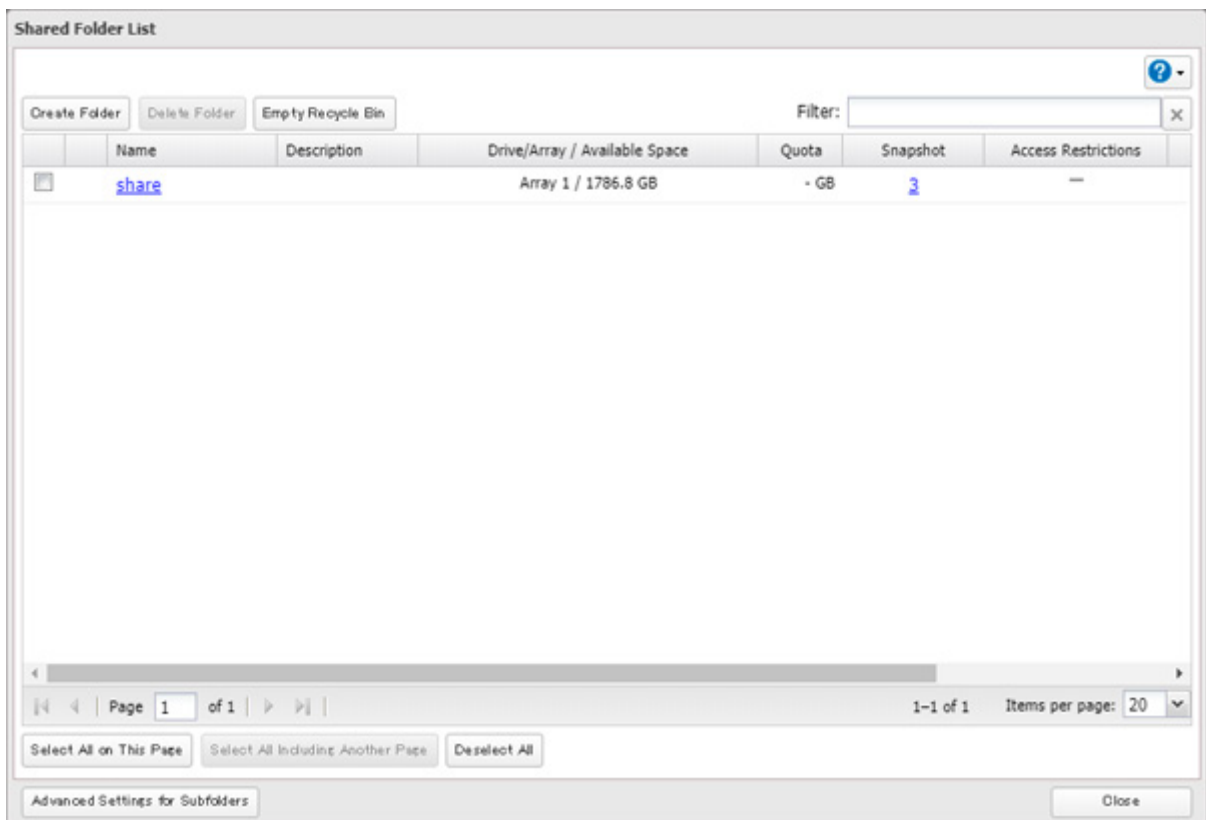

4 Click *Advanced Settings* at the lower-left corner of the window.

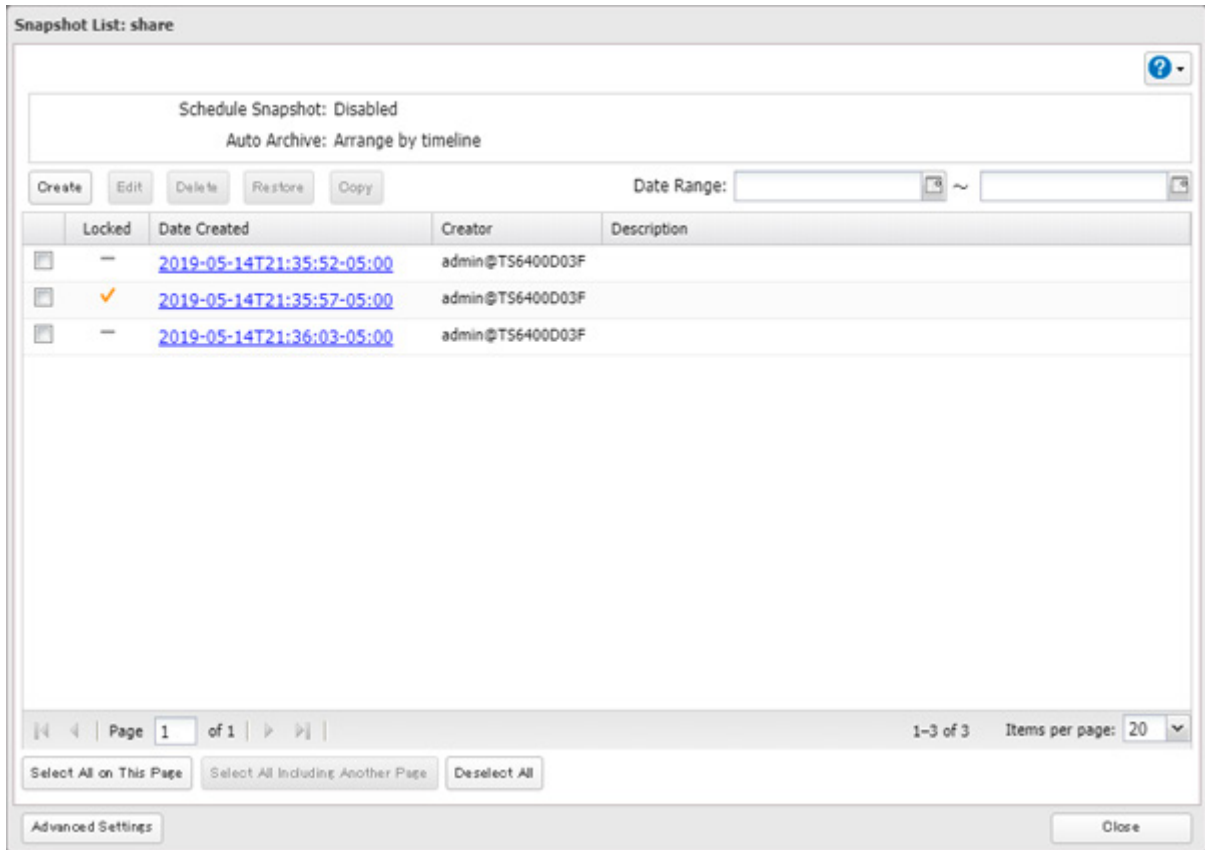

5 Click the *Auto Archive* tab.

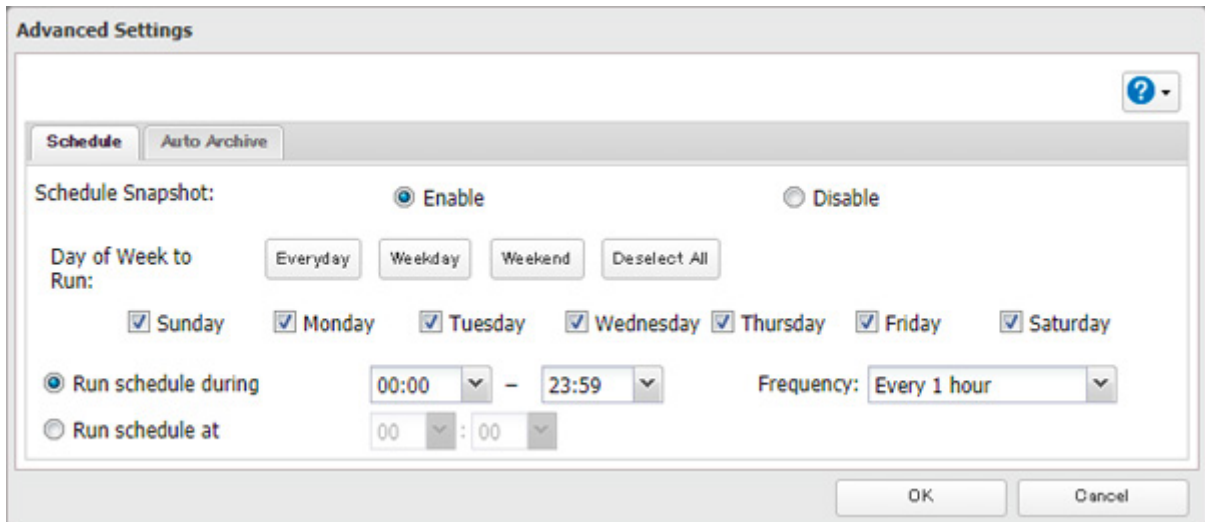

- 6** Select the rule to keep the snapshots. For more detailed information on archiving snapshots, refer to the [“Archive Rule for Snapshots”](#) section below.

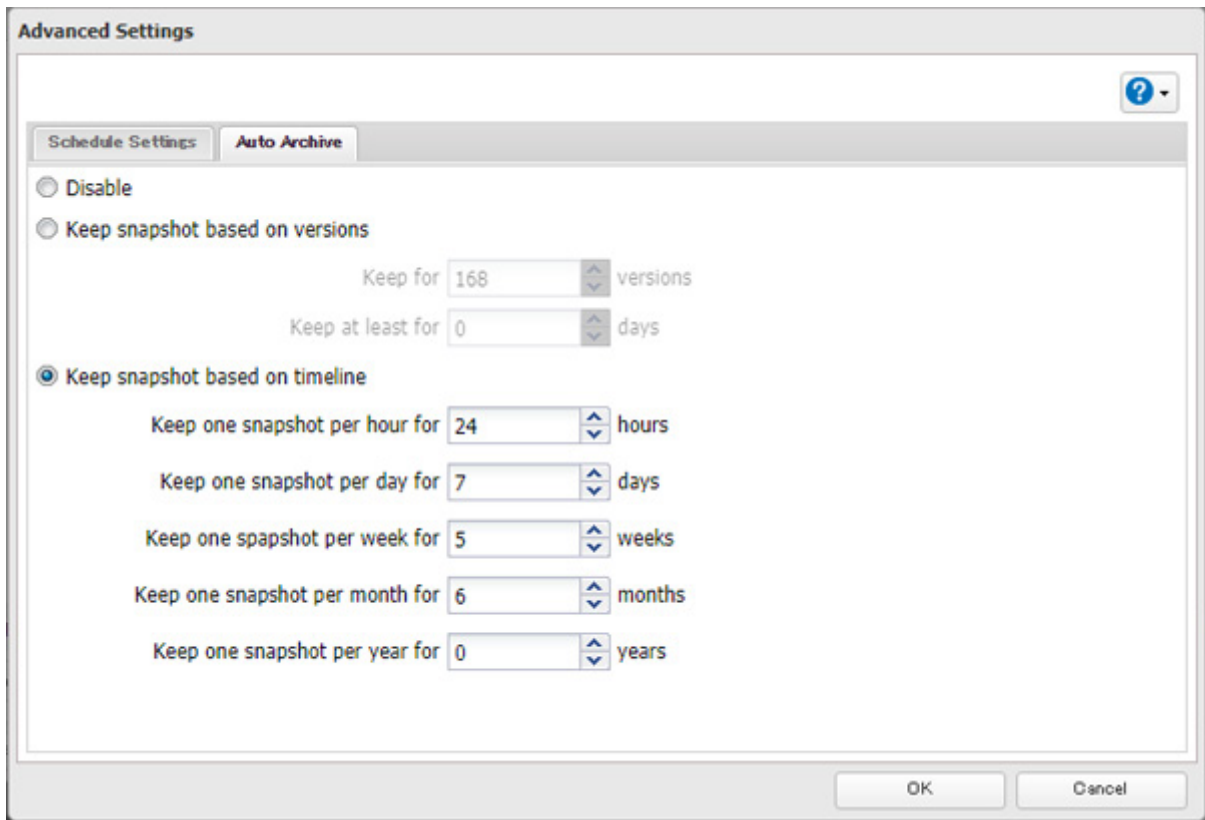

- 7** Click *OK*.

## For iSCSI Volumes

- 1** From Settings, click *Storage*.



- 2** Click the settings icon (⚙️) to the right of “iSCSI”.



**3** Select the checkbox for the target iSCSI volume and click *Show Snapshot List*.

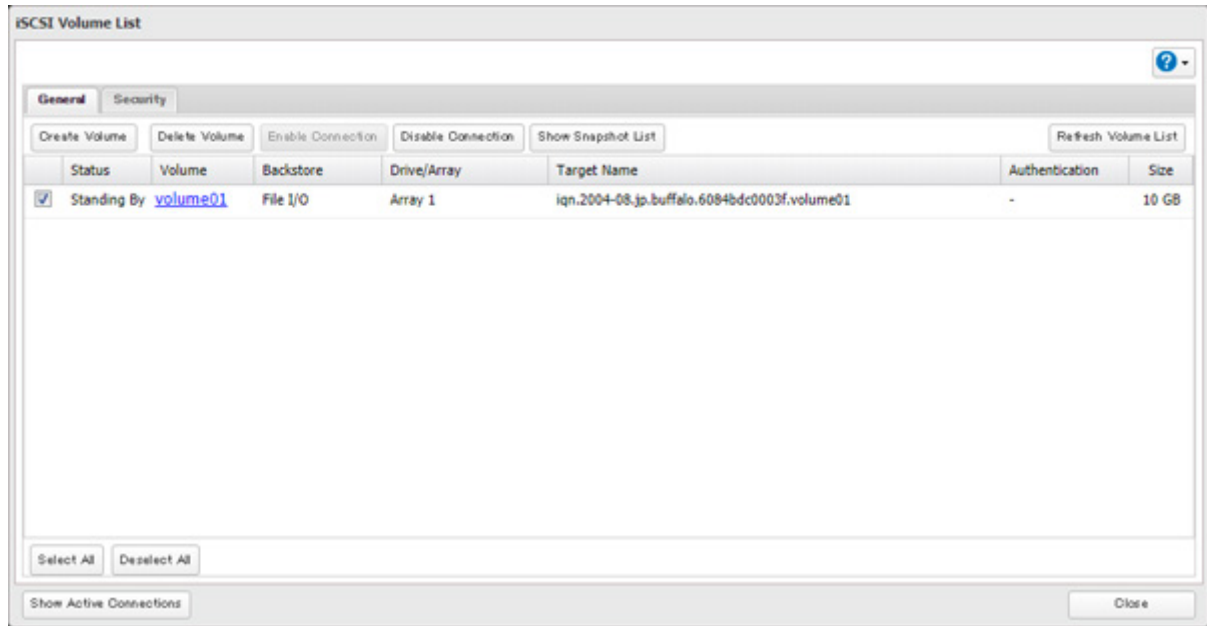

**4** Click *Advanced Settings* at the lower-left corner of the window.

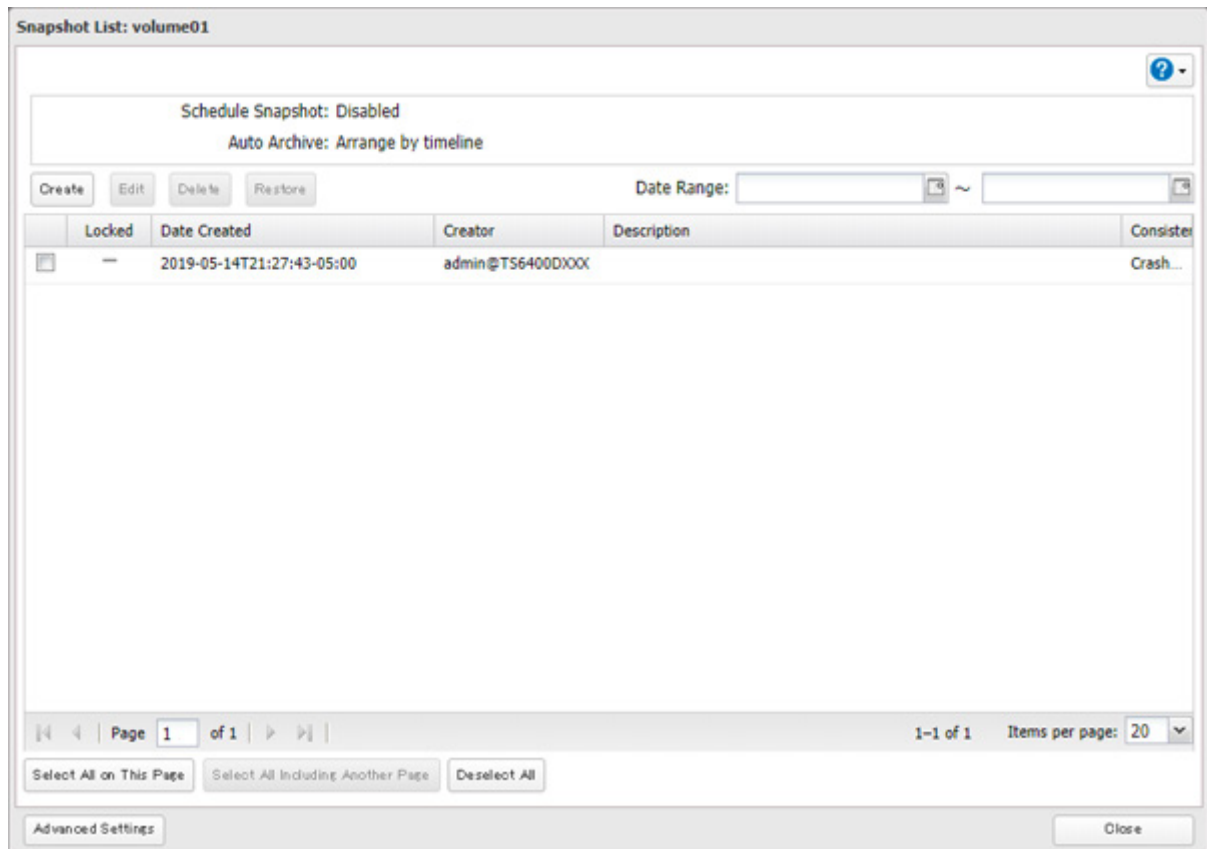

## 5 Click the *Auto Archive* tab.

**Advanced Settings**

**Schedule** | **Auto Archive**

Schedule Snapshot:  Enable  Disable

Day of Week to Run:

Sunday  Monday  Tuesday  Wednesday  Thursday  Friday  Saturday

Run schedule during 00:00 - 23:59 Frequency: Every 1 hour

Run schedule at 00 : 00

OK Cancel

## 6 Select the rule to keep the snapshots. For more detailed information on archiving snapshots, refer to the [“Archive Rule for Snapshots”](#) section below.

**Advanced Settings**

**Schedule Settings** | **Auto Archive**

Disable

Keep snapshot based on versions

Keep for 168 versions

Keep at least for 0 days

Keep snapshot based on timeline

Keep one snapshot per hour for 24 hours

Keep one snapshot per day for 7 days

Keep one snapshot per week for 5 weeks

Keep one snapshot per month for 6 months

Keep one snapshot per year for 0 years

OK Cancel

## 7 Click *OK*.

## Archive Rule for Snapshots

### Version-Based

If you enter specific versions, the snapshots created from the latest up to the entered versions will be kept. Snapshots that don't match the version will not be removed. There is an option to exclude from the target versions

until a set number of days has passed. If you set this option and the specified days haven't passed yet, the snapshots will be kept even if they match the target versions to be deleted.

**Timeline-Based**

This rule uses a timeline of when the snapshot was created to keep snapshots. Using this rule will keep any snapshots created at closest to 0 minutes on the hour and 12:00 a.m. (midnight) on the day.

The following example illustrates a scenario of when a snapshot is regularly created during 12:00 a.m. to 11:00 p.m. for every hour everyday and the default archive rule is used, for 24 hours, 7 days, 5 weeks, 6 months, and 0 years.

**Current time:** 31st, 11:59 p.m.

	Mon	Tue	Wed	Thu	Fri	Sat	Sun
1st	1  12:00 a.m.	2	3	4	5	6	7
2nd	8  12:00 a.m.	9	10	11	12	13	14
3rd	15  12:00 a.m.	16	17	18	19	20	21
4th	22  12:00 a.m.	23	24	25  12:00 a.m.	26  12:00 a.m.	27  12:00 a.m.	28  12:00 a.m.
5th	29  12:00 a.m.	30  12:00 a.m.	31  12:00 a.m.				

Snapshots created every hour between 12:00 a.m. to 11:00 p.m. today are kept by matching the hour-based rule. One snapshot per day is also kept for the last seven days by matching the day-based rule. One snapshot on every Monday is also kept for the last five weeks by matching the week-based rule. One snapshot on every first day of the month is also kept for six months by matching the month-based rule. If you change the year-based rule from the default settings, one snapshot on January 1st will also be kept for the specified years.



## Backing Up Data on the TeraStation

You can back up the TeraStation folders to another shared folder on the same TeraStation, a connected USB drive, or a shared folder on another Buffalo NAS device, either on the same network or on another network. For best results, using a 10GbE port to connect a backup device is recommended.

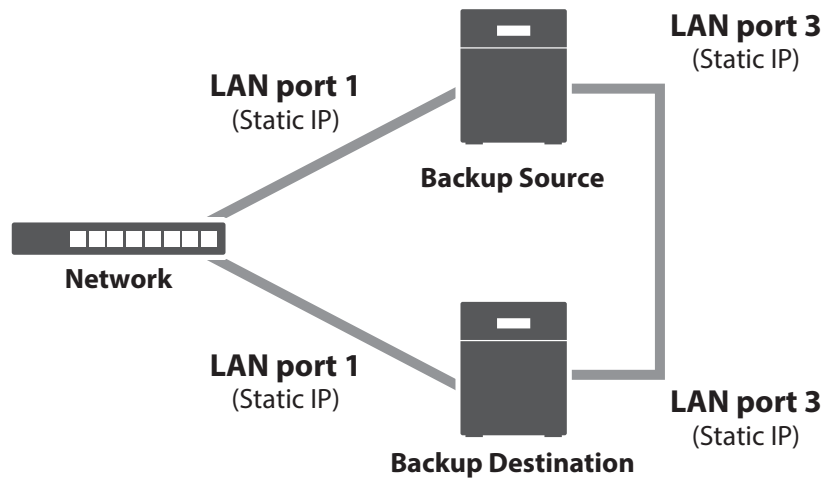

The following describes what can be configured as backup sources and backup destinations.

### Folders Available as Backup Sources

Folder Type	Full backup	Overwrite (incremental)	Overwrite (differential)	Management backup	Snapshot backup	iSCSI backup
Shared folder on this TeraStation	Yes	Yes	Yes	Yes	Yes	Yes <sup>*3</sup>
USB drive connected to this TeraStation <sup>*1</sup>	Yes	Yes	Yes	Yes	<b>No</b>	<b>No</b>
Shared folder on another Buffalo NAS device <sup>*2</sup>	Yes	Yes	Yes	Yes	Yes	Yes
Shared folder on rsync-compatible device	Yes	Yes	Yes	Yes	<b>No</b>	<b>No</b>

### Folders Available as Backup Destinations

Folder Type	Full backup	Overwrite (incremental)	Overwrite (differential)	Management backup	Snapshot backup	iSCSI backup
Shared folder on this TeraStation <sup>*2</sup>	Yes	Yes	Yes	Yes	Yes	Yes <sup>*3</sup>

Folder Type	Full backup	Overwrite (incremental)	Overwrite (differential)	Management backup	Snapshot backup	iSCSI backup
USB drive connected to this TeraStation <sup>*2,5</sup>	Yes	Yes	Yes	Yes <sup>*4</sup>	<b>No</b>	<b>No</b>
Shared folder on another Buffalo NAS device <sup>*2,5,6</sup>	Yes	Yes	Yes	<b>No</b>	Yes	Yes <sup>*7</sup>
Shared folder on rsync-compatible device	Yes	Yes	Yes	<b>No</b>	<b>No</b>	<b>No</b>

\*1 You can select up to the second level of folders. However, if the folder name of second level folders contains symbols, that folder may not appear as the backup source.

\*2 The folder should select the “Backup” checkbox for “LAN Protocol Support” on the shared folder settings.

\*3 This includes both shared folders and iSCSI file I/O volumes.

\*4 The compatible file systems are ext3, XFS, Btrfs, and NTFS.

\*5 If the “Inherit subfolders’ access restrictions” option is selected when creating a backup job, use Btrfs, XFS, or ext3 file systems.

\*6 If the “Inherit subfolders’ access restrictions” option is selected when creating a backup job, the device should be the Buffalo NAS device whose subfolders’ access restrictions is available.

\*7 The folders should be created on a Btrfs-formatted area.

## Preparing a Backup Destination

First, configure a shared folder on a Buffalo NAS device or connected USB device as a backup destination. The following procedure explains using another shared folder on a TeraStation as a backup destination. The procedure may vary depending on which Buffalo NAS device is selected as a destination.

**Note:** If you want to set this TeraStation as the backup destination for an rsync-compatible device, refer to the [“If Backing Up from rsync-Compatible Devices to the TeraStation”](#) section instead of following the procedure below.

- 1 From Settings, click *File Sharing*.

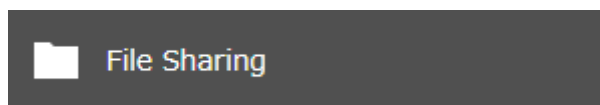

- 2 Click the settings icon (  ) to the right of “Folder Setup”.



- 3 Choose the folder to set as a backup destination.

- 4** Under “LAN Protocol Support”, select the “Backup” checkbox on the *Basic* tab.



- 5** Click *OK* and proceed to the next step to create a backup device access key.

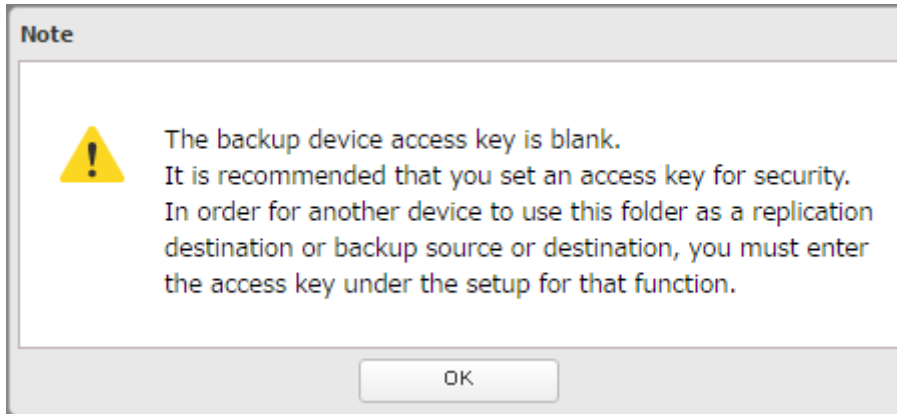

- 6** Enter the desired characters into the backup device access key field and click *OK*.

Backup Device Access Key:

**Note:** You may leave this field blank if you do not want a backup device access key, but for security reasons we highly recommend entering one for the shared folder. If a backup device access key is configured for the shared folder, that folder will not show up as a target for the backup source or destination when configuring a backup job on another Buffalo NAS device unless it’s entered. You may create multiple folders using different backup device access keys for backup and replication, but only one access key can be used on the TeraStation. Folders that are configured with a different access key cannot be used.

## Configuring a Backup Job

You can configure backup jobs by using another shared folder on the Buffalo NAS device or a USB drive connected to the TeraStation as a destination. You can also back up to a Buffalo NAS device on another network as long as the two networks are connected by a VPN or the route is configured properly.

- 1** From Settings, click *Backup*.



- 2** Click the settings icon (  ) to the right of “Backup”.



- 3** If you had configured a backup device access key for the backup source folder on another Buffalo NAS device or the backup destination folder, click *Set*. If you hadn't, skip to step 5.

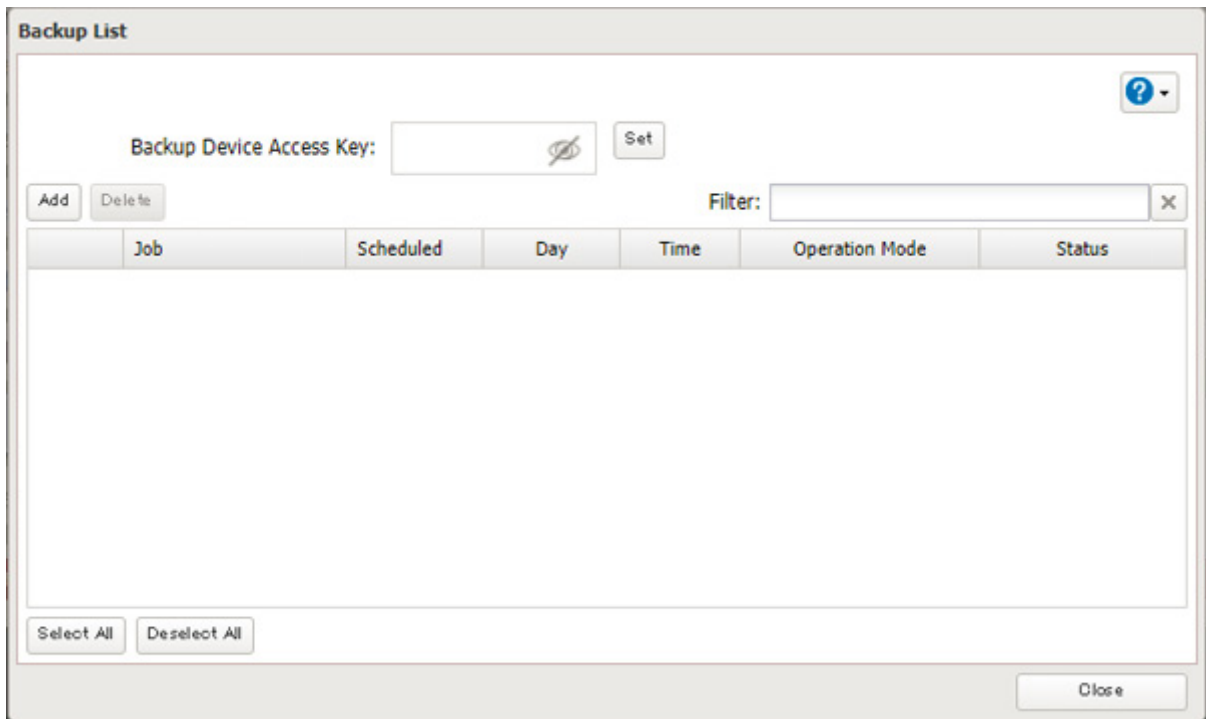

- 4** Enter the backup device access key and click *OK*.

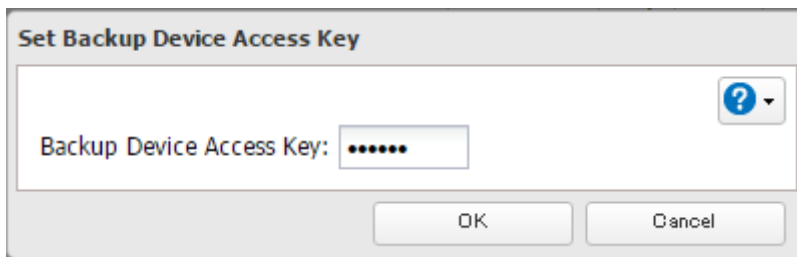

**5** Click *Add*.

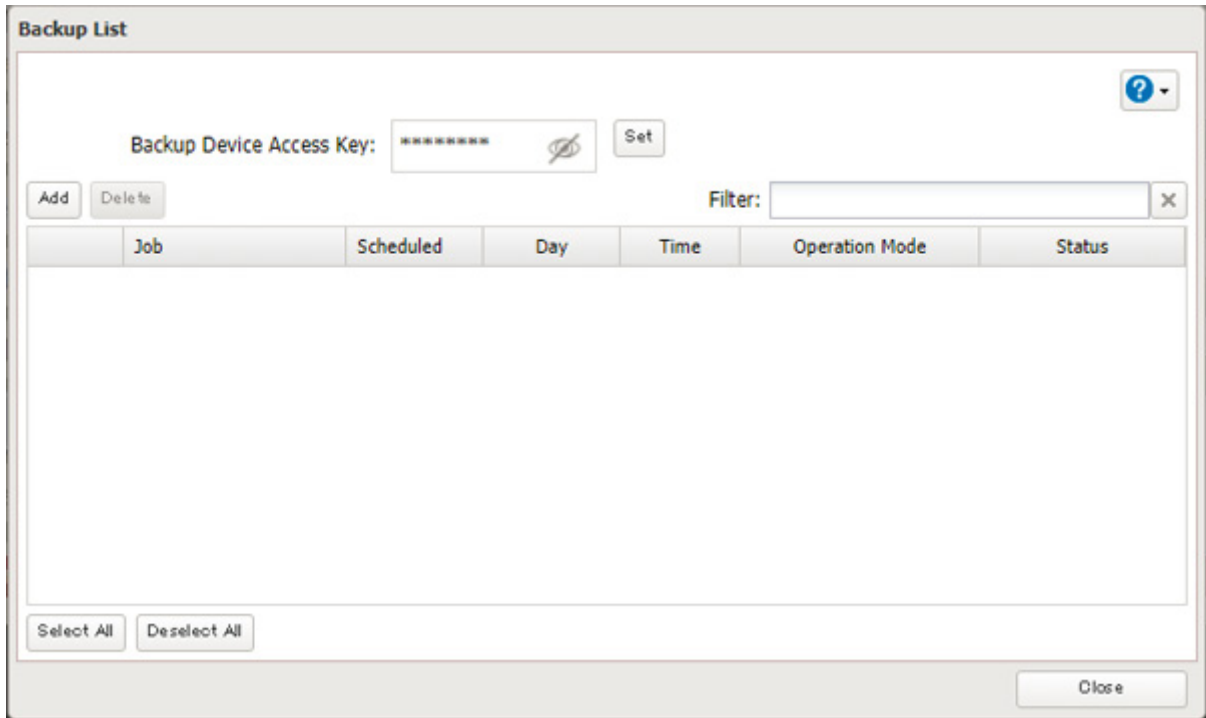

**6** Select backup settings such as date and time to run. Refer to the differences between the backup modes in the following [“Backup Modes”](#) section.

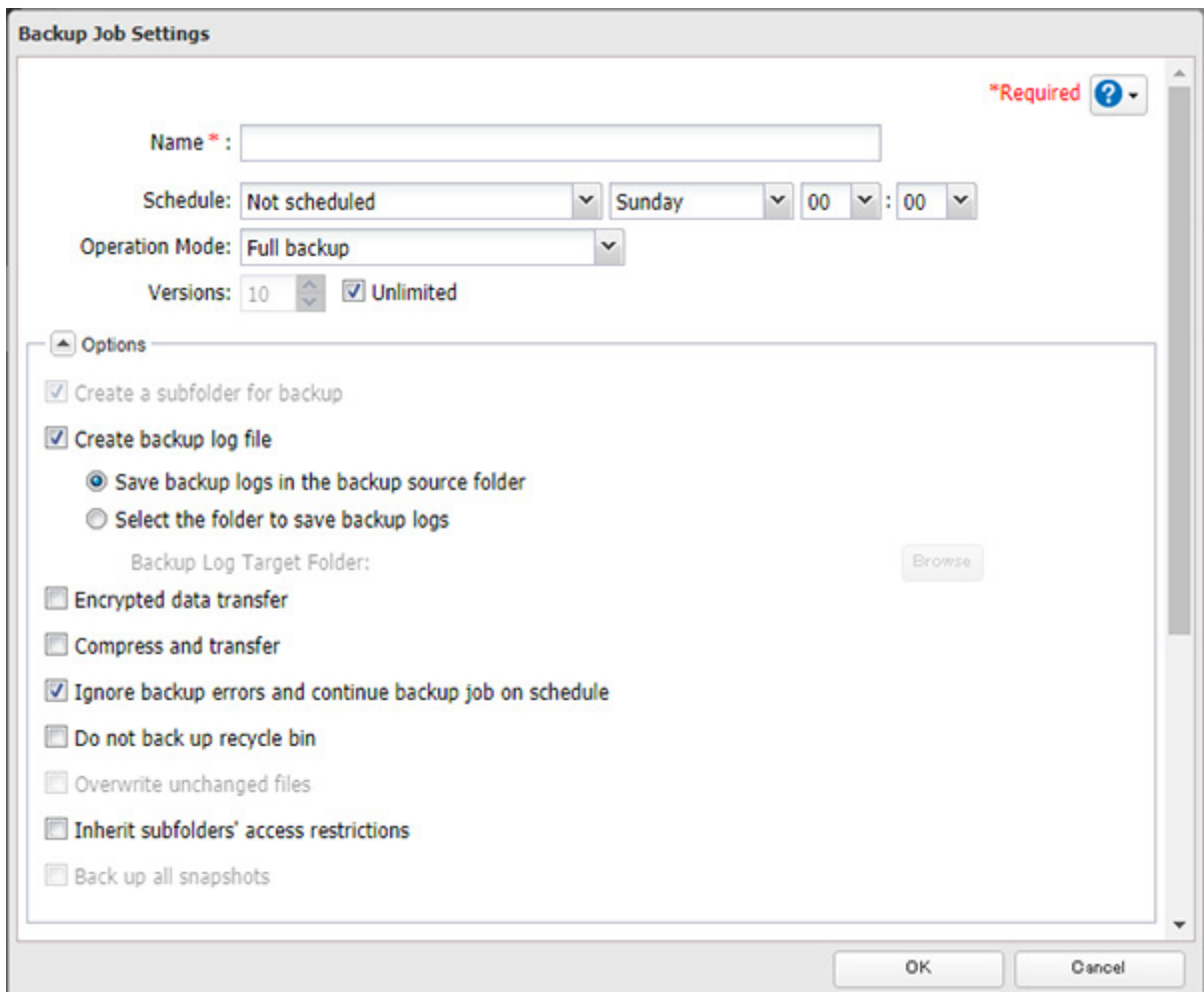

**7** Click *Add*.

**8** Select the shared folder that will be the backup source and destination.

**Notes:**

- You can specify the LAN port to use for backup such as “(LAN3)”. However, if you connect two or more LAN ports to the same network, the faster LAN port will take priority even if you specify the LAN port used. For example, if both ports LAN1 and LAN3 are connected to the same network and LAN3 is faster, then that port will be used even if you had configured LAN1 to be the port used.  
To use a slower LAN port for backup in this environment, configure the LAN port settings to a different network segment.
- If you want to back up to a Buffalo NAS device on another network, follow the procedure below to add the Buffalo NAS device on another network before selecting the backup folders.
  - a. Click *List of Servers*.
  - b. Click *Add*; select the “Add Buffalo NAS device” option, enter the IP address or hostname of the destination Buffalo NAS device, then click *OK*.
  - c. Click *Close* when completed.
  - d. Click *Refresh* and make sure the desired Buffalo NAS device has been added to the list.
- If you want to back up to an rsync-compatible device, follow the procedure below to add the rsync-compatible device before selecting the backup folders.
  - a. Click *List of Servers*.
  - b. Click *Add*; select the “Add rsync-compatible device” option, enter the IP address or hostname of the destination device, then click *OK*. If you want to encrypt the rsync access, enable rsync over SSH and enter the rsync account settings.
  - c. Click *Close* when completed.
  - d. Click *Refresh* and make sure the desired rsync-compatible device has been added to the list.

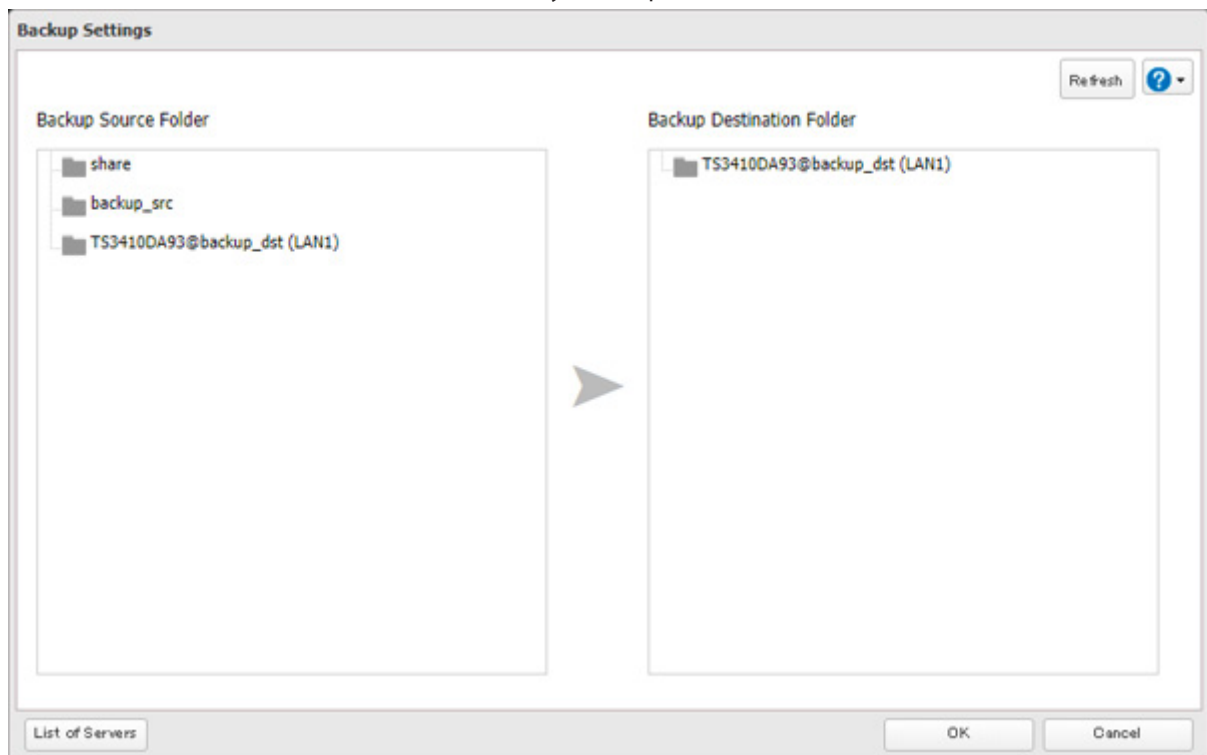

**9** Click *OK*, then click *OK* again. Jobs will be added to the backup list.

**Notes:**

- Up to eight backup jobs can be configured at a time, and 25 backup source and destination folder pairs can be used in one backup job.
- During setup, you may choose to encrypt and/or compress backup data. Encrypted data will be transferred securely on the network. Compressed data will ease network loading and is recommended for slow or heavily-loaded network connections. Enabling either will increase the CPU load on the source TeraStation so that the transfer speed will become slower, and backup time will be slower than if they are disabled. Encrypted or compressed data will be decrypted or decompressed on the destination TeraStation.
- To inherit the subfolders' access restriction settings to the backup destination, the backup destination should also support the subfolders' access restrictions. Check it before creating a backup job.
- To back up data between Buffalo NAS devices on a network using jumbo frames, make sure that both devices are configured to use identical (or similar) MTU sizes. If MTU sizes are significantly different, the backup job may not be properly performed. In such a case, select the default MTU size (1500 bytes) for both devices.
- You can also specify a hostname by a fully qualified domain name (FQDN).
- Windows-based TeraStations with multibyte characters in the hostname may not be detected as a backup destination, and folders in these devices cannot be used as backup destination folders.
- Backup data, such as ".DS\_Store" files, from macOS may include characters that cannot be read on FAT32-formatted drives in its filename. For best results, reformat the drive before using it as a backup destination.

## **If Backing Up from rsync-Compatible Devices to the TeraStation**

If you want to set an rsync-compatible device as the backup source and back up data on the rsync-compatible device to the TeraStation, you will need to enable rsync access on the TeraStation.

**1** From Settings, click *File Sharing*.

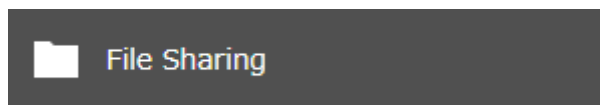

**2** Click the settings icon (⚙️) to the right of "rsync".



- 3** Enter this TeraStation's admin password into the "Password" field and click *OK*.

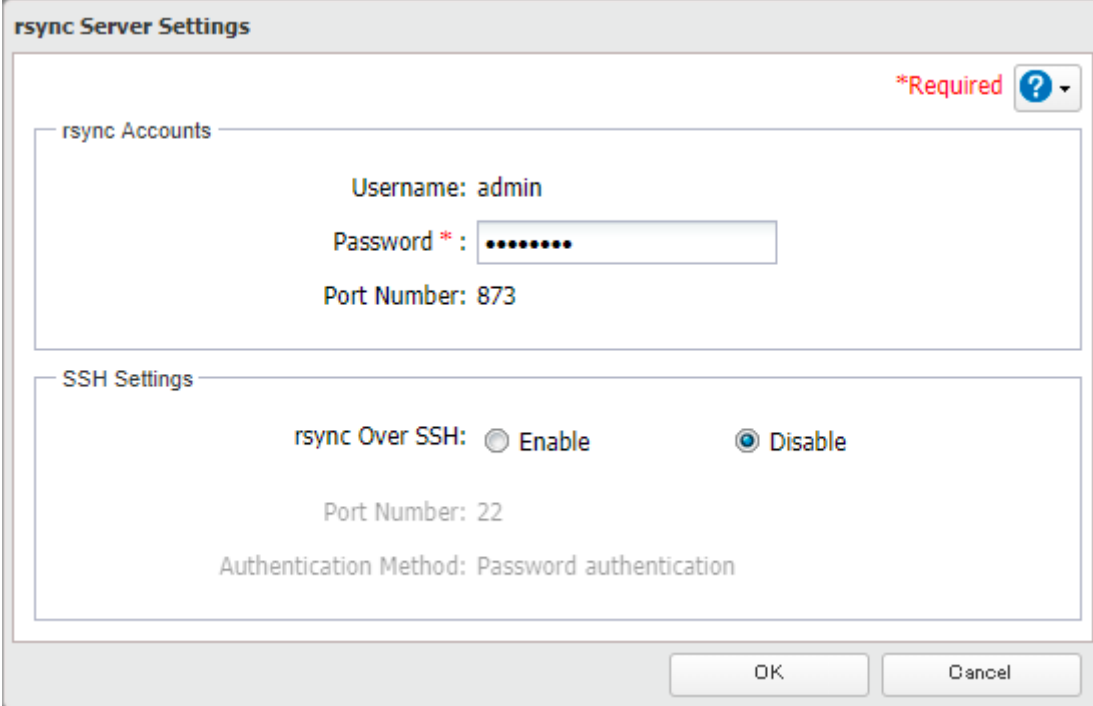

The image shows a dialog box titled "rsync Server Settings". It is divided into two sections: "rsync Accounts" and "SSH Settings".

**rsync Accounts:**

- Username: admin
- Password \*: [Redacted with 8 dots]
- Port Number: 873

**SSH Settings:**

- rsync Over SSH:  Enable  Disable
- Port Number: 22
- Authentication Method: Password authentication

At the bottom right, there are "OK" and "Cancel" buttons. A red asterisk and a question mark icon are visible in the top right corner of the dialog box.

**Note:** If you want to encrypt the rsync access, enable rsync over SSH.

- 4** Move the rsync switch to the  position to enable rsync.



## Backup Modes

The following types of backup jobs may be selected:

Type	Files included
Full backup	All files in the source will be backed up to the destination. You can specify how many backup versions to keep from 1–400, or select "Unlimited" to keep all backups until the drive is full. If a specific number of backup versions is specified, the backup destination folder should be on the same TeraStation that the backup job is configured from, or on an external USB drive attached to that TeraStation.
Overwrite (incremental)	The first backup job runs like a full backup. In subsequent backups, files added to the source as well as files deleted from the source are kept in the backup folder.
Overwrite (differential)	The first backup job runs like a full backup. As each additional backup job runs, files will be added to and deleted from the backup folder. The backup destination folder is always the same size as the backup source folder.



Type	Files included
Management backup	<p>Each time a backup is executed, management information is stored, and only files that have changed are copied or deleted. Data is retrieved from the previous backup file for files that were not changed. This is useful for making backups with limited space or for referencing status at a particular point in time (for data snapshot applications). The destination folder for a management backup should be a local folder on this TeraStation or on a USB drive attached to it. The destination folder will be set to read-only. Do not use folders from drives formatted with FAT.</p> <p>You can specify how many backup versions to keep from 1–400, or select “Unlimited” to keep all backups until the drive is full. The backup destination folder should be on the same TeraStation that the backup job is configured from, or on an external USB drive attached to that TeraStation.</p>
Snapshot backup	<p>Files and snapshots on the backup source will be backed up to the backup destination. Each backup job will create a snapshot before the job runs. The first backup job runs like a full backup. As each additional backup job runs, files will be added to and deleted from the backup folder.</p> <p>The number of snapshots kept after backing up to the backup destination will vary depending on the auto-archive settings. If snapshots are backed up on versions later than the versions set on the backup destination, they will be reduced to the latest-configured versions.</p> <p><b>Note:</b> If you want to see the history of snapshots on the backup destination folder, use shadow copy or click the “Restore” button in Settings. Refer to the <a href="#">“Using Snapshots”</a> section above.</p>
iSCSI backup	<p>Imaged iSCSI volume data will be backed up. Each backup job will create a snapshot before the job runs. These folder pairs can be configured. The backup source and backup destination will be paired together: shared folders on this TeraStation and iSCSI volumes, or shared folders on another Buffalo NAS device and iSCSI volumes on this TeraStation.</p> <p>The first backup job runs like a full backup. As each additional backup job runs, files will be added to and deleted from the backup folder.</p> <p>The number of snapshots kept after backing up to the backup destination will vary depending on the auto-archive settings. If snapshots are backed up on versions later than the versions set on the backup destination, they will be reduced to the latest-configured versions.</p>

## Backup Logs When Backup Fails

When backup fails, the I54 message appears on the LCD panel and the following backup error codes may be displayed in the “Status” field. Read the description and try the respective corrective actions for each error to resolve it.

Code	Description	Corrective Action	Log Example
Code 3	The backup destination USB drive could not be found.	Check that the backup destination USB drive is connected to the TeraStation properly.	rsync error: errors selecting input/output files, dirs (code 3) at main.c(634) [Receiver=3.1.0]
			Can't write to backup destination(target disk is broken?).

Code	Description	Corrective Action	Log Example
Code 5	The backup destination shared folder could not be found.	Check that the Ethernet cable is securely connected and that the hub or other devices on the network are turned on.	rsync error: error starting client-server protocol (code 5) at main.c(1504)
	Authentication failed.	Try adding the rsync-compatible NAS device from the server list again.	@ERROR: auth failed on module
	A registered user does not have permission to run.	Check the settings of the rsync-compatible NAS device.	@ERROR: permission denied
Code 10	The Ethernet cable was disconnected from the backup source TeraStation when the backup job started.	Reconnect the Ethernet cable.	rsync error: error in socket IO (code 10) at clientserver.c(128) [sender=3.1.0pre1]
	A backup destination doesn't support the subfolders' access restrictions.	Select another backup destination or remove the subfolders' access restrictions.	
Code 11	The drive capacity of the backup destination TeraStation became full.	Delete unnecessary files and folders.	rsync error: error in file IO (code 11) at receiver.c(389) [receiver=3.1.0]
	Files larger than 4 GB were backed up to the FAT32-formatted USB drive.	Reduce the file size to 4 GB or less, or change the file system to one other than FAT32. Refer to the <a href="#">"Adding an External Drive"</a> section in chapter 4 for compatible file systems.	rsync: write failed on "filename": File too large (27)
Code 12	Could not communicate between backup source and destination TeraStations.	Check that the Ethernet cable is securely connected and that the hub or other devices on the network are turned on.	rsync error: error in rsync protocol data stream (code 12) at io.c(515)
	The settings of the TeraStation were changed while the backup job was running.	Do not change the settings while the backup job is running. If changed, the connection is temporarily terminated and the backup job will fail.	
Code 14	Insufficient memory on the TeraStation was not enough so that the backup job did not run.	Reduce the number of backup destination files or disable any other functions running at the same time.	ERROR: out of memory in flist_expand
Code 22			rsync error: error in IPC code (code 14) at main.c(655) [receiver=2.6.8]
			rsync: fork failed in do_recv: Cannot allocate memory (12)
			rsync error: error allocating core memory buffers (code 22) at util.c(120) [sender=2.6.8]
Code 20	The connection was disconnected while the backup job was running.	Do not change the settings while the backup job is running. If changed, the connection is temporarily terminated and the backup job will fail.	rsync error: received SIGINT, SIGTERM, or SIGHUP (code 20) at rsync.c(242)

Code	Description	Corrective Action	Log Example
Code 23	Invalid characters were used in the filename or folder name of the backup destinations.	Change the filename or folder name using compatible characters. Available characters are described in the <a href="#">“Adding a Shared Folder”</a> section in chapter 3.	rsync error: some files could not be transferred (code 23) at main.c(702)
	The backup destination files were updated while the backup job was running.	Do not overwrite the backup destination files while the backup job is running. If updated, the backup destination files will not be backed up and the backup job will fail.	
	The TeraStation backed up the data to the FAT32-formatted USB drive, then the capitalization of letters in the filenames or folder names on the backup source TeraStation was changed.	Do not change the capitalization of letters in the filenames and folder names on the backup source TeraStation if the backup destination USB drive is formatted to FAT32. Linux on the TeraStation is case-sensitive but FAT isn't, so the same filename and folder name that only differs in the capitalization of letters will not be identified and treated as the same file or folder. To back up properly, using Btrfs, XFS, or ext3 is recommended.	
Code 24	The backup destination files were updated while the backup job was running.	Do not overwrite the backup destination files while the backup job is running. If updated, the backup destination files will not be backed up and the backup job will fail.	rsync warning: some files vanished before they could be transferred (code 24) at main.c
Code 30	The Ethernet cable was disconnected from the backup source or destination TeraStations while the backup job was running.	Reconnect the Ethernet cable.	rsync error: timeout in data send/receive (code 30) at io.c(195) [sender=3.1.0]
B14	Insufficient TeraStation memory.	Restart the TeraStation and try again.	-
B101	The backup destination TeraStation does not exist.	Check that the backup destination TeraStation is turned on, the Ethernet cables are securely connected, and the hostname of the backup destination TeraStation is not changed.	-
B102		Check that the backup destination folders on the backup destination TeraStation exist in the shared folder list and the backup destination folders are configured for backup in Settings.	-
B103	The backup source folders on the backup source TeraStation do not exist.	Check that the backup source folders on the backup source TeraStation exist in the shared folder list.	-

Code	Description	Corrective Action	Log Example
B104	The backup destination folders on the backup destination TeraStation do not exist.	Check that the backup destination folders on the backup destination TeraStation exist in the shared folder list.	-
B105	The drives were not recognized.	Check that the drives are recognized properly in Settings. If you configure the "usbdisk" folders for the backup source or destinations, confirm if these folders exist in the shared folder list.	-
B106	The file systems of the USB drive are not supported.	Check that the USB drive is formatted to the compatible file systems. If you configure the management backup in the backup job, FAT format cannot be used for the backup destination.	-
B107	The device files such as "/dev/null" etc. does not exist.	Restart the TeraStation and try again.	-
B108	Credentials to access a shared folder on the rsync-compatible NAS device were not found.	Try adding the rsync-compatible NAS device from the server list again.	-

## Replication

Replication copies all data from a share to a share on a different TeraStation. This is an easy way to configure a reliable system to provide data protection in the event your main TeraStation fails. To configure replication, connect an Ethernet cable to the LAN port of each TeraStation and follow the procedure below. For best results, use static IP addresses and a 10GbE port for connecting both replication TeraStations (source and destination).

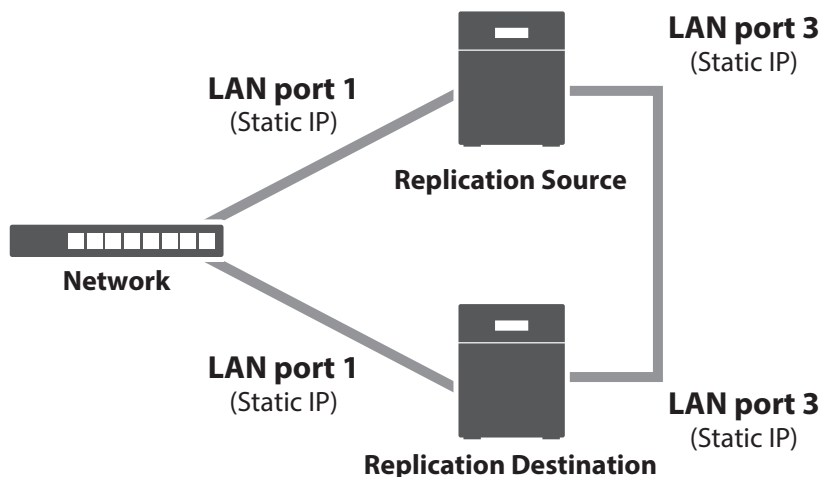

**Note:** Replication source data is copied to the replication destination folder with a differential overwrite. Any data that is not in the replication source will be overwritten.

The following describes what can be configured as replication sources and replication destinations.

### Folders Available as Replication Sources

- Shared folders on this TeraStation

## Folders Available as Replication Destinations\*

- Shared folders on this TeraStation
- Shared folders on another Buffalo NAS device\*\*,\*\*\*

\*The folder should select the “Backup” checkbox for “LAN Protocol Support” on the shared folder settings.

\*\*If the “Inherit subfolders’ access restrictions” option is selected when creating a backup job, use Btrfs, XFS, or ext3 file systems.

\*\*\*If the “Inherit subfolders’ access restrictions” option is selected when creating a backup job, the device should be the Buffalo NAS device whose subfolders’ access restrictions is available.

## Preparing a Replication Destination

First, configure a folder as a replication destination. Follow the procedure below to prepare a replication destination.

- 1 From Settings, click *File Sharing*.

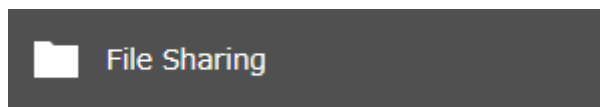

- 2 Click the settings icon (⚙️) to the right of “Folder Setup”.



- 3 Choose the folder to set as a replication destination.

- 4 Under “LAN Protocol Support”, select the “Backup” checkbox on the *Basic* tab.



- 5 Click *OK* and proceed to the next step to create a backup device access key.

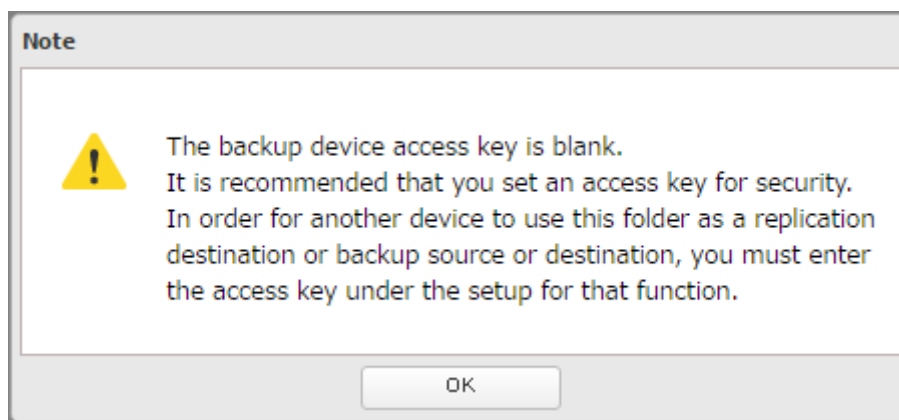

- 6 Enter the desired characters into the backup device access key field and click *OK*.



**Note:** You may leave this field blank if you do not want a backup device access key, but for security reasons we highly recommend entering one for the shared folder. If a backup device access key is configured for the shared folder, that folder will not show up as the replication destination when configuring a replication job on another Buffalo NAS device unless it's entered. You may create multiple folders using different backup device access keys for backup and replication, but only one access key can be used on the TeraStation. Folders that are configured with a different access key cannot be used.

## Configuring a Replication Job

- 1 From Settings, click *Backup*.



- 2 Click the settings icon (  ) to the right of "Replication".



- 3 Click *Edit*.

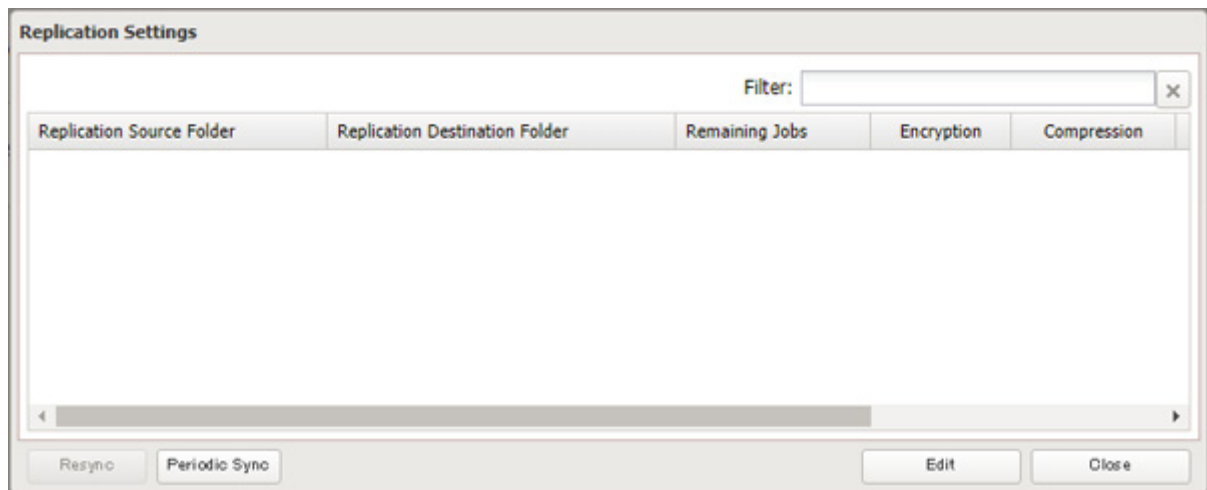

- 4** If you had configured a backup device access key for the replication destination folder, click *Set*. If you hadn't, skip to step 6.

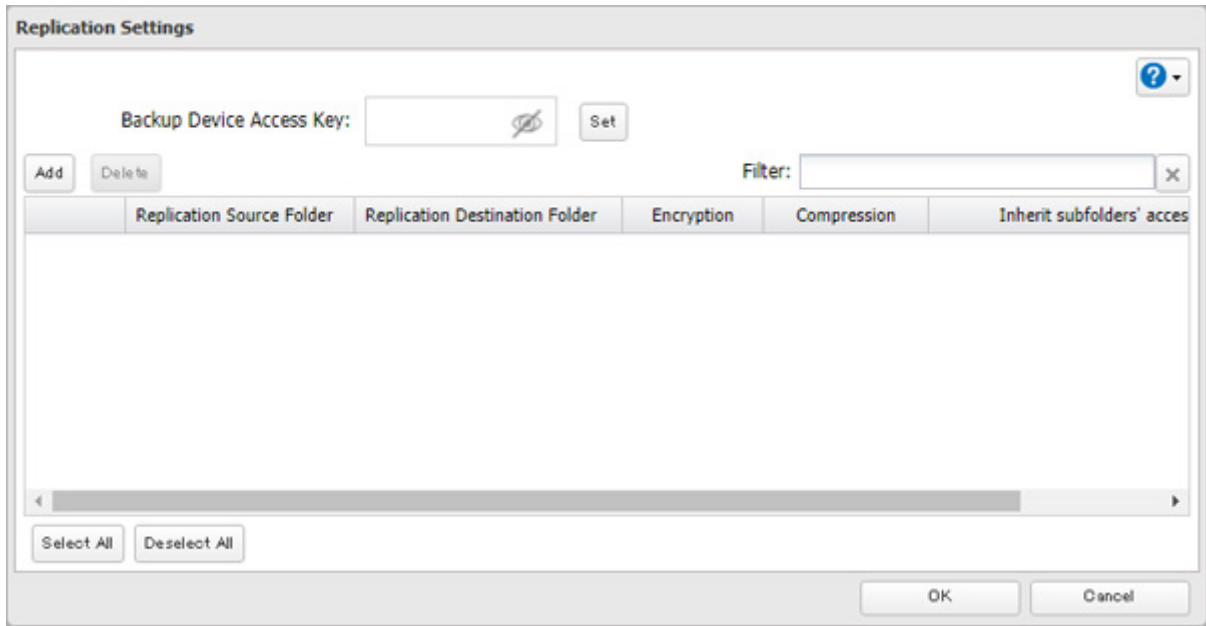

- 5** Enter the backup device access key and click *OK*.

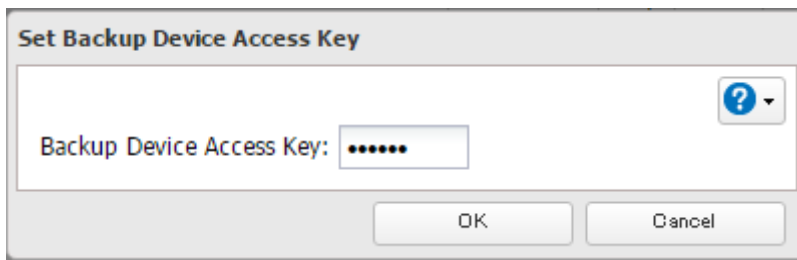

- 6** Click *Add*.

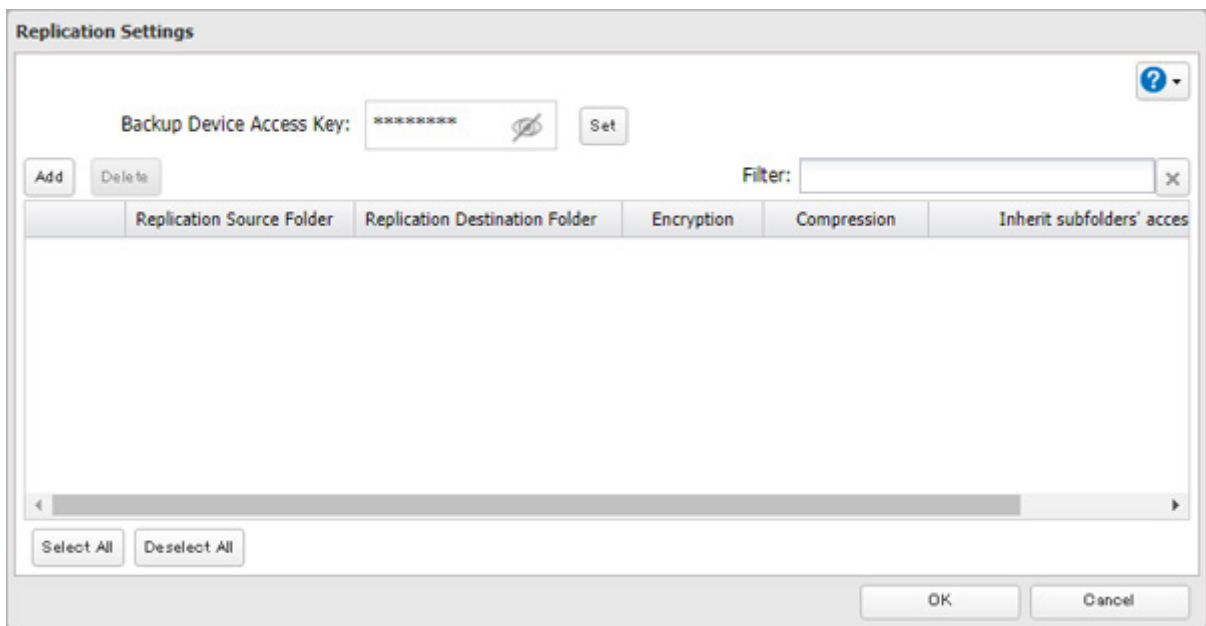

- 7** Select the shared folder that will be the replication source and destination, then click *OK*.

**Notes:**

- You can specify the LAN port to use for replication such as “(LAN3)”. However, if you connect two or more LAN ports to the same network, the faster LAN port will take priority even if you specify the LAN port used. For example, if both ports LAN1 and LAN3 are connected to the same network and LAN3 is faster, then that port will be used even if you had configured LAN1 to be the port used. To use a slower LAN port for replication in this environment, configure the LAN port settings to a different network segment.
- If you want to back up to a Buffalo NAS device on another network, follow the procedure below to add the Buffalo NAS device on another network before selecting the backup folders.
  - a. Click *List of Servers*.
  - b. Click *Add*; select the “Add Buffalo NAS device” option, enter the IP address or hostname of the destination Buffalo NAS device, then click *OK*.
  - c. Click *Close* when completed.
  - d. Click *Refresh* and make sure the desired Buffalo NAS device has been added to the list.

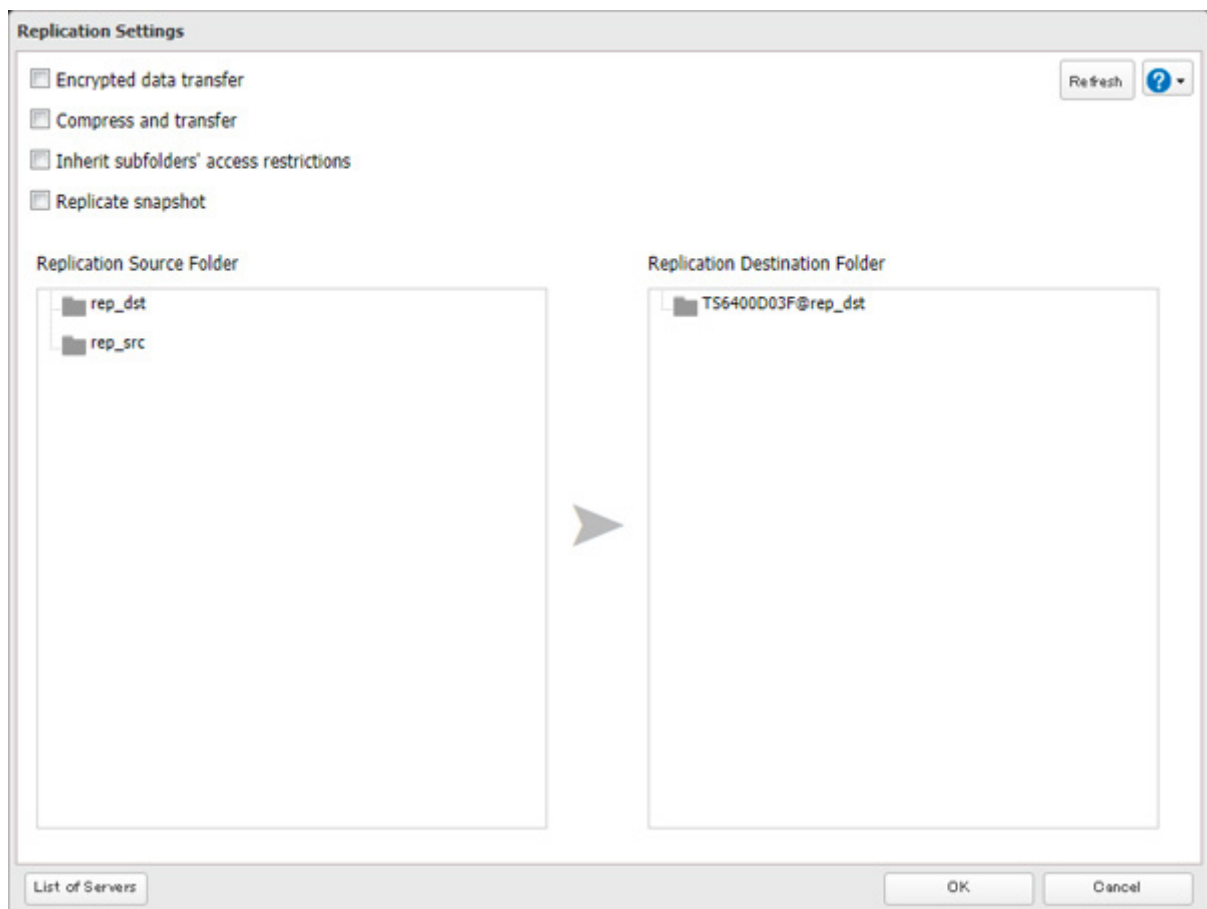

**8** Click *OK*, then *Yes*.

**Notes:**

- During setup, you may choose to encrypt and/or compress replication data. Encrypted data will be transferred securely on the network. Compressed data will ease network loading and is recommended for slow or heavily loaded network connections. Enabling either will increase the CPU load on the source TeraStation so that the transfer speed will become slower, and replication time will be slower than if they are disabled. Encrypted or compressed data will be decrypted or decompressed on the destination TeraStation.
- A maximum of 64 shared folders can be configured for replication.
- Don't use the same TeraStation for both failover and replication, or replication and Time Machine.
- Don't configure replication from one source folder to multiple destination folders.



- If a network problem causes a replication error, unsynced data may be shown as “0” even though replication is incomplete. Click *Resync* to recover from the replication error. All files from the source folder will be copied to the destination folder.

## Synchronizing Between Source and Destination TeraStations Periodically

To copy files that are saved via other file sharing protocols such as AFP or FTP to the replication destination regularly, configure “Periodic Sync” in Settings. Follow the procedure below.

- 1 From Settings, click *Backup*.



- 2 Click the settings icon (⚙️) to the right of “Replication”.



- 3 Click *Periodic Sync*.

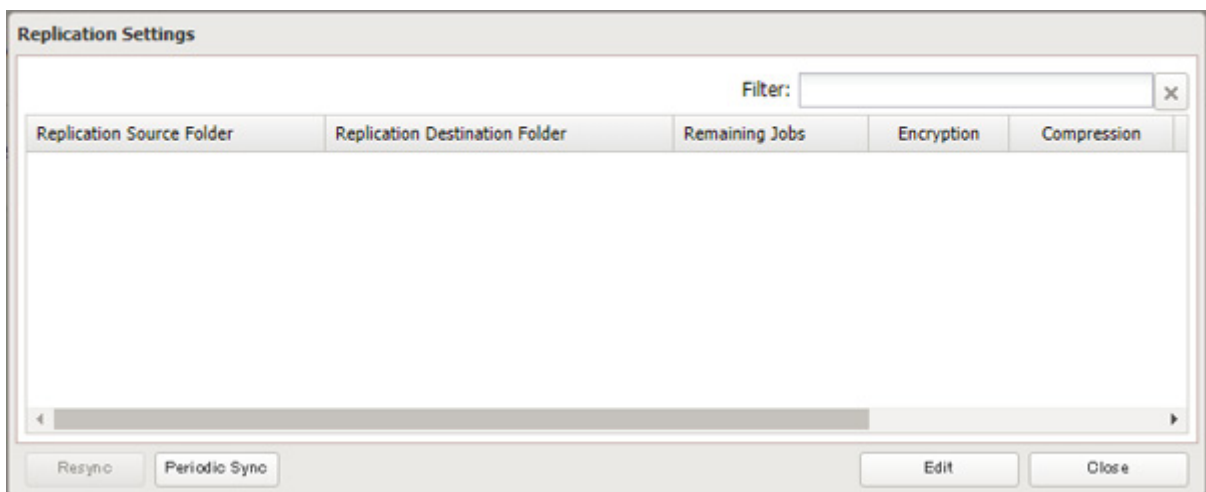

- 4 Select “Daily” or “Weekly” from the “Schedule” drop-down list. If “Daily” is selected, configure the sync period. If “Weekly” is selected, specify the weekdays and the sync period.

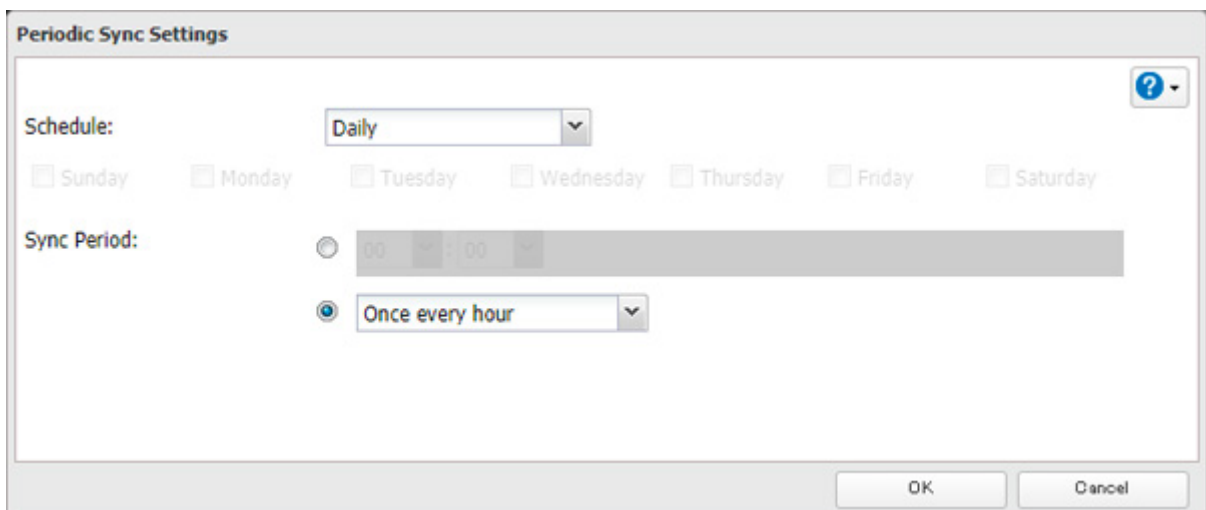

**5** When the configuration is completed, click *OK*.

## Failover

With failover, two TeraStations are connected to the network for redundancy. If an issue renders the main TeraStation inaccessible, operation automatically switches to the backup TeraStation.

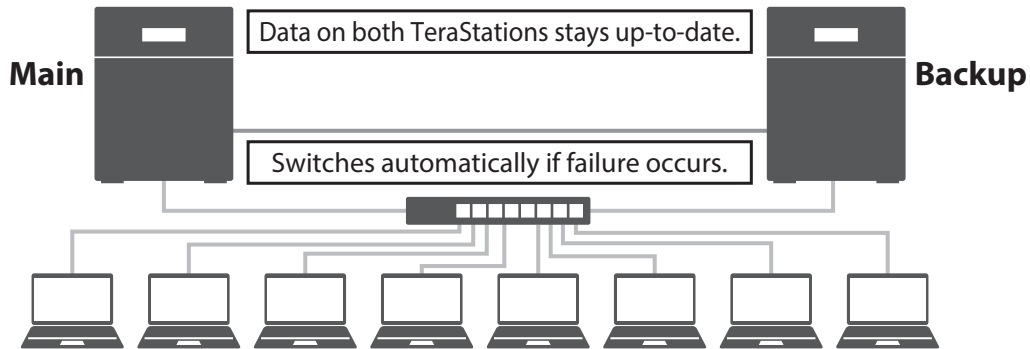

Failover will activate during any of the following situations:

- **The backup TeraStation cannot detect the main TeraStation within a specified time**  
If the backup TeraStation has not received a packet from the main TeraStation within a specified time, the backup TeraStation considers the main TeraStation to have failed. By default, it will try five times and wait 60 seconds. If this is triggered by accident, reconfigure failover from the main TeraStation.
- **Errors**  
Failover will occur if any of the following errors occur:  
E12 (cooling failure), E14 (cannot mount RAID array), E16\* (drive not found), E22\* (cannot mount drive), E30\* (drive failure)  
\*This triggers when the drive is configured in JBOD.

### Notes:

- Only use identical model and capacity TeraStations for failover. If the capacity of the main TeraStation is larger than that of the backup TeraStation, an I33 replication error will occur.
- All drive bays of a TeraStation should be occupied if it will be used for failover. Failover will not work if a drive is missing from any bay.

## Before Configuring Failover

If you want to use both failover and Active Directory, configure Active Directory on the main TeraStation before configuring failover.

Also, use the same LAN ports for transferring data and configure both TeraStations with static IP addresses for the purposes of failover. It is recommended to use a 10GbE port for failover.

## Using the Same LAN Port for Both File Sharing and Failover

Using this setup, if the main TeraStation fails, the backup TeraStation will replace it completely. The backup TeraStation will be updated over normal network traffic.

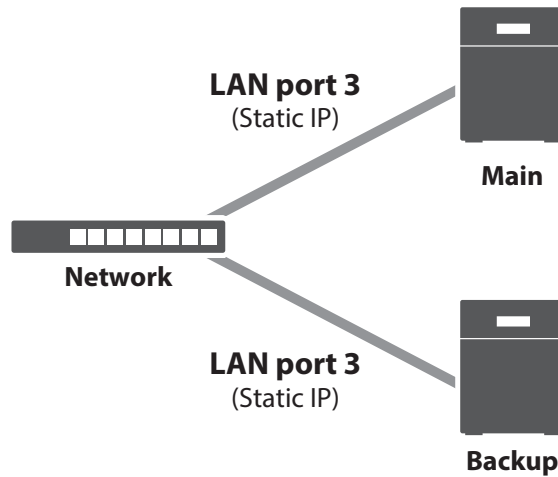

## Using Different LAN Ports Between File Sharing and Failover

With this setup, the backup TeraStation and main TeraStation are connected by a second Ethernet cable connecting their LAN port 3. Updating is done over this dedicated network path, so updates are quicker and don't interfere with normal network traffic.

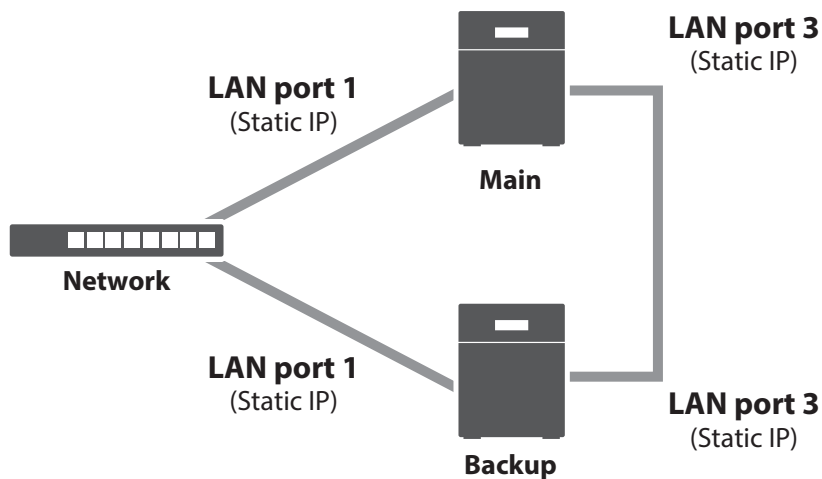

## Usage Restrictions

---

### Functional Restrictions

Failover is not available when any of the following functions are enabled:

Replication, sleep mode, encrypted drive volume, LVM volume, iSCSI volume, port trunking, Dropbox Sync, Microsoft Azure Storage Sync, Microsoft OneDrive Sync, hot spare, access restrictions by Active Directory domain

### Setting Restrictions

The following functions will not be available while failover is enabled:

Initializing settings, changing the RAID settings, formatting drives, iSCSI volume, changing the backup TeraStation's settings, turning the TeraStation on and off, updating the firmware

While failover is enabled, shutdown, power-on, and firmware update operations can be made available by temporarily changing the TeraStation to maintenance mode. Maintenance mode can be enabled or disabled at

*Backup > Failover* in the main TeraStation's Settings. Click *Maintenance mode* to enable maintenance mode, or click *Cancel maintenance mode* to disable maintenance mode.

To update the firmware while in maintenance mode, the main TeraStation can be updated from Settings, but the backup TeraStation cannot. Download the firmware updater from the [Buffalo website](#) for the backup TeraStation and try updating the firmware on it.

## Non-Transferable Settings

The settings below are not copied from the main TeraStation to the backup TeraStation. Make a note of the original settings so that they can be configured manually if a failover error occurs.

IP address, hostname, WebAccess, UPS synchronization, the backup job settings either if specifying shared folders on the backup TeraStation or USB drives as the backup destination, and USB drives' shared folder settings

## Using with UPS

Once failover is configured, you cannot set up a UPS for the backup TeraStation. Configure your UPS before configuring failover. UPS recovery can be configured for both the main and backup TeraStations.

## Configuring Failover

- 1 From Settings for the main TeraStation, click *Backup*.



- 2 Click the settings icon (  ) to the right of "Failover".



- 3 Click *Configure Failover*.

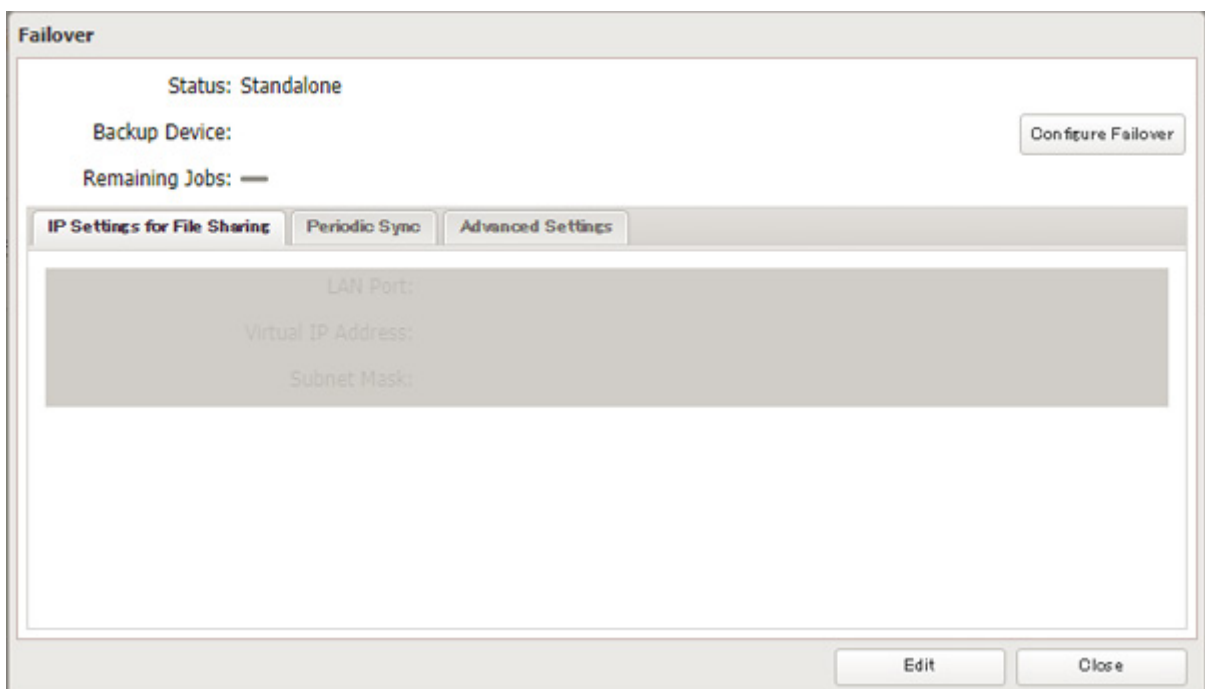

- 4** Select a TeraStation to be the backup destination device and enter its administrator username and password (by default, the username is “admin” and the password is “password”).

**Failover Settings**

\*Required ?

**Backup Device Settings:**

Backup Device: TS6400D015

Administrator Username \*: admin

Administrator Password \*: .....

**IP Settings for File Sharing:**

LAN Port: (LAN1) 10.16.4.15

Virtual IP Address \*: 10.16.4.250

Subnet Mask \*: 255.255.255.0

**Backup LAN Port:** (LAN1) 10.16.4.15

**Snapshot:**

Copy

Do not copy

**Access Restrictions for Subfolders:**

Inherit

Do not inherit

Use TeraStations of the same model and storage capacity for the main and backup units. Set the MTU size to 1500 bytes for both units.

Continue Close

- 5** Select the LAN port to be used for sharing files and enter a virtual IP address and subnet mask. The LAN port you have selected here will also be used for pinging. If you select the same LAN port as the backup LAN port, the backup TeraStation will replace the main TeraStation even if just a network error occurs.

**About virtual IP addresses:** A virtual IP address is an IP address that will be used for file sharing while failover is configured. By assigning a different IP address from the one to be assigned to the LAN port, you can access the TeraStation for sharing files, as well as open Settings using the virtual IP address. This IP address will be inherited to the backup TeraStation when failover occurs, so you can access the backup TeraStation even if you don't know the backup TeraStation's static IP address.

Configure an unused IP address for the virtual IP; make sure it uses the same segment as the main and backup TeraStations.

- 6** Select the LAN port to be used for transferring data via failover.
- 7** Configure whether or not to inherit the settings of subfolders' access restrictions to the backup TeraStation, then click *Continue*.
- 8** If the administrator username and password is correct, the backup TeraStation will beep. Press and hold the function button to accept the settings from the main TeraStation. When you press the function button, the backup TeraStation will stop beeping.

- 9 Press the function button. When you press the function button, the TeraStation will beep once. Press and hold the button until the backup TeraStation beeps again.
- 10 The I51 message will appear on the LCD panel and NAS Navigator2 for both TeraStations. Wait until initialization finishes. Failover is configured after it finishes and the I51 message disappears.

**Notes:**

- If you want to cancel the failover settings while both the main and backup TeraStations are working properly, click *Force Failover to Stop* on both TeraStations and restart them. After the TeraStations are restarted, make sure that all settings such as IP address and files on the shared folders are correct. When you cancel failover settings, attributes of the shared folders on the backup TeraStation will become read-only. Change the attribute settings to the desired options if necessary.
- If replication is configured for more than one folder, initialize the TeraStation before configuring failover.
- The main TeraStation cannot be used as the backup location for Time Machine.
- Do not use the same TeraStation for both failover and replication, or failover and Time Machine.
- If email notification is enabled and failover occurs, navigate to *Management > Email Notification > Edit* in the main TeraStation's Settings and click *OK*.
- MTU size settings for main and backup TeraStations should be 1500 bytes. To change the MTU size, navigate to *Network > IP Address > Edit*, and change the MTU size to "1500" bytes.
- Files whose filenames contain more than 80 alphanumeric characters will not be backed up.
- If the I33 message appears on the LCD panel, navigate to *Backup > Replication* and click *Resync*.
- The RAID array on the backup TeraStation may be reconfigured and resynchronized as part of the failover configuration process. This is expected behavior and not an error.

## Replacing to the Backup TeraStation Manually

---

If "Switch to backup unit manually" is selected on the *Advanced Settings* tab in the main TeraStation's Settings, the backup TeraStation will not replace the main TeraStation if the main TeraStation fails. To have the backup TeraStation replace the main TeraStation, you can either:

- Log in to Settings for the backup TeraStation and click *Set as Main Unit*.
- Or, press and hold the function button on the backup TeraStation.

**Note:** If the main TeraStation fails but all LAN ports' link on the backup TeraStation is up, the backup TeraStation cannot replace to the main TeraStation from Settings. In such a case, use the function button instead.

## Reconfiguring After Failover Occurs

---

When the backup TeraStation replaces the main TeraStation, the I49 message may appear on the backup TeraStation's LCD panel and NAS Navigator2. To configure failover again, follow the procedure below using the new TeraStation unit. The following procedure is an example using the replaced backup TeraStation ("main TeraStation") and the new TeraStation ("backup TeraStation").

If you don't want to configure failover with the new TeraStation, cancel the failover settings by following the steps 1–5 below and restart both TeraStations. The I49 message will disappear.

**Note:** The following procedure will also work if failover occurs unexpectedly.

- 1 After failover occurs, log in to Settings for the main TeraStation.
  - If you have configured to synchronize with the UPS device connected to the failed TeraStation, the E10 message will be displayed on the main TeraStation. In such a case, follow the procedure below to change the UPS settings on the main TeraStation. If you hadn't, skip to the next step.
    - a. Disconnect the UPS cable from the failed TeraStation and connect it to the main TeraStation.
    - b. Click *Management*.

- c. Click the settings icon (  ) to the right of “Power Management”.
- d. Click *Edit*.
- e. Select “Sync with UPS connected to this TeraStation” and reconfigure the desired UPS settings.
- f. Click *OK* when completed.

**2** Click *Backup*.



**3** Click the settings icon (  ) to the right of “Failover”.

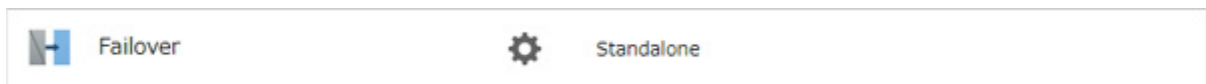

**4** Click *Configure Failover*.

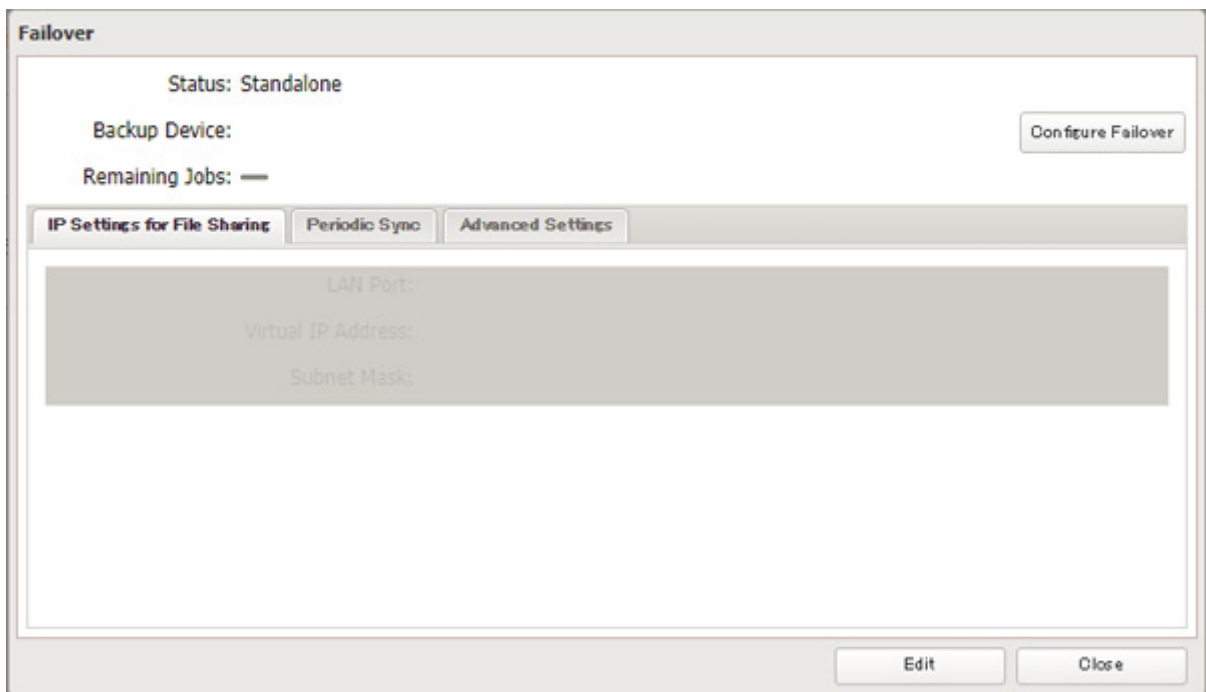

**5** Click *Force Failover to Stop* to cancel the failover settings.

**6** Shut down this main TeraStation.

**7** Turn the backup TeraStation on.

**8** Log in to Settings for the backup TeraStation, then rename the TeraStation’s hostname and configure the IP address so that it has a new static IP address.

**9** Power on the main TeraStation. To configure the UPS sync on the backup TeraStation, configure the settings here. Otherwise, skip to the next step.

To synchronize with the UPS device connected to the main TeraStation, follow the procedure below on the backup TeraStation.

- a. Click *Management*.
- b. Click the settings icon (  ) to the right of “Power Management”.

- c. Click *Edit*.
- d. Select “Sync with UPS connected to another Buffalo NAS device on the same network” and configure the main TeraStation as a sync source.
- e. Click *OK* when completed.

**10** Reconfigure failover by referring to the [“Configuring Failover”](#) section above.

## **Synchronizing Between Main and Backup TeraStations Periodically**

To copy files that are saved via other file sharing protocols such as AFP or FTP to the backup TeraStation regularly, configure “Periodic Sync” in Settings. Follow the procedure below.

**1** From Settings for the main TeraStation, click *Backup*.



**2** Click the settings icon (  ) to the right of “Failover”.



**3** Click the *Periodic Sync* tab.

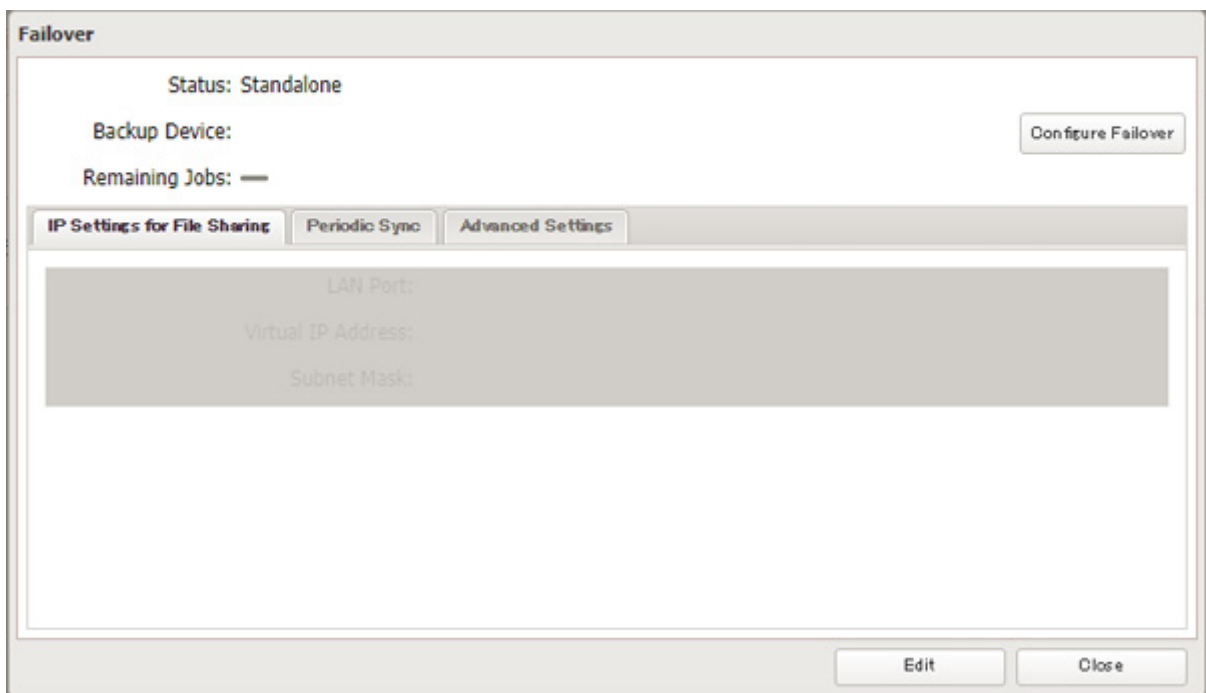

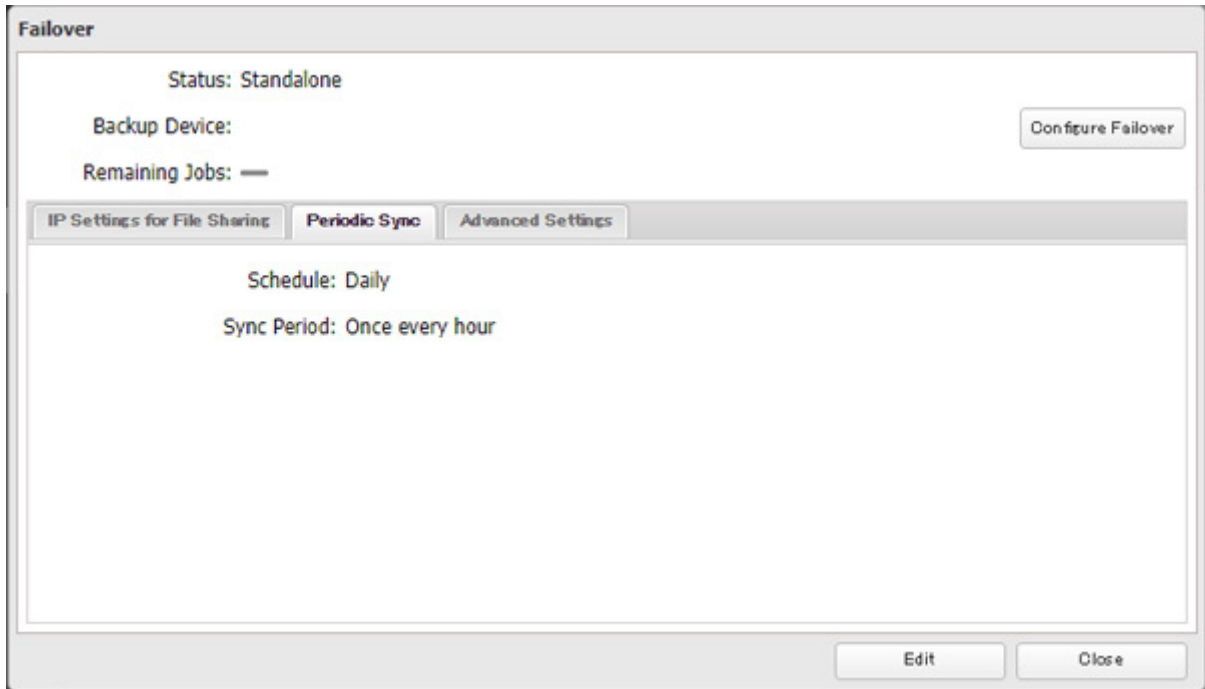
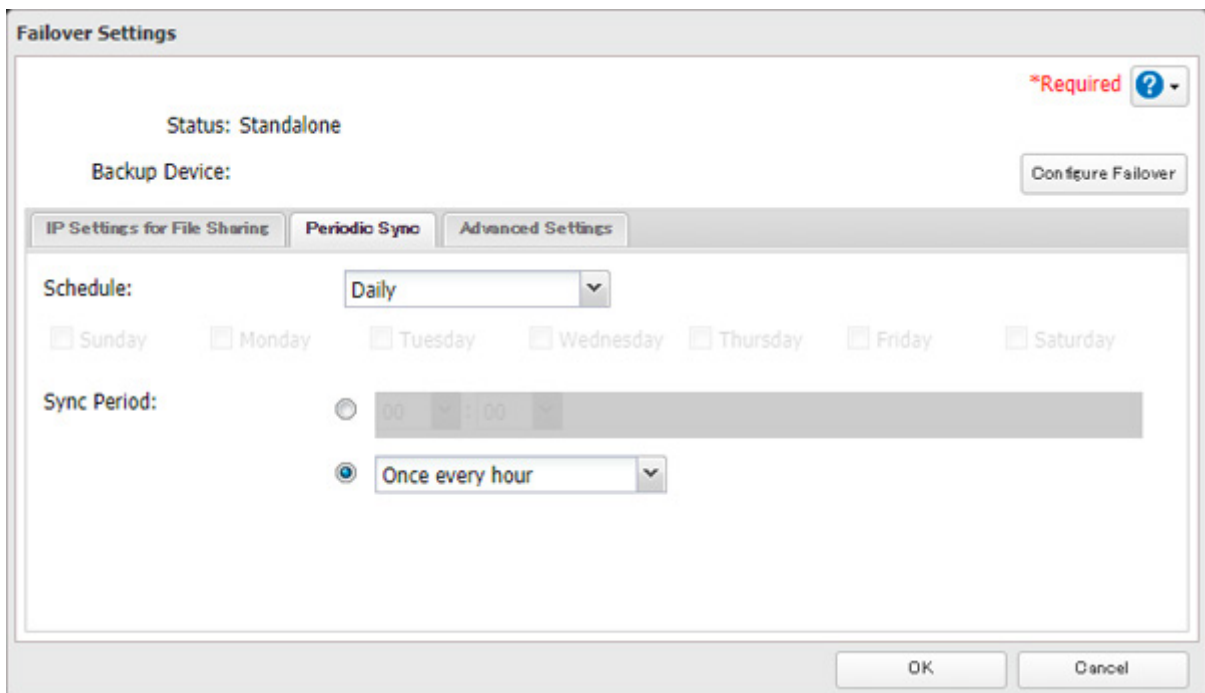

**4** Click *Edit*.**5** Select “Daily” or “Weekly” from the “Schedule” drop-down list. If “Daily” is selected, configure the sync period. If “Weekly” is selected, specify the weekdays and the sync period.**6** When the configuration is completed, click *OK*.

---

## Backing Up Your Mac with Time Machine

---

Time Machine is a backup program included with macOS. Configure your TeraStation as shown below to use Time Machine.

## 1. Preparing a Shared Folder for Time Machine

- 1 From Settings, click *File Sharing*.

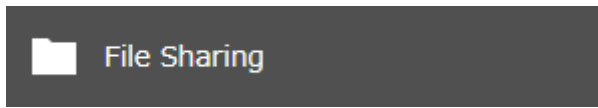

- 2 Move the AFP switch to the  position to enable AFP.



- 3 Click the settings icon (  ) to the right of "Folder Setup".



- 4 Choose a shared folder as your backup destination for Time Machine.

- 5 Under "LAN Protocol Support", select the "AFP (Mac)" checkbox on the *Basic* tab and click *OK*.

- 6 Click *Close*.

## 2. Configuring a Shared Folder as a Backup Destination

- 1 From Settings, click *Backup*.



- 2 Click the settings icon (  ) to the right of "Time Machine".

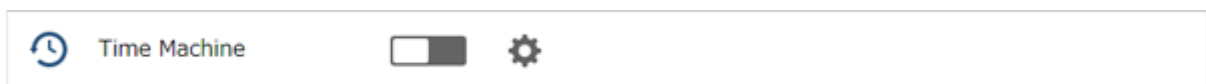

- 3 Click *Edit*.

- 4 Click *Browse*.

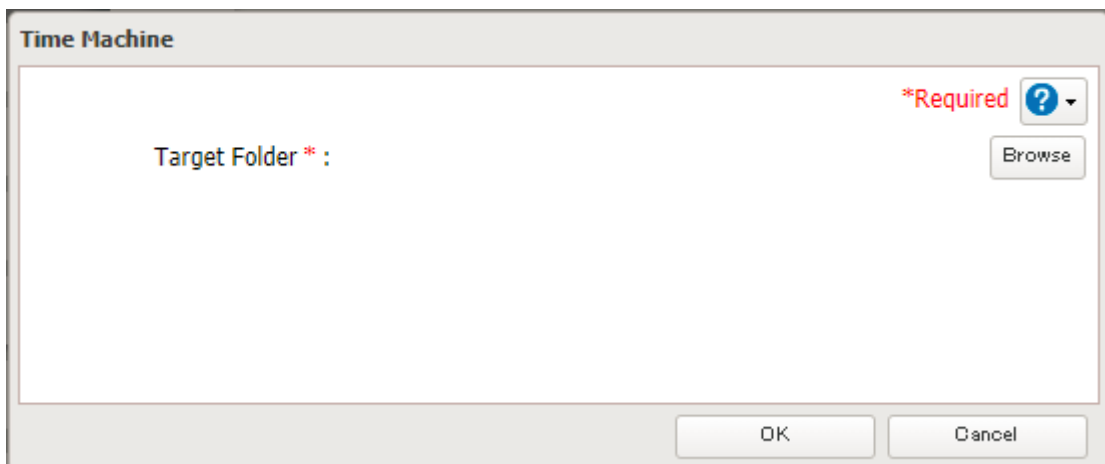

- 5 Select the shared folder that you enabled AFP for in the previous steps, then click *OK*.

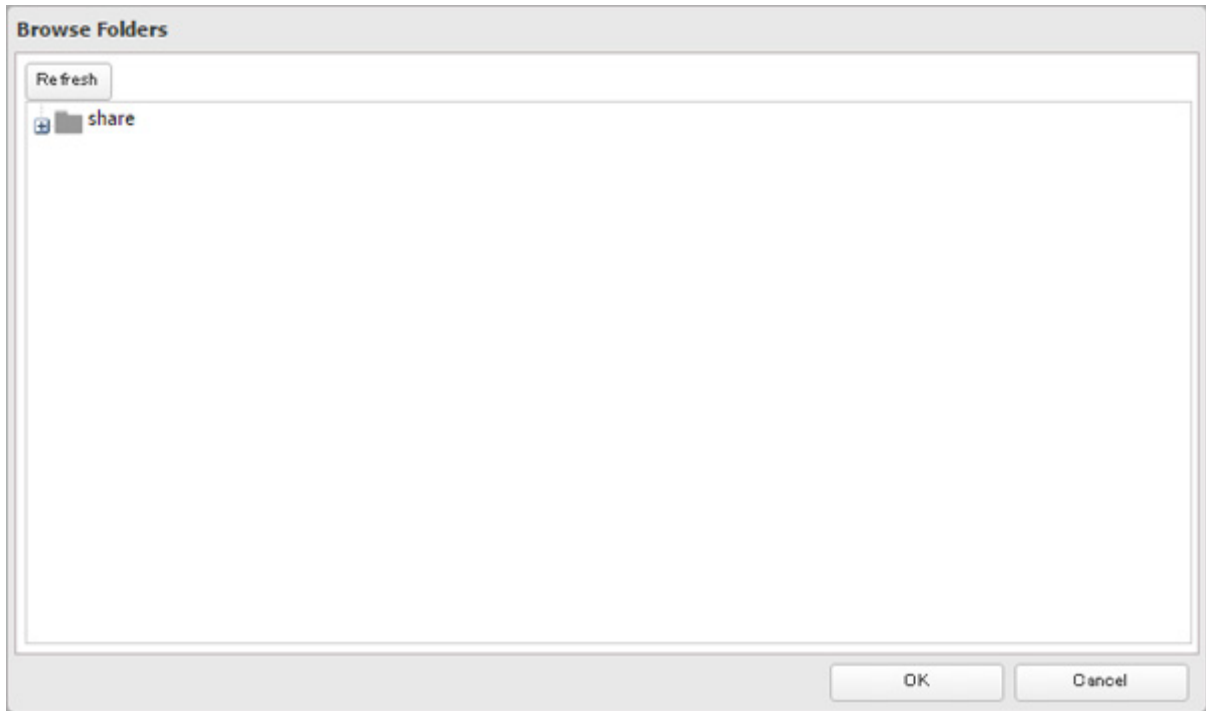

- 6 Click *OK*, then click *OK* again.

- 7 Move the Time Machine switch to the  position to enable Time Machine.

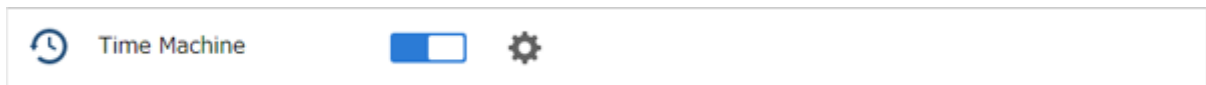

### 3. Configuring Time Machine on macOS

- 1 From the Apple menu, open *System Preferences*.

**2** Click *Time Machine*.

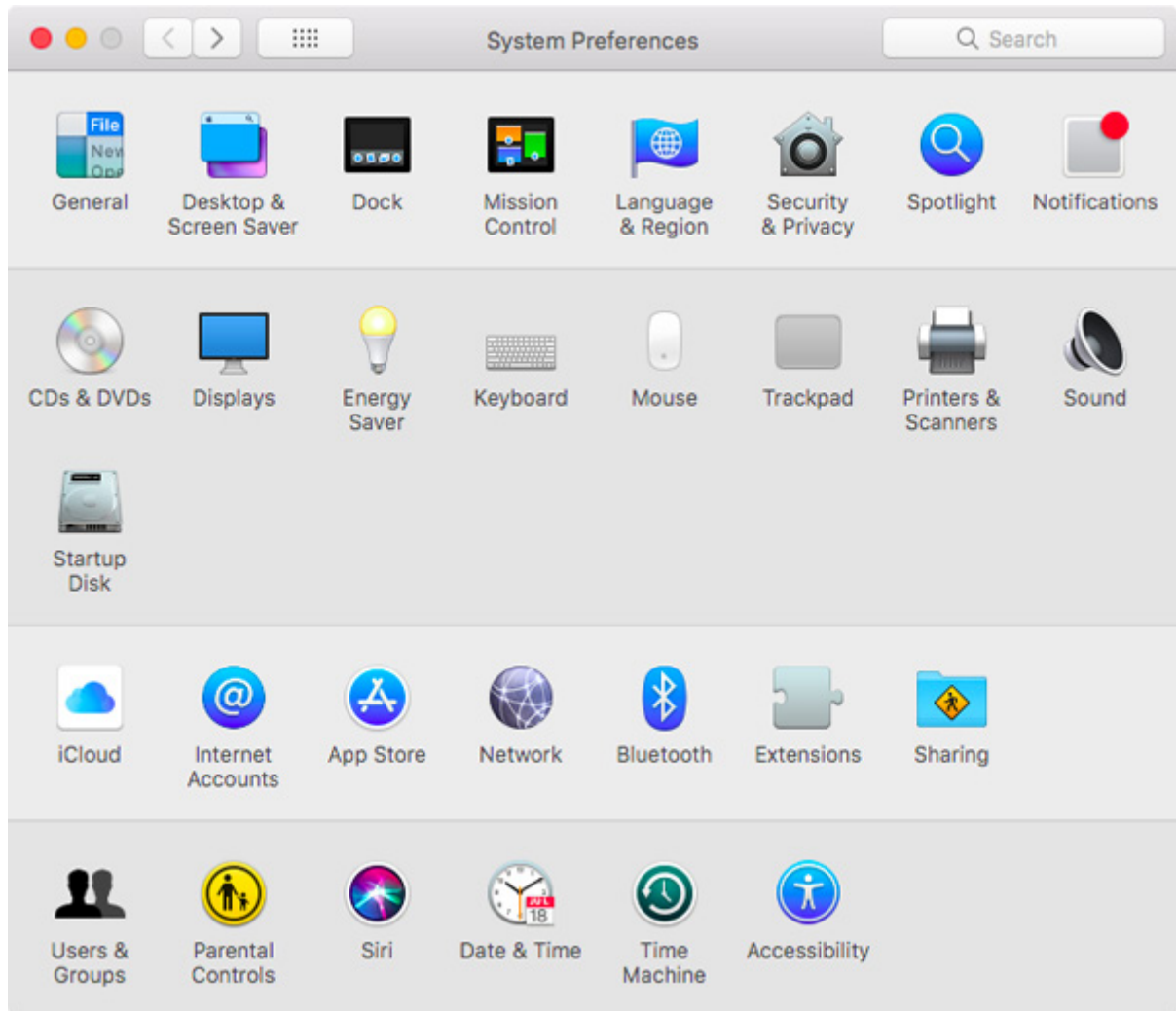

**3** Click *Select Backup Disk*.

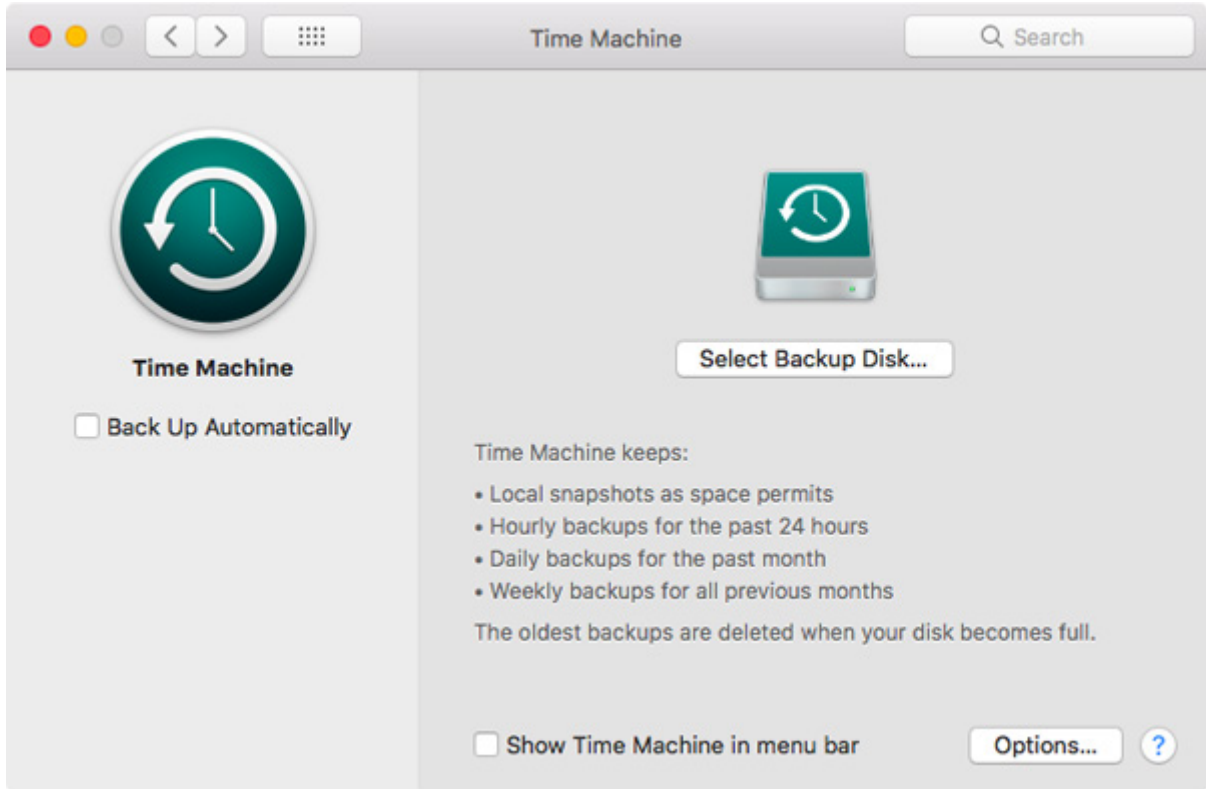

**4** Select the TeraStation, then click *Use Disk*.

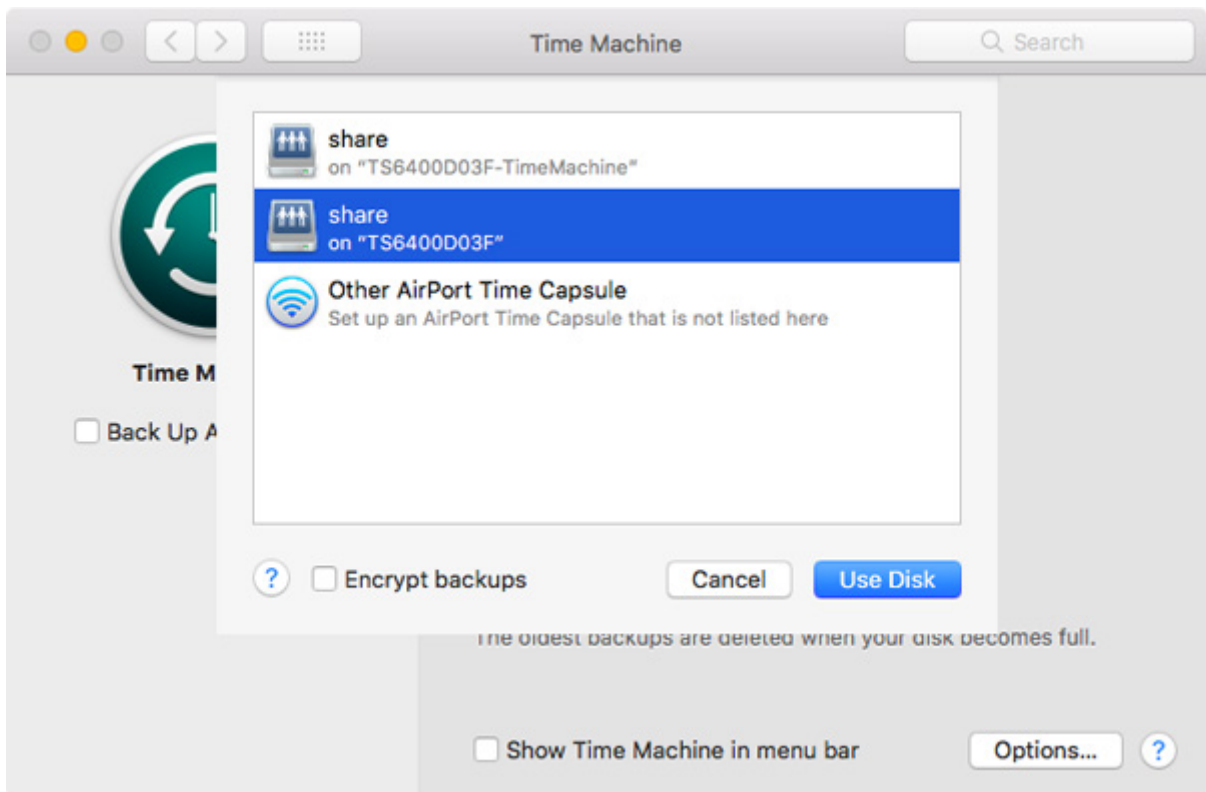

**5** Click *Connect*.

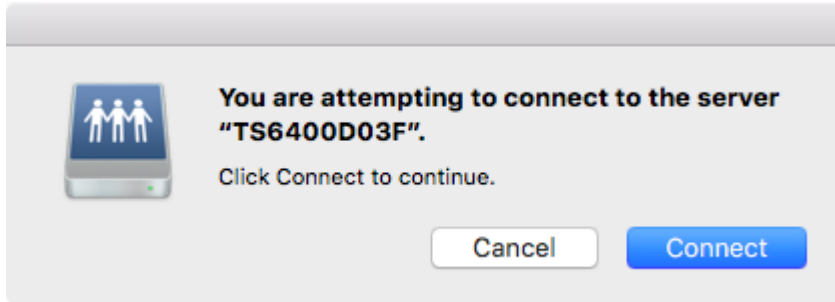

**6** Enter a username and password to be used for accessing the shared folder and click *Connect*.

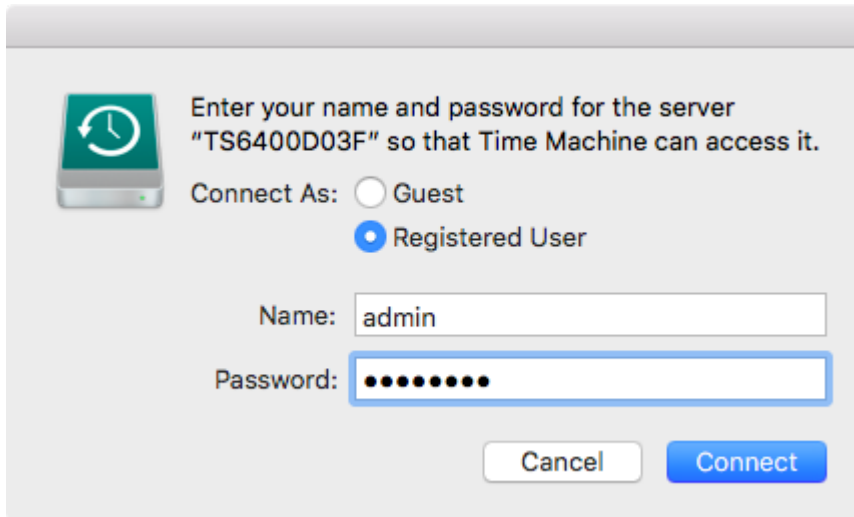

**Note:** If access restrictions are not configured on the destination share, log in with the administrator account. The default username and password for the administrator account are “admin” and “password”. If access restrictions are configured, log in with an account with write privileges.

**7** Time Machine will count down from 120 seconds, then backup will begin.

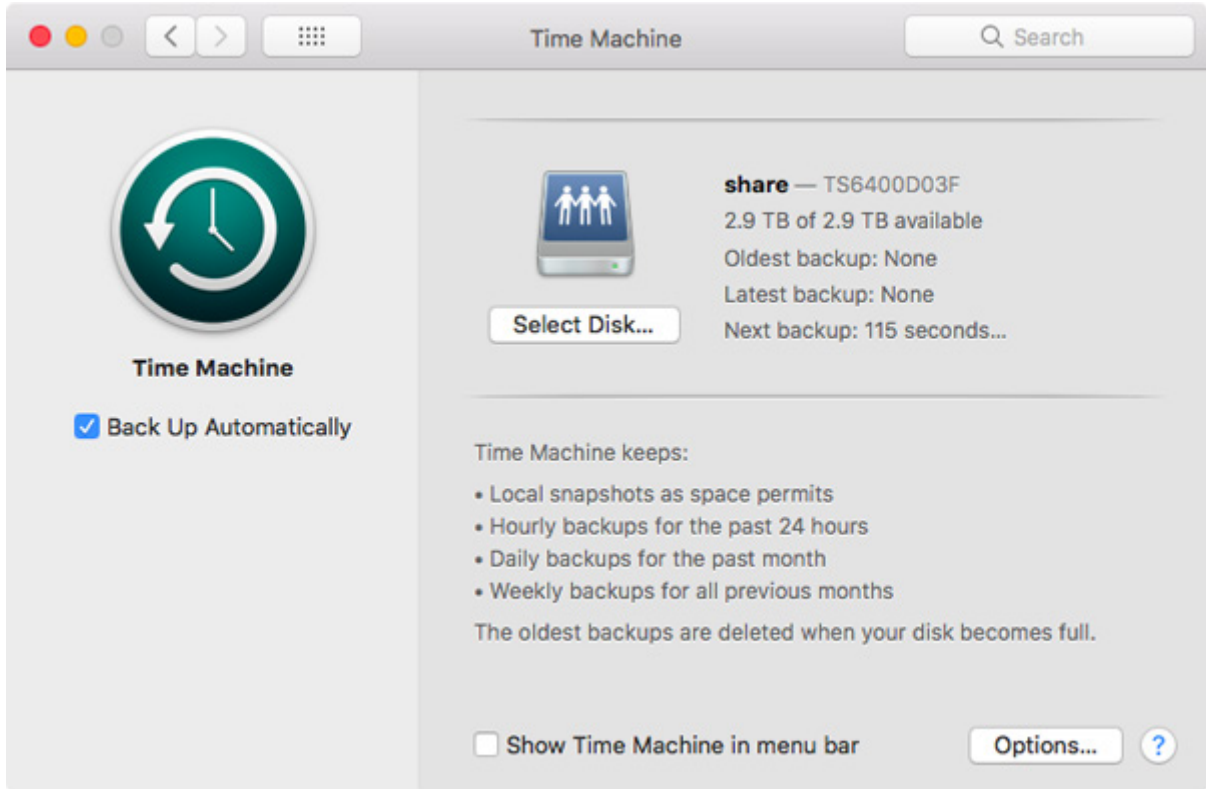

# Chapter 6 Remote Access

## WebAccess

WebAccess is a software utility for accessing the files in the shared folder of your TeraStation from your computer or mobile devices through the Internet. **Be careful when configuring WebAccess. Certain settings can make the files in the shared folder available to anyone on the Internet, without any access restrictions.**

**Note:** WebAccess supports downloading up to 10,000 files at a time. Attempting to download 10,000 or more files at a time may result in unexpected behavior.

- 1 From Settings, click *File Sharing*.

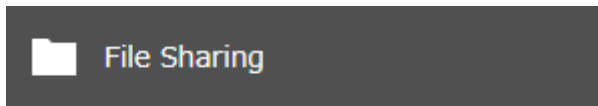

- 2 Click the settings icon (⚙️) to the right of "WebAccess".

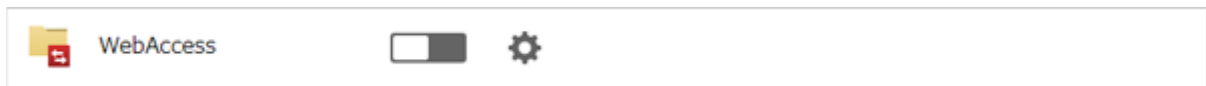

- 3 Click *Edit*.

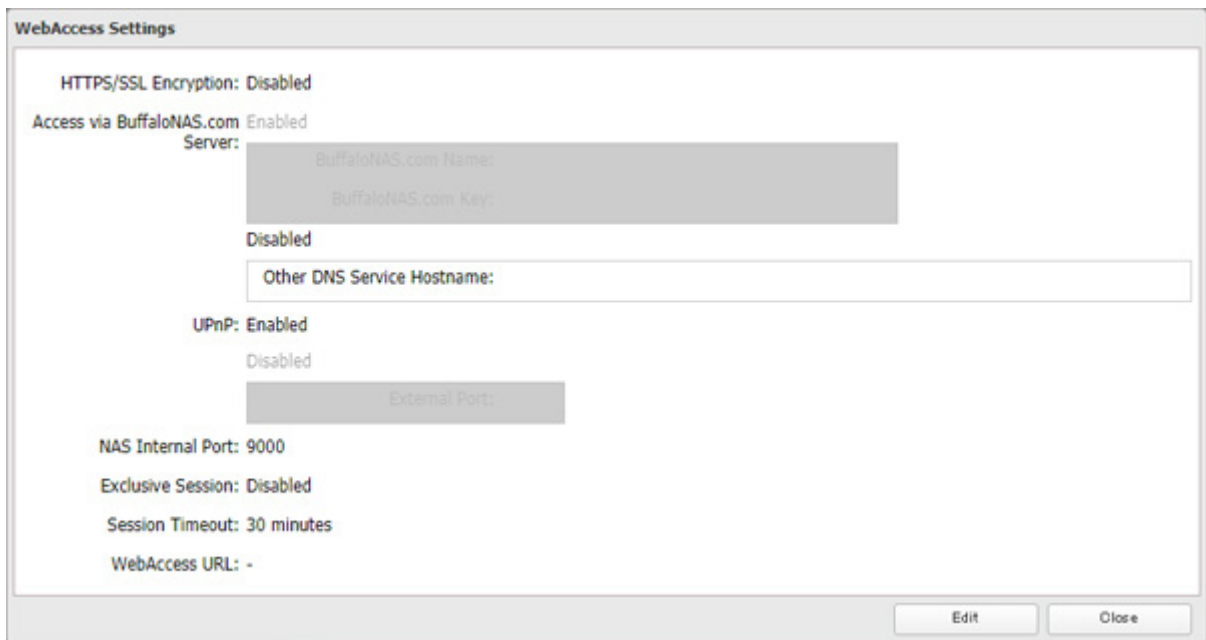



#### 4 Configure the desired settings, then click *OK*.

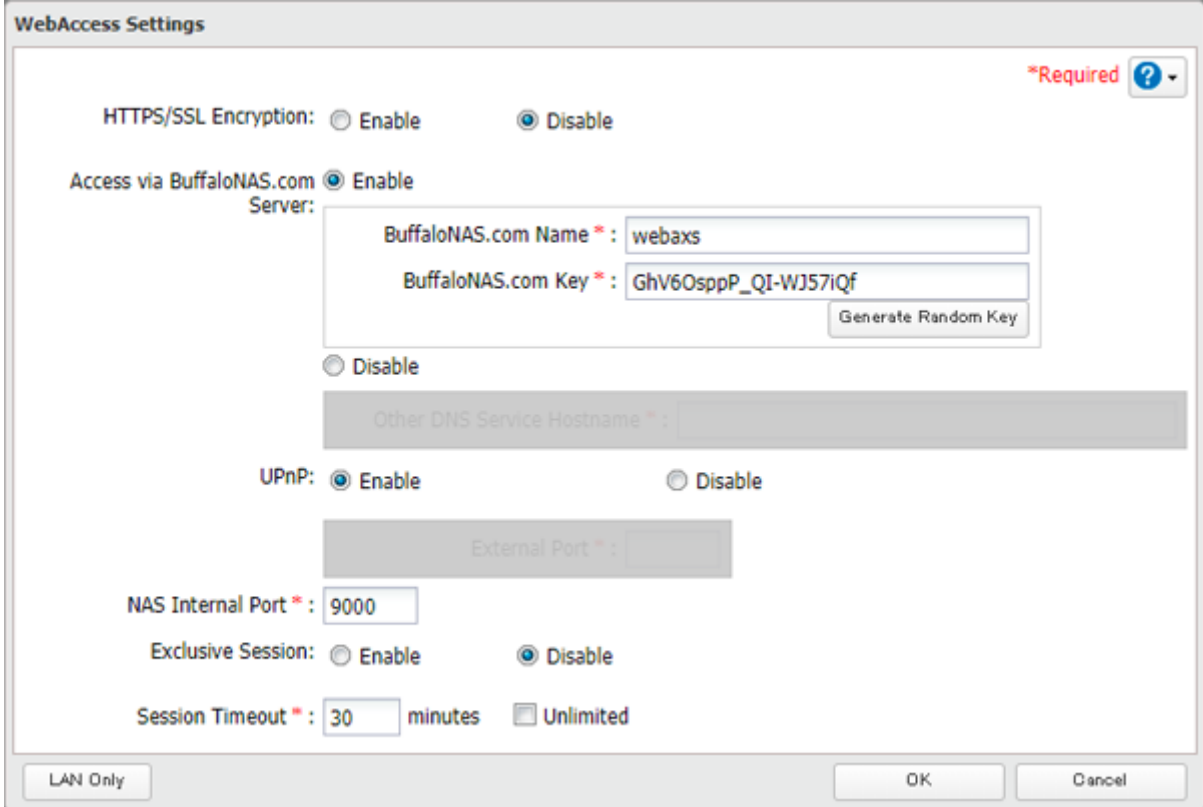

The image shows the 'WebAccess Settings' dialog box. It has a title bar 'WebAccess Settings' and a '\*Required' indicator with a help icon. The settings are as follows:

- HTTPS/SSL Encryption:  Enable  Disable
- Access via BuffaloNAS.com:  Enable
- Server:
  - BuffaloNAS.com Name \*: webaxs
  - BuffaloNAS.com Key \*: GhV6OsppP\_QI-WJ57iQf
  - Generate Random Key button
- Disable
- Other DNS Service Hostname \*: (disabled field)
- UPnP:  Enable  Disable
- External Port \*: (disabled field)
- NAS Internal Port \*: 9000
- Exclusive Session:  Enable  Disable
- Session Timeout \*: 30 minutes  Unlimited

Buttons at the bottom: LAN Only, OK, Cancel.

- To use SSL encryption for more secure data transfers, enable “HTTPS/SSL Encryption”.
- You may use the BuffaloNAS.com server as a DNS server, or disable it to use a different DNS server.
- Choose a “BuffaloNAS.com Name” and “BuffaloNAS.com Key” for your WebAccess account. Names and keys may contain between 3 and 20 alphanumeric characters, underscores (\_), and hyphens (-).
- If “Exclusive Session” is enabled, multiple users cannot be logged in to WebAccess at the same time. Only the last login will be active.
- Enter a time in minutes (1 to 120, or “Unlimited”) before inactive users are logged out of WebAccess.

#### 5 Move the WebAccess switch to the position to enable WebAccess.



#### 6 Click the settings icon ( ) to the right of “Folder Setup”.



#### 7 Select a shared folder to publish.

##### Notes:

- For best results, create a new dedicated share for WebAccess.
- When accessing shared folders through WebAccess from a remote location, a username and password may be required for certain operations. For best results, create a user account with permissions on the WebAccess share before using WebAccess.

#### 8 Under “LAN Protocol Support”, select the “WebAccess” checkbox on the *Basic* tab.

#### 9 Click the *Option 2* tab.

**10** Select the desired WebAccess security level for “WebAccess Permissions”.

**Allow anonymous:** Anyone can access (view) shared folders. (Access restrictions configured for shared folders will not work.)

**Allow all groups and users:** All groups and users registered on the Buffalo NAS device can use WebAccess. (Access restrictions configured for shared folders will not work.)

**Use inherited folder permissions:** Users and groups have the same access permissions with WebAccess that they do locally. If access restrictions are not set for the shared folder, then this option will not be shown.

Whether a user or group can access a folder through WebAccess depends on a combination of WebAccess settings and the shared folder’s settings.

		Not logged in	Access restrictions for the logged-in users		
			No access	Read-only	Read and write
WebAccess permissions	Allow anonymous	R	R/W	R/W	R/W
	Allow all groups and users	-	R/W	R/W	R/W
	Use inherited folder permissions	-	-	R	R/W

R/W: Read and write, R: Read-only, -: No access

**11** Click *OK*.

There are many ways to access WebAccess folders depending on your device:

- From a computer, supported browsers include Microsoft Edge, Firefox, Google Chrome, Internet Explorer 9 or later, Safari 9 or later. Refer to the help guide at the BuffaloNAS.com website after connecting with your BuffaloNAS.com name for more detailed information.
- To access from an iOS device, install the “WebAccess i” application from the App Store. Refer to the help guide for the app for more detailed information.
- To access from an Android device, install the “WebAccess A” application from Google Play. Refer to the help guide for the app for more detailed information.

---

## FTP

---

By default, the TeraStation’s shares are only accessible by users connected to the same network or router as the TeraStation. The optional FTP server allows users outside the local network to access the TeraStation.

**Note:** FTP is intended for users who already have FTP client software and have experience with it.

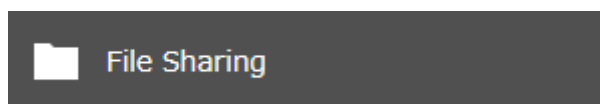
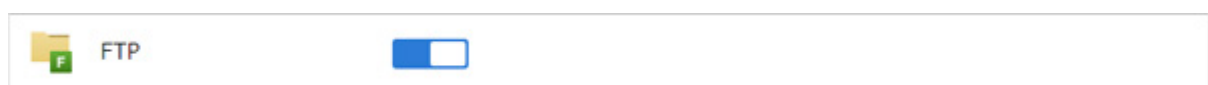
**1** From Settings, click *File Sharing*.**2** Move the FTP switch to the  position to enable FTP.

- 3** Click the settings icon (  ) to the right of “Folder Setup”.



- 4** Choose a folder to enable remote FTP access on.

- 5** Under “LAN Protocol Support”, select the “FTP” checkbox on the *Basic* tab; select read-only or read and write for the shared folder’s attribute on the *Option 2* tab and click *OK*.

### Accessing the TeraStation with an FTP Client

To access the TeraStation via FTP, configure your FTP client software with the following settings:

- Hostname: IP address of the TeraStation
- Username: The TeraStation’s username
- Password: The TeraStation’s password
- Port: 21

### Accessing the TeraStation with an Anonymous User

To allow anonymous access to your FTP share, disable access restrictions. Configure your FTP client software with the following settings for anonymous FTP access:

- Hostname: IP address of the TeraStation
- Username: Anonymous
- Password: Any character string
- Port: 21

#### Notes:

- If the TeraStation joins a domain, domain and anonymous users cannot remote access via FTP. Domain users will be able to access remotely using SFTP.
- Shared folders connected by FTP are available from the “/mnt” folder. The examples of default locations are:  
   /mnt/array1/share  
   /mnt/disk1/share  
   /mnt/usbdisk1
- If a file was created or copied using AFP, you may be unable to delete it using an FTP connection. If this occurs, use an SMB or AFP connection instead to delete the file.
- For FTP connections, make sure that the total filename including the folder path is 250 single-byte characters or less.

---

## Synchronizing with Dropbox

---

The TeraStation supports synchronizing with Dropbox, the online cloud service. Once linked, you can share TeraStation files via Dropbox (or Dropbox files via TeraStation). To link your TeraStation with your Dropbox account, follow the procedure below.

**Note:** To use Dropbox Sync, you will need a Dropbox account and an available empty Dropbox folder. If you don’t have a Dropbox account, or if you need to create a new empty Dropbox folder, refer to the Dropbox website.

## Configuring a New Job

- 1 From Settings, click *Cloud Storage*.



- 2 Move the Dropbox Sync switch to the  position to enable Dropbox Sync.



- 3 Click the settings icon (  ) to the right of "Dropbox Sync".



- 4 Click *Add*.

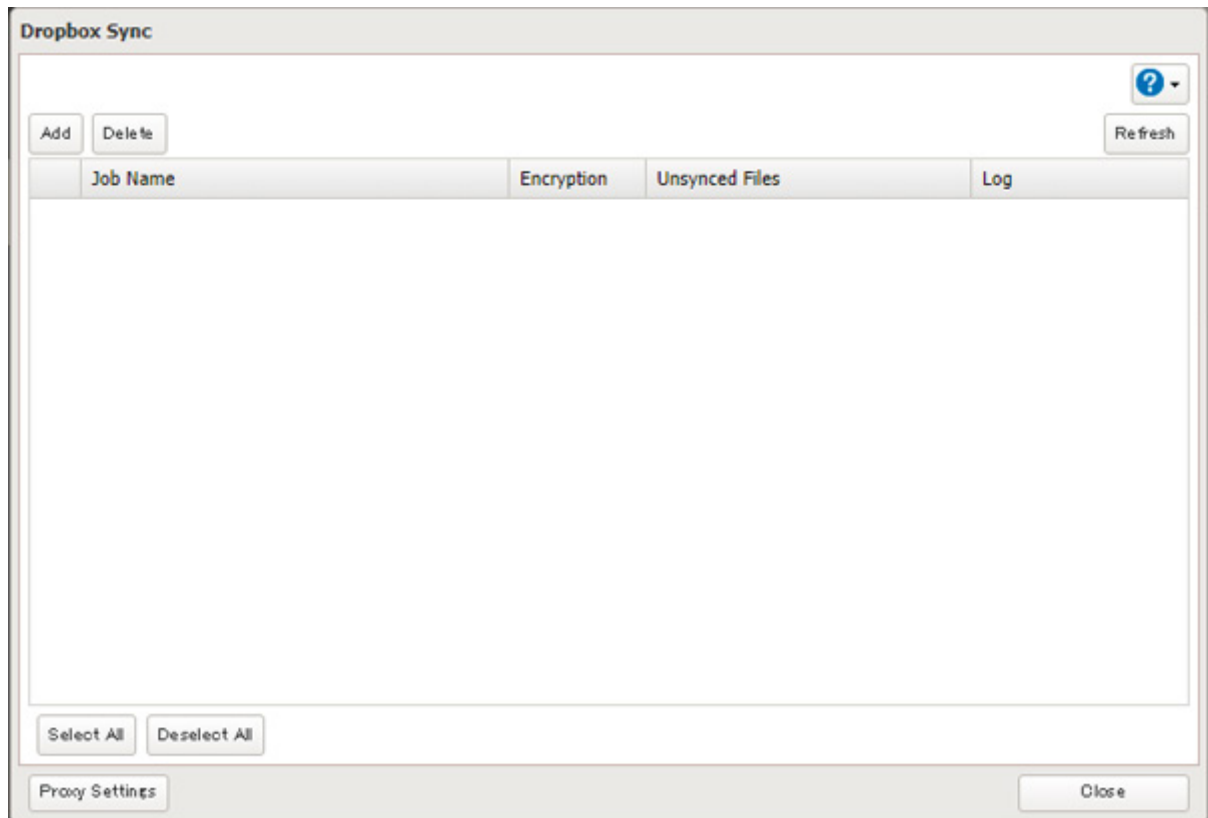

**5** Click *View Dropbox Authentication Page*.

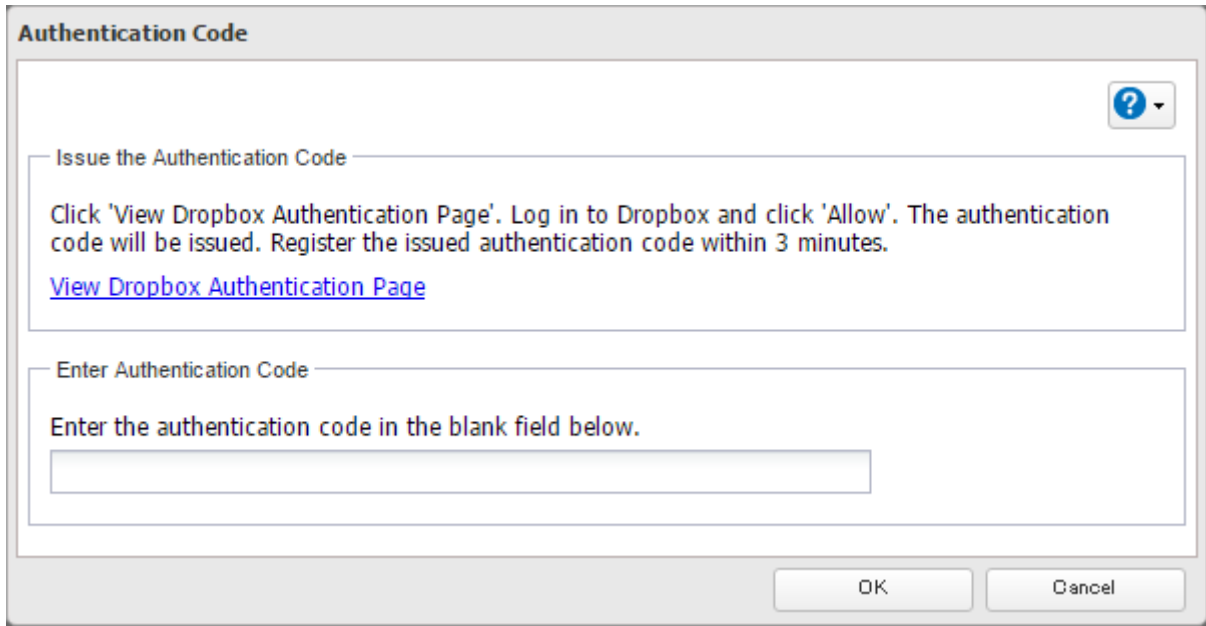

**6** The authentication site that is offered by Dropbox will be displayed. Log in to the website with your Dropbox account, then click *Allow*.

**7** The authentication code will be displayed. Copy the authentication code and return to Settings. Authentication code reregistration should be finished within three minutes.

**8** Paste the authentication code and click *OK*.

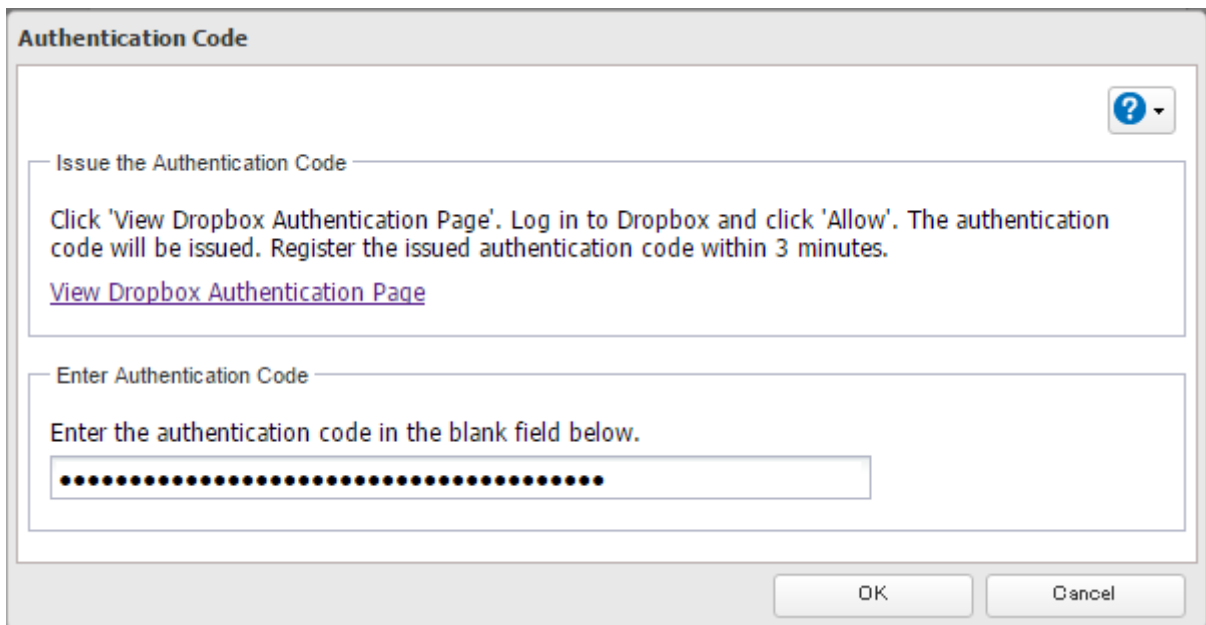

**9** Enter the desired job name; select the TeraStation and Dropbox folders, and configure encryption. Click *OK*.

If you enable encryption, you will need to set an encryption password. The password cannot be changed once you configure it. Please take note of the password and keep it secure. If you forget the password, delete the old job first, then create a new job using the same Dropbox account.

**10** Click *OK*.

**Note:** Up to eight Dropbox jobs can be configured at a time.

## Changing Job Settings

Follow the procedure below to change any job settings you have already configured.

**1** From Settings, click *Cloud Storage*.

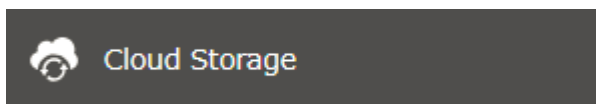

**2** Click the settings icon (⚙️) to the right of "Dropbox Sync".



**3** From the job list, click the job whose settings you want to change.

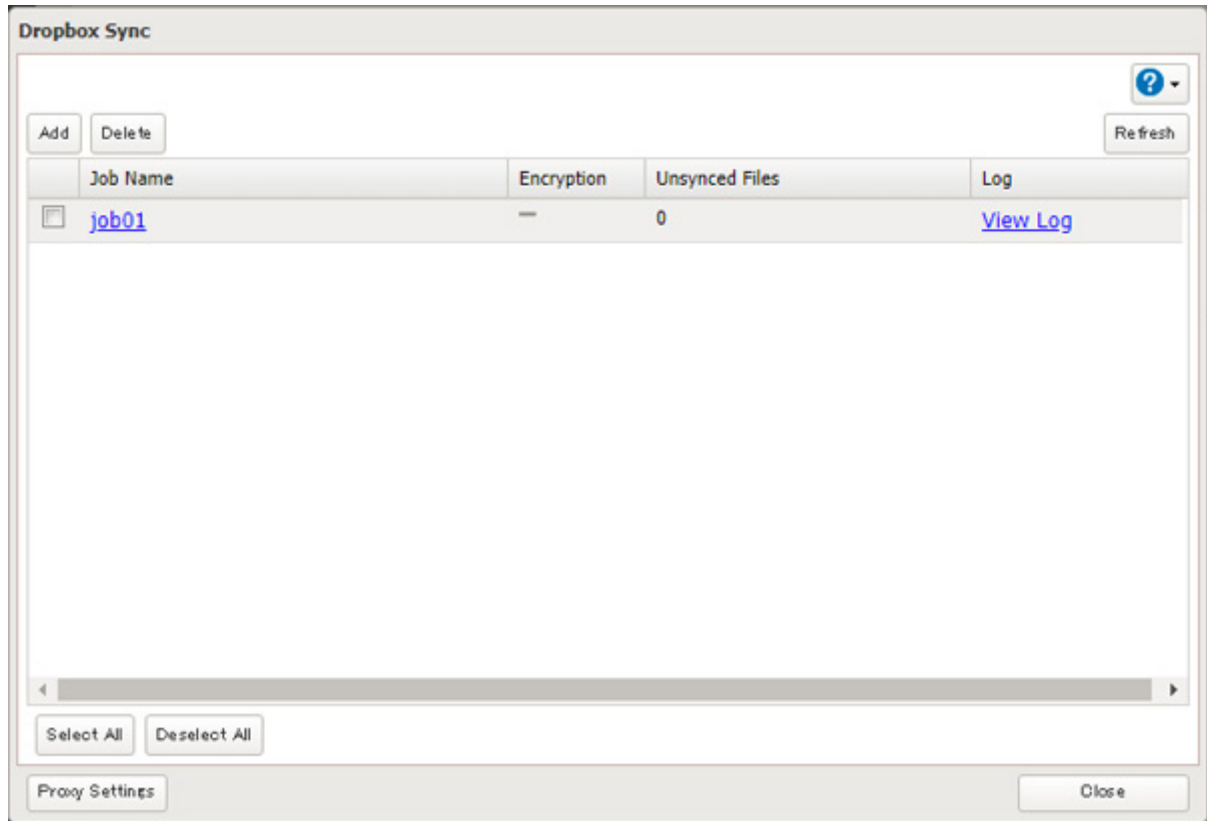

**4** Click the *Options* tab.

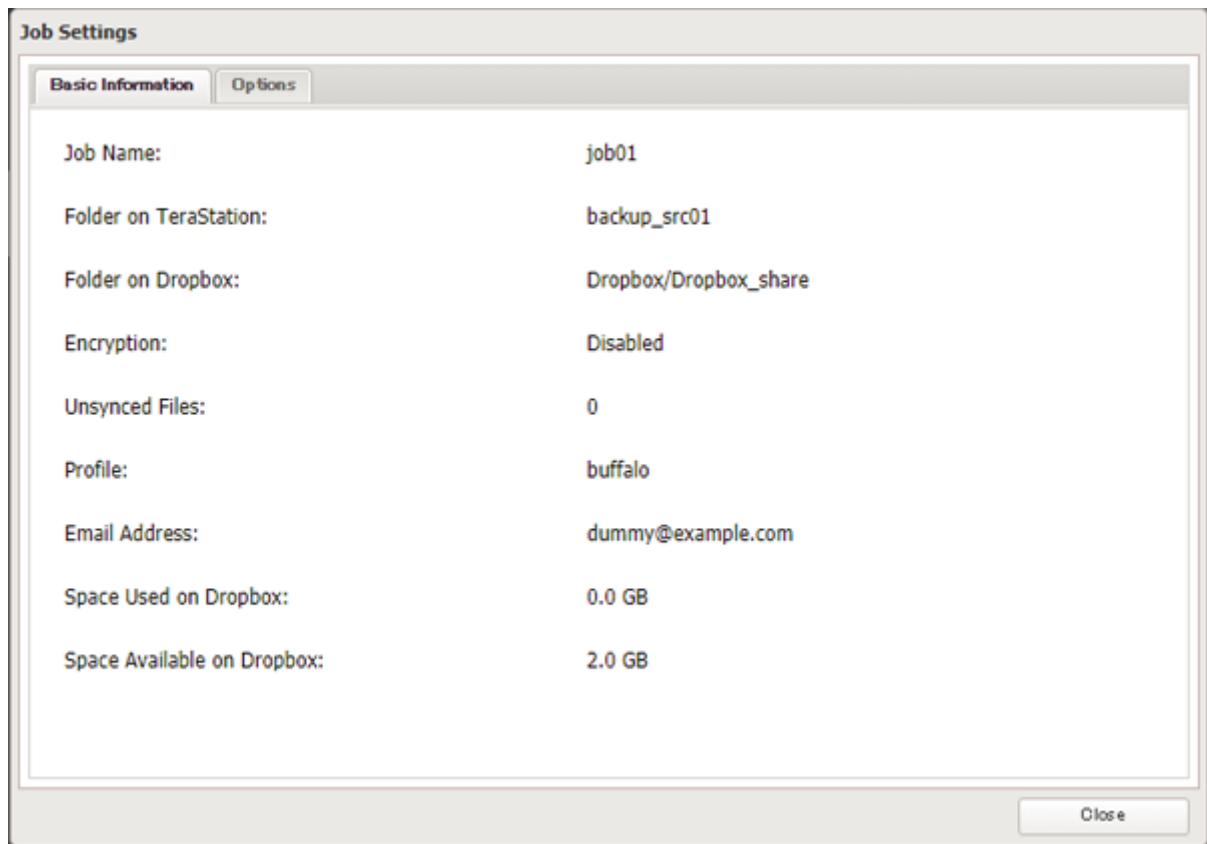

**5** Click *Edit*.

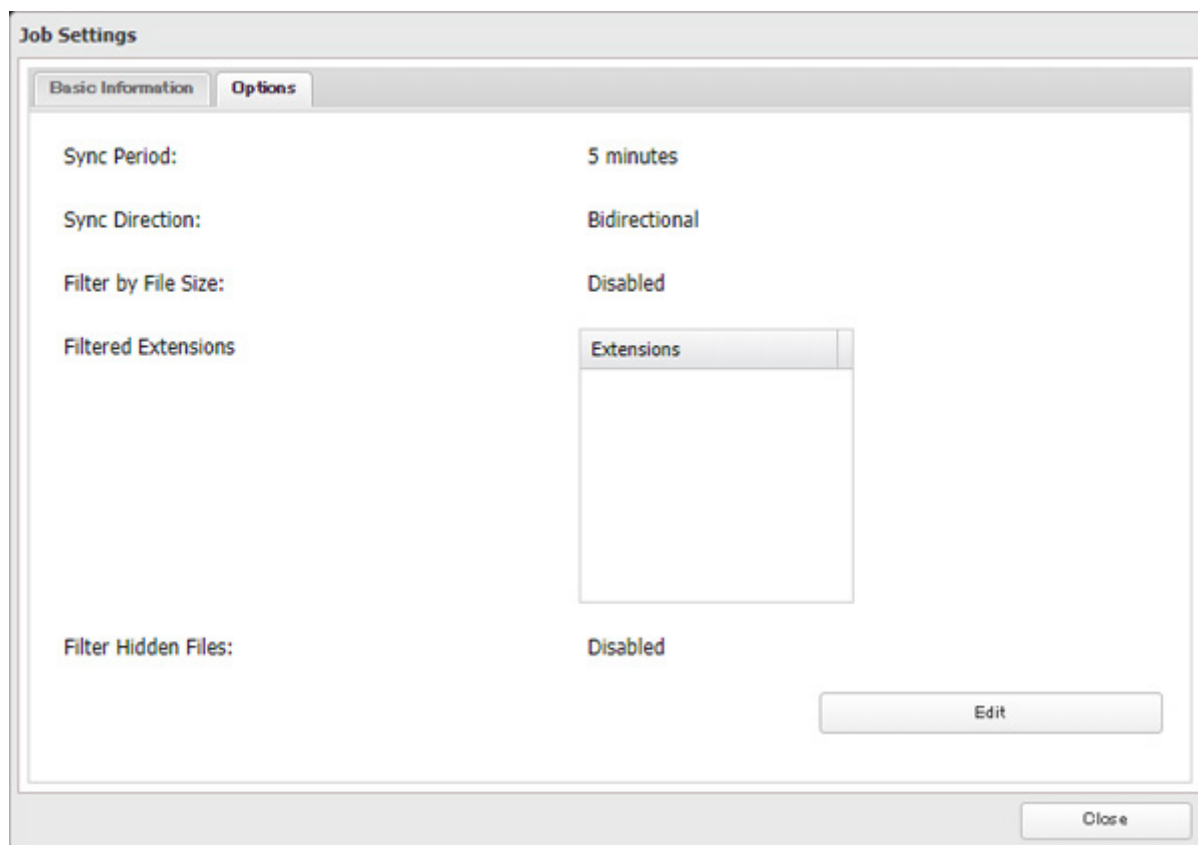



## 6 Configure the desired settings and click OK.

**Job Settings**

Sync Period: 5 minutes

Sync Direction: Bidirectional

Filter by File Size:  Enable  Disable

Maximum Size: 1 MB

Filtered Extensions:

Extensions

Add Delete

Filter Hidden Files:  Enable  Disable

OK Cancel

### Notes:

- When encryption is enabled, files uploaded to Dropbox not using Dropbox Sync will not be downloaded to the TeraStation even if the sync direction is configured to “Bidirectional” or “Download only”.
- Refer to the following website for synchronization restrictions between the TeraStation and Dropbox: <https://www.dropbox.com/help/145>
- Folders that are configured for Dropbox Sync cannot be renamed or used for replication.
- When specific settings are changed, the changes will not be applied and the files on Dropbox may not be synchronized to the TeraStation. In such a case, delete the target files to be synchronized and upload them to Dropbox again or delete the job and recreate it again. The following are the specific circumstances when files may not be synchronized:
  - Uploading or downloading fails.
  - File extensions are removed from filtering.
  - The sync direction is changed.
- If using Dropbox through a proxy server, click *Proxy Settings*. From the displayed page, you can select whether to use the configured settings or configure an identical proxy server. If using the identical proxy server, select “New settings” and enter the proxy server name, port number, username, and password. Ask your network administrator for detailed proxy server settings.
- Files that are 900 MB or larger cannot be downloaded using Dropbox Sync. However, even if the file size is smaller than 900 MB, downloading may fail when multiple processes are running at the same time.
- Regardless of whether file filtering was configured, the following files will not be uploaded to Dropbox:
  - desktop.ini

- thumbs.db
- Files whose filename contains the symbols / \ > < : " | ? \*
- Files whose filename ends with either a space or period
- Files whose filename starts with either ~\$ or .~
- Files whose filename starts with ~ and have the file extension .tmp

## Creating a Shared Link (Windows Only)

Buffalo offers a Windows application, “B-Sync”, that can create shared links for the files stored in the TeraStation folders. You can download the application from the [Buffalo website](#). Refer to the application help for the usage procedure.

## Using Microsoft Azure for Data Preservation

The TeraStation supports synchronizing with Microsoft Azure, the online cloud storage service. Once linked, you can back up data on the TeraStation to Azure Storage, or restore data from Azure Storage to the TeraStation.

Microsoft Azure offers multiple types of storage and the TeraStation is compatible with Blob Storage. There are three types of blobs: block blobs, page blobs, and append blobs. The TeraStation only works with block blobs to store your data.

This feature is meant for situations such as disaster recovery and not a catch-all backup function. After linking the TeraStation and Microsoft Azure, data on the TeraStation will not be bidirectionally synchronized between the TeraStation and an Azure container.

### Notes:

- Depending on the services you have purchased, prices for operations and amount of data will vary. To avoid being charged unexpectedly expensive fees, we recommend staying aware of the price structure for data storage and operations and regularly checking how much have been charged.
- To access data that have been backed up to the container, use “Microsoft Azure Storage Explorer”.
- If using Azure Storage through a proxy server, click *Proxy Settings*. From the displayed page, you can select whether to use the configured settings or configure an identical proxy server. If using the identical proxy server, select “New settings” and enter the proxy server name, port number, username, and password. Ask your network administrator for detailed proxy server settings.

To link your TeraStation with a Microsoft Azure Storage account, follow the procedure below.

## Creating a New Backup Job

**1** From the Azure portal, create your Azure Storage account and a container before proceeding with the procedure.

**2** From Settings, click *Cloud Storage*.

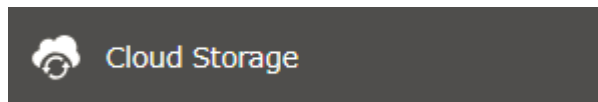

**3** Move the Microsoft Azure Storage Sync switch to the  position to enable Microsoft Azure Storage Sync.



4 Click the settings icon (  ) to the right of "Microsoft Azure Storage Sync".



5 Click *Add*.

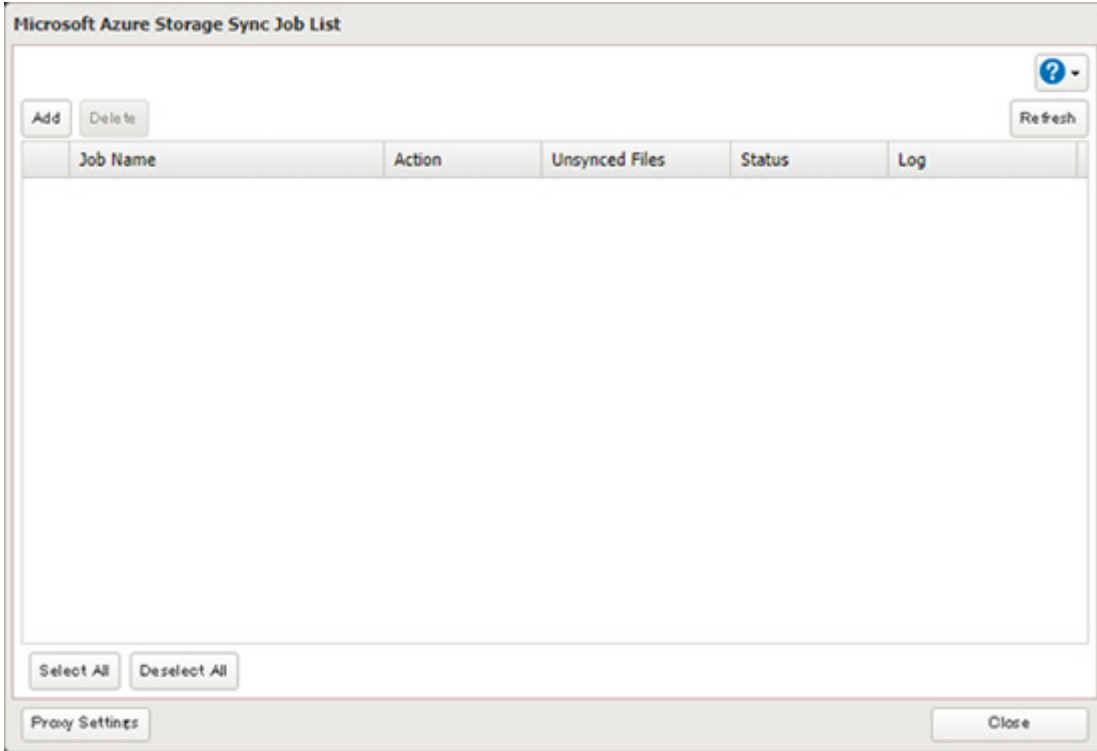

6 The job setup wizard will open. Enter your Azure Storage account name and access key, then click *Next*.

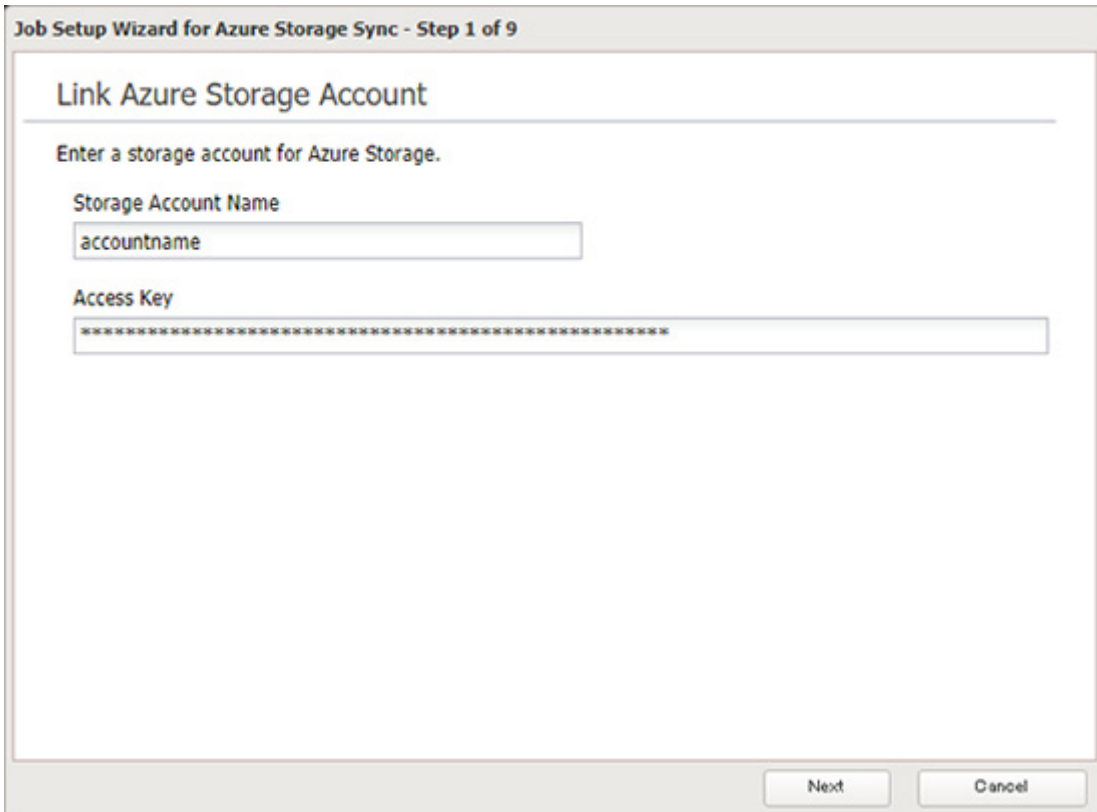

**7** Enter the desired job name and click *Next*.

Job Setup Wizard for Azure Storage Sync - Step 2 of 9

### Enter a Job Name

Enter a job name to create.

Job Name

Back Next Cancel

**8** Select “Backup” and click *Next*.

Job Setup Wizard for Azure Storage Sync - Step 3 of 9

### Select Sync Action

Select the sync action for your files.

Backup (TeraStation to Azure Storage)  
Back up files from the backup source folder to a container. The first time the backup job runs, it will act as a full backup. Files added to the source are kept in the container in subsequent backups. You can select the action for files deleted from the source on the following page.

Restore (Azure Storage to TeraStation)  
Restore files from a container to a shared folder on the TeraStation.

Back Next Cancel

- 9 Select the desired shared folder on the TeraStation as the backup source folder and enter the container name for the backup destination, then click *Next*.

**Job Setup Wizard for Azure Storage Sync - Step 4 of 9**

### Configure Job Pairs

Select the shared folder that contains desired files for backup as the backup source and enter a container name.

Backup Source Folder  
backup\_src01

Container Name  
test5

Back Next Cancel

- 10 Specify the sync period and click *Next*.

**Job Setup Wizard for Azure Storage Sync - Step 5 of 9**

### Configure Sync Period

Select the interval of time between each backup.

Backup Interval  
5 Minutes

Back Next Cancel

- 11** Select the desired action to take for files in the container that share the same name as files in the backup source after they are deleted, then click *Next*.

The screenshot shows a dialog box titled "Job Setup Wizard for Azure Storage Sync - Step 6 of 9". The main heading is "Configure File Sync Action". Below the heading, there is a text instruction: "Select the action to take for files in the backup destination container after deleting files with the same name from the backup source folder." There are two radio button options: "Delete from container" (which is selected) and "Keep in container". Under "Delete from container", the text says "Delete the files from the backup destination container." Under "Keep in container", the text says "Keep the files as is in the backup destination container." At the bottom of the dialog, there are three buttons: "Back", "Next", and "Cancel".

- 12** Configure whether to filter the backup target files. The following screen is available to configure file filtering by file size and whether they're hidden. Configure the desired filtering settings and click *Next*.

The screenshot shows a dialog box titled "Job Setup Wizard for Azure Storage Sync - Step 7 of 9". The main heading is "Configure File Filters 1". Below the heading, there is a text instruction: "Configure the requirements for filtering files. If any files in the backup source folder meet any of the following requirements, those files will not be backed up." There are two sections: "Maximum Backup File Size" and "Filter Hidden Files". Under "Maximum Backup File Size", there are two radio button options: "Limit size" and "Allow full size" (which is selected). Below "Limit size", there is a "Size Limit:" label, a text box containing the number "1", a spinner control, and the label "MB". Under "Filter Hidden Files", there are two radio button options: "Enable" and "Disable" (which is selected). At the bottom of the dialog, there are three buttons: "Back", "Next", and "Cancel".

- 13** The following screen is available to configure file filtering by extensions. Configure the desired filtering settings and click *Next*.

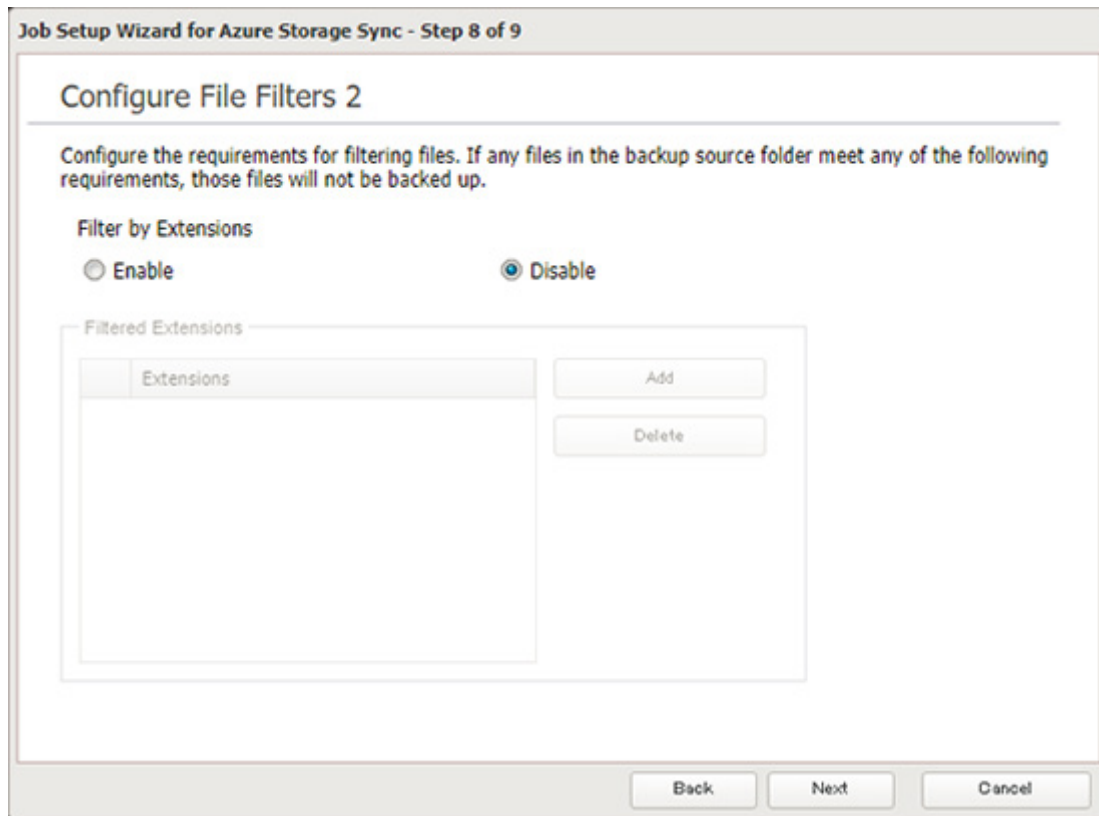

- 14** Confirm that all settings are properly configured and click *OK*.

**Notes:**

- Regardless of whether file filtering was configured, the following files will not be backed up to an Azure Storage container:
  - desktop.ini
  - thumbs.db
  - Files whose filename contains the symbols / \ > < : " | ? \*
  - Files whose filename ends with either a space or period
  - Files whose filename starts with either ~\$ or .~
  - Files whose filename starts with ~ and have the file extension .tmp
- Do not copy files that are 10 GB or larger, and do not copy 100,000 or more files to the backup source folder at once. If you do and backup fails, check the network environment speed and try again with fewer files.

## Creating a New Restore Job

- 1** From the Azure portal, create your Azure Storage account and a container before beginning the following procedure.
- 2** From Settings, click *Cloud Storage*.

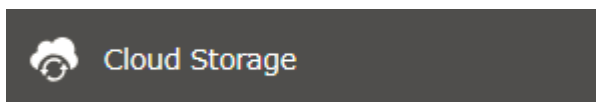

**3** Move the Microsoft Azure Storage Sync switch to the  position to enable Microsoft Azure Storage Sync.



**4** Click the settings icon (  ) to the right of "Microsoft Azure Storage Sync".



**5** Click *Add*.

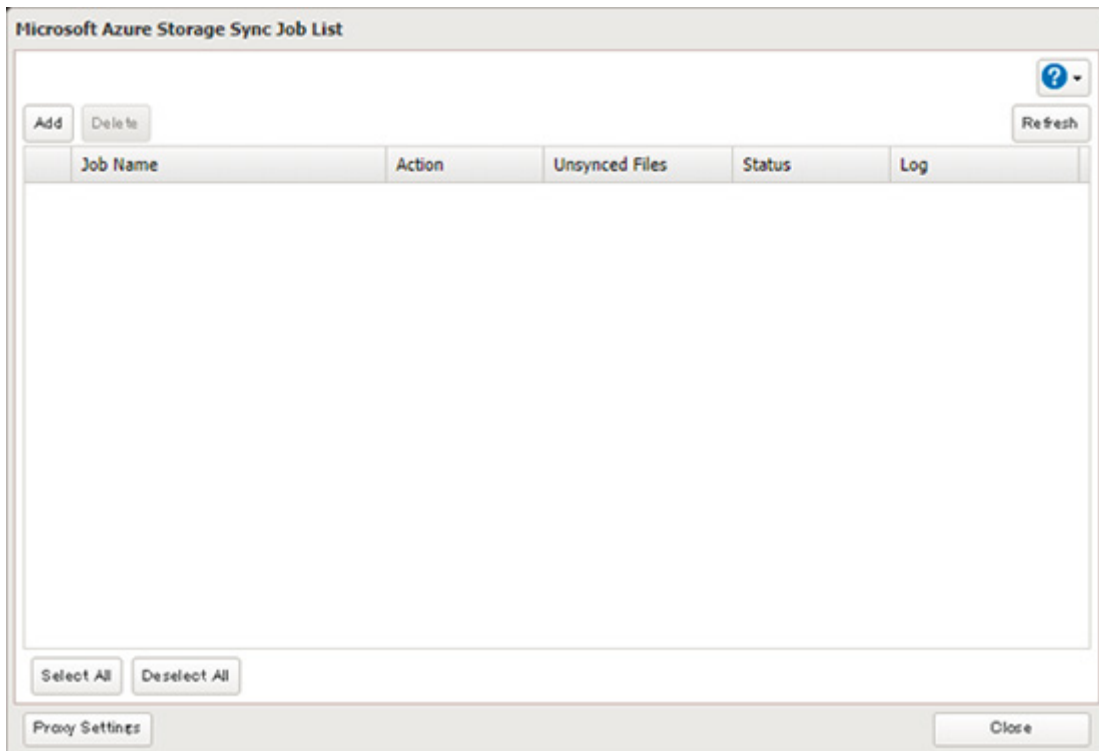



**6** The job setup wizard will open. Enter your Azure Storage account name and access key, then click *Next*.

**Job Setup Wizard for Azure Storage Sync - Step 1 of 9**

### Link Azure Storage Account

Enter a storage account for Azure Storage.

Storage Account Name  
accountname

Access Key  
\*\*\*\*\*

Next Cancel

**7** Enter the desired job name and click *Next*.

**Job Setup Wizard for Azure Storage Sync - Step 2 of 9**

### Enter a Job Name

Enter a job name to create.

Job Name  
job01

Back Next Cancel

- 8 Select “Restore” and click *Next*.

**Job Setup Wizard for Azure Storage Sync - Step 3 of 9**

### Select Sync Action

Select the sync action for your files.

Backup (TeraStation to Azure Storage)  
Back up files from the backup source folder to a container.  
The first time the backup job runs, it will act as a full backup. Files added to the source are kept in the container in subsequent backups. You can select the action for files deleted from the source on the following page.

Restore (Azure Storage to TeraStation)  
Restore files from a container to a shared folder on the TeraStation.

Back Next Cancel

- 9 Enter the container name for the restore source and select the desired shared folder on the TeraStation as the restore destination, then click *Next*.

**Job Setup Wizard for Azure Storage Sync - Step 4 of 5**

### Configure Job Pairs

Enter a container name for the restore source and select a shared folder as the restore destination for restored files.

Container Name  
test5

Restore Destination Folder  
restore\_dst01 Create Folder

Folder Level for Restored Files

First level  
Files will be restored to the first level of the restored destination folder.

Second level  
A folder will automatically be created in the restored destination folder and files will be restored to this folder. This folder name will be the date on which the job was created.

Back Next Cancel

- 10 Select either to restore data into the first level folder (root folder) or the second level (subfolder) of the restore destination folder, then click *Next*.

**11** Confirm that all settings are properly configured and click *OK*.

**Note:** When deleting a completed restored job, it can be converted to a backup job. If that restore job had been configured to restore to the second level on the shared folder, restored data will automatically move to the first level. If there are files with the same filename in the first level folder, those files will be overwritten.

## Changing Job Settings

Follow the procedure below to change any job settings you have already configured.

**1** From Settings, click *Cloud Storage*.

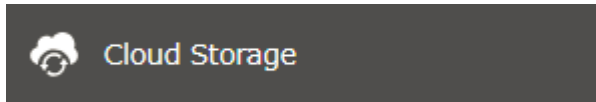

**2** Click the settings icon (  ) to the right of "Microsoft Azure Storage Sync".



**3** From the job list, click the job whose settings you want to change.

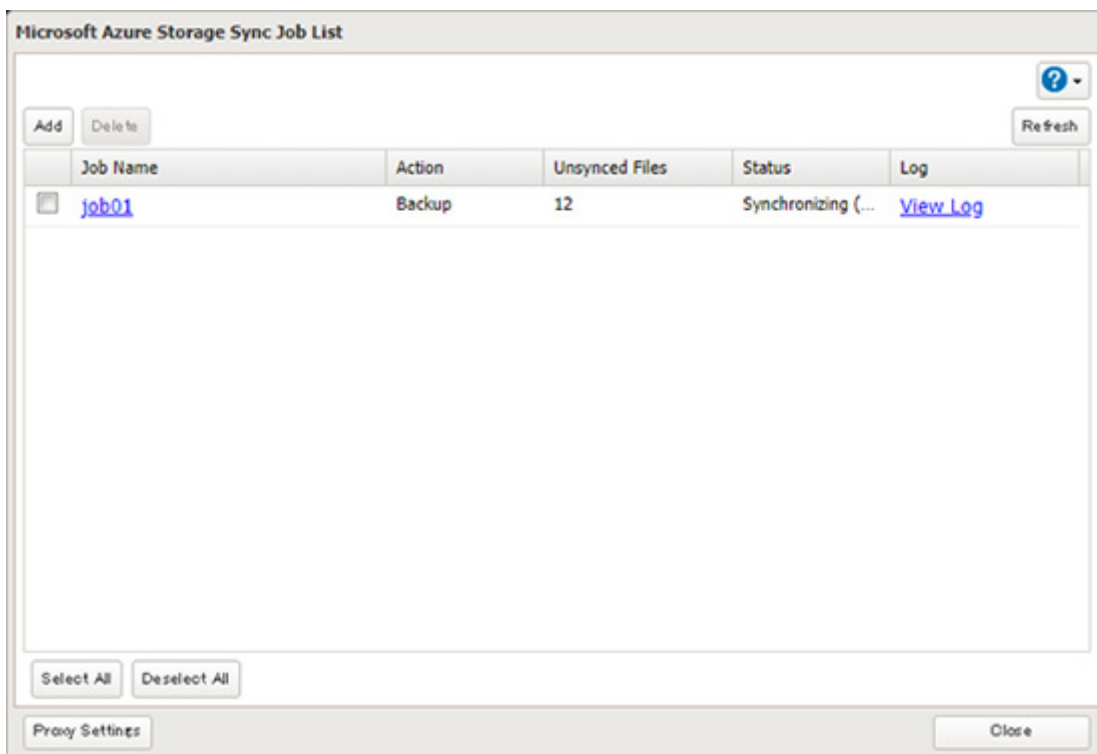

**4** Click the *Options* tab.

The screenshot shows the 'Job Settings' dialog box with the 'Options' tab selected. The 'Basic' tab is also visible. The settings are as follows:

Storage Account Name:	accountname
Job Name:	job01
Sync Action:	Backup
Files Deleted in Backup Source:	Keep in container
Backup Source Folder:	backup_src01
Container Name:	test5

A 'Close' button is located at the bottom right of the dialog box.

**5** Click *Edit*.

The screenshot shows the 'Job Settings' dialog box with the 'Options' tab selected. The settings are as follows:

Backup Interval:	5 Minutes
Maximum Backup File Size:	Allow full size
Filter Hidden Files:	Disabled
Filter by Extensions:	Disabled

An 'Edit' button is located at the bottom right of the dialog box, and a 'Close' button is located at the bottom right of the dialog box.

## 6 Configure the desired settings and click OK.

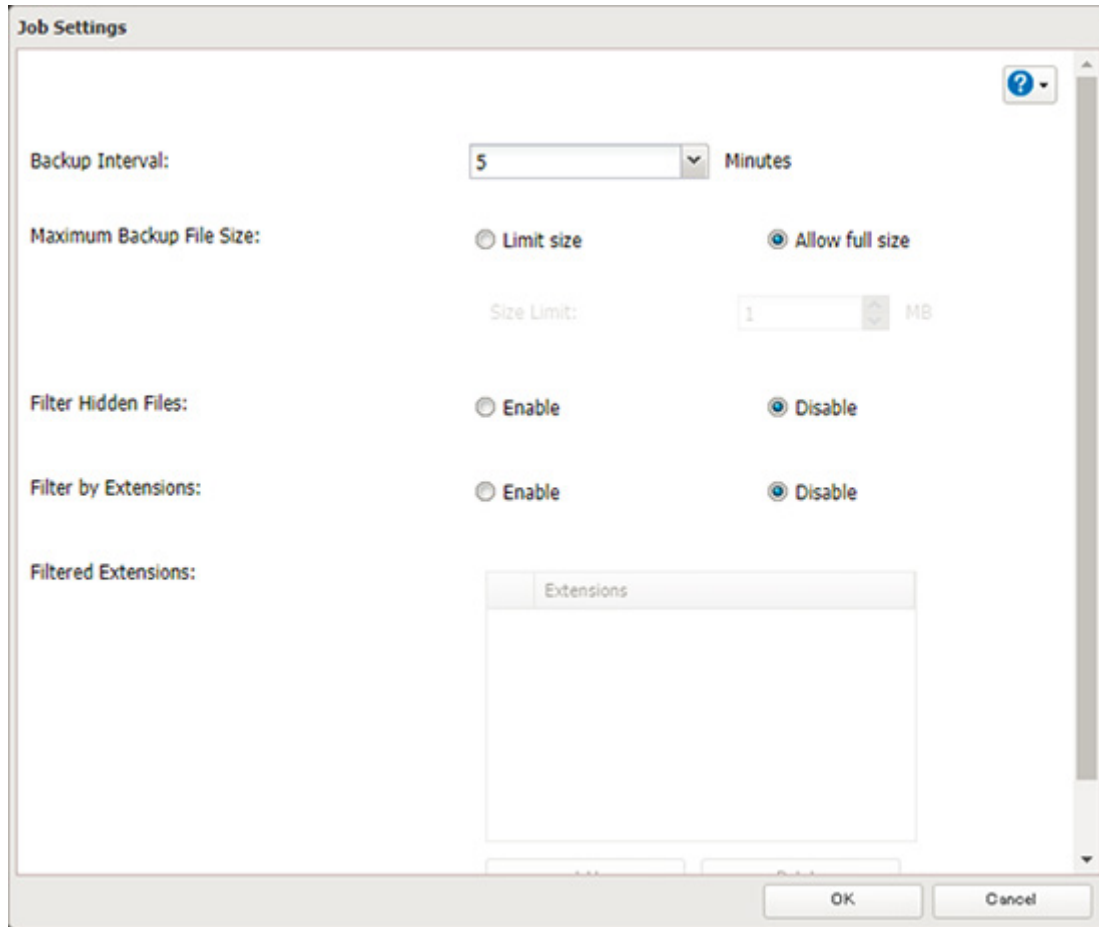

## Synchronizing with Microsoft OneDrive

The TeraStation supports synchronizing with Microsoft OneDrive, the online cloud storage. Once linked, you can share the TeraStation files via OneDrive (or OneDrive files via the TeraStation). To link your TeraStation with your Microsoft account, follow the procedure below.

**Note:** To use Microsoft OneDrive Sync, you need a Microsoft account and an available empty OneDrive folder. If you don't have a Microsoft account, or if you need to create a OneDrive folder, refer to the Microsoft website.

### Configuring a New Job

1 From Settings, click *Cloud Storage*.

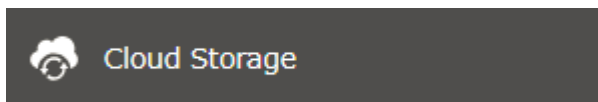

2 Move the OneDrive Sync switch to the  position to enable OneDrive Sync.



**3** Click  to the right of "Microsoft OneDrive Sync".



**4** Click *Add*.

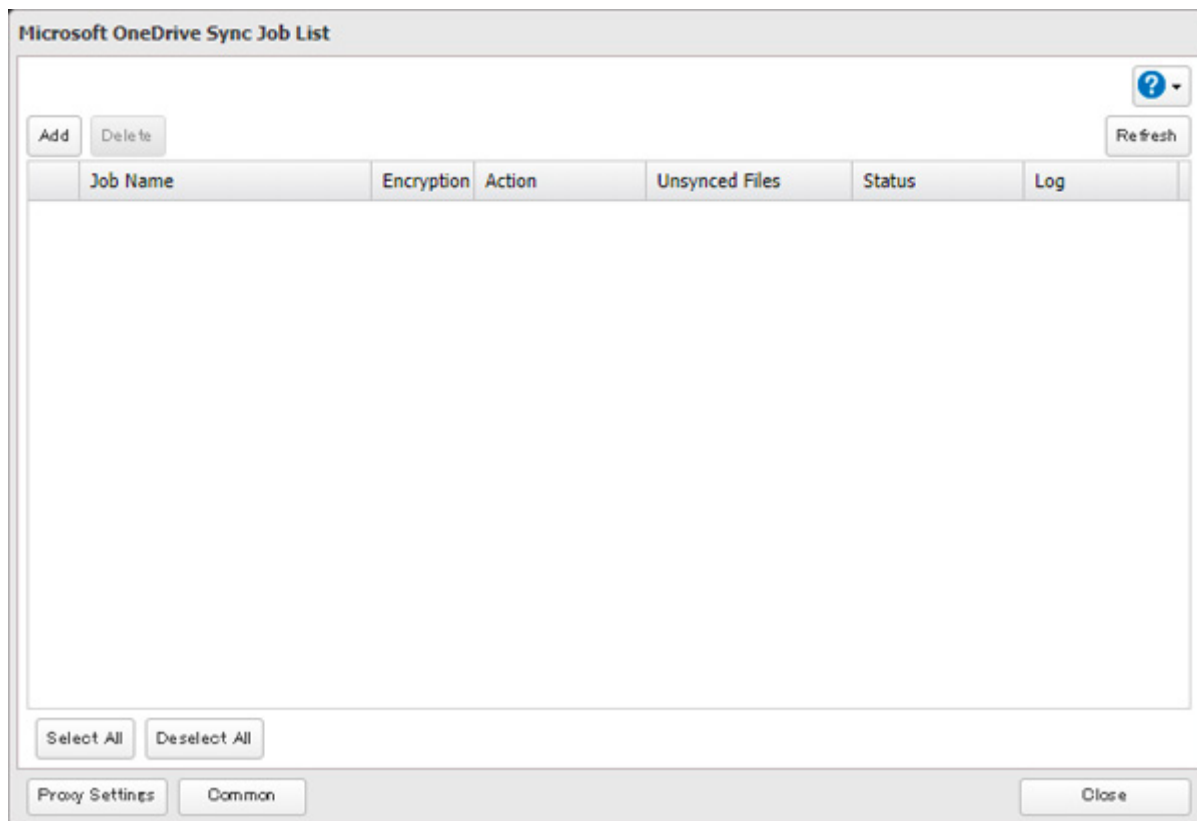

**5** The sign-in window will open. Enter the username and password of your Microsoft account, then sign in.

- 6 Enter the desired job name and click *Next*.

Job Setup Wizard for OneDrive Sync - Step 1 of 10

### Enter a Job Name

Enter a job name to create.

 ?

Next Cancel

- 7 Select the sync action and behavior for when files with the same name are already in the target folder. The behavior for when files with the same name already exist will work when the files that have the same name on both the TeraStation and OneDrive are changed. Click *Next* after configuring.

Job Setup Wizard for OneDrive Sync - Step 2 of 10

### Select Sync Action

Select the sync action for your files.

Bidirectional

Files with Same Names

- Keep files on OneDrive  
If there is a file conflict when syncing, files on OneDrive will be saved over other versions.
- Keep files on the TeraStation  
If there is a file conflict when syncing, files on the TeraStation will be saved over other versions.
- Keep files with newer modified date  
If there is a file conflict when syncing, files with the newer modified date will be saved over other versions.

Back Next Cancel

- 8 Select the desired TeraStation and OneDrive folders. If you want to create an empty folder first, click *Browse* under "Folder on TeraStation", then click *Create Folder* on the selecting folder window that appears. Click *Next* after selecting the folders.

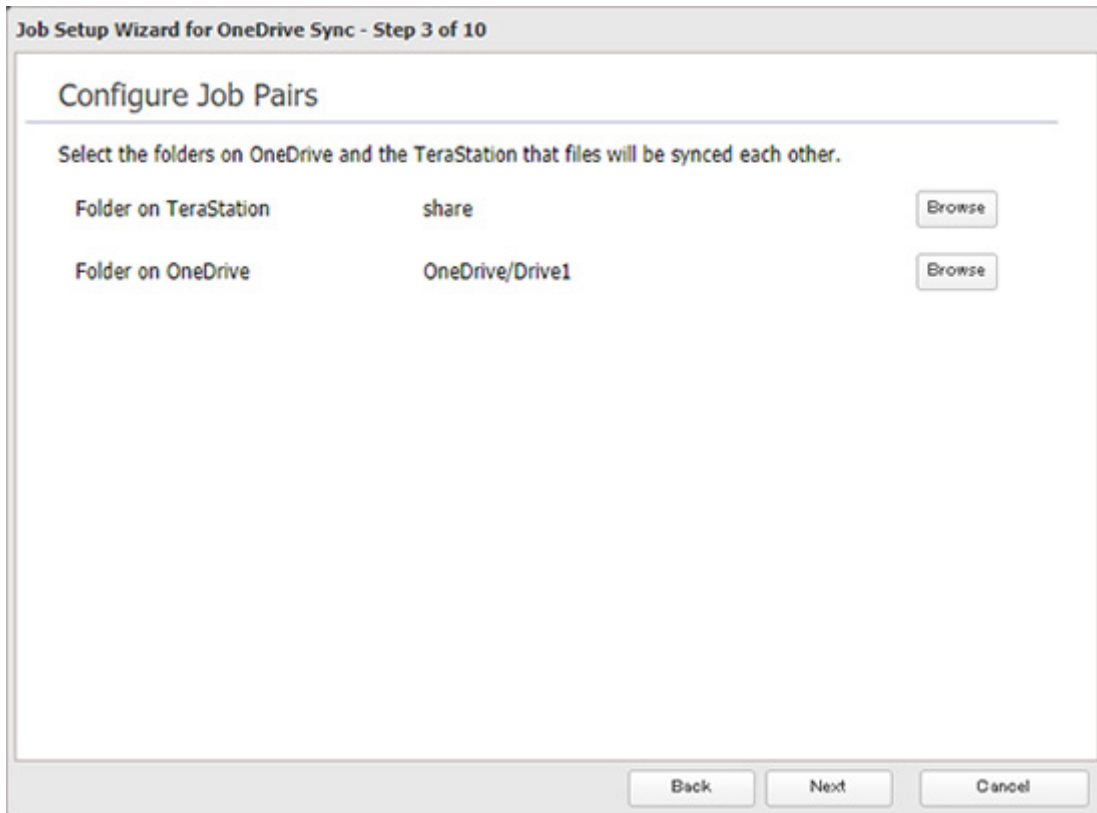

**Note:** The 6th level and deeper of shared and OneDrive folders cannot be selected.

- 9 Specify the sync period and click *Next*.

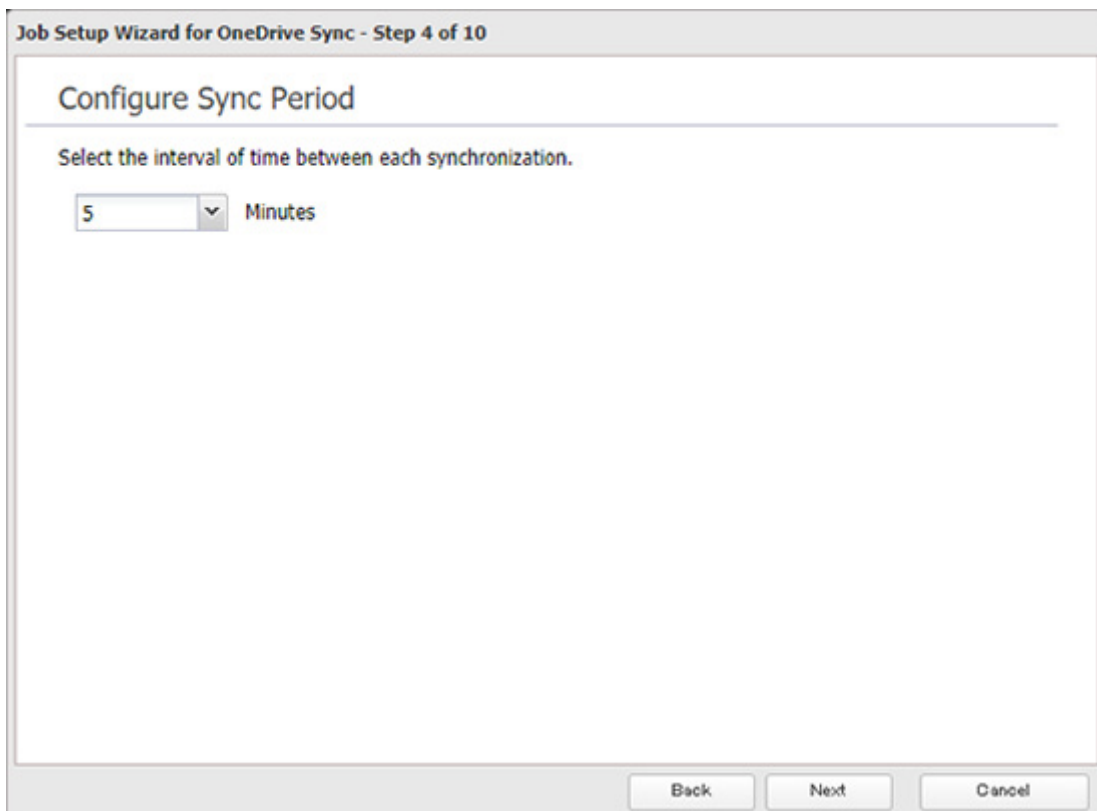



- 10** Files will be uploaded during the start and end time of the period configured in step 9 above. If you want to always upload files during the configured sync period, select “Always sync within the sync period” for “Frequency”. Click *Next* after configuring.

The screenshot shows a dialog box titled "Job Setup Wizard for OneDrive Sync - Step 5 of 10" with the sub-header "Configure Schedule". Below the sub-header is a horizontal line, followed by the instruction: "Configure a schedule for a job. If you select 'Daily' for frequency, specify the start and end time. If you select 'Weekly' for frequency, specify the day of the week and times." The "Frequency" dropdown menu is set to "Daily". The "Start Time" dropdown is set to "01:00" and the "End Time" dropdown is set to "05:00". Under "Day of Week", there are seven checkboxes for "Sunday", "Monday", "Tuesday", "Wednesday", "Thursday", "Friday", and "Saturday", all of which are currently unchecked. At the bottom of the dialog are three buttons: "Back", "Next", and "Cancel".

- 11** Select whether to encrypt the files using a password. When encryption is enabled, uploaded files will be archived in zip format and encrypted using the entered encryption password. Click *Next* after selecting.

The screenshot shows a dialog box titled "Job Setup Wizard for OneDrive Sync - Step 6 of 10" with the sub-header "Configure Encryption". Below the sub-header is a horizontal line, followed by the instruction: "Enable encryption for the files when uploading to OneDrive." There are two radio buttons: "Enable" (which is selected) and "Disable". Below the radio buttons is a text input field labeled "Encryption Password" containing ten asterisks. To the right of the input field is a blue question mark icon. Below the input field is a text box containing the following text: "Setting an encryption password with 10 or more characters is recommended. The encryption password cannot be changed once it's configured. Make sure to manage the password carefully after it has been saved." At the bottom of the dialog are three buttons: "Back", "Next", and "Cancel".

- 12** Select whether to check for file consistency. If an inconsistency occurs with a file between the TeraStation and OneDrive, that file will be updated using the latest file version even if it hasn't been changed. Click *Next* after selecting.

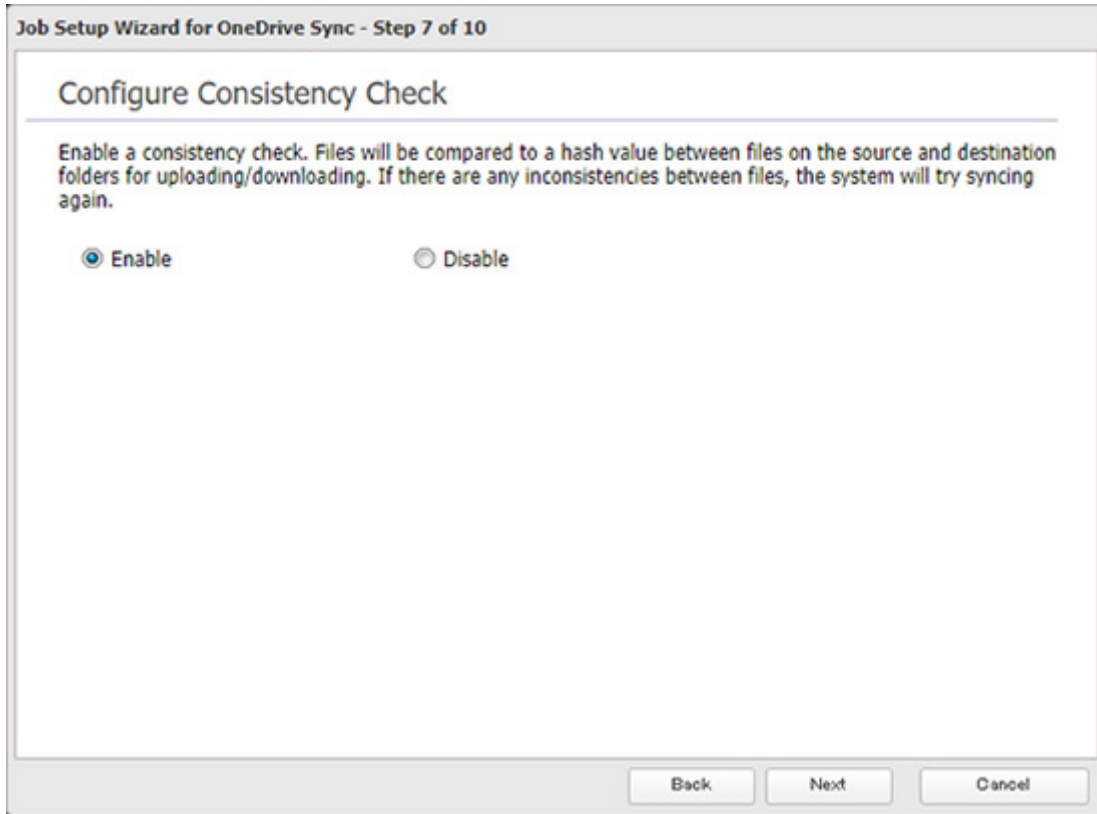

- 13** Configure whether to filter the target files. The following screen is available to configure file filtering by file sizes and whether they're hidden. The file size filtering will work only for the upload process. The available maximum size is up to 15360 MB (15 GB). "Hidden files" refer to files whose filename starts with a period. Configure the desired filtering settings and click *Next*.

The screenshot shows a dialog box titled "Job Setup Wizard for OneDrive Sync - Step 8 of 10" with the main heading "Configure File Filters 1". Below the heading is a sub-heading "Configure File Filters 1" and a descriptive text: "Configure the requirements for filtering files. If any files in the folder on either the TeraStation or OneDrive meet any of the following requirements, those files will not be synced." There are two sections: "Filter by File Size" and "Filter Hidden Files". In the "Filter by File Size" section, the "Enable" radio button is selected, and the "Maximum Size" is set to "1" MB. In the "Filter Hidden Files" section, the "Disable" radio button is selected. At the bottom of the dialog are three buttons: "Back", "Next", and "Cancel".

- 14** The following screen is available to configure file filtering by extensions. Configure the desired filtering settings and click *Next*.

The screenshot shows a dialog box titled "Job Setup Wizard for OneDrive Sync - Step 9 of 10" with the main heading "Configure File Filters 2". Below the heading is a sub-heading "Configure File Filters 2" and a descriptive text: "Configure the requirements for filtering files. If any files in the folder on either the TeraStation or OneDrive meet any of the following requirements, those files will not be synced." There is one section: "Filter by Extensions", where the "Enable" radio button is selected. Below this is a "Filtered Extensions" section containing a list box with the extension "tmp" and a checkbox next to it. To the right of the list box are two buttons: "Add" and "Delete". At the bottom of the dialog are three buttons: "Back", "Next", and "Cancel".

**15** Confirm that all settings are properly configured and click *OK*.

**Notes:**

- Files whose filename contains the symbols " # % & \* / : > < ? \ } { ~ cannot be synchronized. This symbol limitation is based on "Normalization Form Canonical Composition (NFC)". If you copy files that contain these symbols to the TeraStation folder from macOS, the filenames may be converted to different ones that don't contain these symbols.
- Depending on your network environment, you may fail to download larger files. To prevent this issue, divide the file into smaller files or compress the files to a smaller size before uploading them to OneDrive.

## Changing Job Settings

Follow the procedure below to change any job settings you have already configured.

**1** From Settings, click *Cloud Storage*.

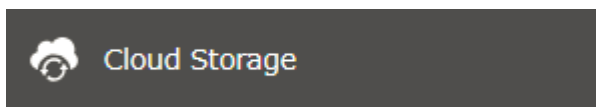

**2** Click  to the right of "Microsoft OneDrive Sync".



**3** From the job list, click the job whose settings you want to change.

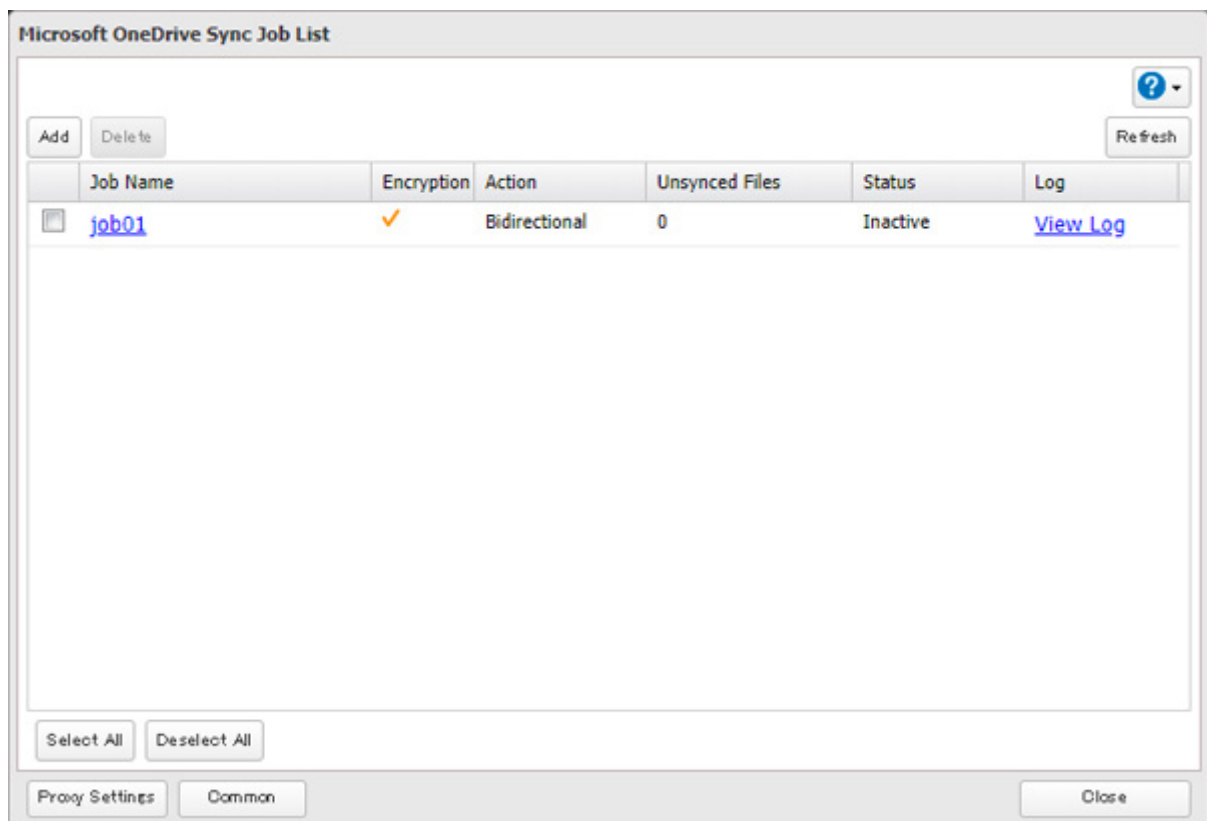

**4** Click the *Options* tab.

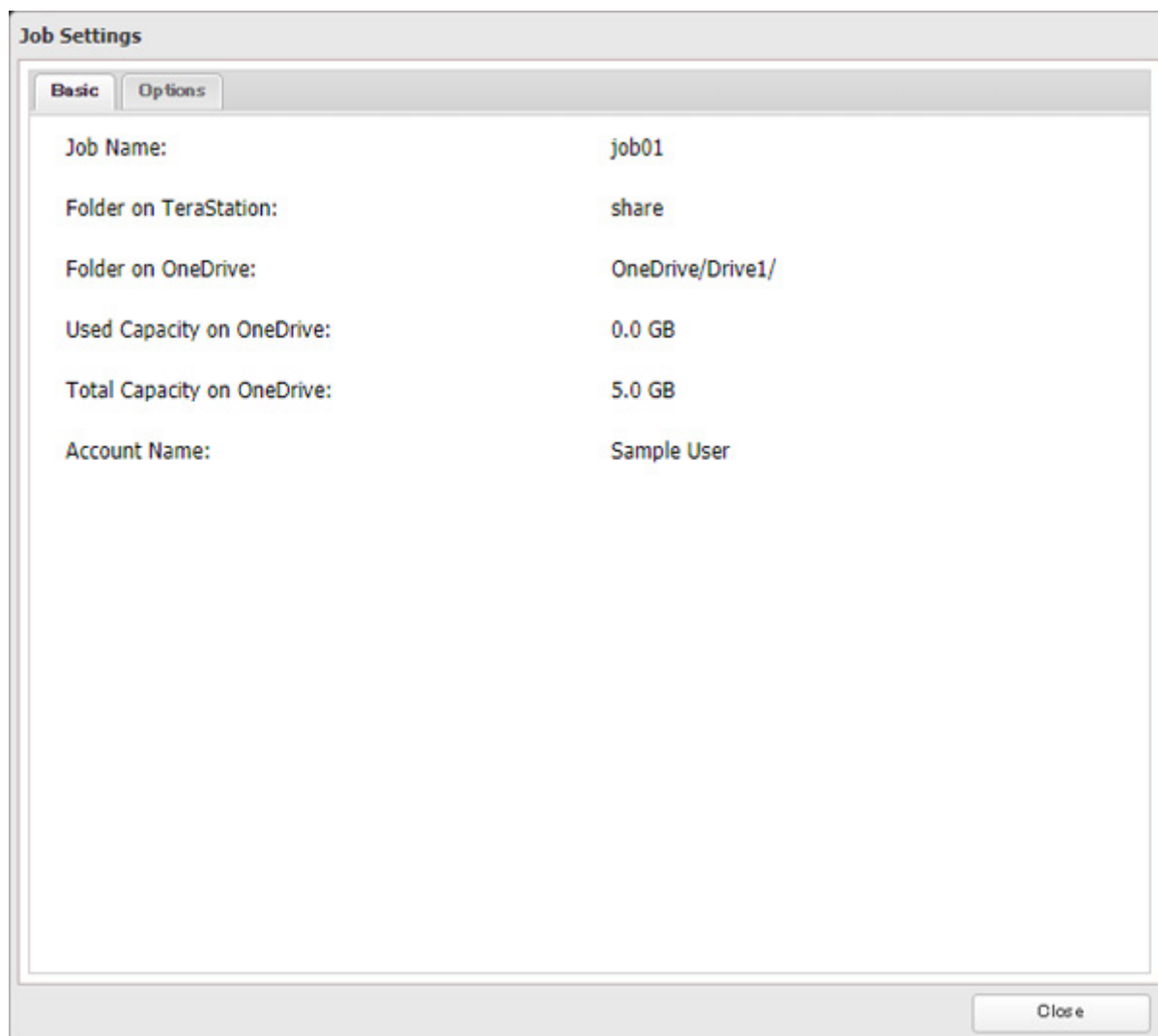

**5** Click *Edit*.

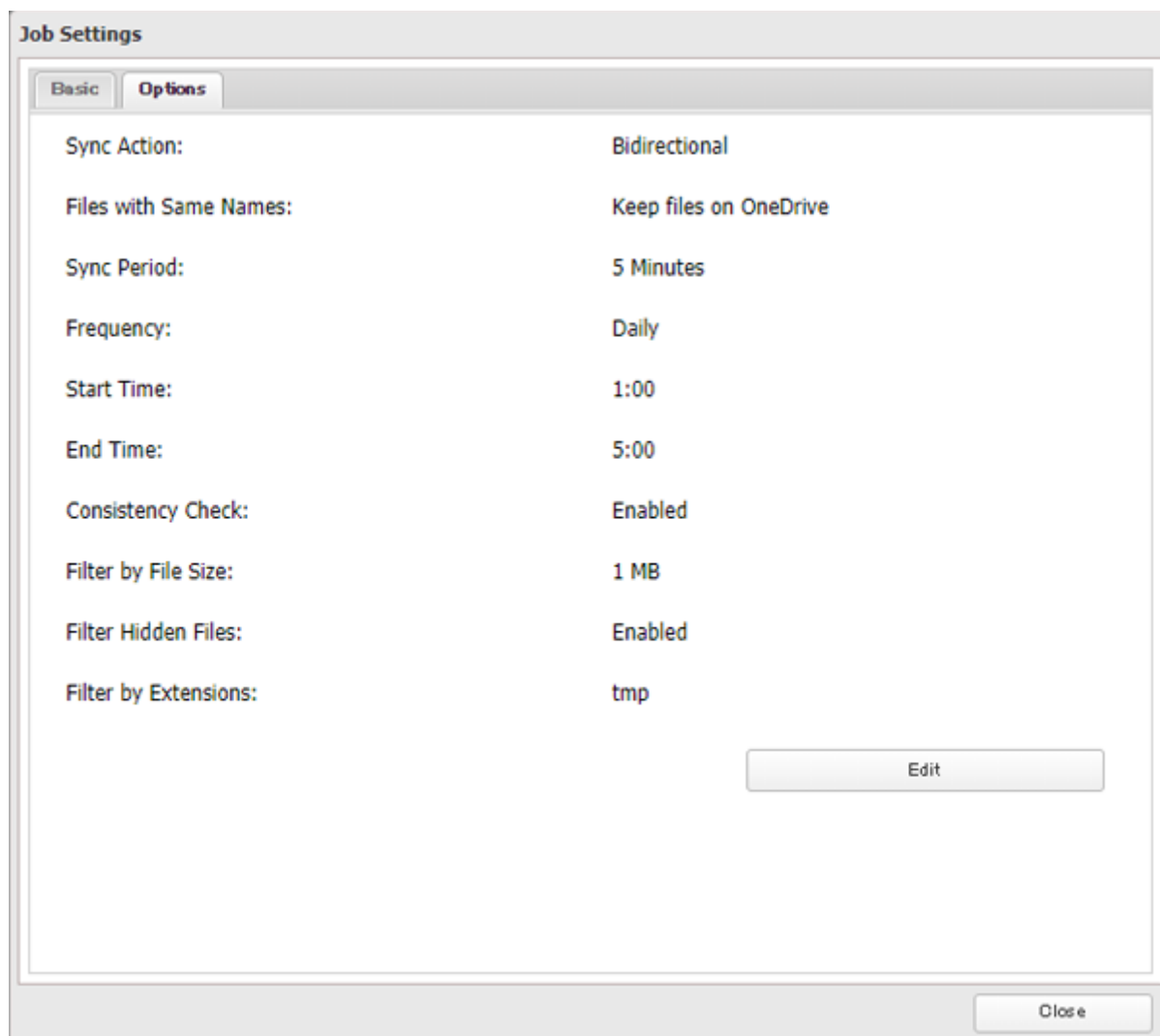

## 6 Configure the desired settings and click OK.

## Corrective Actions for in Case of Error

You may encounter error messages that contain the following error codes when creating OneDrive Sync jobs, or the error log may contain the following error codes as well. If you encounter one of the following error codes, refer to the table below and try the respective corrective action. If the error code is not listed on the table, please refer to the Microsoft website instead; <https://docs.microsoft.com/en-us/onedrive/developer/rest-api/concepts/errors?view=odsp-graph-online>.

Code	Description	Corrective Action
access_denied	Access denied for the requested information.	To link with OneDrive, please consent the request from OneDrive.
server_error	The authentication server encountered a temporary error.	Please try again later.
temporarily_unavailable	The authentication server is too busy.	Please try again later.
authcode_notfound	The authentication server is too busy.	Please wait for about 10 minutes and try again.
auth_server_error	The authentication server encountered a temporary error.	The authentication server will recover within UTC 12:00 midnight–8:45 a.m. (Mon–Fri). Please wait until it recovers.
auth_server_maintenance	The authentication server is currently undergoing maintenance.	The maintenance will finish within UTC 12:00 midnight–8:45 a.m. (Mon–Fri). Please wait until the maintenance finishes.

Code	Description	Corrective Action
activityLimitReached	There are too many requests so data could not be synchronized.	Check that the same Microsoft account is used on another TeraStation or Microsoft applications. This error may be resolved by reducing the maximum number of threads per job on the window that appears by navigating to the job list and then clicking <i>Common</i> .
network_error	Could not register the authentication code.	Check that the network or proxy server settings are correct.
Unexpected error	Unknown error.	Please try again later.



# Chapter 7 Advanced Features

---

## Email Notification

---

Your TeraStation can send you email reports daily, or when settings are changed or an error occurs. You can configure the events that will trigger notifications from any of the following functions: quotas, drives (internal, external, or RAID array), fan, backup, replication, failover, system alert.

Refer to the contextual help in Settings for more detailed information such as when the notification email will be sent or the differences between the notification categories.

- 1 From Settings, click *Management*.

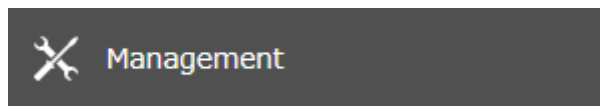

- 2 Move the email notification switch to the  position to enable email notification.



- 3 Click the settings icon (  ) to the right of "Email Notification".

- 4 Click *Edit*.

- 5 Enter your email server settings, notification email's default subject, then configure recipients and the time when email reports will be sent. Click *OK* to send a test email.

If you select an authentication type other than “Disable” from the drop-down list, you can enter the sender email address and credentials of the email server.

**Email Notification**

\*Required ?

SMTP Server Address \* :

SMTP Port \* :

Authentication Type:

Sender Address:

POP3 Server Address:

POP3 Port:

SSL/TLS:

Username:

Password:

Subject \* :

Add Delete Select from List

Recipients * :		Name	Recipients	Class

Select All Deselect All

Send Daily Report at:

OK Cancel

- To change the events of email reports, click *Advanced Report Settings*. On the displayed screen, select or clear the category’s checkboxes.

**Report Settings**

Categories		<input checked="" type="checkbox"/> Daily Report	<input checked="" type="checkbox"/> Info	<input checked="" type="checkbox"/> Notice	<input checked="" type="checkbox"/> Error
Drive Quota	Shared Folder			<input checked="" type="checkbox"/>	
Storage	Internal Drive	<input checked="" type="checkbox"/>	<input checked="" type="checkbox"/>	<input checked="" type="checkbox"/>	<input checked="" type="checkbox"/>
	RAID Array	<input checked="" type="checkbox"/>	<input checked="" type="checkbox"/>	<input checked="" type="checkbox"/>	<input checked="" type="checkbox"/>
	USB Drive	<input checked="" type="checkbox"/>			<input checked="" type="checkbox"/>
Fan					<input checked="" type="checkbox"/>
Backup			<input checked="" type="checkbox"/>	<input checked="" type="checkbox"/>	
Replication				<input checked="" type="checkbox"/>	
Failover			<input checked="" type="checkbox"/>	<input checked="" type="checkbox"/>	
System Alert			<input checked="" type="checkbox"/>		

OK Cancel

The notification emails will be categorized into the following importance levels:

Levels	Details
Daily Report	Describes the status of the TeraStation in a daily report email.
Info	Sends a notification email if an event occurs. Info reports will contain just information such as capacity information, job starts/completes, etc.
Notice	Sends a notification email if a non-critical error occurs. Notice reports will contain warnings such as something has failed, but the function or unit can continue operating as usual. It is recommended to do the corrective action for the notice as soon as possible.
Error	Sends a notification email if a critical error occurs. Error reports will describe critical failure which prevents a function or unit from operating. It is recommended to do the corrective action to for the error immediately.

---

## Sleep Mode

---

To save energy, you can specify times to put the TeraStation into sleep (standby) mode, during which the drive and LEDs are turned off.

- 1 From Settings, click *Management*.

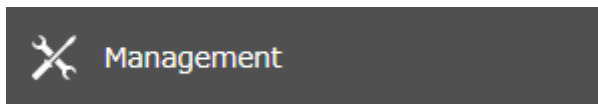

- 2 Click the settings icon (  ) to the right of "Sleep Timer".



- 3 Click *Edit*.

#### 4 Specify the timer interval, wake-up time, and time to go into sleep mode, then click *OK*.

The screenshot shows the 'Sleep Timer Settings' dialog box. It contains three timer configuration sections:

- Timer 1:** Schedule: Weekly. Days: Sunday, Monday, Tuesday, Wednesday, Thursday, Friday, Saturday (all checked). Wake Up at: 07:00. Begin Sleep at: 22:00.
- Timer 2:** Schedule: Disable. Days: Sunday, Monday, Tuesday, Wednesday, Thursday, Friday, Saturday (all unchecked). Wake Up at: 00:00. Begin Sleep at: 00:00.
- Timer 3:** Schedule: Disable. Days: Sunday, Monday, Tuesday, Wednesday, Thursday, Friday, Saturday (all unchecked). Wake Up at: 00:00. Begin Sleep at: 00:00.

Buttons: OK, Cancel

#### Notes:

- Up to three timers can be set.
- The time to enter sleep mode can be set from 12:00 a.m. to 3:45 a.m. of the next day. The time to wake from sleep mode can be set from 12:00 a.m. to 11:45 p.m. If the time to enter sleep mode is after 12:00 a.m., the wake-up time setting may be from 4:00 a.m. to 11:45 p.m.
- The time to enter sleep mode should not be set to the same time as or earlier than the start time.
- If a timer is scheduled during logging in to Settings, checking or formatting a drive, running backup process, or setting backup job within five minutes of the current time, the TeraStation will not change to standby mode when the configured time is reached.
- If scheduled times in the timer overlap, the operation is performed using the widest time interval.
- Examples of timer settings are shown below:
  - **Example 1:**  
If running at a current time of 10:00 a.m. Wednesday  
Timer 1: Daily 12:00–24:00  
Timer 2: Not used  
Timer 3: Not used  
No operation is performed at 12:00 p.m. and the unit goes into sleep mode at 12:00 a.m.
  - **Example 2:**  
If running at a current time of 10:00 a.m. Wednesday  
Timer 1: Daily 9:00–18:00  
Timer 2: Wednesday 10:00–20:00  
Timer 3: Not used  
On days other than Wednesday, normal operation begins at 9:00 a.m. and the unit goes into sleep mode at 6:00 p.m. On Wednesday, the unit goes into sleep mode at 8:00 p.m.

- **Example 3:**

If running at a current time of 10:00 a.m. Wednesday

Timer 1: Daily 9:00–18:00

Timer 2: Wednesday 10:00–1:00 a.m. of the next day

Timer 3: Not used

On days other than Wednesday, normal operation begins at 9:00 a.m. and the unit goes into sleep mode at 6:00 p.m. On Wednesday, normal operation begins at 10:00 a.m. and the unit goes into sleep mode at 1:00 a.m. of the next day.

- **Example 4:**

If running at a current time of 10:00 a.m. Wednesday

Timer 1: Daily 9:00–18:00

Timer 2: Wednesday 7:30–22:00

Timer 3: Not used

On days other than Wednesday, normal operation begins at 9:00 a.m. and the unit goes into sleep mode at 6:00 p.m. On Wednesday, normal operation begins at 7:30 a.m. and the unit goes into sleep mode at 10:00 p.m.

- To wake the TeraStation from sleep mode manually, press and hold the power button for three seconds.

---

## Wake-on-LAN

---

The TeraStation supports Wake-on-LAN, which allows it to be turned on remotely.

- 1** From Settings, click *Network*.



- 2** Click the settings icon (  ) to the right of "IP Address".



- 3** Click *Edit*.

#### 4 Enable “Wake-on-LAN”, then click OK.

Wake-on-LAN:  Enable  
 Disable

Gateway Owner: Assign automatically

Default Gateway Address: 192.168.10.1

DNS Owner: Assign automatically

Primary DNS Server: 192.168.10.1

Secondary DNS Server:

Services Restarted After: 1 seconds

OK Cancel

Wake-on-LAN is now enabled. As long as the TeraStation is connected to a power source and the network, you can turn it on remotely.

#### Notes:

- After receiving the Wake-on-LAN packet, the TeraStation may take approximately five minutes to be ready to use.
- If a power outage occurs while Wake-on-LAN is enabled, the TeraStation will automatically start up after power is restored.
- To use Wake-on-LAN, you'll need Wake-on-LAN software that sends magic packets. The TeraStation does not include Wake-on-LAN software.
- The TeraStation does not support using Wake-on-LAN and port trunking at the same time. You may use either feature, but not both at the same time.
- If the TeraStation is connected to a Buffalo wireless router configured for remote access, then it may be turned on from outside the local network (from the WAN side). To use this feature, connect the router to LAN port 1 or 2 on the TeraStation.

---

## UPS (Uninterruptible Power Supply)

---

If a UPS (sold separately) is attached, the TeraStation can be automatically shut down to protect data in the event of a power outage.

- 1 Plug the power cable of the UPS to a wall socket.
- 2 Connect the power cable of the TeraStation to the UPS.
- 3 Connect the UPS and TeraStation.
- 4 Turn on the UPS, then the TeraStation.
- 5 From Settings, click *Management*.

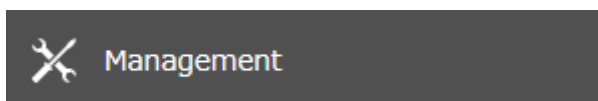

- 6 Click the settings icon (  ) to the right of “Power Management”.

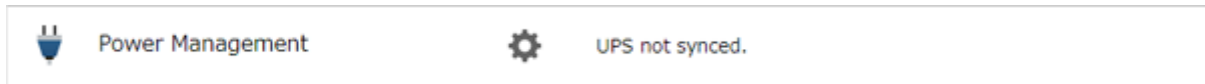

- 7 Click *Edit*.

- 8 Configure the desired settings, then click *OK*.

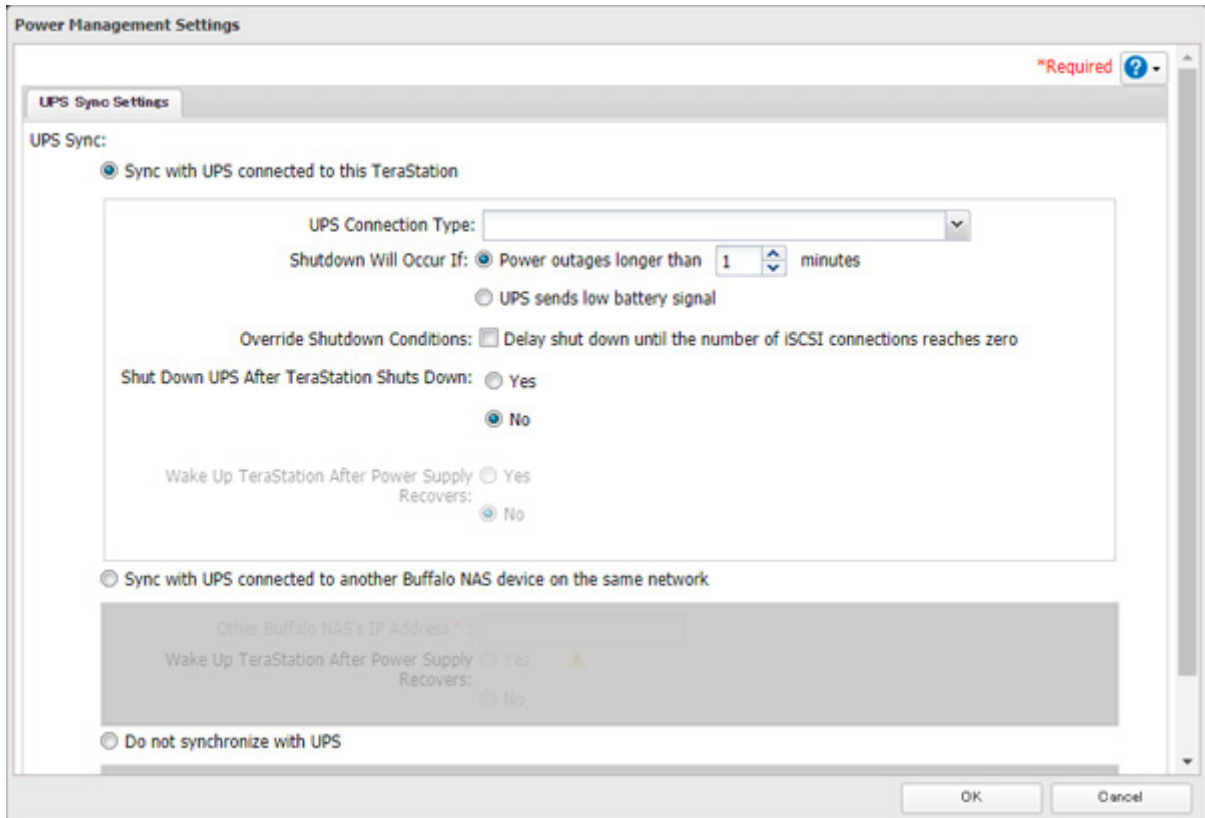

#### Notes:

- If the TeraStation is connected directly to a UPS, select “Sync with UPS connected to this TeraStation”. If a different Buffalo NAS device is connected to the UPS, select “Sync with UPS connected to another Buffalo NAS device on the same network”. After making this selection, enter the IP address of the Buffalo NAS device that will be the sync source into “Other Buffalo NAS’s IP Address”.
- If you don’t want to connect any UPS devices, select “Do not synchronize with UPS” and the operation for if a power supply failure occurs. If “Use last state” at “AC Power Recovery” is selected, the TeraStation will revert to the state before the power supply failure occurs. If “Stay off” is selected, the TeraStation will remain off even after the TeraStation shuts down due to the power supply failure.
- When the TeraStation restarts after an automatic shutdown such as from a power outage or power supply issue, verify that external power has been restored. If the TeraStation is turned on while it is still running on the UPS and external power has not been restored, the automatic shutdown will not be performed, even after the specified time elapses.
- If the power supply from the UPS to the TeraStation stops and restarts when UPS recovery is enabled, the TeraStation will automatically restart.

## Port Trunking

Two Ethernet cables can be used to establish two separate communication routes, providing LAN port redundancy and improving communication reliability. The use of two Ethernet cables enables access to the TeraStation even if one of the cables is disconnected.

The port trunking modes that can be set in the TeraStation are shown below:

Trunking Mode	Characteristics
Active-backup	Only one NIC slave in the bond is active. A different slave becomes active if and only if the active slave fails.
TLB	The outgoing network packet traffic is distributed according to the current load (relative to the speed) on each network interface slave.
ALB	The incoming and outgoing network packet traffic is distributed according to the current load on each network interface slave. The receive load balancing is achieved by ARP negotiation.

**Note:** If the TeraStation is being used as an iSCSI drive, disable iSCSI before changing network settings such as port trunking. Navigate to *Storage > iSCSI* in Settings and move the iSCSI switch to the **off** position temporarily.

**1** Use an Ethernet cable to connect the hub LAN port and TeraStation LAN port.

**Notes:**

- Do not connect the second Ethernet cable to the TeraStation yet.
- If using an intelligent switch, configure the LAN ports on the switch first, before connecting to the TeraStation.

**2** From Settings, click *Network*.



**3** Click the settings icon (  ) to the right of "Port Trunking".

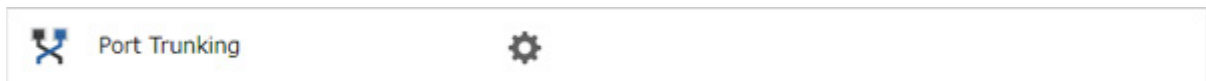

**4** Select the LAN port that will be used and choose a port trunking bond.



- 5 Select the port trunking mode and click *OK*.

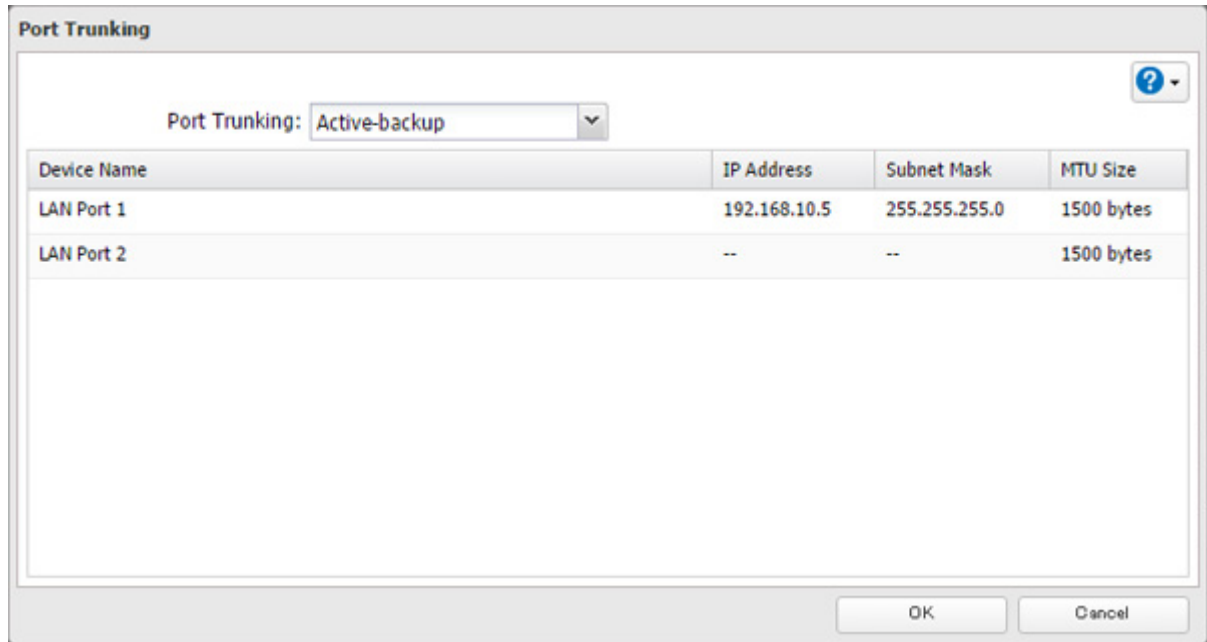

- 6 Connect the hub's LAN port and TeraStation's LAN port using the second LAN cable. If you are using an intelligent switch, connect to the LAN port that was previously configured for port trunking.
- 7 Follow the procedure on the screen to restart the TeraStation.

## Offline Files for Windows

The "offline files" feature that is included with many versions of Windows can be used with files on the TeraStation. You will be able to work on files stored on the TeraStation even when your PC is disconnected from the network. When you next connect to the network, the updated files are written and synchronized. Follow the procedure below to configure offline files.

- 1 From Settings, click *File Sharing*.

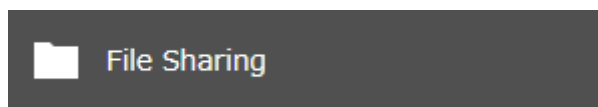

- 2 Click the settings icon (⚙️) to the right of "Folder Setup".



- 3 Click the shared folder for offline files.
- 4 Choose either "Manual caching of documents", "Automatic caching of documents", or "Automatic caching of programs and documents" on the *Option 1* tab, then click *OK*.

**Manual caching of documents:** User selects files that are cached.

**Automatic caching of documents:** Opened files can be cached locally for offline use. Previous versions of files that are not synchronized are automatically replaced by the latest versions.

**Automatic caching of programs and documents:** Opened files can be cached locally for use offline. Previous versions of files and applications executed on the network that are not synchronized are automatically replaced by the latest version of the files and applications.

- From File Explorer, right-click the icon of the shared folder on the TeraStation for which you have set the offline feature, then click *Always available offline*. If the offline file wizard opens, follow the procedure on the screen.

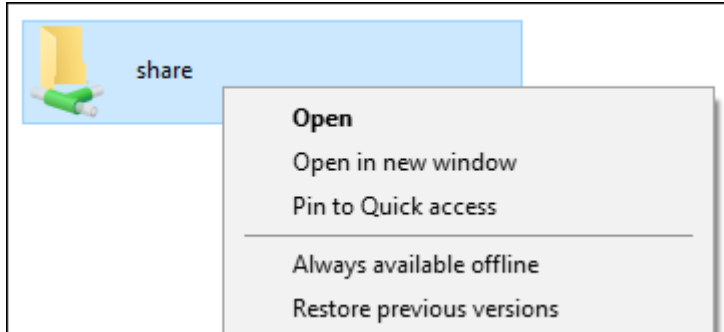

- When the offline settings and synchronization settings are completed, the files and folders set appear as shown:

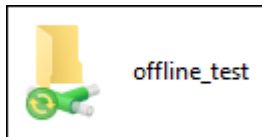

- If the computer is disconnected from the network after synchronization is completed, the offline file function can be used.

Offline files can be accessed by the original Universal Naming Convention (UNC) where the data was saved.

#### Notes:

- If you cannot access offline files, try the following procedure:
  - Reconnect the computer to the network.
  - From Control Panel, change the view to the icon view and click *Sync Center*. Click *Sync All* to synchronize all offline files.
  - Disconnect the computer from the network and verify that you can access offline files.
- If you have configured the recycle bin for the shared folder, temp files may be created in the recycle bin.

---

## Accessing from an NFS Client

---

**Note:** (US customers only) Buffalo's customer support will help configure the NFS settings on your TeraStation, and will support VMware and Windows clients but will not provide support for configuring your Linux or other UNIX clients. There are various types of UNIX and the procedures for configuring NFS with them will vary considerably. For help configuring your NetWare, Linux, or other UNIX clients for NFS support, please consult each client's own documentation and support.

- From Settings, click *File Sharing*.

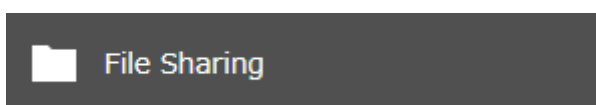

**2** Click the settings icon (  ) to the right of "Folder Setup".

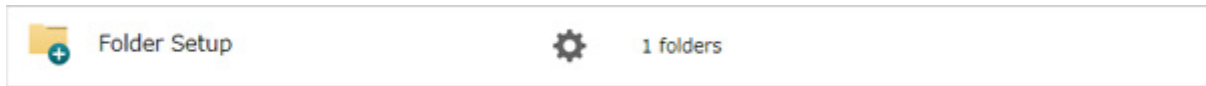

**3** Choose the shared folder that will be accessible from the NFS client.

**4** Under "LAN Protocol Support", select the "NFS" checkbox on the *Basic* tab and click *OK*.  
Note the NFS path. It will be used later for accessing data from an NFS client.

**5** Click *Close*.

**6** Move the NFS switch to the  position to enable NFS.



**7** Click the settings icon (  ) to the right of "NFS".

**8** Click the *Client Settings* tab.

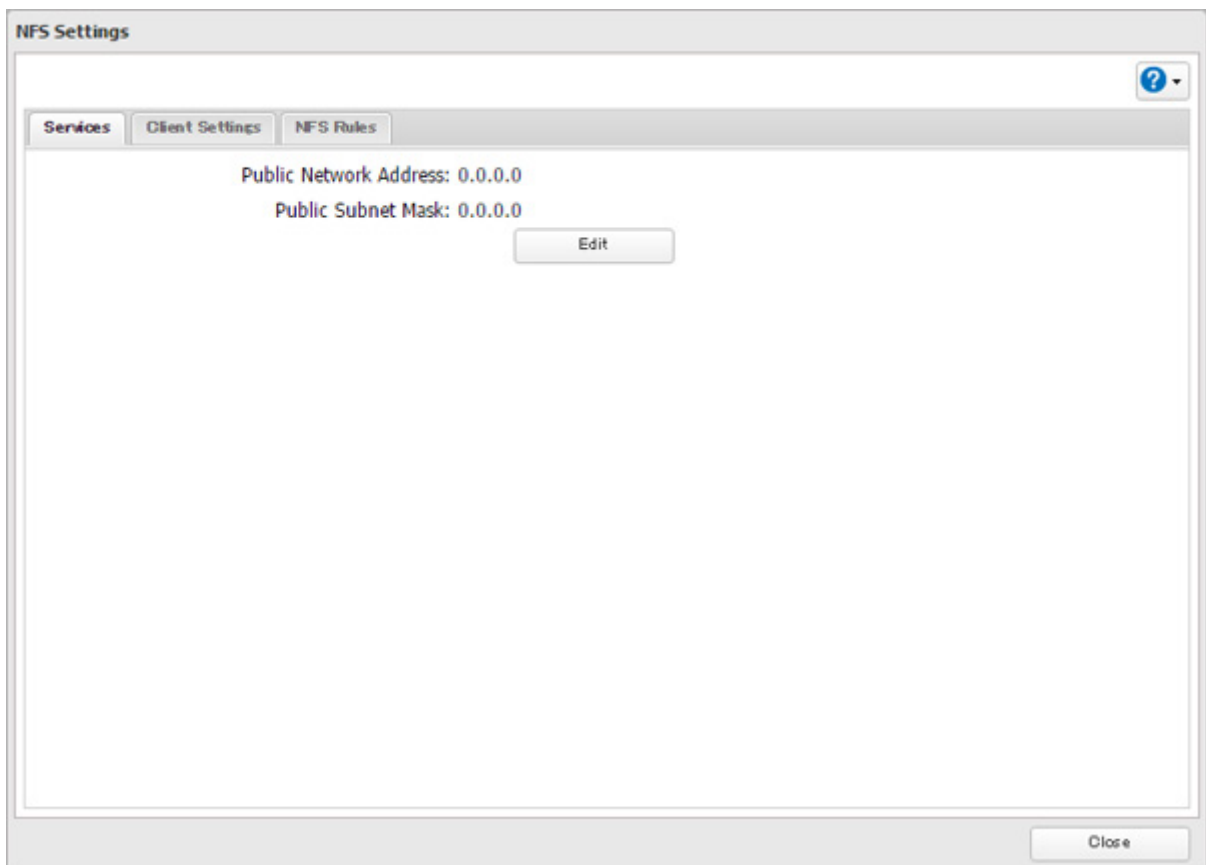

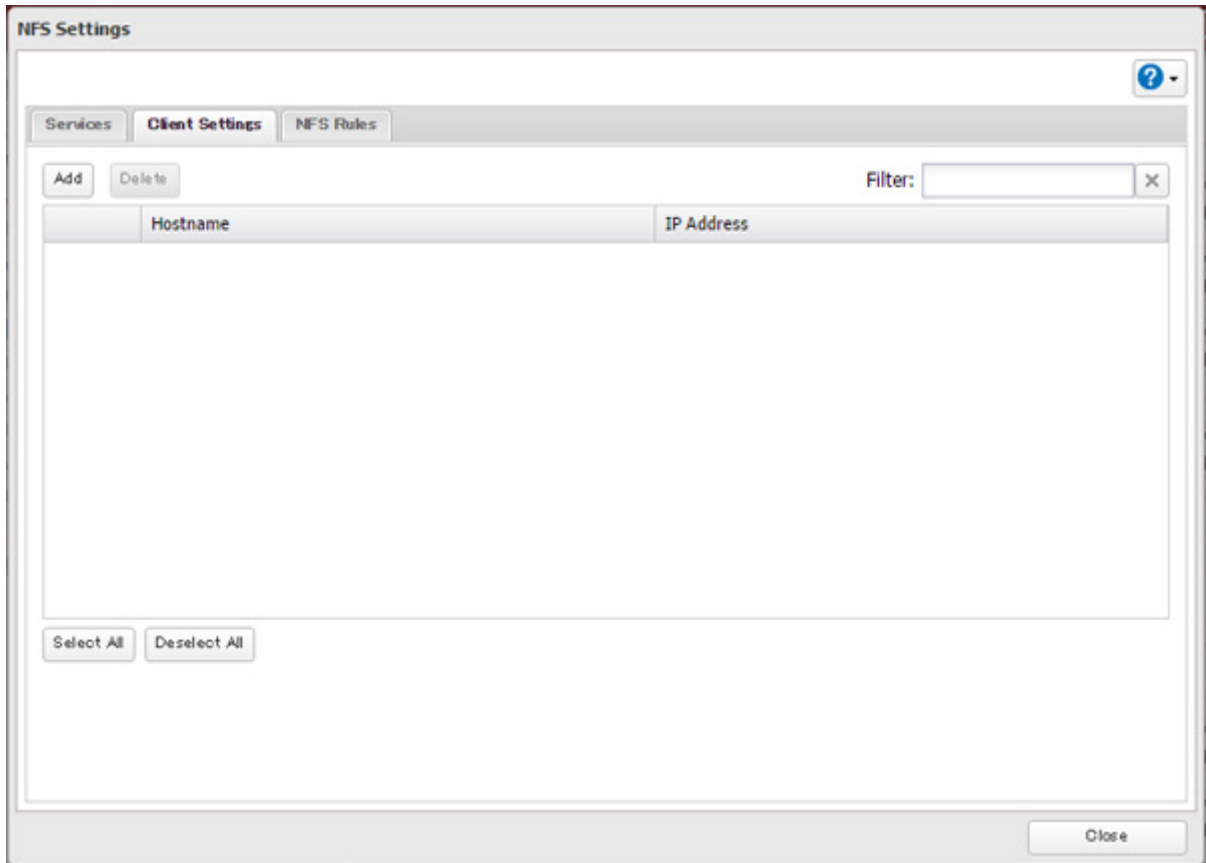
**9** Click *Add*.

**Note:** To delete a client, select the checkboxes of the clients from the lists and click *Delete*.

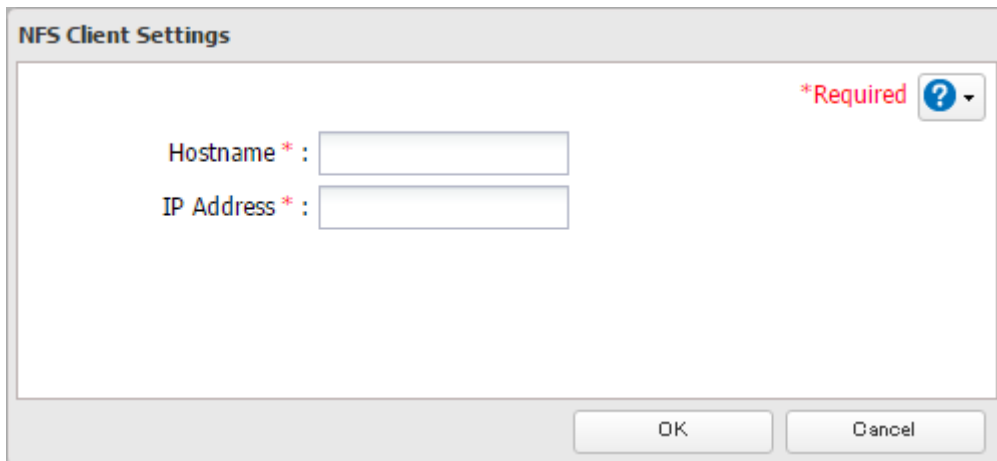
**10** Enter the hostname and IP address of the NFS client, then click *OK*. You should add all NFS clients to access the shared folder.

**11** Click the *NFS Rules* tab.

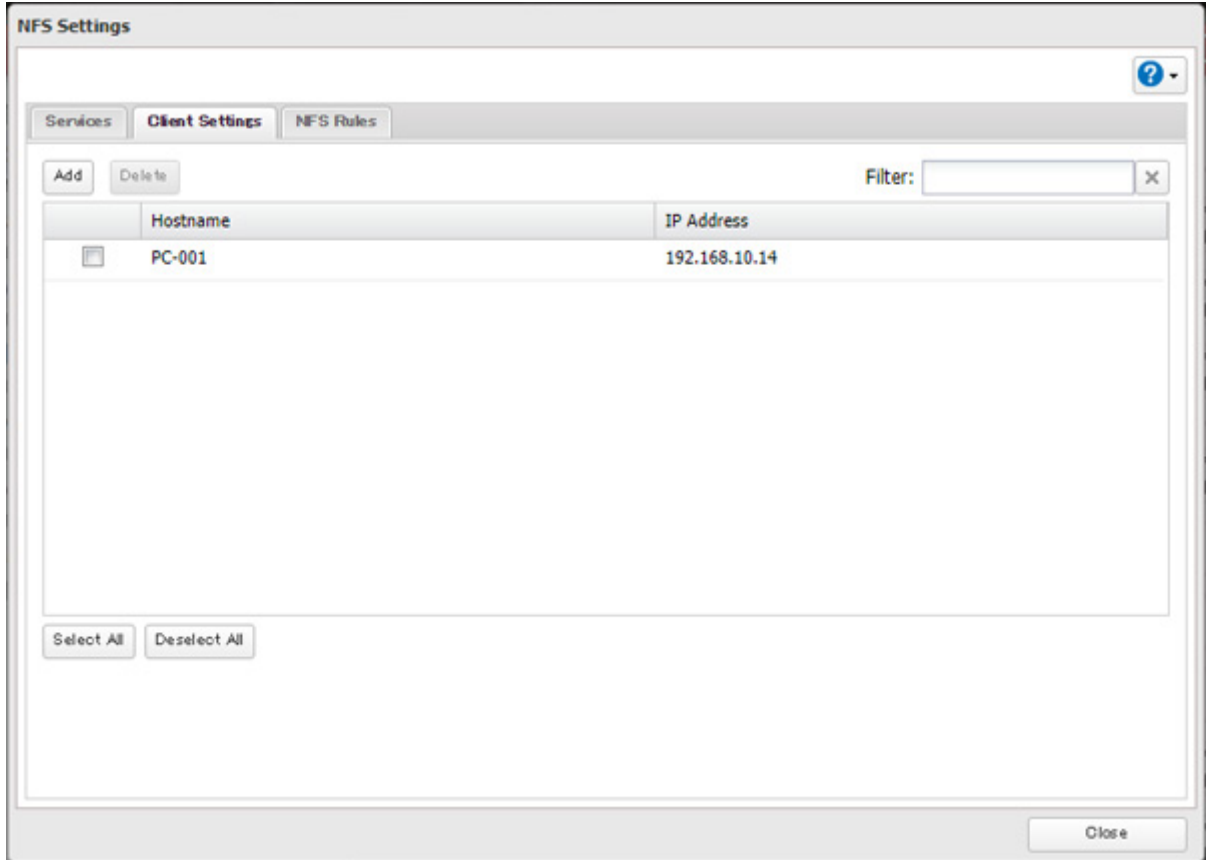

**12** Click *Add*.

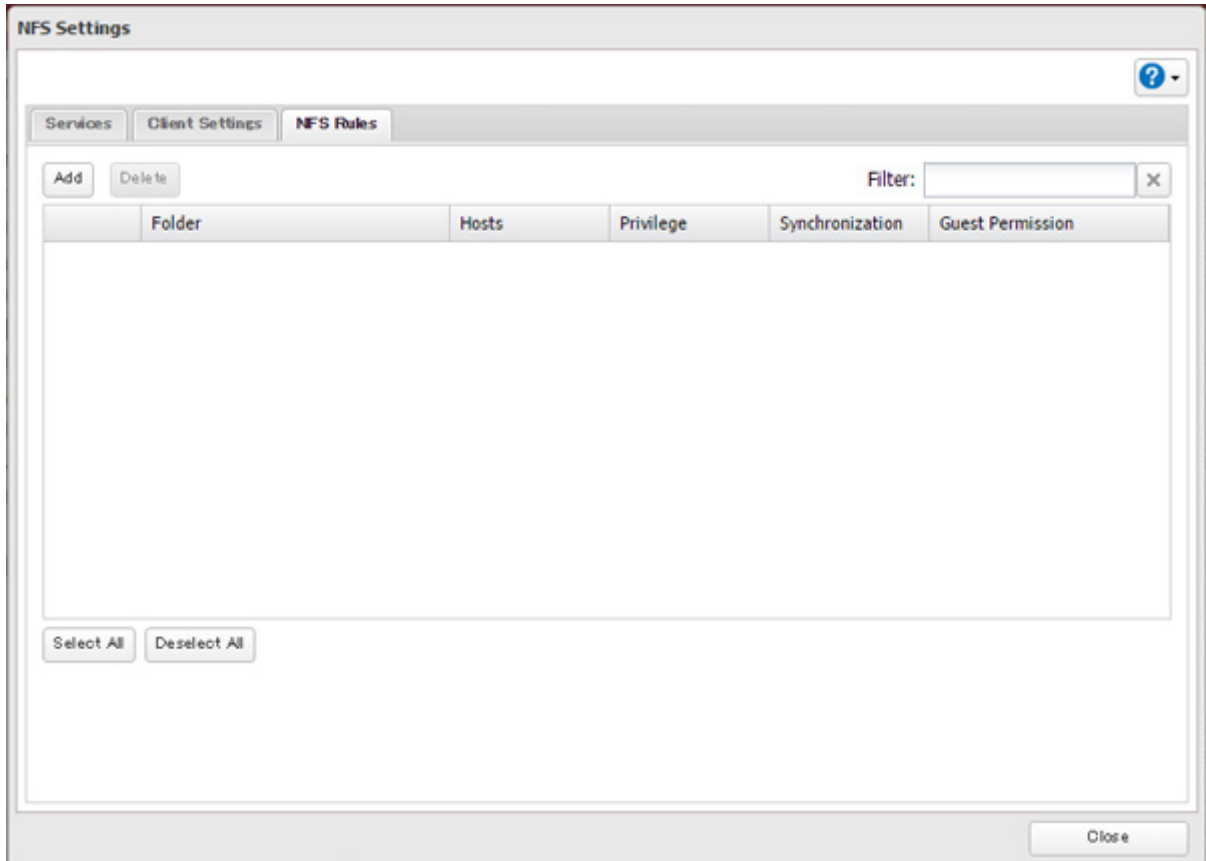

- 13** Choose the folder to restrict access to, and enter the clients that will have restricted access into the “Hosts” field. Clients may be entered by hostname, IP address, or IP address range. Wildcards are supported. Separate multiple entries with commas. You may assign read-only or read and write access to the listed clients. Rules override any settings made from the *Services* tab.

- 14** Click *OK*.

#### Notes:

- To restrict NFS access to a specific network or client, navigate to *File Sharing > NFS > Services* and click *Edit*. Enter the address of the network. For example, if your local network subnet has a router at 192.168.1.1 and clients with IP addresses in the range from 192.168.1.2 through 192.168.1.48 with subnet mask 255.255.255.0, then the “Public Network Address” would be 192.168.1.0 and the “Public Subnet Mask” would be 255.255.255.0. This would mean that only clients on this local network would be able to access the NFS share. If the default settings are used (0.0.0.0 for both the public network address and the public subnet mask), then access to the NFS share will not be restricted.
- If you configure “Guest Permission” to “Forced” on the screen navigating to *NFS Rules > Add*, user ID and group ID should be 65534 when the data is written from NFS clients; this is recommended for SMB or other protocols as well. Use “Ignored” if the TeraStation only enables NFS connection.
- Be aware that some NFS clients may be able to access via NFS although the clients do not exist in the allowed NFS client list.

## NFS Mount Commands

Enter the mount command to access the shared folder from the NFS client. The mount command depends on your operating system. The examples below assume that IP address of your TeraStation is 192.168.11.10, “/mnt/array1/share” is the desired NFS path, and “/mnt/nas” or drive letter “z” is the mount point.

#### For Linux:

```
mount -t nfs 192.168.11.10:/mnt/array1/share /mnt/nas
```

#### For Windows Service for Unix 3.5:

```
mount 192.168.11.10:/mnt/array1/share z:
```

**Note:** A shared folder whose folder name contains multibyte characters cannot be accessed.

#### For Solaris 10:

```
mount -F nfs 192.168.11.10:/mnt/array1/share /mnt/nas
```

#### For macOS:

```
mount -t nfs -o resvport 192.168.11.10:/mnt/array1/share /mnt/nas
```

---

## Encrypting Data Transmission

---

### Encrypting Settings Data

---

All communication with Settings can use SSL encryption if you access the Settings page by changing “http://” to “https://” in the browser address bar or click *Secure Connection* from the login window. Once you are logged in using the HTTPS connection and wish to disable SSL encryption, click *Normal Connection* from the login window.

### Encrypting FTP Transfer Data

---

You can encrypt passwords using SSH for secure FTP communication. First, open a shared folder’s settings; under “LAN Protocol Support”, select the “SFTP” checkbox on the *Basic* tab and click *OK*. Also, you have to enable the SFTP service by moving the SFTP switch to the **on** position on “File Sharing”.

**Note:** If SFTP is enabled, guest users and anonymous users will not be able to access shared folders.

### SSL Keys

---

SSL keys are used during setup screen operations and FTP communication. SSL (Secure Socket Layer) is a type of encryption system called public key encryption. Generally, SSL is managed by the two files below.

#### server.crt (SSL Certificates)

The TeraStation sends the file to a computer, and the computer uses it to perform encryption. The TeraStation receives the encrypted data and uses server.key (the private key) to decrypt the data.

In SSL, this key contains the server certificate, and depending on your computer environment, a check may be performed to determine the trustworthiness of the certificate. The server certificate included in the TeraStation’s default settings was created by Buffalo, and in some cases, the security certificate warning message may appear in your browser or another security software. Disregard this message and continue.

**Note:** Use TLS 1.2 SSL Certificate.

#### server.key (SSL Private Key)

This file is used as a pair with server.crt (server certificate). This is required for decrypting the data that was encrypted by the server certificate, and this is normally not revealed.

**Note:** The passphrase for the private key must be removed before importing to the TeraStation.

### Updating SSL Key Files

To update a server certificate and a private key for SSL, follow this procedure.

- 1** From Settings, click *Management*.
- 2** Click *SSL*.
- 3** Register “server.key” for “Secret Key” and “server.crt” for “Server Certificate (.crt)”, then click *Import*.

#### Notes:

- Place the SSL key files (server.key, server.crt) directly below the C root drive. The SSL key files may be unable to be updated if it is placed in folders or paths that contain multibyte characters.
- If Settings cannot be displayed after updating, initialize the TeraStation settings.
- Updating the firmware initializes an SSL key.

## SNMP

If SNMP is enabled, you can browse your TeraStation from SNMP-compatible network management software.

- 1 From Settings, click *Network*.



- 2 Click the settings icon (⚙️) to the right of "SNMP".

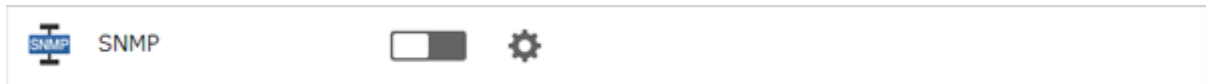

- 3 Click *Edit*.

- 4 Select whether to use SNMP version 2 or version 3.

**SNMP Settings** \*Required ?

Use SNMPv2

SNMP Community Name \* :

Trap Notify:  Enable  
 Disable

Trap Settings

Trap Notify Community Name \* :

Trap Notify IP Address \* :

Use SNMPv3

Username \* :

Authentication and Privacy Protocol: SHA / AES

Authentication and Privacy Password \* :

Password (Confirm) \* :

- 5 Configure the desired settings, then click *OK*.

- 6 Move the SNMP switch to the position to enable SNMP.





**7** SNMP has been configured for the TeraStation. For further use, configure your SNMP-compatible network management software using the Buffalo-specific MIB (management information base) file. The MIB file is available from the [Buffalo website](#).

Depending on which SNMP client software you use, the procedure for configuring the software will differ. For more detailed information on configuring the client software, refer to its help or included manual.

## Saving and Applying Settings

The TeraStation's settings can be saved to a USB drive and restored to another TeraStation of the same series. Use this feature to back up and copy settings to a new TeraStation.

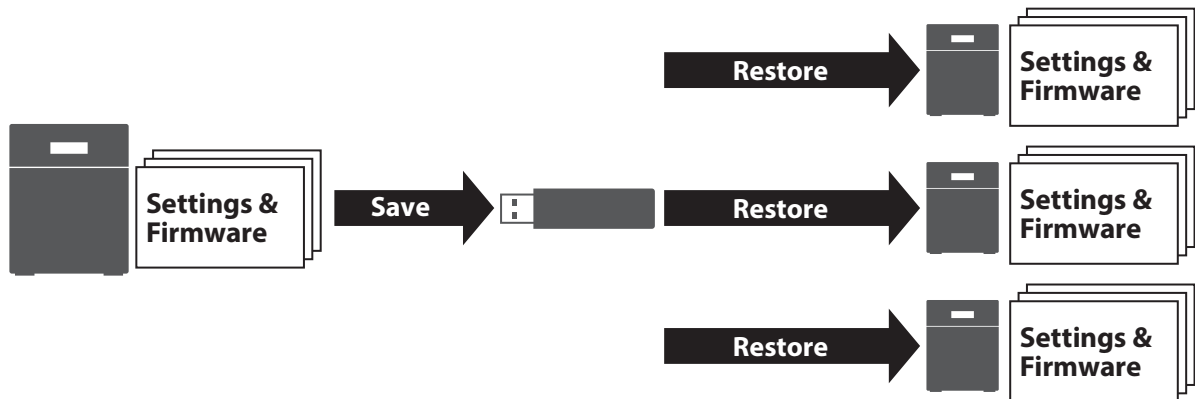

Write down the drive configuration (number of drives, RAID, LVM, etc.) of the TeraStation whose settings were saved. Make sure that any TeraStations that you apply these settings to have exactly the same drive configuration before you apply the settings. If the drive configuration is different, you may get unexpected results.

The following settings are not saved or restored:

Category	Settings
File Sharing	Subfolders' access restriction settings in the shared folders
	All settings for USB drives
	All settings in "Snapshots"
Storage	All settings in "Drives"
	All settings in "LVM"
	All settings in "iSCSI"
	USB drive information
Cloud Storage	Job settings of Dropbox Sync
	Job settings of Microsoft OneDrive Sync
Network	All settings except for service port restrictions, Wake-on-LAN, and MTU size settings in "IP Address"
	All settings in "Port Trunking"
Backup	All settings in "Failover"
Management	The TeraStation's hostname
	All settings in "Power Management"
	All settings in "SSL"
	Display language in Settings

## Saving Settings

**1** Insert a 1 GB or larger USB drive (not included) into a USB port on the TeraStation.

**Note:** All data on the USB drive will be erased!

**2** From Settings, click *Management*.

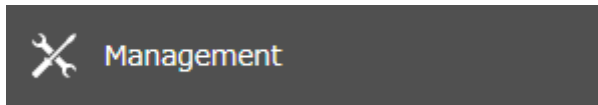

**3** Click the settings icon (  ) to the right of "Configuration Management".



**4** Select "Save current configuration to a USB drive".

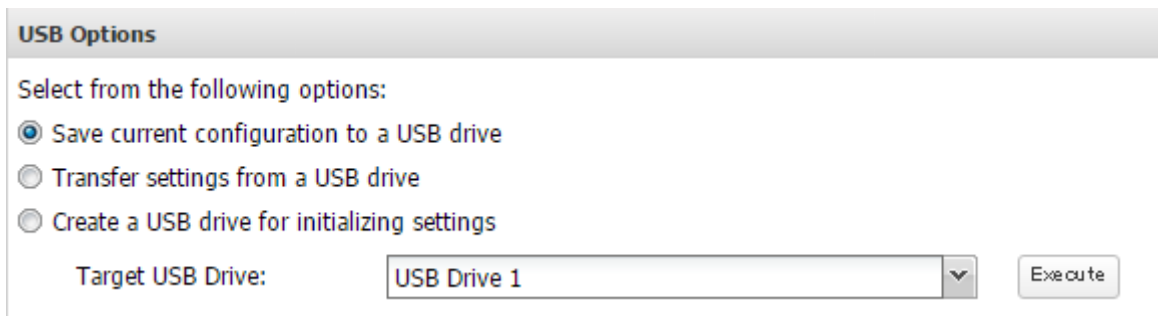

**5** From "Target USB Drive", select the USB drive that is connected to the USB port on the TeraStation, then click *Execute*.

**6** The "Confirm Operation" screen will open. Enter the confirmation number, then click *OK*.

**7** The TeraStation will save the settings. When saving settings is completed, click *OK*.

## Troubleshooting:

If the settings are not saved to the USB drive successfully, you may receive an error message such as "The specified operation cannot be executed.". Verify:

- The USB drive has a capacity of 1 GB or larger.
- The USB drive is not write-protected.
- Failover is configured on the TeraStation.

## Applying Settings

---

The saved settings can be applied to a different TeraStation of the same series. If applying settings to another TeraStation, the unit's current firmware version will be changed to the version used to save the settings.

**1** Insert the USB drive with the saved settings to a USB port on the TeraStation.

**2** From Settings, click *Management*.

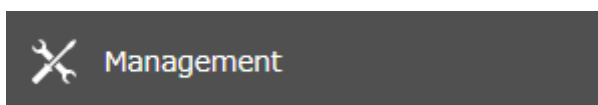

- 3** Click the settings icon (  ) to the right of “Configuration Management”.



- 4** Select “Transfer settings from a USB drive”.

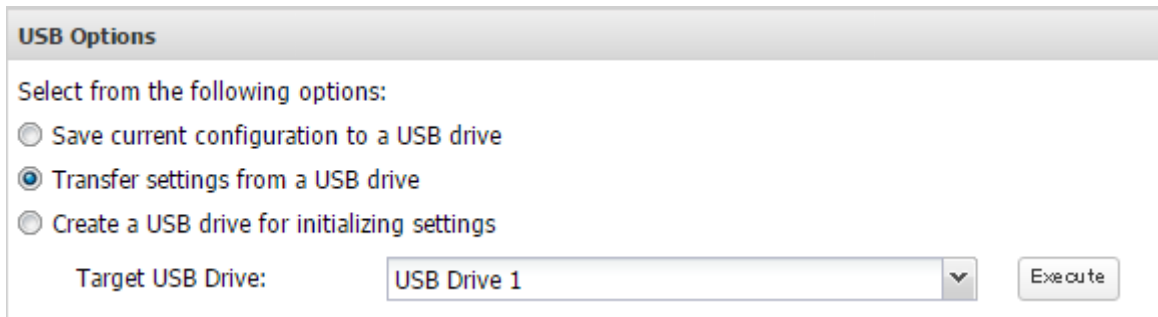

- 5** From “Target USB Drive”, select the USB drive that is connected to the USB port on the TeraStation, then click *Execute*.
- 6** The “Confirm Operation” screen will open. Enter the confirmation number, then click *OK*.
- 7** The TeraStation will apply the settings. When applying settings is completed, click *OK*.

---

## Transferring Another TeraStation’s Settings

---

You can transfer saved settings from another series TeraStation to your TeraStation. The following settings can be transferred:

- Shared folders which are created from “File Sharing” > “Folder Setup”
- Access restrictions
- Users
- Groups

**Note:** This feature currently supports the following TeraStation series as of November 2018. The latest compatibility information will be on the [Buffalo website](#).

- TS-X series firmware version 1.58 or later
- TS3000 series
- TS4000 series
- TS5000 series
- TS3010 series
- TS5010 series
- TS6000 series

---

## Creating a Config File (.nas config)

---

### Procedure for TS-X Series

To transfer settings from TS-X series TeraStations, it will use the “NS-SHFT” software to create a config file. The NS-SHFT can be downloaded from the [Buffalo website](#).

For the procedure on creating the config file, refer to the NS-SHFT user guide.

## Procedure for TeraStations Other Than TS-X Series

Follow the procedure below to create a config file on a TeraStation that is not a TS-X series.

- 1** Refer to the user manual of the TeraStation that you want to transfer settings for saving settings to a USB drive.
- 2** Access the “usbdisk x” shared folder while connecting the USB drive to the TeraStation whose settings were saved in the previous step. The “x” in the folder name represents the USB port number you connected the drive to.
- 3** Copy and paste the .nas\_config file to the desired location on your computer.

## Transferring Settings

Follow the procedure below to transfer settings from another series TeraStation.

- 1** Before transferring access restrictions with Active Directory domain users, make sure the migration target TeraStations are joined to the same domain controller. To have the unit join the domain network, refer to the procedure on the “[Active Directory](#)” section in chapter 3.  
If you didn’t configure access restrictions with Active Directory domain users, skip to the next step.

- 2** From Settings, click *Management*.

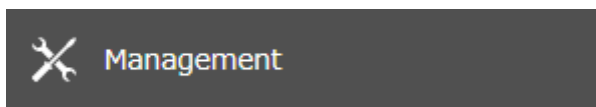

- 3** Click the settings icon (  ) to the right of “Configuration Management”.



- 4** Click *Browse* and choose the config file (.nas\_config) that was created with the migration source TeraStation. If the config file was created with a password, enter it into the “Password” field.

**Configuration Migration**

Migrate another TeraStation's users, groups, shared folders, and access restriction settings. Select the config file (.nas\_config) that was saved on the other TeraStation.  
 Note: If the migration source TeraStation is configured with Active Directory, this TeraStation should also have the same configuration, or else migration will not work.

For detailed information about compatible products for migration or the procedure to save the config file, refer to the [user manual](#).

Config File (.nas\_config):

Password:   
 (if needed)

- 5** Click *Import*.
- 6** The “Confirm Operation” screen will open. Enter the confirmation number, then click *OK*.
- 7** The TeraStation will transfer the settings. When transferring settings is completed, click *OK*.

**Notes:**

- If the migration target TeraStation contains shared folders, users, and groups that share the same name as the transferred settings, the existing settings will be overwritten. If the users and groups meet the following conditions, the settings will not be transferred: users that share the same name with groups already existing on the migration target TeraStation, and groups that share the same name with users on the migration target TeraStation.
- If the migration target TeraStations have already added some shared folders, users, and groups, the transferred settings may exceed the maximum number of allowed shared folders, users, or groups. After migration finishes, open Settings and verify that all settings were properly transferred.

---

## Restoring Factory Defaults

---

### Initializing from Settings

---

To initialize the TeraStation to its factory defaults from Settings, follow this procedure.

- 1 From Settings, click *Management*.

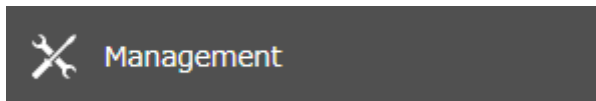

- 2 Click the settings icon (  ) to the right of "Restore/Erase".



- 3 Click *Initialize TeraStation*.

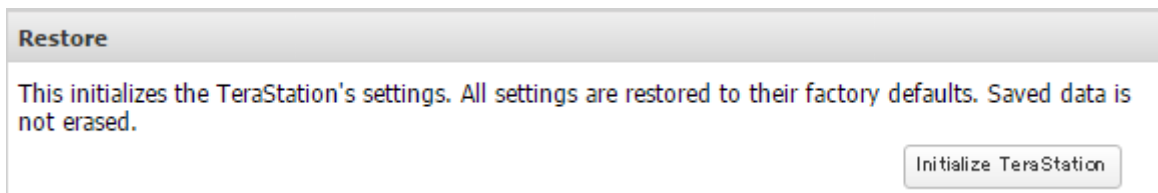

- 4 The "Confirm Operation" screen will open. Enter the confirmation number, then click *OK*.
- 5 The TeraStation will restore its factory default settings. The I26 message will appear on the LCD panel when restoring settings. When it disappears, the initialization is completed.

### Initializing with the USB Initialization Drive

---

An initialization drive will restore the settings on your TeraStation to their factory defaults. You can initialize them without logging in to Settings. Follow the procedure below to create an initialization drive.

**Notes:**

- Initializing settings with the USB drive is available for the same TeraStation unit that created the initialization drive.
- Normally, making and using an initialization drive will not affect data on the TeraStation. However, always back up your data regularly!
- This USB drive can be used to recover the system if your TeraStation doesn't boot at all. In this case, if the data partition is damaged, then all your data will be deleted by the recovery process.

## Creating an Initialization Drive

**1** Insert a 1 GB or larger USB drive (not included) into a USB port on the TeraStation.

**Note:** All data on the USB drive will be erased!

**2** From Settings, click *Management*.

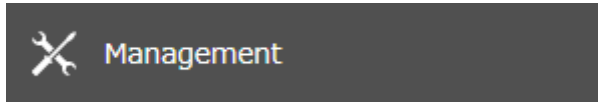

**3** Click the settings icon (  ) to the right of "Configuration Management".



**4** Select "Create a USB drive for initializing settings".

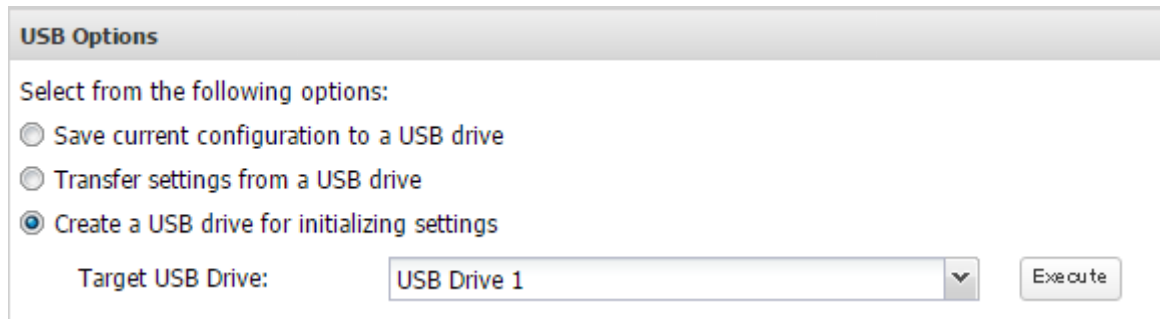

**5** From "Target USB Drive", select the USB drive that is connected to the USB port on the TeraStation, then click *Execute*.

**6** The "Confirm Operation" screen will open. Enter the confirmation number, then click *OK*.

**7** The TeraStation will create the initialization drive. This will take about a minute. When creating the USB initialization drive is completed, refresh the browser and log in to Settings again.

## Initializing with the USB Drive

To initialize the settings on your TeraStation with the USB drive as created above, follow the procedure below.

**Note:** If using the initialization drive to initialize, the unit's current firmware version will be changed to the version used to create the initialization drive.

**1** Turn off the TeraStation by pressing and holding the power button for three seconds.

**2** Insert the USB drive into a USB port on the TeraStation. Make sure that no other USB drives are currently connected to any USB ports on the TeraStation.

**3** Power on the TeraStation while holding down the function button.

**4** When the I41 message appears on the LCD panel, press the function button.

**5** The TeraStation will initialize the settings. The I37 message will appear on the LCD panel when initializing settings. When the initialization is completed, the TeraStation will restart automatically.

Dismount the USB drive before unplugging it. Refer to the [“Dismounting Drives”](#) section in chapter 4 for the procedure on dismounting drives.

## Resetting the Administrator Password

If you forget the admin username or password and cannot log in to Settings, or wrong network settings are configured and Settings becomes inaccessible, initialize these settings by holding down the init button (refer to the TeraStation diagram in chapter 1) on the front panel for three seconds. Normally this will reset the admin username and password, IP address settings other than Wake-on-LAN, port trunking, SSL, and security port settings to their factory default values.

This button can be disabled in Settings; to do so, navigate to *Management > Restore/Erase > Edit* under “Init Button Settings”, then select “Keep current admin username and password” and click *OK*.

## Logs

### Displaying TeraStation’s Logs

Follow the procedure to check the TeraStation’s logs.

- 1 From Settings, click *Management*.

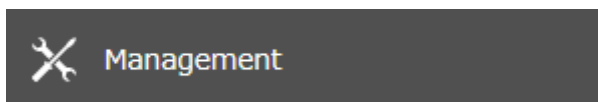

- 2 Click the settings icon (  ) to the right of “Logs”.



- 3 Select a log to view.

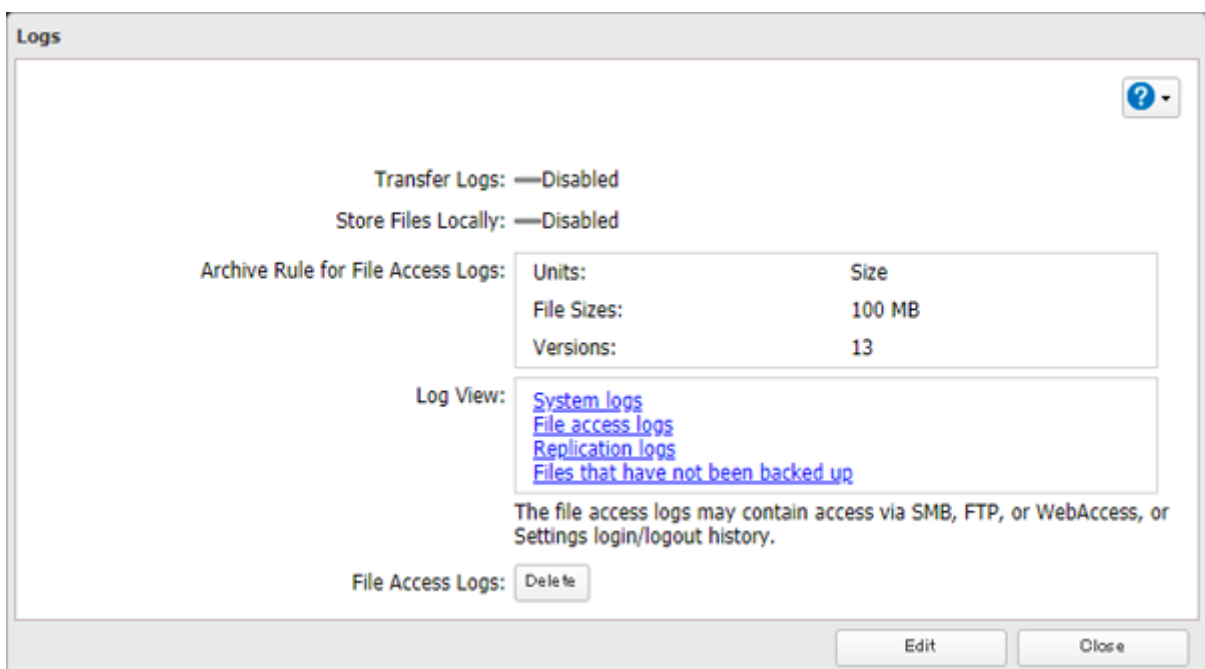

The file access log stores file access events that occurred on the internal drives. File access on USB drives are not logged.

**Note:** All logs are encoded in UTF-8 format. To show them correctly, change the software encoding to “UTF-8”.

## Transferring Logs to the Syslog Server

**1** From Settings, click *Management*.

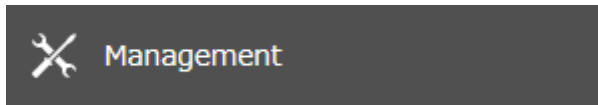

**2** Click the settings icon (  ) to the right of “Logs”.



**3** Click *Edit*.

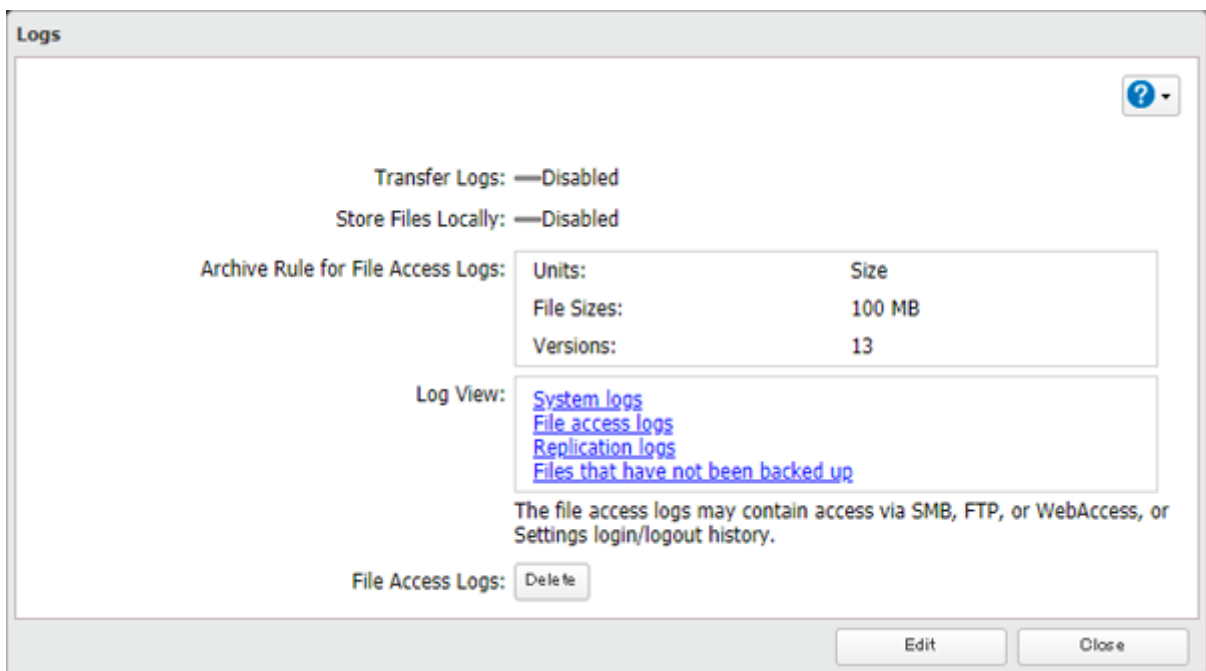



**4** Enable “Syslog Transfer”.

**Logs** \*Required ?

**Syslog Transfer:**  Enable

Syslog Server IP Address \* :

Logs to Transfer:  System logs  
 File access logs

Disable

**Share Link to Logs:**  Enable

Target Shared Folder \* :  Browse

Disable

**Archive Rule for File Access Logs:**

Units:  Day  Week  Month  Size

File Sizes \* :  MB

Versions \* :

Archive Size: 1300 MB

**5** Enter the IP address of the syslog server where you want to transfer the logs to.

**6** Select the type of log that you want to transfer from “Logs to Transfer”.

**7** Click *OK*.

## Creating a Link to the Logs in the Shared Folder

**1** From Settings, click *Management*.

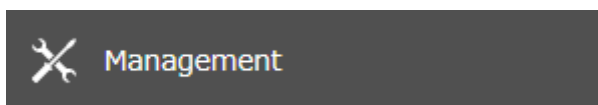

**2** Click the settings icon (  ) to the right of “Logs”.

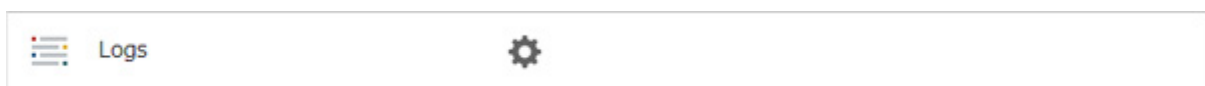

**3** Click *Edit*.

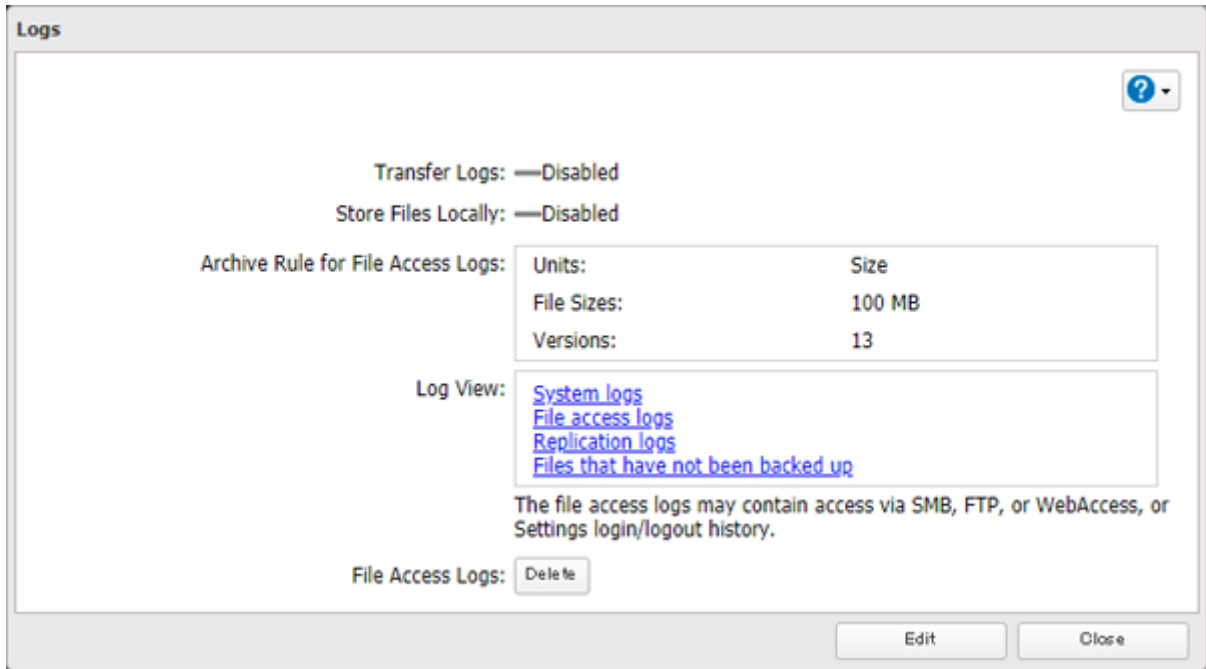

**4** Enable “Share Link to Logs”.

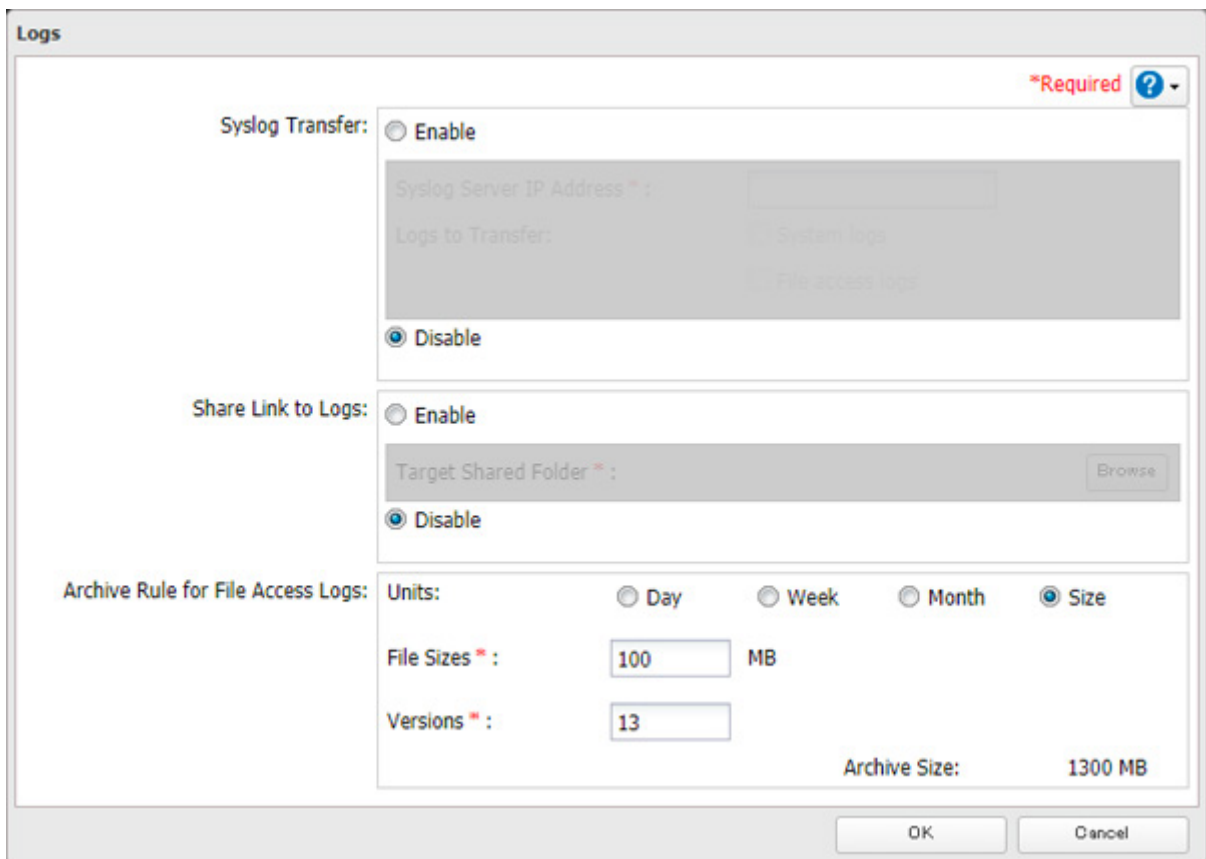

**5** Click *Browse* and select the shared folder where the link will be created in “Target Shared Folder”. Click *OK*.

Under the selected shared folder, a folder named “system\_log” will now contain the logs.

## Changing Archive Rules for File Access Logs

You can configure how many logs are kept or how long each log will be kept on the TeraStation.

- 1 From Settings, click *Management*.

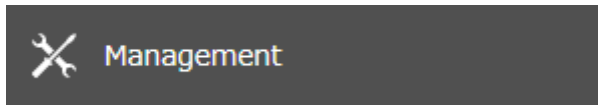

- 2 Click the settings icon (  ) to the right of "Logs".



- 3 Click *Edit*.

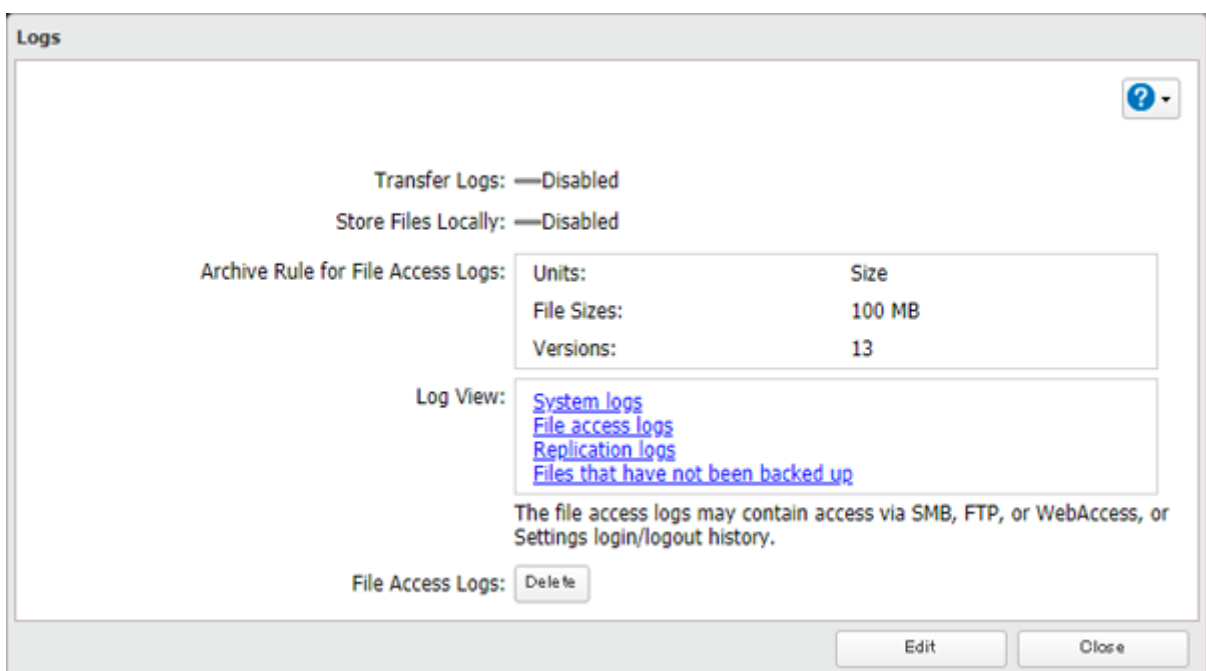

- 4 Select the unit and version to save logs to the right of "Archive Rule for File Access Logs". For example, if you select "Month" for the unit and enter "7" for the version, the file access logs for the next 7 months will be saved on the TeraStation.

Available duration and capacity to save logs will vary depending on the unit. The following values are available:

- Unit (Day): 1–367 for all versions
- Unit (Week): 1–53 for all versions
- Unit (Month): 1–13 for all versions

- Unit (Size): 1–100 for file sizes and 1–13 for all versions

**5** Click *OK*.

**Notes:**

- To delete the saved logs, click *Delete* at the window in step 3.
- If there is not enough space to save logs, the I70 message will appear on the LCD panel. When it appears, delete unnecessary logs or move them to another device from the TeraStation. To access logs, go to the “system\_log” folder created on the shared folder that you have configured the link to logs. If no free space is available elsewhere, older logs will automatically be deleted.

## Updating the Firmware

If new firmware is available, a message is displayed when the TeraStation boots. You can update the firmware either manually or automatically.

**Notes:**

- If all drives and RAID arrays on the TeraStation have LVM enabled but no LVM volumes have been created, you will not be able to update the firmware from Settings.
- Settings will not be available while the firmware is updating. Don't try to access Settings from another computer until the update is completed.

## Updating Manually

**1** From Settings, click *Management*.

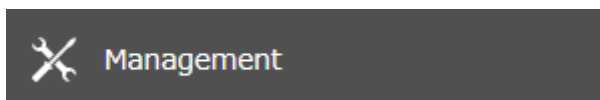

- 2 Click the settings icon (  ) to the right of "Update".

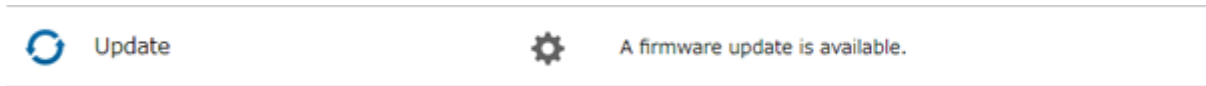

- 3 Click *Install Update*.

- 4 When updating the firmware is completed, refresh the browser and log in to Settings again.

You can also download the latest firmware from the [Buffalo website](#).

## Updating Automatically

---

- 1 From Settings, click *Management*.

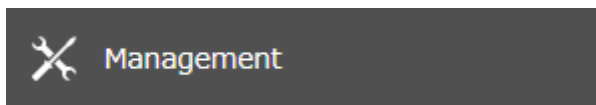

- 2 Click the settings icon (  ) to the right of "Update".

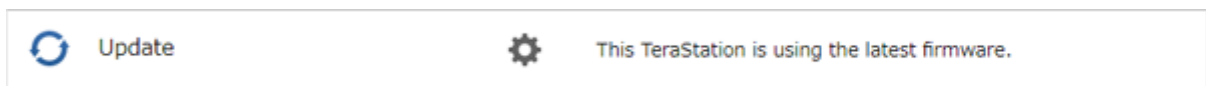

- 3 Click *Edit*.

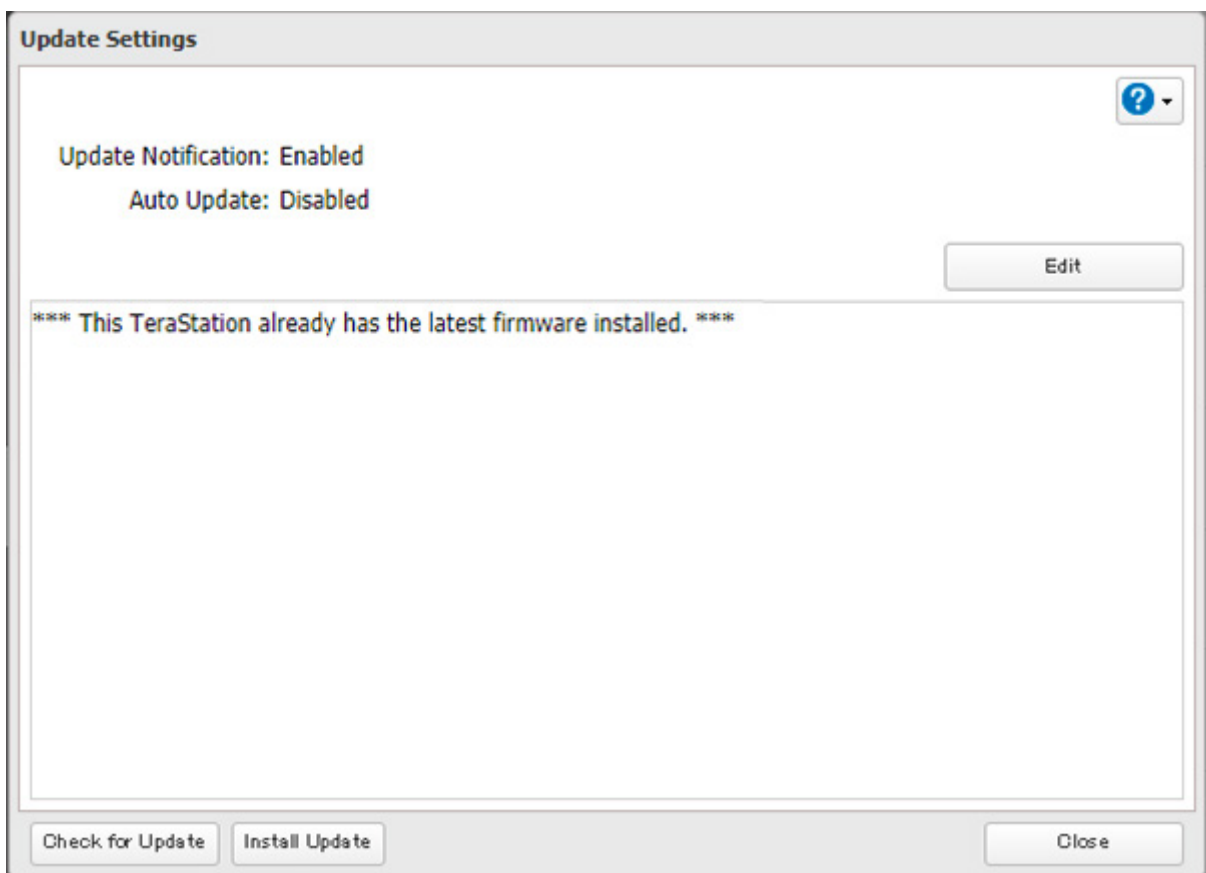

- 4** Select “Update the firmware automatically” and click *OK*.

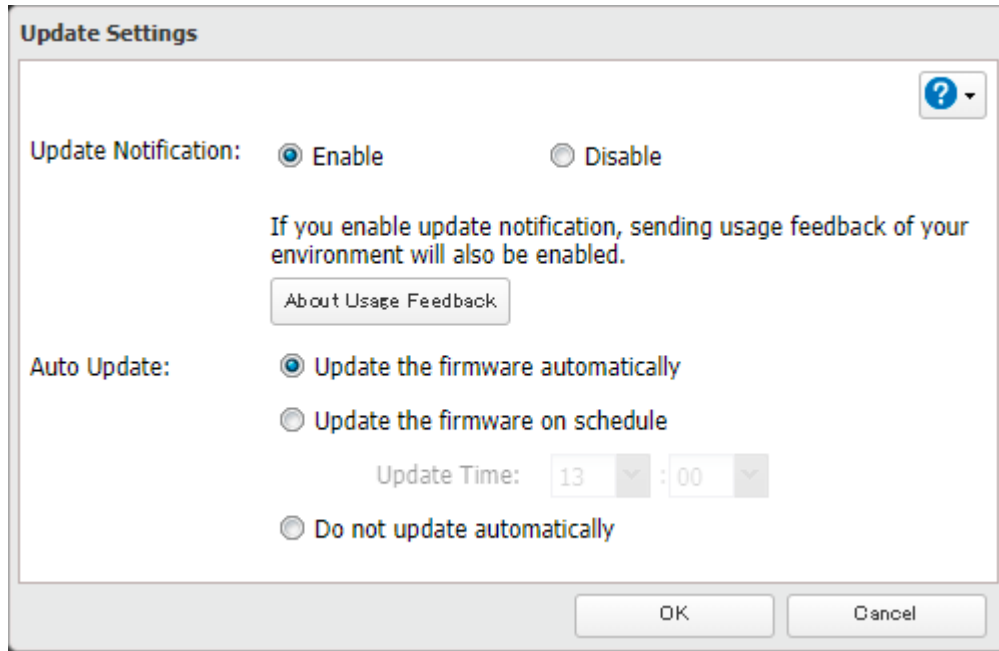

Alternately, you may choose to schedule updates for a specific time of day.

---

## Configuring Update Notification

---

Configure whether or not to receive a notification when new firmware becomes available.

- 1** From Settings, click *Management*.

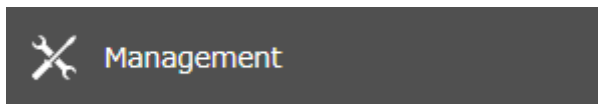

- 2** Click the settings icon (⚙️) to the right of “Update”.

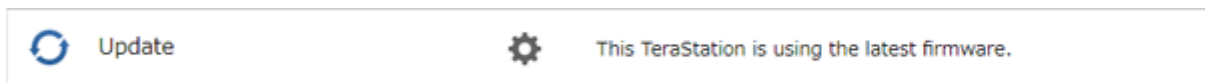

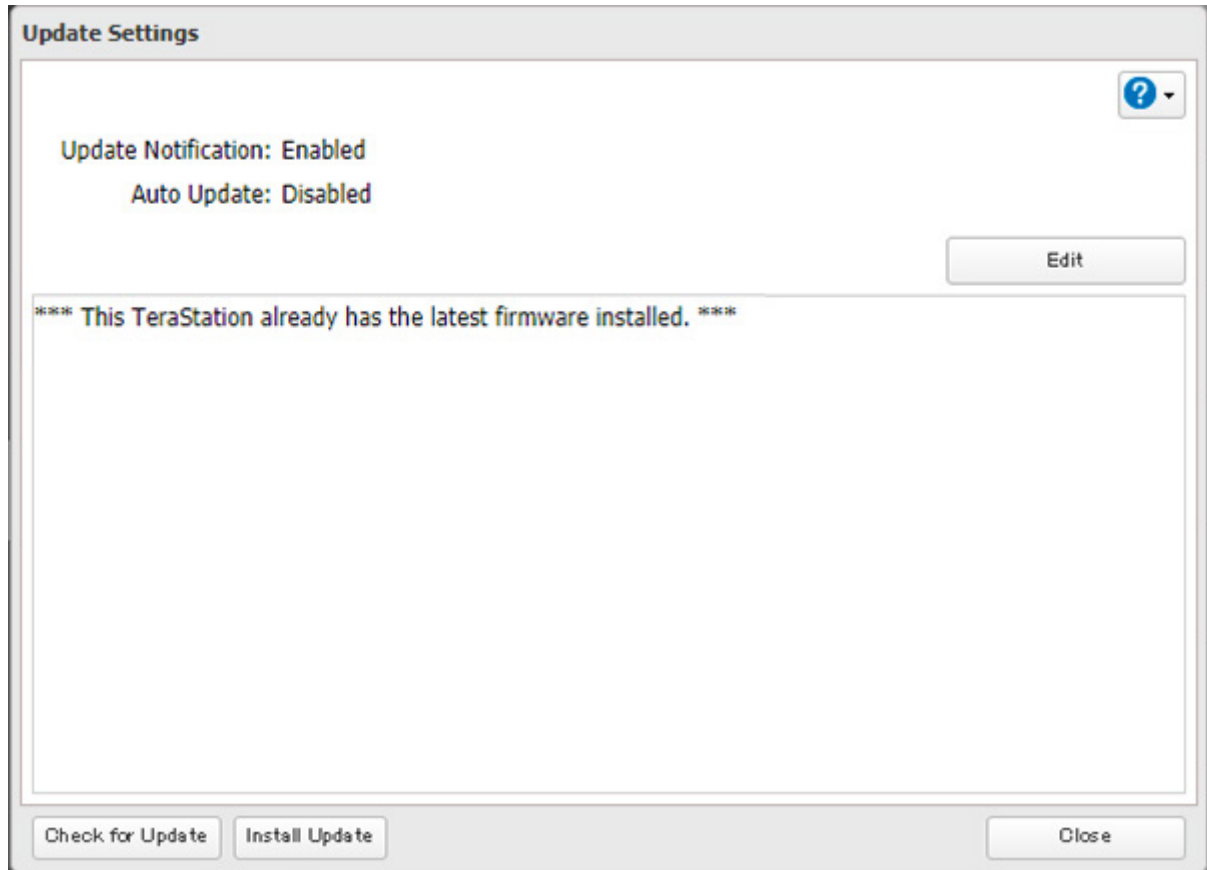
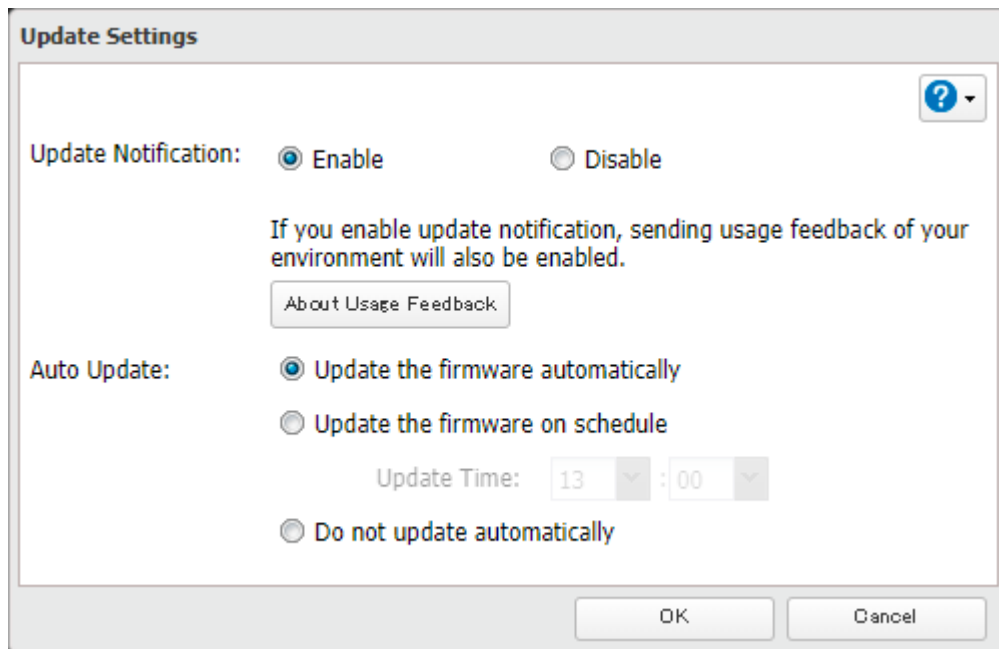
**3** Click *Edit*.**4** Select to enable or disable update notification and click *OK*.

For further optimized firmware updates and product usability improvements, Buffalo may ask you to send your usage and environment information, such as a number of shared folders and client computers, and/or S.M.A.R.T. information. The collected information will only be used for improving future firmware stability and product development and no other purpose.

If update notification is enabled, it will also automatically enable sending usage feedback to Buffalo. If you don't want to send this information to us, disable update notification.

**Note:** If a backup job is running and the update time arrives, auto update will be skipped. After backup is completed, auto update will run at the next upcoming update time.

## Name, Date, Time, and Language

Configure the TeraStation's hostname, date, time, and language as shown below.

**Note:** If the TeraStation is being used as an iSCSI drive, to change the settings, navigate to *Storage > iSCSI* in Settings and move the iSCSI switch to the **off** position temporarily before changing settings.

- 1 From Settings, click *Management*.

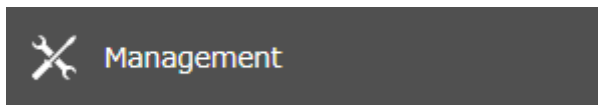

- 2 Click the settings icon (  ) to the right of "Name/Time/Language".



- 3 Click *Edit*.

- 4 Click the *Name* tab, then configure the TeraStation's name and description.

The name will be used for identifying your TeraStation on the network. When your TeraStation is detected, the name will be used as the hostname. The hostname may contain up to 15 alphanumeric characters and hyphens (-). The first and last characters should not be a hyphen.

 A dialog box titled "Name/Time/Language" with a red asterisk and a help icon in the top right corner. It has four tabs: "Name", "Time", "Language", and "Management Information". The "Name" tab is selected. Below the tabs are two text input fields: "Name \* : TS6400D03F" and "Description: TeraStation". At the bottom right are "OK" and "Cancel" buttons.



- 5 Click the *Time* tab. Enable the NTP server and select the “Use default NTP server” checkbox. If you disable the NTP function, click *Use Local Date/Time* to use your computer’s time settings for the TeraStation.

By default, the TeraStation adjusts its clock automatically by using a default NTP server. This NTP server belongs to Internet Multi Feed Inc. For more information, visit <http://www.jst.mfeed.ad.jp>.

To use a different NTP server, clear the “Use default NTP server” checkbox and enter a new NTP IP address or its hostname, then click *OK*. If an NTP server is specified by name instead of IP address, make sure that a DNS server is configured for the TeraStation.

**Note:** The internal clocks of the TeraStation and other devices on your network may run at slightly different speeds. Over a long period of time, your network devices may show somewhat different times, which can cause network problems. If clocks on your network vary by more than five minutes it may cause unexpected behavior. For best results, keep all clocks on the network set to the same time by adjusting them regularly, or use an NTP server to correct them all automatically.

- 6 Click the *Language* tab. Select the language to be used.

**Note:** This tab changes the language used by the TeraStation for email notifications and other functions. To change the language displayed in Settings, go to Settings and click *Language* from the menu bar. Choose your desired language from the drop-down list.

- 7** Click the *Management Information* tab. Enter the desired location and administrator information.

The screenshot shows a dialog box titled "Name/Time/Language". It has four tabs: "Name", "Time", "Language", and "Management Information". The "Management Information" tab is active. Below the tabs, there are two text input fields: "Location:" and "Administrator:". To the right of the "Location:" field, there is a red asterisk and a question mark icon, indicating a required field. At the bottom right of the dialog box, there are two buttons: "OK" and "Cancel".

- 8** When all settings are completed, click *OK*.

## Beep Alerts

You can set the TeraStation to beep if certain errors occur.

- 1** From Settings, click *Management*.

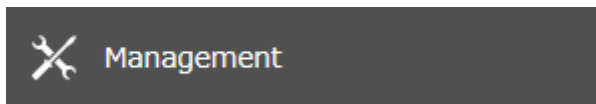

- 2** Click the settings icon (  ) to the right of "Notifications".



- 3** Click *Edit*.

- 4** Click the *Alert Sound* tab.

- 5** Select the triggers to make the alert beep, then click *OK*.

The screenshot shows a dialog box titled "Notification Settings". It has two tabs: "Alert Sound" and "Front Panel". The "Alert Sound" tab is active. Below the tabs, there is a section titled "Triggers When Beeping:" with four checked checkboxes: "Overheating", "Drive error", "Fan failure", and "UPS power failure". At the bottom right of the dialog box, there are two buttons: "OK" and "Cancel".

## LCD and LEDs

You may configure options for the LCD panel and adjust the brightness of the LCD panel and LEDs on the TeraStation.

- 1 From Settings, click *Management*.

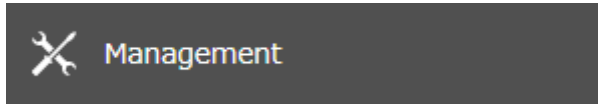

- 2 Click the settings icon (  ) to the right of "Notifications".



- 3 Click *Edit*.

- 4 Click the *Front Panel* tab.

- 5 Configure your settings, then click *OK*.

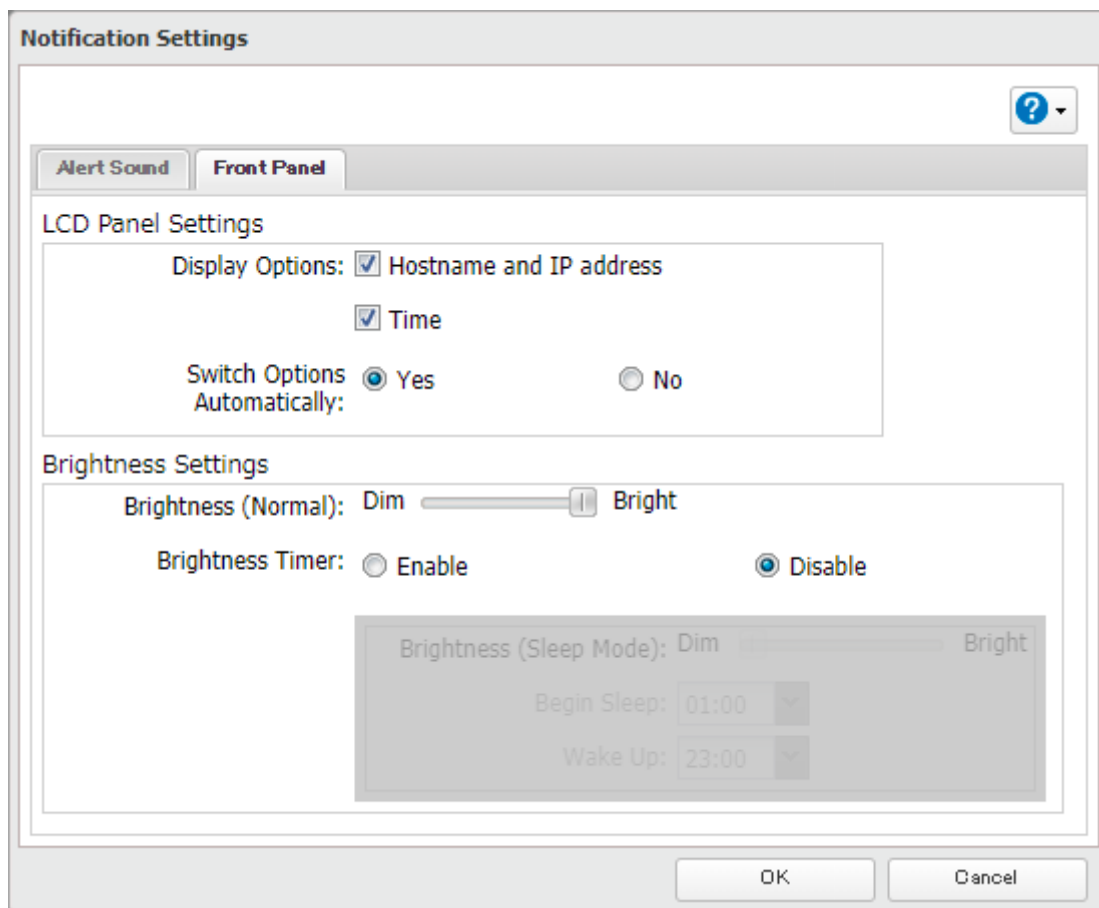

## Proxy Server

If you place the TeraStation on a network that passes through a proxy server, configuring the proxy server settings is recommended. Unless you configure the proxy settings, firmware updates in Settings will not work. To configure the settings, follow the procedure below.

- 1 From Settings, click *Network*.



- 2 Click the settings icon (⚙️) to the right of "Proxy Server".



- 3 Enable "Proxy Server".

 A dialog box titled "Proxy Server Settings". In the top right corner, there is a red asterisk followed by the word "Required" and a blue question mark icon. The main area contains:
 

- "Proxy Server:" followed by two radio buttons: "Enable" (which is selected) and "Disable".
- "Address \*:" followed by a dropdown menu showing "http" and an empty text input field.
- "Port:" followed by a spinner box showing "80".
- "Username:" followed by an empty text input field.
- "Password:" followed by an empty text input field.

 At the bottom of the dialog box, there are two buttons: "OK" and "Cancel".

- 4 Enter the proxy server IP address or hostname, port number, username and password, then click *OK*.

Once you configure the proxy server settings, you may use the settings for other cloud storage services such as Dropbox by selecting the "Configured settings" option on each settings page.

---

## Jumbo Frames

---

If your other network devices support jumbo frames, you may be able to increase network performance.

- 1 From Settings, click *Network*.



- 2 Click the settings icon (⚙️) to the right of "IP Address".



**3** Click *Edit*.

**IP Address List**

Interface	Type	DHCP	IP Address	Subnet Mask	MTU Size	More D
LAN Port 1	1GbE	✓	192.168.10.64	255.255.255.0	1500 bytes	▶
LAN Port 2	1GbE	✓	—	—	1500 bytes	▶
LAN Port 3	10GbE	✓	—	—	1500 bytes	▶

Wake-on-LAN: Disabled  
 Gateway Owner: Automatically assigned (LAN port 1)  
 Default Gateway Address: 192.168.10.1  
 DNS Owner: Automatically assigned  
 Primary DNS Server: 192.168.10.1  
 Secondary DNS Server: Not assigned  
 Services Restarted After: 1 seconds











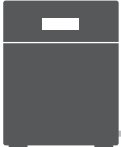



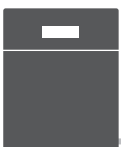

Allowed Protocols for Each Port    Port Trunking    FQDN Mapping    Edit    Close

**4** Select or enter the desired MTU size and click *OK*.

**IP Address List**

Interface	DHCP	IP Address	Subnet Mask	MTU Size
LAN Port 1	<input checked="" type="checkbox"/>	192.168.10.36	255.255.255.0	4084
LAN Port 2	<input checked="" type="checkbox"/>		255.255.255.0	1500
LAN Port 3	<input checked="" type="checkbox"/>		255.255.255.0	1500

MTU sizes of 1500–9216 bytes are supported. The stated size doesn't include 14 bytes of header and 4 bytes of FCS. The default MTU size is 1500 bytes. MTU sizes of 1501 bytes or more are considered jumbo frames.

Connection			Transmission	
				Transfer data using jumbo frames.
				Transfer data without using jumbo frames.
				Transfer data without using jumbo frames.
				No data can be transferred.

**Note:** Make sure the TeraStation's MTU size is smaller than the hub or router's. Larger MTU sizes may not transfer the data to the TeraStation correctly.

## Changing the IP Address

Normally, the TeraStation's IP address is set automatically from a DHCP server on your network. If you prefer, you can set it manually. An easy way to do this is to change it on NAS Navigator2 running on a computer connected to the same router (subnet) as the TeraStation. The procedure to change the IP address in Settings is below.

**Note:** If the TeraStation is being used as an iSCSI drive, to change the settings, navigate to *Storage > iSCSI* in Settings and move the iSCSI switch to the **off** position temporarily before changing settings.

- 1 From Settings, click *Network*.



- 2 Click the settings icon (⚙️) to the right of "IP Address".



**3** Click *Edit*.

**IP Address List**

Interface	Type	DHCP	IP Address	Subnet Mask	MTU Size	More D
LAN Port 1	1GbE	✓	192.168.10.64	255.255.255.0	1500 bytes	▶
LAN Port 2	1GbE	✓	—	—	1500 bytes	▶
LAN Port 3	10GbE	✓	—	—	1500 bytes	▶

Wake-on-LAN: Disabled  
 Gateway Owner: Automatically assigned (LAN port 1)  
 Default Gateway Address: 192.168.10.1  
 DNS Owner: Automatically assigned  
 Primary DNS Server: 192.168.10.1  
 Secondary DNS Server: Not assigned  
 Services Restarted After: 1 seconds

Allowed Protocols for Each Port   Port Trunking   FQDN Mapping   Edit   Close

**4** Clear the “DHCP” checkbox and enter the desired IP address and its subnet mask.

**IP Address List**

Interface	DHCP	IP Address	Subnet Mask	MTU Size
LAN Port 1	<input type="checkbox"/>	192.168.10.36	255.255.255.0	1500
LAN Port 2	<input checked="" type="checkbox"/>		255.255.255.0	1500
LAN Port 3	<input checked="" type="checkbox"/>		255.255.255.0	1500

**5** Select “User (static)” for both “Gateway Owner” and “DNS Owner” options from the drop-down list, then enter the desired default gateway address and DNS server addresses.

Gateway Owner: User (static) ▼  
 Default Gateway Address: 192.168.10.1  
 DNS Owner: User (static) ▼  
 Primary DNS Server: 192.168.10.1  
 Secondary DNS Server:  
 Services Restarted After: 1 ▼ seconds

OK   Cancel

**6** Click *OK*.

**Notes:**

- Only one default gateway and DNS address can be configured for all LAN ports. Different network addresses cannot be assigned to the LAN ports.
- Do not set the IP address of the same segment for all LAN ports. This may cause unstable network communication.
- Network services such as SMB or AFP will restart when the Ethernet cable is disconnected/reconnected or if a network issue occurs. You can specify the time to delay the restart at the “Services Restarted After” option.

## Mapping IP Address and Hostname

The TeraStation allows you to map an IP address and a hostname (FQDN) of another host you would like the TeraStation to communicate with, such as the domain controller. If you configure the mapping pair, the TeraStation can be accessed using the configured pair when name resolution is needed. Follow the procedure below to configure FQDN mapping.

- 1 From Settings, click *Network*.



- 2 Click  to the right of “IP Address”.



- 3 Click *FQDN Mapping*.

**IP Address List**

Interface	Type	DHCP	IP Address	Subnet Mask	MTU Size	More D
LAN Port 1	1GbE	✓	192.168.10.64	255.255.255.0	1500 bytes	▶
LAN Port 2	1GbE	✓	—	—	1500 bytes	▶
LAN Port 3	10GbE	✓	—	—	1500 bytes	▶

Wake-on-LAN: Disabled

Gateway Owner: Automatically assigned (LAN port 1)

Default Gateway Address: 192.168.10.1

DNS Owner: Automatically assigned

Primary DNS Server: 192.168.10.1

Secondary DNS Server: Not assigned

Services Restarted After: 1 seconds

Allowed Protocols for Each Port
Port Trunking
FQDN Mapping
Edit
Close



**4** Click *Add*.

The screenshot shows a dialog box titled "Mapped IP Addresses". At the top right is a help icon (question mark in a blue circle). Below the title bar are two buttons: "Add" and "Delete". The main area contains a table with two columns: "FQDN" and "IP Address". The table is currently empty. Below the table are two buttons: "Select All" and "Deselect All". At the bottom of the dialog are "OK" and "Cancel" buttons.

**5** Enter the hostname (FQDN) and the IP address that you want to map, then click *OK*.

The screenshot shows a dialog box titled "FQDN Mapping Settings". At the top right is a help icon (question mark in a blue circle) with the text "\*Required" in red to its left. Below the title bar are two input fields. The first is labeled "FQDN \*" and the second is labeled "IP Address \*". The asterisks indicate that these fields are required. At the bottom of the dialog are "OK" and "Cancel" buttons.

**6** Click *OK* again to apply settings.

---

## Boot Authentication

---

Boot authentication allows you to authenticate the TeraStation while it's booting, and also prevents the TeraStation from being used in an unauthorized or unexpected manner, such as in cases of theft.

If authentication fails, the TeraStation will stay on, but all functions and services are stopped. Users will not be able to log in to Settings to make changes or access any shares.

## Notes Before Use

---

- To use boot authentication, a Windows PC is necessary to serve as the authentication server.
- When activating boot authentication, the drives on the TeraStation will be formatted and all data on the drives will be erased. Back up any important data to another device. Even though the data is deleted, the RAID array will be kept as is.
- Assigning the TeraStation a fixed IP address is recommended for boot authentication.
- When boot authentication settings finish, export the configuration file for backup. Refer to the “Exporting Managed TeraStations to a File” section in the Boot Authentication Tool help for the procedure.
- Boot authentication cannot be enabled if any of the following functions are enabled: drive encryption, LVM, iSCSI, and failover. Conversely, these functions cannot be enabled while boot authentication is enabled.

## Important Notice

---

This feature was developed with the intention of preventing critical data leakage by rendering the TeraStation unusable in cases of misoperation or missing important setting files. Before configuring boot authentication, back up the data on the TeraStation by referring to the [“Backing Up Data on the TeraStation”](#) section in chapter 5, and then create a settings initialization drive by referring to the [“Creating an Initialization Drive”](#) subsection above. With these preparations, a TeraStation that is unusable may be initialized and reverted to a usable state.

If any of the situations below occur, the TeraStation will stop booting and become inaccessible.

- The TeraStation is unable to communicate with the authentication server due to the server crashing or it being on another network.
- The TeraStation unit has been deleted from Boot Authentication Tool or the Boot Authentication Tool database has been erased.
- Security level is configured to “High” and the wrong passcode is entered three times.

## Setting Up the Authentication Server on a Windows PC

---

To set up the authentication server, follow the procedure below. The authentication server must be placed on the local network or VPN.

This is an example procedure using Windows 10. The procedure may vary depending on which version of Windows you use.

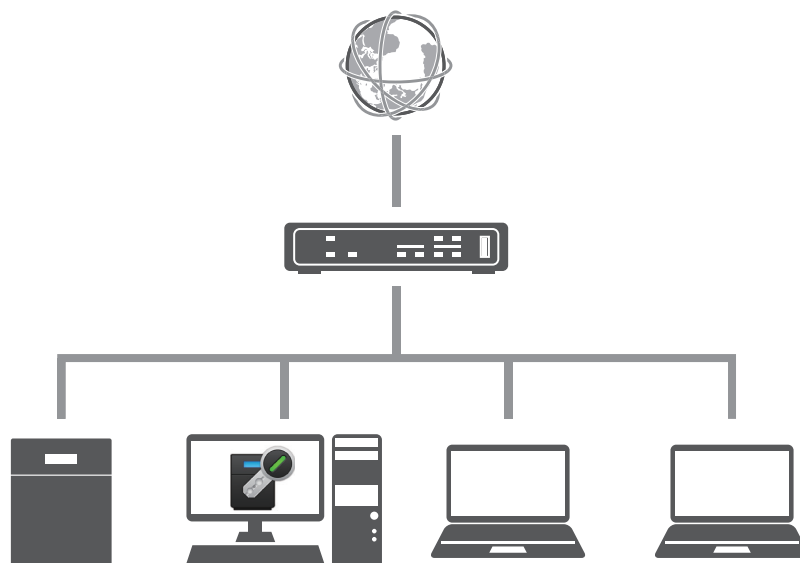



**Note:** For proper operation, make sure that the TeraStation and the authentication server are on a network with only one router. If there are two or more routers on the network, the authentication server may not acquire the correct TeraStation status. For example, if the TeraStation’s IP address has been changed, its status does not change to “Warning”.

- 1 Download the application for the authentication server, “Boot Authentication Tool”, from the [Buffalo website](#) and install it onto the Windows PC.
- 2 Register the specific port number that is used on the application as a firewall exception rule. Navigate to *Control Panel > System and Security > Windows Defender Firewall* on the authentication server.
- 3 Click *Advanced settings*.
- 4 Click and right-click *Inbound Rules*, then click *New Rule*.
- 5 Select “Port” and click *Next*.
- 6 Select “TCP”, enter the port number that is used on the application to the right of “Specific local ports”, and click *Next*. The default port number on the application is “7010”. The port number can be confirmed on the *Options* tab of the application.
- 7 Click *Next*, then click *Next* again.
- 8 Enter a desired name for the setting and click *Finish* to complete.

## Configuring Boot Authentication on the TeraStation

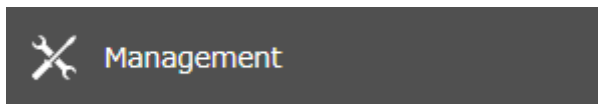
- 1 From Settings, click *Management*.



- 2 Click the settings icon (  ) to the right of “Boot Authentication”.



- 3 Click *Edit*.

- 4 Enter the authentication server’s IP address or hostname and port number, specify the security level and communication time settings, then click *Activate*.

**Boot Authentication Settings**

\*Required 

Authentication Server Address \* :

Port Number \* :

Security Level \* :  Medium  High

Medium: If the TeraStation cannot communicate with the authentication server and the passcode was entered incorrectly, the original passcode will remain valid.

High: If the TeraStation cannot communicate with the authentication server and the passcode was entered incorrectly 3 times, the TeraStation will become unusable.

Notes from Settings:

Server Communication Time \* :  :

Activate Deactivate OK Cancel

- 5 The drive formatting process will start. Click *Yes*.
- 6 The “Confirm Operation” screen will open. Enter the confirmation number, then click *OK*.
- 7 The format will begin. Wait until it finishes. When formatting finishes and the TeraStation is added to Boot Authentication Tool, boot authentication setting is completed.

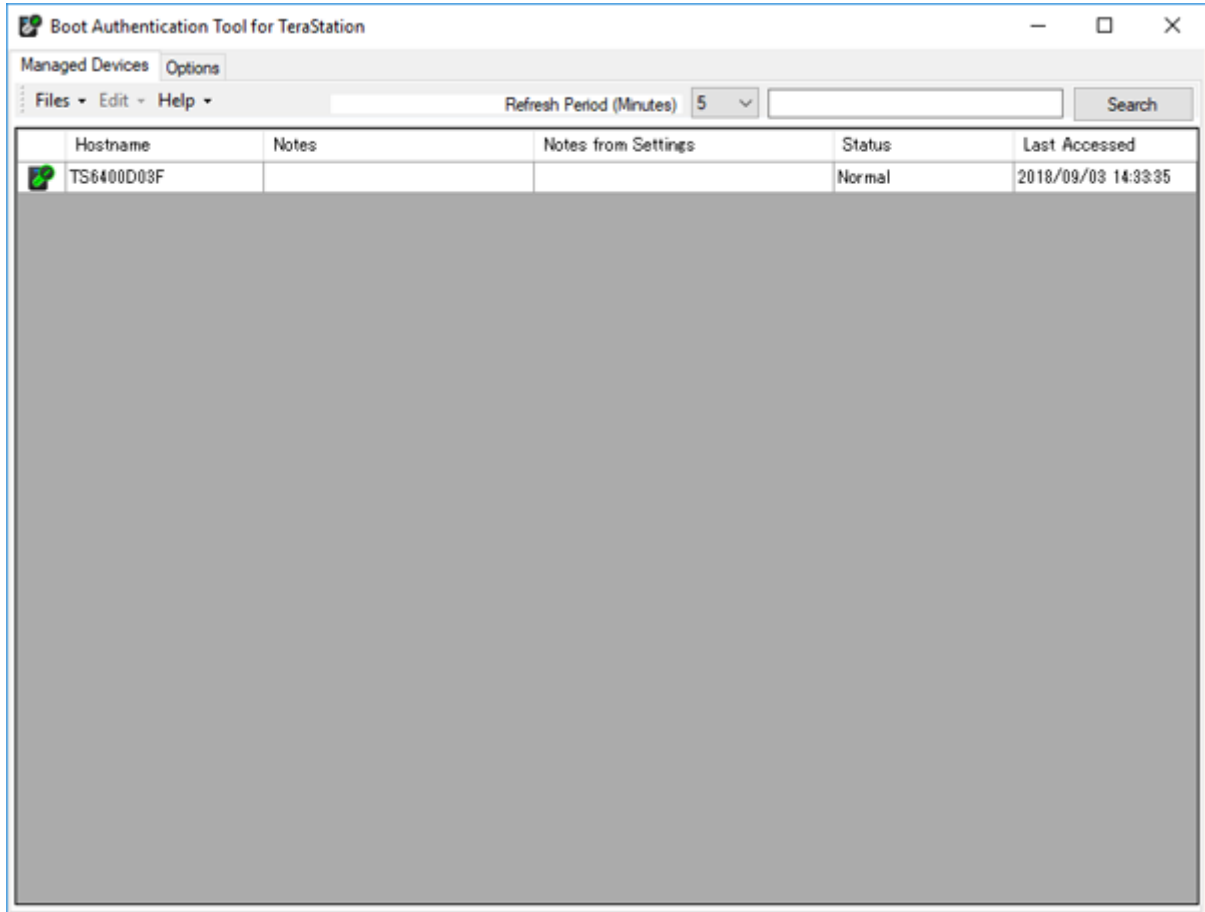

**Note:** To activate, deactivate, or change the boot authentication settings, the TeraStation must be communicating with the authentication server.

## If the TeraStation Cannot Be Accessed

If the TeraStation cannot communicate with the authentication server or vice versa, such as in a case of network failure, the TeraStation will not be accessible. If the TeraStation is not accessible, manually authenticate the TeraStation by following the procedure below.

**Note:** The procedure defines an “authentication server administrator” as someone who manages the authentication server using Boot Authentication Tool, and a “user” as one attempting to access the TeraStation from a remote location.

- 1 When the user tries to access the TeraStation's Settings and the TeraStation is not available, the screen below will be displayed. Have the user forward the decryption key to the authentication server administrator.

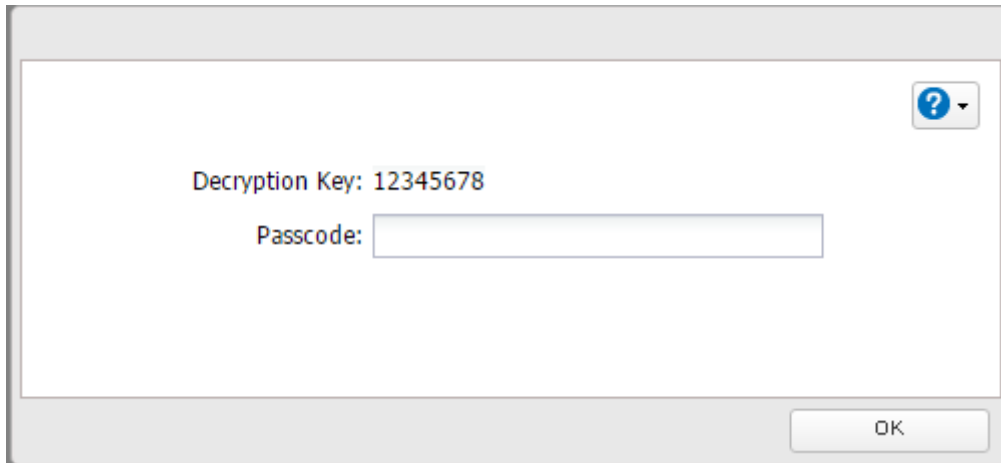

- 2 Open Boot Authentication Tool on the authentication server.
- 3 From Boot Authentication Tool, right-click the target TeraStation from the list and click *Decrypt Passcode*.
- 4 Enter the decryption key received from the user and click *Decrypt*.

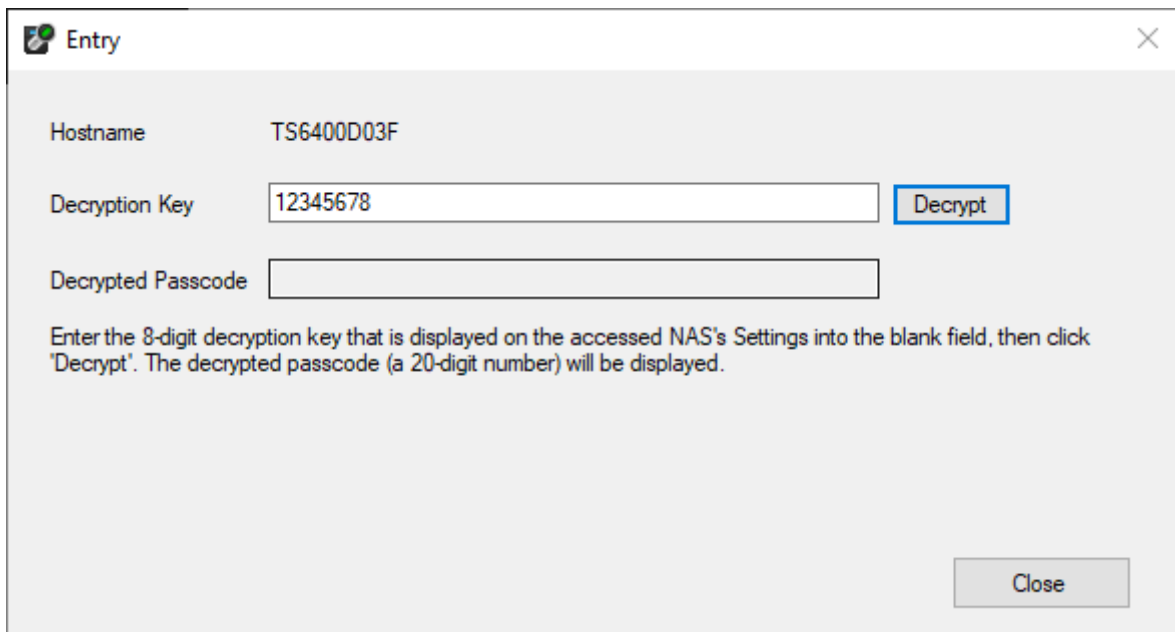

**5** The decrypted 20-digit passcode will be displayed. Send the passcode to the user.

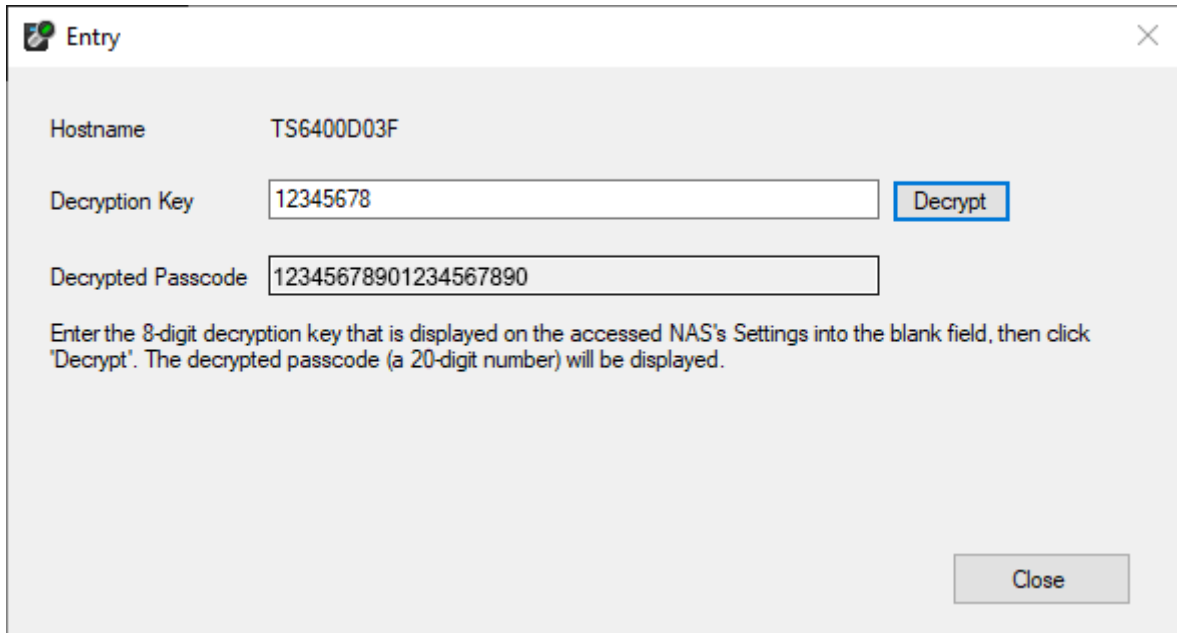

**6** The user can then enter the 20-digit passcode into Settings and click *OK*.

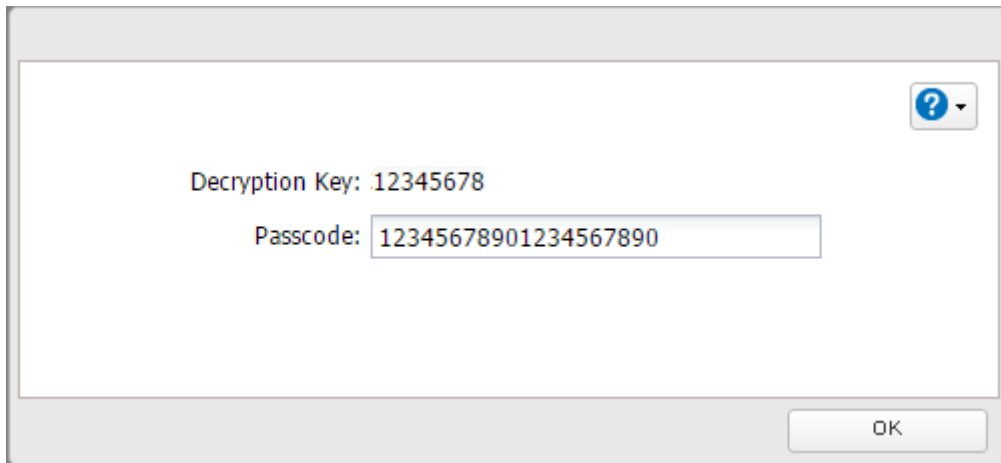

If the passcode is authenticated, the TeraStation will become available. The user can click *OK* to log in to Settings.

# Chapter 8 Drive Replacement

Drive replacement procedures will vary depending on which RAID mode you have configured. Refer to the replacement procedure in the following sections corresponding to the configured RAID mode. The following drive replacement examples use the case of the TS6400DN series TeraStations.

---

## Replacing Drives

---

### LEDs

Drives in the TeraStation show a green status LED during normal operation. If a drive fails, its error LED will glow red.

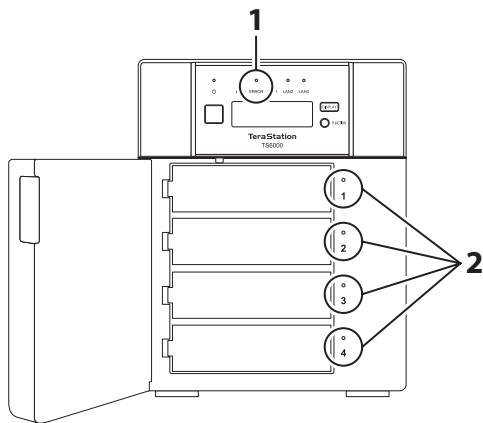

#### 1 Error LED

Glows red if a drive has failed.

#### 2 Status LEDs

The failed drive's status LED will be glowing a steady red. A drive with a red status LED is ready to hot-swap.

#### Notes:

- Do not unplug a drive whose status LED is green instead of red. Dismount it first or shut down the TeraStation before swapping a working drive. If you remove the drive without properly dismounting it, data may be lost or the TeraStation may malfunction.
- For the replacement drive of other series TeraStations, use a Buffalo OP-HDN series drive. The replacement drive should be the same size or larger as the original drive. If a larger drive is used, the extra space will not be usable in a RAID array.
- To avoid damaging the TeraStation with static electricity, ground yourself by touching something made of metal before handling any sensitive electronic parts.
- After a drive is replaced, it will take about 30 minutes before normal file reading and writing operations are restored. Settings may not be accessible during this period.
- Do not change the order of the drives in the TeraStation. For example, pulling out drive 1 and replacing it with drive 2 may cause data to be corrupted or lost.
- If the LCD panel does not change after a new drive is installed, click *Rediscover Drive* in Settings.

## Using a Redundant RAID Mode

Back up the saved data to another location before replacing the failed drive. If one or more drives fail during the drive replacement, data can no longer be retrieved from the TeraStation.

- 1 Open the front cover with the included key.

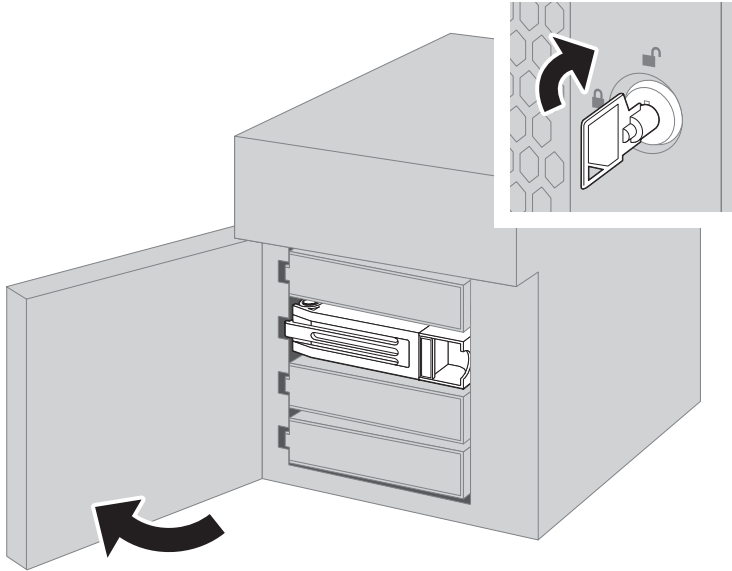

- 2 The failed drive's status LED will be glowing red. Push its unlock button and swing the lock mechanism out.

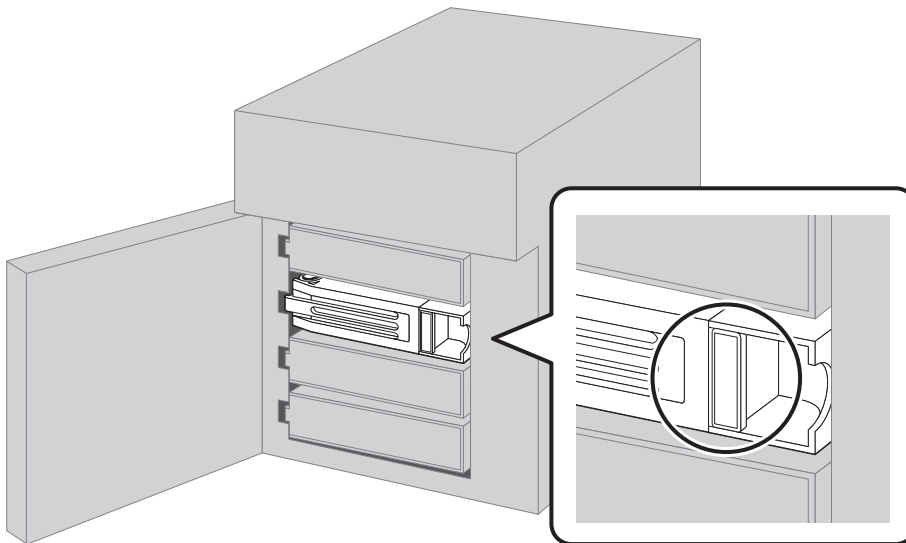



**Drives without red status LEDs lit are still on. Do not unplug or remove them.**

**3** Pull out the drive cartridge and remove it from the TeraStation.

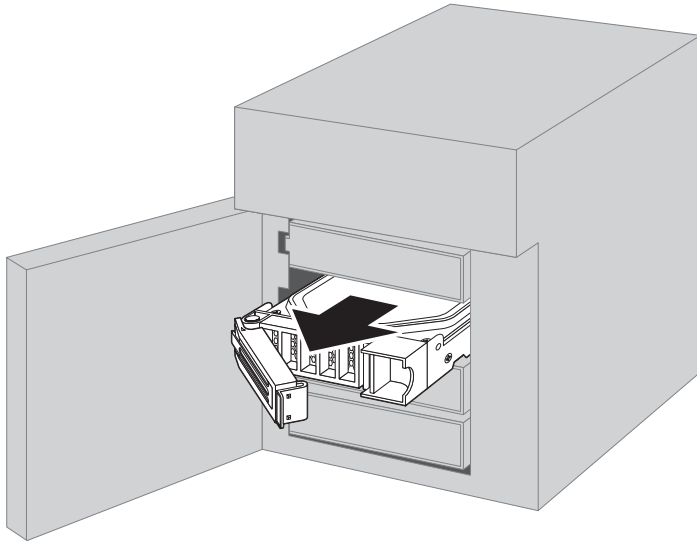

**4** Insert the new drive into the empty slot. Slide the drive in with the locking mechanism open.

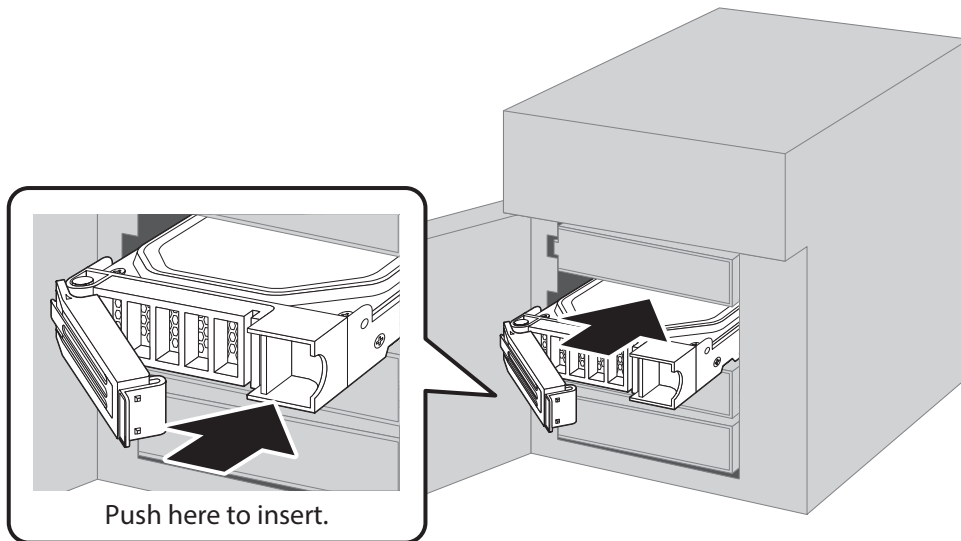

- 5 Swing the lock back down until it clicks into place.

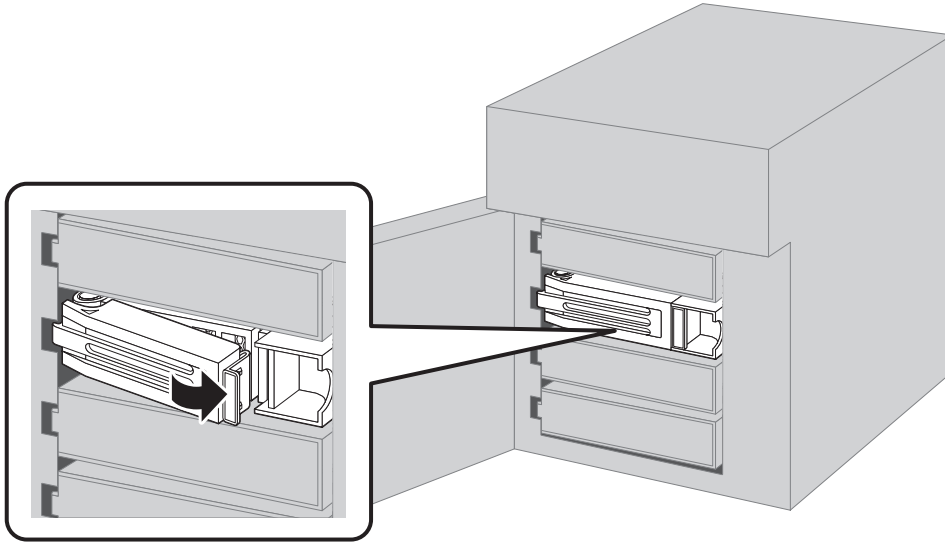

- 6 When the replaced drive is recognized, the status LED will flash red and the I31 message will appear on the LCD panel.

- 7 Close the front cover.

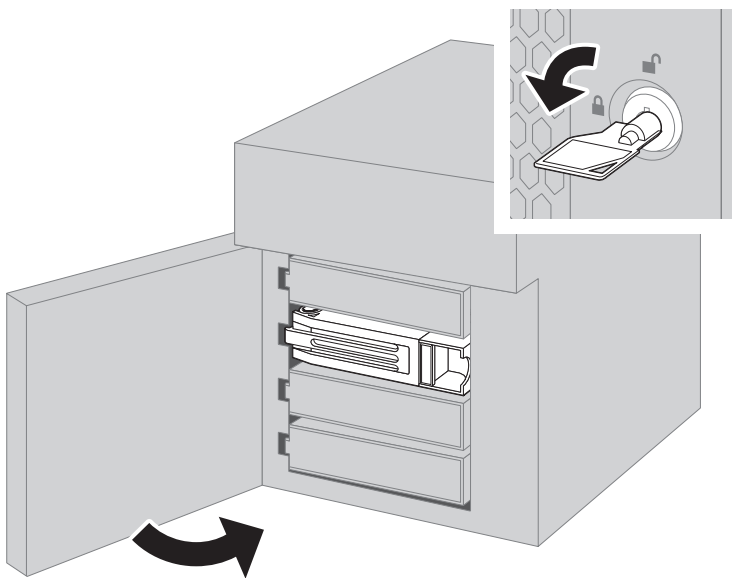

- 8 Press the function button on the front of the TeraStation. The TeraStation will beep once. Press and hold the button until the TeraStation beeps again.

If replacing multiple malfunctioning drives at once or replacing one drive in an environment where two or more arrays are in degraded mode, you will have to rebuild the RAID array from Settings. Log in to Settings and navigate to *Storage > RAID*, then select the replaced drive and click *Recover RAID Array*.

The TeraStation will start rebuilding the RAID array automatically. After a few minutes, the I18 message will be displayed until the array is rebuilt. Wait until the message disappears.

## Using RAID 0

Drives in a RAID 0 array do not automatically turn off in the event of a malfunction. Shut down the TeraStation before replacing the failed drive. This section describes the process of replacing a drive with **the TeraStation off**.

**Note:** If a drive malfunctions in RAID 0, all data on the RAID array will be lost. All of the settings for the shared folders (such as access restrictions) are erased after replacing a drive from a RAID 0 array.

- 1** Turn off the TeraStation.
- 2** Open the front cover with the included key.
- 3** The failed drive's status LED will be blinking red. Push its unlock button and swing the lock mechanism out.
- 4** Pull out the drive cartridge and remove it from the TeraStation.
- 5** Insert the new drive into the empty slot. Slide the drive in with the locking mechanism open.
- 6** Swing the lock back down until it clicks into place.
- 7** Close the front cover.
- 8** Press the power button on the TeraStation.
- 9** When the replaced drive is recognized, the status LED will flash red and the I32 message will appear on the LCD panel.
- 10** From Settings, navigate to *Storage > RAID*.
- 11** Select the RAID array for which the failed drive was being used and click *Delete RAID Array*.
- 12** The "Confirm Operation" screen will open. Enter the confirmation number, then click *OK*.
- 13** From *Storage > Drives*, select the replaced drive and click *Format Drive*.
- 14** The "Confirm Operation" screen will open. Enter the confirmation number, then click *OK*.
- 15** From *Storage > RAID*, choose "RAID 0" from the RAID mode drop-down list and click *Create RAID Array*.
- 16** The "Confirm Operation" screen will open. Enter the confirmation number, then click *OK*.
- 17** Click *OK* when completed.

The new RAID 0 array will be created. Next, create a shared folder by referring to the "[Adding a Shared Folder](#)" section in chapter 3.

## Using JBOD

---

This section describes the process of replacing a drive with **the TeraStation off**.

**Note:** If a drive malfunctions in JBOD, all data on the drive will be lost.

- 1** Turn off the TeraStation.
- 2** Open the front cover with the included key.
- 3** The failed drive's status LED will be blinking red. Push its unlock button and swing the lock mechanism out.
- 4** Pull out the drive cartridge and remove it from the TeraStation.

- 5** Insert the new drive into the empty slot. Slide the drive in with the locking mechanism open.
- 6** Swing the lock back down until it clicks into place.
- 7** Close the front cover.
- 8** Press the power button on the TeraStation.
- 9** When the replaced drive is recognized, the status LED will flash red and the I32 message will appear on the LCD panel.
- 10** From Settings, navigate to *Storage > Drives*.
- 11** Select the replaced drive and click *Format Drive*.

The drive will be formatted. Next, create a shared folder by referring to the [“Adding a Shared Folder”](#) section in chapter 3.

## Using a Hot Spare

---

If your TeraStation’s drives are in a redundant RAID mode and you have a hot spare enabled, a malfunctioning drive in the array is replaced to the hot spare and the RAID array is rebuilt automatically. The status LED will continue to glow red for the failed drive even after the RAID array is rebuilt with the hot spare. After you replace the failed drive with a new drive, follow the procedure below to configure a hot spare as a new drive.

- 1** Open the front cover with the included key.
- 2** The failed drive’s status LED will be glowing red. Push its unlock button and swing the lock mechanism out.
- 3** Pull out the drive cartridge and remove it from the TeraStation.
- 4** Insert the new drive into the empty slot. Slide the drive in with the locking mechanism open.
- 5** Swing the lock back down until it clicks into place.
- 6** When the replaced drive is recognized, the status LED will flash red and the I31 message will appear on the LCD panel.
- 7** Close the front cover.
- 8** Press the function button on the front of the TeraStation. The TeraStation will beep once. Press and hold the button until the TeraStation beeps again.

The replaced drive will be automatically registered as a hot spare.

To use the replaced drive as a normal drive rather than a hot spare, navigate to *Storage > RAID* and click the RAID array, select the new drive, and click *Set as a normal drive*.

---

## Replacing a Non-Malfunctioning Drive

---

**Do not replace a drive that is not malfunctioning.**

If you must change a drive that is not malfunctioning, either first dismount it in Settings, referring to the [“Dismounting Drives”](#) section in chapter 4, or shut down the TeraStation before replacing the drive. If you need to replace more than one drive at the same time, replace the drives one at a time to preserve your data. When replacing the non-malfunctioning drive, the RAID array will function as below:

### **Operating in RAID 0 Mode**

All data on the RAID array will be deleted after replacing the drive. You will not be able to use the TeraStation until you delete and rebuild the RAID array with the new drive.

### **Operating in JBOD**

All data on that drive will be deleted after replacing the drive. You will not be able to use the TeraStation until you format the new drive.

### **Operating in a Redundant RAID Mode**

If you are using a redundant RAID mode such as RAID 1, 5, or 6, the RAID array will be in degraded mode after replacing the drive. You will not be able to use the TeraStation until you rebuild the RAID array with the new drive.

# Chapter 9 Utilities

## NAS Navigator2 for Windows

NAS Navigator2 is a utility program that makes it easy to display Settings, change the Buffalo NAS device's IP address, or check its drive. To install NAS Navigator2, download the installer from <http://d.buffalo.jp/TS6000/>. NAS Navigator2 will run in the system tray when the computer is on.

Double-click the NAS Navigator2 icon (  ) to start NAS Navigator2.

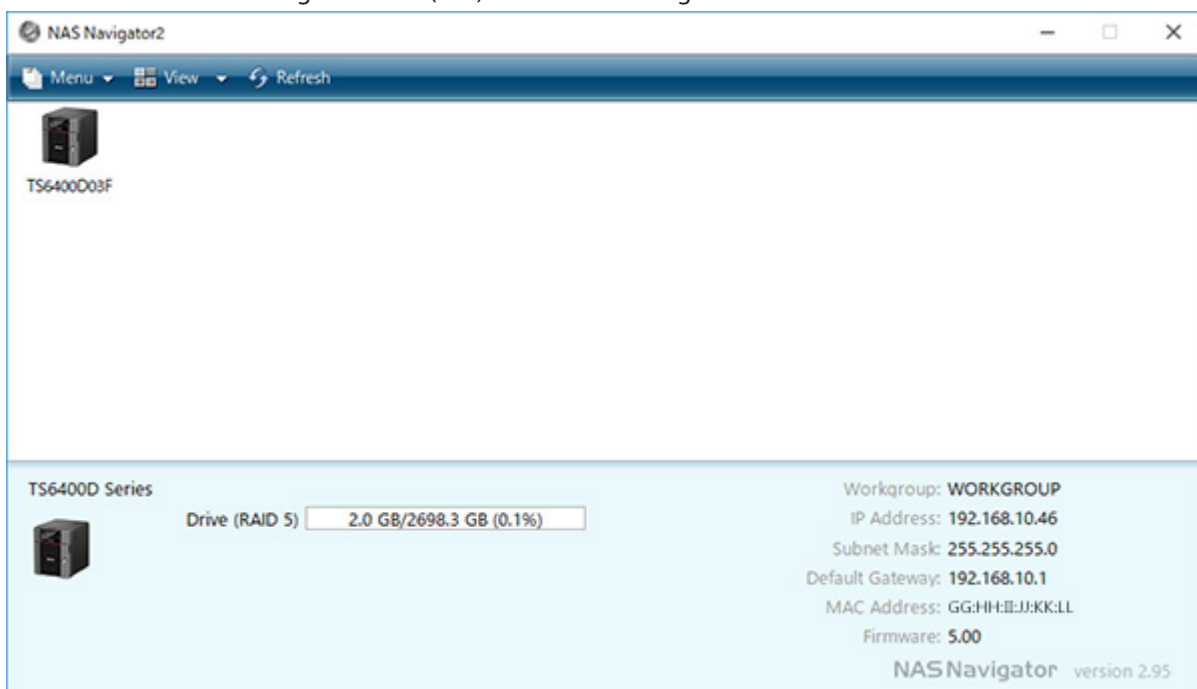

Click a Buffalo NAS device's icon to display total capacity, used space, workgroup name, IP address, subnet mask, default gateway, MAC address, and firmware version.

Double-click the icon to open a shared folder on the Buffalo NAS device.

Name		Description
Menu	Map Share*	Assigns the Buffalo NAS device's shared folder as a network drive.
	Disconnect Share*	Unmaps the network drive.
	Map All Remote Shares to Drive Letters	Assigns all Buffalo NAS devices' shared folders as network drives. This is available only when a shared folder has been created.
	Create Desktop Shortcut*	Creates a desktop shortcut to the Buffalo NAS device's shared folders.
	Launch NAS Navigator2 on Startup	Launches NAS Navigator2 in the system tray when Windows boots.
	Display Errors	If an error occurs, an error message will appear from the NAS Navigator2 icon in the system tray.
	Properties*	Opens the properties page that lets you configure the Buffalo NAS device's IP address or open Settings.
	Close	Closes NAS Navigator2.
View	View	<b>Icons:</b> Displays icons. <b>Details:</b> Displays the hostname, product name, workgroup, IP address, subnet mask, and default gateway.
	Sort by	If you have multiple Buffalo NAS devices on the network, you may choose to display them in order of hostname, product name, workgroup, IP address, subnet mask, or default gateway.
Browse*		Opens the Buffalo NAS device's shared folders.
Refresh		Searches for the Buffalo NAS devices on the network again.
I'm here*		Causes your Buffalo NAS device to beep.
Right-click your device's icon to show these menus.	Browse Shares	Opens the Buffalo NAS device's shared folders.
	Settings	Opens Settings for the Buffalo NAS device.
	Properties	Opens the properties page that lets you configure the Buffalo NAS device's IP address or open Settings.
	Map Share	Assigns the Buffalo NAS device's shared folder as a network drive.
	Disconnect Share	Unmaps the network drive.
	Create Desktop Shortcut	Creates a desktop shortcut to the Buffalo NAS device's shared folders.
	I'm here	Causes your Buffalo NAS device to beep.

\*Click on the Buffalo NAS device's icon to display these options.

When NAS Navigator2 is closed, right-click the NAS Navigator2 icon in the system tray for the following options.

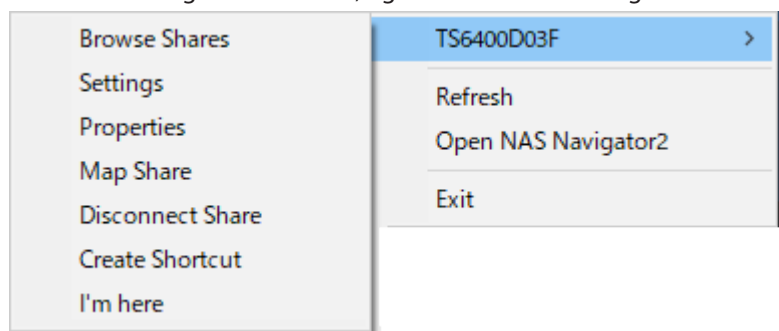

Name	Description	
Buffalo NAS device name	Browse Shares	Opens the Buffalo NAS device's shared folders.
	Settings	Opens Settings for the Buffalo NAS device.
	Properties	Opens the properties page that lets you configure the Buffalo NAS device's IP address or open Settings.
	Map Share	Assigns the Buffalo NAS device's shared folder as a network drive.
	Disconnect Share	Unmaps the network drive.
	Create Shortcut	Creates a desktop shortcut to the Buffalo NAS device's shared folders.
	I'm here	Causes your Buffalo NAS device to beep.
Refresh	Searches for the Buffalo NAS devices on the network again.	
Open NAS Navigator2	Opens the NAS Navigator2 window.	
Exit	Exits NAS Navigator2.	

The following menus may be accessed from the Buffalo NAS device's properties page.

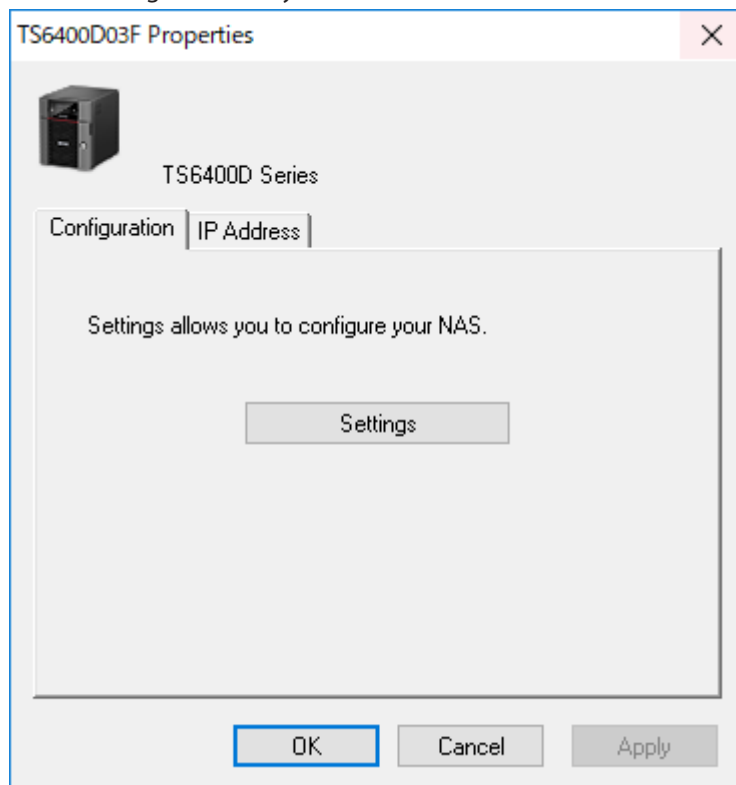

Name	Description
Configuration	Click <i>Settings</i> to open the configuration interface.
IP Address	Select the "Use DHCP" checkbox to assign an IP address from the DHCP server automatically. If there is no DHCP server on the network, you cannot use this function. Select the "Renew IP address" checkbox to obtain an IP address from the DHCP server. You can manually enter a static IP address, subnet mask, and default gateway.

## Mounting as a Network Drive

You can easily assign a shared folder as a network drive using NAS Navigator2.



- 1 Double-click the NAS Navigator2 icon (  ) to start NAS Navigator2.
- 2 Right-click your Buffalo NAS device's icon and select *Map Share*.
- 3 An icon for the mapped share will appear in Computer or This PC. You can use this network drive just like any other drive.

## Changing the IP Address

- 1 Double-click the NAS Navigator2 icon (  ) to start NAS Navigator2.
- 2 Right-click your Buffalo NAS device's icon and select *Properties > IP Address*.
- 3 Clear the "Use DHCP" checkbox and enter the desired settings, then click *OK*. If the username and password prompt appears, enter the admin username and password.

## NAS Navigator2 for macOS

NAS Navigator2 is a utility program that makes it easy to display Settings, change the Buffalo NAS device's IP address, or check its drive. To install NAS Navigator2, download the installer from <http://d.buffalo.jp/TS6000/>. Click the NAS Navigator2 icon (  ) in the Dock to start NAS Navigator2.

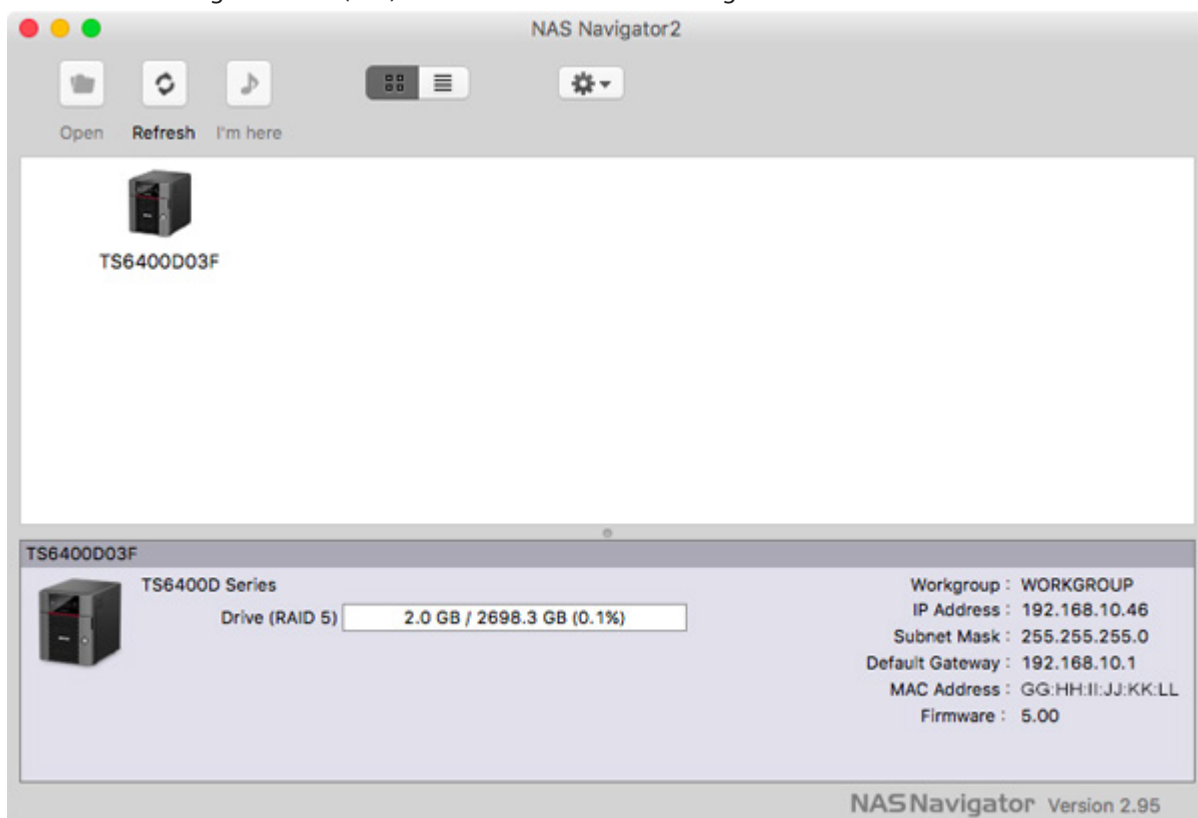

Click a Buffalo NAS device's icon to display total capacity, used space, workgroup name, IP address, subnet mask, default gateway, MAC address, and firmware version.

Double-click the icon to open a shared folder on the Buffalo NAS device.

Name	Description
Open	Opens the Buffalo NAS device's shared folders.

Name		Description
Refresh		Searches for the Buffalo NAS devices on the network again.
I'm here		Causes your Buffalo NAS device to beep.
Settings		Opens Settings for the Buffalo NAS device.
Configure		Opens the properties page that lets you configure the Buffalo NAS device's IP address or open Settings.
Label Color		Selects the color of the name displayed below the icon.
View Options		Lets you choose the icon size, position, and view mode.
Auto Power Mode		Auto power mode can turn supported Buffalo NAS devices on the network on and off automatically.
To display these options, hold down the control key and click your device's icon.	Open Folder	Opens the Buffalo NAS device's shared folders.
	Settings	Opens Settings for the Buffalo NAS device.
	Configure	Opens the properties page that lets you configure the Buffalo NAS device's IP address or open Settings.
	I'm here	Causes your Buffalo NAS device to beep.
	Label Color	Selects the color of the name displayed below the icon.

The following menus may be accessed from the Buffalo NAS device's properties page.

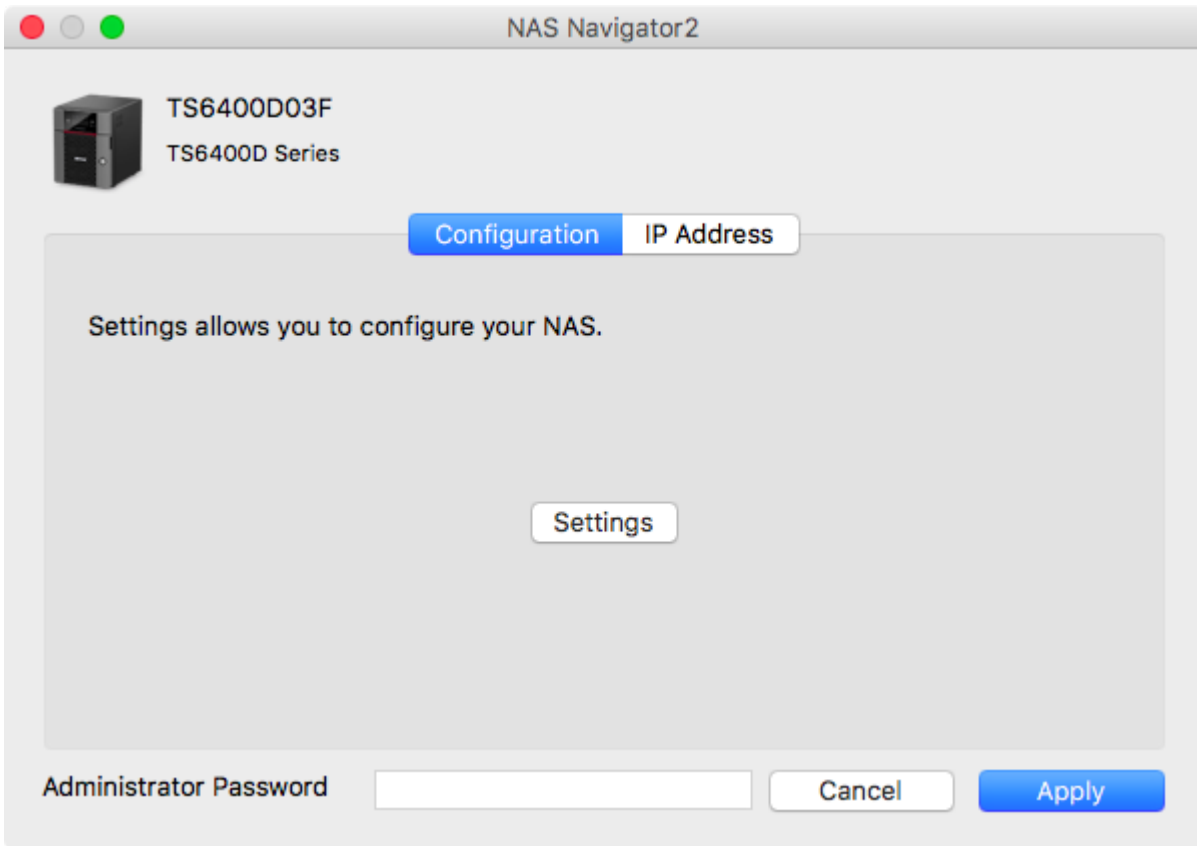

Name	Description
Configuration	Click <i>Settings</i> to open the configuration interface.
IP Address	Select the "Use DHCP" checkbox to assign an IP address from the DHCP server automatically. If there is no DHCP server on the network, you cannot use this function. Select the "Renew IP address" checkbox to obtain an IP address from the DHCP server. You can manually enter a static IP address, subnet mask, and default gateway.

## Mounting as a Network Drive

---

You can map a shared folder as a network drive using NAS Navigator2 on macOS.

- 1** Click the NAS Navigator2 icon (  ) in the Dock to start NAS Navigator2.
- 2** Double-click the Buffalo NAS device's icon or click the Buffalo NAS device's icon while holding down the control key, then select *Open Folder*. Enter a username and password with the rights to access the shared folder.
- 3** If selecting the shared folder window appears, select the shared folder you want to mount and click *OK*.
- 4** The shared folder is now mounted as a network drive.

## Changing the IP Address

---

- 1** Click the NAS Navigator2 icon (  ) in the Dock to start NAS Navigator2.
- 2** Click the Buffalo NAS device's icon while holding down the control key, then select *Configure > IP Address*.
- 3** Clear the "Use DHCP" checkbox; enter the desired settings and the administrator password, then click *Apply*.

---

## NovaBACKUP

---

NovaBACKUP is a Windows utility that lets you back up data on your computer.

The NovaBACKUP installer is available from <http://d.buffalo.jp/TS6000/>. Select the region and model to go to your specific model's d.buffalo website. Download the NovaBACKUP installer and install it onto your computer.

To download the installer, you will need the serial number of your TeraStation. The serial number is printed on the label on the back or top of the unit. For TS6400RN series TeraStations, the serial number is located on the front as well. Refer to the "[Diagrams](#)" section in chapter 1 for information on where to find the serial number.

# Chapter 10 Appendix

---

## TeraStation Does Not Work Properly

---

If an error occurs that prevents the TeraStation from booting up properly, one or more of the following symptoms may occur:

- The power LED keeps blinking instead of turning into a solid glow; follow the procedure at the [“Power LED Keeps Blinking”](#) section below.
- An “i” symbol is displayed with the TeraStation icon and the I61 message appears on NAS Navigator2; follow step 3 or later at the [“Power LED Keeps Blinking”](#) section below.
- An “i” symbol is displayed with the TeraStation icon and “EM” is added to your TeraStation’s hostname on NAS Navigator2; follow the procedure at the [“Booting the TeraStation in Emergency Mode”](#) section below.
- The LCD panel lights up in red with the “Invalid Firmware” message; follow the procedure at the [“Booting the TeraStation in Emergency Mode”](#) section below.

If one or the above occurs, follow the appropriate procedures below to recover from the error.

### Power LED Keeps Blinking

---

While the TeraStation’s power LED keeps blinking, you may see the I61 message on NAS Navigator2 or the LCD panel. In such a case, follow the procedure below to recover from the message.

- 1** Press and hold the power button for three seconds to turn off the TeraStation.
- 2** Turn it on while holding down the function button. You should hold down the function button for at least 10 seconds after pressing the power button.
- 3** When the power LED changes from blinking to glowing, let go of the function button and open Settings from NAS Navigator2.

- 4** Make sure that “Recover firmware” is selected from the drop-down list under “Action”, then click *OK*.

### Drive Setup

Unit Firmware Version : 5.00-4.03

Drive	Status	Info	Version	Model Name	Capacity	Primary Drive	Action
Drive 1	Recognized	System#1_(D:1/4)	5.00-4.03	ST8000VN0022-2EL112	7452 GB	<input checked="" type="radio"/>	Recover firmware ▾
Drive 2	Recognized	System#1_(D:2/4)	5.00-4.03	ST8000VN0022-2EL112	7452 GB		Recover firmware
Drive 3	Recognized	System#1_(D:3/4)	5.00-4.03	ST8000VN0022-2EL112	7452 GB		Recover firmware
Drive 4	Recognized	System#1_(D:4/4)	5.00-4.03	ST8000VN0022-2EL112	7452 GB		Recover firmware

Select the action to take when recovering the firmware.

Revert settings to those of the last shutdown  
This will revert settings to those that were saved before the last shutdown.

Revert settings to those of the last boot (Time When Boot Occurred: 04/15/2019 10:18:31)  
This will revert settings to those that were saved during the last boot.

No operations are required for the connected drives. Restart the TeraStation using the power button. However, if the TeraStation boots up in drive setup mode again, select “Recover firmware” under “Action”. To shut down the TeraStation, press and hold the power button for 3 seconds. Turn off the TeraStation before disconnecting any drives. Some settings may not work correctly when using drives that were used with other series units without formatting them. For more detailed information, refer to the user manual.

Rediscover Drive

**Note:** There are two more options for “Action” other than “Recover firmware”. The details for all options are below:

- **Use the drive’s firmware:** The TeraStation will boot using the firmware on the drive.
- **Recover firmware:** The TeraStation will be recovered using the firmware on the NAND flash.
- **Format drive:** The drive will be formatted.

- 5** The “Confirm Operation” screen will open. Enter the confirmation number, then click *OK*.

- 6** The recovery process will start. When the process is completed, the TeraStation will shut down automatically. Press the power button to turn it on.

The TeraStation will be recovered from the malfunction that is keeping the power LED blinking. Make sure the TeraStation finishes booting properly.

**Note:** If the TeraStation does not recover from the error after trying the procedure above, try again from the first step.

## **Booting the TeraStation in Emergency Mode**

If the TeraStation boots up in emergency mode, depending on your TeraStation model, an “i” symbol is displayed with the TeraStation icon and “EM” is added to your TeraStation’s hostname, or the LCD panel lights up in red with the “Invalid Firmware” message.

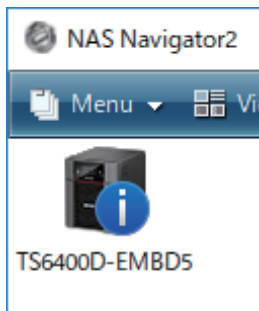

TS6400D  
Invalid Firmware

To recover from emergency mode, follow the procedure below.

- 1 Download the firmware updater from the [Buffalo website](#).
- 2 Extract the downloaded file by double-clicking it and launch the updater.
- 3 Update the firmware for the TeraStation unit that is currently in emergency mode.

When the "i" symbol and "EM" disappear from the icon and the hostname on NAS Navigator2, and the LCD panel returns to glowing blue, the TeraStation is no longer in emergency mode.

**Note:** If the TeraStation does not shut down properly due to a power outage or the power cable getting disconnected while the TeraStation is on, data on the TeraStation may be corrupted when the TeraStation boots in emergency mode. In such a case, the corrupted data may not be recoverable even if you try the procedure above.

---

## Cleaning the Dustproof Filter

---

If your TeraStation has a front cover and you are trying to clean the dustproof filter on the front cover, follow the procedure below.

- 1 Open the front cover with the included key.

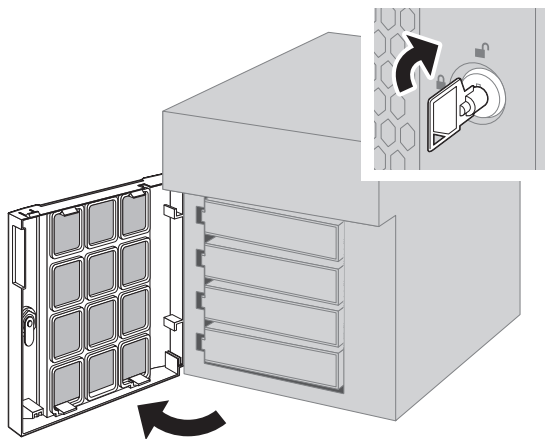

**2** Remove the front cover while holding the hook downward.

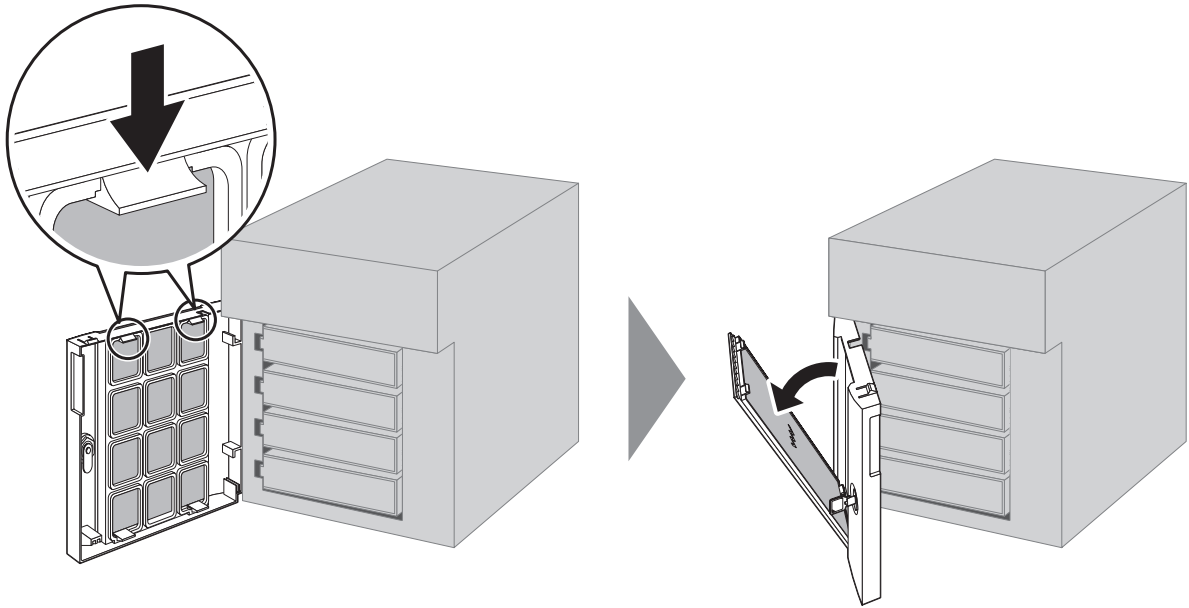

**3** Remove the dustproof filter from the front cover and clear any dust, such as by using a vacuum cleaner.

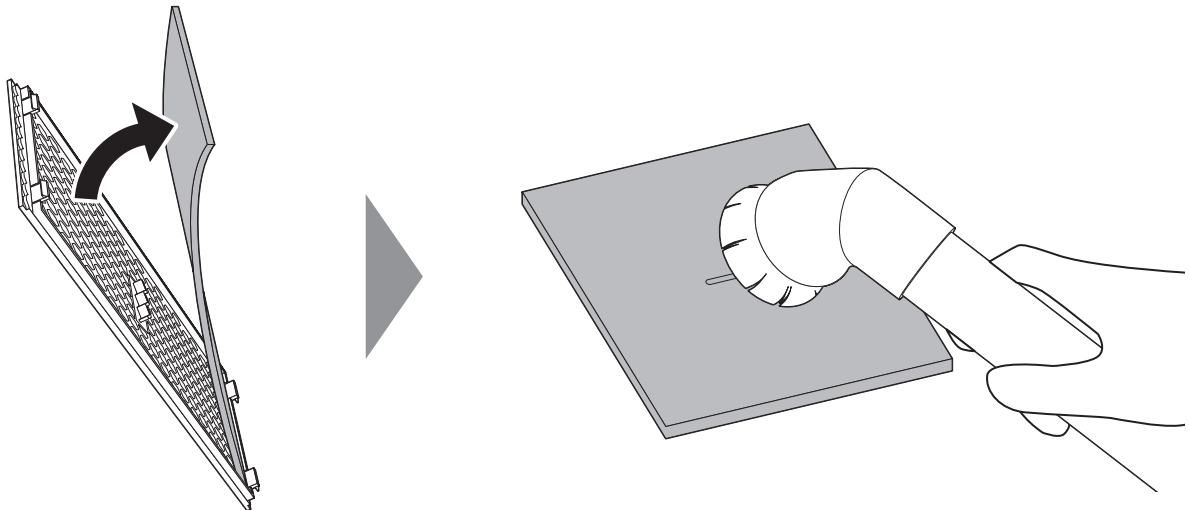

**4** When cleaning is completed, return the filter and the front cover.

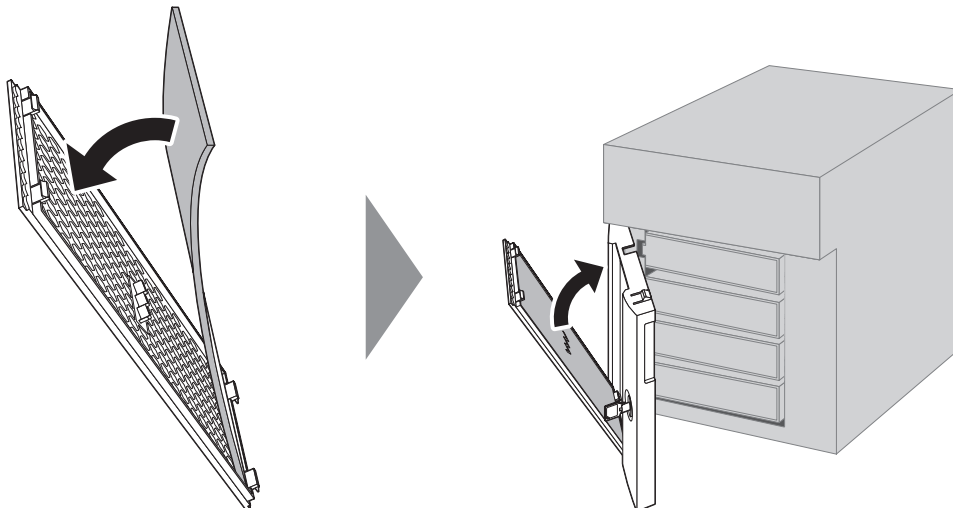

## 5 Close the front cover.

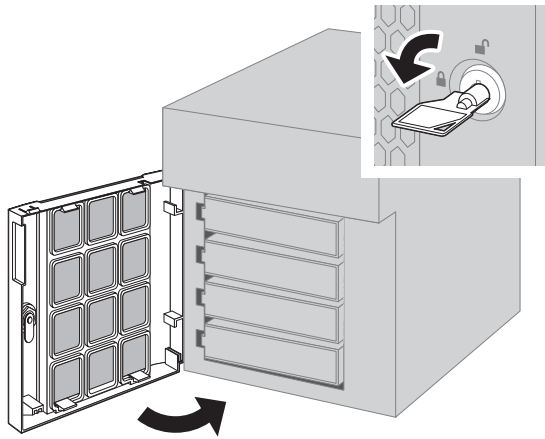

## LCD Panel

The LCD panel can be cycled through different modes by pressing the display button on the front of the TeraStation.

### Modes

LCD Message		Description	Corrective Action
LANx <b>Note:</b> The "x" indicates the number of the LAN port where the Ethernet cable is connected.	LANx Not Connected	Not connected to a network.	Connect an Ethernet cable to the LAN port.
	LANx Half Duplex 10 Mbps	Connected at 10 Mbps half duplex.	-
	LANx Full Duplex 10 Mbps	Connected at 10 Mbps full duplex.	-
	LANx Half Duplex 100 Mbps	Connected at 100 Mbps half duplex.	-
	LANx Full Duplex 100 Mbps	Connected at 100 Mbps full duplex.	-
	LANx 1000 Mbps	Connected at 1000 Mbps.	-
	LANx 2.5 Gbps	Connected at 2.5 Gbps.	-
	LANx 5 Gbps	Connected at 5 Gbps.	-
	LANx 10 Gbps	Connected at 10 Gbps.	-
	LANx Port Trunking	Displays if port trunking is configured.	-
Model Name/ Firmware Version	TS6400D FW Version 1.00	Displays the model name and firmware version of your model. <b>Note:</b> This example is using a TS6400DN unit. The numbers and letters after "TS" may vary depending on your model.	-
Hostname	Hostname: TS6400Dxxx	Displays the hostname. <b>Note:</b> The "xxx" is assigned using the last three-digits of MAC address.	-



LCD Message		Description	Corrective Action
Date and Time	Date Time YYYY/MM/DD hh:mm	Displays the date and time set in the TeraStation.	-
IP Address	LANx DHCP 192.168.11.150	Displays the IP address. If acquiring from a DHCP server automatically, "DHCP" will be displayed. If configuring a static IP address, "Static IP" will be displayed.	-
	LANx Port Trunking	Displays if port trunking is configured.	-

## Errors

If an error occurs, one of the following messages will appear on the LCD panel and the error LED will glow red. You can also confirm the current status from Settings or using NAS Navigator2. However, NAS Navigator2 may show the error as an unknown error. In such a case, check the Dashboard in Settings.

**Note:** The "x" in the LCD message is the number of the drive or array involved in the process.

LCD Message	Description	Corrective Action
E10 UPS Running Off Battery	The TeraStation is running on the UPS battery due to a power outage.	Shut down the TeraStation safely and wait until the power outage ends. If certain settings are configured, the TeraStation may shut down automatically when the error is detected.
	If the setting to use the UPS connected to this TeraStation has been configured, the UPS cable may be disconnected.	Verify that the UPS cable or LAN cable is connected properly.
	If the setting to use the UPS connected to another TeraStation on the same network has been configured, the LAN cable of this TeraStation may be disconnected.	
E11 Fan Failure	An error occurred in the fan speed.	Check that no foreign objects or dust are clogging the fan. If any foreign objects or dust are found, use a pair of tweezers, air duster, or other tools to remove them. If the error is displayed again, contact Buffalo technical support for assistance.
E12 Cooling Failure	A rise in the system temperature may have exceeded the allowable safety value.	Do not place objects in the area around the TeraStation. Also, move the TeraStation to a cool location.
E14 Can't Mount Array x	The RAID array cannot be mounted.	Run the drive check on the RAID array by referring to the " <a href="#">Checking Drives</a> " section in chapter 4.
E16 Drive x Not Found	Unable to find the drive.	The drive may be disconnected or may have failed. After shutting down, reinstall the drive.
E22 Can't Mount Drive x	Unable to mount the drive.	Format the drive. After formatting, if the error still appears after rebooting, replace the drive. If the error is displayed again, contact Buffalo technical support for assistance.

LCD Message	Description	Corrective Action
E27 Lost Failover Target	Unable to find the backup TeraStation.	Reconfigure the backup TeraStation for failover by referring to the <a href="#">“Configuring Failover”</a> section in chapter 5.
E30 Replace Drive x	An error occurred, so the drive was removed from the RAID array.	Replace the drive by referring to the drive replacement sections in chapter 8.
E41 NVRAM Failure	The NVRAM inside the TeraStation failed.	Contact Buffalo technical support for assistance.

## Status

After you change settings, one of the following messages will appear on the LCD panel and the info LED will glow amber. You can also confirm the current status from the Dashboard in Settings or using NAS Navigator2. However, NAS Navigator2 may show the status as an unknown error. In such a case, check the Dashboard in Settings. You can click the “Clear” button to delete messages from the Dashboard.

**Note:** The “x” in the LCD message is the number of the drive, array, or job involved in the process.

LCD Message	Description	Corrective Action
I01 Rebuilding System Array	Checking the system area.	-
I10 System Is Overheating	A rise in the system temperature may have exceeded the allowable safety value.	Move the TeraStation to a cool location. Do not place objects in the area around the TeraStation.
I11 Bad Sectors on Drive x	The drive has too many bad sectors.	Replace the drive by referring to the drive replacement sections in chapter 8.
I12 Degraded Mode	Operating in degraded mode.	Check if the E30 message is also displayed. In such a case, refer to the corrective action for the E30 message.
I13 Formatting Array x...	Formatting the RAID array.	-
I14 Checking Array x...	Checking the RAID array.	-
I15 Scanning Array x Data...	Examining the error status of the RAID array. <b>Note:</b> Transfer speeds are slower during the examination process.	-
I16 Creating Array x...	Creating the RAID array.	-
I18 Rebuilding Array x...	Rebuilding the RAID array. <b>Note:</b> Transfer speeds are slower during the rebuilding process.	-
I19 Rewriting Array x...	Rewriting the RAID array.	-
I20 Formatting Drive x...	Formatting the drive.	-
I21 Checking Drive x...	Checking the drive.	-
I22 Rewriting Drive x...	Rewriting the drive.	-
I25 Updating Firmware...	Updating the TeraStation firmware. <b>Note:</b> Do not turn off the TeraStation’s power.	-

LCD Message	Description	Corrective Action
I26 Initializing Settings...	Initializing all settings.	-
I27 Checking USB Drive x...	Checking the USB drive.	-
I28 Formatting USB Drive x...	Formatting the USB drive.	-
I31 Push Func to Use New Drive x	Displays when pressing the function button to rebuild the RAID array after replacing the drive.	Press the function button to rebuild the RAID array.
I32 New Drive x Detected	Displays after replacing the drive when the RAID array needs to be rebuilt in Settings or formatting is necessary.	From Settings, either rebuild the RAID array or format the drive.
I33 Replication Failure	An error occurred in replication, or synchronization between the main TeraStation and the backup TeraStation failed during failover configuration.	From Settings, navigate to <i>Backup &gt; Replication</i> and click <i>Resync</i> to execute resynchronization. If you configured the subfolders' access restrictions to be inherited to the replication or failover destinations, disable them or change the destinations. If the error is displayed again, contact Buffalo technical support for assistance.
I37 Recovering System...	Settings initialization in progress.	-
I38 Recovery Finished	Settings initialization is completed.	-
I40 All Data Will Be Deleted	Beginning settings initialization. All data on the drive 1 will be deleted.	-
I41 Push Func to Start Recovery	Press the function button on the front to start the settings initialization process.	-
I42 Preparing Recovery	Preparing to start the settings initialization process.	-
I43 Unsupported Hardware	The TeraStation was started from the USB initialization device, but the settings cannot be initialized from this USB initialization device.	-
I44 Drive 1 Not Found	Initialization from the USB initialization device was initiated, but drive 1 was not detected.	Make sure that drive 1 is present and fully inserted in its slot.
I45 Recovery Failure	Initialization failed.	-
I46 Migrating RAID Array x...	Data migration or conversion (RAID migration) is in progress. <b>Note:</b> Do not turn off the TeraStation's power.	-
I47 Don't Power Off System!	Data migration or conversion (RAID migration) is in progress. <b>Note:</b> Do not turn off the TeraStation's power.	-
I48 Push Func to Start Failover	This TeraStation is ready to become the failover backup for the main TeraStation.	Press and hold the function button on the front of the target TeraStation until it stops beeping to accept failover backup status.

LCD Message	Description	Corrective Action
I49 Lost Failover Main	The main TeraStation in the failover configuration cannot be found.	Make sure that the main TeraStation is on, working, and connected to the network.
I50 Failover in Maintenance Mode	Failover maintenance is in progress. <b>Note:</b> Do not turn off the TeraStation's power.	-
I51 Initializing Failover...	Initializing the failover configuration. <b>Note:</b> Do not turn off the TeraStation's power.	-
I52 New Firmware Available	A new firmware version has been released.	Update the firmware by referring to the <a href="#">"Updating the Firmware"</a> section in chapter 7.
I54 Backup Job x Failure	The backup job failed.	Refer to the <a href="#">"Backup Logs When Backup Fails"</a> section in chapter 5 and try the respective corrective actions.
I55 Recovery Not Authorized	Authentication during initialization of settings failed.	Settings can only be restored for the TeraStation whose settings were originally saved.
I59 Boot Auth Failure	Boot authentication failed.	Try the manual authentication by referring to the <a href="#">"If the TeraStation Cannot Be Accessed"</a> section in chapter 7.
I61 Drive Setup Mode	The unit is in drive setup mode.	Recover from drive setup mode by referring to the <a href="#">"Power LED Keeps Blinking"</a> section.
I64 Cloud Sync Failure	Connecting to the cloud storage service failed.	Open Settings and check the job status for which the cloud storage service failed. Refer to the error log on the job list of the specific cloud storage service and check the cause of the error.
I70 No Space to Save Logs	There is not enough space to save file access logs.	Delete unnecessary logs or move them to another place.
I71 Old Logs Removed	The space is occupied so older logs were removed.	Delete unnecessary logs or move them to another place.

## Default Settings

Administrator's Name	admin
Password	password
Shared Folders	"share" for both Windows and Mac computers. <b>Note:</b> The recycle bin is enabled by default.
IP Address	The TeraStation will get its IP address automatically from a DHCP server on the network. If no DHCP server is available, then an IP address will be assigned as follows: IP address: 169.254.xxx.xxx ("xxx" is assigned randomly when booting the TeraStation.) Subnet mask: 255.255.0.0
Registered Groups	"hdusers", "admin", and "guest" You cannot edit or delete these default groups.
Microsoft Network Group Settings	WORKGROUP
MTU Size	1500 bytes

SMB	Enabled	
	SMB Protocol	Auto
	Recycle Bin Permissions	All users
	macOS Temp Files	Keep when original file is deleted
AFP	Enabled	
FTP	Disabled	
SFTP	Disabled	
WebAccess	Disabled	
NFS	Disabled	
rsync	Disabled	
RAID Scanning	Disabled	
iSCSI	Disabled	
Dropbox Sync	Disabled	
Microsoft Azure Storage Sync	Disabled	
Microsoft OneDrive Sync	Disabled	
SNMP	Disabled	
Time Machine	Disabled	
NTP	Enabled	
Email Notification	Disabled	
Init Button Settings	Restore admin username and password to factory defaults	
Boot Authentication	Disabled	
RAID Mode	TS6200DN: RAID 1 TS6400DN, TS6400RN: RAID 5	

## Specifications

Check the [Buffalo website](#) for the latest product information and specifications.

1GbE LAN Interface	Standards Compliance	IEEE 802.3ab (1000BASE-T), IEEE 802.3u (100BASE-TX), IEEE 802.3 (10BASE-T)
	Data Transfer Rates	10/100/1000 Mbps (auto sensing)
	Number of Ports	2
10GbE LAN Interface	Standard Compliance	IEEE 802.3an (10GBASE-T), IEEE 802.3bz (2.5GBASE-T, 5GBASE-T), IEEE 802.3ab (1000BASE-T), IEEE 802.3u (100BASE-TX)
	Data Transfer Rates	2.5/5/10 Gbps, 100/1000 Mbps (auto sensing)
	Number of Ports	1
Common Specs for LAN Interface	Connector Type	RJ-45 8-pin (auto MDI-X)
	Supported Protocols	TCP/IP
	Network File Services	SMB/CIFS, AFP, FTP/SFTP, NFS, HTTP/HTTPS, SNMP
	MTU Sizes	1500–9216 bytes
USB Interface	Standards Compliance	USB 3.0
	Data Transfer Rates	Max. 5 Gbps
	Number of Ports	TS6200DN, TS6400DN: 2 TS6400RN: 3
	Connector Type	Type A

Internal Hard Drives	Number of Drive Bays	TS6200DN: 2 TS6400DN, TS6400RN: 4
	Drive Interface	SATA 6 Gbps
	Supported RAID	TS6200DN: 0, 1, JBOD (individual drives) TS6400DN, TS6400RN: 0, 1, 5, 6, 10, JBOD (individual drives)
	Replacement Drive	Buffalo OP-HDN series drive <b>Note:</b> The replacement drive should be the same size or larger as the original drive. The drives listed above are available from the <a href="#">Buffalo website</a> .
Other	Power Supply	TS6200DN, TS6400DN: AC 100–240 V, 1.5 A, 50/60 Hz TS6400RN: AC 100–240 V, 2.5–1.25 A, 50/60 Hz
	Dimensions (W × H × D, excluding protruding parts)	TS6200DN: 170 × 170 × 230 mm; 6.7 × 6.7 × 9.1 in. TS6400DN: 170 × 215 × 230 mm; 6.7 × 8.5 × 9.1 in. TS6400RN: 430 × 44.3 × 430 mm; 16.9 × 1.7 × 16.9 in.
	Weight	TS6200DN: approx. 5.0 kg; 11.0 lbs TS6400DN: approx. 7.4 kg; 16.3 lbs TS6400RN: approx. 8.9 kg; 19.6 lbs
	Power Consumption	TS6200DN, TS6400DN: max. 85 W TS6400RN: max. 100 W
	Operating Environment	Temperature: 0–40°C; 32–104°F Humidity: 10–85% non-condensing
	Compatible Devices	Windows PCs, tablets, and Intel Mac computers with wired or wireless Ethernet connection.
	Supported OS	Windows 10, 8.1, 7 Windows Server 2016, 2012 R2, 2012, 2008 R2, 2008 macOS 10.14, 10.13, 10.12, 10.11