

# Cisco Catalyst 9115 and 9117 Series Access Points

---

# Contents

Revision history .....	Error! Bookmark not defined.
<b>Wi-Fi 6 primer – how is it different from 802.11ac? .....</b>	<b>3</b>
<b>Choosing the right access point .....</b>	<b>6</b>
Models .....	6
<b>Access point physical hardware and mounting options .....</b>	<b>7</b>
Channel rail adapters .....	11
Wall mounting the access point .....	12
Changing the color of an access point .....	13
<b>Unique installations .....</b>	<b>14</b>
Clean rooms (healthcare) .....	14
Above the ceiling tiles .....	15
Stadium and harsh environments .....	17
Areas with high vibration .....	18
Warehouse and factory environments .....	18
Ethernet cable recommendation .....	20
Antenna cable recommendation .....	20
Access point spacing recommendations .....	21
Installations in IDF closets (telecommunications or other electrical equipment) .....	21
Installations inside and around elevators .....	21
<b>External antenna options and patterns .....</b>	<b>22</b>
For use with the Cisco Catalyst 9115E Access Point .....	22
Cisco Catalyst 9115I internal antenna model .....	29
<b>Understanding external antenna deployments .....</b>	<b>34</b>
<b>Power over Ethernet .....</b>	<b>36</b>
<b>General considerations regarding access points .....</b>	<b>37</b>



This document is intended for trained and experienced technical personnel familiar with the existing Cisco Wireless Networking Group (WNG) product line and features.

### Wi-Fi 6 primer – how is it different from 802.11ac?

The Cisco® Catalyst® 9115 and 9117 Series Access Points are built upon the emerging standard known as Wi-Fi 6. This next-generation Wi-Fi is all about high-efficiency wireless (getting the most out of every packet that is on the air) in a way that improves the user experience.

**Figure 1.** Next-generation Wi-Fi 6

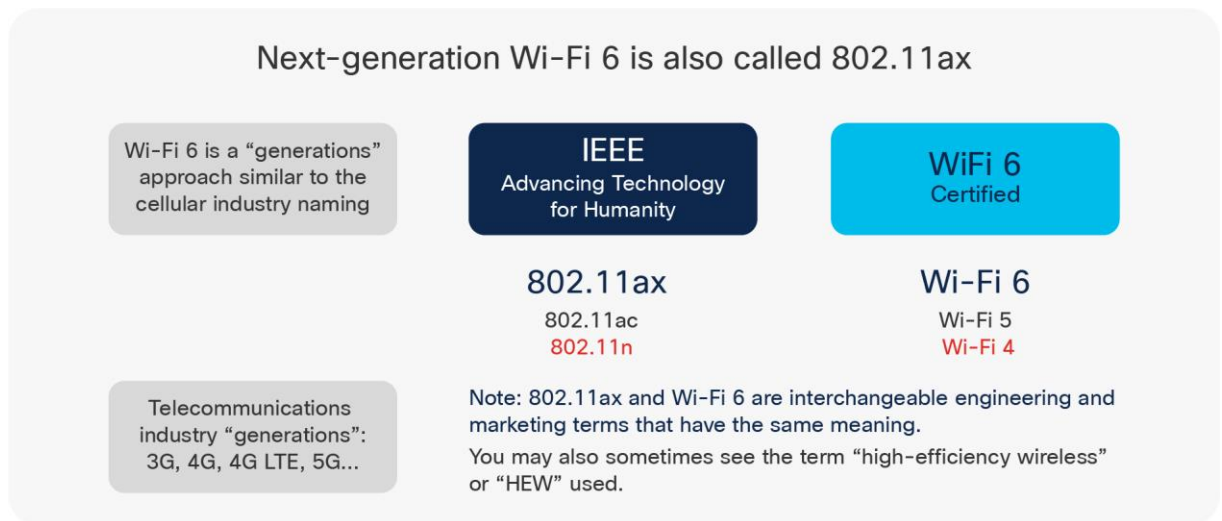
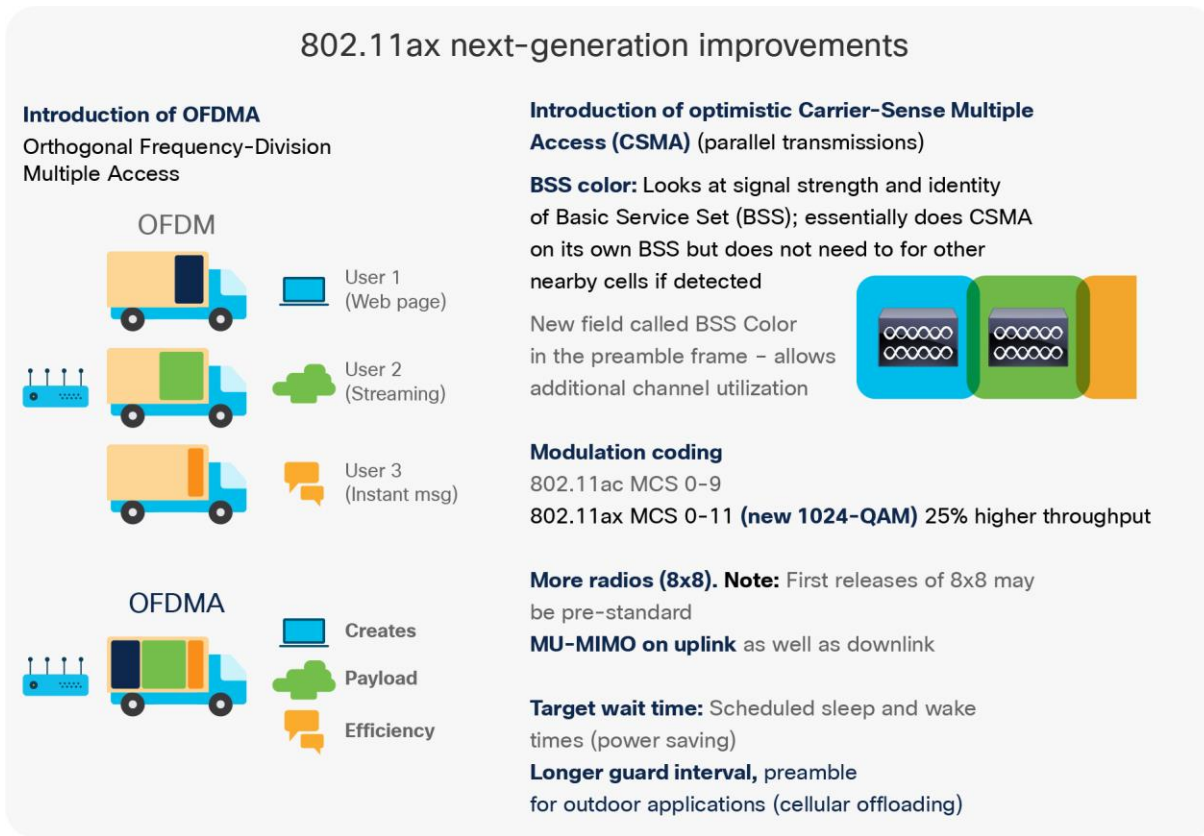


Figure 2. 802.11ax improvements



**Figure 3.** Differences between 802.11ac and 802.11ax

### Differences Wi-Fi 5 and Wi-Fi 6

A look at the physical layer enhancements in .11ax

Wi-Fi 5	Wi-Fi 6	Take-aways
5.0 GHz band only	2.4 GHz and 5 GHz enhancements	2.4 GHz enhancements for small packets and sleep (IoT)
4X4 MIMO	Up to 8X8 MIMO - Note: Possible first releases of 8X8 may be Pre-Standard - What is optional?	Double streams faster T-PUT (8X8 certification still a bit fluid)
Multi-User MIMO (one to many) <downstream>	Multi-User MIMO (one to many) <upstream and downstream> up to 8X8	Multi-User MIMO UP/DN and small packet (phone and IoT)
Modulation type OFDM	Modulation type OFDM, OFDMA OFDMA - Aggregates multiple users into single larger packets 4X longer symbol time 12.8 (us)	OFDMA and longer symbol time helps with outdoor links and cellular offloading
Bandwidth 20, 40, 80, 80+80, 160	Bandwidth 20, 40, 80, 80+80, 160	No change in channel plan
Data subcarrier modulation BPSK, QPSK, 16-QAM, 64-QAM, 256-QAM	Data subcarrier modulation BPSK, QPSK, 16-QAM, 64-QAM, 256-QAM, 1024-QAM	Faster modulation at 1024-QAM
Channel reuse - CSMA	Channel reuse - CSMA also optimistic CSMA - supports parallel transmissions in nearby BSS's "coloring"	Allows for additional channel utilization

**Low-Density Parity-Check (LDPC) - Method of ECC used over noisy channels was optional now required in .11ax**

## Choosing the right access point

### Models

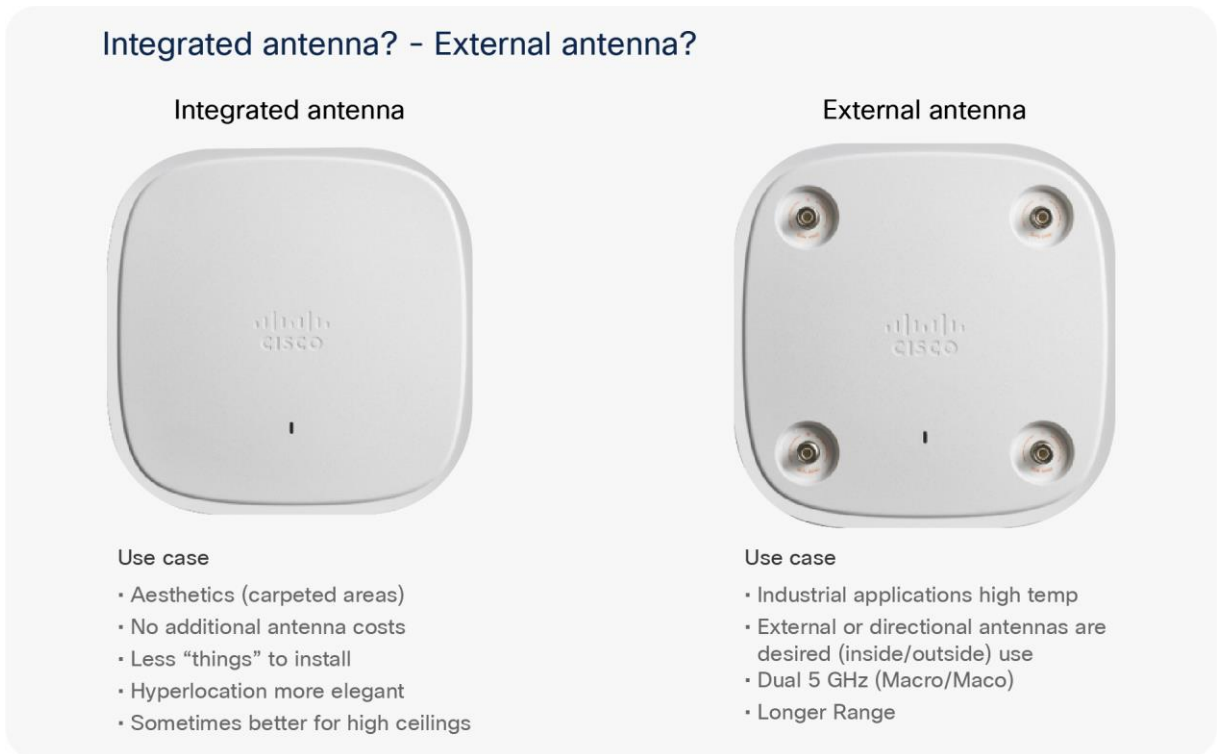
**Figure 4.** Features of the Cisco Catalyst 9115 and 9117AX Series Access Points



The Cisco Catalyst 9115 Series has models supporting internal (AXI) and external (AXE) antenna options. The 9115E model is ideal in areas where external antennas are already deployed or where a directional antenna is desired.

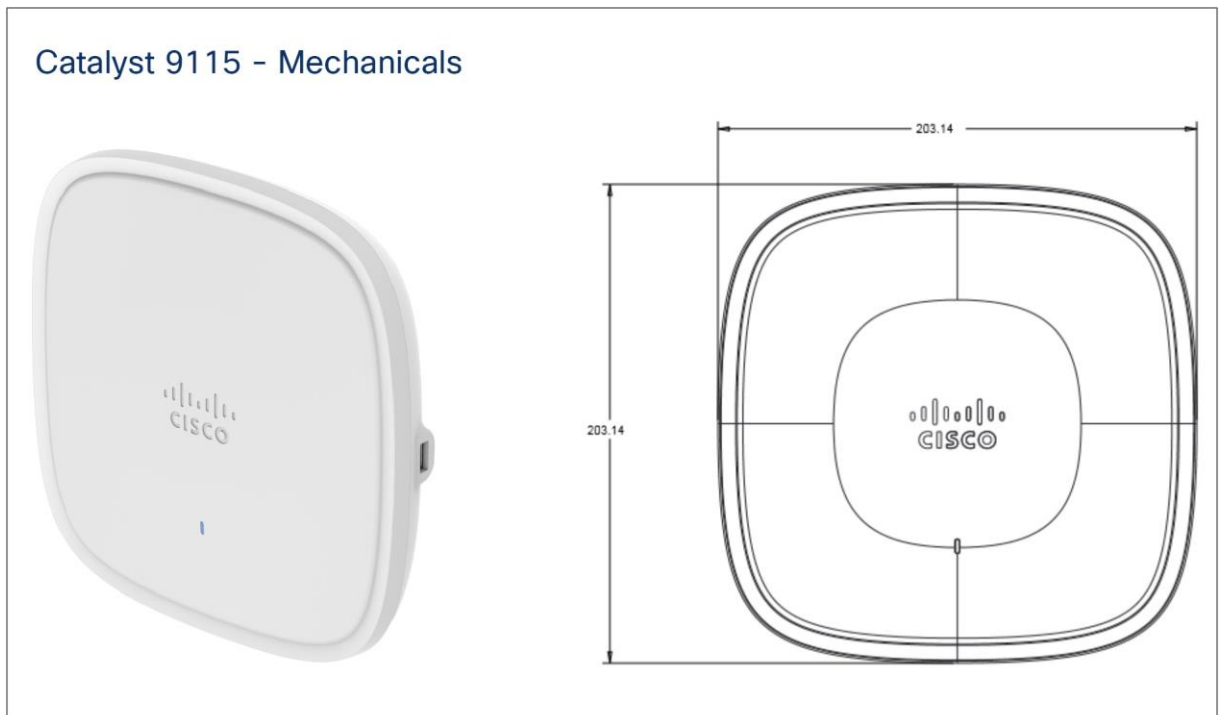
The internal antenna versions (9115I and 9117I) are ideal for carpeted areas where ceiling installations are desirable.

**Figure 5.** Choosing an integrated antenna or an external antenna

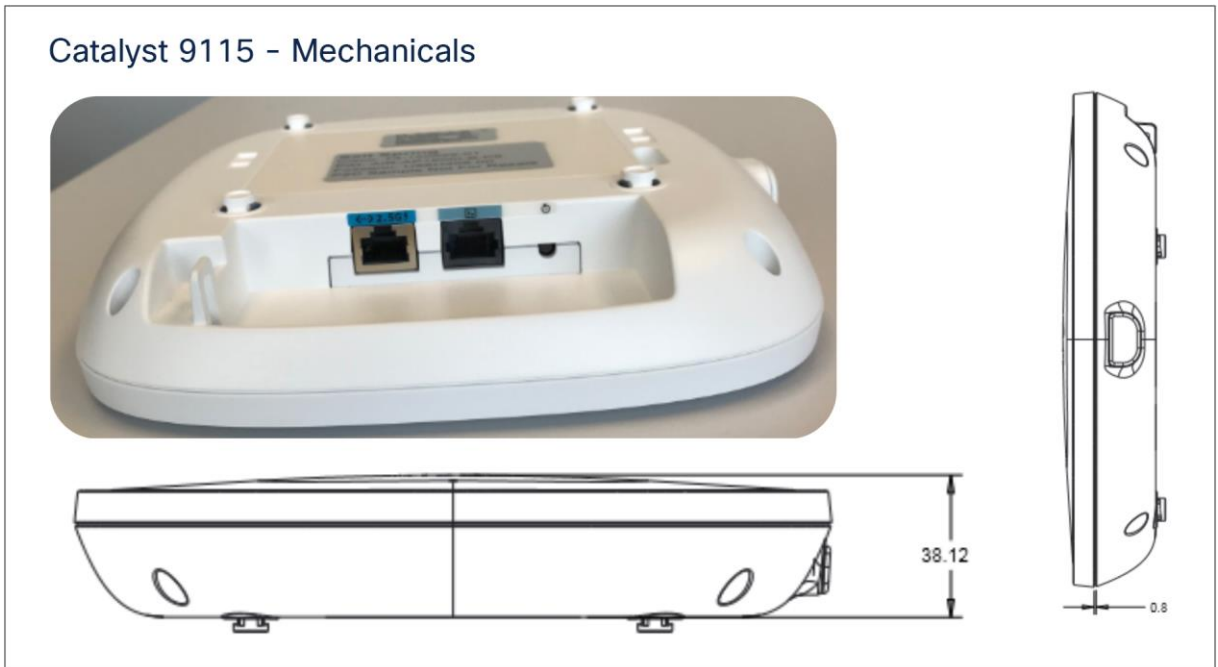


## Access point physical hardware and mounting options

**Figure 6.** Cisco Catalyst 9115 Series mechanicals

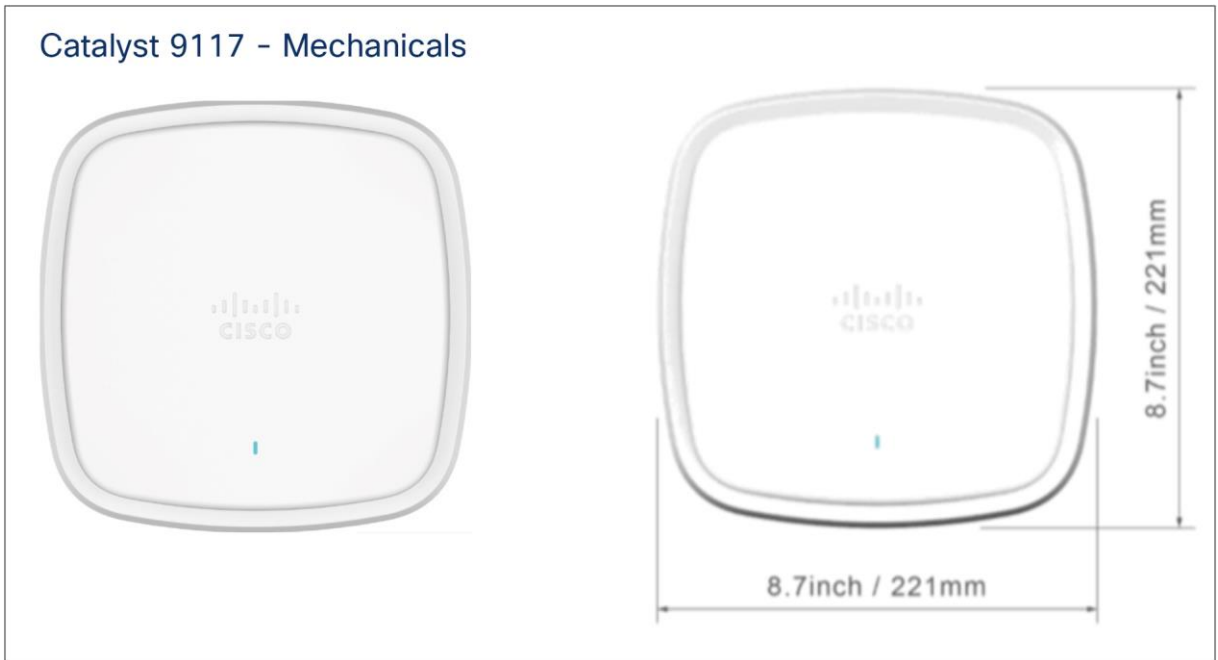


**Figure 7.** Cisco Catalyst 9115 Series mechanicals (continued)





**Figure 8.** Cisco Catalyst 9117 Series mechanicals

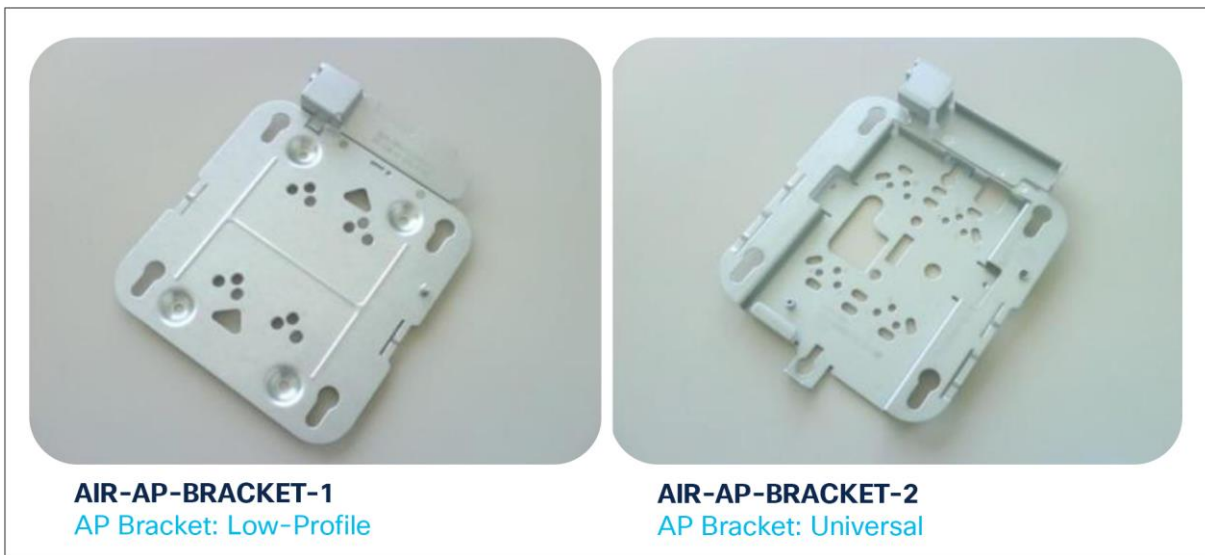


**Figure 9.** Cisco Catalyst 9117 Series mechanicals (continued)



Many different installation options are available, depending on the requirements of the customer. Brackets are available from Cisco as well as third-party companies. During the ordering process, the customer may choose one of two brackets (but not both). Each bracket is a zero-dollar (\$0) option at the time of configuration. If the customer does not choose a bracket, the default is AIR-AP-BRACKET-1, which is the most popular for ceiling installations. The other choice is a universal bracket that carries part number AIR-AP-BRACKET-2 (Figure 10).

**Figure 10.** Brackets available for mounting access points



If the access point will be mounted directly to a ceiling on the gridwork, the AIR-AP-BRACKET-1 mounts flush and has the lowest profile. However, if the access point will be mounted to an electrical box or other wiring fixture, or inside a NEMA-rated enclosure or perhaps wall mounted, the AIR-AP-BRACKET-2 is a better choice. The extra space in the bracket allows for wiring, and the extra holes line up with many popular electrical boxes. When the bracket is mounted to the ceiling gridwork, the clips used will depend on whether the ceiling tiles are recessed. Two different styles of ceiling clips, recessed and flush rails, are available (Figure 11).

**Figure 11.** Ceiling clips



### Channel rail adapters

When mounting access points to ceiling channel rails such as the ones shown in Figure 12, an optional channel adapter is used: AIR-CHNL-ADAPTER. It comes in a 2-pack and attaches to the ceiling grid clip shown in Figure 11. Refer to Figures 13 and 14.

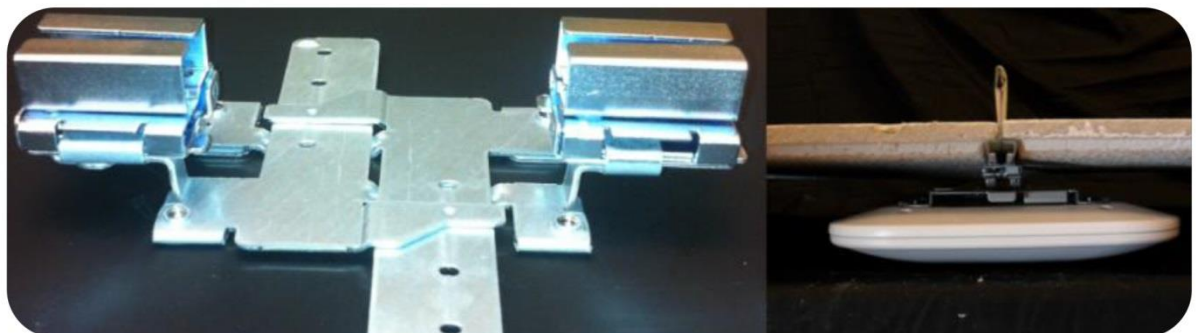
**Figure 12.** Examples of channel rails



**Figure 13.** AIR-CHNL-ADAPTER (left) slides onto the rails



**Figure 14.** AIR-CHNL-ADAPTER mounted to rail clip (left) and finished installation (right)



## Wall mounting the access point

When wall mounting is desired, the installer should understand that walls can be a physical obstacle to the wireless signal; therefore, 360-degree coverage may be compromised by the wall. If the wall is an outside wall and/or the goal is to send the signal in a 180-degree pattern instead, a directional antenna often referred to as a “patch” antenna may be a better choice, assuming that the external antenna access point model is used.

Avoid wall-mounting access points with internal antennas unless you use an optional right-angle mount (available from third-party vendors), as the internal antenna model was designed to mount to a ceiling to provide 360-degree coverage. See Figure 15.


**Figure 15.** Wall-mount options



If the access point is wall mounted in a non-ceiling orientation, the signal may penetrate the floors above and below, causing unintended coverage that could result in additional, needless roaming access when a mobility client, such as a user with a Wi-Fi phone, walks by on an adjacent floor.

**Figure 16.** Wall mounting access points with internal antennas

### Wall mounting access point with internal antennas



Wall mounting is acceptable for small deployments such as hotspots, kiosks, transportation or small coverage areas. **But NOT for enterprise deployments.**

Note: Wall mounting may create unwanted coverage areas on the floor above or below


This is not desirable for voice as it may cause excessive roams and is directional as metal is behind the antennas (backside)

Coverage is always **more uniform** when installed on the ceiling tile or grid area

### Changing the color of an access point

If you want to change the color of an access point, rather than painting the access point, which would void the warranty, consider using colored vinyl tape or a colored plastic cover from Oberon (Figure 17).

**Figure 17.** Third-party option for changing the color, adding a custom logo, or hiding the LED



If the environment requires an AP color change or you have a requirement to remove the Cisco logo or LED you have options

[www.oberonwireless.com](http://www.oberonwireless.com)

**Phone (814) 867-2312**

**Part numbers:**  
1140/3500i/3600i-SKIN  
3600e-SKIN  
1260/3500e-SKIN

**Specifications:**

- Fabricated from textured ABS plastic
- The skin is virtually transparent to access point radio frequency signals
- Attaches to access point with Velcro tabs (included)
- Standard color is black
- Skins are paintable
- Custom colors are available on request. Please contact your Oberon representative

---

Another option is a vinyl “skin” such as the ones in Figure 18.

**Figure 18.** AccelTex “skins” for access points



## Unique installations

### Clean rooms (healthcare)

Many hospitals and factories have requirements to wipe down or gently spray the environment with a chemical (often a diluted solution that has cleaning and disinfectant properties).

Cisco Catalyst access points can be wiped down using a Steris product called Spor-Klenz.

If the clean room environment requires metal ceilings or areas where tile is not practical, a metal enclosure from Oberon or AccelTex can be used (Figure 19).

**Figure 19.** Oberon metal enclosure protects and secures the access point in clean rooms



### Above the ceiling tiles

The Cisco Catalyst 9115 and 9117 Series are rated for installation in the plenum area (UL-2043). Many customers prefer to locate the access point so that nothing is visible on the ceiling. In some cases this is preferred for aesthetic reasons, so customers may install the access point above a drop ceiling. This also may be preferred in high-theft areas such as classrooms or in areas where policy dictates that nothing be visible on the ceiling.

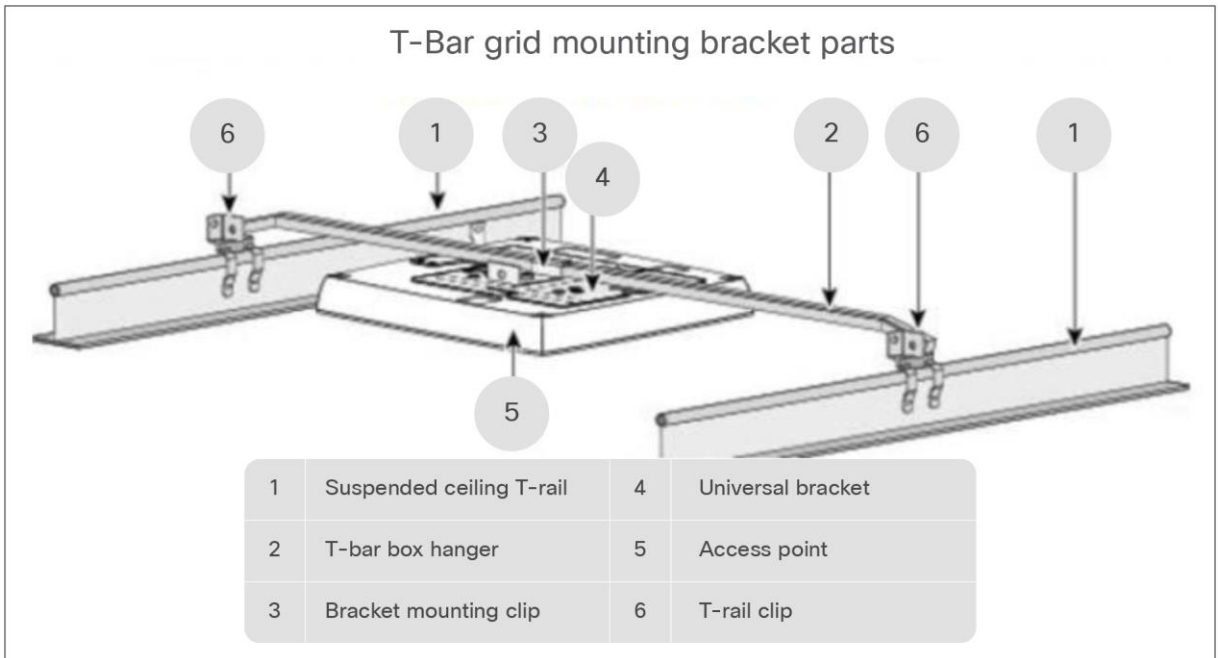
When this is a hard requirement, optional T-bar hanger accessories from third-party companies such as Erico and Cooper can be used (Figure 20). The Erico Caddy 512a or the Cooper B-Line BA50a or similar T-bar grid hangers can be used.

For more information, see:

<http://www.erico.com>

<http://www.cooperindustries.com>

**Figure 20.** Example of hanging an access point above the ceiling tiles



**Note:** Installing access points above the ceiling tiles should be done only **when mounting below the ceiling is not an option**. The tiles must not be conductive; such installations can degrade advanced RF features such as voice and location, so verify coverage and performance. Always try to mount the access point as close to the inside middle of the tile as possible, and avoid areas with obstructions (Figure 21).

**Figure 21.** Installing an access point above ceiling tiles: Pick an area clear of obstructions, and avoid ceiling clutter



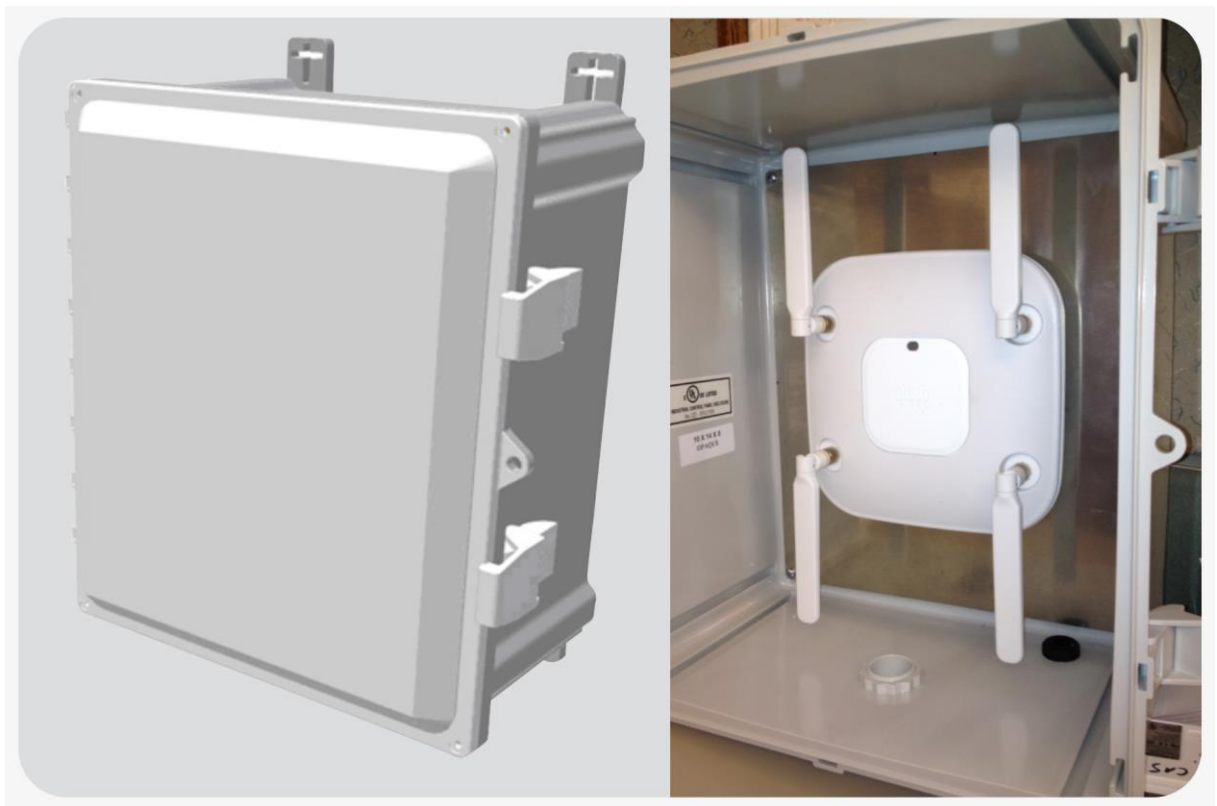


### Stadium and harsh environments

Customers wishing to install access points in harsh environments where they may be exposed to weather, such as sporting areas, stadiums, open garden areas, or warehouse freezers, may wish to use a NEMA-type enclosure.

**Note:** Some access points may not be certified for outdoor deployments in a NEMA-rated enclosure (Figure 22). This varies by country; for example, some regulatory agencies permit NEMA-rated access point enclosures if the access point is indoors, such as in a freezer, but may prohibit their use outdoors. This seems to vary with regard to weather radar compliance and often UNII-1 compliance, etc. Check with your Cisco account team or the communications regulatory agency that has jurisdiction in your part of the world.

**Figure 22.** Example of NEMA 16x14x8 enclosure with pressure vent on bottom



Third-party sources for NEMA-rated enclosures include:

<https://www.oberonwireless.com>

<https://www.acceltex.com>

<https://www.terra-wave.com>

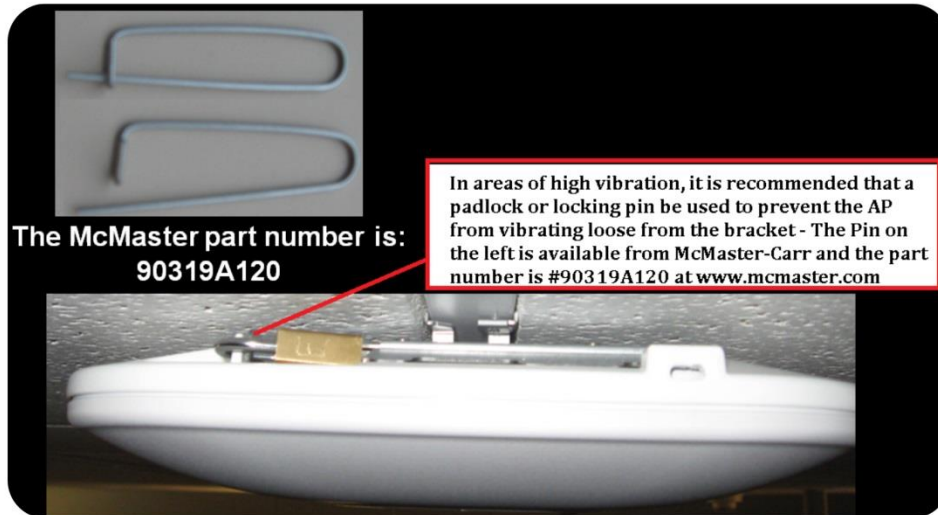
When using a NEMA-rated enclosure, try to have the cables exit from the bottom of the enclosure, so that rain and moisture do not run down the cable into the enclosure. Also, the color of the enclosure may affect the heat rating; for example, a black enclosure will get much hotter in the sun than a white one.

You may also want to use a pressure vent to prevent moisture accumulation.

### Areas with high vibration

If the access point is installed using a “side arm” type mount or other mounting location where there is a likelihood of high vibration, it is recommended that a padlock or metal pin be used to prevent the access point from vibrating loose from the bracket (Figure 23).

**Figure 23.** A metal pin or padlock will not deteriorate over time, so it is a better option than a plastic tie



### Warehouse and factory environments

Warehouse installations are often difficult because of the very high ceilings and the clutter of material being stored. When performing a coverage check (site survey), always check the coverage at “full stock” levels, as the material being stored can change the RF coverage, creating loss of uniform coverage. Also, try to position the access points as close to the users as possible, perhaps lowering the antennas when it is practical to do so. If the access point is 30 feet in the air, that is 30 feet farther the signal has to go, in the best case scenario. When configuring coverage for aisles, try to use directional (patch) antennas on the wall and shoot down the aisles, or use low-gain omnidirectional antennas on the ceiling (such as dipoles) or units with integrated antennas, as high-gain omnidirectional antennas tend to have more nulls. See Figure 24.

Another option is to mount the access point lower using pipe and electrical box mounting techniques. Refer to the example in Figure 24.

**Figure 24.** Access point placement in a warehouse environment (an external dipole “E” or internal antenna “I” could be used)



When mounting an access point at the end of a pipe or electrical conduit box, use the universal bracket Cisco AIR-AP-BRACKET-2, as it will mate to the holes of most electrical boxes (Figure 25). Conduit and adapters can be purchased at most electrical or home repair centers.

**Figure 25.** Mounting an access point onto an electrical conduit box (ceiling T-bar or conduit)



### Ethernet cable recommendation

While the 9115 and 9117 Series access points will work fine with Category 5e for new cable installations, it is recommended that customers use Category 6a, as this is the cabling required by the 10 Gigabit Ethernet standard.

### Antenna cable recommendation

Whenever practical and possible, keep antenna cable runs as short as possible. Cisco offers Low-Loss (LL) and Ultra-Low-Loss (ULL) cables, which have the same characteristics as Times Microwave LMR-400 and LMR-600.

Part numbers for Cisco cables consist of "AIR-CAB" and then a length. For example, a 20-foot length of LL cable with an RP-TNC connector is Cisco AIR-CAB-020LL-R. These heavy black cables are not plenum rated and are primarily for outdoor use or manufacturing areas.

**Figure 26.** When drilling holes for cable, allow for the size of the connector (typically 5/8 inch)



---

## Access point spacing recommendations

If you have a Wi-Fi device such as an access point and you are going to use another access point in the vicinity on a different channel, it is recommended that you space the access points approximately 6 feet (2 meters) apart. Avoid clustering the access points or the antennas from different access points together, as this could cause degradation in performance. This recommended distance is based on the assumption that both devices operate in the unlicensed band and do not transmit RF energy more than 23 dB — that is, 200 mW. If higher power is used, space them farther apart.

Should you have other devices that transmit, especially if they operate in the same frequency ranges —for example, frequency-hopping legacy access points or other devices that operate close in frequency to those of the access point (think below or above the 2.4- and 5-GHz bands) — you should consider moving or separating the devices as far apart as can reasonably be done. After you have done this, check for interference by testing both devices at the same time under heavy utilization (load) and then characterize each system independently to see how much, if any, degradation exists.

**Warning:** In order to comply with FCC, EU, and EFTA RF exposure limits, antennas should be located at a minimum of 7.9 inches (20 cm) or more from the body of all persons. See the installation guide under declaration of conformity for more on this.

## Installations in IDF closets (telecommunications or other electrical equipment)

When installing access points near other electrical or telecommunications equipment, keep all wiring and metal away from the antennas, and avoid placing the antennas near electrical lines. Do not route electrical wiring or Ethernet cables in the near field (6 to 15 inches) of the antenna. Try to refrain from installing the access point in the electrical closet, as the best place for the access point is as close to the users as possible and practical. If you remote antenna cables from such a closet, you may be required to use plenum-rated cable (see local fire and safety regulations for more on this).

The following URLs will help you understand interference:

[https://www.cisco.com/en/US/prod/collateral/wireless/ps9391/ps9393/ps9394/prod\\_white\\_paper0900aecd807395a9\\_ns736\\_Networking\\_Solutions\\_White\\_Paper.html](https://www.cisco.com/en/US/prod/collateral/wireless/ps9391/ps9393/ps9394/prod_white_paper0900aecd807395a9_ns736_Networking_Solutions_White_Paper.html)

[https://www.cisco.com/warp/public/cc/pd/witc/ao1200ap/prodlit/wrlan\\_wp.pdf](https://www.cisco.com/warp/public/cc/pd/witc/ao1200ap/prodlit/wrlan_wp.pdf)

[https://www.cisco.com/en/US/prod/collateral/wireless/ps5678/ps10981/white\\_paper\\_c11-609300.html](https://www.cisco.com/en/US/prod/collateral/wireless/ps5678/ps10981/white_paper_c11-609300.html)

## Installations inside and around elevators

Elevator coverage can sometimes be accomplished by placing access points in the near field of the elevator, typically on each floor near the elevator door. Since elevators often have metal doors and the shafts are often concrete or contain other materials that degrade Wi-Fi coverage, it is important to check the coverage inside the elevator. While such coverage can be challenging, it is often doable, especially if the elevator is only a few floors.

High-rise elevators are more challenging, since roaming issues are problematic as the client is cycling through a large number of access points rather quickly. Some companies that do in-elevator advertising have put a patch antenna on the floor inside the shaft and a patch antenna on the bottom of the elevator car, while other companies have used leaky coaxial cable running on the side of the shaft.

When installing any Wi-Fi equipment inside elevator cars or shafts, be sure to follow local regulations, as many times such installations are prohibited, either for safety reasons or because the building owner or local fire department may prohibit them. Also, it is dangerous, and only elevator repair persons or contractors experienced with this kind of work should be in those areas.









## External antenna options and patterns

### For use with the Cisco Catalyst 9115E Access Point

The 9115E external antenna access point is compatible with the Cisco antennas listed in Table 1.

**Table 1.** Cisco antennas for use with the 9115E

### Indoor Access Point – Approved Antenna options

Product ID	Description		Gain
AIR-ANT2524DB-R/=	2.4 GHz 2 dBi/5 GHz 4 dBi Dipole Ant., Black, connectors RP-TNC		2 dBi (2.4 GHz) 4 dBi (5 GHz)
AIR-ANT2524DG-R/=	2.4 GHz 2 dBi/5 GHz 4 dBi Dipole Ant., Gray, connectors RP-TNC		2 dBi (2.4 GHz) 4 dBi (5 GHz)
AIR-ANT2524DW-R/=	2.4 GHz 2 dBi/5 GHz 4 dBi Dipole Ant., White, connectors RP-TNC		2 dBi (2.4 GHz) 4 dBi (5 GHz)
AIR-ANT2535SDW-R	2.4 GHz 3 dBi/5 GHz 5 dBi Low Profile Antenna, White, connectors RP-TNC		3 dBi (2.4 GHz) 5 dBi (5 GHz)
AIR-ANT2566P4W-R=	2.4 GHz 6 dBi/5 GHz 6 dBi Directionnel Ant., 4-port, connectors RP-TNC		6 dBi (2.4 GHz) 6 dBi (5 GHz)
AIR-ANT2524V4C-R=	2.4 GHz 2 dBi/5 GHz 4 dBi Ceiling Mount Omni Ant., 4-port, connectors RP-TNC		2 dBi (2.4 GHz) 4 dBi (5 GHz)
AIR-ANT2544V4M-R=	2.4 GHz 4 dBi/5 GHz 4 dBi Wall Mount Omni Ant., 4-port, connectors RP-TNC		4 dBi (2.4 GHz) 4 dBi (5 GHz)
AIR-ANT2566D4M-R=	2.4 GHz 6 dBi/5 GHz 6 dBi 60 Deg. Patch Ant., 4-port, RP-TNC		6 dBi (2.4 GHz) 6 dBi (5 GHz)

**Note:** These are all dual-band, dual-resonant antennas. **Do not use single-band antennas on this product** unless you choose to disable the other radio band within the access point.

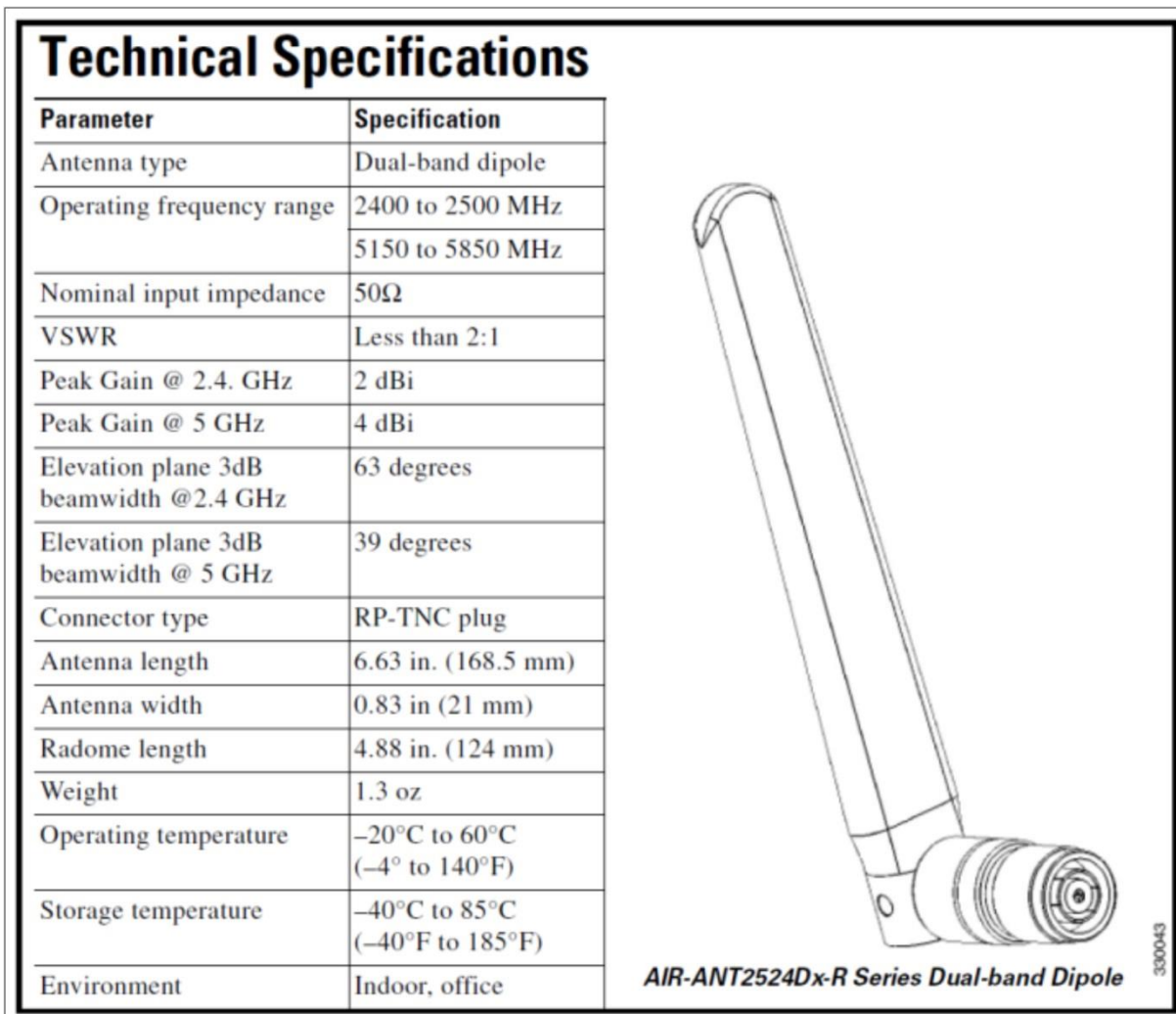
For additional information on Cisco antennas, see the Cisco Antenna Reference Guide at this URL:

<https://www.cisco.com/go/antenna-ref>

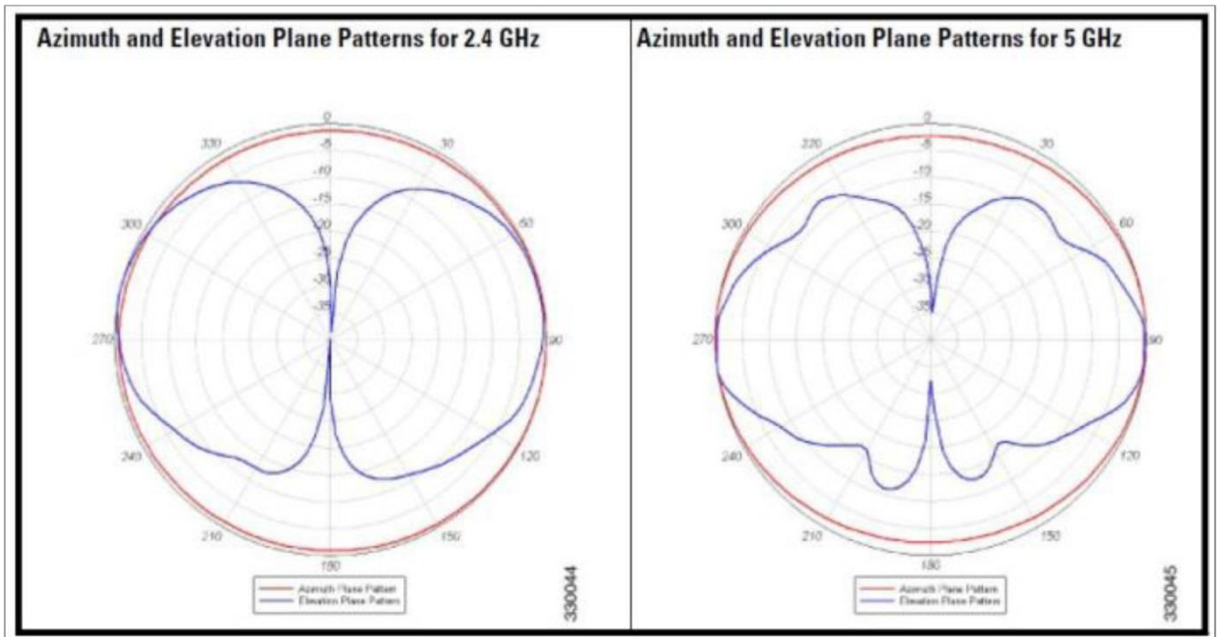
The two most popular external antennas for the 9115E access point are the AIR-ANT2524Dx-R dual-band dipole antenna (Figures 27 and 28) and the AIR-ANT2566P4W-R dual-band patch antenna (Figures 29 and 30).

Figures 32 through 35 give specifications for two dual-band omnidirectional antennas, the AIR-ANT2524V4C-R and AIR-ANT2544V4M-R.

Figure 27. Specifications for the AIR-ANT2524Dx-R dual-band dipole antenna



**Figure 28.** Radiation pattern for the AIR-ANT2524Dx-R dual-band dipole antenna



**Figure 29.** Specifications for the AIR-ANT2566P4W-R dual-band patch antenna

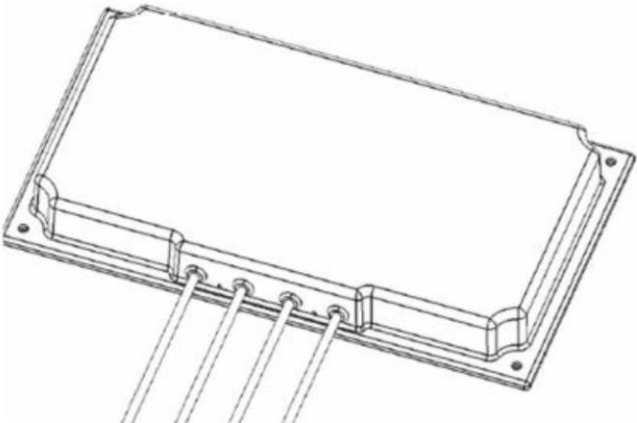
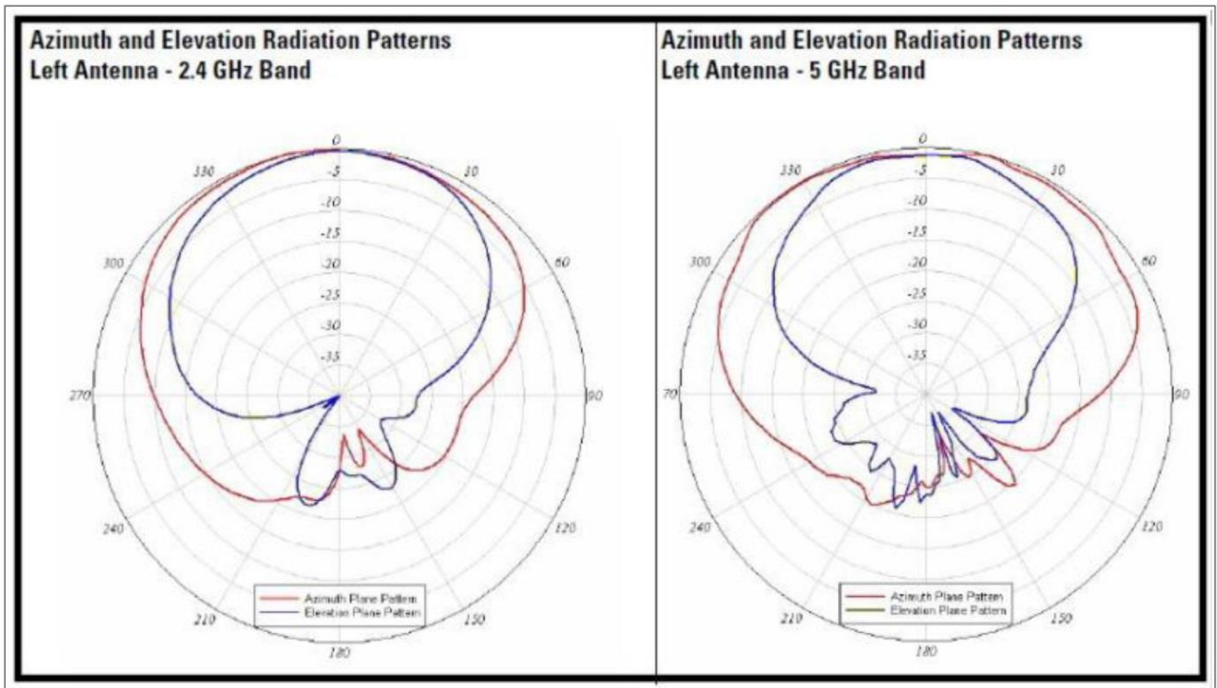
Antenna type	4-element dual-band MIMO	 <p><b>AIR-ANT2566P4W-R 4 Element Dual-Band Patch (indoor / outdoor use)</b></p>
Operating frequency range	2400 to 2484 MHz 5150–5850 MHz	
VSWR	2:1 or less	
Gain	6 dBi in both bands	
Polarization	Linear, vertical	
Azimuth Plane 3-dB Beamwidth	2.4 GHz band: 105° 5 GHz band: 125°	
Elevation Plane 3-dB Beamwidth	2.4 GHz band: 70° 5 GHz band: 60°	
Length	6.3 in. (16 cm)	
Width	11 in. (27.9 cm)	
Depth	1.2 in. (3.05 cm)	
Weight	1.4 lbs	
Cable length and type	3 ft. (91.4 cm) plenum rated	
Connector	RP-TNC	
Environment	Indoor/outdoor	
Operating temperature range	-22° to 158° F -30° to 70° C	

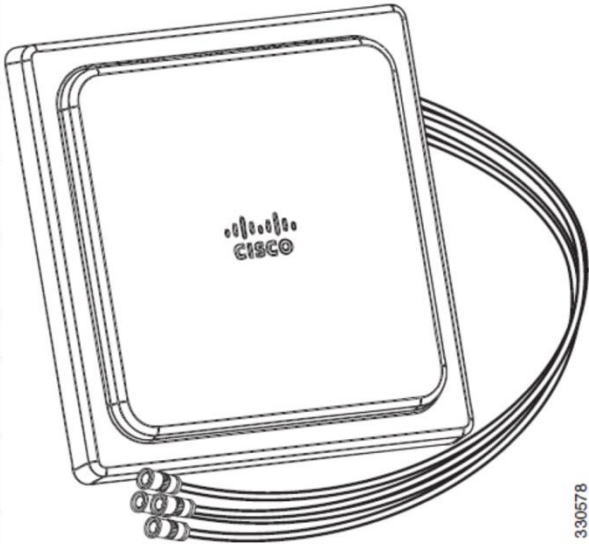


Figure 30. Radiation pattern for the AIR-ANT2566P4W-R dual-band patch antenna



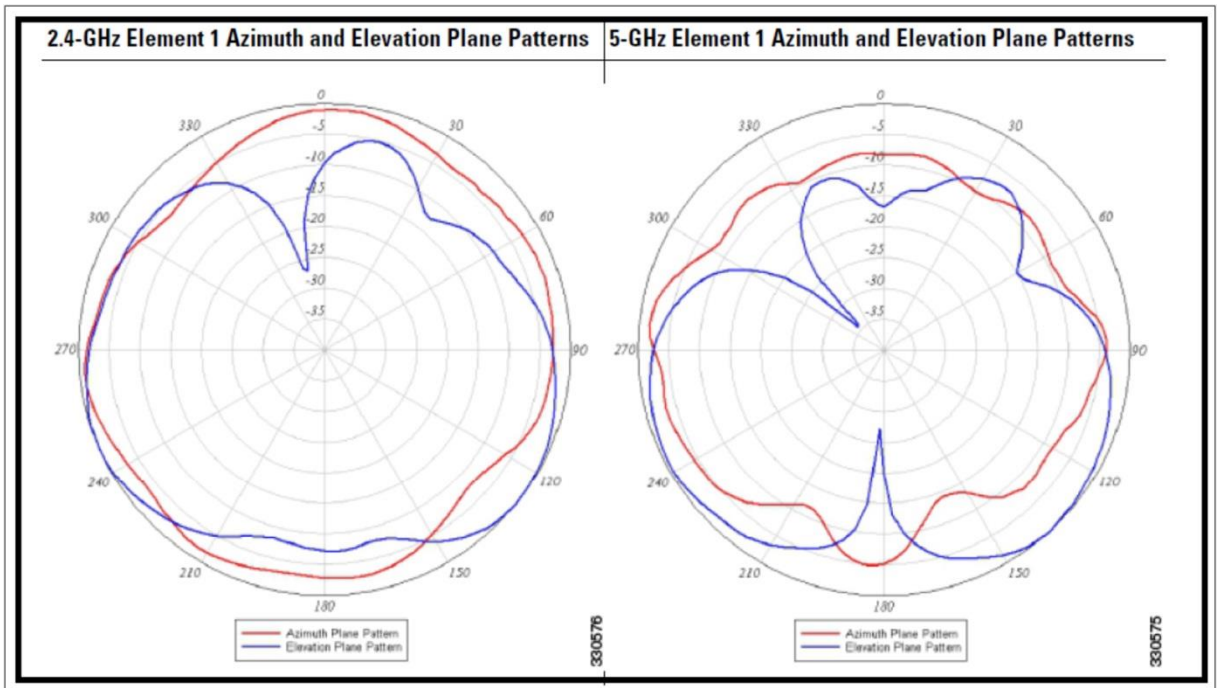
Assuming that the antenna is mounted on a wall, the azimuth (in red) is the signal going forward from the antenna, and the elevation in blue is the “up/down” pattern.

**Figure 31.** Specifications for the AIR-ANT2524V4C-R dual-band omnidirectional antenna


Antenna type	4-Element, Dual-band, Low Profile Omni	
Operating frequency ranges	2400–2484 MHz 5150–5850 MHz	
VSWR	2:1 or less in both bands	
Peak gain	2.4-GHz band: 2 dBi 5-GHz band: 4 dBi	
Polarization	Linear	
Azimuth plane 3 dB beamwidth	Omnidirectional	
Elevation plane 3 dB beamwidth	2.4-GHz band: 69° 5-GHz band: 60°	
Length	7.25 in (18.4 cm)	
Width	7.25 in (18.4 cm)	
Depth	1 in (2.5 cm)	
Weight	1.3 lb (0.59 kg)	
Cable	3 ft (91.4 cm) plenum rated, UV stable	
Connector	RP-TNC	
Environment	Indoor	
Temperature range	32°F to 133°F (0°C to 56°C)	

336578

Figure 32. Radiation pattern for the AIR-ANT2524V4C-R dual-band omnidirectional antenna

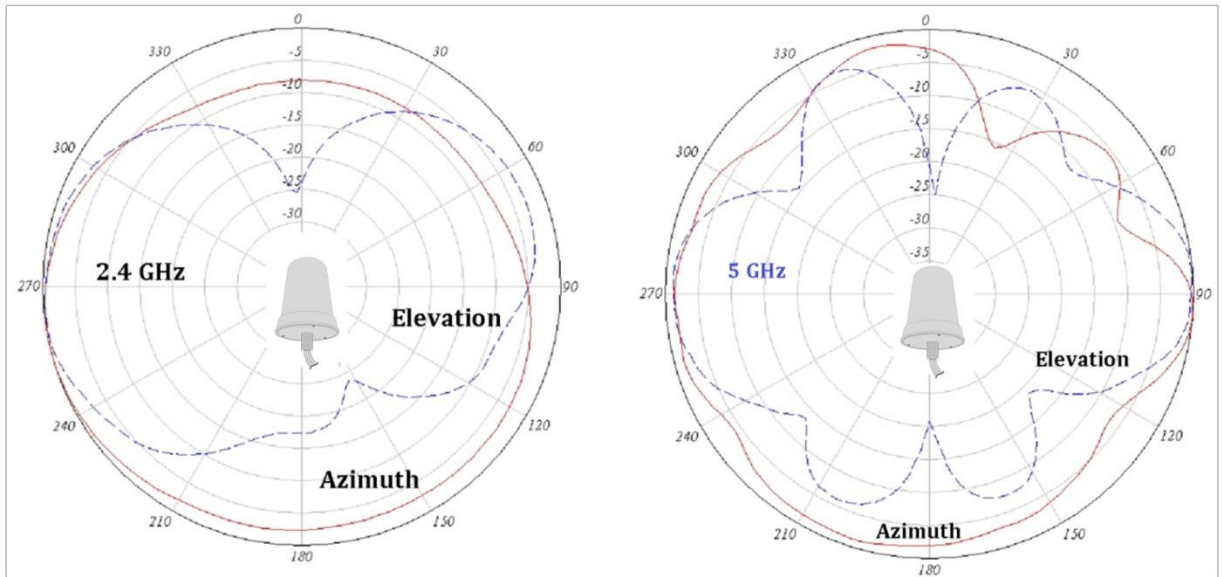


**Figure 33.** Specifications for the AIR-ANT2544V4M-R dual-band omnidirectional antenna

Antenna type	4-element MIMO omnidirectional	
Operating frequency range	2400-2484 MHz	
	5150-5850 MHz	
Nominal input impedance	50Ω	
VSWR	2:1 or less	
Peak gain	2.4-GHz band: 4 dBi	
	5-GHz band: 4 dBi	
Polarization	Linear, vertical	
Azimuth plane (3 dB beamwidth)	Omnidirectional	
Elevation plane (3 dB beamwidth)	2.4-GHz band: 60°	
	5-GHz band: 33°	
Length	8.6 in (21.8 cm)	
Diameter	6.3 in (16 cm)	
Weight	Antenna: 1.48 lb. (671.5 g);	
Cable	3-ft. (91.4 cm) plenum	
Connector	RP-TNC	
Environment	Indoor/outdoor	
Temperature range	-22° to 158° F (-30° to 70° C)	

**Figure 34.** Radiation patterns for the AIR-ANT2544V4M-R dual-band omnidirectional antenna

**Note:** For larger patterns, see the individual specification sheet for this antenna.



### Cisco Catalyst 9115I internal antenna model

Figure 35. Cisco Catalyst 9115I antenna system

### Catalyst 9115 - Antenna system

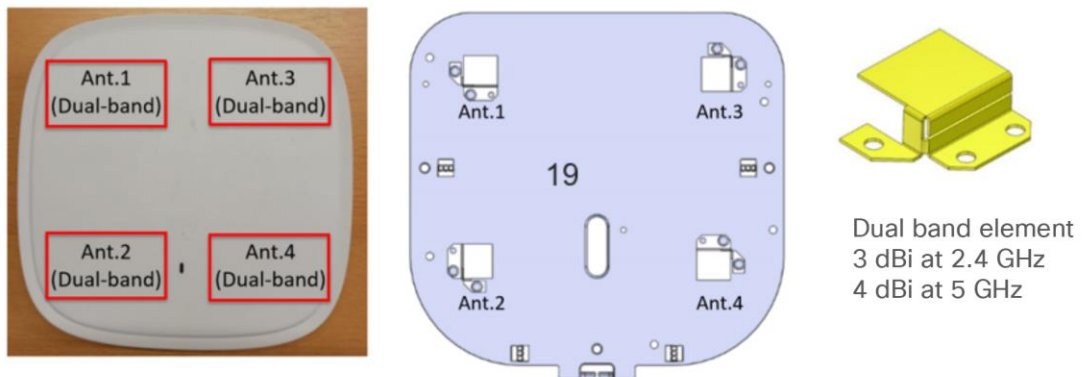


Figure 36. Cisco Catalyst 9115I 2.4-GHz antenna patterns

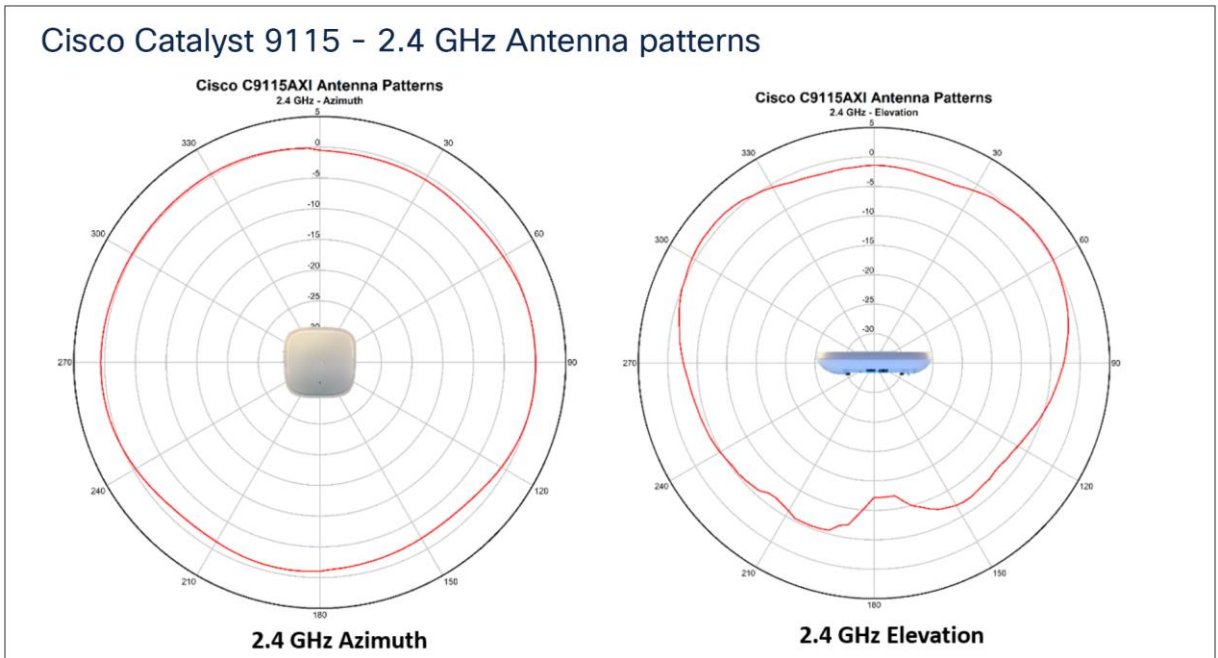
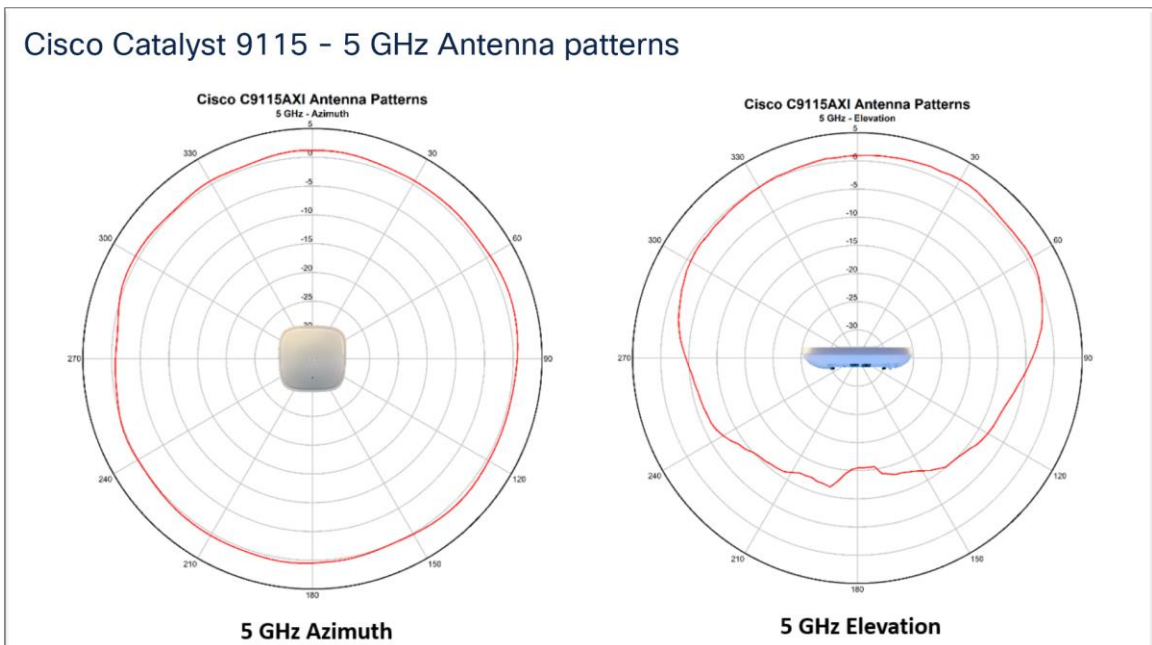
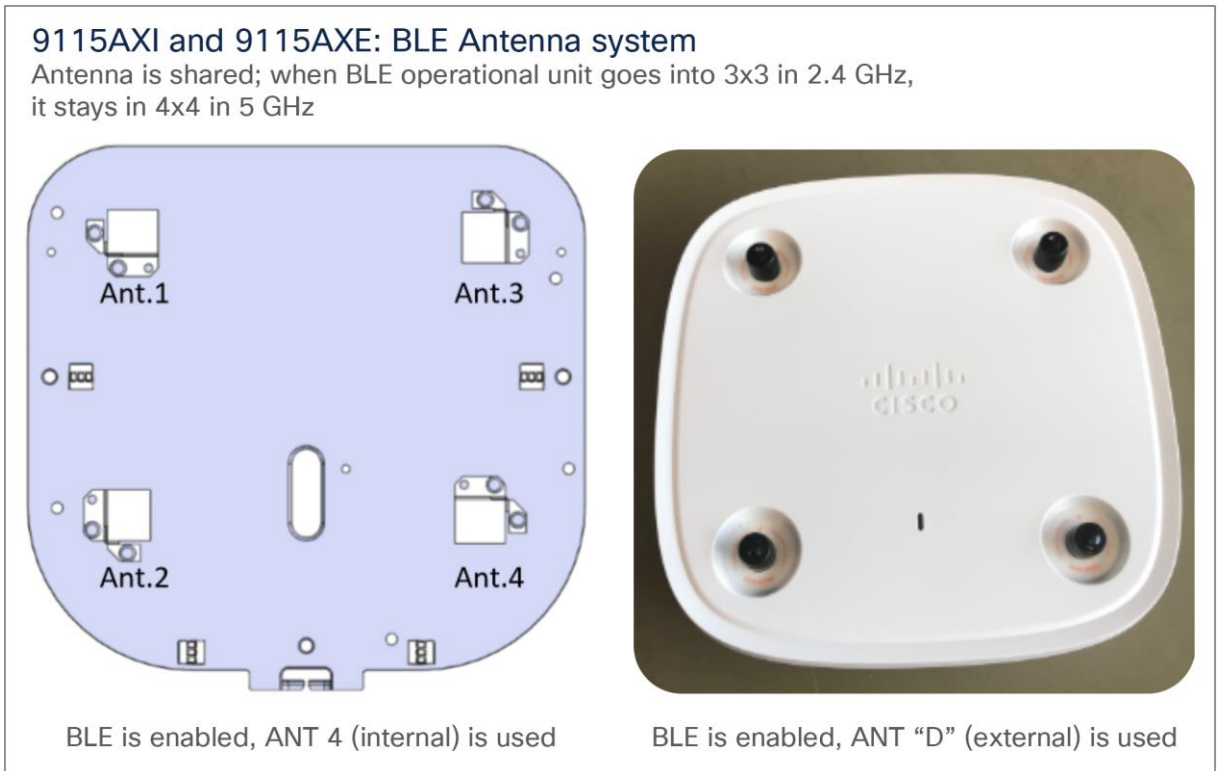


Figure 37. Cisco Catalyst 9115I 5-GHz antenna patterns



**Figure 38.** Cisco Catalyst 9115I and 9115E BLE antenna system



**Figure 39.** Cisco Catalyst 9117 antenna system

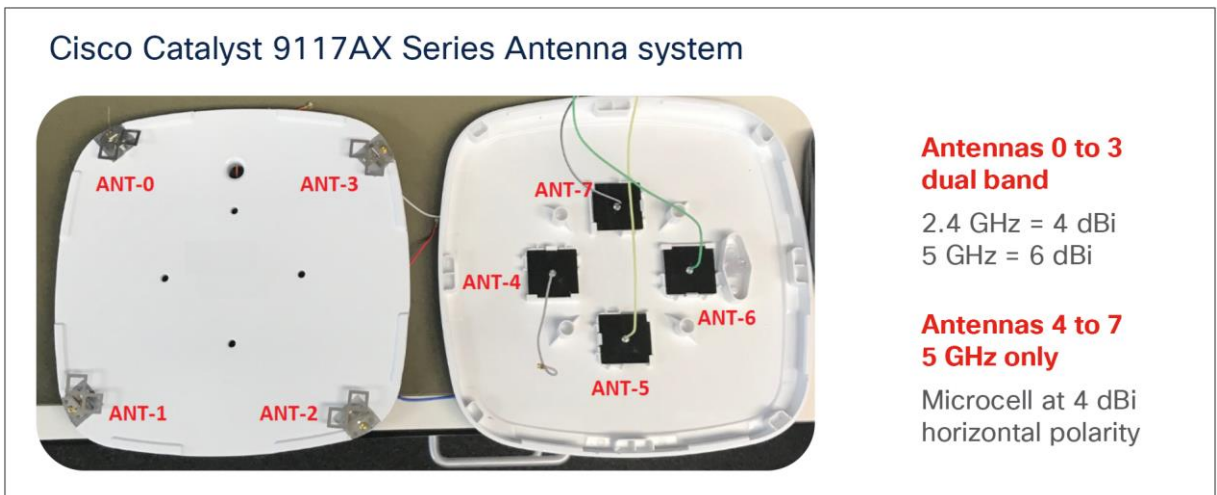


Figure 40. Cisco Catalyst 9117 2.4-GHz antenna pattern

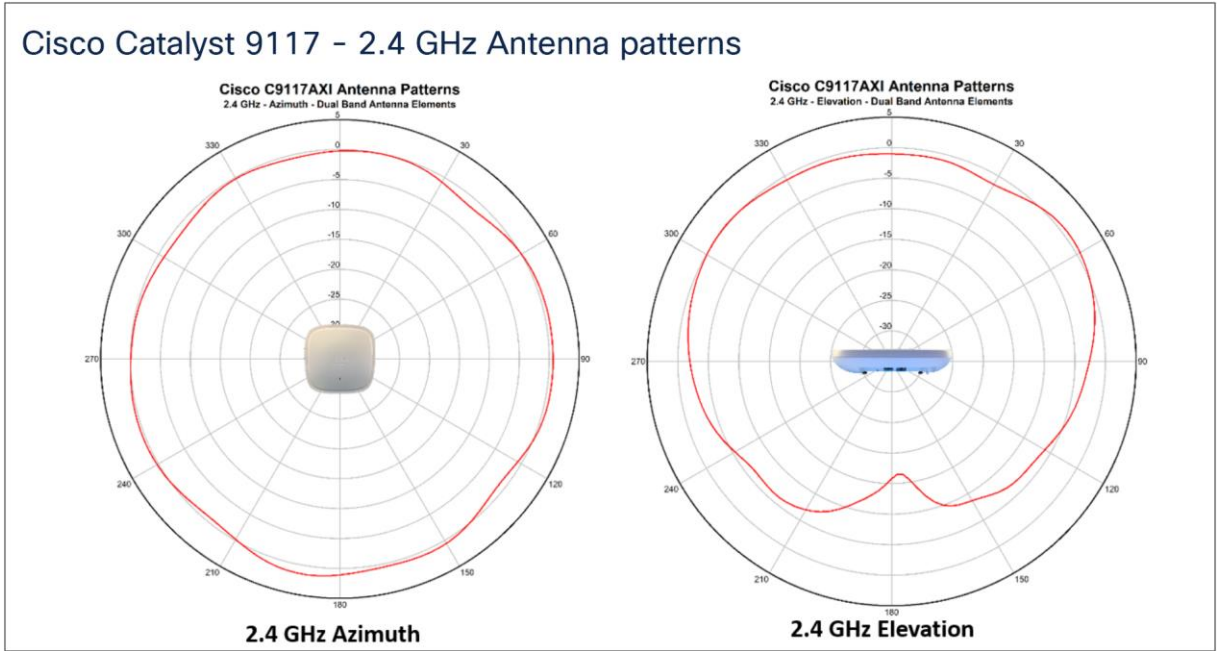


Figure 41. Cisco Catalyst 9117 5-GHz antenna pattern

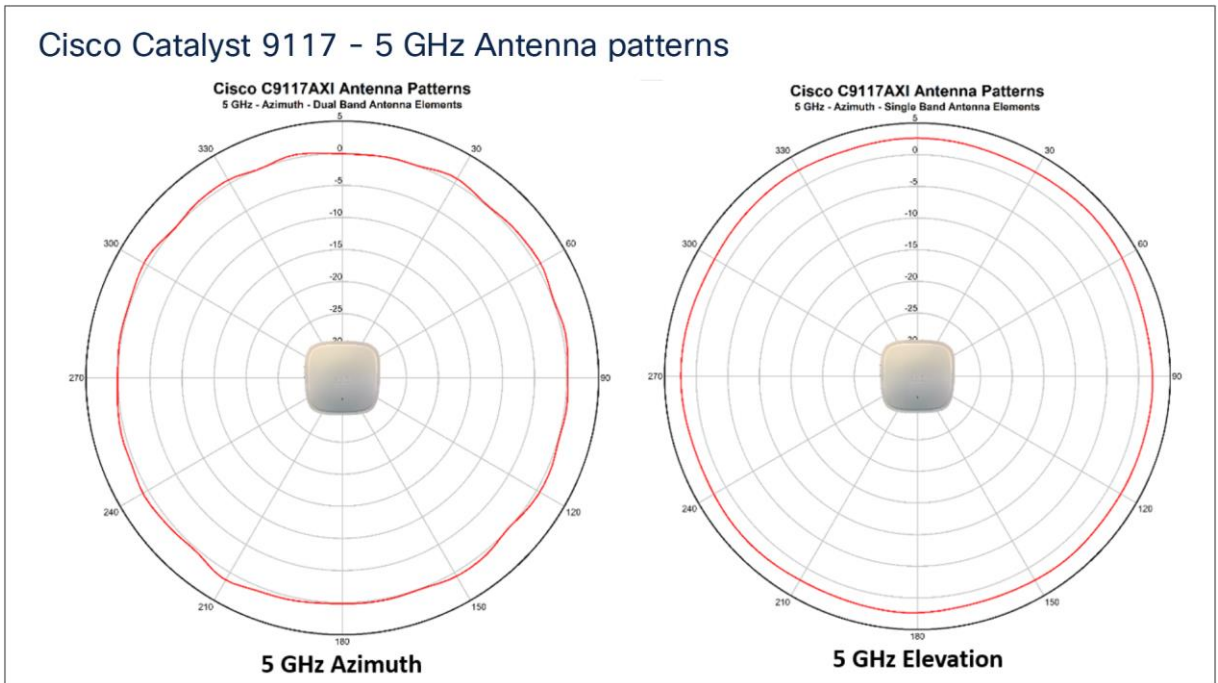




Figure 42. Cisco Catalyst 9117 5-GHz microcell antenna pattern

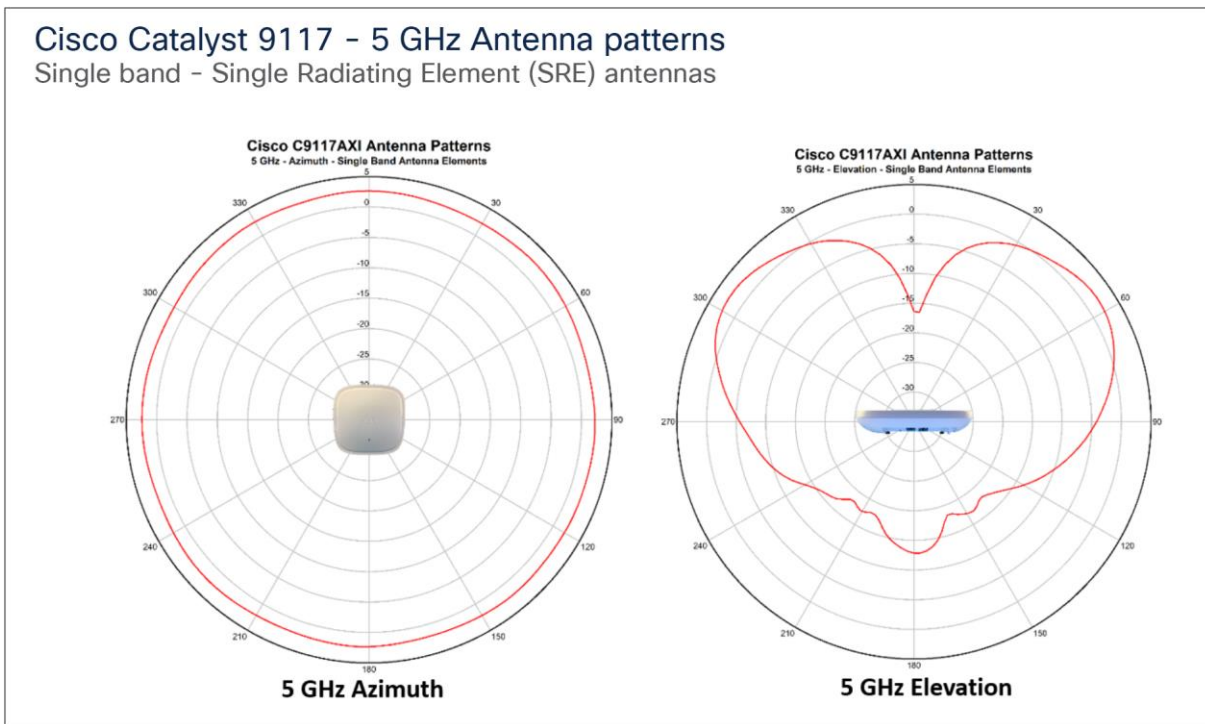


Figure 43. Cisco Catalyst 9117 BLE antenna system

### 9117AX Series BLE Antenna system

**ANT-0** **ANT-3**

**ANT-1** **ANT-2**

**BLE operation**

**Note:** Normally in 2.4-GHz mode, the AP operates in **4x4 mode**.

When BLE is selected and in operation, ANT-3 is RF switched from client serving and becomes the BLE antenna.

When this happens, the 2.4-GHz radio goes into **3x3 mode**.

## Understanding external antenna deployments

All Cisco antenna connectors are labeled “A,” “B,” “C,” and so on. “A” has a higher priority than “B” or “C/D,” so if the access point supports, say, three or four antennas, and you have only two antennas, you would use them on ports “A” and “B” (for the short term, until you could install the additional antennas).

While it is **not recommended** that you use fewer antennas, the product (in a pinch) would support 802.11a/b/g clients or single-spatial-stream N clients using only one or two antennas. **However, there is a significant performance hit and you would lose beamforming and key 802.11ax functionality.** Should you do this, you would also want to configure the access point software to not use the other antennas.

The following applies when using a MIMO (dual-radiating element) antenna such as:

AIR-ANT2524V4C-R: Dual-band omnidirectional – 2/4 dBi ceiling-mount omni use

AIR-ANT2544V4M-R: Dual-band omnidirectional – 4/4 dBi wall-mount omni use

AIR-ANT2566P4W-R: Dual-band directional – 6 dBi patch wall-mount use

With these antennas, it is not critical which antenna lead goes onto which antenna port on the access point, so long as all the antenna ports on the access point are connected to the antennas. In the case of the patch antenna AIR-ANT2566P4W-R, since the elements are spaced physically apart (side by side) in the plastic housing, there is a slight improvement if you use the outer two elements on the patch on ports “A” and “B,” but again it is only a small improvement and not critical (Figure 44). That is why we do not label them.

**Figure 44.** Patch antenna leads



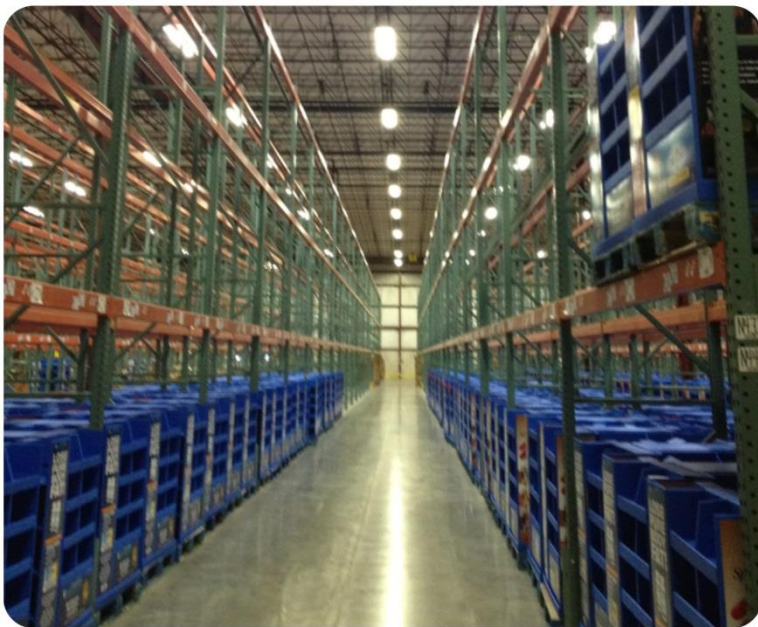
Remember, the best antenna placement is the one in which the antenna is physically closest to the actual users. If you are mounting multiple single-package dual-band antennas, such as dipoles, externally, spacing is not critical, but try to space them as far apart as practical (with “A” and “B” the farthest apart).

**Figure 45.** Antenna spacing



Avoid spacing antennas more than 10 feet apart (antennas should be in same RF coverage area).

**Figure 46.** In areas where high amounts of metal are present, a site survey is required



When using 802.11n/ac/ax rates in areas with a high level of metal, such as distribution areas or airport hangars, sometimes lower-gain antennas (on the ceiling) can perform better, as these antennas tend to radiate the signal in all directions, increasing the chance that multipath will enhance the signal. Of course, if you have a clear shot, a patch antenna at the end of an aisle at roughly the same height as or just above the WLAN client is preferred.

## Power over Ethernet

Tables 2 and 3 show the power requirements for the Cisco Catalyst 9115 and 9117 Series Access Points.

**Table 2.** Cisco Catalyst 9115 Series power requirements

### Cisco Catalyst 9115 Series power requirements

#### 802.3at Full Feature

Power Source	Power Type	2.4GHz Radio	5GHz Radio	Link Speed	USB	LLDP	CDP
802.3at	PoE	4x4	4x4	2.5G	Y	20.4W	20.4W

#### 802.3af Reduced Feature

Power Source	Power Type	2.4GHz Radio	5GHz Radio	Link Speed	USB	LLDP	CDP
802.3af	PoE	2x2	2x2	1G	N	15.4W	15.4W

**Table 3.** Cisco Catalyst 9117 Series power requirements

### Catalyst Catalyst 9117 Series power requirements

#### 802.3bt/ Cisco UPoE+, Cisco UPoE Full Feature

Power Source	Power Type	2.4GHz Radio	5GHz Radio	Link Speed	USB	LLDP	CDP
802.3bt/UPoE+, UPoE	PoE	4x4	8x8	5G	Y	28.9W	34.2W

#### 802.3at Full Feature \*

Power Source	Power Type	2.4GHz Radio	5GHz Radio	Link Speed	USB	LLDP	CDP
802.3at	PoE	4x4	8x8	5G	N	25.4W	30.0W

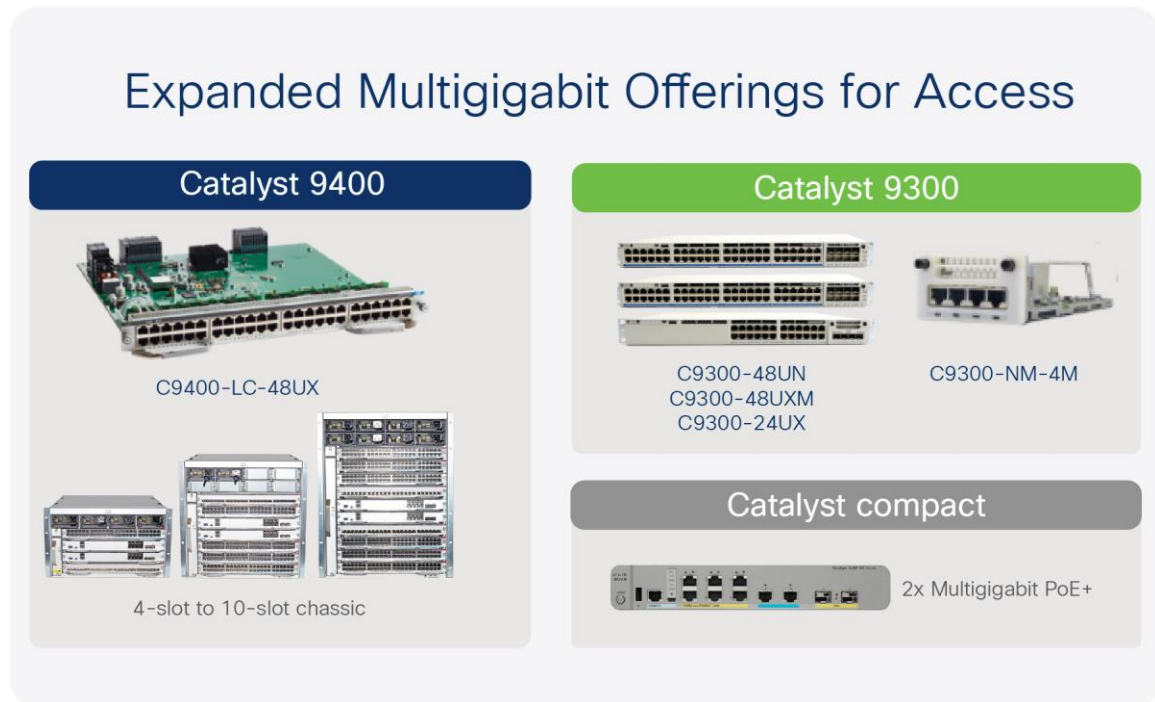
#### 802.3af Reduced Feature

Power Source	Power Type	2.4GHz Radio	5GHz Radio	Link Speed	USB	LLDP	CDP
802.3af	PoE	2x2	2x2	2.5G	N	15.4W	15.4W

\* = USB port can be enabled, but 5GHz Radio reduced to 4x4

Cisco has a line of Multigigabit products that can easily power these access points.

Figure 47. Cisco Catalyst Multigigabit switches

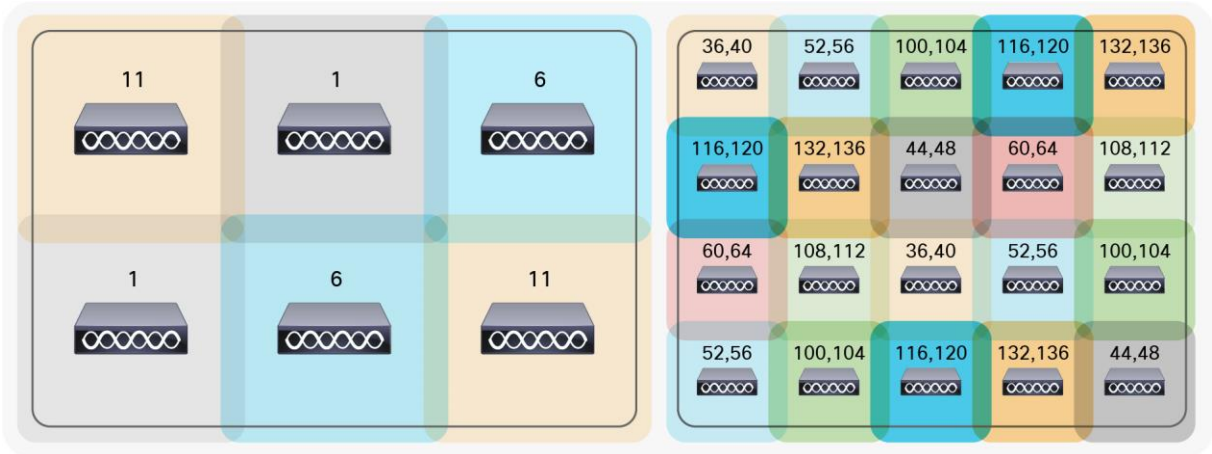


## General considerations regarding access points

The following are some guidelines to remember regarding all access points.

- Always try to mount the access point as close to the users as possible for best performance. Be aware of the environment; for example, hospitals have metal doors, and coverage can change when the doors close. Old buildings can have metal gridwork in the plaster, or asbestos can be present. Avoid mounting the access point or antennas near metal objects, as doing so can change the coverage area.
- When using the 2.4-GHz frequency, the same 1, 6, 11 channel scheme is used as in the 5-GHz channel scheme. Avoid putting all of the access points on the same channel, and reuse channels as you can (Figure 48). See our other deployment guides for more on this topic.

**Figure 48.** Example of channel usage in 2.4 and 5 GHz (two channels used if 40 MHz)



- Try to determine which clients are going to be used, and check the coverage using those clients. For example, a PDA or Wi-Fi phone might not have the same range as a notebook or tablet.  
Tip: Verify coverage using the worst-performing clients that you intend to deploy.
- While site surveys are generally recommended, if the design is done at half power and Cisco Radio Resource Management (RRM) is in place, sometimes a limited site survey (coverage check) is adequate for smaller venues. For very challenging environments, such as train connectivity, oil and gas facilities, large hospitals, etc., Cisco has an Advanced Services team that can be contracted to help you get up to speed or perform your installation. See your Cisco account team for more information.



**Americas Headquarters**  
Cisco Systems, Inc.  
San Jose, CA

**Asia Pacific Headquarters**  
Cisco Systems (USA) Pte. Ltd.  
Singapore

**Europe Headquarters**  
Cisco Systems International BV Amsterdam,  
The Netherlands

Cisco has more than 200 offices worldwide. Addresses, phone numbers, and fax numbers are listed on the Cisco Website at <https://www.cisco.com/go/offices>.

Cisco and the Cisco logo are trademarks or registered trademarks of Cisco and/or its affiliates in the U.S. and other countries. To view a list of Cisco trademarks, go to this URL: <https://www.cisco.com/go/trademarks>. Third-party trademarks mentioned are the property of their respective owners. The use of the word partner does not imply a partnership relationship between Cisco and any other company. (1110R)